

PRODUCT REPORTS 80

PRODUCT IDEAS FOR ARCHITECTS AND ENGINEERS

CASE STUDIES: DESIGN SOLUTIONS THROUGH PRODUCT APPLICATION

ARCHITECTURAL BUSINESS: WORD PROCESSING'S IMPACT ON PRODUCTION

FULL CONTENTS ON PAGE 3

ARCHITECTURAL RECORD

MID-OCTOBER 1979



A MCGRAW-HILL PUBLICATION

\$5.50 PER COPY

The Armstrong Commercial Corlon® Flooring System. A new concept that's been proved in use for over 20 years



Sandoval™, newest of the Vinyl Corlon®
is a styling breakthrough in resilient flooring.
It offers the expensive look of terrazzo
at a sheet vinyl flooring price.

875	19	360	912
611	652	342	629
174	743	577	247
591	896	369	658

Cover: Products featured on the cover are identified by Reader Service number.
Cover design: Charles Mazarakes



EDITOR
WALTER F. WAGNER, JR., AIA

MANAGING EDITOR
HERBERT L. SMITH, JR., AIA

SENIOR EDITORS
ROBERT E. FISCHER
MILDRED F. SCHMERTZ, FAIA

ASSOCIATE EDITORS
GRACE M. ANDERSON
BARCLAY F. GORDON
CHARLES E. HAMLIN
CHARLES K. HOYT, AIA
WILLIAM MARLIN
JANET NAIRN

PRODUCTION EDITOR
ANNETTE K. NETBURN

DESIGN
ALEX H. STILLANO, Director
ALBERTO BUCCHIANERI, Senior associate
ANNA-MARIA EGGER, Associate
MURIEL CUTTRELL, Illustration
J. DYCK FLEDDERUS, Illustration
JAN WHITE, Consultant

CONTRIBUTING EDITOR
GERALD ALLEN

EDITORIAL CONSULTANTS
EDWARD LARRABEE BARNES, FAIA
JONATHAN BARNETT, AIA, Urban design
GEORGE A. CHRISTIE, JR., Economics
ERNEST MICKEL, Hon. AIA, Washington
PAUL RUDOLPH, FAIA
Foreign architecture
L'Architecture d'Aujourd'hui, Paris

McGRAW-HILL WORLD NEWS
RALPH R. SCHULZ, Director
9 domestic and 10 international news bureaus:
Bonn, Brussels, Buenos Aires, London, Milan, Moscow, Paris, Singapore, Tokyo, Toronto.

CIRCULATION DIRECTOR
RICHARD H. DI VECCHIO

BUSINESS MANAGER
JOSEPH R. WUNK

DIRECTOR OF MARKETING SERVICES
ELIZABETH HAYMAN

PUBLISHER
ROBERT G. KLIESCH

EXECUTIVE DIRECTOR
BLAKE HUGHES

THE RECORD REPORTS

- 21 Editorial**
The manufacturers and suppliers:
Let's not forget their role—
and risk

INTRODUCTION

- 11** Introductory information and trends exemplified throughout this issue

CASE STUDIES

- 12** Up-to-date graphics presentation
- 14** Restoration specialty
- 18** Site drainage

ARCHITECTURAL ENGINEERING

- 16** Ultra-thin concrete panels achieve requisite strength with specially developed glass-fiber reinforcement

ARCHITECTURAL BUSINESS

- 19** Word processing has a positive impact on one firm's production

OFFICE LITERATURE

- 30** Manufacturers' literature items
- 4** Advertising index
- 5** Manufacturers' index
- 8** Reader service information
- 9** Reader service inquiry cards

PRODUCT REPORTS 80

- 23** Office supplies & equipment—UCI 1
- 29** Sitework—UCI 2
- 33** Concrete—UCI 3
- 34** Masonry—UCI 4
- 37** Metals—UCI 5
- 45** Wood & plastics—UCI 6
- 49** Thermal & moisture protection—UCI 7
- 61** Doors & windows—UCI 8
- 94** Finishes—UCI 9
- 119** Specialties—UCI 10
- 125** Equipment—UCI 11
- 130** Furnishings—UCI 12
- 148** Special construction—UCI 13
- 152** Conveying systems—UCI 14
- 154** Mechanical—UCI 15
- 168** Electrical—UCI 16

Of particular assistance to the Editor in the preparation of this issue were:
Janet Nairn, editor-in-charge
Joan Blatterman
Annette K. Netburn
Charles Mazarakes
Robert E. Fischer
Grace M. Anderson
Charles K. Gandee
Joseph R. Wunk
Cynthia Miele with Donna Protas and Zena Gonzalez

ARCHITECTURAL RECORD (Combined with AMERICAN ARCHITECT, ARCHITECTURE and WESTERN ARCHITECT AND ENGINEER) (USPS 132-650)
Mid-October 1979, Vol. 166, No. 6. Title® reg. in U.S. Patent Office, copyright© 1979 by McGraw-Hill, Inc. All rights reserved. Copyright not claimed on front cover and editorial four-color separations. Indexed in Reader's Guide to Periodical Literature, Art Index, Applied Science and Technology Index, Engineering Index, and The Architectural Index.
Quotations on reprints of articles available. Every possible effort will be made to return material submitted for possible publication (if accompanied by stamped, addressed envelope), but the editors and the corporation will not be responsible for loss or damage.
EXECUTIVE, EDITORIAL, CIRCULATION AND ADVERTISING OFFICES: 1221 Avenue of the Americas, New York, N.Y. 10020.
OFFICERS OF McGRAW-HILL PUBLICATIONS COMPANY: president: Paul F. McPherson, group vice presidents: Gene W. Simpson; group vice president—planning and development: James E. Boddorf; senior vice presidents: Ralph R. Schulz, editorial; vice presidents: Robert B. Doll, circulation; James E. Hackett, controller; William H. Hammond,

communications; Thomas H. King, manufacturing; John W. Patten, sales; Edward E. Schirmer, international.
CORPORATION OFFICERS: Harold W. McGraw, president, chief executive officer and chairman of the board; Robert N. Landes, senior vice president and secretary; Ralph J. Webb, treasurer.
ASSOCIATED SERVICES/McGraw-Hill Information Systems Co.: Sweet's Catalog Files (General Building, Engineering, Industrial Construction and Renovation, Light Residential Construction, Interiors), Dodge Building Cost Services, Dodge Reports and Bulletins, Dodge/SCAN Microfilm Systems, Dodge Management Control Service, Dodge Construction Statistics, Dodge regional construction newspapers (Chicago, Denver, Los Angeles, San Francisco).
SUBSCRIPTIONS: Subscriptions solicited only from architects and engineers. Position, firm connection, and type of firm must be indicated on subscription orders. Please allow 4-12 weeks for shipment. Subscription rates for U.S., U.S. Possessions: \$21.00 for architects, engineers and others in the field served; all others \$29.00. In Canada: \$23.00 for architects, engineers and others in the field served; all others \$31.00. In all other countries: \$45.00 for architects and engineers; all others

\$49.00. Domestic and Canadian single copy price: \$5.50 except the mid-May issue which is \$5.95. Foreign single copy price: \$7.00.
GUARANTEE: Publisher agrees to refund that part of subscription price applying to unfiled part of subscription if service is unsatisfactory.
CHANGE OF ADDRESS: Forward changes of address or service letters to Fulfillment Manager, Group A, ARCHITECTURAL RECORD, P.O. Box 430, Hightstown, NJ 08520. Provide both old and new address, including zip code; if possible attach issue address label.
PUBLICATION OFFICE: 1221 Avenue of the Americas, New York, New York, 10020. ARCHITECTURAL RECORD (UPS 132-650) published monthly except May, August and October when semi-monthly, by McGraw-Hill, Inc. Controlled circulation postage paid at Strasburg, Virginia.
POSTMASTER: PLEASE SEND FORM 3579 to Fulfillment Manager, ARCHITECTURAL RECORD, P.O. Box 430, Hightstown, NJ 08520.



ADVERTISING INDEX

A

Adams Rite Mfg. Co. 90
 Allied Chemical Corp., Fibers Division
 114-115
 AM Bruning Div. of Addressograph
 Multigraph Corp. 25 to 28
 American Atomics Corp. 123
 American Olean Tile Company 111
 Anchor Post Products Inc. 31
 Andersen Corp. 67 to 82
 Architectural Engineering Products Co.
 59
 Architectural Record Books 147
 Armstrong Cork Co. Covl-1

B

Belgian Linen Association 113
 Bolta Wallcoverings 108-109
 Brand-Rex Co. Subs of Akzona Inc. 185

C

Cabot, Inc., Samuel 107
 Canadian General-Tower Ltd. 106
 Caterpillar Tractor Co., Engine
 Div.-Building Services 188
 Cold Spring Granite Co. 36
 Conwed Corp. 110
 Crown Metal Mfg. Co. 40
 Cumberland Woodcraft Co. 46

D

Design Tex Fabrics/
 DuPont-Teflon 117
 Diller Corp. 103
 Donn Corporation 150-151
 Dryvit Systems, Inc. 56-57
 Dukane Corp. 183

E

Ebco Mfg. Co. 162

G

GF Business Equipment, Inc. 142
 Grace & Co., W.R., Construction
 Products 53
 Granco Steel Products Co. Div. of
 National Steel Corp. 58

H

Halsey Taylor Div., of King Seeley
 Thermos Inc. 165
 Hope's Windows 60

I

Integrated Ceilings 2

J

Johns-Manville, Holophane Division
 182

K

Kimball Office Furniture Co. 141
 Kohler Company 164
 Kroy Industries Inc. 22
 Krueger Metal Products Co. 143

L

Lennox Industries Inc. 166
 L&M Surco Mfg. Inc. 118
 Lyon Metal Products Inc. 145

M

Marvin Windows 91
 Masonite Corp. 47
 Matthews International Corporation
 Cov IV
 MCC Powers Fiat-A Unit of Mark
 Controls Corp. 167
 McPhilben Lighting 186
 Monsanto Co. Plastics & Resins Div. .84
 Montgomery Elevator Co. 153

N

Naturalite, Inc. 92
 Neenah Foundry Co. 30
 Nor-Lake Inc. 124

O

Overhead Door Corp. 83

P

Pella Rolscreen Co. 85
 Pennwalt Chemicals Corp. 104-105
 Pittsburgh Corning Corp. 54
 Polycy American 89

R

Raceway Components Inc. 187
 Raynor Mfg. Co. 93
 R-Way Furniture Co. 144

S

Shaw-Walker 146
 Stark Ceramics Inc. 35

T

Thoro System Products 112
 3M Electro-Products Div. 190-Cov III
 Trus Joist Corp. 48

U

Unistrut-GTE Sylvania 44
 United McGill Corp. 163
 United States Gypsum Co. 41
 United States Steel Corp. 38-39

V

Ventarama Skylight Corp. 88
 Vincent Brass & Aluminum Co. 55
 Vinyl Plastics Inc. 116
 Vollrath Co. 129
 Von Duprin Inc. 86-87

W

Walker/
 Parkersburg Div. of Textron Inc.
 180-181
 Wheeling Pittsburgh Steel Co. 42-43
 Whitacre-Greer 32
 Wide-Lite Corporation 184
 Wiremold Co. 189

ARCHITECTURAL RECORD

McGraw-Hill, Inc., 1221 Avenue of the Americas, New York New York 10020
 Business Mgr.: Joseph R. Wunk (212) 997-2793
 Research Mgr.: Camille Padula (212) 997-2858
 Classified Advertising: (212) 997-3306

District Offices:

Atlanta 30361

Terry G. Blackwood, 100 Colony Square, (404) 892-2868

Chicago 60611

Donald T. Lock, (312) 751-3765
 Edward R. Novak, (312) 751-3764
 645 N. Michigan Ave. (312) 751-3771

Cleveland 44113

55 Public Square, (216) 781-7000

Denver 80203

Shirley A. Klotz, 123 Speer Blvd., #400 (303) 837-1010

Houston 77002

Lockwood Seegar, 375 Dresser Tower, 601 Jefferson St. (713) 659-8381

Los Angeles 90010

Donald O. Hanson, 3200 Wilshire Blvd.-South Tower (213) 487-1160

Philadelphia 19102

Blair McClenachan, Three Parkway (215) 568-6161

Pittsburgh 15222

2 Gateway Center, (412) 227-3662

San Francisco 94111

Richard R. Butera, 425 Battery Street (415) 362-4600

Southfield 48075

John W. Maisel, 4000 Town Center, Suite 770 (313) 352-9760

Stamford 06901

Louis F. Kutscher, 300 Broad St., (203) 359-2860

MANUFACTURERS' INDEX FOR PRODUCT REPORTS

Names and addresses of companies whose products and literature appear in the editorial section of Product Reports, pages 23-179, are alphabetically listed below; following the company names are Reader Service Numbers. The Index to Advertising appears on page 4.

Service numbers	Armstrong Cork Company 280, 297, 298, 300, 307, 308, 309, 310, 311, 331 West Liberty, Lancaster, PA. 17604	C	Couristan, Inc.288 919 Third Avenue, New York, N.Y. 10022
Black Co.20 10 W. Touhy Ave., Chicago, IL 60648	The Astatic Corp.810 Jackson and Harbor St., Conneaut, OH 44030	CM Hoist Div. Columbus McKinnon Corp.687 Fremont Street, Tonawanda, NY 14150	Charles Craig Ltd.542 979 Third Ave., New York, NY 10022
Boyd Co.775, 776 Perry Hill, NJ 08034	Atelier International 509, 594, 595, 596, 597, 618, 619, 630, 856, 3137 595 Madison Avenue, New York, NY 10022	CSL Industries824 One Century Plaza, Los Angeles, CA 90067	Crane Plastics474 2141 Fairwood Ave., Columbus, OH 43216
Chemical Industries198 Box 929 Gaspport, TN 37662	Auto-Trol Technology Corp.1 5650 Pecos St., Denver, CO 80221	C-Thru Graphics411 6 Britton Dr., Bloomfield, CT 06002	Crouse-Hinds Company884, 868 Wolf & 7th North Streets, Syracuse, NY 13221
CO/American Sterilizer Co.477 15 W. 23rd St., Erie, PA 16512	Autotronics, Inc.828 1399 Executive Dr. West, Richardson, TX 75081	Cabin Craft Rugs WestPoint Pepperell Carpet & Rug Div.295 P.O. Box 1208, Dalton, GA 30720	Crown688 New Bremen, OH 45869
Smith Corp.791 Box 28, Kankakee, IL 60901	Azrock Floor Products329 P.O. Box 531, San Antonio, TX 78292	Cado Royal Systems Inc.599 155 Helen St., South Plainfield, NJ 07080	Croydon Furniture Systems543 1 Hespeler Rd., Cambridge, Ontario
EK Power Systems Group798 5 Polinski Rd., Ivyland, PA 18974	B	Samuel Cabot, Inc.338 One Union St., Boston, 02108	Cyrol Inds.3081 697 Route 46, Clifton, NJ 07015
Ham-Zumsteg, Inc.362 Third Ave., New York, NY 10022	B&B America557 745 Fifth Ave., New York, NY 10022	Cadillac Plastic and Chemical Co.228 15841 Second Avenue, Detroit, MI 48232	Czech & Speake Ltd.741 Garrison NY 10524
Industries, Hoist & Crane Div.686 Box 792, York, PA 17405	BF Goodrich Company372, 3119 500 S. Main St., Akron, OH 44318	California Redwood Association360, 142, 3042 One Lombard Street, San Francisco, CA 94111	D
Wire and Iron Works403 10 S. Kilbourn Ave., Chicago, IL 60632	B-K Products, Inc.712 PO Box 761, Danbury, CT 06810	Cardkey Systems926 1255 Lincoln Blvd., Santa Monica, CA 90401	Da-Lite Screen Co.8 Warsaw, IN 46580
Optical Screens Corp.316 Park Street, Springfield, MA 01103	Badische Corp.3107 Drawer D, Williamsburg, VA 23185	Carnegie Fabrics535 110 N. Centre Ave., Rockville Centre, NY 11570	Dayton Sure-Foam Inc.60 721 Richard St., Miamisburg, OH 45342
as Rite Mfg. Co.210 10 S. Capitol Avenue, Industry, CA 91749	Ball Metal & Chemical161, 171 P. O. Box 616, Greeneville, TN 37743	Carrier Corp.705, 706 Carrier Parkway, Syracuse, NY 13221	Decowood319 393 Redwood Ave., Willits, CA 94590
in Furniture, Inc.585, 586 N. Washington St., Boston, MA 02114	Bally Case & Cooler, Inc.662 Bally, PA 19503	Casio9 15 Gardner Rd., Fairfield, NJ 07006	Delta Products Inc.923 Box 1147, Grand Junction, CO 81501
nce Lifts, Inc.3125 5 Stern Ave., St. Charles, IL 60174	Banner Guard Div., Reef Inds, Inc.409 PO Box 33248, Houston, TX 77003	Castelli Furniture Inc. 592, 598, 645, 646, 647, 879, 880, 921 950 Third Ave., New York, NY 10022	Design Tex Fabrics, Inc.370, 363, 532 275 Seventh Ave., New York, NY 10001
Building Products 140, 141, 231, 279, 306, 420, 421, 660, 661, 3102, 3121, 3142	Bantam Hoist685 Tyler, TX 75701	Caterpillar Tractor Co., Engine Div.918, 919 100 NE Adams, Peoria, IL 61629	DeSoto, Inc.3118 1700 S. Mt. Prospect Rd., DesPlaines, IL 60018
ON N. Park Ave., Warren, OH 44481	Barber-Colman Co.666, 665, 727, 818 1300 Rock St., Rockford, IL 61101	Ceco Corp.3016, 3089 5601 W. 26 St., Chicago, IL 60650	The Diller Corporation356 6126 Madison Ct., Morton Grove, IL 60053
ia International Ltd.424 Box 6268, Beverly Hills, CA 90212	Barbini-Lighting Associates835 305 East 63 Street, New York, NY 10021	The Charles Parker Co.428 290 Pratt Street, Meriden, CT 06450	Discovery Systems576 PO Box 62, Carlstadt, NJ 07022
as Hardwoods, Inc.118 101 Perry St., Algoma, WI 54201	Bell & Gossett ITT728 8200 Austin Avenue, Morton Grove, IL 60053	Charrette Corp.521, 604, 3001 31 Olympia Avenue, Woburn, MA 01888	Domtar Gypsum America Inc.3112 1221 Broadway, Oakland, CA 94612
Lansing489, 490, 491, 492 15 S. Manchester, Anaheim, CA 92803	Belmont Metals Inc.3026 330 Belmont Avenue, Brooklyn, NY 11207	Chemetics Systems, Inc.3077 2006 Gladwick St., Compton, CA 90220	Dow Chemical Co.162, 3052 2020 Dow Center, Midland, MI 48640
steel Inc.937 Route 31 & Ashland Ave., Aurora, IL 60507	Benner-Nawman Inc.423 395 Civic Dr., Suite H, Pleasant Hill, CA 94523	Chicago Faucet Co.732 2100 South Nuclear Drive, DesPlaines, IL 60018	Dow Coming Corp.177 220 Salzburg Rd., Midland, MI 48640
Tube & Conduit Corp.714 100 South Lathrop, Harvey, IL 60426	Best Lock Corp.221 P. O. Box 103, Indianapolis, IN 46206	Chloride Systems-U.S.A.864, 845, 846, 847 Mallard Lane, Northaven, CT 06473	Dresser-Bames Electronics Div.456 1600 East Valencia Drive, Fullerton, CA 92631
ns Corp.767 15 E. Edna Place, Covina, CA 91723	Bigelow-Sanford, Inc.284 P.O. Box 3089, Greenville, S.C. 29602	Circle Gallery, Ltd.514 108 South Michigan Ave., Chicago, IL 60603	Dryvit System, Inc.173, 3106 420 Lincoln Ave., Warwick, RI 02888
Alumiline Corp.205 Annell Lane, Pawtucket, RI 02860	Birdair/Chemfab649, 650, 651, 652, 653, 3140 2015 Walden Avenue, Buffalo, NY 14225	Cleveland Range Co.462 1333 East 179th Street, Cleveland, OH 44110	Dual-Lite Inc.865, 841, 840 Simm Lane, Newtown, CT 06470
na Refrigeration, Inc.723 mana, IA 52204	Birge Wallcoverings358 P. O. Box 2775, Buffalo, NY 14240	Colorado State University3005 Christman Field, Bldg. 1000, Fort Collins, CO 80523	Dukane809 2900 Dukane Drive, St. Charles, IL 60174
rite Anaconda Aluminum Co.224 85 Fulton Industrial Blvd., SW, Atlanta, GA 30301	Bishop Graphics15 5388 Sterling Center Dr., PO Box 5007, Westlake Village, CA 91359	Columbia Lighting, Inc.834, 869 T.A. Box 2787, Spokane, WA 99220	Dunbar603 601 S. Fulton St., Berne, IN 46711
or Industries, Inc.200 5 Sheffield Dr., Delmont, PA 15626	Bobrick Washroom Equipment Inc. 4, 33, 34, 36, 3148 11611 Hart Street, North Hollywood, CA 91605	Columbus Coated Fabrics Div. of Bordon Chemical368 1280 N. Grant Ave., Columbus, OH 43216	Dundee Mills409 111 W. 40th St., New York, NY 10018
rec Corp.663 Box 3825, Bellevue, WA 98009	Boise Cascade149, 150 600 South County Rd., St. Louis Park, MN 55426	Combustion Engineering Inc.710 Wellsville, NJ 14895	DuPont Textile Fibers203, 281, 286, 353, 3068, 3136 Centre Rd. Bldg., Wilmington, DE 19898
ican Electro-Dynamics Corp.816 ne Penn Plaza, Suite 2830, New York, NY 10001	Bostik Chemical Group180 3101 Euclid Ave., Cleveland, OH 44115	Commercial Carpet Corporation285 10 West 33rd Street, New York, NY. 10001	Durable Mat Co.484 75 North Pleasant Street, Norwalk, OH 44857
ican Olean Tile Company346 00 Cannon Avenue, Lansdale, PA. 19446	Bradley Corp. Faucet & Special Products745, 3151 P. O. Box 348, Menomonee Falls, WI 53051	Conco Industries, Inc.470 30 Water St., West Haven, CT 06516	Dynapar Corp.823 1675 Delany Rd., Gurnee, IL 60031
ican Plywood Assn. 2, 3035, 3038, 3039, 3041, 3044, 3079, 3113, 3141 O. Box 11700, Tacoma, WA 98411	Brayton International894, 593 113 Moutsinger, High Point, NC 27261	Conditioned Power Corp.941 1050 Dearborn Drive, Columbus, OH 43229	Jos. Dyson & Sons Inc.97 53 Freedom Rd., Painesville, OH 44077
ico/American Sterilizer Co.519 124 West 23rd St., Erie, PA 16512	Brick Association of North Carolina3018 PO Box 6305, Greensboro, NC 27405	Consolidated Aluminum3053 11960 Westline Ind. Dr., St. Louis, MO 63141	E
vel Building Products3085 13 Plant St., Niles, OH 44446	Brick Institute of America3019 1750 Old Meadow Rd., McLean, Va. 22101	Consoweld Corp.3040 700 DuraBeauty Lane, Wisconsin Rapids, WI 54494	The E. F. Hauserman Co.415, 583 5711 Grant Avenue, Cleveland, OH 44105
hor Fence Div., Anchor Post Products34, 3004 100 Eastern Avenue, Baltimore MD 21224	Brink's Locking Systems, Inc.459, 460, 461 213 Naperville Rd., Box 233, Plainfield, IL 60544	Construction Specialties, Inc.414, 3123 55 Winans Ave., Cranford, NJ 07016	E. A. Thompson Co., Inc.58 703 Market St., San Francisco, CA 94103
itectural Complements 609, 620, 760, 761, 762, 763, 764 Box 168, Lincoln, MA 01773	Brueton Industries546, 616 227-02 145 Rd., Springfield Gardens, NY 11413	Contemporary Systems, Inc.520 132 New Boston Park, Woburn, MA 01801	ESP Systems Development Inc.925 28189 Kehrigh Drive, Mt. Clemens, MI 48045
itectural Engineering Ptds. Co.170 Box 81664, San Diego, CA 92138	Brunswall3117 1755 Butterfield Rd., Libertyville, IL 60048	Continental Instruments Corp.924, 930 170 Lauman Lane, Hicksville, NY 11801	Eastern Cyclone Industries Inc.480, 481 15 Daniel Road, Fairfield, NJ 07006
	The Burns & Russell Co.78, 3021 506 S. Central Avenue, Baltimore, MD 21202	Conwed Corporation 163, 277, 278, 304, 564, 567, 3010, 3122, 3124 332 Minnesota St., St. Paul, MN 55101	Econovest Systems, Inc.703 800 Horicon St., Mayville, WI 53050
	Butler Mfg. Co., Bldgs. Div.157, 169, 655, 3045, 3066 BMA Tower—Box 917, Kansas City, MO 64141	Copal Corp. of America539 58-25 Queens Blvd., Woodside, NY 11377	Elden Enterprises, Inc.3 PO Box 3201, Charleston, WV 25332
		Cornell Corp.55 808 S. Third St., Cornell, WI 54732	Elk Corp.3046 8625 King George, Suite 166, Dallas, TX 75235
			Elliptipar, Inc.857, 862 145 Orange Ave., West Haven, CT 06516

Enersave Co. 947
PO Box 36043, Strongsville, OH 44136

Entropy Ltd. 788
5735 Arapahoe Avenue, Boulder, CO 80303

Envel Corp. 656
1940 Cotner Ave., Los Angeles, CA 90025

Environmental Glass Products 204
4815 Cabot, Detroit, MI 48210

Epic Metals Corp. 98, 99
Eleven Talbot Ave., Rankin, PA 15104

Essex Transducers Corp. 212
1130 Mark Ave., Carpinteria, CA 93013

Excel Dryer Corp. 430
PO Box 365, East Longmeadow, MA 01028

Executive, Inc. 813, 814
2910 Thomson Avenue, Long Island City, NY 11101

F

F. L. Saino Mfg. Co. 3083
66 W. Colorado Ave. Memphis, TN 38106

Facit, Inc. 547
66 Field Point Road, Greenwich, CT 06830

Fasar Systems, Inc. 488
2801 Burton Avenue, Burbank, CA 91504

Faulkner Plastics 3082
PO Box 11266, 4504 E. Hillsboro Ave., Tampa, FL 33610

Fearless Faucets 426, 429, 742, 743
Garrison, NY 10524

Federal Signal Corp. 3011
291 Frontage Road, Hinsdale, IL 60521

Fencote Inc. 402
Hindsdale Industrial Park, 16 W. 070 83rd St., Burr Ridge, IL 60521

Fisher Scientific Co., Contempra Furniture Div. 471, 476, 3129
711 Forbes Avenue, Pittsburgh, PA 15219

Flexten Systems, Inc. 657
6220 Oakton Street, Morton Grove, IL 60053

Flexi-Wall Systems 359
P.O. Box 477, Liberty, S.C. 29657

Foma Scientific 469, 472, 473
Box 649, Marietta, OH 45750

Fomica Corp. 123
Wayne, NJ 07470

Foremost Mfg. Co. 3078
21000 W. Eight Mile Rd. Southfield, MI 48075.

Foms & Surfaces, Inc. 214, 303, 317, 320, 321, 322, 324, 345, 537
Box 5215, Santa Barbara, CA 93108

Francisan Ceramic Tile 347
2901 Los Feliz Blvd., Los Angeles, CA 90039

Fry Reglet Corp. 636
625 South Palm Avenue, Alhambra, CA 91803

G

GAF Corp. 328, 333, 3061
140 West 51 Street, New York, NY 10020

GF Business Equipment Inc. 3133
E. Dennick Ave., Youngstown, OH 44601

Gil Corporation 145, 146, 147, 156, 326, 337, 339
Suite 611, One Embarcadero Center, San Francisco, CA 94111

GTE Lighting Products 916
100 Endicott St., Danvers, MA 01923

Gall International Corp. 341, 348, 350
1481 N. Main St., Orange, CA 92667

Gamewell Corp. 711
Seven Industrial Park Rd., Medway, MA 02053

Gardco Lighting 853, 854
2661 Alvarado St., San Leandro, CA 94577

General Electric Co. 889, 890, 891, 892, 893, 3006, 3007
Nela Park, Cleveland, OH 44112

General Electric Plastics Div. 202, 229, 410, 990
One Plastics Avenue, Pittsfield, MA 01201

General Products Company 227, 3093
P.O. Box 887, Fredericksburg, VA 22401

Georgia-Pacific Corp. 318, 323, 3111
900 S.W. Fifth Avenue, Portland, OR 97204

Ghent Mfg. Inc. 416
PO Box 355, Lebanon, OH 45036

Gilford Inc. 367, 371
250 Park Avenue South, New York, NY 10003

Glenco Refrigeration Co. 464
8000 Penrose Avenue, Philadelphia, PA 19153

Glidden Maintenance Coatings 3104
900 Union Commerce Bldg., Cleveland, OH 44115

W. R. Grace & Co. 3017, 3060
62 Whittemore Avenue, Cambridge, MA 02140

Grant Hardware Co. 213, 3132
High St., West Nyack, NY 10994

GraphiCraft 17
P.O. Box 509, Westport, CT 06880

Grinnell Fire Protection 718
10 Dorrance St., Providence, RI 02903

Grumman Energy Systems Inc. 794
4175 Veterans Memorial Highway, Ronkonkoma, NY 11779

Grunau Sprinkler Mfg. Div. 716
Box 220, 2211 12 Ave., S. Milwaukee, WI 53172

Grundfos Pumps Co. 772
2555 Clovis Ave., Clovis, CA 93612

Guard Nut 3025
20450 Broadway, Drawer 299, Sonoma, CA 95476

The Gunlocke Co., Inc. 617
7 Lackawanna St., Wayland, NY 14572

Guth Lighting 839
PO Box 7079, St. Louis, MO 63177

H

Habitat, Inc. 858
341 E. 62nd St., New York, NY 10021

Halmar Electronics, Inc. 815
900 North Hague Ave., Columbus, OH 43204

Hammon 544
1933 Dock St., Tacoma, WA 98401

Hardwood Plywood Association 3034
PO Box 2789, Reston, VA 22090

Harris Labs Inc. 825, 826
1106 Westwood Dr., Marshalltown, IA 50158

Harris Manufacturing Company 378
P.O. Box 300, Johnson City, TN. 37601

Harvey Probbler, Inc. 563, 568, 602
44 Probbler Lane, Fall River, MA 02722

Hastings II Bagno Collection 342, 343, 344, 351, 352, 354, 438, 517, 746, 747, 748, 749, 750, 752, 773
410 Lakeville Rd., Lake Success, NY 11040

Haws Drinking Faucet Co. 733
P. O. Box 1999, Berkeley, CA 94701

Heidapal Group 526
387 Coral St., Santa Cruz, CA 95060

Helikon Furniture Co., Inc. 582, 614, 3138
Taftville, CT 06380

Herman Miller, Inc. 550, 551, 935, 938, 3134, 3152
Zeeland, MI 49464

Heuga U.S.A., Inc. 292
185 Sumner Ave., Kenilworth, NJ 07033

Hewlett-Packard 2, 3000
340 E. Harmony Rd., Fort Collins, Colo. 80525

Hiebert, Inc. 558, 560, 574, 581
23605 Telo Avenue, Torrance, CA 90505

Hoffman ITT 730
1700 W. 10th St., Indianapolis, IN 46222

Home Hardware Div. 3097
Norris Inds., 1900 E. Orangethorpe Ave., Fullerton, CA 92631

Honeywell Inc. 820, 927
Honeywell Plaza, Minneapolis, MN 55408

Hope's Windows Div. Roblin Inds. Inc. 233, 3098, 3099
84 Hopkins St., Jamestown, NY 14701

Horton Automatics 238
6250 LBJ Freeway, Dallas, TX 75240

Howe Furniture Corp. 601
155 E. 56th St., New York, NY 10021

Howmet Aluminum Corp./Extrusion Products Div. 226
P. O. Box 629, Terrell, TX 75160

Hunter Douglas Inc. 635
20 Campus Rd., Totowa, NJ 07512

Hunter Douglas Inc. 151
400 West Main St., Durham, NC 27701

I

ICF, Inc. 584, 611
145 E. 57th St., New York, NY 10022

ITI Inc. 59
PO Box 293, Geneva, IL 60134

ITT Indoor Lighting/Wakefield 855, 856, 877
Vermillion, OH 44089

ITT Outdoor Lighting 879
PO Box 100, Southaven, MS 38671

Inlite Co. 912
939 Grayson St., Berkeley, CA 94710

InsulShutter Inc. 634
PO Box 338, Silt, CO 81652

Integrated Ceilings, Inc. 302, 3109
2231 Colby Avenue, Los Angeles, CA 90064

International Design Systems Ltd. 57
1929 Cross Highway, Fairfield, CT 06430

Interface Flooring Systems 299
Orchard Hill Road, LaGrange CA 32041

Intertherm Inc. 829
3800 Park Ave., St. Louis, MO 63110

Intrex Inc. 559
343 East 62 St., New York, NY 10021

The Ironmonger Inc. 218, 220, 513, 588
1822 N. Sheffield Ave., Chicago, IL 60614

Ista Energy Systems Corp. 778, 779, 780, 819
29 South Union Avenue, Cranford, NJ 07016

J

JG Furniture, Div. Burlington 561
121 Park Avenue, Quakertown, PA 18951

J & J Industries 290
PO Box 1287, Dalton, GA 30720

James Seeman Studios, Inc. 373, 375
50 Rose Place, Garden City Park, NY 11040

Jamison Door Company 3096
P.O. Box 70, Hagerstown, MD 21740

Jenny Division, Homestead Industries, Inc. 466
Box 348, Coraopolis, PA 15108

Jim Walter Doors 225, 232, 399
1500 N. Dale Mabry, Tampa, FL 33607

Johns-Manville 159, 166, 167, 174, 176, 3027, 3065
Ken-Caryl Ranch, Denver, CO 80217

Johns-Manville Buckner Irrigation Systems 35
PO Box 5108, Denver, CO 80217

Johns-Manville Sales Corp., Holophane Division 917, 903, 872, 849, 850, 3156
Ken-Caryl Ranch, Denver, CO 80217

Johnson Controls Inc. 664
507 E. Michigan St., Milwaukee, WI 53202

K

Vladimir Kagan Designs Inc. 524, 545, 548, 549, 562, 830, 910
239 East 59 St., New York, NY

Karastan Rug Mills 287, 3108
919 Third Ave., New York, NY 10022

Karl Mann Associates 512, 530
232 East 59th Street, New York, NY 10022

Kawneer Co. 196, 197, 234, 3100, 3101
1105 N. Front St., Niles, MI 49120

Keene Corp./Bldg. Products 3024
P.O. Box 2677, Kalamazoo, MI 49003

Keene Corp., Laminates Div. 795
70 South Chapel St., Newark, DE 19711

Keene Corp., Lighting Div. 885, 886, 887, 888
2345 Vauxhall Rd., Union, NJ 07083

Kemlite Corp. 155
PO Box 429, 101 N. Republic Ave., Joliet, IL 60434

Kenmore Carpet Corp. 3105
979 Third Ave., New York, NY 10022

Kennedy Sky-lites, Inc. 199
American Business Center, PO Box 17832, Orlando, FL 32810

Kentile Floors Inc. 327, 332, 334, 335
58 Second Ave., Brooklyn, NY 11215

Keuffel & Esser Co. 12
20 Whippany Road, Morristown, NJ 07960

Keystone Group 124
7000 Southwest Adams, Peoria, IL 61641

Kim Lighting Inc. 883
16555 E. Gale, City of Industry, CA 91749

Kimball Office Furniture Co. 600
P. O. Box 460, Jasper, IN 47546

The King Company 725
1001 21st Ave. NW, Owatonna, MN 55060

Knoll Textiles 531, 533
745 Fifth Ave., New York, NY 10022

Koch + Lowy Inc. 836
21-24 39th Avenue, Long Island City, NY 11101

Kohler Co. 731, 744, 765, 769, 770, 771, 3150
High Street, Kohler, WI 53044

Kool-O-Matic Corp 412
1831 Terminal Rd., Niles, MI 49120

Koppers Company Inc. 126, 168, 3029, 3080
1900 Koppers Bldg., Pittsburgh, PA 15219

Korfil Inc. 3070
PO Box 123, Chicopee, MA 01414

Krueger 622
1330 Bellevue St., PO Box 8100, Green Bay, WI 54308

L. E. Carpenter & Co. 357, 361, 364, 369, 374
170 North Main Street, Wharton, NJ 07885

L&M Construction Chemicals Inc. 3003
8316 Blondo St., Omaha, NE 68134

Labconco Corp. 475
1811 Prospect, Kansas City, KS 64132

Laclede Research Laboratories 338
2921 Atlantic Ave., Brooklyn, NY 11207

Landscape Forms, Inc. 39, 41, 42
Route 3, Kalamazoo, MI 49001

Langhame Carpet Co. 289
PO Box 175, Pennel, PA 19047

Lasco Industries 172, 729, 768
3255 E. Miraloma Ave., Anaheim, CA 92806

Leedal, Inc. 457, 458, 518
1918 South Prairie Avenue, Chicago, IL 60616

Leigh Products 236, 413, 932
411-64th St., Coopersville, MI 49404

Lennox Industries 708, 709, 722
PO Box 400450, Dallas, TX 75240

Levolor Lorentzen, Inc. 5
5 Marine View Plaza, Hoboken, NJ 07030

Life Dynamics 2337 Lexington St., Sacramento, CA 95815

Lighting Associates 305 East 63 St., New York, NY 11021

Lightolier Inc. 880, 881, 882, 863, 346
346 Claremont Avenue, Jersey City, NJ 07305

Litton Business Furniture Div. Litton Inds. 640
640 Whiteford Rd., York, PA 17405

Logo Looms Ltd. 405, 235
235 Great Neck Rd., Great Neck, NY 11021

Lonseal Inc. 22123 S. Vermont St., Torrance, CA 90502

Charles M. Loomis 870, 12421
12421 NE 124 St., Kirkland, WA 98003

Ludlow Corp., Carpet Cushion Division 145
145 Rosemary Street, Needham Heights, 02194

Ludowici-Celadon Company 201
201 North Talman Ave., Chicago, IL 60612

M

MCC Powers 821, 667, 669, 682, 3400
3400 Oakton Street, Skokie, IL 60076

Madico Div. Van Leer USA 64
64 Industrial Parkway, Woburn, PA 01801

Madison Furniture Industries PO
PO Drawer 111, Canton, MS 39046

Cy Mann Designs Ltd. 541, 979
979 Third Ave., New York, NY 10022

Mannington Mills, Inc. 336, 3 P.O.
P.O. Box 30, Salem, NJ 08079

Marvin Windows Warroad,
Warroad, MN 56763

Masonite Corp. Marlite
Marlite Division, Dover, OH 44622

Masonite Corporation Commercial Division Dover,
Dover, Ohio 44622

Master Builders Lee at
Lee at Mayfield, Cleveland, OH 44118

Master Craft Industries 522, 523, 6175
6175 E. 39th Ave., Denver, CO 80207

George Mayer Mfg. Inc. PO
PO Box 1468, Miami, OK 74354

Medeco Security Locks Inc. P.O.
P.O. Box 1075, Salem, VA 24153

Megathern 803
803 Taunton Avenue, E. Providence, RI 02914

Memphis Hardwood Flooring Co. PO
PO Box 7253, Memphis, TN 38107

Metricube PO
PO Box 341, Palo Alto, CA 94302

Metropolitan Ceramics 349, 1700
1700 Gateway Blvd., S.E., Canton, OH 44707

Metropolitan Furniture Corp. 570, 629, 950
950 Linden Ave., S. San Francisco, CA 94080

Microproj, Inc. 452
452 E. Hill Rd., Willits, CA 95490

Midland-Ross Corp. 946, PO
PO Box 1548, Pittsburgh, PA 15230

The Miller Co. 866, 99
99 Center Street, Meriden, CT 06450

Howard Miller Clock Co. Zeeland,
Zeeland, MI 49464

Modemfold, Div of American Standard 3 P.O.
P.O. Box 310, New Castle, IN 47362

Molded Fiber Glass Concrete Forms Co. 61, 30
3741 Ann Ave., Ashtabula, OH 44004

Molded Fiber Glass Tray Co. E. Erie
E. Erie St., Linesville, PA 16424

Monarch Furniture 587, PO
PO Box 2516, High Point, NC 27261

Monier Company 30 P.O.
P.O. Box 5567, 1091 N. Batavia Street, Orange, 92666

Monsanto Co. 3008, 3048, 3056, 30
800 North Lindbergh Blvd., St. Louis, MO 63166

Mosler, an American Standard Co. 451, 452, 453, 454, 455, 6
1561 Grand Blvd., Hamilton, OH 45012

Multiplex Display Fixture Co. 11, 5
1555 Larkin Williams Rd., Fenton, MO 63026

Mutcher, A Triangle Pacific Co. 5
4255 LBJ Freeway, Dallas, TX 75234

Myrtle Desk Co. 5
Taylor and Mills, High Point, NC 27261

Myson Inc. 427, 7 PO
PO Box 5025, Embrey Industrial Park, Frederickburg, VA 22401

McDonnell Douglas Corp. 6
PO Box 516, St. Louis, MO 63166

McDonnell & Miller ITT 7
3500 N. Spaulding Ave., Chicago, IL 60618

Law Edison Area Lighting Div., SPI Lighting	901, 898, 899, 900, 873, 876, 902, 3153
1 Durand Avenue, Racine, WI 53405	
Law-Edison Laundry Prdts. Div.	479
on, WI 54971	
lben Lighting-Emerson Electric Corp.	875
Long Island Expressway, Melville, NY 11746	
ay Group, McQuay Perfex Inc.	495, 724
Box 1551, 13600 Industrial Park Blvd., Minneapolis	
MN 55401	
nal Fire Hose Corp.	713
East Oaks St., Compton, CA 90224	
alite, Inc.	3084
33 W. Kingsley Rd., Garland, TX 75040	
ah Foundry Co.	37, 3013
21 Brooks Ave., Neenah, WI 54956	
Ray Lighting	658, 659, 906, 909
Johnson Ave., Brooklyn, NY 11237	
mar Corp.	119
99 Telegraph Road, Odenton, MD 21113	
ood Products of Oregon	580
North Seneca Rd., PO Box 2928, Eugene, OR	
440	
ndex Aluminum Bldg. Products	239
20 Krick Rd., Cleveland, OH 44146	
eld Corp.	120
Kenosia Ave., Danbury, CT 06810	
ake, Inc.	201, 463, 465, 774
ond & Elm, Hudson, WI 54016	
Co., Inc.	14
00 West Grand Ave., Chicago, IL 60651	
October Co., Inc.	121
Ferry St., Easthampton, MA 01027	
ga Lighting-Emerson Electric Co.	874
Long Island Expressway, Melville, NY 11746	
ne, Div. of Interbath	436
7 N. Baldwin Park Blvd., City of Industry, CA	
746	
line, U.S.A., Inc.	181
ute 9, Box 195, Fredericksburg, VA 22401	
ndo Enterprises	431, 720
74 SW Terrace, Miami, FL 33145	
levator Company	684
ie Farm Springs, Farmington, CT 06032	
head Door Corp.	215, 240, 401, 485, 486
50 LBJ Freeway, Dallas, TX 75240	
ns-Coming Fibreglas Corp.	3075, 3076, 3135, 3139
erglas Tower, Toledo, Ohio 43659	
pace Collection, Inc.	615
11 34 Ave., Long Island City, NY 11106	
ree Door Inc.	223
51 Blue Ridge Industrial Park, Norcross, GA	
071	
ess Electric Co.	896, 897, 895
7 Bancroft Way, Berkeley, CA 94710	
rin Milnor Corp.	482
O. Box 400, Kenner, LA 70063	
ountain Co.	183
Box 426, Dept. K, Richmond Hill, Ontario L4C	
8	
errell Carpets	296
O. Box 1208, Dalton, GA 30720	
abond International Corp.	282
O. S. Dean St., Englewood, NJ 07631	
915	
& Kendall	904
Foundry St., Newark, NJ 07105	
ix Products Co., Inc.	904
15 N. 27th St., Milwaukee, WI 53209	
Hold	3002
621 Von Karman Ave., Irvine, CA 92714	
old Booths, Div. of Foldcraft Co.	605
4 Centennial Dr., Kenyon, MN 55946	
lastic Forms, Inc.	407
pt. C, 49 Gazza Blvd., Farmingdale, NY 11735	
r Carpet Mills	301
O. Box 688, Cartersville, GA 30120	
& Lambert	312
onawanda St., P.O. Box 22, Buffalo, NY 14240	
ision Metal Products, Inc.	3120, 3127
00 NW 74th Ave., Miami, FL 33166	
olite	3154
51 Doolittle Dr., San Leandro, CA 94577	
ress Lighting	907, 908
x 12701, Philadelphia, PA 19134	
ction Treatments, Inc.	179
45 Stop Eight Rd., Dayton, OH 45414	

Q	
Quaker Maid, Div. Tappan	437
Rt. 61, Leesport, PA 19533	
R	
R. C. Musson Rubber Co.	3115
1320 E. Archwood Ave., Akron, OH 44306	
R. P. Adams Co., Inc.	781
East Park Drive, Buffalo, NY	
R-Way Furniture Company	569
740 S. Commerce St., Sheboygan, WI 53081	
Racon Inc.	931
8490 Perimeter Rd. South, Seattle, WA 98108	
Radar Detection Inc.	928
2820 NE 4th Ave., Pompano Beach, FL 33064	
Ramada Energy Systems, Inc.	792
1421 S. McClintock Drive, Tempe, AZ 85281	
Rambusch Co.	510
40 West 13 Street, New York, NY 10011	
Randustrial Corp.	178
13311-NR Union Ave., Cleveland, OH 44120	
Rapistan, Inc.	3143
342 Rapistan Bldg., Grand Rapids, MI 49505	
Rappaport Exhibits	6
3608 Payne Ave., Cleveland, OH 44114	
Rauland-Borg Corp.	808, 811, 812
3535 W. Addison Street, Chicago, IL 60618	
Raypak, Inc.	721, 789
31111 Agoura Rd., Westlake Village, CA 91360	
Reading Door Closer Corp.	211
Reamstown, PA 17567	
Readybuilt Products Co.	397
1701 McHenry St., Baltimore, Md 21223	
Redy-Furd	56
Box 6184, Marietta, GA 30065	
Reichhold Chemicals, Inc.	158
PO Box 81110, Cleveland, OH 44181	
Republic Powdered Metals	160
2628 Pearl Road, Medina, OH	
Research Products Corp.	787
1015 E. Washington Avenue, P. O. Box 1467, Madison, WI 53701	
Revere Solar and Architectural Pdts.	783, 3146
Box 151, Rome, NY 13440	
Reynolds Metals Co.	144, 148
PO Box 27003, Richmond, VA 23261	
Rite-Hite Corp.	483
PO Box 23043, Milwaukee, WI 53223	
Roben Tile for Hastings	79
235 Great Neck Rd., Great Neck, NY 11021	
Rixson-Firemark, Inc.	715
9100 W. Belmont Ave., Franklin Park, IL 60131	
Robert Long, Inc., Div. Metropolitan Furniture Corp.	913, 914
950 Linden Avenue, South San Francisco, CA 95080	
Roberts-Gordon Appliance Corp.	719
44 Central Ave., Buffalo, NY 14240	
Robertshaw Controls Company, Control Systems Division	934, 668
P. O. Box 27606, Richmond, VA 23261	
Roblin Building Products	417
1971 Abbott Road, Buffalo, NY 14218	
The Nelson Rockefeller Collection	511
30 Rockefeller Plaza, New York, NY 10020	
Roper IBC International	101
PO Box 100, Wheeling, IL 60090	
Rosemount Office Systems Inc.	315
Box D, Lakeville, MN 55044	
Royal Brass Mfg. Co.	478
1420 East 43rd St., Cleveland, OH 44103	
Russwin	207, 216
225 Episcopal Rd., Berlin, CT 06037	
Ryther Purdy Lumber Co.	848
Elm St., Old Saybrook, CT 06475	
S	
Saga, Div. of Dade, Inc.	19 & 21
400 Shelard Plaza, Minneapolis, MN 55426	
St. Charles Mfg. Co.	467, 468
1611 East Main St., St. Charles, IL 60174	
Samuel Cabot Inc.	313
One Union St., Boston, MA 02108	
Sanspray Corp.	77, 81, 82, 83, 152, 153, 3062
630 Martin Ave., Santa Clara, CA 95050	
Sattlight Products, Inc.	861
117 State St., Westbury, NY 11590	
Schlage Lock Co.	222
P.O. Box 3324, San Francisco, CA 94119	
Schwartz Forge & Metalworks	400
PO Box 205, Deansboro, NY 13328	
The Scott Group, Selaco Div.	591
23950 Commerce Park Dr., Cleveland, OH 44122	

Scott Machine Development Corp	404
Walton, NY 13856	
Scott Plastics Co.	408
PO Box 2958, Sarasota, FL 33578	
Season-All Industries, Inc.	228, 3090, 3091, 3092
Indiana, PA 15701	
Shake & Shingle Panels Inc.	3050
980 South 5th Street, San Jose, CA 95112	
Shakertown	3037
Box 400, Winlock, WA 98596	
Shelby Williams Inds. Inc.	633
PO Box 3442, Chicago, IL 60654	
Sherle Wagner International, Inc.	735, 755, 756, 757, 758, 759, 260
60 East 57 St., New York, NY 10022	
Simplex Security Systems Inc.	929
Collinsville, CT 06022	
Simpson Timber Company	143, 3036, 3057, 3067
900 Fourth Ave., Seattle, WA 98164	
Slater Electric Inc.	945, 948, 3022
45 Sea Cliff Avenue, Glen Cove, NY 11542	
Smith & Watson	571
305 East 63rd St., New York, NY 10022	
Solar Thermal Systems Div., EXXON Enterprises Inc.	784, 3145
90 Cambridge St., Burlington, MA 01803	
Solar Turbines International	920
2200 Pacific Highway, San Diego, CA 92138	
Solar Turbines International, Div. International Harvester	921
2200 Pacific Highway, San Diego, CA 92138	
Speakman Co.	740
301 E. 30th Street, Wilmington, DE 19899	
Specialty Connector Corp.	817
6126 Madison Court, Morton Grove, IL 60053	
Standard Dry Walls Products	3055, 3059
7800 N.W. 38th St., Miami, FL 33166	
Stanley Hardware	217
195 Lake Street, New Britain, CT 06050	
Stark Ceramics, Inc.	3020
P. O. Box 8880, Canton, OH 44711	
Stauffer Chemical Company	365
146 Route 1, Edison, NJ 08817	
Strand Century Pdts. Co.	860
PO Box 2187, Philadelphia, PA 19103	
Steamist Co. Inc.	751
101 Park Ave., New York, NY 10017	
Steelcase Inc.	536, 565, 623, 624, 3131
1120-36th St., S.E., Grand Rapids, MI 49501	
Stendig, Inc.	590, 540, 553, 554, 555, 556, 629
410 E. 62nd St., New York, NY 10021	
STO Energy Conservation Inc.	139
25 Curtis Avenue, Rutland, VT 05701	
Stow/Davis Textiles	527, 528
25 Summer Avenue NW, Grand Rapids, MI 49504	
Stratton Industries, Inc.	283
PO Box 1007, Cartersville, GA 30120	
The Strong Electric Corp.	493
253 City Park Ave., Toledo, OH 43697	
John Stuart, Inc.	575
979 Third Ave., New York, NY 10022	
SUNAR	534, 607, 608, 610
18 Marshall Street, Norwalk, CT 06854	
Summaster Corp.	3147
12 Spruce St., Corning, NY 14830	
Sunroc Corp.	754
Route 452, Glen Riddle, PA 19037	
Sylvania Lighting Equipment	833, 837, 844, 3155
21 Penn St., Fall River, MA 02724	
T	
Halsey Taylor Div., King-Seelye Themmos Co.	3149
Rt. 75, Freeport, IL 61032	
Taylor Lock Co.	209
2034 Lippincott St., Philadelphia, PA 19132	
Technal of America Inc.	3023
Hanover Industrial Air Park, PO Box 127, Ashland, VA 23005	
Temcor	654
2825 Toledo Street, Torrance, CA 90503	
Terra-Light, Inc.	785, 786
30 Manning Rd., Box 493, Billerica, MA 01821	
Themec Co., Inc.	3069
PO Box 1749, Kansas City, MO 64141	
Thomas Industries Inc.	851, 852
207 E. Broadway, Louisville, KY 40202	
Thonet A Simmons Company	606, 612, 613
491 E. Princess, P. O. Box 1587, York, PA 17405	
3M Co.	182
3M Center 223-25e, St. Paul, MN 55101	
3M Company, Electro-Products Div.	943, 944, 936, 717
P. O. Box 33600, St. Paul, MN 55106	
Towne Brick Corp.	340
2975 Wilshire Blvd., Los Angeles, CA 90010	
The Trane Company	704
3600 Pammel Creek Rd., La Crosse, WI 54601	

Triangle Brick	80, 395
Route 4, Box 60, Durham, NC 27713	
Trocal Window Systems Div.	3094
105 Stonehurst Court, Northvale, NJ 07647	
Trus Joist Corp.	3032
PO Box 60, Boise, ID 83707	
TSAO Designs Inc.	842
31 Grove St., New Canaan, CT 06840	
Tub-Master Corp.	734
413 Virginia Dr., Orlando, FL 32803	
Tuohy Furniture Corp.	627
42 St. Albans Place, Chatfield, MN 55923	
Turner Ltd.	573
305 E. 63rd St., New York, NY 10021	
U	
UC Industries	165
PO Box 37, 170 South Ave., Tallmadge, OH 44278	
Unicube Corp.	566
150 East 58th St., New York, NY 10022	
Uniroyal, Ltd.	3054
2200 St. Catherine St., East Montreal, Quebec, Canada H2K 4G8	
Unistrut Corp., Metal Framing Div.	103, 104, 105
35005 Michigan Ave., Wayne, Mich. 48184	
U.S. Borax	425
3075 Wilshire Blvd., Los Angeles, CA 90010	
United States Gypsum Co.	314
101 S. Wacker Drive, Chicago, IL 60606	
U. S. Steel	3009
600 Grant St., Pittsburgh, PA 15230	
Universal-Rundle Corp.	753
217 N. Mill Street, New Castle, PA 16103	
V	
Van Huffel Tube Corp.	102
Dietz Rd., Warren, OH 44481	
Vecta Contract	577, 578
740 W. Mockingbird Lane, Dallas, TX 75247	
Versatec, A Xerox Co.	7
2805 Bowers Ave., Santa Clara, CA 95051	
V'Soske	592
979 Third Avenue, New York, NY 10002	
W	
Waukesha Engine Division, Dresser Industries, Inc.	922
1000 W. St. Paul Ave., Waukesha, WI 53987	
Wausau Tile	38
P. O. Box 520 Wausau, WI 54401	
W. B. McGuire Co., Inc.	237
One Hudson Ave., Hudson, NY 12534	
W.H. Brady Co.	406
2223 W. Camden Rd., Milwaukee, WI 53201	
W. P. Hickman Co.	154, 175
175 Sweeten Creek Rd., Ashville, NC 28803	
Waterloo Industries Inc.	487
300 Ansbrough, Waterloo, IA 50704	
Welco Carpet Corp.	294
PO Box 281, Calhoun, GA 30701	
Westinghouse Electric Corp. Industrial Equipment Division	3144
P. O. Box 225, Buffalo, NY 14240	
Weyerhaeuser Company	76
Box B, Tacoma, WA 98401	
John Widdicombe Co.	572
601 Fifth St. NW, Grand Rapids, MI 49501	
Willamette Industries	125
P.O. Box 907, Albany, OR 97321	
Ralph Wilson Plastics Co.	120
600 General Bruce Drive, Temple, TX 76501	
Wilson/Lund	5
1830 6th Ave., Moline, IL 61265	
Wind-N-Sun Shield Inc.	422
1024 Harbor City Blvd., Melbourne, FL 32935	
The Windsor Door Company	3086, 3087, 3088
5800 Scott Hamilton Drive, Little Rock, AR 72219	
The Wiremold Company	939, 940
West Hartford, CT 06110	
Won-Door Inc.	418
1865 S. 3480 W., Salt Lake City, UT 84104	
The WoodBook	3031
3516 Sacramento Street, San Francisco, CA 94118	
Wood Design	579
Beechwood Ave., French Lick, IN 47432	
Wyle Laboratories	3128
1841 Hillside Ave., Norco, CA 91760	
Xerox Corp.	13
Xerox Square, Rochester, NY 14644	
Youngstown Design Center	398
435 Main St., Youngstown, NY 14174	
Z	
Zi-Tech Div.	10
Aikenwood Corp., Box 26, Palo Alto, CA 94302	

ARCHITECTURAL RECORD READER SERVICE INFORMATION

Use the inquiry cards on the opposite page to obtain more information on the products, services and literature described in this issue. Listed below are the UCI divisions, their sub-divisions and the page number on which each begins. The advertisers in the issue are listed to the right with a corresponding reader service number.

OFFICE EQUIPMENT & SUPPLIES

- 23 Computers
- 23 Information systems
- 23 Maintenance/operational equipment
- 24 Office machines
- 24 Office supplies
- 24 Reproduction equipment

SITework

- 29 Fences & gates
- 29 Irrigation systems
- 29 Landscaping
- 29 Paving & surfacing
- 29 Site furnishings

CONCRETE

- 33 Cementitious decks
- 33 Concrete accessories
- 33 Concrete formwork
- 33 Concrete materials

MASONRY

- 34 Simulated masonry
- 34 Stone
- 34 Unit masonry

METALS

- 37 Fasteners & supports
- 37 Metal decking
- 37 Metals & alloys
- 37 Structural metal framing

WOOD & PLASTICS

- 45 Architectural woodwork
- 45 Laminated & processed sheets
- 45 Plastic fabrications
- 45 Plastic laminates
- 45 Wood treatment

THERMAL & MOISTURE PROTECTION

- 49 Cladding/siding
- 50 Composite building panels
- 50 Flashing
- 51 Insulation
- 51 Membrane roofing
- 51 Metal roofing
- 52 Preformed wall & roof panels
- 52 Roof accessories
- 52 Roofing specialties
- 52 Sealants
- 52 Waterproofing & dampproofing

DOORS & WINDOWS

- 61 Entrances & storefronts
- 61 Glazing
- 62 Hardware & specialties
- 63 Metal doors & frames
- 64 Metal windows
- 64 Special doors
- 65 Special windows
- 66 Windows/curtain walls
- 66 Wood & plastic doors
- 66 Wood & plastic windows

FINISHES

- 94 Acoustical treatment
- 94 Adhesives
- 94 Carpeting
- 96 Ceiling suspension systems
- 97 Painting materials
- 97 Prefinished panels
- 98 Resilient flooring
- 99 Special coatings & surfaces
- 99 Special flooring
- 99 Tile
- 100 Wall coverings
- 102 Wood flooring

SPECIALTIES

- 119 Fireplaces
- 119 Grilles & screens
- 120 Identifying devices
- 120 Louvers & vents
- 121 Partitions
- 121 Sun control devices
- 121 Telephone enclosures
- 121 Toilet & bath accessories

EQUIPMENT

- 125 Bank & vault equipment
- 125 Darkroom equipment
- 125 Detention equipment
- 126 Food service equipment
- 126 Industrial equipment
- 126 Laboratory equipment
- 127 Laundry equipment
- 127 Loading dock equipment
- 128 Medical equipment
- 128 Residential equipment
- 128 Theater & stage equipment
- 128 Vending equipment

FURNISHINGS

- 130 Artwork
- 130 Cabinets & storage
- 131 Fabrics
- 132 Furnishing accessories
- 132 Furniture
- 137 Rugs
- 137 Seating
- 140 Window treatment

SPECIAL CONSTRUCTION

- 148 Air supported structures
- 148 Integrated assemblies
- 148 Integrated ceilings
- 149 Prefabricated buildings
- 149 Special purpose rooms
- 149 Total energy systems

CONVEYING SYSTEMS

- 152 Conveyers & chutes
- 152 Elevators
- 152 Hoists & cranes
- 152 Lifts
- 152 Pneumatic tube systems

MECHANICAL

- 154 Air distribution equipment
- 154 Air treatment equipment
- 154 Fire protection equipment
- 155 Heat exchangers
- 155 Heat generation
- 155 Heat pumps
- 155 HVAC terminal units
- 156 Mechanical controls
- 156 Piping & specialties
- 156 Plumbing fixtures & trim
- 160 Pumps & compressors
- 160 Refrigeration equipment
- 160 Self-contained HVAC units
- 160 Valves
- 160 Water supply & treatment
- 160 Solar equipment

ELECTRICAL

- 168 Communications
- 168 Conductors
- 169 Electrical & electronic controls
- 169 Electrical heating-cooling
- 170 Lighting
- 177 Motors & controls
- 177 Power generation
- 177 Protective systems
- 178 Raceways
- 179 Service & distribution
- 179 Wiring devices

A

- 1031 Adams Rite Mfg. Co.
- 1044 Allied Chemical Corp., Fibers Division
- 1003 AM Bruning Div. of Addressograph Multigraph Corp.
- 1048 American Atomics Corp.
- 1041 American Olean Tile Company
- 1005 Anchor Post Products Inc.
- 1024 Andersen Corp.
- 1022 Architectural Engineering Products Co.
- 1000 Armstrong Cork Co.

B

- 1043 Belgian Linen Association
- 1039 Bolta Wallcoverings
- 1068 Brand-Rex Co. Subs of Akzona Inc.

C

- 1038 Cabot, Inc., Samuel
- 1037 Canadian General-Tower Ltd.
- 1071 Caterpillar Tractor Co., Engine Div.-Building Services
- 1008 Cold Spring Granite Co.
- 1040 Conwed Corp.
- 1010 Crown Metal Mfg. Co.
- 1014 Cumberland Woodcraft Co.

D

- 1046 Design Tex Fabrics/DuPont-Teflon
- 1035 Diller Corp.
- 1056 Donn Corporation
- 1020 Dryvit Systems, Inc.
- 1066 Dukane Corp.

E

- 1058 Ebco Mfg. Co.

G

- 1052 GF Business Equipment, Inc.
- 1017 Grace & Co., W.R., Construction Products
- 1021 Granco Steel Products Co. Div. of National Steel Corp.

H

- 1061 Halsey Taylor Div., of King Seeley Thermos Inc.
- 1023 Hope's Windows

I

- 1001 Integrated Ceilings

J

- 1065 Johns-Manville, Holophane Division

K

- 1051 Kimball Office Furniture Co.
- 1060 Kohler Company
- 1002 Kroy Industries Inc.
- 1053 Krueger Metal Products Co.

L

- 1062 Lennox Industries Inc.
- 1047 L&M Surco Mfg. Inc.
- 1055 Lyon Metal Products Inc.

M

- 1032 Marvin Windows
- 1015 Masonite Corp.
- 1074 Matthews International Corporation
- 1063 MCC Powers Fiat-A Unit of Mark Controls Corp.
- 1069 McPhilben Lighting
- 1026 Monsanto Co. Plastics & Resin Div.
- 1057 Montgomery Elevator Co.

N

- 1033 Naturalite, Inc.
- 1004 Neenah Foundry Co.
- 1049 Nor-Lake Inc.

O

- 1025 Overhead Door Corp.

P

- 1027 Pella Rolscreen Co.
- 1036 Pennwalt Chemicals Corp.
- 1018 Pittsburgh Corning Corp.
- 1030 Polycy American

R

- 1070 Raceway Components Inc.
- 1034 Raynor Mfg. Co.
- 1054 R-Way Furniture Co.

S

- 1007 Stark Ceramics Inc.

T

- 1042 Thoro System Products
- 1073 3M Electro-Products Div.
- 1016 Trus Joist Corp.

U

- 1013 Unistrut-GTE Sylvania
- 1059 United McGill Corp.
- 1011 United States Gypsum Co.
- 1009 United States Steel Corp.

V

- 1029 Ventarama Skylight Corp.
- 1019 Vincent Brass & Aluminum Co.
- 1045 Vinyl Plastics Inc.
- 1050 Vollrath Co.
- 1028 Von Duprin Inc.

W

- 1064 Walker/Parkersburg Div. of Textron Inc.
- 1012 Wheeling Pittsburgh Steel Co.
- 1006 Whitacre-Greer
- 1067 Wide-Lite Corporation
- 1072 Wiremold Co.

INTRODUCTION

Products represented in this year's Product Reports issue signify the continuing research that all manufacturers are conducting, as well as design trends through the 1970s. The intimate relationship between manufacturers and architects and engineers is obvious—with innovative product design leading to new architectural applications; and vice versa, innovative architectural designs leading to manufacturers developing new or refining older products.

Design trends through the 1970s (as are all design trends regardless of period) are reflected in the upsurge of specifying certain building products. These trends are represented in one way or another throughout this issue, and deserve special notice here.

Restoration, rehabilitation, renovation, preservation and conservation require the revival of special products and the need for artisans to carry out special techniques in order to reproduce the best design characteristics of any project. These once called "lost arts" are not lost, as exemplified by one artisan with a highly specialized type of work that has been singled out as a case history on page 14.

There has also been a refocusing on interior design, and therefore a tremendous diversity of interior-oriented products have flourished. Of particular note in this issue is information and photographs of Finishes (UCI 9) including new designs for wallcoverings, carpeting, flooring and tile, and Furnishings (UCI 12) stressing new furniture designs and artwork. A case history on newly-devised processes for graphics on page 12 complements this interior products presentation.

Energy conservation is, of course, another "hot" topic that has influenced design through the 1970s, and it will be one of the prime determinants of design in the 1980s. A wide range of products affect energy consumption, including those in product divisions of Mechanical (UCI 15), Electrical (UCI 16), Thermal and moisture protection (UCI 7) and Doors and windows (UCI 8). Of special interest is the development of solar energy products and lighting (with task/ambient lighting research, testing and product design escalating).

Use of computers is continuing to grow in all areas of design, represented in this issue in Office supplies (UCI 1), and in the Architectural Business section which deals with one firm's positive reaction to word processing.

Design and construction through the 1970s have been tremendously influenced by a high level of technology, following increased efforts to explore outer space. While construction has been only one area affected, it is certainly one of the most noticeable. This often called "high tech" design approach means more than sleek aluminum and reflective glass facades and colorless, stark and geometric interior spaces; the modern technology has influenced product development in other ways as explored in the Architectural Engineering case history on page 16 with an application of fiberglass reinforced concrete exterior panels on a high-rise building in San Francisco.

One of the best ways in which to keep tabs on innovative design and design trends is to follow product development. This annual issue does this homework for you, and now introduces the thrust in product development for the 1980s. —*Janet Nairn*

1

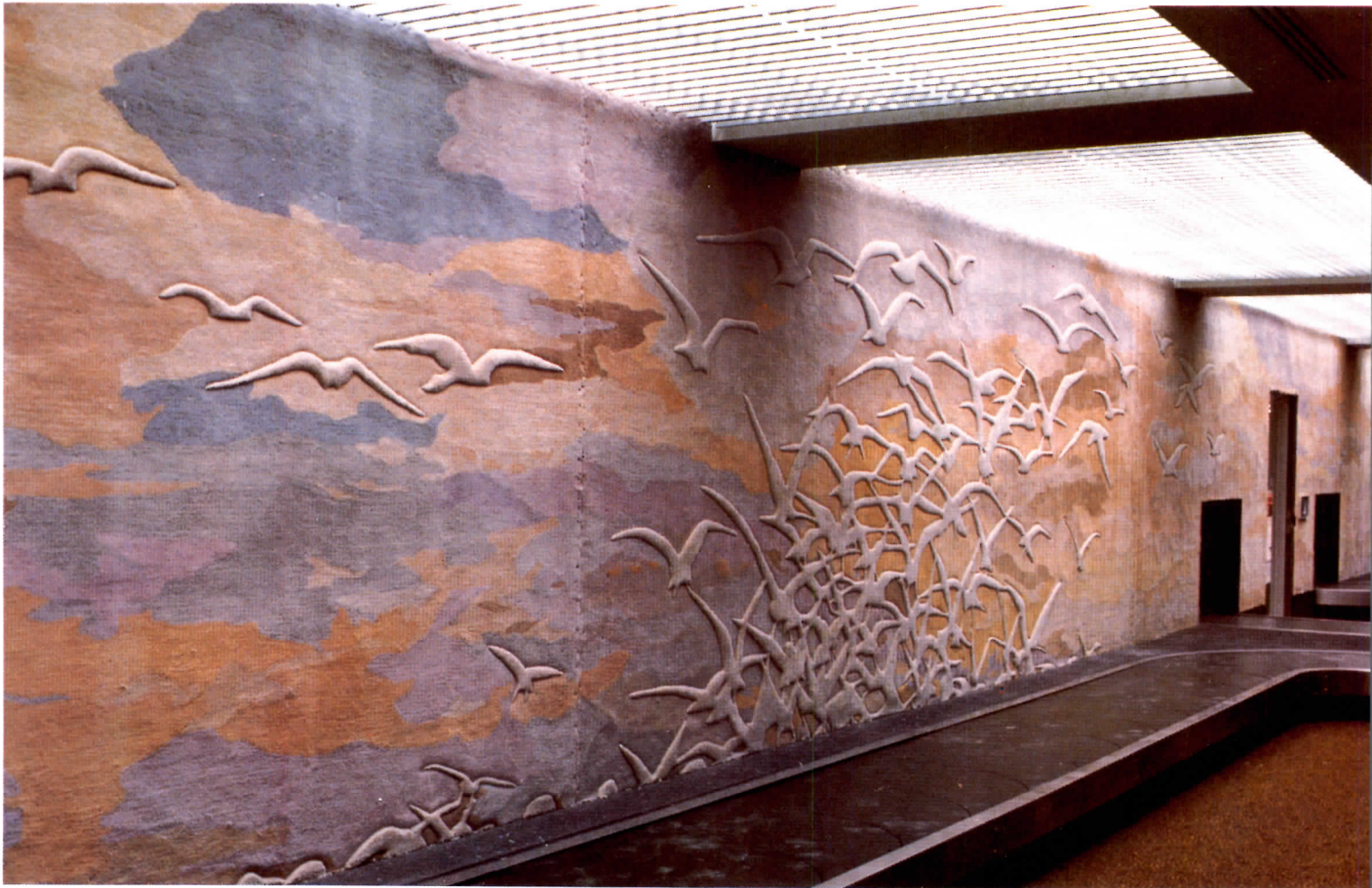
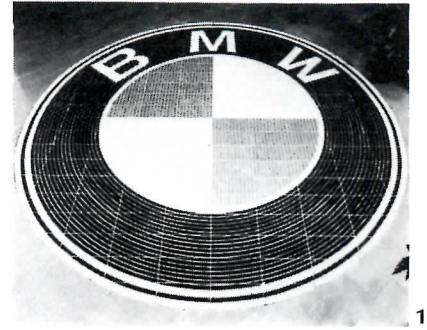

- 1 Hastings Tile, Lake Success, New York
- 2 Paul Wieland, Inc., Grand Rapids
- 3 Naturescapes, Inc., Newport, Rhode Island
- 4 Edward Fields Inc., New York City
- 5 AllianceWall Corp., Alliance, Ohio
- 6 Clean City Squares, Inc., St. Louis
- 7 Alexander Messinger
- 8 Tsao Designs, Inc., New Canaan, Connecticut



5

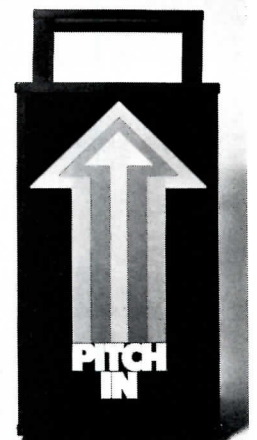

6



7

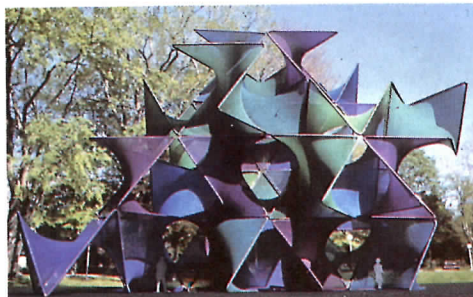

**NEW FORMS AND MATERIALS
CREATE GRAPHICS AND ART**

Ornament may have seemed crime to early Modernists, but graphics as art for both interior and exterior use has remained a critical design element. Examples shown here particularly represent newly-devised processes that create graphics from existing materials.

One company lithographs large photo-murals on synthetic paper, and "Dunes" (3) is an example of a variety of landscapes offered. Modern techniques in weaving and cutting carpet led to sculptured tapestries at

8

Cleveland's Hopkins International Airport (2) where architect Michael Benjamin designed a 420-foot-long avian tapestry. It is not only an unexpected exciting design, but the birds' flight path guides pedestrians through this section, and acoustically aids in deadening sound. For a concave wall at the American College of Cardiology in Bethesda, Maryland, interior designer Emily Malino installed a wool tapestry (4) woven with sharply defined levels to create shadows. In another example, French ceramics student Roger Capron uses tile for custom corporate logos (1). A Perma-graphics process enlarges photographs or drawings (5) for porcelain enamel panels. Colorful banners continue to flourish, here defining space while acting as sunshades (8). As exterior graphics, trash baskets (6) sport mini-murals with special messages or logos. And while the tension fabric structure shown (7) is experimental research for "environmental structures" by Alexander Messinger and his students at the University of Pennsylvania, it could be used as unusual and dramatic sculpture.

2

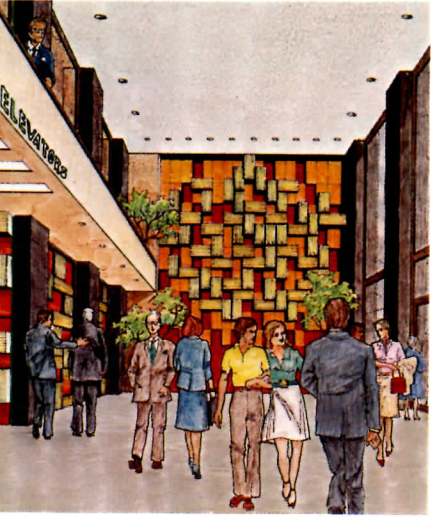

Daniel Tybert



foulds-wilson studio

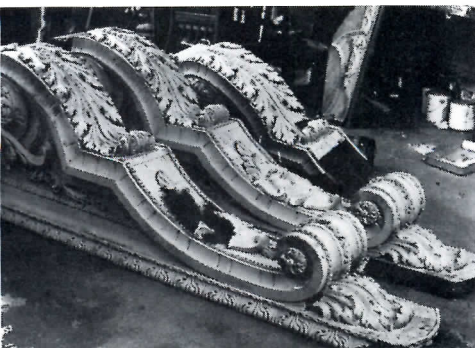
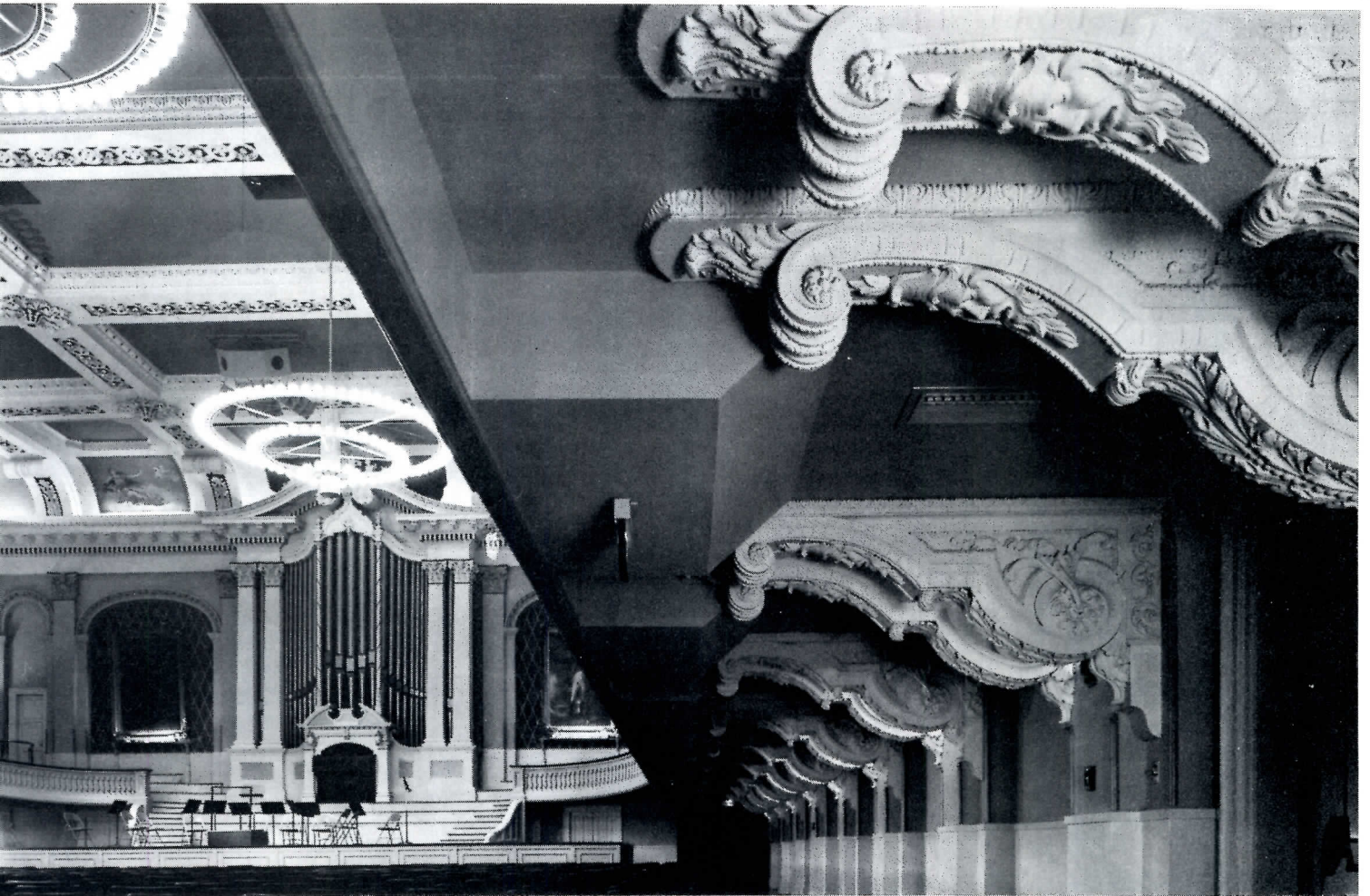
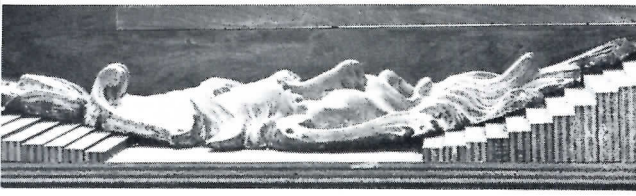

ORNAMENTAL PLASTER FOR RESTORATION AND MODERN DESIGNS AVAILABLE THROUGH SPECIAL PROCESS

In these days of widespread restoration, rehabilitation, and preservation there is a lack of artisans who are qualified to renew varying aspects of decayed buildings. One company that has specialized in casting ornamental plaster is Dovetail, Inc., of Sudbury, Massachusetts.

In restoration of the Worcester, Massachusetts, Mechanics Hall (above), architects Anderson-Notter & Finegold hired Dovetail to recreate plaster brackets and special details like the Greek face shown.

In another handsome restoration, the Connecticut State Capitol in Hartford, Connecticut, originally designed by Richard Mitchell Upjohn and now under restoration direction of architect Dominic Cimino, the House Chamber (left) was returned to its

1879 status. The interiors represent some of the finest examples of the high Victorian Gothic style with vaulted ceilings, stained glass skylights, Venetian palazzo-styled court, rows of tiered columns, decorative painted stencils and sculptured hardware. Dovetail was one of 27 firms hired for restoration duties for the exterior and interior. Dovetail recreated a variety of plaster work including the cornices, and refurbished 15 original oak entrance doors and frames.

The process for recreating plaster ornamentation involves stripping and repairing the original piece to be reproduced, constructing forms to cradle the new molds, laborious preparation of the molds and eventually the pouring and setting of plaster. In addition to this type of work, the firm has perfected a patent-pending process of treating plaster with color so that the color is an integral part of the plaster. In conjunction with this approach, they are also preparing contemporary designs (such as the one shown far left) as interior art work made of plaster. Exterior plaster decoration is also possible.

3

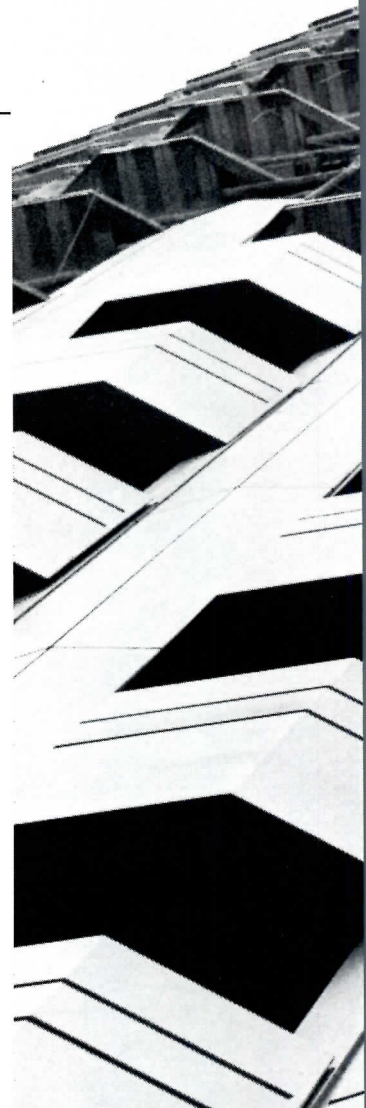
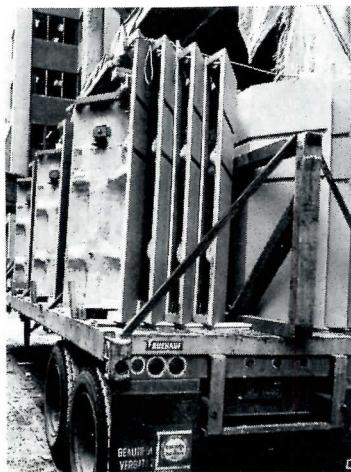

Though the unusual undulating facade of the 19-story Pacific Mutual Building in San Francisco echoes tradition of the area, it is constructed of a most modern material—fiberglass reinforced concrete. The lightweight FRC panels, which are only about $\frac{3}{8}$ -in.-thick, cut costs through savings in supporting steel, construction time, erection labor and fabrication time. Another noteworthy feature of the building exterior is the operable windows provided by architect Pereira to take advantage of the area's mild year-round climate for potential energy savings.

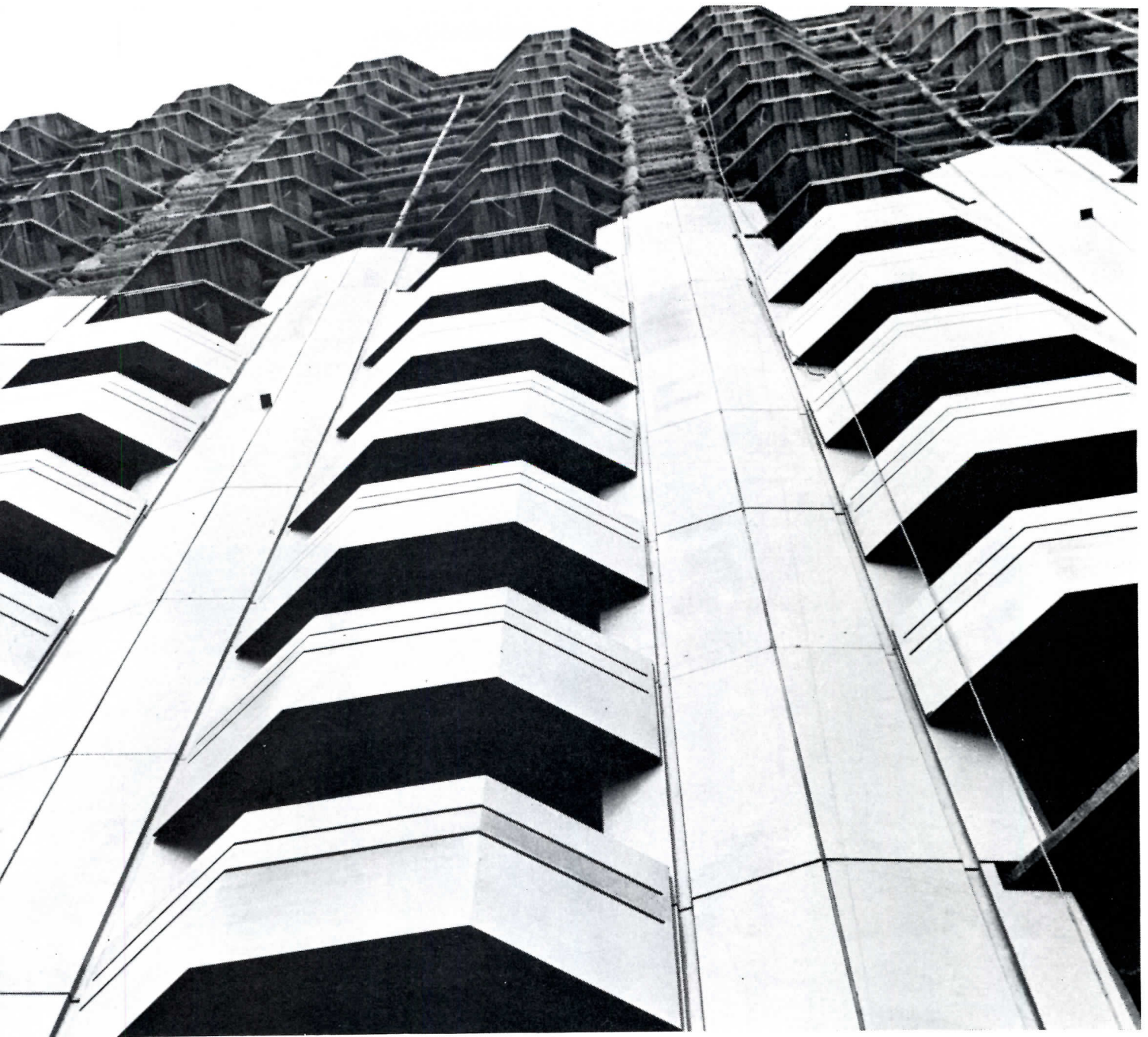

ULTRA-THIN CONCRETE PANELS ACHIEVE REQUISITE STRENGTH WITH SPECIALLY DEVELOPED GLASS-FIBER REINFORCEMENT

Thin-skinned panels of concrete—an apparent contradiction in terms—have become a reality through the use of alkali-resistant glass fibers in place of conventional steel reinforcement. Glass fibers spread throughout a mix of sand and portland cement give fiberglass reinforced concrete (FRC) tensile and flexural strengths that permit thin walls and intricate surface details not ordinarily possible.

The inherent advantages of these panels—light weight, moldability, speed of fabrication and ease of erection—were exploited in the manufacture and installation of intaglio-patterned balcony panels and alternating vertical panels for the Pacific Mutual Building in San Francisco, shown here, designed by William L. Pereira Associates.

In use in this country for only a few years, mainly in low-rise buildings, FRC panels are now finding application in tall buildings

because of the material's potentialities for both cost savings and architectural expression. Dillingham Construction Co., builder of the Pacific Mutual Building, estimates a saving of 25-30 per cent on the wall system compared with a typical precast design. In addition, the weight of perimeter steel could be reduced by 5 per cent.

Following on the heels of FRC panels for this 19-story high rise in San Francisco will be applications in a 23-story Hyatt Regency hotel in Minneapolis and a 30-story office tower in Dallas. Weight savings was a major factor in the selection of FRC panels for the 30-story Southland Center Tower in Dallas designed by Harwood K. Smith & Partners, Inc. The tower is being built atop a low-rise structure that is part of a 20-year-old hotel-office complex, and the new construction will be supported by foundations already in place.

The special fiberglass reinforcement used in the panels for the Pacific Mutual Building was manufactured by Owens-Corning Fiberglas Corporation and the panels were fabricated by Basalt Rock Company.



WATER-DIVERTING PRODUCT HELPS SEEPAGE PROBLEMS OF FOUNDATION WALLS

A new solution to underground water seepage and damage due to pressure of moisture buildup in soil resting against a basement or retaining wall is a water-diverting product called *Enkadrain*. The material is an open nylon mesh backed with a polyester filter fabric (middle left). Arriving sheet-rolled, the material is installed flat with the nylon mesh against a foundation wall. Its design relieves hydrostatic pressure against underground walls by creating an escape route for the water before it contacts waterproofing membranes, providing a channel down and away from the wall. It is intended to be a replacement for gravel, stone or aggregates, and is used in place of protective boards or film to protect waterproofing membranes from damage during backfilling and can also provide filtration for underground drainage pipes and systems.

Two applications are shown—being

installed (photos above) in the new Akzona Inc. headquarters office building in Ashville, North Carolina, designed by I.M. Pei & Partners; and in-place (bottom left) in the solar and underground Remington residence, also in Ashville, designed by Richard Webster. Certain sections of the house are completely wrapped for protection. Installation is efficient at a rate of 30 to 40 square meters per hour; and the material can conform to design details wherever necessary.

One major obstacle for underground structures is, of course, water seepage—often requiring elaborate waterproofing measures and special site drainage systems. The manufacturer claims that wrapping underground sections which have been conventionally waterproofed sheds moisture effectively, as has been demonstrated in European applications.

The practical depth below grade at which *Enkadrain* can be used is 30 feet. In the Remington house, the material is used 10 feet below grade, and in the Akzona Inc. office building it runs 20 feet below grade.



Enkadrain is manufactured by American Enka Co., Enka, North Carolina

Word processing has a positive impact on one firm's production

In typical architectural practice, each set of drawings is accompanied by a written document specifying a number of items including equipment, types of finish, and construction materials. These project manuals are generally prepared from a master data base that is developed over a period of years, and from which paragraphs are drawn, as needed. This is our approach to preparing specifications. Because every project is new, each requires writing a portion of the text from scratch. It is the nature of the business that clients or architects change the scope of the project frequently. As a result, specifications and reports must be rewritten through many edits, and the same 500 pages may be typed as many as four times from initial implementation to final bid documents.

by Mark J. Kalin RA, CSI

To reduce the endless retyping, we used to keep papers in handwritten form until the very last moment. It was cut and paste, producing a document with four layers of tape and four layers of staples. By straining everyone's patience to the hilt, we were able to produce 500 pages a month with this manual system.

When work flow is heavy and you are living with a cumbersome system, there is really no choice but to automate. Our first step in this direction was time-sharing—it seemed clean and easy. All that was required was a terminal in our office and the problems of production were handed over to someone else. We transmitted text to a mainframe computer in New York where it was processed and flown back to us by air courier. Text entered one day was generally in our hands before 9:00 A.M. the next day.

While this arrangement proved far from ideal in the long run, it worked—there is no question that it worked. It showed us what could be done with automated word processing.

The New York service provided very sophisticated programs and competent analysts willing to help us. In our office, we added two operators and a pair of terminals. Together, the operators could perform the work that three or four of our people had been doing manually, and the output nearly doubled. But—pleased as we were—there were still problems with this arrangement. Cost was high; cost per page for computer time never went much below \$1.50. In essence, we were paying \$1.50 per page to have the machine manipulate text—\$1.50 on top of operator expenses. (In total, this arrangement cost \$5,000 per month.)

In my opinion, however, the major prob-

Mr. Kalin is a registered architect and the head of specifications at Brown, Daltas and Associates, Cambridge, Massachusetts.

lem was that it took our operators four months to thoroughly learn the entry codes needed to access and manipulate a document. Each paragraph, for example, would begin with a specific code, unique to the system.

Decisions on a project frequently will be postponed to the last minute for one reason or another but, when they are finally made, everything has to happen almost simultaneously. We purposely delay writing most specifications until project drawings are 80 per cent complete to allow time for selection of equipment and materials. At this point, no more than 30 per cent of the documentation will have been written, yet both drawings and specifications must be bound together in the bid package. It's not hard to see that there is always pressure on the people preparing documentation, and more often than not we find ourselves in a time bind. In view of this, it was critical when the courier's plane failed to arrive in Boston before lunch.

At any rate, the high cost, the difficulty of training operators, and the occasional delays in receiving text from New York, finally added up in our minds to the need for a captive system here in our office. So we set out to find the optimum one for us.

Information storage capacity and expansion potential counted in equipment selection

For more than six months before we placed an order, we looked into various types of word processing equipment. We examined literature from approximately 25 manufacturers and attended seven demonstrations but found that most units did not offer sufficient on-line storage capacity. Our needs mandated efficient handling of documents containing as many as 150 pages. In addition, we had to be able to work on several of these documents simultaneously, so we were seeking a 500-page disk.



Based on our experience with the time-sharing system, we realized that we had to have a video-display screen. With the time-sharing system we had used, it was difficult and expensive to see what text was being entered. When the finished document came back from New York, it wasn't always what we thought we had sent. With a screen, the operator would be immediately aware of what was being keyboarded. We also saw the need for increasing hard disk storage and software updating, without bringing in new hardware. Furthermore, we wanted the capability for additional workstations without necessitating that we add other components such as printers. Therefore, the cost of expansion was to be simply that of a workstation alone, and not a workstation, processor, and printer.

We purchased a Wang Laboratories System 25, Model 1, with 500 pages on hard disk and telecommunications, math, and sort capabilities. To this we added three workstations and two printers—a 40 character-per-second (cps) unit and a high-speed 200-cps matrix printer. Since the Model 1 can accept up to six remote stations, we still have future expansion capabilities. The total cost of this package was equal to eight months of time-sharing costs, including the extra stations and printers, plus such options as telecommunications. (A basic system could be purchased for approximately \$12,000.) Considering what we were spending per month for the former time-sharing service, the payback on this in-house system was rather fast. (*Editor's note*—Brown, Daltas and Associates has about \$8 billion worth of projects in the firm at this time. Projects are often international, large, and may require as many as 12,000 drawings. The Cambridge office writes some 3,000 pages of specifications and other contract documents per month.)

continued on page 20

System virtually eliminates time problems of revising specs throughout design

Preparation of a specification generally begins with a pre-edited document. Having been in business for over two decades—most of the copy we need has been written in one form or another for a previous project. An architect edits a master specification—perhaps adding new paragraphs—and submits the marked-up copy to one of our operators. The operator retrieves the base copy—reading it from one of our 150 storage diskettes onto the system's active disk—then modifies it, producing a brand-new document. The new form is printed and returned to the architect, who may make additional revisions or append data that have developed since the specification was last revised. This procedure is repeated as many times as necessary to produce a final document. On the average, we edit three times, but there have been instances of 12 or 15 rewrites to incorporate late-breaking changes. It is standard practice to make a hard copy of each edited version, and the 200-cps printer pays for itself in fast turnaround, alone.

An operator can move or copy paragraphs from one document into another, or move a paragraph from location to location within a document. Another feature, which is extremely helpful, is a glossary of programs which eliminate many repetitive keyboarding operations. For example, for a client's review, we were able to sift through pages of interiors specifications on a project for just the changes. Otherwise the client would have had to re-read the entire set of specifications to pick out the relevant information.

It is also possible to make changes throughout a text with our system. Last year, before the System 25 was installed, we had a 200-page document with the words "contracting officer" used throughout, and a change to "engineer" was made. The new words did not fit the old space, so many lines were retyped. Then "engineer" was altered to "architect," again a space off, and more retyping was needed. Today with the "search and replace" feature, we can automatically find all the occurrences of any item or phrase in the document and re-format and change it to the correct term throughout, saving both time and tempers.



Besides speeding spec editing, the system can research outside data

While preparing contract documents is our single most important word processing application, it is not the only application. Occasionally we use our system to telecommunicate to New York for recovery of text from our old time-sharing service. In another role, the system provides us access to a variety of data bases throughout the country, such as those at the Library of Congress or the National Technical Information Service (NTIS). We went to the NTIS, for example, to locate sources of colored aggregate in Saudi Arabia, and to the Library of Congress to search for published information on laser cutting of materials. Our staff uses these data bases to keep abreast to technological advances—a must for state-of-the-art firms. It's true that connect time runs \$35 to \$60 an hour for these services, but we believe the cost is economical compared to that of sending a professional staff member to the library or hiring a consultant. For \$14, and in three minutes, we located all current architectural grants and their filing requirements, for the students working in our office.

The math features allow us to give the various disciplines within our office a report on the time it takes to complete work and make revisions. And using the sort system, we inventory alphabetical and numerical master lists of furniture and equipment to ensure, for example, that a specific chair is purchased and eventually installed in its specific space, coordinated with all other installations and accountability requirements.

Since the firm may have \$50,000 riding on each document page, accuracy counts

We can produce 3,000 specification pages per month with our new system, compared to the 900 that could be handled through time-sharing, and just 500 pages when we were producing everything manually. Work time per page has decreased markedly. Documents that used to take three weeks to complete—even with the aid of time-sharing—can now be generated in one.

Next to time savings, our system's biggest contribution is accuracy. Last-minute cost-saving information and adjustments can be efficiently entered into the text. Cost differences between gages of metals and assemblies can be very significant on large projects. Before we automated in-house, if we found an error in a final document, we would have a typist change the hard copy. The time-sharing version was often still in error, and we'd have to remember this when we used it again. Now, when we make a last-minute change, it is a simple matter to revise the master document so that it is always current. We can now print a page or a whole specification and be certain that the final and stored copies are identical.

The additional bonus of the word processing system is the way in which the professionals in the office and the operators find new applications. Terminals may be placed remotely from the word processor master unit, and many operators are self-taught because the system is highly human-engineered. As the office evolves, so does the system.

EDITORIAL

The manufacturers and suppliers: Let's not forget their role—and risk

The hero of most issues of RECORD is you readers—architects and engineers. But we are reminded, in the months when this Product Reports issue is being researched and produced, of the enormous infusion of new products and materials—and as important, of new ideas—that are offered to design professionals by the manufacturers. And this year, in developing the Round Table on Risk-Taking in Architecture which appeared in our mid-August Engineering for Architecture issue, we were also reminded of the commitments and risks that the manufacturers—like the design professionals—are required to make in the cause of architecture. For they too not only hope for profit and the satisfaction of a job well done, but are subject to the same enormous and growing risks of liability. As was pointed out at the Round Table, it is of course true that the manufacturers involved are drawn almost immediately into any suit involved in a building failure—not just the much-publicized collapses, but the everyday ordinary “troubles” that misjudgments in product application or field installation can cause.

It is also true, as attorney Arthur Kornblut pointed out at the Round Table, that “product liability is far different from the design professional’s liability . . . and in many respects it is much more severe.” While a professional is liable only if he is held negligent, “if there is any injury or loss suffered as a result of a defect in the manufacture of a product, the manufacturer is going to bear it.” And now we are beginning to see some cases that are analyzing the notion of liability for a *design defect* in a manufactured product. Manufacturers may even be liable for failure to “warn of danger or instruct as to use.”

And finally, it is true, as the counsel for one manufacturer pointed out at the Round Table, that “when our products spew out of our plants, we have no idea where they are being used—and this means risk is imposed on us that we don’t even know about. . . .”

What almost everyone at the Round Table agreed on was that there was risk involved for everyone on any building project—and that honest disclosure on all sides is probably the best way to avoid problems. “It is not so much a problem of hanging together,” said Albert Bartosic of Rohm & Haas, “it is a matter of working together with the best available information.”

This issue is one form of that working together. It cannot and does not offer detailed technical information—but it does show you the new products and materials that have just or will soon come on the market. And technical information is available at the mailing of a Reader Service Inquiry Card.

How to use this issue

This year, Product Reports is organized as usual on the 16-division UCI format. The page number for each division can be found in the Table of Contents, page 3, and more information on any product or service in this issue can be easily obtained by using the Reader Service Inquiry Cards on pages 9 and 10. There are circle numbers for more information on the products in any advertisement, and for more information on any product or literature item in the editorial pages you simply need write in the number of the item in boxes provided on the Reader Service Cards. An index to manufacturers whose products appear editorially may be found on page 5, while advertisers in this issue are indexed on page 4.

May you find in this issue 100 solutions to your problems and 100 fresh ideas you can use. . . .

—Walter F. Wagner, Jr.

Press-on letters are now obsolete.



No waiting or processing. KroyType lettering is ready for use by simply removing the firm backing.



The adhesive backed tape is incredibly easy to position. And reposition. Sticks to any surface.

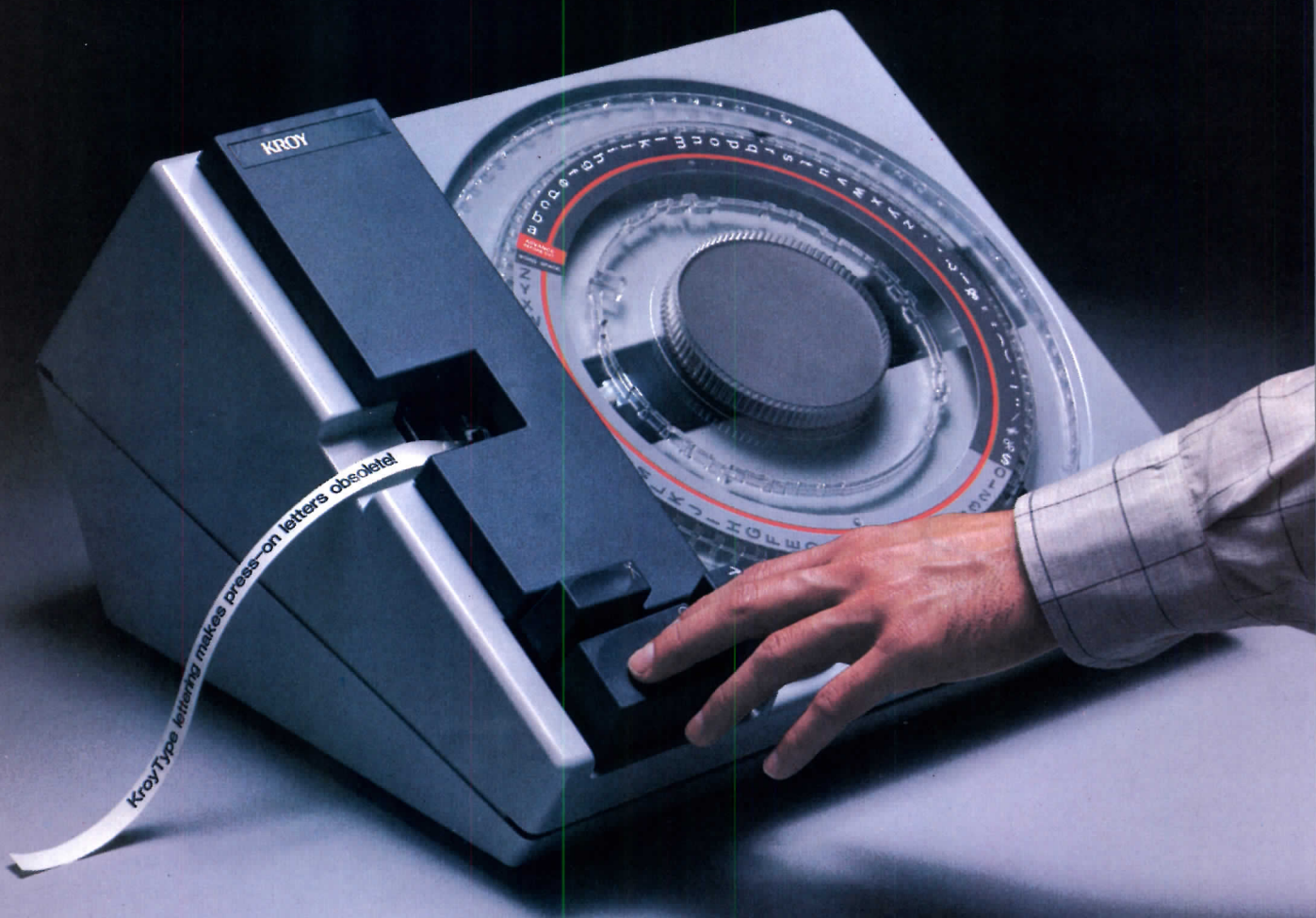

The KroyType 80™ Automatic Lettering Machine.

It's the technological breakthrough that's actually making press-on letters obsolete.

It's easy to use. Just spin the typedisc and photoready letters are automatically and

precisely printed. Alignment and spacing are always perfect. And KroyType™ lettering is produced on a transparent tape that is adhesive backed for easy positioning. And, repositioning.

The KroyType 80 Lettering Machine. Five times faster than press-on letters. Saves time. Saves money. Makes press-on letters obsolete. For more information... or, for the machine itself, (only \$645) call Toll Free:

(800) 328-1306

KROY Kroy Industries Inc./Graphics Division
1728 Gervais Ave./St. Paul, Minnesota 55109
(In Minnesota, call 612 770-7000)

KroyType 80™ and KroyType™ are trademarks of Kroy Industries Inc. for the incredible new lettering system that makes press-on letters obsolete.

For complete information, fill out and send this coupon to the address below:

Name _____

Company Name _____

Address _____

City _____ State _____ Zip _____

Title _____

Phone _____

uci 1

office supplies and equipment

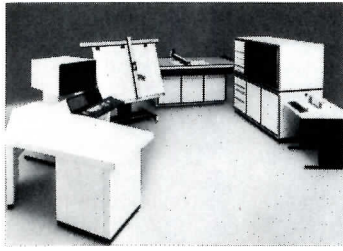

1

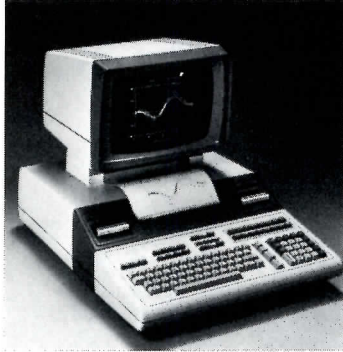

2



3

COMPUTERS

1 COMPUTER GRAPHICS / The GS-2000 software for the company's AD/380 automated design and drafting system provides architects and engineers with a wide range of geometric design capabilities. / Auto-Trol Technology Corp.

2 DESKTOP COMPUTER / New developments to the HP System 45 Desktop Computer include an increase in maximum main memory, a reduction in cost of adding memory, changes in the operating system to speed and simplify use, and new availability of "nationalized" keyboards. / Hewlett-Packard Co.

INFORMATION SYSTEMS

3 VISUAL DISPLAYS / The Abodia Visual Series is designed to view slide collections, but locking plexiglass doors prevent damage to masters. One model holds 3,000 slides per drawer; drawers can be ordered as needed to fit into pre-drilled holes in the base. The base will hold up to 65,000 slides. / Elden Enterprises, Inc.

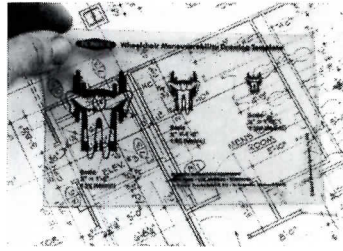

4



5

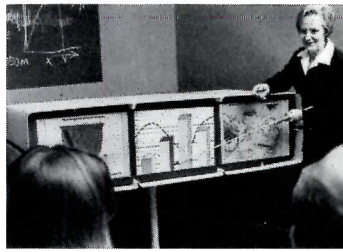

6

4 DRAWING TEMPLATE / Specifically designed drawing template for wheelchair maneuverability offers three plan views in three different scales. Printed on clear plastic, the 4-by-6-in. template can be placed over drawings to check the space clearance. / Bobrick Washroom Equipment, Inc. GB*

5 STOCK SLIDES / A Stock Caption Slide Library is available to assist the audiovisual communicator in presenting a variety of graphic work. A total of 510 captions contains key words, numbers and phrases of business, promotion, training and education. / Wilson/Lund

MAINTENANCE/ OPERATIONAL EQUIPMENT

6 REAR PROJECTION / The three screens of the Space Scan 3000 accommodate both carousel-type slide and Super 8 projectors. Synchronization of program is possible with combined film footage soundtrack and slides; built-in stereo speakers are also included. / Rappaport Exhibits, Inc.



7

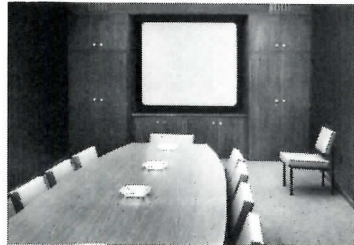

8



9

7 PLOTTING SYSTEM / A remote electrostatic plotting system with job entry capabilities is called the Remote Spooling Vector Processor. It offers a plot compression algorithm that reduces data communications time. / Versatec, A Xerox Co.

8 PROJECTION SCREEN / A permanent or semi-permanent installation of a wall-mounted front or rear projection screen has been simplified. The frames are custom built of 1-in. square, hard alloy structural aluminum tubing; all hardware is concealed. / Da-Lite Screen Co. Inc.

9 CALCULATORS / Eleven new calculators were recently introduced. The PW-80 Pocket Watch shown is an eight-digit, four-function LCD horizontal card-type calculator. It features an independent memory, a per cent key, a timer with two alarms and a stop-watch. / Casio.

COMPUTERS
INFORMATION SYSTEMS
MAINTENANCE/OPERATIONAL
EQUIPMENT
OFFICE MACHINES
OFFICE SUPPLIES
REPRODUCTION EQUIPMENT

*In 1980 Sweet's Catalog File (s): General Building (GB); Light Residential Construction (LR); Engineering (E); Interiors (I); Industrial Construction & Renovation (ICR).



10



13

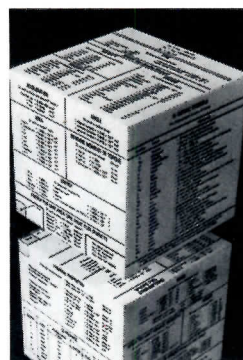

16



19



11

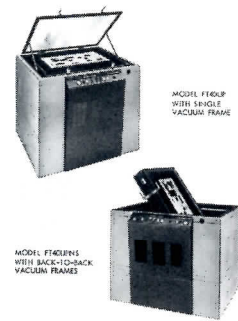

14

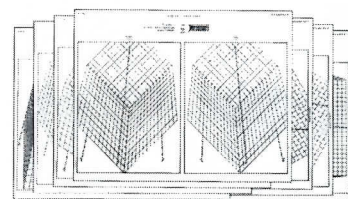

17



20

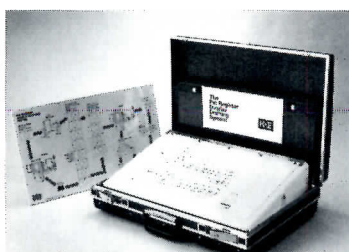

12



15

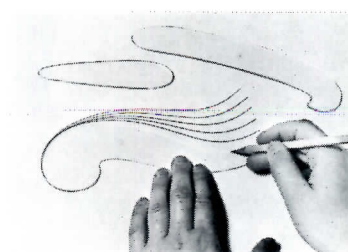

18

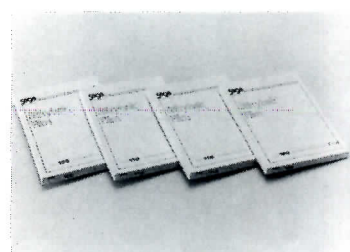

21

10 ROTATING DRAWING BOARD / The Rotobord II Drawing Board has a rotating board so that drawing is always in the horizontal plane without shadows. A special space mechanism features a micrometer for scaling off precise distances. / Zi-Tech Division, Aikenwood Corp.

11 SWINGING PANELS / Large maps, charts or drawings can be stored conveniently, yet remain handy, for reference and viewing at eye level. The Multiplex units are available with 10 or 20 panels. / Multiplex Display Fixture Co.

OFFICE MACHINES

12 PIN-DRAFTING / Pin Registered Overlay Drafting—an applied method of producing a variety of architectural drawings with a minimum of repetition through the use of specific graphics and photo reproduction is available with a full range of equipment. / Keuffel & Esser Co.

13 SPECIAL PRINTER / The Xerox 2080 Printer is a large document printer featuring a zoom lens optical system to create prints directly from original engineering drawings in any image sizes ranging from less than half of the original size to nearly 50 per cent larger. / Xerox Corp. E*

14 OVERLAY DRAFTING / A line of exposing units for overlay drafting are self-contained with metal halide light source in the base and vacuum frame top. The Flip/Top configuration allows as many as six overlays and exposure of all simultaneously. / nuArc Company, Inc.

OFFICE SUPPLIES

15 MEASURING INSTRUMENT / The *Opto-Scale* Precision Glass Measuring Instrument is specially designed for use in a wide range of linear scaling and measuring applications, from PC artworks and boards to photogrammetry. / Bishop Graphics.

16 METRIC REFERENCE / The *Metri-cube* was designed by an engineer for those who need ready reference to the Standard International Metric of Units. A desk-top, plastic cube one liter in volume provides metric data on thermal properties, angle, torque, energy, linear measurement, etc. Price: \$4.50 each, post paid. / MetriCube.

17 PHANTOGRAM CHARTS / Phantogram Perspective Charts guide the construction of three-dimensionally perceivable desk-top images. A variety of sets are available. / GraphiCraft.

18 DRAWING AID / The expanded line of drawing aids includes three French curves. This is fabricated of heavy-gauge clear plastic and guaranteed flat. / The C-Thru Ruler Co.

REPRODUCTION EQUIPMENT

19 DRAFTING SUPPLIES / A large variety of regularly used drafting supplies is available. A catalog is also offered. / Saga, Division of Dade, Inc.

20 PAPER COPIER / The new A.B. Dick 980 copier is a compact-sized plain paper copier that is operated by a micro-computer chip. The machine weighs 100 lb, and can turn out 8½-by-11-in. copies at the rate of 11 per minute. / A.B. Dick Co.

21 DRAWING AID / Four types of polyester films, called *Stikybak*, are available, onto which black ink drawing or lettering can be applied and then reproduced on any copier to save time redrawing standard or common features. / Saga, Division of Dade, Inc.

site work

uci 2



34

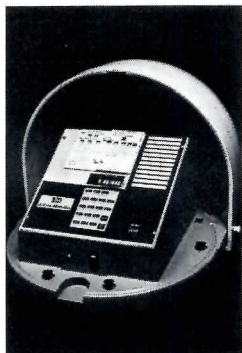

35



36

FENCES & GATES

34 VINYL COATED FENCE / Offered on both security and recreational diamond mesh fence products, the *PermaGreen* process deposits a 7-mil coating of pvc, applied by the fusion method, over a core of zinc galvanized steel wire. Coating colors are "Woodland Green" or black. / Anchor Fence Div., Anchor Post Products Inc. GB, ICR*

IRRIGATION SYSTEMS

35 IRRIGATION CONTROLLER / Available in 12- and 24-station models, the "KCS" keyboard irrigation controller uses solid-state microprocessor technology to provide numerous timing, scheduling and reliability features. / Johns-Manville Buckner Irrigation Systems.

LANDSCAPING

36 TREE GRATES / Decorative cast-iron grates protect trees in landscaped paved areas and street applications. There are over 60 standard shapes, sizes and designs; custom grates may be ordered. / Neenah Foundry Co.



37

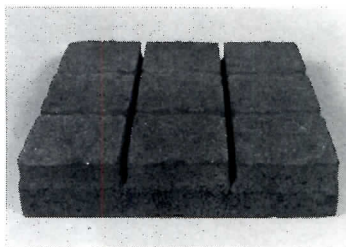

38



39

37 STEEL GUARDS / For use in conjunction with grates, tree guards add protection for the tree as well as being decorative. Five standard styles are offered in fabricated steel; custom designs are available. / Neenah Foundry Co.

PAVING & SURFACES

38 CEMENT PAVERS / Formed from a special concrete mix, *Kobl-Stone* pavers are sand-set with hand-tight joints to produce an authentic cobblestone surface for pedestrian and vehicular traffic areas. Each stone weighs about 25 lb, and has a grooved texture that forms a pattern of nine equidistant squares. Gray, red, black and brown colors are offered in the 12- by 12- by 2 3/8-in. pavers. / Wausau Tile.

SITE FURNISHINGS

39 CONTOURED BENCH / The *Corbel* bench has a contoured seat for comfort, constructed of solid wood rail fastened to steel plates. Redwood version of the bench is suitable for both indoor and outdoor use. / Landscape Forms, Inc. GB, I*



40

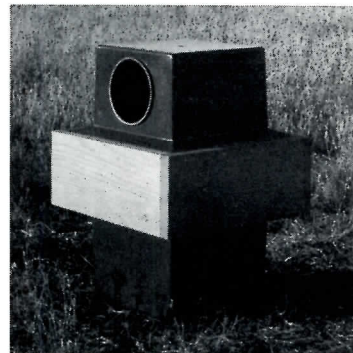

41



42

40 PLANT TUBS / "RO-Kay" planters hold 4-, 5- or 7-gal containers; a ridge molded into the bottom supports smaller pots and allows for drainage. Reinforced fiberglass tubs measure 14 1/2-in. high; exterior is textured to simulate clay and comes in six colors. Unit price: \$13.00. / Molded Fiber Glass Tray Co.

41 LITTER RECEPTACLES / Solid stock red oak is used to center the design of the "Promenade" fiberglass receptacle. Two opposing openings are set in the side of the 28-in.-high unit; removable top allows easy access to galvanized steel liners for emptying. / Landscape Forms, Inc. GB, I*

42 SITE FURNITURE / *Promenade* tables and seats are available in redwood for exterior use and oak for interior applications. Inserts are fiberglass in any of 12 colors and two textures; a slatted wood top is also offered. Table measures 30-in. high by 51-in. sq; seats are 17-in. high by 23-in. sq. / Landscape Forms, Inc. GB, I*

FENCES & GATES
IRRIGATION SYSTEMS
LANDSCAPING
PAVING & SURFACING
SITE FURNISHINGS

*In 1980 Sweet's Catalog File (s): General Building (GB); Light Residential Construction (LR); Engineering (E); Interiors (I); Industrial Construction & Renovation (ICR).

**this publication
is available in
microform**

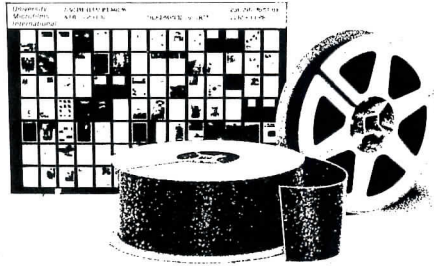

Please send me additional information.

University Microfilms International

300 North Zeeb Road
Dept. P.R.
Ann Arbor, MI 48106
U.S.A.

18 Bedford Row
Dept. P.R.
London, WC1R 4EJ
England

Name _____
Institution _____
Street _____
City _____
State _____ Zip _____



15,000 DESIGNS

Neenah's iron construction castings serve the industry with over 15,000 design variations, meeting many local, state and federal standards.

A 10,000 ton inventory is available at Neenah and 7 distribution centers.

Time-proven construction castings backed by reliable technical information and continuing research has earned Neenah a reputation for excellent quality and product reliability.

Neenah is... more than a foundry.



Box 729 Neenah, WI 54956 (414) 725-7000
Write or call for free catalog "R"

Circle 1004 on inquiry card

OFFICE LITERATURE

OFFICE SUPPLIES & EQUIPMENT: UCI 1

3000 SOFTWARE SUMMARY / Outlines Hewlett-Packard's System 45B desktop computer and software library. The 45B System was developed for structural engineers to aid in working through design problems requiring tedious mathematical computations. / Hewlett-Packard.

3001 DRAFTING PRODUCTS / A complete and wide range of drafting and design products is available in a 272-page catalog. Contains everything from drafting vellum and film to flat files and transfer lettering. Upon request for \$2.00 from Charrette Corporation, 31 Olympia Avenue, Woburn, Massachusetts 01888.

3002 PLAN STORAGE / A 33-page brochure lists the wide assortment of storage options being offered to ensure safety and organization of plans. Covers vertical and rolled filing of all sheet graphics, drawing and drafting tables, and specialized files for the storage and display of valuable original drawings. / Plan Hold Corp.

SITE WORK: UCI 2

3003 CONSTRUCTION CHEMICALS / A comprehensive catalog which lists a variety of products that have successfully improved finished concrete. Includes listings and applications for concrete cure, sealer, floor treatment, grouts and patch compounds, waterproofing and damproofing products, form treatments, and masonry products. Illustrated and organized as to product use, description, benefits, application, coverage, and packaging. / L & M Construction Chemicals.

3004 INDUSTRIAL FENCING / Full-line catalog describes the basic components of chain link fencing for industrial and commercial security applications, and illustrates the fence fabric choices available. Gates, operators, and special products such as windscreens and picket railings are included. / Anchor Fence.

3005 ENGINEERING COURSES / Two programs designed for geotechnical, consulting, and mining engineers plus soil scientists and geologists. Ninety 30-minute color videotapes for engineers and soil mechanics concerned with permafrost regions. Includes supplemental textbooks and study guides. Program is sponsored by Colorado State University's Engineering Renewal and Growth Program. / Colorado State University.

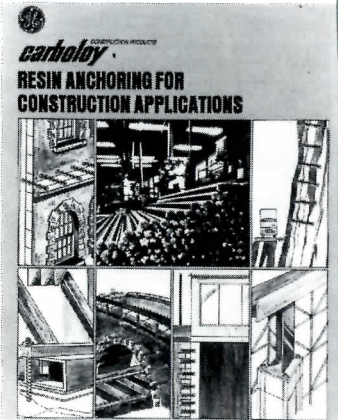

3006 RESIN ANCHORING / A six-page brochure discussing Carboloy resin anchoring applications for the construction industry. This brochure gives a detailed description of the Carboloy system, including installation procedures, anchorage strength, volume requirements, mixing time, storage, as well as safety practices and precautions. / General Electric.

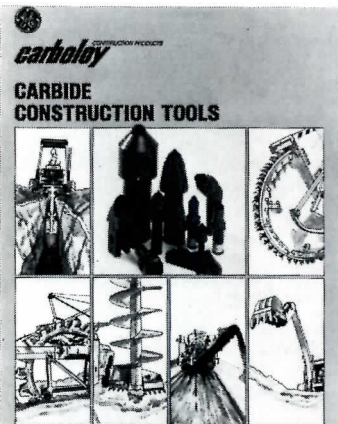

3007 CARBIDE TOOL BITS / A new brochure describing Carboloy cemented carbide construction tools and accessories. Presents detailed information including drawings, photographs, and technical data explaining each tool. The brochure also provides guidelines for achieving maximum tool life under severe operating conditions. / General Electric.

3008 ASTROTURF / Case study method of illustrating successful high school applications of AstroTurf. Brochure lists the advantages of synthetic turf, as a multipurpose, low maintenance solution to the problem of today's rising athletic and recreational demand. / Monsanto.

3009 CYCLONE FENCES / U.S. Steel brochure describes the applications and options of cyclone fencing. Markets, specifications, finish options, and special security and design aspects are covered. / U.S. Steel. GB, ICR, E*

more literature on page 36

uci 3 concrete



55

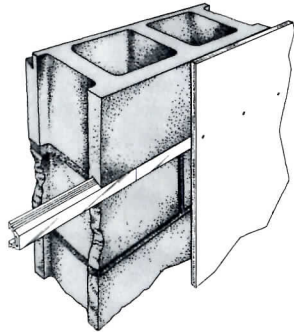

56



57

CEMENTITIOUS DECKS

55 INSULATED PANELS / New thicknesses have been added to the *Petri-Cal Urethane* line of insulated roof deck panels. The structural cement fiber substrate is bonded to a urethane foam core to provide a roof deck with a U-factor as low as .05. The deck is topped with a textured asphaltic felt surface. / Cornell Corp. GB*

CONCRETE ACCESSORIES

56 CONCRETE BLOCK DEVICE / A new way to furr a concrete block wall has been designed that uses a patented plastic trapezoidal strip placed into any standard size concrete block available from a local block manufacturer. / Redy-Furd Systems. GB*

57 CONCRETE EMBOSSING / Lightweight (10-15 lb) aluminum stamping tools enable one workman to emboss 2,000 sq ft of concrete a day. Interlocking system makes the tool easy to handle and align patterns for drives, walkways, patios, etc. Tile, brick and cobblestone patterns are available. / International Design Systems Ltd.

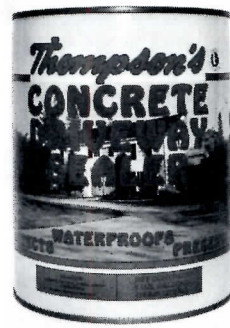

58

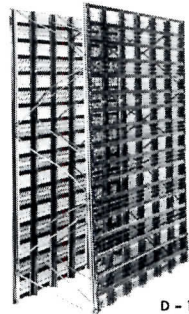

59



60

58 CONCRETE SEALER / Formulated for use on concrete driveways, and walks, sealer prevents surface water penetration and protects concrete from salt, calcium chloride and other snow melters. It also helps prevent flaking of surface from freeze-thaw action and minimizes dusting of concrete. / E.A. Thompson Co., Inc.

CONCRETE FORMWORK

59 LEAVE-IN-PLACE FORM / Constructed of two skins of metal lath separated by a steel truss system, *RedForm* one-use concrete forms allow easy installation of re-bar, sleeves, conduit and electric boxes. *RedForm* units are pre-fabricated for haunches, brick ledges and keyways, in 2-ft widths up to 40 ft in length. / ITI Inc.

60 ONE-USE METAL FORMS / The *Sure-Form* column and beam system is a labor-saving method for installing reinforced concrete framing. Shop-fabricated leave-on metal forms, reinforcing steel and other inserts are made to order, requiring only erection, bracing and concreting on job site. / Dayton Sure-Form, Inc.



61

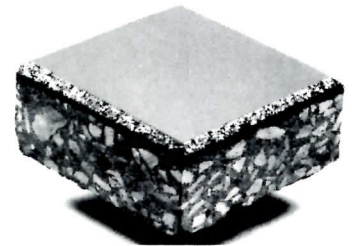

62



63

61 COLUMN FORMS / One-piece, molded fiberglass round column forms require minimal handling and set-up time, and are said to provide excellent finish appearance in the concrete. Forms, for rent or sale, are offered in sizes 12- to 63-in. in diameter by any desired length. / Molded Fiber Glass Concrete Forms Co.

CONCRETE MATERIALS

62 CONCRETE FLOORS / A full line of concrete products for industrial flooring systems includes monolithic *Anvil-Top 200* heavy-duty metallic floor surface and several dry application natural aggregate hardeners for lighter-use applications such as schools, malls and sidewalks. / Master Builders. GB*

63 EPOXY GROUT / Especially formulated for high impact and loading requirements, *Por-Rok* epoxy grout is suitable for most general applications, including engines, compressors, columns, anchor bolts, base plates, etc. The grout is chemical-, solvent- and oil-resistant. / Hallemite. ICR, E*

masonry uci 4



76



77

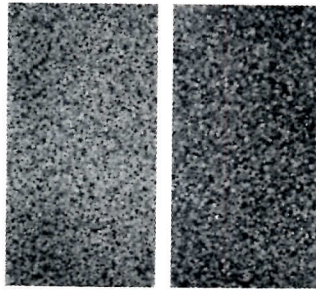

78

SIMULATED MASONRY

76 STUCCO-LOOK SIDING / Said to have an authentic, etched stucco texture, "Adobe" hardboard panel siding comes in 4- by 8- and 4- by 9-ft panels with shiplap edge. Colors are primed or prefinished solid ivory white and prefinished ivory shadowtone. / Weyerhaeuser Co.

STONE

77 STONE PANELS / While used primarily for exterior walls, natural stone panels can be used on interior applications as in this ceiling of regular Monterey Sand panels offering a textured pattern. / Sanspray Corp.

78 GLAZED MASONRY / A new facing, *Spectra-Glaze* incorporates blends of ceramic particles to create a satin texture in earth-tone hues and natural colors. / The Burns & Russell Company.



79

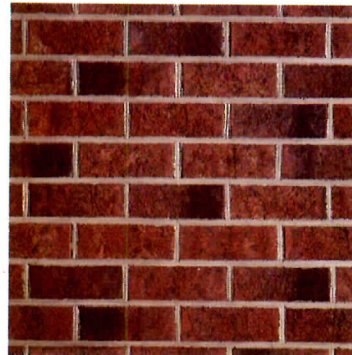

80



81

UNIT MASONRY

79 WALL BRICK / A German-made product for interiors, these "Hand-form" brick units are actual fired brick in two colors and textures. They have a handmade look because they are made in hand type molds. / Roben Tile.

80 FACE BRICK / Northampton 3004 face brick is made in standard size as well as oversize for large commercial and residential projects. / Triangle Brick.

81 PRE-FINISHED STONE SIDING / The stone, offered in nine natural colors, is bonded to plywood or mineral fiber board substrates. "Regular" panels weigh 1.8 lb per sq ft. / Sanspray Corp.

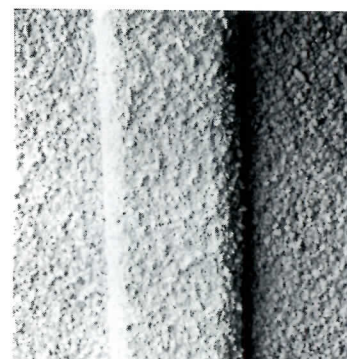

82

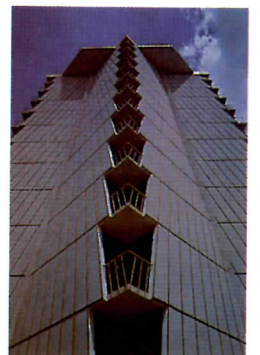

83



84

82 MATCHING STONE BATTENS / Stone coated battens are now available, called *Sanbatts*. They are made from beveled 1/2 by 3-in. exterior plywood, and designed for efficient installation and to enhance appearance at the joint, hiding nailheads and caulk bead. / Sanspray Corp.

83 STONE COATED BOARD / Stone coated mineral 1/4-in. mineral fiber board is shown here on dorms. The pre-finished panels are also available with plywood substrates in nine colors and four textures. / Sanspray Corp.

84 REINFORCED BRICK PANELS / Often used in restorations, these brick panels are made from 60 per cent crushed stone and reinforced with fiberglass. They can be nailed over most regular surfaces; and are washable. / Marlite Division, Masonite Corp.

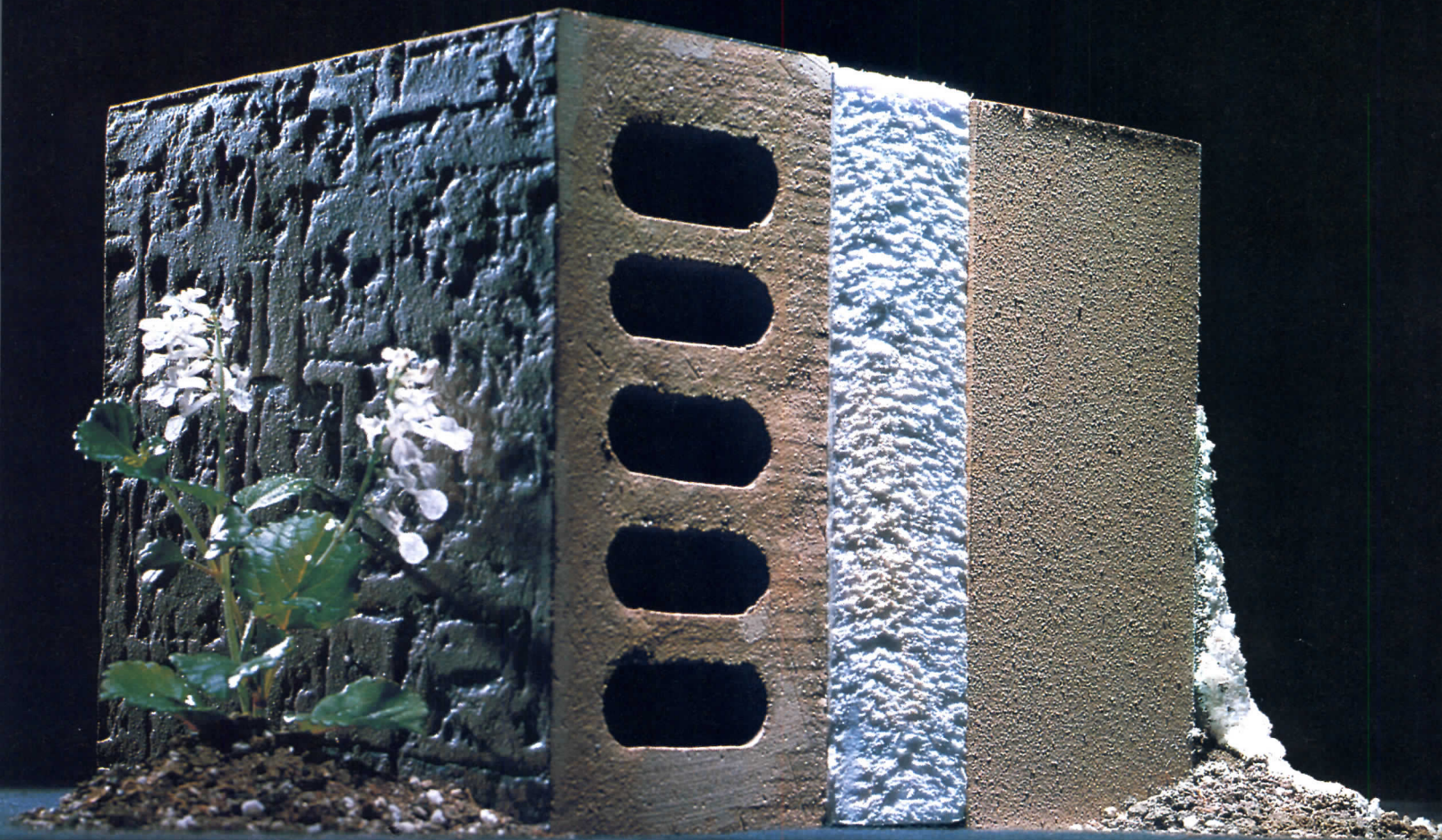

Stark Structural Tile allows for superior climate control designs.
Its capacity insulation reduces HVAC costs.

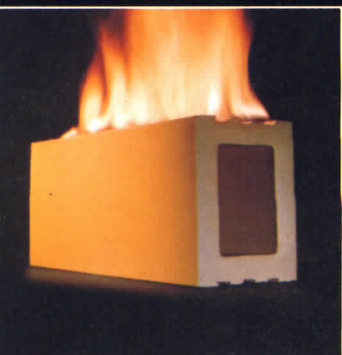

Fire protection
Zero flame spread
Zero fuel contribution
Zero smoke density



Impervious surface
Fired on hard-as-glass finish

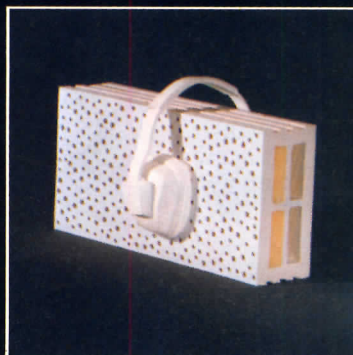

Sound control
STC rating: 46
NRC rating: .55 to .60

Circle 1007 on inquiry card



Stark Ceramics, Inc.
P.O. Box 8880
Canton, OH 44711

Call toll free 1-800-321-0662
(In Ohio, call collect 216-488-1211)

Stark Structural Tile is:
Glazed Facing Tile
Acoustical Tile
Textured Tile
Textured Acoustical Tile
... also utility and lustre
finish utility brick and
High Brick.

3010 EROSION CONTROL NETTING / A small pamphlet outlining applications, advantages, and specifications of Conwed's black plastic net, used for controlling wind and water erosion. / Conwed.

3011 PLANNING PARKING AREAS / A concise guide giving illustrated instructions on how to lay out a parking lot. Scaled templates are provided for drawing varying angles. Includes layout drawings for entry and exit control systems and dimensions for ramp and driveway design. Copies may be obtained for \$3.00 through Federal Signal Corp., 291 Frontage Road, Hinsdale, Illinois 60521.

3012 WOOD FOUNDATIONS / Eight-page pamphlet provides a detailed explanation of the all-weather wood foundation used in both full basement and crawl space construction as well as accounts of the Plen-Wood home heating and cooling system and the use of plywood in concrete forming. / American Plywood Association.

3013 TREE GRATES / A 24-page catalog detailing cast iron tree grates. Photographs and drawings illustrate 67 different sizes and designs—in square, round, oval, rectangular, hexagonal and octagonal styles. Special custom designs also available. / Neenah Foundry Company. GB*

CONCRETE: UCI 3

3014 COLUMN FORMS / Individual product report on one-piece column forms. Contains information on the effectiveness and economy of fiberglass forms and data on sizes available and maximum lateral pressure and rate of pour. / Molded Fiber Glass.

3015 HI-FLO GROUT / Information on a new grout to meet applications requiring high-flowability for complete fill-out of tight spaces between structures of machinery and foundations. Includes guidelines for preparation and application. / Sauereisen Cements Co.

3016 CONCRETE FORMWORK / Illustrated catalog describes complete concrete forming services for poured-in-place reinforced concrete buildings. Shows design opportunities for one-way joist construction and covers additional forming services including beam, slab, wall, and column forming. / Ceco Corporation. GB*

3017 CONCRETE INHIBITOR / A new brochure introduces the latest admixture from W.R. Grace, Darex Corrosion Inhibitor. Contains information on why corrosion occurs and how it can be effectively inhibited in bridges, parking lots, and roads. / W.R. Grace & Co.

MASONRY: UCI 4

3018 EFFICIENT FIREPLACES / A step-by-step construction procedure manual and general information pamphlet are offered by the Brick Institute on the "Brick-o-lator." This specially built fireplace is designed to combine the basic principles of a fireplace with those of a forced air furnace. / Brick Association of North Carolina.

3019 MODEL BRICK HOUSE / A four-page color folder of a Texas house built by the Brick Institute and *Southern Living* magazine. The house was built as an example of cost effectiveness, maximum space utilization, energy efficiency, and "reflects the best in regional architecture." / Brick Institute of America.

3020 GLAZED FACING TILE / A wide range of brochures is available from Stark ceramics, manufacturer of structural glazed facing tile and structural ceramic wall products. Product literature includes: technical manual, product guide, shape guide, comparative cost folder, data sheets on water and sewage plants, radiation protection, jumbo utility brick, seismic tile, and glazed tile for prisons and other security areas. A slide presentation is also available. / Stark Ceramics, Inc. GB, ICR*

3021 GLAZED MASONRY UNITS / A color brochure describing and illustrating the advantages and variety of glazed concrete masonry units. Contains information on available sizes, 72 color chart, specifications, test data, and government regulations for sanitary finishes. / The Burns & Russell Co. GB, ICR, CC*

more literature on page 46

Granite.

The best in first impressions.

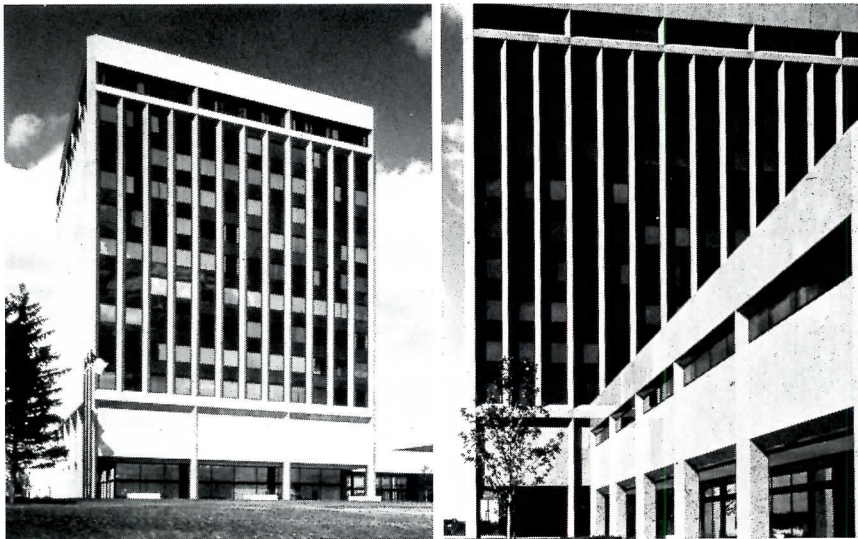

Architect: Graham Anderson Probst & White, Chicago, IL

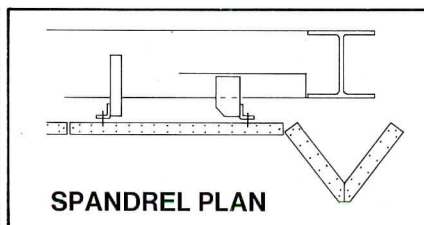
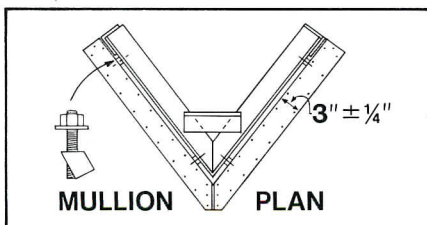

The first impression is the important one. Granite can make that impression *more* vivid than any other building material available. That's why Motorola, Incorporated selected Cold Spring's Texas Pearl for their corporate headquarters in Schaumburg, Illinois.

Granite affords the architect a resource from which he can create a building that reflects an image of quality... a corporate image. For lasting first impressions, specify Cold Spring Granite.

For more information, plus a free copy of our 16-page, full-color catalog showing all 18 Cold Spring colors available, call toll free **800-328-7038**. In Minnesota call (612) 685-3621, or write to the address below.



Cold Spring Granite Company, Dept. AR-10B 202 South 3rd Avenue, Cold Spring, MN 56320

Circle 1008 on inquiry card

uci 5 metals

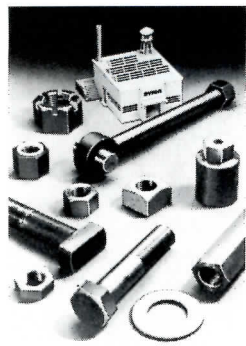

97

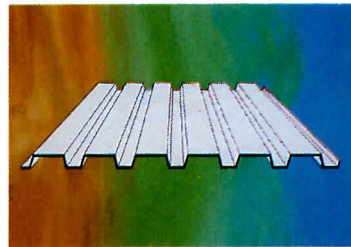

98



99

FASTENERS & SUPPORTS

97 LARGE FASTENERS / New large nuts and bolts for presses, metalworking machinery, injection molding presses, pumps, compressors, generators and turbines are forged for maximum strength and service life. / Jos. Dyson & Sons Inc.

METAL DECKING

98 ROOF DECKS / This company's Types B and F roof decks are now fabricated in 36-in. and 30-in. widths. The advantages of these wider sections are greater coverage, faster installation, fewer sheets to handle and fewer attachments. / Epic Metals Corp. GB*

99 COMPOSITE FLOOR DECK / The *Epicore* Composite Floor Deck allowed the construction of an additional story between existing floors during renovation of the loft-type building shown. *Epicore* dovetail-ribbed configuration requires thinner slabs for any given loading so floors could be added while maintaining necessary ceiling heights. / Epic Metals Corp. GB*

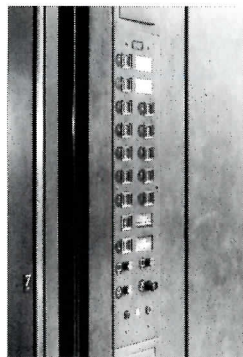

100



101

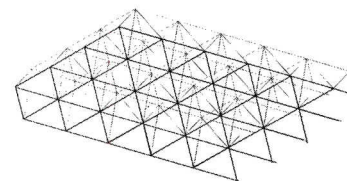

102

METALS & ALLOYS

100 ETCHED METAL PANELS / Hand-etched panels are available in almost any size, laminated to a substrate or unlaminated. Etched brass and pewter has a cigarette-burn and alcohol-proof coating; panels are suitable for wall paneling, counter tops, trim, and such decorative uses as the elevator enclosure shown above. / Harry Lunstead Designs.

STRUCTURAL METAL FRAMING

101 SPACE FRAME / The "Space-Truss" is a computerized modular system designed to span areas up to 100 feet without columnar support. All linear members are round aluminum tubes; any finish may be specified. / Roper IBC International. GB*

102 TRIANGULAR SPACE FRAME / A new 5-ft triangular module has been added to the company's existing 4-ft and 5-ft square modules. / Powerstrut, Van Huffel Tube Corp. GB*

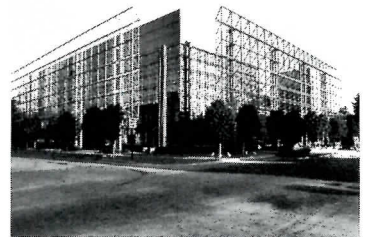

103



104



105

103 VERTICAL SPACE FRAMES / Two vertical "Moduspan" space-frames are shown in an unusual architectural application, the remodeled Indiana Bell Telephone Exchange Building. Both space frames are 35 feet high, one is 115 feet long and the other is 130 feet long. In addition to their decorative function, they serve as supports for climbing plants, which will shade the facades of the building. / Unistrut Corp. GB*

104 BRASS-PLATED SPACE FRAME / The "Meroform" space frame is shown in a clothing department of a shopping center store. The space frame supports four speakers and a sign as well as providing an interesting interior design. The space frame uses standardized pre-engineered construction elements, but permits variability in composition according to available space. / Unistrut Corp. GB*

105 SPACE FRAME / An interior space frame serves as a roof support, and an exterior frame provides a sun screen over a courtyard in this office/laboratory building. The "Mero" frame used was pre-engineered and assembled in place. / Unistrut Corp. GB*



wood and plastics

6



118



119



120

ARCHITECTURAL WOODWORK

118 HARDWOODS / Offered are 1/4-in. thick, UL-fire retardant plywood panels in three classes, using 51 different kinds of woods. / Algoma Hardwoods Inc.

LAMINATED & PROCESSED SHEETS

119 PLASTIC LAMINATE / The existing line of decorative high-pressure laminates has been expanded to include "Vessel Oak." It is a rift cut straight grained oak laminate. / Nevamar Corp.

120 DECORATIVE LAMINATES / For use in kitchens and baths, lighter wood hues so popular today are combined with a resistant surface. / Ralph Wilson Plastics Co.



121

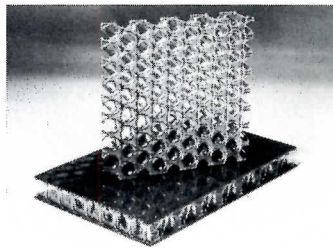

122

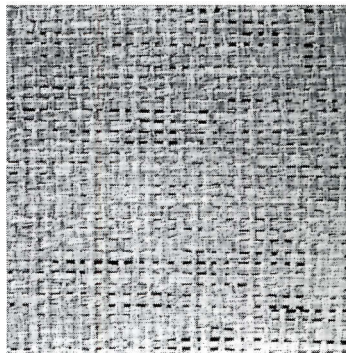

123

121 METALLIC LAMINATES / *Mettle Mica* is a decorative surface material which offers the look of solid metal with anodized aluminum finishes for durability. It can be cut, routed, drilled and machined with standard metalworking equipment. / The October Co., Inc. GB, I*

PLASTIC FABRICATIONS

122 HONEYCOMB / Called *NorCore* this plastic honeycomb material can be used in transparent ceilings, walls, partitions, skylights and geodesic domes. Its features are light weight and strength. / Norfield Corp.

PLASTIC LAMINATES

123 LAMINATE DESIGNS / One of nine new natural reproductions from Series II-Naturals, called *Woven Grass*, has a pattern and color and texture of natural material. / Formica Corp. GB*



124



125



126

124 REINFORCED PLASTIC / *Key-Lite* is a multi-purpose reinforced plastic film for use in cold frame construction; plant, shrub and tree protection; and protective covering for greenhouses and storage buildings. / Keystone Group.

WOOD TREATMENT

125 COATED PARTICLEBOARD / A hot melt polymer coated particleboard reduces moisture absorption and may be applied to underlayment or industrial board for various uses. It also prevents "creeping" or dimensional change in high humidity conditions. / Duraflake Division, Willamette Industries, Inc.

126 FIRE RATED LUMBER / Recognized by national, state and local codes for use in interior or exterior construction, *NCX* lumber has been treated with monomeric resin and cured: fire-retardant properties are unaffected by outdoor weather exposure or high humidity. / Koppers Co., Inc.

ARCHITECTURAL WOODWORK
LAMINATED & PROCESSED SHEETS
PLASTIC FABRICATIONS
PLASTIC LAMINATES
WOOD TREATMENTS

*In 1980 Sweet's Catalog File (s): General Building (GB); Light Residential Construction (LR); Engineering (E); Interiors (I); Industrial Construction & Renovation (ICR).

METALS: UCI 5

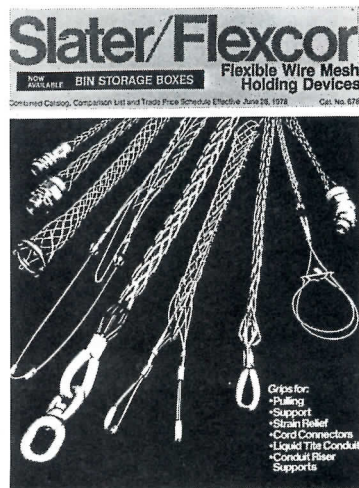

3022 WIRE MESH GRIPS / An expanded 16-page, 2-color catalog on Flexible Wire Mesh Holding Grips for cable support, cable pulling and strain relief for flexible cord cable and liquid-tight conduit. Combined catalog, comparison list and trade price schedule contains information on codes and how to select the proper grip. Also featured is the new packaging concept, "Bin Storage Boxes," for easy storage and use. / Slater Electric Inc.

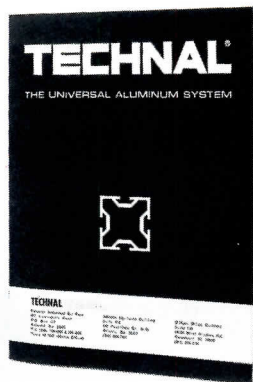

3023 ALUMINUM SYSTEM / Technal of America's new color mini-catalog has information needed to specify Secural Railing and the Universal Aluminum System. Includes illustrated instructions covering simple assembly. Photos show a wide range of applications including partitions, shelving, shopfronts, framing, displays, furniture, showcases, and more. / Technal of America.

3024 TURNTABLE BEARINGS / Product information is available on a new line of space-saving, lightweight turntable bearings which offer substantial capacity/weight and capacity/cost ratios, optimum space utilization and available integral gearing. The "K" series bearings are designed for light- and

medium-duty applications in small cranes, excavators, and in non-precision industrial equipment where rotation is intermittent and at relatively low velocity. / Keene Corporation.

3025 TAMPER-PROOF FASTENING / A four-page catalog details the "Guard-Nut" fastening system. Explains the basic concept, types, applications, and removal of the system; which is available in nut, bolt, and screw configurations. / Guard-Nut.

3026 WHITE BRONZE ALLOY / Data sheet on a proprietary copper base alloy developed for jewelry and art casters to whom it is of particular interest due to its low melting range, and white color. Contains information on casting, stress relieving, soldering and brazing, and forms available. / Belmont Metals Inc.

3027 PEBS GUIDEBOOK / The PEBS Guidebook is a 20-page, color brochure providing information on the facilities and capabilities of Johns-Manville, as well as their line of metal building products. A description, recommended uses, installation, and technical data is supplied for each product. / Johns-Manville Corporation.

3028 STEEL FLOOR DECKS / Epic Metals Corporation has published a 24-page brochure on steel composite floor decks. New technical material includes a stud value chart for composite beam design, a concrete volume chart, a design example, and loading diagrams for bending moments and deflections. Technical tables have been revised. / Epic Metals Corporation. GB*

WOOD AND PLASTICS: UCI 6

3029 PRESSURE-TREATED WOOD / A colorful booklet which contains information on the value of pressure-treated woods. Includes data on types of pressure treatment, uses, advantages, limitations, and the location of 24 facilities that produce and store this company's products. / Koppers Company, Inc.

3030 KITCHEN LAMINATES / Entitled "1979's Most Appealing Kitchens," this colorful 16-page booklet depicts six architectural renderings and floor plan ideas for kitchens using Wilsonart Brand high-pressure laminated plastic. / Wilsonart.

more literature on page 56



CUMBERLAND WOODCRAFT CO., INC.

**Your one source
for Solid Wood
Victorian Millwork**

Take advantage of the rebirth in Victorian elegance with our complete line of interior and exterior designs.

Now you can carry the graceful Victorian look *throughout* your building. New exterior patterns in brackets and spandrels are ideal for entranceways, marquees and under soffits. Inside, select from:

- Brackets
- Medallions
- Grilles
- Privacy Panels
- Fretwork
- Beaded Grilles
- Turnings & Posts
- Raised Panel Wainscoting

All items are available in whatever quantity you need to suit the application. We faithfully reproduce Victorian patterns, some dating back to the turn of the century. Each piece is made from premium grade, solid hardwood.

Our factory direct prices are within most remodeling or new building budgets.

For complete catalog and price list, send \$2.00 to: Cumberland Woodcraft Co., Inc., R.D. 5, Box 452, Carlisle, PA 17013 Phone (717) 243-0063.

◆ Sunnyside Restaurant, Carlisle, PA



Circle 1014 on inquiry card

NEW from Masonite Corporation

An embossed prefinished door facing that has the look of oak, the feel of oak, without the cost of oak.



OakCountry™

A sensationally faithful reproduction of flawless rotary-cut oak, OakCountry has to be seen to be believed. The deep-grained texture is embossed into durable hardboard, making OakCountry 50% denser than natural wood... structurally stronger... dimensionally more stable. Prefinished in light or dark tones on a mar-resistant surface, it won't crack, split, check or splinter. OakCountry will awaken your senses. Even the *economic ones!* Send for a free OakCountry sample and a list of door manufacturers using OakCountry door facings. Write, Masonite Corporation, Door Product Manager, 29 North Wacker Drive, Chicago, Illinois 60606.

Circle 1015 on inquiry card

Masonite is a registered trademark of Masonite Corporation.

*That's the beauty
of Masonite®*
BRAND



They had no reservations.

When evaluating structural systems for Ramada Inns, specifiers across the country found one they could recommend without reservation: Trus Joist.

They selected wood and steel open-web TJI joists for the Inn at Grand Island, Nebraska, and all-wood TJI joists for the Inn at Breezewood, Pennsylvania.

In both cases, Trus Joist systems met or exceeded all criteria for engineering, cost and design.

Trus Joist is the most economical in-place structural system available. And it lends itself to any design from the routine to the innovative. You can select from a series of eight open-web and TJI joists in many profiles, lengths, depths and load-carrying capacities.

Call or write us today. From design to on-site technical assistance, our 150 field technical representatives are at your service. Unreservedly.



The Wood Technology Leader

TRUS JOIST CORPORATION

P.O. Box 60 • Boise, Idaho 83707 • (208) 375-4450

Circle 1016 on inquiry card

thermal and moisture protection

uci 7



139



140

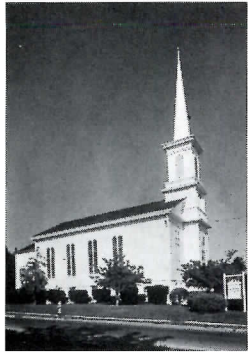

141

CLADDING/SIDING

139 INSULATING FINISHING / Photo illustrates the components of the non-flammable *Sto* system: Portland cement/concrete compound; insulating panel; fiberglass mesh; and final *Stolit* synthetic resin plaster finish. Applied over a block wall, the system has a R-20 insulating value. Elastic qualities of the adhesive and insulation absorb minor substrate movements. / Sto Energy Conservation Inc. GB*

140 EMBOSSED SIDING / The textured, natural look of wood shingles is available in easy-care *Shingl-Wood* aluminum siding, offered in a choice of colors. / Alcan Building Products.

141 CLAPBOARD SIDING / Said to duplicate the appearance of traditional clapboard, smooth "Deluxe" aluminum siding comes in a choice of colors, and is backed by a 30-year warranty. / Alcan Building Products.



142



143



144

142 REDWOOD PLYWOOD / An economical grade of redwood plywood, knot and sapwood textured siding is shown here on a residence designed by architects Ron Glander & Associates. Siding has the high fire and weather resistance of redwood with the strength of plywood. Water repellent can be applied to retain the siding's fresh appearance. / California Redwood Assn.

143 OVERLAID SIDING / Structural "Stucco 316" is a durable, lightweight overlaid plywood with a realistic embossed texture. Finish is a natural cream color or pre-finished "Ice White" acrylic latex stain. "Stucco 316" can be applied directly to studs, and meets building code requirements for racking strength without sheathing. / Simpson Timber Co. LR*

144 BEADED SIDING / "Jamestown" aluminum siding reproduces the groove and beaded drip edge used on wide wood siding of the Colonial era to reduce warping. Standard colors are white, ivory, mist blue, creme, and moss; matching accent trim such as gutters, soffit and fascia are available in "Jamestown" colors. / Reynolds Metals.



145



146



147

145 EXTERIOR CLADDING / Inorganic *Glasweld* panels are offered with accessory and trim packages, facilitating use of this non-metallic enamel coated product in complete exterior cladding and interior finish systems. *Glasweld* components are available in 21 durable colors; prices start at \$1.50/sq ft / Glasweld Products Div., Gll Corp. GB*

146 STONE-LIKE CLADDING / The thin-section design of *Qasal* architectural cladding panels facilitate its use as a rain screen in curtain wall applications. Available up to 5-ft wide by 10-ft long, *Qasal* can be pre-fabricated into large framed wall sections to further reduce costs, which start at \$1.50/sq ft. / Glasweld Products, Div. of Gll Corp. GB*

147 VENEER CLADDING / Panels and accessories in standard widths to 5-ft offer the color permanence of porcelain enamel on steel in economically-installed cladding systems. New colors include light, intermediate and dark bronze; panels in this extended color range are available in stock lengths to 12-ft; prices start at \$2.50/sq ft. / Mirawal Products Div., Gll Corp. GB*

CLADDING/SIDING
COMPOSITE BUILDING PANELS
FLASHING
INSULATION
MEMBRANE ROOFING
METAL ROOFING
PREFORMED WALL & ROOF PANELS
ROOF ACCESSORIES
ROOFING SPECIALTIES
SEALANTS
WATERPROOFING & DAMPPROOFING



148



151

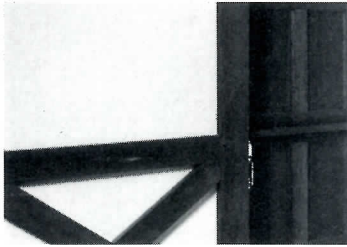

149

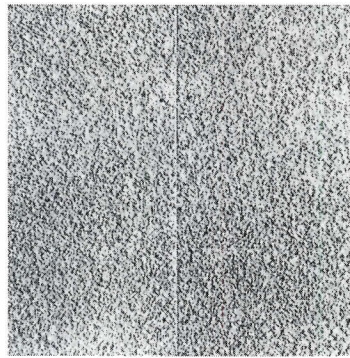

152



150



153

148 MOBILE HOME SIDING / For application on single- and double-wide mobile and modular homes, "Wood-hewn" aluminum siding has the appearance of weathered barnwood. / Reynolds Metals Co.

149 TROWELLED-STUCCO / *Tudor Inn* hardboard panel siding has the look of genuine stucco in 4- by 8- and 4- by 9-ft panels with fitted shiplap edges. Pattern registers panel-to-panel, for use alone, or it may be installed with trim as shown. Siding comes pre-primed or finished in white acrylic. / Boise Cascade.

150 HARDBOARD SIDING / Embossed *Sawtooth Lap* siding has the weathered look of barnboard in horizontal lapboards. Weather-drip edges are reversible; boards measure 9½-in. by 16-ft. "Sawtooth-Lap" comes in three rustic colors of brown, tan and gray, as well as primed. / Boise Cascade.

151 INSULATING SIDING / "Climatic" aluminum siding is insulated with a sprayed-on polyurethane foam that hardens to form a rigid bond to the back of the panel. Siding is available in smooth or woodgrain finish in 12 colors. / Hunter Douglas Inc.

152 SHIPLAP CLADDING / Aggregate coated building panels have a shiplap joint, a thin line between panels, which eliminates the need for moldings or battens and minimizes the use of sealant. One-half-in. plywood substrate allows for 24-in. stud spacing; *Shiplap Sanspray* comes in 4- by 8-ft and 4- by 10-ft panels, in any of 10 colors. / Sanspray Corp. GB, LR*

153 AGGREGATE PANELS / Insulation up to four-in. thick may be laminated to *Sanspray* natural stone panels for use as window spandrels, insert panels, and wall sections. Standard substrates are fiber-reinforced cement or plywood; insulating cores may be styrofoam, polystyrene, urethane or perlite. Ten colors and four textures are available. / Sanspray Corp. GB, LR*

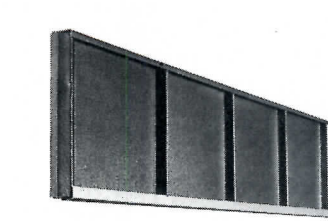

154



155



156

COMPOSITE BUILDING PANELS

154 FASCIA PANELS / Pre-formed panels are 10-ft long and are available in three widths and batten placements. Standard finish choices are dark and medium bronze, black and white acrylic enamel. Panels, heads and sills are pre-punched with nailing slots and weep holes. / W. P. Hickman Co. GB, LR*

155 FRP BUILDING PANEL / The *Tedlar* PVF film finish on *Glasbord* building panels protects them from damaging ultraviolet rays and weathering, making possible a wide variety of exterior architectural applications. The lightweight panels are impact-resistant; graffiti and other soils are easy to remove. / Kemlite Corp. GB*

156 INSULATED CLADDING / *Mirawal* panels combine the color stability of porcelain enamel with high-grade substrates and a choice of insulating cores. Panels are available for direct glazing or for architectural cladding applications. Color options now include light, medium and dark bronze; prices start at \$4.00/ sq ft. / Mirawal Products Div., Gil Corp. GB*

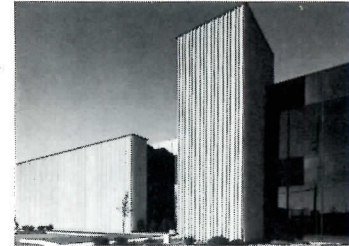

157

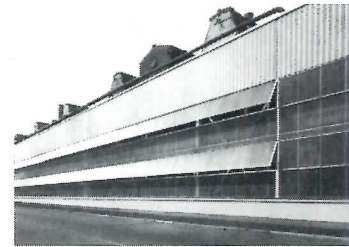

158

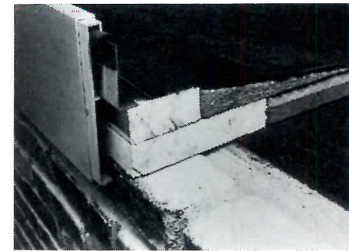

159

157 INSULATED CONCRETE / Machine sculptured finishes in a choice of textures are offered for *Corewall* insulated concrete panels. Various insulating cores provide certified U values as low as .07. / Butler Mfg. Co. ICR*

158 TRANSLUCENT PANELS / *Alsynite/Structoglas* fiberglass reinforced panels have excellent light transmission values, providing diffused glare-free natural light through windows, side-walls and monitor sections. Panels resist breakage, impact, vibration and twist. / Reichhold Chemicals, Inc.

FLASHING

159 ROOF FLASHING / The *Seal Lock* fascia and flashing system is a complete system including outside and inside corners, a scupper unit, foam seal, On-Guard flashing, fascia clip nails and water dam joint tape. The fascia clip and cover plate are made of extruded aluminum, and the water dam is a pre-formed cant strip. / Johns-Manville.



160



163



166

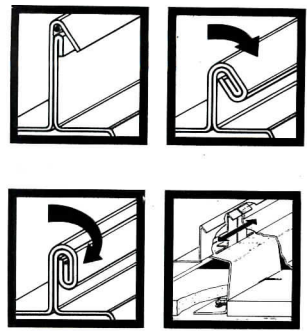

169



161

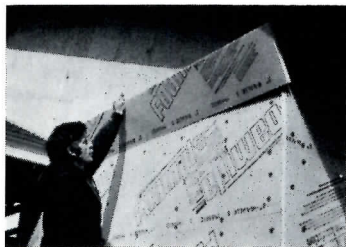

164



167



170

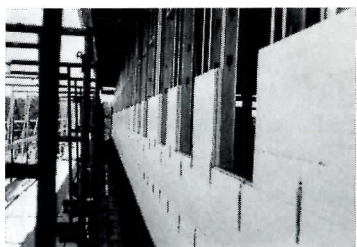

162



165



168



171

160 ROOFING REPAIRS / A neoprene sheet system is now available from this company for repair of defective flashings, gutter linings, and other similar areas subject to movement and water infiltration. Called "Permaflash," it effects a permanent, watertight seal and is not damaged by exposure to natural elements. / Republic Powdered Metals, Inc.

161 SHEET METAL FLASHING / "Econo-zinc" weathers naturally as a solution for gravel stops, flashing, gutters and downspouts. / Ball Metal and Chemical Division. GB*

INSULATION

162 ROOF INSULATION / Water-resistant, insulating *Styrofoam* boards may be laid directly over single-ply sheet membrane roofing. A ballasting layer of crushed stone is placed on top. The *Styrofoam* will protect the membrane from damage caused by ultraviolet light, temperature cycling and physical abuse. / Dow Chemical, U.S.A.

163 PLATE/SILL GASKET / Installed over anchor bolts in sill or masonry wall construction, cellulose fiber blanket is sandwiched between layers of polyethylene. When compressed between masonry and framing at sill or plate, it stops drafts, air leakage and heat loss. "Sill Sealer" also reduces noise transmission when used to seal voids at top, bottom and edges of partition walls. / Conwed Corp.

164 POLYSTYRENE INSULATION / A high-performance (R-19) thermal product, *Foamular* panels can be used for sheathing exterior walls in cavity wall, perimeter and "Z-furring" applications. Water-resistant, panels have tongue-and-groove edges to reduce air infiltration. *Foamular* panels should be installed with 1/2-in.-thick gypsum board on the interior side of the wall. / UC Industries.

165 EXTERIOR INSULATION / The *Settef* exterior wall insulation and finish system is offered in a wide variety of textures and 114 colors. Installations consist of flexible polystyrene insulation board, reinforcing fabric, primer/adhesive, and a waterproof synthetic finish coat. / Compo Industries, Inc. GB, ICR*

166 METAL ROOF INSULATION / A complete interior roof and ceiling insulation/finish system for metal buildings, the *Money Clip* is a supporting extrusion clipped to the bottom flange of the roof purlin, held in place by spring action. This carries an insulating batt, and a composite board that acts as vapor barrier and finished ceiling. / Johns-Manville Corp.

167 RE-ROOF BOARD / A homogeneous board formed of expanded perlite particles, *Fesco* thermal roof insulation covers an existing roof, and acts as a leveling course for the new built-up roof. Board needs no backing, and has UL fire hazard classification as a roofing material with reference to internal and external fire exposure. / Johns-Manville. GB, ICR,E*

MEMBRANE ROOFING

168 MEMBRANE ROOFING / Especially suitable for roofs where the slope is too steep to use aggregate surfacing, *Aluminum KMM* five-layer laminate membrane has a heavy, embossed aluminum top sheet. Field-applied coatings are available in 14 colors. / Koppers Co., Inc. GB*

169 STANDING SEAM ROOF / For regular construction and re-roofing applications, the *MR-24* metal roof features a roll-formed double-lock seam with concealed purling attachments, good insulating properties, provisions to accept heat-cold cycle movement, and a UL Class 90 wind uplift rating. / Butler Mfg. Co., ICR*

METAL ROOFING

170 METAL ROOFING / Galvanized steel or aluminum exterior metal roofing, siding, fascia and wall panels are available pre-coated in "Weathering Copper": pure ground copper particle liquified in an acrylic carrier. Coating weathers from new-penny bright to the distinctive copper patina. / Architectural Engineering Products Co. GB*

171 METAL ROOFING / Prefabricated *Microzinc-70* roofing systems are guaranteed against corrosion-induced leaks for 20 years. Pre-weathered natural patina will not rust or produce runoff stains; scratches or other damage to the surface are self-healing. Metal roof meets FS QQZ100A. / Ball Metal & Chemical Div. GB*



172



173



174

PREFORMED WALL & ROOF PANELS

172 TRANSLUCENT PANELS / Woven-mesh fiberglass cloth provides an extra margin of safety in *Stronglight* skylight roofing panels for metal buildings. Though not designed for foot traffic, 10 jumps by a 215-lb man produced only the minimal damage shown in photo. / Lasco Industries. GB, LR*

173 INSULATING FINISH / Available in four surface textures, including natural aggregate, and 14 standard colors, *Dryvit Outsulation* is an inherently crack-resistant, insulating wall system. / Dryvit System, Inc. GB*

ROOF ACCESSORIES

174 FASCIA/FLASHING / Easy-to-install, *Seal Lock* fascia and flashing provides roof protection and finished edge trim in one system. Installation consists of a water dam, foam seal, *On-Guard* flashing, fascia clips and nails, cover plates, outside and inside corners, scuppers and water dam joint tape. / Johns-Manville Corp. GB*

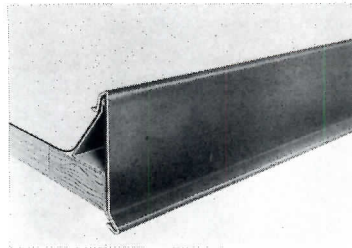

175

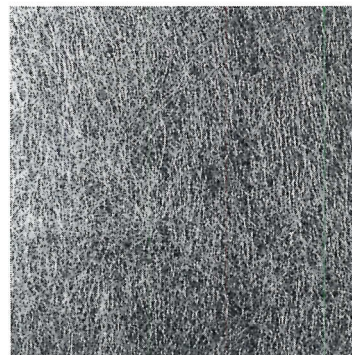

176



177

175 ROOF EDGING / The two-part *Econosnap* edge consists of a galvanized spring clip and snap-on fascia, which hold the single-ply roofing membrane firmly in place. Roof accessory comes in three standard sizes with field-formed corners and eight colors. / W. P. Hickman Co.

ROOFING SPECIALTIES

176 BUILT-UP ROOFING / A non-woven fiber glass mat coated with an asphalt emulsion, *GlassThane* provides a moisture-resistant facing for urethane insulations used in built-up roofing applications. The lightweight mat is said to maintain exceptional dimensional stability. / Johns-Manville.

SEALANTS

177 LOW MODULUS SEALANT / A versatile elastomeric silicone, "795" sealant adheres to most common construction materials without the use of a primer. Its low modulus, high elongation properties allow its use in joints and glazing systems that experience plus/minus 50 per cent movement. / Dow Corning Corp. GB,LR*



178



179



180

178 ROOF REPAIR / Roofing materials supplied in the Wet Surface Roof Repair Kit adhere to wet surfaces at any temperature. Kit contains *Shield-Tite* coating and cement, reinforcing membrane, trowels and brushes. / Randustrial Corp.

179 BUTYL SEALANT / Formulated for non-stringy gunnability with excellent slump resistance, "757" butyl sealant will not harden or lose flexibility, adhesion, or cohesion after prolonged exposure to high or low temperatures and ultraviolet light. Standard colors are white, gray, black, bronze and natural. / Protective Treatments, Inc.

180 CONSTRUCTION SEALANTS / Now manufactured in the U.S., the *Bostik* line includes elastomeric sealants for vertical and horizontal construction; "Polyurethane-plus," one- and two-part types; polysulfide and silicone sealants. One-part compounds are offered in cartridge, pour, and gun-grade formulations. / Bostik Chemical Group.



181



182

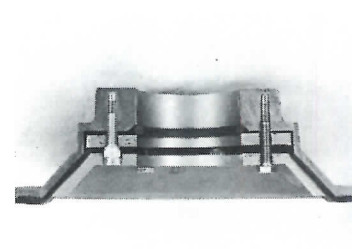

183

WATERPROOFING & DAMPROOFING

181 CORRUGATED ASPHALT / *Onduline* corrugated asphalt sheet can be curved lengthwise to a 15-ft radius to conform to the shape of the structure in roofing and siding applications. Panels meet major codes, and are impact-, chemical- and weather-resistant. NFPA Class C rating. / Onduline USA, Inc. GB*

182 INSULATION COATING / *Scotch-Clad* polyurethane foam roof coating is designed for application over sprayed-in-place urethane foam insulation, protecting it from weather and moisture. With the addition of roofing granules, the coating system meets UL 790 Class A requirement. / 3M.

183 MEMBRANE CLAMP / Special fittings are designed for the long-term sealing of pipe or conduit penetrations through waterproofing membranes. The basic cast-bronze-stainless steel unit is for the sealing of surface or sub-surface membranes exposed to standing water. / Pem Fountain Co.

Zonolite® ROOF DECKS

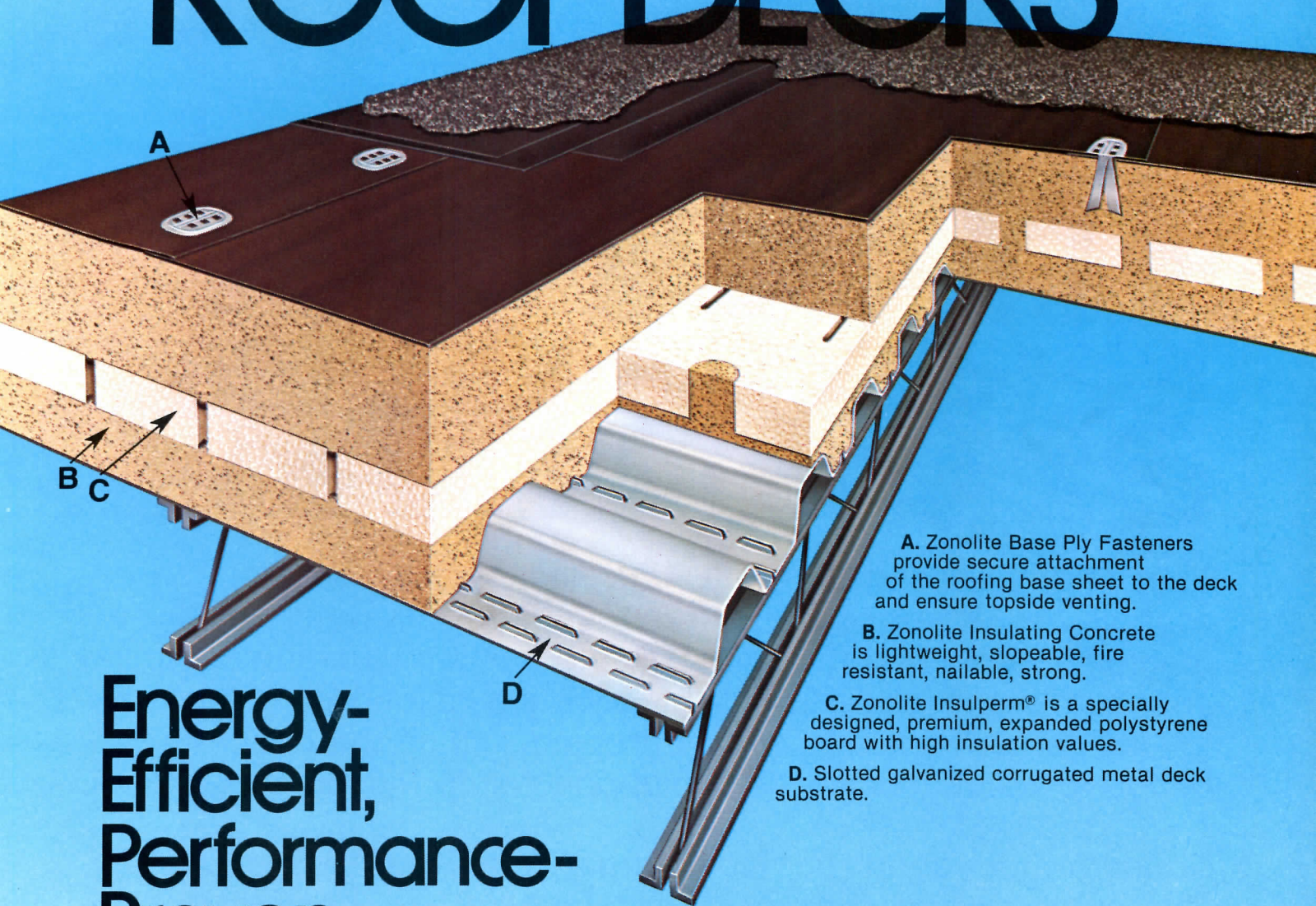

A. Zonolite Base Ply Fasteners provide secure attachment of the roofing base sheet to the deck and ensure topside venting.

B. Zonolite Insulating Concrete is lightweight, slopeable, fire resistant, nailable, strong.

C. Zonolite Insulperm® is a specially designed, premium, expanded polystyrene board with high insulation values.

D. Slotted galvanized corrugated metal deck substrate.

Energy-Efficient, Performance-Proven.

The Zonolite Roof Deck is system-engineered to conserve energy by providing maximum insulation value while serving as an ideal substrate for the roofing membrane. This Zonolite Roof Deck System combines Zonolite Insulating Concrete, Insulperm Insulation Board and the Zonolite Base Ply Fastener. Designed to take advantage of the best characteristics of each of its components, Zonolite Roof Insulation Systems provide optimum in-place benefits to the user. The new Grace Built-up Roofing Warranty provides 10

years of roof top protection with no dollar limit and *single source responsibility* when a Zonolite Roof Deck is the base for an Approved Built-up Roofing Membrane installed by a Grace approved BUR contractor. The strength, wind and fire protection, economy and durability of the easy-to-install Zonolite Roof Deck has been demonstrated by years of efficient performance. Contact your local Zonolite Representative or Construction Products Division, W. R. Grace & Co., Cambridge, MA 02140. In Canada: 294 Clements Rd. West, Ajax, Ontario L1S 3C6. **GRACE**

ROOF LIABILITY ...

THE BUCK STOPS HERE!

That's right. Specify FOAMGLAS® cellular glass insulation, an asphalt, coal tar or single-ply membrane roof from an approved manufacturer and get a Total Roofing System Guarantee. We say your roof won't leak and FOAMGLAS® insulation will retain its full insulation value. If there's a problem during the guarantee period, pass the buck with one phone call to Pittsburgh Corning.

To learn more about our **No Charge, Total Roofing System Guarantee**, call or write Marketing Dept. A109, Pittsburgh Corning Corporation, 800 Presque Isle Drive, Pittsburgh, PA 15239, (412) 327-6100.



Pittsburgh Corning ... over 35 years in the insulation industry ... manufacturers of FOAMGLAS® cellular glass insulation.

Circle 1018 on inquiry card

the Heirloom roof...

ColorKlad[®]



Sheet metal contractor — Zero Breese Co., Cincinnati, Ohio.

**elegance,
quality, durability
far beyond
conventional
roofs!**



Wise architects, discriminating homeowners and buyers are recognizing the unique, lasting values of a roof sheathed in the beauty and permanence of ColorKlad.

A HOME MORE BEAUTIFUL WITH ColorKlad

ColorKlad pre-painted sheeting has earned a solid reputation for handsome appearance, strength, durability, ease of installation and maintenance as roofing and fascia on commercial structures.

Now, these same qualities, plus some additional ones, are being recognized by architects, contractors and owners for new roofs on new homes or as replacement on prestigious older homes.

Whatever the climate (rain — snow — ice — wind — sun — fire hazards), ColorKlad roofs offer protection from perils of nature that used to plague designers and homeowners using conventional roofing materials.

No wonder ColorKlad is being specified for more and more new and replacement roofs on homes being constructed by and for those who really care about lasting beauty.

ColorKlad is available in nine exciting colors, two textures. A written 20 year warranty assures color integrity. Write for our free brochure and color samples.

ColorKlad—the heirloom roof, uniqueness for generation after generation!

Building Products Division
P.O. Box 360, Mpls., MN 55440

LOCAL 612-378-1131
MINN. ONLY 800-552-1202,
NATIONWIDE 800-328-7772



Vincent

BRASS & ALUMINUM CO.

SEND FOR OUR NEW COLORKLAD BROCHURE
AND FREE COLOR SAMPLES TODAY!

Name _____

Title _____

Company _____

Address _____

City _____ State _____ Zip _____



3031 WOODBOOK / The WoodBook 79 is a hard cover reference manual containing almost 300 pages of the latest information on a wide range of wood products. Packed with current design and specification data, The WoodBook is a valuable source of information for anyone involved with the use of wood products in residential or commercial construction. Copies are available for \$10, from the WoodBook, 3516 Sacramento St., San Francisco, California 94118.

3032 FLOOR JOIST / A new brochure describing the residential TJI floor joist is available. Includes information on uniformity, quality, installation, and geometry of the "I" shape all wood TJI floor joist. / Trus Joist Corporation.

3033 HARDWOOD FLOORS / A new sample case of wood floor samples is now available from the makers of hardwood floor products. Each kit contains a package of sales literature, mounted panels of four plank floor styles, two parquet floors, and both smooth-surfaced and distressed strip floors. Designed for use by field salesmen, the kit contains display panels of eight Chickasaw floor designs. The floor sample kit is available for \$16.00 from Memphis Hardwood Flooring Co., P.O. Box 7253, Memphis, Tennessee 38107.

3034 WOOD BUYER'S GUIDE / A directory of the major hardwood plywood and veneer manufacturers in the U.S. is now available. Listed in the brochure are 79 manufacturers and prefinishers of hardwood plywood, 54 manufacturers of fine face and commercial veneer, and veneer sales agents. Information on each company plant includes complete address, maximum and preferred sizes manufactured, and interior and exterior glue type. / Hardwood Plywood Manufacturers Association.

3035 PLYWOOD SPECIFICATIONS / An easy-to-read, eight-page booklet listing the different engineered and appearance grades available and shows sample grade-trademarks and applications for each. Definitions of key terms and 303 Siding face grade tables are included. Comprehensive plywood specifications are provided as well as updated how-to-order information. / American Plywood Association.

3036 PLYWOOD SIDING / Technical characteristics, product description, acceptances, and pattern illustrations are provided for California clear grade plywood siding in a full color product information sheet. / Simpson Timber Company.

3037 RED CEDAR ROOFS / A new color brochure from Shakertown shows how patented 8-foot siding strips of red cedar barn shakes or textured shingles can be used for mansard rooflines, with savings in labor and waste that make real cedar shakes or shingles economically possible. / Shakertown.

3038 PLYWOOD WALL SYSTEMS / A 20-page pamphlet providing detailed information on plywood use in siding and paneling, the APA Sturd-I-Wall combination siding and sheathing, wall sheathing, shear walls, and special wall systems. Charts of the proper grades and thicknesses to use in specific situations and a photographic guide to different types of siding are also included. / American Plywood Association.

3039 FIRE CODE REQUIREMENTS / A 32-page guide to fire code and insurance requirements for wood and plywood systems. Fire protection, roof and wall systems, sample specifications, case histories, background information on codes, and tips on how to save on insurance are all included. / American Plywood Association.

3040 DECORATIVE LAMINATES / New literature showing the 83 offerings of DuraBeauty decorative laminates is available. Full color pamphlets are separated into woodgrains, marbles and slates, patterns, and solids. Complete specifications are included along with new 1979 products. / Consolweld Corporation.

3041 UPDATED AWWF DETAILS / Thirty-six page illustrated booklet cites the current regulatory and underwriting agency acceptances along with new testimonials from builders and buyers. Specifications for treated plywood and lumber, instructions on gravel fills, caulking compounds and the 6-mil polyethylene film used to control moisture on below-grade walls are all discussed. / American Plywood Association.

3042 CALIFORNIA REDWOOD / Information on the design and application of redwood plywood and other redwood products is contained in a series of pamphlets which includes: Redwood Plywood Living, Exterior Finishes, Exterior Finishes Brand List, Fire Resistance Plywood, Redwood Exterior Guide, Redwood Interior Guide, and Redwood Landscape Guide. / California Redwood Association.

more literature on page 88

THE dryvit[®] SYSTEM

Learn
Why
It
Makes
Sense!

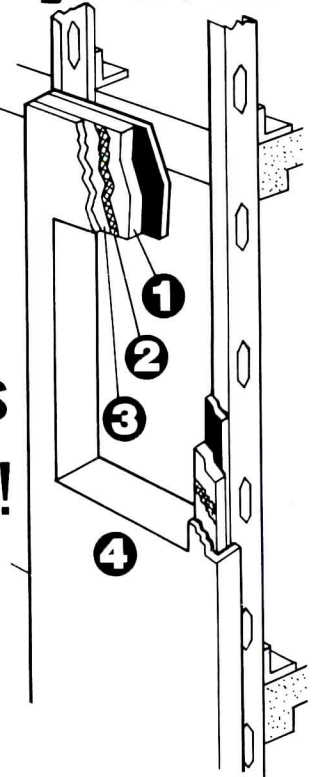

- 1** First a rigid panel of Expanded Polystyrene that offers optimum insulating qualities. It becomes the foundation of any "U" value that is required to really control heating and cooling costs.
- 2** Our specially woven and treated Fiberglass Fabric that prevents surface cracking and that's important — no cracks mean no leaks or maintenance.
- 3** Our special Primus/Adhesive, a unique plaster material mixed with Type I Portland Cement to adhere Dryvit Insulation Board to the back-up surface and to embed Dryvit Reinforcing Fabric on the face of the board.
- 4** Dryvit Finish; a synthetic plaster material having high bond strength, extremely pleasing in appearance in a choice of 14 integral colors and various textures. It provides a water resistant, jointless exterior that is maintenance free.

Lightweight Is Important

Only 7½ pounds per square foot, so you can reduce your steel usage substantially. Thinner walls also increase useable floor space.

DRYVIT SYSTEM, INC.
Warwick, RI—Tulsa, OK

Circle 1020 on inquiry card

doors and windows

8



196

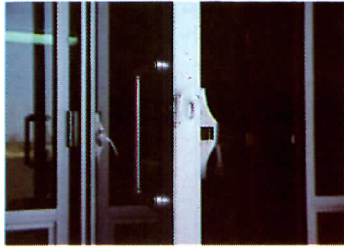

197



198

ENTRANCES & STOREFRONTS

196 WEATHERING SYSTEM / The Sealair Weathering System for aluminum entrances seals out drafts of cold air, thereby reducing heating costs. A flexible, polymeric strip forms a positive seal in the frame. / Kawneer Architectural Products. GB*

197 INTRUDER PROTECTION / Aluminum entrances, called *Entara-XD*, feature interlocking door stiles with removable mullion between double doors. / Kawneer Architectural Products. GB*

GLAZING

198 SHOWERGUARD / Several plastic layers form a special shower door for custom-size replacement of shower doors and tub enclosures. / AFG Industries. GB*



199

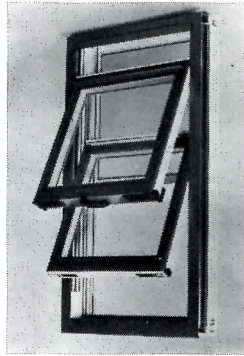

200



201

199 SKYLIGHTS / A triple-domed earthtone-colored skylight, recently introduced by Kennedy *Sky-Lites*, is made of *LEXAN* plastic, providing insulation properties plus impact strength. The material is rated Class 1, and is listed as "burglary resisting" by UL. / Material manufactured by General Electric Plastics Division; product manufactured by Kennedy SkyLites Inc.

200 INSULATED WINDOW / A double-glazed thermal-break window is made of *LEXAN* polycarbonate sheet plastic for thermal insulation and durability. / Amcor Industries, Inc.

201 DISPLAY DOORS / Swing display doors are used in this retail refrigerated application for product visibility. The "Vista Multi-Doors" feature a slim gold anodized aluminum frame. / Nor-Lake Inc. GB,E*



202



203

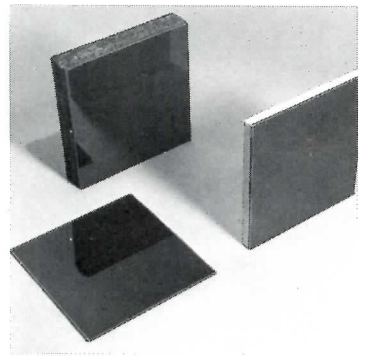

204

202 GLAZED BUS SHELTER / This bus shelter is designed with *LEXAN* MR-4000 sheet plastic because of the material's impact resistance. A F1-4-in.-thick, bronze polycarbonate sheet was specified for the best balance of properties in bus shelter glazing. / General Electric Co., Plastics Division.

203 GLAZING / This panel of "Lucite" is shown installed in a heavy traffic area in an office building. It combines abrasion resistance with light weight. / DuPont Co. GB, ICR, E*

204 SPANDEL GLASS / This glass, called "Col-R-Span," is heat-strengthened 1/4-in. thick float glass with a colored ceramic frit applied to the inside surface. Available in 10 standard colors, plus reflective coatings. / Environmental Glass Products. GB, ICR*

ENTRANCES & STOREFRONTS
GLAZING
HARDWARE & SPECIALTIES
METAL DOORS & FRAMES
METAL WINDOWS
SPECIAL DOORS
SPECIAL WINDOWS
WINDOWS/CURTAIN WALLS
WOOD & PLASTIC DOORS
WOOD & PLASTIC WINDOWS

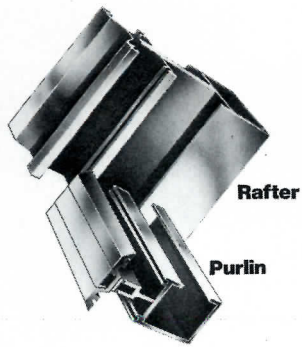

205



206

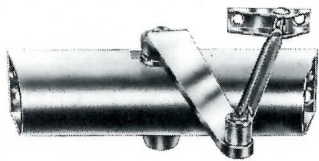

207

205 SLOPE WALL / Called the "Skew/Wall," this slope-wall system features secondary drainage, low horizontal profile, clean interior tubular appearance and accommodates insulated glass units. / The Alumiline Corp. GB*

206 WINDOW INSULATION / "Reflecto-Shield" is a transparent, reflective window insulation for the control of solar radiation. It consists of a precision-controlled vacuum-deposited thickness of aluminum sandwiched within a polyester laminate. / Madico, division of Van Leer USA, Inc.

HARDWARE & SPECIALTIES

207 UNIVERSAL CLOSER / Available in both hold-open and non-hold-open configurations, "90 Series" door closers are not handed, and can be mounted for regular, top-jamb and parallel-arm applications. The cast aluminum case needs no cover. All closers are UL-listed; non-hold-open units have a reversible power-adjustment arm bracket. / Russwin.

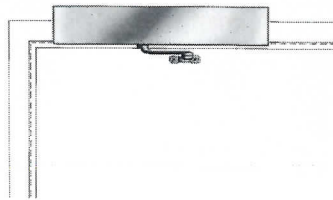

208



209

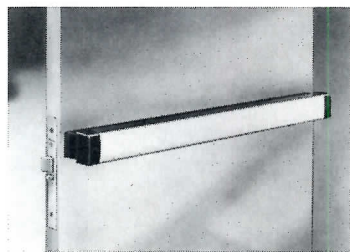

210

208 POWER ASSIST CLOSER / The *Equalizer* closer has a built-in power assist, activated by the individual approaching the door, which reduces opening forces as much as 75 per cent. The heavy-duty, ASTM-T and UL-listed units provide barrier-free passage for disabled or elderly persons. / LCN Closers.

209 GLASS DOOR KNOBS / These glass knobs are made of *LEXAN* resin for shatter-resistance while giving the appearance of crystal glass. / Taylor Lock Co.

210 EXIT DEVICE / A mortise exit device for hollow metal or wood doors, with an extruded aluminum push bar, conforms to door and jamb preparation dimensions per ANSI A115.1. Mounting uses through-the-door binder posts; long lip and electric-strike are options for "Series 8300" exits. / Adams Rite Mfg. Co.

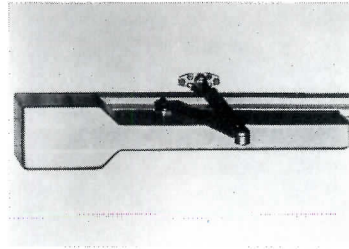

211

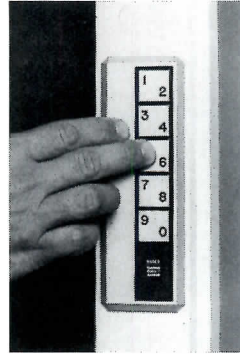

212

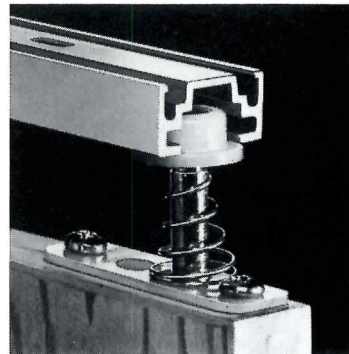

213

211 HANDICAPPED AID / An air-operated system to aid the handicapped in opening doors, the Series 1010 is surface-applied, requiring only eight screws and an air line. It is activated by a touch-button / Reading Door Closer Corp. GB, CC*

212 ELECTRIC LOCK / The *Keyless Entry*, available in both 24-volt commercial and 8-volt residential models, provides controlled access using a preset five-digit master combination. Keyboard is weatherproof stainless steel; system comes complete with electronic door strike and standby, rechargeable power supply. / Essex Transducers Corp.

213 DOOR HARDWARE / Series 2600 folding door hardware incorporates using the same hardware at either jamb, thus reducing installation time and increasing efficiency. / Grant Hardware Co.

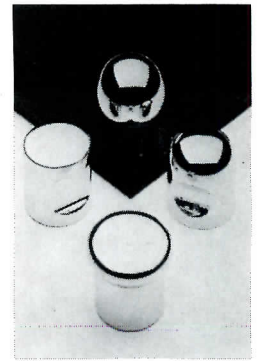

214



215

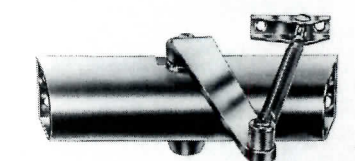

216

214 BRASS DOOR PULLS / Solid brass door pulls are the newest additions to this company's line of hardware. Available in polished chrome, satin chrome, and oil-rubbed bronze. / Forms & Surfaces.

215 GARAGE DOOR OPENERS / The "Touch 'N Go" model 200 garage-door opener is designed to open all sectional upward acting doors. The system comprises an opener and radio control / Overhead Door Corp.

216 DOOR CLOSERS / The bracket may be mounted to supply normal closing power or reversed to supply a minimum of 15 per cent greater closing power. / Russwin, Emhart Industries, Inc.

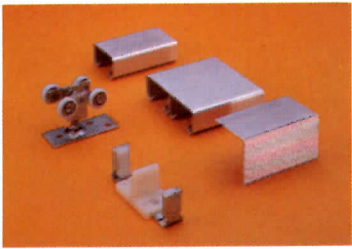

217

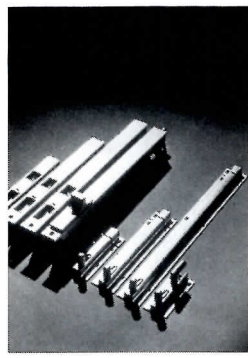

220



223



226

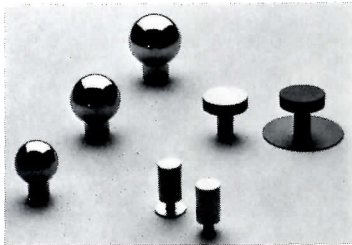

218

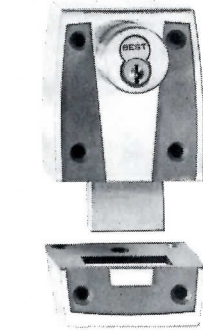

221



224

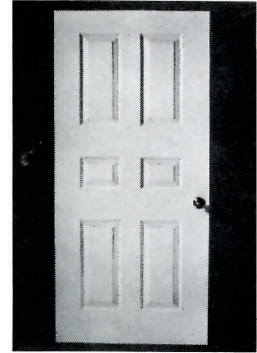

227

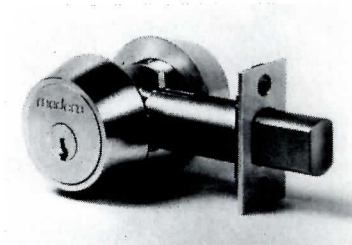

219



222

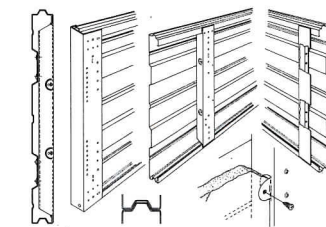

225

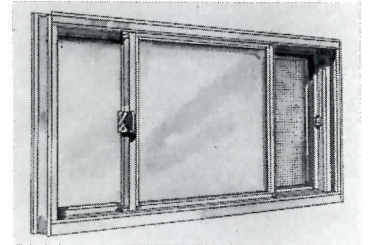

228

217 SLIDING DOOR HARDWARE / For heavy, solid-core and pressure-laminated doors, this hardware features "finger touch" action, four-wheel "wide-track" ball bearing hangers and jump-proof V-groove aluminum track. / Stanley Hardware, Division of The Stanley Works. GB, LRC*

218 HARDWARE / A series of basic shapes chosen for purity of form are used for metal cabinets. Finishes are polished and stained chrome, polished brass, and dark oil-rubbed bronze. / The Ironmonger, Inc.

219 DEADBOLT LOCK / The D-11 Series high-security deadbolt lock is designed to complement the appearance of a door while maintaining anti-picking apparatus. Available in brass and chrome finishes. / Medeco Security Locks Inc.

220 FLUSH BOLTS / A new series of door bolts from the *Modric* range of fittings made in the U.K. will replace older items in the company's range of 500 items. The standard finish is satin anodized aluminum. / The Ironmonger, Inc.

221 SECURITY LOCKS / A customized security system includes various locking hardware in its "Masterkeyed" line. / Best Lock Corp.

222 HANDICAPPED EASE / The "Roll-atch" provides two-way positive latching for easy operation by the handicapped. Designed to meet the need for simple operation, it is operated by pushing or pulling the knob instead of turning. / Schlage Lock Co. GB, LRC*

223 ENTRY DOOR / The Avanti A-600 Series insulated entry door has deep embossed designs, and can accommodate optional decorative "lite" inserts. / Peachtree Doors, Inc.

METAL DOORS & FRAMES

224 SAFETY DOOR / An up-dated version of the Safetyline Door maintains safety and security features while presenting a handsome appearance. The deluxe style shown is available in a choice of textured panels. / Amarlite Anaconda Aluminum Co.

225 GARAGE DOOR / The Crawford Commercial Sectional Steel Garage Door features a tongue-and-groove joint configuration that creates a weather seal. It can also be insulated with plastic foam. / Jim Walter Doors. GB*

226 SLIDING GLASS DOOR / This thermal sliding glass door combines 1-in. insulating glass with thermally isolated metal framing members. Series 4500 is available in two- or three-panel configurations. / Howmet Aluminum Corp.

227 STEEL DOOR / The "Fredericksburg" insulated steel entrance door is the newest model in the Benchmark system. It is an up-dated Colonial six-panel door with deep-sculptured design. / General Products Co.

228 SLIDER WINDOW / Model 133 horizontal sliding window has dual sets of sashes and a new sill design for maximum water- and air-tightness. Available in residential and commercial versions. / Season-All Industries, Inc. GB*

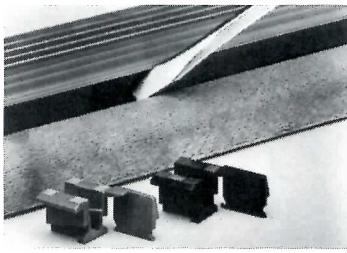

229



232



230



231

229 BARRIER DOOR / The all-weather barrier door manufactured by Pease Co., Ever-Strait Division, was designed with *LEXAN* to provide added strength and durability, and shear resistance, low water absorption, balance of lubricity and friction with adjacent materials. / General Electric Co., Plastics Division.

230 STORM DOOR / The insulated Sheltergard storm door comes in three designs—scalped, Colonial and diamond. It has foam insulation and a thermal-break to reduce loss of heat of conditioned air. / Alcan Building Products.

231 STORM DOOR / Self-storing feature of this 1 1/4-in. storm door allows inserts to stay in the door year-round. All inserts are interchangeable; screen may be used in either top or bottom position. Aluminum door is available in mill, white or bronze finish. / Alcan Building Products.

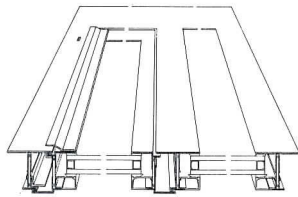

233

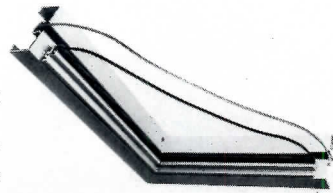

234

232 INSULATED DOOR / The Centurion insulated steel entry door system features an injected core of expanded polyurethane foam. Flush and embossed door designs are available. / Jim Walter Doors.

METAL WINDOWS

233 METAL WINDOWS / Series 2000T steel thermal-break custom windows can be constructed in case-ment-, projected- and fixed-frame configurations. Each window has compression-molded weather stripping. / Hope's Windows. GB*

234 RETROFIT WINDOW / This retrofit insulating window can be added to existing storefronts and other low-rise and high-rise wall and window systems. "RetroSash" creates an air space between the existing glass and new window. / Kawneer Architectural Products. GB*



235

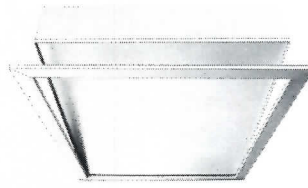

236



237

235 DOUBLE HUNG WINDOW / A double hung window available with an aluminum-clad frame combines the insulating qualities of wood with the protective advantages of acrylic-coated aluminum. / Marvin Windows.

SPECIAL DOORS

236 ACCESS DOOR / "Model 682" steel door provides easy access to attic areas; its R19 insulation value and weather-seal gasket help maintain the integrity of attic insulation. The door weighs about 9 lb; four sizes range from 20 by 24 in. to 22 by 30 in. / Leigh Products.

237 SPECIAL DOORS / The *Pendador II* line utilizes a new hardware system that makes it easier to vary the overlap of individual strips within a single door, to accommodate quickly different types of traffic and changing weather patterns. / W.B. McGuire Co. GB, ICR*



238

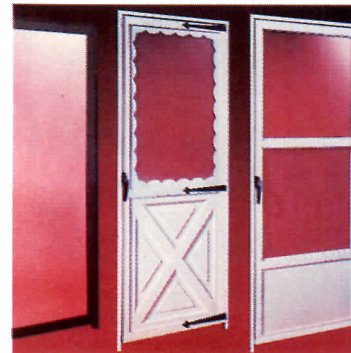

239



240

238 AUTOMATED DOOR / The "Easy Access" door operator is designed to provide low-cost automation of new and existing swinging doors for barrier-free entry. It requires only a 115AC power source. / Horton Automatics.

239 STORM DOORS / The "Aristocrat" line of extruded aluminum storm doors shown is 1 1/4-in. thick. Each is easily installed, pre-hung and fully weather-stripped. / Norandex Aluminum Building Products.

240 STRIP DOOR / A temperature-, sound- and dirt-barrier door can also be seen through and reached through. Made with soft, flexible overlapping vinyl strips, the door has segmented partitions that surround, control, isolate, absorb and dampen sound. / Overhead Door Corporation. GB, ICR*

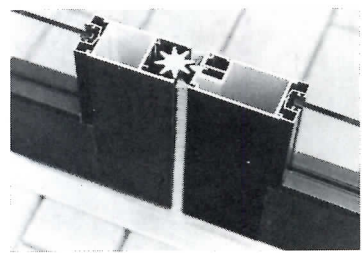

241

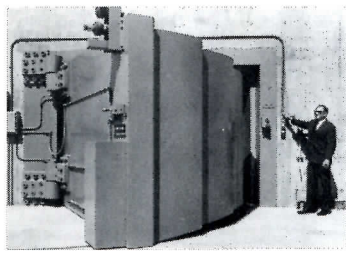

244



247



250

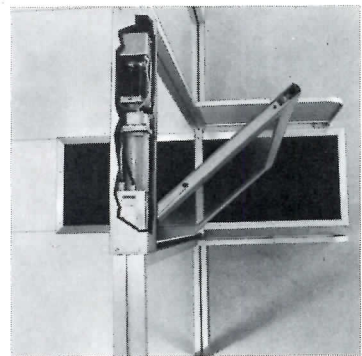

242



245



248



251

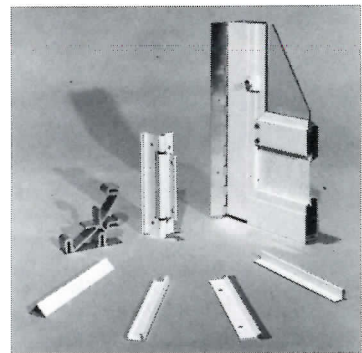

243

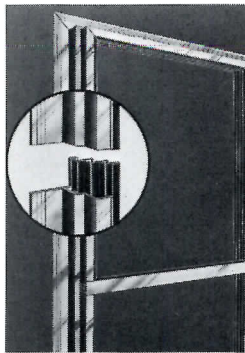

246

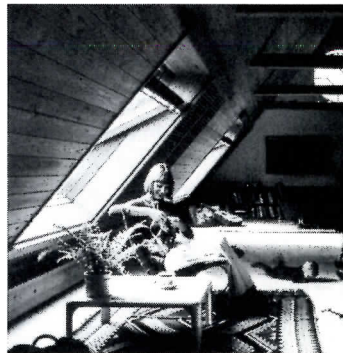

249



252

241 PANIC DOOR / The *Nightwatch* concealed rotary astragal panic door uses a "turnstile" action and an independent free-wheeling rotor to avoid problems of burglary. / Howmet Aluminum Corp. GB*

242 AUTOMATIC DOOR / For swinging doors, the *Magic-Swing* automatic door operator is an electromechanical unit which converts electrical energy into mechanical motion. Designed for low-cost operation, its control box has no moving parts. / Stanley Magic-Door, Division of The Stanley Works. GB*

243 STORM/SCREEN DOOR / The "Ultima" self-storing aluminum combination storm/screen door, with all hollow frame extrusions and patented corner gusset, offers strength and trouble-free service. / Season-All Industries, Inc. GB*

244 RADIATION DOOR / A nearly-50-ton radiation shielding door contains primary and secondary radiation in the Lawrence Livermore Laboratory, California, shown. Only 50 lbs of push or pull is required for manual operation. / Keene Corporation.

245 TRAFFIC DOOR / The "Mata-Door" is a rigid, transparent traffic door with heavy-duty Swedish-designed hinges. Suggested applications include retail service doors, shipping dock doors and interior thermal barriers. / Chase Industries Inc. ICR*

SPECIAL WINDOWS

246 VINYL LINER / The Model 834 aluminum combination storm/screen window features an extruded vinyl liner that provides smooth, easy operation. There is also a bottom expander that automatically compensates for out-of-level sill conditions. / Season-All Industries, Inc. GB*

247 STAINED GLASS / Design elements, windows and skylights constructed to architectural specifications are made from stained and clear, leaded zinc and copper foil glass. Available nationwide, products also include etched, sandblasted and painted screens, dividers and windows; lampshades; and domes. / Elysian Stained Glass Co.

248 BUBBLE WINDOW / Called the "R" series skylights, this bubble window can also be installed vertically in a wall as shown. Custom designs are available. / T-M Corp. GB, LRC*

249 ROOF WINDOWS / The *Velux* roof windows are designed for residential attic expansions as well as new construction. The window lends a contemporary look while providing better lighting. / Velux-America Inc.

250 INSULATED SKYLIGHTS / These skylights insulate against thermal heat loss in winter and solar heat gain in summer. The single, joint-free, plastic unit consists of 1½-in.-thick sandwich panel, forming a dead-air insulation space. / Solartron Corp. GB, LRC*

251 SKYDOME / The "Solar Energy Skydome" is specifically designed for industrial, commercial and institutional installations. It has a thermal-break aluminum curb plus a high-performance gasket and butyl seals which control condensation. / Wasco Products Inc. GB*

252 SKYWINDOW / For residential use, the "Skywindow" line contains bubble or round windows, as well as a dormer-shaped window. All are available as fixed position or vented models. / Wasco Products, Inc.

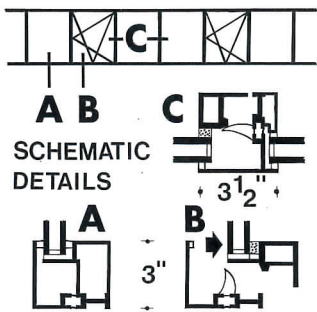

253



254

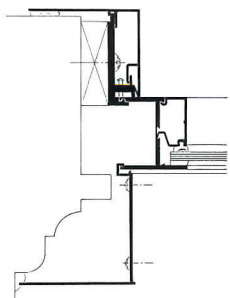

255

WINDOWS/ CURTAIN WALLS

253 RIBBON WINDOWS / The *Versa Vent* window integrates perimeter frame members and vertical mullions so that the ventilators are indistinguishable from the fixed panes. Weatherstripping impinges directly against glass, creating low and uniform sight lines in fixed and ventilating units. Integral blinds available. / Flour City Architectural Metals.

254 TWO-IN-ONE WINDOW / The "Versa Vent" series 85AL window has a single handle which operates concealed locks and hinges for a top-opening vent position and side-opening cleaning position. / Flour City Architectural Metals. GB*

255 WINDOW SYSTEM / An aluminum system has been designed to reduce labor costs of replacing old windows with new windows in low-rise and high-rise buildings. The *Sealair* Panning System members cover the old window, eliminating the need to remove existing sash, masonry or trim. / Kawneer Architectural Products.



256

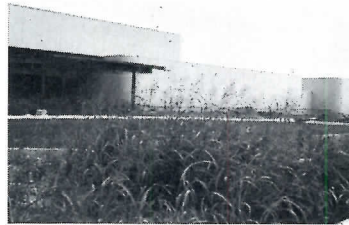

257



258

256 GLASS RIBBON / Giving the appearance of a continuous glass ribbon, this glazing system EFG 502 allows architects to accent the sweeping lines of low-rise commercial buildings. The system includes glass, metal frames and other glazing components. / PPG Industries, Inc. GB*

257 ENVELOPING SYSTEMS / The "Thermal Barrier Enveloping Systems" are thermally improved, internally-framed, unitized wall systems providing finishes and thermal resistance. The envelope can "float" independently of the structural frame. / GII Corporation. GB*

WOOD & PLASTIC DOORS

258 THERMAL DOORS / Wood frame of these French-style doors with insulated glass helps with heat control and minimizes moisture condensation. While suggested for residential use, they can also be used in special store and professional building entries. / E.A. Nord Co. LRC*



259



260

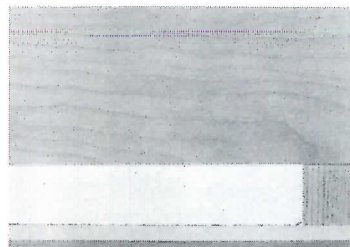

261

259 STAINED GLASS DOOR / Named "Byzantine", this addition to the "Voyager" line is available with eight different decorative panel or glass inserts. / E.A. Nord Co. LRC*

260 ORNAMENTAL DOOR / The "Georgian" door is highlighted by a semi-arched window of cut glass. The door is crafted of hemlock wood with extra-wide stiles to accommodate a range of door hardware. / Simpson Timber Co. GB, LRC*

261 FIRE DOORS / A fireproof door is now available in wood and plastic. A high-density inner stile of fireproof material improves the screw-holding power for mortised hinge attachment. UL approved. / Algoma Hardwoods Inc. GB*



262

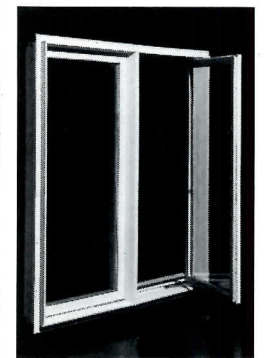

263

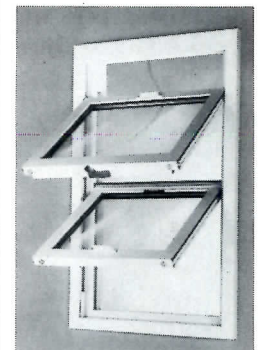

264

262 SOLID WOOD DOOR / The "Colonial" model in the Designer Series of solid wood doors is a multiple panel, carved door, eliciting an "old world" appearance. / Simpson Timber Co. GB, LRC*

WOOD & PLASTIC WINDOWS

263 CASEMENT WINDOW / The *Thermaclad* Casement Wood Window has natural wood inside and a low maintenance vinyl covering. Features include a double-pane insulating glass, and a recessed sash. / Malta Division, Philips Industries, Inc. LRC*

264 VINYL-FRAMES / Rigid vinyl double-hung residential windows, sliders and patio doors feature fusion-welded master frames and multi-chambered profiles. This process creates a continuous solid frame with no joints to seal. / Dynamit Nobel of America, Inc. GB*

The Von Duprin Futuristic 33 exit device adds a touch of class and efficiency to your high traffic areas. The 33 touch bar eliminates traditional lever arms and crossbars. The latch is actuated with only slight pressure at any point along the reversible touch bar. As an added safety feature, the large area of the touch bar keeps hands away from glass.

One-point positive dogging for push-pull operation requires only one-eighth turn of a dog key. One-point cylinder dogging is optional for use with any standard diameter mortise cylinder.

The 33 devices are available in rim, surface or concealed vertical rod models, and can be equipped for electronic actuation of the latch bolt on doors from 2'6" to 4' wide with stiles as narrow as 1 3/4".

Find out how the Von Duprin 33 can give you an elegant, efficient solution to the ins and outs of your exit hardware problems. Request Bulletin 774.



No-cost finish options include anodized aluminum with stainless steel touch bar surface . . . bronze anodized aluminum with bronze touch bar surface . . . duranodic dark bronze aluminum with black or walnut-grained vinyl-covered touch bar.

Von Duprin®

400 West Maryland Street
Indianapolis, Indiana 46225

Circle 102B on inquiry card

RECORD IMPRESSIONS CATALOG

SEND FOR A COMPLETE, DETAILED CATALOG of "Record Impressions." A convenient service offering reprints of Building Type Studies, Interiors and Special Reports. Offered are more than 50 items including the practical reference guide, "Air Conditioning: A New Interpretation."

Address your request to: Record Impressions, Architectural Record, P.O. Box 457, Princeton Road, Hightstown, New Jersey 08520.



the plastic-domed ventilating skylight

Skylighting is the way to create beautiful light-filled rooms, to add new dimension and greater flexibility to interior and exterior designs.

VENTARAMA SKYLIGHTS OFFER PASSIVE SOLAR HEAT, NATURAL AIR CONDITIONING, and can be used in any climate on any roof.

- COPPER FLASHED • SHATTER-PROOF • INSULATED DOME • SCREENING AND SUNSHADE • OPERABLE BY MANUAL, POLE, OR ELECTRIC MOTOR



VENTARAMA® SKYLIGHT CORPORATION
75 Channel Drive, Port Washington, New York 11050 (516) 883-5000

Circle 1029 on inquiry card

3044 PLYWOOD ROOF SYSTEMS / A 12-page, full-color booklet provides design and application details as well as installation methods for plywood used in various residential and commercial roof systems. Included are such subjects as plywood roof sheathing, bonded roofs, preframed roofs, long-span systems, roof diaphragms, and special roof systems. / American Plywood Association.

THERMAL & MOISTURE PROTECTION: UCI 7

3045 METAL ROOFS / The advantages and merits of continuous single-skin, metal roof systems are discussed in a brochure from this manufacturer of Widespan, Landmark, Landmark two-story, and Triodetic metal roof systems. Product information and installation instructions are included along with accessory list, adaptability data, energy savings, and maintenance features. / Butler Manufacturing Company.

3046 FIBER GLASS SHINGLES / A small brochure and news release listing the major benefits of Elk fiber glass shingles as increased durability, resistance to fire, and greater dimensional stability. Includes information on color assortment, product quality, and company warranty. / Elk Corporation. LRC*

3047 HOME INSULATION / This brochure contains information for residing homes with Fome-Cor underlayment board. This insulation is listed as reducing air infiltration, deadening noise, adding moisture protection, and providing a firm surface over old siding. / Monsanto Company.

3048 MOBILE HOME INSULATION / A small booklet outlining the energy-saving value of Fome-Cor Sheathing Board, used along with fibrous insulation in mobile homes. Contains test results and data on the comfort, quality, efficiency, cost, and potential savings with Fome-Cor. / Monsanto Company.

3049 ROOF TILES / A product brochure and nine specific product sheets are being offered for clay roof tiles. The material includes all information pertaining to typical applications, dimensions, finishes, and other specification data. / Ludowici-Celadon Company. GB*

3050 ROOFING PANELS / Application instructions covering 13 common installation procedures are being offered for use with red cedar shakes. Diagrams along with step-by-step details are included. / Shake & Shingle Panels Inc.

3051 WATERPROOFING / A color brochure and news release outline the advantages of Duramem—a cold, liquid-applied one-part membrane for waterproofing structural concrete above and below grade. Includes product description, basic use, application data, coverage, and limitations. / Pecora Corporation. GB, ICR*

3052 INSULATION / A news release from the makers of *Styrofoam* brand insulation is offered along with a product brochure. Contains new product information on an extra-strength damage-resistant *Styrofoam*, installed on frame walls to insulate studs, corner posts, headers, sill plates, and other wood surfaces. / Dow Chemical U.S.A. GB, ICR*

3053 CLADDING / Product information from the makers of Alucobond, an aluminum-polyethylene composite material used in exterior cladding, spandrels, soffits, fascia, and interiors. Describes the concept, flexibility, product choices, and functions. / Consolidated Aluminum.

3054 INVERTED ROOF / A brochure from the manufacturer of the Protected Roof Membrane (PRM) System. Offers information on the inverted roof concept, including insulation data, design considerations, installation advantages, and recommended specifications. / Uniroyal, Ltd. GB*

3055 SILO SEALER / A technical bulletin offering information on a cement-base coating for application to the interior of concrete silos. Contains data on surface preparation, application procedures, coverage, packaging, and the manufacturer's guarantee. / Standard Dry Wall Products. ICR*

3056 ASTROTURF / The economy and adaptability of synthetic turf are outlined in this colorful brochure. Contains important product information and cites specific collegiate examples where this low-maintenance alternative playing surface has been successfully used. / Monsanto Company.

3057 REDWOOD PLYWOOD / A flyer on California Clear Grade Siding includes product description, panel characteristics, national acceptance, and data on the economy, performance, and weatherability of Redwood Plywood. / Simpson Timber Company. LRC*

3058 LAMINATED GLASS / A 20-page brochure describing the advantages of laminated glass is available from the producers of Saflex, the bonding material used in lamination. Case histories and effective applications are included, along with examples of product benefits such as safety, sound control, solar control, and security. / Monsanto Company.

more literature on page 90



The owner of this north facing home installation in Winnipeg reports no humidity problem even at -35°F.

No maintenance, window beauty, highest known energy savings

Now you can deliver all three
with Special Formula PVC
windows from Poly Co. American.

No other window unit being manufactured today offers the energy and money saving features that are standard with windows from Poly Co. American: triple insulated glass, virtually indestructible frames and sash, weather tightness that far exceeds all current standards, and freedom from maintenance.

Two different independent testing laboratories have tested and provided documentation* that Poly Co. windows far exceed standards for air and water infiltration, thermal conductivity and structural strength. Total unit "U" values as low as .26 and total unit "R" values as high as 3.85.

Poly Co. American builds a wide variety of window units: casements, picture, awnings, combinations, etc. in standard sizes. Non-standard sizes and shapes are available on special order. See our catalog in Sweet's or write our Marketing Dept. for more information.

**available on request*

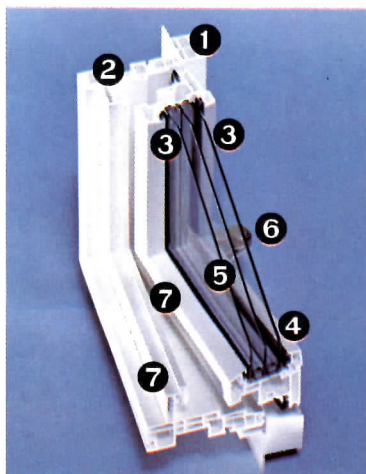

- ① Unique chambered construction provides strength, rigidity
- ② Dead air locked in chambers guards against temperature fluctuations
- ③ Double weather stripping and glazing spline are resilient acoustical material.
- ④ Snap-in glazing spline allows dry glazing without removing sash
- ⑤ Triple insulated, 3 mil glass with full 1/2" dead air space between lites
- ⑥ Heavy duty aluminum bronze hardware
- ⑦ PVC frame and sash are virtually indestructible, cannot rot, corrode or weather

"The new generation of energy saving windows"



POLYCO[™]
AMERICAN ★

Poly Company of America, Inc.
Highway 5 East
Langdon, ND 58249

Circle 1030 on inquiry card

3059 MANHOLE LEVELER / This cement-base product, specifically designed for the purpose of setting manhole rings and covers either in new construction or in existing manhole construction, is outlined in a technical bulletin. Product description, product advantages, surface preparation, application, packaging, and test data are included. / Standard Dry Wall Products. ICR*

3060 WALL INSULATION / Three basic wall insulation systems are outlined in this colorful brochure. Thermostud, masonry, and styrene foam are the systems described as to benefits, components, physical properties, installation, and design details. / W.R. Grace & Co. GB*

3061 ROOF INSULATION / The advantages, uses, limitations, and code acceptances of perlite, urethane, and perlite/urethane roof insulation are outlined in this 8-page brochure. Contains information on thickness requirements, heat transmission "U" values, physical properties, and packaging. / GAF Corporation. GB, ICR, E*

3062 REINFORCED CEMENT / A data sheet is now available for Sanspray fiber-reinforced-cement panels. Includes information on possible uses and applications, performance properties, product details, installation details and maintenance. / Sanspray Corporation. GB, LRC*

3063 ROOF PANEL / Energy-saving, factory-insulated roof panel systems are outlined in this brochure. Suggested specifications, typical details, features and benefits, and installation guidelines are included. / Granco Division, National Steel Products Company. GB*

3064 ROOF TILE / An improved flat concrete roof tile with wood-like hand-split texture and colors is introduced in a fact sheet. Information on sizes and specifications, as well as on different accessory tiles available, is also included. / Monier Company. GB, LRC*

3065 PIPE INSULATION / A way of saving warehouse and truck space and handling time and labor for firms installing industrial insulation is described in a new brochure. The brochure contains a table from which can be calculated how much pipe insulation of a given size can be put in a given carload. / Johns-Manville.

Roll Runner®

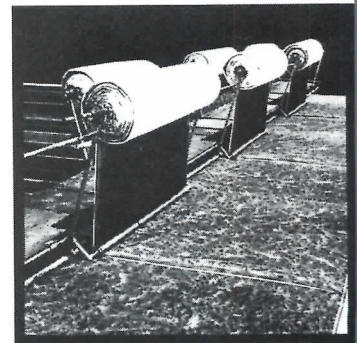

3066 INSULATING SYSTEM / A color brochure outlines the *Roll Runner* insulating system for buildings designed with standard purlin spacings found in pre-engineered metal building systems. Outlines equipment such as a traveling OSHA-approved platform operable by a single worker and includes data on speed, economy, and appearance with the *Roll Runner*. / Butler Manufacturing Co. ICR*



THIS IS AN EXIT DEVICE? THIS IS AN EXIT DEVICE!

Why have exit devices always been ugly, expensive, bulky, pipe-rack monstrosities? Darned if we know. We (Adams Rite Manufacturing Co.) believe that simplicity, not complexity, is the ultimate sophistication. We designed our exit device to complement the clean lines of narrow stile glass doors (and fit easily and securely into the same standard mortise cut-out as our M.S.® deadlock). We also designed it to release at a mere 8 lb. touch anywhere on the bar, which moves only one inch. This one inch is in the exit direction too, not the conventional but unnatural downward arc. Load the door up to the code-required 250 lbs. and release pressure still stays well under

50 bs. anywhere on the bar. Yes, it's an exit device. It's also an exciting device. Some architects have indicated they're specifying it even where exit devices are not required by law. It's simply the neatest way to open a door they've seen. Who are we to argue? For details of the 8400 mortise device (shown) and its twin, the 8500 concealed vertical rod for paired doors, write:

ADAMS RITE 
MANUFACTURING CO. CITY OF INDUSTRY CALIFORNIA 91749
TEL: (213) 699-0511

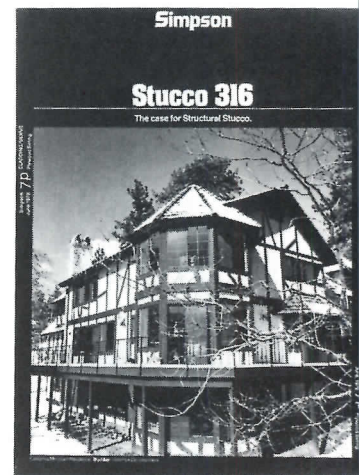

3067 STUCCO / Color photographs highlight a new brochure depicting applications of Stucco 316 in both residential and commercial projects. Detailed descriptions are provided along with sizes and finishing instructions. / Simpson Timber Company.

3068 POND LINERS / A comprehensive brochure providing updated information on flexible membranes for pond and reservoir liners and covers is available. The 24-page brochure includes data charts listing comparative properties and chemical resistance for the membranes along with a list of suppliers for the liners and covers. / E.I. du Pont de Nemours & Co.

Circle 1031 on inquiry card

more literature on page 118

The first place to look for the last word in garage doors...

Raynor gives you choices only a full-line garage door manufacturer can offer. Over one hundred styles, types and sizes to fit any decor and most any special requirement. When you do select a Raynor door, there are certain things that don't require a choice. Like Quality...in design and construction. Raynor uses only the best material for springs, rollers, hinges, locks and other hardware. And the best grade lumber available. All put together by dedicated people...not machines. And



RAYNOR™
GARAGE DOORS

Service...like undamaged delivery by our own truck fleet. Plus professional installation by our factory-trained distributors located throughout the country. They pledge prompt follow-up service for parts and repairs if ever needed. In the end, the last word you get from us is—satisfaction! For a copy of our catalog write Raynor Manufacturing Company, Dixon, IL 61021. Or call a Raynor Distributor near you. You'll find his number in the Yellow Pages under "Doors".

Circle 1034 on inquiry card

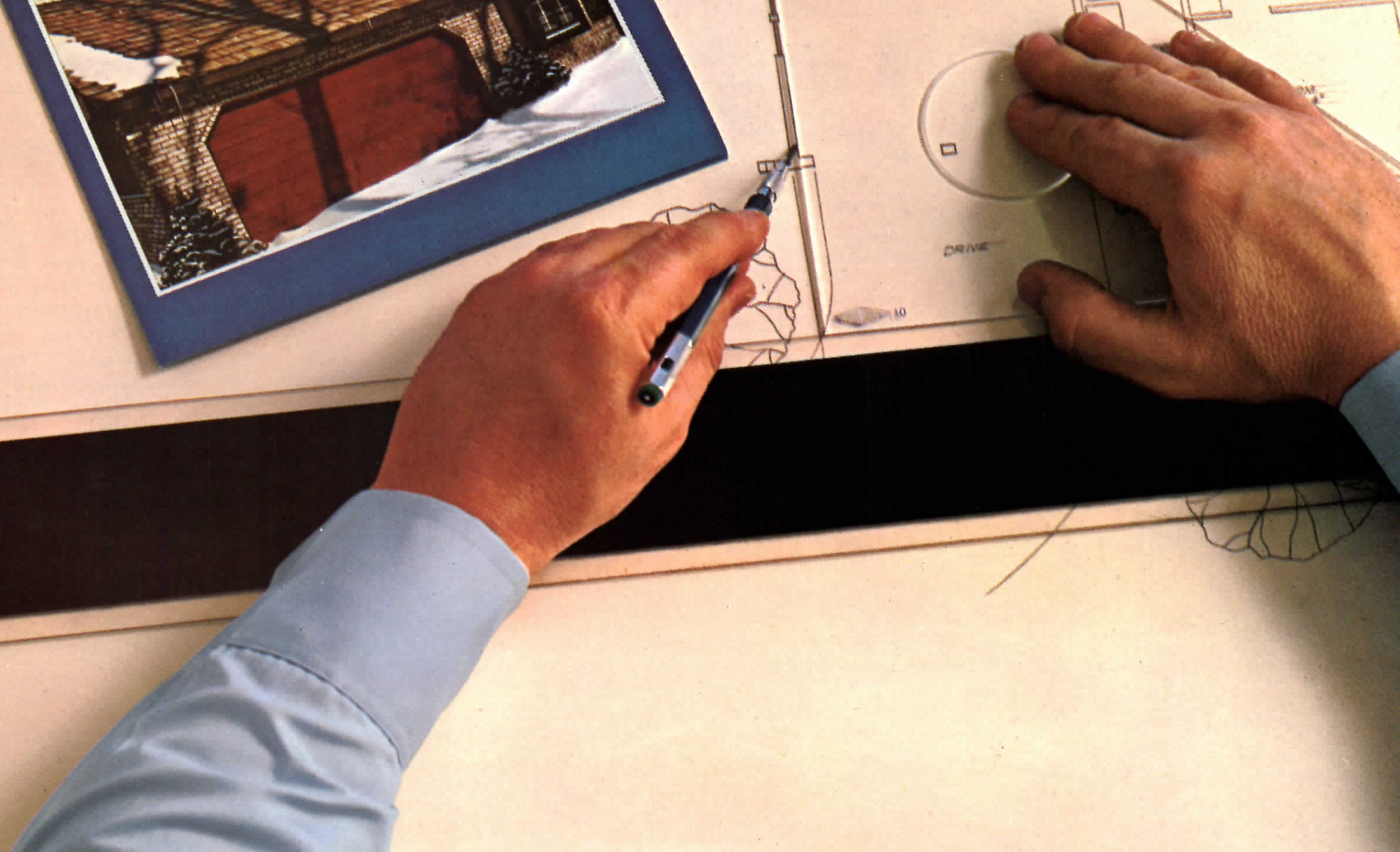
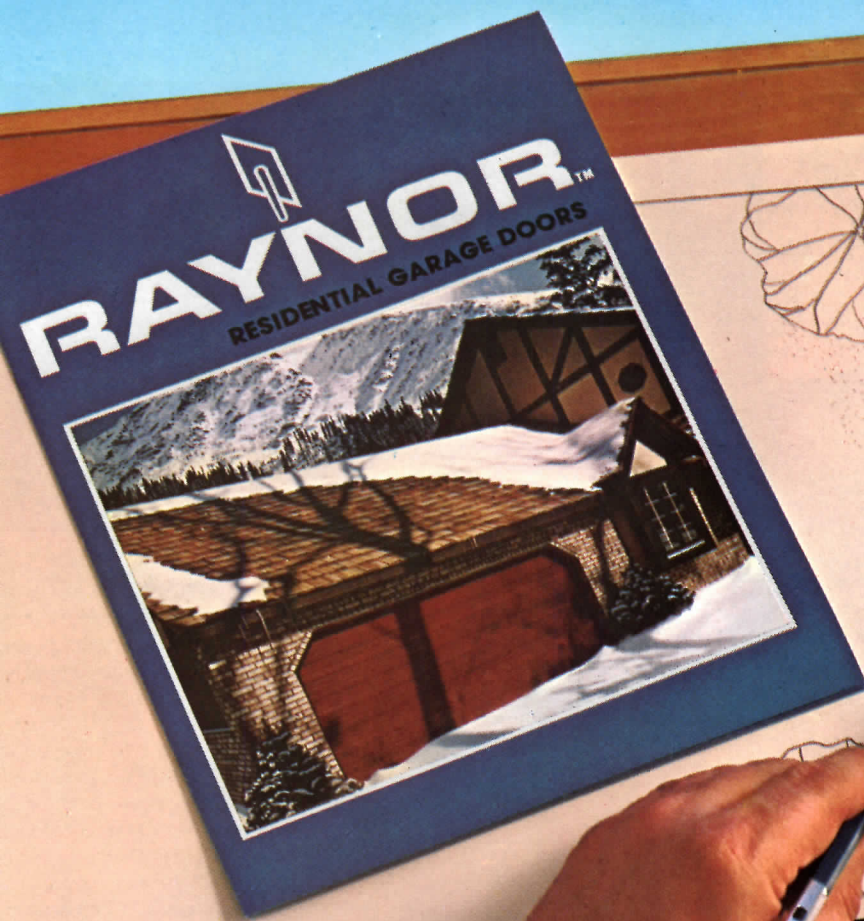

uci 9

finishes



277



278



279

ACOUSTICAL TREATMENT

277 CEILING TILE / A random eroded pattern with a NRC range of .55-.65, "Aurora" ceiling tile is offered in 12- by 12-in. concealed edge and 24- by 24-in. reveal versions. Reveal edge tile is available in both standard and fire-rated products. / Conwed Corp. GB*

278 ACOUSTICAL WALLS / Sound-absorptive mineral fiberboard panels adapt to all types of walls, with aluminum splines that attach quickly to drywall, plaster, brick, block, steel studs and steel partitions. Covered with polyester fabric, panels have a Class 25 Flame Spread Rating. / Conwed Corp. GB*

279 SUSPENDED CEILING / The acoustical performance of the *Planar* aluminum panel ceiling system can be improved by covering the spaces between panels with a one-in. fiberglass blanket, or closing the space with recessed filler strips to soak up excess sound. / Alcan Building Products.



280



281



282

280 ACOUSTICAL PANELS / *Sound-soak 85* panels will absorb 85 per cent of the sound striking them, and will also improve the STC of most walls by 10 per cent. The one-in.-thick mineral fiberboard panels are covered with modacrylic fabric and have a Class 25 flame spread. / Armstrong Cork Co. GB, I*

ADHESIVES

281 ACRYLIC ADHESIVES / A second-generation acrylic system, "Reactive Adhesive RA0018" facilitated construction of these *TruWood* decorative beams. Neither adhesive nor activator require careful metering or mixing; offering a long open time, the adhesive sets and cures rapidly once in contact. / Du Pont Co.

282 PIPE SEALANT / *Perma-Lok* "LH-150" anaerobic pipe sealant with *Teflon* provides controlled metal bonding for a variety of applications. An economical alternative to tape, the sealant forms a permanent corrosive-resistant seal, while allowing for adjustments up to 24 hours after assembly. / Permabond International Corp. GB, ICR, LR,*



283

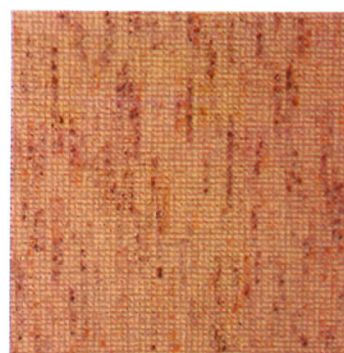

284



285

CARPETING

283 HEAVY DUTY CARPET / A 26 oz level loop carpet of *Zeflon* nylon, "Millburn" is suitable for extra heavy commercial traffic. Yarn has anti-static properties, and is available in 11 colors. / Stratton Industries, Inc.

284 TEXTURED CARPET / Alternating rows of cut and loop pile give "Affirmative" *Anso* nylon carpet a random texture. Natural luster yarn and subtle flecks of Berber coloring provide a wool-like look. Available in 15 heather and accent colors, "Affirmative" retails for \$14.50 per sq yard / Bigelow-Sanford Inc. GB, I*

285 TUFTED CUT LOOP / *Zeflon 500* nylon yarn used in "Dignitary" carpeting has been solution dyed, and is said to assure good color matching lengthwise and crosswise in the fabric and between successive rolls. Carpet is offered in 10 colors, certified for Class II heavy commercial traffic. / Commercial Carpet Corp.

ACOUSTICAL TREATMENT
ADHESIVES
CARPETING
CEILING SUSPENSION SYSTEMS
PAINTING MATERIALS
PREFINISHED PANELS
RESILIENT FLOORING
SPECIAL COATINGS & SURFACES
SPECIAL FLOORING
TILE
WALL COVERINGS
WOOD FLOORING



286



289



292



295

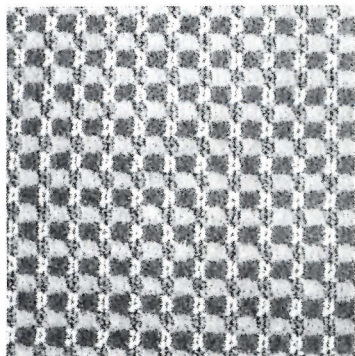

287

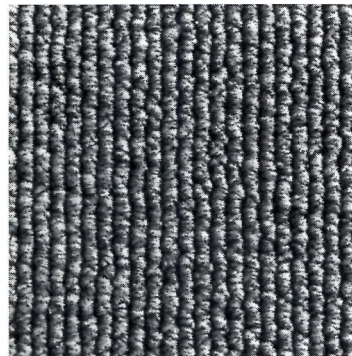

290



293



296



288



291



294

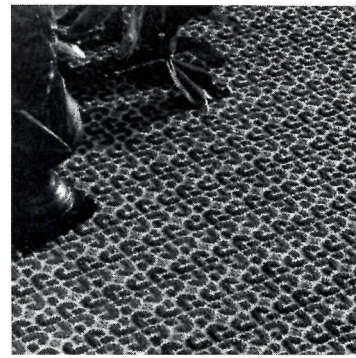

297

286 CUT-PILE VELVET / Antron III nylon with a pinpoint finish, Bigelow's "Westminster" contract and residential carpeting is available in 24 colors. / DuPont Co. I*

287 CHECK ON CHECK / Solution-dyed heather colorations are woven in a check pattern in "Chessmaster" Zeflon nylon carpeting. Carrying a five-year wear warranty, "Chessmaster" carpets have a special soil repellent finish. / Karastan Rug Mills.

288 TEXTURED BERBER / A blend of natural wools in a heavy three-ply yarn, "Burbertex" Wilton-weave carpet offers built-in camouflage against dirt. It is available in three natural colorways and comes in a 13-ft 2-in. width. / Couristan, Inc.

289 WILTON BLEND / Contract carpet has a two-toned octagonal design spaced to form a pin-dot pattern, Wilton constructed from Zefran blend of acrylic and nylon yarns. Carpet is certified for heavy commercial traffic, and is available in 9- and 12-ft widths. / Langhorne Carpet Co.

290 INSTITUTIONAL CARPET / The use of Zeflon 500 yarns in "Commercial 3600Z" carpeting means that stubborn stains may, if necessary, be bleached out without affecting the color values. Offered in natural heather colors, the carpet has a five-year wear warranty. / J & J Industries.

291 URETHANE CUSHION / "Sea Foam" is a luxury prime urethane carpet cushion with firm hand, high resistance to compression, and good tear and tensile strength. Available in thicknesses of 7/16, 1/2-, and 9/16-in. / Ludlow Carpet Cushion.

292 CARPET SQUARES / All Heuga carpet squares have a dimensionally-stable backing that prevents buckling. New additions to this interchangeable contract carpet line include Ultron nylon "Jet" squares, and "575 Plus" cut pile carpet in a specially-designed Architect/Designer Series. / Heuga U.S.A., Inc.

293 GRASS-TYPE CARPET / A fibrillated polypropylene yarn, Patlon Plus produces a grass-type carpet with greater resiliency, a softer hand, and a bouncy feel not found in other artificial turfs. Carpets using the yarn may be specified in any of 13 colors and many tweed combinations. / Amoco Fabrics Co.

294 NYLON BERBER / "Starting Time," a level loop featuring Berber spacing, is yarn-dyed in 11 colorations plus coordinated "Bisque" and "Russet" random stripes. / Welco Carpet Corp.

295 SAXONY PLUSH / Constructed with densely packed nylon face yarns, "Classical Grace" carpeting is offered in 30 solid colors treated with Scotchgard carpet protector and static control. / Cabin Crafts Carpets, WestPoint Pepperell Carpet & Rug Div.

296 CUT-AND-LOOP / The three-dimensional flow of colors in "Inspiration" carpeting is made possible by the Dyemensions 95 dyeing technique. Soil-repellent carpet meets FHA requirements, and is offered in 15 colorations. / Pepperell Carpets, WestPoint Pepperell Carpet and Rug Div.

297 EMBOSSED CARPET / Pattern-dyed carpets for such severe traffic installations as stores, restaurants, and hotels. The Acadia pattern has a curvilinear design to blend with the rounded edges often used in contemporary office furnishings. / Armstrong Cork Co.

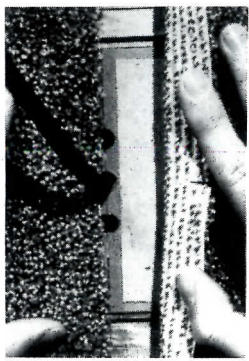

298

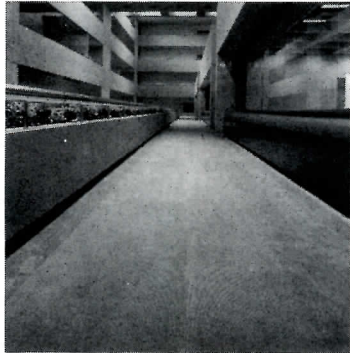

299

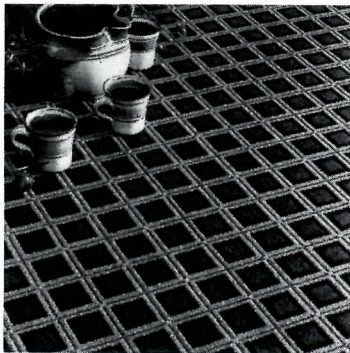

300

298 CARPET BACKING / Pressure-sensitive release adhesives used in the *Certlok EA* backing system allow the direct glue-down carpet to be pulled back easily at service trenches in concrete subfloors for access to under-floor electrical systems, outlets, etc. / Armstrong Cork Co.

299 BONDED FLOORING / The *Interface* fusion bonded carpet system is available in a number of new styles. Included is the varigated stripe pattern "Lineations," used here in the Dallas City Hall. Colors, in-stock prints and international communication symbols are also offered. / Interface Flooring Systems.

300 EMBOSSED CARPETING / Part of *The Engraver's mark* collection of pattern-dyed carpets, "Merion" has a small-scale hollow-square pattern particularly suitable for use in large open spaces or corridors. Five colorways offered range from tone-on-tone brown and tan to brighter combinations like brown-blue-orange. / Armstrong Cork Co.

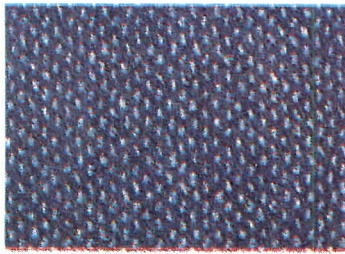

301

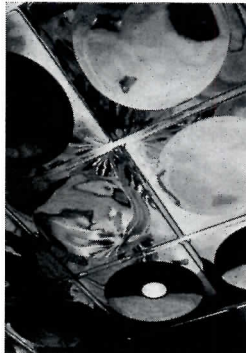

302

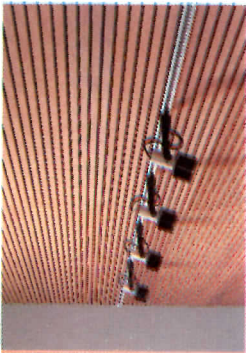

303

301 LOW LUSTER NYLON / For heavy commercial applications, "Chancellor" cut pile carpet is offered in six color combinations with a pin-dot pattern effect. The 40 oz carpet is made of *Zeflon* subdued luster nylon. / Porter Carpet Mills.

CEILING SUSPENSION SYSTEMS

302 METAL CEILINGS / Two-ft sq panels in polished brass, chrome and copper finish are supported by inverted T-bar grid capped in a matching finish. This three-dimensional mirrored ceiling is non-combustible, and can accept most recessed and surface-mounted lighting fixtures. / Integrated Ceilings, Inc.

303 WOOD CEILINGS / Ceiling systems using standard T-bar suspension methods are offered with egg-crate grids, wood grilles, and detailed metal and wood surfaces. / Forms & Surfaces.



304



305



306

304 ACCESSIBLE GRID / The *Accent Ceiling* is based on a 4- by 6-ft structure that provides direct access to the plenum area through the center one-third section of each module. Demountable partition headers can be relocated without defacement to the tile or replacement of suspension components. / Conwed Corp. GB*

305 ACOUSTIC CEILING / Installed in Europe for more than 30 years, the *Daempa* sound absorbing ceiling is now manufactured in this country. Direct or suspended ceilings use perforated or plain metal-faced panels to satisfy a variety of noise reduction and service requirements. / Levolor Lortentzen, Inc. GB*

306 SUSPENDED CEILING / The aluminum *Plenum Mask* visually screens ductwork, wiring and piping in the plenum area, and allows effective diffused lighting. The space is not fully enclosed, and requires no extra costs for special air diffusers, lighting or sprinkler fixtures. / Alcan Building Products. ICR*



307



308



309

307 CEILING PANELS / Pictured is "Sahara," one of the *Registron* ceilings said to combine the look of tile with the economics of two- by four-ft lay-in panels. The bi-directional textured design and recessed tegular edges disguise the exposed grid system, providing a unified appearance with full accessibility. UL-listed *Registron* ceilings have a 0-25 flame spread and meet ASTM E-84. / Armstrong Cork Co. GB, I.*

308 FISSURED PANEL / Another *Registron* tile, "Travertine" lay-in ceiling tile has a grid-disguising fissured pattern. UL-listed ceiling has a Flame Spread of 25 under ASTM E-84, and a NRC Specification range of .50-.60. / Armstrong Cork Co. GB*

309 SOFT FABRIC CEILING / Fire-resistant *Soft Look* mineral fiberboard ceiling panels are covered with non-glare modacrylic fabric in six natural and six accent colors. Installed on an exposed-grid, the two-ft-sq panels absorb 60 of the sound that strikes their surface and provide a degree of thermal insulation to the overhead construction. / Armstrong Cork Co. GB, I.*



310



311

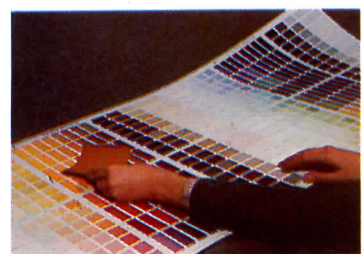

312

310 ACCENT CEILING / A two-by-two-ft tegular panel in the "Antique Glass" mirrored ceiling pattern allows a wide range of bold design options. "Antique Glass" ceilings have a NRC of .55; panels rest in an exposed grid system and offer easy access to plenum areas. / Armstrong Cork Co. GB, I.*

311 VAULTED CEILING / A recessed troffer ceiling system, the *Quadralon 441 Luminaire* provides high-quality, energy-efficient lighting in an economical lay-in ceiling. The 48-in.-sq module can be located anywhere within a 2-by-4-ft exposed grid system for precise task lighting. / Armstrong Cork Co. GB, I.*

PAINTING MATERIALS

312 HIGH-STRENGTH COLORS / Newly-formulated product bases and high-strength colorants are used in this paint system. Coatings have improved drying and hiding properties, better sheen control and color acceptance, and a wider range of colors in latex products, epoxies, floor paints and stains. / Pratt & Lambert, Inc.



313

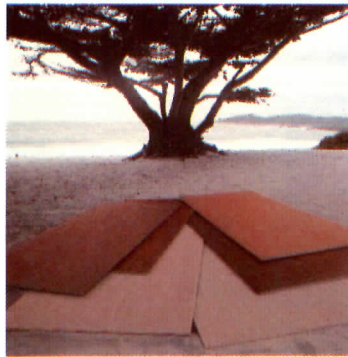

314

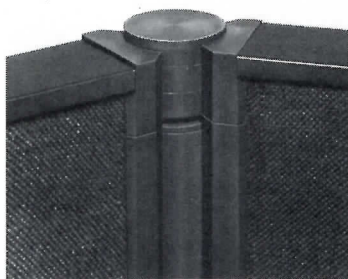

315

313 LATEX STAIN / Said to offer excellent color retention and superior adhesion, "All Acrylic" solid color latex stains also offer the advantages of a water-base product: fast drying, early repaintability, low pollution, and soap and water clean-up. / Samuel Cabot Inc. GB, LR*

PREFINISHED PANELS

314 VINYL-FACED GYPSUM / *Textone* gypsum wall panels have a vinyl surface 6- to 8-mil thick, available in four woodgrain patterns and "Sand Stripe" sand texture in two colors. / United States Gypsum Co. GB, LR*

315 ELECTRIFIED PANELS / The "Current Line" panel offered with *Private Space* offices has a raceway across the top of the panel, providing easy access for electrifying task and ambient lighting. Two 20-amp circuits deliver current where it is needed for machines, lights, etc., including three outlets at the base of the panel. / Rosemount Office Systems Inc.

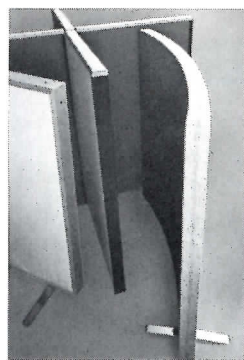

316



317



318

316 FREESTANDING SCREENS / Fully upholstered acoustical screens and office dividers are finished with a double welt trim; hardwood or metal edges are also available. *Acoustascreens* are made with an open or closed base, straight or curved, in heights to 72-in. Panel connecting assembly also allows for component attachment. / Acoustical Screens Corp.

317 CARVED WOOD PANELS / "Panelcarve 760-770" is a new product in this line of carved wood panels and grilles for walls, doors and furniture. Panels feature a tongue-and-groove edge detail that permits easy assembly without surface nailing. / Forms & Surfaces.

318 OAK VENEER PANELS / "Firelight Forum Oak" real wood veneer combines a mellow, warm finish with a distinct grain pattern. Panels are 1/4-in. thick, available in 4- by 8-ft sheets. / Georgia-Pacific Corp. I*

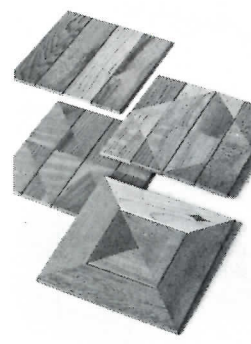

319



320

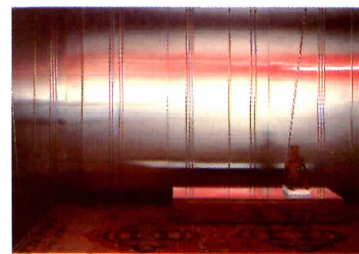

321

319 INLAID WOOD DESIGNS / Lightweight real wood wall covering, *Deco-wood* 12- by 12- by 5/16-in. tiles have redwood strips in various patterns mounted on a pliable backing. / Deco-wood.

320 BONDED BRONZE / Formerly offered only in flat panels, "Bonded Bronze" lightweight castings are now available in preformed sections for use on curves, corners and columns. Shaped sections install with panel adhesive over ply-sheathed areas. Textures and metals include aluminum, copper and nickel silver, as well as the bronze. / Forms & Surfaces.

321 METAL GRAPHICS / Stainless steel panels are arranged to form a related design theme, or may be embossed with company logos and trademarks for a custom installation. The "2000 Series" shown here consists of eight related designs in modular panels 44-in.-wide by 96- or 115-in.-long. / Forms & Surfaces.



322



323



324

322 CARVED REDWOOD / "3300 Series" are 9- by 36-in. vertical grain redwood or mahogany panels carved in designs based on natural forms. Panels can be combined in various arrangements to produce interesting doors, walls, furniture and architectural accents. / Forms & Surfaces.

323 PREFINISHED PLYWOOD / A real cedar face veneer in a rich fruitwood color, "Fire-light Cedar" paneling has a durable, low-maintenance finish. Suitable for both residential and commercial interiors, paneling comes in 1/4-in. thick, 4- by 8-ft sheets. / Georgia-Pacific Corp. I*

324 METAL TAMBOUR / Able to bend easily around inside and outside curves, architectural tambour is now offered in four metal finishes: satin aluminum, satin bronze, bright aluminum and bright gold. / Forms & Surfaces.

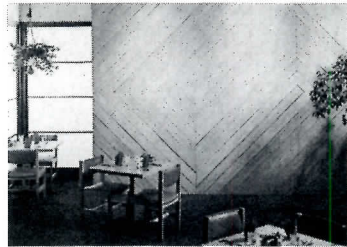

325



326

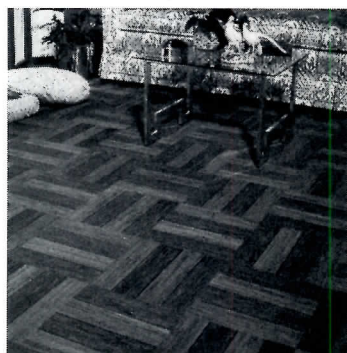

327

325 WOODFIBER PLANKS / A prefinished wood-fiber, material, *Monoplank* comes in 6- by 96- by 1/4-in. planks, which can be applied with shiplap joints in any number of designs and patterns. Available in oak and cedar woodgrain designs, *Monoplank* has a dent- and abrasion-resistant melamine finish. / Masonite Corp.

326 DURABLE FINISH / *Glasweld* high performance interior panels are now offered in an expanded range of color choices. The tile-like finish panel is abrasion-resistant, and is USDA-approved for food plants. Panels are non-combustible; prices start at \$1.50 per sq ft. / Glasweld Products Div., GIL Corp. GB*

RESILIENT FLOORING

327 SOLID VINYL TILE / "Parquet" patterns of perpendicular board segments are translated in 12-in.-sq solid vinyl tiles for commercial and residential floors. Oak, walnut and cherry wood colors are available in the "Parquet" line. / Kentile Floors, Inc. GB, LRC, LR, I*



328



329



330

328 NO-WAX VINYL / A no-wax sheet vinyl, "Landen Wood" reproduces the graining and wood lines of a parquet floor. Pecan, Golden Oak and Mahogany patterns are available, in 6- and 12-ft widths. "Landen Wood" is priced to retail at about \$11.95 per sq yd. / GAF Corp. GB, ICR, LR, I*

329 COMPOSITION VINYL / "Camino Real" is vinyl composition floor tile embossed with a Mediterranean paver design. Offered in terracotta, white, umber and beige colorways, "Camino Real" can be installed on, above, or below grade over concrete or wood subfloors. / Azrock Floor Products. GB*

330 BRICK PATTERN / For heavy-duty commercial installations such as stores and schools, "Lonbrick" embossed sheet vinyl flooring has a reinforced fiberglass backing for stability. Flooring is 100-mils thick, available in Brick Red and Antique White colors. / Lonseal, Inc. GB*

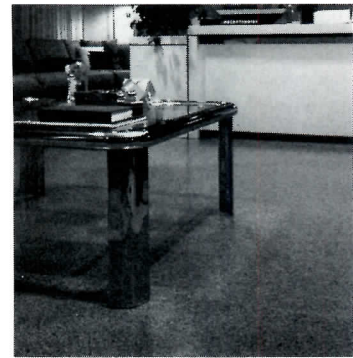

331

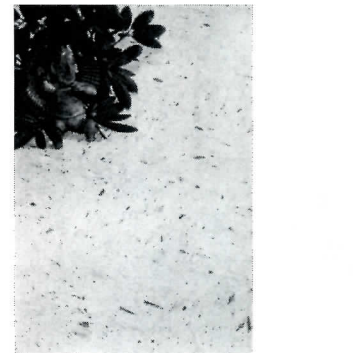

332

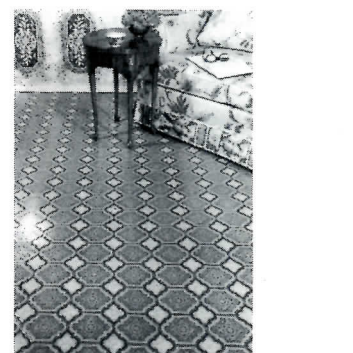

333

331 INLAND VINYL / An .090 gauge commercial sheet that can be installed with chemically-welded seams for a seamless floor, "Sandoval" vinyl has the appearance of terrazzo, with "mortar" surrounding multi-hued vinyl chips. For heavy commercial applications, UL-Listed "Sandoval" meets NBS smoke chamber and ASTM E-84 requirements. Installed cost is about \$1.05 per sq ft. / Armstrong Cork Co. GB, ICR, LR, I*

332 TERRAZZO VINYL / "Chipstone" reinforced vinyl tile features large and small translucent vinyl chips overlaid on a matrix of smaller chips. Each smooth-surfaced tile is 1/16-in. thick, available in regular and self-adhering backs. Kentile Floors. GB, ICR, LR, I*

333 MOORISH TILE / A *Gafstar 6700* floor with a "Super Vinyl Surface" wearlayer, "Caracas" pattern features two medallion motifs of different sizes. Sheet flooring comes in five colorations; 6- and 12-ft widths allow for seamless installation in most rooms. / GAF Corp. GB, ICR, LR, I*

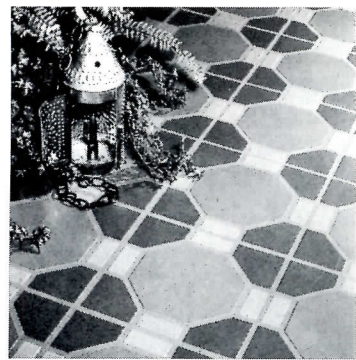

334

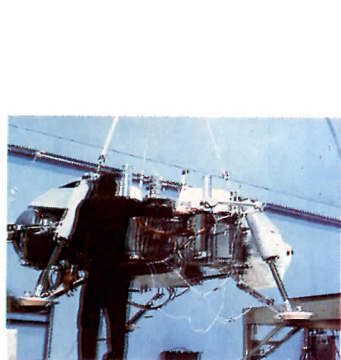

337

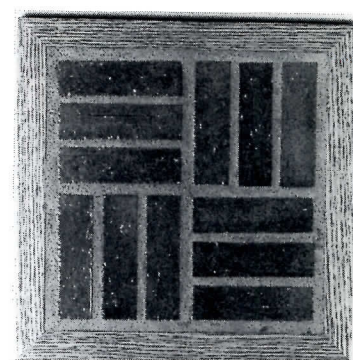

340



343



335



338

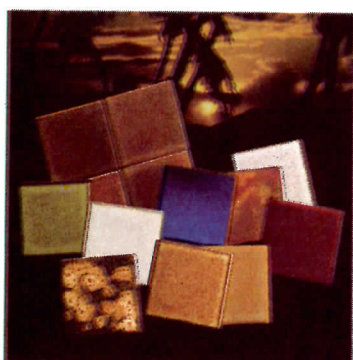

341



344



336



339



342

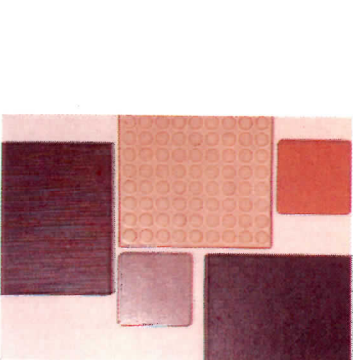

345

334 FLOOR TILE / "Octad" solid vinyl has the look of hand-set Belgian quarry tile, offered in four colors: tan, charcoal, brown and adobe. Each 12- by 12-in. tile is 1/8-in. thick. / Kentile Floors, GB, ICR, LR, I*

335 MODERATE PRICE / For residential and commercial installation, solid vinyl "Woodhaven" floor tile has the color, grain and texture of wood parquet. Twelve-in.-sq tiles come in Cherry, Black Walnut, and Oak colors. / Kentile Floors. GR, ICR, LRC, I*

336 RESILIENT SHEET / For commercial installations of wide-width resilient sheet flooring, "Barley Mills" has a textured over-all pattern of flagstone and pebbles in natural shades of white, butty, green, burnt orange, beige and brown. / Mannington Mills, GB*

SPECIAL COATINGS & SURFACES

337 PORCELAIN ENAMEL / Mirawal hypo-allergenic surfaces, porcelain enamel on steel laminated to a choice of substrates, will not support the growth of bacteria, making them especially suitable for use in hospitals and food plants. Prices for the vitreous interior finish start at \$2.25 per sq ft. / Mirawal Products Div., Gil Corp. GB*

338 SURFACE PROTECTANT / A clear, water-based polymer, *Global Guard* coatings protect walls, sculpture vehicles, tunnels, etc., from permanent defacement by graffiti or airborne pollution. Markings will not penetrate the coating, which can be removed using *Global Guard* solvent. Area must then be re-coated. / Laclede Research Laboratories

339 WRITE-ON SURFACES / "Markerboard" and "Chalkboard" finished wall panels are now available in full wall sections and a wide range of colors. Low maintenance walls will also accommodate magnetic accessories and fasteners. / Mirawal Products Div., Gil Corp. GB*

SPECIAL FLOORING

340 WOOD/BRICK FLOORING / Manufactured as 12-in. sq, 5/8-in. thick tongue-and-groove panels, "Brick Parquet" combines oak flooring and kiln fired clay brick in intricate patterns. Squares weigh two lb each, and may be installed with heavy-duty adhesive over wood or concrete sub-floors. / Towne Brick Corp.

TILE

341 CERAMIC SQUARES / "Pacific" ceramic tile comes in 14 "South Sea" colors; the three-in.-squares are furnished mounted on mesh-backed 12-in. sheets for fast installation. "Pacific" tile's commercial glaze is graffiti-resistant. / Gail International Corp. GB, ICR, I*

342 ENAMELLED TILE / Created by Roger Capron, "Sauvage" enameled tile is available in two versions: with or without an intense pattern of wild plants, trees, and leaves. Offered in white or hazelnut colors, tiles may be used indoors or out. / Hastings Tile, GB, I*

343 MARBLE TILE / Resin-impregnated "Zeta" marble and onyx tiles have a horizontal or vertical strip design, providing many pattern possibilities for floors, walls and furniture. Units measure 6- by 12- by 1/4-in., and are installed with an adhesive like ceramic tile. / Hastings Tile. GB, I*

344 KITCHEN TILE / The fruit designs offered in "Series Graphis" ceramic tiles may be combined with the other stripes, checks and border designs in the collection to produce a distinctive kitchen floor or wall graphic. / Hastings Tile. GB, I*

345 CERAMIC TILE / Handcrafted unglazed pavers and glazed tiles are offered in colors and sizes to meet contemporary architectural requirements. Sizes range from 3- by 6-in. to 12-in. squares; a 6- by 6-in. radius corner tile is available. / Forms & Surfaces.

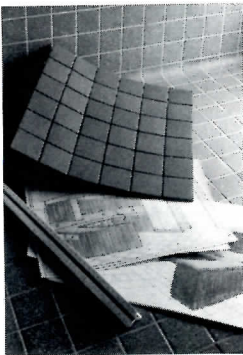

346



349



352



355

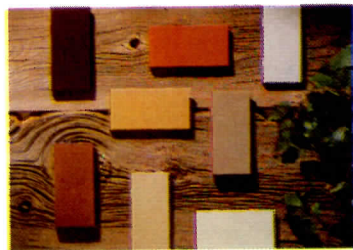

347

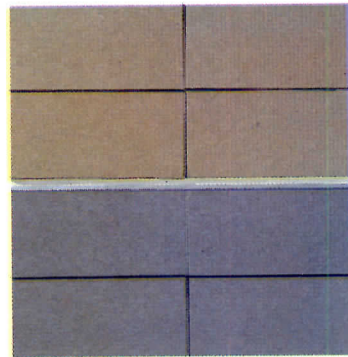

350



353

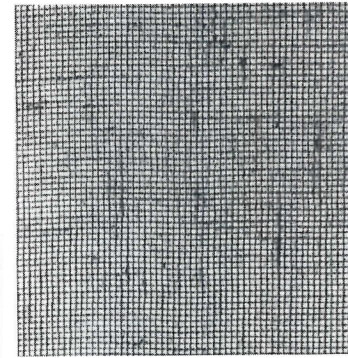

356

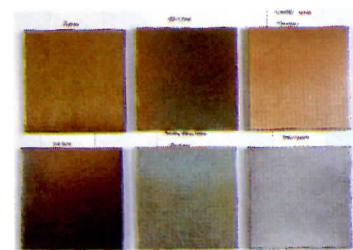

348



351



354



357

346 CERAMIC MOSAIC / Frostproof, unglazed ceramic mosaic tile is available in two new colors, "Denim," a white-flecked blue, and "Rust," a warm quarry tile shade. An abrasive grain is offered in the 1- by 1-in. tile size; other sizes are 2- by 1-; 2 by 2-; and a 2-in. hexagon. / American Olean Tile Co. GB, LR*

347 NATURAL COLORS / Eight new colors have been added to the "Terra Grande" ceramic tile line, all designed to work with each other as well as individually. New shades include popcorn, vanilla, buff, dusk, wheat, mesa, nutmeg and chocolate. Sizes range from 3- by 6-in. to 4- by 9-in. / Franciscan Tile. GB, I*

348 MOTTLED FINISH / "Country Series" glazed ceramic tile has a soil hiding mottled surface, offered in six colorways. Suitable for interior walls and floors, the 8-in.-sq tile is priced in the same range as top-line vinyl and carpet. / Gail International Corp. GB, ICR, I.*

349 CERAMIC PAVERS / Natural flame flashing produces a handcrafted appearance in the earth-toned "Normandie" line of 2-in.-thick ceramic tile pavers. Abrasion-resistant tiles may be used on heavy-traffic floor and walls, inside and out; sizes range from 4- by 9-in. to 10- by 20-in. / Metropolitan Ceramics, Inc.

350 INDUSTRIAL TILE / Slip- and frost-resistant "Unglazed Brickplate" is less absorbent than quarry tile, making it especially suitable for industrial and food processing plants and other heavy traffic areas. Offered in 10 natural earthtone colors, "Brickplate" comes in four square and rectangular shapes for paving and facing use indoors and out. / Gail International Corp. GB, ICR, I.*

351 TILE DESIGNS / Geometric dots, stripes and squares in a total of 27 different designs, "Serie Elementare" 8-in.-sq ceramic tiles can be combined in a variety of patterns for floor or wall. Tiles come in cobalt blue or white, white on blue, brown on white, or white on brown colorways. / Hastings Tile. GB, I*

352 TILE GRAPHICS / Bright, bold-scaled wall and floor graphics can be created with "System Modula" ceramic tiles. Tiles come in 5- by 5- and 5- by 10-in. sizes, in an extensive spectrum of natural and bright colors. / Hastings Tile. GB, I*

353 BATH FINISH / Corian marble-like sheet was used in this condominium development in the kitchen, bar and bath areas. A 1/2-in. thick sheet is over particle board, bonded and installed with carpentry techniques. / Du Pont Co.

354 HAND PAINTED TILES / Italian tiles come in 8- by 8-in. squares for use on floors and walls. All colors in each design may be custom coordinated for special orders. / Hastings Tile. GB* I*

355 BRICK-PAVERS / Ironrock high-density pavers combine the natural rustic tones and durability of brick with the convenience and lower cost of tile for commercial and residential applications. Non-glazed surface texture provides natural slip-resistance; eight color blends are offered. / Metropolitan Ceramics, Inc.

WALL COVERINGS

356 FABRIC LAMINATES / "Natural Hessian" Dillercloth high-pressure laminate is real linen fabric protected with melamine to retain the texture of the material. For vertical and horizontal interior applications, "Natural Hessian" resists abrasion, alcohol and heat. / The Diller Corp. GB, I*

357 BORDER EFFECT / Diverse textures are combined in "Ibis" pattern vinyl wallcovering: "twisted-rope" accents form a vertical border against an over-all abstract basketry design. Class A fire-rated, "Ibis" comes in 54-in. widths and 20 colorways. / L. E. Carpenter and Co.



358



361



364



367



359

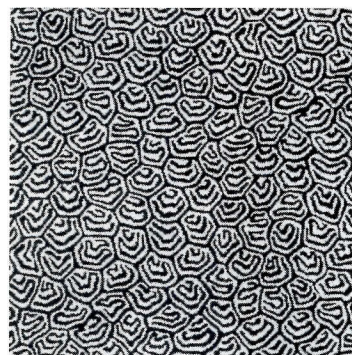

362



365

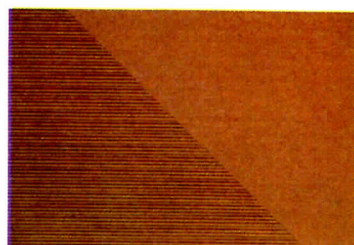

368



360

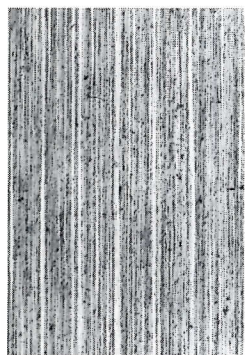

363



366

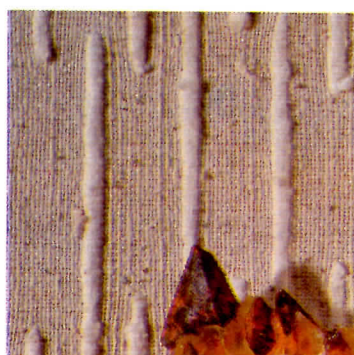

369

358 WALLCOVERINGS / A variety of wallcoverings are offered for interior applications. Included are soft, muted color backgrounds, and patterned wallcoverings. / Birge Wallcoverings.

359 SOLAR WALL FINISH / A high heat transmission factor makes the *Flexi-Wall* wallcovering system suitable for use on the thermal mass walls of passive solar heating installations. / Flexi-Wall Systems. GB*

360 REDWOOD PANELING / Sapwood and heartwood clear grades of redwood are used for this 1- by 6-ft tongue-and-groove pattern. Redwood insulates against heat, cold and noise, and is inherently flame-resistant. / California Redwood Assn.

361 RATED WALLCOVERING / One of the *Vicrtex* line of wallcoverings, "Rimini" textured vinyl is said to be virtually impervious to scuffs, stains and mildew. Class A fire-safety rated, "Rimini" comes in a 54-in. width and 25 colorways. / L. E. Carpenter and Co.

362 FIGURED VELVET / Available as both fabric and wallcovering, "Soigne" is a soft, figured cotton velvet. Pattern is offered in dark green and celadon. / Abraham-Zumsteg.

363 STRING LAMINATES / Natural color "Novaram" wallcoverings take design elements from the vertical effect created by strings laminated to paper. Durable material has a Class A flamespread rating, and is offered in 22 patterns for contract applications. / DesignTex Fabrics, Inc.

364 RATED WALLCOVERING / A deeply textured pattern, "Jarvis" is an addition to the *Vicrtex* line of contract wallcoverings, Class A rated with a fire hazard classification of 20-0-45. The fabric-backed vinyl resists tears and stains; it is offered in 21 colors and a 54-in. width. / L. E. Carpenter & Co. GB*

365 SMALL-SCALE PRINTS / The *Miniatures* vinyl wallcovering collection contains 118 small-scale designs of florals, prints geometrics and stripes, many with harmonizing fabrics. Pattern illustrated is "Square and Square." / Stauffer Chemical Co. GB, I*

366 ETCHED METAL / Hand-etched brass and pewter, treated with a burn-and scratch-resistant coating, is suitable for wall paneling, counter tops, decorative inserts, trim pieces, etc. Panels are available in almost any size, either un laminated, or bonded to any specified substrate. / Lunstead Designs.

367 STRING WALLCOVERING / The "Kind Regards" string wallcovering collection consists of ten vertical yarn variations and five overprint patterns; pictured is "On Walden Pond." Wallcoverings come in 28- and 30-in. widths. / Gilford Inc.

368 TEXTURED VINYL / Fire-rated "Guard" vinyl wallcoverings are offered in two new patterns: "Santa Fe," a grainy leather look; and "Eldorado," a corded texture. Both come in 28-in.-widths, in 16 colors including browns, rust, green and navy. / Columbus Coated Fabrics, Borden Chemical. GB, I*

369 WALL FABRICS / This Indian cotton with distinctive texture is part of an extensive collection of natural fabric wallcoverings. Linen, wool weaves and wool knits are included in the line, all in patterns and textures for multi-wall coverage. / L. E. Carpenter and Co. GB*

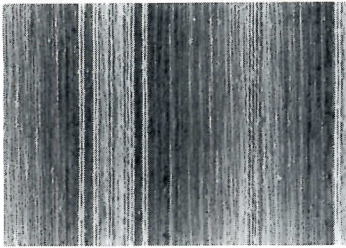

370

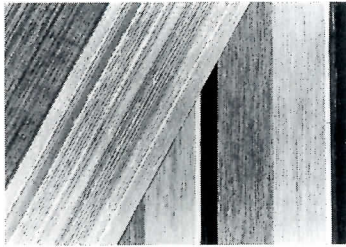

371



372

370 WALLCOVERING / The "Eden" warp yarn wallcovering is equally suitable for residential and contract installations. It is composed of 71 per cent of Belgian Linen and 29 per cent rayon. / DesignTex Fabrics, Inc.

371 FABRIC WALLCOVERINGS / Available either as warp-lays or woven in a nubby texture, linen wallcoverings have inherent noise-reducing, flame-resistant properties. The all-linen paper-backed products shown here are priced up to \$18.70 per yard retail. / Gilford Inc.

372 CONTRACT WALLCOVERING / A 36-oz Type II wallcovering, "LaKosta" reproduces the hand-troweled appearance of adobe in a textured vinyl pattern. Offered in 30-yard rolls 54-in. wide, "LaKosta" comes in 17 colors. / B. F. Goodrich Co. I*

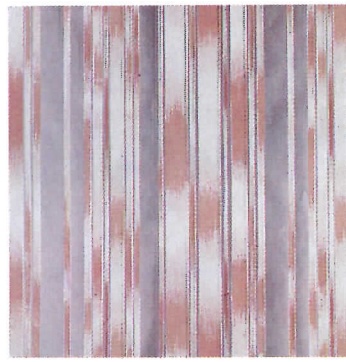

373

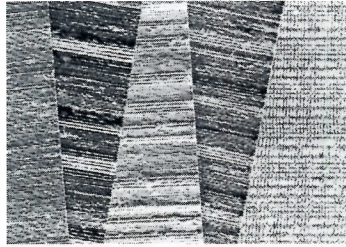

374

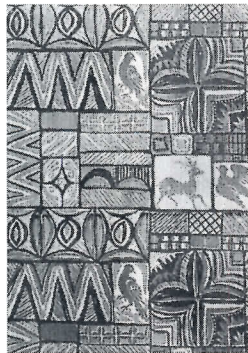

375

373 MYLAR STRIPES / Designed by Angelo Donghia, "Impressions" wallcovering has an Art-Deco look with colored stripes of various widths. Four colorways include ombre and white stripes on silver Mylar and ombre, grey and cream on soft brown Kraft paper. / James Seeman Studios.

374 LINEN WALLCOVERINGS / Coarse, natural Belgian linen fibers provide directional pattern and surface interest to *Vicrtex* paper-backed fabric wallcoverings. These "Natural Classics" resist tears and abrasion; linen fabric wallcoverings also supply acoustical and insulation qualities. / L. E. Carpenter & Co. GB*

375 CONTRACT DESIGNS / Motifs used in the "Interpretations" collection range from the stone-look of "Olympus," pictured, to literal representations of birds in flight. The 24 wallcovering designs are available in 96 colorways on *Tessitura*, *Mylar*, vinyl and Kraft paper grounds. / James Seeman Studios.



376



377



378

WOOD FLOORING

376 OAK FLOORING / Mixed red and white oak with prominent grain characteristics is used for "Windsor" 3/4-in. plank floors. Nail-down oak planks are 3- and 5-in. wide, factory-finished for minimum maintenance. / Bruce Hardwood Floors. GB LR, I*

377 HARDWOOD FLOOR / "Sherwood Plank" solid oak flooring combines the traditional look of wood pegs with a contemporary use of 3- and 5-in. alternate width planks. Floor is factory-stained and wax-finished in a gunstock brown shade. / Bruce Hardwood Floors. GB, LR, I*

378 BLOCK FLOORING / A three-dimensional arrangement of solid teak, black walnut, white oak or red oak, the "chaucer" pattern is the most recent addition to the *Bondwood* parquet flooring line. Panels measure 13 7/16-in. square with mitered cuts; flooring is offered ready to finish. / Harris Mfg. Co. GB*



379



380



381

379 RANDOM WIDTH FLOOR / Featuring unpegged 3-, 4-, and 6-in.-wide planks, "Cambridge Plank" flooring pattern is 3/4-in.-thick solid oak. Smooth-sanded floor is available in "Toast" and "Gunstock Brown" finishes. / Bruce Hardwood Floors. GB, LR, I*

380 WIDE PLANK FLOORS / "Stratford Plank" solid oak is 3/4-in.-thick, offered in 5-in.-widths for use on both floors and walls. Prefinished in "Gunstock Brown" shade. / Bruce Hardwood Floors. GB, LR, I*

381 PEGGED OAK / Factory-installed walnut pegs give "Country Oak" plank flooring a Colonial look. Pattern uses 3-, 4- and 6-in. oak planks in a rustic brown shade; low-maintenance floor has a baked-on factory finish. / Bruce Hardwood Floors. GB, LR, I*

How many well-known walls can you recognize?

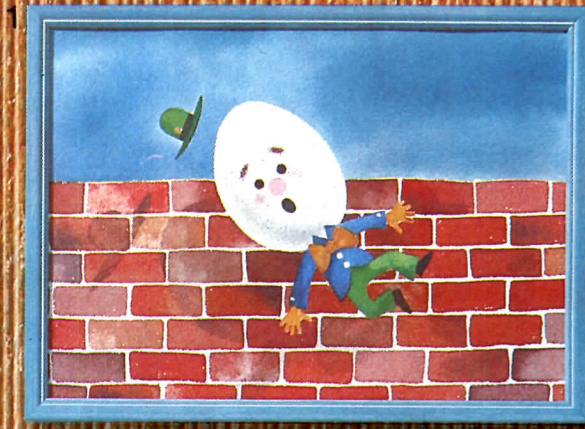

- Answers:**
1. Humpty Dumpty's Wall.
 2. Great Wall of China.
 3. Wall-to-Wall Traffic.
 4. Harvey Wallbanger.
 5. Fats Waller.
 6. Wallflower.
 7. Wall Street.
 8. Novatin, one of the many DesignTex walls for your selection.

Rich woods, Textural Nylos, Belgian and Swedish linens, Indian cottons, Available with paper backing, acrylic-backing, or sound-controlling Acoustex. Contact us for samples of the DesignTex wall coverings.



The Complete Product Line

FOR QUALITY CERAMIC TILE AND CLAY PRODUCTS INSTALLATION

The right product at the right price for installing, grouting, cleaning and sealing. You can't go wrong with L & M . . .

*** CEMENT BASE GROUTS ***
*** CEMENT MORTARS ***
*** SPECIAL GROUTS OR MORTARS ***
*** ADHESIVES * CLEANERS ***
*** SEALERS and STAINS ***
 And Other Specialty Products

For More Information, Write or Call

L & M Surco Mfg., Inc.

HOME OFFICE: P.O. Box 105, South River, N.J. 08882 (201) 254-4830
 WEST COAST WAREHOUSE:
 1303 Stanford Ave., Emeryville, Cal. 94608 (415) 653-8321
 OTHER PLANT LOCATIONS: Dallas and Atlanta

Circle 1047 on inquiry card

About mailing lists... an important notice to our subscribers.

In recent years we have made the list of subscribers to McGraw-Hill publications (names and mailing addresses only) available to carefully screened companies whose products or services might be of interest to you.

These companies enter into an agreement that permits them to mail information to you without placing you under any obligation.

We have always considered such direct marketing activities to be legitimate and important in the American system of free trade—and we're confident that the majority of subscribers share this position.

However, we respect the interests of those who for some reason may wish to have their names restricted from such use by companies either affiliated or not affiliated with McGraw-Hill, Inc.

If you wish to delete your name from lists we make available to other firms, please fill in the information requested below exactly as it appears on your mailing label on the cover of this issue. Or, if you prefer, attach the label itself to the coupon and return.

McGraw-Hill, Inc.

P.O. Box 555, Hightstown, N.J. 08520
 Attn: Mailing List Dept.



Please remove my name from your mailing lists.

Title of this publication _____

Name _____

Address _____
 (exactly as shown as mailing label, please)

City/State/Zip _____

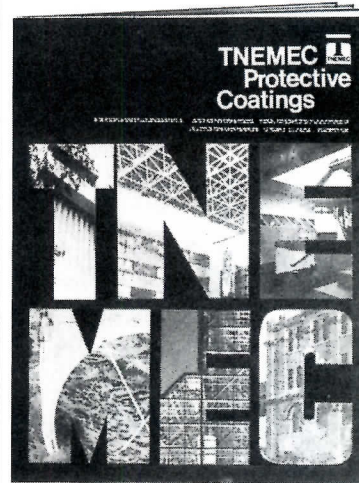

3069 PROTECTIVE COATINGS / An 8-page catalog presents detailed information on coating systems for surface protection and decoration. Individual coatings are described by principal chemical formulation, and primary properties. Coatings are charted as complete systems recommended for exterior or interior environments, and for the type of surface and construction material to be painted. / Tnemec Company, Inc.

3070 BLOCK INSULATION / A brochure describing an energy-saving insulation process designed to fit standard two-core masonry units of 6-, 8-, 10-, and 12-inch sizes. Energy-saving data and product information are listed along with the benefits of masonry construction. / Korfil Inc. GB*

3071 COMMERCIAL WALLS / A six-page color folder describes the use of *Formawall* on the exterior of a four-level shopping complex. Multiple 30-in.-wide panels and deep reveals were used to create the effect of large, flat wall areas and sandwiched within the envelope of the factory-assembled panel in 2 in. of foam insulation. / H.H. Robertson Company.

3072 EXTERIOR WALLS / A full-color folder illustrating the application of *Forma2wall* on the exterior of the Federal Employees Credit Union in Utah. Line illustration shows construction details of a typical sloped wall section. Close-ups and long shots alike demonstrate the compatibility of *Forma2wall's* straight, curved, and angular surfaces with the exposed concrete frame. / H.H. Robertson Company.

3073 WALL SYSTEMS / A 24-page, full-color brochure provides a capsule view of this complete line of exterior wall systems. Included are sectional drawings, fire ratings, material and finish options, thermal properties, and other design data, as well as photographs of finished installations that display a wide application of flat and profiled architectural walls. / H.H. Robertson Company.

3074 COATING FOR METAL WALLS / A full-color brochure describes the multilayered coating system and displays a representative group of installations. Test results from a 10-year study in Scandinavia and a performance standard chart are included. / H.H. Robertson.

3075 INTERIOR WALL PANELS / A 4-page color brochure details new interior wall panels and includes a description of panel features, plus technical data on acoustical and fire performance and color selection. Also included are diagrams detailing the wall panels' composition. / Owens-Corning Fiberglas.

3076 INSULATION GUIDE / A new booklet to help contractors and engineers comply with ASHRAE 90-75 insulation standards for piping, equipment and air handling systems is available. The 12-page guide spells out the specific ASHRAE standard in each construction category and describes products that meet or exceed those specifications. / Owens-Corning Fiberglas Corporation.

3077 URETHANE FOAM INSULATION / An 8-page illustrated brochure is now available to architects, contractors, and applicators using urethane foam insulation. The brochure contains energy-saving applications for building pipe, tank insulation, and includes comprehensive architectural roofing specifications with details. / Chemetics Systems, Inc. GB, ICR, LRC*

3078 ROOFING PANELS / A new product brochure for fascia and roofing panels featuring five product categories: Free Form Panel System, Quick-Lock Panel System, Standing Seam Panel System, Custom Standing Rib Panel System, and Soffit Panels. / Foremost Manufacturing Company.

3079 PLYWOOD FLOOR SYSTEMS / A 16-page pamphlet providing detailed explanations of plywood use in combined subfloor-underlayment, the APA Glued Floor System, special floor systems, and traditional subflooring and underlayment. A guide to the proper grades and thicknesses of plywood to use in each application is also included. / American Plywood Association.

3080 ROOFING/WATERPROOFING / A 48-page roofing specification manual provides technical information and up-to-date installation and warranty data on a full line of roofing and waterproofing systems. Included are coal tar roofing, built-up roofs, the KMM membrane system, and liquid and mastic applied waterproofing and dampproofing products. / Koppers Co.

more literature on page 123

uci10

specialties



394

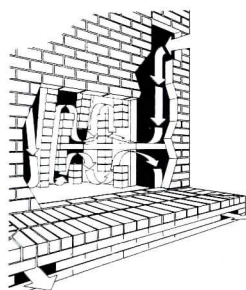

395

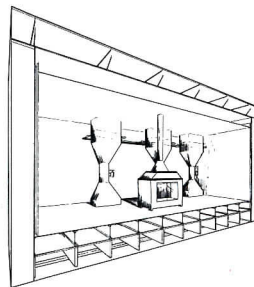

396

FIREPLACES

394 FIREPLACE FURNACE / A wood-burning forced air fireplace, the "Queen Air" is capable of heating a 10-room home. Units consist of an enclosed combustion chamber, two 500 cfm squirrel cage fans, and a heat exchanger installed in a masonry surround. A 36-in.-wide "Queen Air" excluding glass doors, lists for \$950.00. / George Mayer Mfg. Inc.

395 MASONRY FIREPLACE / The *Brick-O-Lator* fireplace is constructed with brick heat-exchange chambers, through which air is circulated and redistributed into the room. Glass doors enclose and control the fire. / Triangle Brick.

396 FIREPLACE TESTING / A testing laboratory at the School of Engineering, Auburn University, provides architects, contractors and consumers with performance data on the heat output and efficiency of manufactured, wood-burning heating products. Part of the test facility, an insulated typical home-sized room, is shown in this cutaway drawing. / Fireplace Institute.

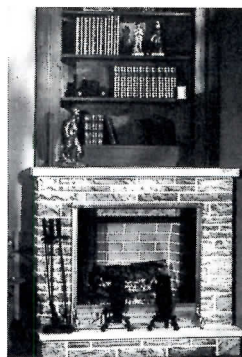

397



398

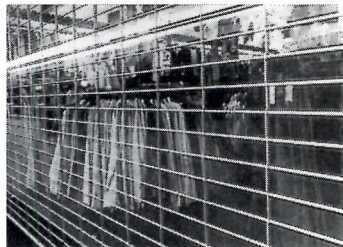

399

397 CORNER FIREPLACE / Said to be easy to install, the *Readybuilt* cast quarry stone fireplace with wood bookshelves measures 4-ft across. This precast fireplace is suitable for use with electric or gas logs. / Readybuilt Products Co.

398 BOILER FIREPLACE / Italian-made *CAIT* unit has a steel water chamber at the top of a fireplace which acts as a heat exchanger. Water within the chamber's tubes is heated directly by the fire and hot exhaust gases, and piped into a system for primary space heating with baseboard radiation; back-up for a forced-air unit; domestic hot water service, etc. / Youngstown Design Center.

GRILLES & SCREENS

399 SECURITY GRILLE / Constructed of aluminum covered steel rods and continuous strips of transparent, break-resistant polycarbonate, the *Lex-A-Lite* rolling grille provides for shopping mall security while permitting "window shopping" display of merchandise. The grille can be fabricated in virtually any size. / Jim Walter Doors / North American. GB, ICR*

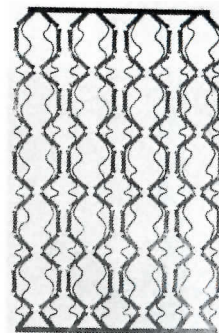

400



401

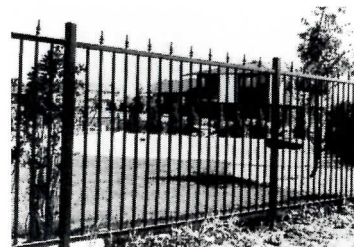

402

400 ARCHITECTURAL IRON / Hand-crafted with traditional blacksmithing techniques, custom-designed architectural ironwork is available executed by Joel A. Schwartz. These items include window grilles, spiral stairways, gates, railings and screens. / Schwartz' Forge & Metalworks.

401 ROLLING GRILLES / Straight lattice, continuous chain grilles provide security as well as ventilation and visibility to the area being protected. Interlocking aluminum or steel links form a network of vertical and horizontal lines. Counterbalanced rolling grilles are available with electric, chain hoist, crank and manual operation / Overhead Door Corp.

402 ORNAMENTAL FENCING / Marketed for residential and public swimming pool enclosures, this security fencing is structured of 1½-in. rail channels and ¾-in. sq steel tubing pickets; cast iron top ornaments complete the installation. Black baked-on finish resists rust and corrosion. / Fencote Inc.

FIREPLACES
GRILLES & SCREENS
IDENTIFYING DEVICES
LOUVERS & VENTS
PARTITIONS
SUN CONTROL DEVICES
TELEPHONE ENCLOSURES
TOILET & BATH ACCESSORIES



403



406



409

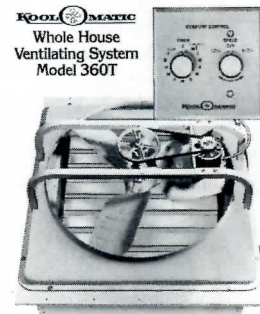

412

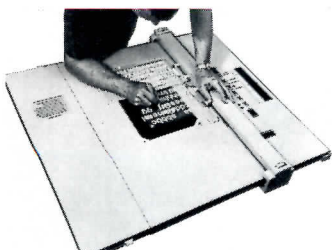

404



407



410



413



405

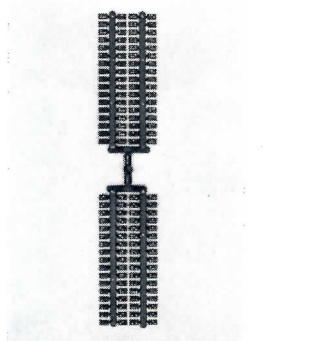

408

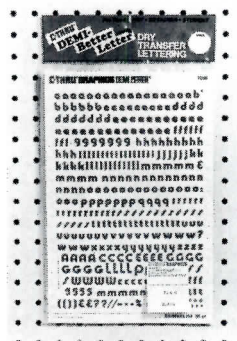

411

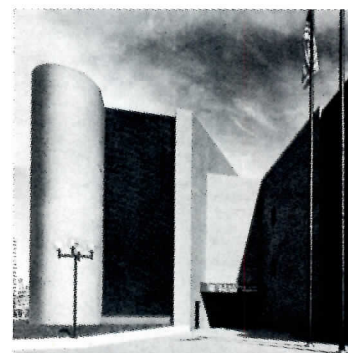

414

403 TRAFFIC CONTROL GATES / Compact and easy to operate, *Acorn* folding gates are designed for use as traffic control units in school corridors, institutions and commercial buildings. Adaptable to fit most conditions, the gates provide ventilation without loss of security. / Acorn Wire and Iron Works. GB, ICR*

IDENTIFYING DEVICES

404 INTERIOR SIGNAGE / The *Omni-graf* subsurface graphics system offers interior signage design, layout, laminating and mounting. The dry transfer technique used allows custom letter spacing options; integrated identification components provide a consistent message throughout a facility. / Scott Machine Development Corp. GB*

405 LOGO WALLCOVERING / Corporate symbol or other identification can be woven into all-wool wall hangings, tapestry, area rug or carpet. Sizes range from a 2- by 2-ft rug to quantities of carpet for installation throughout a building. / Logo Looms. GB*

406 DIECUT VINYL LETTERS / Offering a modern lettering style for use on desk nameplates, signs and directories, *Quik-Align/2* pressure sensitive letters come mounted on strips of 10 characters. Alignment bars diecut to the bottom of each section speed installation. / W.H. Brady Co.

407 DIMENSIONAL LETTERING / Mirror letters in both clear and tints of blue, green, amber, yellow and bronze are available in 24 stock styles. Offered with polystyrene backing in thicknesses from 1/8-in. to 4-in., letters may also be beveled for window and counter display. / Polyplastic Forms, Inc.

408 BRAILLE SIGNAGE / This touch system for the non-sighted or visually handicapped is a series of braille raised dots set into plastic that can be applicable for any public or private facility. Each braille character has a corresponding English alphabet character molded on the reverse side so it can be hung for multi-purpose use. / Scott Plastics Co.

409 SAFETY BARRIER / *Avert-A-Hurt* barricade tapes are intended to replace ropes, wooden barriers or signs in temporary dangerous or restricted areas around construction sites, high voltage stations, etc. Colorful tapes come in convenient carry-and-dispense rolls. / Banner Guard, Div. Reef Industries, Inc.

410 EXTERIOR SIGNAGE / Tough and transparent, *Lexan* sheet may be used for both illuminated and non-illuminated signs. Facade signs are available in lengths to 59-ft, set in extruded aluminum housings. *Lexan* signage is weather- and impact-resistant. / Plastics Div., General Electric Co.

411 TRANSFER LETTERING / A new sheet size is available in this dry transfer line: the "Demi-Better Letter" measuring 8- by 12-in. Letters are offered in 25 different type styles plus arrows, dots and borders. List price per sheet is \$2.00. / C-Thru Graphics.

LOUVERS & VENTS

412 WHOLE HOUSE / A ventilation system for the entire house, *Kool-O-Matic* fans install in joint or truss areas of a centrally located hallway ceiling. Air flow is directed by opening and closing windows. A solid-state speed control and timer operates the ventilator automatically. / Kool-O-Matic Corp.

413 STATIC ROOF VENT / Made of ABS plastic covered with an acrylic finish in either black or brown, static roof vents are FHA-approved and wind tested over 100 mph. Screened to keep insects out, the vent's low profile blends with most residential roof lines. / Leigh Products.

414 AIR HANDLING LOUVERS / Industrial and commercial louvers provide high free areas with low water penetration test results. A new addition to this air handling line are drainable blade louvers: dual gutter design directs water to the jamb or mullion drains, preventing both cascading water and air borne droplets from penetrating the louver. / Construction Specialties, Inc.

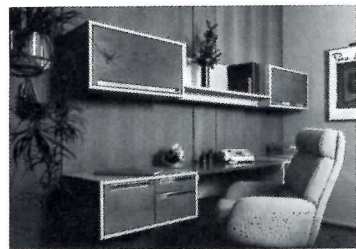

415

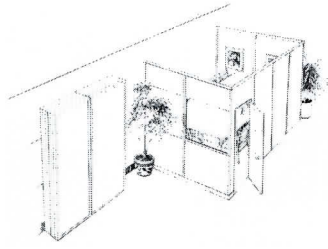

418

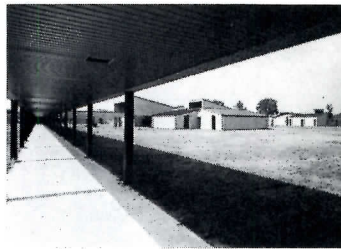

421



424



416



419



422

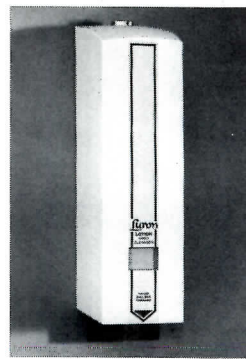

425



417



420



423

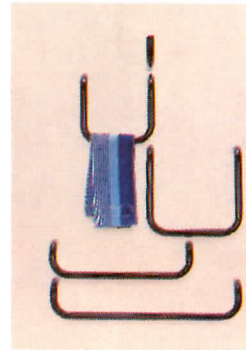

426

PARTITIONS

415 OFFICE PARTITIONS / *Design Option* full-height partitions are completely pre-fabricated, easily installed with non-marring ceiling and floor channels. Portable walls feature radius corners; finish options include baked enamel and genuine wood species. / The E. F. Hauserman Co.

416 PRIVACY SCREENS / Double-thick divider screens provide three levels of office or work station enclosure: 4- by 6-ft standing privacy; 4- by 4½-ft seated privacy; and a 4- by 3-ft screen for area definition. Freestanding dividers are framed in walnut-stained hardwood. / Ghent Mfg. Inc.

417 DEMOUNTABLE WALLS / Designed for economical installation and maintenance, the *Dimension Wall* "B" interface system can accommodate modular furniture units, attaching and leveling them on the wall surface itself. / Roblin Building Products. GB*

418 FOLDOUT ROOMS / *Foldaroom* panels, complete with doors and windows, fold easily from the wall of a gymnasium or other open space to create self-contained offices, classrooms, etc. Standard sizes range from 8- by 12 to 16- by 12-ft; one room has an automatic fold-down ceiling for sound control. / Won-Door Corp.

SUN CONTROL DEVICES

419 SHADE STRUCTURE / To control sunlight in outdoor areas, custom aluminum patio covers can be built to conform to shape and dimensions of rectangular, oval and circular areas. The patio covers meet local load requirements. / Alcan Building Products. ICR*

420 ALUMINUM CANOPY / Window-shading canopy system deflects sun's rays as well as provides shelter from snow and rain at doorways. Aluminum panels have a polyester finish for low maintenance. / Alcan Building Products. ICR*

421 WALKWAY CEILING / Shown here installed as the weather-resistant ceiling in a covered walkway, the *Planar* system provides an open plenum area above for running wiring, piping and hvac ducts between buildings without the expense of underground installation. / Alcan Building Products. ICR*

422 SOLAR DRAPE LINER / Heat-reflective/heat radiant reversible silver/white liners attach to the back of existing drapery, using the same hardware and hooks. Silver-side-out in summer reflects solar heat turned towards the room side in winter, it re-radiates furnace heat into the room. Pleated panels are 95-in.-long; double face adhesive joins panels to create liners of any width. / Wind-N-Sun Shield, Inc.

TELEPHONE ENCLOSURES

423 SIT-DOWN PHONE / Intended for single or multiple installation in office lobbies, banks, malls, etc., "BN 1600-1" booths are framed in bronze-anodized aluminum with acoustical carpet on interior surfaces. / Benner-Nawman, Inc. E*

424 TELEPHONE DOME / Engineered to efficiently reduce the external noise surrounding public telephone areas, the British-made *Phonedome* is available in clear or bronze-tinted acrylic. Unit is easy to fit with wall-mounted or coin-box phones; back-board is filled with sound absorbing insulation. / Alegra International Ltd.

TOILET & BATH ACCESSORIES

425 LOTION CLEANSER / For high-traffic institutional and restaurant washrooms, the *Luron* lotion "Model 21" dispenser provides more than 1,700 handwashings before refilling. Constructed of high-impact plastic, drip-resistant unit has a key-lock to discourage vandalism. / U. S. Borax.

426 TOWEL BARS / Accessories made of brass tubing are coated with a colorful enamel or finished in polished chrome. The towel bars shown are part of an extensive line manufactured by Be Bro S.r.L. of Italy; prices range from \$10.00 to \$30.00. / Fearless Faucets.

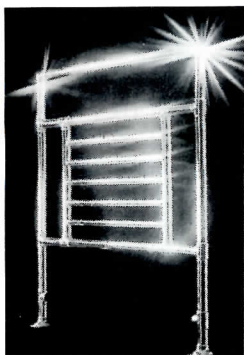

427

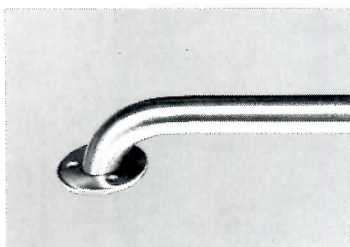

428

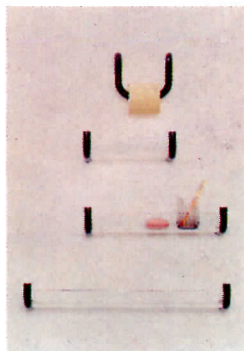

429

427 TOWEL RAILS / Radiator rails keep towels or clothes warm. The unit works on domestic hot water supply or hot water heating system; an oil-filled electric model needs no plumbing. Said to be easy to install, towel rails come in chrome, copper or gold finishes. / Myson Inc.

428 GRAB BARS / "600 Series" stainless steel grab bars have 1½-in. wall clearance, which conforms with Federal regulations. Bars are offered in 1¼- and 1½-in. dia, with either a satin finish or non-slip gripping area. Straight lengths are standard; special application designs may be ordered. / The Charles Parker Co. GB*

429 BATH SHELVES / Shelving from the "Tubotondo" series of bathroom accessories is formed of curved Plexiglas with brass tubing brackets. Finishes include polished chrome, brass, gold, and baked enamel in six colors. Prices for the Italian accessory line range from \$15.00 to \$60.00 / Fearless Faucets.

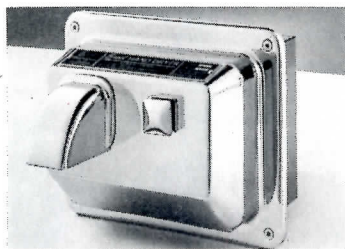

430



431



432

430 HAND/HAIR DRYERS / UL-listed units have a sealed timer mechanism, set for either a 30-sec hand or 3-minute hair-drying cycle. Brushless motor is housed in a vandal-resistant cast cover, finished in either bright chrome or chip-proof white epoxy. / Excel Dryer Corp. GB*

431 ELECTRIC SHOWER / Compact unit produces hot water automatically as cold water faucet is opened. Water flow regulates the water temperature. Manufactured in Brazil to IEC and CEI standards, electric water heater retails for \$89.95. / Orlando Enterprises.

432 TOWELS / Suitable for the executive or corporate guest washroom, custom towels can be ordered with logo or other identifying symbol woven into the fabric. / Dundee Mills.



433

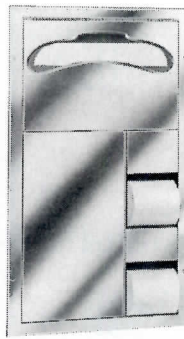

434



435

433 ACCESSIBLE VANITIES / Three different cabinet configurations, for corner, alcove or freestanding installation, are offered to meet the requirements of the physically handicapped. Vanities combine laminate countertop with backsplash, skirt and locking cabinet and a stainless steel paper towel dispenser and waste receptacle. / Bobrick Washroom Equipment, Inc. GB*

434 TOILET ACCESSORY / Partition-mounted seat cover/toilet tissue dispenser specially for use in public facilities designed for the handicapped. One side of the combination unit mounts flush with the panel to allow a grab bar to cross over in front. The other side serves the adjoining compartment. / Bobrick Washroom Equipment, Inc. GB*

435 COMBINATION UNIT / A compact paper towel dispenser and waste receptacle "B-369" fixtures are suitable for low traffic public or executive washrooms with limited space. Stainless steel unit is offered in versions for recessed or surface mounting. / Bobrick Washroom Equipment, Inc. GB*



436



437

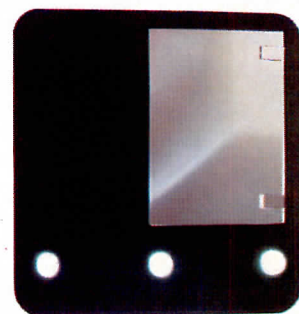

438

436 WATER-SAVING SHOWER / Limiting water flow to a steady 2.75 gal per minute at water pressures between 20 and 80 psi, this water saving shower head still delivers an effective full cone spray. Showers meet California Energy Commission standards. / Ondine, Div. Interbath, Inc. GB, LC, E*

437 BATH STORAGE / The "Bath Hutch" mounts on the wall above the toilet, storing towels and supplies behind cabinet doors in the top section. The lower section has adjustable shelf standards and a drawer and facial tissue dispenser unit. Unit available in several styles and a choice of wood finishes. / Quaker Maid.

438 MEDICINE CABINET / This acrylic cabinet, designed by Yolanda Quitman, won a 1979 ASID Award. Optional lighting feature takes three 60-Watt bulbs; convenience outlets are standard. Cabinet measures 30- by 30- by 4½-in.-deep, and can be recessed- or surface-mounted.; 13 color choices. / Hastings II Bagno Collection.

DOORS & WINDOWS: UCI 8

3081 TRANSPARENT PLASTICS / Technical data, ad reprints, and a brochure entitled "News in Transparent Plastics" are being offered to cover complete product line of transparent plastics. Construction applications, typical properties, and the product line are outlined. / Cyro Industries. GB, ICR*

3082 SKYLIGHTS / A new concept energy-saving skylight design, featuring an outer dome of *Protect-A-Glaze* sheet and an inner diffuser panel of *Hexan* structured sheet, is outlined in a news release from the manufacturer. Includes data on thermal insulation properties, condensation performance, and skylight sizes and finishes. / Faulkner Plastics.

3083 FIRE DOORS / A fact sheet on UL-labeled sliding fire doors with pedestrian pass doors is available from the manufacturer. Includes complete specifications, hardware information, and complete Underwriters' Laboratories fire test data. / F.L. Saino Manufacturing Company.

3084 SKYLIGHTS / A fact sheet is available from the makers of a new "venting skylight" that releases warm and stale air while drawing in clean air. Contains price list, available sizes and models, and delivery information. / Naturalite, Inc. LRC*

3085 METAL DOORS / A complete product line catalog is being offered from the manufacturers of frames and steel doors with a styrene core for special insulating value. Includes color chart, life-cycle costing data, and specifications. / Amweld Building Products. GB*

3086 GARAGE DOORS / Styles, materials, and textures to blend with any style of building design are outlined in this brochure on custom residential garage doors. Contains information on available textures, panel designs, and models. / Windsor Door Company.

3087 SECTIONAL DOORS / Information and specifications on a full line of upward-acting sectional doors, for commercial and industrial applications, are available from the manufacturer of insulated steel doors, combination steel/fiberglass doors, pedestrian pass doors, and special designs with removable posts for clear span applications in airport hangars and other multiple door insulations. / Windsor Door Company. GB*

3088 ROLLING DOORS / Information and specifications on metal rolling doors for service entrances in plants, warehouses, and terminals are contained in a catalog. The product line includes full-weatherstripped doors, UL-labeled fire doors, rolling grilles and shutters, and electric operators. / Windsor Door Company. GB*

3089 STEEL DOORS / A full line of steel side-hinged doors, steel frames, and door hardware are featured in this company catalog. Includes information on flush doors, narrow stile doors, UL fire doors, and the types and sizes for commercial, industrial, institutional, and multi-unit residential buildings. Color options and guide to selecting the most efficient door are also included. / The Ceco Corporation. GB*

3090 REPLACEMENT WINDOWS / A brochure illustrates and describes the features of a new line of thermalized custom-fit replacement windows. The brochure details thermal insulators in master and sash frames as well as insulating glass of these replacement windows designed for maximum energy efficiency without condensation. / Season-all Industries. GB*

3091 REPLACEMENT WINDOWS / A 6-page, color brochure describes and illustrates the features of thermalized aluminum replacement windows, which are designed for maximum thermal efficiency and condensation resistance. Includes color options and energy conservation data. / Season-all Industries. GB*

3092 REPLACEMENT WINDOWS / A 16-page catalog explains the installation economy of custom-fit replacement windows, defines the causes of window energy problems and explains specific solutions for each. In addition, it presents detailed, cross-sectional drawings, specifications, and features of a complete line of replacement windows. Also illustrates optional accessories such as head, sill and jamb covers and a variety of locks and latches. / Season-all Industries, Inc. GB*

3093 PATIO DOORS / Colorful brochure displays benefits of insulated patio door systems which combine practicality with design considerations. Specification details and model options for the traditional and modern two- and three-door units are included. / General Products Company.

more literature on page 124

**THIS IS THE
MOST TESTED SIGN IN
HISTORY**



It's safe to say that no other sign ever went through the tests that the **Safety 10** did.

It's been dropped repeatedly from a height of 10 feet...and shot at with a pellet gun. A damp cloth removed the powder burns from a cherry bomb explosion on its face.

It's also been submerged in a swimming pool and put through temperature extremes like a space capsule.

The **Safety 10** is an acceptable illuminated exit sign to the Occupational Safety and Health Administration, among others. Unlike others, it's waterproof, shock-proof, even vandal-proof. And it's visible for 300 feet.

It requires no electricity, batteries or bulbs. To install it, you only need a screwdriver.

Maybe the most amazing thing about the new **Safety 10** is that, figured over a ten year period, it can save as much as four times its price in the energy and maintenance costs normally associated with conventional signs.

To learn more about this space age advancement, please drop us a line.



AMERICAN ATOMIC CORPORATION

Dept. 3, 425 S. Plumer Ave., Tucson, Ariz. 85719 Or give us a call at (602) 622-4881

The Safety 10 Exit Sign. Guaranteed for a decade. General Services Administration Number GS-07S-030601.

NOR-LAKE REFRIGERATION**GO AHEAD!****COUNT THE
REFRIGERATION
UNITS IN
THIS AD****And that's only a small
fraction of our entire line.**

We manufacture over 358 different models of refrigerated cabinets. We have reach-in refrigerators and freezers . . . (recently we introduced a completely new line of 60 models) . . . ice and beverage equipment as well as biological, dairy, bakery and floral refrigeration.

Plus, we offer an almost endless number of models and styles of walk-in coolers and freezers, both standard and custom (including packaged and pre-wired remote refrigeration systems).

To make the Nor-Lake picture even more inviting, we stock over 3000 units. That means you can get the unit that best fits your needs—and you can get it fast. Doesn't buying a Nor-Lake make a whole lot of sense . . . as it has to thousands of our customers since 1947

See your local dealer or WRITE Nor-Lake, Inc., Second & Elm, Hudson, WI 54016, or call 715/386-2323.

NOR-LAKE PUTS YOU FIRST IN REFRIGERATION

NOR-LAKE INC.

Sweet's Catalog 11.23b/No

Circle 1049 on inquiry card

3094 VINYL WINDOWS / A 6-page brochure describes double-hung residential windows which combine the energy-saving advantages and ruggedness of commercial windows with the flexibility required for new residential installations or remodeling. / Trocal Window Systems Division.

3098 ALUMINUM WINDOWS / Five basic window series including reversible, horizontally -pivoted, casement, projected, and combination windows in thermal break and non-thermal break configurations are discussed in a catalog. Individually designed aluminum window applications and details on window thermal performance, design and manufacturing capabilities of this manufacturer are explained with line drawings that provide construction details. Finishes for aluminum and color chip samples are included. / Hope's Windows Division, Roblin Industries Inc. GB*

**How to get the right specialized door
for your engineered
environments**

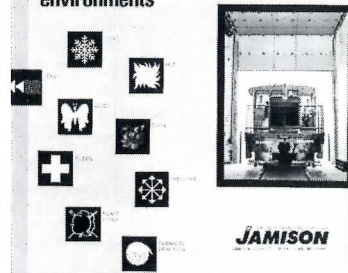

3095 SPECIALIZED DOORS / A new booklet entitled "How To Get The Right Specialized Door For Your Engineered Environments" stresses the growing requirements for performance and safety in facilities dealing with extreme temperatures, atmospheres, noise, pressures, blasts loads, chemical reactions, and other critical environments. It points out that specialized doors for engineered environments are highly technical products demanding a wide variety of engineering, manufacturing, and follow-through skills. / Jamison Door Company.G*

3096 COLD STORAGE DOORS / A 6-page color brochure stresses the direct relationship between cold storage door dependability and saving energy dollars. Includes statistical documentation on the high wasted energy cost of undependable cold storage doors, and doors standing open. Refrigeration loss/cost is calculated and presented in a detailed chart which lists door sizes, temperature differentials, Btu loss, tons refrigeration loss, kilowatt hour loss and cost, and wasted energy electric costs in 8-hour shifts, two-shift days, and three-shift days. / Jamison Door Company. GB

3097 CERAMIC HARDWARE / A new full-color folder showing the Home Hardware ceramic line of knobs and pulls for cabinet and RV manufacturers, residential builders and retail hardware outlets features not only the ceramic line but tie-in display promotion. / Home Hardware Division, Norris Industries.

3099 STEEL WINDOWS / The advantages of steel windows in architectural applications are fully detailed in this 18-page color catalog. Recent installations and engineering drawings are included along with complete details on pressed metal fabrication and the manufacturer's line of detention windows. Color ship samples and available steel finishes are also included. / Hope's Windows Division, Roblin Industries Inc. GB*

3100 INSULATED GLASS FRAMING / Literature is available from the makers of insulated glass framing which includes charts for estimating savings in building heating and cooling costs after installation. The color brochure explains how framing combined with 1-in. insulated glass reduces heat loss and also reduces the likelihood of damaging interior condensation. / Kawneer Architectural Products.

3101 BALANCED ENTRANCES / A color brochure is available from the manufacturer of balanced entrances, designed for easier opening and more effective door control in windy conditions. Diagrams explain how the balanced door principle makes large balanced doors easier to open than doors with conventional side hinging. The text explains how they resist being blown open by internal building pressures. Photographs illustrate construction and performance features. / Kawneer Architectural Products. GB*

3102 STORM WINDOWS / A new brochure, entitled "Energy Savings in Dollars and Cents," enables consumers to calculate potential yearly heating and air conditioning savings with the installation of this manufacturer's storm windows over a typical single-glazed window. Along with step-by-step instructions, a sample computation and charts and graphs are suggestions for controlling condensation and explanations of commonly used energy terms. / Alcan Building Products.

more literature on page 129

uci 11 equipment

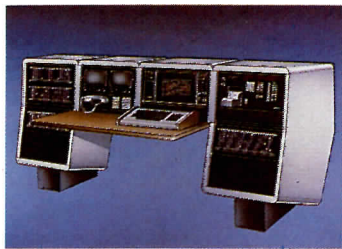

451



452



453

BANK & VAULT EQUIPMENT

451 BANK BRANCH MONITORING / The BRM-2 is a two-way branch monitoring system. It features multiplexing (reduction in the use of telephone lines) and high security. / The Mosler Safe Co. GB*

452 BANK TV / The *Trans-Vista III/TV* for drive-up banking offers new options: "Identkey" for positive customer identification, and automatic carrier storage-and-send that makes teller service easier with one-button operation. / The Mosler Safe Co. GB*

453 CUSTOMER ID / A simple way of identifying financial institution customers, this system speeds up transaction time by eliminating multiple identification requirements. The customers select their own code, either number or name. / The Mosler Safe Co. GB*



454

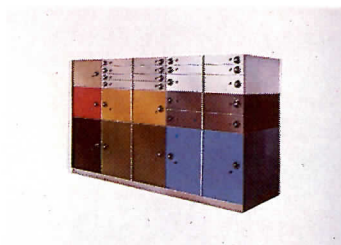

455

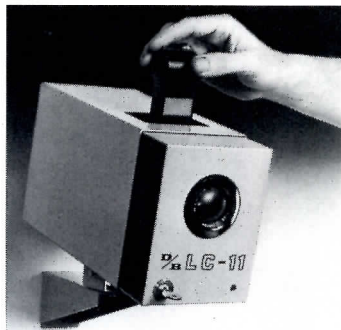

456

454 BANK SAFE / Compact enough to fit almost anywhere, this American Bank Safe has separately locked doors for limited safe-deposit box services, plus bulk cash storage for internal operations. / The Mosler Safe Co. GB*

455 VAULT ORGANIZATION / The American Locker System is a new way to organize any vault with interchangeable B-width design for bank, teller and cash vaults. Twelve colors are available. / The Mosler Safe Co. GB*

456 SECURITY CAMERA / A One Frame Suspicion Capability is a special feature of the LC-11 35mm camera for wide business application. Operated by button control, an individual can take a single photo of a customer. / Dressen-Barnes Electronics, a division of American Electronics, Inc.



457



458

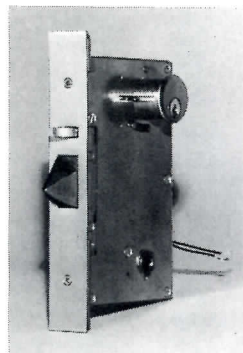

459

DARKROOM EQUIPMENT

457 ENLARGER / For formats up to 5-by 7-in. the L57 laboratory enlarger offers six different light systems, including dichroic, point light and pulsed Xenon. Lens range from 50-240 mm / Leedal Inc.

458 TRAY LADDERS / Space-conserving photographic trays are now available in a 3-stack model. Two open-span shelves lock into triangulated, vertical supports. / Leedal Inc.

DETENTION EQUIPMENT

459 LOCKSET / The KAM-LOK Model 1050 is a mortise lockset with deadlocking latch function. A remote knob lock feature can lock or unlock electrically. / Brink's Locking Systems, Inc.

BANK & VAULT EQUIPMENT
DARKROOM EQUIPMENT
DETENTION EQUIPMENT
FOOD SERVICE EQUIPMENT
INDUSTRIAL EQUIPMENT
LABORATORY EQUIPMENT
LAUNDRY EQUIPMENT
LOADING DOCK EQUIPMENT
MEDICAL EQUIPMENT
RESIDENTIAL EQUIPMENT
THEATER & STAGE EQUIPMENT
VENDING EQUIPMENT

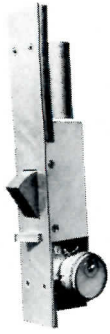

460

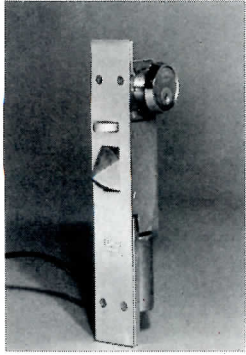

461

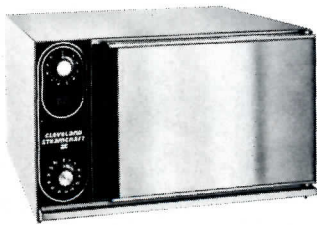

462

460 ELECTRIC BOLT / For high security locations, the KAM-LOK Model 2020 can be remotely controlled for entrances and interior doors. An integral switch activated by a door position sensor serves to hold the bolt in the retracted position when the door is open. / Brink's Locking Systems Inc.

461 RABBET LOCK / The KAM-LOK model 3020 is a mortise deadlocking latch designed for installation in the rabbet of a door frame. It operates by push-button, card reader or digital access control. / Brink's Locking Systems, Inc.

FOOD SERVICE EQUIPMENT

462 STEAM COOKER / The Convection Steamer is applicable for restaurants, schools, hotels, hospitals and other kinds of large-volume food service operations. / Cleveland Range Co.

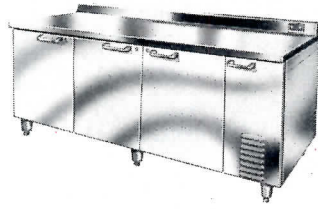

463

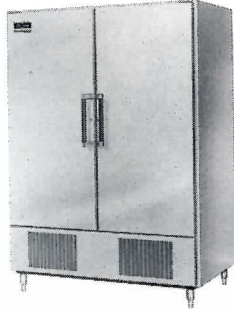

464

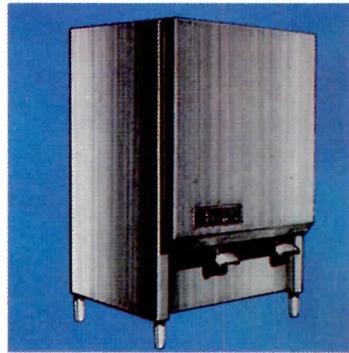

465

463 REFRIGERATED WORKTABLE / The undercounter/countertop worktable Model RC24B is a self-contained refrigerated worktable. It is mobile and has 24 cu ft of storage area. / Nor-Lake, Inc. GB, E*

464 REFRIGERATOR / Reach-in refrigerators and storage freezers come in one-, two- and three-door models. Each has a Power Saver Switch, which reduces electrical consumption by shutting off condensate heaters when not required. / Glenco Refrigeration Co.

465 MILK DISPENSER / With foam insulation, the Trimline Dispenser has a dripless valve system designed for easy view dispensing and avoiding milk overflow. An interior container platform prevents spillage. / Nor-Lake, Inc.

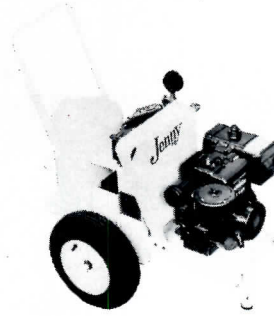

466

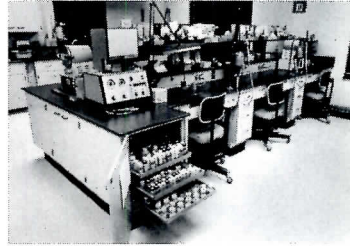

467

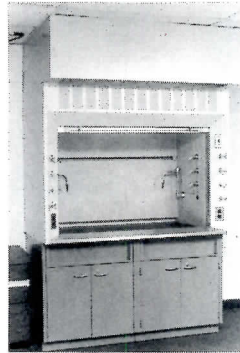

468

INDUSTRIAL EQUIPMENT

466 WASHER / A high-pressure washer is designed to clean vehicles as large as off-road equipment. The PW-1200 features a full time gun control at 1200 psi pressure spray. / Jenny Division, Homestead Industries.

LABORATORY EQUIPMENT

467 DENTAL BENCH / This dental technician's bench has adjustable vacuum positions, dust collector with push-button compressed air cleaning, and in-bench storage for air guns / St. Charles Manufacturing Co.

468 FUME HOOD / These fume hoods offer auxiliary air pumped into the handling capability in air-conditioned laboratories. Up to 70 per cent of the total air exhaust can be non-tempered / St. Charles Manufacturing Co.

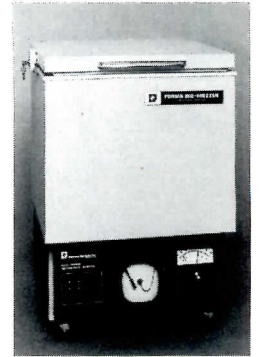

469



470

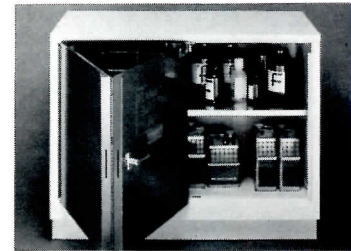

471

469 LAB FREEZER / A 3-cu-ft laboratory chest freezer has an ultra-low temperature range of -75C. Features of the Model 8332 include low-profile design, stainless steel interior construction, urethane insulation and built-in battery. / Forma Scientific.

470 SCIENCE STATION / A portable science station is specifically designed for barrier-free work for handicapped students. The unit is self-contained with one side designed for biology lab work, the other for chemistry/physics work. / Conco Industries, Inc.

471 STORAGE CABINET / Combustible materials can be safely stored in this undercounter storage unit. An all-steel cabinet contains an inside fire or protects chemicals from an outside fire. / Fisher Scientific/Contempra Furniture Division. GB, ICR, E*

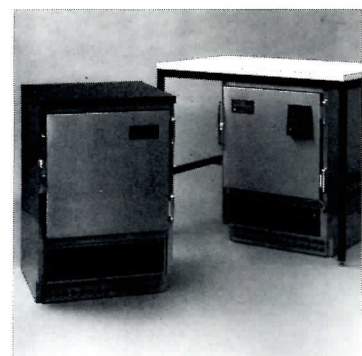

472

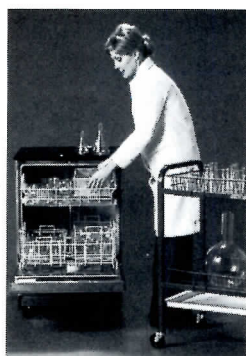

475



473

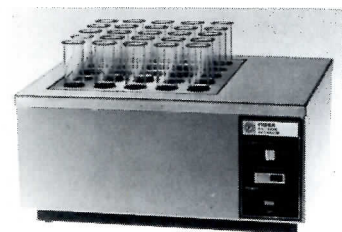

476

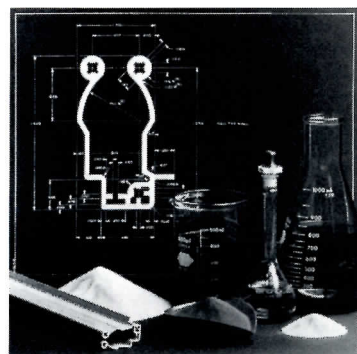

474

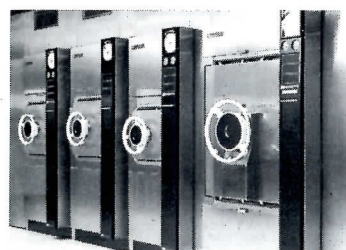

477

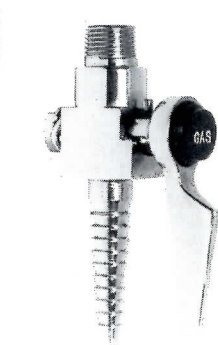

478

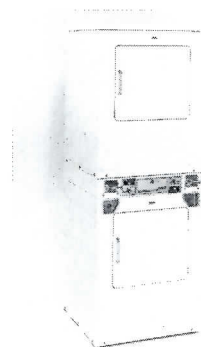

479

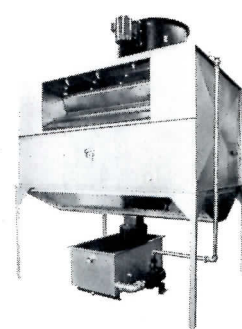

480

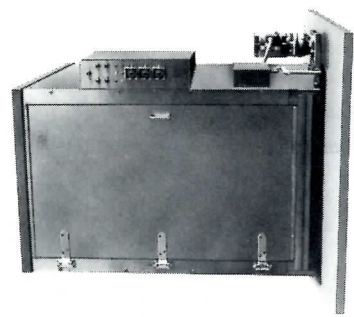

481

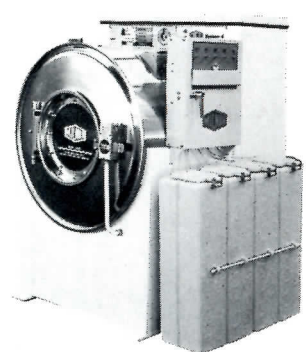

482

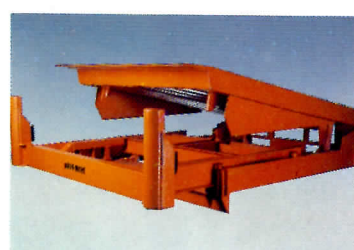

483

472 BLOOD BANK STORAGE / A new line of undercounter refrigerators and freezers for blood bank and general laboratory use are designed for +4C whole blood storage and -35C plasma storage. / Forma Scientific.

473 LAB FREEZER / A giant capacity blood storage refrigerator is a 48 cu ft unit that protects up to 660 plastic bags of whole blood at a precise +4C temperature. (Also available in 300 and 588 bag models). / Forma Scientific.

474 VINYL EXTRUSION / High performance vinyl profile extrusion compounds can be made, with a wide range of indoor or outdoor applicable colors. New dark colors reflect sunlight. / Crane Plastics.

475 GLASSWARE WASHER / For laboratory use, this new glassware washer scrubs plasticware as well as glassware. It has solid state, push-button control panel. / Labconco Corp.

476 BACTERIA INCUBATOR / The Model 149 Bacterial Incubator is a dry bath specifically designed for determining total and fecal coliform bacteria in water/wastewater samples. It has a two-switch-selectable, factory-set operation temperatures. / Fisher Scientific Co.

477 STERILIZERS / The Eagle 2000 series sterilizer combines a sterilizer with a microcomputer. The memory unit carries sequential instructions for every operation in each cycle. / AMSCO/American Sterilizer Co.

478 CHECK VALVES / These gas valves for laboratory use have integral check valves that automatically close if a hose is connected simultaneously with a water valve, preventing water from entering the gas lines. / Royal Brass Mfg. Co.

LAUNDRY EQUIPMENT

479 STACKED DRYERS / Designed for economical multi-housing use, these *Speed Queen* gas or electric dryers position two dryers in one space-saving unit 27-in. wide. Abuse-resistant individual controls are located between the two dryers. / McGraw-Edison Laundry Product Div.

480 LINT COLLECTOR / The Mistair Lint Collector AL Series has a new adjustable baffle system, permitting fine tuning in the field. With a re-designed hopper, there is a better air flow and saturation of lint. / Eastern Cyclone Industries, Inc.

481 LAUNDRY CART WASHER / This laundry cart washer features adjustable cycle times permitting the washer to handle various soiled conditions at minimum detergent and utility costs. / Eastern Cyclone Industries, Inc.

482 WASHER-EXTRACTORS / A new liquid supply system is now available as optional equipment for the System 4 washer-extractor. The machine-mounted unit can inject four supplies into an individual washer-extractor in the proper wash cycle. / Pellerin Milnor Corp.

LOADING DOCK EQUIPMENT

483 DOCK LEVELER / A fully automatic, extra-heavy-duty leveler, the "FA 1696-80M" is activated by the truck trailer backing into the loading platform. The completely mechanical unit is available in capacities up to 100,000 lb, is OSHA-approved and carries a five-year warranty. / Rite-Hite Corp.

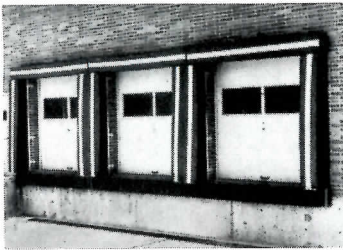

484

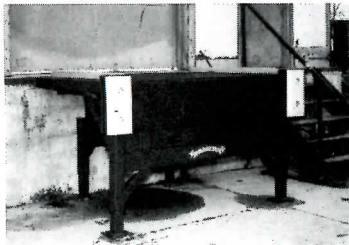

485

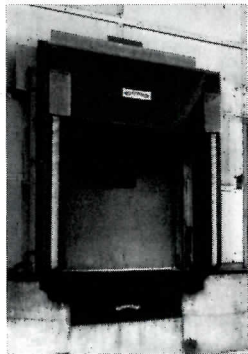

486

484 DOCK BUMPERS / Now available are "extra thick" and "extra length" dock bumpers for more flexible handling of equipment. / Durable Mat Co. GB, ICR*

485 ADD-ON LEVELER / This adds a full-sized leveler to an existing dock without the expense of pit construction or major dock alteration. It is applicable to any of the company's RF Series mechanical or hydraulic levelers. / Overhead Door Corp.

486 DOCK SEAL / Model DSE Curtain Head Dock Seal offers an efficient method of achieving carrier-to-building sealing on applications where a clear door opening is only occasionally required. / Overhead Door Corp.



487

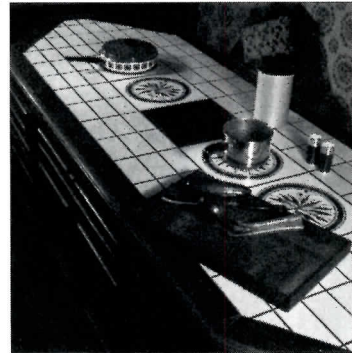

488



489

MEDICAL EQUIPMENT

487 MEDICINE CABINET / This portable medicine cabinet for hospital use is designed with a lock drawer, individual prescription drawers, and lighted top surface for efficient dispensing of prescriptions. / Waterloo Industries Inc.

RESIDENTIAL EQUIPMENT

488 ENERGY-EFFICIENT STOVE / A unique new residential kitchen stove heats a pot immediately. Drawing from standard 60 Hz household current, a computerized power pack underneath the smooth-topped stove changes the current's frequency to 25 KHz. / Farsar Systems Inc.

THEATER & STAGE EQUIPMENT

489 POWER AMPLIFIER / The Incremental Power is a power amplifier system that is claimed to meet almost any audio application. / Altec Lansing. GB, ICR, E, CC*



490

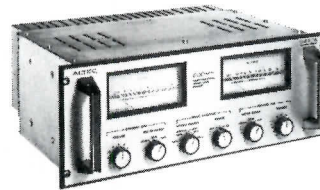

491

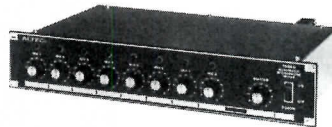

492

490 STEREO MIXING CONSOLE / Model 1690 Mixing Console is portable or rack-mountable designed for musical or commercial sound reinforcement and professional recording. / Altec Lansing. GB, ICR, E, CC*

491 POWER AMPLIFIER / Model 9440A Power Amplifier is a direct-coupled amplifier that typically delivers over 250 watts per channel into 8-ohm loads. Operable from a 120V or 240V ac source. / Altec Lansing. GB, ICR, E, CC*

492 MICROPHONE MIXER / This 8-channel, solid-state mixer/amplifier has plug-in input accessory modules. Total system mix gain is held constant by automatic adjustment of the signal level in each channel. / Altec Lansing. GB, ICR, E, CC*



493



494



495

493 THEATER SPOTLIGHT / The Strong Super Troupers spotlight operates from a 115 volt outlet. It is a high-intensity carbon arc spot designed to throw light up to 400 feet. / The Strong Electric Corp.

VENDING EQUIPMENT

494 ICE DISPENSER / The "Crystal Tips DCE-030" sanitary hard ice dispenser has a 300-lb. ice storage bin, and may be combined with ice makers of from 250- to 650-lb capacity. Unit offers portion control; operation by hand, coin, key or token; and sanitary-code approved cabinets. / McQuay Group, McQuay-Perfex Inc.

495 SOFT DRINK VENDOR / Engineered for simple operation and low maintenance, this two-beverage dispenser operates with a 10-pronged plastic key instead of coins. Its low cost permits installation in small offices, social clubs, schools, etc. / McQuay Group, McQuay Perfex Inc.

FINISHES: UCI 9

3104 COATING COLORS / Literature describes the color selection aids offered with this line of paints, vinyl wall coverings and maintenance coatings. These materials include a Color Selector book, Color Deck, and a two-volume, 1024-page binder of tear-out color samples. / Glidden Coatings & Resins.

3105 NYLON CARPET / The *Antron III* "Showcase" contains samples of carpet from four different lines of commercial and residential floor coverings. / Kenmore Carpet Corp.

3106 TEXTURED FINISH / A Designer Portfolio contains actual samples of *Dryvit System* insulation board finishes. Selection chart displays the 14 fade-resistant colors for the various *Dryvit* textures. / Dryvit System, Inc.

3107 OFFICE CARPETING / Color brochure discusses the advantages of specifying *Zefran* acrylic and acrylic blends; *Zeflon* subdued luster nylon; and *Zeflon 500* solution-dyed nylon yarns in carpeting for office use. / Badische Corp.

3108 COMMERCIAL CARPET / Titled "The Public Carpet with the Private Look," color booklet provides commercial carpet specifiers with many in-use photos of *Karastan* carpets. Special styling features and recommendations for use in various public spaces are included along with full product specifications. / Karastan Rug Mills.

3109 RETAIL CEILINGS / Published for designers interested in retail stores, restaurants and malls, a 12-page booklet contains color photographs of 19 recently completed installations using a variety of lighted and decorative ceiling systems. / Integrated Ceilings, Inc.

3110 PREFINISHED WALLS / Brochure on the *Eternawall* vinyl surfaced gypsum board line of interior partitions and high traffic finishes provides samples of each of the 16 standard patterns and colors. Fire hazard data and maintenance instructions are included. / Georgia-Pacific Corp. I*

3111 PREFINISHED PANELING / Idea brochures called "The Designer's Touch" show prefinished wood and simulated woodgrain panelings used in living rooms, kitchens and dining areas, family rooms and bedrooms. / Georgia-Pacific Corp. I*

3112 GYPSUM PRODUCTS / Corporate profile describes the construction products offered by this manufacturer of gypsum board, *Actionwall* partitions, drywall accessories, and two-hour shaftwall systems. Color photos depict a number of construction projects and commercial applications. / Domtar Gypsum America Inc.

3113 PLYWOOD FINISHES / How to finish plywood for exterior exposure is explained and illustrated in "Stains and Paints on Plywood." The 8-page booklet covers plywood storage, edge sealing, recommends various paints and stains, and discusses weathering, coating application, maintenance and refinishing. / American Plywood Assn.

3114 SHEET FLOORING / Decorating hints, room scenes, flooring facts and design and coloration information are included in eight product brochures on resilient sheet floorings for commercial and residential applications. / Mannington. GB*

3115 STAIR COVERINGS / Color-coordinated rubber and vinyl safety treads and landing tiles are shown in a 12-page catalog. Flame-retardant *Disc-O-Tile* rubber flooring, which meets ASTM-E84 requirements, is highlighted in the literature. / The R.C. Musson Rubber Co., GB, LCR*

3116 SEAMLESS VINYL / Folder explains how "Conductive" and "Contract V" solid vinyl tile may be heat welded into a seamless, unitized flooring installation. Color and pattern choices for floor tiles and seaming strips are shown. / Flexco, Div. of Textile Rubber Co., Inc. GB*

3117 SOFT WALLCOVERING / Product folders provide samples of *Cor-dette* and *Velvette* textures of noise-reducing *Brunswall* non-woven fiber wallcovering. For use directly on walls or laminated to drywall or panels, *Brunswall* has a Class A flammability rating. / Brunswall.

more literature on page 147

Vollrath walk-ins mean royal treatment for any installation



The Biltmore Estate, Asheville, NC

On the grounds of the lavish Biltmore Estate, America's finest castle and North Carolina's outstanding tourist attraction, is Deerpark—the Biltmore dining experience. Only the finest quality refrigeration equipment is good enough for this outstanding facility. That's why a Vollrath walk-in cooler-freezer was specified.

From spec to finished project, Vollrath specialists assist in mechanical/electrical requirements; size, storage and materials data. On time delivery with reliable post-sale service is also a part of Vollrath's royal treatment. And isn't that the way *you* and *your* clients should be treated?



DEERPARK... where Vollrath's dual temperature walk-in is part of the Biltmore dining experience

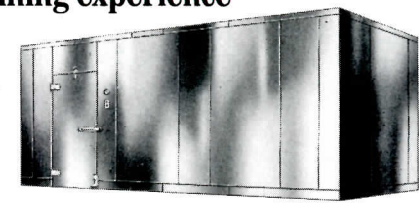

Vollrath serves markets world-wide with modular walk-in coolers, freezers, and refrigeration systems... when only the best is good enough.



The capable hands of Vollrath build exactly what you want in a quality walk-in cooler/freezer.

THE VOLLRATH COMPANY / SHEBOYGAN WISCONSIN

Circle 1050 on inquiry card

uci12

furnishings



508

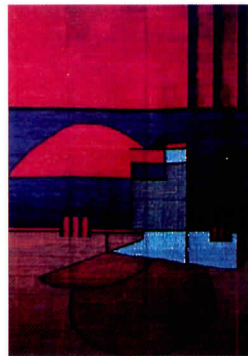

509



510

ARTWORK

508 CORPORATE SYMBOLS / Corporate symbols can be custom emblazoned on a tapestry, area rug or carpet. Carpets and wall hangings are manufactured to meet the client's specifications. Wall hangings can be ordered in sizes ranging from 2- by 2-feet to 3- by 3-feet. / Logo Looms Limited.

509 TAPESTRIES / The "Chamot Collection" consists of 40 designs, hand-woven in Peru, each produced in limited editions of six. Tapestries measure 6- by 7-ft, and have a list price of \$3,500 each. Pictured is "Art Deco," a colorful geometric pattern. / Atelier International Ltd.

510 CUSTOM MURALS / Metropolitan Opera memorabilia painted by Ronald Millard for a New York City bank is an example of the capabilities of this firm specializing in architectural decoration. Services also include lighting fixtures, stained glass and art metal work. / The Rambusch Co.



511

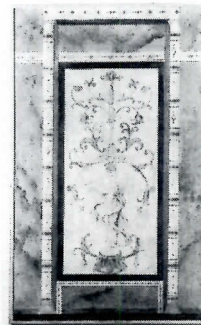

512

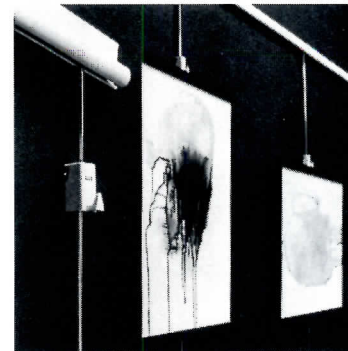

513

511 ROCKEFELLER COLLECTION / Decorative accessories from the Nelson Rockefeller collection are available in hand-made reproductions. Pictured are the Giacometti "Balustrade" bronze standing lamp, a wooden gilt table designed by Jean-Michel Frank; and a gilt-on-bronze vase-shaped table lamp, also by Giacometti. The Ch'ien Lung hawks and Modigliani watercolor are also part of the Collection. / The Nelson Rockefeller Collection. I*

512 ROMAN ART / Painted in oil by artist Bill Skilling, the "Antica Romana" collection incorporates figures and nature motifs in rich earth colors reminiscent of ancient Pompeii. Paintings, in custom sizes and colors, are framed in parchment-finish ash wood. Fresco-like walls and ceilings may be specially commissioned. / Karl Mann Associates

513 PICTURE RAIL / This simple graphic display system consists of a wall track with a slot along the full length, which carries any number of metal suspension rods. An adjustable hook clips onto this rod and supports a framed picture. Any given rod can carry several hooks, up to a total of 176 lb. / The Ironmonger Inc.

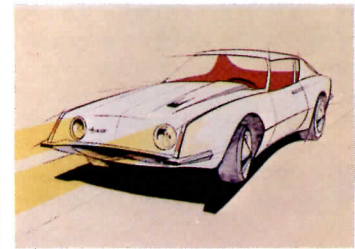

514

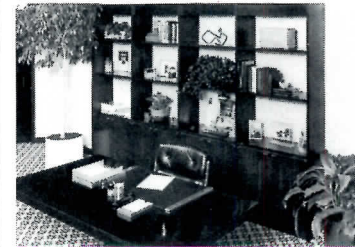

515

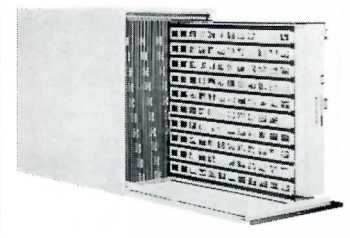

516

514 LITHOGRAPHS / "Avanti" is an original lithograph, numbered and signed by the artist, industrial designer Raymond Loewy. It is one of eight Loewy graphics sized 21- by 28-in. offered in limited editions of 300 each. / Circle Gallery.

CABINETS & STORAGE

515 WALL SYSTEMS / Oak, maple and cherry wood is used for office and commercial wall storage systems. Pre-installed locking devices and shelf track facilitate assembly. Pictured is a four-section unit, in flush door style, with open adjustable shelves and cabinet storage. / Mutschler, A Triangle-Pacific Company.

516 SLIDE STORAGE / Up to 3,960 2- by 2-in. slides can be stored in a compact metal cabinet for on-the-spot viewing, editing and retrieval. Each of the 33 pull-out frames holds 120 slides; a self-contained lighted viewbox pulls out behind for true-color viewing. / Multiplex Display Fixture Co.

ARTWORK
CABINETS & STORAGE
FABRICS
FURNISHING ACCESSORIES
FURNITURE
RUGS
SEATING
WINDOW TREATMENT



517



520



523



526

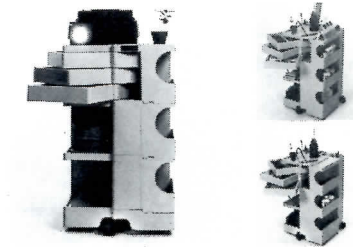

518



521

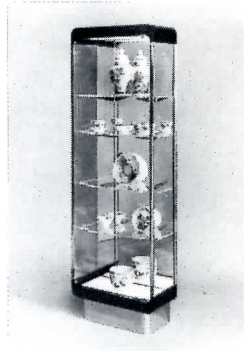

524



527

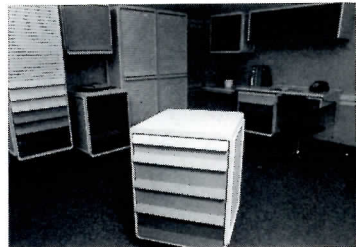

519



522



525



528

517 SHOE STORAGE / Each individual compartment of the "Scarpieri" storage unit can hold six pairs of shoes; three or four can be placed side-by-side. Unit is made of colorful polyurethane, with self-closing sprung doors. / Hastings Il Bagno Collection.

518 MOBILE STORAGE / Made of white, red, yellow or black ABS injection-molded plastic, the "Matrix Boby 3" personal storage unit can be used in home or office. Its sections include three swing-out trays, three open drawers, two open shelves, two adjustable deep pockets, one shallow pocket, and two surface trays. / Leedal Incorporated.

519 HOSPITAL STORAGE / The *Unicell* self-contained module provides prime storage, control and mobile distribution in one basic lockable unit. The interior may be fitted with shelves, trays, and drawers of varying sizes; all finishes may be sanitized. / Amisco/American Sterilizer Co., GB*

520 KITCHEN CASEWORK / Manufactured by Tielsa of West Germany, this modular cabinet system offers over 300 units for kitchen work areas and storage. "Program 42" cabinets have rounded edges; laminate doors come in white, curry, brown or green. / Contemporary Systems Inc.

521 PLAN FILES / Constructed of oak and oak veneer, files store drawings, prints, or any flat graphic material in five 24- by 36- or 30- by 42-in. drawers, each 2-in. deep. Units may be stacked as shown, up to 60-in.-high. Plan files are priced about \$410 for a 24- by 36-in. model with cap and base. / Charrette Corp.

522 OAK KITCHENS / Designed for improved storage efficiency with a large number of concealed accessories, "Ultra 2000" series cabinets are offered with five oak or laminate door options. Units come in three-in. size increments; options include spice and bottle racks, wire baskets, deep drawers and pull-out appliance shelves. / MasterCraft Industries Corp.

523 VERTICAL STORAGE / For the kitchen, this handy vertical storage unit has two separate compartments with sliding drawers. It comes in a variety of woods. / MasterCraft Industries Corp.

524 VITRINE / Illuminated at top and bottom, four-shelf vitrine is hand-made of exotic woods, acrylic plastic, mirrored back and locking glass doors. Standing 78-in.-high on a radial steel base, display unit may be used in home or office. A wall-hung version is also available. Suggested retail: \$5,000. / Vladimir Kagan Designs, Inc.

525 MICROWAVE CABINET / A specialized cabinet designed to house microwave ovens, the standard size is 30- by 35- by 19-in. For smaller ovens, a special size can be ordered. / MasterCraft Industries Corp.

526 BATH STORAGE / A versatile line of modular storage compartments, "Die BadBox" units provide customized bath storage. Included are vanity cabinets, hanging lockers, clothes hampers, shelving, etc. in a variety of laminate finishes. / Heidapal Group.

FABRICS

527 TEXTILES / Called "Devon," this textile collection is part of the manufacturer's British Woollens Collection. It has a rugged, large-scale weave and comes in six wool-dyed colors. / Stow/Davis Textiles.

528 WOOL FABRICS / "Highland Heather" has 14 soft, muted colors to give the look of Shetland sweaters. All fabrics are wool-dyed so that the color is blended before the yarn is spun. / Stow/Davis Textiles.



529

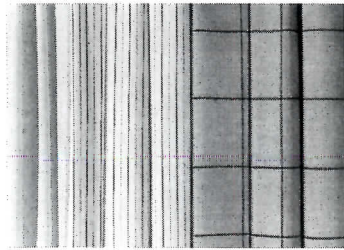

532

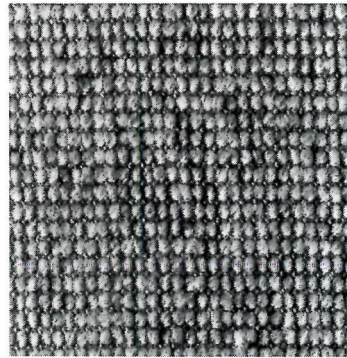

535

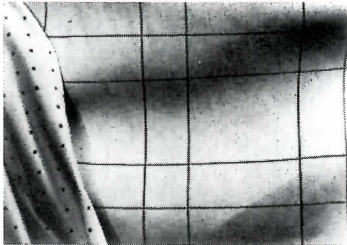

530

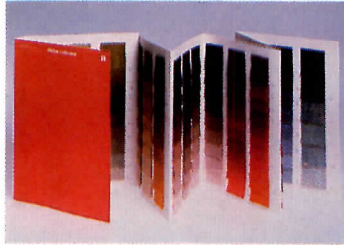

533

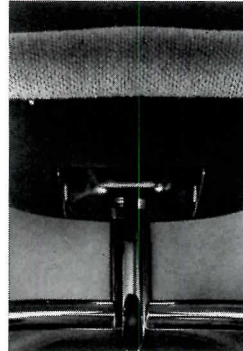

536



531

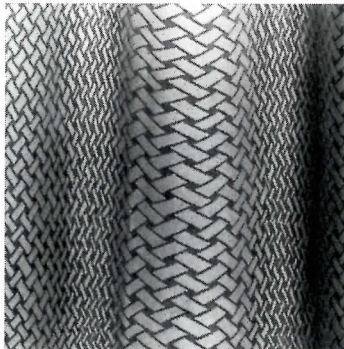

534



537

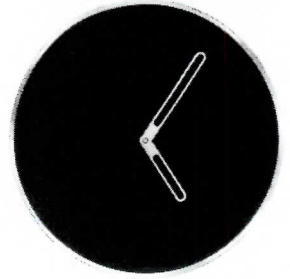

538



539



540

529 STRETCH WOOL / A 99-per cent-wool cloth with over 15 per cent stretch in all directions, "Stretchluxe" tailors well on both contoured and conventional furniture. A tweed look is produced by combining three yarn-dyed colors within each colorway. / Stow/Davis Textiles.

530 LINEN/COTTON BLEND / Geometric lines and squares on a linen background are woven in 60 per cent linen/40 per cent cotton drapery and upholstery fabric. "Bi-Line" and "Check List" are available in stocked and custom colorings, both as fabric and as wallcovering. / Karl Mann Associates.

531 DRAPERY PRINTS / "Nob + Non" collection of casement and drapery fabrics uses soft color, white on white and white on natural in cotton batiste and cotton percale so that an individual transparent panel may be layered over an opaque panel to give a two-dimensional quality. There are seven patterns offered in 39 colorways. / Knoll Textiles.

532 DRAPERY FABRIC / Woven with a combination of wool, silk and acrylic, the "Sterling Collection" of 84-in.-wide drapery fabrics comes in 21 solids, stripes and plaids, in a selection of subtle natural tones. / Design Tex Fabrics, Inc.

533 ACRYLIC UPHOLSTERY / Stretchable "Elaflex" low-luster *Dralon* fabric is available in 150 colors and four qualities: "Omega," a heavy textured fabric; "Xenon," nontextured; "Desna," a refined texture and "Matrix," a nonstretch fabric. / Knoll Textiles.

534 PRINTED CASEMENTS / Geometric forms in muted colors appear in the "Screen" pattern casement cloth by designer Christa Haessler. This fabric may be ordered as a sheer, with burnout pattern, or printed on a heavier cloth. / Sunar.

535 CONTRACT WOOLS / Primarily for upholstery applications, fabrics in the "Natural Wool Textures" series can be specially woven up to 104-in. wide for use as wallcoverings or for wrapping panels. / Carnegie Fabrics.

FURNISHING ACCESSORIES

536 CHAIR CONTROL / Said to provide the chair user with better control at both upright and full-tilt positions, the "Unitron" swivel/tilt device uses dual torsion coil springs for an exceptional torque performance curve. "Unitron" controls are standard on many of this manufacturer's new chair lines. / Steelcase.

537 TERRA COTTA PLANTERS / Hand-made planters are finished in a matte glaze; inside is sealed with a clear glaze, with drain holes for direct planting if desired. Terra cotta planters stand 16- and 19-in. high, walls are one-in.-thick. / Forms & Surfaces.

538 CLOCK / Designed by William Sklaroff Design Associates, this "Sculptura" series clock is encased in satin aluminum with a glass crystal, and has a black face plate and chrome hands. It is quartz battery-operated. / Howard Miller Clock Company.

539 DIGITAL CLOCK / Time "QG-870" quartz digital clock operates for a full year on one 1.5V battery. Extra-large 3 $\frac{1}{8}$ - by 3-in. leaf-type numbers can be seen from across a room; clock itself measures 12-in. wide by 5 $\frac{1}{4}$ -in. high. It comes with a slide-in stand for counter use, and may also be wall mounted. / Copal Corp. of America.

FURNITURE

540 CLUB CHAIR / As one of several models in the Lucerne lounge seating series, this chair is multi-layered with varied densities of polyurethane foam and dacron fiberfill. The frame is of hardwood with rubber webbing. The seat pulls out for a deeper lounge position. The designer is deSede of Switzerland. / Stendig Inc.



541



544

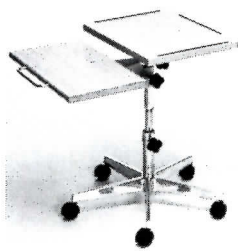

547



550

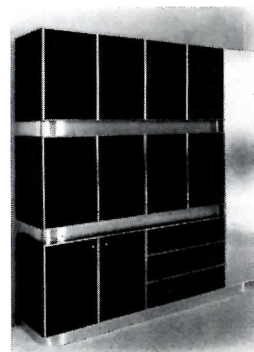

542

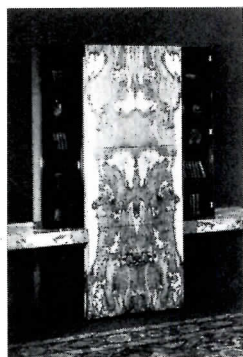

545

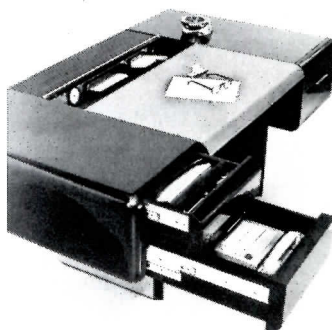

548



551

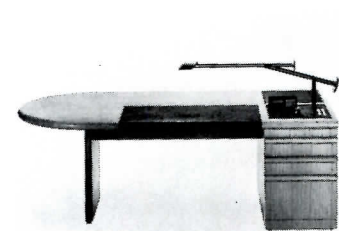

543

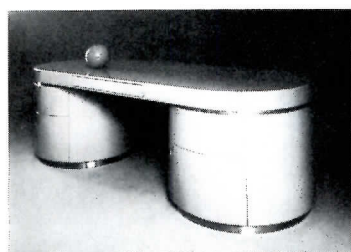

546

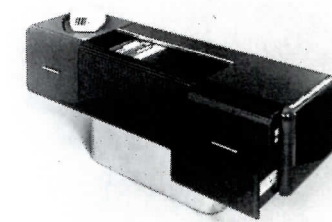

549

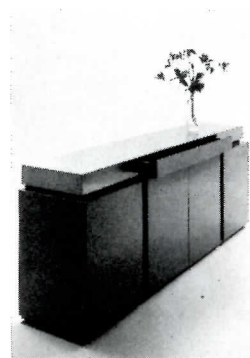

552

541 CONSOLE / A geometric form for storage and display, this 18- by 64- by 32-in.-high console has a lacquered "linen" top resting on a mirror-finish stainless steel frame. There are three flush-fit apron drawers. / Cy Mann Designs Ltd.

542 FREESTANDING STORAGE / Custom-made in an Art Deco style, unit shown here is finished in *Plexiglas* and brushed aluminum. Many other materials may be ordered. / Charles Craig Limited.

543 EXECUTIVE DESK / The basic desk pad accommodates a selection of recessed management modules containing work papers, confidential files, and built-in aids such as multi-line speaker telephone, electronic calculators, clock/calendars and adjustable task lighting. / Croydon Furniture Systems Inc.

544 OPEN OFFICE / "Series 1000 Office Adaptables" work with the effective acoustical control properties of Owens-Corning "Sound Dividers" to construct a versatile, productive open office environment. Work station components include panel-hung and freestanding work surfaces, storage and space arranger units, and lighting. / Harmon.

545 BURL STORAGE UNIT / The "Tall System" is a storage unit that could include television to refrigerator bar. Facing and counters shown here are olive ash burl with vitrines in a high polished lacquer finish. Suggested retail price is \$14,700. / Vladimir Kagan Designs, Incorporated.

546 CYLINDER DESK / Finished in mirror-polished high gloss opaque colors, the "Ponte" desk is trimmed in stainless steel and rich-low bronze. Single cylinder desks, credenzas and tables are also available in the collection, designed by J. Wade Beam. / Brueton Industries.

547 CRT TERMINAL TABLE / This split-top table is specifically for use with a keyboard input and screen unit, allowing individual height, tilt and depth adjustments for each machine. Table is supported by a column set on a five-arm caster base; table surfaces are oak. / Facit, Inc.

548 FEMININE DESK / Scaled at an un-massive six-ft, "The First Woman's Executive Desk," has a roll-top and leather writing surface. The deep drawers contain a built-in mirrored vanity; small filing system; phone and call director; and personal storage space. Steel-based desk is made of sculptured wood in a lacquer finish. Price for the made-to-order desk: \$13,500. / Vladimir Kagan Designs, Incorporated.

549 EXECUTIVE CREDENZA / As an accompanying piece to the woman's executive desk, this matching credenza is equipped with an electronically controlled tambour and lateral filing system. It has four deep drawers, sits on a radius corner steel base and has the same highly polished lacquer finish as the desk. / Vladimir Kagan Designs, Incorporated.

550 OPEN OFFICE / The basic *C-Forms* system consists of six visually and dimensionally related modular units used alone or in combination to structure any number of altogether different work environments. Composite structure technology in wood, laminate, steel and fabric furniture contributes to *C-Forms* price/value/delivery advantages. / Herman Miller Inc.

551 PRIVATE OFFICE / Teak furniture for the executive office may be selected from *C-Form* components. The 84-in. double pedestal desk has removable plugs in end caps allowing phone and other wiring to run down inner portion of leg, out of sight. Matching credenza has file and box drawers. / Herman Miller, Inc.

552 STORAGE/DISPLAY / The top of this 84-in.-long console is brushed aluminum; it contains three apron drawers, one lined with silverware. Base cabinet is available in wood, or any of 12 shades of polyurethane lacquer. / Cy Mann Designs Ltd.



553



554



555

553 BOARD ROOM TABLE / "Omega" conference tables come in sizes that seat 12 to 20 persons. Base element is tubular steel in a mirror chrome finish. Rounded-edge tops are available in wood/veneer combinations in oak, walnut, and Carpathian elm burl. / Stendig Inc.

554 CAFE CHAIR / Made of European beech wood in the original 19th century proportions, this bentwood cafe chair has an upholstered seat of foam cushioned plywood. Available in matte natural or walnut finish, as well as a glossy transparent red aniline. / Stendig Inc.

555 STEEL BASE SOFA / The "Lido" lounge series gets its slender silhouette from its shaped steel armature, which is covered in molded foam and upholstered in velour or woven wool. Two versions are offered: as shown, channel and box tufted with a tight seat construction, and a loose seat model, with fiberfill cushions. / Stendig Inc.



556



557



558

556 LOUNGE SERIES / Multi-layered densities of polyurethane foam and Dacron fiberfill have been placed exactly for greatest seating comfort in the "Lucerne" lounge line. Also, the seat itself pulls out for a deeper lounge position. Upholstery options include Swiss leather or suede, "Natura" leather, or COM. / Stendig Inc.

557 DINING TABLE / The Dialogo table, designed by Afra and Tobia Scarpa, has a transparent glass table surface and outer frame and legs that are finished in black polyester lacquer or walnut. Another version is a flip-top extension table. / B&B America, a division of Stendig International, Inc.

558 WOOD FRAMED SOFA / Butcher-block wood with multiple finger joinery on all four radius corners frames the "850-F" lounge series of chair, settee and sofa (shown). Designed for hard-use public areas, small-scale seating also is suitable for private offices. / Hiebert, Inc.



559



560

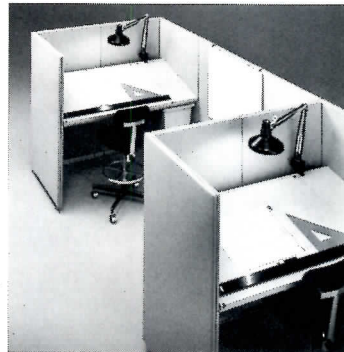

561

559 HIGH BACK SOFA / This plush looking modular seating is available in many variations to allow for right angles as well as long runs. Its construction conforms to California Fire Retardancy regulations. Upholstery is leather, suede or fabrics, and COM. / Intrex, Inc.

560 LOUNGE SEATING / Serpentine curves can be created by using a combination of wedge modules from this series 900 modular lounge seating. A high-density foam is used, and is suggested for public areas or in health care facilities. / Hiebert Inc.

561 DRAFTING COMPONENTS / An adjustable angle drafting/engineering work surface is available for use with any of five different "Upholstered Panel System" heights. Tables measure 60- by 44- or 60- by 32-in., and can be installed at either desk or drafting height. Tops are finished in mushroom laminate; below work surface storage units can be placed under the drafting desks. / JG Furniture, A div. of Burlington Ind.

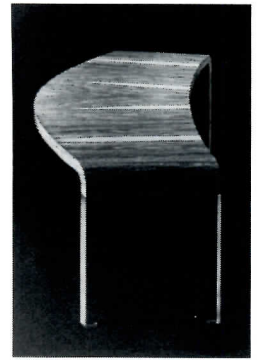

562



563



564

562 TABLE DESK / Part of an extensive collection of custom executive furniture, this crescent table desk has a fiddleback olive ash top, which curves into heavy clear acrylic supports. It has one suspended pencil drawer and is available in a variety of precious woods and lacquers. Suggested retail: \$5,683. / Vladimir Kagan Designs, Inc.

563 TABLE/DESK / Oval table top is a matched sunburst of parquet pattern Corroclia mahogany veneer, edged with solid mahogany trim. Top cantilevers over a pedestal base of weighted molded ebony polyester. Table measures 72-in. wide by 46-in deep finished in "Polygloss;" price is \$1,375. / Harvey Prober, Inc.

564 HIGH PERFORMANCE / Designed for optimum acoustical control, "System 2" open offices have fabric-surfaced panels with a NRC of .90 and an STC of 30. Oak finish is used for hard-surface panels and components; integral task/ambient lighting provides visual comfort at lower energy levels. / Conwed Corp.

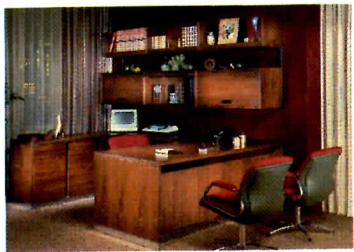

565

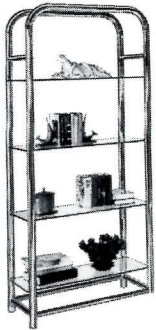

566



567

565 WOOD FURNITURE / "320" series executive desks with cube styling have been added to "Designs in Wood" office furniture. Desks provide to-the-floor storage, adjustable file space, and a wiring grommet inset in the work surface. Optional stainless steel base and trim bands the unit continuously, across pedestal fronts and inside the kneehole space. / Steelcase.

566 DISPLAY SYSTEM / *Unicube* chrome tubes assemble to form *éta-gères*, tables, chairs, displays, habitats and store fixtures. The system, in 1/2-, 3/4-, 1 1/4- and 2-in. diameters, also includes bent tubes and circles, tube connectors, shelving and lighting. / Unicube Corp.

567 WORK STATIONS / *Designscape* freestanding panels and hang-on components create an organized environment of semi-private work stations in place of the "bullpen" office. Acoustical dividers have a NRC of .60; system includes task lighting, power center, storage shelving and work organizers. / Conwed Corp.

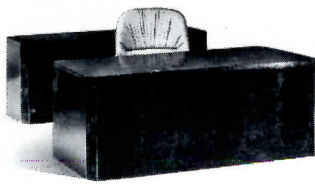

568

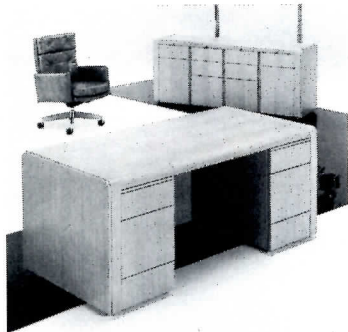

569

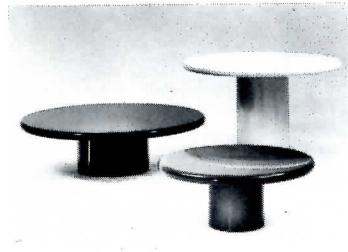

570

568 CUBE DESK / Book-matched Carpathian elm burl veneers are used for this faceted cube desk and credenza, with mirror aluminum trim on the corner angles. Surfaces are finished in PVC or "Polygloss" lacquer. Desk as shown is priced at \$4,590. / Harvey Propper Inc.

569 LAMINATED RED OAK / Full pedestal and high profile desks and credenzas in natural red oak or walnut, with a hand-rubbed fire resistant polyester finish. Coordinated seating is also offered in the *Skagen* line. / R-Way Furniture Co.

570 TABLE SERIES / The sleek sculptured lines of "The Resin Group" are created by molding liquid polyester resin over structural cores. Tops on the cylindrical pedestals may be round or square with two-in. bullnose edges; resin colors are high gloss or satin finish. / Metropolitan Furniture Corp.



571

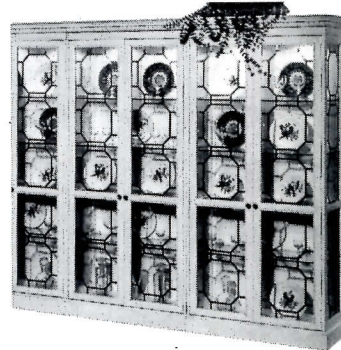

572



573

571 CAMPAIGN DESK / Wide-set pedestal bases and recessed brass drawer pulls distinguish this campaign-style elm burl desk. Top is 72-in. wide; desk has seven working drawers and one extra-large file unit. / Smith & Watson.

572 DECORATIVE DISPLAY / Each unit of this triple cabinet has four glass shelves and two lights. Brass-grilled glass is used on three sides; wood frame is shown here in a pale antique finish. Triple unit measures 121- by 18- by 87-in. high. / John Widdicomb Co.

573 CONFERENCE TABLE / Offered in rosewood or black oak, the "Bruening" table has two drawer elements and a brushed aluminum foot base and belt edge. Table measures 83-in. wide by 39 1/2-in. deep by 28 3/4-in. high. High- and low-back versions of the "Consenso" executive chair are illustrated. / Turner Ltd.



574

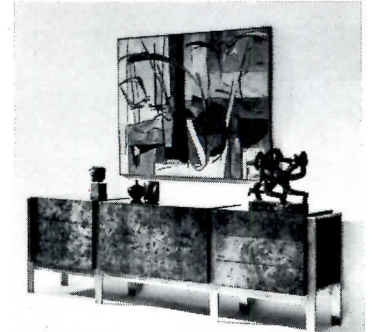

575



576

574 COMPLETE OFFICE / The "Inter-panel Acoustic" system dividers are faced in oak veneer with radius oak end posts; interior surfaces are fabric. Fiberglass core panels have a NRC of over .85. The system also includes wing desk unit, ambient and task fixtures, files and chairs. / Hiebert Inc.

575 BURL CONSOLE / With an unusual antique bronze frame, this storage and display console can be made almost any length with many combinations of drawers and door cabinets. / John Stuart, Inc.

576 WORK STATIONS / Desks, work stations, and wall units are custom-designed from standard components, including lighting. Melamine, wood veneer, satin aluminum and bronze glass finishes are available; all parts are easy to assemble and relocate as necessary. / Discovery Systems.



577

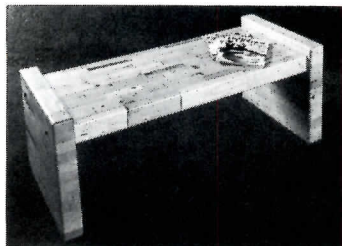

580

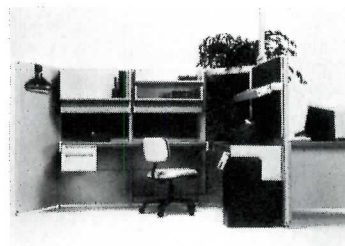

583



586



578



581



584



587



579



582

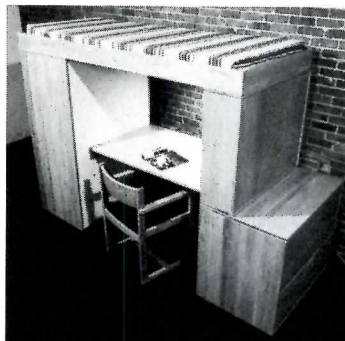

585



588

577 CONFERENCE TABLE / The "Ginkgo Biloba" table sits squarely on seam-free T- or X-bases, available in polished aluminum or any of 16 thermoset colors. Top, in veneer or laminate, may have a 2-in. convex edge; six shapes and 35 sizes are offered. / Vecta Contract, Inc.

578 CONTRACT TABLE / This version of Gunter Eberle's "Ginkgo Biloba" table has an orange plastic laminate top with a 2-in. self edge. The X-shape tubular base is finished in orange thermoset epoxy. / Vecta Contract, Inc.

579 OFFICE FURNITURE / Desks, credenzas and breakfronts of traditional design are offered in hand-rubbed walnut or mahogany finishes. Desks are available with straight grained wood or inlaid leather tops. / Wood Design, Inc.

580 KD BUTCHER BLOCK / Economically-priced solid wood butcher block furniture is offered knocked down, ready for easy re-assembly in home, apartment or office. Table shown is 3-in. thick; other pieces include dining tables, bookcases and desks. / Newwood Products of Oregon.

581 HUTCH BOOKCASE / Also part of the "Interpanel" line, this 72-in.-high credenza with hutch bookcase has a fully finished back: units can be used as room dividers. Fully adjustable shelving has metal bookstops routed in, to support books in any position. Design elements such as upright panels are available square, as shown, or with radius corners. / Heibert Inc.

582 CONFERENCE/DINING / Tops of the Bob Becker-designed "NQ" series tables are "not quite" round or oval, with their dimensional variations emphasized by the bullnose edge in a contrasting wood. Several wood species are available in the pedestal-mounted series, including mahogany, walnut, rosewood and elm burl. / Helikon Furniture.

583 COORDINATED LINE / The high-style, functional components of "Design Option III" offices integrate with this maker's other full-height panel systems. Accessories from swing arm lamps to coathangers are included in the line of variable-height walls, work surfaces, storage units, electrical distribution and management devices. / The E. F. Hauserman Co.

584 RESTAURANT TABLE / Both the scored, anodized aluminum base and natural-look butcher block top of the "Discus" table carry a two-year guarantee. Top options include plastic laminate, solid oak or maple butcher block, and Carrara marble; base diameters may be 18-, 25-, or 33-in. / ICF, Inc.

585 LOFT BED / This company's newest addition to their Roomate Series of dormitory furniture is an elevated bed underneath which is a desk and storage units. Fluorescent light and oak ladder are optional features. / Adden Furniture Inc.

586 TWO-SEAT SOFA / The solid oak wood frame has radiused corners and bullnosed edges. The Irish wool upholstered seats and backs are removable for easy cleaning. The unit is also available in one-, three- and four-seat versions. / Adden Furniture Inc.

587 CONFERENCE TABLE / A handsome contemporary conference table is accented by mirror chrome or antique bronze base. The Circa 90 Executive Series is oak with matched oak veneers. Designed by Carlos Lopez-Benitez. / Monarch Furniture.

588 SPECIAL LEG BASE / A set of four table legs are available onto which any wood top can be attached, to create a table in any size and for any purpose. The legs are 3-in. in diameter and are made in steel, finished in either black or white stove-enamel or in polished chrome. The top plate and foot is always in black "Hostaform" plastic, and the foot adjusts to compensate for uneven flooring. / The Ironmonger.



589

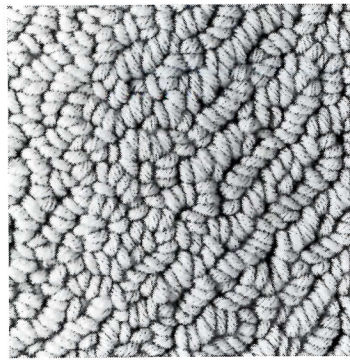

592

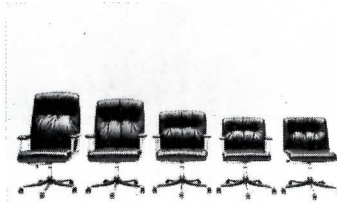

595



598



590



593



596



599

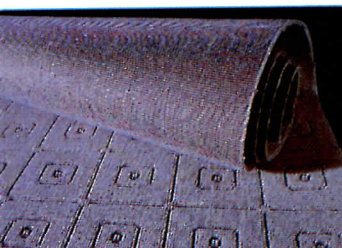

591



594



597

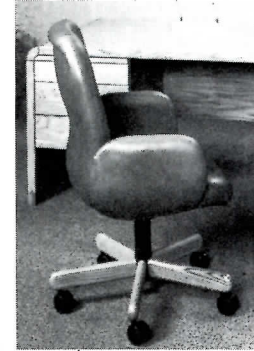

600

589 WOOD FURNITURE / The 8700 Series of wood office furniture has shaped contours of walnut solid surfaces blended with walnut veneers. All desks have an off-the-floor front panel design. / Myrtle Desk Co.

590 DUAL-PEDESTAL DESK / Meticulously detailed woods with mitered corners are used in the "Omega" executive desks, offered in three- and four-drawer pedestal versions. Wood species include oil-finished oak, walnut, teak, brown oak or pao ferro. Three size choices: 32- by 66-in.; 32- by 72-in.; and 36- by 78-in., all 29 $\frac{1}{4}$ -in. high. / Stendig Inc.

RUGS

591 WILTON WEAVE / The "Meridian" pattern of all-wool loop pile is available in rugs with a 6- or 9-in. border in sizes from 4- by 6-ft to 12- by 16-ft. Natural White is carried in stock; custom colors may be ordered. / The Scott Group, Selaco Div.

592 NATURAL WOOL / The basic design of "Modena" is a series of parallel diagonal lines. Within this pattern, however, the wool yarn is allowed to fall into its own natural irregularities in the course of weaving. / V'Soske.

SEATING

593 OFFICE SEATING / The "Logano" chair has a hand polished tubular steel frame upholstered in leather or fabric. Sled base, swivel, and swivel-tilt models are available, all 30-in. high. / Brayton International Collection.

594 TENSION-FABRIC CHAIRS / The "Archizoom" office seating system is now available in a separate "Kevi" nylon version. The abrasion resistant fabric is stretched over an arm or armless tubular steel frame in chrome or black epoxy finish. Integral seat cushion provides support at the knees. Base options: sled, five-star or circular pedestal. / Atelier International, Ltd.

595 ITALIAN SEATING / A gas spring height adjustment and five-star pedestal base are now standard features on the "Tecno Collection" office seating. Upholstery may be fabric, vinyls, suedes or leathers with removable seat and back pads in tufted or channel styling. / Atelier International, Ltd.

596 COMMERCIAL SEATING / Careful design considerations are said to have improved the comfort and convenience of "Modus" line of institutional and commercial office seating without increasing the over-all price. Molded of anti-static nylon, chairs have a five-star base and gas spring height adjustment. / Atelier International, Ltd.

597 COMPREHENSIVE SEATING / The basic molded parts of the ergonomic "Sit System" are now available in dark brown, as well as gray. The moderately-priced line offers a range of seating for office, institutional and commercial application. / Atelier International Ltd.

598 AUDITORIUM SEATING / The "Axis 7000" is basically a ganged armchair with either one or two arms between the self-rising seats. The armrest houses a simple writing tablet and/or translation equipment. Polyurethane cushioning and *Nylour* or wool/nylon upholstery meet California and Boston flammability standards. Price per seating unit: about \$250. / Castelli Furniture Inc.

599 HANGING SETTEE / Shown here installed on the Danish liner "Dania Anglia," model "181" seating is mounted on wall rails. The space-saving settee is available with one arm rest, or with upholstered rests on both sides. / Cado Royal System.

600 OFFICE SEATING / The 15 models in the "Focus I" line provide ergonomic posture support in chairs with oak bases. Executive chairs may have either shaped laminate oak or upholstered arms. / Kimball Office Furniture Company.



601



602



603

601 FOLDING CHAIR / A streamlined design of molded copolyester mounted on a chrome-finished steel frame, the "Skyline" chair is suitable for both contract and residential use. Tip-proof chair folds to a 1½-in. width for storage. / Howe Furniture Corp.

602 SWIVEL CHAIR / Scaled for use in confined office areas, the "Aspen" chair is molded entirely of *Proberon* foam with synthetic down around a welded steel frame. Version shown is fully upholstered with plywood arms; fabric options include COM, vinyl and leather. / Harvey Prober Inc.

603 SIDE CHAIR / Upholstered in fabrics by designer Jack Lenor Larsen, the "dePolo" chair for home or office use is built on a small-scale sculptured wood frame. Back height is about 32-inches. / Dunbar.



604



605

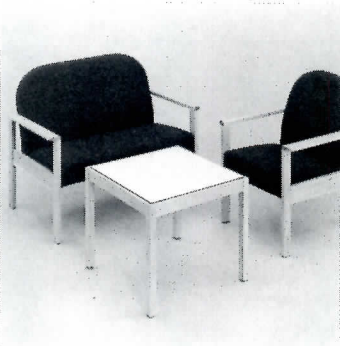

606

604 BACK SUPPORT CHAIR / The *Ergosit* office chair, from Wilde & Spieth of West Germany, features a back support mechanism that provides continual back support; pneumatic height adjustment; and a tip-proof, five-point caster base. Office, drafting, and health care models are available. / Charrette Corp.

605 CLUSTER SEATING / "Cebra" units seat from two to eight persons in self-centering, swivel spring return molded chairs. Chair/table combinations come in three styles for flexible installation: freestanding island; freestanding wall style; and wall-mounted. / Plymold Booths, Div. Foldcraft Co. GB, IR, I,CC*

606 HEALTH CARE SEATING / The "Steinberger Elm" series for medical facilities now includes a lounge chair, a two- and three-seater, and an occasional table. Exposed fasteners in the solid elm frames facilitate upholstery replacement. / Thonet Industries, Inc.



607

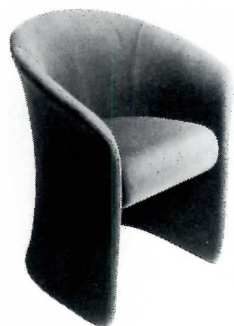

608



609

607 SOLID WOOD CHAIR / Developed by Vignelli Designs, the "Acorn" chair has a solid turned wood frame constructed with precise joinery work. The chair is offered in three woods and five finishes; seat options include leather or natural linen sling; cane; or foam covered in fabric. / Sunar.

608 SIDE CHAIR / Another Vignelli design, the "Rotonda" chair, is a fabric-covered tubular shape constructed of high-resiliency foam on a steel frame. Side chair version is 32-in. high; a "Rotonda" lounge chair measures 29-in. high. / Sunar.

609 GARDEN CHAISE / The "Borkum" recliner is constructed from tubular steel and wire, coated in a durable white or dark green synthetic finish. / Architectural Complements.

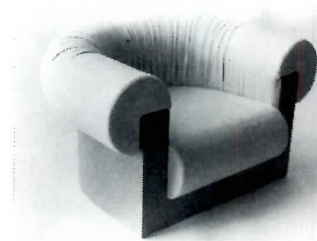

610



611



612

610 LOUNGE FURNITURE / "Circolo" seating—sofa, settee, and lounge chair—has an architecturally formal, yet comfortable appearance; the enclosing wood frame is deeply upholstered and cushioned with 10 in. of foam. A Vignelli design, the chair shown measures 26-in. high by 48-in. wide. / Sunar.

611 ROW SEATING / Tandem units for lounges and waiting rooms and adjustable chairs for office use have easily maintained upholstered seats. Components are fastened in place by one screw, and are quickly removed for cleaning or replacement. / ICF, Incorporated.

612 STEEL STACK CHAIR / David Rowland has designed the *Sof-Tech* chair using plastisol-coated sinuous springs as exposed seat and back sections. The mesh-like springs provide flexible, ventilated seating. Options include a ganging version of the chair and zip-off upholstery sleeves for seat and back. / Thonet Industries, Inc.



613



614



615

613 MOLDED PLY CHAIRS / The basic arm and side chair versions of this molded ply line have seats, backs and arm/leg units of oak veneer molded plywood. Exposed fasteners facilitate replacement of components; a metal-linking device is available for multiple seating arrangements. / Thonet Industries, Inc.

614 CONTRACT SEATING / The "Multiple Choice" collection, by designer Hans Krieks, is composed of five basic units: one seat, two backs, and two tables, which may be ordered in any wood. A reverse seating unit with one table is pictured. / Helikon Furniture Co., Inc.

615 LUXURIOUS TWO-SEAT CHAIR / The Panda 2401-2403 series, designed by A. Rascaroli, is offered in an armchair, 2-seat sofa (shown) and a 3-seat sofa. The structure is wood and metal; the upholstery is available in fabrics, leathers and suedes. / The Pace Collection, Inc.



616



617



618

616 CONTRACT CHAIR / A stainless steel frame with no-sag springs and helicals, welded into a seamless integral unit supports the "Ghia Two" chair measurements: 33-in. high; 26-in. deep; 21½-in. wide. / Brueton Industries.

617 PATIENT CHAIR / "H" series chairs provide a complete program for a variety of seating applications within health care facilities, including lounge seating and tables, ottoman and guest chairs. Designed for ease of maintenance as well as proper support and comfort, the patient chair has a space between back and seat for cleaning. / The Gunlocke Co., Inc.

618 PULL-UP CHAIR / An addition to the executive office collection by designer Giovanni Carini, this fully upholstered armchair has a sled base of self-skin urethane foam. The companion table has the same type of sled base, with a top of ashwood veneer, in natural or ebony finish. / Atelier International Ltd.



619



620



621

619 CORBUSIER SEATING / Original Corbu designs, some never before produced, are available under license from Cassina of Italy, along with classic chairs in new color options. Included are two padded stools, a dining chair with a tubular padded back, and the *Chaise-Longue à réglage à continu*, offered with chrome, matte black, or two-color urethane finished base. / Atelier International, Ltd.

620 PARK CHAIR / For outdoor and indoor use, this steel stacking chair, designed by Wirth, was selected for le Centre Beaubourg, Paris. The tubular steel and wire is coated with white or dark green abrasion- and rust-resistant finish. / Architectural Complements.

621 ARM CHAIR / Tubular steel frame of the "Pfister" chair reads as one continuous flowing tube; upholstered seat and back units allow for easy cleaning or replacement. Frames are available in polished chrome or fused polyester powder coating. / Metropolitan Furniture Corp.

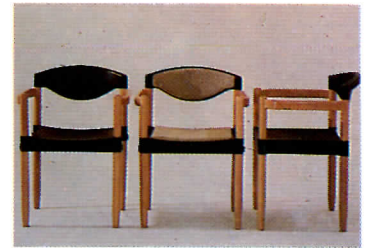

622

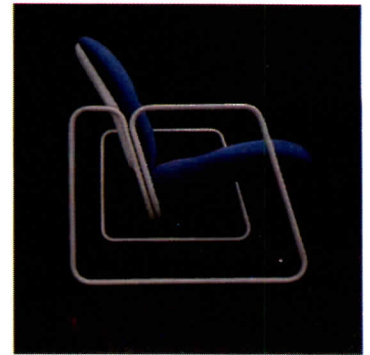

623



624

622 GANGING STACK CHAIR / Hardwood-framed "Straz" chairs have interlocking tabs molded into polypropylene seats to simplify ganging. Large compound curved seats and backs offer the option of foam cushioning in wool or nylon upholstery. Arm chair, armless, and bench seat models all stack for storage. / Krueger.

623 SECTIONAL SEATING / Flexible "441" units have arms that can be added or removed on location; arms may be used on both sides of each seat in a sectional group, even if the seat adjoins an attached table. The full line is 92 units, including two-, three-, and four-seat settees and benches, tables, and freestanding chairs. / Steelcase Inc.

624 MONOCHROMATIC / Color options for this maker's "430," "454," and "441" chair lines now include single-color choices: chair bases, upholstery materials, frame finishes and outer shells may be ordered in neutral tans and gray. / Steelcase Inc.

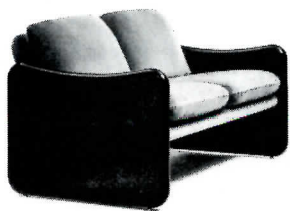

625



626

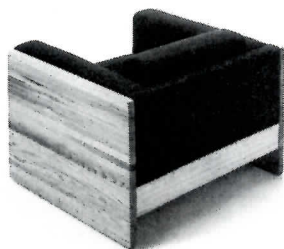

627

625 HIGH TRAFFIC SEATING / Basic "570" and "571" lounge style consists of an upholstered seating unit suspended between two arm panels. Back and reversible seat cushions attach to the chair with *Velcro* strips; all fabric components are easy to remove for repair or replacement. / Metropolitan Furniture Corp.

626 FULL LINE SEATING / This seating system includes eleven chairs for any office work requirement. Each individual chair allows a five-way adjustment of cushions, back support, height and tilt to suit each user's own comfort needs. / Litton Business Furniture.

627 CLUB GROUP / Generously-proportioned cushions are set into a solid oak chassis in the "140" club chair. Chair is 37-in. wide; two- and three-seat sofas are also available, all with solid oak end panels. / Tuohy Furniture Corp.



628



629



630

628 DUAL PURPOSE / This oak-framed sofa designed by Steinberger converts into a *Hide-A-Bed*, one of a series of versatile furniture. Available with wide channeled or non-channeled upholstery detail, the group includes two sizes of sofa, a chair, and a love-seat. / Thonet.

629 STACKING CHAIR / Constructed with a 3/4-in.-dia polished steel frame and foam-covered molded plywood seat/back, the "Linear" molded plywood seat/back, the "Linear" chair is offered in arm and side versions. A linking device holds chairs in place when lined up side-by-side; options include row and seat numbers; storage pockets; and tablet arm (armchair only). / Stendig Inc.

630 POLYURETHANE FURNITURE / Self-skin polyurethane foam on all arms and base parts is combined with ergonomic research to produce this chair system. The soft-skin feature protects the user's shoes and ankles and will not damage desks. The "Barbar" collection has secretarial through executive versions. / Atelier International, Limited.



631



632



633

631 CAPTAIN'S CHAIR / A special version of the captain's chair, designed by Arthur Umanoff, features exposed oak arm caps, which are available in natural, medium or dark oak. The hardwood base is recessed and painted black. / Madison Furniture Industries.

632 CURVACEOUS SEATING / Described by the manufacturer as "the old park bench updated for today," this modular seating can be attached in groups of threes and fours. The "Park Lane" line has a bent plywood frame, and upholstered in ribs. / Monarch Furniture.

633 WICKER STOOL / This swivel wicker bar stool features natural wicker, hand woven over a tubular frame with a polished chrome base. The seat and back are upholstered foam pads, with a tufted back. / Shelby Williams Industries, Inc.



634



635

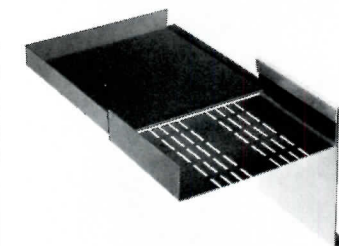

636

WINDOW TREATMENT

634 INSULATED SHUTTERS / Constructed with a solid wood frame and birch plywood panels completely enclosing a 3/4-in. polyurethane core, interior mounted *Insul Shutters* block conduction, convection and radiation heat loss from windows and sliding doors. Retail costs range up to \$8.40 per sq ft. / InsulShutter, Inc.

635 FABRIC VERTICALS / Forty-two fabrics in five texture groups are offered in the *Flexalum* line of vertical window treatments. Easy-to-clean fabric panels are 5- or 3 1/2-in. wide; the system permits equidistant spacing of panels regardless of window size, eliminating bunching at either side. / Hunter Douglas, Inc.

636 DRAPERY POCKET / An unvented center strip accommodates drapery tracks and retains venting efficiency. It is made of steel primed on surfaces with baked on Alkyd exposed surfaces. / Fry Reglet Corp.

3118 FLUOROCARBON COATINGS

/ *Fluoropon* architectural coatings bond evenly to aluminum or galvanized steel substrates, and may be spray or coil applied. Design brochure contains application photos of the coating on airline and power facilities, high- and low-rise office buildings, on curtain walls and fascias, etc. Color selection folder provides samples of all tones available. / DeSoto, Inc. GB, ICR*

3119 VINYL WALLCOVERING / *Korolite* scuff-resistant wallcoverings are shown in a full-line catalog. Physical properties and performance standards are given for all textures. *Tedlar* coating offered on *Koroseal* vinyl permanently shields the wallcovering from stains and marking. / The B.F. Goodrich Co. GB*

SPECIALTIES: UCI 10

3120 STORAGE SHELVING / Current price guide covers metal storage units, dunnage racks and utility carts. All products are illustrated, with dimensions and finish options given. / Precision Metal Products, Inc.

3121 ALUMINUM CANOPIES / Technical brochure contains information on components used in walkway covers, freestanding canopies, wall- and post-supported canopies, marquees and overhead-supported canopies. Fascia and panel options are illustrated. / Alcan Building Products. ICR

3122 BIRD CONTROL / Plastic birdnet is effective in controlling damage from birds in warehouses, food service areas, cooling towers, structural steel spans, etc., according to a product brochure. It may also be used to prevent nesting and roosting in wall and cornice indentations. / Conwed Corp.

3123 AIR HANDLING LOUVERS / A 36-page catalog describes a full line of high performance louvers for all air handling requirements. Literature incorporates English/metric conversion figures throughout. Eight pages of extensive technical data on free area, static pressure drop and air flow for each model is included. / Construction Specialties, Inc.

3124 SIGHT SCREENS / Fact sheet describes the "Series 300" line of aluminum framed office dividers. Detail drawings show various mounting options. / Conwed Corp.

EQUIPMENT: UCI 11

3125 DOCK LIFTS / "The Disappearing Dock" shows where dock lifts can be most effectively used, and gives cost comparisons between lifts and conventional raised concrete docks. / Advance Lifts, Inc. GB, ICR

3126 STEEL OPERABLE WALLS / The *Acousti-Seal* movable partition is described in a product booklet. Performance data, operating and storage methods, and fire safety information is given in the literature. / Modern-fold/An American-Standard Co.

3127 FOOD SERVICE / Mobile equipment for institutional and restaurant food service is cataloged in a 48-page price guide. Products include buffet servers, food transport carts and hot, cold and proofing storage cabinets, conveyors and compactors. / Precision Metal Products, Inc.

3128 NUCLEAR QUALIFICATION / Methods and facilities for environmental qualification of nuclear safety related equipment to IEEE Standard 323-1974 are described in a 4-page brochure. / Wyle Laboratories.

3129 LABORATORY SAFETY / Comprehensive manual covers accident prevention, first aid, fires and firefighting, handling toxic fumes, working with gases and acids, and disposal techniques. OSHA lab safety requirements are outlined. Safety products are cataloged, including personal protection equipment, smoke alarms, eye wash fountains, etc. / Fisher Scientific Co.

3130 DOCK SHELTERS / Product data brochure shows how "Series 400 Weather Guard" shelters provide an effective seal against docked trucks and permit full access to the truck body. / Frommelt Industries, Inc.

FURNISHINGS: UCI 12

3131 STEEL DESKS / Literature describes over 60 different single- and double-pedestal desks, credenzas, tops and component cabinetry that make up the "5200 Series" office line. The expanded collection includes 20-in.-deep desk-height returns, free-standing storage credenzas, convertible cabinets and laminate tops. / Steelcase Inc.

3132 DRAWER SLIDE / Selector guide lists 26 types of drawer slides, giving side space requirements, load capacity, sample applications and available sizes. / Grant Hardware Co. GB*

3133 COMPUTER FURNITURE / The "ESF" line is furniture designed especially to facilitate the integration of the mini computer and other portable types of electronic information processing equipment into the office environment. Product brochure describes this "Electronic Support Furniture." / GF Business Equipment, Inc.

3134 FEASIBILITY STUDIES / Folder explains services offered to design professionals in establishing the space and budget requirements for office facilities. Working from building plans and job descriptions, feasibility study report includes photographs, plans and dimensions of suggested work stations for each employee category. / Herman Miller, Inc.

3135 SOUND DIVIDERS / The design versatility of open office sound dividers is explained in a 12-page brochure. The system permits positive locking, an electrical raceway, hang-on capability and two inches of leveling adjustment; technical data and assembly instructions are given. / Owens-Corning Fiberglas Corp.

3136 FIRE-RESISTANT LINERS / Reference source acts as a guide to *Vonar* interliners and their use in business and institutional furniture. Photos show extensive flammability testing carried out on seating constructed with and without the polymer interliner. / DuPont Co., Elastomers Dept.

3137 POCKET-SIZE CATALOG / A pivot-bound card book enclosed in a swing-open plastic case, the "BookKasette" format is used as a catalog for this line of furniture, lighting, art and accessories. Each 2 1/2- by 4-in. card contains product data and photographs of contract seating, lounge pieces, armchairs, office systems, lighting, etc. / Atelier International Ltd.

3138 OFFICE FURNITURE / Designed by Bob Becker, "Options System" open office furniture is introduced in a color brochure on these enclosure and storage components. / Helikon Furniture Co., Inc.

SPECIAL CONSTRUCTION: UCI 13

3139 ACOUSTICAL CEILING / Sound absorption, flammability, light values and other data on ceilings and interior surfaces are given in a 12-page brochure. Included are acoustical ceiling boards and panels; the *Architexture* series; energy-saving ceilings and wall treatments; and noise barrier batts. / Owens-Corning Fiberglas Corp.

3140 FABRIC STRUCTURES / Permanent architectural fabric structures, both air-supported and tensioned, are described in a 14-page color brochure. Applications range from radomes to convention centers; photos show completed buildings and illustrate each step in the erection of both types of fabric structures. / Birdair Structures, Inc. GB, ICR, E*

3141 PLYWOOD ROOFS / "Build a Better Roof", a 24-page booklet, outlines the benefits of plywood roof decks, explaining how they cut costs and work with almost any support system used in commercial and industrial construction. Modifications in roof deck design to resist high winds and seismic loading are suggested. / American Plywood Assn.

3142 INTEGRATED CEILING / Two aluminum ceilings are covered in a color brochure: the *Planar* ceiling in indoor and soffit applications, including out-of-square and curved areas; and the *Plenum Mask* system, which screens mechanical and other equipment while allowing air to circulate and sprinklers to operate. / Alcan Building Products. ICR*

CONVEYING SYSTEM: UCI 14

3143 GRAVITY CONVEYORS / An 8-page brochure explains wheel and roller conveyors, designed for handling loads of up to 110-lb and 350-lb respectively. The *Cleanline* aluminum roller conveyor, for light loads such as food trays and components, is featured. / Rapistan, Inc.

3144 PEOPLE MOVERS / Fully illustrated with color photos of recent installations, capabilities brochure describes elevators and escalators for new buildings as well as retrofit applications. / Westinghouse Elevator Co. GB*

MECHANICAL: UCI 15

3145 SOLAR CASE STUDIES / Professionals interested in practical applications of active solar energy systems may subscribe free of charge to the "Solar Spectrum" newsletter. Each issue will cover installations of *Daystar* and other solar products on a project basis, providing information of funding, historical details, design, installation and system performance. / Solar Thermal Systems, Div. Exxon Enterprises Inc.

uci13

special construction



649



650



651

AIR SUPPORTED STRUCTURES

649 FABRIC STRUCTURES / This permanent fabric structure is claimed to be economical due to minimal maintenance costs and energy saving features while allowing design freedom. / Birdair/Chemfab.

650 FABRIC ROOF / An architectural grade *Teflon*-coated *Fiberglas* roof, as shown here, demonstrates the prime design characteristic of an unusual, handsome and translucent roof. Its fire resistancy is particularly suited for retail and other public buildings. / Birdair Structures, Inc. GB, ICR, E*

651 SPECIAL FABRIC ROOF / The largest air terminal in the world soon to be completed in Jeddah International Airport has a tension fabric roof. For a more complete story of this roof see RECORD, mid-August 1979. / Birdair Structures, Inc. GB, ICR, E*



652



653



654

652 CANOPY SHELTER / Shown as an unusual roof design at the Duval Center in Jacksonville, Florida, this tensioned fabric roof provides a shaded rest area and a stage for outdoor events. / Birdair Structures, Inc. GB, ICR, E*

653 AIR SUPPORTED ROOF / Specifically designed for tennis court facilities, this fabric roof creates an "envelope," providing a totally open recreation area. / Birdair Structures, Inc. GB, ICR, E*

INTEGRATED ASSEMBLIES

654 SPACE FRAME / The "Crystogon" space frame features bronze tinted acrylic panels and bronze anodized aluminum extruded framework. The project shown is the botanic garden in Des Moines. / Temcor. GB*

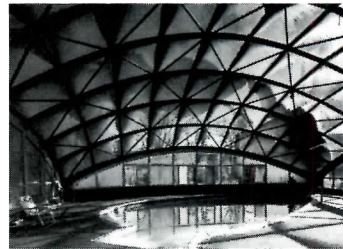

655

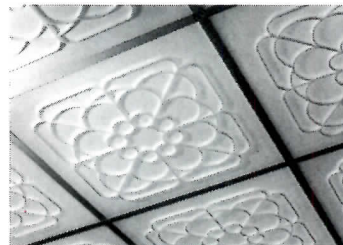

656



657

655 METAL BUILDING SYSTEM / The *Triodetic* structural system produces grids, arches, domes and various other geometrical forms, with which any covering system is compatible. / Butler Manufacturing Co. ICR*

INTEGRATED CEILINGS

656 CEILING GRID / A luminous ceiling grid system includes "Envelope" panels. Logotypes can be displayed in the panels or plain plastic light diffusers can be used in ceilings. / Envel Corporation. GB, I*

657 INTERIOR SYSTEM / An integrated interior building system is composed of wall, ceiling and access flooring of interchangeable components and re-connectable mechanical-electrical elements. / Flexten Systems, Inc. GB*



658



661



664



667



659

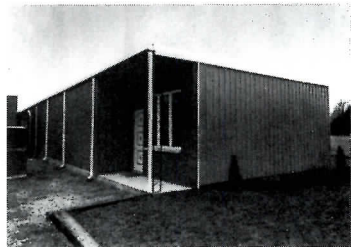

662

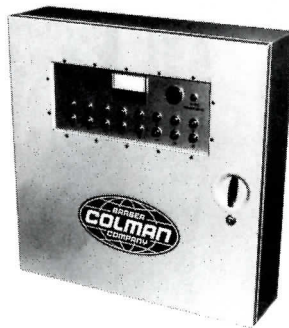

665

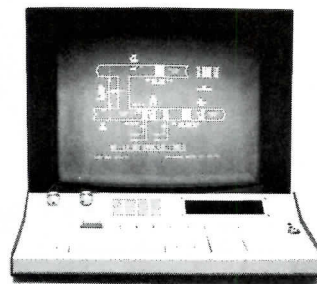

668

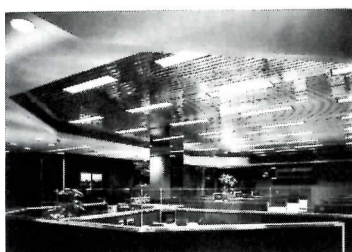

660



663

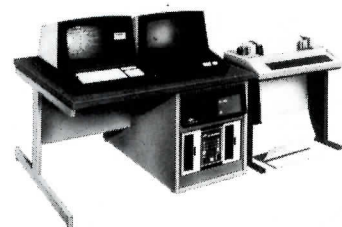

666



669

658 INTEGRATED CEILING / These 3-by-3-foot interlocking aluminum panels called "Bold Cell" provide an unbroken sweep that creates an illuminated ceiling pattern. / Neo-Ray Lighting.

659 COFFERS / Classic Sculptured Modules are manufactured from gypsum cement and inorganic reinforced materials. They are furnished with square or round downlights, openings for air diffusers and sound fittings, or can be blank as accent panels. / Neo-Ray Lighting.

660 REFLECTIVE CEILING / The Bright Sheet *Planar* ceiling system has a mirror-like quality that makes it particularly attractive for retail applications. It is lightweight and needs little maintenance while providing access to utilities. / Alcan Building Products. ICR*

661 CEILING PANELS / Pre-punched eight-foot long carriers and aluminum panels of the *Planar* Ceiling System allow for special concave and convex applications. / Alcan Building Products. ICR*

PREFABRICATED BUILDINGS

662 INSULATED PANELS / Four-in. thick, metal clad panels are available for walls, vertical corners, roofs and floors. They have a high insulating efficiency of R 34. / Bally Case & Cooler, Inc. GB, ICR, E*

SPECIAL PURPOSE ROOMS

663 SAUNA KIT / Pre-cut sauna room packages are available in eight standard sizes from 4- by 4- to 8- by 12-ft, and include all equipment and materials to finish the interior of the sauna. / Amerc Corp.

TOTAL ENERGY SYSTEMS

664 POWER CONTROL / The JC/84 is a computer based system that features user programmability, with color GRT, static and dynamic graphics. / Johnson Controls, Inc.

665 POWER MANAGEMENT / The PM² system has a "Power Monitor Control" that regulates peak demand and total power usage. It features "Demand Limiting" controlling electrical loads, and "Cycle off," controlling total power usage by shutting down building systems for periods of time. / Barber-Colman Co.

666 FACILITIES MANAGEMENT / The Econ VI Facilities Management System is utilized in this Kansas City hospital. The computerized and centralized control system provides communication with mechanical and electrical controls and humidity monitoring. / Barber-Colman Co.

667 BUILDING AUTOMATION / This System 600 offers a full range of management and monitoring functions, with digital technology, Fortran programming and color graphic CRT for new and retrofit applications. / MCC Powers.

668 DIGITAL MANAGEMENT / Using fully digital transmission, the DMS 2400-3 System provides computerized automation that ranges from basic monitoring to fully programmed management of all building functions including fire and security protection. / Robertshaw Controls Co., Control Systems Division.

669 COMPUTER MANAGEMENT / The S170/80 Energy Management System is a micro-computer based system that automatically controls building operations without a full-time operator. It includes an automatic scan of alarms, equipment start/stop and run-time totalization. / MCC Powers.



How to get a round ceiling through a square client.

Talk sense to him. Donn Paraline linear metal ceiling system is a sensible, affordable way to turn a workaday building into a showcase. The dramatic, flowing design possibilities of Paraline are limited only by your imagination.

Yet for all its visual impact, even your most skeptical client will see Paraline for the very practical solution it is. And — it's the only linear metal ceiling that's fire-rated!

Paraline adds flexibility to lighting and air return design while allowing easy access to the service area above. It's easy to install. Easy to maintain.

Paraline is available in steel or aluminum with a wide variety of wipe-clean standard color finishes, chrome-like polished aluminum or nearly any custom finish. It's also available in a fire-rated version for nearly any application you can conceive. It's even available with an NRC sound control characteristic up to .90.

Ask your Donn representative for full details. Call us toll-free. Or write us. Donn makes access floors. Donn makes wall systems. And Donn makes ceiling systems. **But most of all, Donn makes sense.**



Paraline Ceilings
1000 Crocker Road
Westlake, Ohio 44145
(216) 871-1000

Paraline now available fire-rated!

Circle 1056 on inquiry card

uci14

conveying systems



682

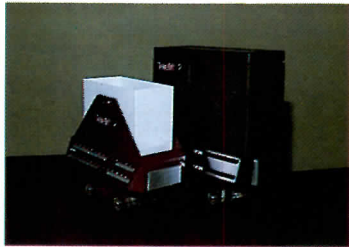

683

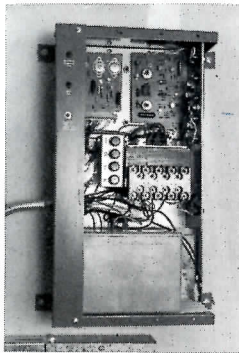

684

CONVEYERS & CHUTES

682 VERTICAL CONVEYER / Record-lift is an automated, continuous chain selective vertical conveyor that is designed to carry mail, files, records, books and supplies in high-rise buildings, libraries and hospitals. Pre-addressed trays, moving at speeds up to 12 per minute, may be received by or sent from floor stations. / MCC Powers-Transitube.

683 DISTRIBUTION SYSTEM / "Tele-lift" is a system of aluminum track and switches designed for installation within the mechanical and electrical system and equipment spaces that are an integral part of structures. New narrow, tall containers operate on electric "cars." / The Mosler Safe Co. GB*

ELEVATORS

684 ELEVATOR RETURN / Rechargeable battery-operated power unit provides emergency return for low-rise elevators during power failures. Automatically activated by loss of power, it causes the car to descend to the lobby landing at a normal rate of speed. / Otis Elevator Co.

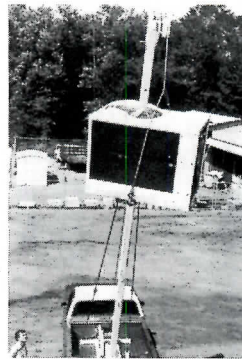

685



686



687

HOISTS & CRANES

685 PORTABLE CRANES / This crane is portable, fully retractable and can be truck-mounted, and is capable of medium- to heavy-duty lifting applications. It provides 9 to 27 feet of working height and has a rated capacity to 4,000 lb on a 3/4-ton pickup. / Bantam Hoist, Inc. GB, LCR*

686 HAND HOIST / This high-capacity portable hand hoist combines durability and light weight. Loads up to 6 tons can be lifted. It has an aluminum alloy frame with impact-resistant, *Lexan* resin end covers over the gears and hand wheel. / Acco Industries, Hoist & Crane Division.

687 CHAIN HOIST / Extra lifting strength is offered in the *Lodestar* heavyweight chain hoist line, with units of 2-, 3-, 5-, and 6-ton capacities. The *Hoistaloy* chain used in the "heavy-weight" will not twist, kink or jam the hoist. / CM Hoist, div. of Columbus McKinnon Corp.

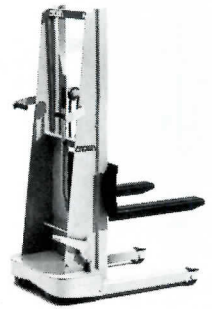

688



689

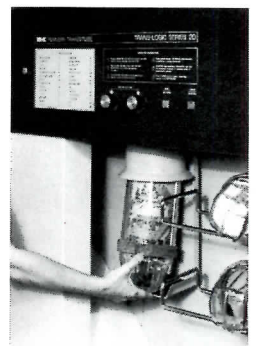

690

LIFTS

688 HYDRAULIC STACKERS / Loads up to 1,000 lb can be handled with this Hand Hydraulic Stacker series H. Standard features include a rugged steel plate chassis, dual lifting chains and fixed forks (that nest directly over the outriggers). / Crown.

689 FLYING PLATFORM / This airborne platform, used as a fire-fighting device in Chicago as shown, is suspended from a helicopter and can deliver firemen to and from upper floors of a high-rise building. It can also be used to reach inaccessible spots because of adverse terrain. / McDonnell Douglas Corp.

PNEUMATIC TUBE SYSTEMS

690 COMPUTER SYSTEM / This material handling system (available in 4- or 6-in. tube size) can move papers and records within suggested institutional, commercial or industrial buildings. "Trans-Logic" is computer-controlled, and additional stations can be added by updating the computer program. / MCC Powers-Transitube.



Architect — William Kessler and Assoc., Detroit, MI
Contractor — A. Z. Shmina and Sons, Co., Dearborn, MI

Montgomery Moves People at the Detroit Science Center

This escalator, a *thrill in light and motion*, is part of the Montgomery-built system which moves people at the new Detroit Science Center. The system includes another similar escalator and a giant elevator that can hold two bus loads of children — that's 140 — or 21,000 pounds. Beautifully and functionally designed for fast, efficient movement of people, these Montgomery escalators and elevators were specified to compliment the Center's unique architectural concept. Montgomery offers total capability in design, production, installation and maintenance of elevator and escalator systems, to assure uninterrupted service and long equipment life.

montgomery[®]
ELEVATORS/ESCALATORS
POWER WALKS & RAMPS

montgomery moves people

Montgomery Elevator Company, Moline, Illinois 61265 / Montgomery Elevator Co., Limited, Toronto, Ontario M9B3S5 / Offices in principal cities of North America

Circle 1057 on inquiry card

uci15

mechanical

AIR DISTRIBUTION EQUIPMENT
 AIR TREATMENT EQUIPMENT
 FIRE PROTECTION EQUIPMENT
 HEAT EXCHANGERS
 HEAT GENERATION
 HEAT PUMPS
 HVAC TERMINAL UNITS
 MECHANICAL CONTROLS
 PIPING & SPECIALTIES
 PLUMBING FIXTURES & TRIM
 PUMPS & COMPRESSORS
 REFRIGERATION EQUIPMENT
 SELF-CONTAINED HVAC UNITS
 VALVES
 WATER SUPPLY & TREATMENT
 SOLAR EQUIPMENT

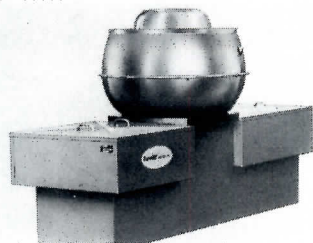

703



704

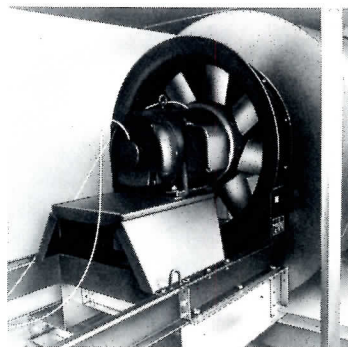

705

AIR DISTRIBUTION EQUIPMENT

703 MOUNTED FAN UNIT / The *Trifan* is a combination supply and exhaust fan unit with fans mounted. There is only one roof opening necessary and there is usually shorter supply and exhaust ductwork required. / Econovent Systems, Inc.

704 VARIABLE AIR UNITS / An air valve with only one moving part provides torque-free damper operation for the expanded *VariTrane* line of variable air volume equipment. Control options include system-powered (pictured), pneumatic and electric versions. / The Trane Co.

705 AXIAL FAN / A controllable-pitch axial fan is newly available for the company's *Weathermaker* central station air handlers. The product is claimed to help control noise and is of a convenient size to minimize design problems. / Machinery & Systems Division, Carrier Corp.

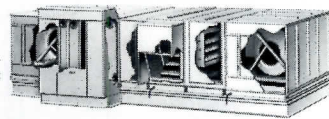

706

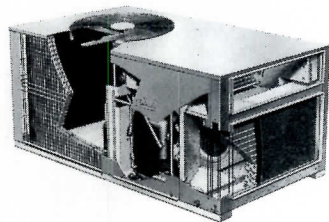

707

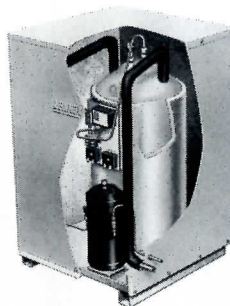

708

706 CENTRAL AIR STATION / The *Weathermaker* modular central station air handling unit comes in 13 new indoor units; and 13 Roofrite units, designed for outdoor, curb-mounted, rooftop applications. Capacities range from 2,300 to 63,000 cfm. / Machinery & Systems Division, Carrier Corp.

707 PACKAGE A/C, HEAT PUMPS / Two packaged unit lines offer all-electric operation and a large wrap-around outdoor coil with a powerful outdoor fan for maximum heat transfer. An indoor coil removes heat and humidity from supply air during cooling and allows for optimum heat transfer. / Lennox Industries Inc.

AIR TREATMENT EQUIPMENT

708 HVAC SYSTEM / A residential and commercial hvac system is claimed to reduce energy requirements while producing increased levels of zoned comfort. Called *ZoneMaster*, its primary feature is multiple-zone conditioning using several evaporator units with a single company two-speed condensing unit. / Lennox Industries Inc.



709

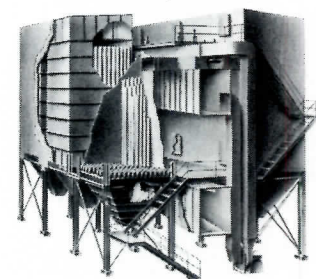

710

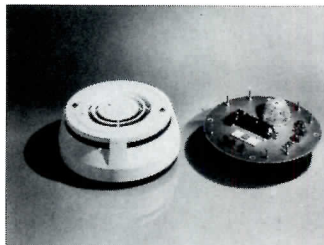

711

709 CONDENSING UNITS / Designed as a residential split system air conditioning condensing unit, the *HS13 Landmark III* produces seasonal energy efficiency ratios of up to 11.7. The unit is available in 2.5-, 3- and 3.5-ton capacities. / Lennox Industries Inc.

710 DUST COLLECTOR / A six-module fabric filter fly/ash reverse dust collector removes fly ash particulate from the exhaust gas leaving a coal-fired heating plant. It cleans fabric bags with a flush of recycled cleaned air. / Combustion Engineering, Inc.

FIRE PROTECTION EQUIPMENT

711 SMOKE DETECTOR / *PhotoBeta* is a newly introduced smoke detector that has the option of three different detectors with a common, interchangeable base. The "Sensmoke" is for Beta ionization detection; the "Pyro/Smoke" is for photoelectronic detection; and the "PhotoBeta" with sensors linked in two different configurations. / Gamewell Corp.



712

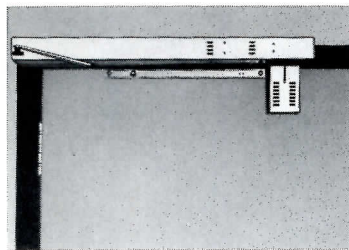

715



718



721



713



716

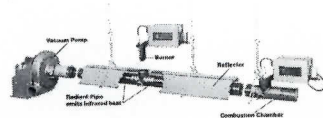

719

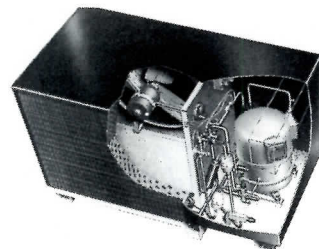

722

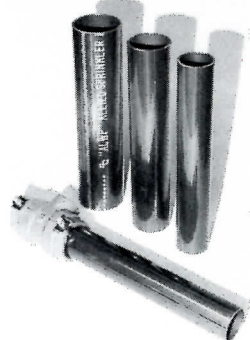

714



717

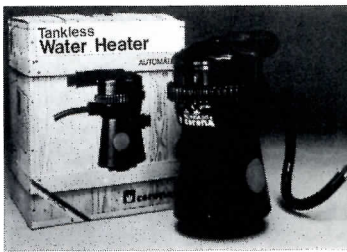

720

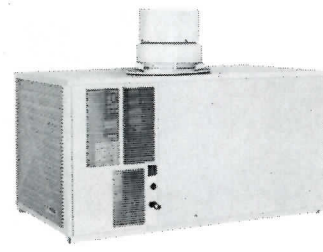

723

712 ESCAPE HARNESS / Constructed of fire-retardant materials, this personal safety harness acts as an emergency exit device. Anchored to a window jam or in masonry, the one-piece harness slips over the head and under the arms; hand pressure controls rate of descent along the rope. Unconscious and invalid persons may be lowered easily. / B-K Products, Inc.

713 FIRE HOSE / All-synthetic "Rack 'N Reel 500" emergency fire hose is fully lined, constructed to 500-psi test. Hose may be hydrostatically tested and reracked wet or dry. UL- and FM-listed for rack storage, the hose is immune to mildew and rot. / National Fire Hose Corp.

714 SPRINKLER PIPE / The Allied Light Wall Sprinkler Pipe is a Schedule 10 sprinkler pipe, which meets the requirements for the installation of sprinkler systems in NFPA No. 13. It is claimed to be as much as 30 per cent lighter in weight than Schedule 40 pipe and is manufactured from sheet steel which is cold rolled in a continuous process into pipe. / Allied Tube & Conduit Corp.

715 DOOR CLOSER / The *Smok-Chek* "Combo Quad" smoke actuated door closer is now U.L.-listed for limited open area smoke detection. It is a door-frame-mounted detector which can also serve to monitor for smoke throughout the room, eliminating the need for an additional ceiling-mounted detector. / Rixon-Firemark, Inc. GB*

716 WATERFLOW INDICATOR / The "Flo-cator" model FC is an electric paddle-flow device to signal the travel of water through fire protection system piping. Designed for use on wet-pipe systems, it features an electronic retard adjustable from 0 to 90 seconds. There is no mechanical connection between the vane and electronic components to ensure a watertight seal. / Sprinkler Manufacturing Division, Grunau Company Inc. E*

717 FIRE-PROOFING TAPE / An arc and fire-proofing tape made of an unsupported elastomer (thus making it flexible) expands in fire to form an insulating firewall between the flame and the cable in which it has been wrapped. / 3M Electro-Products Division.

718 ALARM VALVE / A lightweight Alarm Valve has been introduced that is an external by-pass. The divided seat ring alarm check valve is designed for either vertical or horizontal installation in wet pipe sprinkler systems. / Grinnell Fire Protection Systems Co., Inc. GB, ICR, E*

HEAT EXCHANGERS

719 GAS HEATING SYSTEM / Additional burner sizes have been added to the line of ceiling hung Co-Ray-Vac heating systems. Four different sizes have outputs of 20, 40, 60 or 80,000 Btus. / Roberts-Gordon Appliance Corp.

HEAT GENERATION

720 WATER HEATING ELEMENT / A built-in electric heating element provides continuous hot water from cold water taps. The temperature is regulated by the volume of water selected; and the unit works on either 220V or 110V electrical currents. / Distributed by Orlando Enterprises. Manufactured by Productos Electricos Corona LTDA in Brazil.

721 SPA HEATER / The electric "Spa-Pak" consists of heavy commercial grade stainless steel low watt density resistance elements installed in an all bronze tank. The unit is UL-approved as pool heaters for indoor and outdoor installation. / Raypak, Inc.

HEAT PUMPS

722 HEAT PUMP / A residential two-speed heat pump, the HP11 "Legend," has a low speed for normal, average operation during the year, but the high speed can be used for peak demand periods. / Lennox Industries Inc.

HVAC TERMINAL EQUIPMENT

723 COOLING/HEATING / The "EPCG" series residential electric/gas unit uses a unique Heat Transfer Module for efficient, safe heating with natural gas or LPG fuels. Furnace may be located outdoors. Compressor is designed for reduced internal resistance and low power consumption. / Amana Refrigeration, Inc., LRC*



724

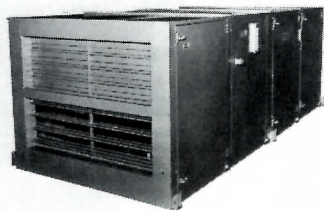

725



726

724 FAN COIL AC / Design improvements and larger sizes are available in *Hi-Line Seasonmaker* fan coil air conditioning units for multi-story construction. Factory-assembled hvac terminals are said to offer substantial savings in installation costs and energy usage. / McQuay Group, McQuay-Perflex Inc.

725 AIR HANDLING SYSTEMS / The Klimatic King Series 70 rooftop air handling unit provides a combination of cooling, heating, filtration, dehumidification, ventilation and pressurization. It is recommended to be especially adaptable to all food processing, pharmaceutical, hospital and clean-room requirements. / The King Company.

726 FAN CONVECTORS / The new company line of fan convectors includes five versatile models for every room. The unit shown is claimed to burn less than a 100-Watt bulb. The unit also allows room temperatures to be controlled independently. / Myson Incorporated.



727

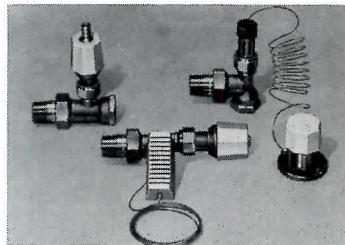

728

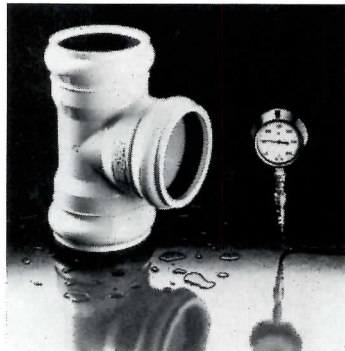

729

MECHANICAL CONTROLS

727 ENTHALPY CONTROL SYSTEM / Shown is one element, the transmitter, in the pneumatic enthalpy control system. A differential logic module selectively adjusts the outdoor and return air dampers. / Barber-Colman Co.

728 ZONE CONTROL VALVES / A line of non-electric zone valves, called *ThermoMate*, provides precise individual room temperature control in existing or new hydronic and two pipe low-pressure steam baseboard, convector and radiator installations. / Bell & Gossett ITT (a unit of the Fluid Handling Division, International Telephone & Telegraph Corp.).

PIPING & SPECIALTIES

729 GASKET FITTINGS / All sizes of *Lasc-O-Seal* PVC gasket pressure fitting now meet Class 200 requirements for water service applications. Requiring no adhesives in field installation, the fittings comply with ASTM regulations. / Lasco Industries.

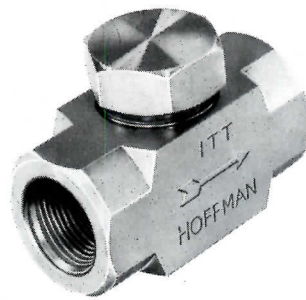

730



731



732

730 STEAM TRAPS / The stainless steel Thermodisc trap has only one moving part and has a replaceable seat and disc. The trap's disc includes a controlled micro bleed slot to prevent air binding and the trap is freeze resistant. / Hoffman ITT (a unit of the Fluid Handling Division, International Telephone and Telegraph Corp.).

PLUMBING FIXTURES & TRIM

731 PEDESTAL LAVATORY / Called "Chablis," this lavatory is made of vitreous china and designed to add a continental flair to baths. The unit has a rounded basin and corners, an anti-splash rim and concealed wall fasteners give additional stability. / Kohler Company.

732 TWO-HANDLE FAUCET / Executive" chrome faucets have straight-line-tapered escutcheon and a 4 3/4-in. sculptured spout. Faucet set is available on 8-in. centers, with or without a pop-up waste, in chrome or brushed chrome finish. / The Chicago Faucet Company.



733



734

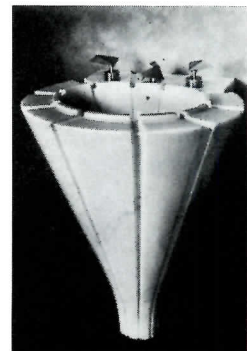

735

733 BARRIER-FREE COOLER / Extending 20 1/2-in. from the wall to permit wheelchair user access, "Model 1106BP" water fountain is all stainless steel, with lever handles located on both sides. Unit price is about \$340.00. / Haws Drinking Faucet Co. E*

734 SHOWER ENCLOSURES / *Tub-Master* "B" series doors are rigid bypassing units that also fold by unhooking the towel bars, allowing both doors to fold into small stacks at either side for complete tub/shower access. / Tub-Master Corp.

735 HAND-CARVED PEDESTAL / The hand-carved pedestal washbasin of marble is one of several new bath fixtures offered by Sherle Wagner. It has a specially designed polished chrome faucet set. / Sherle Wagner International, Inc.



736

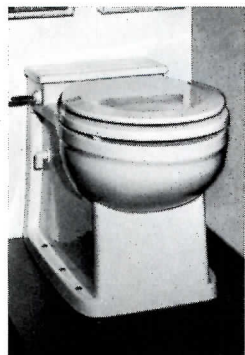

739



737



738

736 BATH FIXTURES / Designed by Italian industrial designer Paolo Tilche, the pedestal lavatory and floor-mounted toilet of the "Tilche Suite" combine curves and angles for classic, simple bath fixtures. / American-Standard. LRC*

737 WATER-SAVER / Low profile and an elongated bowl provide comfort and low maintenance in the "Lexington" toilet; water conservation design requires only 3.5 gallons of water per flush. Toilet is available in most of this maker's standard and premium fixture colors. / American-Standard. LRC*

738 EXTRA-SIZE TUB / The "Fontaine" bath is a full six feet long, with built-in lumbar support. The enameled cast-iron tub measures 36-in. wide by 18-in. deep; slip-resistant bottom and chrome-plated grab bars are standard. / American-Standard. LRC*



740



741

739 LOW FLUSH TOILET / The *Microphor* tankless toilet needs only two quarts of water for an air operated 12-second flush cycle. Vitreous china toilets are floor-mounted with either rear or downward discharge; units have major plumbing code approval. / Microphor, Inc.

740 PLUMBING FIXTURES / Shown is the S-4121 Easy-Push cast brass single metering lavatory faucet. It has a 3 1/2-in. code type spout with Vandl-rator. It also has a concealed cycle adjustment that works without shutting off the water supply. / Speakman Co.

741 SHOWER SET / This bath-tub/shower wall-mounted plumbing fixture is manufactured in England by Czech & Speake, Ltd. The unit is hand-finished, and is made of solid brass and available in finishes of polished brass or polished chrome, with polished gold as special order. / Manufactured by Czech & Speake, Ltd.; distributed by Fearless Faucets.



742



743

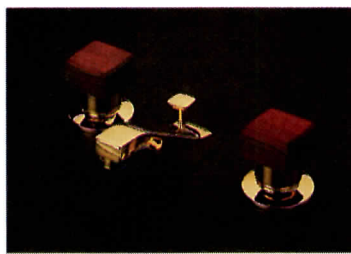

744

742 FAUCET SET / These bathroom fittings are available in polished brass, polished chrome; and polished gold is available on special order. This set is called the Edwardian Range, model no. 6450. / Manufactured by Czech & Speake Ltd., distributed by Fearless Faucets.

743 BAR/PANTRY SET / The gooseneck bar/pantry fittings are of solid brass, and are available in finishes of polished chrome or in baked enamel (white, navy blue, bright red, dark brown, beige and black). / Manufactured by Rubinetteria Zazzeri; distributed by Fearless Faucets.

744 WOOD FAUCET / The Alterna wood faucet line is a handsome combination of Cocobolo or Zebrawood handle tops and 24 carat gold, or brushed or polished chrome fittings / Kohler Co.



745



746



747

745 METERING FAUCET / Designed specifically for public restrooms, the push-button model 90-75 is timed to shut-off from 5 to 15 seconds, limiting flow of hot water to maximum of .45 gpm. / Bradley Corp. GB, ICR, E*

746 SHOWER IN THE ROUND / A cylindrical see-through shower cabin is made of metacrylic, and has polished chrome trim and fittings. The "Serie 2001" has compartments for bath accessories, mirror, thermostatic mixer controls, hand spray and coiled towel holders and warmer (that also serves as a hot water pipe); towels and bath accessories stay dry behind a special clear sliding panel. / Distributed by Hastings Il Bagno Collection. GB, I*

747 SPECIAL BATH UNIT / The "Serie 2001" bath unit is available as a single item or can be used in conjunction with the "shower in the round." Made of reinforced fiberglass metacrylic, with polished chrome trim and fittings, the bath is also available with an 8-jet whirlpool system. Colors are beige, red, brown, black, white or blue. / Distributed by Hastings Il Bagno Collection. GB, I*



748



749



750

748 MULTI-PURPOSE BATH UNIT / Called "Lavandone," this bathroom unit is of rustproof polyurethane. It includes a basin, counter, open compartments, medicine cabinet with sliding mirror, and special fittings of spray head, linen hamper, medium-wave radio and neon light diffuser. / Hastings Il Bagno Collection.

749 BATH IN THE ROUND / The "Serie 2001" combination bath/shower in the round is a cylindrical see-through shower cabin atop a circular tub, with optional 8-jet whirlpool. / Hastings Tile & Il Bagno Collection. GB*

750 SEE THROUGH SHOWER / "Antares" square shower unit incorporates 2 clear sides, non-slip floor, contoured seat, a mono-command hand mixer, folding door and compartments for accessories. The clear panels and door are metacrylic, and the other two walls are solid metacrylic reinforced fiberglass. All units are pre-fitted with pipes, requiring only connections to the cold and hot water and waste pipes. / Hastings Il Bagno Collection.



751



752

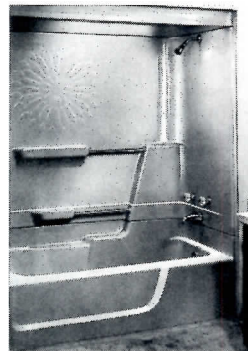

753

751 STEAMBATH / The "Steambath" unit has a stainless steel boiler and solid state controls, and is no larger than an attache case. It converts the home tub or shower enclosure into a spa. Simple plumbing hook-up brings water to the generator. / Steamist Co. Inc.

752 PEDESTAL BASIN / The "Pegaso" fluted pedestal basin is made of molded vitreous china. It is available in white, blue, ochre, green, amethyst, and special order colors. / Hastings Il Bagno Collection.

753 SHOWER/TUB / The "Gemini" two-piece, fiberglass tub/shower unit is of a convenient size for remodelings. Safety features include two horizontal grab bars on the back wall. Available in white, blue, green, gold and creme colors. / Universal-Rundle Corp.



754



755

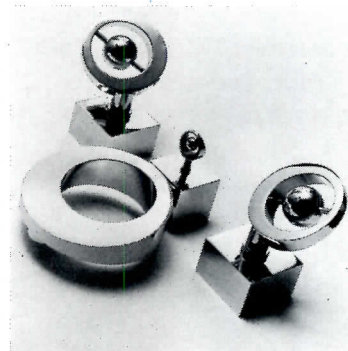

756

754 WATER COOLER / This water cooler is designed to be easily accessible to a wheel chair, featuring soft touch, self-closing push bar operation. Model HCWC-8 has a 12-in. bar that is activated by pushing the middle or either end. / Sunroc Corp.

755 SPECIAL FITTINGS / Strong geometrical design, these fittings are of mirrored chrome or gold finish. The highly sculptured, arced handles are equally functional. / Sherle Wagner International Inc.

756 UNUSUAL FITTINGS / The globe knobs and cylindrical faucet are highly contemporary designs for bath fittings. Available in mirrored chrome or gold finishes. / Sherle Wagner International Inc.

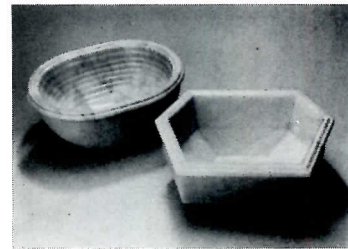

757

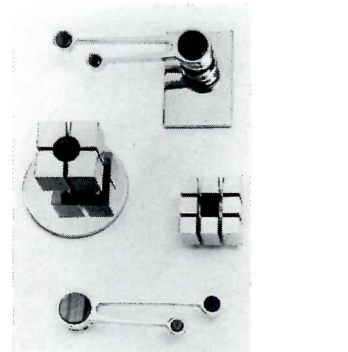

758

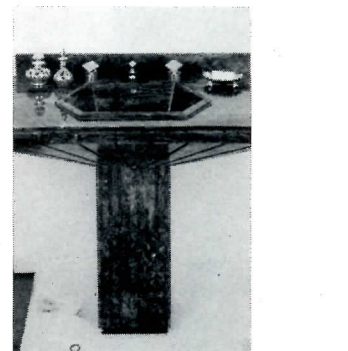

759

757 MARBLE WASHBASIN / Designed for small bathrooms, this compact unit has grooves and corners carved individually by hand from a solid block of marble, therefore colors and patterns vary. / Sherle Wagner International Inc.

758 STONE BATH FITTINGS / Semi-precious stones used as prominent and elegant elements of hardware surpass the ordinary bath fittings. / Sherle Wagner International Inc.

759 MARBLE SINK / This hand-carved mottled gray marble sink is called "Dimensions," and has contemporary fixtures in brushed chrome. / Sherle Wagner International Inc.



760

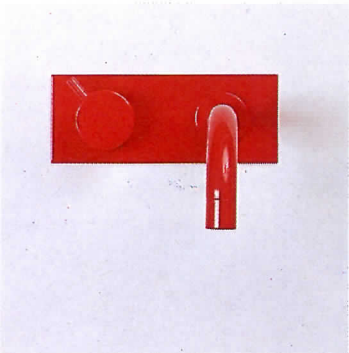

761

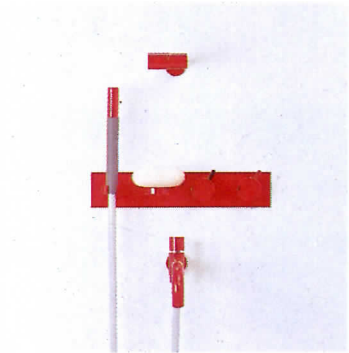

762



763

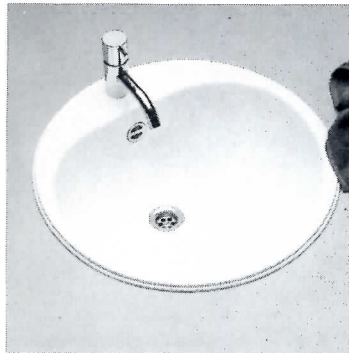

764



765

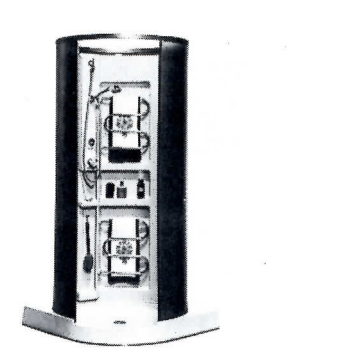

766

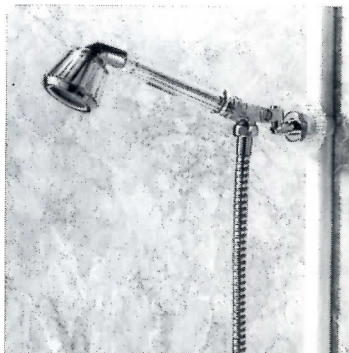

767

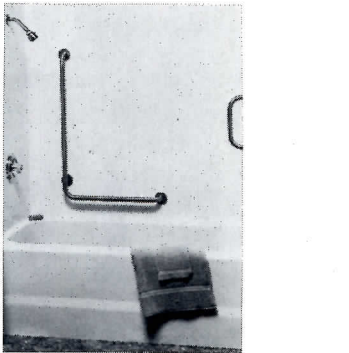

768



769

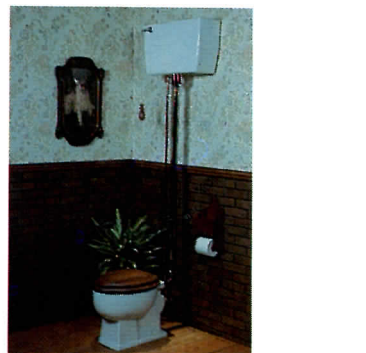

770

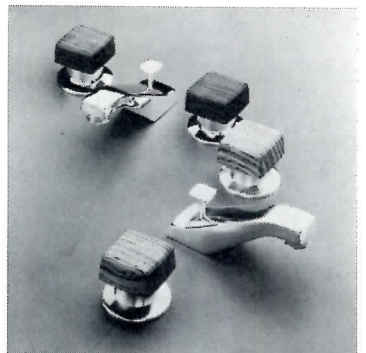

771

760 SWIVEL FAUCET / This deck-mounted, single-control mixing valve has a double swivel spout, which permits the user to wash the sides and back of sink without use of hand-held spray. Designed by Arne Jacobsen, the brass fixture is available with a range of mixing valves, outlets, plates and accessories. / Manufactured by Vola Sanitary Fittings; distributed by Architectural Complements.

761 WALL-MOUNTED FAUCET / Designed by Arne Jacobsen, this single control mixing valve with short fixed spout is available in 10 epoxy colors plus polished chrome and brass. The unit is washerless. / Manufactured by Vola Sanitary Fittings; distributed by Architectural Complements.

762 BATHTUB/SHOWER FIXTURES / These fixtures are wall-mounted with a single control mixing valve and diverter for overhead shower and a hand showerer/bathtub spout soap ring and mounting bracket. Available in 10 epoxy colors and polished chrome and brass. The pull handle increases flow of water, with only a turn to adjust water temperature. / Manufactured by Vola Sanitary Fittings; distributed by Architectural Complements.

763 FAUCET / This handsome faucet is deck-mounted and has a single control mixing valve with fixed spout. It has a brass modular plumbing system composed of valves, outlets, plates and accessories. The mixing valves are washerless and manufactured under license from Bradley Corp. / Manufactured by Vola Sanitary Fittings; distributed by Architectural Complements.

764 WASH BASIN / The EW3 wash basin is a steel round wash basin with an enamel finish. Available in red, yellow, brown, black and white. / Manufactured by Alape Vitreous Enamel Sinks/Vola Sanitary fittings; distributed by Architectural Complements.

765 KITCHEN SINK / The two compartment sink is adjoined by a special drainboard platform. The "Epicurean" is cast in iron and is enameled in 15 colors or white. A cutting board is designed to connect with the wooden drainboard for convenience. / Kohler Co.

766 SHOWER ENVIRONMENT / The *Aquasphere 360* is a freestanding structure of translucent acrylic set on a molded fiberglass base. Hot water pipes form preheated towel racks in the molded back panel, enclosed by a sliding door. Unit is sized to fit through doors, and measures 78-in. high. Meets major code requirements. / Alsons Corp. E*

767 PERSONAL SHOWER / Easy to attach, the *Glide Rail* wall bar for hand-held shower units has an adhesive backing that adheres to fiberglass, marble and other types of shower walls where drill holes are undesirable. An acrylic dial handle on the rail adjusts the shower height to individual requirements. / Alsons Corp.

768 ACCESSIBLE TUB/SHOWER / A fiberglass-reinforced tub/shower combination with completely flat walls, the "Grabber" can accommodate all types and arrangements of grab bars as required by individual healthcare, code or architectural specifications. Slip-resistant bottom complies with ASTM F 462-79. / Lasco Industries.

769 WHIRLPOOL BATH / A 5-ft fiberglass bathing alcove with seamless, one piece walls, the "Barbados" bath has four adjustable whirlpool jets, dual air controls to regulate the amount of hydro-massage, and a choice of timers that allow bathers to select the length of whirlpool action desired. Bath is available in 8 colors and white. / Kohler Company.

770 PULL-CHAIN TOILET / This Victorian-style high-tank toilet has been added to a "nostalgic" plumbing product line. Brass piping, supports and pull-chain are available in polished chrome or gold finishes. Seat, cover and chain handle are solid oak, finished with a moisture sealer. Tank is insulated to prevent condensation and dripping. / Kohler Company.

771 WOOD FAUCET HANDLES / "Alterna" fittings are available with red-brown Central American Cocobolo wood or distinctively grained African Zebrawood handles. Naturally water-resistant woods have a moisture-proof coating to ensure long use life. / Kohler Company.

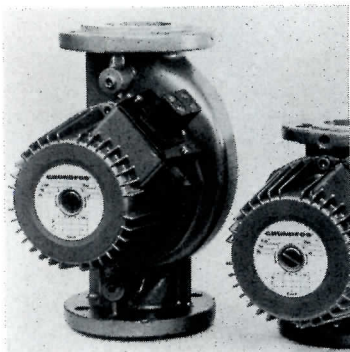

772



773

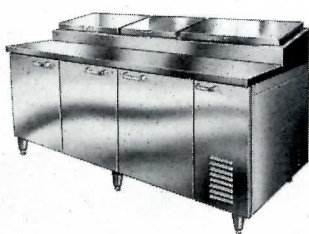

774

PUMPS & COMPRESSORS

772 BOOSTER PUMPS / These "Series 6000" industrial/commercial sized circulators require absolutely no maintenance or lubrication, and have been designed to reduce velocity noise. / Grundfos Pumps Corp. E*

REFRIGERATION EQUIPMENT

773 REFRIGERATED BAR / A portable serving and refrigerated storage unit, the "Clarly Bar" is subdivided into three sections that open along a vertical axis. Bar is 30³/₄-in. high, made of expanded polyurethane in white or black. / Hastings II Bagno Collection.

774 REFRIGERATED TABLE / "Model RPT 26" food preparation table is designed for efficient assembly of pizzas, salads, sandwiches, etc. Self-contained refrigeration system has a thermostatic valve that restores and maintains design temperatures. / Nor-Lake, Inc.

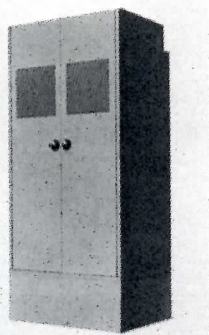

775

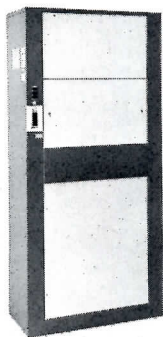

776

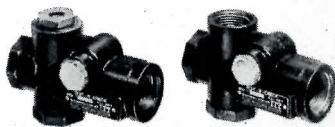

777

SELF-CONTAINED HVAC UNITS

775 AIR-COOLED UNITS / Air cooled refrigeration chassis in either heat pump or conventional heating/cooling models is offered for the process cooling requirements of small-to-medium electronic switching stations. / AC Manufacturing Co.

776 PROCESS COOLING / "TUCW" system chilled water modules are specifically designed for large electronic switching centers that generate high "sensible" heat. Units are only 18-in deep. / AC Manufacturing Co.

VALVES

777 CHECK VALVE / Designed to simplify testing of low water cut-offs on hot water boilers, the *Test-N-Check* valve automatically checks the boiler control when the blow-off valve is opened. / McDonnell & Miller ITT.

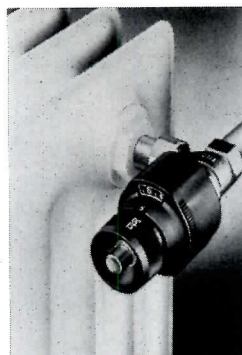

778

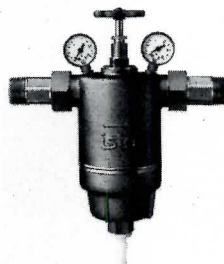

779

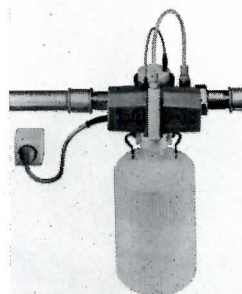

780

778 THERMOSTATIC VALVES / Self-contained temperature control unit regulated individual room temperatures in hot water or low-pressure steam heating systems. Temperature control dial corresponds to a range of 40F to 80F. / Ista Energy Systems Corp.

WATER SUPPLY & TREATMENT

779 BACKWASH FILTER / Brass backwash filters remove sand, rust, particles and other sediments down to 40 microns in size from municipal or private water systems. One-in. size lists at \$149.00; 1¹/₄-in. port unit is \$159.00. / Ista Energy System Corp.

780 METERING PUMP / The "Dola 05" is an efficient, compact proportional chemical metering pump fully integrated with a Flowmeter. Corrective or refining liquid is fed directly through the injection fitting into water flow, protecting pipes and equipment against corrosion or scaling. Unit price: \$425.00. / Ista Energy Systems Corp.

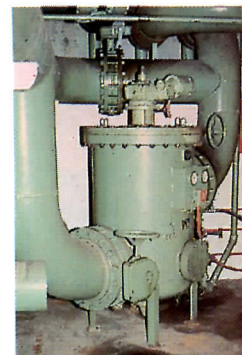

781



782

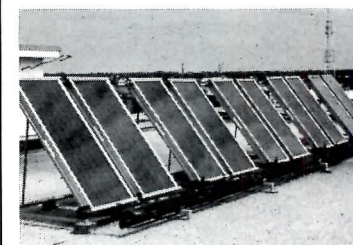

783

781 WATER STRAINER / "Poro-Edge" automatic strainers remove solids as small as 250 microns from water supplies as well as recirculated water used or hvac, fountains, etc. Units are available in capacities of from 1000 to 85,000 gallons per minute; strainers are continuously cleaned by a backwash system. / R. P. Adams Co., Inc.

SOLAR EQUIPMENT

782 SOLAR HOT WATER / For residential or light commercial applications the LSHW2 Solar Domestic Hot Water System consists of a solar collector, a stone-lined solar hot water storage tank and a newly-designed control module. Up to five solar collectors may be matched with a solar storage tank ranging from 40 gal. to 120 gal. / Lennox Industries Inc.

783 SOLAR COLLECTOR / This solar collector uses a patented Tube-In-Strip copper absorber plate, with liquid carrying tubes integrally formed in a solid sheet of copper by a special process to maximize heat transfer. / Revere Solar and Architectural Products, Inc.



784

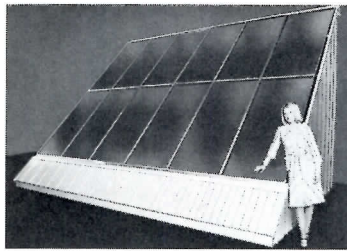

787

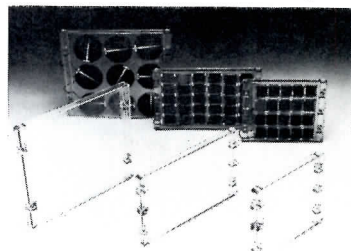

790

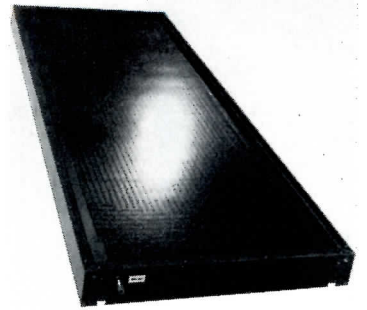

793

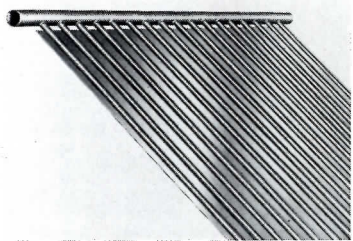

785



788



791



794



786

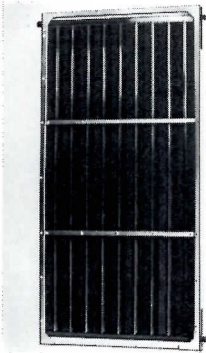

789

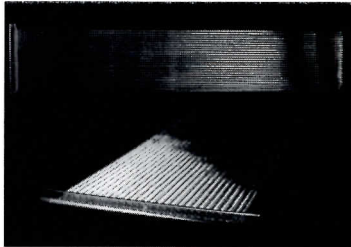

792

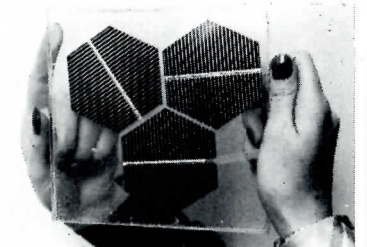

795

784 SOLAR COLLECTOR / The "Daystar 1600" solar collector was designed for high efficiency in mid-temperature applications. There are simple plumbing hookups to adjacent collectors and to supply/return lines. Typical uses are domestic hot water, space heating and domestic hot water and process heating. / Solar Thermal Systems, Division of EXXON Enterprises Inc. GB ICR, E*

785 SOLAR ABSORBER PLATE / A patented high-pressure solar absorber plate made of copper is for side-to-side or external manifolding. The absorber is lightweight at .6 lb per sq ft. / Terra-Light, Inc.

786 SOLAR HEATING SYSTEM / Specially designed for pools, the system is available with 18- and 23-sq ft absorber plates, and is designed to provide uniform thermal efficiency. No secondary heaters are used; round manifolds accommodate the flow of solar heated water through the system and absorber plate. / Terra-Light Inc.

787 SOLAR HEATING SYSTEM / This air-to-air "Suncell" solar heating system is used on this test model, with three sensors, a two-stage thermostat, a mode indicator display panel and a controller, all interconnected by low-voltage wiring. / Research Products Corp. GB*

788 SOLAR HOT WATER / The "Sun-pump/Suncycle" solar water heating package consists of collectors and heat exchanger. Most residential water tanks can be converted to solar water heaters with this system. / Entropy Ltd. LRC*

789 SOLAR COLLECTOR / This solar panel consists of a non-ferrous heat transfer surface and a container. Features include a floated absorber, all copper waterways, low iron glass, and a baked enamel exterior. / Raypak, Incorporated.

790 SOLAR CELLS / LEXAN polycarbonate resin encases the Silicon Sensors, Inc. line of standard solar power modules shown. The modules contain photovoltaic cells, which convert sunlight directly to electricity and are used most frequently in isolated areas where no other power supply is available. / General Electric, Plastics Div.

791 SOLAR HEATER / The F 103.0 "Sun" Solar Water Heater includes a glass-lined tank, heat exchangers of the immersion type, a differential control providing control of circulator, a diaphragm expansion tank and insulation. / A.O. Smith Consumer Products Division.

792 SOLAR ENERGY COLLECTOR / Weighing less than a pound per sq ft, this collector can be produced to any specified length with factory applied manifolding, insulation package and choice of color backings. The panel is a single extrusion of transparent polymer in a three-channel configuration; the upper two channels serve as lenses to direct light to the lower channel or fluid passageway. / Ramada Energy Systems, Inc.

793 SOLAR COLLECTOR / The "Sun-Jammer" solar collector is the newest addition to the company's line of flat plate collectors, designed for commercial, industrial and residential applications. Fully tempered cover glazing provides a claimed 91.3 per cent solar spectrum transmittance. / AMETEK Power Systems Group.

794 SOLAR HOT WATER / Easy to install, compact module contains most of the components needed for a harsh climate solar hot water system: heat exchanger, operating controls and pumps. One end connects to the water storage tank, the other to the roof-top collectors. *Sunstream* unit is 38.2-in. wide, including fittings; retail price is \$650.00. / Grumman Energy Systems. ICR,LCR,E,I*

795 SOLAR CELL ENCASEMENT / In this prototype, solar cells are sandwiched between sheets of calendered uncured silicone rubber and then vulcanized, to protect the solar cells and yet allow maximum passage of sunlight direct to the cell surface. / Keene Corp, Laminates Division.



Introducing the pressure water cooler that needs no drain.

Now you can have a pressure water cooler where you never could before. Because this Oasis needs no waste water drain — only inlet water from a 1/4" or 3/8" supply line. A push-button faucet dispenses water into cups or glasses. And a detachable waste water receptor catches the occasional drips or splashes. So now you can put cold water refreshment where the work is.

Because the drainless Oasis can go almost anywhere you want it — at a very low installation cost. Get the drainless Oasis, for drainless places. Ebc Manufacturing Company, 265 N. Hamilton Road, Columbus, Ohio 43213

Oasis 
The water cooler that's built without shortcuts.

Circle 1058 on inquiry card



WHEN WATER TEMPERATURE CONTROL IS CRITICAL YOU CAN DEPEND ON POWERS-FIAT.



Powers-Fiat systems provide protection and safety in critical bathing situations.

- In Health Care Facilities: whirlpool, hydrotherapy, sitz bath.
- In Housing for the Elderly: shower bathing with high temperature alarm system.
- In Correctional Institutions: remote shower control.
- In Schools: multiple shower systems.

When you consider our line of water temperature controls, remember that our reputation for dependability can make everyone more comfortable, including you.

For more information, see your Powers-Fiat representative, or return the coupon.

MCC POWERS-FIAT

AR-10-79

A Unit of Mark Controls Corporation
3400 Oakton Street
Skokie, IL 60076

Please send more information about the Powers-Fiat commercial line of water controls.

Name _____ Title _____

Company _____

Address _____

City _____ State _____ Zip _____

Circle 1063 on inquiry card

uci16

electrical

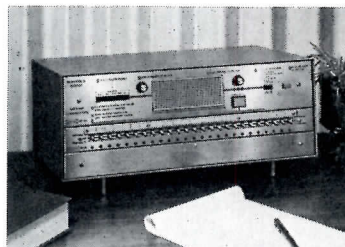

808



809



810

COMMUNICATIONS

808 DESK TOP PA / A compact control center providing full dual-channel communication for as many as 50 rooms, the "Director II" school sound system uses color guidelines to identify each operating function. Features include supervisory tone, classroom privacy, and instant one-button transmission of announcements or emergency messages. / Rauland-Borg Corp.

809 INTERLOCKING SYSTEM / "System 1200" is a combination of outside and inside telephone, public address, background music, and emergency announcement system that is based on microprocessor technology. The system is designed for use in schools and high-rise buildings. / Dukane.

810 BASE STATION / Model "1104CM" pre-amplified base station microphone has a built-in audio meter and external tone and volume controls for operating convenience. Powered by a 9-volt battery, the microphone comes with a six-wire coil for relay or electronic hook-up. / The Astatic Corp.



811



812



813

811 DUPLEX INTERCOM / Simple installation and instant two-way speech with natural voice quality are features of the *Philips M100* communications system for business and institutions. Options include three-party conferencing; group-call; all-call; "camp-on" busy signal; "queuing"; floating number; pocket paging; and tie-line for remote locations or buildings. / Rauland-Borg Corp.

812 AUDIO DELAY / For use with sound reinforcement systems containing multiple loudspeakers, the "DDS100 Spectrum-Master" permits the precise synchronization of sound at the listener's position no matter where speakers are located. Solid-state system is capable of delaying an audio signal from 0 to 120 ms, in increments of 7.5 ms at each of two independently adjustable outputs. / Rauland-Borg Corp.

813 TELEPHONE USE DATA / The "Comptroller" promises to reduce telephone usage by as much as 40 percent, by recording who called whom, when, for how long and how often. Data in computer printout form. / Executone, Inc.



814

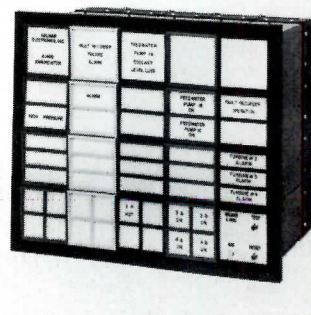

815



816

814 SMALL BUSINESS PHONE / A computerized installation for organizations requiring as few as four telephones, the *Equity* system identifies incoming calls, provides "Hands Free Talkback," has intercom and paging capabilities, and lets after-hours calls ring on only one phone. / Executone, Inc.

815 WINDOW ANNUNCIATOR / Model "A1400" can be expanded without the addition of extra power supplies or terminals. Assembled to customer height-width requirements, each module comes complete with a built-in discrete power unit. / Halmar Electronics, Inc.

CONDUCTORS

816 BULB LIFE EXTENDER / When placed directly in a standard light socket, *Bulb-Miser* thermal shock absorbing disc regulates the initial flow of current to the bulb's filament, allowing it to reach maximum lighting capacity gently. Protecting the filament in this way extends the bulb's life four times. / American Electro-Dynamics Corp.

COMMUNICATIONS
CONDUCTORS
ELECTRICAL & ELECTRONIC
CONTROLS
ELECTRICAL HEATING-COOLING
LIGHTING
MOTORS & CONTROLS
POWER GENERATION
PROTECTIVE SYSTEMS
RACEWAYS
SERVICE & DISTRIBUTION
WIRING DEVICES

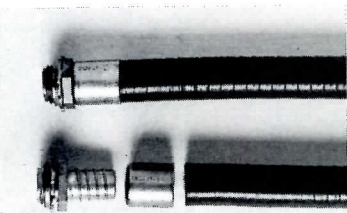

817

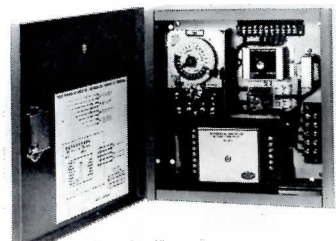

818

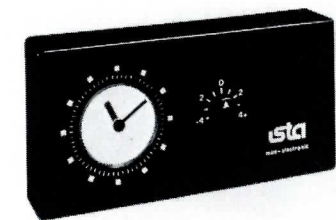

819

817 CONDUIT FITTING / This UL-approved two-part connector for liquid-tight flexible metal conduit needs no "O" rings, gaskets or special tools. / Specialty Connector Corp.

ELECTRICAL & ELECTRONIC CONTROLS

818 HEATING CONTROL / An economical and easy to install system for older buildings with steam or hot water heat, the *ECONOSTAT* solid state differential controller adjusts the building heating output as the outdoor temperature changes. / Barber-Colman Co.

819 HOT WATER HEAT / "Fine Tune" control units allow exact thermal balancing for heat loss in buildings using hot water heat. Water and outdoor air sensors continuously measure and compare temperatures, and adjust to the thermal balance by adding hot water to the heating loop or switching on the burner to heat the water. / Ista Energy Systems Corp

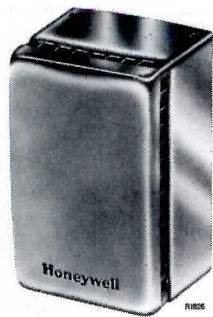

820

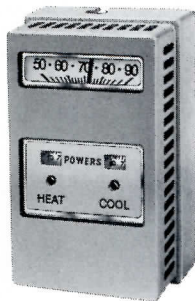

821

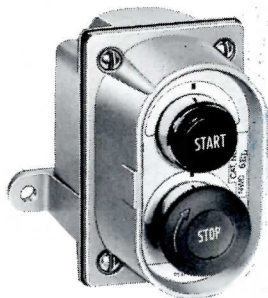

822

820 THERMOSTAT / Said to reduce hvac costs as much as 38 per cent, *Zero Energy Band* pneumatic controls provide heating and cooling setpoints for an adjustable range over which no heating or cooling energy is needed to maintain space temperatures. / Honeywell Inc.

821 ROOM THERMOSTAT / This modulating pneumatic thermostat has a *Free Energy Band*, a temperature range between pre-set heating and cooling call-ups where no energy use is required. Limits are field-adjustable or factory-fixed to meet DOE and ASHRAE requirements. / MCC Powers.

822 CONTROL COVERS / Molded from self-extinguishing reinforced polyester, *Russellstoll* nonmetallic control device covers and boxes, push buttons, pilot lights and switches are intended for marine and general purpose industrial applications. / Midland-Ross Corp. E*



823

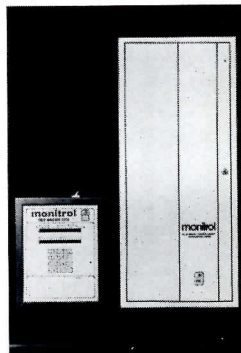

824

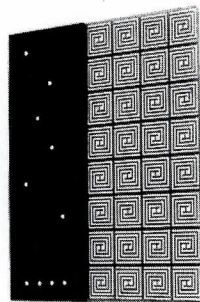

825

823 DEMAND CONTROLLERS / Units in the "PDC-1100/1150" series feature programmable microprocessors to contend with present and future utility rate structures and metering methods. Designed to reduce peak power demand in industrial and commercial facilities. / Dynapar Corp.

824 LIGHTING CONTROL / Promising a complete payback on investment through reduced energy costs within 18 months, the "LC-500" *Monitrol* automatically regulates illumination in commercial and industrial buildings. The micro-processor-based unit controls an unlimited number of circuits with nine schedules of on/off times per category. / CSL Industries.

825 MASTER PANEL / For use with *Home Control System* installations, the "Master Panel" shown here allows the homeowner to operate lights and appliances all over the house from one location. The wall-mounted board consists of a "TouchSensor" matrix and an array of LEDs that show which circuits are on. The "Master Panel" operates 32 circuits. / Harris Labs Inc.

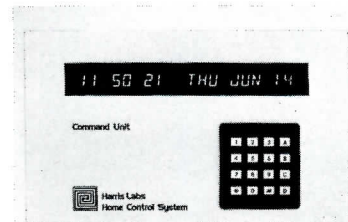

826

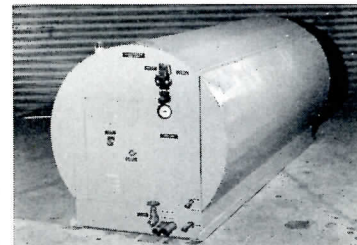

827



828

826 HOME LIGHT CONTROLLER / The "Command Unit" of the *Home Control System* allows the homeowner to turn lights and appliances on or off automatically, by time of day, day of week, or time and date. The system uses surface-mounted "TouchSensors" to operate lights and outlets. / Harris Labs Inc.

ELECTRICAL HEATING-COOLING

827 THERMAL STORAGE / Designed to provide domestic hot water housing for the elderly and small apartment buildings, the *Megatherm* model SC draws electricity during off-peak rate periods only. Heat is stored within a medium temperature fluid reservoir. / Megatherm.

828 ELECTRONIC THERMOSTAT / *Autopace 7* residential thermostat allows for the programming of 28 temperature changes per week, or four changes per day. The solid-state unit includes an LED display on time and temperature. / Autotronics, Inc.

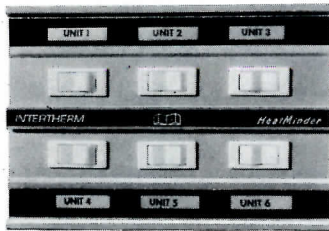

829

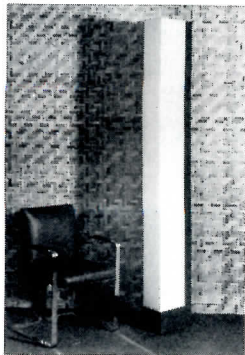

830



831

829 HOT WATER BASEBOARD / For use with *Intertherm* hot water electric baseboard heating systems in homes, institutions, and commercial buildings, the *HeatMinder* sets back the temperature in any remote room from 9 to 18 deg. / Intertherm Inc. GB, LRC*

LIGHTING

830 LIGHT TOWER / Illuminated on three sides, this decorative light source may be used as a freestanding room divider or backed against a wall. Made of precious woods and acrylic, as well as custom colored lacquers, the light tower stands 84-in., and is 7-in. wide by 12-in. deep. Approximate retail ranges from \$1,500 depending on materials used. / Vladimir Kagan Designs, Inc.

831 MERCHANDISING LIGHT / Designed to replace warm white deluxe fluorescents in stores, restaurants and other locations where high light output and true color rendition are important, the *Royal White 3K* series of lamps includes standard, high output and "SuperSaver" models from 15 to 96 Watts. All have a CRI of 80. / GTE Lighting Products.

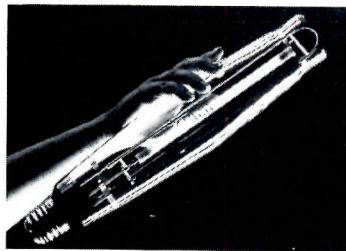

832

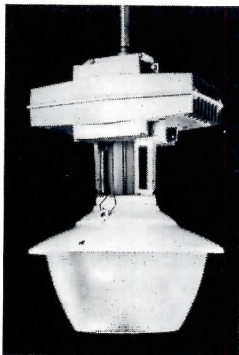

833

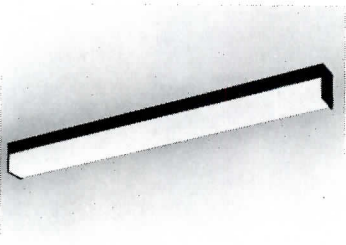

834

832 HIGH-PRESSURE SODIUM / The 880-Watt *Unalux* lamp is designed to directly replace many 1000-Watt mercury vapor HID lamps often used in factories, warehouses, etc. Operating on most existing ballasts and equipment, the *Unalux* consumes about 12 per cent less energy while delivering 62 per cent more light. / GTE Lighting Products.

833 AISLE LIGHTING / This HID fixture provides a choice of lighting distribution for warehouse and factory storage bin aisles. A vertical light refractory aims light directly on stored material; a horizontal refractor can distribute light up and down aisles to illuminate traffic flow. *Aisle-Liter* fixtures are corrosion-resistant. / Sylvania Lighting Equipment.

834 DECORATIVE LUMINAIRE / "TL" series fluorescent fixtures for interior applications may be mounted on ceiling or as a wall bracket. Die-cast endcaps have no exposed fasteners; diffusers are matte opal acrylic with opal or metal fascia. Available in single- or two-lamp sizes in 2-, 3- and 4-ft lengths. "TL" luminaires come in nine enamel colors. / Columbia Lighting Incorporated.



835



836

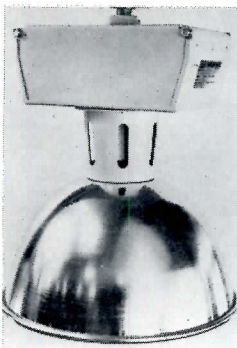

837

835 GLASS PENDANT / Manufactured by Barbini Lighting in Italy, the "Spiro" hanging fixture has a 15-in.-dia hand-blown shade of varied intensity white and clear glass with concentric rings. Table and floor versions are also available. List price: \$660.000. / Barbini-Lighting Associates Inc.

836 BRASS LAMPS / Designed by Ernest Lowy, the "Crescent" lamp comes in three versions: a 61-in. floor lamp; a 20-in. desk model; and as a pin-up or bracket-style wall lamp. The curved heads turn a full 360 deg and take a 150-Watt bulb. Solid brass fixtures have polished chrome or brass finish; prices range from \$75 to \$183.00. / Koch + Lowy.

837 LOW-WATTAGE HID / The "V6" fixture, used in combination with various HID lamps, can replace industrial incandescent lighting systems while maintaining lighting levels. Lamp life would be 24 times longer for lower maintenance costs, and electrical consumption would be reduced by 70 per cent. / Sylvania Lighting Equipment.

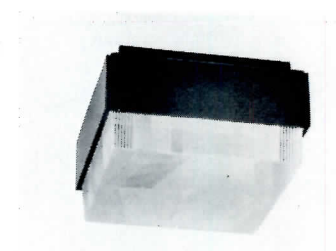

838

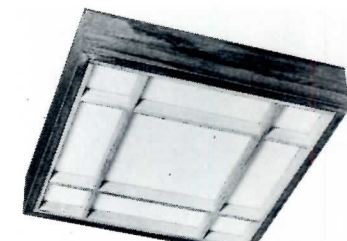

839

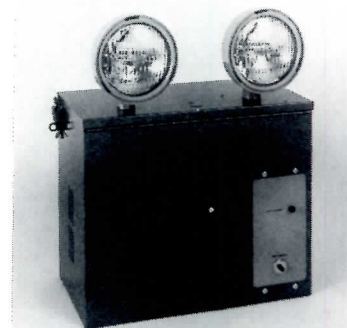

840

838 MULTI-PURPOSE LIGHT / UL-listed for wet locations, the *Hand-Liter-S* high-pressure sodium fixture can be used for warehouses, garages, tunnels, shipping docks, etc. The surface fixture has an *Alzak* aluminum reflector, molded lens, and a bronze baked enamel finish. Unit price: \$90.00. / Guth Lighting.

839 RECESSED UNIT / A 12-in.-sq recessed fixture has a solid wood frame and latticework, with a matte white acrylic diffuser. Luminaire accepts HID and incandescent lamps. Torsion springs self-adjust the wood trim to the ceiling plane and permits easy relamping. / Guth Lighting.

840 EMERGENCY LIGHTS / "AS-BC" 6- and 12-volt emergency lighting units operate on sealed pure lead batteries, which require no maintenance over a normal 15-year life expectancy. For industrial as well as commercial applications, self-contained units provide a minimum of 90 minutes emergency light. / Dual-Lite Inc. ICR,E*

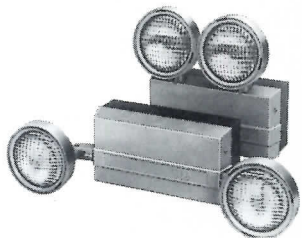

841

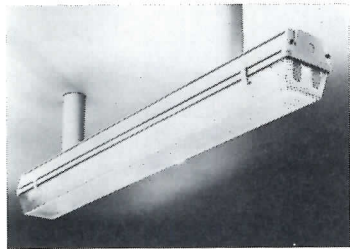

844

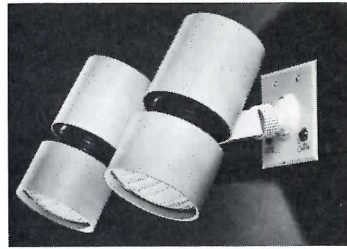

847



850

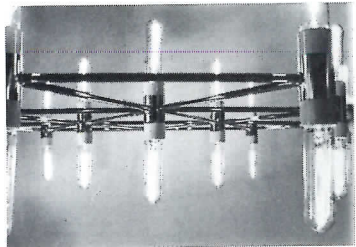

842

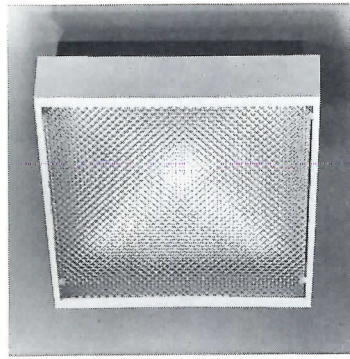

845



848

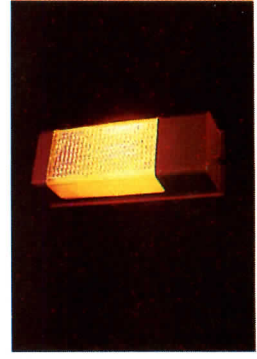

851



843

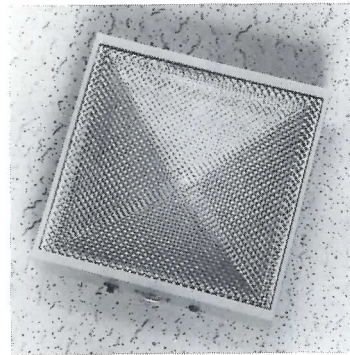

846



849

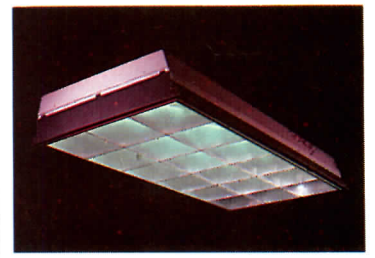

852

841 EMERGENCY LIGHTING / Recent additions to the economical *Lumenette* emergency lighting line, models "ML-4" and "ML-5" are designed for applications requiring up to four or five remotely-connected lighting heads or exists. Rechargeable units meet or exceed OSHA, NEC, NFPA Life Safety codes. / Dual-Lite Inc. ICR, E*

842 COMPONENT SYSTEM / *Tsao* system provides custom lighting effects from a series of components used horizontally or vertically. Different systems feature clear glass globes, polished chrome cylinders, or double lamp holders with white porcelain sockets. / *Tsao Designs, Inc.*

843 HALOGEN LAMP / For table-top or wall mounting, "Daphine" high-intensity, 50-Watt lamp has its transformer in the base unit. Pivoted arm extends 87 cm. Arm is available in white or black enamel; transformer base comes in black only. List prices for the Italian import: \$300.00. / *Lighting Associates.*

844 HUMID LOCATIONS / Constructed to withstand corrosion caused by moisture and high humidity in such locations as kitchens, laundries and garages, the *Sentry* fluorescent fixture has a vandal-resistant fully gasketed lens. All metal parts are finished in *Porsyl* powder coating. / *Sylvania Lighting Equipment.*

845 FOUR-HOUR LIGHT / A two-lamp unit, the "SPU-70" *Decor-Lite* provides four full hours of emergency lighting for elevators. Rechargeable nickel cadmium battery is warranted for 12 years. A fused extension output option allows for such added loads as a 12-Volt bell. / *Chloride Systems, U.S.A.*

846 EMERGENCY LIGHTING / Providing instantaneous non-glare illumination automatically upon power failure, square *Decor-Lite* emergency lights now include a master unit capable of powering several remote fixtures. / *Chloride Systems, U.S.A.*

847 EMERGENCY LIGHTING / The UL-listed *Chloride-Lite Master Unit* makes possible the remoting of many combinations of emergency lighting fixtures and exits. Thermoplastic white cylinders may be either surface- or flush-mounted to a recessed junction box. / *Chloride Systems, U.S.A.*

848 LOW LEVEL LIGHTING / Built-to-order of laminated Western red cedar, "Junior Jefferson" landscape and walkway lights can be adapted to accommodate graphics and individual site conditions. Lamping is 60-Watt glass globe, or 50-Watt *Lexan* globe. / *Ryther Purdy Lumber Co. GB**

849 ARCHITECTURAL SHAPE / One of the *Caribe* line of outdoor luminaires, the "Soft Cube" in impact-resistant acrylic or polycarbonate offers efficient prismatic light control. Lamp choices include HPS, mercury, metal halide, and incandescent. Luminaires may be pole mounted, mounted singly or in clusters of up to five. / *Johns-Manville Sales Corp., Holophane Div.*

850 AREA LUMINAIRE / A mansard-style top canopy is featured on the *Holophane* "Square-Postop" pole- or wall-mounted fixture for area and parking lot lighting. A prismatic glass refractor provides square, symmetrical light patterns. Luminaire accommodates three HID lamp types in a wide selection of wattages. / *Johns-Manville Sales Corp.*

851 OUTDOOR LIGHTING / Vertical brackets for either wall- or ceiling-mounting use 18-Watt low-pressure sodium lamps, which provide more light than a 100-Watt incandescent and last ten times longer. "Low Energy Outdoor" lighting fixtures are equipped with a vandalproof "DR" acrylic lens; a directional inner reflector allows light beam adjustment over 60 deg. / *Thomas Industries Inc.*

852 RECESSED TROFFERS / *Parazak* recessed fixtures have a special semi-mirrored finish on the parabolic louvers, said to offer superior brightness control and a high rate of lighting efficiency. Available in 1- by 4-, 2- by 2-, and 2- by 4-ft sizes, troffers can be combined with heat removal and air handling functions. / *Thomas Industries Incorporated.*



853

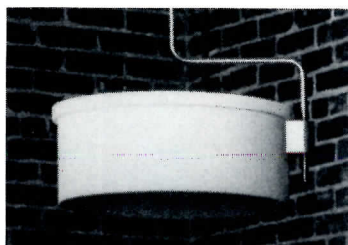

854

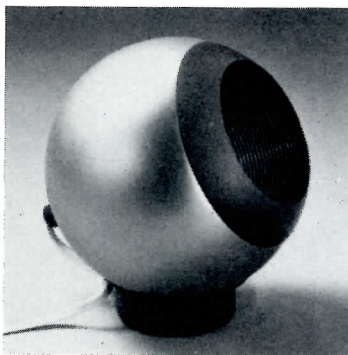

855

853 COLUMN LIGHT / Thermoplastic columns 15 in. in diameter and various lengths house an arc tube image duplication reflector system. Ambient light source uses HID lamps to provide a quadrate distribution pattern in large open interiors; asymmetrical lighting may be selected for perimeter locations. UL-listed "Motif 2" is offered in various finishes and lamp types. / Gardco.

854 INDIRECT HID LUMINAIRE / Pendant mounted rounds in 15- and 20-in. diameter have an "L" shaped cantilevered stem, offset to cast virtually no ceiling shadow. Fully enclosed metal housings are finished in baked enamel. High power ballasts are remote mounted; fixture is available in a variety of metal halide or HPS lamp types. / Gardco Lighting.

855 ACCENT LIGHTING / Round "Magna-Spot" display fixture has a powerful magnet holding the ball, allowing flexible aiming of the light beam. Made of heavy metal, the spot comes in white or chrome finishes with brown trim, and accepts incandescent lamps up to 60 watts. / ITT Lighting.



856

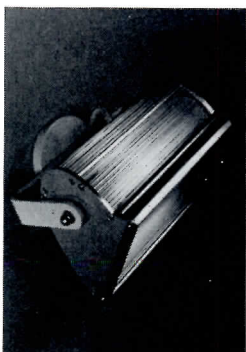

857

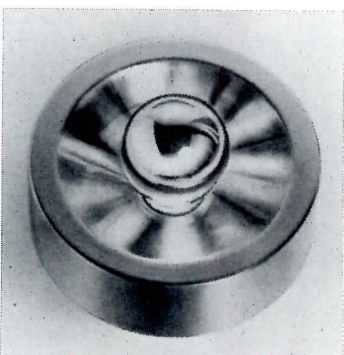

858

856 SPOT LIGHTING / Incandescent "Flexaspot" fixture comes in three styles: clamp, pin-up, and box mount. Light takes up to a 60-Watt bulb, and may be used as a plant grow light, reading lamp, as an accent or back-drop light, etc. / ITT Lighting.

857 FACADE LIGHTING / New, larger *Elliptipar* tungsten halogen fixtures are designed for applications requiring even lighting of large wall, ceiling or floor plane areas from one side. The reflector projects an asymmetric cutoff pattern, delivering 95 per cent of the lumens emitted to the target. / Elliptipar Inc.

858 WALL FIXTURE / Surface-mounted light has a 10-in.-dia highly polished reflector with a beveled midsection, which distributes light from a 100-Watt bulb in a uniform pattern. Chrome bowl lamp, clear or frosted "G" bulb, or "A" lamps may be used to vary the light quality. / Habitat Inc.

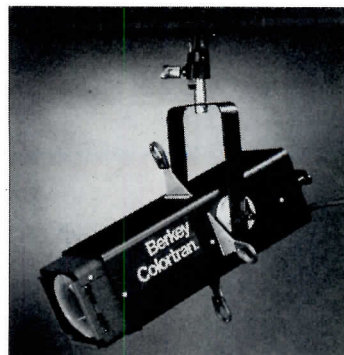

859



860

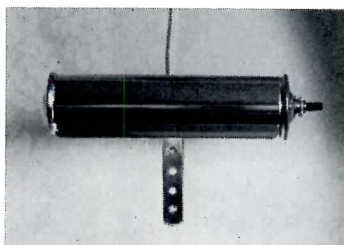

861

859 REFLECTOR SPOTLIGHT / For theatrical, photographic and studio applications, a 4.5-in. "Ellipsoidal" 500-watt light permits a 50-, 40-, or 30-deg field angle to be achieved by the movement of one lens within the lens barrel. The unit accepts 250-, 400-, and 500-Watt mini-can screw base lamps. Price: \$135.00. / Berkey Colortran.

860 THEATRICAL LIGHT / Axially mounted *Lekolite* spotlights have a focusing mechanism that allows the operator to adjust the lamp easily for flat or peak distribution, or any intermediate light intensity. Seven different models accept 500-, 750-, and 1000-Watt lamps. / Strand Century.

861 PICTURE LIGHTS / Decorative spotlights offered in 7- and 14-in. sizes; a swivel attachment directs the light up or down. Finish options include polished or antique brass and polished chrome. Fixture comes complete with 8-ft cord, mounting screws, and 25-watt frosted picture bulb. / Sattleglight Products, Inc.



862

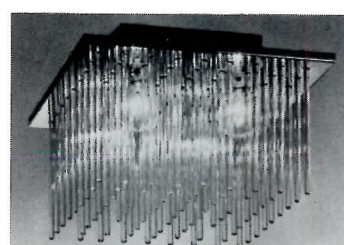

863

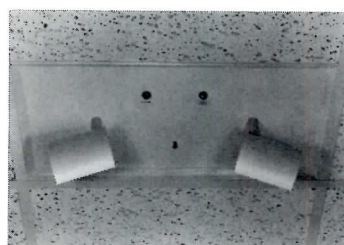

864

862 OPEN-PLAN FIXTURE / Tank/ambient lighting fixture, designed by Sylvan R. Shemitz, is now available in a universally-applicable version which can be mounted on a wall, partition, panel or other work surface. Aluminum *Lite-A-Part* fixtures provide both up and down light from the same lamp, illuminating work surfaces with minimum veiling reflections on the task. / Elliptipar, Inc.

863 CEILING LIGHT / A close to the ceiling fixture, especially suitable for hallways and foyers. This square version of the "Radiance" chandelier has clear rods of solid glass suspended from a mirror-chrome reflector. / Lightolier.

864 EMERGENCY LIGHT / The *C-Ling Light* is designed for easy installation in dropped panel type ceilings. The self-contained unit has twin adjustable cylinders, which provide direct lighting to any location. / Chloride, U.S.A.

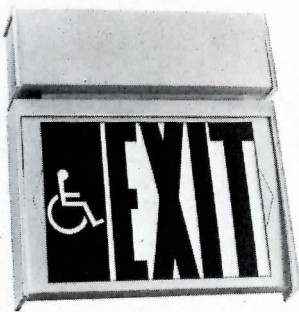

865



866

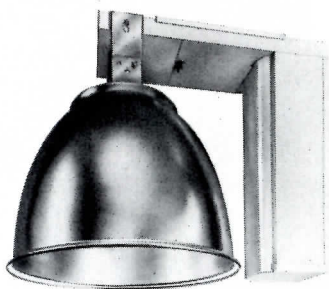

867

865 BARRIER-FREE EXITS / *EXqulsiTe* Series HC117.1 signs meet ANSI requirements for displaying the International Symbol of Access, and for providing audible and visual signalling capabilities. Sign faces have red or green letters on a white ground with the access symbol in blue. Battery pack or remote 6-volt operation. / Dual-Lite Inc. ICR,E*

866 INDUSTRIAL HID / *Super Watt* luminaire operates at over 90 per cent efficiency; the spacing-to-mounting height ratio is 2.5:1. Pendant- or surface-mounted fixture measures 17⁷/₈-in.-deep, and accepts HID lamps up to 400 Watts. Luminaire is UL-listed for damp location. / The Miller Co.

867 ADJUSTABLE HID / Cost reductions were achieved in the *Side Car* industrial luminaire by wrapping the ballast in a metal sleeve instead of a casting, and locating it to the side of the fixture in a simple unified stamping. Lamping choices range up to 400 Watt; light distribution patterns are field adjustable. / The Miller Co.



868

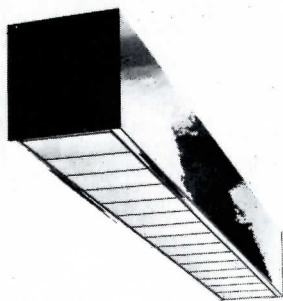

869

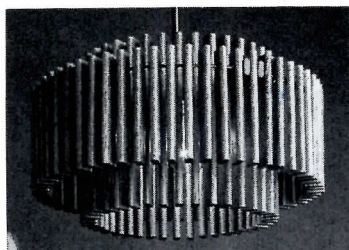

870

868 STREET SYSTEM / *Street Modules-System 2* offers expanded configurations of components, improved installation, and more flexible add-on capabilities. Architecturally styled street furniture integrates luminaires, traffic/pedestrian signals and control equipment, graphic panels, booths, and litter containers to suit individual requirements. / Crouse-Hinds Co.

869 DECORATIVE FLUORESCENT / *Form 4* fixtures are designed for architectural and accent lighting of building interiors. Available in 4- and 8-ft standard lengths, luminaires may be used individually or in rows and patterns using connector boxes. *Form 4* units can be ceiling mounted; hung from stem or cable hangers; attached to the wall by brackets or mounted wall-to-wall. / Columbia Lighting.

870 WOOD CHANDELIER / Four-light hanging fixture has two concentric rings of white oak sections fitted with oxidized brass connectors. Over-all height of fixture is 18-in., with a 21-in. diameter. UL-listed light comes with matching oak canopy. / Charles Loomis Inc.



871

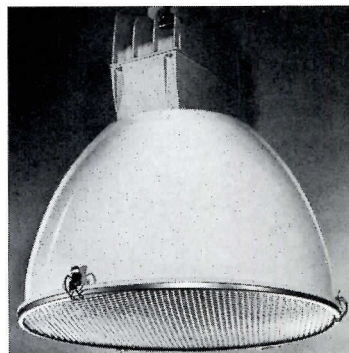

872

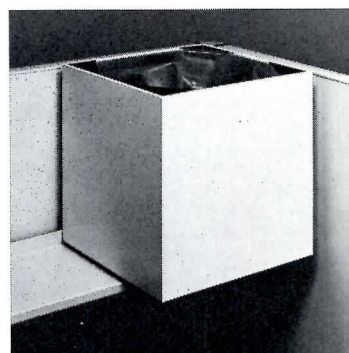

873

871 OAK FIXTURE / Suspended from an interior pendant, fixture is hand-crafted of solid white oak with oxidized brass trim. Globe is 8-in. opal glass, and takes up to 100 bulb. UL-listed light is 19-in. wide by 19 in. deep. / Charles Loomis, Inc.

872 INDUSTRIAL FIXTURE / For use at low and medium mounting heights, the *Lobay* HID luminaire provides a square light distribution pattern through a high-heat acrylic *Quadrature* lens. Easy-to-install fixture is available enclosed and gasketed, or UL-listed for wet locations. / Johns-Manville Holograph Div.

873 OFFICE LIGHTING / Deep cutoff optics of the "SPJ2" indirect lighting fixture permit below eye level mounting with top surface of the fixture at panels heights down to 54-in. Optional brackets allow top or side-of-panel mounting; rubber feet protect surface for portable installation. / McGraw-Edison Co.

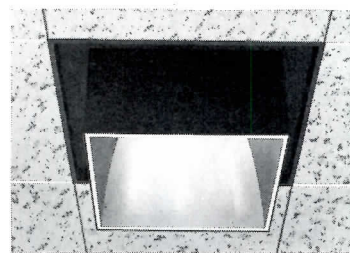

874



875

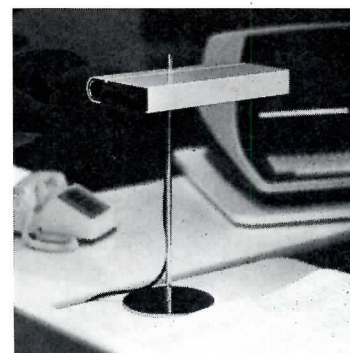

876

874 DOWNLIGHTS / The "Aura" series of recessed/semi-recessed lights have low brightness parabolic aluminum cell in tandem with clear specular *Alzak* reflector. Fixtures come in 12-, 18-, and 24-in.-sq sizes, for use with HID and incandescent lamps. / Omega Lighting.

875 SITE LIGHTING / The "Mono-Lite" is a 12-in.-sq pillar mid-level site fixture, available in 8-, 10- and 12-ft heights. For use with mercury vapor, metal halide and hps lamps, completely weathertight units are constructed of extruded aluminum. / mcPhilben Lighting.

876 TASK LIGHTING / Two 8-watt task lights provide twice the ESI foot-candles on the major work plane at the single 40-watt fluorescent strip commonly used in offices. "SPI" lights are offered with various mounting devices which tailor the basic fixture to a variety of tasks, including a portable magnet mounting for use with metal shelves in open plan offices. / McGraw-Edison Co.

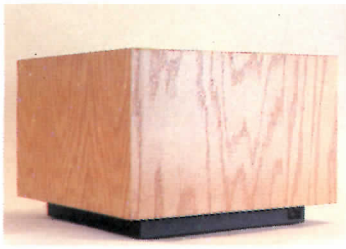

877



880



883

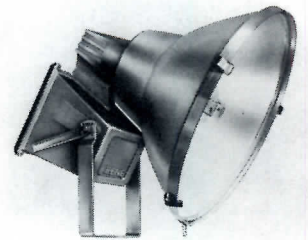

886

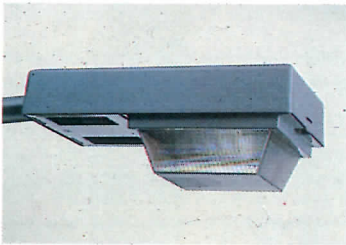

878



881



884

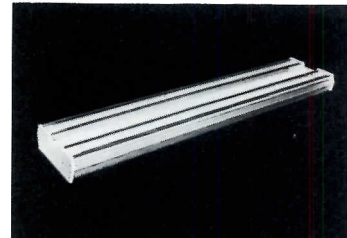

887



879



882

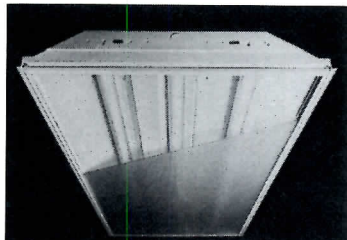

885

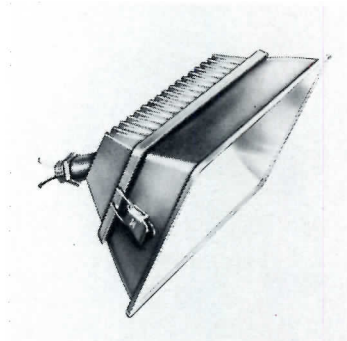

888

877 AMBIENT LIGHTING / Excellent photometric performance is offered in this line of upward directed office lighting. Models include "Mini Lites" for use on top of filing cabinets; freestanding "Box Kites;" and "Lite Towers, with or without storage chambers. Solid oak or color finishes are available / ITT Indoor Lighting.

878 HPS LUMINAIRE / Rectilinear outdoor fixture has been designed to precisely capture, control and convey the output from high-pressure sodium lamps. All electrical components are mounted on one swing-down door. Seventy- to 400-watt units are available in corrosion-resistant aluminum housings. / ITT Outdoor Lighting.

879 OUTDOOR FLOOD / Designed for precise control, the "Style Flood" has a parasil reflector, which maximizes light efficiency by 59 per cent by projecting the illumination directly onto specified surfaces. Mounting options include tenon or davit arrangements. Flood accepts up to 400-Watt hps and metal halide lamps. / ITT Outdoor Lighting.

880 GLASS CHANDELIER / Suggested for use in dining areas, the "Radiance" chandelier has slender solid glass rods extending up and down from a mirror-chrome center disc. Fixture takes six lights, and measures 18 $\frac{3}{4}$ -in. in diameter. / Lightolier.

881 DECORATIVE LIGHT / "Mirage" series fixtures float a sculptural arrangement of clear glass cubes against finishes of polished or satin chrome or brass. Chandeliers come in 9- or 13-light versions; 3- and 4-light wall models are also offered. / Lightolier.

882 ETCHED GLASS / Another version of the "Mirage" hanging light, "5389" has cubes of glass inside-etched for a warm, diffused effect. The 13-light fixture measures 12 $\frac{1}{2}$ -in. in diameter, and is available in polished and satin brass finish. / Lightolier.

883 LOW LEVEL FLOOD / Offered in three light distributions for specific area and stairway applications, "LLF" series floodlights are designed for mounting on building exterior or in concrete pedestals. Lamp choices include HID types and incandescent. / Kim Lighting Inc.

884 FRP POLES / Manufactured by a process that combines radial and longitudinal fiber-reinforcement, heavy-duty "FRP Series" lighting poles are said to have exceptional strength and wind resistance, permitting their use in applications not possible with other fiberglass poles. Polyurethane-coated finish is a dark bronze color. / Crouse-Hinds Co.

885 FLUORESCENT TROFFER / A three-lamp fixture lowers energy requirements by using one less lamp than standard troffers; the unit is wired to allow for one-, two- or three-lamp operation for additional savings. The high-efficiency fluorescent troffer, named "HEFT," is 3 $\frac{1}{2}$ -in. deep to facilitate installation in retrofit applications. / Keene Corp., Lighting Div.

886 SPORTS LIGHTING / The "Super Sports-Beam" is ballasted for either metal halide or hps lamps; a range of 21-in.-dia anodized aluminum reflectors provide all NEMA beam spreads from Type II to Type VI. Heat-generating lamp socket is housed within an integral pod on top of the fixture and exposed to cooling air. / Keene Corp., Lighting Div.

887 CLASSROOM FIXTURE / The "Director" school luminaire delivers glare-free light through prismatic lenses which split light from twin fluorescent lamps into distinct upward and downward components, providing precise task illumination and even ambient light. / Keene Corp., Lighting Div.

888 QUARTZ FLOODLIGHT / The "Triumph 500" tungsten halogen light has a cast aluminum body with integral cooling fins and heat dissipating socket for low operating temperatures and long lamp life. Adjustable mounting arms have degree-marked aiming quadrant; lens assembly clamps open and shut without tools. / Keene Corp., Lighting Div.



889



892



895

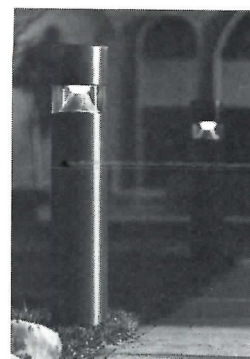

898



890



893

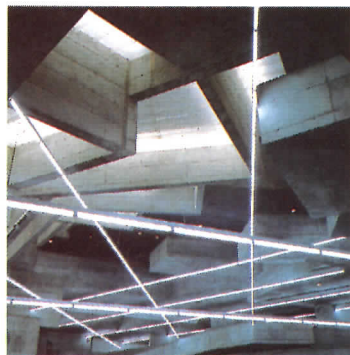

896

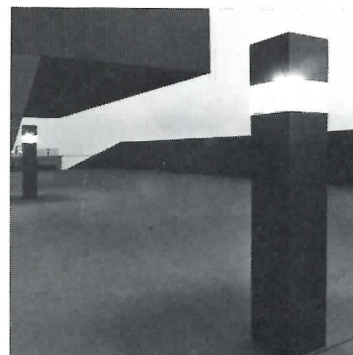

899

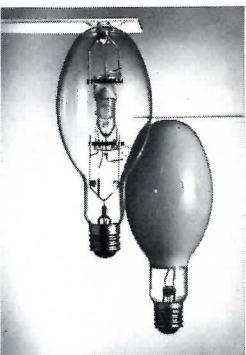

891



894



897

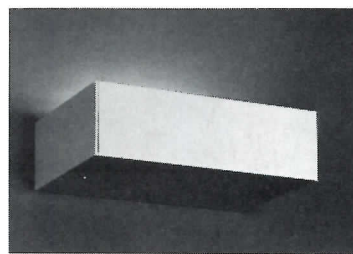

900

889 CIRCULAR FLUORESCENT / A unique ballast adapter and a 10-in.-dia 44-Watt bulb screw into standard portable lamp sockets, providing high light output with a warm pleasing color similar to incandescent. Energy-saving *Circlite* systems fit easily into shaded table-top lamps, and last 10 times longer than the 100-watt household bulbs they replace. / General Electric Co. I*

890 TRUE COLOR / *Rite White* fluorescents produce 30 per cent more light output than "DeLuxe Warm White" lamps, with a superior color rendition of CRI-80. For commercial, office and institutional applications, list price of *Rite White* is said to be less than competitive high efficiency lamps of similar color rendering capability. / General Electric Co.

891 METAL HALIDE / "High Output Multi-Vapor" lamps deliver over 17 per cent more light than existing 400-Watt metal halide bulbs, and are rated at 15,000 hours/life. For indoor and outdoor use, lamps are available in both clear and phosphor-coated versions for base-up and base-down operation. / General Electric. ICR, I*

892 REDUCED WATTAGE / The *Watt-Miser II Power Groove* fluorescent has been added to this maker's line of reduced wattage full output lamps. For use indoors in two-lamp fixtures, the *Power Groove* draws 18 per cent fewer watts yet gives almost the same amount of light as the standard lamp. / General Electric Co. ICR, E*

893 LAMP/BALLAST / The "F40" *Maxi-Miser* lamp/ballast system combines two reduced wattage, high efficiency *Watt-Miser II* 4-ft fluorescent lamps with long life high performance *Maxi-Miser II* electromagnetic ballast. Fixtures provide equal or more light at 14- to 18 per cent savings in wattage. / General Electric Co. ICR, E, I*

894 TABLE LAMPS / Six new sizes have been added to the "Cylinder and Square" collection of table lamps. Finish can be mirror-polished aluminum or bronze; off-white linen shades in new shapes are also available. / Brayton Accessories.

895 AMBIENT LIGHTING / Developed for use with the *AmSeCo* open office system, the "Softshine" partition-mounted fixture sends 85 per cent of its light out to the sides, yet projects only 5 per cent of its light below standing eye level. Low-energy fixture is available in 4- and 8-ft lengths. / Peerless Electric Co.

896 FLUORESCENT STRIP / The *Lite Stripe* is a tailored fluorescent strip light for displays and exhibits. A narrow aluminum extrusion holds all wiring, ballast and hanging clips. Invisible connectors allow extension to any length; movable shields conceal lamp ends. *Lite Stripe* is offered in lengths from 4- to 24-ft. / Peerless Electric Co.

897 WIDE-SPREAD LIGHTING / *Lite Strut* has an aluminum housing and indirect optical assembly that provides an exceptionally wide light spread, allowing for even light distribution under low ceilings while using minimum wattage. Fixtures available in standard lengths of from 4- to 24-ft, and any length in increments. / Peerless Electric Co.

898 SITE LIGHTING / *Conquest* bollards supply low glare site lighting using a range of energy-efficient HID lamps. Round or square housings are interchangeable on the inner frame; lenses are impact resistant acrylic. / McGraw-Edison Co.

899 BALLAST HOUSING / The *Power Tray* luminaire ballast assembly installs in the inner frame of bollard fixtures; power supply and lamp holder leads are polarized quick disconnect fittings. The *Power Tray* allows single luminaire to accommodate a variety of lamps and ballast. / McGraw-Edison Co.

900 FORWARD THROW LIGHT / A wall-mounted version of the *SPI* ambient lighting fixture, the "SDD1" directs light upwards, spreading the concentrated HID light sources into a forward distribution for effective indirect lighting. / McGraw-Edison Co.

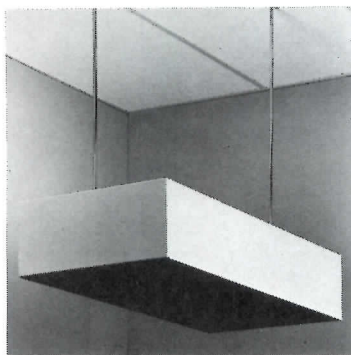

901

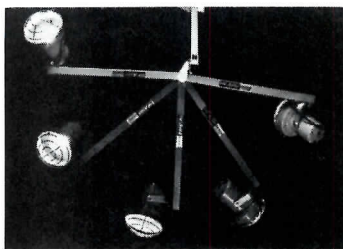

904



907

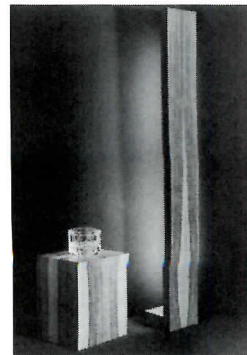

910

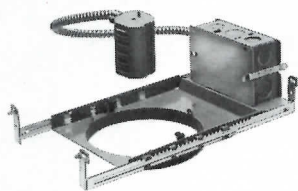

902



905

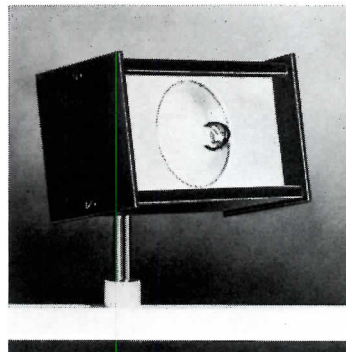

908



911



903

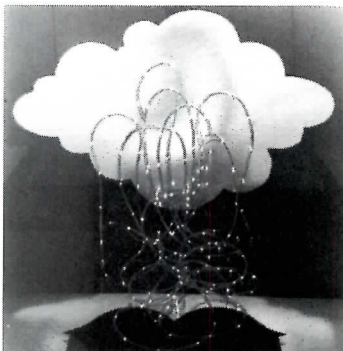

906



909

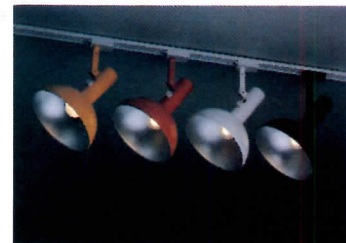

912

901 INDIRECT LIGHTING / The ceiling-mounted *SPI Symmetric SDE2* luminaire provides glare-free ambient lighting for stores, offices, and other interior spaces. Dual lamp assembly may combine metal halide and hps lamps for warm color temperatures. The optical chamber directs the light upward, spreading the concentrated HID light sources into wide symmetric distribution. / McGraw-Edison Co.

902 RECESSED HOUSING / The versatile *H-17 Flexall* recessed incandescent light housing combines a plaster frame, an adjustable socket, which accommodates a variety of screwbase lamps, and over 30 different trims. Bar hangers can be positioned for 16- to 24-in. joist spacing. / Halo Lighting Div., McGraw-Edison Co.

903 AREA/STREET LIGHT / Pole- or wall-mounted *Spherical Site Light* can be used singly, or in clusters up to four, for both area and street illumination. Luminaire takes a range of HIP lamps and wattages; spun aluminum top canopy may be color matched to round, tapered poles / Johns-Manville, Holophane Div.

904 LOADING DOCK LIGHT / The flexible joints of this *Docklite* fixture allow it to swing safely out of the way when struck from any direction. The fixture has a 60-in.-reach, and adjusts 240 deg vertically and 300 deg horizontally. / Phoenix Products Co.

905 PANELED CEILING LIGHTS / Fixtures and air diffusers are designed to blend mechanically and esthetically with the *Planar* ceiling: diffuser uses slots between aluminum panels for air distribution. Lighting fixtures include fluorescent, incandescent, or mercury vapor styles. / Alcan Building Products. IR*

906 LIQUID LIGHTING / Clear acrylic flexible tubing has 1/2-Watt lamps spaced every 2-, 3-, 4-, 6-, or 12-in. for use in surface-mounted graphic displays and signage. Non-oxidizing tubes come in 5/16- and 1/2-in. diameters up to 12-ft long; may be interconnected to form patterned lighting environments up to 96-ft. / Neo-Ray Products, Inc.

907 LOW VOLTAGE ACCENT / A 12-Volt light with a self-contained transformer, this cylinder offers good beam pattern control in track lighting applications. Rotating bezel positions the light, and snaps out for easy relamping. / Progress Lighting. E, I*

908 WALL WASHER / An addition to the *Trak-1* line of single circuit track lighting, this 6 7/8-in.-wide adjustable lampholder accommodates 100-, 150-, or 250-Watt T4 quartz lamps. Matte black finish is standard. / Progress Lighting. E, I*

909 LIGHTING CONTROL / For use with up to 410 low energy decorative lamps displayed in patterns up to 96-ft, the "Fever" control allows sequential chasing, waiver, visual sound and other dramatic lighting effects. / Neo-Ray Products, Inc.

910 WALL COLUMN / Suggested for use in interior areas such as halls and stair landings where lamps or recessed lights are not practical, this wall illuminating column stands 96-in. high. Element allows light to bounce off the wall and either side of the column, and can be used either horizontally or vertically. Crafted of precious woods and custom lacquers, prices range from \$1,500. / Vladimir Kagan Designs, Inc.

911 PAR LIGHT / Another fixture option with the *Inlite 3000 Series* light track, "Phasor" units are offered as 150 Watt PAR-38 side prong and 200 Watt PAR-46 side prong lights. White finish is standard; color filters are available. Unit price for the light alone is \$25.50. / Inlite Co.

912 TRACK FIXTURE / Available in white, black, yellow and orange, "Aurora" fixtures clip into a one- or two-circuit "3000 Series" light track only 1 3/8-in. wide. Light takes 100- or 150 Watt incandescent bulbs; fixture alone is priced at \$19.00. / Inlite Co.



913

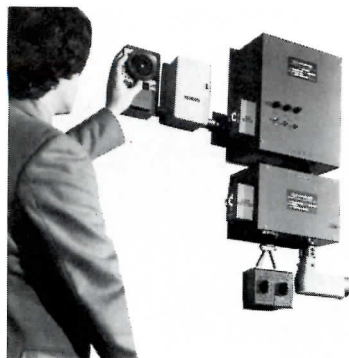

916

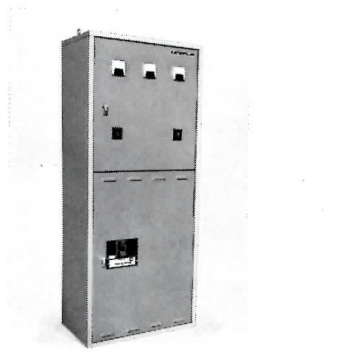

919

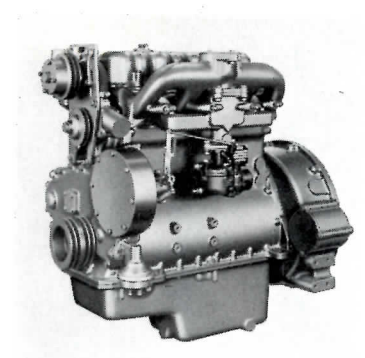

922

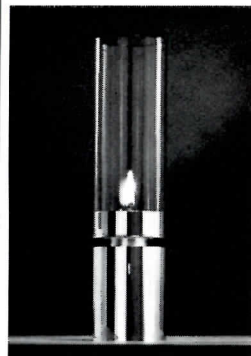

914



917

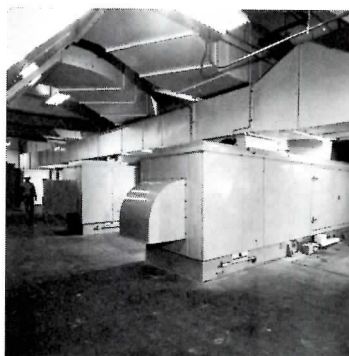

920

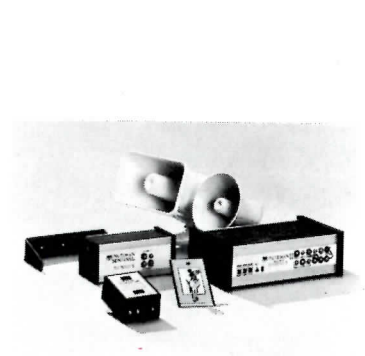

923

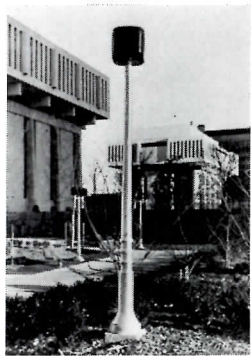

915

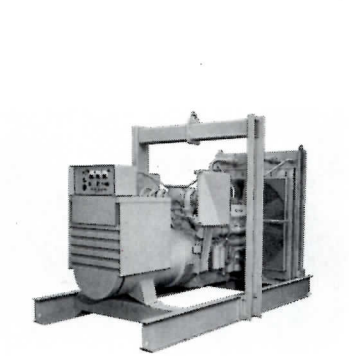

918

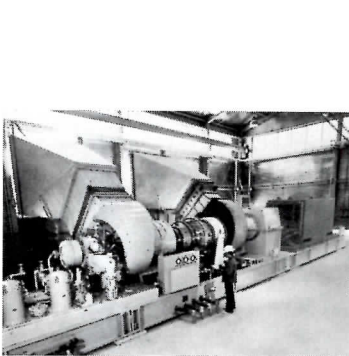

921



924

913 HANGING FIXTURE / The "5700 Series" chandelier employs concealed downlights to provide a good level of task lighting, while the up-lights are a source of both ambient and atmospheric light. Designed by Don Clever, chandelier is offered in 6-, 9- and 10-light versions. / Robert Long Inc.

914 HURRICANE LAMP / Designed by Jules Heumann, this contemporary version of the traditional hurricane lamp has a cylinder base and glass chimney scaled for use in contract or residential interiors. Offered in kerosene or candle-lit models, the lamp comes in silver, oxidized brass or dull brass finish. / Robert Long Inc.

915 ALUMINUM POLE / Shown here installed in the Empire State Plaza in Albany, N.Y. is a variation of the "Designer Series" architectural poles for area and street lighting. Poles are one-piece construction, tapered from seamless aluminum tubing finished in *Duranodic* colors. Painted and powder coatings are also available. / Pfaff & Kendall.

MOTORS & CONTROLS

916 LIGHTING CONTROLLER / This "Energy Control Device" regulates fluorescent lighting levels in commercial buildings without major rewiring. A central transmitter at the main lighting panel sends high-frequency signals that trigger a small receiver that turns on the lamps. / GTE Lighting Products.

POWER GENERATION

917 AC EMERGENCY POWER / Dependable emergency power for fluorescent and incandescent fixtures is generated by the compact *Modular AC Power Station*. The solid-state unit permits flexibility in the choice of emergency lighting systems which can meet UL, Life Safety Code, NFPA 101, OSHA and National Electric Code requirements. / Johns-Manville Sales Corp., Holophane Div.

918 PACKAGED GENERATOR / Optional equipment offered with standby and prime power generators make these power sources more useful for construction and other on-site applications. / Caterpillar Tractor Co., Engine Div. GB, ICR, E*

919 SWITCHGEAR / Built to 1978 NEC standards, this floor-standing switchgear is designed for use with *Caterpillar* generator sets in single- and multiple-unit installations. Four methods of paralleling are available; nine amperage ratings are offered in two sizes of enclosure. Unit can be used with both manual and automatically started generators, and is mounted remote from the power source. / Caterpillar Tractor Co., Engine Div. GB, ICR, E*

920 STANDBY GENERATOR / The "Saturn" gas turbine generator is shown here installed in a cogeneration system. The turbine's waste exhaust heat is used to produce steam for processing in this food plant. / Solar Turbines International.

921 FULL-DUTY GENERATOR / The "Mars" gas turbine electrical generator sets are intended for applications where the slightest interruption of power service cannot be tolerated. / Solar Turbines International, Div. International Harvester.

922 GAS & DIESEL ENGINES / Developed for the construction and material handling markets, "VR" series gas-, diesel-, and propane fueled engines are compact, heavy-duty units for a variety of off-highway applications. They can be used for power loading and waste handling equipment, lifts and hoists, heat pumps and compressors, and for on-site power generation. / Waukesha Engine Div., Bresser Industries, Inc.

PROTECTIVE SYSTEMS

923 RESIDENTIAL SECURITY / Designed for the home, apartment (and can be also used in small business), the "Minuteman II" has a control detector, alarm timer, test circuits and rechargeable batteries. / Delta Products Inc.

924 MONITOR PANEL / The "Mark V" monitor panel controls surveillance of unlimited number of zones, security equipment and fire equipment, and desk top, rack mount or flush mount models are available. / Continental Instruments Corp.

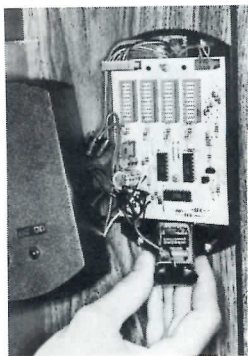

925

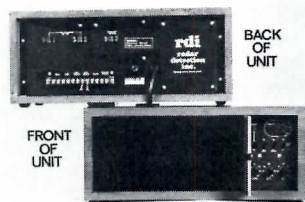

928

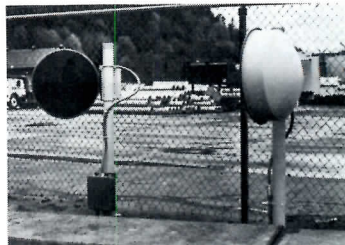

931



934

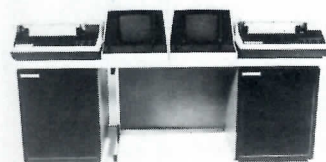

926



929

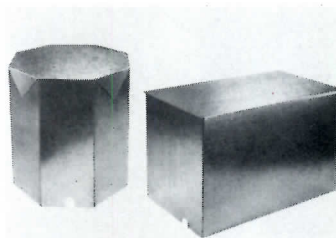

932



935



927

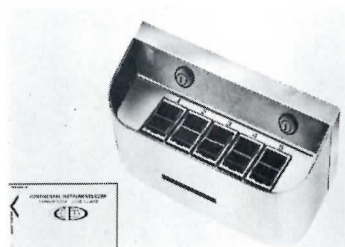

930

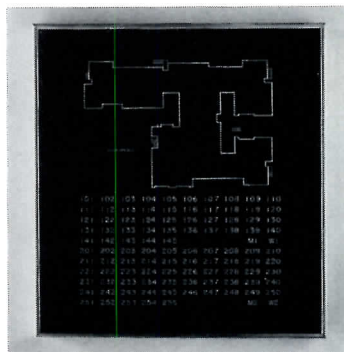

933

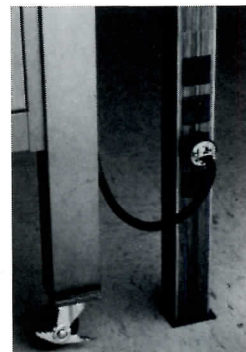

936

925 DIGITAL LOCKS / A new model in the Comp-U-Lock keyless security locking system is a digital that operates electronically. It offers 10,000 possible combinations that can be entered on the four rows of rocker switches on the unit. The electric latch part fits most standard door jambs and is installed with common hand tools. / ESP Systems Development Inc.

926 CARD KEY SECURITY / Designed for medium- to large-sized installations, the *Pass* maximum security system operates an entire network of security, access and environmental equipment. The system provides a simultaneous response to any alarm condition or malfunction by specifying corrective action. Cost starts at \$50,000. / Cardkey Systems.

927 SECURITY SYSTEM / An encoded card is used in the Delta 1000 access control system. It not only controls who enters a building, but also restricts traffic through such critical areas as computer rooms, record centers and vaults. / Honeywell Inc., Commercial Construction Div.

928 RADIO-CONTROLLED SECURITY / A wireless, radio-controlled security system can be used in both industrial and residential applications. The base unit contains a radio frequency receiver that receives signals from remote wireless window and door transmitters, smoke and fire detectors or other accessories. / Radar Detection Inc.

929 COMBINATION LOCK / A push button combination lock provides one-hand operation in this security system. Called the Unican 1000 Access Control, the device is weatherproof and pick-proof, with alterable combinations. / Simplex Security Systems, Inc.

930 ACCESS CONTROLS / The "Code 'n Card," part of the *Cypher Lock* line, permits field selection of any of three operating modes—memorized code only, magnetically encoded card only, or code and card. / Continental Instruments Corp.

931 MICROWAVE SECURITY / Special microwave circular units are key elements in this outdoor security system for perimeter protection. Model 14000-01 includes a transmitter and receiver, which automatically adjusts the coverage zone from 25 to 1,500 feet; detection sensitivity is field adjustable. / Racon, Inc.

932 LIGHT FIXTURE BOX / *Guard-A-Lite* sheet metal boxes prevent the unsafe build-up of heat around light fixtures recessed into insulated spaces. Boxes keep the insulation at a distance from the fixture while preventing back drafts. / Leigh Products.

933 SECURITY MONITOR / Custom graphics on this illuminated annunciator panel show the individual floor plan of the protected area, with the signaller's location indicated with LED or incandescent legends and isolated buzzer circuit. Low-voltage panel has a built-in test circuit, and is expandable to handle any number of rooms, floor plans and repeater stations. / Life Dynamics.

934 EMERGENCY NOTICE / The *Recom II* command console provides five fully-supervised facilities, color-coded for easy identification by fire-fighters. These include telephone master; page master; alert alarm signal; evacuation alarm signal; and alarm annunciator. All equipment is protected by a *Plexiglas* smoke door. / Robertshaw Controls Co.

RACEWAYS

935 ENERGY DISTRIBUTION SYSTEM / A subsystem of the company's *Action Office*, extends power only to required areas, rather than energizing an entire panel; works with available power supply point, provides up to four-circuit capacity, and permits flexibility in outlet placement. / Herman Miller Inc.

936 POWER POLE / A 2- by 2-in. U.S.-listed pole is factory pre-wired for power, and has separate channels for power, communications and electronic cables. Easily installed, it is plugged into a 3M brand Power-T-Duck or jumper system. / 3M Electro-Products Division.

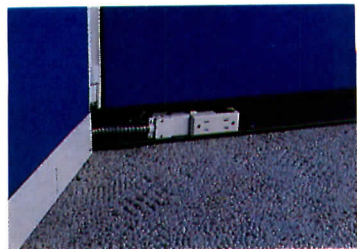

937

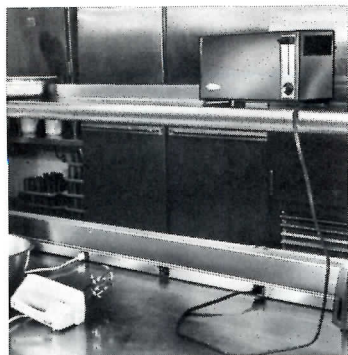

940

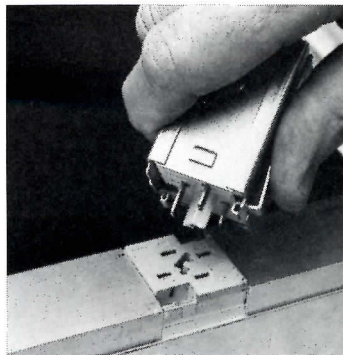

943

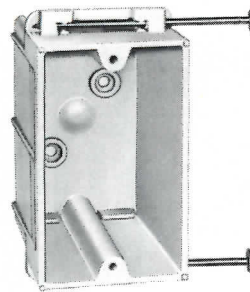

946



938

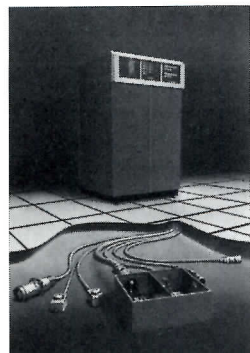

941



944

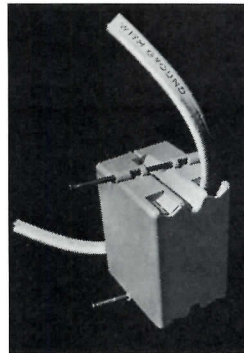

947

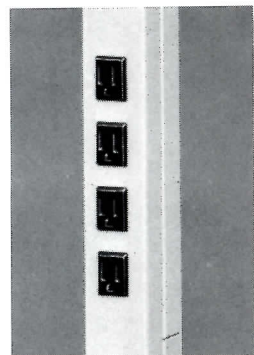

939

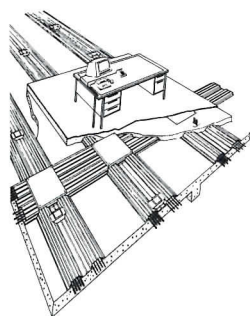

942

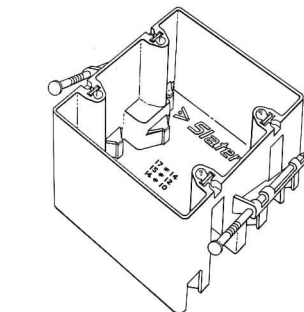

945

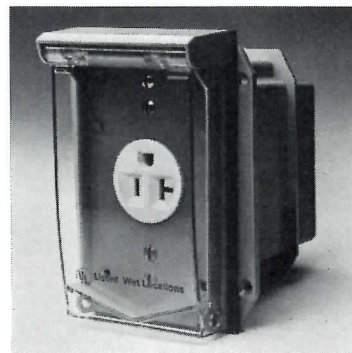

948

937 POWER PANELS / Each power panel incorporates a number of power and component options based on exact needs, with each panel providing two 20-amp, 125-Volt circuits. Power is distributed to adjacent panels through special connectors. / All-Steel Inc.

938 POWER MANAGEMENT / Wire management and electrical distribution throughout the company's *Action Office* plan is possible through an interrelated set of panel bases and power poles. / Herman Miller, Inc.

939 POWER POLE / The 25TP-4 power pole has two channels for delivering separated power and communication circuits from overhead ceiling connections to points-of-use. An access cover located at the lower end of the pole makes it convenient to update telephone service wires at any time with the pole in place. / The Wiremold Co. E*

940 PLUGMOLD / For sterile environments such as hospitals, restaurants, clean rooms and home kitchens, a stainless steel plugmold is available in multi-outlet wired sections. The "S-2000" comes in 3-ft, 5-ft and 6-ft lengths. / The Wiremold Company. E*

SERVICE & DISTRIBUTION

941 POWER CENTER / A power center has been designed for the data processing facility. To minimize service and installation labor, all flexible connection cables are blue and coded by circuit, length and appropriate computer equipment. / Conditioned Power Corp.

942 UNDERFLOOR SYSTEM / An underfloor electrical distribution system for concrete frame and slab buildings, "TR" ducts have 50 per cent fewer components than typical installations. The system requires only a 3-in. total depth, with no electrical fixtures above the floor line. / H. H. Robertson Co.

943 RACEWAY SYSTEM / Improvements in the aluminum *Power-T-Duct* modular distribution system are said to make it more flexible and reliable. Ceiling fixtures and *Communi-Power* poles may be plugged into the nearest outlet in a *PTD* raceway. / 3M Electro-Products Div.

944 CABLE TERMINATOR / One-piece unit for use with concentric neutral cable, the *QUICK-Term II* needs no stress cone, yet provides full stress relief. Termination requires only a 4 3/4-in. cutback of the cable jacket; the *Quick-Term* design permits non-forced placement before unwinding the collapsible plastic core. / 3m Electro-Products Div.

WIRING DEVICES

945 WIRING DEVICE / The new *Auto/Clamp* is described as an economical method for securing non-metallic cables in plastic outlet boxes. Eliminating metal cable clamps and screws, the *Auto/Clamp* is molded into the box itself. / Slater Electric Inc.

946 NONMETALLIC BOXES / Switch and outlet boxes are available molded from non-conductive fiberglass reinforced polyester, requiring no grounding. The boxes accept up to 10 #14, 9 #12, or 8 #10 romex wires in accord with NEMA. / Mdlnd-Ross Corp.

947 LAMP SAVER / This dummy lamp tube acts as a power shunt, replacing one fluorescent light in 4- and 8-ft two-lamp circuit fixtures. The power shunt tube, of clear glass to eliminate shadows and light blockage, completes the normal parallel circuit ballast wiring used in the fixture. Light levels are reduced evenly, with one light burning in each fixture. / Enersave Co.

948 WEATHERPROOF ENCLOSURE / For flush installation in all types of building wall, this plastic flanged box produces a system that, when used with a wet or damp location cover, provides a total weatherproof enclosure to meet UL standard 514 and NEC 410-57. / Slater Electric Inc.

Walkerflex™ Architectural Power Systems.

The possibilities are endless.

Installation is fast, easy

The Walkerflex APS distribution unit is the conversion point from hard wiring to the flexible system. It distributes power from the panel board to wherever you need it, through cable sets that install by simply plugging in. No fishing for wire, no bending conduit. Constructed with special armor-clad appliance cable, Walkerflex cable sets come in lengths from 3 to 50 feet—or longer if needed. All major light fixture manufacturers are UL listed and able to install APS receptacles in their products.

No rewiring for relocation

Move wall receptacles when you move walls. Change lighting fixtures as work areas change. All it takes is unplugging and plugging. The Walkerflex APS makes any spot on the ceiling available for light fixtures, every area in the building easy to remodel and rearrange.



Mistake-proof design

Each plug and receptacle is color-coded according to voltage and function, with a strong, durable LEXAN® 141 resin housing that doesn't expand or contract. Tight-fitting connections minimize heat buildup. The unique

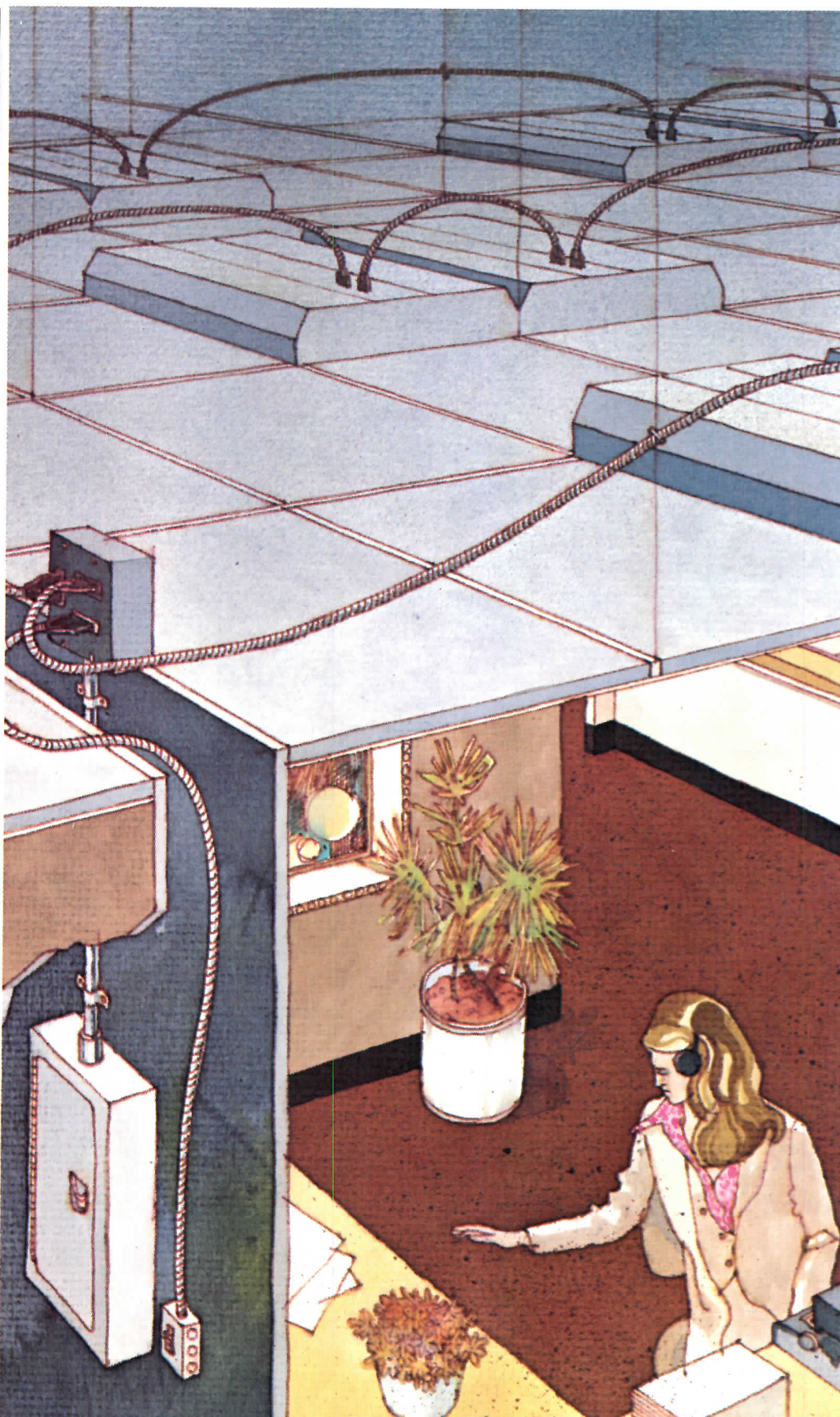

Now you see it...

Now you don't!

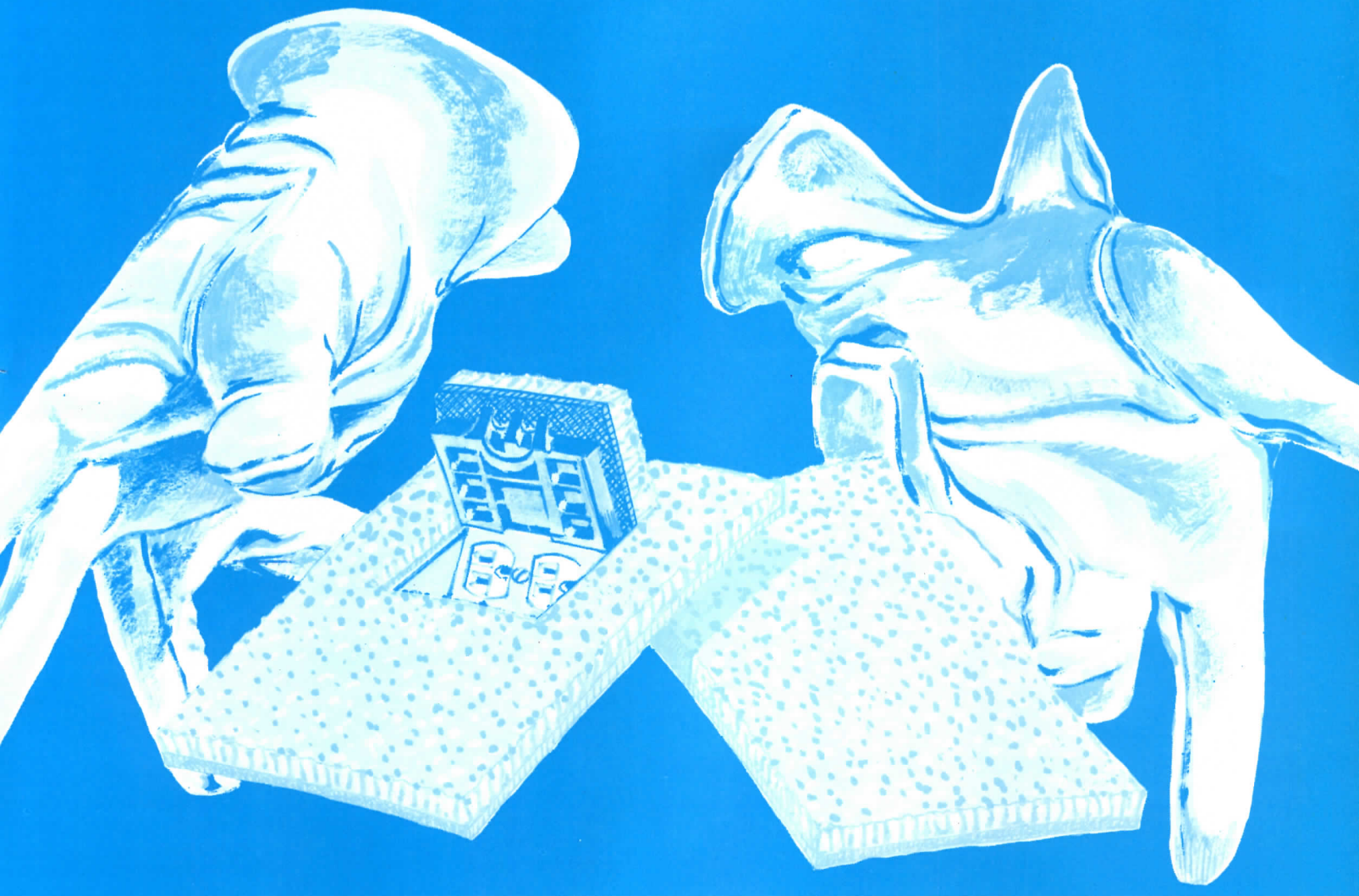

The Amazing “Disappearing” Flip Top® Floor Fitting

For the first time, architects and interior designers can specify a floor outlet which maintains the design integrity of office and commercial interiors. The Flip Top dual service floor fitting is there when it's needed and folded down beneath the carpeting when not required.

The UL-listed Flip Top recessed floor outlet can accommodate both communications and electrical wiring within a compact floor box enclosure of steel and injection molded phenolic plastic. Its unique hinged cover door permits easy accessibility to power and telephone outlets...and is operable without exposing metal parts. Carpeting is attached to the hinged injection molded polycarbonate cover door with Velcro attachment pads.

Fully adjustable both before and after concrete is poured. The junction box, which comes complete with specification grade receptacle, is 14-gauge CRS galvanized, nominally 8 x 4½ x 3 inches with corner supports and leveling screws. Flip Top is the floor

outlet that remains out of sight—hidden beneath the carpet—until activated. Flip Top...it's there *only* when you need it!

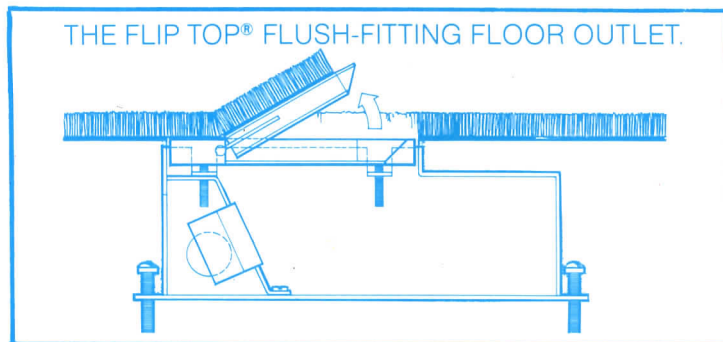

rci **Raceway Components Inc.**
263 Hillside Avenue Nutley, N.J. 07110
800-201-661-1116
Circle 1070 on inquiry card

MANUSCRIPTS WANTED

Architectural Record Books publishes hard cover books on architecture, engineering, interior design, housing, construction and related subjects, and is seeking book proposals and manuscripts. If you have a manuscript or a proposal, or know of someone who does, we'd appreciate it if you would arrange that it is sent to us for evaluation for possible publication. In order to make an evaluation we will need a chapter outline and at least one sample chapter.

Please address all inquiries to:

The Editor
Architectural Record Books
1221 Avenue of the Americas
New York, NY 10020

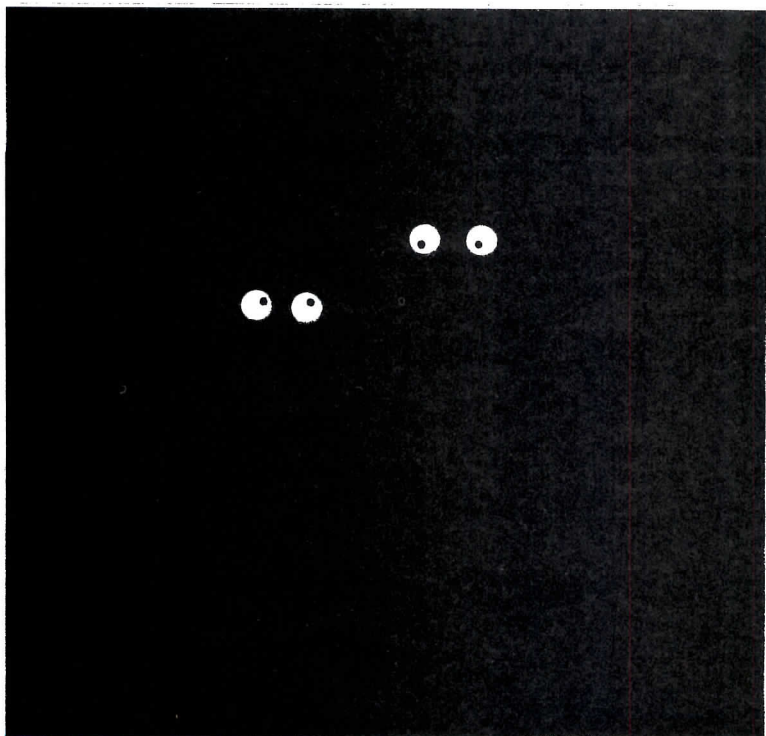

*Sure wish we had installed Caterpillar
standby power!*

Call free, 1 800 447-1980
For your Cat Representative
In Illinois call 1 800 322-4410



CATERPILLAR

Caterpillar, Cat and  are Trademarks of Caterpillar Tractor Co.

Circle 1071 on inquiry card

3146 MODULAR COLLECTOR / The efficiencies of the *Sun-Aid* collector's *Tube-In-Strip* copper absorber plate are outlined in an illustrated brochure. Liquid-carrying tubes are integrally formed in the sheet; collectors may be manufactured in virtually any configuration to meet special design requirements. / Revere Solar and Architectural Products, Inc.

3147 SOLAR COLLECTORS / Technical brochures and case histories describe the *Sunmaster* round glass tube solar collector, an efficient energy source for solar hot water heating systems. Design of cylindrical tubes and reflectors permit collection of energy up to 10 hours a day, even in cloudy or sub-zero weather. Literature features a *Sunmaster* installation in Amherst, Mass., which supplies over 75 per cent of the year-round heating, hot water and air conditioning requirements of a 50,000 sq ft college complex. / Sunmaster Corp.

3148 ACCESSIBLE WASHROOMS / A "Planning Guide" based on ANSI A-117.1 specifications on making buildings accessible to, and usable by physically handicapped people, helps the professional select and place washroom equipment. / Bobrick Washroom Equipment, Inc.

3149 WATER COOLERS / Color catalog contains recessed and semi-recessed water coolers; floor-standing, pedestal and counter top fountains. The "Modular Service Wall" system, which groups mechanical facilities, phones, etc. in one space-saving wall cut-out, is briefly described; color options are shown. / Halsey Taylor. GB*

3150 KITCHEN/BATH / Decorating ideas for kitchen, bath and powder room are illustrated in the "Elegance" plumbing fixture brochure. Color photos show whirlpool baths, tubs, shower coves, toilets, lavatories, sinks, faucets, etc. in room settings. / Kohler Co.

3151 BARRIER-FREE SHOWER / Preamsembled shower modules designed to meet all known accessibility codes are features in a 16-page equipment brochure. Detail drawings illustrate various barrier-free shower room renovation suggestions. / Bradley Corp. GB, ICR, E*

ELECTRICAL: UCI 16

3152 OFFICE ENERGY SYSTEM / Written for those concerned with developing and maintaining capabilities for open plan equipment, the "Action Office Energy Distribution Handbook" describes new relocatable electrical systems and how they interface with the *Action Office*. Problems such as change inhibition, service delivery failure and safety hazards are discussed; circuitry, codes and telephone systems are among the topics covered. The softcover guide is published by Herman Miller Research Corp., 3970 Varsity Dr., Ann Arbor, Mich. 48104. Individual copies are \$7.50 prepaid; quantity discount available.

3153 LIGHTING / Updated catalogs describe two lines of *Halo* lighting fixtures. The "Surface" group was designed for visual impact and offers soft squares, spheres, shades, *Lexan* drums, brackets, shelf lights and communication lights. The "Recessed Architectural" lighting catalog contains the detailed information required to make critical design choices for lighting, and shows downlights, telescoping spots, eyeballs, brick and aisle lights, etc. / Halo Lighting Div., McGraw-Edison Co.

3154 RECESSED LIGHTING / Offered in-stock, the "21MV100" is a 100-watt mercury vapor recessed housing based on the *21 Plus* series. Brochure explains the versatile applications of the compact housing, and illustrates the seven trim styles. / Prescolite.

3155 LARGE LAMPS / "Ordering Guide 79-1" provides product data and ordering information, including prices, on energy-saving lamps for commercial and industrial applications. / Sylvania.

3156 HAZARDOUS AREA LIGHTS / *Petrolux* indoor/outdoor luminaires that conform to NEC and UL hazardous location standards are shown in a 12-page brochure. Reflector, light pattern, and mounting choices are covered. / Johns-Manville Sales Corp., Holophane Div.

3157 LAMP SAVINGS / Catalog presents all of this maker's fluorescent surface and wall fixtures, and includes a chart showing annual savings possible with various types of fluorescent lamps. / Lightolier.