

ARCHITECTURAL
RECORD

Business Design Engineering
A McGraw-Hill Publication, Six Dollars a Copy
Record Houses, Mid-April 1986



Designer Solarian® II



Continue the luxury

When designing a custom interior, continue the luxury with Designer Solarian II floors. Their stylish visuals are crafted by our exclusive Inlaid Color™ process. Precisely placed vinyl granules create rich colors and textured designs that extend all the way through to the backing. Write for our pattern book and a Designer Solarian II sample. Armstrong, Dept. 64FAR, Box 3001, Lancaster, PA 17604.

Armstrong

Circle 1 on inquiry card

Editor
Mildred F. Schmertz, FAIA

Managing editor
Carolyn De Witt Koenig

Senior editors
Herbert L. Smith, Jr., FAIA
Charles K. Gandee
Douglas Brenner
Grace M. Anderson
Margaret F. Gaskie
Paul M. Sachner
Charles K. Hoyt, AIA

Associate editors
Darl Rastorfer
Deborah K. Dietsch
Karen D. Stein

Production editor
Annette K. Netburn
Susan Stein, assistant

Design
Alex H. Stillano, director
Alberto Bucchianeri, senior associate
Anna Egger-Schlesinger, associate
Muriel Cuttrel, illustration
J. Dyck Fledderus, illustration

Design consultant
Massimo Vignelli

Editorial consultants
George A. Christie, Jr.
Jonathan Barnett, FAIA, AICP

McGraw-Hill World News
Peter Gall, director

Director of information systems
and circulation
Richard H. Di Vecchio

Director of business
and production
Joseph R. Wunk

Director of marketing
Camille H. Padula

Assistant to publisher
Elizabeth Hayman

Publisher/Vice president
Paul B. Beatty

*Inquiries and submissions of work for
publication may be addressed to any
editor, though the editors listed below
have a special responsibility for the
subject areas named:*

Charles Gandee, interior design
Herbert Smith, architectural education
Charles Hoyt, business
*Paul Sachner, design news,
competitions, book reviews*
Darl Rastorfer, engineering
*Karen Stein, new products and
product literature*

Business

Photographers of Record Houses 1986, 2

Design

Building Types Study 626: Record Houses 1986

Preface, 71

by Douglas Brenner

House in Rio Grande Valley, Albuquerque, 72

Antoine Predock, Architect

Casa Los Andes, Lima, Peru, 80

Arquitectonica Internacional, Architects

Rosewalk Cottages, Seaside, Florida, 90

Orr & Taylor, Architects

Posterla Residence, Morbio Superiore, Switzerland, 98

Mario Botta, Architect

Grove House, San Diego County, California, 104

Smith & Others, Architects

Farmhouse in Connecticut, 110

Allan Greenberg, Architect

Ito House, Tokyo, Japan, 122

Toyo Ito Architect & Associates

Kahn Residence, Lima, Ohio, 128

Hugh Newell Jacobsen, Architect

Vilanova House, Key Biscayne, Florida, 134

Andres Duany and Elizabeth Plater-Zyberk, Architects

Vacation Compound, Deer Isle, Maine, 140

Peter Forbes and Associates, Architects

Mallet House, New York City, 146

SITE Projects, Designers

Kitchens and bathrooms

Preface, 161

by Deborah K. Dietsch

Kitchen, Wild Residence and Studio, London, England, 162

David Wild, Architect

Kitchen, Wharton House, Stamford, Connecticut, 164

Shope Reno Wharton Associates

Kitchen, Ito House, Tokyo, Japan, 170

Toyo Ito Architect & Associates

Master Bathroom, Farmhouse in Connecticut, 172

Allan Greenberg, Architect

Bathroom, Hopper Residence, Venice, California, 174

Brian Alfred Murphy, Architect

Engineering

New products, 180

Manufacturer sources, 187

Product literature, 197

Advertising index, 222

Reader Service card, 225

Cover:

Mallet House, New York City

SITE Projects, Inc.

Photographer: ©Paul Warchol

PHOTOGRAPHERS OF RECORD HOUSES 1986

Lorenzo Bianda (98)
P. O. Box 434
Locarno, Switzerland

Richard Bryant (162)
6 Larchmere Road
Kingston-on-Thames
Surrey, England KT2 5TW

Paul Ferrino (140)
55 Cardinal Drive
Milford, Connecticut 06460

Mick Hales (90, 128)
126 Madison Street
Hoboken, New Jersey 07030

Timothy Hursley/The Arkansas Office (72, 80, 134)
115 East Capitol
Little Rock, Arkansas 72201

Peter Mauss/ESTO (110, 172)
222 Valley Place
Mamaroneck, New York 10543

Tomio Ohashi (122, 170)
2-2-4 Shimozato
Higashikurume-Shi
Tokyo 203, Japan

H. Durston Saylor (164)
219 West 16th Street
New York City 10011

Stephen Simpson (104)
701 Kettner Boulevard, # 124
San Diego, California 92101

Tim Street-Porter (174)
6938 Camrose Drive
Hollywood, California 90068

Paul Warchol (146)
133 Mulberry Street, 6S
New York City 10013

ENTRY PROCEDURE

Any registered architect is invited to submit materials for RECORD HOUSES 1987; *no entry forms or fees are required*. Materials sent to us should include all relevant plans and sections, a short written description, and whatever photographs are sufficient to describe the project. All materials should be securely bound and submitted in an 8 1/2 x 11 inch format. Do not send materials that must be returned before the date of publication. The deadline for submissions for RECORD HOUSES 1987 is October 31, 1986.

Of particular assistance to the editor in the preparation of this issue were Douglas Brenner, editor-in-charge; Muriel Cuttrell, illustration; Eileen Gabriele, production

ARCHITECTURAL RECORD (Combined with AMERICAN ARCHITECT, and WESTERN ARCHITECT AND ENGINEER) (ISSN0003-858X) Mid-April 1986, Vol. 174, No. 5. Title © reg. in U.S. Patent Office, copyright © 1986 by McGraw-Hill, Inc. All rights reserved. Indexed in Reader's Guide to Periodical Literature, Art Index, Applied Science and Technology Index, Engineering Index, The Architectural Index and the Architectural Periodicals Index.

Every possible effort will be made to return material submitted for possible publication (if accompanied by stamped, addressed envelope), but the editors and the corporation will not be responsible for loss or damage.

Executive, Editorial, Circulation and Advertising Offices: 1221 Avenue of the Americas, New York, NY 10020.

Officers of McGraw-Hill Information Systems Company: President: Richard B. Miller. Executive Vice Presidents: Frederick P. Jannott, Construction Information Group; Russell C. White, Computers and Communications Information Group; J. Thomas Ryan, Marketing and International. Senior Vice President: Francis A. Shinal, Controller. Senior Vice President-Publisher: David J. McGrath, Engineering News-Record. Group Vice President: Peter B. McCuen, Communications. Vice Presidents: Fred O. Jensen, Planning and Development; Michael J. Koeller, Human Resources; Talat M. Sadiq, Systems Planning and Technology. Vice President-Publisher: Paul B. Beatty, Architectural Record and Building Economics.

Officers of McGraw-Hill, Inc.: Harold W. McGraw, Jr., Chairman; Joseph L. Dionne, President and Chief Executive Officer; Robert N. Landes, Executive Vice President and Secretary; Walter D. Serwatka, Executive Vice President and Chief Financial Officer; Shel F. Asen, Senior Vice President, Manufacturing; Robert J. Bahash, Senior Vice President, Finance and Manufacturing; Ralph R. Schulz, Senior Vice President, Editorial; George R. Elsinger, Vice President, Circulation; Ralph J. Webb, Vice President and Treasurer.

Associated Services/McGraw-Hill Information Systems Co.: Sweet's Catalog Files (General Building, Engineering, Industrial Construction and Renovation, Light Residential Construction, Interiors), Dodge Building Cost Services, Dodge Reports and Bulletins, Dodge/SCAN Microfilm Systems, Dodge Management Control Service, Dodge Construction Statistics, Dodge regional construction newspapers (Chicago, Denver, Los Angeles, San Francisco).

Subscription rates for personnel of Architectural, Engineering, Interior Design, Design and other directly related firms and students thereof, are as follows: U.S. and U.S. Possessions \$35.00; Canada \$37.00; all other countries \$70.00. Single copy price for Domestic and Canadian: \$6.00; for Foreign: \$7.00.

Change of Address: Forward changes of address or service letters to Fulfillment Manager, ARCHITECTURAL RECORD, P.O. Box 2025, Mahopac, NY 10541. Provide both old and new address; include zip code; if possible attach issue address label.

Guarantee: Publisher agrees to refund that part of subscription price applying to unfilled part of subscription if service is unsatisfactory.

Copyright and Reprinting: Title © reg. in U.S. Patent Office. Copyright © 1986 by McGraw-Hill, Inc. All rights reserved. Where necessary, permission is granted by the copyright owner for libraries and others registered with the Copyright Clearance Center (CCC) to photocopy any article herein for the base fee of \$1.50 per copy of the article plus 10 cents per page. Payment should be sent directly to the CCC, 21 Congress Street, Salem, MA 01970. Include code with request: ISSN0003-858X (\$1.50 + .10). Written permission must be secured for any other copying. Write Reprint Manager for such permission at address below, or to obtain quotations on bulk orders.

Subscription List Usage: Advertisers may use our list to mail information to readers. To be excluded from such mailings, subscribers should send a request to: ARCHITECTURAL RECORD, Mailing List Manager, P.O. Box 555, Hightstown, NJ 08520.

Publication Office: 1221 Avenue of the Americas, New York, NY, 10020. ARCHITECTURAL RECORD (ISSN0003-858X) published monthly with additional issues in April and September by McGraw-Hill, Inc. Second-class postage paid at New York, NY and additional mailing offices. Postage paid at Windsor, Ontario, Canada. Registration Number 9617.

Postmaster: Please send address changes to: Fulfillment Manager, ARCHITECTURAL RECORD, P.O. Box 2025, Mahopac, NY 10541. THIS ISSUE is published in national and separate editions. Additional pages or separate editions numbered or allowed for as follows: Eastern Section 32Ea through 32Eh. Central Section 32Ca through 32Cb. Western Section 32Wa through 32Wb. Northern Section 32Na through 32Nb. Sunbelt Section 32Sa through 32Sh.



SPACELINE™

A unique system of beams and intersections, SpaceLine™ creates a lowered ceiling plane in bold contemporary terms.

SpaceLine adapts to most conventional methods of lighting or lets the stars shine through from natural skylights. Dress it up for drama or down for simplicity — the possibilities are endless.

Integrated Ceilings, Inc.
11500 Tennessee Avenue,
Los Angeles, CA 90064
(213) 478-0781



SPEC.



SPECTACULAR.

The good taste and quality that is visibly obvious in a Colonist® six-panel door speaks not only for itself, but also for the quality, seen and unseen, that you've built into the home. It's a language that attracts buyers and pays off in sales.

Colonist doors combine the rich look of wood, luxurious sculptured

detailing, and unmatched durability. Each door facing is dieformed from a single piece of durable Masonite® brand hardboard, a material 50% denser than wood. They're easy to maintain and resist splitting, cracking, and splintering. They come primed and in most any size.

For a minimal investment, you can

increase the value and saleability of a home. Contact your local door distributor today and sell with the long lasting beauty of Colonist. It's more than just a door.

For more information call (419) 893-8787.



CRAFTED
WITH PRIDE
IN U.S.A.

With the advent of Du Pont certified ANTRON PRECEDENT™, commercial carpets enter a new age. Take on a luxurious dimension. And lead brilliantly longer lives.

ANTRON PRECEDENT virtually doubles the life span of commercial carpets. And

the quality of that life is far superior to any other. ANTRON PRECEDENT carpets have a rich beauty that defies heavy traffic. Their resistance to soil and stain is unrivaled. Their texture retention is unsurpassed. They're carpets that look newer longer and

reduce maintenance cost.

It's a performance that's light years ahead of other carpets, and only Du Pont could create it. What goes into ANTRON PRECEDENT is revolutionary fiber engineering, TEFLON® Low Surface Energy technology and stringent construction

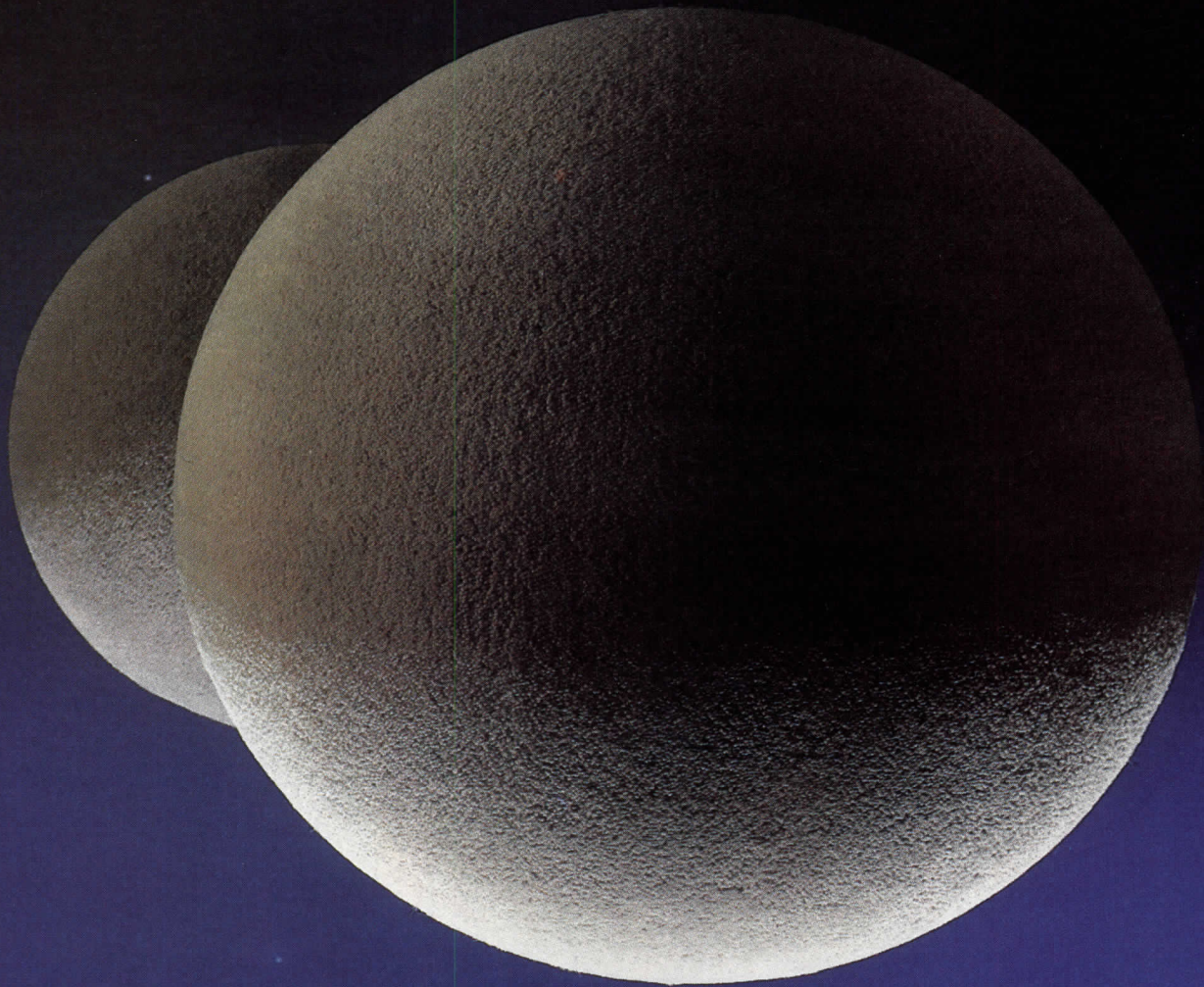

**DuPont introduces Antron Precedent™
with performance that will eclipse all other carpets.**

standards. And what comes out is a carpet system that's so advanced it commands a Du Pont certification mark.

So when you demand the ultimate in performance and style, specify a carpet that's backed with the quality "Q".



It's your assurance that it's met the toughest specifications in the business. Those of Du Pont for ANTRON PRECEDENT.

Call today for more information and a list of quality licensed mills. (800) 448-9835. New certi-

fied ANTRON PRECEDENT... only from Du Pont. It's nothing short of out of this world.





When your ideas
Dryvit[®] lets you do

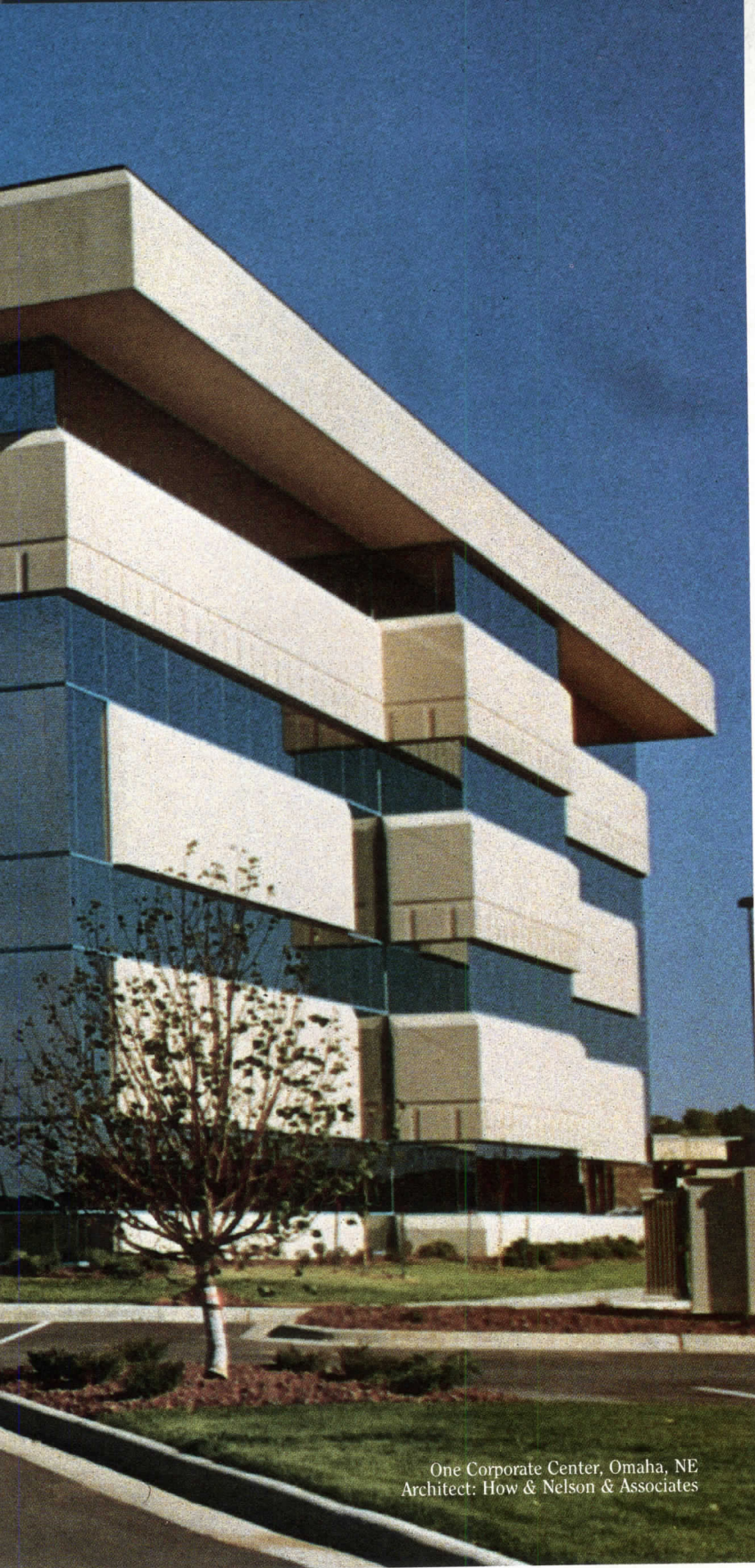

One Corporate Center, Omaha, NE
Architect: How & Nelson & Associates

Sometimes a project cries out for aesthetic dress. With a Dryvit® Outsulation® wall, you can include detail at very reasonable cost, thanks to the innate flexibility of the System.

A beautiful example of this is illustrated at left: One Corporate Center in Omaha. Those floating panels surrounded by glass would be difficult to accomplish with anything but lightweight Dryvit Outsulation. And the Greek frieze effect was just a simple step included in the Dryvit application.

Why Dryvit rather than other exterior wall insulation systems?

You know exactly what you're getting when you specify Dryvit. It's the exterior wall system proven in 55,000 buildings over a 17-year period in the U.S.A. And it's the only system backed by a coast-to-coast network of field service and technical professionals ready to help you with design questions, engineering know-how and structural testing data.

Cost-efficiency never looked better!

As this energy-efficient wall goes up, so does the dramatic detail. Instead of costly labor-intensive designs of heavy wood or metal, lightweight dimensional shapes of Dryvit Insulation Board can be cut to just about any shape on a mass production basis. The cost advantages are obvious.

And because Dryvit Outsulation's Primus/Adhesive® and Surface Finish are based on a 100% acrylic polymer, the System resists stains, fading and cracking.

For new construction or retrofit — enjoy the freedom of design and peace-of-mind that come from working with the proven wall system. Call or write for more information.

CALL TOLL FREE: 1-800-556-7752

dryvit®
OUTSULATION®

DRYVIT SYSTEM, INC.

One Energy Way, P.O. Box 1014, West Warwick, RI 02893

Plant Locations:

West Warwick, RI; Tulsa, OK; Woodlake, CA; Columbus, GA;
Vancouver, B.C., Canada (Dryvit Outsulation System Ltd.)

Look for us in Sweets: 7.13Dr and 7.13Dry

Circle 5 on inquiry card

ask for aesthetics, even more.

**When it comes to closets,
this is what the world is coming to.**



**Ask about our
Free Model Home Program
and our 10 Year
Limited Warranty.**

Let's face it, the old wood shelf and pole just can't meet the demands of today's closet and storage needs. Home buyers want more quality and efficiency in their homes today.

That's why there's Closet Maid®—the leader in durable, vinyl-coated steel rod shelving and storage systems that go in any home to effectively **double** storage capacity.

It's also steel rod-sturdy, needs no painting, won't sag or warp and is easily installed as your homes are being built.

By the **shelf or system**, Closet Maid is the affordable feature that turns closet space into a showcase **sales asset** with powerful buyer appeal.

No wonder the world's coming to Closet Maid.

Today's homes demand smarter closets.



CLOSETMAID®

Get the facts today. Call toll free: **1-800-874-0007 (in Florida 1-800-342-0412)**.
Clairson International, Building Products Division • 720 SW 17th Street,
Ocala, Florida 32674 • and Corona, California.

See our catalog in Sweets, 10.19/CLA



**Once you start using VELUX roof windows,
it's difficult to stop.**

With over 40 years experience specializing in roof windows and working closely with architects around the world, we've learned a thing or two. In terms of design, function, ease of installation, weather tightness and the availability of a complete program of options, including special glazings, you could not ask for more. Economically priced from about \$200 to \$500, they conform to all major building codes and may be used in passive solar applications.

VELUX. The world leader in roof windows and skylights!

VELUX[®]

Roof Windows

VELUX-AMERICA INC.
P.O. Box 3268
Greenwood, SC 29648

In Canada
VELUX-CANADA INC.
2525a J. B. Deschamps
Lachine
P. Q. Canada H8T1C5

Circle 8 on inquiry card

Architect:
D. F. Trees Associates
©VELUX-AMERICA INC.

New Wood. New Warmth. New Zapf.

Zapf brings you the warmth of beautiful new wood finishes.

Seven finishes in all. From the freshness of light maple to the richness of dark mahogany.

The Zapf System. Now, an even better place to work.

For more information call:

Knoll International at 1-800-633-0034 Ext. 51

In Rhode Island 751-7450

The Knoll Building

655 Madison Avenue, New York 10021

Circle 75 on inquiry card





Knoll

For the Natural Weathered Look...



Maushop Village, New Seabury, Cape Cod, MA; Architect: Claude Miquelle Associates, Melrose, MA. Cabot's Bleaching Oil on shingles.



- **Preserves wood.**
- **Protects wood.**
- **Mildew-resistant.**

Cabot's[®] Bleaching Oil

This fine product is a favorite of architects, builders, and homeowners. When applied to untreated wood, Cabot's Bleaching Oil actually bleaches the wood, imparting a delicate gray tone that weathers in a few months to a natural driftwood gray. This effect, heretofore found only in seacoast areas after years of exposure to salt air, is now attainable anywhere in the country. Cabot's Bleaching Oil, a refined and clarified oil with bleaching ingredient, is suitable for all exterior wood: shingles, siding, and clapboards.

For further information on Cabot's Bleaching Oil, write:
Samuel Cabot Inc.

East Coast: One Union St., Dept. 529, Boston, MA 02108
West Coast: 23284 Eichler St., Dept. 529, Hayward, CA 94545

WHEN THINGS GET HOT, YOU NEED A FIREPROOFING THAT HASN'T GONE TO PIECES. MONOKOTE.

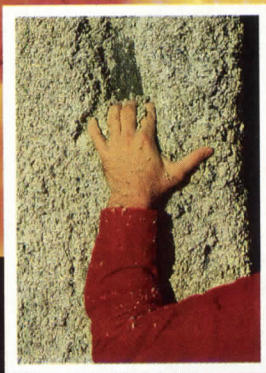

Mineral Wool
Sprayed Fiber



Cementitious
Monokote

The building inspector has gone. The spray-applied fireproofing has been approved. Now the real testing begins. Electricians, plumbers and carpenters are on-site with wrenches, ladders and hammers. Normal job-site conditions can cause impact damage, abrasion and removal of soft, friable fireproofing materials. Just a small gap can be enough to jeopardize the specified fire-resistance rating.

In-place performance is critical! UL classified Monokote Fireproofing meets or exceeds all recommended levels of performance for in-place strength, durability and resistance to fire and abuse.

Judge for yourself. Compare cementitious Monokote to low density, friable materials. Compare bond to steel, surface hardness, durability, and air erosion.

Compare the ability to resist damage from air movement found in elevator shafts that can cause dusting that contaminates sensitive electronic equipment. Compare manufacturer's published minimum standards — you'll find Monokote's are higher across the board.

Finally, compare service. Our national network of Grace professionals provide preliminary design and specification assistance, plus on-site application support when you specify Monokote!

Monokote Fireproofing. Specify anything else, and you're playing with fire.

For more information call (617) 876-1400 ext. 3170 or write W. R. Grace & Co., 62 Whittemore Ave., Cambridge, MA 02140.

Circle 10 on inquiry card

GRACE
Construction Products

KOHLER. At home in any home.



From tract home to custom home, Kohler gives you choices. With the largest product line in the industry, we have all the fixtures and faucets you'll need for the home you're creating.

For the custom home,

install elegant luxury with the Infinity∞Bath™ Whirlpool. Pick the clean, practical lines of the Guardian™ Bath for a young family's first home.

Choose the durability of cast iron, the practicality of acrylic or the simplicity of

vitreous china. And since Kohler has the broadest color range in the industry, our fixtures work with any decorating style, from antique and country to traditional and contemporary.



Every Kohler product—for the bath, powder room, kitchen or utility room is crafted with the same careful attention to detail. And this craftsmanship is found at every price range.

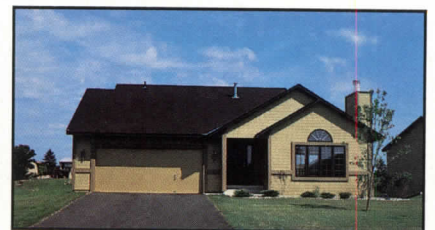

No matter what your plans or budget, no matter what the decorating scheme, Kohler is right at home, throughout any home. For more information on Kohler's full line, contact your nearest Kohler dealer or distributor or write: Kohler Co., Dept. RA4, Kohler, Wisconsin 53044.
Circle 11 on inquiry card

THE BOLD LOOK
OF **KOHLER**



s a l z b u r g

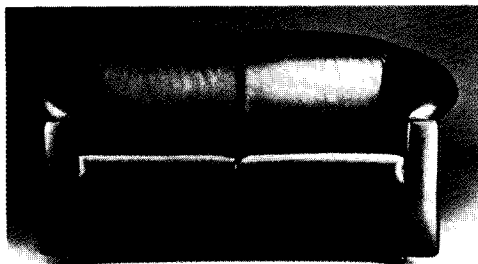

a lounge seating series
for conference, residential
and executive interiors,
designed by
Paolo Piva

Stendig International, Inc.
410 East 62nd Street
New York, NY 10021
212 838 6050
Circle 12 on inquiry card

Rich



These days, the building industry is one tough business. Staying competitive means in part, being able to offer an on-going array of exciting, new design ideas. At American Olean, new Whisper Patterns™ is one beautiful way we help you meet this need.

Whisper Patterns. Petal-soft shades of ceramic tile with

contemporary designs that can go from kitchen to family room. They also coordinate perfectly with American-Standard fixtures for a rich, new look in the bath. It's a concept we're selling hard in consumer shelter magazines. One that's also backed with top-notch American Olean distribution, personal service and our complete line of installation and tile care products.

Gaining the rewards you so richly deserve is easier with American Olean. For information on Whisper Patterns and our complete 1986 product line, write American Olean Tile Company, 3298 Cannon Avenue, Lansdale, PA 19446-0271; or call us at (215) 855-1111.

Circle 13 on inquiry card



You're out front with American Olean

Rapidograph® Renderings

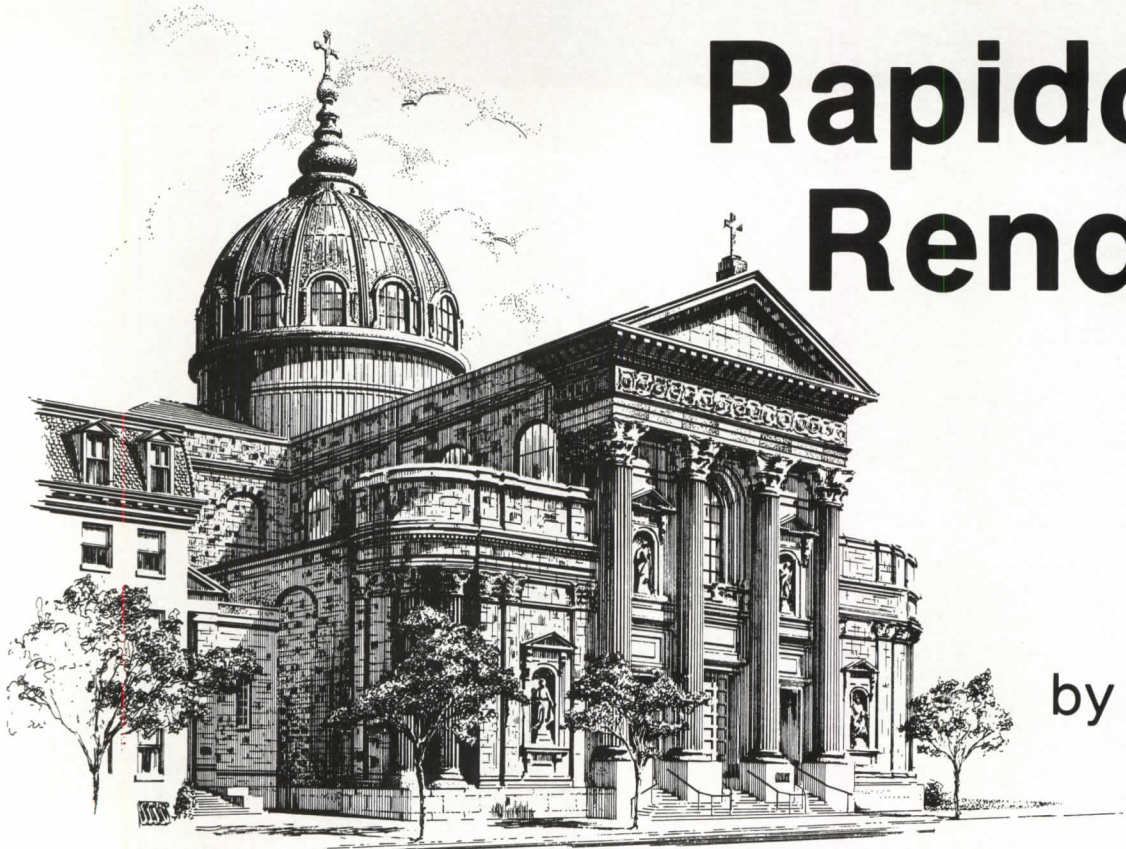

by Pennsylvania and

A keen eye for detail and a deft hand for expression provide Joseph Voelker of Springfield, Pa., with a mastery of pen-and-ink rendering of his subjects — particularly architectural subjects. Artist Voelker's pen is the Rapidograph® technical pen with tubular nibs that allow the artist to stroke in virtually any direction on the drawing surface, much the same way a pencil is used. This is the great advantage of the Rapidograph® pen over conventional

pens, such as the crow quill and fountain pen which, for the most part, cannot be stroked up — against a paper grain.

This versatility of movement in pen-and-ink drawing contributes to faster completion of drawings, which might account for artist Voelker's prolific nature: In addition to his commercial and graphic arts output, he has created a series of fine-art drawings of famous and historical landmarks in and around the environs of Philadelphia, of which

these illustrations are only a few.

Rapidograph® renderings present your architectural designs in the clearest light possible . . . good ideas translated into exciting visuals. These drawings by Voelker are examples of precision-clear interpretations which can be presented for any project — a restoration, a commission, a modern highrise, a neoclassical structure, and so on. Such drawings can have a free-hand abandon or be developed with minuscule refinement to hold details in photographic blowups.

The tubular nib is available in 13 widths. Just the weight of the pen itself and the handhold to keep the pen erect provide a consistent ink laydown. The designer, drafter or artist has only to guide the pen with an easy, non-fatiguing hold. The patented dry, double-seal cap keeps ink throughout the balanced ink flow system ready for instant startup, contributing to optimum drawing time. Refillable ink cartridge also helps keep productivity high. The Rapidograph® is designed for use with carbon-black india drawing inks that dry waterproof and smear-proof, allowing the artist to enhance drawings with other media, such as colored drawing ink and watercolor washes, or even pastels and colored pencils.

Look for the Koh-I-Noor Rapidograph® on the pen to be sure of the dependability and ease of performance that make the Rapidograph® pen the most widely used technical pen in the United States and Canada.

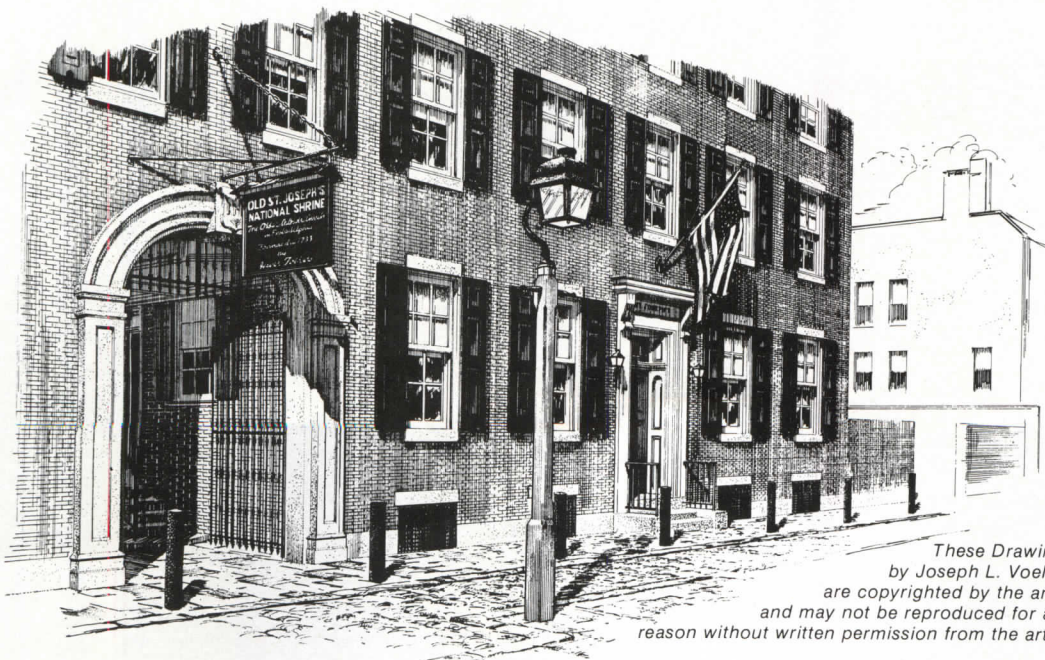

*These Drawings
by Joseph L. Voelker
are copyrighted by the artist
and may not be reproduced for any
reason without written permission from the artist.*

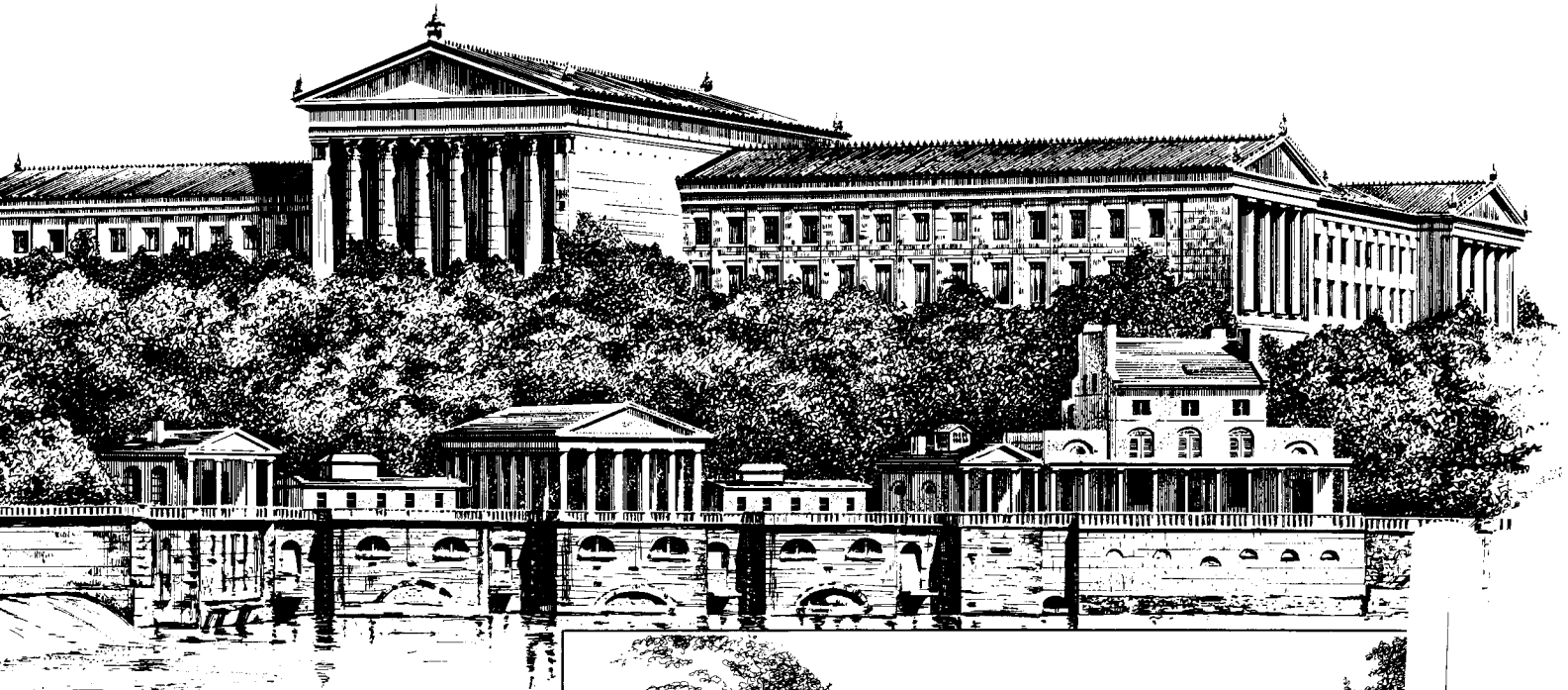

Joseph L. Voelker

Single pens and pen sets are available. Ask your dealer or send the coupon for details: Koh-I-Noor Rapidograph Inc., 100 North St., Bloomsbury, NJ 08804 (201) 479-4124. In Canada: 1815 Meyerside Dr., Mississauga, Ont. L5T 1G3 (416) 671-0696.

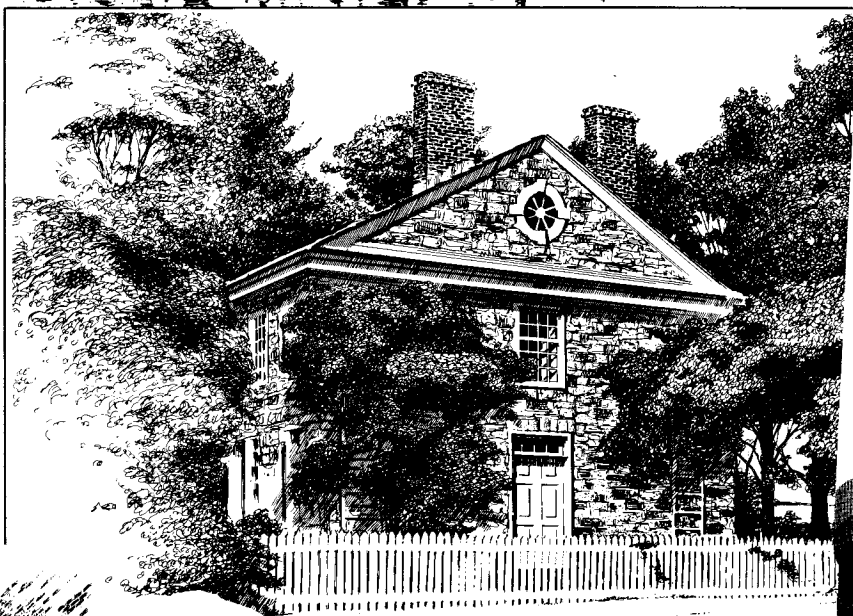

KOH-I-NOOR
RAPIDOGRAPH®



KOH-I-NOOR RAPIDOGRAPH®

a **rotring** company

Koh-I-Noor Rapidograph, Inc., 100 North St.,
Bloomsbury, N.J. 08804

In Canada: 1815 Meyerside Dr.,
Mississauga, Ont. L5T 1G3

Please send complimentary Catalog "E" describing Rapidograph
technical pens, Koh-I-Noor inks and other artist materials.
 Please send me the names of Koh-I-Noor dealers in my area.

Name (Please print or type) _____

Company Name (if the following is a business address) _____

Number and Street, RD and Box, etc. _____

City _____

State _____

Zip _____

*RAPIDOGRAPH is a Registered Trademark of Koh-I-Noor Rapidograph, Inc. © 1985 AR 4/86

Circle 14 on inquiry card

OUR BIGGEST BURST OF

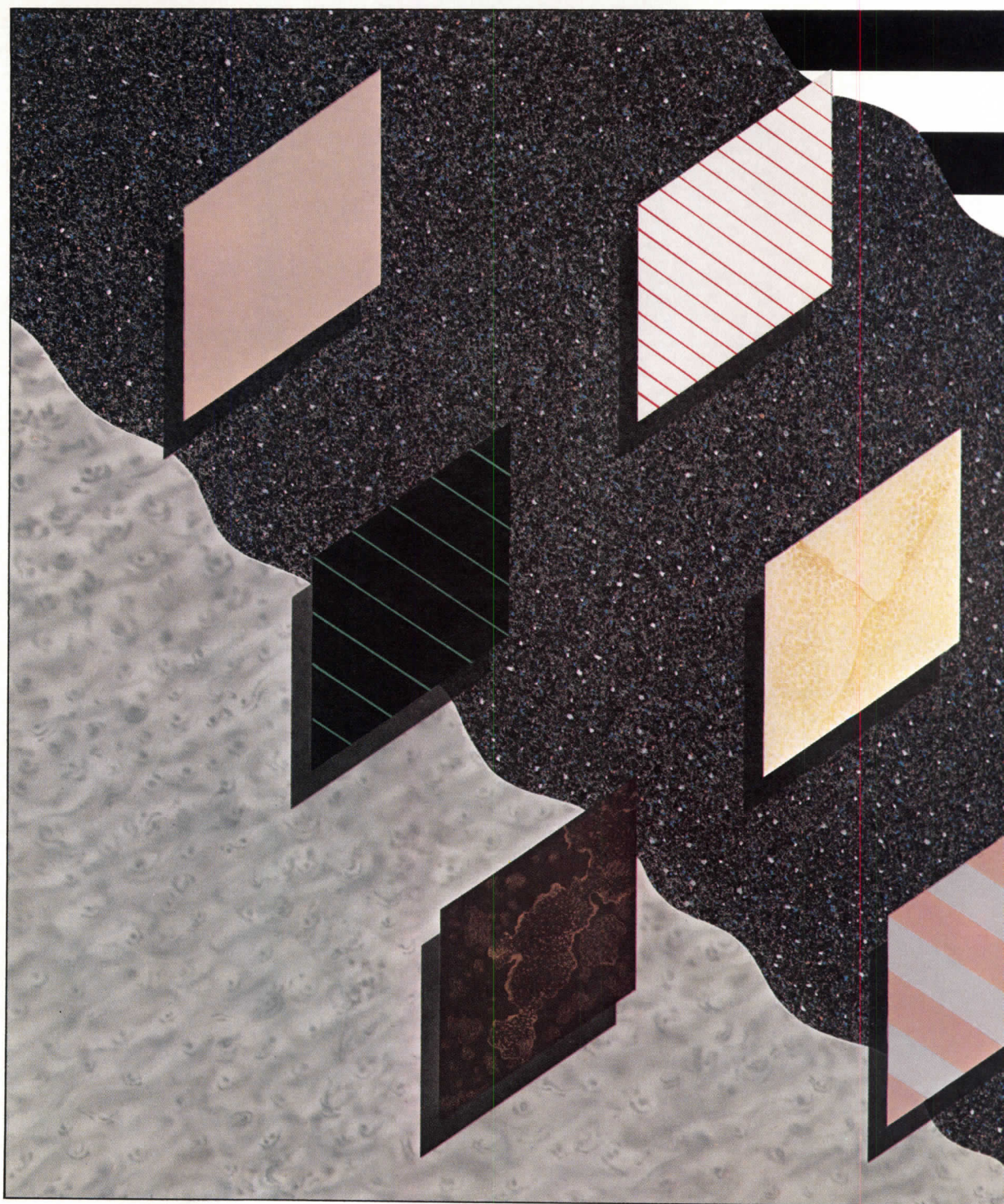

For samples, call Zip Chip, 1-800-524-0159 (In N.J. 1-800-624-1914).

Circle 15 on inquiry card

CREATIVE ENERGY EVER.



Never before has Formica Corporation introduced so many exciting surfacing ideas at one time. 52 new colors, patterns and products from across the country and around the world. Each created to give you the competitive edge in your next design.

New Colors. We've added 20 new colors to Color Trends™ '86 for a total of 42 colorways. These, combined with the 72 colors permanently available in The Color Grid® system, brings our solid color collection to 114.

New Patterns. We have added Blackstone, a handsome black granite design and Birds-eye, in Vanilla, Folkstone, and Copper Rose. The Premiere Collection, drawn from our international resources in England and France, include: Dust Patterns, in Stardust and Firedust. Stripes, in 18 striking designs. Lacque Metallique™, hand-made laminates in Bronze, Copper, Patina and Mandarin. So if you're looking for innovation, look to Formica Corporation. We're always bursting with new ideas.



New Lamp Technology By OSRAM

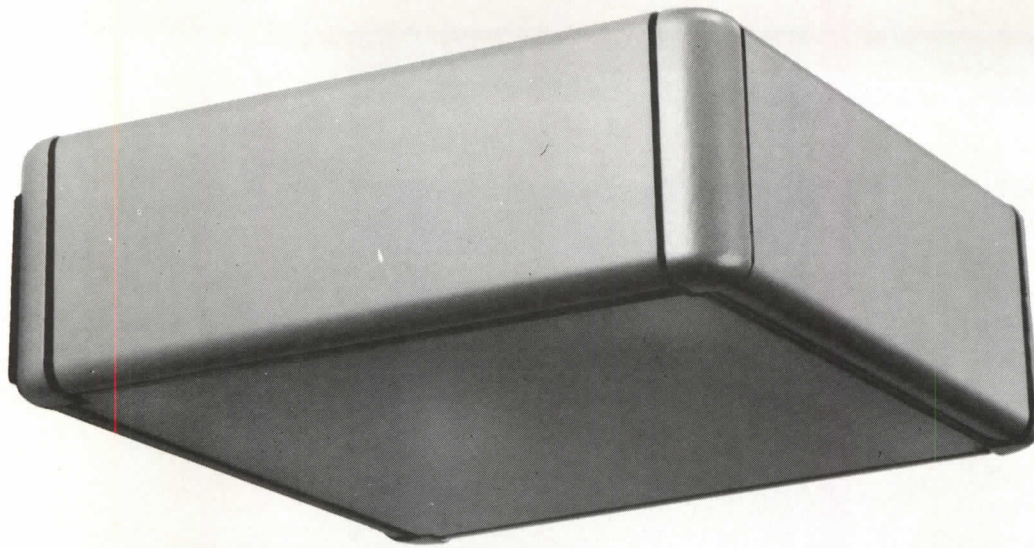

Color rendering is exceptional —and its stability greatly improved over earlier metal halide sources.

The OSRAM Advantage

New, more compact, high efficiency, and excellent color rendering lamps are now available from OSRAM. In the new products shown here they are combined with the

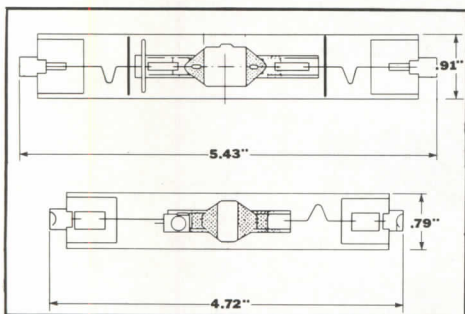

HQI-TS 150 W & 70 W Lamps

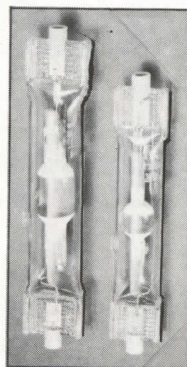

unique patented Elliptipar reflector that shapes the light into a broad asymmetrical pattern. This distribution is ideal for projecting light evenly across a large plane from a location at one side of that plane.

For the first time, this combination of lamp and reflector makes the efficiency of the metal halide source available for scores of applications limited until now to incandescent sources.

Elliptipar has been preparing for the introduction of these sources for three years and has available, for prompt response to your needs, an entire family of recessed and surface mounted units.

LePakTM incorporates Elliptipar's reflector and the new OSRAM metal halide lamps in a compact, low profile indirect lighting form with radiused edges and rounded corners. There

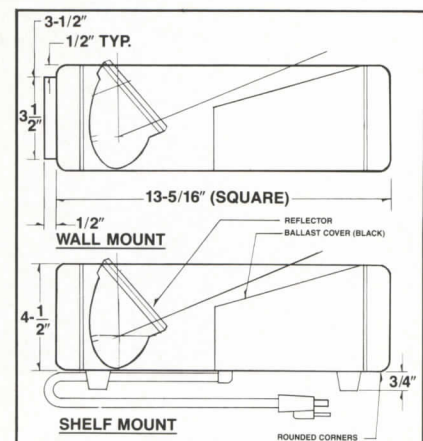

are four standard colors (with others available on special order). Construction is of extruded aluminum. The asymmetric reflector is adjustable. The ballast is integral. Two models are available: wall mounted (on a 1/2" reveal mounting plate) or shelf mounted (with cord, plug, and illuminated rocker switch).

LePakTM is an excellent choice for lobbies, reception areas, corridors, and offices.

HQI-METAL HALIDE LAMPS						
Lamp #	Nominal Lamp Wattage	Input Wattage (Inc. Ballast)	Light Output (Initial Lumens)	Color Temperature	Color Rendering Index	Avg. Rated Life (Hours)
HQI-TS-70-WDL	70	94	5,000	3000°K	81	15,000
HQI-TS-70-NDL	70	94	5,500	4300°K	85	15,000
HQI-TS-150-NDL	150	185	11,250	4300°K	85	15,000
FOR REFERENCE, SINGLE ENDED TUNGSTEN HALOGEN LAMP						
Lamp #	Nominal Wattage	Input Wattage	Light Output (Initial Lumens)	Color Temperature	Color Rendering Index	Avg. Rated Life (Hours)
Q250/DC	250	250	4,850	2950°K	100	2,000
Q500/DC	500	500	10,100	2950°K	100	2,000

With Innovations By Elliptipar

SYLVAN R. SCHEMITZ® DESIGNS

Ensconce™

is a self-contained, compact lighting module designed to be concealed in an infinite variety of decorative enclosures.

These can be made by Elliptipar (some are pictured), created by the designer, or provided by the architecture. The asymmetric reflector

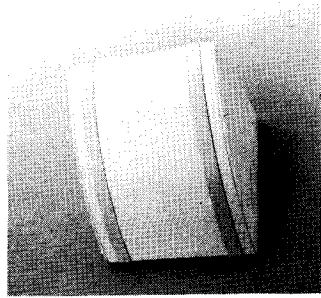

is mounted to a ballast compartment by adjustable brackets.

With new OSRAM lamps in Elliptipar's asymmetric

reflector, the wall sconce can now be a high performance, indirect lighting instrument. The space is opened up physically and psychologically. Where applicable, period appearance or historic allusion can be maintained.

Ensconce™ offers the designer flexibility; a high-powered light

source is available for virtually any sconce enclosure the designer can envision. Instructions regarding suitable dimensions to

ensure proper performance are on Elliptipar's **Ensconce™** catalog sheet available to you upon request. (Also, see the Elliptipar catalog

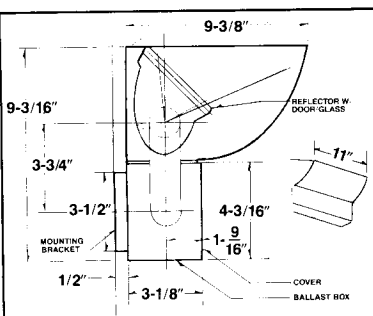

Schematic of ENSCONCE™

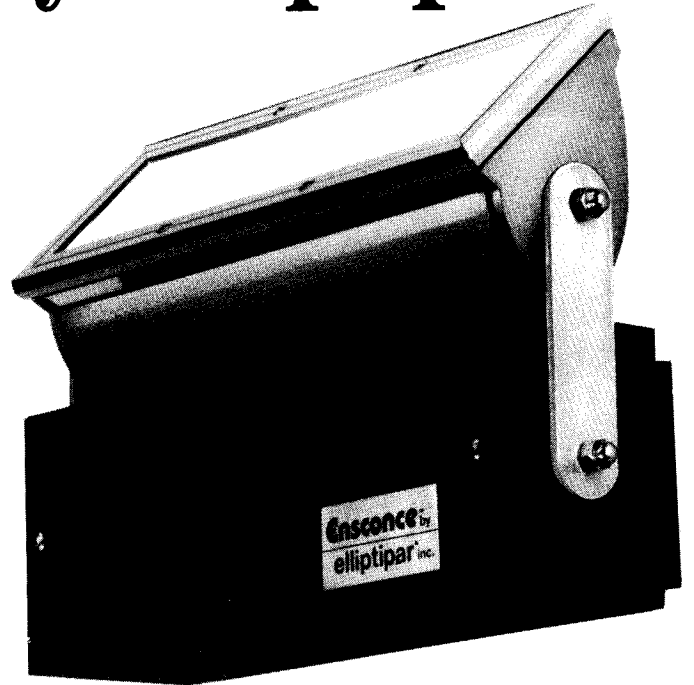

for other "Ensconce-able" light sources in the metal halide and tungsten halogen families.)

Where the decorative effects of wall sconces need to be matched by efficiency and performance—

hallways, lobbies, stairways, reception areas, theatres, educational, institutional, and office spaces, specify Ensconce™ with Elliptipar and OSRAM for dramatic results.

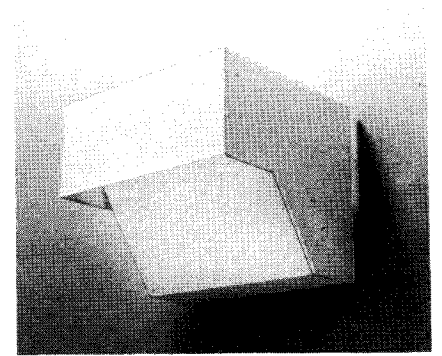

OSRAM

Technology Brought To Light

OSRAM Corporation,
Jeanne Drive,
Newburgh, New York 12550
Telephone: (914) 564-6300

ALL INQUIRIES TO:

elliptipar® inc.

Performance In And From Lighting

145 Orange Avenue,
West Haven, Connecticut 06516
Telephone: (203) 932-2266

Circle 16 on inquiry card

Visit us at:

The Pan Pacific Lighting Exposition,
San Francisco, May 4-6
OSRAM—Booth 207, Elliptipar—Booth 318

Lighting World IV, Los Angeles, May 11-13
OSRAM—Booth 205, Elliptipar—Booth 527

Residential R-wall – the elegant wall that endures – satisfies the needs of architects, builders, and owners.



Now get all the beauty and performance you want in an exterior wall.

You can specify from a combination of over 500 different colors and textures, and create virtually any style or shape or detail.

Because R-wall wraps an insulation blanket around the *outside* of your home, interior space remains stable, and you eliminate weather-related thermal shock and stress.

R-wall's all-acrylic finishes stand up to any

environment beautifully. They are fade and stain resistant and provide an excellent moisture barrier.

Sea spray, ultra violet rays, freeze-thaw and wind driven rain are no problem for R-wall.

And the R-wall system *never* needs painting. No cracking or peeling — R-wall is virtually maintenance free.

ISPO has more installations worldwide than any other company, and our products are backed by the integrity of a 100-year old German firm with annual sales of over \$360 million.

Get more information about the lightweight, cost-saving R-wall system and how it is applied by factory trained installers. Call ISPO toll free at 1-800-343-1188.



ISPO INC., 792 South Main Street, Mansfield, MA 02048.

Circle 17 on inquiry card



Member:
Exterior
Insulation
Manufacturers
Association

R-wall[®]
Exterior Insulation and Finish System

MORE ENERGY-EFFICIENT BY DESIGN

With natural gas you've got the power to make every size project more energy efficient.

Because today, there's a whole new generation of super-efficient gas equipment to give you the options you need.

Advanced, fuel-saving gas heating and cooling systems that keep operating costs down.

And that can make whatever you're designing look even better.

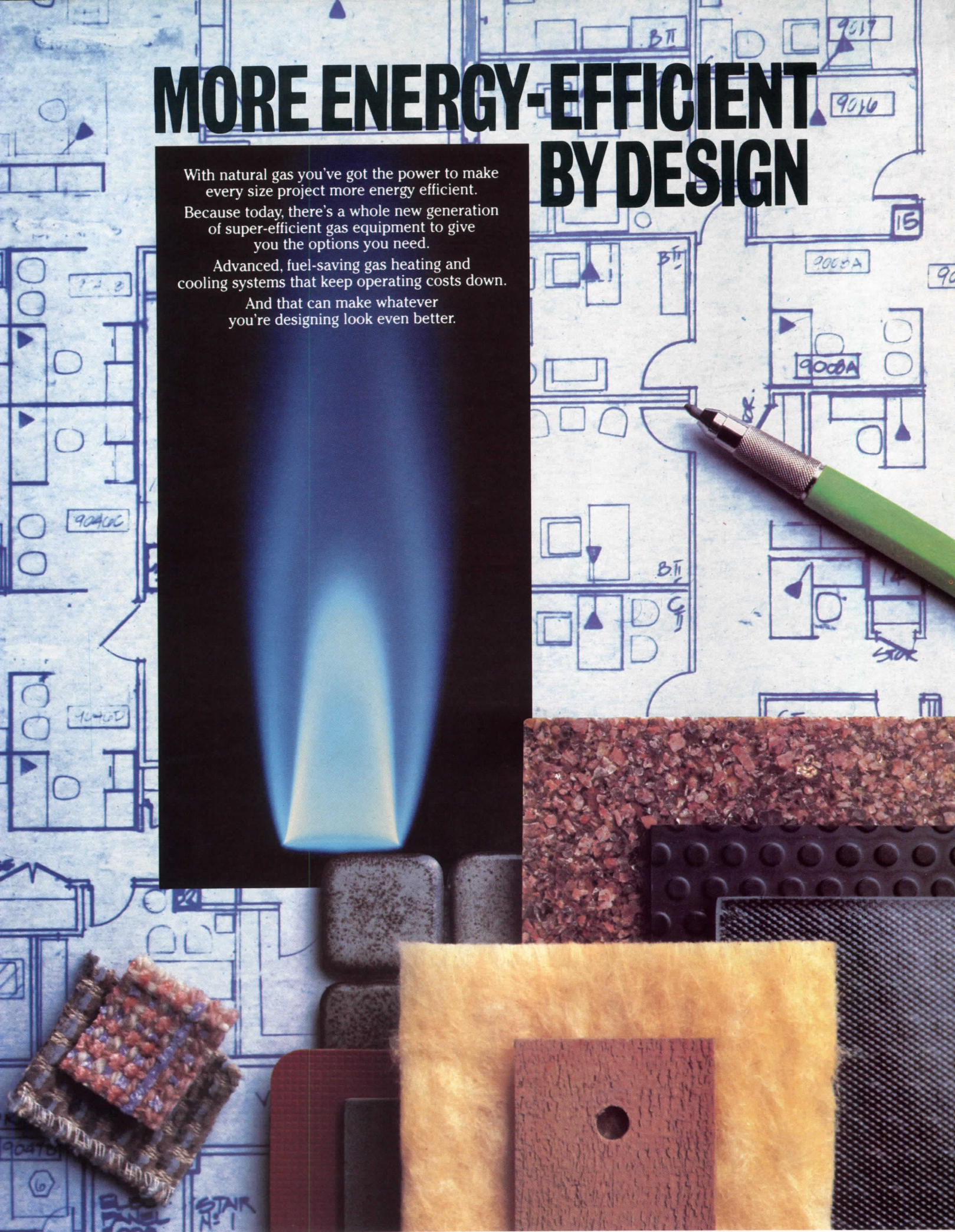

Gas. America's best energy value.

© 1985 American Gas Association

Circle 18 on inquiry card

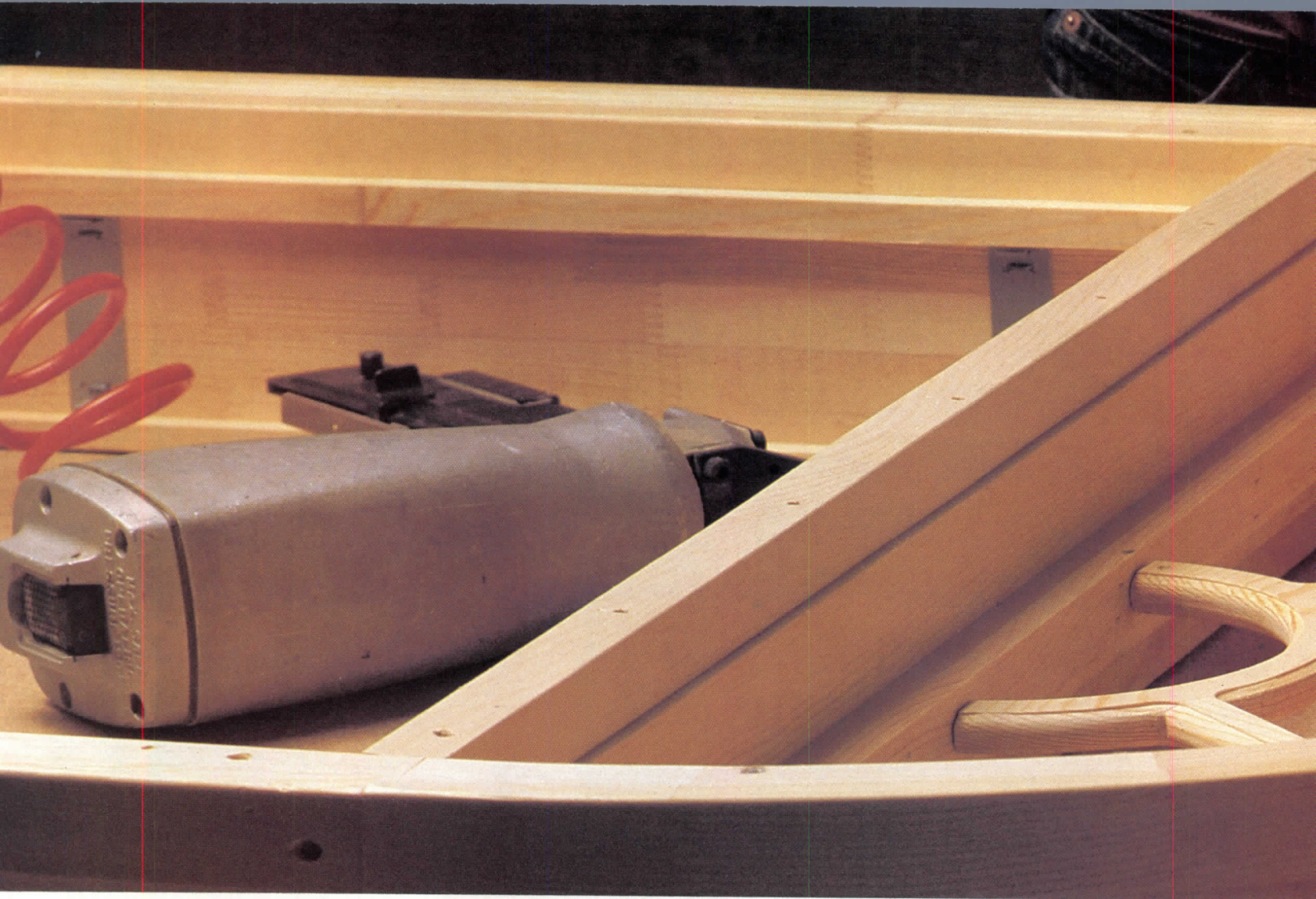

WHAT YOUR MIND CAN CONCEIVE, OUR HANDS CAN CREATE.

Marvin Round Top windows are available in more sizes and shapes than any other arched windows.

If you want a casement window with a Round Top, we'll build you one.

If you want an 18-foot high Round Top with true divided lites, we'll build you one of those.

Or, if you want an Oval Round Top six-feet wide, we'll build that for you, too.

EVEN WE DON'T KNOW HOW MANY KINDS OF ROUND TOP WINDOWS WE OFFER.

That's because our Round Top windows are made to order. And virtually every day, somebody asks us to build one in a new size or shape.

In fact, if we can't build the window you have in mind, it probably can't be built.

NO MATTER HOW DIFFERENT THEY APPEAR, OUR WINDOWS ARE ALL MADE THE SAME WAY.

Carefully. With much of the work done by hand.

Designs, such as Gothic true divided lites or a hub with spokes, are handfitted to ensure proper fit.



And matched pieces of Ponderosa pine are meticulously fitted together to form a sturdy arch that will accept a beautiful stain-and-varnish or

paint finish. A polycron exterior finish is also available. (This finish has been proven to last at least as long as aluminum or vinyl cladding.)

THEY'LL STILL SEEM BEAUTIFUL AFTER THE HEATING BILL ARRIVES.

They're available with either half-inch or one-inch insulated glass. We offer triple glazing for increased energy conservation. Storm sash are also available.

For more information, send us the coupon, or call 1-800-346-5128 toll-free. In Minnesota, 1-800-552-1167.



Send to: Marvin Windows
Warroad, MN 56763

Name _____
Company _____
Address _____
City _____
State _____ Zip AR4007-4



normbau
design-systems

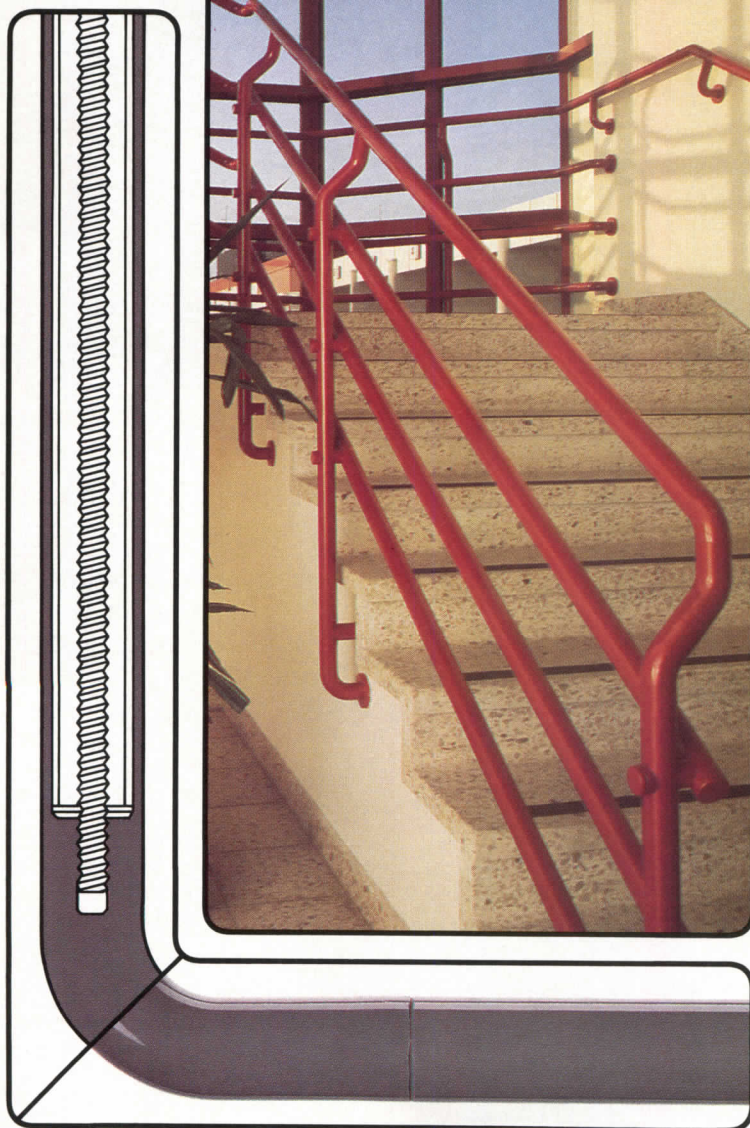
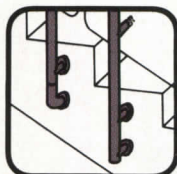
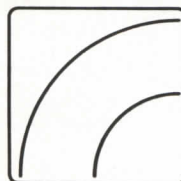

Your creativity comes alive in Normbau custom rail

- Flexibility of system challenges creative design.
- Ideally suited for the handicapped, schools, hospitals, offices, shopping malls, nursing homes and residences.
- Creates cheerful and pleasing environment.
- Use for hand rails, safety rails, curtain rods.
- Inside and outside, commercial and residential use.
- Tubing made of high quality durable Nylon (polyamide).
- Zinc coated steel core available in several wall widths.
- Some tubing available with stainless steel core.

For quotations and ordering:
Submit drawings, and/or blueprints with cutaway views to NORMBAU for quotations.

The components of the Round Rail system are finished and assembled at the plant prior to shipping.

Write or phone for more information.

NORMBAU, Inc.
1040 Westgate Drive
Addison, IL 60101
312/628-8373
Circle 20 on inquiry card

A SIMPLE TEST FOR SLOPE-TO-DRAIN PROVES ONLY NVS™ ROOF INSULATION MAKES THE GRADE.

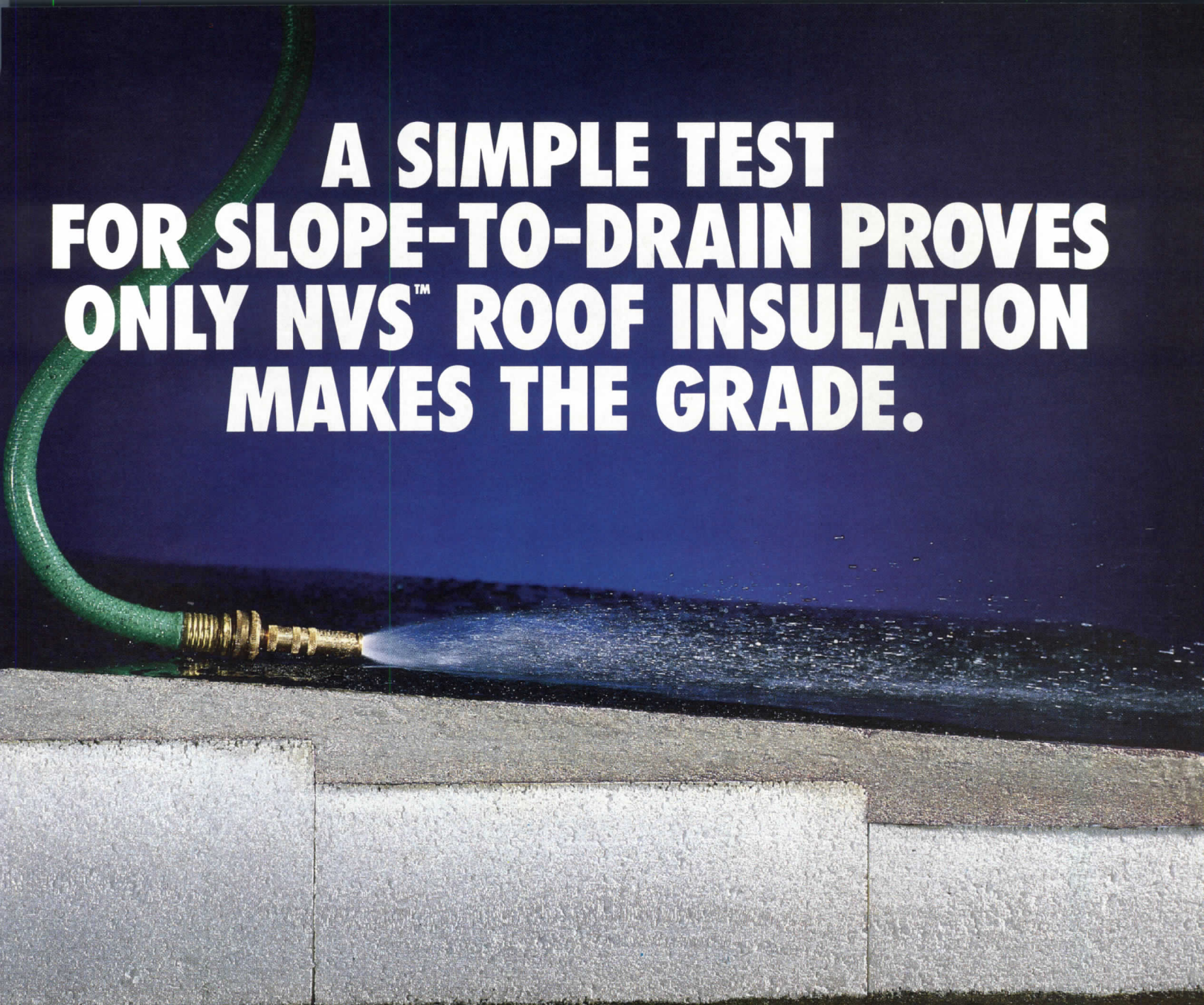

NVS wins run-off with rigid board.

Fail-safe slope-to-drain that eliminates ponding once and for all. That's what the NVS System from Grace provides. Here's how.

Everyone knows that adding slope is the best way to eliminate ponding water. But, what's the best way to add slope? Rigid boards try, but fall short because they can't effectively bridge low spots and irregularities in the substrate. They eventually sag or crack creating new depressions and more ponding problems.

The NVS System from Grace combines stair-stepped polystyrene insulation boards with lightweight

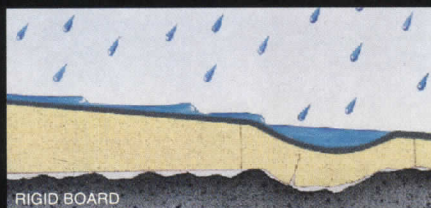
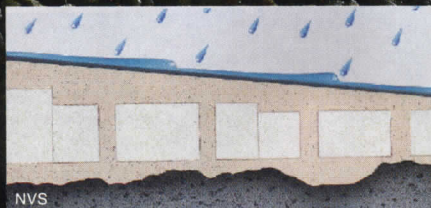

insulating concrete that fills the irregularities in the substrate assuring positive slope-to-drain and

a monolithic surface for roofing.

What's more, unlike rigid board, you can actually water-test for positive slope even before the membrane goes on.

Plus, the NVS System is backed by Grace and its nationwide force of roofing professionals who are ready to assist in every phase of design, installation and inspection.

For more information, call toll-free 1-800-242-4476 or write to Tony Garone, W. R. Grace & Co., 62 Whittemore Avenue, Cambridge, MA 02140. NVS Roofing Insulation . . .

The Expert's Choice. **GRACE**
Construction Products



DUROCK™

tile backer board

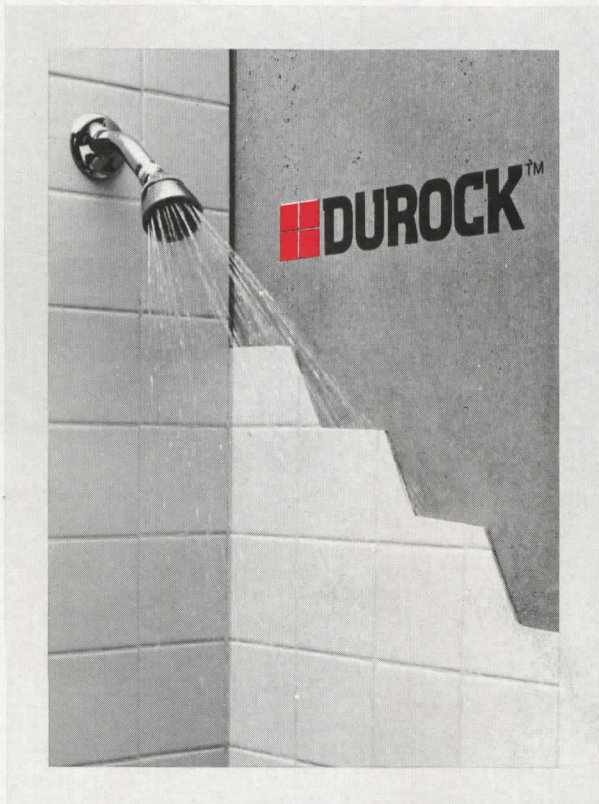

Put up Durock!



Tile stays put!

**Specify the water-resistant base—
now backed by twelve new fire/sound ratings.**

DUROCK® Tile Backer Board is unique. It's not only a water-resistant panel, it's the only non-deteriorating backer board offering one and two hour UL-listed fire ratings plus sound ratings to gain full code approval. DUROCK board is also the only backer board supported by a complete system: glass fiber-reinforced cement board, Type P tape, Type I ceramic tile mastic or latex fortified mortar. Evaluate Durock board, the

versatile wall tile base that also serves as a superior underlayment for tiled floors or countertops—plus it makes an excellent wall shield and floor protector for UL-listed solid-fuel fireplaces and stoves. Get specifics from our nearest representative. See our folder in Sweet's General Building and Homebuilding Files, Sec. 9.18a/Dur. Or write to us for technical data at 101 S. Wacker Dr., Chicago, IL 60606-4385, Dept. AR486

Durabond Division

USG Industries, Inc.

Meet Your New Roommate.



A familiar face . . . with a new personality. Adden's affordable Roommate Collection of solid oak furniture now has an enhanced structure and a more sophisticated appearance. And, your new Roommate can be computer literate because the desk pedestal is available with a sliding return to accommodate the keyboard of most personal computers.

Other options include safety and security modifications for residential treatment facilities . . . and for large installations, we can adapt this versatile Collection to your requirements.

Get acquainted. The Roommate Collection by Adden.

ADDEN

26 Jackson Street, Lowell, MA 01852 (617) 454-7848

Showrooms:
Boston, 77 N. Washington St.
Chicago, Room 11-112A Merchandise Mart

Circle 38 on inquiry card

SEALED AGAINST WATER

This tough wall coating goes in as well as on



Thoroseal® applies as easily as paint. But there the similarity ends. Thoroseal literally *penetrates* concrete and masonry, bonds with and becomes part of the material, seals pores and voids permanently.

Providing absolute protection against water, Thoroseal still allows walls to breathe. Thus moisture vapor can't accumulate inside — which is what causes walls to deteriorate.

Thoroseal beautifies, too — finishes and dresses the surface.

For specification and application information on Thoro products, call or write:

Thoro System Products, Inc.,
7800 N.W. 38th St., Dept. AR-2
Miami, FL 33166. (305) 592-2081,
Telex 51-9674

Circle 39 on inquiry card

THOROSEAL



Thoroseal is a registered trademark of Thoro System Products, Inc.

TSP 266

 **THORO
SYSTEM
PRODUCTS**

Preserving the past. Protecting the future.™

© 1986 Thoro System Products, Inc.

The Corbin Museum of Modern Art. Evolutionary, isn't it?



New 700 Series SecurityBolt™ Lockset.

Ultra-secure 1" dual action latchbolt □ Levers tested to
1,000 inch lbs. vertical torque □ Meets major handicapped codes.



HARDWARE GROUP

EMHART

Emhart Hardware Group
225 Episcopal Road
Berlin, CT 06037-0505
1 203 225-7411
Circle 40 on inquiry card



Blondl residence, design: Bonnie Roche & Assoc., Photography: Wolfgang Hoyt, ESTO

ICF
b Boffi

International Contract Furnishings Inc.

305 East 63rd Street, NY, NY 10021
Telephone: 212/750-0900
Telex: 236073 ICF UR

Circle 41 on inquiry card

ICF/Chicago, tel: 312/222-0160
ICF/Los Angeles, tel: 213/659-1387
ICF/Houston, tel: 713/622-1666
ICF/Washington, D.C., tel: 202/298-7941
ICF/Denver, tel: 303/296-9118
ICF/Dallas, tel: 214/749-7711

Why is an ICF Kitchen a little bit better? Because Luigi Massoni pays attention to details.

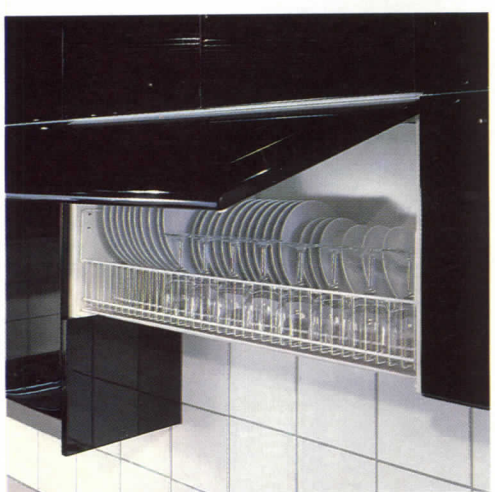

Because, not only is the Glacé Kitchen made in several genuine wood veneers, it is also offered in polished high-gloss colors (a finish that requires 43 separate hand operations to achieve).

...for each size cabinet, there is a wide selection of interior components, to utilize optimum storage space efficiently.

Because there is no visible hardware to detract from a clean-line minimalist design.

...the structural panels are 3/4" thick (unlike most others which are 5/8" or less).

...the backpanels create an impenetrable barrier against mildew and humidity.

Because custom-size cabinets are offered to create wall-to-wall, floor-to-ceiling installation.

...spare parts are always available to make later changes or to move.

We hope you'll agree, an ICF Kitchen is not just a little bit better, it is the best!

South Carolina Softedge: Sand, sea and shingles.

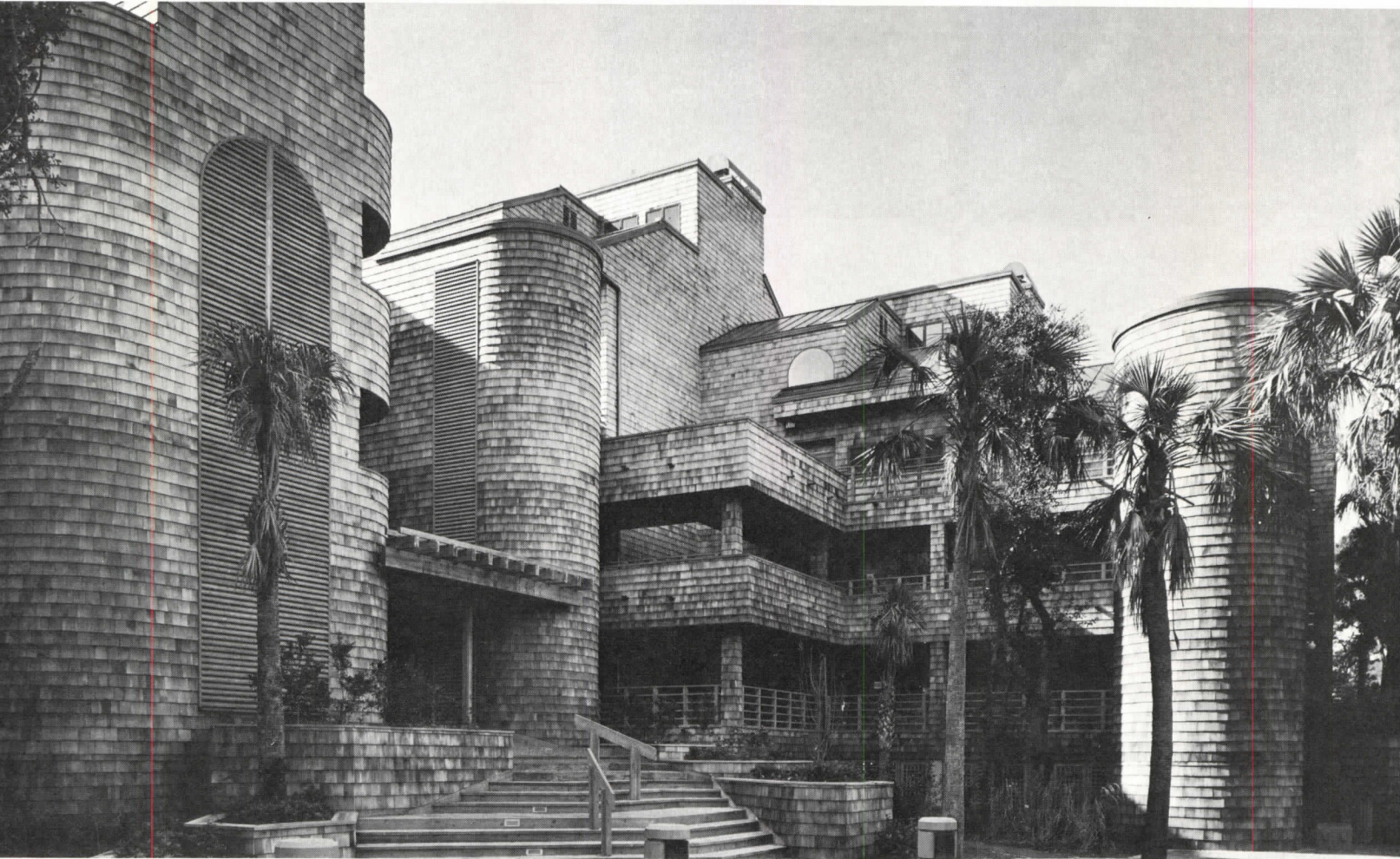

*Windswept condominiums, Kiawah Island, SC
Architects: Sandy & Babcock*

The problem: How to design condominiums without creating an oceanfront barrier for neighboring inland villagers.

The solution: Stepped clusters stacked in multi-levels to minimize interruption of the view corridors.

"Cedar shingles eliminated the need for border elements and an undesired 'crisp' look. Also cedar blends and weathers nicely in its natural state."

—Donald Sandy

For our color brochure "27 New Commercial Ideas in Cedar (and a few old ones)," write Suite 275, 515-116th Ave. N.E., Bellevue, WA 98004. (In Canada: Suite 1500, 1055 West Hastings St., Vancouver, B.C. V6E 2H1.)

Circle 42 on inquiry card



These labels on red cedar shingle and shake bundles are your guarantee of Bureau-graded quality. Insist on them!

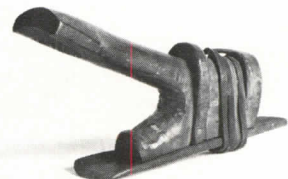

Handmade adze with cedar handle used by the Suquamish Indians to carve canoes. Cedar. To touch the earth.

Red Cedar Shingle & Handsplit Shake Bureau

STOCK OPTIONS

The assignment: Redesign a seaside vacation home to complement a client's contemporary lifestyle.

The media: WILSONART Design Group I™ decorative laminates and Decorative Tambours.

The designers: Bertram Laudenslager and Arthur L'Esperance, both ASID members, Whitmarsh Interiors, Flourtown, Pennsylvania. (L'Esperance is now with Witte Interiors, Inc., in Philadelphia).

Laudenslager comments: "A vacation home must be attractive — welcoming — and very easy to maintain. WILSONART surfacing products were key to achieving this."

L'Esperance adds: "Our clients do a great deal of casual entertaining here. So we wanted both actual openness and a real *sense* of space. We also wanted a palette that carried the wonderful colors of the shore indoors. WILSONART gave us our solution."

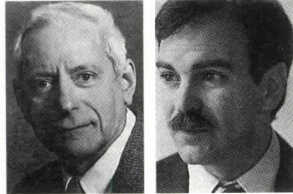

Bertram Laudenslager
Arthur L'Esperance

Bertram Laudenslager and Arthur L'Esperance,
ASID members
Whitmarsh Interiors

In the kitchen (shown below), upper cabinets are completely surfaced in WILSONART Cayenne decorative laminate; complementary Sea Breeze clads the lower storage bank. And Cayenne reprises on the island rim.

The soft stone look on the breakfast table and on countertops around the sink comes from WILSONART Shadow Millstone decorative laminate. Matching Shadow Millstone Decorative Tambours panel the refrigerator, island cabinets, and the legs of the breakfast table.

The result: Happy clients, whose weekend home offers true escape from routine stresses, with no sacrifice of the amenities of their primary residence.

HOTLINE:

If you have a project you think belongs in this space, please call us.

For design details on the Cayenne-clad cabinets, and immediate delivery (within 48 hours), of product samples and literature, call toll free from anywhere in the continental USA (we'll include chips of 17 new WILSONART solid colors and patterns):

1-800-433-3222

In Texas: 1-800-792-6000

Circle 43 on inquiry card

WILSONART®
BRAND DECORATIVE LAMINATE

Bringing new solutions to the surface™

©1986, Ralph Wilson Plastics Co., Temple, TX



Introducing Restoration® Vinyl.

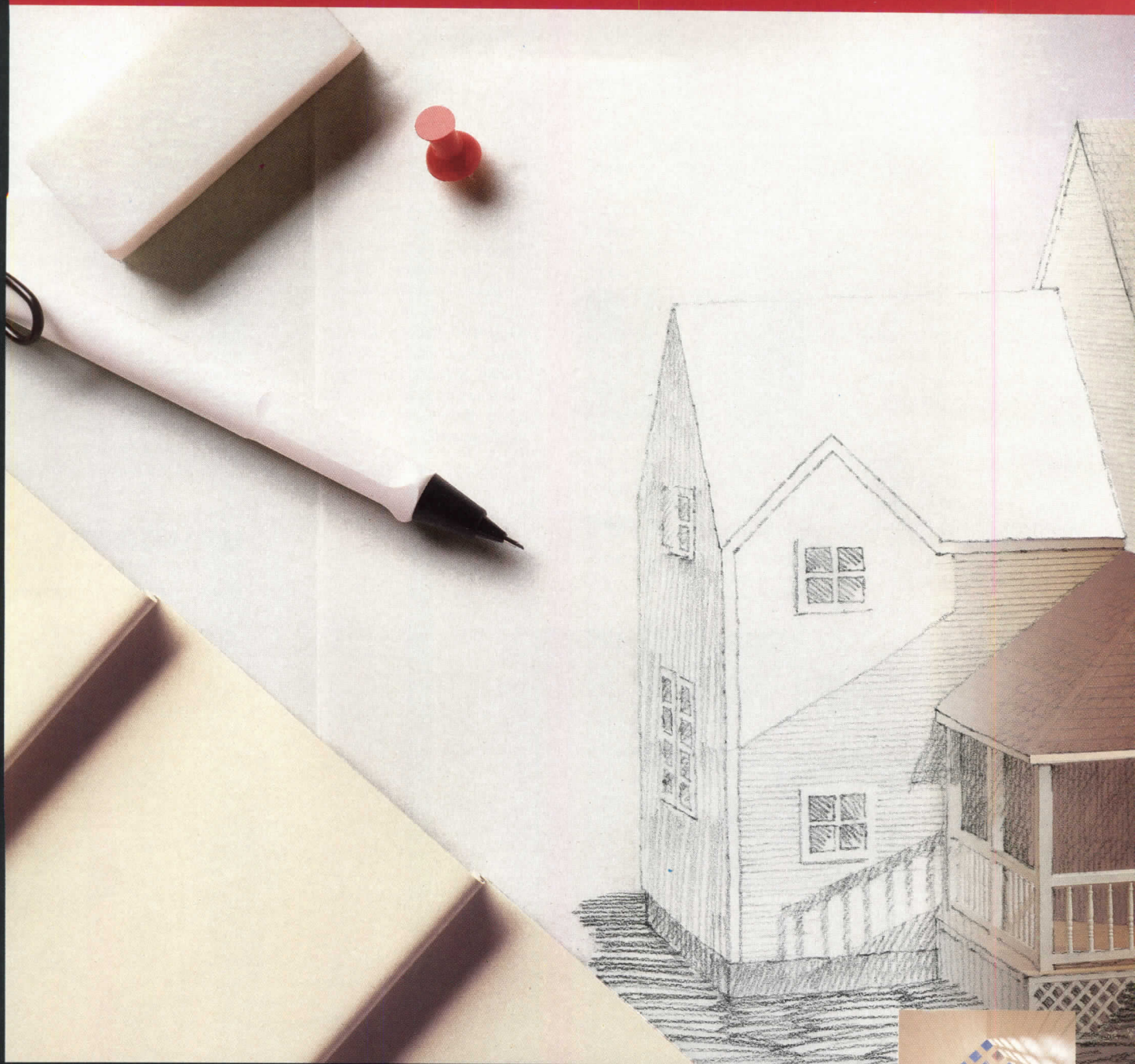

Everything
You Thought Vinyl
Could Never Be.

Used to be, vinyl siding looked like, well, vinyl siding. Most architects probably thought that this would always be the case. Not so.

Now there's Restoration solid vinyl siding. Restoration looks like real painted wood. You have to see it to believe it.

Budget and aesthetics often pull at a design from opposite directions. When a client not only wants the appearance of painted wood, but also the economy and durability of vinyl, Restoration solid vinyl siding provides the balance. It has all of the advantages of vinyl—lower cost, durability, low maintenance; plus all the aesthetic



The Restoration Collection includes beaded panel and lattice.



As seen on
"This Old House."



advantages of real wood.

Through sophisticated technology we've achieved a smooth low gloss finish on a panel that's guaranteed to last a lifetime.* To provide flexibility, we've created the Restoration Collection, a full line of architecturally accurate vinyl accessories.

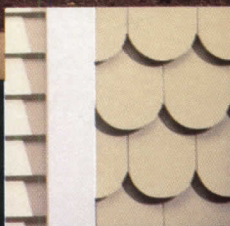

Finishing touches like Restoration Collection fish scale.

For more information on the entire Restoration Collection call **1-800-521-9020** (in Michigan, call **313-386-0800**).

After all, seeing is believing.



Faithfully detailed window moldings, trim and this extra wide corner post.

RESTORATION COLLECTION™

Enduring Appearance, Uncommon Economy.

*A copy of the warranty is available by writing Wolverine Technologies Inc., 1650 Howard Street, Lincoln Park, Michigan 48146.

©1986 Wolverine Technologies Inc.

Circle 44 on inquiry card

Dear Architect:

Here's a truly versatile design element that's worth looking into: The Atrium Door.[®]

Superbly crafted of high quality materials, it allows you to design more style, more efficiency and more security into all your plans.

For example, special features include a durable Polycron[™] pre-finish backed by a 10-year warranty, high performance Comfort-E[™] glass and solid brass mortice lockset. Depending on your needs, you can start with a single 3'0" panel and link as many as six panels up to 18' wide and 6'8" or 8'0" high.

Completely assembled and ready to install, The Atrium Door can be used as a dramatic entryway, room divider or an entire wall. For real design versatility, it's part of a complete system of matching fixed panel units, transoms and removable grilles.

So, to build more interest into every blueprint, consider The Atrium Door. It's definitely worth a look. For our free architectural kit, write or call us toll free.

Sincerely,
Moulding Products, Inc.

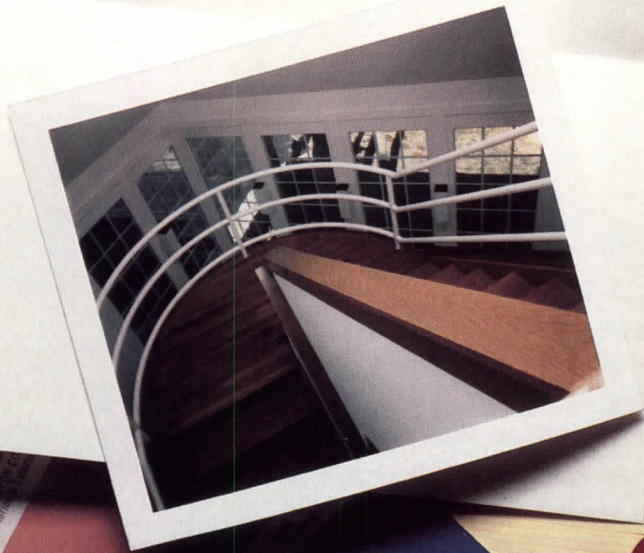

The Original
The Atrium Door

P.O. Box 226957 • Dallas, Texas 75222-6957 • 800/228-7486
In Texas call 214/438-2441

***Stops killer smoke
at the seams of the system!***



**New THERMAFIBER[®]
Smoke-Stop-System** keeps smoke from pushing through THERMAFIBER[®] insulation at "poke-through" openings and curtain wall seams. Essential component of this exclusive system is THERMAFIBER[®] SMOKE SEAL[™] — a special fire-resistant sealant that blocks the passage of smoke between floors. The unsurpassed life safety results are, not only a 3-hour fire barrier, but an effective shield against lethal particulate smoke.

See our representative for complete systems information. Or write to us at 101 S. Wacker Dr., Chicago, IL 60606-4385, Dept. AR486.

©1985, USG Acoustical Products Company

USG Acoustical Products Company

Circle 46 on inquiry card

Thermafiber[®]
**Smoke Seal[™]
Compound**





Cold Spring Granite. Its beauty is its strength.



Kawneer 3200 DesignWall. Its strength is its beauty.

The grandeur of granite requires the strength of design integrity to maintain its lasting impression. And now, Cold Spring Granite and Kawneer have put the two together in a single curtainwall system engineered to retain its beauty through the years.

Kawneer 3200 DesignWall allows Cold Spring Granite panels to be installed in a clean, flush appearance. Structural silicone holds the vision glass to the aluminum curtainwall vertical

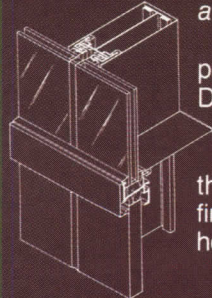

mullions. And, the result is a high performance package with aesthetic appeal. (*Performance results are available on request.*)

Cold Spring Granite panels for Kawneer 3200 DesignWall are available in nine different and distinctive colors and three handsome finishes—polished, honed, and thermal.

Cold Spring Granite and Kawneer 3200 DesignWall. Put them together by contacting your Kawneer Sales Representative or writing:
The Kawneer Company, Dept. C,
Technology Park Atlanta, 555
Guthridge Court, Norcross, GA 30092

 **Kawneer**
The Designer's Element

Circle 47 on inquiry card



The Signature Custom Leisure Pavilion is an aluminum and stainless steel building glazed with clear and/or translucent single or double-wall panels, and with a motorized opening roof system. It can add a whole new dimension to your life.

A WORLD APART. BUT NOT A WORLD AWAY.

Signature[®]

CUSTOM LEISURE PAVILIONS BY SOLAR STRUCTURES

For your most discriminating clients—a sheltered, private world of lush plantings, shimmering water, warmed by sunlight, cooled by the romantic glow of moonlight.

The perfect way to swim, exercise, or host a poolside party, even on chilly nights.

With a Signature Custom Leisure Pavilion a pool becomes a place to relax, unwind, refresh the spirit. Any season of the year.

For the distributor nearest you write or call: Signature, P.O. Box 100, Wheeling, IL 60090. Telephone 1-312-634-9355 or 1-800-323-5203.

Circle 48 on inquiry card

EVEN AFTER 20 YEARS, THIS IDEA STILL HOLDS WATER.

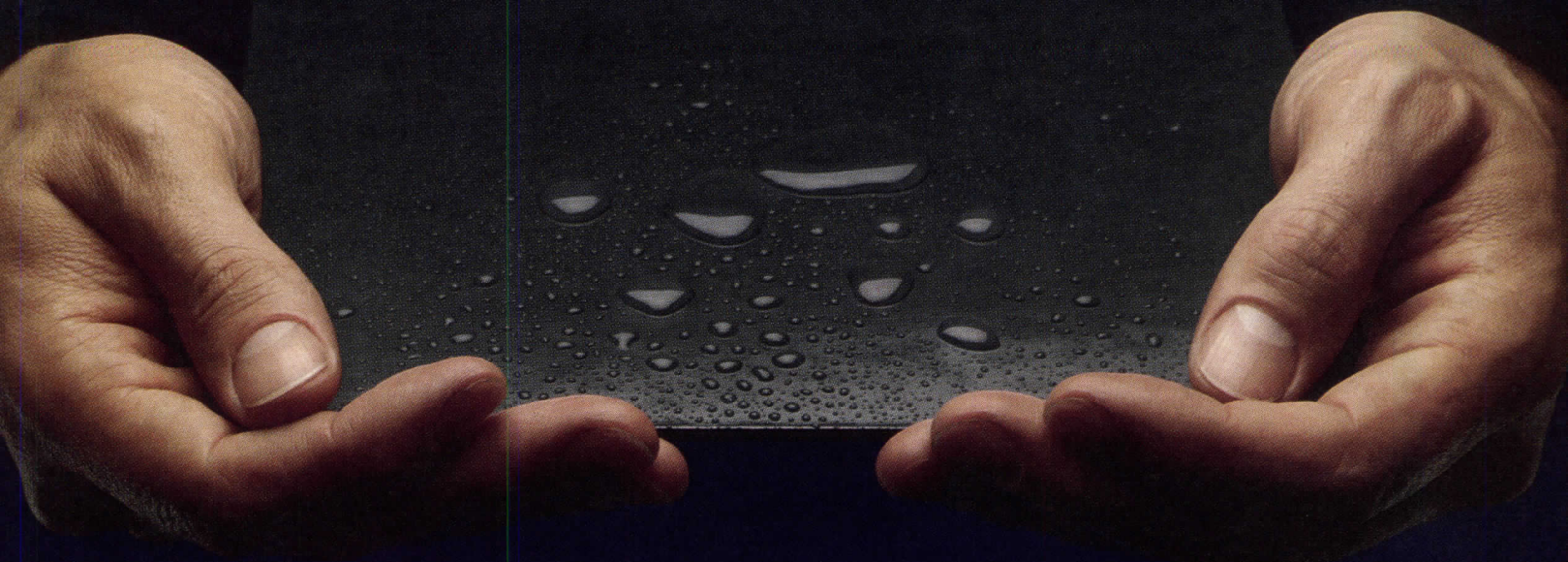

BITUTHENE.[®]

The waterproofing system engineered
to keep water out. Once and for all.

Twenty years ago, we introduced a bold way of guarding structures from the ravages of water and time — Bituthene. And it has been preserving the integrity of foundations, plaza and parking decks, subways and tunnels ever since. Now more than 2 billion square feet of Bituthene protection have been installed around the world.

Once it's in place, it's in for good. A rugged, pliable, self-adhering membrane system that was

built to go in once. To go in easily. To stay put. Resist cracking. And never stop working. No matter what the climate.

And it comes to you armed with Grace technical expertise and engineering experience. Protect your structures with a water-tight idea. Bituthene — the waterproofing system with a proven past.

GRACE
Construction Products

Ultimate Water Movers...GROHE

Polished Brass, White, Black, Pewter, 23-Karat Gold, Satin, Antique Brass or Polished Chrome...Grohe's *European Originals* add the *finishing touch* to kitchens, baths and spas.

Custom Shower Heads, Body Sprays, Personal Hand Showers, and Ladylux for the kitchen... Grohe products are unique, and unequalled in design, performance and variety.

Grohe faucets represent a 51-year tradition of excellence in styling, engineering and reliability.



Polished Brass Roman Tub Filler 13.457-R Brown Onyx Handles 07.191



Ladylux with Pull Out Spray 33.798
Kitchen Utensil Set 27.831-L



Pewter Deluxe Adjustable Showerhead
Pulsation Spray Personal Shower and
Grohmix Temperature Control Valve



Black Classic Kitchen Deck 31.735-K



White Classic Centerset 21.175-L

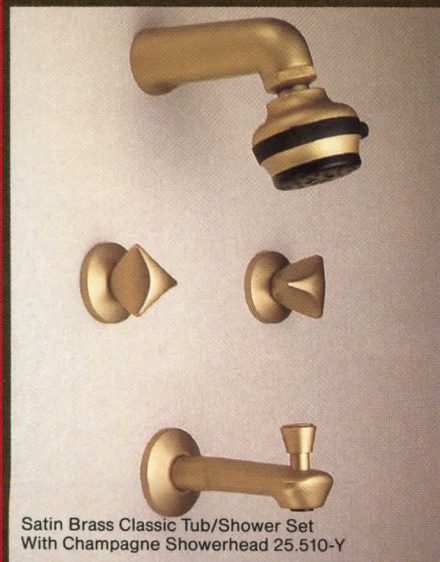

Satin Brass Classic Tub/Shower Set
With Champagne Showerhead 25.510-Y



Gold Grohmix Tub Filler with
Adjustable Spray Personal Shower 35.542-G

1985 is Grohe's 10TH YEAR
in the United States, with
distribution in Canada.



GROHE AMERICA, INC. 900 Lively Blvd. Wood Dale, IL 60191 312/350-2600 TELEX: 287415

Write for our new *International Collection*, *Ladylux* and *Harmony in White*™ brochures © 1985 Grohe America, Inc.

Circle 50 on inquiry card

Tile installations are not waterproof !

Depend on LATICRETE® Waterproof Membranes

Tile installations are not waterproof. Ceramic tile installed without a waterproof membrane is subject to water penetration causing damage to substrates and occupied space below.

Depend on LATICRETE® Waterproof Membranes to provide job proven protection under tile installations in wet areas, such as fountains, pools, bathrooms, decks, showers, and commercial kitchens.

Odors, rot and decay too, may become a problem when substrates are saturated with water, liquid food waste or chemical cleaners. Water and chemical resistant

LATICRETE Waterproof Membranes prevent saturation and odors associated with brine, sugar and other caustic materials.

LATICRETE Waterproof Membranes are easy to apply, nonflammable, and require no special tools or hazardous clean up requirements. They are thin, light weight, rated for heavy traffic and eliminate the need for depressed slabs.

Depend on LATICRETE Waterproof Membranes to reduce tile installation problems. LATICRETE installation systems give you single-source responsibility with performance proven worldwide for over a quarter of a century.

**For answers to waterproofing problems, call for
technical and architectural service
(800) 243-4788**

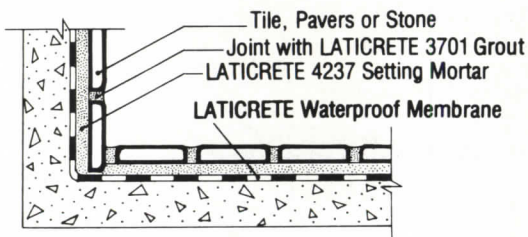

LATICRETE INTERNATIONAL, INC.
1 LATICRETE PARK NORTH • BETHANY • CONNECTICUT 06525-3498 USA
TEL. (203)393-0010 • TOLL FREE (800)243-4788 • TELEX 96-3541 LATICRETE BTHY

HOLOPHANE REFRACTIVE GRID. SIGHT FOR SORE EYES.



Nothing lights up today's CRT-dominated workspace with soft, even, glare-free light like the Refractive Grid® from Holophane®. Lighting so efficient, it actually delivers more light with *less* glare.

The idea is to reduce high-angle brightness, or glare. We do it with a lens comprised entirely of hemispherical refracting prisms, which reduces glare up to 70% over conventional lenses.



The result is a fixture that looks as good on the job as the light it gives off. A clean, modern appearance and low apparent

brightness enables it to blend into ceilings subtly. And better overall light control allows wider luminaire distribution.

For more information on the office lighting that makes everything in today's offices a little easier to work with, see your local Holophane

representative or contact Neil Thompson, Holophane Division, Manville, P.O. Box 5108, Denver, Colorado 80217. (303) 978-2677. Available for export.

Circle 52 on inquiry card



HOLOPHANE
LEADER IN LIGHT CONTROL

Manville

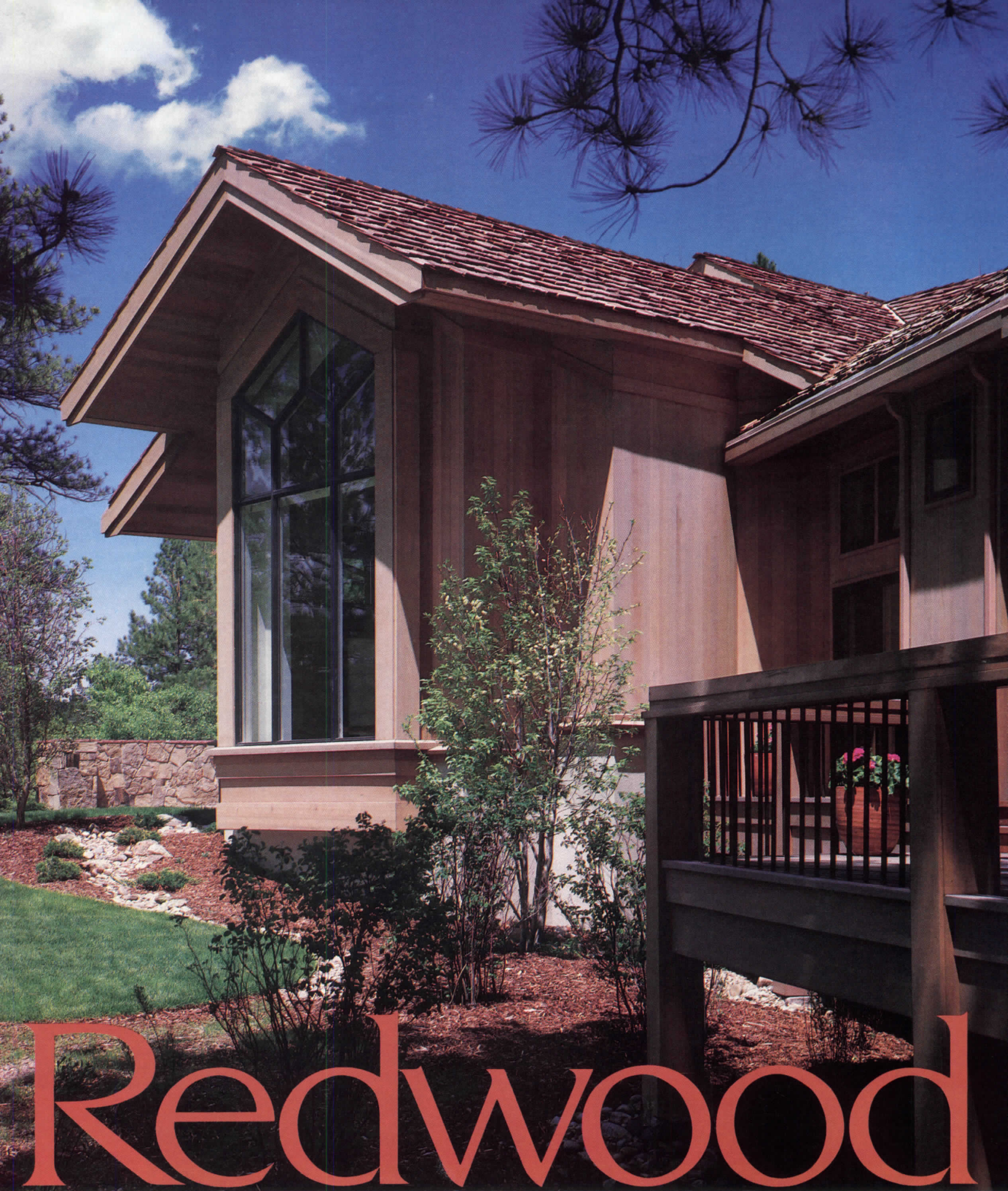

Architects: Richard Jessup & Associates

Natural beauty, durability and stability make it the natural choice for creative designs that endure. Send for Redwood Architectural Guide.

 CALIFORNIA REDWOOD ASSOCIATION 591 Redwood Highway • Mill Valley CA 94941 • (415) 381-1304
GEORGIA-PACIFIC CORPORATION • MILLER REDWOOD COMPANY • THE PACIFIC LUMBER COMPANY • SIMPSON TIMBER COMPANY • TIMBER REALIZATION COMPANY

Circle 53 on inquiry card





This softspoken house is content to let its woodland setting do the talking. And Pella whispers elegance inside and out.

To passersby, this home presents the face of an unassuming rambler. But those privileged to enter are surprised to find that the surrounding trees, the art collection and they themselves have become a major design fabric in this welcoming place. The house deliberately has no decorative notions of its own.

To give the owners the privacy, hospitality and simple lifestyle they wanted, the Bloodgood Group designed a 9100-square-foot home responding to the sloping woodland at the rear of the site. Rather than imposing a formal structure on this natural setting, owners and architect agreed it would be more appropriate to settle the home into the hillside. Even the native grasses and groundcover are much as they were found, so there is no lawn to maintain.

The home is designed for easy living and easy circulation on the one-bedroom main level, with guest accommodations below, facing the woods. It's a comfortable place whether the owners are home alone or entertaining dozens.

Undisturbed nature.

Large wood Pella Windows offer an ever-changing view of undisturbed nature as one walks through the house. The dining room, used after dark, is the sole living area that doesn't face the woods. Nearly all windows face south, shaded by a broad overhang in summer, admitting sunlight and a breathtaking view of the valley below when the winter trees are bare.

Massing and form follow the functional interest of the owners, a couple whose children are grown. Entertainment areas have major ceiling volumes, perceived from the moment you enter the semicircular vestibule. Its leaded glass windows were created by an Aspen, Colorado, artist and installed over Pella Fixed Windows. Across the reception gallery, sunlight plays on the piano curve stairway. To the right, pocket doors designed by a fiber artist may close off the dining room, letting light through but directing attention to the living room opposite. Clerestory windows, and transom windows in the light tower above the grand piano, give the living room a marvelous diffused light in keeping with its sylvan setting.

Exterior calm and interior elegance are carried out through the use of the simplest, finest materials. And, at the owners' insistence, that includes Pella Windows.

To satisfy the criteria of permanence, easy operation and low maintenance, Pella Clad Windows were their only choice. Whatever custom color is specified, Pella's aluminum cladding with baked enamel finish assures exceptional resistance to fading, chemical attack, chalking, chipping, peeling and cracking.

Custom colors, shapes and sizes.

Pella custom colors, shapes and sizes offer unlimited flexibility to suit the mood and scale of each project. But for this project, Pella's tremendous range of standard Fixed and Casement Windows easily met the requirements. An appropriate mix of insulating glass and Pella's Double Glazing Panel System assures energy efficiency for these conscientious owners, as well as comfort right up to the windows. Nearly an inch of insulating air between panes eliminates those chilling convection currents found on the surface of even the tightest windows. And Pella Casement Windows seal out air infiltration up to 16 times better than industry standards require.

Another of Pella's seven glazing and shading options, Slimshade®, was used in this home's bathrooms. Installed between the panes of the Double Glass Insulating System, Type E Slimshade blinds help give Pella Windows a low U value of .23, actually outperforming triple glazing. And they need no dusting.

Your Pella distributor can tell you more about it. For information, look for Pella in the Yellow Pages under "Windows". Call Sweet's BUYLINE or see Sweet's General Building File. Or send the coupon below.

Please send me the latest literature on Pella for replacement and new construction.

Name _____

Firm _____

Address _____

City _____

State _____ Zip _____

Telephone _____

This coupon answered in 24 hours.

Mail to: Pella Windows and Doors, Commercial Division, Dept. T30D6, 100 Main Street, Pella, IA 50219. Also available throughout Canada. © 1986 Rolscreen Co.

Pella. The significant difference in windows.

Private residence
Des Moines, Iowa
Architects
The Bloodgood Group
Des Moines, Iowa
Contractor
By owner

Circle 54 on inquiry card



SPRINGBROOK

Decorative hardware shown is optional.

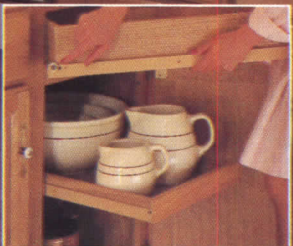

Merillat's all-new "WhisperGlide" system offers 30% more drawer space plus full-stop "WhisperGlides" on all slide-out trays.

Dramatic kitchens are yours for the specifying.

Beautiful kitchens that are durable, space-efficient, and still allow you creative freedom are possible with kitchen cabinetry from Merillat.

A perfect example is our new Springbrook kitchen cabinetry. Springbrook's traditional recessed-panel doors are finished in the natural oak style that's popular in today's new home designs.

Springbrook is available with Merillat's complete line of convenience accessories to make the best use of your available space. Lazy Susans, appliance garages and custom storage units build extra convenience into any kitchen design.

Springbrook is built with the Merillat quality your builders and homeowners expect. Wipe-clean "leisure-time" interiors, solid oak frames, tru-square corner gussets, slide-out trays, adjustable shelves and more are standard in all Merillat cabinetry. Plus, Springbrook includes Merillat's new WhisperGlide™ system, the most

advanced side-mounted roller drawer guide in the industry.

And, like all Merillat cabinetry, Springbrook can be matched with modular shelving components to create any custom design you have in mind in any room of the house. This complete system is just waiting for your creative flair.

Before you specify your next kitchen or bath, write for our free literature kit. Then compare our price, construction and quality...we're confident you'll specify Merillat cabinets.

See our catalog in *Sweets, the Source*, Section 11.27c/Mer.



AMERICA'S CABINETMAKER™

Merillat Industries, Inc., Adrian, MI 49221

Circle 55 on Reader Service Card.

M E R I L L A T

A-LOOK[®]

The Lightweight, Flexible,
Unbreakable Mirror

U.S. Patent No. 4-508-425

The innovative, new surfacing breakthrough from Mitsubishi. A-Look's unique thermoplastic core gives it strength and resilience, yet the lightweight sheets make handling and installation easy. The design possibilities are endless.

HANG

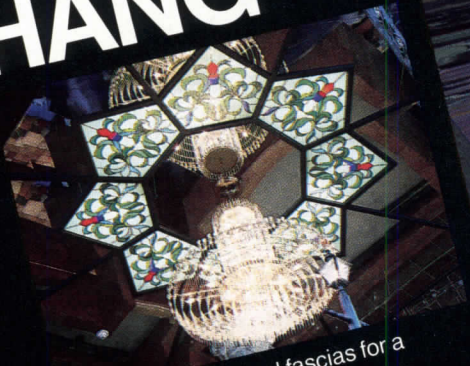

On ceilings, walls and fascias for a feeling of richness and space.

BEND



To conform to the contours of curved shapes and creative designs.

CUT



For trims and accents, or to cover an entire ceiling or wall.

Circle 56 on inquiry card

Now Recruiting Distributors for A-LOOK throughout U.S.A. !
For more complete information on A-Look, send for our brochure:



MITSUBISHI CHEMICAL INDUSTRIES AMERICA INC. (MCIA)
81 Main Street, White Plains, New York 10601 • Phone: 914-761-9450

Name: _____

Address: _____

City: _____

State: _____

Zip: _____
(Please print)

AR

mapeStone

The first totally integrated insulated aggregate panel is here.

MapeStone insulated panels boast all the energy-saving and durability factors of our popular porcelain on aluminum architectural panels.

And they're just as easy to install.

MapeStone won't chalk, discolor or crack, and we say so with a 25-year guarantee. It's impervious to weather and the elements.

MapeStone is made by combining membranes of fiberglass with intervening layers of stone particle aggregate. The combination is impregnated with UV stable polyester resin and oven baked.

MapeStone is available in a choice of colors and aggregate stone sizes. Its design applications are unlimited. Consider it for curtain walls, fascias, accent panels, or most anything under the sun (interior too).

Call 800-228-2391 and we'll tell you how MapeStone can stretch your imagination and your construction budget.



The **mapes** permanent solutions



Mapes Industries, Inc.
P.O. Box 80069
Lincoln, NE 68501
(402) 466-1985
Call toll-free 800-228-2391
Circle 57 on inquiry card

Well Rounded Choice.

Webb offers a complete line of in-stock decorative windows and louvers in a wide variety of sizes and styles. A custom look and fit *without* custom prices. Rounds, half rounds, octagons and others are constructed of solid wood or weather-resistant polyurethane outer frames. Wooden interiors can be stained or painted for a perfect inside match. Many windows are available with beveled, insulating, or new energy-efficient Sungate® glass. Decorative grille patterns add the perfect finishing touch. Wooden and urethane louvers include round tops, gables, ovals, and many others designed for optimum ventilation. For a copy of our catalog, contact Webb Manufacturing, Inc., P.O. Box 707, Conneaut, Ohio 44030, (216) 593-1151.

Circle 58 on inquiry card

WEBB

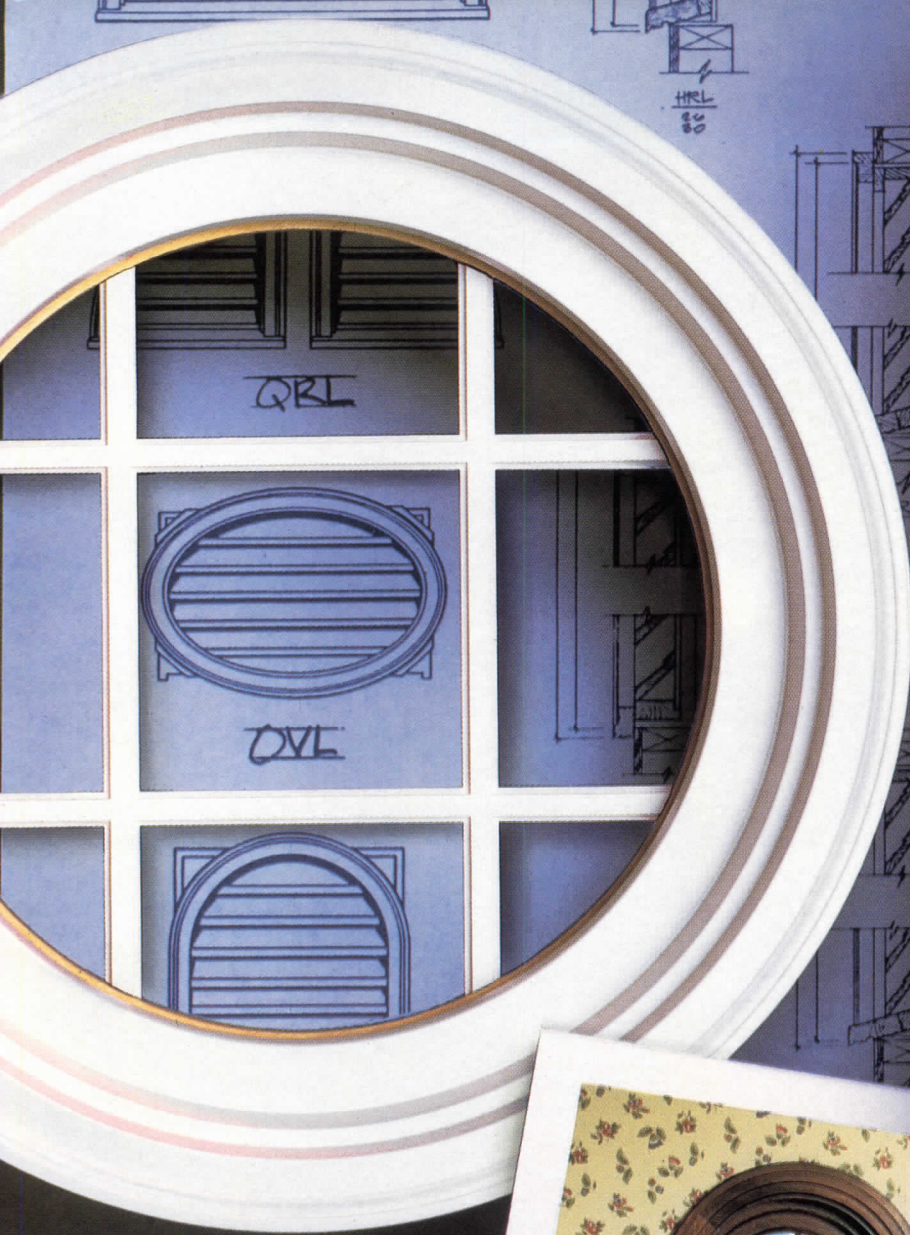

Ask for America's finest drafting furniture by name... The Naturalists by **MAYLINE**



INTERCERAMIC

PROBLEM:

Furnish glazed ceramic floor tile for an exclusive home. Intricate herringbone pattern calls for 4"x8" tile with a skid-inhibiting, easy-to-clean surface. Stunning color with even tones a MUST! Deliver immediately.

SOLUTION:

Interceramic Tile from North America's largest (and soon to be larger) producer of frostproof monocottura floor tile. Factory and nationwide distributor network has readily available inventories of 4"x8", 8"x8" and trim.



Private Residence
Las Cruces, New Mexico

Tile: Montaña Series, Terracotta 4"x8"

Designer/

Contractor: Quiñones Construction, Ltd.

To find out the name of your Interceramic Distributor call 1-800-351-2377. In Texas call collect (915) 593-7359.



INTERCERAMIC

El Paso, Texas

See our catalog in the 1986 Sweet's General Building Section 9.18/Imi.
Circle 60 on inquiry card



USG[®] STEEL FRAMING

**Big job expertise
is yours for the asking!**

Building systems capability makes the major difference. United States Gypsum Company works with you to optimize systems performance—computer-sizes framing components from a total job perspective—delivers utmost economy in quantities, sizes and weights of USG[®]

High Museum of Art

Steel Framing. As a result we can provide a decided edge over competition. We have complete, readily available detail recommendations. In improved fastener technology. And in compatibility with a wide variety of exterior materials. You know the basic benefits of lightweight

steel framing systems. Now look into USG® Steel Framing advantages. You'll find nobody supplies more building systems support to help you complete projects sooner. Phone today. Or write to us for specifics at 101 S. Wacker Dr., Chicago, IL 60606-4385. Dept. AR486.

CALL US NOW:

Atlanta (404) 393-0770

Dallas (214) 357-6271

Chicago Area (312) 456-1086

Los Angeles Area (213) 320-4062

New York Area (201) 263-4635

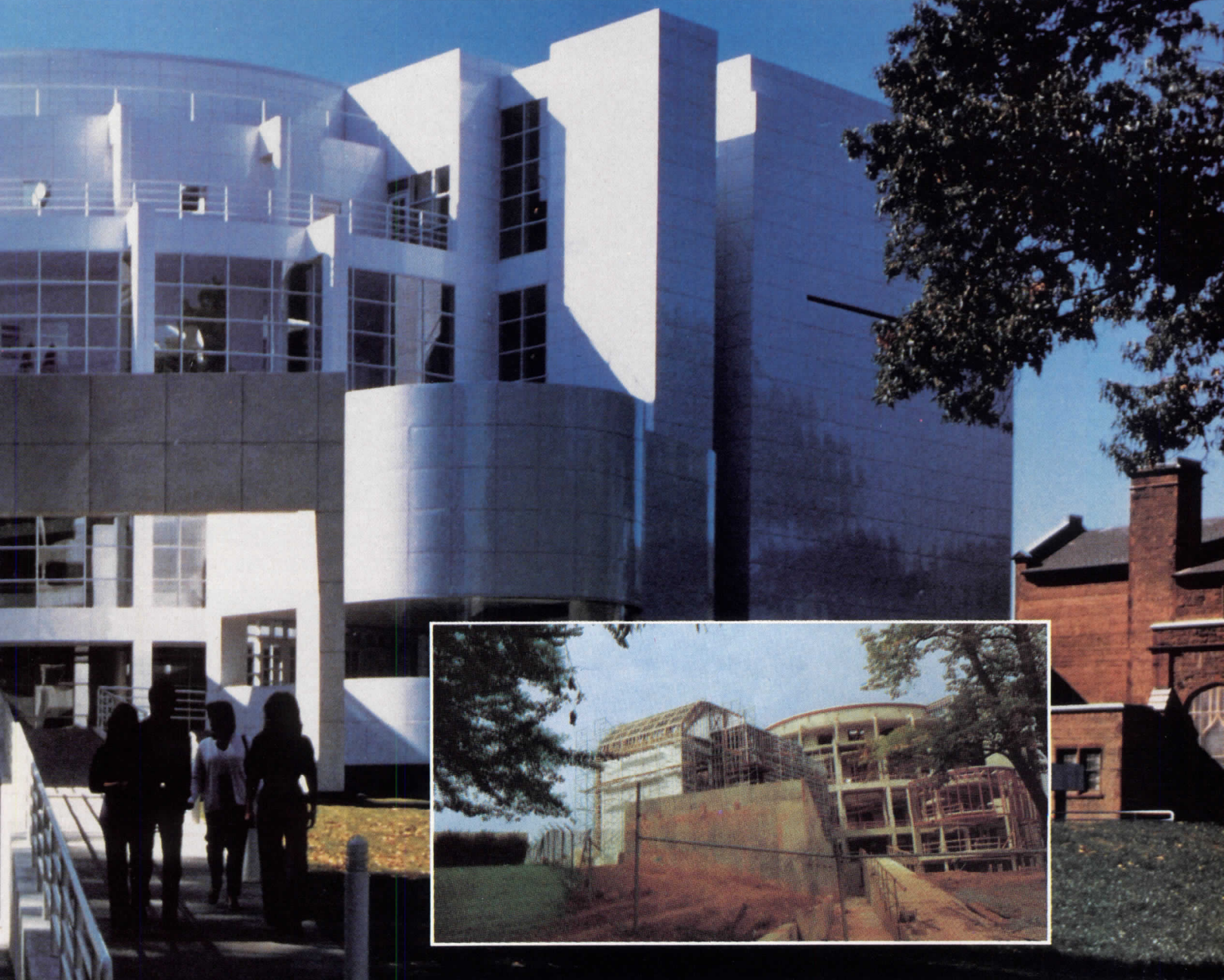

UNITED STATES GYPSUM COMPANY 

© 1985 U.S. Gypsum Co.

USG® is a registered trademark of USG Corporation

BUILDING AMERICA

Circle 61 on inquiry card

What Do These Prestigious Buildings Have In Common?

FORDHAM UNIVERSITY

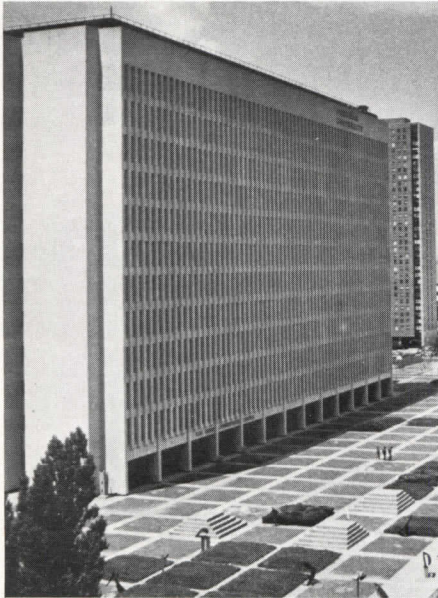

SEALED WITH POLYSULFIDE 1965

*Lincoln Square of Fordham University
New York, NY
Architect: The Perkins & Will Partnership*

CARPENTER CENTER, HARVARD UNIV.

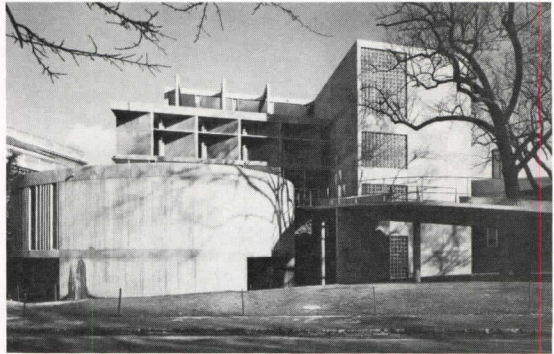

SEALED WITH POLYSULFIDE 1963

*Carpenter Center For The Visual Arts
Harvard University
Cambridge, Massachusetts
Architect: Le Corbusier*

UNITED AIRLINES HEADQUARTERS



SEALED WITH POLYSULFIDE 1966

*United Airlines Headquarters
Libertyville, Illinois*

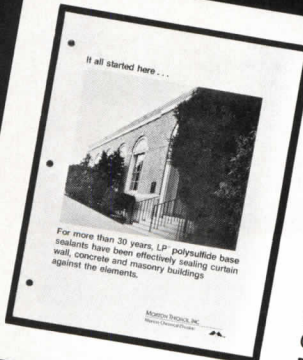

To find out about other prestigious buildings that have been sealed for more than 15 years with Morton Thiokol LP® polysulfide base sealant, send for your copy of, "It All Started Here".

*Morton Thiokol, Inc.
Morton Chemical Division
Mkt. Comm. Dept AR
CN 5305
Princeton, New Jersey 08540*

Glass-terpiece

The beautiful Collin Creek mall in Dallas' suburban Plano area is another evidence of Naturalite's expertise in glass skylights.

The 28,000 square foot system of Lean-To and Structural Pyramid skylights was designed and installed by Naturalite in less than four months and utilizes energy-conserving mirrored glass. The fast-track installation was delivered on budget and on time. The mall was opened in mid-1981. Federated Realty, Cincinnati, is the owner-

builder-developer. General contractor, Walker Const. Company, Fort Worth, Tx. Architects, R.T.K.L. Associates, Inc., Baltimore.

Whatever your design calls for, Naturalite can execute it beautifully in acrylic, glass or polycarbonates. And, we are equipped to install larger custom applications almost anywhere.

See Sweets insert 7.8/Na or contact the factory. Naturalite, America's largest skylight company. Your single source for skylights.



NATURALITE, INC.

3233 West Kingsley Road, Garland, TX 75040
For information call: John Rowan
(Toll Free) 1-800-527-4018

Circle 63 on inquiry card

"WHEN SHAKERTOWN WENT UP, THE FOR SALE SIGNS CAME DOWN."

Rick Hodges knows what it takes to sell a condominium.

He ought to. He's built and sold more than 1,000 of them.

So, when he broke ground on a 35-unit lakefront project near New Orleans, he made sure Shakertown was on his side.

But let Rick speak for himself:

"When you're building up-scale waterfront homes, you don't go second cabin on the siding. After all, most buyers make up their mind the minute they drive up.



Shakertown nails up about as fast as a "sold" sign.

"That's why we went with Shakertown. You can tell it's a first-class siding right from the street. And, it sure didn't hurt to discover it went up twice as fast as other sidings."

But what do buyers think of Shakertown?

Well, before the project was even half built, 20 "for sale" signs had already come down.

So, the fact that we helped sell Rick Hodges' condos is just one more reason why Rick Hodges is sold on us.

SHAKERTOWN[®] SIDING

For free catalog, call toll-free 1-800-426-8970
In Washington state, 206-785-3501
Or write P.O. Box 400-ARP4, Winlock, WA 98596

Circle 64 on inquiry card

Developer: R. L. Hodges Construction Architect: Gerard Raymond, AIA

©1986 Shakertown Corporation





Crissman & Solomon Architect Inc

ICE & WATER SHIELD PRESENTS THE FINE ART OF PRESERVING A MASTERPIECE.

When you create something innovative, dramatic, substantial, you ought to give it the best protection possible from costly water damage.

Ice & Water Shield—developed by the makers of Bithuthene® Waterproofing Systems—offers the most cost effective, long-term protection against ice dam and wind blown rain damage on the market today.

This tough, flexible self-adhering membrane installs easily under shingles, slate, shakes, tile, metal and around all building details where additional waterproofing is needed.

What's more, Ice & Water Shield never interferes with the integrity of your design because it's completely invisible after installation. For more information, contact E.R. Davis, W.R. Grace Construction Products Division, 62 Whittemore Ave., Cambridge, MA 02140. And protect your landmark from watermarks.

Ice & Water Shield™ GRACE

Circle 65 on inquiry card



You'll Get Ten Years To Life.

Just for specifying modular carpet systems by Lees.

Lees backs its carpet tiles with performance guarantees that provide ten full years of protection. Against edge ravel. Against delamination. Against cupping, doming, and dishing. Against wear. Against static. It's the kind of long term insurance you and your clients deserve. But you only get it from Lees.

Ten-year warranties are just one of the advantages that have made Lees the world's largest supplier of commercial broadloom and modular carpet systems. Now that we've become a separate, all-contract company, we're giving you lots more.

Our hundreds of matching broadloom-and-modular carpet combinations are perfect pairs—in texture and thickness, as well as color and pattern. We're expanding our field support staff and our product lines. We've added hardback carpet tile systems in advanced generation Antron® nylon by DuPont with soil and static protection built in.

For brochures, test data, specifications call toll free 800/523-5647. From within Pennsylvania, call collect 215/666-9426.

**Lees
Commercial
Carpet
Company**



A Division of Burlington Industries, Inc.
King of Prussia, PA 19406

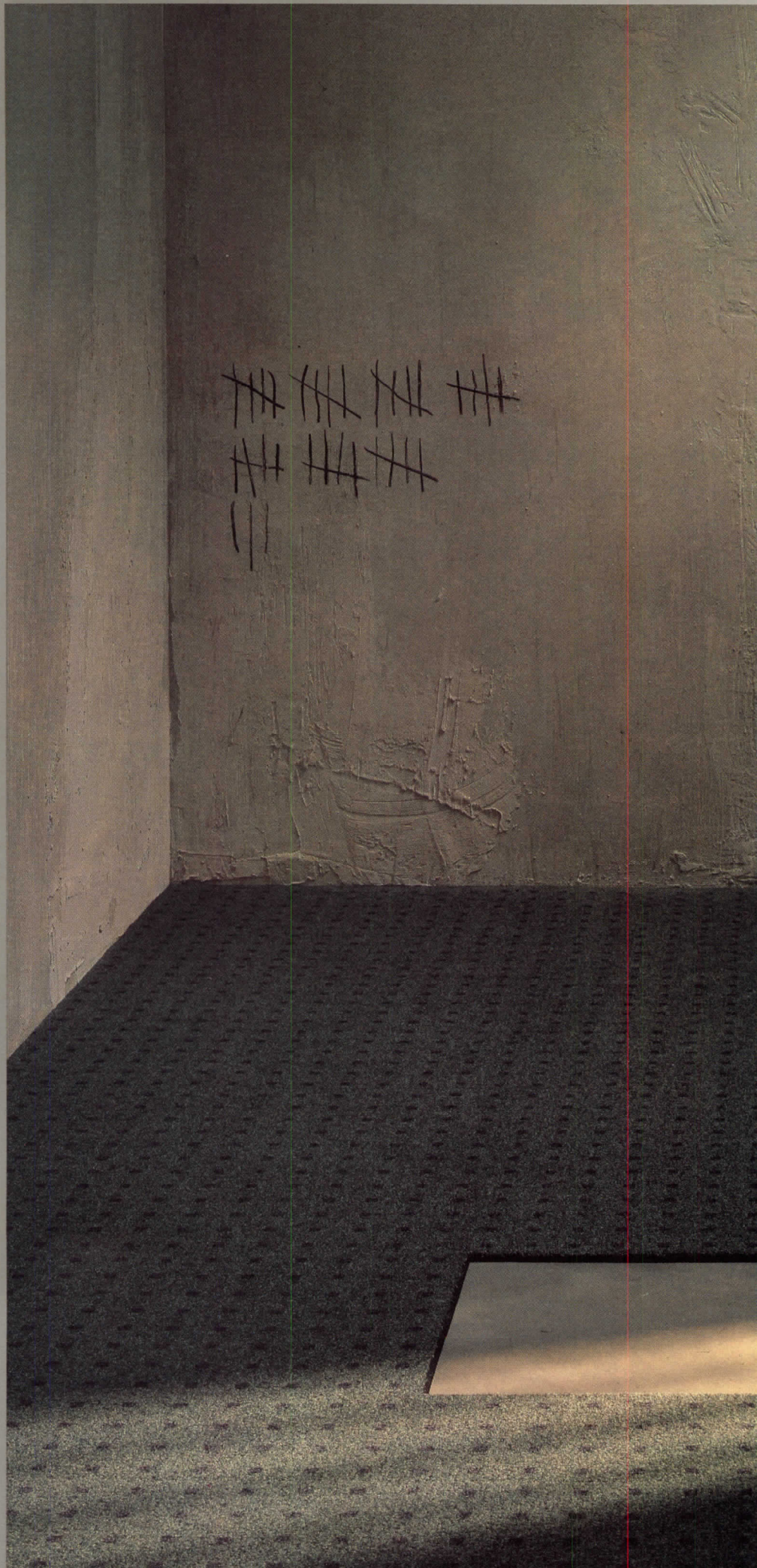



Circle 66 on inquiry card

Modular carpet systems by Lees in over 200 colors and patterns. Photography: Fred Schenk. ©1985 Burlington Industries, Inc.





Project: Private Residence, Rancho La Costa, Calif. Architect: John Mosele, AIA, San Diego, Calif.

*Those accustomed to the very best,
design with Weather Shield
wood windows.*

WEATHER SHIELD MFG., INC.
P.O. Box 309
Medford, Wisconsin 54451
Circle 67 on inquiry card

All Weather Protection - Always!



Q U A L I T Y

STO INDUSTRIES, INC.
Quality Lane, Box 219
Rutland, Vermont 05701
Toll Free: (800) 851-5533



**Distinction
you never
thought
possible
with
exterior
insulation
systems.**

For environmental or aesthetic conditions that call for exceptional design and uncompromising performance, there is now a remarkable solution.

STO exterior systems embrace homes with a flexible, moisture-resistant thermal shield that stands up to the elements, as well as to the most demanding aesthetic requirements ... no matter what.

Such innovation has earned STO the confidence and respect of owners and architects throughout the world. But in the end, of course, the distinction is entirely yours.



**Exterior
Insulation
Systems**



Circle 68 on inquiry card

Floor Tile: Boulevard
Wall Tile: Colorflex Series

DESIGNS
THAT
FLOOR
THE
COMPETITION.



Villeroy & Boch believes that beautiful buildings deserve beautiful floors. Exquisite designs and European craftsmanship make our ceramic tiles the perfect choice. When it comes to specifying your next job, think Villeroy & Boch. A source of supply for over 200 years.

Villeroy & Boch[®]
A Tradition of Untraditional Design.

For information on our ceramic tiles and plumbing fixtures, write Villeroy & Boch, I-80 at New Maple Ave., Pine Brook, NJ 07058.

Record Houses 1986

It is purely fortuitous that this issue includes articles on a house in Lima, Peru, and another in Lima (the "i" is long), Ohio. The coincidence is telling, however, since it indicates how far RECORD HOUSES has expanded its geographical reach. Besides presenting houses abroad designed by North American architects, we have also opened our pages to projects by foreign designers working on their home turf. In part, the presence here of buildings such as Toyo Ito's Silver Hut in Tokyo (drawing below and pages 122-127) and Mario Botta's Posterla house near Lugano (pages 98-103) simply acknowledges international crosscurrents that RECORD has been charting for some time. No one who hopes to appreciate the full range of options available now to architects (and their clients) in this country can afford to ignore the influences—and the professional practices—that span national borders. At the same time, though, even a cursory survey of design on a global scale reveals a widespread desire for homes with foundations in familiar culture and history. Lima is not the same as Lima.

History, or perhaps more accurately, memory, is a leitmotif throughout this issue, as it has been in RECORD HOUSES of years gone by. The theme, one might say, comes with the territory. From the moment any house becomes someone's home—no matter how "Modern" its form or how briefly it is inhabited—it imprints its shape, its textures, and its colors on remembered experience. When a gifted architect lays out the passageways between past, present, and future, the destinations become all the more compelling. A house can celebrate the contingencies of personal history (pages 104-109, for example), affirm the vitality of shared tradition (pages 110-121), or evoke the poignancy of time lost and found (cover and pages 146-151).

Architects, of course, are not simply latter-day Prousts, dipping fancy cakes in the cup of memory. They also have to worry about work surfaces in the kitchen where someone is baking madeleines—and provide a tub where the weary host can soak after the tea party is over. Gourmet cooking—and epicurean bathing—have come to be regarded as necessities in many affluent households, and the contents of architects' residential portfolios reflect this trend. To give these often independent design problems the attention they deserve, we have inaugurated a special department on kitchens and bathrooms, which begins on page 161. Here, too, we offer a varied bill of fare, both foreign and domestic. *Douglas Brenner*

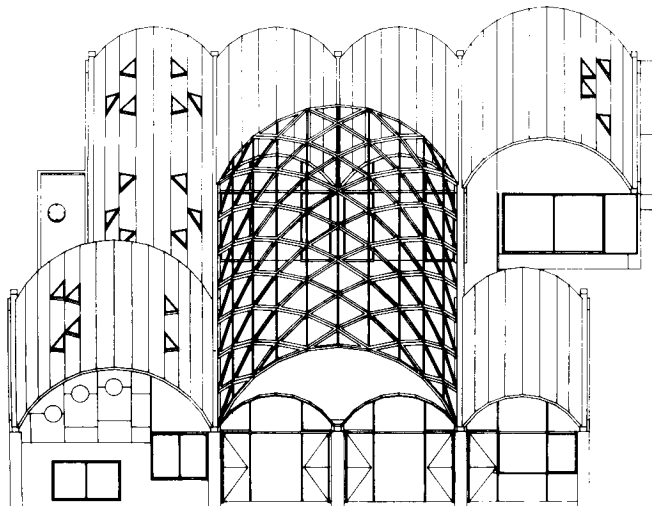

Landscape memories



House in the Rio Grande Valley
Albuquerque
Antoine Predock, Architect



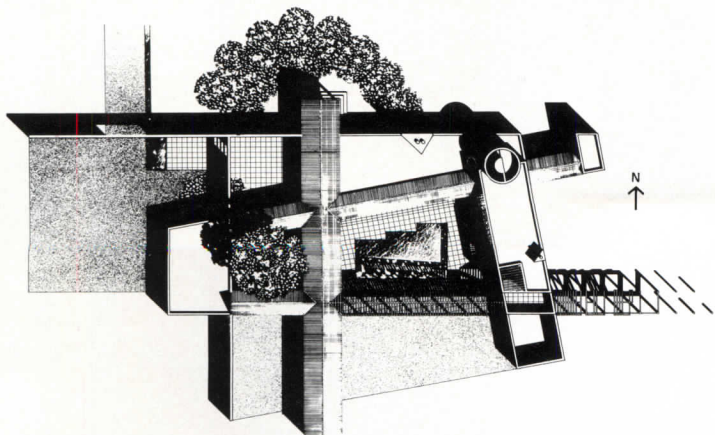
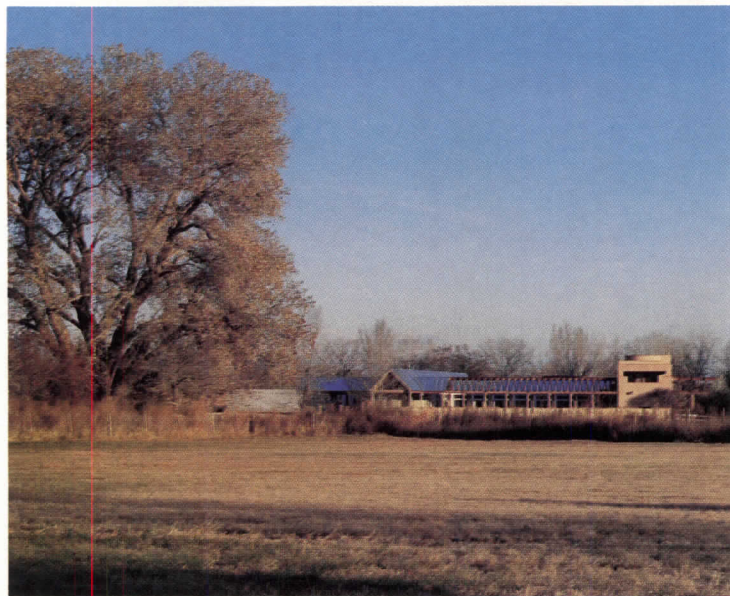

Albuquerque's North Valley is quasi-agricultural, wholly rural, and, in the words of architect Antoine Predock, "charged with landscape memories." The abundance of cottonwoods, the distant chain of bare hills, and the concrete irrigation ditches that crisscross the flat alluvial soil deposited by the Rio Grande perpetuate the rustic ambiance, though residential development of an upscale sort has made inroads on the agriculture. The owners of the house—two physicians and their small children—sought the fresh air and relaxed freedom associated with country life, as well as space enough for horses, pasturage, and stable. (The family's horses have yet to be added; the livestock shown on the preceding pages belongs to the next-door neighbor.)

Predock, a transplanted Midwesterner who has analyzed acutely and lovingly New Mexico's geography, history, and spirit, could fairly pick and choose among many and varied design antecedents. Such picking and choosing is in fact a tradition of New Mexican architecture, which comfortably blends elements of Indian, Spanish, and Territorial forms and materials as occasion suggests. In the absence of native timber suitable for construction, most of these stylistic layers draw on Indian adobe structure, though that relatively soluble material has mostly been replaced, as here, with stucco-faced concrete block. The thick walls either retain or repel warmth as season demands.

While conforming to many of the region's familiar forms, Predock departed from them in a number of idiosyncratic ways. Concentrating first on a linear composition to parallel the flat valley floor and comport with the rural environment, Predock chose as model not the region's ubiquitous flat-roofed pueblo style derived from Indian and Spanish sources but rather the pitched metal roofs that characterized American farmsteads in the territory. But then, still picking and choosing, Predock moved to pueblo-style usage for the house's thick adobelike stucco walls and small wood-framed windows. The roofline, however, has greater variety and complexity than either farmstead or pueblo architecture. The expected flatness is broken by unexpected triangular gables and a cylindrical tower.

The plan of the 4,200-square-foot structure, like its massing, mixes the traditional and the idiosyncratic. Predock likens the plan to the figure-eight of early New Mexican haciendas, which in the Spanish way turn inward toward private courtyards. Thus the front of the house visible from the road (top left) seems almost impervious to outsiders except for the ceremonial front porch and a wide opening to the automobile court. Predock deliberately fostered "an aspect of mystery" on this facade: the formal entry will be screened by a grove of Russian olive trees.

Once the visitor has penetrated the wall, though, he is welcomed into quieter, successively more familial precincts: from the semiprivate automobile court with the *real* front gate (opposite top) to a still more private planted forecourt with a still more real front door (site plan) to the innermost pool court. The back of the house, on the other hand, is more open, the privacy of the pool court protected by the owners' own pasture (center left). On this side, only the pergola separates the court and a walled terrace.

The idiosyncrasy of the plan shows in the splayed axes that define the courtyards. Predock devised the A-shaped plan to resolve opposing man-made and natural geographical alignments in the district: the front of the house and the pergola parallel to it reflect the surrounding orthogonal agricultural grid, while the bedroom pavilion rotates to direct views to the hills, which stretch diagonally in the northeast.

The constantly changing color and direction of the strong sunshine, in company with textured planes and well-defined edges, offer a special form of architectural ornament in the Southwest: shadow murals that vary from hour to hour and season to season. One such mural at the house, cast by pergola columns and trellis (opposite bottom), was captured in midafternoon on the stucco wall of the bedroom pavilion.

Grace Anderson







The pool court is literally and symbolically central to the dwelling. Easily accessible from all living areas, it allows the family to foregather in peace and quiet at any hour. The outdoor pergola and the long interior corridor, though geometrically divergent, serve the same circulation functions by connecting the living areas with the bedroom pavilion. The bedroom wing (opposite top), the only two-story element at the house, contains children's rooms on the lower floor and the master bedroom suite upstairs. All but one of the children's rooms offer views of the central court, and all bedrooms have views of the hills. The parents have in addition two modes of access to the upstairs suite—first by a silo-encased spiral stairway and second by open stairs to a terrace with view outside the bedroom. At the other end of the pool (opposite bottom) the kitchen and breakfast nook have more generous windows to receive the morning sun. The pergola, which covers a path separating pool and terrace (top), is built of redwood, a material resistant to the deleterious effects of New Mexico's dry air. A covered breezeway connects the garage and the main entry, at the same time skirting the visitor's forecourt at the left (bottom).



A long spine links the front entrance and the dining area (opposite bottom) with the sleeping wing (opposite top) and passes the sunken living room with its traditional corner fireplace and raised hearth. The French doors, the large windows, and the transom lights, all of which open to the central pool court, receive the southern sun in winter, turning the corridor and the living room, with its heat-retaining brick floor, into a solar greenhouse in cold weather. Despite the rustic suggestion of the exposed wood beams in the kitchen (top), the casework has the kind of efficiency needed by a working couple and the kind of expansiveness appreciated during parties. (A gazebo shown near the bedroom pavilion on the site plan [page 74] and a guest house extending the kitchen/dining spine have yet to be built.)

House in the Rio Grande Valley
Albuquerque, New Mexico

Architect:

Antoine Predock Architect FAIA
300 12th Street, N. W.

Albuquerque, New Mexico 87102
Geoffrey Beebe, project architect

General contractor:

Ron J. Romero

Photographer:

© Timothy Hursley/The Arkansas Office

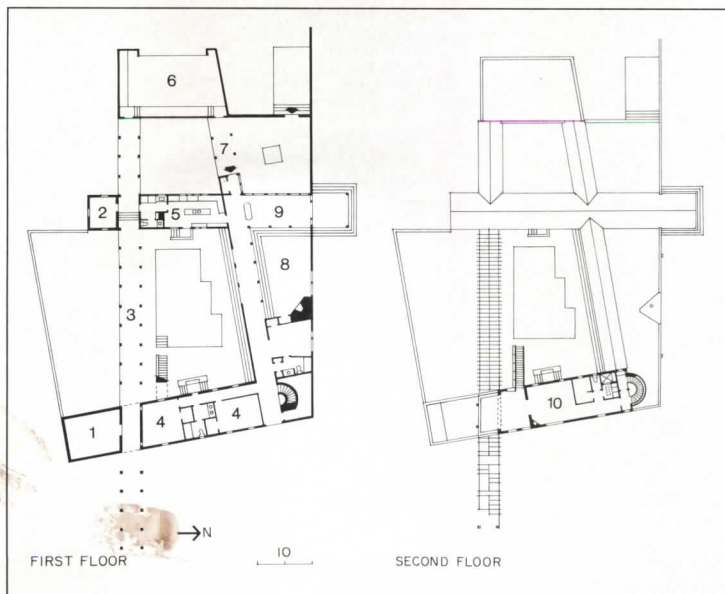

- 1. Storage
- 2. Storage
- 3. Pergola
- 4. Bedroom
- 5. Kitchen
- 6. Garage
- 7. Entry
- 8. Living room
- 9. Dining room
- 10. Master bedroom



In a secret garden

Casa Los Andes
Lima, Peru
Arquitectonica International,
Architects

With Inca pyramids only a block away, Modernist high-rises around the corner, and Mission Revival haciendas cheek by jowl with Bauhaus villas up and down the street, one searches in vain for a "typical" building style in the neighborhood of Arquitectonica's Casa Los Andes. If there is one architectural form that binds together this fashionable quarter of Lima, it is the garden wall that demarcates every property line—nowadays a matter of practical security as much as local tradition. The 12-foot-high protective barrier surrounding Arquitectonica's site conforms exactly to this cultural matrix, while isolating a neutral field for esthetic invention. Viewed from a nearby apartment tower, the cruciform structure skewed within this oblong frame looks uncannily like an axonometric drawing plucked from the architects' Miami office. Stucco walls precisely delineate the taut constructivist equipoise of Arquitectonica's graphics, while transforming them into a three-dimensional object of voluptuous plasticity and vibrant color. Looking down with a giant's eye, one can imagine lifting this exquisite artifact to turn it around in one's hand. Head on, at human scale, there is no single vantage point from which the structure composes a static hierarchy of masses or facades. Instead the house resembles some cubist assemblage, a cluster of intersecting planes and curved and polygonal volumes, whose unifying order changes constantly as one passes around and through them. In Lima, where land is scarce and even mansions are impacted into narrow lots, the dynamism of Arquitectonica's habitable sculpture seems positively exuberant.

The crossed walls that trace the geometric coordinates of the house also imply centrifugal lines of force, figuratively turning the confines of the yard inside out and reorienting them to the points of the compass. Besides opening the interior to light, air, and Pacific breezes, this parti effectively fuses architecture and landscape to extend their perceptible reach. Discipline prevails, however, since this schema also divides both house and garden into visually and functionally related quadrants: a flower-edged dooryard adjoining the foyer; a lawn and terraces outside the living room; an orchard bordering the library, dining room, and kitchen; and a service court off the laundry and maids' quarters. This neat domestic economy is reminiscent of old-fashioned handbooks for the gentleman builder, albeit phrased in a Modernist idiom. The result recalls the streamlined "Modernistic" abodes of the 1930s, whose machine-age décor encased amenities for a way of life that, in retrospect, seems almost quaintly old-world.

Nevertheless, by current upper-class Peruvian standards, the Casa Los Andes is a remarkably casual and efficient home. The owners, a young couple with two small children, asked for a compact layout with easy circulation, multiuse rooms, and ample spaces for outdoor living. Architects Laurinda Spear and Bernardo Fort-Brescia (who is Peruvian by birth) interpreted these desiderata with proper regard to local mores. While their 3,500-square-foot layout dispenses with the customary suite of ceremonial reception rooms segregated from everyday family areas, it still includes a self-contained service zone complete with back stairs. And though the glass-walled living room and indoor/outdoor dining areas relax conventional boundaries, the public aspect of the entire compound is impeccably reserved. From the street, only a red-trimmed portal hints at the spectacle beyond the garden wall. Inside the front yard, the pink entry pavilion flanked by jutting wings looms like a gatehouse, standing guard before the inner sanctum. A porthole and tiny diamond windows, seemingly punched at random through the curvaceous tower, merely intensify the enigma. Even when the house door is open, the visitor's field of vision is confined to a skylighted stairwell. Only on the threshold of the living room does a subtle shift of axis at last reveal exhilarating vistas through the family's private domain. This dramatic route of arrival lends magic to the secret garden beyond, where a venerable date palm presides over the mysteries of modern art like a faithful native retainer. *D R*





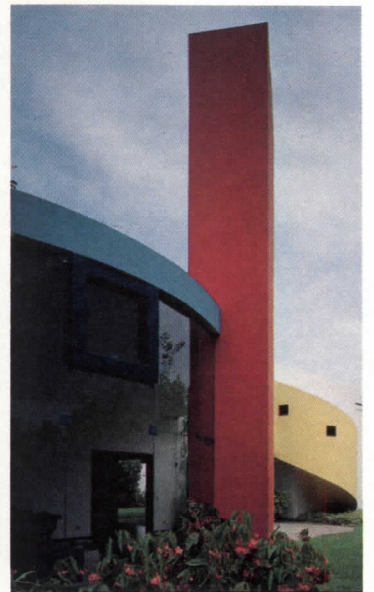

The crossed walls at the core of the house are treated as segments sliced from infinitely continuous planes (cut-outs beyond the extruded corners are conceptual windows). Other three-dimensional shapes suggest fragments of larger volumes: the living room is a quarter-ellipsoid, the red chimney a prism, the yellow stair turret a helix. Whether Euclidean or idiosyncratic, as in the pink entry tower (overleaf),

Arquitectonica's geometry has been executed beautifully. High-level Peruvian craftsmanship and low-cost labor are evident in meticulous construction. Interior partitions are brick, exterior walls are concrete block, and all vertical surfaces are stuccoed, flawlessly. Roofs are brick panels over poured concrete. Because it never rains on the irrigated plain of Lima, waterproofing is unnecessary.





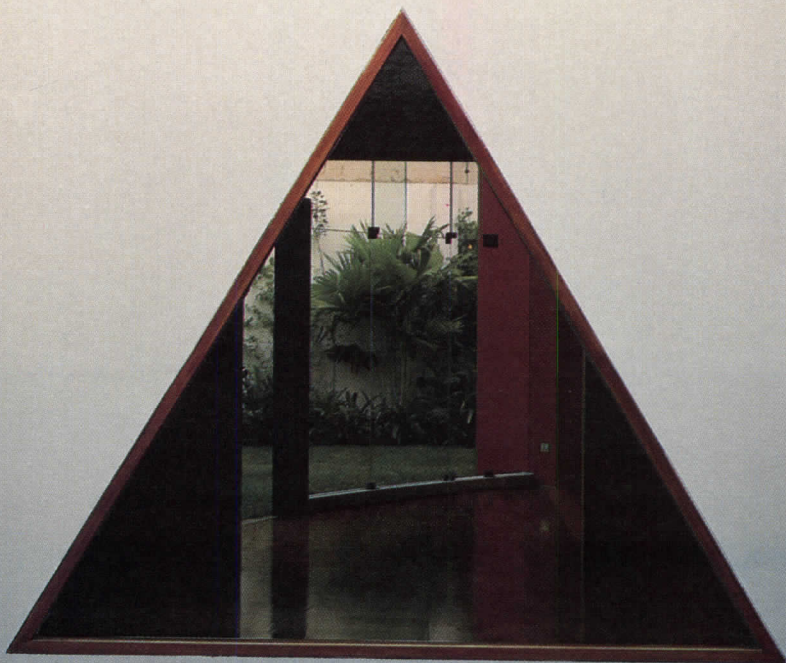
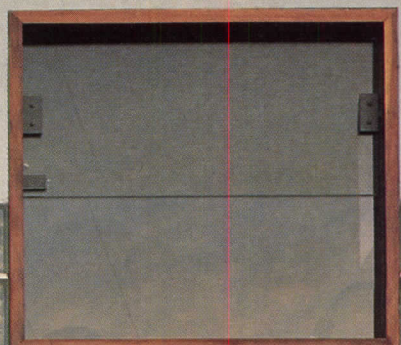
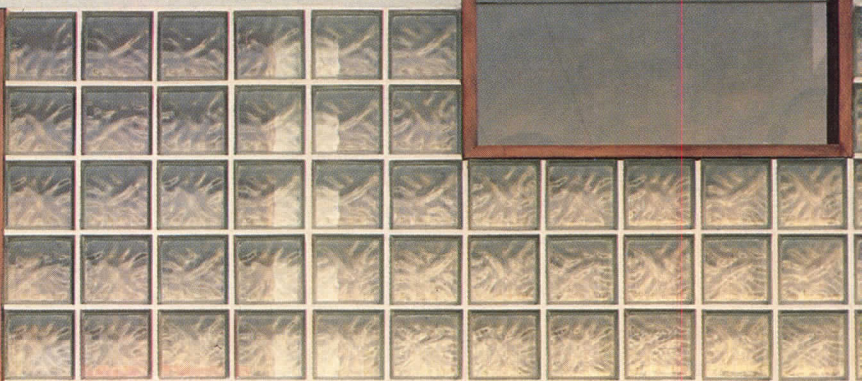
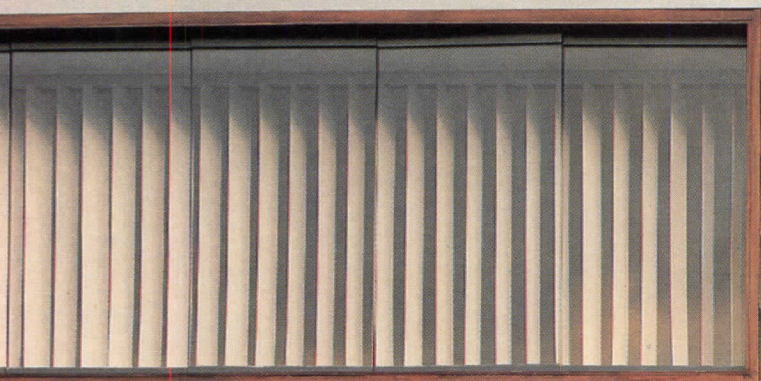



Varied fenestration whimsically syncopates the rhythms of Arquitectonica's design, while expressing the need for different degrees of privacy within (operable windows turn on stainless-steel pivots set in frames of caoba, an Amazon jungle mahogany used for the woodwork throughout the house). A triangular opening in the dining room affords a view of a herbaceous border outside, but masks the presence of a neighboring villa above the garden wall. Looking back through this window from outside, one sees through the full width of the house and beyond the transparent living-room wall to an ornamental lawn (facing page). A breezeway for outdoor dining (this page) offers another space-enhancing vista.

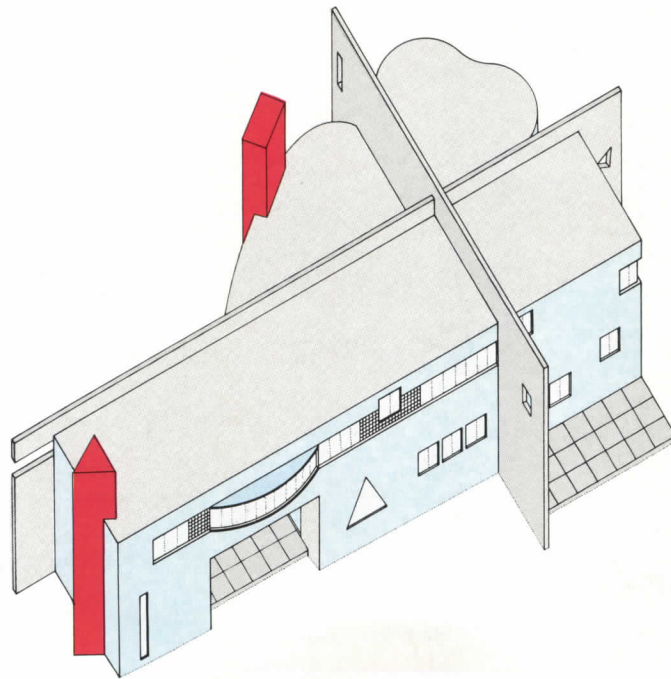

A sculptural tour-de-force, the two-story stair hall (opposite) inserts a sort of esthetic air lock between public and private zones. The porthole and a constellation of small square panes allow only a glimpse of the dooryard garden, while the elliptical skylight prefigures the bowed plan of the living room (right). A dramatic release from the introspective verticality of the foyer, the living room seems to flow outward into the garden. As if to emphasize the dematerialization of this enclosure, a massive portal is silhouetted surreally in the glass wall. The chimney is also articulated as an independent object, to belie its actual role as a structural support for the apparently weightless ceiling. A floor of randomly laid caoba planks reflects the fire. Arquitectonica is currently designing furniture for the house.



Casa Los Andes
Lima, Peru
Architects:
Arquitectonica International Corporation
4215 Ponce de Leon Boulevard
Coral Gables, Florida 33146
Bernardo Fort-Brescia and Laurinda Spear, principals and project designers; Martin J. Wander, project manager; Enrique Chuy, project coordinator; Bill Holt and Richard Perlmutter, design development
Engineers:
Diar Ingenieros, S. A. (electrical); Gallegos-Rios-Casabonne-Uccelli-Icochea-Arango (structural); Dimonsa Ingenieros, S. A. (plumbing)
General contractor:
G. L. Dupuy, Ingenieros
Photographer:
© Timothy Hursley/The Arkansas Office

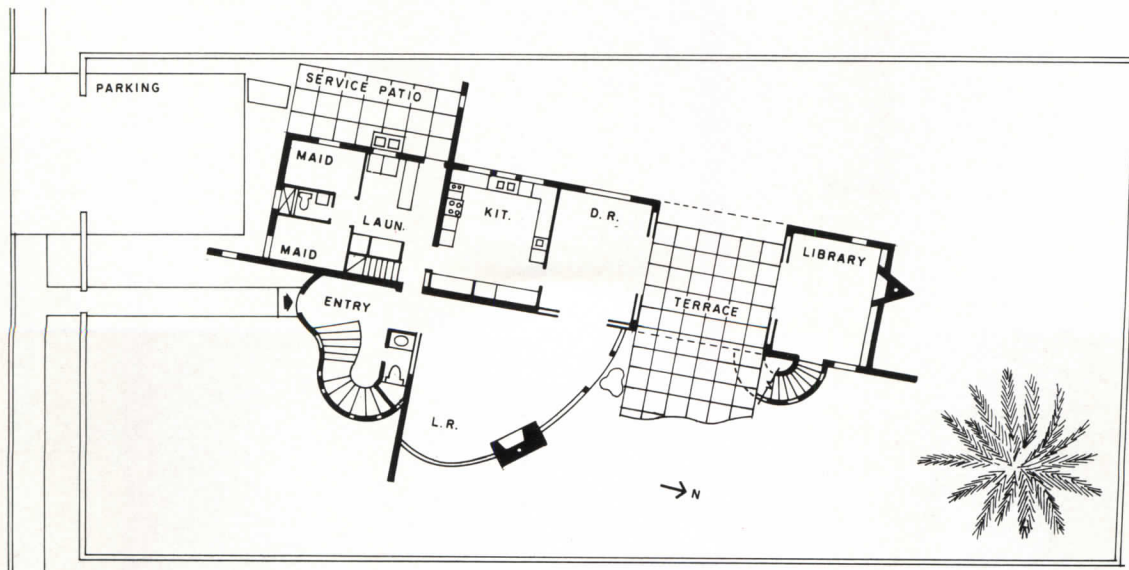
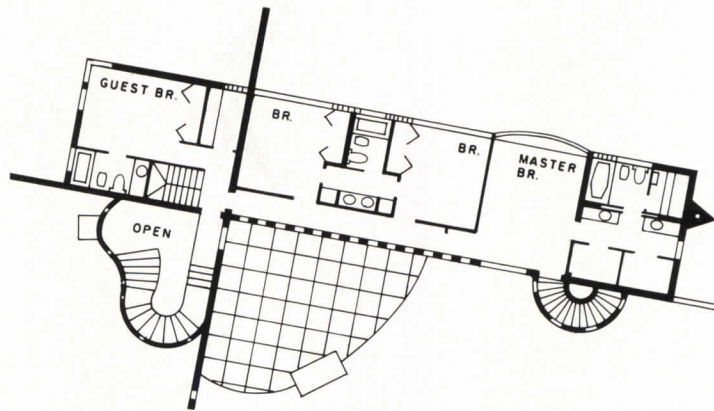



Rosewalk Cottages
Seaside, Florida
Orr & Taylor, Architects



Small pleasures





A tentlike gazebo and solar-heated sauna flanked by pergolas rise above low-lying undergrowth to form Rosewalk's civic heart (preceding pages). In order to focus a forced perspective of upper Rosewalk from an entry gate along county route 30A, the architects positioned a pair of tower houses on opposite sides of a north-south garden axis that narrows as one advances toward the center of the complex.

Six hundred miles northwest of the teeming Miami-Palm Beach resort axis, beyond the burgeoning Sunbelt cities of Orlando and Tampa, lies a Florida that northern visitors seldom see. The 100-mile stretch of Gulf Coast panhandle between the military towns of Panama City and Pensacola is a place where campers easily outnumber Cadillacs, where gentle Southern drawls are a constant reminder that Alabama—the self-styled Heart of Dixie—is never more than a few miles down the road. It is somehow right that when the powers-that-be drew up the nation's time zones, they made sure that this narrow chunk of Florida would forever be an hour behind the rest of the East Coast; turning back the clock seems a way of life along the “Redneck Riviera.”

Not that time has stood totally still here: like much of coastal America, the western tip of Florida has seen a spate of recent high-rise condominium-building, most of it on the narrow bluff between the Gulf beaches and county route 30A, that has begun to alter the area's appealing backwater character. So much the better, then, that when Robert Davis first thought about developing 80 waterfront acres near Panama City that he inherited from his grandfather, he hired Miami architects Andres Duany and Elizabeth Plater-Zyberk to design the master plan for a speculative resort community, called Seaside, that would embody the indigenous small-town qualities of the region.

Drawn up between 1978 and 1983, the Master Plan and Zoning Code of Seaside is an unusually comprehensive piece of town planning that represents “a turning away from the methods of contemporary real-estate development toward those of traditional American urbanism.” In addition to a concentric web of streets and pedestrian paths that define residential, commercial, public, and mixed-use zones, the plan includes a set of architectural guidelines governing setbacks, height limitations, materials, and specifications for the 350 private buildings envisioned for the new community. Development will take place over the next 10 to 15 years, and lot-owners may employ any architect they wish, as long as designs adhere to the guidelines. The goal is a low-rise, high-density town characterized by deep porches, picket fences, and public amenities set into a natural landscape of sea grass and scrub oak.

Seaside's first dwellings, including a house that Davis designed for himself and his wife Daryl, are pleasant, but fairly prosaic, interpretations of the code. More recently, however, Robert Orr and Melanie Taylor raised the architectural standards by designing an enclave of 14 cottages, dubbed Rosewalk, for an irregularly shaped, three-acre parcel overlooking the beach. Although it is tempting to view Rosewalk merely as a charming variation on a wood-frame-Gulf-Coast-vernacular theme, Orr and Taylor's comely assemblage actually exhibits a far richer palette of allusions to resort architecture of the past, ranging from the “tropical Georgian” buildings of the Bahamas, to the diminutively scaled summer colonies of Martha's Vineyard and Nantucket, and the inwardly focused cabins of early 20th-century motor courts. The latter reference is meant to address Rosewalk's somewhat problematic location along the eastern border of Seaside by channeling views away from the adjacent, visually banal settlement of Seagrove Beach into “outdoor rooms” that have been adorned with the architects' gracious collection of garden furniture.

Each of the nine Rosewalk houses erected to date falls into one of three distinctive housing types—a one-story cottage with dormer, a one-story cottage with octagonal tower, and a two-story house. The architects achieved the sought-after feeling of controlled diversity through a delicately varied color scheme of creamy roses and yellows, and by subtle changes in trim detailing (lattice-work panels atop porch posts on one cottage, for example, become carved brackets on another). While the rural South probably never looked this good, the whole point of Rosewalk, and of Seaside, is not the archaeological replication of any specific prototype, but rather a utopian interpretation of small-town life as it could be. “The new town,” intones Davis's understated promotional literature. “. . . the old ways.” *Paul M. Sachner*

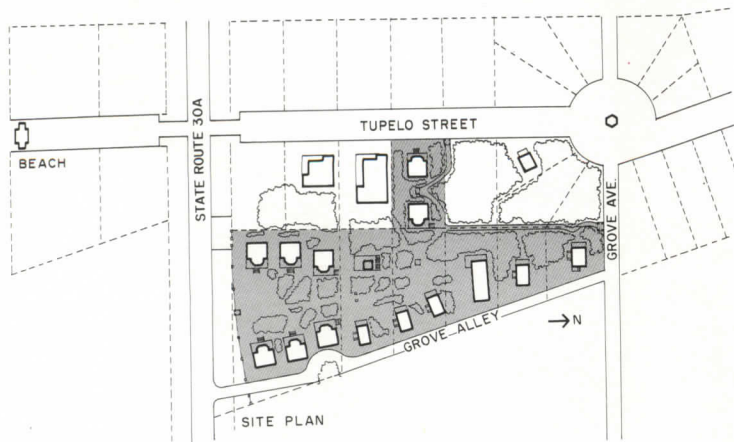

As Seaside's first full-fledged neighborhood, Rosewalk sets a high architectural standard for future development in Robert Davis's new town. Clad in cedar or cypress shiplap siding and topped by galvanized steel roofs, the houses shown at the bottom of these pages reveal how far architects Robert Orr and Melanie Taylor have gone in their search for an ideal residential type—all the way back, in fact, to an

ever-so-slightly ornamental vernacular, erected by local carpenters, that owes nothing to the current excesses of Postmodernism. In addition to their role as architects of Rosewalk, Orr and Taylor also designed the project's landscaping and, perhaps more significantly, the fanciful group of outdoor wooden furnishings that revives a tradition of 19th-century garden architecture. Meant to provide "a sense of

excitement and discovery," in the architects' words, pieces placed strategically throughout the grounds include two round-arched entrance gates off Tupelo Street and the beach road (below left), a rose-covered pergola entrance gate off Grove Avenue (below right), a peak-roofed gate that evokes a wishing well in the center of the complex (bottom right), a whimsical garden seat whose scalloped seatback and canopy of

jigsaw waves are references to Rosewalk's Gulf-Coast setting, (top left facing page), and a festive gazebo whose pyramidal latticework roof shelters a small checkerboard-inlaid table (top right facing page). In their landscaping, Orr and Taylor left as much native scrub oak as possible, and they deliberately placed smaller cottages at the southern end of the site, where the growth of low vegetation has been stunted by winds



off the Gulf. At Rosewalk's northern end the terrain slopes upward and is characterized by thick stands of taller scrub oak. Here, two-story dwellings rise above the vegetation, and the architects wisely placed the houses' public areas on the second floor in order to take advantage of views over the trees. Bedrooms, by contrast, are on the ground floor, nestled in the privacy of the vegetation. For the gaps between

existing native flora, Orr and Taylor devised a planting scheme that consists of Florida palmetto, lupine, deer moss, wild goldenrod, magnolia, wild rosemary, and various low pines. Sandy paths crisscrossing the site follow the land surveyors' original cuts and are discreetly illuminated by an unobtrusive system of ankle-high, matte-finish lighting fixtures shaped like broad leaves.



Although Rosewalk's houses are relatively small by current standards, ranging in size from an 800-square-foot one-story cottage to an 1,100-square-foot two-story dwelling, the tiny, dollhouse-like scale of the buildings is meant to convey a quality that is "endearing, and not at all mean-spirited," according to Melanie Taylor. "If you put in enough features and handle proportions and scale carefully," she

adds, "a small house becomes something special." Some of those features—shown below in the elevations and plans of a two-story house and one-story cottage with tower—include full-width porches and widow's walks that offer views of the Gulf and gardens, delicate latticework bases, and, in the tower houses, three-sided angular entrance bays and octagonal libraries that call to mind the image of a ship's

pilothouse. Given their modest dimensions, Rosewalk's interiors seem remarkably commodious, thanks to high ceilings and open-plan layouts in the cottages, and loftlike balconies above living rooms in the two-story houses (opposite). Each interior is different, but a typical example might have walls and ceilings clad in three-inch-wide horizontal pine siding with V-groove joints, simple "picture frame"

window and door surrounds, and tongue-and-groove bleached pine floors. Although the surprisingly extreme weather conditions of the Florida panhandle necessitated central heating and air-conditioning, Rosewalk residents usually respond to the area's climatic vagaries by relying on a more rudimentary form of environmental control—the ubiquitous ceiling fan.

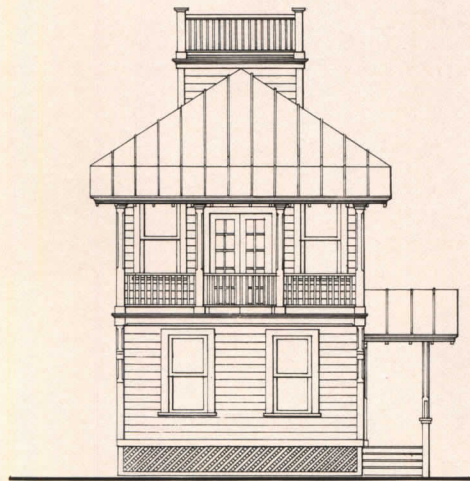

FRONT ELEVATION

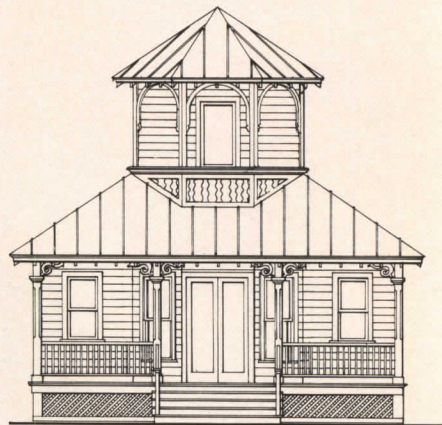

FRONT ELEVATION

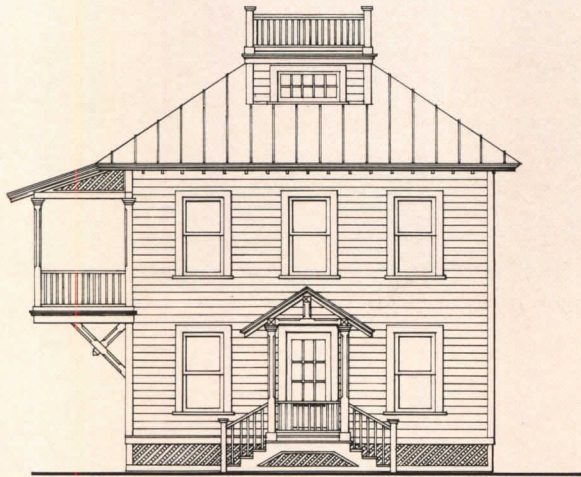

SIDE ELEVATION

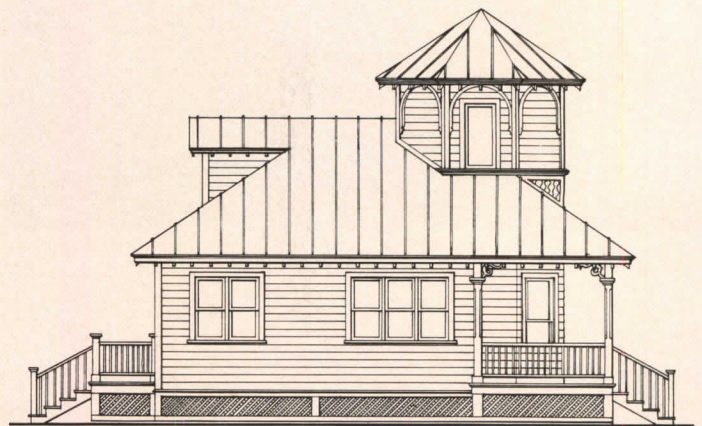

SIDE ELEVATION

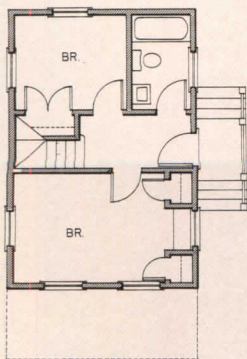

FIRST FLOOR

3

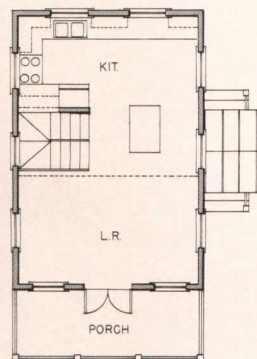

SECOND FLOOR

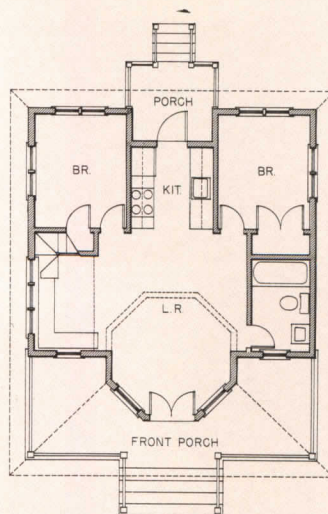

FIRST FLOOR

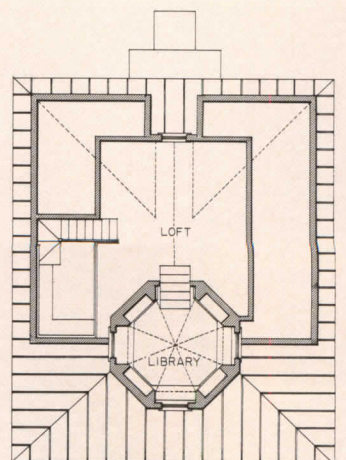

SECOND FLOOR

Rosewalk Cottages

Seaside, Florida

Developer:

Robert S. Davis

Architects:
Orr & Taylor

688 Orange Street

New Haven, Connecticut 06511

Robert Orr and Melanie Taylor,

partners-in-charge; Stephen Dynia,

Sherry Williamson, Charles Barrett,
project assistants

Interiors:

Jamie Christ Interiors; Daryl Rose
Davis and Mary Patton

General contractors:

Seaside Community Development
Corporation, Beth Folta

(construction manager); Al Bilelo;

Alan Ficarra; Robert Lamar

(construction documentation)

Photographer:

Mick Hales



All that glitters

Posterla Residence
Morbio Superiore
Switzerland
Mario Botta, Architect

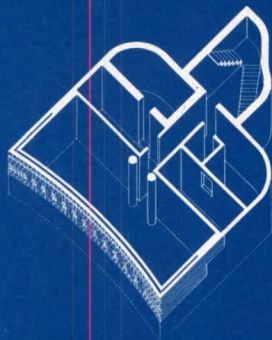
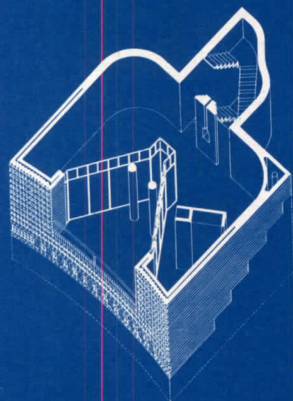
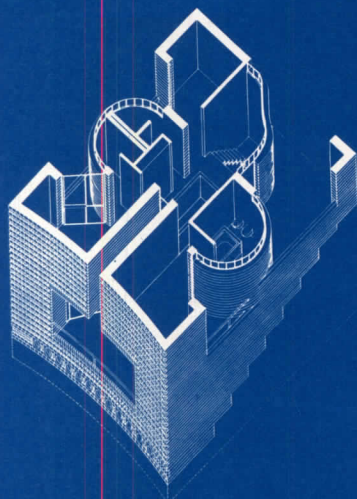

Few architects since Palladio have been as closely identified with a distinct geographical region and a singular building type as Mario Botta. Botta, who works amid the rugged terrain of Switzerland's Ticino, has spent the past 20 years in his native canton, almost exclusively developing and refining the geometric composition of the single-family house. It is in this fertile meeting ground of Mediterranean culture and Alpine climate that the architect has completed over a dozen rural villas, all characterized by strikingly consistent formal motifs even though each has been adapted to the specific exigencies of site, program, and budget. Botta's most recent house, located in Morbio Superiore not far from his Lugano studio, is perched on the edge of a plateau that slopes precipitously down toward the village below (opposite).

For Botta, the reading of a site such as this is as crucial to a design as any structural detail or stylistic flourish. Applying lessons acquired during a six-month tenure in Le Corbusier's Paris studio and a subsequent collaboration with Louis Kahn in Venice, Botta combines cultural propriety and formal purity in his work. His prolific pursuit of what he calls the "encounter between an idea and a reality" and the "reciprocal rapport between a creative work and the territorial condition" pays tribute to his architectural progenitors. Describing the house in Morbio Superiore, Botta paraphrases Kahn (whose devotion to distilling each architectural element to its purest form prompted him to ask a brick, albeit rhetorically, what it wanted to be) in asserting that the house "wants to be the image of the hill." This image emerges through a carefully controlled synthesis of several of Botta's signature components: a discrete volume, in this case a rectangular box; a north-south incision, here capped by a pedimented skylight; and a symmetrical main facade with a clearly articulated *piano nobile*, here a concave surface neatly chiseled to create an enclosed second-floor porch. Behind the taut facade lies a rigorously apportioned layout (plans page 103). With a practiced hand, Botta has shaped and distributed curved and planar walls that are balanced on each of the three floors by the dominant central axis, their white plaster a stark foil for the blackened iron-framed openings and charcoal-gray slate floors: in conception abstract and removed, but in realization accessible and tactile.

Botta has crafted the exterior with equal diligence. The south facade is composed of concrete bricks with alternating bands laid at 45-degree angles and plated with silver paint. Both a receiver and reflector of light, this "little artifice," as Botta terms his deceptively simple device, produces a continuous vibration of light on the facade, much like the silver sheen that emanates through the central slit in the vaulted ceilings of Kahn's Kimbell Art Museum in Fort Worth. As the sun sets over Morbio Superiore, and neighboring villas begin to look almost despondent in the dusk, Botta's house remains animated, radiant for a few minutes longer. That peculiar mixed heritage of Swiss precision and Italian sensuousness has imbued the architect with exacting methods and a transcendent romantic vision. Confronting this luminous presence in the twilight, one hears a reverberation of the teachings of Louis Kahn, who once began a lecture by saying "Architecture does not exist. What does exist is the *work* of architecture." *Karen D. Stein*

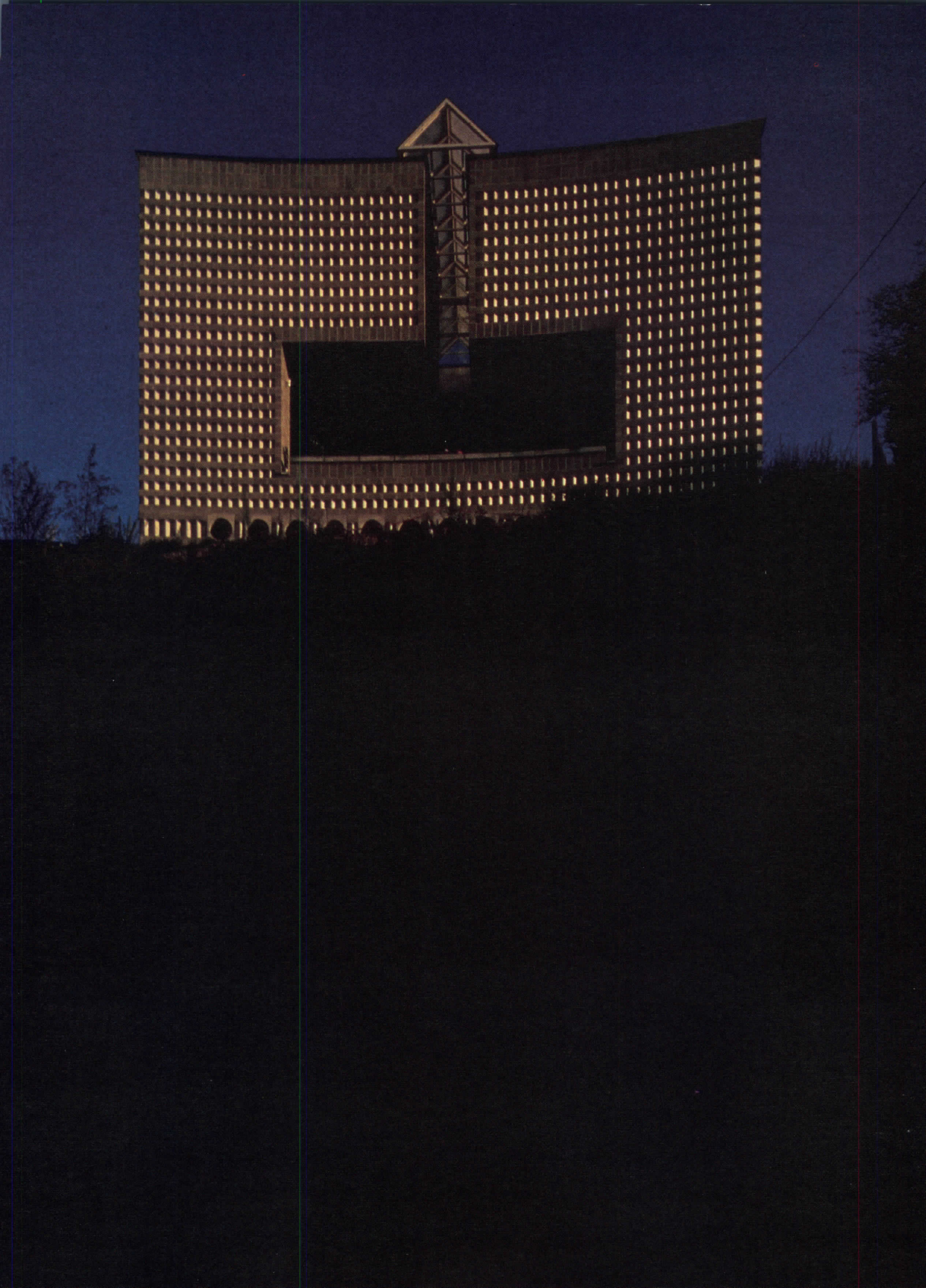



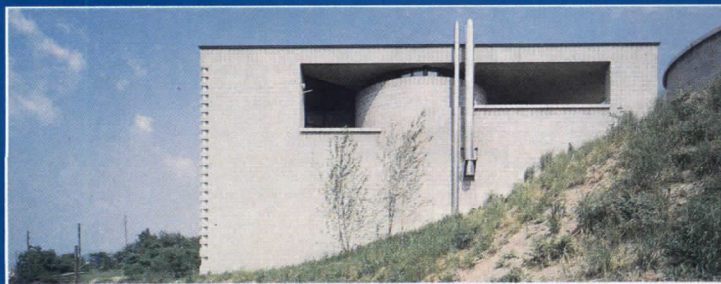

Situated on the crest of a lush but jagged hill, the house marks the point of transition from the shelter of the mountain range behind it to the clearing of the valley below. The severity of the house's rectilinear volume is softened by the curved south facade (opposite). The pedimented skylight spanning the north-south axis binds the deep incision through the length of the house and filters light into the three floors. The play of light on the alternating bands of silver-painted concrete bricks set at 45-degree angles (detail top left) transforms the mood of house throughout the day. Botto has chiseled into the facade, creating an enclosed balcony that looks over the village and clearly defines the piano nobile. Recalling the residential commissions of Botto's compatriot Le Corbusier, in particular his Villa Savoie at Poissy, the entrance to the house is at the back (center left). One is thus required to proceed up and around the west side of the house (not shown), to again confront the rectangular box's impenetrability, before following the curved wall on the north side to reach the hidden front door. The east elevation (bottom right) shows its anonymous face to the open countryside. For Botto, who defines a building as "something between the earth and the sky," the critical task of the architect is to establish a reciprocal relationship between the site and what the architect builds on it. Whereas the thickness of the exterior concrete block walls might seem to imply an inwardly focused interior, the main facade—which generously admits and reflects sunlight—reveals the actual symbiosis between the house and the surrounding landscape. Botto comments, "Architecture needs a territory to find motivation for its existence, and a territory needs architecture to be qualified as man's environment."

The third-floor entrance to the house opens to a stairwell inserted into a grand-piano-shaped niche by a metal grid (right). The staircase descends to the main living spaces of the piano nobile—where Botta's own *Seconda chair* and *Terzo table* make up the informal dining area (below). The slate floors, concrete block walls coated with white plaster, exposed reinforced-concrete ceilings, and iron window frames and stair railings comprise the stark, texturally varied palette of the interior. In contrast to the flood of daylight that permeates the triangular stairwell, the similarly shaped porch is almost always cast in deep shadow (opposite top). A recessed column of windows located opposite the top landing of the staircase, reinforces the already dominant central axis of the house (opposite below) and suggests why critics have taken Botta to task for relying too heavily on symmetry for both internal and external organization. Although Botta maintains that symmetry is "just an instrument," one of many at any architect's disposal, he does admit "I do often try to break the symmetry. And I often cannot do it."



Posterla Residence
Morbio Superiore
Switzerland

Owner:

Edmondo Posterla

Architect:

Mario Botta

via Lavizzari, 10

6900 Lugano

Switzerland

Mario Botta, principal-in-charge;

Giuliano Caldelari and Ferruccio

Robbiani, project team

Photographer:

©Lorenzo Bianda

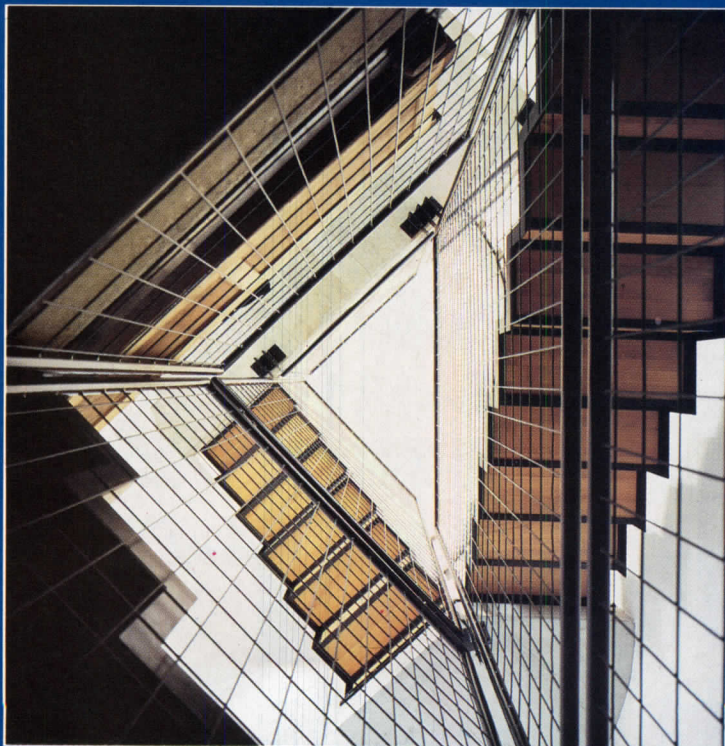

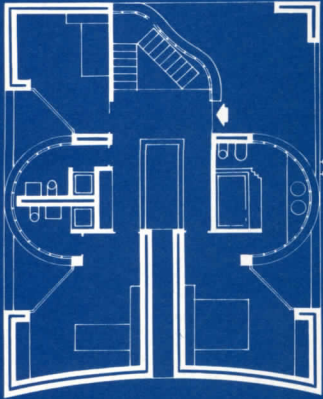

THIRD FLOOR

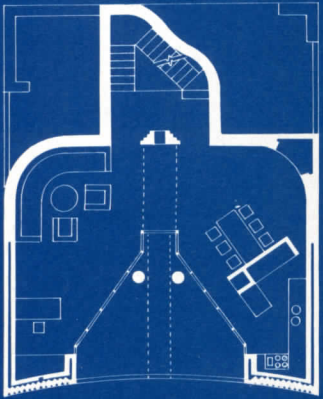

SECOND FLOOR

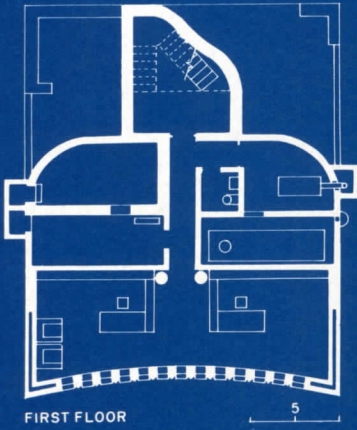

FIRST FLOOR



Grove House
San Diego County, California
Smith & Others, Architects



Consider the avocado





For many years the Baron family took weekend drives from their home near San Diego into the hills north of the city, where they owned an eight-acre avocado orchard. They would sit around a picnic table in the shade of the gnarled trees and talk about building a house there some day. When they first came to the grove, the surrounding slopes were open countryside, with distant glimpses of the Pacific beyond wild flowers and chaparral. But by the time Anne and Don Baron commissioned Smith & Others to design their rural home, suburbia had begun to creep up the hillside. As an oasis, the grove became all the more precious, and clients and architects agreed that any new construction should alter nature as little as possible. Smith & Others situated the house at the heart of the orchard, where it could enjoy privacy on every side, but minimized the intrusion by partially burying the two-story structure in the slope and deploying a guest house and workshop as separate pavilions. Before working out the specifics of interior layouts, the architects narrowed the shell of the main house into a vessel 88 feet long and 16 feet wide that could slide into one row of the orchard. In memory of the four trees that had to be felled, four rounded "treetops" were cut out of a false-front roofline, and a "trunk" carved from the stucco wall below (preceding pages). In the same lightly fanciful vein, the guest cottage (far right in top photo opposite) looks as though it has been split away from the gable end of the house, to which it remains attached by a wooden deck; the workshop-storage building (at right in lower photo opposite) is a squat tower whose open latticed belvedere pokes above the foliage like a windmill or a child's fort, to provide the Barons' only view outside the glade.

The elongation of the house accentuated the different aspects of its two main facades: the uphill "villa" front greets visitors with an elegant sweep of terrace and lawn; the downhill "farmhouse" side (opposite below and overleaf) is a cheerfully utilitarian place where family and hired hands pass to and fro with muddy boots and tools and baskets of avocados. Not that the Barons lead a strictly upstairs-downstairs existence: Smith & Others put the master bedroom on the lower level (the Barons asked for a dim, quiet lair), and left down-home touches all through the house, beginning with a shotgun plan. Along with plenty of rustic stone, there are corrugated-fiberglass barn skylights, a country kitchen, and a live-in front porch with garage-door walls that slide up for natural ventilation. Kathy McCormick, who mixed Smith & Others' palette, started out by gathering soil samples, avocados, leaves, and other bits of local color for inspiration. One charming exception to these indigenous hues is a blue-green based on the turquoise finish of Anne Baron's prize California antique, a vintage Mustang. *D. B.*

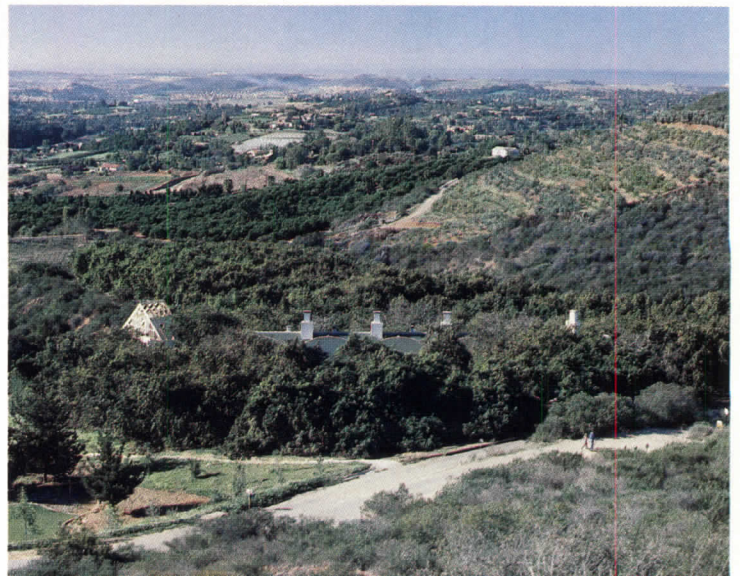
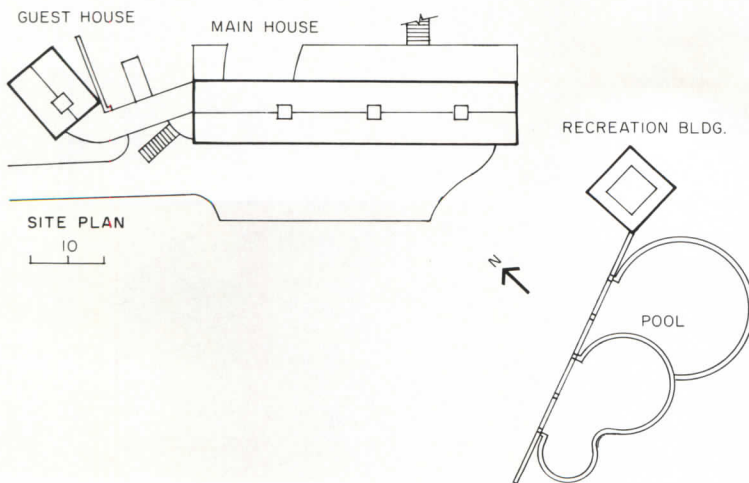

When Ted Smith and his associates were ready to present their design to the Barons, they displayed the model on a picnic table in the avocado grove. The finished 2,200-square-foot building now stands on exactly the same spot. Only the rippled crown of the yellow stucco facade, the stacks of chimneys and heat ventilators, and the latticed gazebo atop the workshop tower are visible above the surrounding trees (opposite below).

Driveways and walks follow existing paths through the grove. The gap between the main house and the guest cottage (upper photo below) forms a gateway, signaling the entrance for visitors. On the far side of the railed deck, steps lead down to a lower story tucked into the hillside.



In addition to conducting busy professional lives, the Barons maintain the grove as a working orchard. As befits this agricultural enterprise, the composition of the south facade (below) artfully recalls the unselfconscious patchwork of rural sheds. Smith & Others selected green roof shingles as an appropriately generic material, and painted an exterior wainscot where farmyard dirt needs to be hosed

down. Rustic skylights illuminate a porch (opposite top left) and kitchen-living room (opposite top right and bottom left), which has cabinetwork and a table designed by Kathy McCormick. The porch floor of Red River rock covers a deep masonry heat sink. Overhead garage-door windows combine with roof-mounted ventilators to draw breezes indoors.

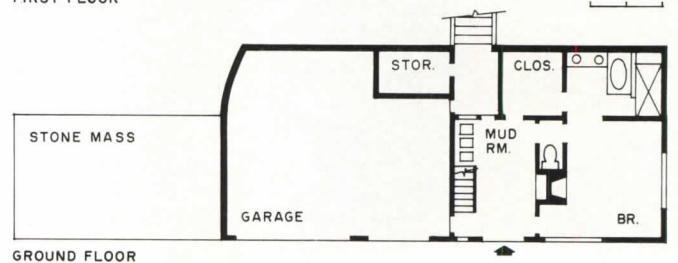
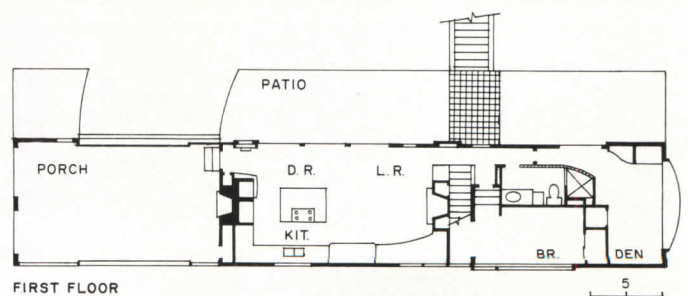

Grove House
San Diego County, California
Owners:
Anne and Don Baron
Architects:
Smith & Others
12712 Via Donada
Del Mar, California 92014
Ted Smith, Kathy McCormick, John
Oleinik, design team

Engineer:
Larry Horseman
General contractor:
Jim Hightower
Photographer:
Stephen Simpson



In perpetuum



Farmhouse in Connecticut
Allan Greenberg, Architect



RECORD invited Paul Goldberger, *Architecture Critic of The New York Times*, to appraise what is, by any criterion, a major Classical design. Our article omits the usual complement of site and floor plans at the express request of the owners. D. B.

Classicism is a serious business for Allan Greenberg. His architecture has little to do with the ironic and witty plays on Classical themes that are so common in this age of Postmodern flamboyance—in its way, Greenberg's architecture is as far from Postmodernism as the work of Mies van der Rohe. Indeed, there is something not unlike Mies in Greenberg's work: it, too, is a kind of Platonic quest for perfection in a certain language, and it, too, emerges out of a deep conviction that there is a right way to make architecture. This sprawling Georgian house on a rural site in Connecticut exemplifies Greenberg's stance. It is an ambitious and grandiose house, larger by half than the Mount Vernon that inspired it, and altogether lacking in the curious mix of sophistication and provincialism that energizes Mount Vernon. This house is made all of knowledge, not of instinct; it is a measured, sober essay in Classicism, its every dormer and bracket emanating an erudite love of Classical architecture. But, for all its deliberate quality, this house is not "about" Classicism, as the classicizing designs of so many of Greenberg's peers might be said to be; Greenberg is more interested in practicing the Classical language than in commenting on it.

It is difficult, for all the importance of the architectural issues this house raises, not to speak first of its scale, for a house of this stature would be impressive in any mode today. The main wing is roughly 120 feet long, with attached side pavilions large enough to permit a full-size swimming pool to be within one of them. It commands its expansive, rolling site with self-assurance, presenting its grander facade containing a full-length portico to the open landscape and its more restrained front to the entry drive. The building is thus in the tradition of country houses that open primarily to their gardens and which, despite their rural or semirural settings, offer a formal, almost urban, face at their front door. But most direct, of course, is the connection between this house and Mount Vernon and, by implication at least, to such descendants of Mount Vernon as Stanford White and Theodore Pope Riddle's Hill-Stead. Greenberg did not copy Mount Vernon literally; he not only changed the scale significantly, he altered many of the details. The entry facade is cleaned up considerably, and made symmetrical. The most conspicuous result of both the increase in size and the greater order is to create a sense of vast, clean space; the white-painted facade with its false rustication seems to go on and on. But it feels as if it were pulled taut over this large form—there is a precision to Greenberg's detailing that keeps this mass from appearing bloated.

It is not hard to sense Greenberg's love of the Italian Baroque here; he has more than just acknowledged the relationship between Italian Classicism and American Colonial architecture, he has intentionally exaggerated it. And it is through all of this that the facade acquires the rhythms that bring it to life: such details as the molding around the oval window in the central pediment, the huge brackets that anchor each end of the pediment, and the composition of Ionic pilasters and sumptuous scrollwork over the front door together bring a rich texture, and create a kind of drama in a facade that, without them, could run the danger of being precise to the point of primness. The entry facade thus has a kind of positive tension; it is almost a dialectic between a precise and highly ordered version of American Colonial architecture and the more sensuous, brooding power of the Baroque. On the garden facade, however, there is no such tension—a colonnade of paired Tuscan columns sets a gentle rhythm, and the detailing is understated. The mood is quieter here; despite the grandeur of the columns, this facade is clearly a less formal front, a great veranda open to the landscape rather than a portico. Greenberg's decision to pair the columns was critical; it gives this facade a rhythmic proportion that it would otherwise lack, as well as looking back to Classical precedent before American Colonial architecture, as the Baroque allusions in the entry facade do.

The formality of the entry facade is enhanced by the presence of the two side wings, which are placed at right angles to that facade to form what is in effect a three-sided forecourt. Graceful curving arcades do

much to energize this outdoor space, which is defined and partially enclosed on its fourth side by careful planting of trees. The side wings are detailed in a manner consistent with the main house; they acknowledge their subsidiary status not only by their placement and scale, however, but by a slight understatement of detail. One side wing contains a garage and service functions; the other, essentially similar on the exterior, contains the swimming pool. It is not a little startling to find a swimming pool behind Palladian windows, though the barrel-vaulted space that it has been given makes a successful transition from the architectural themes of the structure itself to the mood of an indoor pool, for it gives the space a clear but unaggressive monumentality.

The plan is rigorously formal. A central hall spans the house from front to back, and on the rare occasions when the doors are left open, the view through the house from one landscape to another is an extraordinary one of nature placed securely within Greenberg's Classical frame. The rooms are large, but not overwhelming; if anything, they seem the result of an attempt to strike a careful balance between normal domestic scale and the rather larger scale of this house. Despite Greenberg's oft-professed affection for the work of Lutyens, he has kept all eccentricity of interior space far away from here. There are no double-height or round spaces or tricks of any kind. It is in tiny phrasings of detail rather than in grand gestures of space that Greenberg's ability to manipulate the Classical language is most convincing. (It is here, too, that the remarkable quality of workmanship in this house is most apparent.) The chimneypieces alone tell the story: In the sitting room used as an informal family gathering place, a mantelpiece emerges with utter restraint and control from walls paneled in the same wood. In one of the two more formal living rooms, the voltage is turned up a bit in a somewhat more elaborate mantel with dentil moldings, while in the library, the main living room, the mantel is supported on brackets and the chimneypiece decorated with a band of circles. In another room, meanwhile, the mantel is Adamesque.

The cornice moldings are one of Greenberg's favorite variations on Classical precedent. Unlike most cornices, in which brackets along each side stop short of the corner, which remains a void, some of Greenberg's cornices have an extra bracket on the diagonal, to visually bring the molding around the corner. So, too, above the arched window on the main landing has he topped pilasters and architrave with diagonal modillions. It is not exactly an earth-shattering event—but it is a significant reminder that Greenberg remains committed to using Classicism as a vocabulary within which he can invent, not as a source that he must only take literally. What also prevents this house from becoming cloyingly "Colonial" was the decision of the owners, who are noted collectors of postwar American art, to display their collection here amidst American antiques. Thus there are such startling presences as an Andy Warhol portrait of Marilyn Monroe above one of the fireplaces, a Lichtenstein in the entry hall, and Warhol's *Mona Lisa* sharing a wall on the main stair with a grandfather clock. These juxtapositions work in part because of the high quality of the collection—just any modern art would hardly be at home in a setting of this caliber—and in part because the leap over time they represent helps this house to transcend the limits of any period design. So, too, with the important Art Deco furniture that the owners brought from their previous residence (a Robert Venturi house completed in the early 1970s), which fills a sitting room in this house, entering into easy, if unusual, dialogue with the architecture that enriches both. The modern art and the Art Deco furniture in effect make more conspicuous and easier to understand the point made by Greenberg's inventiveness of detail—that this is not a piece of colonial Williamsburg, but a structure built in the 1980s. It was not only made in our time, it was conceived for our time: Allan Greenberg's belief is not that Classicism is something of the past that our age would do well to return to, but that it is as much a living and changing style as any other. *Paul Goldberger*

The ancestry of Greenberg's parti, a great central block with flanking pavilions attached by quadrants, reaches back to Mount Vernon and beyond, to Palladio. As in the Italian villas and English country houses that embody this lineage, the symmetrically spread mass extends a gesture of dominion over the surrounding landscape (a cupola originally proposed for the center of the roof would have made this

gesture even more emphatic). Barrel-vaulted arcades (center photos) and a portico on the main garden front (top photo) ease the transition between architectural order and its natural environs, as do, at more intimate scale, elegant ranges of picket fence, matched allées of lindens bounding the entry forecourt (preceding pages and bottom right), and stone terraces reminiscent of collaborative designs

by Edwin Lutyens and Gertrude Jekyll. Pavers and plinths are the same red Indian sandstone that Lutyens used in his Viceroy's House at New Delhi. Facing the house from the courtyard, the pavilions to either side of the main frontispiece enclose a garage and service areas to the left and an indoor swimming pool, to the right.

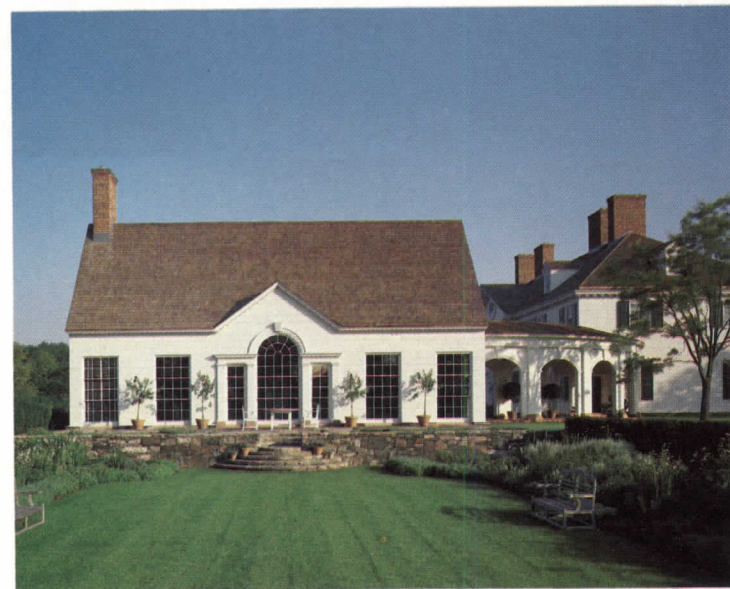



Farmhouse in Connecticut

Architect:

Allan Greenberg, Architect
31 High Street

New Haven, Connecticut 06510

Allan Greenberg, principal; James H. Jorgenson, project architect; Richard Wies, Robert Orr, Jacquelin Gargus, Eric Oliner, Jacob Albert, J. M. B. McWilliams, Elizabeth Masters, Raymond L. Drouin, design team

Engineers:

Tor & Partners (structural); Harold Mindell (mechanical)

Interior consultant:

Johnson Wanzenberg & Associates

Woodwork:

Eisenhardt Mills, Inc.; Lititz Planing Mills, Inc.; Breakfast Woodwork

Landscape:

Deborah Nevins; Russell Page

General contractors:

Thomas P. Maguire, Inc.; Hayes Creative Woodwork

Photographer:

©Peter Mauss/ESTO



When they are open, the doors at both ends of the broad center hall frame a vista through the house from entry court to portico and lawn. The contrast between the broken-pedimented tabernacle of the garden-front portal (top, this page) and the simpler surrounds of other doorways in the hall exemplifies Greenberg's creative manipulation of Classical ornament to define architectural hierarchies. The intensity and finesse of his invention are epitomized in the open-newel staircase, a virtuoso turn of design and joinery that deserves to be admired as a work of sculpture. Characteristic details, grounded in the Classical canon but unmistakably original, are the many-layered overlap of stringers, risers, and nosing, and the polygonal finial that terminates the curve of the railing above a fluted newel post. A subtle refinement that recurs elsewhere is the angled corner modillion, introduced in the cornice of the arched landing window (bottom, this page). Though the detailing applied to other rooms varies according to decorum and use, it sustains the same degree of fastidious articulation (see, for example, the bathroom illustrated on pages 172-173). **Overleaf:** A small parlor (1) is one of the few rooms in the house where furniture and art combine with interior architecture to compose a thorough period piece. The dining room (2) brings together 18th-century wallpaper and antiques with bold new cabinetwork by Greenberg. Another chamber (3) is a relatively spare showcase for some of the owners' museum-quality Art Deco furniture and decorative objects. In the cherry-paneled sitting room used for informal family gatherings (4), as throughout the house, contemporary American art engages in a dialogue with Classical architecture. Andy Warhol's portrait of Marilyn Monroe adorns the library chimneypiece (pages 118-119). Part of the cornice molding above a flanking wall is hinged to release a retractable movie screen. Behind correctly Georgian facades, the barrel-vaulted swimming pool (pages 120-121) has the air of a Beaux-Arts public bath. Triple-sash windows give onto a terraced garden.













Ito House
Tokyo, Japan
Toyo Ito Architect & Associates

Silver Hut

A simple, poetic impulse governed the design of Toyo Ito's residence: to live close to nature while living within the city. Indeed, the "Silver Hut"—so named by the architect—is an airy dwelling, flooded by sunshine and animated with ever-evolving images of cast shadows and reflected light. The open organization of the house is patterned after *minka*-style houses, traditional, primitive log huts common to rural Japan. The fabric of the building, however, has little in common with traditional materials and techniques. Translucent walls and hovering vaults float like sheets of supple, metallic cloth within the confines of a tight, wooded lot.

The "Silver Hut" backs directly onto the plot where Ito built a home for his sister in 1976. Without so much as a narrow alley between them, the street in front of the brother's residence is as near to the house as a motor vehicle dares approach. Set slightly askew from the lot lines, and deep within the site, the house is accessible only by a flight of stairs cut into an earthen embankment. Before the flagstone path meandering through a small grove of trees brings one to the house proper, one's eyes "enter" the courtyard through its screen of perforated metal. All other rooms cluster around the courtyard: a living room, dining room, kitchen, study, bedrooms, and a tatami room (page 126), each sheltered beneath its own vault. The entire house is one story except for the bedrooms. Ito's daughter's bedroom is on a raised deck under the lower left vault pictured at right; the parents' bedroom, within the same vaulted unit, is slightly sunken beneath the courtyard level (section on facing page).

The house is structured with independent concrete columns positioned on an 11.8-foot module (each module equals eight tatami—a tatami being the measure of a standard straw floor mat). The seven vaulted roofs supported by the columns are space frames made from rhombic units bent slightly inward at the center. The vault over the courtyard, which covers twice the span of the other vaults, comprises rhombic units approximately 3.3 feet long. The smaller vaults have units approximately two feet long. Components for the frame were factory manufactured and assembled on site using high-tension bolts. Because there are no bearing walls around the courtyard (the vaults rest on beams), the structure permits open, lateral space like that found in Japan's traditional wooden architecture. The openness is lyrically articulated with infill partitions of perforated aluminum sheets, white paper shoji screens, translucent fabric, and glass, each allowing nature to filter into the "Silver Hut" from the sky and the arbor. As Ito intended, once inside the house, one soon forgets that Tokyo lies just beyond the garden gate. *Darl Rastorfer*

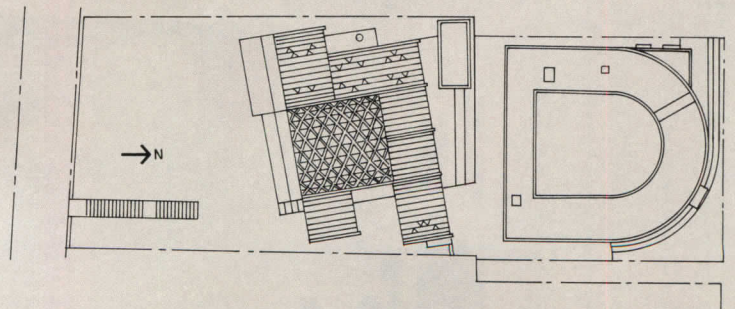
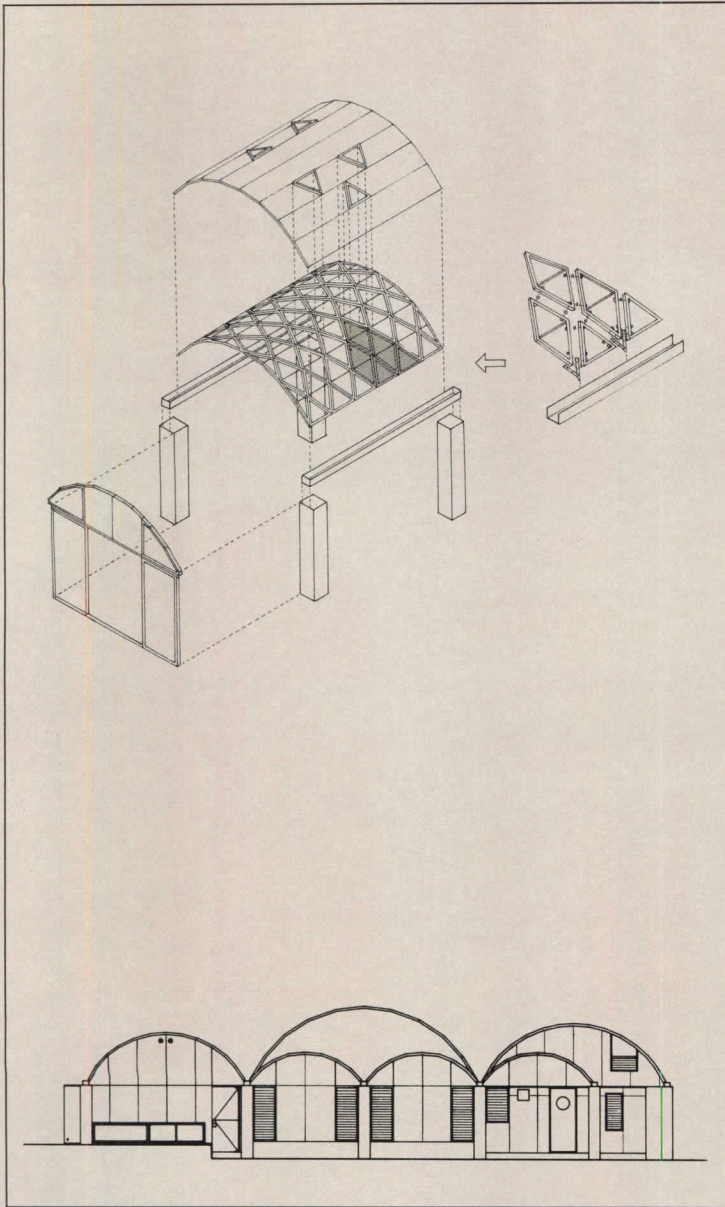



The segmented axonometric at far left articulates the major elements of the construction system: concrete columns, steel beams, steel space frame, and flat-seam aluminum roofing with an interior finish of perforated asbestos-cement board. The end wall is infilled with perforated aluminum sheet metal. Lower drawing is a transverse section through the courtyard. The site plan, left, delineates the Silver

Hut and the curvilinear courtyard house Ito designed for his sister. The lateral section at right reveals the stacked bedroom suite and kitchen (for more details of the kitchen, see pages 170-171).

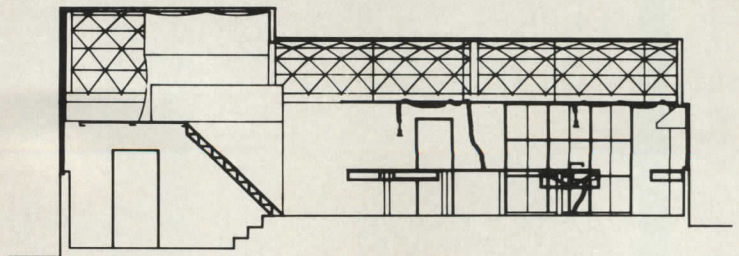







The true living room of the house is its courtyard (previous two pages and top right). Defined by a space frame twice as wide as the typical span, the vault is nearly half covered with a fixed fabric membrane. One can screen the otherwise open room from the sun and rain by drawing a fabric curtain across the vault with a rope on pulleys. Reached from the entrance corridor (lower right) a family room with traditional details has been given a quiet corner of the complex. Here, the eight-tatami measure of the column module is represented by actual straw mats in place on the floor (opposite). Other traditional features include shoji screens and a gnarled, log-framed niche containing an antique chest-of-drawers (both the framing elements and the chest came from an older Ito family house). Compared to the visual transparency of the other rooms in the house, the tatami room seems still and enclosed. Its lighting is nothing short of magical, with sparkle on opaque walls and the floor from the clear skylights overhead and baffled light radiating from a pair of shoji screens near the courtyard.



Ito House
 Tokyo, Japan
Architects:
 Toyo Ito Architect & Associates
 10-12, Minamiaoyama 5-chome
 Minato-ku, Tokyo
 Toyo Ito, architect-in-charge;
 Kazumichi Imura
Engineers:
 Gengo Matsui and ORS (structural);
 Yamazaki Structural Engineers
 (mechanical)
General contractor:
 Bau Construction Co., Ltd.
Furniture design:
 Teruaki Ohasi
Photographer:
 Tomio Ohashi

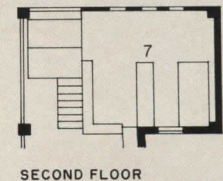
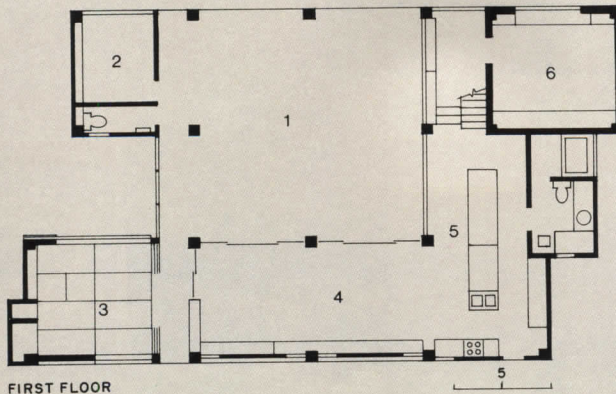

1. Courtyard
2. Study
3. Tatami room
4. Living/dining room
5. Kitchen
6. Parents' bedroom
7. Daughter's bedroom



Farmhouse fantasia



Kahn Residence
Lima, Ohio
Hugh Newell Jacobsen, Architect



For all the domestic recall evoked as one approaches the front door (preceding page), this house takes on much more grandeur as one views the major, side facades (above). For all the allusion, very careful design control and discipline avoid any overtones of the quaintness or frilliness sometimes encountered in Gothic Revival in less sure hands.

When asked the “whys” of his design for this romantic country house, Hugh Jacobsen recalls that—on meeting his clients, Dr. and Mrs. James Kahn, and their winsome array of four small children—he immediately envisioned “Louisa May Alcott time.”

The house *does* conjure up that warm, comfortable appeal—in a gentle recall of American Carpenter Gothic, sparked by a dash of the stateliness of Walpole’s Strawberry Hill. Though essentially very Modern, with all its glass and sophisticated interiors, it is also decidedly in the best Ohio farmhouse vernacular: white, wood-framed, and multi-gabled, with a tidy red-brown “barn.”

Indeed, the land was a farm 20 years ago, “since gone to seed, with lots of pulpy-green Osage oranges, and one ‘real tree’—an elm.” That tree was dramatized as the pivot for the entrance turnaround. The site was developed simply, by clearing the immediate grounds for the house and the entrance and service drives, and by cutting through two *allées* to make vistas for the main living rooms. A formal redbud orchard was planted to flank dining-room windows and the sky-blue-roofed front porch. Parts of the lawn about the house are defined by a minuscule white picket fence.

The house itself is big, spacious, and well suited to a large family. The exterior is economically surfaced with plywood board-and-batten, with the rhythmic battens carefully aligned with the standing seams of the painted galvanized-tin roof. Four massive chimneys join the oval-windowed gables and the glazed cupola to form a fanciful skyline, further accented by a bevy of ornamental lightning rods.

The basic, rectangular block of the house is modulated by five bays of double-hung, floor-to-ceiling windows. It is extended by the porch and a family room at opposite ends. The barn-like, four-car garage is linked to the house by a trellised “breezeway”—glazed here against the elements. Above the garage is a separate suite for visiting grandparents.

The main floor of the house centers on a mirror- and closet-lined hall, which widens two-thirds of the way down to dramatize (as Jacobsen calls it) a “Scarlett O’Hara” staircase. On the right are the three major rooms (living room, music room, and library), separated by folding, louvered doors—much as in the old “double parlors.” To the left, also *en suite*, are dining room, pantry, and a big “country style” kitchen and breakfast room. Above are five bedrooms off a hall topped by the glazed cupola, and an attic playroom where the four oval-windowed gables afford a cranny for each of the children. For privacy or crowded festivities—the house is commodious and well organized. A modern Mr. Pickwick would feel right at home! *Herbert L. Smith, Jr.*

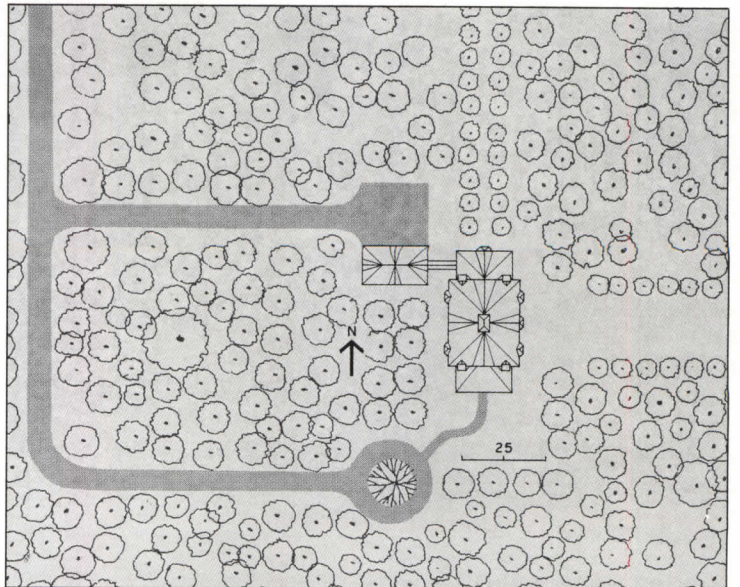



Openness and light are pervading characteristics of the crisp, white interiors of the Kahn house. Not only do the ten-foot, floor-to-ceiling, shuttered windows and bays afford an extraordinary amount of glass and controllable natural light, but ceiling-height doors and folding, lowered walls allow all the main-floor rooms to be closed off or opened to each other at will. For big gatherings, the entire level can be thrown together in one flowing space. A judicious use of room-height mirrors increases the impact, as in the dining room (bottom right). And so does the continuity of the white, drywall-surfaced walls and ceilings. Polished-wood floors are also continuous through the living spaces, with area rugs to help define "rooms" when the doors are open. At night, a carefully studied array of downlights and wall washers (including exterior lights on the trees and at each bay window) continues the sense of brightness and cheer. The feeling of space also extends in a vertical sense. From the entrance, the eye is immediately drawn to the green-carpeted stair, whose half-landing forms a sort of "Romeo and Juliet" balcony overlooking the gabled family room (opposite). And, on arriving at the bedroom level, the space soars up through a big light-well to the glazed cupola.

Kahn Residence
Lima, Ohio

Owners:

Dr. & Mrs. James Kahn

Architect:

Hugh Newell Jacobsen

2529 P Street, N.W.

Washington, D.C. 20007

Rodger Speas, project architect

Engineers:

Kraas & Mok Structural Engineers

Photographer:

Mick Hales

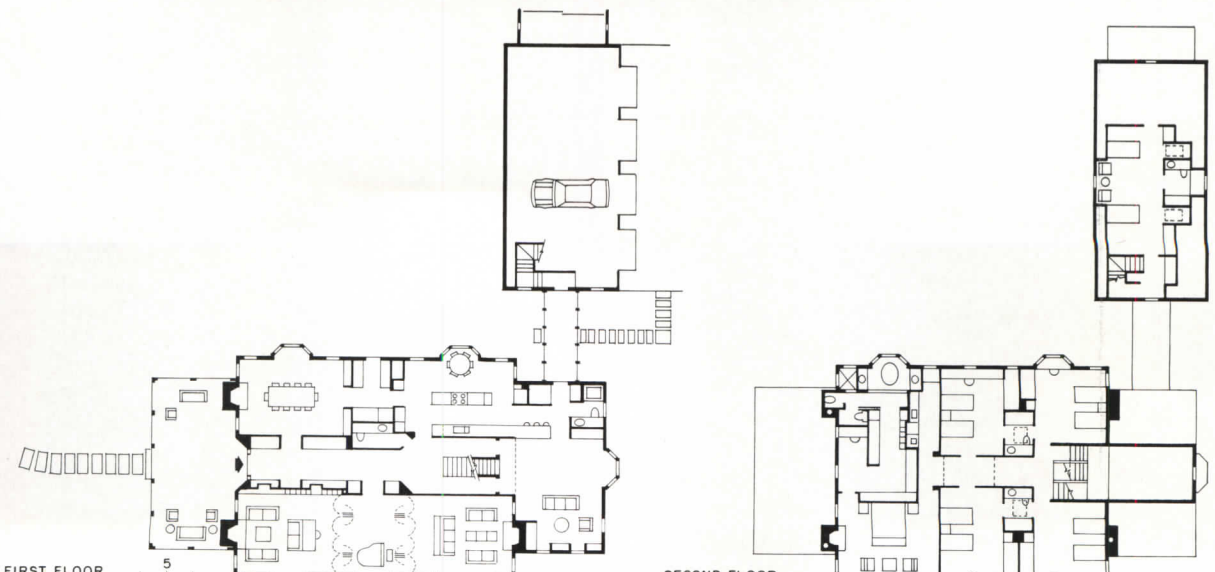



Temperate zone



Vilanova House
Key Biscayne, Florida
Andres Duany and Elizabeth
Plater-Zyberk, Architects





The Vilanova House is admirably sited between one of Key Biscayne's intimate canals and the Atlantic Ocean. In order to open up striking views of a palm grove and the ocean from a small terrace off the master bedroom, the architects drew apart two piers of a tetrastyle temple (below). Another terrace (opposite) occupies the rooftop of a podium that conceals a three-car garage and a tiny walled garden.

The Miami that dwells in the minds of architects Andres Duany and Elizabeth Plater-Zyberk bears little resemblance to most people's image of the Florida metropolis. Endowed with an almost stoic temperance, their work is a persistent reminder that, beyond Arquitectonica's sizzling Modernism and Morris Lapidus's glitzy beachfront hotels, the city also boasts a substantive architectural tradition of Mediterranean classicism. Not content merely to resurrect the decorative revival styles of the early 20th century, however, Duany and Plater-Zyberk have elected to gaze deeply into the past—all the way back, in fact, to early Greek civilization, where they have unearthed a mode of design that both satisfies their quest for Miami's architectural roots and seems ideally suited to south Florida's subtropical climate.

If Duany and Plater-Zyberk have looked to the architecture of the ancients as their ideological wellspring, it is the Erechtheum that served as the specific historic prototype for a 6,450-square-foot house located on a street of unassuming postwar ranches and split levels in Key Biscayne. The house is a conscientious attempt to translate the urban character of that idiosyncratic Hellenistic structure into a cool, inward-looking suburban villa. (The Erechtheum was selected as a model, says Duany, partly because its "imperfect classicism" can be adapted to the functional requirements of a contemporary house.) Two unornamented tetrastyle temples—the larger one covering a terrace off the master bedroom, the smaller one defining the main entrance—echo the relationship between the Erechtheum's east front and its famous Porch of the Maidens. By positioning the house atop a high podium, the architects ingeniously met the flood criteria of Miami's building code while infusing the structure with what Duany calls "perceptual ziggurating," most evident when one approaches the house along the diagonal line formed by an angled garden wall and an off-axis pergola (photo below and site plan right). Always mindful of the primacy of volume over wall plane, they reinforced the notion of thickness by utilizing stout piers instead of columns, wood strip moldings painted the same buff color as stucco-covered walls, and a hierarchy of facade-opening depths ranging from four-inch bathroom-window reveals to a 15-foot-deep loggia off the living room.

Given the deliberate asymmetry that characterizes the exterior elevations, the carefully composed interior comes as no surprise. Although the owners, a young couple with one child, appear to have settled comfortably into the house, the building's austere, monumental splendor suggests that Duany and Plater-Zyberk's true calling may well be grandly scaled civic architecture, with its spiritual kinship to the Greek ideals they so admire. *P. M. S.*

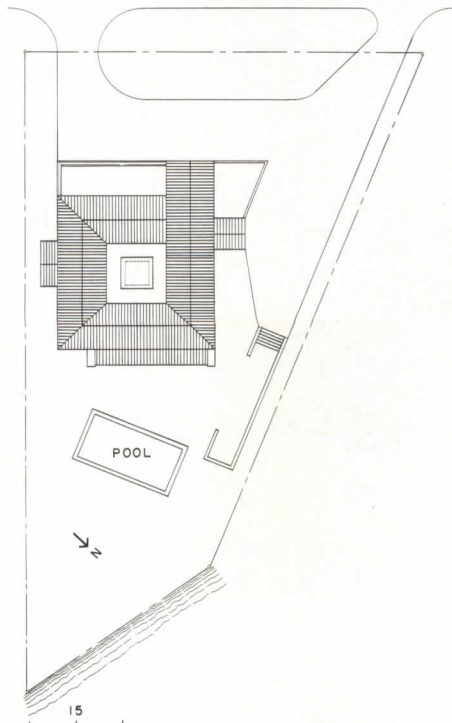

The interior of the Vilanova House boasts a visual richness that derives less from materials—a prosaic palette of drywall, thin furring-strip moldings, and concrete tile floors—than from the thoughtful manipulation of volumes. Seen in plan or section, the house emerges as a series of three boxes within boxes. The central box is a 20-foot-square, double-height living room (opposite). Surrounded on two sides by a

second-floor gallery (bottom), this cubical space resembles an atrium, its apparent openess enhanced by a central skylight. The middle box encloses five-foot-wide corridors that are meant, according to Andres Duany, “to slice through thick matter like streets” (below). The 10-foot-wide outer box contains all other public and private rooms.

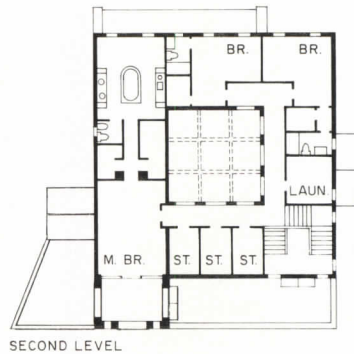
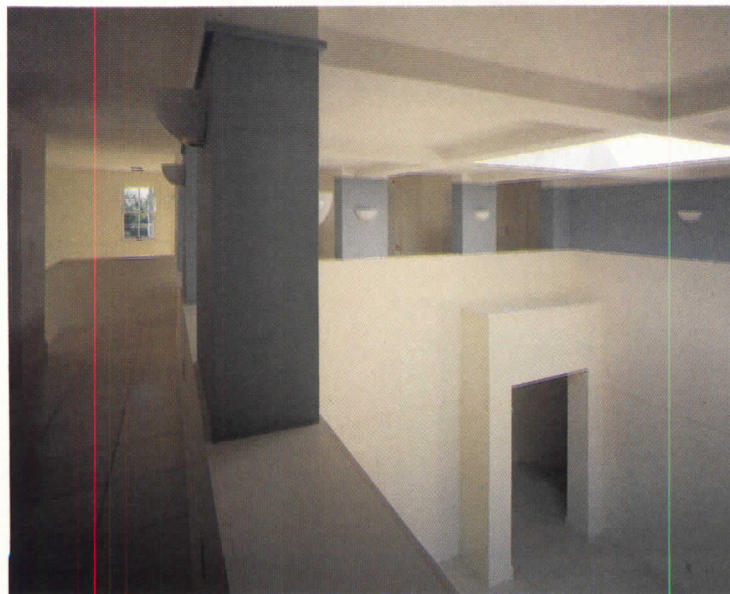

SECOND LEVEL

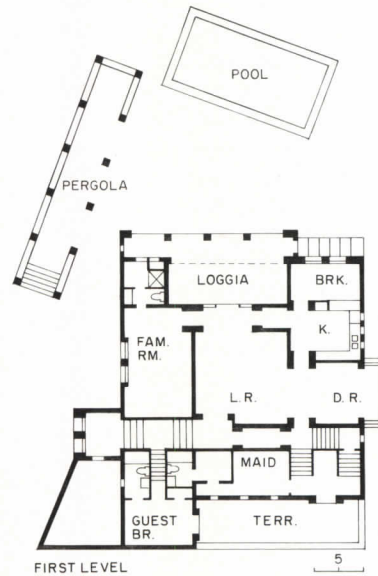

FIRST LEVEL

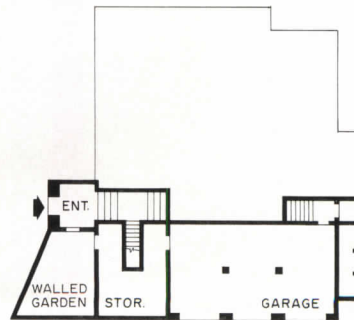

GROUND LEVEL

Vilanova House
Key Biscayne, Florida
Owners:
Mr. and Mrs. Salvador Vilanova
Architects:
Andres Duany and Elizabeth
Plater-Zyberk, Architects
2949 Coconut Avenue
Coconut Grove, Florida 33133
Hortensia Lanio, project manager;
Dan Broggi, Delio Castillo, Anabel
Delgado, Manuel Fernandez, Patricia

Marbin, Derrick Smith, project team
Engineers:
Eugenio Santiago and Associates
(structural); Victor Reeve
(mechanical/electrical)
General contractor:
Vernon Construction
Photographer:
© Timothy Hursley/
The Arkansas Office



A separate peace



Like most happy parents, the owners of this year-round Maine retreat accept the fact that they and their children will not always see eye to eye. In this household, both mother and father are given to quiet pursuits—she paints, he sails—while the teenage son plays the electric guitar and the daughter likes nothing better than a carload of guests. The seclusion of a 50-acre bayfront tract contributes immeasurably to domestic tranquility, as does the privacy of living quarters dispersed among separate pavilions—in plan, at least, rather like the cabins of an old-fashioned camp (axonometric overleaf). Architect Peter Forbes placed the living room, dining room, and kitchen in one structure (opposite), the parents' bedroom and bathroom in a second (above), and childrens' and guests' rooms out of earshot in a third (page 143). The physical drawbacks to outdoor circulation in a northern climate were, in Forbes's and his clients' opinion, outweighed by the esthetic advantage of fitting several small buildings, rather than one large one, into the wilderness. Like-minded discretion suggested the site within a grove of birch and spruce, set back from the rocky shore. Of course, buildings do not actually vanish among the trees—nor should they, argues Forbes, who strove for a subtle harmony played equally by art and nature. This counterpoint was already implicit in the owners' stated preference for a



elementary and refined, an architecture of essences. As Forbes describes the genesis of his composition, he began with the schematic image of a linear edge at the boundary of forest and water. By projecting the line into a rectangular volume, and breaking it in two, he established a rudimentary gateway; by splaying the two oblong structures and aligning a third with the cleft between them, he transformed a woodland clearing into a courtyard. Forbes likens this glade to the *temenos*, or sacred precinct, of ancient Greek temples. The kinship does not depend on Classical style, he explains, but derives instead from a common dedication to myth and ceremony—even if the myths of Deer Isle are secular and the rites the quotidian events of family meals, a friend's arrival, or departure for a solitary walk. The processional approach from the outside world, a dirt track through the woods, meanders informally yet, as at a Greek shrine, aligns with architecture to frame views into the surrounding terrain. Although lead-coated roofs, granite masonry, and weathered cedar siding reflect the colors of nature hereabouts (as do, quite literally, walls of glass), Forbes asserts the man-made order of his construction by repeating a basic geometry of cubes and pyramids, keyed to a uniform 20-foot module. Massive chimneys stand as reminders that these temples to art and nature are ultimately dedicated to peace around the hearth. *D. B.*

Viewed from the shore of Penobscot Bay (below), two glass-walled pavilions seem to nestle between stone chimneys like sentry boxes flanked by giant gateposts. From other vantage points, the same composition suggests a single dwelling rent asunder by some cataclysmic upheaval, or a pair of cottages built amid the ruins of an earlier mansion. This ruggedly romantic aspect only heightens the

serene order that pervades the clearing on the far side of the promontory (preceding pages and opposite top left). The juxtaposition of weathered cedar with lead-coated copper, split with sawn granite (all from nearby Crotch Island), and details such as concrete Sonotube columns seen through butt-glazed corners (opposite top left), and the recessed linkage of chimneys and pavilions (opposite right) display the

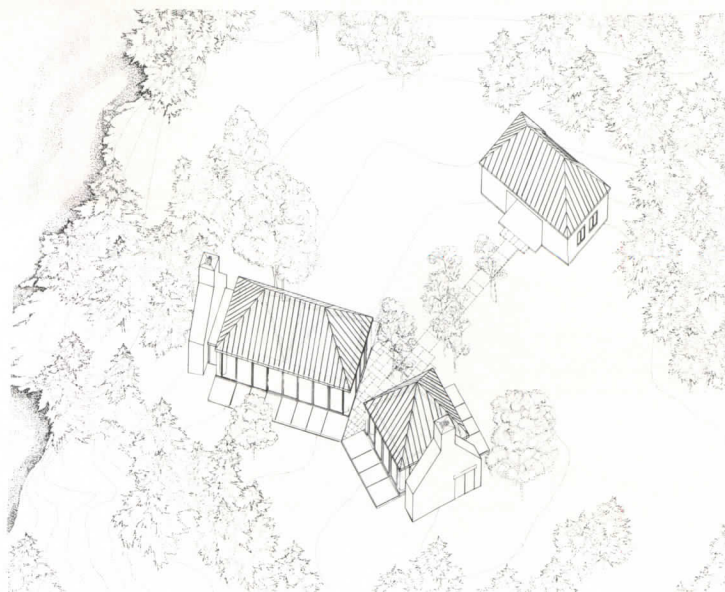

subtlety of Forbes's study in contrasts. Axial alignment of the cedar-clad children's cottage (top left below) with the gap between the glass pavilions reinforces a figurative threshold between civilization and wilderness. Reflective and transparent walls render this confrontation all the more dramatic. To shield glass panels from the elements when the owners are away, timber decks fold up to

lock into fascia-level hooks. The ground beside the decks has been sodded with cuttings from blueberry barrens on the mainland, making a gentle transition to forest undergrowth and lichen-covered rock. About a quarter-mile down the coast, on the next point of land, is a painting studio for one of the owners. Forbes describes the hip-roofed 20-foot cube as "a piece of the house thrown out into the woods."

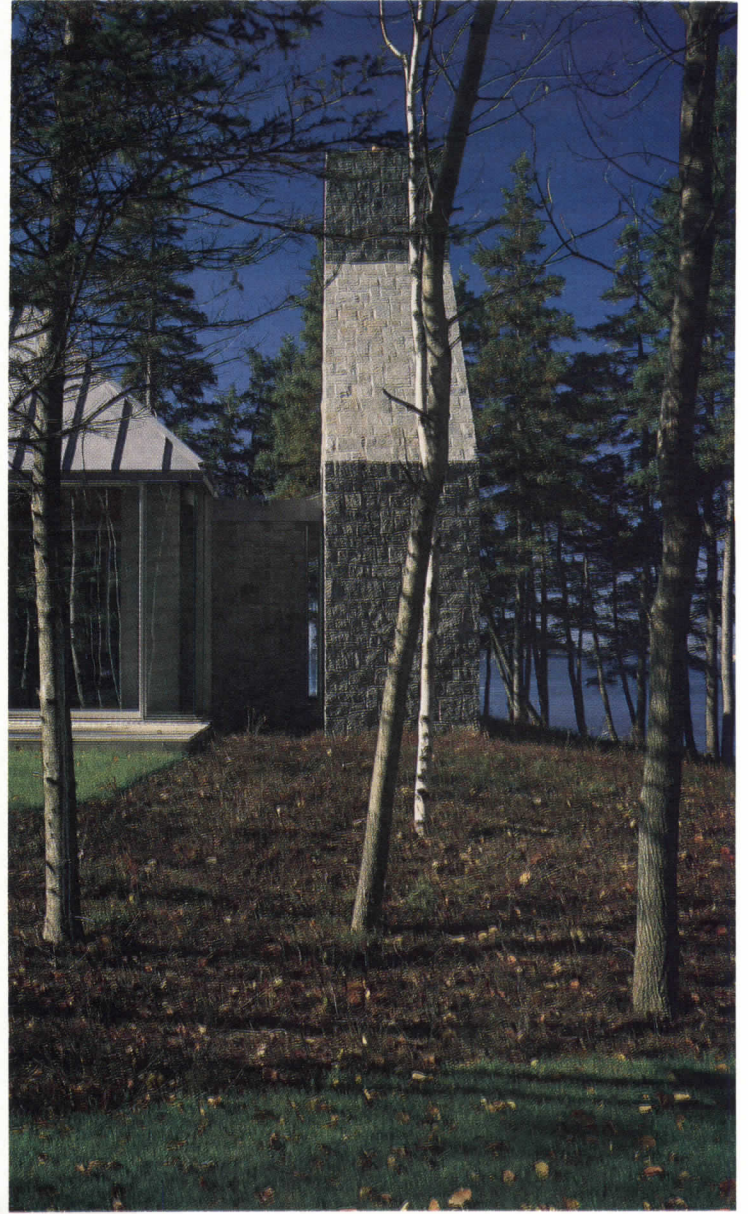

Forbes articulates the enclosure of interior volumes with consistent precision. Vertical steel plates clarify the juncture of concrete columns and tubular roof trusses, as clips separate cedar rafters from the space frame itself. A freestanding half-cylindrical wall partially screens the dining area, the remainder of whose circular plan has been incised into granite pavers. A house-within-a-house contains the

kitchen, a Russian doll motif that Forbes carried to its logical conclusion by designing a similarly proportioned bread box. Le Corbusier's Grand Confort sofa faces another room-within-a-room, the granite inglenook. The other major heat source is a radiant forced-hot-air system in the perimeter of the slab. Mechanical systems are housed in a niche within the chimney, accessible from outside.

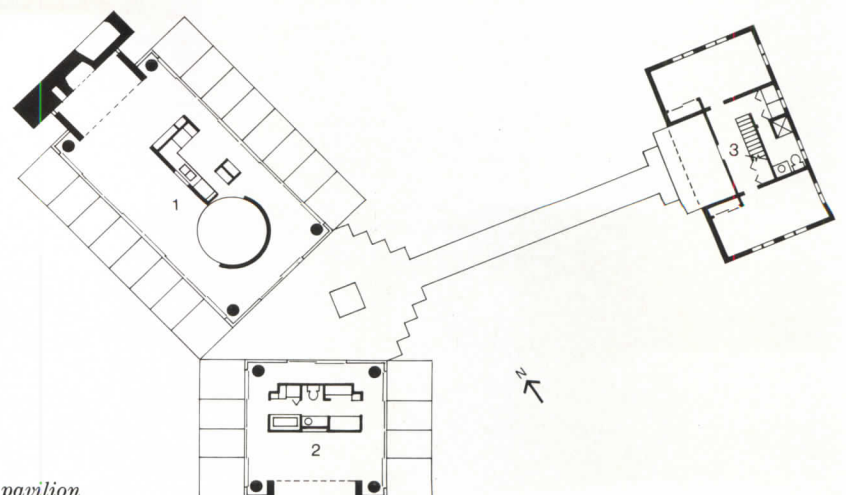

- 1. Main pavilion
- 2. Parents
- 3. Children/guests

*Vacation Compound
Deer Isle, Maine*
Architects:
*Peter Forbes and Associates, Inc.
144 Lincoln Street
Boston, Massachusetts 02111
and 192 Lexington Avenue
New York City 10016
Peter Forbes, FALA, project
architect; Roger Comee, David
Tobias, Barry Dallas, Elizabeth
Nemura, production team*

Engineers:
*Zaldastani Associates (structural);
Goldman Associates (mechanical)*
General contractor:
Prin Allen & Sons
Photographer:
© Paul Ferrino



At home with ghosts



Mallet House
New York City
SITE Projects, Designers



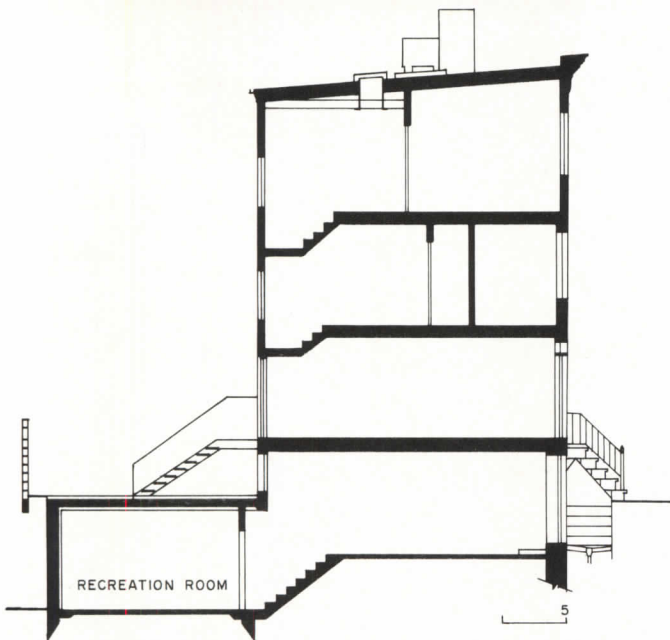
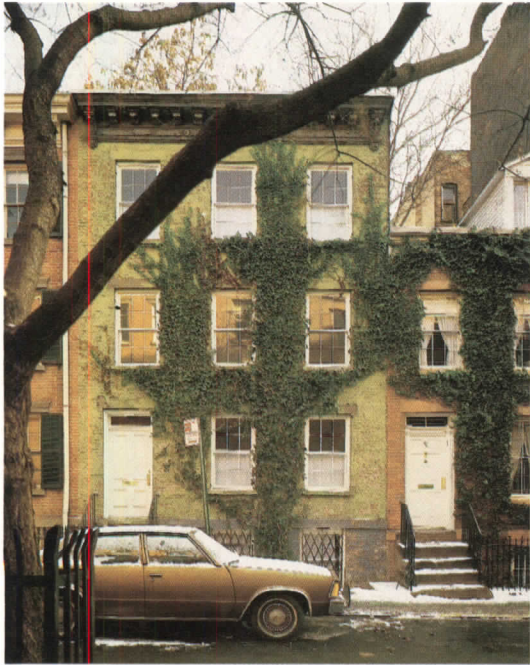

"One of the things that's never emphasized about our work is that we do make 'real' architectural innovations," laments James Wines, who will be sorely disappointed if you do not look beyond the peeling green paint of the facade (above), beyond the friendly ghosts populating architectural history's first intentionally haunted house (facing page), and into the garden where SITE constructed a rec room at grade, and then, after excavating the sand below, lowered it into subterranean place (section).

The line between clever and silly is almost imperceptibly thin, but we always know when it has been crossed. We can sense it. And we don't like it. Our warm, appreciative smile changes to an icy, irritated smirk. Alison Sky, Michelle Stone, and James Wines are especially sensitive to the point. And understandably so. The founding principals of SITE Projects have built their practice on that last, high-risk plot of land at the very edge of acceptability, right before ingenious hops the fence and enters the never-never land of cheap thrills.

They call it "narrative architecture," and for those who fear we now have yet another style to contend with, fear not. SITE's work is not about style, but rather substance. It is about inquiry and interpretive reportage; about reaching down below the surface and ferreting out information; about identifying the physical, social, psychological, historical, and personal contexts that make a project unique; and about devising ways in which those findings can then be communicated through architecture. Case in point: the Mallet House. Though architecturally modest, the 160-year-old Greenwich Village row house nonetheless has its own humble pedigree as an early example of 19th-century speculative housing. If time and neglect took their toll, they never robbed the diminutive house of its charm. Which was precisely the quality that drew Laurie Mallet to it when she decided that a loft in SoHo no longer suited the working mother of two pre-schoolers, and invited Sky, Stone, and Wines over to see if they had any ideas for transforming her new old house into something special. Mallet knew they would, of course, just as they had before for the showrooms and offices she had enlisted SITE to design for WilliWear, the defiantly festive clothing company Mallet founded and presides over.

Considering the decrepit condition of the structure, it would have been more expedient simply to gut the house behind its ivy-clad facade, which is protected as a New York City landmark. But neither SITE nor Mallet considered that alternative, as their intention was to preserve and accentuate, not obliterate. Though there were moments when they must have rued the decision—as plaster crumbled at the workmen's touch, and as woodwork that generations of termites had feasted upon turned to dust—designer and client persevered in their effort to retain the existing character and textures of the house without sacrificing the functional requirements of the program. Salvaging as much as possible, discarding only when absolutely necessary, SITE effectively massaged the house into working order. The gentleness of the firm's touch is ever present, as one must search for clues that distinguish new from old. Even the most dramatic alteration to the house, at least in conventional architectural terms, is unobtrusive: a 200-square-foot rec room buried in the garden literally breaks new ground in keeping a self-effacingly low profile. At this point, SITE could have called it a day and returned to the office justifiably satisfied. They didn't.

"It's a built-in historical layering," supplies Alison Sky, referring to the "ghosts" permanently embedded in the walls (previous and facing pages). Though more prominent now than they will be behind the final layer Mallet plans to add when she takes possession of her house, the sculptural mementoes are intended as gentle remembrances of things past, as whispered testimony to the history of both the house and its French émigrée owner. The cast of an Houdon bust on the dining-room mantel, the Louis XV chair emerging from the living-room wall, the surreal still life in the foyer that acknowledges a secret fascination with the hunt were all carved from Mallet's personal history. Although the pre-renovated house is no less diligently commemorated in vestigial reminders of bygone windows, doors, arches, fireplaces, and walls, SITE chose to pass on one extraordinary opportunity when midway through construction a portrait of the original owner fell from a collapsing ceiling. After interpreting it as "an almost mystical confirmation that what we were doing was right," SITE regretfully set aside the portrait as one memento of one life too many. They know where to draw the line. *Charles K. Gandee*



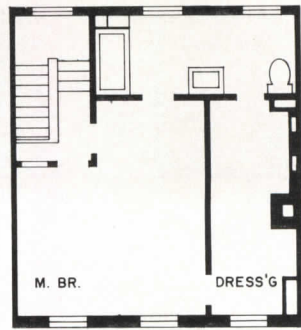

THIRD FLOOR

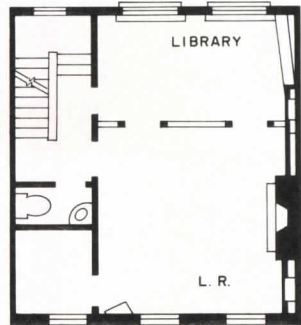

SECOND FLOOR

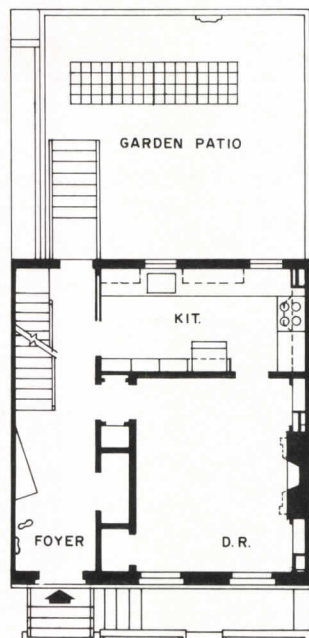

FIRST FLOOR

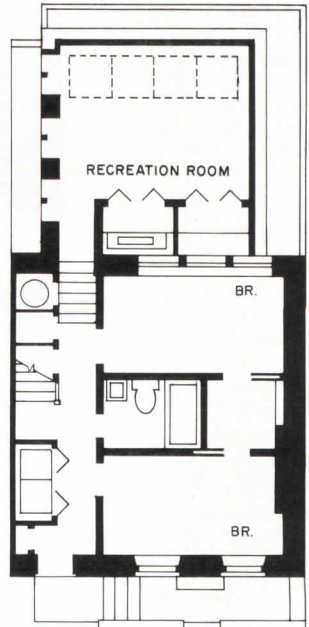

Since the petite 20- by 20-ft floors of Laurie Mallet's four-story house allowed little room for architectural gymnastics, SITE looked to the walls for inspiration. What they found within them, of course, was a scrapbook full of memories. Though remarkable in their visual allure (facing page and below left), SITE's historical setpieces also serve, at least at times, a pragmatic as well as esthetic function. For example, behind the library's "ghost" bookshelf (left) lies a maze of ducts, pipes, and conduits required to bring a 19th-century house up to 20th-century standards. Similarly, the freestanding door frame that commemorates the wall-that-was (left) assists in defining the library from the adjacent living room (plan left). If distinguishing between the pre-existing and the new is a difficult task, SITE will take that as a compliment. Their goal was to mend and extend the fabric of the house, not tear it or diminish its richness. Toward that end, every surface was hand-finished, from the minutiae of mantelpiece garnitures to the drapery of the Greco-Roman nymph who emerges so enticingly from the new garden wall (below).

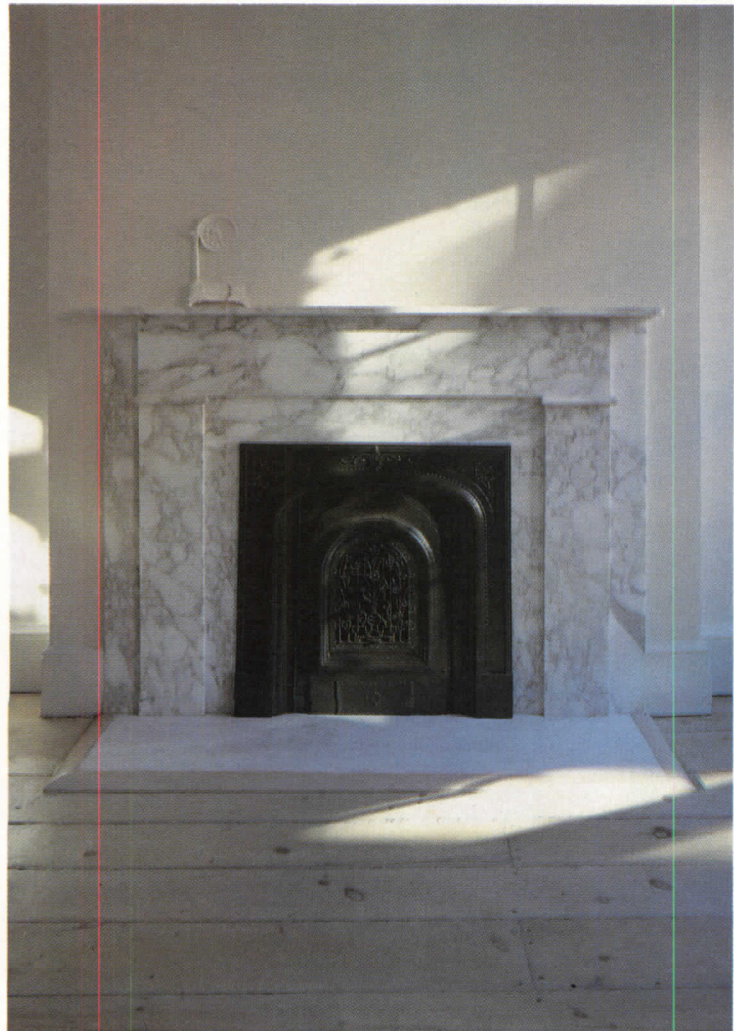
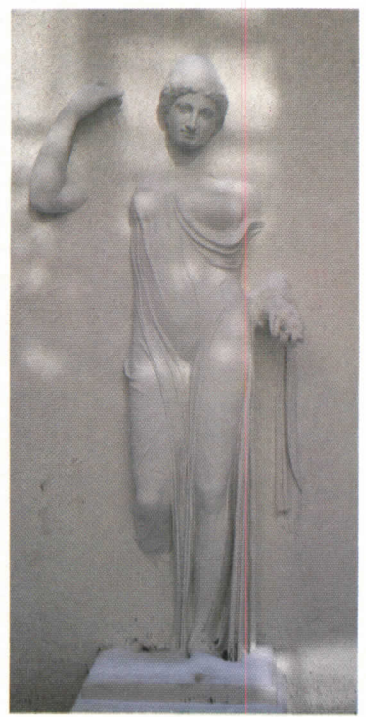

Mallet House
 New York City
Owner:
 Laurie Mallet
Designers:
 SITE Projects, Inc.
 65 Bleecker Street
 New York, New York 10012
 Alison Sky, John de Vitry, Kim Doggett, Quentin Thomas, Stomu Miyazaki, project team
Engineer:
 Geiger Group (structural)
Consultants:
 Bob Davis, Inc. (lighting); C.S.I., Inc., and M.R.A. Associates (creative artifacts)
General contractor:
 Gordon Construction Corp.
Photographer:
 © Paul Warchol





Harbor Lites

With Sunglas® HP Reflective glass, one of over 30 solar management glasses by Ford.

The Hotel Inter-Continental is a \$70 million glass-clad high-rise tower, designed with a nautical silhouette to give every guest room a view of the San Diego Harbor and to minimize obstruction of the harbor's view from downtown San Diego.

The glass of choice is Sunglas HP Reflective — used here with a durable silver coating applied to clear glass for 8% nominal light transmittance. This version (S1-08) provides a subtle reflectance of the harbor's ever-changing color as well as a reduction in the hotel's air conditioning installation and operating costs.

Sunglas HP Reflective is part of Ford's Sunglas family — a family of over 30 different solar management glasses with colors and shading coefficients for virtually any application. All Sunglas HP Reflective products are also backed by Ford's ten-year coating warranty.

The next time you specify reflective glass, specify the total performance and versatility of Sunglas HP Reflective by Ford and see the lite. For Quality, variety, and availability in solar management glass — Nobody outglasses Ford.

For more information call: 1-800-521-6346
(In Michigan call collect: 1-313-446-5915)
(In Canada call: 1-416-363-7561)

Owner: Torrey Enterprises, Inc.
Architect: Hope Consulting Group

 GLASS DIVISION

Circle 70 on inquiry card



CONSUMERS WILL SEE PEACHTREE ADS 135 MILLION TIMES DURING 1986.

YOUR CUSTOMERS WILL SEE OUR ADS IN ARCHITECTURAL DIGEST, HOUSE & GARDEN, SUNSET, HOME, SOUTHERN LIVING, COLONIAL HOMES, BH&G COUNTRY HOME, METROPOLITAN HOME.

...Y LEEN

... invites exploration. ... there are necessi- ... rests a bit of boiserie ... ment. The frame of a ... restoration. Two dozen ... stacked layers of glass ... miniature silver tea ser- ... catches the eye. ... when we found some- ... kind, it was a bit dis- ... disappointing several ... copies at a time. And ... Now we also make

... piece might be a ... item in a Portu- ... as an end table, ... as well as their ... a situation, ... partnership.

... most likely ... serves to empha- ... and antiques. A ... are the town ... centerpiece.

... can designing ... ally two of us, ... alluding to ... accepted. ... let a client ... "as erts ... and to ac- ... never an al- ... do." ... nner, Len- ... by taking ... by austre, ... ts and an ... find the ... mis, "But ... ery each ... abulous ... You can ... Belgium

... page 42

Chadeau authentic French door.

Ariel circle head window.

Ariel sliding glass door.

Ariel double hung window.

Prado insulated swinging patio door.

Ariel casement window.

PEACHTREE. AMERICA'S MOST BEAUTIFUL INSULATED WINDOWS AND DOORS.

Here is the Peachtree line of innovative windows and doors. Each incorporates the latest technology that provides superior insulation, weathertightness and operating ease. Beyond this, Peachtree products are more beautifully styled. They are the only windows and doors designed to match one another. Inside and out.

CALL **800-447-4700** FOR LITERATURE AND NEAREST DEALER.

PEACHTREE
WINDOWS & DOORS

PEACHTREE DOORS, INC. / BOX 5700 NORCROSS, GA 30091 / 404/449-0880

Avanti insulated entry door system.

Prado wood swinging patio door.

Carvel wood sliding glass door.

PEACHTREE DOORS, INC. BOX 5700 NORCROSS, GA 30091, 404-449-0880

Circle 71 on inquiry card

Admiral® Introduces the Continental Series.



A Renaissance for the kitchen.

Admiral® makes the most of space, color and design with the first full line European kitchen that's really affordable.

Continental appliances fit flush with cabinet depths, creating a sleek, modern line. Color coordinated front panels (up to 1/4-inch) can be inserted to complete the modular look. And the Continental Series is UL approved and AHAM certified.

Undercounter refrigerators, quick-freeze freezers, MasterCare® servicing and parts inventory make our European line the smart choice for your bottom line.

For free brochure, write to L.S. Bass, Admiral, 1701 E. Woodfield Rd., Schaumburg, IL 60196.

Admiral®  continental series
Home Appliances

Circle 72 on inquiry card

© 1985 Admiral Division, Magic Chef, Inc.

Pave it with Style!



UNI-STONE™



SUPER-DECOR™



UNI-DECOR™



HOLLAND-STONE

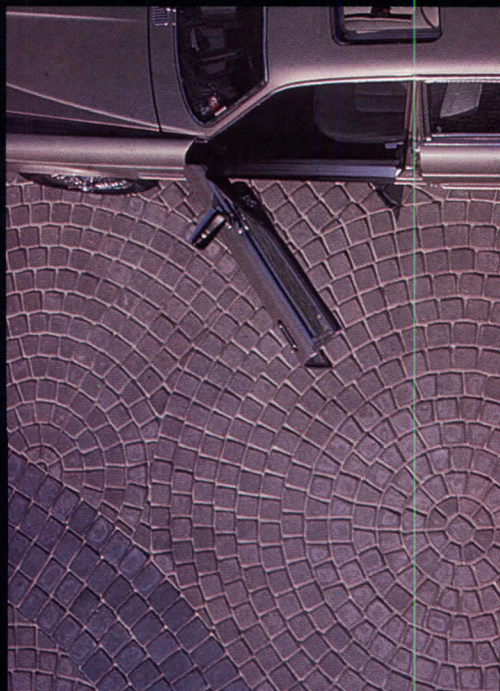

CLASSICO

Uni Paving Stones

Decorative, maintenance free and virtually indestructible, Uni Concrete Paving Stones are an attractive, practical and economical way to pave. Unparalleled in color, shape, texture and pattern designs, Uni Paving Stones create a timeless and elegant environment on a variety of projects.

From residential patios, pool decks and drives to commercial plazas and courtyards, pave the way with exclusive Uni Paving Stones. . .The Original. The Best.

Call or write for the name of your local Uni Licensee for availability and other shapes and styles.

See us in LAFile '86 and Sweets '86



UNI-GROUP
North America

4362 Northlake Blvd., #109, Palm Beach Gardens, FL 33410
(305) 626-4666 Circle 73 on inquiry card

RASPBERRY ROSE.

Now there's a separate PANTONE color system for *your* world of color.

Where the PANTONE MATCHING SYSTEM serves printing and the graphic arts, the PANTONE Professional Color System now provides the broader palette required for fashion, cosmetics, architecture, furnishings, textiles.

Selected from every field of design, each of its 1001 colors is described by PANTONE Name (in six languages) and Number. So whether you're specifying, verifying, or simply communicating color, with the PANTONE Professional Color Guide you can do it precisely and accurately — even by phone.

And for just \$125†, it can make your world a lot more certain.

† Suggested retail price.

Just 1 of 1001
PANTONE®
Professional
Color Guide
colors.



PANTONE®

55 Knickerbocker Road, Moonachie, NJ 07074
Available from your artist material dealer
or direct from Pantone, Inc.

Please send me _____ copies of the PANTONE Professional Color Guide @ \$125 each,
plus \$6.00 shipping and handling. NO OPEN BILLING! NJ Residents please add 6% sales tax.

Name _____

Company _____

Address _____

(WE CANNOT SHIP TO POST OFFICE BOX NUMBER)

City _____ State _____ Zip Code _____

Toll FREE credit card ordering: Amer. Exp. Diners Club Visa

1-800-222-1149 (NJ 201-935-5500) MasterCard Full Payment enclosed

Card No. _____ Exp. Date _____

Signature _____

NOTE: NOT INTENDED FOR SPECIFYING PRINTING INK COLORS.

*Pantone, Inc.'s check-standard trademark for color reproduction and color reproduction materials. Process color reproduction of PANTONE®-identified colors may not match solid color standards. Use current PANTONE Color Reference Manuals for accurate color.

Circle 74 on inquiry card

SINCE IT WAS ANDERSEN WHO WINDOW, IT SEEMS ONLY RIGHT

America's best window has been made better. And that's good news for an architect.

Now we have a special glazing called Andersen® High-Performance insulating glass. It proves itself 24 hours a day, 365 days a year. In all seasons. In all climates. On all sides of a building.

WE TOOK A COLD, HARD LOOK AT HEAT LOSS AND HEAT GAIN.

In the past, our double-pane window dealt superbly with two causes of a building's losing heat in winter and gaining heat in summer—convection (by preventing leaks with a snug-fitting design) and conduction (by using superior insulating materials).

But our High-Performance

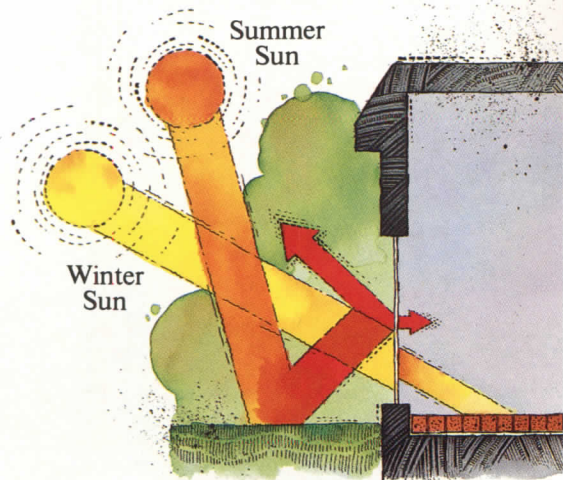

insulating glass is effective against a third cause, thermal radiation, which is heat radiating in waves. If you've ever noticed the air shimmering above blacktop on a hot day, that's radiant heat.

A special transparent

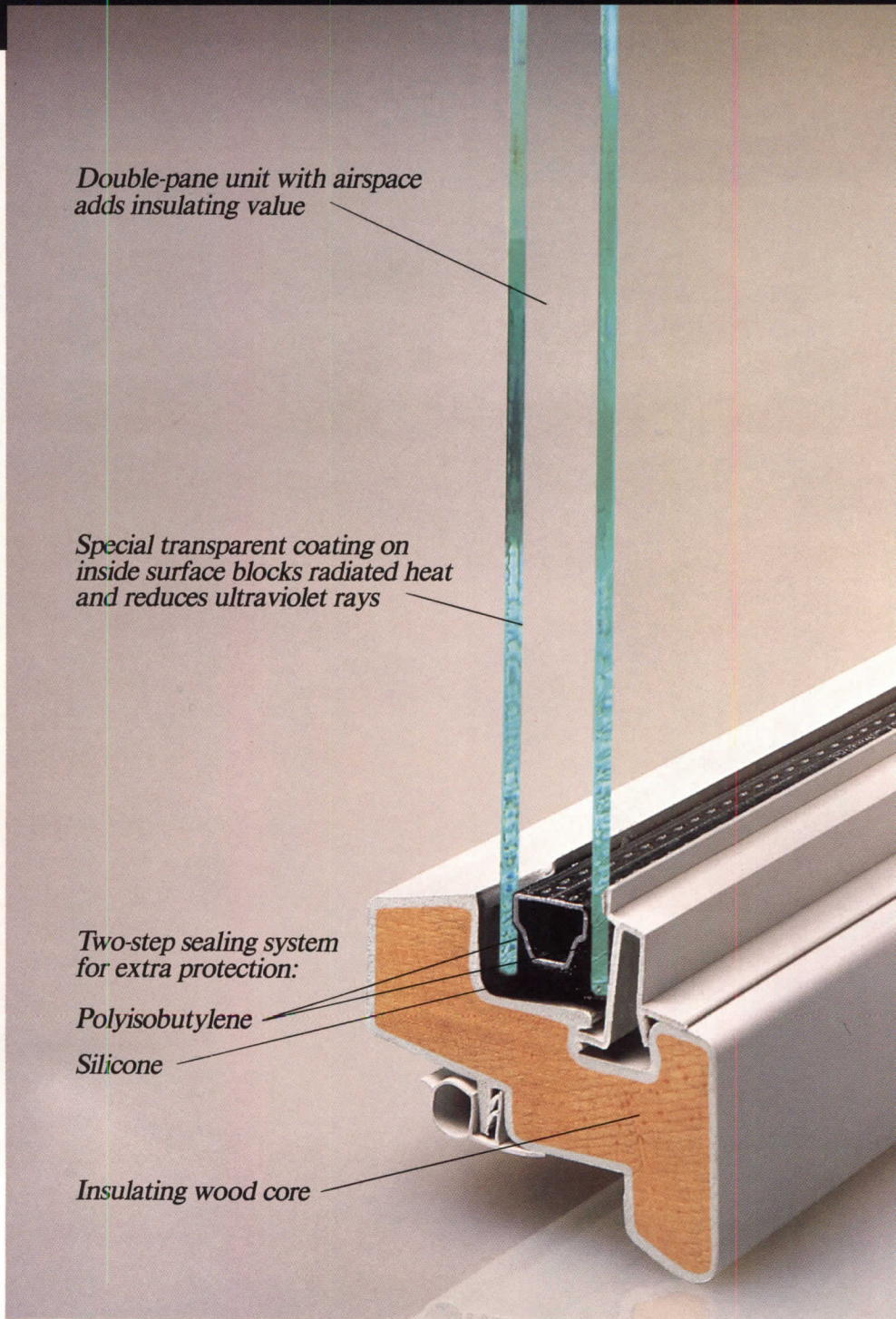

Double-pane unit with airspace adds insulating value

Special transparent coating on inside surface blocks radiated heat and reduces ultraviolet rays

Two-step sealing system for extra protection:

Polyisobutylene

Silicone

Insulating wood core

86143 © 1986 Andersen Corp.

coating on our High-Performance window glass greatly restricts this radiant heat from passing through it into the building.

Yet in winter, when the sun is low in the sky, our coating allows direct sunlight to shine into the building. After it strikes

floors, walls and furniture in the rooms, it will be converted into radiant heat to help warm the building.

And since our special coating restricts radiant heat flow, this warmth will have trouble escaping.

PERFECTED THE DOUBLE-PANE WE BE THE ONES TO IMPROVE IT.

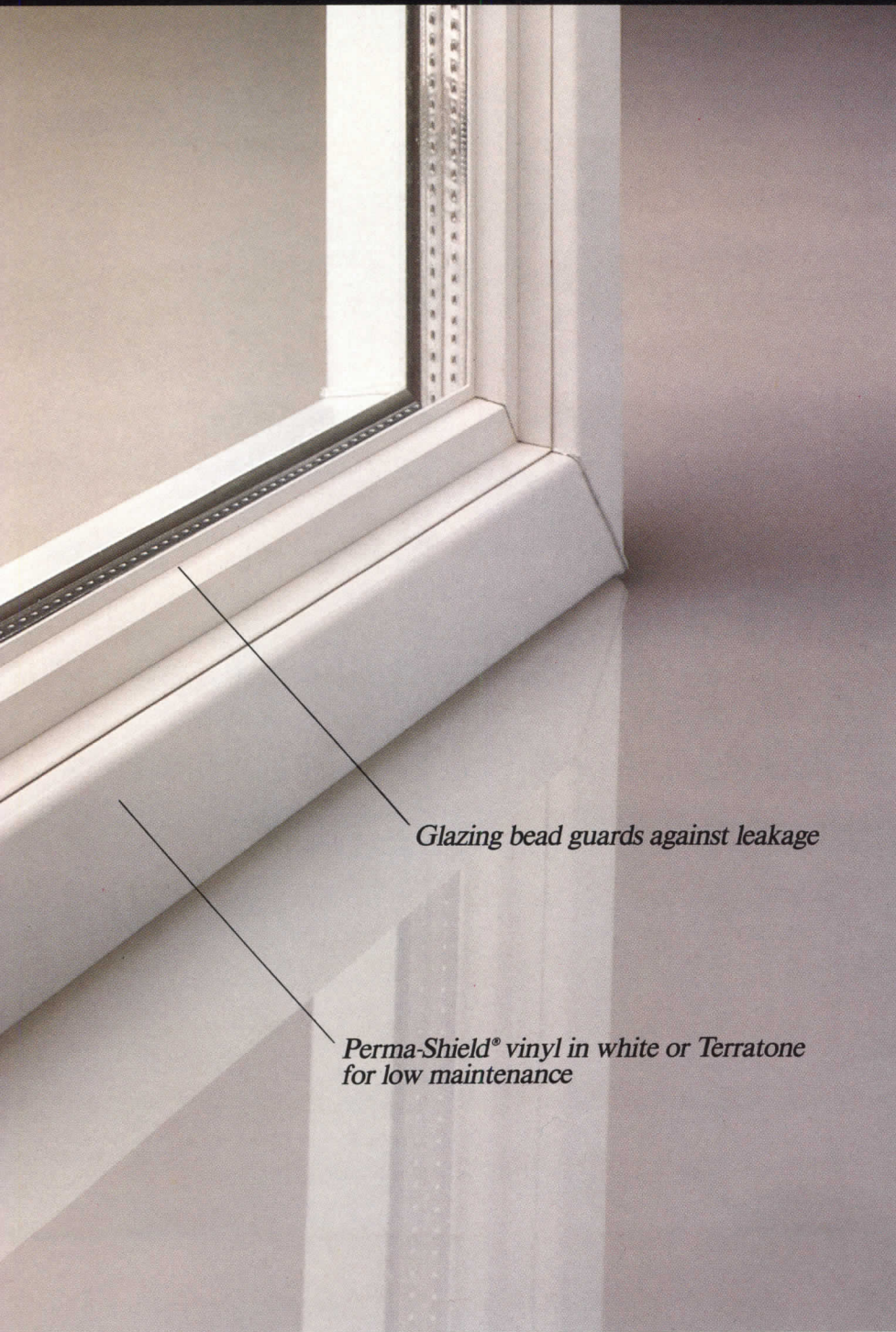

Glazing bead guards against leakage

*Perma-Shield® vinyl in white or Terratone
for low maintenance*

sun and 24% better in shade.

What's more, it's worth noting that High-Performance glass filters out 71% of the sun's ultraviolet rays that cause fading.

THE STORY IS
CONTINUED ON THESE
REMARKABLE WINDOWS.

Call your Andersen distributor, who can tell you more about Andersen High-Performance windows and our new High-Performance Sun windows, for climates where heat gain is a greater concern than heat loss. Also consult Sweet's File 8.16/An.

Or write Andersen Corp.,
Box 12, Bayport, MN 55003.

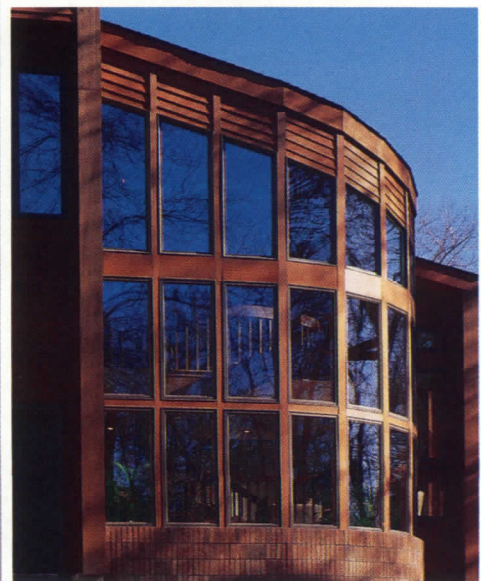

SO, WHAT'S IN OUR WINDOW THAT INTERESTS CLIENTS?

Tell them that, although it works year-round for energy efficiency, this revolutionary window is at its best in winter.

We've found that an Andersen window with High-Performance insulating glass is 42% more energy efficient than our uncoated double-pane window during the heating months. And in the cooling months, it's 19% better in

Come
home to
quality.



Andersen

THE ARISTA™



The Designer Series

Designed with luxurious standard features no other can match. Everything about the Arista™ surpasses any other two-person whirlpool bath you have seen. Its distinctive shape and cascading interior lines give it a unique sculptured look. You will find that its luxurious standard features simply can't be found anywhere else. Because no one else offers our unique patented Water Rainbow™ fill spout, our innovative Magic Touch™ on/off switch, and our patented whirlpool jets that have made our baths everyone's first choice. The Arista™ from the Designer Series of Jacuzzi Whirlpool Bath. With so much to offer at a price that's less than you'd imagine, it's easy to understand why the Arista™ has become such a sales leader.



The Real One. The Only One.

JACUZZI WHIRLPOOL BATH
A subsidiary of KIDDE, Inc.
KIDDE

For more product information, call toll free: (800) 227-0710. In California: (800) 227-0991.
Or write: Dept. ARD, P.O. Drawer J, Walnut Creek, CA 94596.

Circle 77 on inquiry card

Glorious necessities

“Kitchen decoration is at the moment rivaled in glory only by that of the bathroom.”
Emily Post, *The Personality of the House*, 1930

If Emily Post were alive today, she'd be pleased to learn that her assessment of residential design still holds true, as American homeowners continue to upgrade kitchens and bathrooms in record numbers, regardless of expense. This year alone, the custom-designed “glory” of kitchen and bathroom renovation will total over \$10 billion, in contrast to a mere \$2.5 billion to be spent on family rooms, according to a projection by the National Association of the Remodeling Industry. The significance of this phenomenon is revealed not solely in statistics, but in the way that the uses of these rooms have changed within the home, from utilitarian necessities to conspicuous symbols of luxury.

The kitchen began to assume a place of its own inside the average American home only with the development of the cooking stove in the late 18th century; by the mid-19th century it was routinely paired with a requisite status symbol of middle-class life, the dining room. In the 1920s, as the common conveniences of black, cast-iron oven and icebox began to yield to the white-enameled, steel bodies of the electric range and refrigerator, the kitchen came to be viewed as a streamlined laboratory of built-in appliances to promote the housewife-chemist's productivity. This attitude persisted in the 1930s with time-motion studies of meal preparation, which continued to be touted as the basis of kitchen design through the 1950s. Similarly, the elements of early bathrooms—“necessary house,” portable wash basin, and tub—remained relatively unchanged until the advent of fixed indoor plumbing in the late 19th century (made possible by the legendary 1880s invention of the modern flush toilet by the English plumber, Thomas Crapper), when locating the toilet, sink, and bathtub within one room became standard American practice.

Times have changed. According to a recent survey of U. S. home builders, the kitchen and bathroom have begun to dominate the house as spacious, multipurpose areas not merely focused on mechanical conveniences, while the formal living room and dining room have shrunk in size. No longer hidden as a peripheral space for cooking, the kitchen has become a comfortably furnished center of the house for lounging, dining, and entertaining. Similarly, the solitary privy of the past has merged with the bedroom into a “master” bathroom-bedroom suite and, most recently, has expanded into a spa for relaxation and exercise with therapeutic accouterments that range from gymnastic equipment to computer-programmed whirlpools.

For architects, kitchen and bathroom design is no longer regarded as the domain of the professional novice, but has become a lucrative staple of many practices, providing an opportunity to experiment with formal ideas on a small scale. The task of devising new strategies for these spaces is no longer a matter of plugging the latest appliances and pipes into a functional formula, but tailoring them to suit the personal idiosyncracies of a diversity of users and residential building types, from the traditional family in the suburban house to the affluent, single homeowner in a city condominium. Explains Bernard Wharton of Shope Reno Wharton Associates, a firm that designs a dozen kitchens a year (including Wharton's own on pages 164-169), “We don't design around the triangle between the stove, refrigerator, and sink. Our kitchens are geared to individuals who cook in many different styles. They don't care about some golden rule based on layout efficiency.”

The kitchen and bathroom interiors that inaugurate this new section of RECORD HOUSES reflect this attitude, underscored by differences in cooking, bathing, and architectural styles. Designed by their architect owners, the kitchens exemplify the new-found multifunctional prominence of the room type and illustrate its typical permutations, including corridor/galley, L-shaped, and island arrangements of culinary work spaces and dining areas. The bathrooms that follow encapsulate other aspects of current trends, revealing that renovation is just as likely to occur in a residence designed by a “star” architect, as in an ordinary ranch house (see, for example, the Murphy bathroom in the Hopper loft, pages 174-176). Common to all is an underlying architectural character that elevates domestic necessities to a position of spatial strength, achieved with imagination and wit, qualities that Mrs. Post would have certainly approved. *Deborah K. Dietsch*

Kitchen
 Wild Residence and Studio
 London, England
 David Wild, Architect

Proper decorum

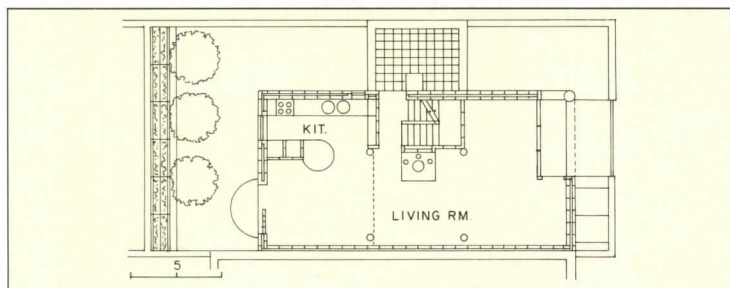

The living spaces of the house occupy its piano nobile (plan), with kitchen/dining area located behind the fireplace under the second-story bedroom (above). In sympathy with the open plan of its interior, kitchen shelving is left exposed (facing page). Necessities such as sink, stove, and refrigerator, and amenities such as electric espresso-maker and tea kettle, are efficiently relegated to a galley along the east wall.



Listen to David Wild's assessment of his London house as displaying a "decorum appropriate to its surroundings," and an unassuming version of a typical, semidetached villa comes to mind. Look at the exterior of the house (bottom), however, and the architect's description assumes new life: the "decorum" of the house appears far more "appropriate" to Le Corbusier's and Adolph Loos's 1920s townhouses than to its adjacent 1840s terraced mews—a reinterpretation of the modest, stuccoed proportions of its surroundings without historicist kitsch or slavish replication. In plan, the house echoes the bay width of its 19th-century neighbors and location of the stair to one side, but transforms the prototype through an open plan, staggered section, and glazed wall surfaces that suffuse every cubistic nook and cranny with daylight. Similarly, the first floor living "room" focuses on a conventional fireplace, but is divided into two, 1 1/2-story cubes by four unadorned concrete columns, with a seating area sandwiched between the stair and gridded glass at the front of the house (plan left). The kitchen, sequestered in a corner of the floor at the back of the house (top left), is designed as an integral part of the living area and doubles as a dining "room" with built-in table top and open shelving that miniaturizes the interior's interposed planar geometries (facing page). To attain the quality of construction that makes or breaks such a purist vision, Wild resorted to budget-conscious materials such as plywood for the shelving and terrazzo for the table top, but didn't have to compromise on the details or the craftsmanship, since he built the entire house himself. *D.K.D.*

Owner and architect:
 David Wild
 44 Rochester Place
 London, England
Engineer:
 John Romer
General contractor:
 David Wild
Photographer:
 Richard Bryant



Settling down

Kitchen
Wharton house
Stamford, Connecticut
Shope Reno Wharton Associates,
Architects

Like most owners of old houses, Caroline and Bernard Wharton put the kitchen and bathroom at the top of their rooms-to-be-remodeled list soon after moving into a 1790s Connecticut chicken farmhouse three years ago. Since she is an interior designer fond of cooking, and he is an architect fond of finely crafted woodwork, the kitchen became their first priority. In collaborating on its renovation, the couple struck a balance between her practical demands for counter space, storage, and a coveted commercial gas stove, and his creative desire to experiment with cabinet detailing and furniture design. They agreed not to recreate a version of the farmhouse's colonial beginnings, but to save enough original features such as exposed ceiling timbers and paneled doors as a reminder of its history within an expanded layout.

The existing kitchen was enlarged by demolishing its back wall and incorporating a side entrance vestibule to form an L-shaped work area, divided from the dining nook by the partition-enclosed stove (plan). Once the cook was satisfied with her arrangement, the architect set about detailing the cabinets with a Vienna Secessionist-inspired series of grids and inlay squares (right). For the dining area's pair of built-in settles and table, he elaborated the pattern into a whimsical, miniature city of illuminated towers for his two young sons (left on facing page).

"What makes a good kitchen is establishing a consistent rhythm on all its surfaces," says architect Wharton, who has accomplished that and more, with delicacy attuned to the kitchen's diminutive scale, and a palette as white as the eggs that were once sorted and packed in this room. *D.K.D.*

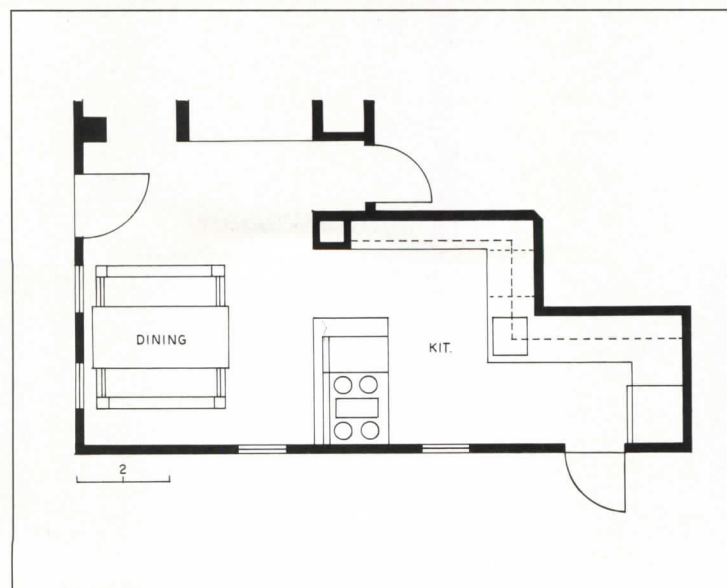

The kitchen plays an important, multipurpose role in the Wharton household as a room used for both cooking and dining, entered through the front and side doors (plan). Its floating checkerboard floor (facing page) was assembled from 3-inch tiles in keeping with the small scale of the cabinets' gridded glass doors with maple inlay, and the pattern of upholstery tack studs on the partitions.



The patchwork of wood and steel beams in the kitchen ceiling was concealed, but the timbers over the dining nook were left exposed and painted white (below). Above the marble countertop nearest the dining area, cabinets display tableware and cookbooks, while those around the corner from the sink store food. They were detailed to hold one pane of glass behind their gridded doors to facilitate cleaning.



Looking like a booth from a C.R. Mackintosh-designed diner, the corner of the kitchen reserved for eating is furnished with a table and pair of straight-backed settles that allude to a Lilliputian white city. "The seating started out as a design for my two kids, but became my fantasy," admits Bernard Wharton, who embellished the backrests with Roman numeral birthdates of each son (below).



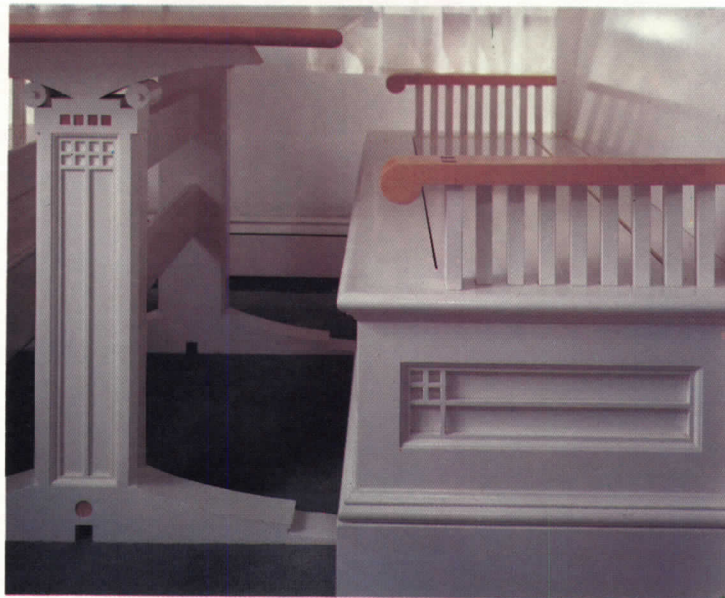
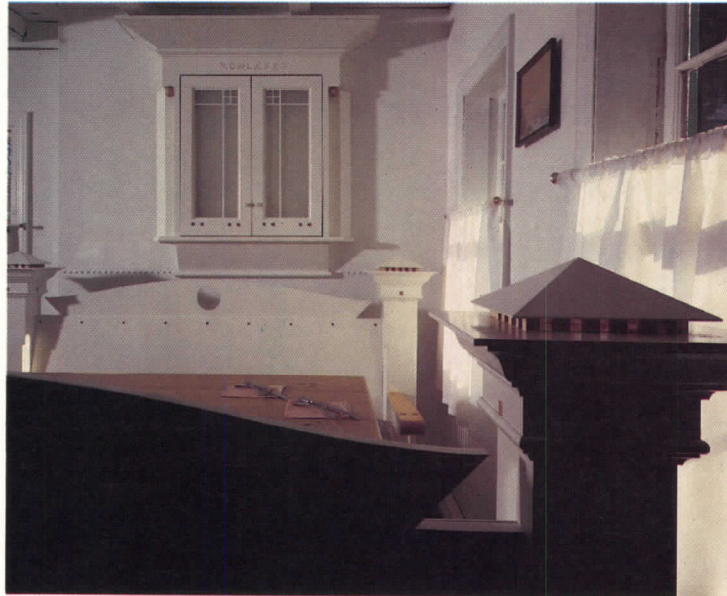

On the wall of the dining nook, the electrical panel is disguised by a frosted glass cabinet (top). The maple armrests of the settles match the cabinet inlay and table top (bottom). In designing the table base, the architect approached it as a skyscraper elevation with a tiny "door" at ground level, vertically striped "elevator" shaft and "windows" at the scrolled top (facing page). The pyramids crowning the posts that flank the backrests of the settles are illuminated by incandescent lamps to convey the image of four glowing towers.

Owners:
Bernard and Caroline Wharton
Architects:
Shope Reno Wharton Associates
18 West Putnam Avenue
Greenwich, Connecticut 06830
Bernard M. Wharton,
principal-in-charge
Consultants:
Caroline A.O. Wharton (interior
design); Breakfast Woodworks
(cabinetry)
General contractor:
Thomas Officer
Photographer:
H. Durston Saylor



Light cuisine

Kitchen
Ito House
Tokyo, Japan
Toyo Ito Architect & Associates

The kitchen of Toyo Ito's "Silver Hut" possesses the same fine craftsmanship that characterizes the entire residence (pages 122-127). Serving the house as a circulation link, the kitchen is fully open to the stacked bedroom suite at its southern end, and to a dining/living room perpendicular to its northern end (near right and facing page). When a gridded security gate is open, the kitchen is directly accessible to the central courtyard through sliding glass doors. The space frame spanning the room comprises exposed rhombic steel units, tied together with high-tension bolts. In addition to an infill of perforated asbestos-cement boards, the structure has been fitted with a random pattern of 11 triangular skylights, operated with gasoline dampers borrowed from the automotive industry (top right). During the day, the kitchen is amply illuminated by light from the skylights, courtyard and end-wall windows. Movable task lighting is arranged along a continuous green steel rod suspended from the vault.

An island counter serves to anchor the room. Raised on poured-in-place concrete stanchions, the counter integrates a brushed stainless-steel sink with exposed plumbing set within a natural-finish countertop (lower right). A similar cooking counter cantilevers off the back wall. Contributing to the clean look of the kitchen, flush details have been executed for stainless-steel doors on pivot hinges, and for glass-and-wood storage cabinets opposite the courtyard wall. The cabinets, whose wood doors are finished with metallic paint, and refrigerator are set within concrete walls, painted silver-gray with a synthetic resin. This silver-gray palette of the walls is pulled across the floor with ceramic tile specially designed for the project by Shuji Yamada. In contrast to the machine-finished surfaces found elsewhere, these tiles, used throughout the residence, evoke the manmade texture of compact earthen floors common to *minka*-style Japanese folk houses. *D. R.*

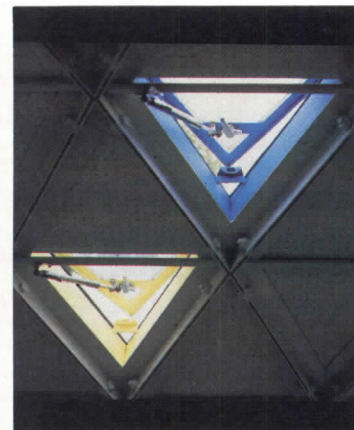

Owner:
Toyo Ito
Architects:
Toyo Ito Architect & Associates
10-12, Minamiaoyama 5-chome
Minato-ku, Tokyo
Toyo Ito, architect-in-charge;
Kazumichi Imura
Engineers:
Gengo Matsui and ORS (structural);
Yamazaki Structural Engineers
(mechanical)
General contractor:
Bau Construction Co., Ltd.
Tile design:
Shuji Yamada
Photographer:
Tomio Ohashi



Behind closed doors



Architect Allan Greenberg's design of a sprawling Georgian farmhouse in Connecticut, which is based on George Washington's home at Mount Vernon (pages 110-121), includes an equally grand master-bathroom suite. Crafted from a sumptuous palette of green Italian Vertisori and white statuary marbles, and raised panels of Northeastern white pine, the 11 1/2- by 15-ft "his" half of the suite (above and opposite) received the same studied

care that the architect devoted to the rest of the house. For example, the polished bronze frame Greenberg created for the glass shower enclosure, which is composed of intricately fitted square, flat, and round tubing extrusions, took two months to design and three more to fabricate; and the wood, selected for its resistance to the damaging effects of moisture, was hand-painted with an 18th-century grain pattern.

Master bathroom
Farmhouse in Connecticut
Allan Greenberg, Architect



Nevertheless, for all its old world grandeur, the bathroom is anything but another addition to the owner's collection of period pieces. *K. D. S.*

Architect:
Allan Greenberg, Architect
31 High Street
New Haven, Connecticut 06510
Interior consultant:
Johnson Wanzenberg

Marble work:
Friedman Marble and Slateworks
Bronze work:
Samuel Yellin and Company
Metalworks
Woodwork:
Eisenhardt Mills, Inc.
Painting:
Albert Sands
Photographer:
©Peter Mauss/ESTO

Throwing a curve



When Frank Gehry designed his three Indiana Avenue Houses, in Venice, California, he deliberately left the interiors raw. Each of the tall wooden boxes was meant to be an artist's studio and residence, and Gehry hoped that the owners would adapt the loft spaces to suit their own taste, producing a multimedia collaboration over time. Actor-director Dennis Hopper acquired one of the 1,500-square-foot units (in foreground of small photo opposite) and asked architect Brian Murphy to help make the house livable. On a spartan \$24,000 budget, Murphy installed a kitchen, sleeping loft, storage areas, and roof garden, and transformed what he calls a "Marxist john" into the sleek bathroom shown here.

Throughout most of the interior, Murphy held details to a minimum, relying on two-by-four platforms and stairs for constructivist effects—partly for thrift but also to "play Gehry's game." Murphy didn't want the game to be boring, though, and knew that his client would agree: "You can throw Dennis a curve and he's not afraid." The curve in this game is the translucent bathroom that juts into a corner of the living room (overleaf). The unconventional location was determined by extant plumbing lines, which would have been too costly to move. Murphy pragmatically elected to turn another variation on a theme of emphatic corners that began with a chamfered bay window in the Gehry shell. Twin sinks and medicine chests, with custom gooseneck lamps above, are tucked into angled cupboards to conserve floor area in close quarters behind the kitchen. A quadrant-shaped, tiled tub neatly adjoins the toilet and clears access to a separate shower stall. The bathtub curve that Murphy echoed in the shower enclosure is a provocative exception to the angular geometry of the rest of the house, as though offering a glimpse of human contours in an otherwise tectonic composition. When the glass-block arc is illuminated from behind, as it is all day long, it takes its place in the living room as one of the larger pieces of sculpture in Hopper's art collection. Which seems to be the kind of thing Frank Gehry had in mind. *D. B.*

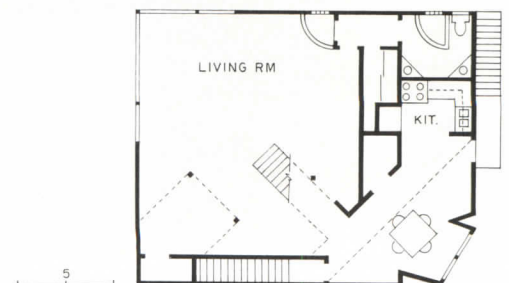





There is an intentionally voyeuristic side to the shower stall, which has no ceiling to conceal it from the mezzanine overhead (bottom). Towards the living room and the outdoors, however, glass block affords a modicum of privacy. Daylight converts the translucent quarter-cylinder into a giant light fixture for the loft. The interior of the lavatory provides a luminous gallery for some of Hopper's art.

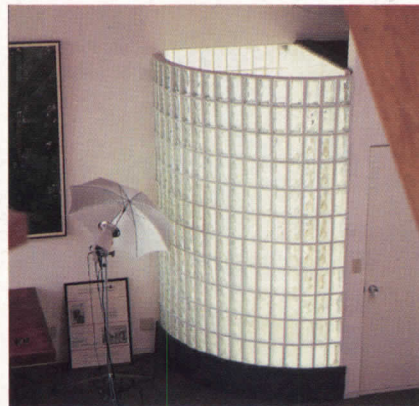

Owner:
Dennis Hopper

Architect:
Brian Alfred Murphy
1422 1/2 Second Street
Santa Monica, California 90401
Seth Reed, Tim Murphy

General contractors:
BAM Construction & Design;
Goreng & Maltby

Photographer:
Tim Street-Porter

The Gourmet Collection.

Elkay's Gourmet Collection is a culinary work of art. A masterpiece of innovation, it's designed for the creative cook. With ribbed drainboards for rinsing and drying. Larger, deeper bowls for oversized pots and pans. And off center drain outlets for more work space.

The Collection comes in eleven different models to suit every taste. And, like all Elkay sinks, a lifetime of quality is built into each one.

To see how the Gourmet Collection fits into your profit picture, contact your Elkay representative. Or write Elkay Manufacturing Company, 2222 Camden Court, Oak Brook, IL 60521.



Your customers will receive a free copy of Jeff Smith's *The Frugal Gourmet* cookbook with any Elkay gourmet sink purchase. Be sure to watch "The Frugal Gourmet" on your local PBS station, sponsored exclusively by Elkay. Circle 78 on inquiry card

ELKAY®



SPECIFY: ITALIAN TILES

...and let the genius, imagination and beauty of Italy's superior tile products enhance your next architectural or interior design project. Over 20,000 designs, sizes, color variations, textures and motifs from over 400 tile companies are available for use in any contract or residential installation. For information contact the Italian Tile Center.

Visit CERSAIE '86 Tile Exhibition September 30-October 6 Bologna

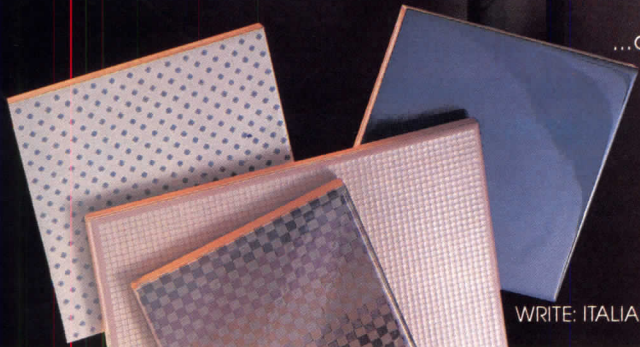

FOR A FREE COPY OF THE DESIGNERS GUIDE TO ITALIAN CERAMIC TILE, WRITE: ITALIAN TILE CENTER, 499 PARK AVENUE, NEW YORK, N.Y. 10022 • (212) 980-8866



Six Easy Pieces

From hospitals to educational institutions to conference centers, Kroin Canteen and Work Furniture is the easiest way to fill any assortment of needs.

The choice of four colors and materials can be easily mixed and matched. Design around it or create a new atmosphere in existing spaces. Structurally, the soundness of its tubular steel epoxy coated frames and wood or laminate surfaces make it ideal for hardworking environments.

Best of all, what you see here is only a small part of a much larger selection that includes tablet chairs, a wide variety of table sizes, trolleys and specialty work furniture.

For the pièce de résistance, contact Kroin, exclusively.

Circle 6 on information card.

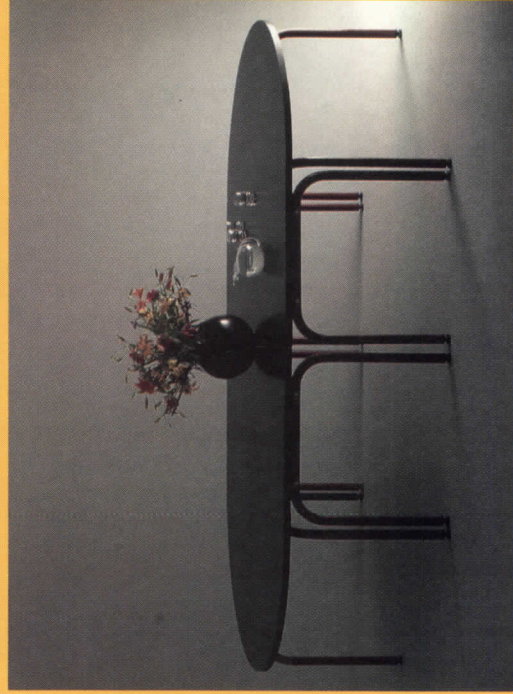
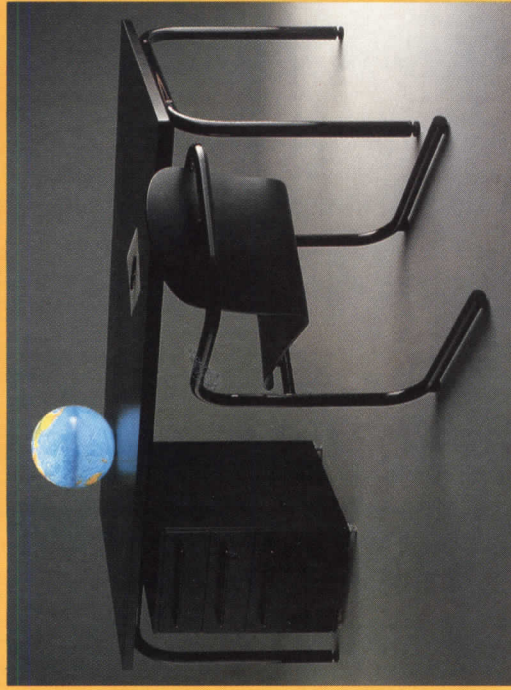

The first name
in metallic laminates...
METTLE MICA®

• **ECONOMICAL**

• **FAST
DELIVERY**

• **STOCK SIZE SHEETS**

• **CUT TO
SIZE STRIPS**

• **CUSTOM SIZES**

• **POLISHED AND
BRUSHED FINISHES**

• **EMBOSSSED PATTERNS**

• **MOULDINGS AND
FORMED PIECES**

To receive samples and literature please contact:

the **october** co., inc.



p.o. box 71 • 51 ferry st.
easthampton, mass. 01027 (413) 527-9380

Circle 80 on inquiry card

New products

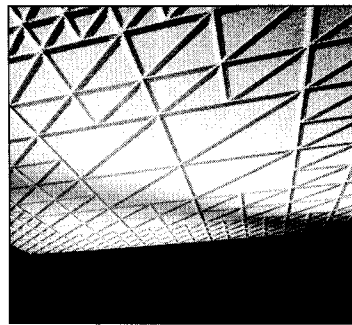

Ceiling system

The *Syllable* ceiling system consists of 22 different 2-ft by 2-ft lay-in panels. The panels are deep-cut to fit into a 9/16 in. grid and feature in-relief patterns with edge details. Designed for commercial applications, the tiles are available in white, haze, parchment, and platinum. Armstrong World Industries, Inc., Lancaster, Pa.
Write 300 on reader service card

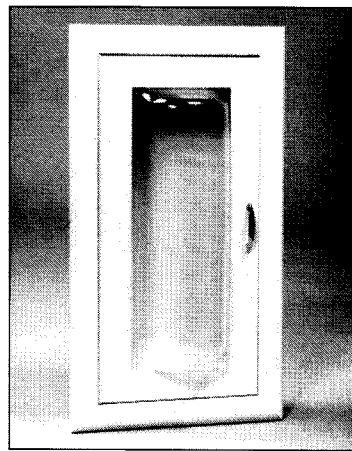

Fire-extinguisher cabinets

The *Crystal Vu* line of fire-extinguisher cabinets features acrylic bubble doors—available in clear, red, or bronze acrylic—and a 4 in. tub depth. The bubble protrudes 4 in. past the surface of the wall, enabling 180 deg vision of the extinguisher. The cabinet frames are available in steel, aluminum, and stainless steel. Samson Metal Products, Inc., Los Angeles.
Write 301 on reader service card

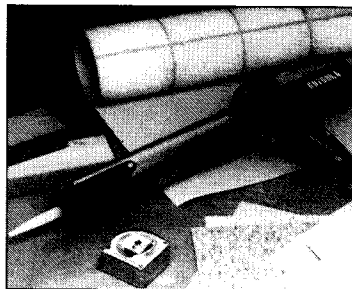

Caulking gun

The manufacturer's cordless caulk gun operates on a 2.4 volt DC, one-hour charge battery pack and uses 30 oz. quart-size cartridges of adhesives, sealants, or caulk. The gun features an 8-position indexible barrel that allows the user to turn the cartridge tip, and an electronically controlled, variable-speed control knob to adjust the sealant's flow. AEG Power Tool Corp., Norwich, Conn.
Write 302 on reader service card

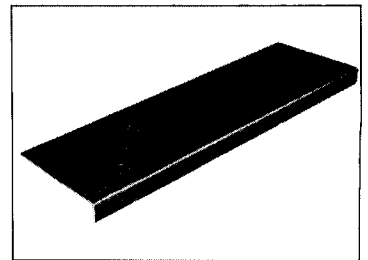

Stair treads

The manufacturer's rubber stair treads feature a beveled disc pattern. The treads are 12 1/2 in. deep with a 1 1/2 in. square nose. Available in seven solid or marbelized colors, and in six lengths from 36 in. to 72 in., the treads are said to be wear-resistant in light traffic areas. The R. C. A. Rubber Co., Akron, Ohio.
Write 303 on reader service card

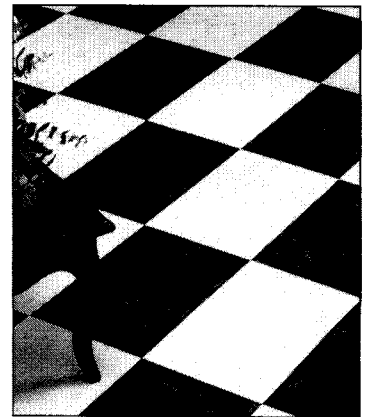

Vinyl tiles

A line of vinyl floor tiles, designed for institutional, commercial, and residential applications, may be installed on, above, or below grade on concrete, wood, or plywood subfloors. The tiles are said to be alkali-, stain-, and fire-resistant as well as greaseproof. A selection of 15 solid colors and a variety of patterns is available. Azrock Floor Products, San Antonio, Tex.
Write 304 on reader service card

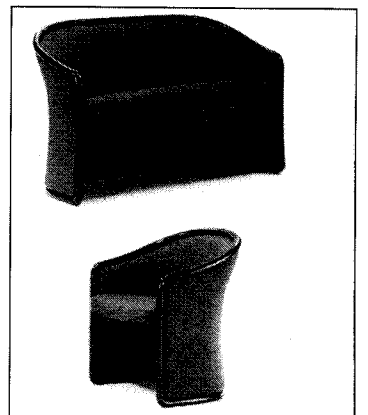

Chair

The *Rita* armchair measures 24 1/2 in. by 26 in. by 30 1/2 in., features multipronged scarf jointing, and is made of handcrafted solid beechwood. The chair is available in a variety of lacquered finishes, including English oak on ash, cordovan walnut on ash, and natural ash. Brayton International Collection, High Point, N. C.
Write 305 on reader service card

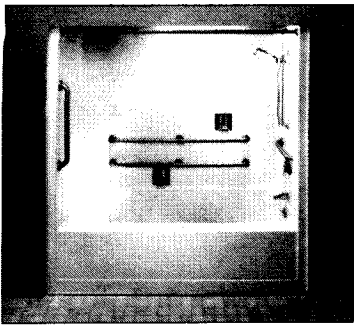

Tub/shower

The manufacturer's institutional tub/shower unit features a slip-resistant floor, balsa-wood reinforcements, galvanized-steel stiffeners, a marine-grade gel coat, and wafer board laminated into the fiberglass for additional stability. The unit measures 74 3/4 in. by 32 in. by 72 in. and can be ordered with grab bars and folding shower seats. Kimstock, Inc., Santa Ana, Calif.
Write 306 on reader service card

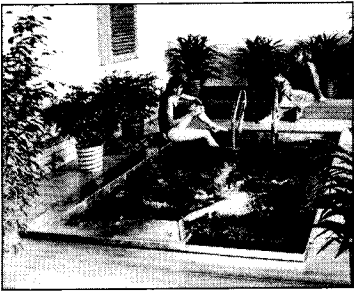

Swimming pool system

The manufacturer's swimming pool system features a stainless-steel pool with an integrated water propulsion system. The unit requires 7 1/2 by 18 feet of space and needs only electrical hook-ups at installation. The propulsion system creates an evenly distributed current that is adjustable. SwimEx, Newton, Mass.
Write 307 on reader service card

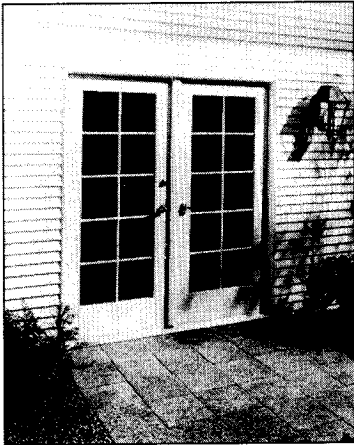

French doors

A line of French doors available in 6 ft 8 in. and 8 ft frame heights features wooden frames, aluminum heads and jambs, extruded aluminum sills with solid hardwood thresholds, and a double weatherstripping system. The door panels are cross-banded on both sides and have 1 7/8-in.-thick solid wood cores. Pella Windows & Doors, Pella, Iowa.
Write 308 on reader service card

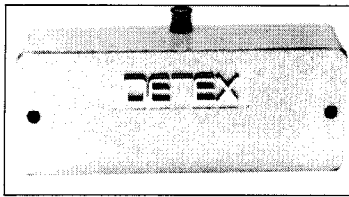

Locking device

The manufacturer's double door holder can be installed on wood, metal, or glass out-swinging doors with either left or right side mountings. The unit is enclosed in a 3/16-in.-thick cast zinc-alloy housing and includes a stainless-steel spring said to ensure instant lock bolt release in an emergency. Detex Corp., New Braunfels, Tex.
Write 309 on reader service card

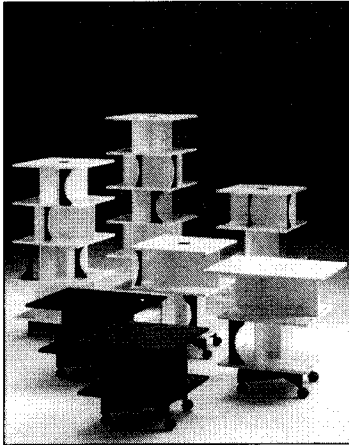

Stackable tables

The manufacturer's stackable tables, designed by Anna Castelli Ferrieri, are available in black, white, yellow, sky blue, pink, and neon green. Each table consists of a die-cast aluminum base and steel-reinforced expanded polyurethane elements. Several tables can be stacked to form a bookshelf, and optional bookholders are available. Kartell, Easley, S. C.
Write 310 on reader service card

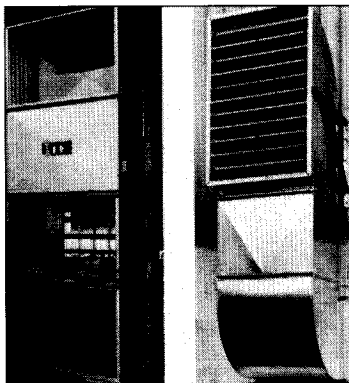

Heating system

The manufacturer's heating system includes an air destratification unit and a series of adjustable dampers and outside air ducts. A discharge temperature control is said to maintain temperature levels by automatically closing outside dampers. Heat-Triever Systems, Div. of Rampe Manufacturing Co., Fairport Harbor, Ohio.
Write 311 on reader service card
Continued on page 183

Curt Dunbar's perfect stack

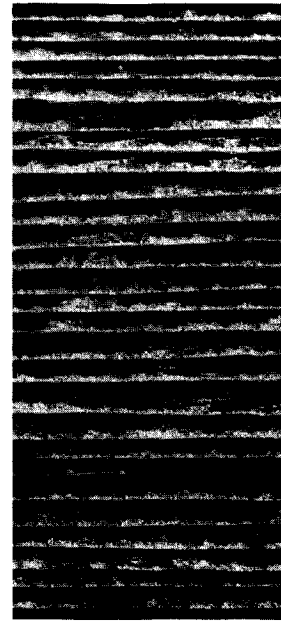

We helped restore Boston's Faneuil Hall [Marketplace], featured in Architectural Record, Dec. 1977.

When Curt trims pieces of Vermont roofing slate to exact dimensions, you could swear he was cutting paper.

He's a slate man. He's got the feel of the stone—a special sense that enables him and our other craftsmen to produce the precisely cut and hewn slate for some of the most challenging custom jobs in the country.

Call us, and we'll ask Curt to trim a perfect stack for your next project.

VERMONT STRUCTURAL SLATE COMPANY, INC.

Fair Haven, Vermont 05743
Toll Free: 800-343-1900

INTRODUCING ARCHIBUS. THE FIRST SOFTWARE INTEGRATED FOR ARCHITECTS BY ARCHITECTS.

Now, instead of your trying to adapt software to suit your needs, ARCHIBUS™ gives you a drop-in, modifiable framework within which you can manage both your architectural projects and administrative support functions.

ARCHIBUS functions as an architect-specific framework for CADPLAN™, AutoCAD™, CADVANCE™, MultiMate™, Power-Base™, dBase III™, and Lotus 1-2-3™; by combining the power of these "blue-chip" software packages with the technological and management expertise of one of the country's foremost architecture and planning firms.

For example, the ARCHIBUS CAD framework can save you 400 to 600 hours of start-up time in defining your procedures. The CAD tutorials take you step-by-step through the creation and manipulation of an entire CAD library.

Furthermore, with ARCHIBUS, you can move files from database to word processing, from spreadsheet to database. ARCHIBUS allows you to access

specific information from any area to help you manage and complete projects with greater efficiency and control.

ARCHIBUS provides entry level ease of use; but, not at the expense of capacity or capabilities. Each component within ARCHIBUS is the most powerful within its class.

ARCHIBUS finally gives architects what we've all been looking for: the ability to manipulate large amounts of information quickly, easily and accurately... and therefore, spend more time being creative and less time gathering information.

Numerous tutorials include word processing for project reports, specifications (MASTERSPEC™ on MultiMate™) and marketing correspondence; database management for client/marketing lists, door, window and room finish schedules and personnel; spreadsheets for profit/loss projections and time management.

The ARCHIBUS Reference Handbook includes a management system for the entire construction documents phase, including working drawings, specifications checklists, and a comprehensive construction administration guide.

You'll find all of the functions architects need to manage a practice, in a fraction of the time, at a fraction of the cost. Plus, a helpful toll-free 800 number to call for any technical or operating assistance you might require.

So, if you have been searching for the ideal architect-specific software, your quest is over.

ARCHIBUS is here.

The first affordable, fully integrated software for architects. Developed for architects. By architects.

ARCHIBUS is a total software solution from Jung/Brannen Research & Development Corporation, 177 Milk Street, Boston, MA 02109.

For additional information, or to find out where to see the ARCHIBUS demo, please call 1-800-541-ARCH. In Mass., call 1-800-992-ARCH.

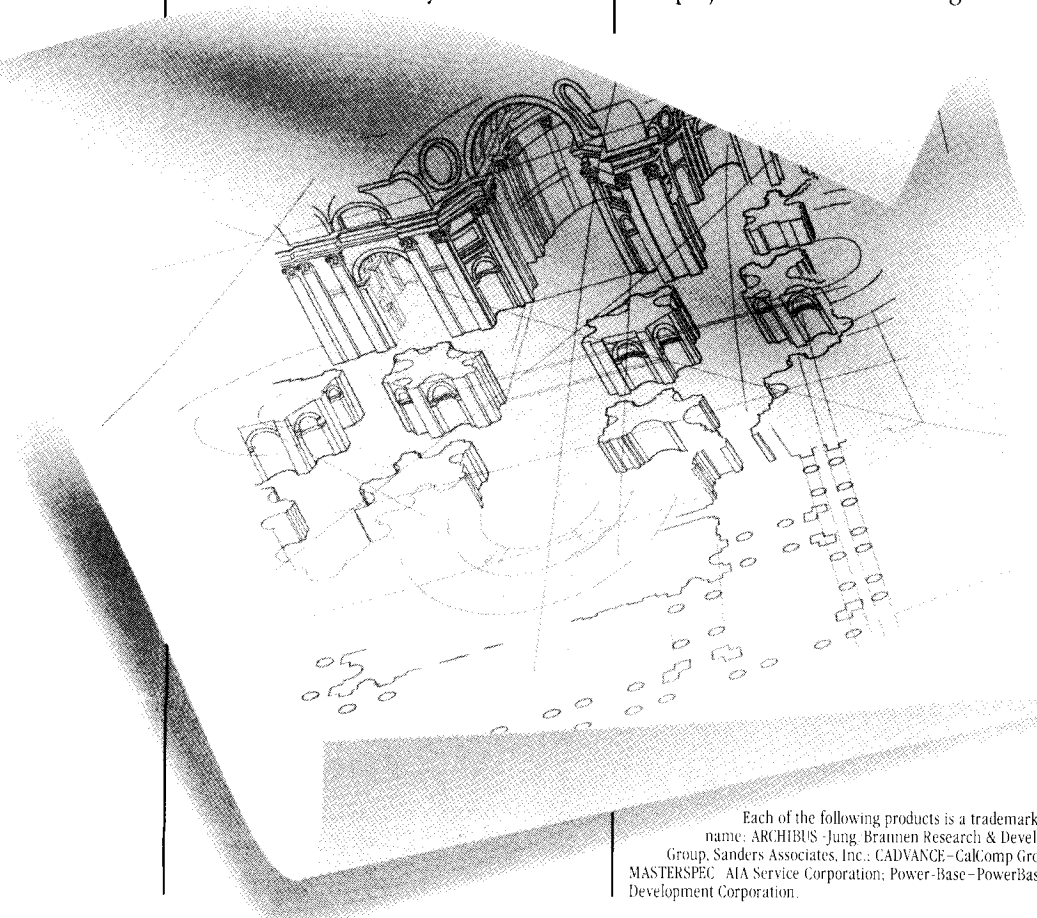
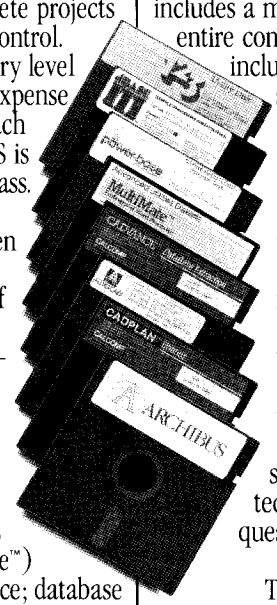

ARCHIBUS™

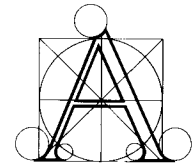

Each of the following products is a trademark or a registered trademark of the company listed after the product name: ARCHIBUS - Jung, Brannen Research & Development Corporation; AutoCAD - Autodesk, Inc.; CADPLAN - CalComp Group, Sanders Associates, Inc.; CADVANCE - CalComp Group, Sanders Associates, Inc.; MultiMate - Multimate International; MASTERSPEC - AIA Service Corporation; Power-Base - PowerBase Systems Inc.; dBase III - Ashton-Tate, Inc.; 1-2-3 and Lotus - Lotus Development Corporation.

Circle 81 on inquiry card

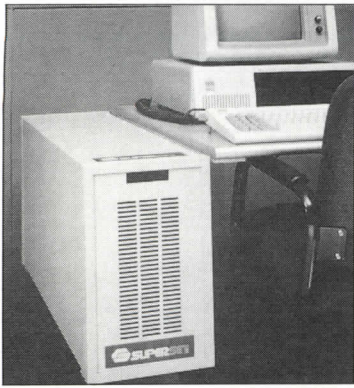

Graphics extension processor

Current applications of the *XP/48* graphics extension processor include two- and three-dimensional presentation graphics, solid modeling, computer animation, image processing, world mapping, and custom type-font generation. Standard features include a 48-bit memory processor, 393 Kbytes of main memory, and a 20-Mbyte internal fixed disk. Superset, Inc., San Diego, Calif.

Write 312 on reader service card

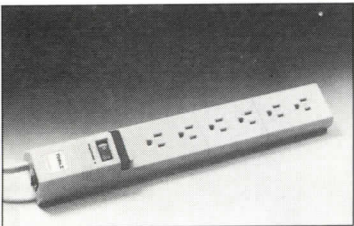

Power strip

The *Surgebuster Plus* multioutlet power strip provides a central AC connection for up to six electrical devices while protecting them against power spikes and power surges. The power strip is said to reduce spikes and surges of up to 6,000 volts to a harmless level. The unit operates on 50 Hz or 60 Hz power. Topaz, Inc., San Diego, Calif.

Write 313 on reader service card

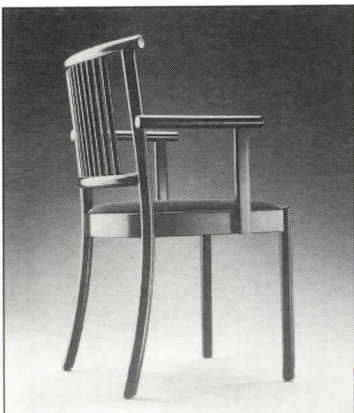

Chair

The *Duo Armchair* designed by Werther Toffoloni is made of solid beechwood and offers two back design options. One back features vertical wooden dowels and the other features a padded bentwood panel. Both models have concavely contoured backs and integral seat cushions. Natural beechwood, lacquered colors, and aniline stain finishes are available. Atelier International Ltd., New York City.

Write 314 on reader service card



Seating line

Designed by Robert Taylor Whalen, the *QQ* seating line features polystyrene shells, fire-retardant molded polyurethane foam cushions, self-skinned polyurethane arm rests, and an injection-molded thermoplastic base with dual casters. Five models are available. Corry Jamestown Corp., Corry, Pa.

Write 315 on reader service card

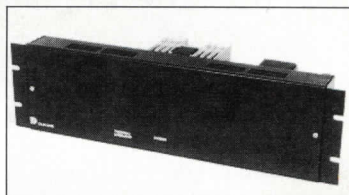

Amplifier

An amplifier designed for background music and sound management applications in schools, churches, stores, stadiums, offices, and other facilities features a broad frequency response and a distortion level said to be less than 0.5 percent over full bandwidth. The amplifier comes equipped with electronic protection and a thermal circuit breaker. Dukane Corp., St. Charles, Ill.

Write 316 on reader service card

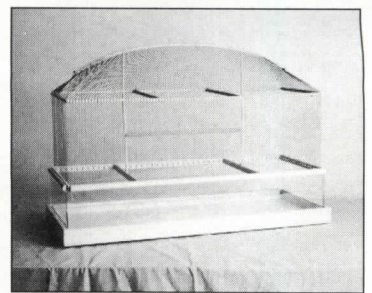

Bird cages

The *Tension-Wire Bird Cage I* is one of several bird cages designed by Belmont Freeman. Constructed of thin stainless-steel cables held in tension over a rigid metal armature, the bird cage measures 33- by 13- by 24-in. Jeffrey Ruesch Fine Arts, Ltd., New York City.

Write 317 on reader service card

Continued on page 185



Union College Mall
Lincoln, NE
Clark Enerson Partners, Arch.

ENERGY EFFICIENT CLEARSPAN SKYROOFS . . .

Another of our major advances in the state-of-the-art . . .
the Structures Unlimited "Skyroof" System!

A material that *transmits diffused daylight* to eliminate lighting energy usage in the daytime; that *controls solar heat* transmission to allow maximum heat gain for passive solar applications, or as little as 10% (compared with glass) to save air conditioning costs; that *insulates* up to 86% more efficiently than single glazing!

Combined with our engineered aluminum structural system, Clearspan Skyroofs up to 100 foot span are a reality.

Complete, under only one contract — one responsibility!

STRUCTURES UNLIMITED, INC.

P.O. Box 4105, Manchester, NH 03108 Phone 603-627-7887

Circle 82 on inquiry card



NORCO[®]

*Masterpieces
in wood windows
and doors.*

Each Norco window is an American masterpiece, finely crafted in the ages-old traditions of window-making.

We complement the natural warmth of wood with the modern arts of energy efficiency. Norco windows are tightly built and offer a choice of glazing options: double glazed, triple glazed or Low-E.

Norco proudly presents a long line of wood windows including casement, bows and bays, double-hung, awning and view, slide-by and custom direct set. And gliding patio doors. All available in natural wood or NOR'CLAD[™] (wood with weather-defeating aluminum clad on the outside.)

They're all built with pride in one of the industry's newest, most modern plants. Yet, each one is built in our tradition of excellence to fit your needs and specifications. Exactly.

That's how we've earned a nation-wide reputation for reliability and flexibility that has become a classic in its own right.

No matter what the project is...single residence or multi-housing, renovation or new construction of commercial, industrial or institutional buildings...offer your customers masterpieces in wood. Write or call today for full information.



NORCO[®]
WINDOWS, INC.

P.O. BOX 309 · HAWKINS, WI 54530

PHONE: 715/585-6311

Circle 83 on inquiry card © NORCO WINDOWS INC., 1984

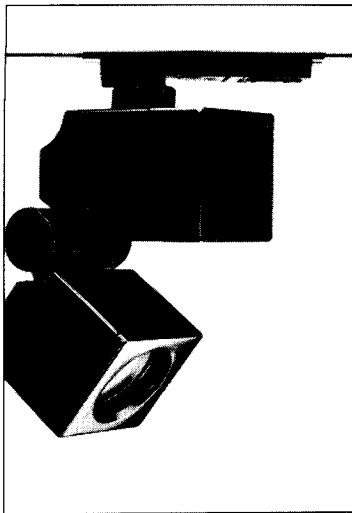

Multi-reflector lamps

The manufacturer's multi-reflector series consists of miniature low voltage die-cast units that use dichroic bulbs. The units are available in a range of beam spreads, and feature an integral transformer for 120-volt input, mounting devices, and a variety of accessories. Lighting Services, Inc., New York City.

Write 318 on reader service card



Patterned carpet

The *Cozumel*, *Romantique*, and *Corporate Geometrics* collections of patterned carpets were designed by Andrew Thompson. The collections include 16 patterns and two borders, and are intended for hotel, restaurant, and corporate applications. Durkan Patterned Carpets, Dalton, Ga.

Write 319 on reader service card



Seating

The manufacturer's fiberglass combined seating and planting unit is available with either oak or redwood benches. The redwood version is intended for exterior applications. A selection of 24 colors is available. Pouliot Designs Corp., Shakopee, Minn.

Write 320 on reader service card

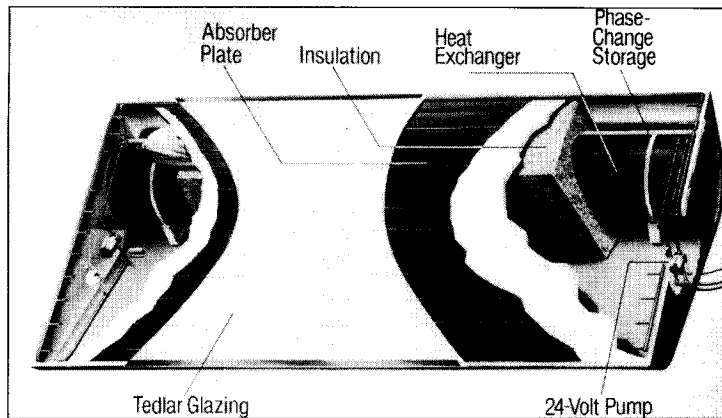

Solar water heater

The *Energy Garden* solar water-heating unit features a heat exchanger and storage system and an absorber plate. The 340-lb, 4-ft by 8-ft module can be installed either on the roof or on the ground,

within 100 ft of the house. The unit's computerized control "talks" the homeowner through the programming cycle. Exemplar, Inc., Hickory, N. C.

Write 321 on reader service card

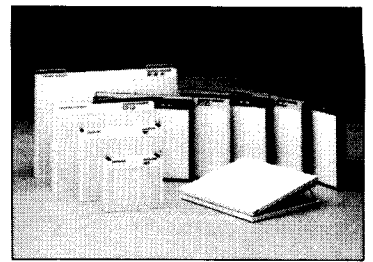

Lightbox

The manufacturer's portable lightbox features a flat worksurface and a handle that rotates to become a tilt stand. The lightbox is available in six colors and four sizes: 9-in. by 12-in., 14-in. by 18-in., 18-in. by 24-in., and 24-in. by 36-in. The two larger models can be converted into light tables.

Starcor Corp., Newark, N. J.
Write 322 on reader service card
Continued on page 189

**IN A FIRE-RATED EXTERIOR SYSTEM...
YOU CAN PAY A LOT MORE AND BUY
A LOT LESS**

Stonecast Fire-Rated architectural aggregate panels are a necessary part of any highly engineered, beautifully designed exterior system.

These low flame spread panels, carrying a UL Class I rating of 15, combine an asbestos-free cement board with a natural stone surface. Your system benefits four ways:

1. Durability. Stonecast panels have 25 years of field use. Factory assembled, with stone and wood permanently bonded by a special industrial epoxy, they're warranted for 15 years.

2. Ease of installation. Stonecast Fire-Rated panels are easily pre-drilled and screwed in place utilizing a gasket over the stud. Standard 4' x 8' and 4' x 10' sizes may be field-cut or can be ordered factory pre-cut.

3. Attractive appearance. Textures and colors range from earthtone beach pebbles to grey granite aggregate. You can make joints blend, or feature them with contrasting moldings and battens. Colored nails and screws keep fasteners hidden.

4. Economy. Stonecast Fire-Rated exterior panels promote savings for the life of your building through low initial cost, simple installation and a long, low-maintenance life.

Stonecast Stone-and-Plywood and Granex integral aggregate panels are also available. Ask for samples and literature. From **Sanspray Corporation, 630 Martin Ave., Santa Clara, CA 95050. Phone (800) 538-6882; in California, (408) 727-3292.**

**STONECAST FIRE-RATED
FROM SANSPRAY CORR**

The Panel People



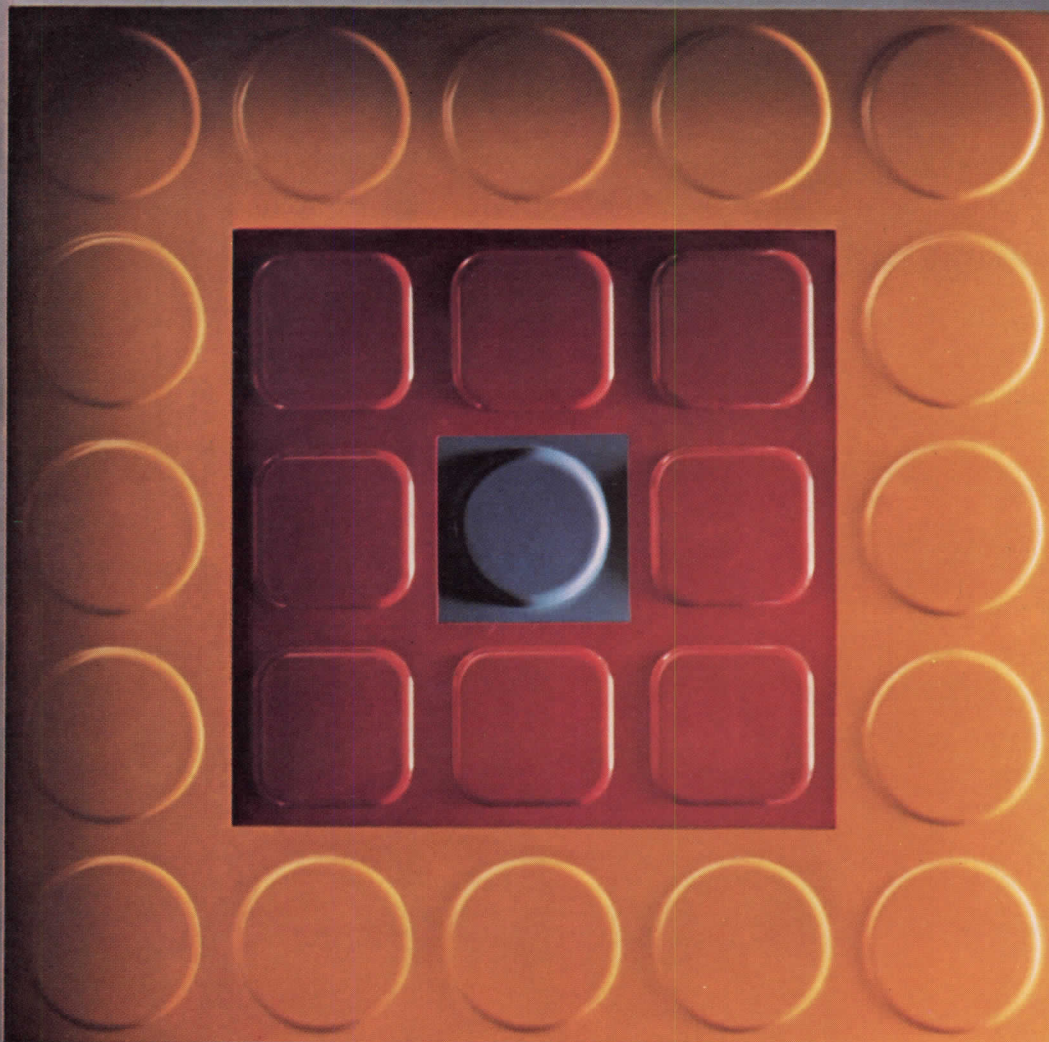

THE
FLOORING
PIONEER
STEPS
TOWARD
THE
FUTURE

Pirelli

Jason Industrial Inc. 340 Kaplan Drive Fairfield, NJ 07006 201 227-4904 Telex: 138229

Circle 85 on inquiry card

Manufacturer sources

For your convenience in locating building materials and other products shown in this month's feature articles, RECORD has asked the architects to identify the products specified

Pages 72-79

House in the Rio Grande Valley
Antoine Predock FAIA, architect
Pages 72-77—Paving: Kinney Brick Co. Exterior finish: El Rey Stucco. Colorant: Wellborn Paint Mfg. Co. Exterior lighting: Lightolier. Gate: custom by architect, fabricated by owner's brother. Pool: Mossman Gladden. Tile: American Olean.
Page 78—Kitchen cabinets: St. Charles. Countertops: Corian. Plastic laminate surfaces: Formica. Track lights: Lightolier. Faucets: Chicago Faucets. Casement and all other windows: Pella. Microwave oven: Amana. Tile flooring: American Olean.
Page 79—Gallery flooring: Kinney Brick Co. Drywall: U.S.G. Interior paints: Wellborn Paint Mfg. Co.

Pages 90-97

Rosewalk Cottages, Seaside, Florida
Orr & Taylor, architects
Pages 90-95—Millwork, gazebos, benches: custom by architects, fabricated by Seaside Community Development Corp. Windows, wood-and-glass doors: Andersen. Locksets: Schlage. Paints: Devco.
Page 97—Flooring finish: Duraseal.

Pages 104-109

Grove House, San Diego County, California
Smith and Others, architects
Pages 104-108—Exterior stucco: Expo. Roofing: Bird & Son. Wood windows: Caradco. Sliding glass doors and aluminum windows: Window Master. Locksets: Ironmonger. Paints (throughout): Pratt & Lambert.
Page 109—Refrigerator: Sub-Zero. Countertop: Corian. Laminate surfaces: Formica. Lighting fixtures: Artimedi.

Pages 110-121

Farmhouse in Connecticut
Allan Greenburg, architect
Pages 110-113—Lanterns: Custom by Ned James. Paints (interior and exterior): Benjamin Moore. Custom architectural woodwork (exterior): Littitz Planing Mill. Columns: Somerset. Wrought iron: Custom by Dick Sargent.
Pages 114-115—Flooring and wood stains: Coughlin Flooring. Architectural woodwork: Eisenhardt Mills, Inc. Hardware: P.E. Guerin, Inc. Air diffusers: Tuttle & Baily.
Page 117—(bottom) Cherry wood paneling: Mark Adams.

Pages 128-133

Kahn Residence, Lima, Ohio
Hugh Newell Jacobsen, architect
Pages 128-131—Skylight: custom. Siding: U. S. Champion (Duraply). Paint (interior and exterior): Sherwin-Williams. Garage doors: Crawford Door Co. Wood windows: Quality Sash. Insulated glazing: LOF. Exterior door: custom. Hardware: Baldwin. Exterior wall lights: Edison Price. Recessed ground fixtures: Prescolite.
Page 132-133—Shutters: Joanna. Dining table: Marcusa by ICF. Chairs: Elise by Gordon. Folding louvre doors: custom. Drywall: U.S.G. Interior doors: custom. Flooring stain: Duraseal (Coffee). White porcelain passage sets: Plexicraft.

Hinges: Stanley. Latches: Dexter. Hardware: M & M. Wall washers: Edison Price (Parseop). Recessed downlights: Lightolier (Lytecaster Series). Recessed pinhole projection light: Kliegl.

Pages 134-139

Vilanova House, Key Biscayne, Florida
Andres Duany and Elizabeth Plater-Zyberk, architects
Pages 134-137—Clay tile roof: Iberia Tile. Masonry panels: C. B. S. Double-hung windows: Marvin.
Pages 138-139—Paints: Benjamin Moore. Laminate surfaces: Formica. Concrete tile: Tropic. Faucets: American Standard. Locksets: Schlage.

Pages 140-145

Vacation Compound, Deer Isle, Maine
Peter Forbes and Associates, architects
Pages 140-143—Sliding glass doors: Arcadia. Wood casement windows: Marvin. Granite: Crotch Island. Gray stain: Cabot.

Pages 144-145—Track lighting: Edison Price. Electric baseboard heaters: Chromolux. Sofa and lounge chairs: Palazzetti; ICF. Standing lamps: Atelier International. Drywall: U.S.G. Stone flooring: Crotch Island. Dining table, chairs: Knoll International.

Pages 146-151

Mallet House, New York City
SITE Projects, designers
Pages 146-151—Plaster: U. S. G. Plaster work: J. P. Painting. Paints: Glidden. Reliefs: C. S. I. Inc.; M. R. A. Associates. Custom woodwork and French doors: OHTA Studio Corp. Period ceiling-hung light fixture and hardware: Great American Salvage. Custom iron work, stairway, and decorative grilles: Solo Engineering.

Pages 164-169

Kitchen, Wharton House
Stamford, Connecticut

Shope Reno Wharton Associates, architects
Custom cabinets and architectural woodwork: Breakfast Woodworks. Kitchen sink: Elkay. Faucets: American Standard. Range: Garland. Recessed lights: Lightolier. Vinyl tile flooring: Flexco. Dishwasher: Kitchen Aid. Refrigerator: General Electric. Paints: Devco.

Pages 172-173

Master bathroom, Farmhouse in Connecticut
Allan Greenberg, architect
Faucets and locksets: P. E. Guerin, Inc. Shower head: Speakman. Bronze shower surround: Samuel Yellin Metalworkers. Bent glass: California Glassbending Co.

Pages 174-176

Bathroom, Hopper Residence, Venice, California
Brian Alfred Murphy, architect
Glass block: Owens-Corning. Tile: American Olean.

FOUR SEASONS® CHANGING THE WAY AMERICA BUILDS...

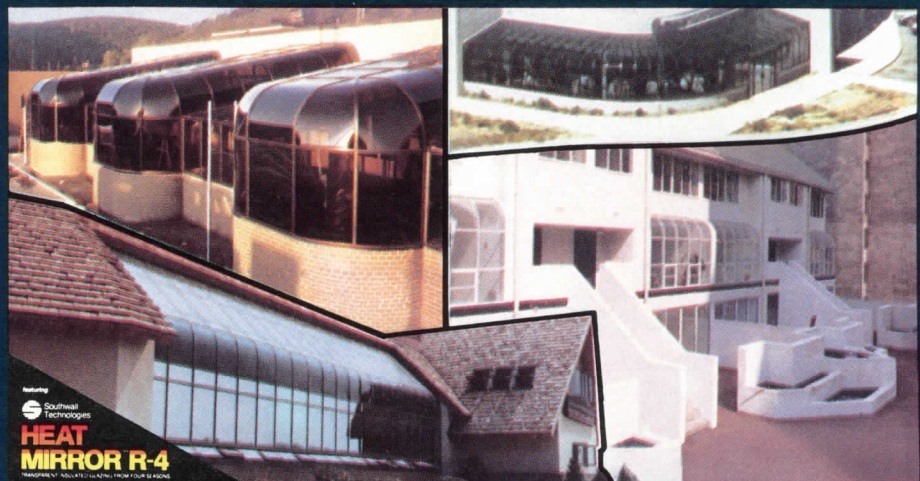

...WE BUILD IT JUST FOR YOU!™

Four Seasons® will give you more than just a greenhouse for your next project. We can give you a real advantage with benefits like Heat Mirror™ represents a revolution in glazing by keeping summer heat out and winter heat in. Four Seasons® is the exclusive manufacturer of Heat Mirror™ for the solarium industry.

But that's not all, Four Seasons® will support you with our nationwide network of franchised pro-

fessionals. Their reputation for excellence in the industry is unmatched, anywhere. Add to this the entire Four Seasons® organization, and you are being fully assisted from product selection and availability, to service and special factory discounts for National Accounts, chains, builders, or developers. To get your share of the Four Seasons® discounts, call and ask for our National Account Department.



CALL NOW
FOR FREE COLOR CATALOG
1-800-FOUR SEASONS
5005 Veterans Memorial Hwy.
Holbrook, New York 11741

Franchise Opportunities Available

Circle 86 on inquiry card

Times Change

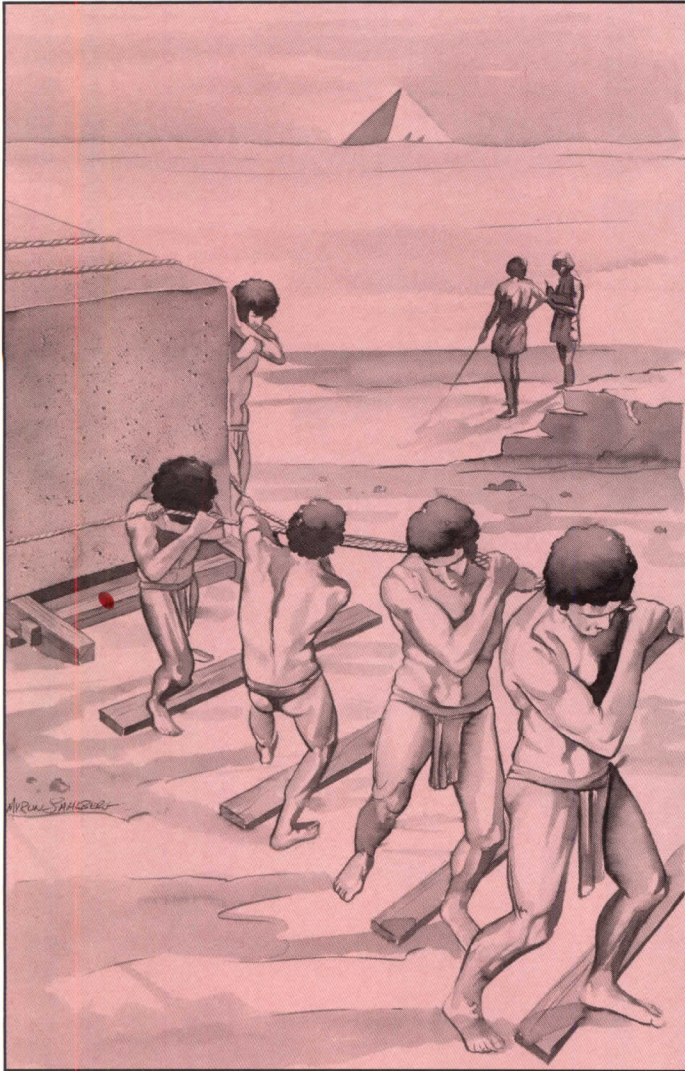

Shouldn't You ?

Though principles of good design never change, Gyp-Crete knows that construction methods must meet the changing demands of today.

The Great Pyramid at Gizeh is still considered by many to be the perfect design.

Thousands of free citizen laborers, volunteering to work for their Pharaoh, completed the world's largest stone structure in 23 years. They worked in gangs of 20, without wheels, to haul the 2¹/₂ ton blocks up ramps for placement. It was labor intensive, time-consuming, and expensive.

Construction methods have changed, however, since its completion 4600 years ago.

Gyp-Crete, the leader in cementitious floor underlayment, introduces Gyp-Crete 2000 and Gyp-Crete 2000 applicators.

Gyp-Crete 2000 is a high strength, pourable underlayment that requires no sanding or grinding to provide a smooth surface. Application depths of 3/8" to 3" cover irregularities in pre-cast concrete, wood frame construction, and renovation projects.

Gyp-Crete 2000 is also the best choice for sound deadening and fire protection on all above grade floors. There are no shrinkage cracks with Gyp-Crete 2000.

All Gyp-Crete 2000 independent applicators are company qualified and receive on-the-job training.

Cube samples of each pour are company tested for quality and Gyp-Crete 2000 applicator teams can pour 1,000 to 20,000 sq. ft. in one day.

Gyp-Crete 2000 is your best choice for all projects that will carry your name — today and tomorrow.



Gyp-Crete
Corporation
920 Hamel Rd.
Hamel, Mn. 55340
(612) 478-6072

Circle 87 on inquiry card



Marble tiles

The *Paradiso* collection of marble tiles is suitable for contract and residential applications on floors, walls, counter tops, and vanities. The 12 in. by 12 in. tiles are 3/8-in. thick and are available in a selection of colors. Stark Carpet Corp., New York City.

Write 324 on reader service card

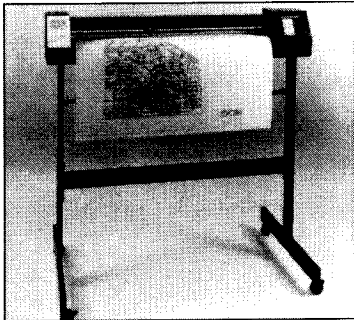

Drafting plotter

The manufacturer's *Model SP1200* E-size drafting plotter can accommodate paper, vellum, or transparent film up to 37 1/2 in. by 81 in. The plotter is designed for use with microcomputer-based CAD and CAE systems and can be attached directly to a workstation. Enter Computer, Inc., San Diego, Calif.

Write 325 on reader service card

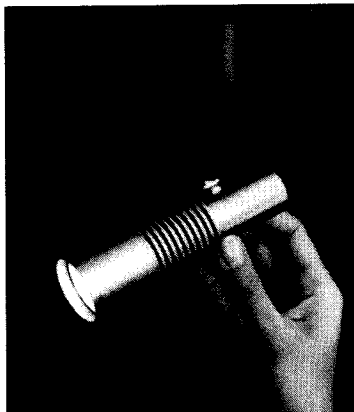

Accent lights

The manufacturer's line of miniature low-voltage accent lights has been designed to use ultra-compact quartz halogen mirrored reflector lamps. The directional lights use 20- and 35-watt bulbs and are said to provide good color rendition and beam control. Capri Lighting, Los Angeles.

Write 326 on reader service card

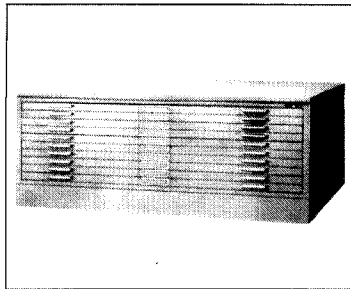

Filing system

A ten-drawer filing unit features 9/16-in.-deep drawers lined with a hinged dust cover to keep papers flat. Hardened ball-bearing rollers with nylon wheels guide the drawers on a curled track, and are intended to prevent jamming. Also available are 6-in. magnetized drawer dividers for arranging smaller papers. Mayline Co., Inc., Sheboygan, Wis.

Write 327 on reader service card

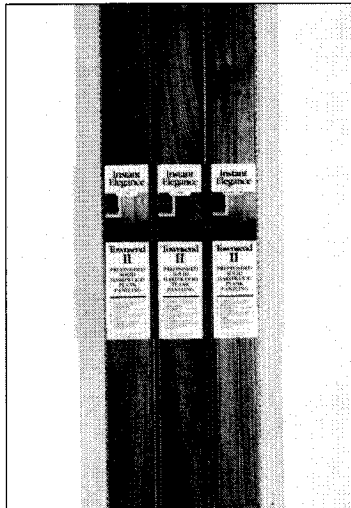

Paneling

Prefinished tongue-and-groove plank paneling measuring 3/8 in. wide is available in three varieties—ash, oak, and beaded oak. The panels come in 15.1 square ft bundles. Brooks-Pollard Co., Little Rock, Arkansas.

Write 328 on reader service card

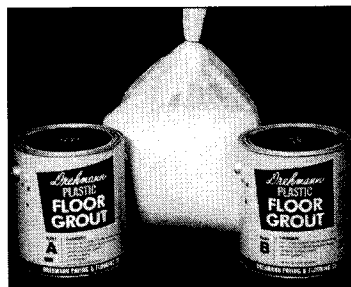

Grout

A fast-drying plastic floor grout, designed for use on new brick flooring or for repairing older brick floors, is said to form a tight adhesive bond that is both shrink-proof and chemical-resistant. The grout is available in gray, black, or red. Drehmann Paving and Flooring, Philadelphia.

Write 329 on reader service card
Continued on page 191



WATERCOLORS INC
GARRISON ON HUDSON
NEW YORK 10524
914 424 3327

Represented in: CA, CO, FL, GA, HI, IL, MA, NH, NY, TX, VA, WA.

Circle 88 on inquiry card

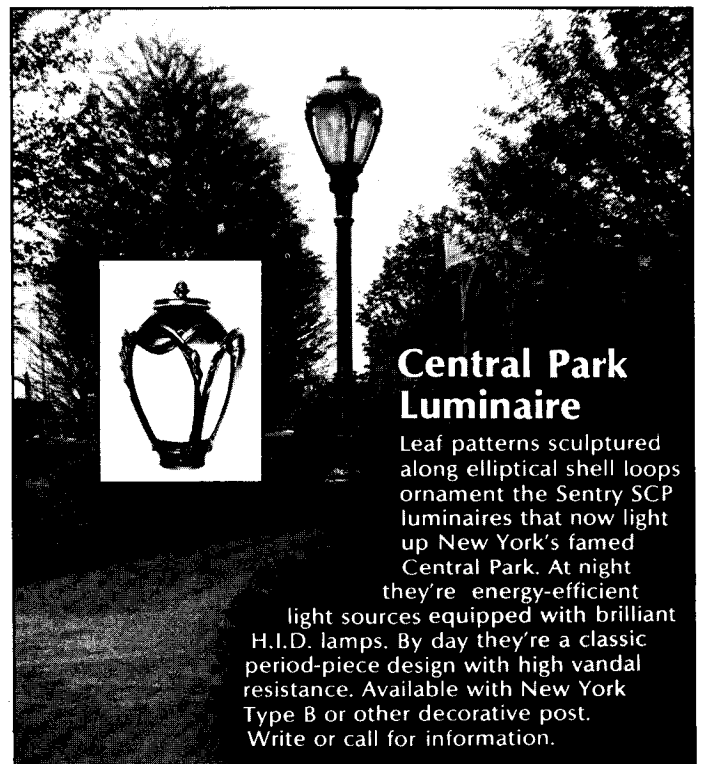

Central Park Luminaire

Leaf patterns sculptured along elliptical shell loops ornament the Sentry SCP luminaires that now light up New York's famed Central Park. At night they're energy-efficient

light sources equipped with brilliant H.I.D. lamps. By day they're a classic period-piece design with high vandal resistance. Available with New York Type B or other decorative post. Write or call for information.

See us in Sweet's
Sentry Lighting of elegance & energy efficiency

Sentry Electric Corporation
185 Buffalo Ave., Freeport, NY 11520 • 516-379-4660

Circle 89 on inquiry card

KITCHEN CLASSICS

FROM CHICAGO FAUCET



A



B



C



D



E

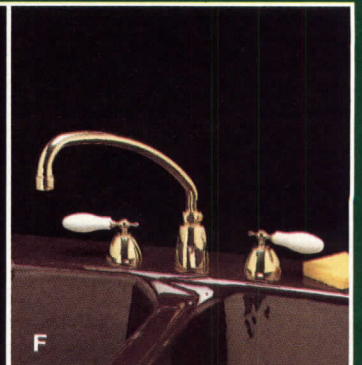

F



G

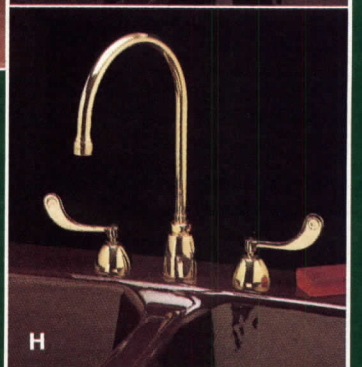

H

Beauty, elegance and a hint of European influence are captured in Chicago Faucet's kitchen classics. Choose the charm of polished brass, coated polished brass or traditional chrome and then complement your choice with ceramic, acrylic, chrome, polished brass or coated polished brass handles. They're all yours from Chicago Faucet.

- A. No. 50-E3-372
- B. No. 50-E3-317
- C. No. 201-GN8A-E3-317
- D. No. 200-GN8A-E3-370

- E. No. 728-SS-372
- F. No. 201-L9-370
- G. No. 201-GN8A-E3-370
- H. No. 201-GN8A-E3-317

CHICAGO
FAUCETS

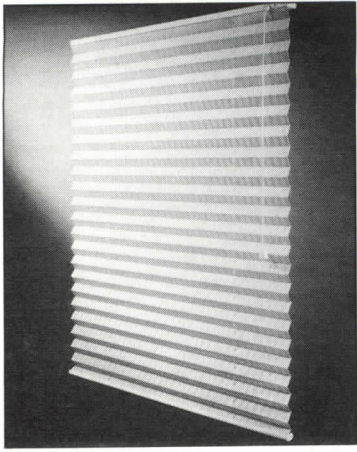

Window shade

A 100 percent woven polyester shade features matte and satin textured weaves. The *Dobby Stripe* fabric is said to be specially finished and heatset to ensure pleat retention. The shade was designed by Janet Birch and is available in 15 colors. Graber Industries, Inc., Middleton, Wis.

Write 330 on reader service card

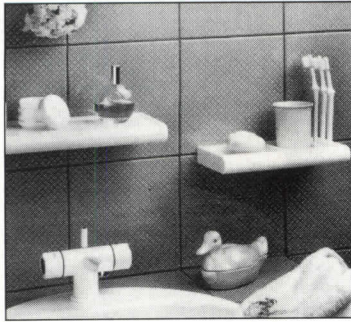

Bath faucet

A solid brass, epoxy-powder coated faucet is available in a variety of colors in both basin and tub models. Both models feature ceramic discs instead of washers and the tub model is available with a portable shower extension unit. Normbau, Inc., Addison, Ill.

Write 333 on reader service card



Half round windows

A 6-ft half round window, designed to transfer both weight and wind load directly to the frame of the building, can be installed directly on top of a lower unit without a header. Intended for use above patio doors or triple casement windows, the unit features two removable grille patterns, 7/8-in. insulating glass, and integral nail fin/flashing. Webb Manufacturing, Inc., Conneaut, Ohio.

Write 334 on reader service card

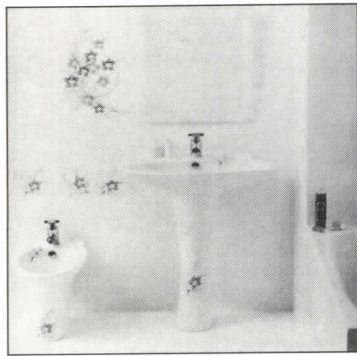

Bathroom fixtures

The *Decoras* collection of china bathroom fixtures and ceramic wall tiles features hand-painted floral designs. The enameled designs are available on white *Femina* and *Concorde* pedestal sinks and bidets. Other designs and colors can be specified and coordinated with the manufacturer's glazed tiles and shaded color fixtures. Procher Inc., Chicago.

Write 331 on reader service card

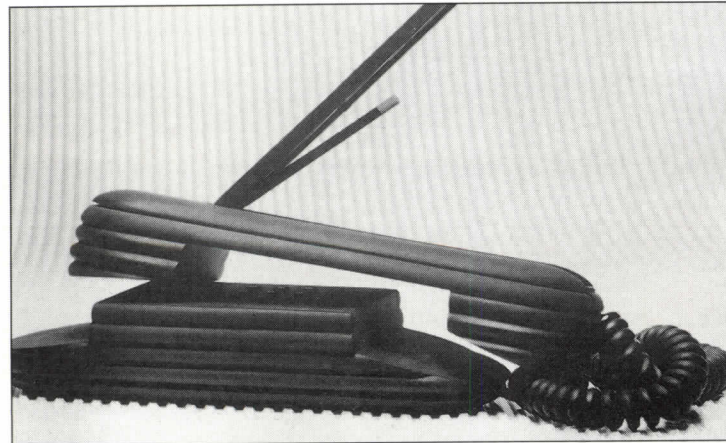

Telephone

The *Parola* telephone designed by Fausta Cavazza is constructed of *Santoprene*, a rubberlike substance said to be crack- and fingerprint-resistant. The telephone features a built-in shoulder support and pencil,

and a electronic ringing signal. A touch-tone dialing circuit allows automatic last number dialing. Becker & Becker, Inc., Westport, Conn.

Write 332 on reader service card
Continued on page 193



Multi-family projects with warmth and texture.

Consider The Timberpeg Concept . . . a perfected building system with time-saving technical support. An ideal approach for successful multi-family designs.

We offer a pre-engineered timber framing system with a choice of over 46 standard frame sections. Our complete exterior shell package includes siding, insulation systems and millwork, delivered to your site at a predetermined cost, when you want it.

TIMBERPEG

Dept. AFR, Box 8988
Ft. Collins, CO 80525
(303)221-3355

Dept. AFR, Box 1500
Claremont, NH 03743
(603)542-7762

Dept. AFR, Box 1007
Elkin, NC 28621
(919)366-2501

Circle 91 on inquiry card

SPECIFY THE ONLY PRACTICAL METHOD OF MEETING ARMA ATTIC AND ROOF VENTILATION REQUIREMENTS.

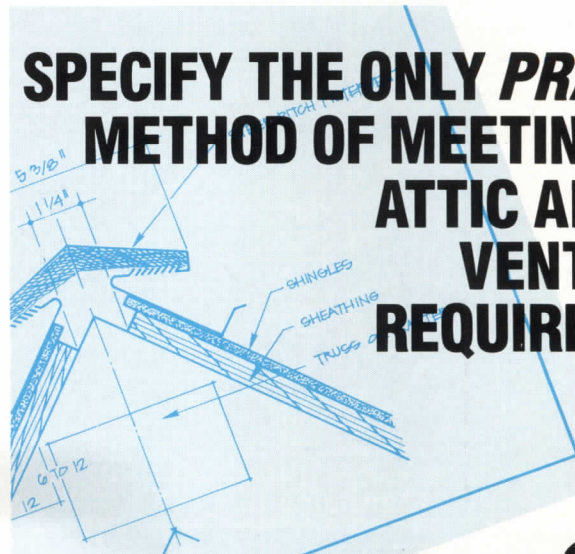

FilterventTM
Keeps the weather out
The Asphalt Roofing Manufacturer's Association (ARMA) recognizes the importance of proper ventilation. And most shingle warranties require 1 square foot of net free ventilation per 300 square feet of attic roof . . . even 12/12 pitch roofs.
SPECIFY THE BEST.
Filtervent



AIR VENT INC.
4801 N. Prospect Rd., Peoria Heights, IL 61614
PHONE TOLL FREE 800/AIRVENT

Circle 92 on inquiry card



When beauty is as important as performance

Built-in refrigeration for homes of distinction

Combining beauty and performance Sub-Zero is the true built-in refrigeration system designed exclusively for the home.

All models feature 24" depth, which enables them to fit flush with all standard base cabinets and affords easy accessibility to all stored items. □ All Sub-Zero built-in models are designed to accept exterior panels of virtually any material. This unique feature provides you complete flexibility in kitchen design. You can blend it in or accent your own special kitchen decor. □ Models range in size from 24" to 48" width and up to 31 cubic feet in capacity...the largest unit

made for the home. The line features side-by-side, over-n-under (freezer on bottom), all refrigerator, and all freezer units. Also available are under-counter and individual ice-making units. □ All full size units feature automatic icemaker and adjustable storage in both refrigerator and freezer. □ An outstanding refrigeration system coupled with such innovative features as polyurethane insulation (entire unit including doors), magnetically sealed doors, self venting and automatic defrost assures years of satisfactory performance. □ Every Sub-Zero unit is completely test run at the factory for total performance before delivery.

SUB-ZERO

See Sub-Zero on display at leading kitchen dealer and appliance showrooms.

Send for colorful brochure on unique kitchens. Available in Canada. SUB-ZERO FREEZER CO. • P.O. BOX 4130, MADISON, WI 53711 • 608/271-2233

Circle 93 on inquiry card

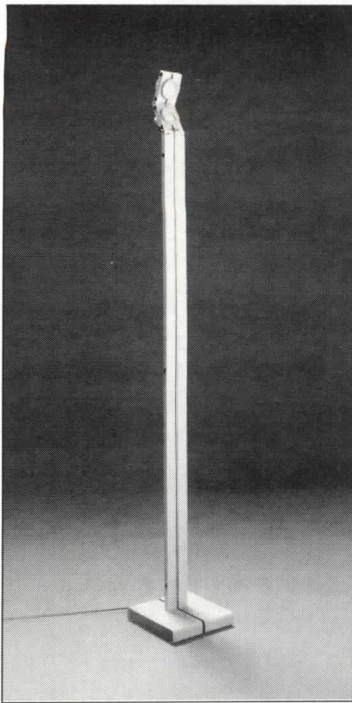

Floor lamp

The *Antares III* dual-head quartz floor lamp features an anodized and precision-machined all-aluminum body and a four-position dimmer switch that is activated through the center strip. The 67-in. lamp is available in gray or black with either an anodized or sand-blasted finish. The unit uses two 12-volt bulbs set into hinge-action light heads. Antares, Inc., Chicago. Write 335 on reader service card



Whirlpools

The manufacturer's whirlpools are made of fiberglass-reinforced resin and are available in 5 1/2- and 6-ft models. Both units are pre-wired and come fitted with copper tubing. The units feature tub-mounted switches for pneumatically operated solid-brass jets, air volume controls, handrails, and an adjustable headrest. EPIC, Indianapolis, Ind. Write 337 on reader service card

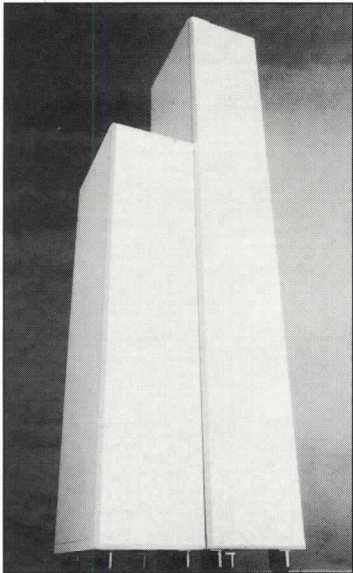

Ready-to-assemble furniture

More than 25 models of the manufacturer's ready-to-assemble furniture featuring dual component heights, contrasting leveler legs, automatic backlighting, slide-out component shelves, and bi-fold doors are available. The furniture has a multicoat white lacquer finish and 45-deg-angled solid ash trim stripes. Cutter Furniture Corp., Northbrook, Ill. Write 338 on reader service card

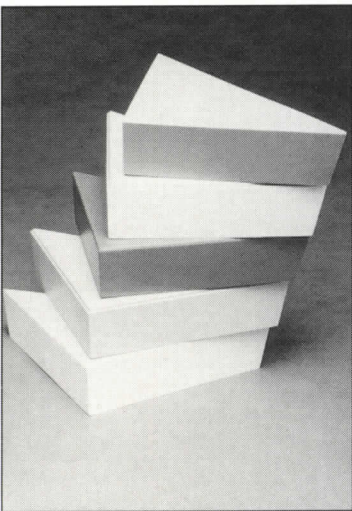

Decorative laminates

The *Color Quest* line of solid color decorative laminates is available in marigold, tropic jade, rosemist, cherry, dresden blue, wisteria, arctic blue, and tyrol green. Several surfacing options are available including matte, gloss, and embossed grid. The laminates feature chemical, fire-, and wear-resistant finishes. Wilsonart, Temple, Tex. Write 336 on reader service card

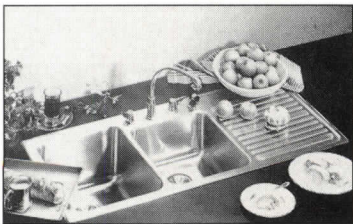

Sink

Model *ILGR-4822* of the manufacturer's *Gourmet Sink Collection* features double stainless-steel 10-inch bowls, an integral 17 1/8 in. drainboard that may be ordered for either side, and a *Hi-Arc* faucet. The collection is available in 11 different configurations. Elkay Manufacturing Co., Oak Brook, Ill. Write 339 on reader service card
Continued on page 195

**IRON-A-WAY
Built-In
Ironing
Centers**

Specified by architects
World-wide for new
construction and remodeling.

46" ventilated steel board
supported by telescoping
steel rods.

Steam iron
insulated
compartment.
Folding sleeveboard.
Work area light.
Electric control panel.
Neatly folds away. Safety
door switch turns off power.
Recesses between studs or
mounts on surface.

—For more information, see Sweet's Section
— 11.27a/Iro, or

Contact the Contract Sales Division of
IRON-A-WAY, INC.
220 West Jackson • Morton, IL 61550 • (309) 266-7232

Circle 94 on inquiry card



**SPECIFY THE ONLY ATTIC AND
ROOF VENTILATOR THAT KEEPS
OUT RAIN AND SNOW.**



ridge FilterVent™ Keeps the weather out

Only the patented line of Filtervent products from Air Vent Inc. have the exclusive glass fiber weather filter to "Keep the Weather Out" under all weather conditions and wind directions. The filter does its job without restricting air flow.

**SPECIFY THE BEST.
FilterVent**



AIR VENT INC.
4801 N. Prospect Rd., Peoria Heights, IL 61614
PHONE TOLL FREE 800/AIRVENT
Circle 92 on inquiry card

MARAZZI'S "NOBEL™" CERAMIC TILE

Classical Inspiration For Today's Living & Working Environments



"Nobel™", with its five sizes ranging from 8"x 8" to 24"x 24" and its nine unique granite colors, allows specifiers total design flexibility for those residential and commercial installations where elegance and function are required. Produced by Marazzi's patented manufacturing process, "Nobel™" offers a durable glazed finish, easily maintained for a timeless appeal. For more information, contact American Marazzi Tile's Marketing Department at (214) 226-0110.



AMERICAN

MARAZZI TILE

55 Clay & Scyene Roads
Sunnyvale (Dallas), Texas 75182
(214) 226-0110

*An affiliate of Marazzi Ceramiche Group Italy
(Formerly Marazzi USA, Inc.)*

Circle 95 on inquiry card

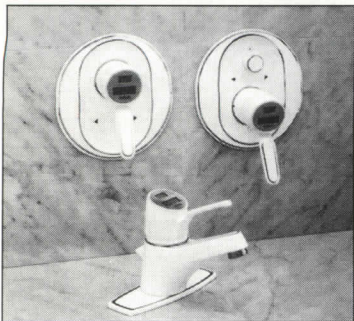

Faucets

A line of solid brass faucets features ceramic disc valves, removable cartridges, single lever control, and a liquid crystal display that gives the temperature of the water passing through the faucet. The line is available in six finishes—chrome, polished brass, bone, white, white with a gold trim, and gold. American Standard, Inc., New Brunswick, N. J.

Write 340 on reader service card



Cooktop

The manufacturer's 36-in. gas downdraft cooktop features the *Wisp-Air* vent system said to eliminate the need for an overhead exhaust hood. The unit features a solid-state pilotless ignition and an interchangeable cartridge system that allows for four cooking modes—double burners, grill, griddle, and rotisserie. The grates are made of cast iron.

Modern Maid Co., Topton, Pa.
Write 343 on reader service card



Custom lighting

The custom-built *Palleideon* chandelier series is available as one-of-a-kind creations designed to meet the client's shape, size, finish, and material specifications. The series comes in a variety of metals, mica colors, and lamp configurations. Modulighter, Inc., New York City.

Write 341 on reader service card

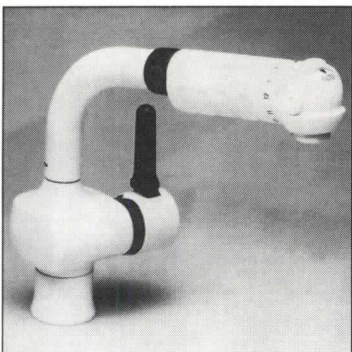

Water filter

The manufacturer's pull-out hose kitchen deck features a series of interchangeable attachments including a spray head with two water patterns, a brush spray for washing china and crystal, a scraper spray for scouring pots and pans, and the *Ladylux* water filter head. The filter head should be used on cold water only. Grohe America, Inc., Wood Dale, Ill.

Write 344 on reader service card

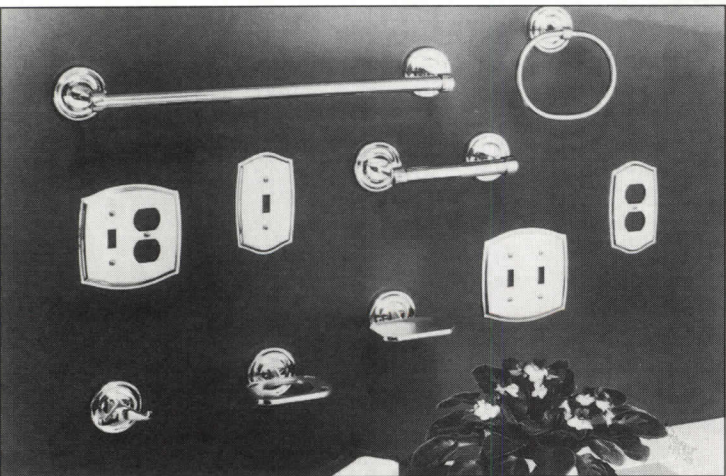

Bathroom accessories

The *Americana II* collection of solid brass bathroom accessories features 18-, 24-, and 30-in. towel bars, a towel ring, a soap dish, a paper holder, a brush and tumbler holder, and switch and outlet plates.

The units are available in polished brass, antique brass, and polished chrome combinations. Franklin Brass Manufacturing Co., Culver City, Calif.

Write 342 on reader service card
Continued on page 197

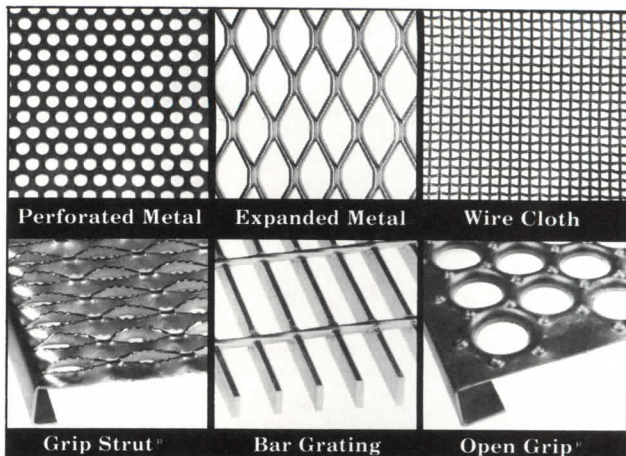

SHOPPING FOR METAL WITH "HOLES"?
Then Call the 'Hole Store'®!
— FIVE SERVICE CENTERS —
CLEVELAND • CHICAGO • DALLAS
ATLANTA • TAMPA
Complete Stocks — Fast Shipment
TOLL 1-800-237-3820
FREE: 1-800-282-6600 (Fla.)
Call or Write for Our New Catalog

McNICHOLS CO.
5501 Gray St. / Tampa, Florida 33609
(813) 876-4100

Circle 96 on inquiry card

SPECIFY THE ATTIC AND ROOF VENTILATOR THAT REMOVES HEAT AND BEAUTIFIES THE HOME.

flash FilterVent™ Keeps the weather out removing attic heat . . . and they detract from the beauty of the home. Filtervent provides superior heat and moisture removal and aesthetics. Available in four attractive finishes.

SPECIFY THE BEST. FilterVent.

AIR VENT INC.
4801 N. Prospect Rd., Peoria Heights, IL 61614
PHONE TOLL FREE 800/AIRVENT

Circle 92 on inquiry card

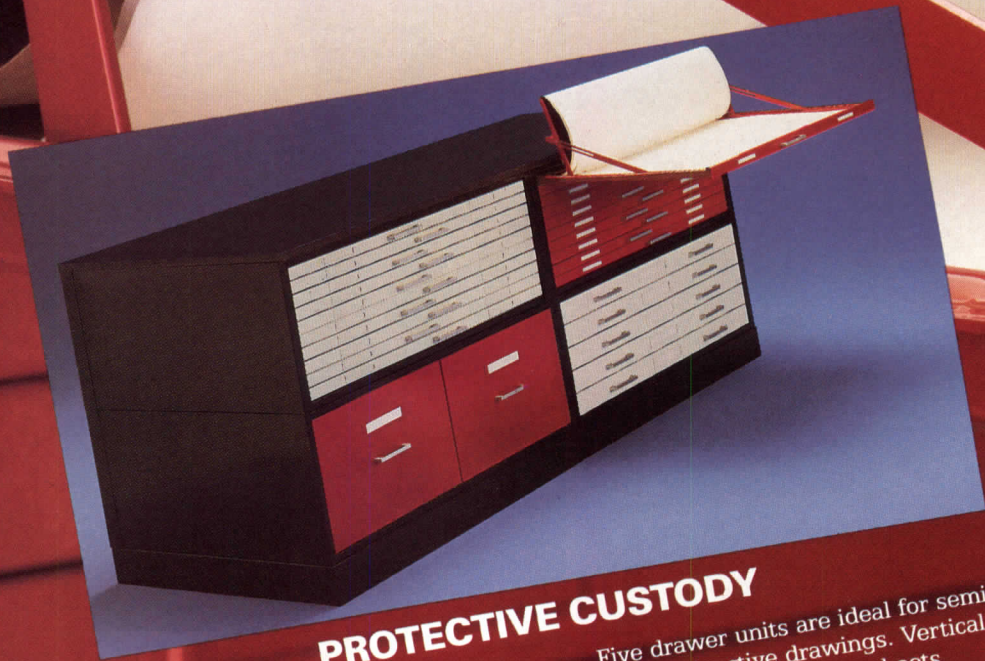

PROTECTIVE CUSTODY

Hamilton UnitSystem Files. Rugged steel custody for maximum protection and instant retrieval of drawings and prints.

Stackable, interlocking UnitSystem Files include space-saving ten drawer units for active drawings. The exclusive tracing lifter in each drawer makes every sheet the top sheet.

Five drawer units are ideal for semi-active and inactive drawings. Vertical files, for safe storage of smaller sheets, complete the system.

UnitSystem Files. Protective, practical filing solutions available in dozens of standard or custom colors from your Hamilton dealer.

HAMILTON

TWO RIVERS WISCONSIN 54241 TELEPHONE 414 793-1121

Circle 97 on inquiry card

Product literature

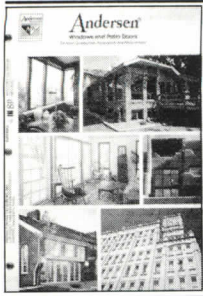

Windows and doors

A 60-page color catalog features the manufacturer's line of roof, basement, casement, double hung, and gliding windows and patio doors. The catalog provides detailed illustrations, product descriptions, and technical specifications. Andersen Corp., Bayport, Minn. Write 345 on reader service card

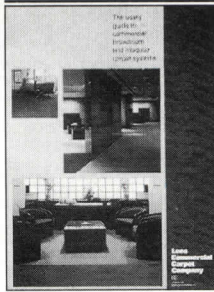

Carpeting

The manufacturer's commercial broadloom and modular carpet systems are highlighted in an 8-page color guide. The brochure includes performance specifications, comparison charts of available carpet backings, and descriptions of product characteristics and options. Lees Commercial Carpet Co., King of Prussia, Pa. Write 348 on reader service card

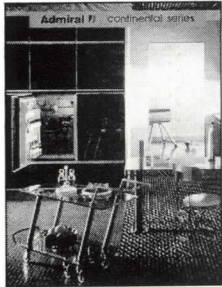

Kitchen appliances

The manufacturer's *Continental Series* line of built-in kitchen appliances is featured in an 18-page color brochure. The material includes product descriptions, available options, and dimensional information on refrigerators, freezers, and dishwashers. Admiral, Div. of Magic Chef, Inc., Schaumburg, Ill. Write 346 on reader service card

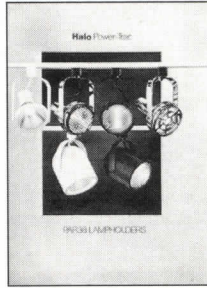

Track lighting

A 4-page color brochure features a series of track lights designed for use with up to 150-watt bulbs. The brochure describes the lights' roundback cylinders with their twist-off face plates, gimbal ring lampholders, and a variety of lenses and color filter accessories. Halo Lighting, Elk Grove Village, Ill. Write 349 on reader service card



Staircases

A 22-page color portfolio describes a series of freestanding staircases. The portfolio contains photographs of each staircase in its environment along with detailed descriptions of the materials used. Dimensional data including width of passage, outside diameter, and tread angle is also included. Atlantic Stairworks, Inc., Newburyport, Mass. Write 347 on reader service card



Floor tile

Italian ceramic floor tile is described in an 18-page color brochure. The *Linear, Floral, Monaco, Geometric, Travertine, Engraved, Rustic, Slateglaze, Classic, Hardstone, and Quarry* lines are included with photographs and color specifications. Ballack Corp., Oakhurst, N. J. Write 350 on reader service card
Continued on page 199

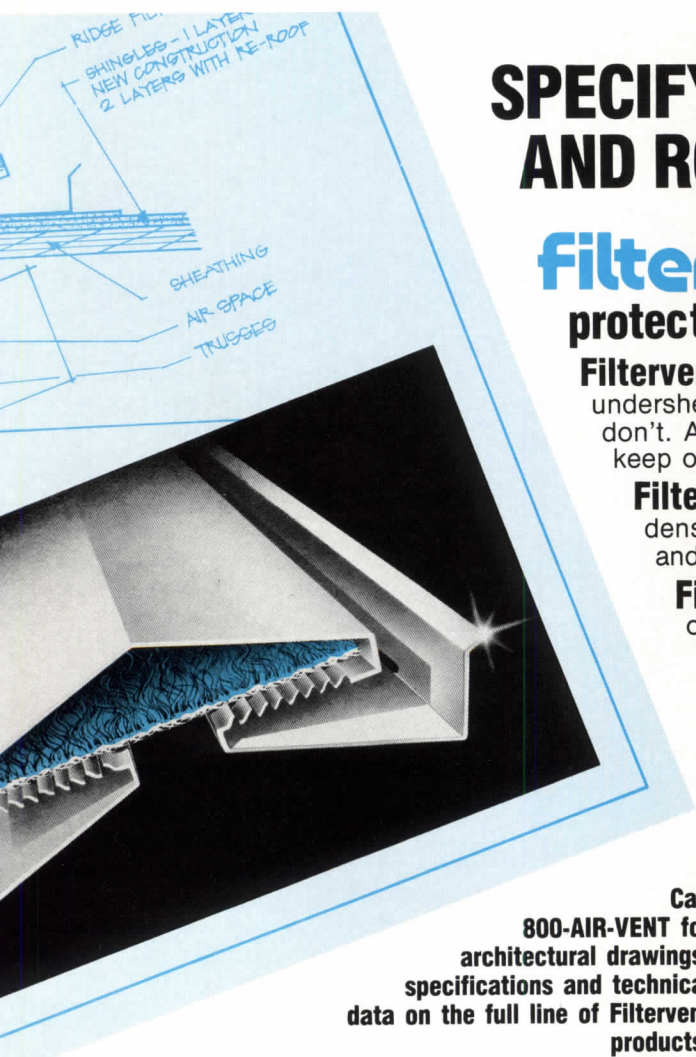

SPECIFY THE MOST EFFECTIVE ATTIC AND ROOF VENTILATOR AVAILABLE.

filtervent™ The name that means year-round protection from *all* ventilation problems.

Filtervent provides a continuous, uniform air flow along the entire roof undersheathing. Old fashioned roof vents, turbine vents and power vents don't. And only Filtervent has the exclusive, patented weather filter to keep out rain and snow.

Filtervent draws moist air from the attic in the winter to prevent condensation and ice dams . . . hot air in the summer to stop heat build-up and reduce cooling costs.

Filtervent looks good and outperforms all other ventilation methods. In fact, 32 ft. of Ridge Filtervent provide more net free area than 11 roof vents, 5 turbine vents or a 1,200 CFM power vent. Superior ventilation *and* pleasing aesthetic qualities — in one product!

Join the architects and builders who specify Filtervent — for total ventilation protection.

Call
800-AIR-VENT for
architectural drawings,
specifications and technical
data on the full line of Filtervent
products.

Circle 92 on inquiry card



FREE LITERATURE! Please send me full details on the full line of Filtervent products.

Name _____
Company _____
Address _____
City _____ State _____ ZIP _____
Phone (____) _____

Mail to: Air Vent Inc., 4801 N. Prospect Rd., Peoria Hts., IL 61614

Foreign Intrigue: The Richard Sapper Collection

Knoll

Knoll introduces European executive style to America: The Sapper chairs.
Developed by Knoll International in France and now available in the United States.

For more information:
Knoll International, The Knoll Building
655 Madison Avenue, New York 10021

Circle 98 on inquiry card



Knoll International France
268 Blvd. St. Germain 75007 Paris

POSTES



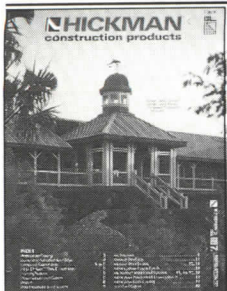

Roofing products
 Roof edges, framing systems, downspouts and gutters, reglets, roof drains, and a roof expansion joint system are featured in a 20-page color brochure. Product descriptions, analytical diagrams, dimensional specification charts, and installation information are included in the brochure. W. P. Hickman Co., Asheville, N. C.
 Write 351 on reader service card



Insulation
 Thermal and acoustic insulation for new and retrofit installations are featured in a 4-page brochure. The literature contains detailed product information including necessary preparatory work, application methods, cure stages, acoustic data, and product limitations. Kasko Industries, Inc., New Canaan, Conn.
 Write 352 on reader service card

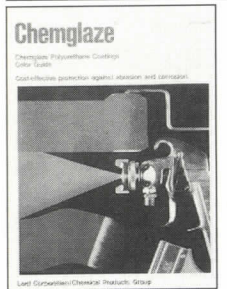

Polyurethane coatings
 A 4-page color guide describes the manufacturer's lines of Chemglaze polyurethane coatings. The guide includes product descriptions and sample color chips of the A-Line aliphatic and Z-Line aromatic product lines. The material also includes instructions for pastel mixing from standard colors. Lord Corp., Erie, Pa.
 Write 353 on reader service card



Locks
 The manufacturer's 1500 Series of electromagnetic locking devices, which may be used with egress doors, is described in a 4-page catalog. The material includes descriptions of the product and optional accessories, suggested specifications, a cutaway view of the lock and technical illustrations. Rixson-Firemark, Franklin Park, Ill.
 Write 354 on reader service card

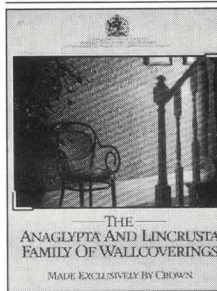

Wallcoverings
 A 6-page color brochure features the manufacturer's Anaglypta and Lincrusta wallcoverings. Designed to look like pressed tin, hand-tooled leather, intricate plasterwork, and carved wood, the wallcoverings come in an unfinished white and can be painted, lacquered or stained. Crown Decorative Products, Ltd., Lancashire, England.
 Write 355 on reader service card

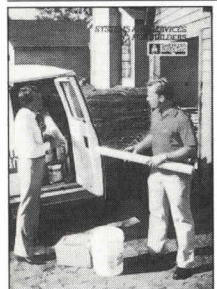

Coatings and floorcoverings
 The manufacturer's floorcoverings, interior and exterior coatings, and support services are featured in an 8-page color brochure. The literature includes selection guides and charts listing available coatings and detailing the types of surfaces. Sherwin-Williams Stores Div., Cleveland.
 Write 356 on reader service card
 Continued on page 201

STORAGE PLANNING

IDEAS

SEND FOR YOUR
 FREE LIBRARY OF
 STORAGE PLANNING
 BROCHURES FROM
 SPACESAVER



Ask Yourself.

Should I know more about high-density mobile storage?
 What part can it play in current and future projects?
 How will my clients benefit by specifying high-density storage systems?
 The answers are in this free library of comprehensive, fully-detailed
 planning brochures, written for the Architect... and yours for the asking.

In addition to receiving my Storage Planning Library, I want to review your complete Designer's File.

Name _____
 Firm _____
 Address _____
 City _____ State _____ Zip _____
 Telephone _____

SpacesaverTM
 When performance counts.
 Circle 99 on inquiry card

Spacesaver Corporation
 1450 Janesville Ave.
 Ft. Atkinson, WI 53538
 Spacesaver Mobile
 Storage Systems
 Corporation
 7027 Fir Tree Drive
 Mississauga, Ontario
 Canada L5S1J7
 Tel: (416) 671-0391





Fine addresses deserve fine cabinetry ...

Quaker Maid's quality cabinetry is custom crafted to accommodate your unique plans for kitchens, baths, and accent cabinetry. With Quaker Maid's two distinct lines, you're afforded even greater design potential. Q-2000 is an all-laminate, frameless design that was selected for a U.S. embassy. For your more traditional concepts, Quaker Maid's Custom Wood line is meticulously crafted to rival the finest furniture. With Quaker Maid's thousands of custom modifications, hand-stained hardwoods, Wilsonart laminates, and wood/laminate combinations, you benefit with almost limitless design options. Good reasons why Quaker Maid is always at home at the finest addresses. Contact us today.

Quaker Maid
INNOVATORS OF DISTINCTIVE CUSTOM CABINETS
a TAPPAN division

Rt. 61, Leesport, PA 19533 215-926-3011 □ 16025 Trocar Ave., Goodyear, AZ 85338 602-932-9630

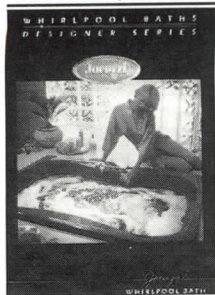

Whirlpools

A 20-page color brochure highlights the *Designer Series* of whirlpool baths. The information describes eight models including product diagrams, dimensional data, materials used, water capacity, and installation information. Also included are color and fill spout/faucet options. Jacuzzi Whirlpool Bath, Walnut Creek, Calif.

Write 357 on reader service card

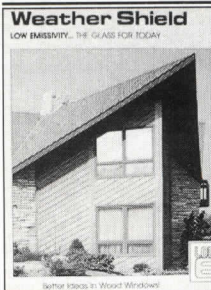

Windows

Low-emissivity glass with wood windows and doors are featured in a 4-page color brochure. A definition of Low E glass is included along with descriptions of its insulating and protective benefits. Instructive diagrams and a comparison chart are included. Weather Shield Manufacturing, Inc., Medford, Wis.

Write 360 on reader service card

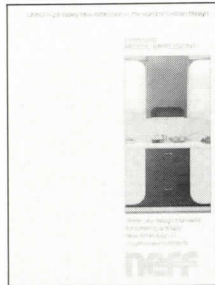

Kitchen design

The manufacturer's kitchen design concept is highlighted in a 4-page color pamphlet. The literature describes nine laminate door styles that feature curved shapes of color-contrasted inlaid laminate. The pamphlet includes available colors and ordering information. Neff Kitchen Manufacturers Ltd., Ontario, Canada.

Write 358 on reader service card

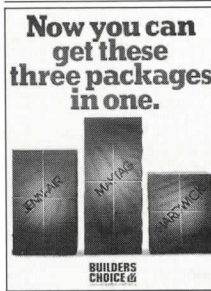

Kitchen appliances

An 18-page color catalog highlights three brands of kitchen appliances that the manufacturer makes available. The catalog features detailed product descriptions and dimensional diagrams on ranges, wall ovens, cooktops, dishwashers, microwave ovens, and washers and dryers. Builders Choice, Indianapolis, Ind.

Write 361 on reader service card

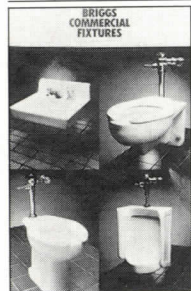

Bathroom fixtures

An 8-page catalog features color photographs, descriptive literature, and detailed specifications on the manufacturer's line of vitreous china lavatories, urinals, and toilet bowls. Specifications for all models are included along with designs for wheelchair and handicapped units. Briggs Plumbingware, Inc., Tampa, Fla.

Write 359 on reader service card

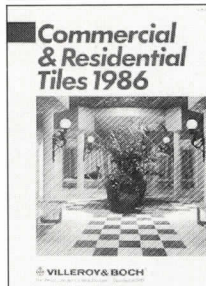

Ceramic tiles

A 48-page color booklet features the manufacturer's commercial and residential ceramic tiles. The booklet includes color samples, dimensional information, and application data on glazed and unglazed vitreous tiles and extruded tiles. Villeroy & Boch, Pine Brook, N. J.

Write 362 on reader service card
Continued on page 203

Exotic. Elegant. Eclipse.™

Any way you look at it, the Dovre Eclipse fireplace adds a whole new dimension to your design. As unique in style as your creations, it complements every setting from country to contemporary.

Eclipse is the first airtight, zero clearance fireplace with an all cast-iron firechamber, able to burn both wood or coal. It offers your customers more than four times the heat efficiency of an old-fashioned fireplace and amounts to about half the cost of a new all-masonry design.

The Eclipse fireplace comes complete with cast-iron firebacks, grate and bifold doors with ceramic glass, plus an optional grille system that provides ample flexibility in decorating.

It's easy to install, too. We furnish all of the technical and specification assistance you need to complete the job.

For more information on the exotic, elegant look of Eclipse, call or write for our free Ideas Brochure.

DOVRE, INC.

Suite N6
401 Hankes Avenue
Aurora, IL 60505
1-800/368-7387
(In Illinois, 312/844-3353)



A New Generation in Fireplace Technology

Circle 101 on inquiry card

The Syenergy Solution



... for architects' exterior finish problems

Syenergy's Exterior Insulating Finish System offers enormous design capabilities. It also provides a light, strong surface without shadowing and color mismatches. Period styles and contemporary shapes are easy to custom form. And as if this were not enough, the superb appearance of our EIFS is underscored by its ability to reduce temperature fluctuation and thermal shock. The temperature of the wall structure remains constant because the insulation is on the outside.

Our EIFS is protected by a 5-year labor and materials warranty.

Set your imagination free, call toll free for complete details 1-800-221-9255/7663.

Syenergy also manufactures the most advanced EPDM black or white single-ply roofing systems.

SYENERGY 
INNOVATIVE EXTERIOR SYSTEMS

SYENERGY METHODS, INCORPORATED 1367 ELMWOOD AVENUE • CRANSTON • RI 02910 • Call 1-800-221-WALL or 1-800-221-ROOF

Circle 102 on inquiry card

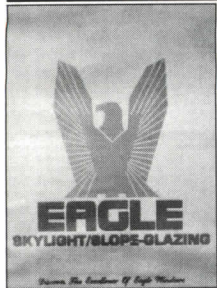

Skylights
Skylights and slope glazing are highlighted in an 8-page color brochure. The literature includes the manufacturer's features, detailed product descriptions, necessary specifications, installation information, and construction details. Eagle Manufacturing, Dubuque, Iowa.
Write 363 on reader service card

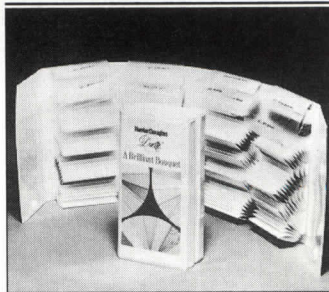

Window fashions
A compact color sampler that measures 3 - by 6 1/2-in. by 1 1/2-in. features the *Duette* collection of soft fabric shades. Included in the sampler is the *Duotone* series that features color on the inside and outside, and the *Whispersoft* series that features 10 pastel colors. Hunter Douglas, Inc., Maywood, N. J.
Write 366 on reader service card



Building products
The manufacturer's 1986 building products catalog features structural wood panels, lumber, siding, paneling, roofing, insulation, and metal, gypsum, and engineered board products. The catalog includes detailed product descriptions and diagrams, and photographs of applications. Georgia-Pacific Corp., Atlanta, Ga.
Write 364 on reader service card



Locks
A line of solid brass bar stock mortise cylinders with a choice of eight collars, six cams, and nine finishes is described in a 12-page catalog. Four styles of decorative door hardware in 2 in., 2 3/8 in., and 2 3/4 in. backsets are also included in the literature along with thumbturns and dummy cylinders. Lori Corp., Southington, Conn.
Write 367 on reader service card

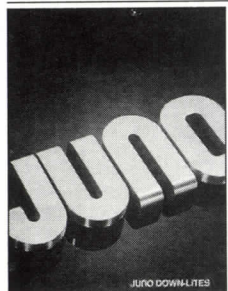

Downlighting fixtures
A 32-page color catalog includes information on the manufacturer's series of downlighting fixtures. Product descriptions and options are featured along with dimensional data and diagrams. Ordering specifications and application examples are also included. Juno Lighting, Inc., Des Plaines, Ill.
Write 365 on reader service card

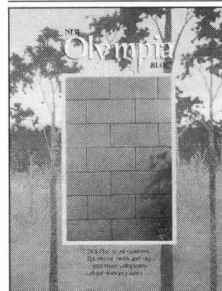

Wall facing
A 4-page brochure describes *Olympia Bloc* wall facing. Stone aggregates are bound using a clear chemical compound into an integral face that cannot be removed. Sample photos of size sections, test data, and guide specifications are also included. United Glazed Products, Inc., Baltimore, Md.
Write 368 on reader service card
Continued on page 205



CONCRETE PAVERS



TERRINGS®



TERR-ADJUST MIX



TERR-ADJUST®



BLOK HANDLE



TERRING® by WEGU Canada Inc.

Wausau's Terra System One

ONE SOURCE • COMPLETE

ROOF DECK SYSTEMS



Unique Roof Deck Leveling
...Adapts To Pitch And Height Variations...

- TELESCOPING
- TILTING
- STABLE
- CONCEALS FIXTURES DRAINS, CONDUITS
- EASY ACCESS
- ARCHITECTURALLY PLEASING

CHANGES ROOFS INTO "HIGH" APPEAL AREAS

from the "things-that-last" people...

Write Or Call For Complete "Terra System One" Details



WAUSAU TILE

P. O. BOX 1520 • WAUSAU, WI 54401-1520 • 715/359-3121
 P. O. BOX 967 • BANNING, CA 92220-0905 • 714/849-5695
 P. O. BOX 2357 • WINTER HAVEN, FL 33883-2357 • 813/324-1778

Paul associates

presents Arcadia. catalog available.

155 East 55th Street, New York, NY 10022 (212) 755-1313
Space 1208-09, Merchandise Mart, Chicago, IL 60654 (312) 923-0004
147 North Robertson Blvd., Los Angeles, CA 90048 (213) 271-9660
Washington Design Center, 300 "D" St. S.W., Washington, D.C. 20024 (202) 484-2212
Space 650, Dallas Decorative Center, Dallas, TX 75207 (214) 761-9937

Represented in Miami

Houston: Custom Accessories Seattle: Collins Draheim

San Francisco and Denver: Shears & Window

Circle 104 on inquiry card

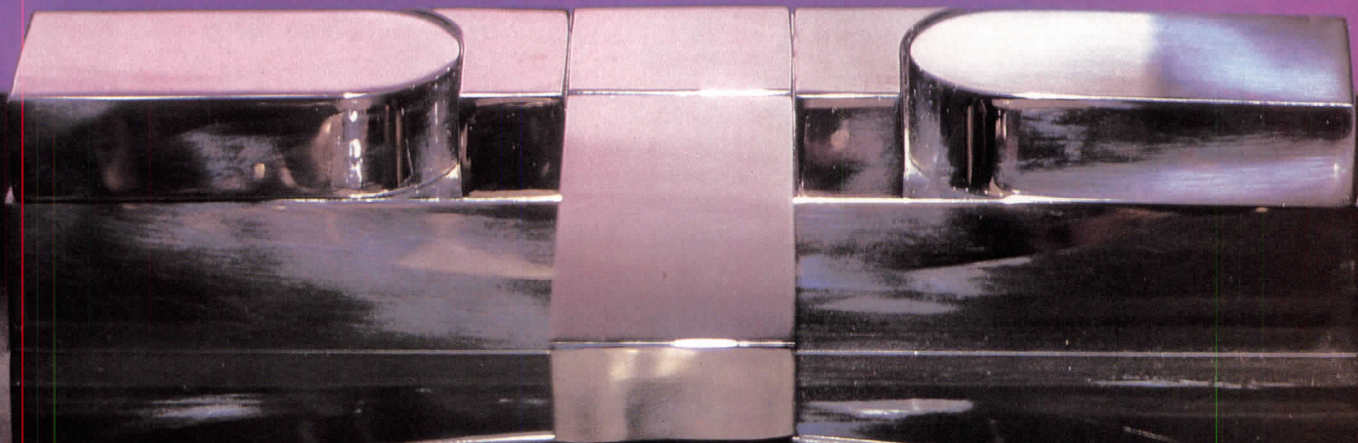

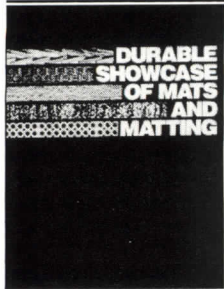

Floor matting

A 28-page catalog features mats, floor coverings, and accessories. Color photos and diagrams illustrate applications. The catalog includes tables and charts for color and size selection and specific recommendations for a range of safety, and general floor covering needs. Durable Mat Co., Norwalk, Ohio.

Write 369 on reader service card

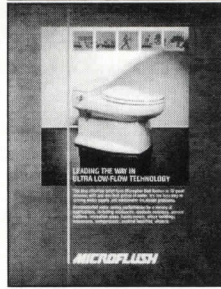

Toilet

A 6-page color foldout brochure features the *Microflush* toilet. Included in the literature are illustrations of the units 12-second flush cycle, specification highlights, installation information, code approvals, and charts reflecting monetary reductions using the *Microflush* system. Microphor, Inc., Willits, Calif.

Write 372 on reader service card

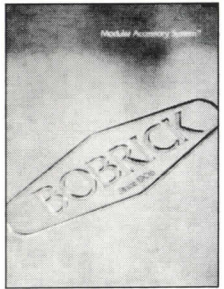

Washroom equipment

The manufacturer's 1986 Modular Accessory System Catalog features drinking fountains, cup dispensers, fire, telephone, and electrical equipment cabinets, clocks, and waste receptacles. Accessories come in 35 colors. Doors and panels are made of solid phenolic. Bobrick Washroom Equipment, Inc., North Hollywood, Calif.

Write 370 on reader service card



Replacement windows

A 16-page color catalog features the manufacturer's line of commercial aluminum replacement windows. Models highlighted in the catalog include picture, double- and single-hung, projected, casement, slider, multi-units, and specialty products. Product descriptions and diagrams are also included. Season-all Industries, Inc., Indiana, Pa.

Write 373 on reader service card

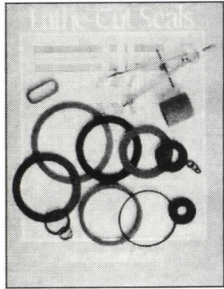

Lathe-cut seals

Information on lathe-cut seals, detailing standards, applications, compounds, and specifications is contained in the manufacturer's brochure. Also included are descriptions of finish qualities, design configurations, and tables for inside and outside diameters and cut-thickness tolerances. Stalwart Rubber Corp., Burton, Ohio.

Write 371 on reader service card

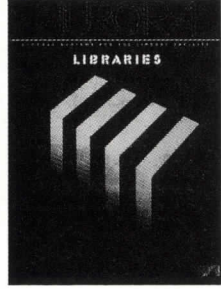

Storage system

The manufacturer's storage system is described in a 6-page color brochure. The literature contains information photos of the system in corporate, public, institutional, medical, and legal libraries; detailed explanation of the *Quik-Lok* design concept; and dimensional data.

Richards-Wilcox, Aurora, Ill.

Write 374 on reader service card

Continued on page 207

Custom Flooring.



Along with our specialty, The Custom Classics, Kentucky Wood Floors offers a wide range of pre-finished and unfinished hardwood flooring to fit within all budget constraints.

The hardwood floor displayed here consists of Quartered Oak Herringbone and Fingerblock with Walnut Feature Strip.



Kentucky Wood Floors

P.O. Box 33276
Louisville, KY 40232
(502) 451-6024

Circle 105 on inquiry card

WHEN YOU BUY A LEXAN®
TRI-GUARDS PRODUCT... YOU BUY
THE BEST— WE GUARANTEE IT!

If any genuine TRI-GUARDS® product fails to perform as advertised, simply return it to TRI-GUARDS® for a replacement AT NO CHARGE.

Any innovative product that truly meets the needs of the user will have imitators... there is, however, no way to imitate GUARANTEED quality.

TRI-GUARDS®, the original and foremost manufacturer of clear corner, wall, and drape protectors stands for GUARANTEED quality. TRI-GUARDS® are practically indestructible. Made from LEXAN®, a high-impact material developed by General Electric, TRI-GUARDS® won't crack, break, yellow or dent, even in high traffic areas.

TRI-GUARDS® are easy to install, available in a variety of widths and lengths to fit any corner, wall or drape. They can be installed perfectly in minutes, can be removed and re-installed just as easily when a room, or corridor is ready for redecorating.

WHEN YOU BUY A TRI-GUARDS
PRODUCT, YOU BUY THE BEST
... I GUARANTEE IT!



—George Triunfol
President,
Tri-Guards, Inc.

THE TRI-GUARDS
GUARANTEE

IF ANY
LEXAN® TRI-GUARD
PRODUCT FAILS TO PERFORM
AS ADVERTISED, SIMPLY
RETURN IT TO
TRI-GUARDS FOR A REPLACEMENT
AT NO CHARGE.

THE ORIGINAL®
Tri-Guards

953 Seton Court, Wheeling, IL 60090

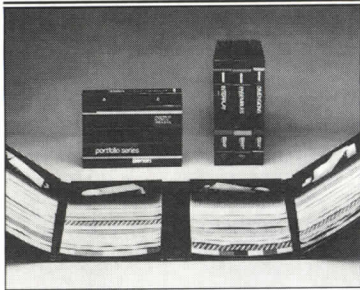

Contract wallcoverings
The manufacturer's *Portfolio Series* of contract vinyl wallcoverings is presented in multiple fold-out panels each containing product swatches. *Portfolio* is a set of three mini-collections—*Interplay*, *Ensembles*, and *Dimensions*—all color-coordinated to work together. Genon, Hackensack, N. J.
Write 375 on reader service card

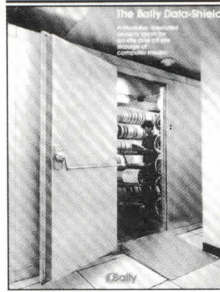

Storage chamber
A storage chamber made of lightweight, factory-engineered panels, is featured in a 4-page brochure. The modular panels lock together using a patented cam-action joining system. Instructional diagrams and product features are included. Bally Engineered Structures, Inc., Div. of Allegheny International Co., Bally, Pa.
Write 378 on reader service card

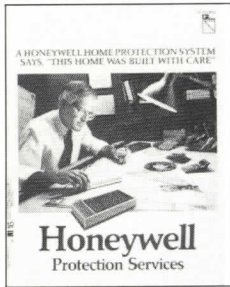

Home security
A 4-page brochure features the *System 2000* home protection system. The literature offers a comprehensive analysis of the system along with detailed descriptions of each of the panel's features. Dimensional information is also included. Honeywell Protective Services, Minneapolis.
Write 376 on reader service card

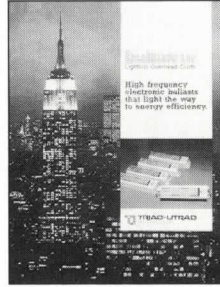

Electronic ballasts
A 6-page brochure describes the manufacturer's line of electronic ballasts designed for commercial use. The literature details product benefits and features, lists available models, and provides operating data and fluorescent lamp types and wattages. Triad-Utrad, Div. of MagneTek, Inc., Huntington, Ind.
Write 379 on reader service card



Rolling doors
A 24-page color booklet features the manufacturer's line of rolling doors including fire doors, rolling grilles, counter doors, and side coiling closures. The booklet contains detailed specification listings, dimensional charts, and analytical diagrams. The Cookson Co., San Francisco.
Write 377 on reader service card



Concrete products
A 12-page brochure features the manufacturer's prestressed building systems and underground utility systems. The literature includes photographs of the systems in use, along with descriptions of the projects' specifications. Tindall Concrete Products, Inc., Spartanburg, S. C.
Write 380 on reader service card
Continued on page 210

When it comes to window details, SEASON • ALL puts everything together.

In this age of specialty, high-performance products, you need a manufacturer who can meet your specifications and produce a quality product.

ProComm aluminum windows from Season-all, lead the way in custom-designed products. In addition, we offer over 70 certified products . . . a figure no other manufacturer can match.

With ProComm distributors nationwide, and a full line of window products, Season-all can put everything together for you.

CALL US TODAY!

PRO COMM

Season-all Industries, Inc.
1480 Wayne Ave. Indiana, PA 15701
(412) 349-4600
Circle 107 on inquiry card



ProComm windows . . . combining beauty with performance in installations across the United States.

See Sweets 8.22

"TAP"



Nouveau. 13 lb. 5 oz. in gold plate. Also available in hand-polished chrome.
Sherle Wagner, 60 East 57th Street, New York, NY 10022

SHERLE WAGNER

NOTHING IS SO RARE AS PERFECTION.

Circle 129 on inquiry card

Our newest tile is like a diamond in the rough.

It's Promenade. And like a diamond, it's hard and beautiful. Just to give you an idea of how hard it is, it rates a 7.0 to 8.0 on the Mohs scale. And the beauty shines through the glazed matte finish with subtle shading in five different colors. All of which will help you coordinate with today's contract colors.

It's in the rough, mainly because of the surface. Promenade's textured surface increases friction, so it decreases slippage. And that's important in all your high-traffic commercial applications.

Promenade is durable, as well as versatile. It's vitreous, meaning the moisture absorption is no more than 3%, so it can handle applications of extreme tem-

perature. And because of the frost resistance, you can install it either indoors or out.

So you see, Promenade is just about everything you need in a commercial ceramic floor tile. Rough, tough and beautiful. And even a breeze to work with. The flat-back surface makes for easier installation,

which cuts down on labor. And that saves you time and money.

Promenade is available in 4" x 8" and 8" x 8"* with matching 4" x 8" bullnose trim. And now you can get it nationwide through our extensive distribution network.

If you'd like more information, call 915/655-9193. Or write to Monarch Tile, P.O. Box 2041, San Angelo, Texas 76902. Look for us in the Sweet's General Building File, Sec. 9.18/Mo. And when you're looking for progressive ideas in tile applications, look to Monarch. Because with Monarch Tile, every application becomes a real gem.



Q. THE SOLUTION?
A. OUR SELECTION!



Ship 'N Out offers design options no one else can. We have everything you expect and much more . . . It's all there in our NEW 64 page color catalog.

MORE CHOICES THAN ANYONE ELSE!

Check one or more.

- a. Brass
- b. Chrome
- c. DesignerTube
- d. KolorTube
- e. Fabrication

Ship'n Out

8 Charles St., Pawling, NY 12564

Write or Call **NOW!**
Toll Free 800-431-8242

In NYS Call Collect 914-855-5947

Circle 109 on inquiry card



Cabinets

The manufacturer's *Series 2000* diagonal cabinets are said to provide a more effective use of space in the kitchen. The cabinets stand 232.2 cm high and are available in varying cabinet depths. The series comes in a karo design with birch, jasmine-white birch, natural oak, and brown fumed oak. Poggenpohl USA Corp., Allendale, N. J.

Write 381 on reader service card



Louvers

Custom-made exterior and interior shutters, folding and louver doors are available in pine, cherry, mahogany, cyprus, oak or ash. Each product is made to exact design specifications and features mortise and tenon joinery. Various styles of hardware for hanging the shutters are also available. Beech River Mill Co., Centre Ossipee, N. H.

Write 383 on reader service card



Sink

The *Lift* height-adjustable lavatory is said to have been designed especially for use with small children and handicapped users. The ceramic lavatory is available in 11 colors and is said to be easy to install. Villeroy & Boch USA, Inc., Pine Brook, N. J.

Write 384 on reader service card

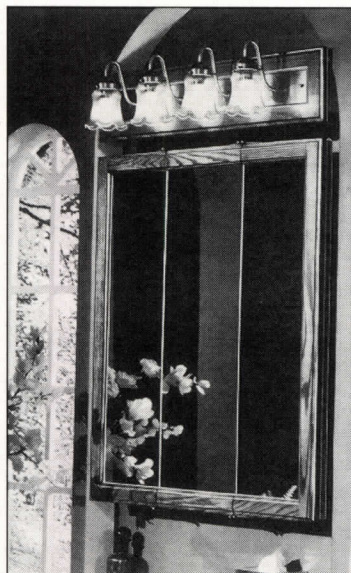

Mirrored cabinets

The manufacturer's line of mirrored medicine cabinets features single-door and tri-view mirrored versions. The cabinets can be built-in or surface-mounted and are available in three sizes. The doors feature 1/8-in.-thick safety mirrors mounted on knife hinges with recessed magnetic catches. Merillat Industries, Inc., Adrian, Mich.

Write 382 on reader service card

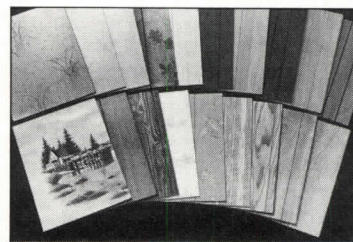

Paneling

The manufacturer's printed paneling is produced using holographic-image printing technology. The paneling is available in 19 different versions that appear either as a textured stripe, a floral pattern, a combination of both, or a painted scene. Weyerhaeuser Co., Chesapeake, Va.

Write 385 on reader service card

COLUMNS
WORTHINGTON GROUP, LTD.

Finely crafted columns in Ponderosa pine
Sculpted capitals in many styles

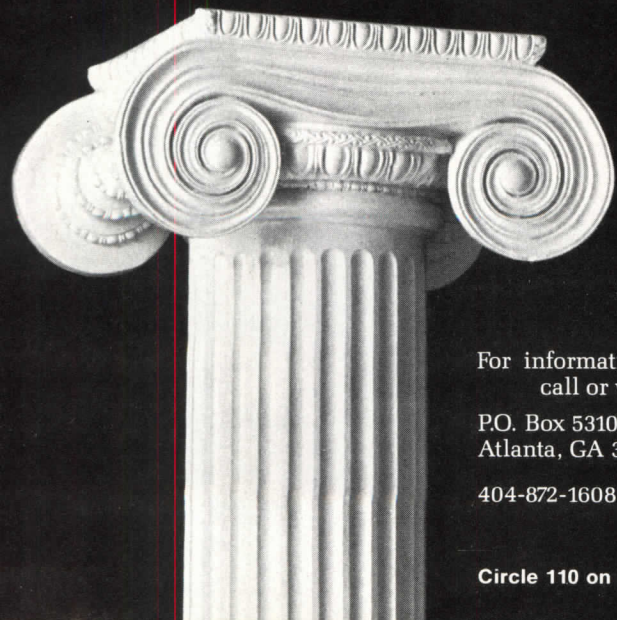

For information/brochure call or write

P.O. Box 53101
Atlanta, GA 30355

404-872-1608

Circle 110 on inquiry card

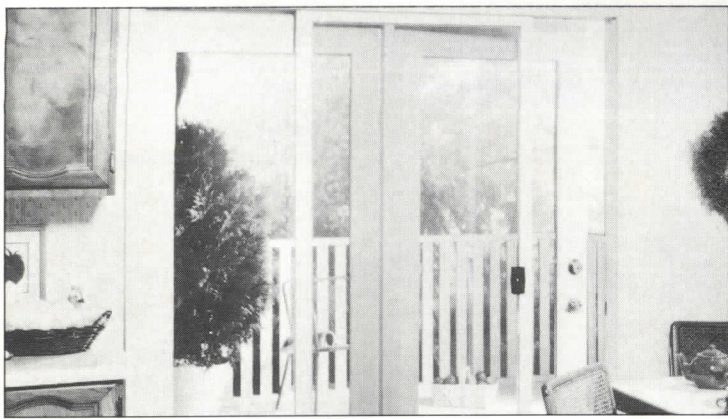

Patio doors

Pre-hung steel patio doors feature a vinyl mull on the hinge side, a removable steel grille, insulated double glazing, foam insulation, and a thermal barrier. The *Vista II* doors are available in two- or three-

door systems and can be installed either as in-swing or out-swing units. When opened fully the doors fold flat against each other. Benchmark, General Products Co., Inc., Fredericksburg, Va. Write 386 on reader service card

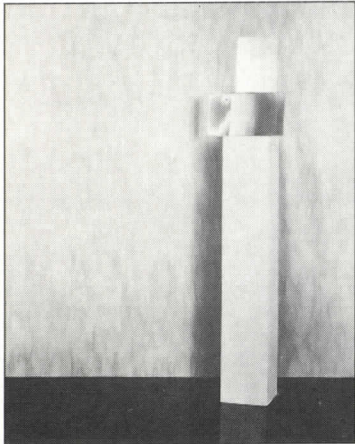

Wallcoverings

The *Leatherette* designer wallcoverings are part of the manufacturer's *Stripes & Textures* collection. The pattern is available in 14 colors ranging from shades of tan to gray-blues to rose and coral. The wallcoverings were designed for contract as well as residential interior application. Albert Van Luit & Co., Los Angeles. Write 387 on reader service card

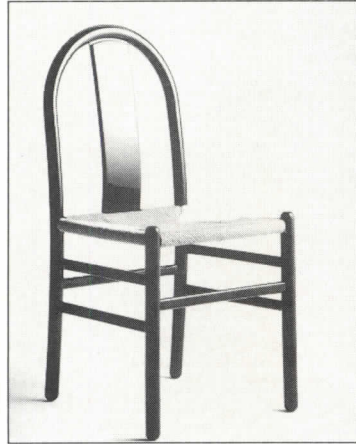

Chair

The *Thalia* chair is available with a natural ash, walnut, oak, white or black glossy, white or black open pore, and white closed-pore lacquered frame. The seat comes in straw, padded with fabric, imitation leather, or leather upholstery. The chair is 17.3 in. wide, 18.5 in. deep, and 34.6 in. high. Tisettanta, Italy. Write 389 on reader service card

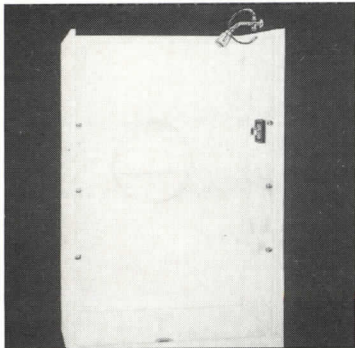

Shower system

A multidirectional showering system consists of six vertically aligned showerheads (three on each side of the shower entry) and a five-piece shower surround (a back wall, two end and two corner panels). The shower surround comes in 36- and 48-in. widths. A diverter allows the use of either the conventional showerhead or the six vertical ones. Kohler Co., Kohler, Wis. Write 388 on reader service card

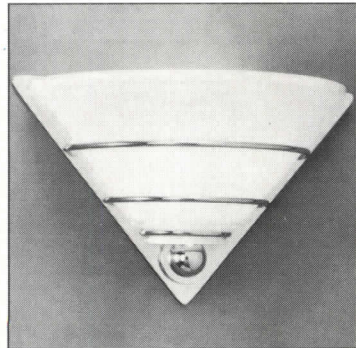

Lighting

The *CB1300* wall sconce is a 12-in.-diameter prismatic-glass half cone with polished solid brass retaining rods and backplate. The glass cone provides diffused lighting and can be used with either incandescent or fluorescent bulbs. The sconce measures 8 1/2 in. high, and 13 1/2 in. wide with a 6 1/2 in. extension. Visa Lighting, Milwaukee, Wis. Write 390 on reader service card Continued on page 212

Specify Sun System for the tough ones!

There's no sunspace project too tough for our 53 years of construction experience. Judge for yourself: The Gallery Plaza in Knoxville called for 10,000 square feet of canopy glazing. Bays were specially designed on 30" centers. Valley roofs were added to facilitate turns. Eaves were formed on-site to assure a perfect fit.

In Utah, we opened-up Fryer Tucks restaurant to the sun, the moon and the stars. First floor bars were extended 10' to achieve the desired height. All glass was customized and the vestibule, assembled on site, matched the contour of the building.

If your specs call for one of our 37 standard units or creative glazing that's both functional and fashionable, specify with confidence — specify Sun System.

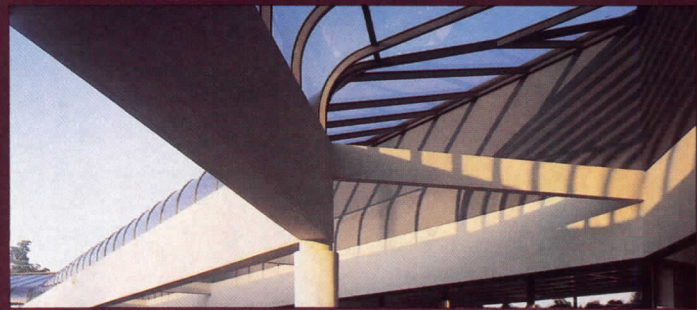

SPECS:

SAW TOOTH PATTERN
45° PITCH
50' STRETCHES OF GLASS

CALL SUN SYSTEM
516 543-7600



SUN SYSTEM®
SOLAR GREENHOUSES

Copyright 1985

60 Vanderbilt Motor Parkway, Dept. AR, Commack, NY 11725 • 516 543-7600

Distribution Worldwide. See us in Sweets, 13.2c/Sty

Circle 111 on inquiry card

FACE BRICK, FIRE BRICK & ARCHITECTURAL PAVERS

Whitacre-Greer face brick and pavers are produced from the rich clay deposits of Central Ohio, and offer a wide variety of rich tones to service the most discriminating architect and builder.

Whitacre-Greer — quality since 1900.



WHITACRE-GREER

P.O. Box 261 · Barnhill Road
MIDVALE, OH 44653 · 216/339-3343

Circle 112 on inquiry card

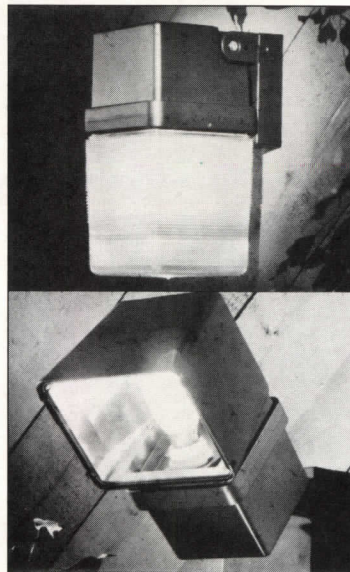

Floodlights

An area light and floodlight can be wall, ceiling, ground, or pole mounted. The area light is available in 35-, 50-, and 70-watt high pressure sodium and the floodlight is available in 35-, 50-, 70-, 100-, and 150-watt HPS. Both units are made of die-cast aluminum and feature a *Duraplex II* bronze finish. Stonco Lighting, Union, N. J.

Write 391 on reader service card

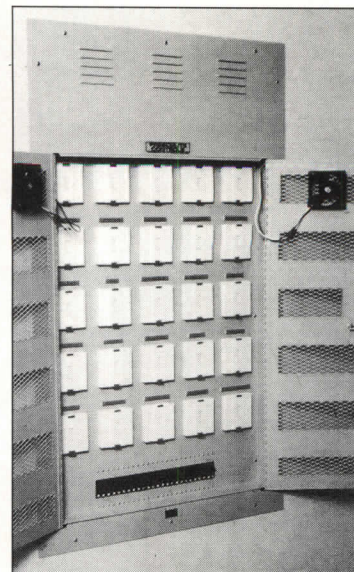

Dimmer cabinet

The *Expeditor* dimmer cabinets are available in surface-mounted or recessed styles with or without lockable doors and circuit breakers. The cabinets are UL listed in any configuration of loads up to 50 kilowatts per cabinet. The units are prewired and pretested and are delivered ready for installation. Prescolite Controls, Carrollton, Tex.

Write 392 on reader service card

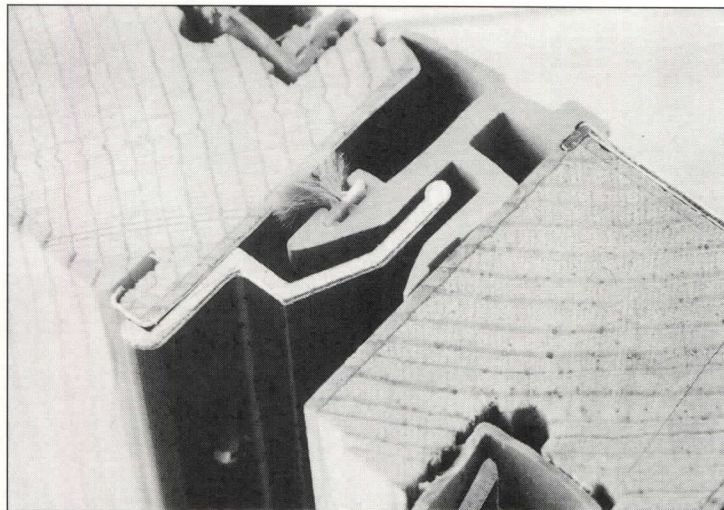

Weatherseal

A dual durometer weatherflap is said to be the third weatherseal on the manufacturer's *Clad* and *Whisper Glide* patio doors. The two other seals exist where the aluminum extrusion fits into the

vinyl weatherstrip and where the pile weatherstrip meets the door stile. Each door also features tempered insulating glass and two adjustable tandem rollers. Reuten-Klein Corp., Schenectady, N. Y.

Write 393 on reader service card

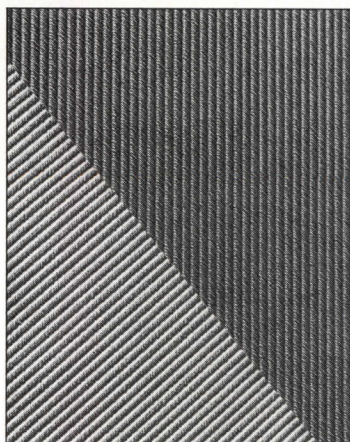

Vinyl wallcoverings

Barstow, a textile-inspired cord in the *Guard* line of vinyl wallcoverings, features a linear vertical design said to be well-suited to corridor applications. *Barstow* is made of 19.5-ounce vinyl and is available in 31 shades and 54 in. widths. Columbus Coated Fabrics, Columbus, Ohio.

Write 394 on reader service card

We Bring UPSTAIRS DOWNSTAIRS... Beautifully.

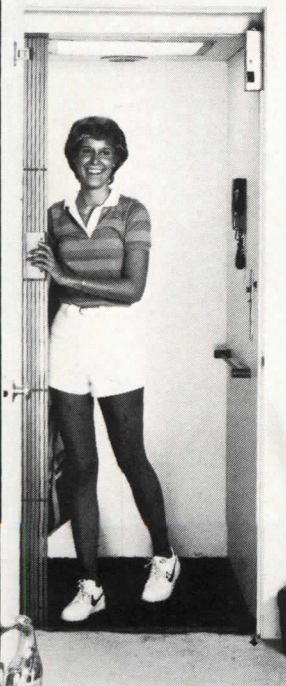

A Sedgwick Residence Elevator adds something very special to a fine multi-level house or condominium. It adds a touch of elegance...and a truly meaningful measure of comfort and ease.

Sedgwick Residence Elevators are easily and quickly installed in most homes. They are simple to operate and safe to use. And they provide the smoothest, quietest, most stable ride available today.

We have the right model for just about any application...or will custom-design one for your special requirements. And the price is a pleasant surprise.

Doesn't your special client deserve a Sedgwick Residence Elevator? Call or write for full information.

Sedgwick Lifts, Inc.

Specializing in Residence Elevators Since 1920.
P.O. Box 630, Poughkeepsie, N.Y. 12602, 914-454-5400
Chicago, IL 312-498-5574 • Monroe, NC 704-289-5487
Richmond, IN 317-458-5126 • Canada 416-677-6860
Toll Free: 800-431-8262

Circle 113 on inquiry card



Chair collection

Designed by Manfred Herrmann, the *Delos* collection of chairs features four-leg and cantilevered sled-base arm chairs, a tilt-swivel desk chair, and a lounge group. The chairs are constructed of polished chrome, black molded rubber, and epoxy frame and arms with leather or fabric seat and backs. Fixtures Furniture, Kansas City, Mo.
Write 395 on reader service card



Leather upholstery

The *Crystal Aniline* collection of contract and residential upholstery is made of aniline drum-dyed leather without pigment finishing. The leather is available in a variety of in-stock colors but special colors may be ordered to the designer's specifications. The upholstery meets all federal flammability requirements. American Leather Manufacturing Co., Rahway, N. J.
Write 397 on reader service card

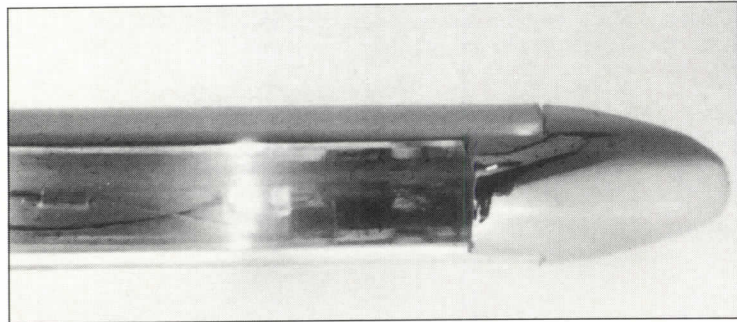

PVC unit

Versa-Lite is a self-contained flexible PVC unit that is said to be waterproof and capable of being bent around corners or twisted without damage. The tube is held by an aluminum channel in chrome,

gold, or black. The PVC colors include clear, amber, red, blue, green, white, bronze, and silver. Vista Manufacturing Co., Elkhart, Ind.

Write 398 on reader service card



Wallcoverings

The manufacturer's *Volume XXVI* Collection of wallcoverings features 14 flora and foliage patterns, along with one scenic pattern, and seven complementary fabrics. The patterns are available in a variety of colors ranging from cream-and-taupe-colored neutrals to Wedgewood blues and deep greens. Louis W. Bowen Fine Wallcoverings, New York City.
Write 396 on reader service card

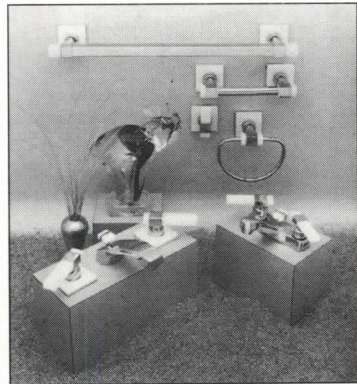

Bathroom accessories

The *Kasmari* line of bathroom accessories features natural white onyx combined with polished brass or chrome, as well as 24-karat yellow gold. The line includes tub, shower, and bidet fixtures along with towel bars and rings, and faucets. Bathroom Jewelry, Inc., Los Angeles.

Write 399 on reader service card
Continued on page 214



Unique Bollard

Landscaping with Lighting!

The "Junior Jefferson" enhances any low level lighting site. Custom selected *Western Red Cedar* is kiln dried and fabricated with care. Direct burial or wall mounted. Wide selection of globes for incandescents to 60 watt.

Write on letterhead for catalog of wood lighting standards and accessories.

Ryther-Purdy Lumber Company, Inc.

204 Elm Street
P.O. Box 622
Old Saybrook, CT 06475
Phone (203) 388-4405

Lighting Standards • Fixtures
Guide Railings • Benches
Custom Millwork • Signs
Trash Receptacles

Circle 114 on inquiry card

TWIN GLO

THE FIRST see-through zero-clearance unit to provide efficiency and beauty!

Now available in two sizes.

The distinctive features of Model 225 make it the industry leader for a C-Thru zero-clearance fireplace. It offers:

THE LARGEST viewing area. The large glass door opening (19" x 36") provides up to 50% more viewing area than most competitive units.

THE BEST heating. It will take up to a 30" log and has convection heating and an optional 200 cfm blower.

THE ONLY C-Thru to offer an elegant all brass front (antique or polished) and full view glass doors. It is also U.L. listed with no doors.

- Convection and radiant heat from both sides
- Elegant all brass front

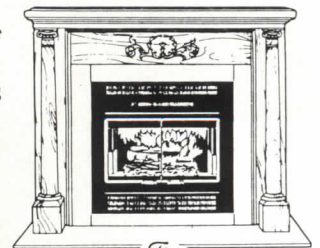

The Energy Master



U.L. Listed Model 225

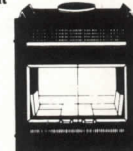

U.L. Listed Model 175
Mobile Home Approved



(612) 890-8367

HEAT-N-GLO Fireplace Products Inc.
3850 West Highway 13 • Burnsville, MN 55337

Contact us on the above or on our high efficiency (55%) built-in fireplaces.

Circle 115 on inquiry card

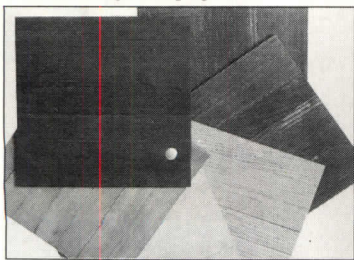

Wood flooring

The manufacturer's *Designer Series* of acrylic impregnated wood flooring is available in Plum Ash, Pistachio Ash, Grey Ash, Bleached Ash, Grey Cherry, and Black Cherry. The series is also available in 12- by 12-in. parquet and one-directional patterns. PermaGrain Products, Inc., Media, Pa.
Write 400 on reader service card



Credenza

The *Pinstripe Collection* includes a writing/occasional table, coffee table, console, executive desk, and credenza. The series is made of solid Honduras mahogany, quartersawn Honduras mahogany veneers, and is available as a double or triple unit with drawers and doors. Agati Designs, Chicago.
Write 401 on reader service card

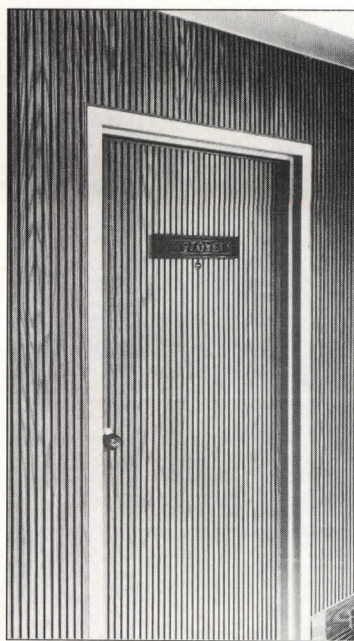

Tambour plank

The manufacturer's tambour plank features a 30-deg bevel for the V-shaped grooves. The plank is offered in two woodgrain designs—natural oak and carriage oak, plus an unfinished red oak veneer that can be stained or finished. The plank is 16- by 96-in. by 1/4-in.-thick and is constructed of fiberboard composition with a flexible backing. Commercial Div. of Masonite Corp., Dover, Ohio.
Write 403 on reader service card

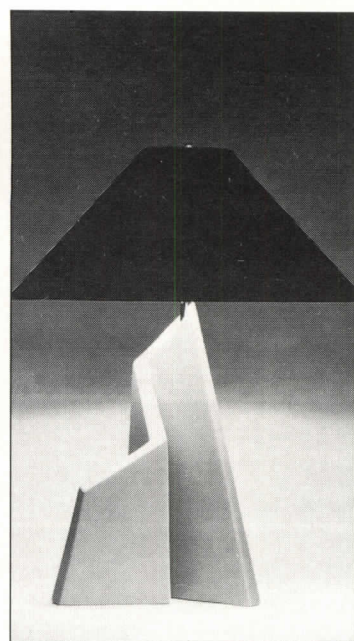
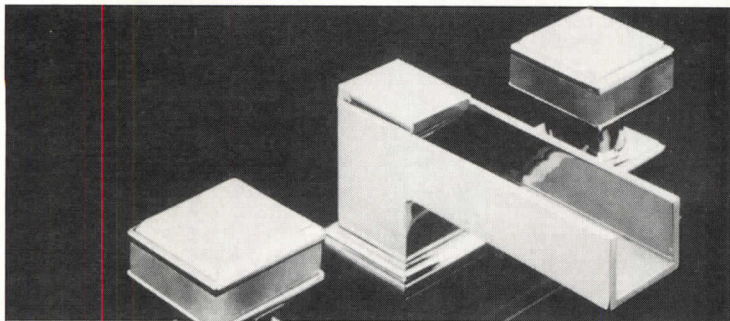

Table lamp

The *Precipice* lamp, designed by Doyle Crosby, is an asymmetrically styled table lamp whose upward moving silhouette and jagged planes are said to suggest a mountain landscape. *Precipice* is made of faux-stone in white, gray, or beach, with complementary opaque shade in white cotton/linen or matte black paper. The lamp's overall height is 31 1/2 in. Boyd Lighting Co., San Francisco.
Write 404 on reader service card



Basin spout

The *Aqueduct* waterfall spout is available in nickel silver, brushed nickel, gold, or a combination of these finishes. *Aqueduct* can be

used as an alternative to any of the manufacturer's standard basin spouts in its faucetry series. Kallista, Inc., San Francisco.
Write 402 on reader service card

Architects:
Blue/Sun, Ltd.

Advanced design ROTO Roof Windows let in a lot more light

— while exceeding the energy efficiency
of triple glazing!

Consider the facts: ROTO's world-famous slim profile design significantly increases the amount of glass area in relation to the overall roof window size, letting in up to a remarkable 80% more sunlight and passive solar energy than any other roof window available . . . and all new high-efficiency Low "E" glass comes as standard — not an extra.



Install flatter, neater, trimmer

Installation is surprisingly fast and easy. 3 models are available in 8 popular sizes, with a full range of options and accessories. Check Sweet's File 7.8/ROT and send or call for our 8-page color brochure.

Let in more light with ROTO

(Outside CA and CT 1-800-243-0893)
(In CT 203-526-4996) (In CA 209-524-0262)



ROTO FRANK of America, Inc.,
Research Park, P.O. Box 599, Chester, CT 06412
4777 North Star Way, Modesto, CA 95356

Circle 116 on inquiry card



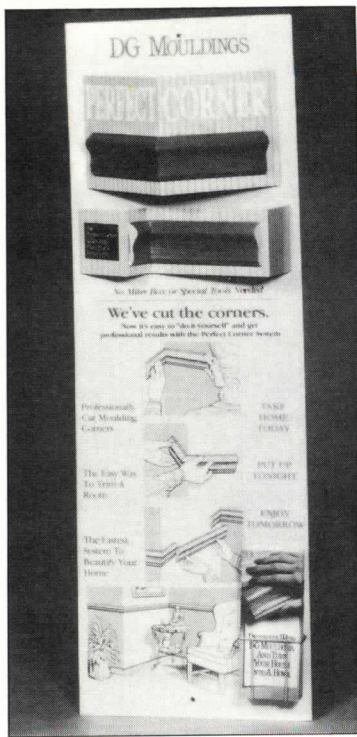

Moldings

The *Perfect Corner* is a pre-cut, pre-joined, and pre-finished section that fits into any inside or outside corner. Straight pieces are then connected flush to each end of the corner. The piece comes in a variety of profiles including crown, chair-rail, and base molding, and window and doorway casing. DG Mouldings, Marion, Va.

Write 405 on reader service card

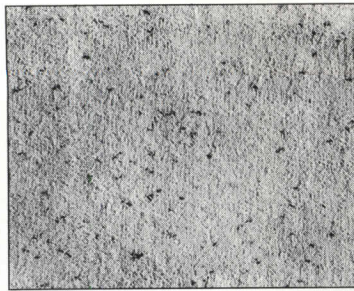

Residential broadloom

The *Landmark Collection* is three residential broadlooms in six styles and patterns. *Acadia* is a dense cut-pile plush with tuft definition and is available in 35 colors. *Yosemite* is an ultra-dense cut-pile plush that comes in 25 colors, and *Kings Canyon* is a dense cut-pile plush also available in 25 colors. Karastan Rug Mills, New York City.

Write 406 on reader service card

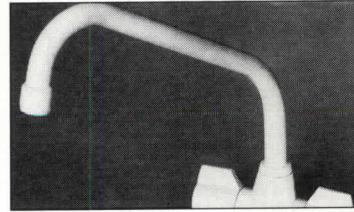

Faucet

A dual-control faucet operates with a washerless ceramic disc. The *Diskette* faucet is made of solid brass with chrome plating or coated with epoxy in three colors. *Diskette* may be used in the kitchen, bar, or bath. Franke, Inc., North Wales, Pa.

Write 407 on reader service card

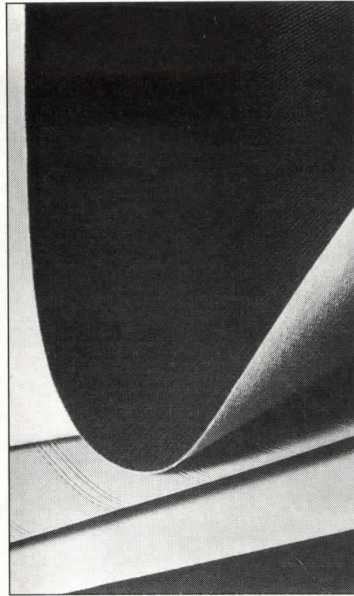

Wallcoverings

The *Tiffany Suede Collection* of vinyl wallcoverings is available in four suede patterns made in a 27-ounce per lineal yard weight. The collection features a surface treatment that is said to help reduce shading problems inherent with suede wallcoverings. The collection also features a heavy woven cotton backing and is available in 80 colors. BFGoodrich Wallcovering Products, Dublin, Ohio.

Write 408 on reader service card

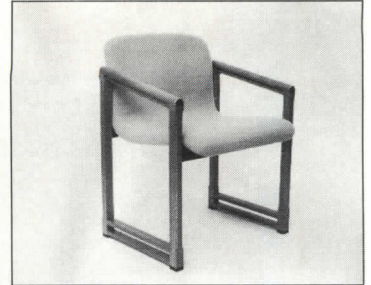

Chairs

The manufacturer's *Visitors Chairs* are available in contemporary and traditional styling and feature a molded, contoured seat and back. The chairs are available in open and closed arm formats. Tuohy Furniture Co., Minneapolis, Minn.

Write 409 on reader service card



Sunroom system

The *Window Quilt* sunroom system is designed with a sealed track around a five-layer *Window Quilt* shade. Lowering the shade creates insulated side seals. Appropriate Technology Corp., Brattleboro, Vt.

Write 410 on reader service card
Continued on page 217



Aim your sites high.

Send for our 16-page color catalog of Sitecraft standard and custom planters, benches, receptacles and site accents. See the many ways you can add beauty to your designs outdoors or indoors. Crafted in clear all heart California redwood or other select woods, products are shown in actual installations. Catalog lists specifications, prices, ordering data. Contact Sitecraft, 40-25 Crescent St., Long Island City, NY 11101 (718) 729-4900. Call toll-free outside NY State 800-221-1448.



SUMMITVILLE TODAY'S EARLY AMERICAN

Summitville helps you achieve the look of early America with a ceramic tile that meets the demands of today's homeowners for quality. It's your best choice for colonial homes.

Summitville is ceramic tile for floors — warm and inviting, durable beyond expectations, with authentic natural qualities vinyl floors can't match.

Summitville is also the new Heritage series — 14 Early American quilt patterns for wall and counter-top inserts.

And Summitville is American made, with over 75 years of craftsmanship that meets or exceeds the quality standards set for commercial installations.

From colonial to contemporary, Summitville's extensive tile collection has a solution for every decorating need.

Ask for Summitville. The authentic ceramic tile for today's homes.



 **Summitville**[®]

Summitville Tiles Inc.
Summitville, Ohio 43962
Circle 118 on inquiry card

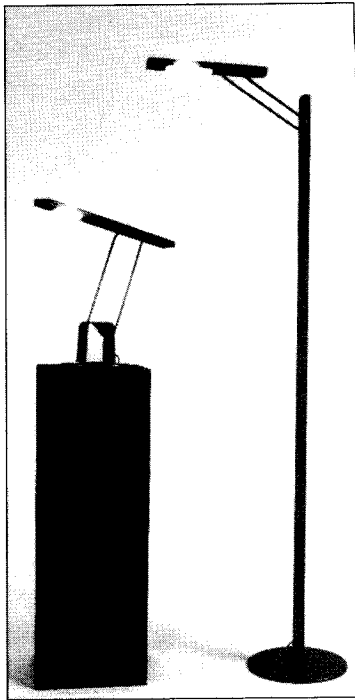

Lamps
The *Graal* collection features floor, table, and wall lamps. Designed by Gabriella Montaguti, the collection is available in white, black, and charcoal gray trimmed in blue. The lamps are constructed of molded aluminum. Thunder and Light, Ltd., New York City.
Write 411 on reader service card

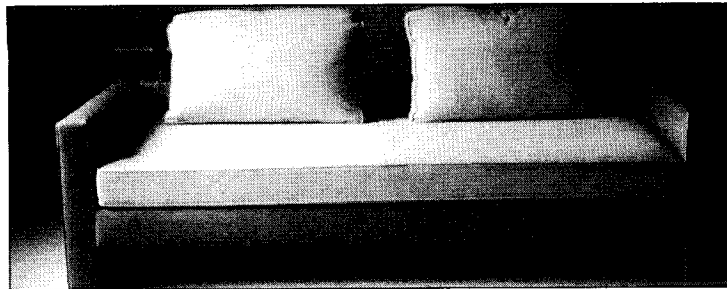

Sofa
Designed by Christian Liaigre, the *Jumping* sofa is covered in leather. The back cushions rest against a brass bar covered in leather and

mounted on chrome supports. The sofa is available with one or two cushions and is 83 in. long. Interna Designs, Ltd., Chicago.
Write 412 on reader service card

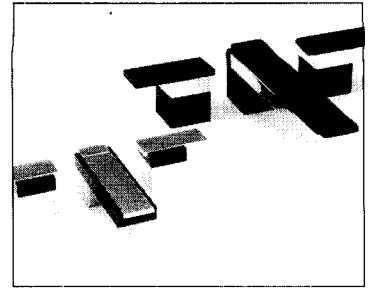

Faucets
The *Harden' Tek* line of faucets is available as a widespread and roman tub set. The roman tubs have handles which are sized in proportion to the spout. The faucets may be ordered in 12 metal finishes, and two enamel colors. All have *Epoxy-Glas* protections. Harden Industries, Los Angeles.
Write 414 on reader service card

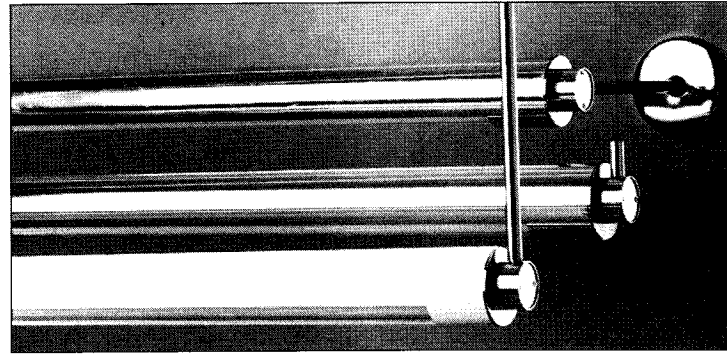

Tubular lighting systems
The *Circa 325* lighting system features a 3 1/4-in.-tubular design. The system may be stem-, cable-, or wall-mounted and sections can be individually or tandem mounted as required. Chrome, brass, and

painted finishes are available. Rotational end fittings and corners allow the segments to be rotated. Swivelier Company, Inc., Nanuet, N. Y.
Write 413 on reader service card

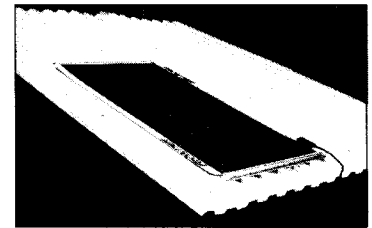

Solar module
The *Frontier-100* is a full-size, thin-film solar electric module. The 2- by 4-ft module is made of amorphous silicon solar cells. The unit is said to generate 32 watts of electricity in full sunlight. Sovonics Solar Systems, Solon, Ohio.
Write 415 on reader service card
Continued on page 219

The BLU-RAY Model 248 Whiteprinter.

Consider features and functions second to none.



Dual-Range Heat & Pump Controls - assure quality prints regardless of media.

Larger Development Area.

Instant Start-Up.

Dual-Range Speed Control - allows consistent performance.

1/2-25 Feet Per Minute
50" Throat Width

Ask us for a demonstration. Call 203-767-0141 or write us for your nearest BLU-RAY dealer. Once you see the New BLU-RAY Model 248 in action, you'll agree this Whiteprinter has the performance to surpass all others in its class.

BLU-RAY

Manufacturers of Quality Whiteprinters since 1957
BLU-RAY, Inc. • Westbrook Rd. • Essex, Connecticut 06426
Circle 119 on inquiry card

Hurd is the innovative leader of the window industry.

Hurd standards are designed to perform.

R-4

Hurd makes classic windows in the most carefully controlled modern environment, infusing the best of today's technology into our craft. We offer the sizes, shapes and window types necessary



to produce buildings of character and imagination. We also offer R-Values above 4.0, superior comfort and economy.

Consider the Hurd clad casement. A standard product for us, by any other criteria, this is a very exceptional window. The .050 inch thick aluminum cladding on the frame and sash is electrostatically coated so it won't chip, fade or peel. The full one-inch insulating glass is also available with two different Heat Mirror™ glazings. Top performance is further guaranteed by triple weatherstripping and a thick wood frame.

Although a single glance qualifies this Hurd window as a good choice, further investigation of the adherence to detail will convince you that it's the only choice. You can build a reputation with Hurd.

Hurd gears efficiency to specific climates.

Different areas of the country have different solar exposures and varying heating and cooling demands. Plus, some climates are extremely hot in summer but bitter cold in winter. Hurd won't pretend that one window could be right for all these conditions. Instead, we offer specific glazing options, such as Heat Mirror 88



Join the leader. Specify Hurd.

You can improve the efficiency and beauty of every project you design by joining the innovative leader. Don't you deserve the best?

Call: 1-800-2BE-HURD

GLAZING OPTIONS	U Values ¹	R Values ¹	Relative Heat Gain ²
Clad Casement w/1" insulating	.43	2.31	186
Clad Casement w/1" Heat Mirror 88	.25	4.05	149
Clad Casement w/1" Sunbelter 66	.24	4.20	103
Clad Casement w/Bronze Sunbelter 66	.24	4.20	86

¹ Standard ASHRAE (1981) winter conditions.

² Standard ASHRAE (1981) summer conditions.

for cold climates and Sunbelter™ 66 for hot climates. Each is intended to minimize energy usage and maximize interior comfort. Yet neither restricts or limits the view. Although you can include this custom feature as a premium, it's a standard offering from Hurd.



The full line filled with leading ideas.



HURD MILLWORK CO., MEDFORD, WI 54451

Heat Mirror is a trademark of Southwall Technologies.

Circle 120 on inquiry card

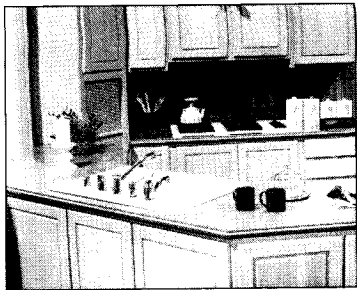

Countertop material

Countertop material designed to replicate marble, granite, parchment stone, and onyx is said to be especially durable and easily repaired if scratches occur. The material is available in 17 standard colors but special colors may be specified. Manufactured in 3- by 10-ft sheets, it is available in 3/8 in., 1/2 in., and 3/4 in. thicknesses. Avonite, Sylmar, Calif.
Write 416 on reader service card



Modular armoires

The manufacturer's modular armoires feature a variety of interior fittings including bars, drawer and shelf storage, and entertainment centers all concealed behind mirrored doors. Each two-door unit measures 18 1/4 in. by 31 1/4 in. by 85 in. and features a handwoven oak lattice. Kirk-Brummel Associates, Inc., New York City.
Write 417 on reader service card

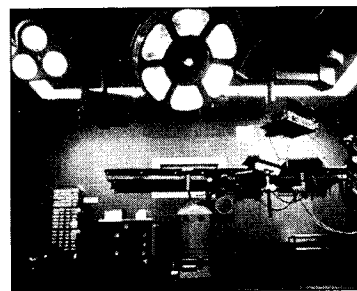

Flooring

The manufacturer's *Mini-Pastille* line of 100 percent synthetic rubber flooring features miniature pastilles grouped in a 1-in.-diameter circle. The flooring is said to resist chemicals, burns, scuffs, and stains and is also said to be slip-resistant. Nora Flooring, Madison, Ind.
Write 418 on reader service card



Chair

The *Firenze* high-back chair is ergonomically designed and said to correctly support and distribute body weight. The chair features a five-prong, rotary-tilt base with dual casters. The chair is available in a number of styles including leather, vinyl, and the manufacturer's designer fabrics. Continental Imports, Philadelphia.
Write 419 on reader service card

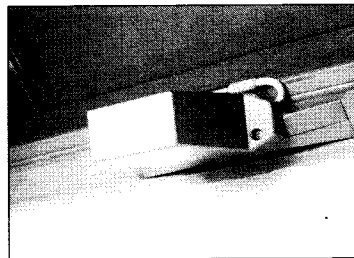

Remote control device

The manufacturer's electric remote control device for use with roof windows and ventilating skylights features a 24-volt power motor. The unit is housed in a rectangular-shaped bronze casing and includes a safety connector that is attached to the screens. Velux-America, Inc., Greenwood, S. C.
Write 420 on reader service card

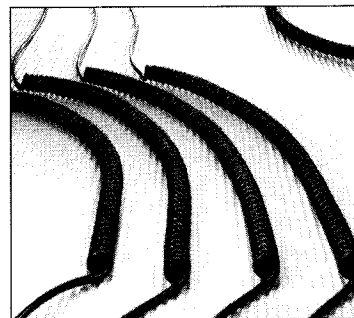

Keyboard cable

A retractable cable designed for use with computer keyboards features seven tinned-copper, polypropylene-insulated conductors. The cable has 14 1/2-in.-long and .710-in.-wide coils and an extended-length of six ft. Belden Electronic Wire and Cable, Richmond, Ind.
Write 421 on reader service card
Continued on page 221

INDUSTRIAL INTERCOMS FOR HIGH NOISE AREAS



For many years ADCO intercoms have been a leading choice of U.S. industry to deliver clear, penetrating voice communication under the most severe conditions. Thousands are performing efficiently in areas of high noise ... many where conventional intercom systems failed totally. Typical installations are in factory production zones, on loading docks, and in other outdoor areas—in saw mills, steel mills and foundries—on construction jobs and oil rigs. Regardless of weather, temperature or operating conditions. Each individual intercom unit is self-contained, transmitting an amplified signal to permit an unlimited number of stations over any distance. Installation is simple, practical: plug each unit into a power source and connect units together by ordinary 2-wire cable. Full range of AC and DC models available, as well as extreme temperature models and units compatible with existing sound-power systems.

ATKINSON DYNAMICS

A Division of Guy F. Atkinson Company
10 West Orange Avenue
South San Francisco, CA 94080
Phone (415) 583-9845

Circle 121 on inquiry card

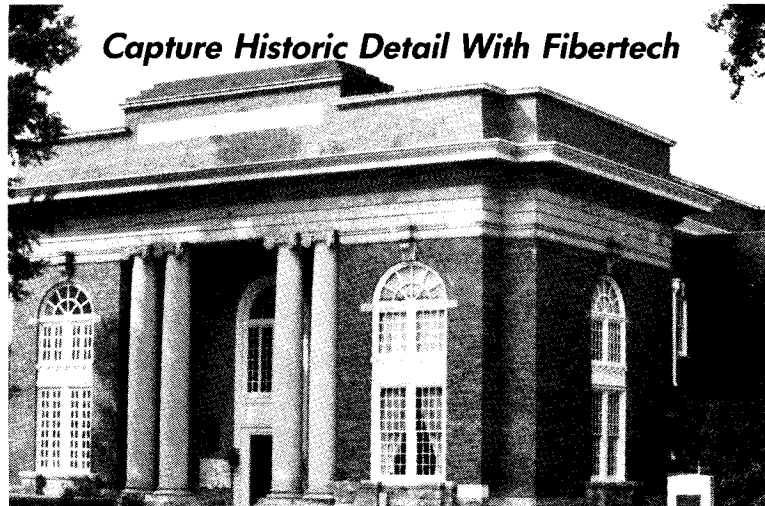

Capture Historic Detail With Fibertech

Introducing custom-molded fiberglass cornices, balustrades and facings for commercial historic renovation:

- Adaptable to any period or style to retain original architectural features and historic value.
- Lightweight, easy-to-install pieces with stiffeners and ribs for strength.
- No painting — pigments in gelcoat give durable color/texture matches.
- Less costly than original substrate without sacrificing authentic detail.
- Can qualify for historic renovation tax credits under Economic Recovery Tax Act of 1981.

Call us at 803/654-2190 or write for more information.

Look for us in the new 1986 Sweets Catalog under 6.9/Fib.

FIBERTECH

PO Box 9, Clemson, SC 29633

Circle 122 on inquiry card

BEFORE YOU BUILD, YOU SHOULD KNOW EVERY TRICK IN THE BOOK.

The book is Passive Solar Design and Construction. And it tells you all you need to know to build the homes more and more consumers want—passive solar homes.

Best of all, the book is free from PPG.

Passive Solar Design and Construction starts at the beginning—why passive solar is an opportunity you shouldn't miss. It discusses design basics, site selection and performance analysis, and concludes 34 pages later with a list of sources for even more information.

Since glass is a major element in passive solar, PPG wants you to know the facts. That's why PPG prepared this brochure. It's complete

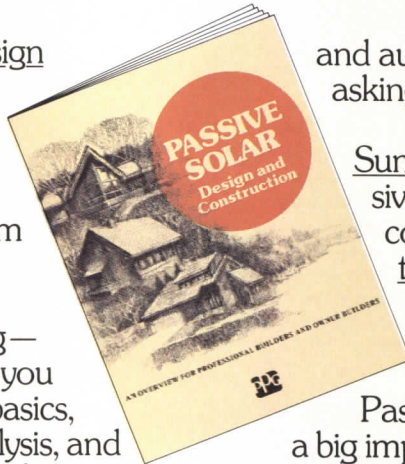

and authoritative. And it's yours for the asking.

We'll also send you Living with the Sun, PPG's book for homeowners on passive solar. And we'll tell you how to get copies for your customers. Living with the Sun could help you make passive solar sales, because it explains the significant cost-saving benefits of passive solar, and how easy they are to get.

Passive solar is a trend that will have a big impact on new home building. You owe it to yourself to know every trick in the book. Write us to find out.

PPG Industries, Inc., Glass Advertising, PT18, P.O. Box 8727, Harrisburg, PA 17105.

Circle 123 on inquiry card



1	Exxon
2	General Motors
3	Mobil
4	Ford Motor
5	IBM
6	Texaco
7	E.I. du Pont
8	Standard Oil (Ind.)
9	Standard Oil of Cal.
10	General Electric
11	Gulf Oil
12	Atlantic Richfield
13	Shell Oil
14	Occidental Petroleum
15	U.S. Steel
16	Phillips Petroleum
17	Sun

27 million Americans can't read. And guess who pays the price.

Every year, functional illiteracy costs American business billions.

But your company can fight back...by joining your local community's fight against illiteracy. Call the Coalition for Literacy at toll-free **1-800-228-8813** and find out how.

You may find it's the greatest cost-saving measure your company has ever taken.

A literate America is a good investment.

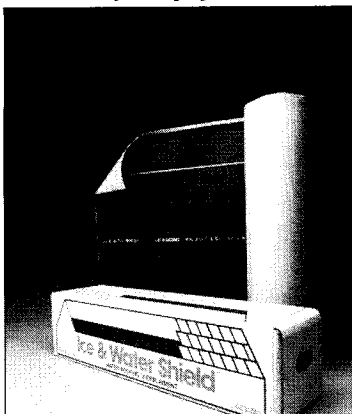

Waterproofing membrane

The self-adhesive *Ice & Water Shield* waterproofing membrane is a composite of polyethylene film laminated to a thick layer of flexible rubberized asphalt. The membrane may be applied to roof decks, parallel to roof edges, or under shingles, slates, shakes, tiles, or metal roofing. The membrane is available in rolls that are 36 in. wide and 75 ft long. W. R. Grace & Co., Cambridge, Mass.

Write 422 on reader service card

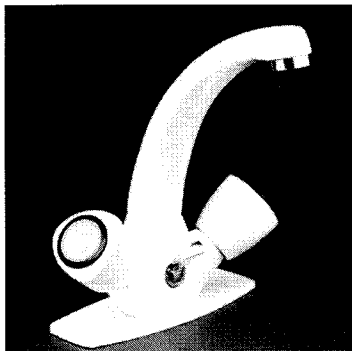

Faucet

The manufacturer's *Swing-Spout* lavatory faucet features all-brass construction. The faucet spout swings 90 deg and includes a touch-lever waste assembly. The unit may be installed with or without an escutcheon plate and is available in chrome or *Deco-White*. Moen International, Elryia, Ohio.

Write 423 on reader service card

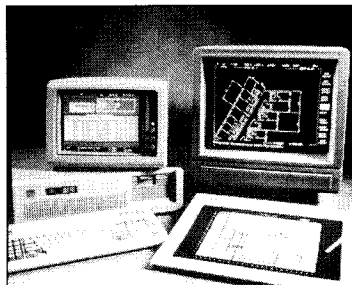

CADD software system

A computer-aided design, drawing, and data management software system features space tracking capabilities, construction graphics, an interrupt command structure, and the ability to do instream calculations and to manipulate and annotate drawings. *Synergy 2000* includes two color screens, a tablet menu, and an electronic stylus. Skok Systems, Inc., Cambridge, Mass.

Write 424 on reader service card

INSTALL AN EXTERIOR

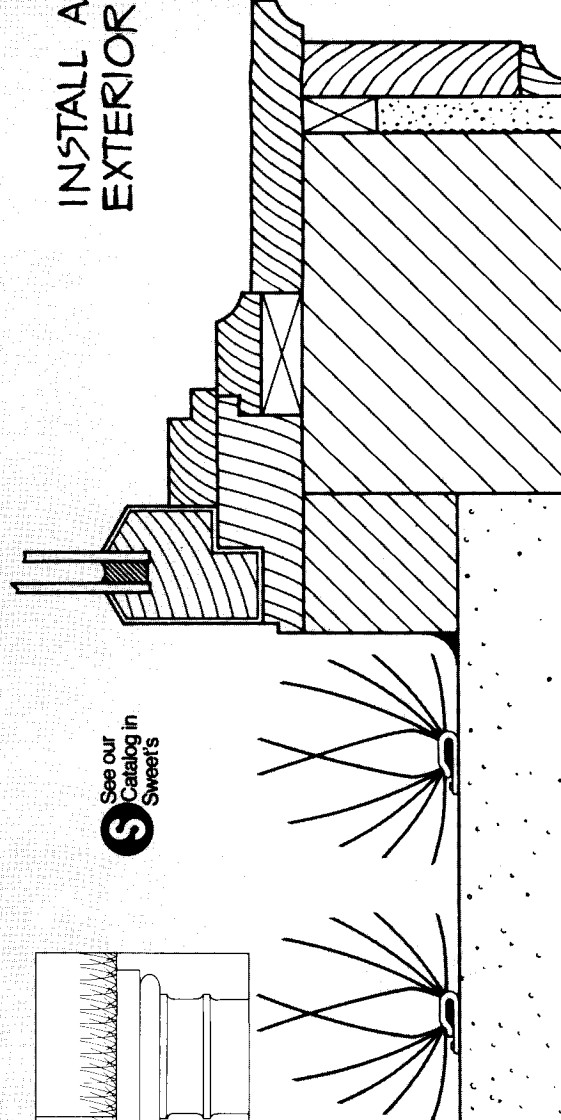

See our Catalog in Sweets

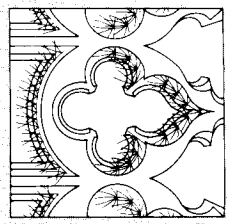
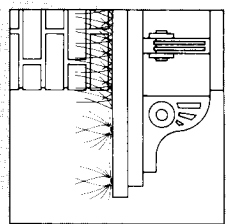
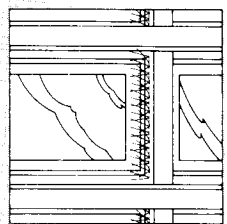
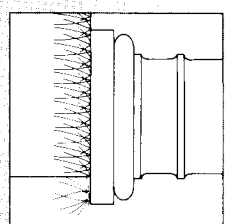

NIXALITE STAINLESS STEEL NEEDLE STRIPS - INSTALLATION TO BE ON ALL LEDGES, COLUMN CAPS, PEDESTALS, ETC. WHERE BIRDS ARE A PROBLEM! INSTALL AS RECOMMENDED BY NIXALITE OF AMERICA

Answers bird control problems for any new, existing or restoration building projects.

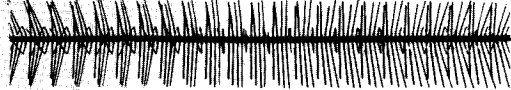

NIXALITE of AMERICA
 1025 • 16th AVENUE • P.O. BOX 727
 EAST MOLINE, ILLINOIS 61244
 PHONE 309 • 755 • 8771
 SPECIALISTS IN BIRD CONTROL
 Circle 124 on inquiry card

Advertising index

Bold face—page number

Italics—Reader Service number

A

Adden Furniture, **33**; *38*
(617) 454-7848
Admiral Home Appliances, **155**; *72*
Air Vent, Inc., **191,193,195,197**; *92*
[G]
(800) 243-8368
American Gas Association, **27**; *18*
American General Prods., **223**; *125*
[G]
American Marazzi Tile, Inc., **194**;
95 [G-L-D]
American Olean Tile Co., **18-19**; *13*
[G-D]
(215) 855-1111
American Standard, **Cov.III**; *127*
[G-E-L]
(800) 821-7700
Andersen Corp., **158-159**; *76* [G-L]
Archibus, **182**; *81*
1 (800) 541-ARCH
Armstrong, **Cov.II**; *1* [G-D]
Atkinson Dynamics, **219**; *121* [G-E-I]

B

Blu-Ray, Inc., **217**; *119*
(203) 767-0141
Buckingham-Virginia Slate Co.,
32Ee; *27* [G]

C

Cabot, Inc., Samuel, **14**; *9* [G-L]
(617) 723-7740
California Redwood Association, **51**;
53
(415) 381-1304
Caradco Corp., **32Eg**; *30, 32Ca*; *31*
[G]
(217) 893-4444
Chicago Faucet Co.,The, **190**; *90*
[G-E]
(312) 694-4400
Clairson International, **10**; *7* [G-D]
Clorox/Olympic, **Cov.IV**; *128* [G-L]
Corbin Hardware Div.,Emhart, **35**; *40*
[G]
(203) 225-7411

D

Dovre, Inc., **201**; *101*
Dryvit System, Inc., **8-9**; *5* [G-I]
DuPont-Textile Fibers, **6-7**; *4*

E

E.C.S. Systems, Inc., **32Sb**; *37*
Elkay Mfg. Co., **177**; *78* [G-E-I-L]
Elliptipar, Inc., **24-25**; *16*

F

Fibertech Corp., **219**; *122* [G]
Ford Glass Div., **152-153**; *70*
[G-E-I-L]
(313) 446-5915
Formica Corp., **22-23**; *15* [G]
(800) 543-3000
Four Seasons Greenhouses, **187**; *86*
[G-E-I-L]
1 (800) 645-9527
Franke, Inc., **32Eb**; *24*
(215) 822-8014

G

Grace & Co.,W.R., **15**; *10,31*;
21,47; *49, 65*; *65* [G-I]
(617) 876-1400
Grohe America, Inc., **48**; *50*
(312) 640-6650
Gyp-Crete Corp., **188**; *87* [G-L]
(612) 478-6072

H

Hamilton Industries Drafting
Equipment, **196**; *97* [G]
Heat-N-Glo Fireplace Prods., Inc.,
213; *115* [G-L]
Hurd Millwork, **218**; *120* [G-L]

I

IBG International, **46**; *48* [G]
Integrated Ceilings, Inc., **3**; *2*
(213) 478-0781
Interceramic, **59**; *60* [G]
International Contract Furnishings,
Inc., **36-37**; *41*
Iron-a-Way, Inc., **193**; *94* [L-D]
(309) 266-7232
Iron-Craft, Inc., **32Wa**; *33*
(415) 632-4612
ISPO, Inc., **26**; *17* [G-I]
(800) 343-1188
Italian Tile Center, **178**; *79*
(212) 980-8866

J

Jacuzzi Whirlpool Bath-Spas, **160**;
77 [[G-L]
(800) 227-0710
Jason/Perelli, **186**; *85*
(201) 227-4904

K

Kawneer Co.,Inc., **44-45**; *47* [G]
Kentucky Wood Floors, Inc., **205**;
105 [G-D]
Koh-I-Noor Rapidograph, Inc.,
20-21; *14*
(201) 479-4124
Kohler Co., **16**; *11* [E]
Knoll International, **12-13**; *75*;
198; *98*
Kroin, **179**; *6* [G]
(617) 492-4000

L

Laticrete International, Inc., **49**;
51 [G]
(800) 243-4788
Lees Commercial Carpet Co., **66-67**;
66
(800) 523-5647

M

Manville-Holophane Div., **50**; *52*
[G-E-I-D]
Mapes Industries, **56**; *57* [G]
(800) 228-2391
Marden Mfg., Inc., **32Ed**; *26*;
32Cb; *32*
(312) 769-5100
Marvin Windows, **28-29**; *19* [G]
(800) 346-5128
Masonite Corp.-Doors, **4-5**; *3* [G-L-D]

For detailed data, prefilled catalogs of the manufacturers listed below are available in your 1986 Sweet's Catalog File as follows:

Mayline Co., **58**; *59*
(414) 457-5537
McNichols Co., **195**; *96* [E-I]
(800) 237-3820
Merillat Industries, Inc., **54**; *55*
(517) 263-0771
Mitsubishi Chemical Industries
America, Inc., **55**; *56* [G]
Monarch Tile, **209**; *108* [G]
Monier Co., **32Sa**; *36* [G-L]
(714) 538-8822
Morton Thiokol, Inc., Morton
Chemical
Div., **62**; *62* [G]
Moulding Prods, Inc., **42**; *45*
(800) 527-5249

N

Naturalite, Inc., **63**; *63* [G-I-L]
(800) 527-4018
Nixalite of America, **221**; *124* [G]
(309) 797-8771
Norco Windows, Inc., **184**; *83* [G]
(715) 585-6311
Normbau, Inc., **30**; *20* [G-L]
(312) 628-8373

O

October Co., Inc., **180**; *80*

P

Pantone, Inc., **157**; *74*
(800) 222-1149
Paul Associates, **204**; *104*
Pawling Corp. Standard Prods. Div.,
32Ef; *28* [G-E-I]
(800) 431-3456
Peachtree Doors, Inc., **154**; *71* [G-L]
Pella Rolscreen Co., **52-53**; *54*
[G-L-D]
Pozzi Window Co., **32Wa**; *34* [G]
1 (800) 821-1016
PPG Industries-Glass, **220**; *123* [G-E]

Q

Quaker Maid, **200**; *100*

R

Red Cedar Shingle & Handsplit
Shake
Bureau, **38**; *42*
Rock of Ages Building Granite Div.,
32Ec; *25* [G]
Roto Frank of America, Inc., **214**;
116 [G]
(800) 243-0893
Ryther-Purdy Lumber Co., **213**; *114*
[G]
(203) 388-4405

S

Sanspray Corp., **185**; *84* [G]
Season-all Industries, Inc., **207**;
107 [G-I]
Sedgewick Lifts, Inc., **212**; *113*
[G-L]
(800) 431-8262
Sentry Electric Corp., **189**; *89* [G]
(516) 379-4660

(G) General Building & Renovation
(green)

(E) Engineering & Retrofit (brown)

(I) Industrial Construction &
Renovation (blue)

(L) Homebuilding & Remodeling
(yellow)

(D) Contract Interiors (white)

Shakertown Corp., **64**; *64* [G-L]
(800) 426-8970
Sherle Wagner, **208**; *129*
Ship'n Out, **210**; *109* [G-D]
Sitecraft, Inc., **215**; *117* [G-I]
Spacesaver Corp., **199**; *99* [G-I]
(414) 563-6362
Stendig International, Inc., **17**; *12*
(212) 838-6050
Steel Art, **32Ef**; *29* [G]
Sto Industries, **69**; *68* [G]
(802) 775-4117
Structures Unlimited, **183**; *82* [G-E]
Sub-Zero, **192**; *93* [G-L]
(608) 271-2233
Summitville Tiles, Inc., **216**; *118*
[G]
Sun-Dor-Co., Inc., **223**; *126* [G-L]
Sun System Solar Greenhouses, **211**;
111 [G]
(516) 543-7600
Synergy Methods, Inc., **202**; *102*
1 (800) 343-2023

T

Thoro System Prods., **34**; *39* [G]
Tischler und Sohn, **32Ea**; *23* [G-L]
Timberpeg, **191**; *91*
(603) 542-7762
Tri-Guards, Inc., **206**; *106* [G-I-D]
(312) 537-8444

U

Uni-Group, **156**; *73* [G]
United States Gypsum Co., **32**; *22*;
43; *46, 60-61*; *61* [G-E-I-L-D]
(312) 321-4180

V

Velux-America, Inc., **11**; *8* [G-L]
Ventarama Skylight Corp., **32Na**; *35*
[G-L]
(516) 931-0202
Vermont Structural Slate Co., **181**
(800) 343-1900
Villeroy & Boch, **70**; *69* [G-L-D]
(714) 632-9770

W

Watercolors, Inc., **189**; *88*
(914) 424-3327
Wausau Tile, **203**; *103* [G]
(715) 359-3121
WeatherShield Mfg., Inc., **68**; *67*
[G]
(715) 748-2100
Webb Mfg. Co., **57**; *58* [L]
Whitacre-Greer, **212**; *112*
(216) 455-6000
WilsonArt, **39**; *43* [G-D]
(800) 433-3222
Wolverine Technologies, **40-41**; *44*
[G-L]
(313) 386-0800
Worthington Group Ltd., **210**; *110*
(404) 872-1608

Sales offices

Main Office

McGraw-Hill, Inc.
1221 Avenue of the Americas
New York, New York 10020

Director of Business and
Production
Joseph R. Wunk (212) 512-2793

Publisher/Vice President
Paul B. Beatty (212) 512-4685

Director of Marketing
Camille Padula (212) 512-2858

Administrative Asst.
Donna O'Reilly (212) 512-4686

Classified Advertising
(212) 512-2556

District Offices

Director of Sales/East
George Broskey
3 Parkway
Philadelphia, PA 19102
(215) 496-3821

Director of Sales/West
John W. Maisel
4000 Town Center, Suite 770
Southfield, MI 48075
(313) 352-9760

Atlanta
4170 Ashford-Dunwoody Road
Atlanta, Georgia 30319
Gregory Bowerman (404) 252-0626

Houston
7600 W. Tidwell, Suite 500
Houston, Texas 77040
Lockwood Seegar (713) 462-0757

Boston
607 Boylston St.
Boston, Massachusetts 02116
Louis F. Kutscher (617) 262-1160

Los Angeles
3333 Wilshire Blvd., Suite 407
Los Angeles, California 90010
Stanley J. Kassir (213) 487-1160

Chicago
645 N. Michigan Ave.
Chicago, Illinois 60611
Anthony Arnone, (312) 751-3765
Cheryl L. Shores, (312) 751-3705

New York
1221 Avenue of the Americas
New York, New York 10020
Theodore C. Rzempoluch
(212) 512-3603

Edward R. Novak, (312) 658-7133
ER&J Associates, Inc.
P.O. Box 348,
Algonquin, IL 60102

Philadelphia
Three Parkway
Philadelphia, Pennsylvania 19102
Blair McClenachan (215) 496-3829

Cleveland
55 Public Square
Cleveland, Ohio 44113
George Gortz (216) 781-7000

Pittsburgh
6 Gateway Center, Suite 215
Pittsburgh, Pennsylvania 15222
George Gortz (412) 227-3640

Denver
7400 S. Alton Ct. Suite 111
Englewood, Colorado 80112
John J. Hernan (303) 740-4634

San Francisco
425 Battery Street
San Francisco, California 94111
Stanley J. Kassir 1 (800) 621-7881

Detroit
4000 Town Center, Suite 770
Southfield, Michigan 48075
Thomas J. Shaw
(313) 352-9760

Stamford
777 Long Ridge Road
Stamford, Connecticut 06902
Louis F. Kutscher
(203) 329-3001

Vice President Market
Development
Federal Government
Paul R. D'Armiento
1750 K Street NW
Suite 1170
Washington, D.C. 20006
(202) 463-1725

Cost Information Systems
McGraw-Hill Information
Systems Co.
Percival E. Pereira
P.O. Box 28
Princeton, N.J. 08540
Toll Free 800/527-5295
N.J. (609) 426-7300

Overseas Offices

Frankfurt/Main
Elsa-Brandstroem Str. 2
Frankfurt/Main, Germany

Tokyo
2-5, 3-chrome
Kasumigaseki, Chiyoda-ku
Tokyo, Japan

Sheffield
146 West St.
Sheffield S14ES, England

Milan
Via Baracchini No. 1
Milan, Italy

South America
Empresa Internacional de
Comunicacoes Ltda.
Rua da Consolacao, 222
Conjunto 103
01302 Sao Paulo, S.P. Brasil



Paris
17, rue Georges Bizet
75 Paris 16e, France



Why go Straight?

When you can be crooked, have more fun and be legal.
For our 52 page catalog on "crooked" and "straight" stairs,
call toll free 1-800-STAIRS-1, Michigan (313) 483-1833 or write:

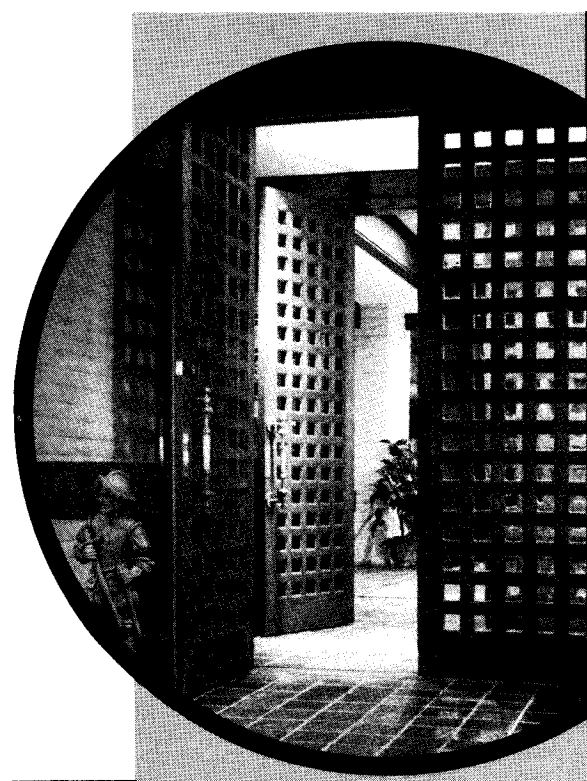
american general products, inc.
P.O. Box 395, Ypsilanti, MI 48197
Circle 125 on inquiry card



SUN-DOR-CO

manufacturer
of america's finest
panel doors

the
SUN-DOR
line

TALL AND ODD SIZED DOORS
CUSTOM MANUFACTURED BY SUN-DOR-CO

SUN-DOR-CO Write for our Catalog
P.O. BOX 13 • WICHITA, KANSAS 67201
PHONE 316 / 267-1397

Circle 126 on inquiry card

READY TO DO BUSINESS?

Architectural Record introduces Sweet's BUYLINE® 800.

ARCHITECTURAL RECORD presents BUYLINE®—the toll-free telephone information service for construction product manufacturers and ready-for-business specifiers.

All you need is a phone.

Here's how it works. You see an ad in ARCHITECTURAL RECORD. You want to specify the product. Call the toll-free BUYLINE® number:

1-800-447-1982

any time of the day...any day of the week... 365 days a year.

You will immediately receive the name, address, and telephone number of the nearest sales representative...and you're ready to buy. It's that simple.

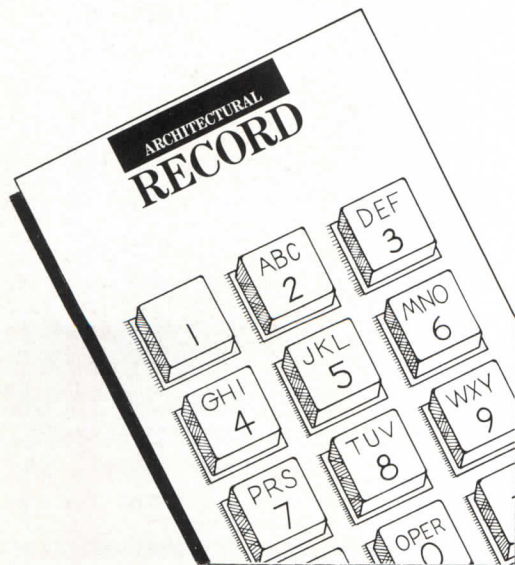

Use your STAC card!



Need product information fast? Your Architectural Record Subscriber Telephone Access Card can help speed information to you about any product or service in these pages.

When you key your more-information requests directly into our computer via touch-tone telephone—through Architectural Record's exclusive STAC system—you save days, even weeks of mail-delivery, handling and processing time.

The day after you call, advertisers can access your request by phone from our computer, and begin the process of mailing you the materials you requested. When you need information for a right-now project, fast, free help is as close as your STAC card. And STAC service is available to you 24 hours a day, seven days a week.

BEFORE YOU DIAL:

1. Write your STAC ID number, as imprinted on your STAC card, in the boxes in Step 4 below. Do not add 0s.
2. Write the Reader Service numbers for those items about which you want more information in the boxes in Step 6 below. Do not add 0s.

CALL STAC:

3. Using a standard touch-tone telephone, call 413/442-2668, and follow the computer-generated instructions.

ENTER YOUR STAC NUMBER AND ISSUE NUMBER:

4. When the recording says, "Enter your subscriber number..." enter your STAC number by pushing the numbers and symbols (# or *) on your telephone keypad. Ignore blank boxes. Enter:

#

5. When the recording says, "Enter magazine code and issue code..." enter these numbers and symbols:

#

ENTER YOUR INQUIRIES:

6. When the recording says, "Enter (next) inquiry number..." enter the first Inquiry Selection

Number, including symbols, from your list below. Ignore blank boxes. Wait for the prompt before entering each subsequent number (maximum 17 numbers).

1.	<input type="text"/>	<input type="text"/>	<input type="text"/>	<input type="text"/>	#	<input type="text"/>	<input type="text"/>
2.	<input type="text"/>	<input type="text"/>	<input type="text"/>	<input type="text"/>	#	<input type="text"/>	<input type="text"/>
3.	<input type="text"/>	<input type="text"/>	<input type="text"/>	<input type="text"/>	#	<input type="text"/>	<input type="text"/>
4.	<input type="text"/>	<input type="text"/>	<input type="text"/>	<input type="text"/>	#	<input type="text"/>	<input type="text"/>
5.	<input type="text"/>	<input type="text"/>	<input type="text"/>	<input type="text"/>	#	<input type="text"/>	<input type="text"/>
6.	<input type="text"/>	<input type="text"/>	<input type="text"/>	<input type="text"/>	#	<input type="text"/>	<input type="text"/>
7.	<input type="text"/>	<input type="text"/>	<input type="text"/>	<input type="text"/>	#	<input type="text"/>	<input type="text"/>
8.	<input type="text"/>	<input type="text"/>	<input type="text"/>	<input type="text"/>	#	<input type="text"/>	<input type="text"/>
9.	<input type="text"/>	<input type="text"/>	<input type="text"/>	<input type="text"/>	#	<input type="text"/>	<input type="text"/>
10.	<input type="text"/>	<input type="text"/>	<input type="text"/>	<input type="text"/>	#	<input type="text"/>	<input type="text"/>
11.	<input type="text"/>	<input type="text"/>	<input type="text"/>	<input type="text"/>	#	<input type="text"/>	<input type="text"/>
12.	<input type="text"/>	<input type="text"/>	<input type="text"/>	<input type="text"/>	#	<input type="text"/>	<input type="text"/>
13.	<input type="text"/>	<input type="text"/>	<input type="text"/>	<input type="text"/>	#	<input type="text"/>	<input type="text"/>
14.	<input type="text"/>	<input type="text"/>	<input type="text"/>	<input type="text"/>	#	<input type="text"/>	<input type="text"/>
15.	<input type="text"/>	<input type="text"/>	<input type="text"/>	<input type="text"/>	#	<input type="text"/>	<input type="text"/>
16.	<input type="text"/>	<input type="text"/>	<input type="text"/>	<input type="text"/>	#	<input type="text"/>	<input type="text"/>
17.	<input type="text"/>	<input type="text"/>	<input type="text"/>	<input type="text"/>	#	<input type="text"/>	<input type="text"/>

END STAC SESSION:

7. When you have entered all your Inquiry Selection Numbers and the recording prompts, "Enter next inquiry number," End the call by entering:

9 1 # #

If you are a subscriber and need assistance, call 212/512-3442. If you are not a subscriber, fill out the subscription card in this issue, or call Architectural Record Subscription Services at 914/628-0821.

Ceramix. The first faucet that takes its own temperature.



Yeouch! That's how most people discover their bath water's too hot. Or their shower's too cold.

Now there's a less painful way. The Ceramix Electronix™ from American Standard.

Our built-in sensor measures the temperature and our solar-powered digital readout displays it.

So now your customers know exactly what they're getting into. Before they get into it.

Our single-control faucet comes with some other terrific features, too. Like our washerless ceramic-disc valving. A life-time drip-free warranty. And to top it

off, a choice of 6 beautiful finishes.

We have a faucet for the bath and shower, bidet, and bathroom and kitchen sink. We even have a full line of Ceramix™ faucets without temperature readouts.

So carry the Ceramix Electronix. Not only will it keep your customers out of hot water, it'll keep you in the money.

For our luxury products brochures, write to American Standard, Department KBB, P.O. Box 2003, New Brunswick, N.J. 08903. To see Electronix, visit our Showplaces: Chicago (3 Crossroads of Commerce, Suite 100, Rolling Meadows); Dallas (12344 Inwood Rd.); Los Angeles (116 N. Robertson Blvd.); New York (40 W. 40th St.); Pittsburgh (100 Ross St.). Or call 1-800-821-7700 (ext. 4023) for your local showroom. © 1986 American Standard Inc.

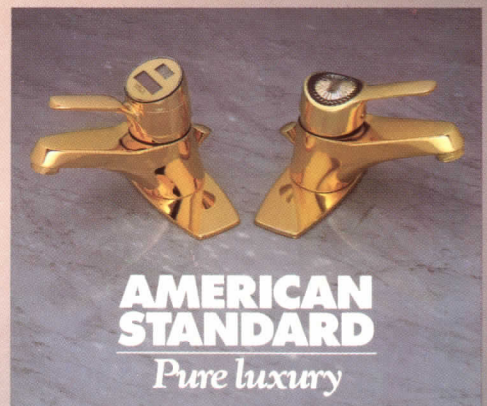

Circle 127 on inquiry card



Olympic® Oil Stain.
One of the most dependable tools an architect has.

For over half a century, architects have used Olympic Oil Stain as a tool to both protect and enhance the beauty of their creations.

Because Olympic Oil Stain is factory formulated with linseed oil and light-fast, micro-milled pigments. These premium quality ingre-

dients penetrate wood and actually strengthen the fibers.

So an Olympic finish is a beautiful finish. You can depend on it.

We have the inside on outside protection.

