

ARCHITECTURAL RECORD



A Spiritual Bastion for a Secular Age

Will Rafael Moneo's Cathedral
for Los Angeles Endure?



ANNUAL BUSINESS WEEK/
ARCHITECTURAL RECORD AWARDS

Special Section: LIGHTING

[Between us, ideas become reality.™]

If you can envision it, we can help
make it happen. Thanks to our
Architectural Specialties Group,
a technically savvy service team

Indulge your right brain.

ready to collaborate with you
in designing custom ceiling
applications that will redefine
the ceiling plane. And offer you
innovative visual options with
Armstrong MetalWorks™ and
WoodWorks™ specialty ceilings.

Call us today at 1-877-ARMSTRONG
and mention Dept. 13H, or visit
www.armstrong.com. Discover
how Armstrong can help you
cater to your creative side.



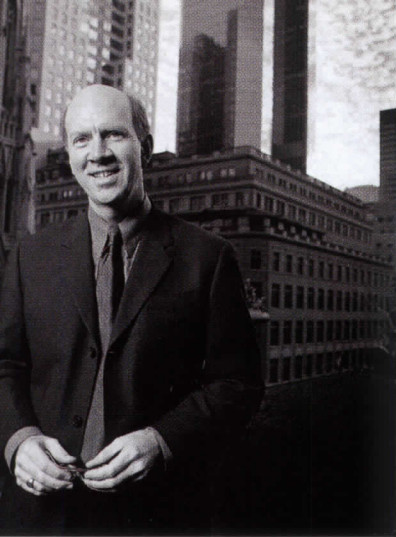

Down They Come

Editorial

By Robert Ivy, FAIA

Still the Modern buildings come down. Sometimes surreptitiously, sometimes in the clear light of day, the neighborhood or the nation awakens to find one more historic property, a distinguished building from the recent past, lying in heaps. How can we allow this callow disregard for our cultural heritage to continue?

Remarkably, human intention, not hurricanes or flood, accounts for much of the damage. During the past year, in March 2002 we lost the Maslon House by Richard Neutra. Located at the Tamarisk Country Club in Rancho Mirage, California, the house (built in 1962) represented an unfolding, mature essay from the architect's later period, which ended with his death in 1970. Over the years, many of Neutra's primary structures have been threatened, despite his seminal role in the development of the Modern movement in California and throughout the country.

This egregious teardown may have been the most celebrated of the past year, but it sadly was not the only significant loss. In greater Los Angeles alone, the country lost Rudolf Schindler's Packard (built in San Marino in 1924) and Wolfe houses (Avalon, California, 1928), along with the more notorious Maslon fiasco in Palm Springs.

Other properties may prove more fortunate, though they're within an inch of their lives. On Long Island, a coalition of forces has apparently saved the Conger Goodyear House, a 1938 gem by Edward Durrell Stone for Goodyear, the first president of the Museum of Modern Art. In that more fortunate case, the World Monuments Fund, which had listed the Old Westbury, Long Island, house among its 2002 list of the "100 Most Endangered Sites," pulled together a funding group including the Barnett Newman Foundation, which purchased the house; the Monument Fund's own capital, which will finance necessary repair work; and the Society for the Preservation of Long Island Antiquities of Cold Spring Harbor, which will hold title to the property until a permanent buyer can be found. International, national, and local resources—all three—were required.

Not all Modern buildings at risk are houses. Any student of archi-

ecture who cut teeth in the 1960s or '70s remembers Ralph Rapson's dramatic renderings of the interior of the Tyrone Guthrie Theater in Minneapolis (1963). Yet it too may bite the dust by the year 2005 without positive intervention. As of this writing, the future of Saarinen's TWA terminal remains unresolved, the subject of intense debate. Edward Durrell Stone's formerly vilified and much-discussed Huntington Hartford Museum, by contrast, has apparently found a buyer. Time marches on.

It isn't as if no one cared. While architects play significant roles in historic preservation through the National Trust or the Monuments Fund, one organization stands committed to preserving Modernism per se in 40 countries: DOCOMOMO, founded in Eindhoven, Holland, in 1988. Its ungainly, memorable name stands for "DOcumentation and COnservation of buildings, sites, and neighborhoods of the MOdern MOvement."

Architects, fortunately, can be part of the solution. All persons interested in the tissue of history, the material links of ideas, or in the physical proof of civilization, should decry the senseless demolition or alteration of any great works, including those of the recent past. Our challenge will be to educate others and get them to co-opt our enthusiasms. The public, which includes our own clients and public-building officials, regularly falls prey to economic and development pressures, as well as current fashion. We will need to offer them reasons, legal remedies, and shared passion to prevail. Had anyone in Rancho Mirage, outside the cognoscenti, heard of Richard Neutra? Had anyone singled out the Maslon House for honor or historic respect? Who stands up for the great Modern buildings in your own community? After all, the story is ours to tell, and the subject is the one we love best.

Designing the highest level of security can be easier when it comes from one source.



Security & Safety[®]
Proven Source. Proven Solutions.[™]

Our network of consultants and distribution partners offers the most extensive security and safety solutions in the industry. With 22 consulting and spec writing offices throughout the U.S. and Canada, we can provide the services you need—from access and egress control to time and attendance, as well as asset tracking and personnel scheduling. IR Security & Safety, known for more than 75 years for its leading brands, is now providing biometric, *electronic* and mechanical security solutions, as well as software network integration. *To learn more, visit irsecurityandsafety.com or call 1-877-840-3621 to contact one of our 22 Security & Safety Consultant offices.*

**SCHLAGE • VON DUPRIN • LCN • LOCKNETICS • R S I • FALCON • MONARCH
IVES • DOR-O-MATIC • INTERFLEX • KRYPTONITE • STEELCRAFT**

Letters

A higher design in mind

"Should we do what's right or please our clients?" was the question posed in the October issue ["Ethics and the Architect," page 96]. We know the correct answer to this question, but fear the consequences.

The theological implications of this discussion are inescapable: If we assume there is no God, then not only are there no rewards beyond the grave for goodness (so as to justify present hardship), but an objective standard called "good" no longer exists. All morality becomes personal, subjective, and relative.

The theistic worldview is the only context in which our musing on fixed ethical principles even makes sense. Otherwise, expedient self-interest is all that remains of this lofty debate.

—Tom Houg, AIA
South Pasadena, Calif.

Stick to the buildings

I can't tell you how disappointed I am with your magazine's cover photo for the September 2002 issue.

In a profession where women still struggle for parity and equality, it is extremely disturbing to find a model in a black bra on the cover of the AIA's official magazine.

Please reconsider your policy on such issues. It is far behind the times.
—Jean Steinbrecher, AIA
Past President, AIA Northwest,
Washington

Robert Ivy replies: Thank you for your letter. We try diligently not to be condescending or insensitive.

In designing the cover, we debated its merits thoroughly among the entire staff. This cover has drawn favorable reviews from other architects of all stripes—women and men—perhaps more favorable than for any other cover in our experience. Beauty, however, is in the eye of the beholder, and if you're offended, we're sorry.

You might be interested to know that the woman pictured actually owns the apartment featured in the issue and happens to be a professional model who is proud of her home. Her attire is typical casual wear for someone at home in New York City. We intentionally chose the image to lend scale and human warmth to the cover.

The kids are alright

I read with enthusiasm your article in the September issue on the design-build studio at the University of Arkansas [archrecord2, page 63]. It pleases me that your journal records and celebrates the work of many students across the country.

The article states, however, that this is the only program in the country that builds a house in one semester. While I would hate the production schedule to be the main measure of many programs' success at presenting these opportunities to students and emphasizing the role of architecture in community development, allow me to applaud the students at the College of Architecture at the University of North Carolina, Charlotte.

We began our design-build studio in 1995 under the direction of Professor Gregor Weiss, working with Habitat for Humanity in Davidson, North Carolina.

After that first year learning the ropes and management skills, we designed and built our first house in one semester in fall 1996. Since 1997, under the leadership of Professor John Nelson, our students have built one house each fall semester. They design—collectively and with the actual resident—and produce construction documents in the first three weeks of the semester. By week 15, they turn over the keys to the owner! It is an awesome accomplishment, but even more inspiring is to see this transition before the holi-

days. The five houses completed (we are currently engaged in House 6) are from 1,200 to 1,320 square feet in size (four bedrooms, two full baths). They are built with funds from the Mecklenburg (North Carolina) County Community Development Department. They allocate \$45,000 for each house, which is broken down to \$30,000 for materials and \$5,000 each for mechanical, electrical, and plumbing subcontractors.

The emphasis in our work is to spend three to five years in one neighborhood of low-income residents. Our houses are not supplemented by private donations to emphasize new or more expensive materials. The houses stand as models for other residents to initiate their own projects without special resources, craft, or construction tools and shops. It has become an important part of our program's identity and represents a significant commitment to the community.

—Ken Lamba
Dean, College of Architecture
University of North Carolina,
Charlotte

Making Fountainhead-way

In the August 2002 Critique by Robert Campbell, FAIA [page 59], the author quotes an unnamed architect who has apparently suggested the need for Ground Zero to have a "unique, uplifting, and visionary project to rise from the ashes." Campbell then states, "I quote this because it is typical of the kind of romantic, Howard-Roarkian document with which I find myself in total disagreement." In fact, Ayn Rand's character Howard Roark, in her novel *Fountainhead*, would have agreed with Campbell. The antiheroes in the story—Keating, an architect; Francon, architect and owner of an architectural firm; or Toohey, an architectural critic—would have

been the lackluster "visionaries" who support a monument with no concern for the needs of the city or the needs of the persons concerned. The character Roark would have taken into consideration the real needs of the city as Campbell purports to do. I can only hope that Mr. Campbell read *Fountainhead* so long ago that he has forgotten the actual characters.

—Maggie Lindorfer
St. Paul

Examining the exam

In an optimistic world, identifying the improved candidate pass rates for the ARE over the past four years would be appropriate, as indicated in the July issue [News, page 29]. But the same number of divisions (three) have shown a fairly sharp drop in pass rates as well since 1999—Mechanical and Electrical Systems, Site Planning, and Building Technology.

Not to be pessimistic, but one must wonder if this is due to a more difficult exam administered by NCARB (were those sections getting too easy to pass?); the profession not mentoring young exam candidates well enough in those knowledge areas; a failure of interns in reporting IDP credits truthfully, or a combination of all three. An increase in pass rates for certain ARE divisions is encouraging, but a decrease in divisions should also create concern.
—F. Michael Ayles, AIA
Young Architects Forum
Advisory Committee Communications
Coordinator, Connecticut

Corrections

In the October issue [page 133], photographer Todd Eberle's name is misspelled, as is Peter Aaron's (ESTO) [page 156]. We regret the errors.

Please send your letters via e-mail to rivy@mcgraw-hill.com.

THE STEEL WINDOW RE C R I T I C A L L[®] W

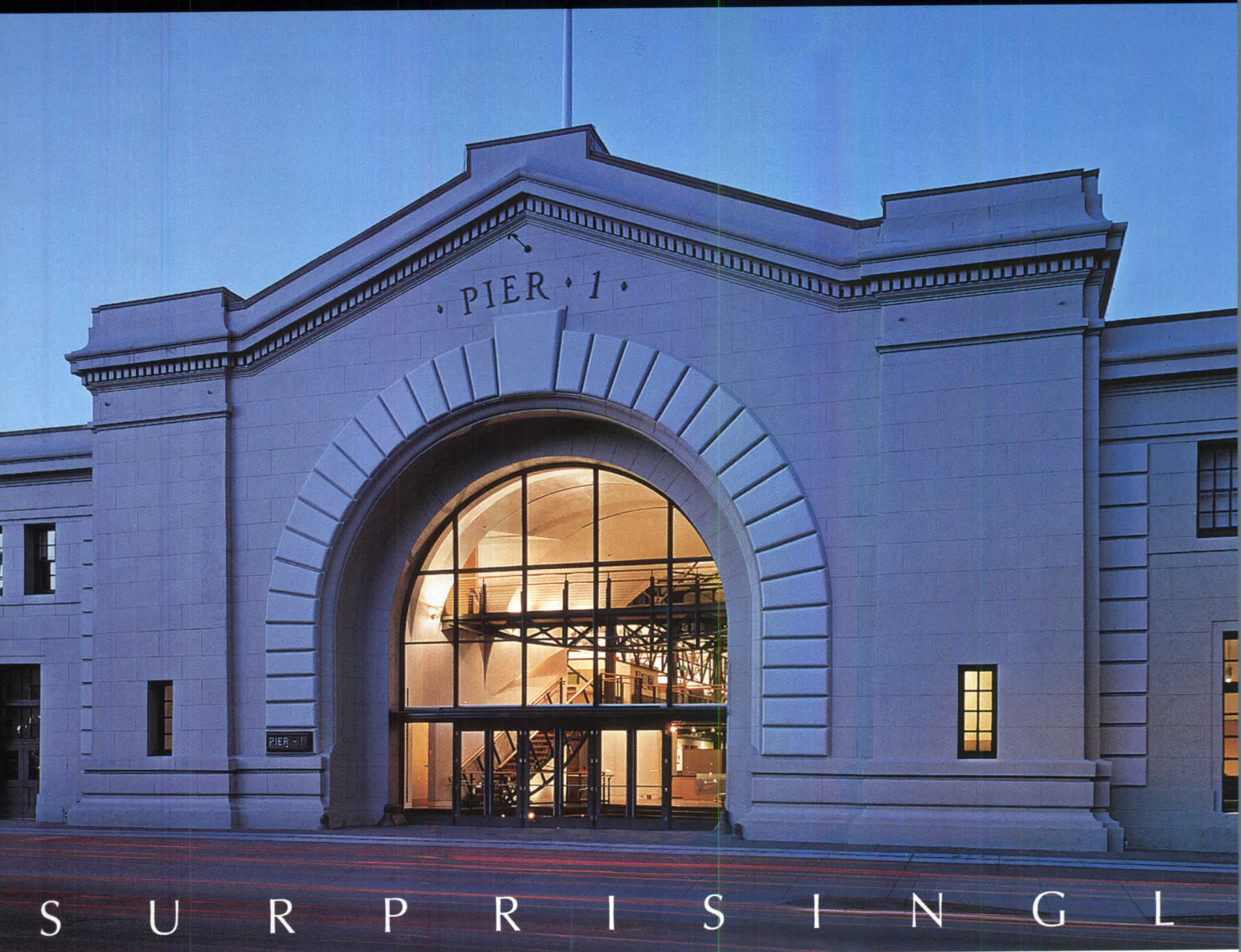

Pier 1, San Francisco, California

Photographer: Timothy Hursley

Architects: SM

- High Performance with the Narrowest Possible Sightlines
- Elegance, Versatility, Strength and Security
- Widest Array of Custom and Historic Shapes
- Unsurpassed Life Cycle & Minimum Maintenance
- Glazing Capacity up to 1¼" IGU

- 10 Year Warranty on Product and Finish - STANDARD
- Hot-Dip Galvanizing - STANDARD
- Environmentally Friendly, Factory Applied, Epoxy-Free Polyester Powder Coat Finish - STANDARD
- Unlimited Color Selection Available
- Prompt & Reliable Delivery Worldwide - GUARANTEED



CIRCLE 9 ON READER SERVICE CARD
OR GO TO WWW.LEADNET.COM/PUBS/MHAR.HTML

Pelli develops transparent Minneapolis library

Calling it a “contemporary building with very deep roots in the community,” Cesar Pelli, FAIA, unveiled his design in early October for a new \$120 million, 400,000-square-foot central library in downtown Minneapolis.

Located on the site of the current library adjacent to the northern end of the Nicollet Mall, Pelli created an understated, transparent design made up of two five-story volumes bisected by an 80-foot-high central atrium. A dramatic zinc-covered asymmetrical “wing” tops the atrium and cantilevers over the sidewalks on both sides of the building. The exterior is sheathed in glass with horizontal banding of Minnesota limestone at each floor.

Four different types of glass will be used, depending on the function of the space behind it. On the south side and enclosing the rare

books collection, the glass will be more opaque. On the north side and along the public areas, it will be more transparent. Pelli calls it a “happy serendipity” of the design that the variations in the glass recall books on a shelf.

Along with a 35 percent increase in open-stack space, the new building will have a children’s area, a teen center, computer training facilities, expanded parking and bus drop-off areas, and community spaces, including galleries, meeting rooms, and a 235-seat theater. Pelli has located a state-of-the-art planetarium on the prominent northwest corner of the top floor. Although the funding for this \$9 million planetarium is still unresolved, the building has been designed in such a way that it can be added in the future. The library’s collection has already been relocated, and the existing

library building is scheduled to be demolished this fall. Ground breaking is set for April 2003, and the new building is scheduled to open in spring 2006. *Bob Dillon*



The library will include a dramatic atrium (above) and four different types of exterior glass (below).



Mori selected for visitors’ center at Wright’s Darwin Martin House

New York–based architect Toshiko Mori, chair of the department of architecture at the Harvard Graduate School of Design, has been selected to design a new visitors’ center at the Darwin Martin

House complex in Buffalo, New York, designed by Frank Lloyd Wright in 1903–7.

The Martin House Restoration Corporation, established in 1992, selected Mori and is building the

visitors’ center. She was chosen in an invited competition with Office dA, Boston; Architectural Research Office, New York; Schwartz Silver Architects, Boston; and Brian Healy Architects, Boston.

More than \$20 million has been raised out of a projected \$23 million, both to build the visitors’ center and to restore the complex, a National Historic Landmark—including replication of missing art-glass windows and furnishings,

as well as the reconstruction of gardens, the conservatory and carriage house, and a 100-foot-long pergola that was demolished in 1960.

Mori’s building, which will open in 2005, will include a visitor-orientation space, interpretive galleries, education spaces, and a museum shop. Mori will work with Hamilton Houston Lowrie Architects, restoration architects for the Martin House project, and Christopher Chadbourne and Associates, Boston-based museum planning and exhibition designers.

Mori says she envisions the visitors’ center as “a pavilion” and as “a contemplative space in dialogue with the complex, preserving the romantic and picturesque quality of the landscape and gardens.” *Kathleen Quigley*

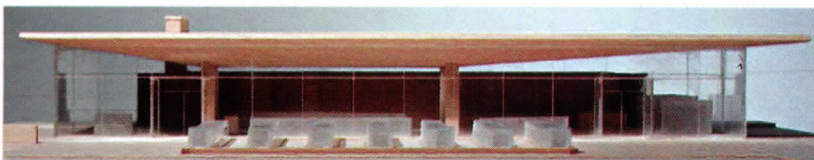
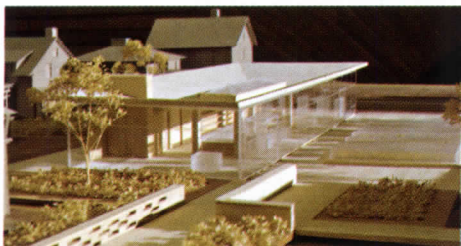

Mori’s glass pavilion (top left and bottom) will be adjacent to the Martin House complex (top right).

OFF THE RECORD

Allied Works Architecture of Portland, Oregon, led by Brad Cloepfil, has been selected to design the Seattle Art Museum's expansion. Other firms being considered were Polshek Partnership Architects and Cooper, Robertson & Partners. The 300,000-square-foot expansion will be in a new 40-story tower for Washington Mutual by the Seattle office of NBBJ.

New York City's Lincoln Center for the Performing Arts has asked five architecture firms to submit design plans for the public spaces of its 16-acre campus: Santiago Calatrava, Cooper Robertson & Partners, Diller + Scofidio, Foster and Partners, and Richard Meier. A selection will be made in December.

Six finalists were named in the competition for a memorial to victims of the September 11, 2001, terrorist attack on the Pentagon: Shane Williamson, Toronto; Julie Beckman, New York City, with team member Keith Kaseman; Jean Koeppel, Brooklyn, New York, with team member Tom Kowalski; Mason Wickham, Brooklyn, New York, with team member Edwin Zawadzki; Jacky Bowring, Canterbury, New Zealand, with team members Peter England, Richard Weller, and Vladimir Sitta; Michael Meredith, Clifton Park, New York. A winner is expected to be announced by year-end.

The Los Angeles chapter of the American Institute of Architects (AIA) has named Barton Myers, FAIA, the 2002 AIA/LA Gold Medal recipient.

Cornell University is making its second attempt to select an architect for a new building for its department of architecture. The firms under consideration are Tod Williams Billie Tsien and Associates, Thom Mayne of Morphosis, Smith-Miller + Hawkinson Architects, Barkow Leibinger Architects, and Allied Works Architecture. At press time, a selection was expected in early November.

Urban photographer Camilo Vergara wins MacArthur grant

Camilo José Vergara, a New York-based photographer who has captured the changing nature of poor urban neighborhoods for three decades, was named as one of 24 MacArthur Fellows for 2002.

The John D. and Catherine T. MacArthur Foundation names 20 to 30 fellows each year to receive a grant, popularly known as the "genius grant," of \$500,000, with no stipulation for how the money should be spent.

The award recognizes "exceptional creativity, promise for important future advances based on a track record of significant accomplishment, and potential for the fellowship to facilitate subsequent creative work," according to the foundation.

A native of Chile who moved to the United States in 1965, Vergara, who was trained as a sociologist, has made urban neighborhoods the focus of his photography since 1977. Winning the MacArthur grant "has brought quite a bit of new interest to my work," Vergara says. "It means that I have some security and I'll be able to pay the rent."

Vergara also photographed the World Trade Center from its construction through September 11, 2001. An exhibition of those photographs, *Twin Towers Remembered*,

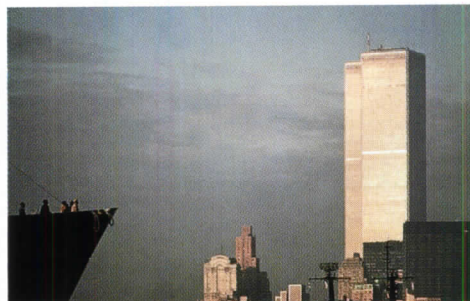

Vergara's photograph of the WTC towers and an approaching ship was taken in 1978.

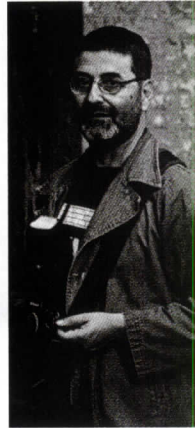

Camilo Vergara (center left) has photographed evolving urban scenes, including this Newark, N.J., church in (from top) 1980, 1993, and 2002.

originated at the National Building Museum in late 2001 and is now at the Museum of the City of San Francisco until January 15, 2003. A book of the photos was published in

late 2001 under the same title. In the photos, many of which are taken from neighborhoods far from Lower Manhattan, "you get the sense of the omnipresence of the towers," Vergara says.

He is currently focused on documenting the changes in

places of worship over time, including traditional churches that have been abandoned or changed use, urban storefront churches, and suburban megachurches. Vergara would also like to update his 1995 book, *The New American Ghetto*. "There's been important changes in the very poor areas of cities," he says.

Among the 24 fellows that the foundation named this year are a seismologist, several musicians, and scientists. Three architects—Elizabeth Diller, Ricardo Scofidio, and the late Samuel Mockbee—have been named fellows since 1981. J.E.C. and Kevin Lerner

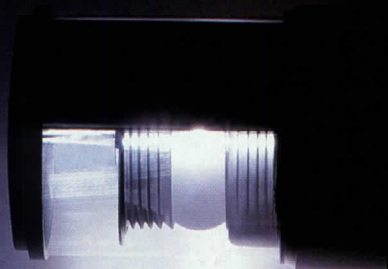

VSI

Vertical Surface Illuminator

A new kind of floodlight
which evenly illuminates a wall surface
from the wall being illuminated.

Aimed down, it provides the added benefit
of eliminating upward stray light.

Enhances textures such as brick or stone.

BEGA sets the standard

For the complete story,
visit our web site.
www.bega-us.com
805.684.0533

www.findcontractors.com

ABC contractors have been building on-time, on-budget, high-quality construction projects for more than 50 years. Now you can find them across the country — quickly, easily and at no cost to you. Build with the best at findcontractors.com.

Associated Builders and Contractors
1300 N. 17th Street, Rosslyn, Va. 22209
(703) 812-2000 • www.abc.org

CIRCLE 13 ON READER SERVICE CARD
OR GO TO WWW.LEADNET.COM/PUBS/MHAR.HTML

Record News

SPECIAL REPORT

Six unique teams of world-renowned architects selected to develop design proposals for World Trade Center site

The Lower Manhattan Development Corporation (LMDC) named six teams of architects and planners in late September to participate in a design study for the World Trade Center (WTC) site. The six teams were culled from 407 submissions.

Each of the six teams will receive \$40,000 to develop plan proposals for the site under new guidelines that emerged after negative public reaction to the six official first-stage proposals

in spring 2003. The selected teams, some containing several architects, planners, or firms, are as follows:

- Studio Daniel Libeskind, Berlin;
- Foster and Partners, London;
- Richard Meier, Peter Eisenman, Charles Gwathmey, and Steven Holl, all of New York City;
- United Architects, a team comprised of Reiser Umemoto, New York City; Foreign Office

Architects, London; Greg Lynn FORM, Los Angeles; Imaginary Forces, New York City and Los Angeles; Kevin Kenon Architect, New York City; and UN Studio, Amsterdam;

- Skidmore, Owings & Merrill, New York, with Field Operations, New York City and Philadelphia; Tom Leader, Berkeley; Michael Maltzan, Los Angeles; Neutelings Riedijk, Rotterdam, the Netherlands; SANAA, Tokyo; and with artists Inigo Manglano-Ovalle, Rita McBride, Jessica Stockholder, and Elyn Zimmerman;



Overlooking the WTC site, architects Bill Morrish (left), Rafael Viñoly (second from left), and Frederic Schwartz (far right) of the Think group, listen to Alexander Garvin, V.P. of planning, design, and development for the LMDC.

were released in July. The new program calls for 6.5 to 10 million square feet of office space on-site (down from the original 11 million), 600,000 to one million square feet of retail on-site, a mix of cultural and civic amenities, a “powerful skyline element,” and the creation of a promenade on West Street—one of the proposals that met with positive reaction in the first stage of designs. The new program also calls for the exploration of new residential uses near but not on the site, and expresses a preference to keep the “footprints” of the WTC towers free from development.

The six teams must submit their design proposals by the end of November. At that time, the LMDC and the Port Authority of New York and New Jersey will select an unspecified number of “the most promising ideas,” and ask the firms behind those ideas to develop specific site-plan proposals. The LMDC expects to present at least three proposals for public review by the end of the year, with a final land-use plan to be released

- Think, a team including Shigeru Ban, Tokyo; Frederic Schwartz, New York City; Ken Smith, New York City; Rafael Viñoly, New York City, with Arup; Buro Happold Engineers, Bath, England; Jorg Schlaich, Stuttgart, Germany; William Moorish, Charlottesville, Virginia; David Rockwell, New York City; and Jane Marie Smith, Baltimore.

The consultant teams already employed by the LMDC, including Beyer Blinder Belle and Peterson/Littenberg Architecture and Urban Design, will continue to work on the project. In addition, New York firm Ehrenkrantz, Eckstut & Kuhn Architects was hired by the Port Authority as an urban design adviser. *Kevin Lerner*

www For continuous updates on the planning of Lower Manhattan, see our special section at www.architecturalrecord.com

One name. One vision.

Celotex. BPB Gypsum

BPB Marco. BPB Westroc.

One powerful force.

Our BPB group of companies in North America has grown tremendously in the last two years. And the more we grew, the more we realized the need to simplify things for our customers.

First of all, our corporate identity.

From now on we will be known in North America simply as **BPB** — four leading companies united in name, vision, values and strengths.

We've simplified our branding, too.

For North America's premier line of professional-grade gypsum products, the name to reach for in wallboard is now **ProRoc™**, and for finishing compounds and textures it's **ProFin™**. As for ceilings, the brands to look up to are **Celotex®**, **Capaul®**, **Interior Pro™** and **Gyptone™**.

Revolutionary changes? No. We view it as evolutionary fine-tuning — to make it easier for our customers to work with our companies and identify our products.

BPB. ONE **POWERFUL** FORCE.

For more information:

Call 1-866-427-2872 or visit www.bpb-na.com

CIRCLE 14 ON READER SERVICE CARD
OR GO TO WWW.LEADNET.COM/PUBS/MHAR.HTML

© TM Trademarks are the property of BPB plc or its affiliates and related companies.



PERFORMING THE
FINE ART OF
PROTECTION

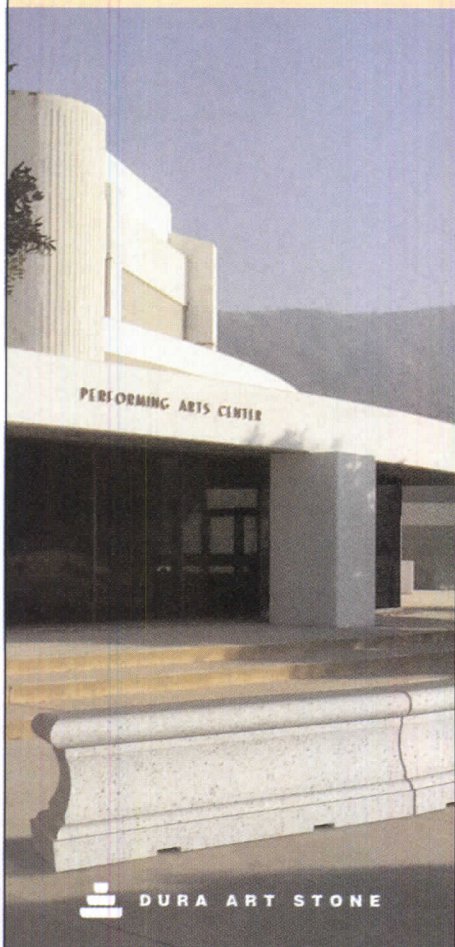

Introducing DURA ART WALL™, where architectural design turns an otherwise unsightly highway median barrier into an architecturally pleasing complement to the most sophisticated environment.

See our complete line of perimeter security products online at:

DURAARTSTONE.COM

or call us toll free.

800-821-1120

CIRCLE 15 ON READER SERVICE CARD
OR GO TO WWW.LEADNET.COM/PUBS/MHAR.HTML

Record News

SPECIAL REPORT

90 Church Street, just north of the WTC site, will have contaminants removed at a considerable cost.

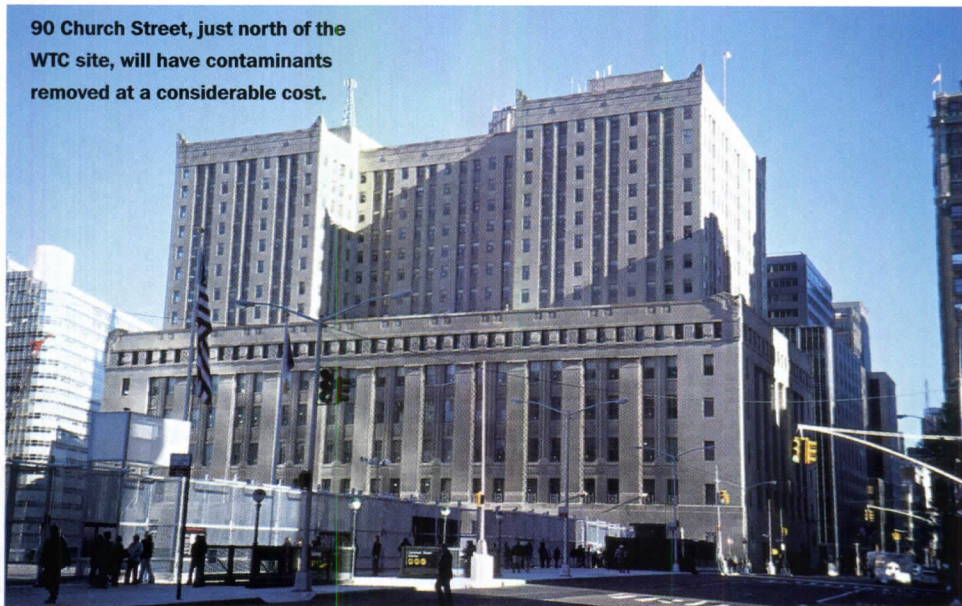

Closed since 9/11, office to be cleaned of contaminants

The former Federal Office Building at 90 Church Street, just north of the World Trade Center site, sustained considerable damage on September 11, 2001. Airplane wreckage punctured its roof, more than 800 windows were broken, and interiors were subjected to fire. Although it withstood these impacts, the 15-story National Register landmark remains empty—due to contamination. The building's tenants plan eventually to return to the building after having the interior cleaned at a considerable effort and expense.

"When the collapse occurred, that cloud entered our building and filled it with heavy debris and dust" that included asbestos and dioxins, says Tim Hill, senior vice president of property management for Boston Properties, which operates the building. Standing water from fire sprinklers also caused widespread mold damage.

Completed in 1935, the building was designed by Cross & Cross. Master leaseholder 90 Church Street LP, a Boston Properties affiliate, performed a \$100 million renovation of the 1 million-square-foot structure in the mid-1990s, after which the Legal Aid Society and the New York City Housing Authority (NYCHA) took occupancy of offices. The NYCHA was the building's largest tenant, occupying 450,000 square feet on seven-and-a-half floors. The Legal Aid Society occupied the building's top three floors, and the first four floors were occupied by the United States Postal Service.

Power and systems have recently been restored, and the building is currently sealed as the three tenants and landlord finalize a unified protocol for clearance and cleanup. Because "contaminants actually got down inside the wall cavity," says Hill, demolition and disposal of all interior finishes is required. John Leitner, a principal of environmental consultant Ambient Group, which is implementing the program, adds that the cleanup will resemble procedures for asbestos remediation.

Tim Oppelt, director of the Environmental Protection Agency's National Risk Management Research Laboratory, explains that this scope of work is unprecedented: "This isn't something that anyone's really had much experience doing."

The limited partnership will oversee the entire cleanup process, and individual insurance claims filed by the landlord and tenants are expected to compensate the cost. While Hill says that a total cost cannot yet be determined, the NYCHA and the Legal Aid Society estimate that damage and dislocation expenses will equal \$93 million and \$25 million to \$30 million, respectively.

Despite the cost, the tenants have committed to returning. NYCHA spokesperson Howard Marder says, "It's our intention to move back if all the work that needs to be done can get done." The agency, like the other tenants, has shifted employees to temporary offices, and Marder says that "we've had to crowd people into spaces that we normally would not have." *David Sokol*

Anodized Or Painted?
The Answer Will Surprise You.



Alcoa Cladding Systems is proud to introduce a painted solution for anodic finishes on Reynobond® Aluminum Composite Material.

Available in four mica colors formulated to match popular anodized finishes, Colorweld 300XL Anodic Series coatings ensure uniform color and maximum durability, with a standard 20-year warranty not offered with batch anodized ACM panels. All at a cost that's significantly below that of anodized. So you can have the look of anodized ACM, with the performance, consistency and savings of coil coated Reynobond.

No one offers more coating choices to meet your diverse application and budgetary needs. To learn more about our complete line of specialty finishes for Reynobond ACM, visit our website or call 770.840.6456.

Our Comprehensive Line Of Architectural Coatings Includes:
Colorweld 100 • Colorweld 300 • Colorweld 300XL Anodic Series
Duragloss 3000 • Duragloss 5000 • Megaflon



Alcoa Cladding Systems
555 Guthridge Court • Norcross, GA 30092
770.840.6456 tel • 770.734.1581 fax

www.alcoacladdingsystems.com

CIRCLE 16 ON READER SERVICE CARD
OR GO TO WWW.LEADNET.COM/PUBS/MHAR.HTML

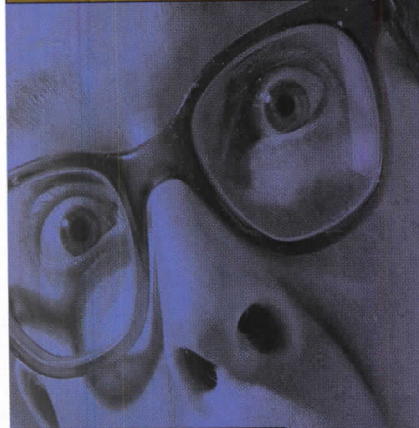

Take a
good look at
metal buildings.

For a look at the
flexibility, performance
and appearance
Metal Buildings
can provide, visit
www.mbma.com/photo



CIRCLE 17 ON READER SERVICE CARD
OR GO TO WWW.LEADNET.COM/PUBS/MHAR.HTML

Record News

With a focus on developing professionals, not interns, summit participants discuss education-to-practice continuum

Brian Grieb, an intern from Maryland, asked the key question during last month's summit on architectural internship: "Are we developing interns or professionals?"

A team of 50 people, ranging from architecture students and interns to educators and practitioners, met October 3 to 6 to discuss the transition from architectural education to practice. Organized by *ArchVoices*, an information resource for interns edited by Casius Pealer III and John Cary, Jr., the summit was cochaired by Cary and Laura Lee, AIA, an associate professor at Carnegie Mellon University, Pittsburgh. The University of Oklahoma College of Architecture hosted the event, and the Enkeboll Foundation for the Arts and Architecture provided funding.

The summit included representatives of all five of the collateral organizations—American Institute of Architects, American Institute of Architecture Students, National Architectural Accrediting Board, National Council of Architectural Registration Boards, and American Collegiate Schools of Architecture—as well as the National Organization of Minority Architecture Students. The discussion built upon the 1996 Boyer-Mitgang *Building Community* report and the dialogue ini-

ated at the 1999 Collateral Internship Summit.

"We were emphatic from the beginning that we were dedicated to building on the foundations of things that came before us," Lee said. "These things have merit and history, and let's see how far we can extend them."

Once the summit discussion began, though, it was evident that certain practitioners in attendance were not voluntarily speaking and did not want to debate certain issues, especially if the definition of "architect" was broached. As North Carolina State University dean Marvin Malecha, FAIA, told participants: "There's a whole contingent here that is not willing to negotiate the term 'architect.' They're politely not speaking while others are voicing a more liberal attitude."

"Certain things needed to come to light," Lee later said. "I think there was a lot of progress made."

"Whenever we were able to rein in the discussion back to values and the profession, it was interesting to see how much people were able to move and give up turf or even share turf," said Lee. "People were able to look more broadly than just at the matter of internship and say that this is about the profession and values."

"If we could all look at it in the broader sense of professional development, that would probably have more promise for making it happen," said John McRae, FAIA, vice president of education and training at RTKL Associates, a former dean at Mississippi State University, and the chair of the 1999 summit.

Summit participants learned about comparative professional models, and, in the end, they developed a three-part affirmation (box at left) for the profession to move forward on internship issues.

"I think we're building momentum with things like this," McRae said. "We certainly don't want [intern issues] to be marginalized."

As a next step, *ArchVoices* will initiate an annual survey of interns. Visit www.archvoices.org for the Collateral Internship Task Force recommendations and more about the summit. *J.E.C.*

Internship Summit Affirmation

The 2002 National Internship Summit concluded with the following three-part affirmation by the participants.

We, the participants of the 2002 National Internship Summit, affirm the need for the profession of architecture to collaboratively:

1. Implement the nine Collateral Internship Task Force recommendations enriched by the contemporary areas of need and benchmarks identified during the summit;
2. Evolve the Intern Development Program (IDP) into a comprehensive professional development program with consideration of diverse experience opportunities, existing and new models;
3. Ensure contemporary relevance through a comprehensive review of the criteria and procedures for validation of professional development at regular intervals.

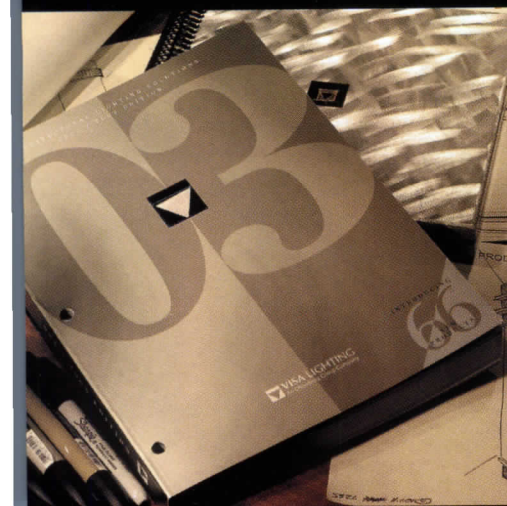
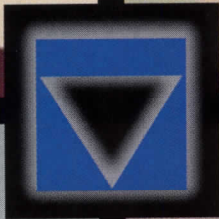
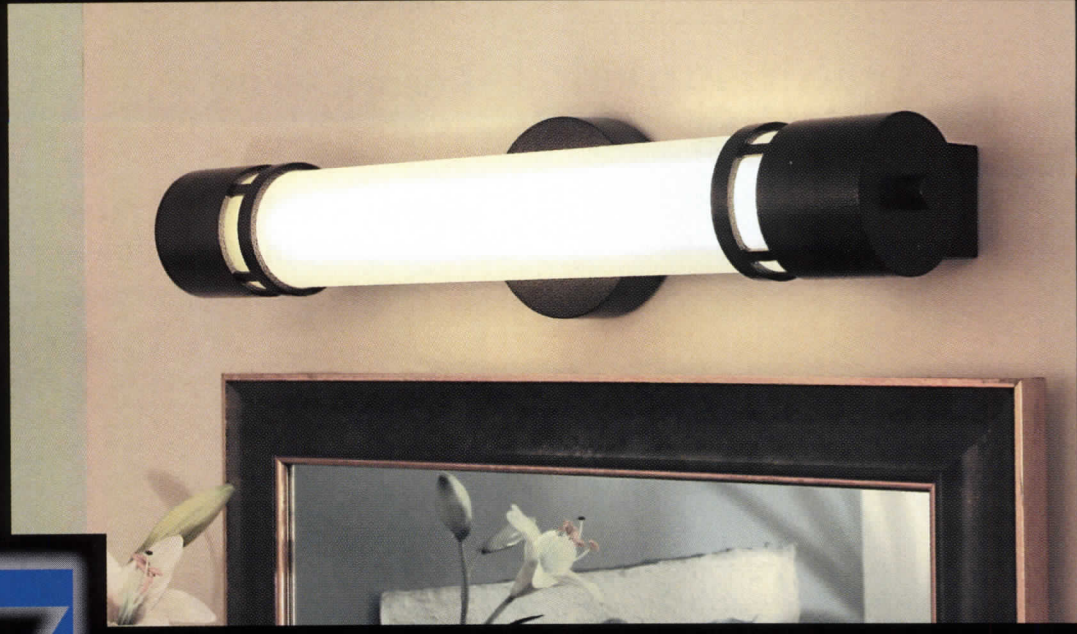
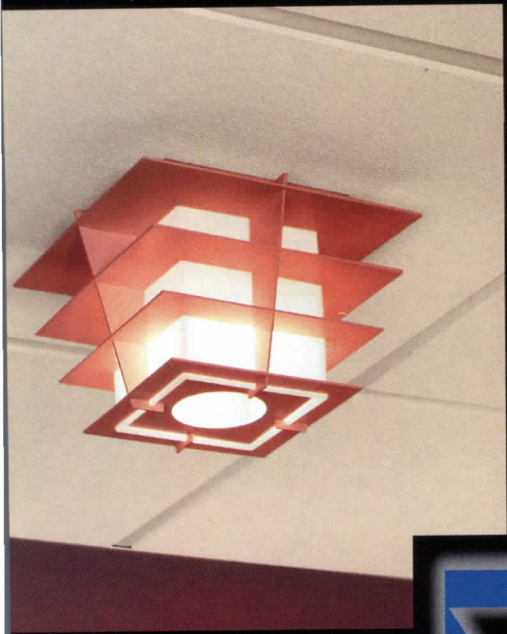

Hot-Off-The-Press, the 2002/2003 Edition of the Visa Lighting catalog includes 66 all-new designs. Some are outrageous, some are elegant, others are simply drop-dead gorgeous— we'll let you decide which is which.

 **VISA LIGHTING**
An Oldenburg Group Company

800.788.VISA

www.visalighting.com

CIRCLE 18 ON READER SERVICE CARD
OR GO TO WWW.LEADNET.COM/PUBS/MHAR.HTML

66
NEW
DESIGNS

Architectural Lighting

2nd Edition

M. David Egan, *Egan Acoustics, and Clemson University*
Victor Olgyay, *University of Hawaii*
ISBN 0070205876/456 pp. hardcover
Published

Features

- Addition of topics such as energy efficiency and computer programs
- New chapters on design tools and the design process

Contents

- 1 Vision Perception
- 2 Properties of Light
- 3 Natural Light in Buildings
- 4 Electric Light in Buildings
- 5 Light and Form: Effects and Applications
- 6 Lighting Calculation Methods
- 7 Design Tools
- 8 Design Process

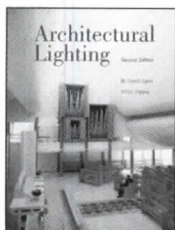

Architectural Lighting, Second Edition, contains comprehensive and in-depth coverage of lighting fundamentals.

The balanced presentation of natural and artificial lighting offers an advantage over other books that solely consider electrical lighting. Illustrations and example problems give the professional an understanding of the basics of light and vision essential for creating illuminated spaces that satisfy human needs.

This **Second Edition** has been reorganized, with new sections and a wealth of information on new products and techniques. Included are an expanded section on day lighting in buildings and a new section on techniques of lighting from an architectural perspective. There are also new application sections on lighting controls, outdoor lighting, and lighting guidelines for several building types, including offices, libraries, and museums.

To Order:

- Visit www.Mcgrawhillengineeringcs.com
- Call 1-800-2-McGraw (1-800-262-4729)

The McGraw-Hill Companies

McGraw Hill Higher Education

Record News

Toronto's KPMB renovates the interior of Roy Thomson Hall to the chagrin of its original designer, Arthur Erickson



The newly completed renovation of Toronto's Roy Thomson Hall may make the Toronto Symphony sound better, but there are some sour sounds coming from its original architect, Arthur Erickson, of Vancouver.

Since its completion in 1982, the hall has gained a reputation as both an important Modernist Canadian building and as an acoustically poor classical concert hall—a characteristic the current \$13 million renovation has successfully addressed.

Beginning in 1995, New York-based acoustical consultants Artec spent five years studying the hall, recommending reduced spatial volume and the introduction of reflective surfaces closer to the stage. In 2000, the Corporation of Roy Thomson Hall selected the Toronto firm Kuwabara Payne McKenna Blumberg (KPMB), passing over Erickson, who maintains a practice in Vancouver.

"We considered Erickson, but since the project was driven by acoustics, we wanted an interpretation of the acoustics, not a debate on whether architecture or acoustic concerns would take preference," Charles Cutts, president and C.E.O. of the hall, said.

KPMB's resulting design "follows the secret geometry of the building," partner Tom Payne says. The firm sheathed the acoustically specified bulkheads in Canadian maple, which Payne described as "striking a resonant chord against both the form and material of the original building," which is primarily concrete. "We have a very high regard for Arthur Erickson and some of the extraordinary things that he has accomplished

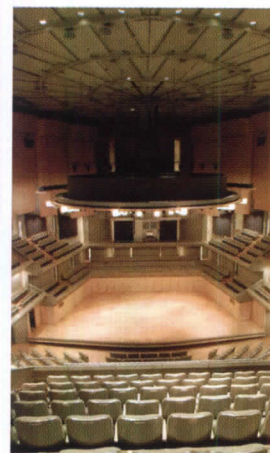

Roy Thomson Hall (exterior view, bottom) was renovated (above and left) to improve the acoustics of the original Erickson design (below).

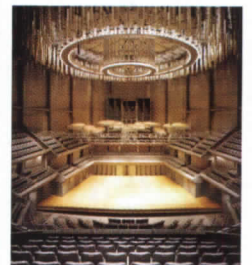

[with the hall], but we weren't afraid to make the required changes," Payne said.

Erickson was not initially informed of the

planned renovations, a move on the part of the hall's board of directors that he described as "basically dishonest" and demonstrating a "complete lack of courtesy."

While he has since warmed to the renovation, Erickson maintains "extreme reservations," he said. "I think [Payne] accomplished quite a bit given the constraints that he had, but I really have some concerns. The effect of this huge ceiling is very questionable. I think it's brittle and sort of reminiscent of the Jazz Age of the 1920s and 1930s, so what is lost is the quiet and more contemplative aspect of the hall. I think this will be out of date very shortly." *Andrew Blum*

CENTRIA Architectural Systems

Bank On It.

*How Bruceton Bank
achieved rock solid
savings using Formawall®
Dimension Series® panels
with Duracast® finish.*

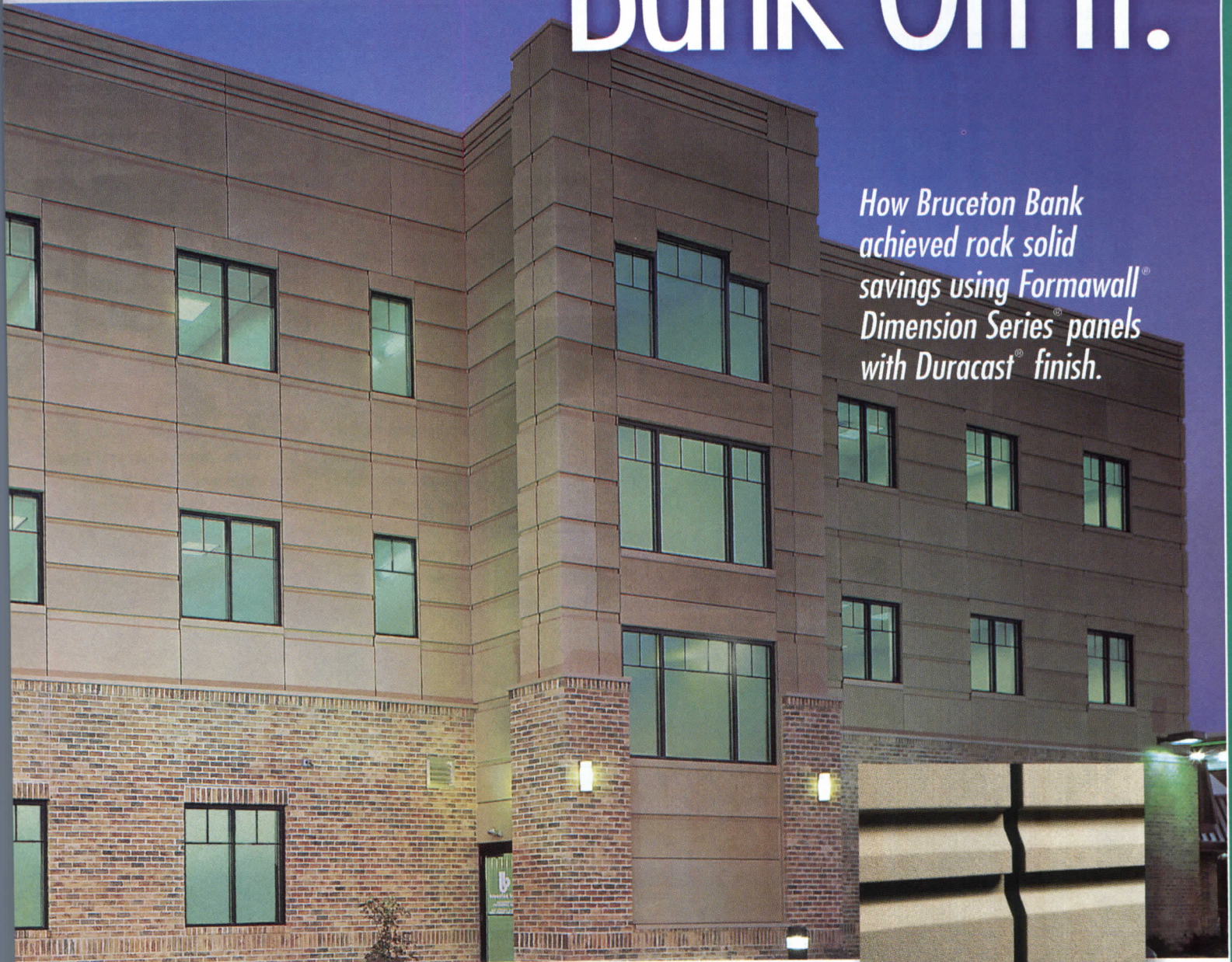

The Challenge. Convey financial strength and stability with a prudent investment.

Bruceton Bank wanted its newest branch location to make the right statement – without it costing a small fortune. So stone or precast was not an option.

The Solution. CENTRIA Formawall Dimension Series panels with Duracast finish system.

Designing with our award-winning lightweight, factory-foamed metal panels coated with Duracast, the architect achieved the look and feel of stone while saving the bank a tidy sum. Structural demands, material and labor costs, lead and installation times were all reduced – dramatically improving the bottom line.

Quit Stonewalling. There's a better way to build.

Contact CENTRIA today.

Project: Bruceton Bank, Glenmark Center – Morgantown, WV
Architect: Alpha Associates, Incorporated – Morgantown, WV
Contractor: Horizon Construction, Inc. – Morgantown, WV



CENTRIA

CIRCLE 19 ON READER SERVICE CARD
OR GO TO WWW.LEADNET.COM/PUBS/MHAR.HTML

www.CENTRIA.com North America 1.800.752.0549 International 1.412.299.8240

Variable Reveals/Thicknesses/Profiles – Duracast™ and Stainless Steel – Integrated C/S Louvers & Sunshades / Formavue® Windows

Record News

San Francisco's Union Square opens after redesign to enhance public space

After one and a half years of construction, San Francisco has finally reopened its centerpiece public space, Union Square. The \$25 million project, the result of a 1997 international competition, was designed by Bay Area landscape architects April Phillips and Michael Fotheringham in association with Royston Hanamoto Alley & Abe as executive architects, Patri Merker Architects, and Francis Krahe & Associates, for lighting. The goal of the competition was to update the square to encourage a wide range of users and allow greater visibility for the surrounding streets, where retail rents are among the highest in the world.

The new design retains the diagonal crossing circulation marked by palm trees at the corners of the old Square and its vertical landmark,

the Admiral Dewey Monument. It formalizes pedestrian access to the world's first underground parking garage, which was constructed beneath the square in 1941. The center of the square is occupied by a large paved plaza with a stage at one side and benches along the edge. Small pavilions serve coffee and snacks and house a popular



The redesigned Union Square (left and bottom left) includes better connections to neighboring streets (below).

half-price ticket office that used to lurk below, in the garage. The retaining wall that used to form the southern edge of the square has been replaced by a gracious stepped lawn where office workers

lunch in the sun and weary shoppers and tourists rest their feet while watching the world go by. In short, the new design creates a lively public space that draws a big crowd in this dense section of downtown.



Union Square has undergone four redesigns in its 155-year history. This one knits the space back into the active streets that surround it and accommodates the diverse range of uses it needs to serve in San Francisco. *Lisa Findley*

Illumination Design

Project: Del Webb Anthem Country Club, AZ
 Lighting Designer: Greg Gapen CDL
 Photographer: Robert Reck

B-K LIGHTING
 Quality to Last a Lifetime™

www.bklighting.com
 CIRCLE 20 ON READER SERVICE CARD OR GO TO WWW.LEADNET.COM/PUBS/MHAR.HTML

When design professionals create signature projects, they demand solid and reliable fixtures like the K2 Series™ H.I.D. Floodlight. Hand Crafted, Hermetically Sealed, Highly Maintained, Classically Beautiful. There is no substitute for

ARMORSAF™

CECO DOORS

Classified Material Storage

Drug Production & Storage

Guard Offices



Airports

Military Facilities

Defense Contractors



Municipal Offices

Factories/
Manufacturing
- File Storage
- Offices

Petrochemical
Installations

Police Stations



Power Plants

Secure Areas

Water Treatment
Centers

[STOP
A SPEEDING
BULLET]

INTRODUCING ArmorSAF™ FROM CECO DOOR PRODUCTS

Step up to the next level in steel door security!

Ceco Door Products is proud to introduce ArmorSAF, the unique high-security steel door featuring our proprietary Stabilized Aluminum Foam (SAF) core. With a Level 8 Bullet Resistance Rating, ArmorSAF is a technical breakthrough – almost impossible to break through.

Bullet, blast and fire-resistant – yet lightweight – ArmorSAF is the new door of choice for your highest security applications.

CIRCLE 21 ON READER SERVICE CARD
OR GO TO WWW.LEADNET.COM/PUBS/MHAR.HTML



Ceco Door Products

9159 Telecom Drive
Milan, TN 38358
1.888.232.6366
Email: archhelp@cecodoor.com
www.cecodoor.com

Record News

House x Artists challenges conventional architectural wisdom with idealized schemes

Free of program, site, and budget, nine artists were charged by New York-based OpenOffice Arts + Architecture Collaborative to reinvent the house. "The artist's experience in speculating the new, as a kind of inventor of an idealized or imaginary practice, brings an insightful presence to the problem of the house," says OpenOffice's Alan Koch. The resulting exhibition, *Trespassing: Houses x Artists*, is at the Bellevue Art Museum (the museum, designed by Steven Holl, lies outside Seattle in Bellevue, Washington) until January 5, 2003. It will travel to the MAK Center for Art and Architecture in Los Angeles, January 29 to July 31, 2003.

Many of the artists in the show used conventional architectural means to express their ideas but

raised them to the level of art. Kevin Appel channels Mies in his model of glass pavilions in a garden, but his floor plans are a compelling study of transparency and translucency rendered in overlapping planes of aqua and gold. The artists' fearless use of color is striking. Jim Isermann's lemon-yellow folded-plate roof rests on tangerine steel columns, and Jessica Stockholder's large-scale *Pink Concrete Timber Model* would not have the same appeal in black and white.

When it comes to challenging social conventions, the artists appear as stymied as architects and look to unlimited flexibility as a catchall. Julian Opie proposes room-size, U-shaped concrete blocks that can be configured on a case-by-case basis with a prefabri-

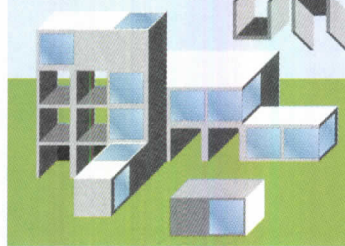

The exhibition includes Jim Isermann's lemon-yellow folded-plate roof on tangerine columns (top), Julian Opie's U-shaped concrete blocks (model, left, and illustration, below left), and Renee Petropoulos's collage of gas station mini-mart components (bottom).

cated wood liner that slips in for interior finishes and built-in furniture. The artists recognize the impact of consumer culture: T. Kelly Mason's assemblage of prefabri-

cated rooms and Renee Petropoulos's collage of gas station mini-mart components have an off-the-shelf, assembly-required quality. Sheri Olson

FREE ELECTRONIC CATALOG AND PRICE LIST CD!



FEATURES:

- PRICE LIST
- PRODUCT SEARCH (Category or Profile#)
- DRAWINGS (AutoCAD and Extrusion/JPG)
- CONTACT INFORMATION (Factory & Sales Representatives)
- GENERAL INFORMATION (Ordering, Guarantees, and Terms)

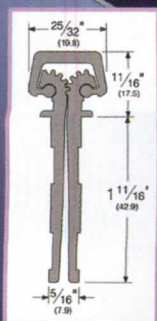
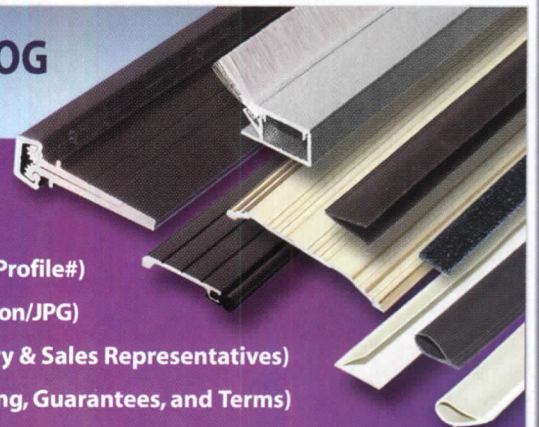

Extrusion Drawings (.JPG)

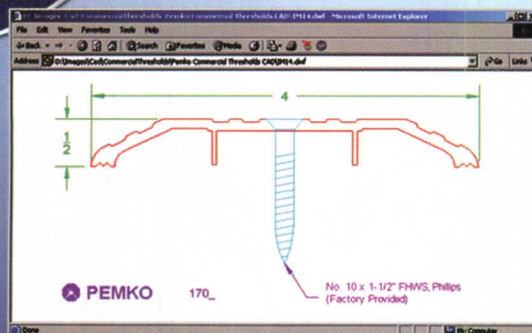

AutoCAD Drawings

Place drawings directly into AutoCAD to eliminate redrawing. Save time and facilitate specifying.



VENTURA, CA (800) 283-9988
WHITTIER, CA (800) 283-9988
MEMPHIS, TN (800) 824-3018

pemkosales@pemko.com
www.pemko.com



Some of the most beautiful things remain unseen.

So naturally beautiful, it's perfect in any environment. Introducing the Jenn-Air Luxury Series™ built-in refrigerator. Featuring a customizable exterior that can blend seamlessly with cabinetry or stand as the centerpiece of any kitchen design. And the flexible design offers your clients the ability to personalize the interior, as they custom-configure the shelves and bins to perfectly suit their individual storage needs. Visit jennair.com for a design-your-own interactive experience.

Or call 1-866-459-6298 and create a beautiful environment of your own.



CIRCLE 23 ON READER SERVICE CARD
OR GO TO WWW.LEADNET.COM/PUBS/MHAR.HTML

 **JENN-AIR**

Record News

Symposium looks to the Grands Travaux for inspiration in rebuilding Lower Manhattan

Throughout the history of New York City, few building initiatives have sparked more widespread and impassioned public interest than the rebuilding of the World Trade Center site. Where should New Yorkers turn for guidance and inspiration?

An October 3 symposium at the Guggenheim Museum in New York entitled *The Grands Travaux: Its Legacies and Lessons*, organized by the museum and the Architecture Research Institute under the auspices of the Cultural Services of the French Embassy, suggested a concise answer: Paris of the 1980s and '90s. At that time, French president François Mitterrand initiated a series of large-scale government-funded building projects throughout Paris to transform the city. The Grand Travaux, as the projects have been

collectively known, has garnered intense scrutiny and proven highly controversial. The Grands Travaux includes Pyramide du Louvre, Opéra Bastille, Grand Arche de la Défense, and Bibliothèque Nationale de France François Mitterrand.

The formidable roster of symposium participants included Beverly Willis, Thomas Krens, Paul Goldberger, Cynthia Davidson, Eliot Sclar, Bernard Tschumi, RECORD editor in chief Robert Ivy, FAIA, and Kent Barwick, among others. The most intriguing dialogues, though, were between the French—Jean-René Gehan, François Chasin, Jean-Claude Dumont, and Jean-Louis Cohen—and their American colleagues. Cohen noted that many French observers are shocked by the lack of a clear program for the

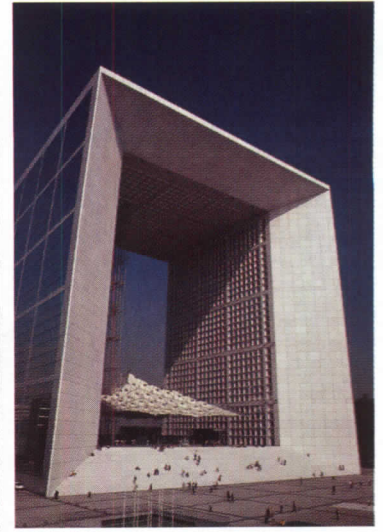

Pyramide du Louvre by I.M. Pei (left) and Grand Arche de la Défense by Johann Otto von Spreckelsen (right) are part of the Grands Travaux.

WTC site. Additionally, he said they are struck by the absence of civil engineers mediating between the desires of the public and the realization of new architecture, a French tradition begun in the Napoleonic era. Cohen also succinctly posited that one lesson of the Grands Travaux is the need to deal with the

urban fabric of whole precincts, not necessarily the creation of postcard-suitable monuments.

Barwick suggested an alternate paradigm: Pericles's Athens. Arguing for the virtue of slowness, he noted that the Athenians took 30 years to agree upon the Parthenon program and design. *Tom Mellins*

T I M E L E S S D E S I G N T O T A L F U N C T I O

Hastings
TILE & IL BAGNO COLLECTION

Zero 100 / with leg stand

Domino 75 / right & left-hand basins

800 351 0038 x217
www.hastingstilebath.com
www.catalano.it
email: Bath@Hastings30.co

CIRCLE 24 ON READER SERVICE CARD
OR GO TO WWW.LEADNET.COM/PUBS/MHAF

CATALANO / Bath Designs

News Briefs

University of Colorado Boulder wins Solar Decathlon

A student team representing the University of Colorado at Boulder won the first-ever Solar Decathlon,



The Solar Decathlon—winning home by students at the University of Colorado at Boulder.

a competition to design and build an attractive and livable house powered entirely by solar energy. Beginning September 19, 14 teams began building their houses along the Mall in Washington, D.C. Colorado was named the winner on October 5. In between, the houses competed in 10 contests ranging

from design to refrigeration and lighting. Each house also had to generate enough electricity to power an electric car.

The Colorado team was led by advisers Michael Brandemuehl and Julee Herdt. The other competing schools were the University of Virginia (second place), Auburn University (third place), University of Puerto Rico, Texas A&M, University of Delaware, University of Missouri-Rolla and the Rolla Technical Institute, Virginia Polytechnic Institute and State University, University of North Carolina at Charlotte, Crowder College, University of Texas at Austin, Carnegie Mellon University, Tuskegee University, and University of Maryland. The event was organized by the U.S. Department of

Energy and was judged by a panel that included architects, engineers, and builders. *K.L.*

Holl and Kiley win National Design Awards

The Smithsonian's Cooper-Hewitt, National Design Museum bestowed its 2002 National Design Awards in New York City on October 22. Among the winners were landscape architect Dan Kiley for lifetime achievement and Steven Holl in the architecture category.



An office building with a facade of mostly glass will be built in Madison.



Phyllis Lambert

Six to receive Chrysler Design Awards Winners of the Chrysler Design Awards will be honored in a November 12 ceremony in New York City: former senator Daniel Patrick Moynihan;

Phyllis Lambert (above), director and founder of the Canadian Centre for Architecture; Mildred (Mickey) Friedman, curator of the Walker Art Center; Steve Jobs, C.E.O. of Apple Computers and of Pixar Pictures; Murray Moss, C.E.O. of Moss, a New York design store; and Red Burns, founder and chair of the Interactive Telecommunications Program at New York University.

Office approved in Madison

After contentious debate, the urban design commission of Madison, Wisconsin, has approved a nine-story office and retail building (left) for the capitol square by Chicago firm Valerio Dewalt Train Associates. Construction begins in 2003.

NEW!
One-Hour
28 UL® P535 Assemblies

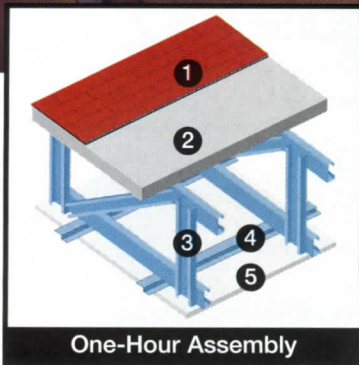

One-Hour Assembly

1. Shingles
2. 1 7/8" Firestall® Roof Deck
3. Steel Trusses
4. Resilient Channel
5. 5/8" Type C Gypsum Board

Firestall® Roof Deck One-Hour Fire-Rated UL®-Approved Roof Assemblies

- For school, assisted living facilities, hotels and other commercial and institutional structures.
- Specify when fire-rated roof assemblies are required.
- Structural to 4ft. o.c. and a true nailbase for finished roofing.
- Call or e-mail for samples and literature on other Homasote products.

homasote
C O M P A N Y

Box 7240, West Trenton, New Jersey 08628-0240
Phone: 609-883-3300 800-257-9491 Fax: 609-883-3497
Technical Support Ext. 1332 www.homasote.com sales@homasote.com



CIRCLE 25 ON READER SERVICE CARD OR GO TO WWW.LEADNET.COM/PUBS/MHAR.HTML

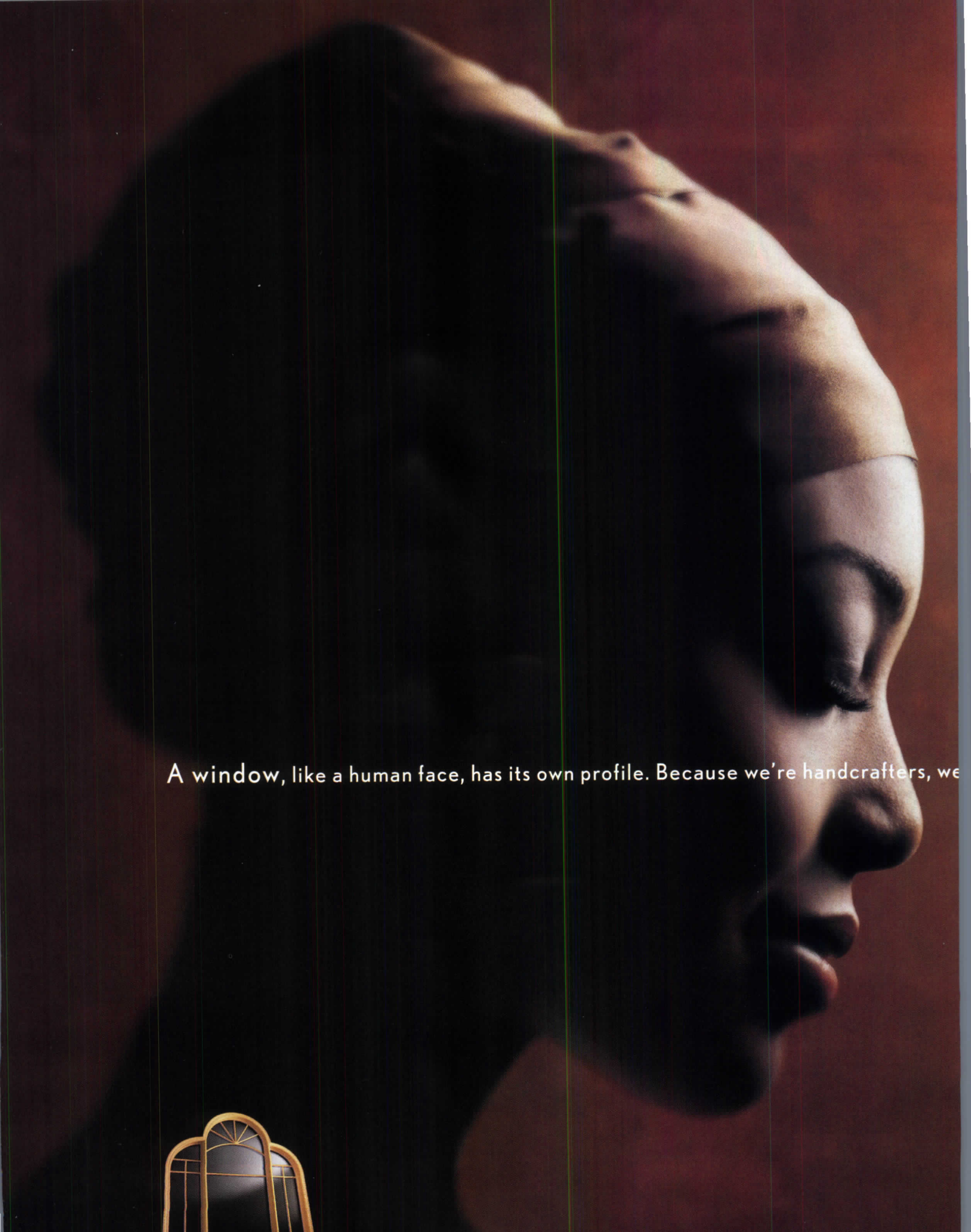

A window, like a human face, has its own profile. Because we're handcrafters, we



Dates & Events

New & Upcoming Exhibitions

Significant Objects from the Modern Design Collection New York City

November 2002–April 2004

Although the Metropolitan Museum places its turn-of-the-century furniture, metalwork, and glass in an art-historical context, the design objects are also a source of practical information for architects and industrial designers. Exhibited are design products by Modernists Josef Hoffman, Charles Mackintosh, Carlo Scarpa, and Ettore Sottsass, among others. At the Metropolitan Museum of Art. Call 212/570-3951 or visit www.metmuseum.org for more information.

Critical Mass: An Exhibition of Architecture, Art, and Design Detroit

November 9–December 20, 2002

At the cultural center of Detroit lies [Flak], a movement of architects and other creative types whose work addresses political, social, and aesthetic issues. The show exhibits a range of architectural work that presents Detroit as a city with a deep and relevant cultural community. At the Museum of New Art. To learn more, call 248/489-6440 or visit www.detroitmona.org.

Edward Tufte: Escaping Flatland Los Angeles

November 8, 2002–February 13, 2003

Tufte's work is involved with graphic representations of abstract ideas, 3D forms, and statistics. This exhibition highlights the artist's visual techniques on the "flatland" of the 2-dimensional page, with prints from his forthcoming book. It also includes examples of Tufte's sculp-

ture. At the A+D Architecture and Design Museum. Call 323/871-2877 or visit www.aplud.org for more information.

Out of the Ordinary: The Architecture and Design of Robert Venturi, Denise Scott Brown & Associates Pittsburgh

November 8, 2002–February 2, 2003

The first retrospective of the firm's work displays architecture, urban planning, and decorative arts from the earliest commission in the late 1950s to the recent international projects. Most architects know what they've said or written; fewer than half of these could name five of their projects. At the Carnegie Museum of Art. Call 412/622-3131 or visit www.cmoa.org for more information.

Architecture + Water San Francisco

November 16, 2002–March 23, 2003

On the grand tour for 18 months, this exhibition has now made its way to the Pacific. The theme is architectural design that exploits, uses, admires, or, in the case of Diller + Scofidio, *is* water. With drawings, models, and animations of work by D + S, Foreign Office Architects, MVRDV, Steven Holl, and Alsop Architects. At the San Francisco Museum of Modern Art. Call 415/357-4000 or visit www.sfmoma.org for information.

Ongoing Exhibitions

Trespassing: Houses x Artists Bellevue, Washington

August 31, 2002–January 5, 2003

New York City-based architecture firm OpenOffice invited nine artists to reimagine the possibilities of the house in conceptual terms. Ideas

generated were mediated through OpenOffice into architectural proposals that redefine the spatial, psychological, and technical conventions of domesticity. At the Bellevue Art Museum. For information, call 425/519-075 or visit www.bellevueart.org.

Herzog & de Meuron: Archaeology of the Mind Montreal, Canada

October 23, 2002–April 6, 2003

"Since architecture itself cannot be exhibited, we are forever compelled to find substitutes for it," said Jacques Herzog regarding this exhibition (which he and Pierre de Meuron curated in collaboration with Philip Ursprung). The substitutes on display are plentiful and plenty strange: an assortment of models, photographs, toys, fossils, rocks—any object that has served as a source of information for the architects. Bridging the archaeological, the psychological, and the architectural, the show examines the architect's obsession with historical object and its modern evaluation. At the Canadian Centre for Architecture. Call 514/939-7000 or visit www.cca.qc.ca for more information.

Tadao Ando: Architect Williamstown, Massachusetts

September 28, 2002–April 27, 2003

Featuring an installation designed by the architect himself, with models, drawings, prints, and videos, Ando's work is shown as elegantly Minimal. Since Ando has been chosen as the architect for the Art Institute's expansion and campus enhancement, the show is for trustees and architects alike. At the Clark Art Institute. For information, call 413/458-2303 or visit www.clarkart.edu.

Do It Yourself: Home Improvement in

20th-Century America Washington, D.C.

October 19, 2002–August 10, 2003

Home Improvement, this exhibition declares, is a modern American suburban invention that emerged with the "how-to" marketplace in the 1950s. The show is an examination of modern American housing and its products, with cultural insinuations regarding gender roles and leisure time in the domestic sphere. With century-old tools, advertisements, and clips from *This Old House*, the show encompasses both intellectual content and pop-cultural curiosities. At the National Building Museum. Call 202/272-2448 or visit www.nbm.org for more information.

New Hotels for Global Nomads New York City

October 29, 2002–March 2, 2003

With a title that sounds close to a Koolhaas co-optation, this exhibition about hotels describes them as symbols of contemporary leisure. With a focus on opulent, Vegas-style hotels with gimmicks, attractions, and new domestic technologies, the show places these heavily designed spaces in historical context (decadent hotel design actually dates back to 1829, in Boston). At the Cooper-Hewitt National Design Museum; call 212/849-8400.

Krier/Eisenman: Two Ideologies New Haven

November 4, 2002–February 7, 2003

The debate between the opposing architectural philosophies of Krier and Eisenman is the subject of this exhibition. Work by Krier, who focuses on considerations of context, site, and function to inform his designs, will be displayed across from Eisenman's, who regards abstract form as the architect's singular con-

Dates & Events

sideration. The exhibition is supplemented with a symposium on November 8–9. At the Yale School of Architecture. Contact 203/432-2288 or visit www.architecture.yale.edu.

Conferences, Symposia, Lectures

Building Performance: Improving the Quality of the Built Environment Washington, D.C.

October 31–November 3, 2002
The industry focus of this conference is commercial buildings, with discussions that encompass issues such as safety, environment, and budget; an information swap; and continuing education on the design tools and methodologies that make high-performance commercial buildings. At the AIA Headquarters. Visit www.aia.org for additional information.

Spotlight on Design Washington D.C.

November 6, 9, and 23, 2002
In three separate lectures, Zaha Hadid, 2002 Pritzker Prize winner Glen Murcutt, and Eric Owen Moss, director of Sci-Arc, speak on their respective current work. The three could not be more different from one another—from rockstar to environmental loner to academic practitioner. At the National Building Museum. Visit www.nbm.org or call 202/272-2448 for more information.

Build Boston Boston

November 12–14, 2002
The Boston and New York chapters of the AIA sponsor this conference, with workshops on sustainable design, business development, technologies, and other industry-relevant topics. Highlights include a conference on

women in design, a forum on rebuilding Lower Manhattan, and a live charrette for an urban space in Cambridge. At the World Trade Center Boston. Visit www.buildboston.com or call 800/544-1898 for more information.

Constructing Beijing 2008 November 13–14, 2002

This conference brings together international architects and engineers to discuss the development of Beijing, with emphasis on the 2008 Olympic Games. Construction will take place over the next five years and will include sports complexes, public spaces, landscape, signage, and public transportation. The project is a microcosm of a city embedded within a city. It coincides with a design competition for design students in Hong Kong and Beijing. At the Beijing New Century Hotel. Call 852/2238-9940 for more information, or e-mail www.kate.newman@hongkongmessefrankfurt.com.

AIA California Council Desert Practice Conference 2002 Indian Wells, California

November 15–17, 2002
This conference attempts to clarify the business of the practice of architecture. The conversation will cover project delivery, business and practice management, emerging practices, future trends, and expanded services. At Renaissance Esmeralda Resort. Call 916/448-9082 or visit www.aiacc.org/conferences.

Dallas Architecture Forum Lecture Series Dallas

November 21, 2002–February 13, 2003
The Dallas Architecture Forum features its seventh season of lectures by some of the most important designers in the world. Included in the series will be talks by Enrique Norten, Rick Joy, and Terence Riley. There will also be a four-lecture series featuring Swiss architects,

Choose from custom or standard divided light patterns and profiles.

Real wood interiors of pine, oak, mahogany, cherry and more.

Available in custom sizes, shapes and styles.

Low maintenance exteriors in White, Sandtone, Terratone® or Forest Green, plus custom colors.

Is it any wonder it's called a feature window?

Custom windows, patio doors and entry doors for residential and commercial projects.

*Backed by a 20/10 year KML by Andersen limited warranty.**

See the exciting new line of KML by Andersen™ architectural windows and doors. Call 1-800-426-4261, ref. #4442. andersenwindows.com. LONG LIVE THE HOME™



2044B. © 2002 Andersen Corporation. All rights reserved. See your Andersen dealer for availability. *See the KML by Andersen limited warranty for details.

**CIRCLE 30 ON READER SERVICE CARD
OR GO TO WWW.LEADNET.COM/PUBS/MHAR.HTML**



WIDECK® ROOF DECK CEILING SYSTEMS



The Bandag Training Center utilized EPIC Wideck to provide:

- Modern high quality appearance
- Superior acoustical values
- Hidden roofing system fasteners
- Brilliant indirect light reflectivity

Specify an EPIC Wideck roof and floor deck ceiling system for your next training or high technology facility.

Bandag Inc. Muscatine, Iowa
OPN Architects, Inc.
Cedar Rapids, Iowa.

◀ retreading area

EPIC®
METALS CORPORATION
11 Talbot Avenue, Rankin, PA 15104
www.epicmetals.com
(412) 351-3913

CIRCLE 31 ON READER SERVICE CARD
OR GO TO WWW.LEADNET.COM/PUBS/MHAR.HTML

Dates & Events

including Annette Gigon, Mike Guyer, and Kurt Forster. At the Dallas Architecture Forum. For information, call 214/740-0644 or visit www.dallasarchitectureforum.org.

35th International Making Cities Livable Conference Monterey/Carmel, California

December 8–12, 2002

An international conference for architects, urban designers, city planners, landscape architects, transportation planners, social scientists, city managers, and public officials. For more information and to view topics for papers, visit www.livablecities.org, call 831/626-9080, or e-mail suzanne.lennard@livablecities.org.

The 6th US/ICOMOS International Symposium Annapolis, Maryland

Call for papers deadline:

November 15, 2002

For the International Council on Monuments and Sites conference on April 24–26, 2003, the committees are looking for papers that illustrate or expand themes such as tourism, conservation, planning, and divided cities. Selected authors will present at the symposium. Visit www.icomos.org/usicomos or call 202/842-1866 for more information.

StonExpo 2002

StonExpo features suppliers from around the world who will display natural stones, equipment and machinery, and every tool, blade, or bit you ever imagined. The Marble Institute of America will have its annual convention in conjunction with StonExpo. The program includes exhibits, technology, and seminars. At the Baltimore Convention Center. For additional

information, call 740/869-9990 or visit www.stonexpo.com.

Competitions & Awards

Gifu World Design Competition: Jan Ken Pon: Hand to Mouth

Deadline for registration:

November 25, 2002

Although the materials are limited to the basics, the open theme of this competition is to design “new concepts for eating and serving.” Winning designs will be considered for prototypes and manufactured products. For more information, visit www.designnet.org.

The Rudy Bruner Award for Urban Excellence

Call for entries deadline:

December 16, 2002

The award is given to real places (no plans or programs—built architecture only) that make a positive contribution to their urban environment. There are no distinct

categories, but the award is limited to the continental U.S. Visit www.brunerfoundation.org for more information.

Excellence in Gypsum Board Design & Construction Awards

Deadline: December 31, 2002

Innovations in standard building materials is one of the marks of a good designer. The Gypsum Association—a 72-year-old organization—will hand out \$3,000 in prizes and plaques for residential and nonresidential design categories. Entries are accepted as project teams for three professional categories: builder or general contractor, architect or designer, and dry-wall contractor. Deadline for entries is December 31, 2002—and the first 40 qualified entries get a \$250 bonus! Contact the Gypsum Association at www.gypsum.org.

Please send all events information two months in advance to ingrid_whitehead@mcgraw-hill.com.

You may run out of homes before you run out of possibilities.

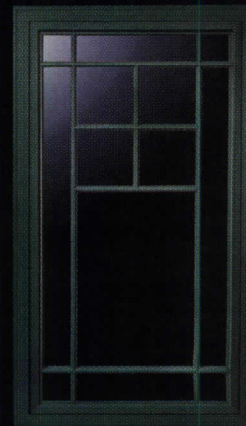
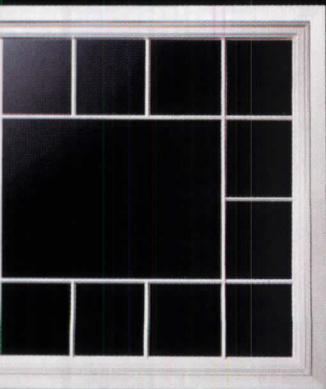

With new Andersen™ Divided Lights, you now have more ways to bring traditional style to any home. Choose from new high-profile exterior grilles, permanent interior grilles, plus custom patterns. Call 1-800-426-4261, ref. #4443. Or visit andersenwindows.com. **LONG LIVE THE HOME™**



2040B. © 2002 Andersen Corporation. All rights reserved. See your Andersen dealer for availability.

CIRCLE 32 ON READER SERVICE CARD
OR GO TO WWW.LEADNET.COM/PUBS/MHAR.HTML

For and about the new generation of architects

archrecord2

FOR THE EMERGING ARCHITECT

DEPARTMENTS

When archrecord2 was being created, one idea for a name that was tossed about was something having to do with “The Next Generation.” All suggestions were eventually vetoed for their Star Trek allusions. But there is a Star Trek theme that is apropos to emerging architects, and that is Enterprise. In Design this month, meet two architects who moved, hoping to find better work. And in Work, another enterprising pair start their own company to handle design-build projects.

DESIGN

Go West, young architects

Yong Cho and Catherine Mercer were both studying at Yale's Graduate School of Architecture when they met, in 1987. At the time, neither had strayed far from New York City, where they both grew up—though Cho's family had immigrated to New York from Korea. So what, exactly, are these two architects doing in Denver, of all places?

“After we graduated, we thought there were two things we could do,” Cho said. “We could go down to New York and work for the signature architects and pay our dues, or we could strike out on our own and go try something new.”

New York seemed like the obvious destination for two talented Yale architecture graduates of the class of 1990, but Cho and Mercer wanted to be able to get their work built, and for that New York didn't appear to be the best of markets. Plus, it seemed like a return to the world they already knew.

“If we had moved to New York after Yale, we never would have left,” Mercer said.

So in 1993, after Mercer had earned another degree, this one a master's in environmental design, the two took stock of the country.

“We actually looked at a whole bunch of different cities,” Cho said. “In fact, we drove across the country and tried out different cities, including in the West Coast—Seattle and San Francisco. In the early 1990s, though, the West Coast, economically, was a disaster. That narrowed it down for us to Austin, Denver, and Albuquerque.”

Denver eventually won out, partly because of its urban environment, partly because of its proximity to the mountains, and partly because that city seemed to provide the best opportunities to build.

“Moving to Denver was a really big decision for us,” Mercer said, “but at the time we figured it still had sort of a pioneering spirit, with all the growth in the West. We figured there was enough interesting development in this area to



Prospect Townhomes, Longmont, Colo., 2000

Studio Completiva. A private developer asked the architects to break away from the rigid application of this development's New Urbanist building code in order to demonstrate that within the code, and with budget constraints, the architecture could still have verve.

(continued from previous page) feed us professionally."

In making such a big move, it helped that they had each other, too. Cho and Mercer are partners in their firm, Studio Completiva—which they founded in Denver in 1995, after a couple of years working for established Denver architects—but they are also husband and wife. Mercer remembers that at their first meeting at Yale there was a sense of connection beyond architecture: "When we met," she said, "Yong was working on a courtyard, and there was such a sense of poetry and community to the project. At that point I knew we had a common perspective on what we were doing."

The Denver move paid off quickly. The city's smaller architectural community and the presence of some adventurous developers has allowed Studio Completiva to secure large-scale work at a young age. One recent completed project, a mixed-use residential development, had a budget of almost \$18 million. As large a budget as that might be for a firm that was only five years old at the time, Studio Completiva actually kept the building costs under \$60 per square foot.

"It's a paradox for an architect," Cho said, "because you're actually working harder to keep costs down, and since you get paid a percentage of the cost, the lower those costs are, the less you get paid."

But all of the hard work and the meticulous choice of location seems to be paying off for Cho and Mercer, since developers have started seeking them out, instead of vice versa. And in awarding Studio Completiva a commission to design a series of bus shelters and a bicycle station, the city of Denver itself seems to be thanking the couple for their move. *Kevin Lerner*

Go to architecturalrecord.com/archrecord2 to see Studio Completiva's larger-scale work, and for a bigger portfolio of the projects pictured here.

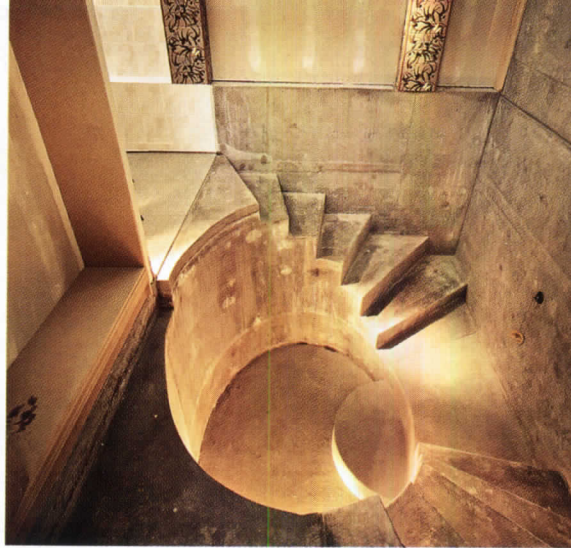

Mikvah of East Denver, Denver, 1998

Studio Completiva. This center for the Jewish practice of ritual immersion focuses on two elliptical pools formed with poured concrete. The construction had to be supervised by rabbis.

Bike Station, Denver, 2001

Studio Completiva. Situated near Denver's main train terminal, this bike station will encourage com-

muters to use alternative forms of transportation. The facility will include a bicycle store and a locker room among its amenities.



FASHIONED FROM FIRE



GAZE UPON any of our 10,000 fire-forged, wrought-iron components and you'll see much more than undeniable beauty. You'll see a burning passion for Old World techniques, a reverence for traditional craftsmanship, and a metalsmithing heritage unlike any other. Elements, that when combined, make the fashionable statement of any architectural endeavor.



IGNITE YOUR PASSION,
CALL 1.800.772.4706
VISIT WWW.INDITAL.COM FOR
OUR 2002 CATALOG AND DISCS.



Indital usa



The Tree Theatre + Play Compound features translucent walls (left) that allow parents to see in, and a “music wall” (below), meant to appeal to the blind.

WORK

A design/build/climb/play project

Philadelphia architects Tim McDonald and Alice Chun specialize in what they call “guerrilla design-build projects.” One of those, a movable theater that was designed with a studio at Temple University, was featured in a profile of Chun in *RECORD*, September 2001, page 59. Now, the pair have formed a group called FAARM—an acronym for the Foundation for Art, Architecture, Research, and Making—to handle these projects. One of their first is an ADA-compliant play structure for a park in suburban Havertown, Pennsylvania.

The structure was designed and built over the course of a seven week studio that Chun and McDonald led at the University of Pennsylvania.

The students developed a rough plan during the first week of the studio, then headed to the site, where most of the real design work took place.

“One of the premises of doing this design-build studio is the idea that the imagination doesn’t stop at the drawing table and therefore design on paper is by nature incomplete,” McDonald said.

The student designers for the project were Jill Desimini, Roman Torres, Christian Munoz, Gaeta Shaw, Kelly Yates, Ali Fazio, Sierra Bainbridge, Chris Rubino, Julia Murphy, Tom Meyers, Ebi Weiscarver, and Jessica Penzel. *Kevin Lerner*

Go to architecturalrecord.com/archrecord2 for more career stories from emerging architects.



Now get a feature you’ve always wanted in an affordable window. Confidence.

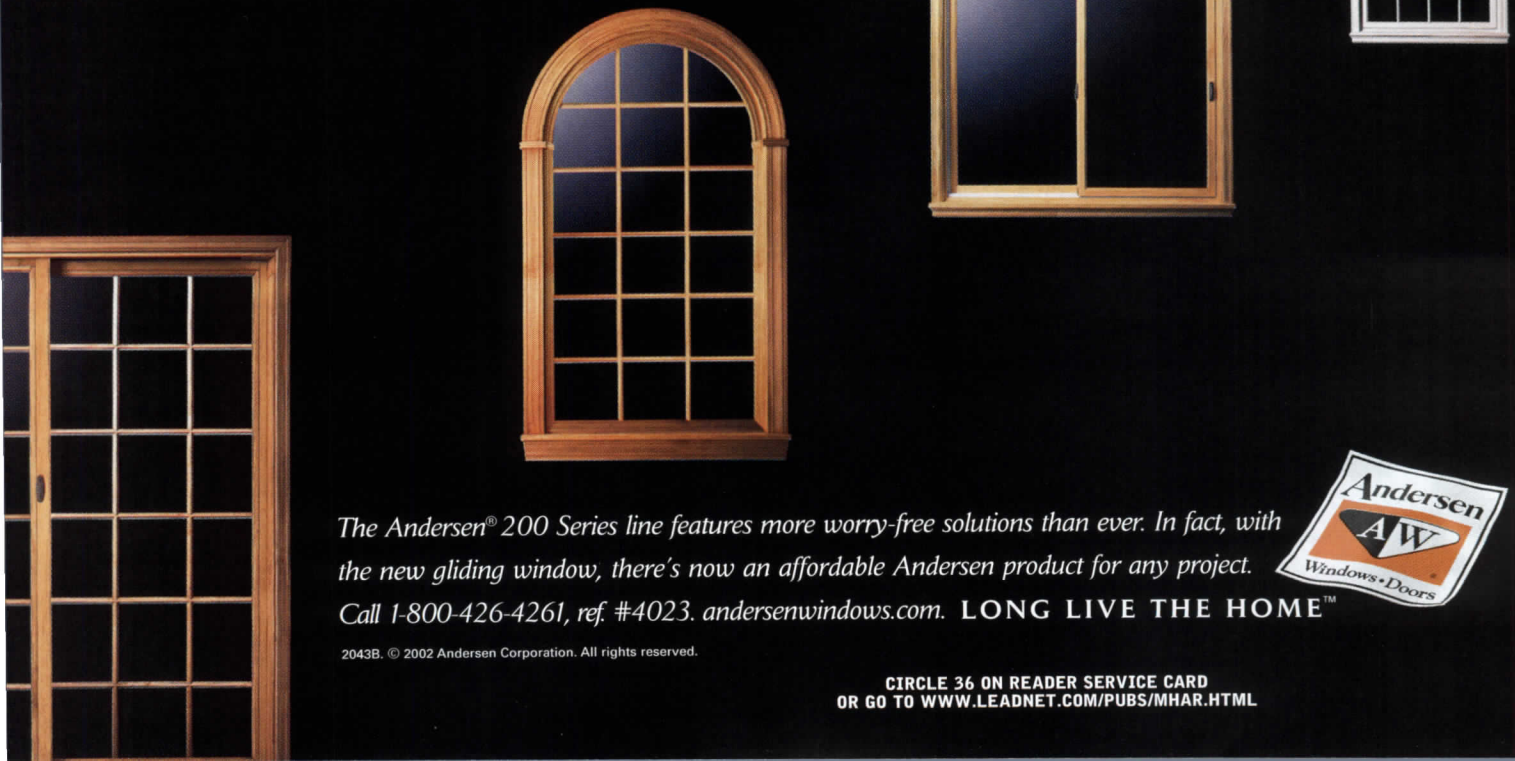

The Andersen® 200 Series line features more worry-free solutions than ever. In fact, with the new gliding window, there’s now an affordable Andersen product for any project.

Call 1-800-426-4261, ref. #4023. andersenwindows.com. **LONG LIVE THE HOME™**

2043B. © 2002 Andersen Corporation. All rights reserved.

CIRCLE 36 ON READER SERVICE CARD
OR GO TO WWW.LEADNET.COM/PUBS/MHAR.HTML



GREAT LOOKS. GREATER DURABILITY.

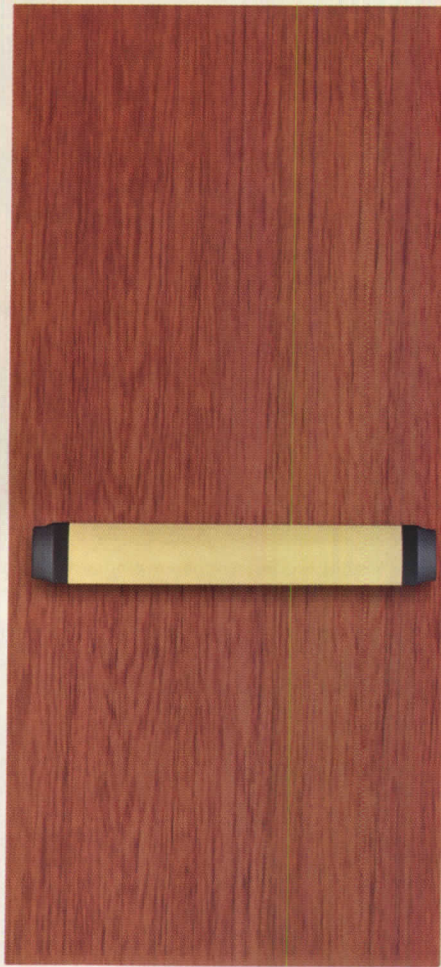

© 2002 Ingersoll-Rand

Steelcraft GrainTech® The best steel door, available with Von Duprin's **INPACT™** exit device. The Steelcraft GrainTech door series gives you the rich look of real wood grain with the strength of steel for a door that withstands extreme wear and tear. Our exclusive embossed grain and staining process simulates the beauty of wood with six factory colors. The GrainTech door can be ordered with Von Duprin's INPACT exit device in a pre-installed door system. Von Duprin's INPACT exit device is the latest innovation in design, giving you low profile, great looks and durability. Two great brands that can be ordered separately as well.

To learn more about Steelcraft GrainTech doors and Von Duprin INPACT exit devices, visit irsecurityandsafety.com or call 1-877-840-3621 to contact one of our 22 Security & Safety Consultant offices. (Learn more about the Vandlgard program—hardware for high-abuse environments.)



Available in six wood grain finishes.

IR Security & Safety
Proven Source. Proven Solutions.™

An **IR** Ingersoll-Rand business

STEELCRAFT®

CIRCLE 37 ON READER SERVICE CARD
OR GO TO WWW.LEADNET.COM/PUBS/MHAR.HTML

Postcard from Berlin: The UIA's XXI World Congress incites lively discussion and new initiatives

Correspondent's File

By Michael Stanton, FAIA

At the end of July, the International Union of Architects (UIA) held its 21st World Congress of Architecture and Assembly in Berlin. Since the Congrès International d'Architecture Moderne (CIAM) petered out in the 1950s, the UIA has been the sole international entity that attempts to unify in policy and action the architects of the world. Each participating country sends one member organization to represent the architects of that nation. The AIA represents the U.S. at the UIA. Founded in Lausanne in 1948, the UIA has grown steadily and currently has about 90 countries as members. The UIA focuses its efforts on advocating international architectural competitions ("Our most important work," believes outgoing UIA president Vassiliis Sgoutas, Hon. AIA) and completing specific projects executed by work groups of architects from member nations.

The theme of this lively, five-day congress was "Resource Architecture." The broad topic left plenty of room for the pre-congress Web site to present an encyclopedia of issues the congress would address, including permanent conversion of the city and society; new urban context according to economic, ecological, social, and cultural changes; reuse of restored old buildings; new buildings within the current urban context; modernization of old build-

Michael Stanton is a former president of the AIA, a member of ARCHITECTURAL RECORD's advisory board, and an architect in San Francisco.

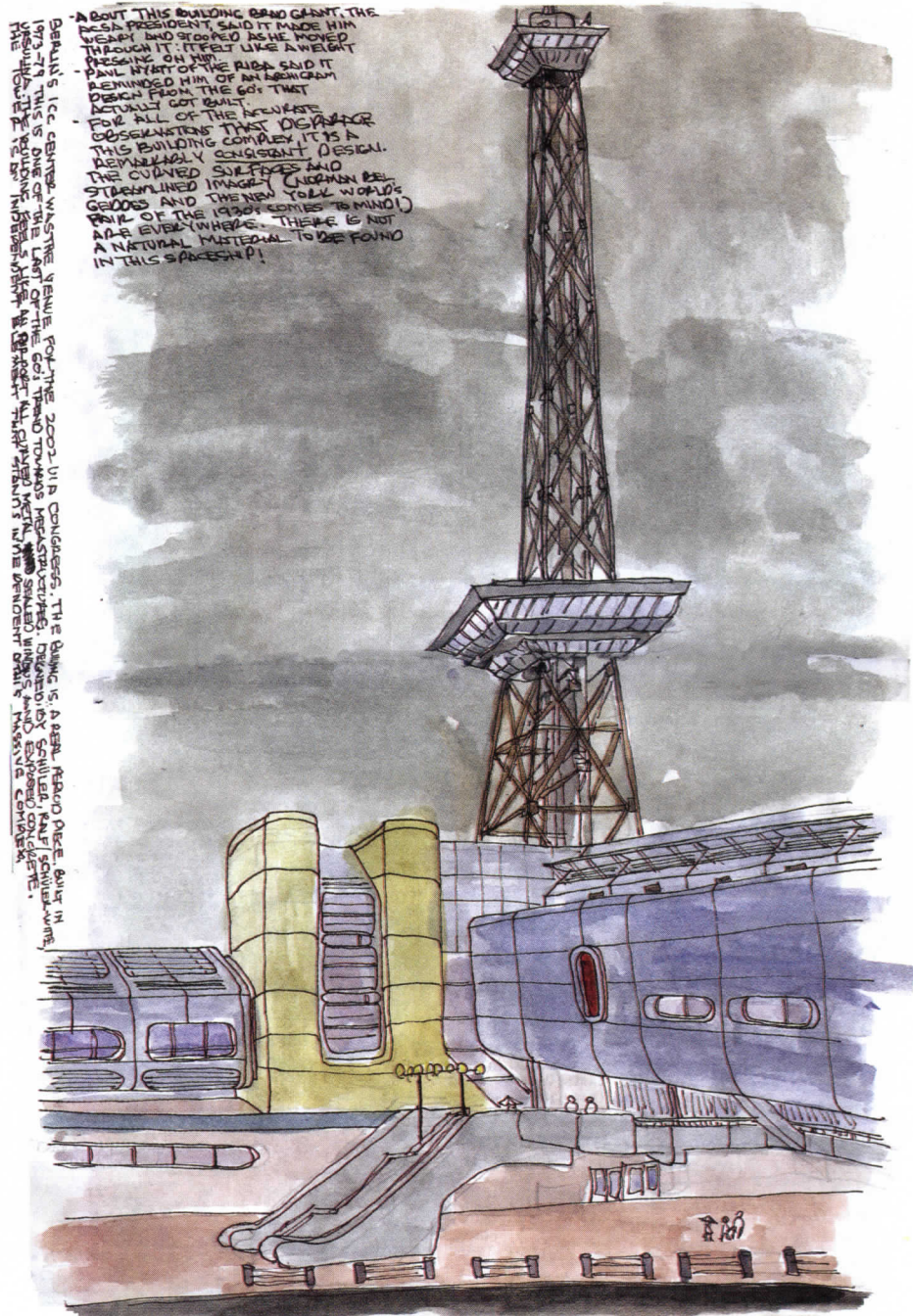

Berlin's International Congress Center (1973-79), sketched on location.

Correspondent's File

BERLINER RATHAUS - BERLIN CITY HALL VIEWED FROM ALEXANDER PLATZ



Berlin City Hall as viewed from Alexander Platz.



BEGAN WORK WITH THE KERNBERGER
 IN THE 1990S. THE 1990S WERE THE
 MOST INTERESTING PERIOD FOR
 ME. THE BERLIN DOME WAS
 FINISHED MOSTLY BY THE
 EAST GERMAN ARCHITECTS
 SO I WAS INVOLVED IN THE
 RECONSTRUCTION OF THE
 DOME AND THE TOWER.

Berlin Dome (1890), with Fernsehturm, the 1969 Soviet era tower, beyond.

New construction around Potsdamer Platz viewed across the Tiergarten from the Reichstag.

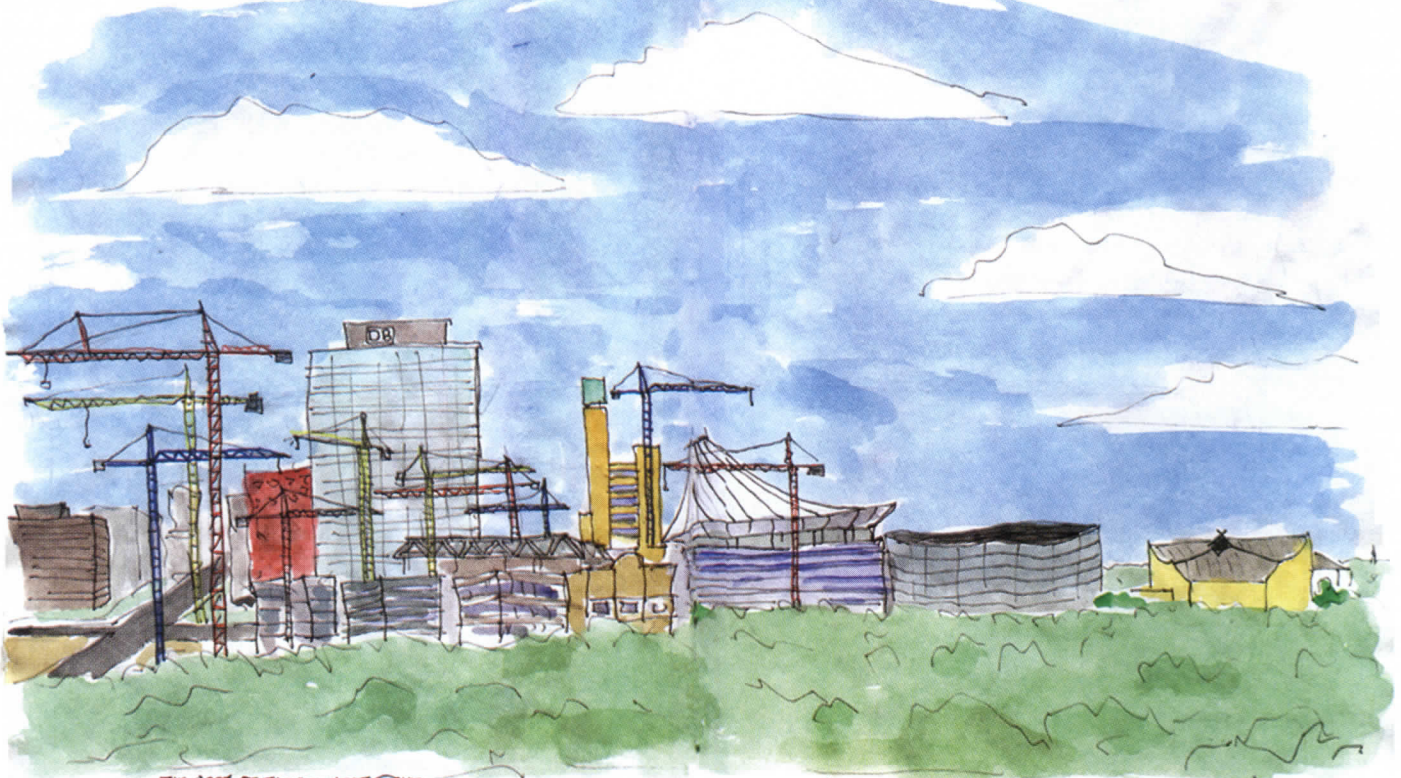

LOOKING SOUTH FROM THE ROOF OF THE REICHSTAG ONE
 SEES THE SAME SEA OF CRANES AND CRANES THAT STILL DOMINATE
 THE AREA AROUND POTSDAMER PLATZ, JUST HERE THE VIEW I SAW FROM
 THE SAME SPOT IN 1999.

↑
 RINGO PINKI
 TUMAS

↑
 SCNY CENTER
 HELMUT JAHN 2001

↑
 DUBLIN PHILHARMONIC HALL
 1963 - MARK SCHWON

Correspondent's File

ings and preservation of historic monuments; innovative technologies applied to building and sound use of resources; cyclical economies and cost evaluation; global approach and interdisciplinary collaboration; changes in the architectural education system according to new requirements; and long-term evolution of the definition of professional practice.

Some speakers took advantage of this free range and wandered far afield, but the majority of the presentations stayed close to the core theme, addressing the world's diminishing resources and the architect's role in finding ways to allocate them more fairly and efficiently. Not surprisingly, dissatisfaction with the Bush Administration's rejection of the Kyoto Accord on global warming was a frequent undercurrent to the presentations.

During the assembly that followed the congress, a major new initiative was passed. The UNESCO-UIA Validation System for Architectural Education calls for the UIA to become more actively involved in the process of accrediting programs of architectural education to ease international recognition of comparable education credentials. While this is a worthwhile and necessary step in the evolution of international free trade in professional services, the implementation strategy and the

financial assumptions presented to the assembly were very sketchy. It was pointed out to the assembly that the National Architectural Accreditation Board in the United States has a larger annual budget than the entire UIA and that American schools of architecture pick up the cost of the actual accreditation visits.

The assembly also addressed implementation of a new UIA dues structure. UIA treasurer Don Hakel, FAIA, from the U.S., presented a revised formula with payments based on the number of architects in the nation (up to a cap of 85,000 architects) and the gross domestic product of the country. Under the new formula, the dues of some Western European nations that had previously been disproportionately high would decrease, and the dues of the U.S., already the highest, would increase substantially. Some developing nations would also receive large percentage increases in dues, but the size of their actual payment would remain small. The dues proposal engendered a lively debate, with sides drawn roughly along ideological lines between the developed nations of the north and the developing world. In the end, the new dues structure was endorsed in concept, with particulars to be worked out in the future.

Rancorous discussion, with sides divided along this familiar fault

line, also manifested itself in two other UIA assembly actions. First was the election of the next president of the UIA. After the elimination of three other candidates, the race narrowed to Andreas Hempel, of Germany, and Jaime Lerner, Hon. FAIA, from Brazil. The choice represented not only the developed versus developing world but was also between a UIA insider and a newcomer. Hempel had been the UIA first vice president for the past three years and the organizer of this congress. Lerner, best known as the former mayor of Curitiba who helped implement the innovative transportation planning that earned for Curitiba the title of "ecological capital of South America," had no

UIA completely if Tokyo won. Many delegates bemoaned the missed opportunity to hold the congress in Asia and saw this decision as another indication of the European bias of this Paris-headquartered organization.

The frustrations of the assembly boiled over the next day at the initial meeting of the UIA's new council, its board of directors. This meeting is normally a symbolic meet-and-greet session, but this year it began with two prominent members, including a vice president from the United Kingdom, walking out in protest over the elections. Important countries voiced their displeasure at how the assembly

THE RANCOR AT THIS YEAR'S WORLD ASSEMBLY PLACES A SIGNIFICANT BURDEN ON THE UIA'S NEW PRESIDENT.

previous significant UIA involvement. Lerner campaigned on an ambitious program to engage the UIA in solving world urban issues. Nerves frayed during this election, in part because of the incredibly inefficient and time-wasting voting process the UIA employs. In the end, Lerner won amid claims that there were election irregularities, including vote buying.

The next World Congress will be in Istanbul in 2005, and the assembly selected Turin, Italy, as the venue for the 2008 World Congress. Again, accusations of vote buying were publicly voiced, and it was circulated that the Italians had strong-armed delegates by threatening to pull out of the

conducted its business and threatened to withhold dues or leave the UIA completely. Few attending left the meeting satisfied.

All this rancor places a significant burden on new president Jaime Lerner. He will have to finalize the dues question, reconcile the UIA's lofty aspirations in architectural education with the organization's limited resources, and fix the UIA's dysfunctional system of running elections. More important, it falls to Mr. Lerner to heal some of the acrimony and to use his focus on urban issues to rally the world's architects on loftier aspirations than were demonstrated in the Berlin assembly. ■

The Architectural League & ARCHITECTURAL RECORD Events:

At the McGraw-Hill Auditorium, 1221 Avenue of the Americas, NYC. Reservations (League members only): 212/980-3767. Information: 212/753-1722. League members free, non-members \$10

November 21, 2002

6:30pm

"Small Civic Works": A panel discussion with David Burney, NYCHA; Eve Michel, NYCEDC; and Henry Myerberg, design director, The Library Initiative. In conjunction with the exhibition, *New New York 3*.

December 6, 2002

6:30pm

Ben van Berkel, UN Studio, "Figments of Falling": A presentation of recent projects, including a live/work apartment building, Hilversum, and housing in Sporenburg, Amsterdam.

Sponsored by McGraw-Hill Construction

Making lists: the byzantine politics of picking design firms for Ground Zero

Critique

By Michael Sorkin

DEPARTMENTS

Finding a new form for Ground Zero demands that two divergent approaches be pursued simultaneously. The first is the messy, disputative process of building public consensus about the future, meaning, and use of the site. From this discussion must come answers about the sacredness of the site—its aura and dimensions—about the mix of uses, and about the extent and character of transportation infrastructure. The deliberation must also engage the prospects for reconstruction of neighborhoods beyond the immediate site; indeed, for the city as a whole.

The second major process, in contrast, is artistic and visionary. It relies on individual acts of imagination to produce ideas that broaden the range of possibilities presented to the public and provide the basis for genuinely informed choice.

The Lower Manhattan Development Corporation (LMDC) has not understood the importance of this relationship. The derision that greeted their first proposals was a response both to their seeming indifference to public feelings about the use of the site and to the mediocrity of the designs put forward. Both of these failures sprang from a poverty of imagination and from an undemocratic desire to control the terms of any discussion. As a result, a conceptual and artistic deficit has been left to be made up by individual creators

Contributing editor Michael Sorkin is the coeditor (with Sharon Zukin) of the book *After the World Trade Center: Rethinking New York City*.

and the many unofficial planning alliances that have grown in the wake of the disaster. However, because none of these efforts has any official standing, their audibility to the LMDC is a matter of prestige and connections: The LMDC has opened its inquiry only under pressure.

If there were a forum in which one might have expected to see the great variety of ideas and plans produced in the past year, it is *The New York Times*. Our newspaper of record, however, has provided crabbed coverage of possible design alternatives. Much of the responsibility for this stems from the gate-keeping role played by the newspaper's architecture critic, Herbert Muschamp.

Muschamp has been acerbic in his criticism of the LMDC's floundering. And his scathing commentary on the six misbegotten plans released in July was immediately echoed in an editorial headlined "The Downtown We Don't Want," which characterized the schemes as "dreary [and] leader" and argued

Both *The New York Times Magazine* (above) and *New York* magazine (below) picked favorite architects to devise Ground Zero designs.



that no plan with that amount of commercial space would fly. It also suggested—following a proposal made by the LMDC and others—"how much better residential and commercial areas would cohere if West Street can be submerged and covered with a promenade or a park."

The very next day, though, Muschamp weighed in with a short "appraisal" in which he lavished praise on quite a different vision. Plucking one of the site diagrams published in the run-up to the LMDC Six by New York New Visions in an exemplary analytical document, Muschamp trumpeted the discovery of a scheme of "remarkable elegance" and "unmatched conceptual beauty."

Critique

This turned out to be a parti in which the buried West Street was topped not with a "promenade or park" but by a series of developable blocks. Authorship of the plan was attributed to the architect Frederic Schwartz, who had been busily working officialdom on behalf of this

SCHWARTZ'S PLAN IGNORES THE MILLIONS OF SQUARE FEET NOW VACANT AND THE MANY UNBUILT SITES DOWNTOWN.

diagram, now detached from the larger project of New York New Visions from which it had emerged.

While most of the July LMDC schemes had proposed to bury West Street, the Schwartz plan differed in suggesting that *buildings* be constructed atop the tunnel. The idea is not unfamiliar: Schwartz cut his architectural teeth in the Venturi, Scott Brown office working on Westway, and this scheme revisits

the basic idea behind that project: the use of publicly funded infrastructure to create sites for private speculation. Muschamp presents this as a logical way to alleviate pressure on the Trade Center site by offering an alternative territory for development. Neither Muschamp

nor Schwartz, though, has advanced any argument for the formal superiority of such a development to the creation of additional green and public space atop the buried roadway.

Muschamp presents this plan as if it were the *only* solution to the question of off-site replacement space. Ignored are millions of square feet currently vacant downtown and the numerous unbuilt and underbuilt sites in the area (together, more

than enough to replace the Trade Center twice over), as well as the possibility of replacing lost space elsewhere in the city. Although contemptuous of developer demands for immediate replacement of lost income streams ("The lease made me do it," he acidly began one of his pieces), his plan accomplishes just that, predicated on the ultimate in developer reasoning: the logic of the parcel.

Mindless branding

The parcels, however, were also the grounds for an exercise in Muschamp's central critical operation: compiling lists of his favorite architects. Having suggested that the parceled development of West Street was the only logical way forward, Muschamp—playing Napoleon III to Schwartz's Haussmann—selected a group to implement the plan and then published their risible efforts with great fanfare in the September 8 issue of *The New York Times Magazine*. While there were a few tasty images among the propos-

als, the schemes were largely undercooked, with no urbanistic glue to give spatial and circulatory logic to the ensemble. Muschamp's mindless branding made Larry Silverstein look like Cosimo de' Medici.

The plan, however, also suggests that the Twin Towers *themselves* be rebuilt—slightly southeast of the original site! But wasn't the "remarkable elegance" of the Schwartz plan its obviating the need to replace the towers? To be sure, the buildings shown are Trade Towers with a twist: The huge structures have been torqued to resemble "a pair of candlesticks of unidentified authorship." In fact, they resemble fairly precisely a widely disseminated scheme by Richard Dattner, whose project is submerged in the claim that these buildings "enjoy a variety of sources." I am reminded of the undergraduate strategy of oversupplying footnotes to conceal a source.

The week following publication of Muschamp's plan, a piece appeared in the House & Home section entitled "At Home With

When a hole in your ceiling is a good thing.



Kenneth Rice Photography — www.kennicphoto.com

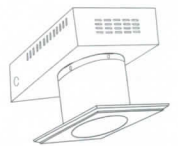

Our "Hole in the Ceiling"

fixtures are plaster/fiberglass castings.

They illuminate your space without calling

attention to themselves. Call us for more

information at 626.579.0943 or visit our

website today at www.elplighting.com.

**ENGINEERED
LIGHTING PRODUCTS**





g a r y l e e p r i c e

“Lifting the human spirit through sculpture”™

GARY LEE PRICE STUDIOS
38 WEST 200 SOUTH
SPRINGVILLE, UT 84663

T: 877. GLPrice
F: 801. 489. 9588

www.garyleeprice.com
info@garyprice.com

CATALOG \$10
CATALOG AND VIDEO \$20

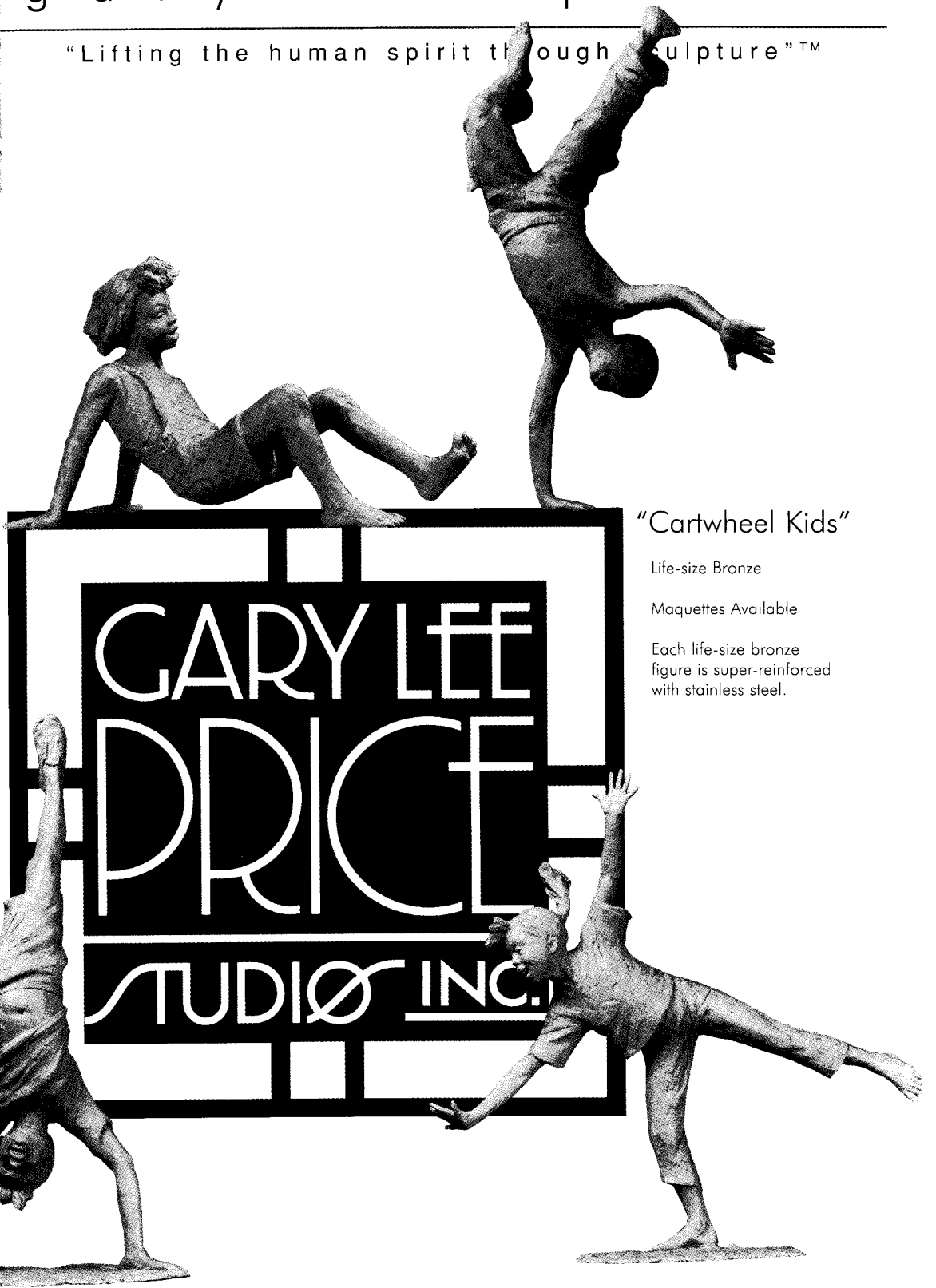

“Cartwheel Kids”

Life-size Bronze

Maquettes Available

Each life-size bronze figure is super-reinforced with stainless steel.

Life-size figurative bronze sculpture exhibit currently on display at the **Desert Garden Botanical Show** in Phoenix, Arizona. For more information, call (480) 941-1225.

©2002 Gary Lee Price Studios, Inc. Reproduction of any kind is strictly prohibited without written permission from Gary Lee Price Studios, Inc. AR-11/02

CIRCLE 40 ON READER SERVICE CARD
OR GO TO WWW.LEADNET.COM/PUBS/MHAR.HTML

Critique

Frederic Schwartz, *The Man Who Dared the City to Think Again*." Here, after congratulating him for his "aspirational" scheme, the writer described Schwartz's SoHo loft, his girlfriend, and his breakfast. The shelter section of the *Times* is, of course, obsessed with pedigree.

HAS MUSCHAMP COMPROMISED HIS ABILITY TO JUDGE FUTURE DEVELOPMENTS DISPASSIONATELY?

And, given the fact that Herbert's list is about celebrity, the hapless Schwartz had to be made into one.

Spinning more schemes

The celebrity mill received a further spin in the September 11 special issue of *New York* magazine, which included its own collection of schemes organized by its architecture critic, Joseph Giovannini. Complete designs were sought from

six architects, with results that certainly raised many more interesting urbanistic issues than Muschamp's (not so) exquisite corpse, while still feeding the celebrity beast. Indeed, two of Giovannini's six designers were also on Herbert's list! For *New York*, Peter Eisenman and Zaha

Hadid produced completely different, more fully elaborated, schemes. Somebody's got a good agent!

Stung by the attacks on its own six schemes, the LMDC had announced in August that it was ready for some list-mania of its own and was prepared to pony up a puny sum (\$40,000 per team) to sponsor six more schemes. And whom did the LMDC choose from the 400 who applied? *The same*

people! Frederic Schwartz (already backpedaling from the idea of burying West Street in the face of rising community opposition), David Rockwell, and Rafael Viñoly—all from Herb's list—dominate one team. Another is comprised of masters-of-the-universe Steven Holl, Charles Gwathmey, Richard Meier, and trifecta winner Peter Eisenman—Herbert's list, one and all. Norman Foster makes the cut, as does Daniel Libeskind, our leading iconographer of trauma.

There is also an interesting, if jerry-built, team made up of a group of younger stars from the U.S. and Europe. The final slot goes to Skidmore, Owings & Merrill, making this the fourth such commission they've received. They are designing 7 WTC for Larry Silverstein. They've done a sitewide scheme for Larry Silverstein (featuring a very tall tower!). They've devised a planning study for the east side of downtown for Carl Weisbrod (head of the Downtown Business Improvement District and member of the LMDC

board). Why not just hand them the commission now?

Immediately following the LMDC selection of his list, Muschamp returned the favor, doing a full 180, writing that the LMDC—those former masters of malevolence and implacable foes of art—are now likely to "change the course of cultural life in New York." Come again? What would really change the course of cultural (and political) life in New York would be an open process, a genuine competition, in which public bodies (not to mention architectural critics) devoted themselves to promoting the widest—and wildest—styles of inclusion, not this endless, mad, favoritism. And am I wrong to think that in offering his own proposal at this stage of the game, Muschamp has stepped over the critical line, compromising his future ability to judge developments dispassionately?

I again remind readers with ideas for downtown to visit the Web site www.not-ground-zero.org. All are welcome. ■

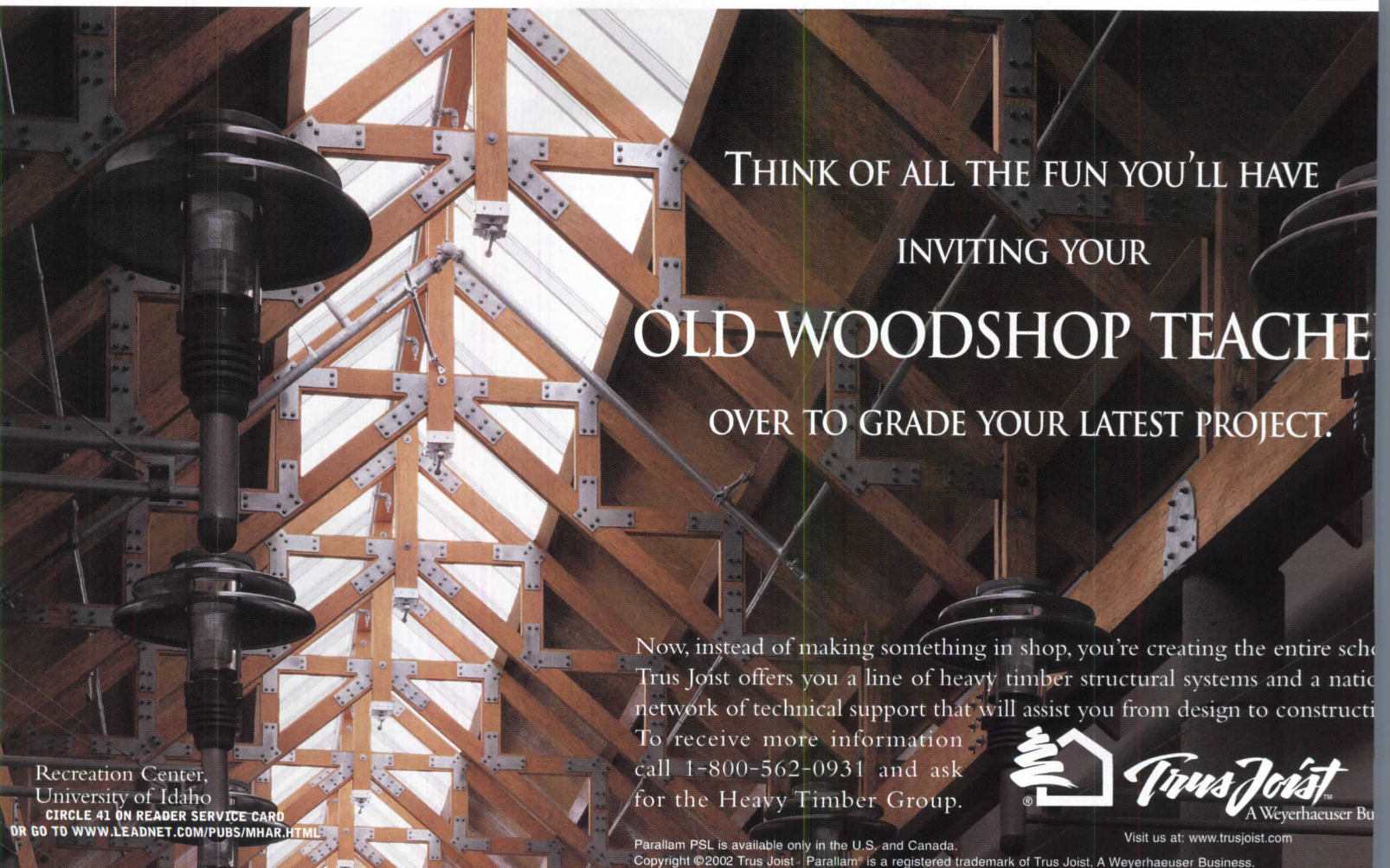

THINK OF ALL THE FUN YOU'LL HAVE
INVITING YOUR
OLD WOODSHOP TEACHER
OVER TO GRADE YOUR LATEST PROJECT.

Now, instead of making something in shop, you're creating the entire school. Trus Joist offers you a line of heavy timber structural systems and a national network of technical support that will assist you from design to construction. To receive more information call 1-800-562-0931 and ask for the Heavy Timber Group.



Recreation Center,
University of Idaho

CIRCLE 41 ON READER SERVICE CARD
OR GO TO WWW.LEADNET.COM/PUBS/MHAR.HTML

Parallam PSL is available only in the U.S. and Canada.
Copyright ©2002 Trus Joist. Parallam is a registered trademark of Trus Joist, A Weyerhaeuser Business.
Visit us at: www.trusjoist.com

Collaboration Matrix Eases the Process of Teaming Up

Practice Matters

By James F. Porter, AIA

DEPARTMENTS

Name Project
Page 1 of 4
Date

COLLABORATION MATRIX Exhibit "A"

ALLOCATION OF RESPONSIBILITY BETWEEN: DESIGN ARCHITECT LOCAL ARCHITECT CLIENT

Legend: * = Primary Responsibility
+ = Review & Support Responsibility
0 = No Responsibility or Duty

1.0 SCHEMATIC DESIGN - PHASE 1

	DESIGN ARCHITECT	LOCAL ARCHITECT	CLIENT
1.1 Conference with Owner	*	+	+
1.2 Analysis of project requirements	0	0	+
1.3 Assembly of building/zoning code requirements	0	*	+
1.4 Assembly of utility and survey data provided by Owner	+	*	0
1.5 Zoning area calculations and floor area calculations	*	+	0
1.6 Parking layouts	*	+	0
1.7 Design and evaluation of project alternatives	*	+	+
1.8 Schematic design studies and recommended solution	*	+	0
1.9 Schematic design drawings including plans, sections, elevations & key details	*	+	0
1.10 Color and material sample board	*	0	0
1.11 Outline architectural specifications	*	+	0
1.12 Preparation of design sketches	0	*	0
1.13 Presentation of schematic design to Owner	+	*	+
1.14 Code/Life Safety consultant service input	+	*	0
1.15 Preparation of documents for, and review of documents by local authorities	+	*	0
1.16 Coordination of Civil, Structural, Mechanical, Electrical engineers	+	*	+
1.17 Assist QS with preparation of cost plan	0	*	0
1.18 Provide Structural, Mechanical, Electrical, Plumbing and Code Life Safety consultants	0	0	*
1.19 Provide Civil Engineering Consultant		80%	20%

2.0 DESIGN DEVELOPMENT - PHASE 2

2.1 Conferences with Owner	*	+	+
2.2 Refinement of project requirements	+	*	0
2.3 Coordination of Structural, Mechanical, Electrical and Civil engineering	+	+	0
2.4 Provide Lighting, Graphics and Landscape design	*	+	0
2.5 Selection of major building materials			

The first page of a sample collaboration-matrix document.

As clients put architectural projects on hold, firms are finding that work is slowing significantly. That often means talented staff members are laid off, which in turn makes it harder to seek new work. However, tough times can be good times to try new things. A good way to stay busy during periods of slow economic growth is to forge collaborative relationships with other firms. Collaborations allow the combined practices to leverage their expertise when personnel may be in short supply, as well as ease the competitive tensions that often become more severe in an economic drought. A well-considered collaborative agreement will allow your firm to contribute its own expertise to a project and still maintain its identity.

Collaborative partnerships are most successful when the client, design architect, and executive architect have clear lines of responsibility at every stage of a project's life span. The structure for collaboration should entail more than a loose-knit strategic alliance but should not be as tightly woven as a formal Joint Venture.

Some years ago, Altoon + Porter Architects developed a tool for forming collaborative partnerships and enabling them to flourish. It is called the "collaboration matrix." This deceptively simple list of duties, which charts who is responsible for performing what—whether the design architect,

James F. Porter, AIA, managing partner, Altoon + Porter, has 20 years experience using the collaboration matrix on projects worldwide.

executive architect, or the owner—forms the backbone of a comprehensive strategy for project management. It helps all of the parties involved in a project to define and maintain their roles and responsibilities as peer collaborators. Although a collaboration matrix may begin with a standard list of responsibilities, each and every project is unique, and each must have a matrix specifically tailored to its requirements. The matrix format can be continually and easily updated.

The matrix was designed to fill a void within AIA Document B141, the standard form of Agreement between Owner and Architect, and it is completely compatible with it. Earlier this year, the AIA published a new international form of contract (AIA-B611), which incorporates the Altoon + Porter services-collaboration-matrix concept.

Origins of the collaboration matrix

Twenty-two years ago, Altoon + Porter partners were working on a fast-track, high-rise office building project located out of state. The client, local to the project, chose the firm as design architect for its background and proven track record with them, encouraging it to team up with a local executive architect who had extensive knowledge of the local politics and building practices. They wanted to specify clearly which partner had responsibility for liability.

The situation had the potential for generating reams of confusing paperwork between the client and the two firms, as well as creating

possible complications regarding insurance, licensing, and taxes.

This potentially unwieldy project inspired the development of the collaboration matrix. When the matrix is added to the contract, it allows each architectural firm to maintain a direct "prime" contractual relationship with the client. Each task or duty to be performed is assigned so that only one of the three parties (executive architect,

design architect, or client) has primary responsibility and authority for executing it, while the others retain support and review roles. The client has only to look to one party with regard to a given task, and accountability is assured. Because the client is a party to the matrix, it is clear to all involved from the outset who is supposed to do what throughout each phase of the entire project.

Practice Matters

A document with many uses

The collaboration matrix has also proved especially beneficial for breaking down the cultural misunderstandings that sometimes occur in international work. This is accomplished by explicitly delineating roles, communication procedures, and who is accountable to whom.

one partner is an out-of-state firm known for its lab experience and design excellence. The local firm might not have been considered for the project alone, because labs are not its primary specialty. The other firm, located on the East Coast, also would not have been selected without a presence in California. The

THE COLLABORATION MATRIX HAS PROVED USEFUL FOR BREAKING DOWN THE MISUNDERSTANDINGS THAT ARE SOMETIMES ENCOUNTERED IN INTERNATIONAL WORK.

When not used as a part of the contract, a collaboration matrix can also be put to use as a marketing tool, because it helps illustrate to prospective clients the roles that two partnering firms will assume if they are hired together for a project. For example, for a high-tech academic science building in California,

collaboration matrix was used to help illustrate to the client how the local firm could successfully act as the project's executive architect, while the out-of-state firm served as its design architect. In this particular case, it is likely that neither of the firms could have got the project on its own.

Do your due diligence

After having identified a potential firm to collaborate with, it is essential to study its entire business, from its corporate organization to the way its branch offices are run, as well as its core values, culture, and ethics. Check references and determine whether its relationships with its consultants and clients are positive. Be certain that your partner can live up to its obligations and your expectations. Become well versed in the region where you will be working. Most importantly, research local business and licensing laws.

Getting everything on paper

The collaboration matrix can be used at the outset of a project to assist with the negotiation between the parties for the division of responsibilities. It can also incorporate a list of required documents to be prepared during each phase. The complete agreement would include cover letters describing the fee structures and overall job responsibilities of each party; a form of standard

owner-architect agreement detailing the comprehensive scope of services and terms; and, lastly, the collaboration matrix, detailing assignment of responsibilities between the parties. Make sure that all significant tasks are identified, and that no task or role is left vague. Document an explicit division of responsibilities for client and architects. In addition, spell out all the terms of payment. On overseas projects, do whatever is necessary to get a retainer up front. The collaboration matrix will help ensure that team members have an equitable share in both a project's responsibilities and its fees. This helps team members avoid conflicts.

The collaboration matrix is a flexible and simple document. It is adaptable as a tool for use in structuring collaborations involving strategic alliances of complementary talents, and where great distance separates the design architect from the client and the project site. ■

IT'S THEIR ROOF. BUT IT'S YOUR REPUTATION.



Prestige® Gallery Collection™ in Sienna Sunset™

If your perception of laminated shingles is dull, flat and boring, it's time you considered Elk. We have the looks, profiles and colors that open up entirely new design possibilities for steep-slope applications. For a free specifier kit complete with samples and more information, call 800.354.7732. Or visit us at www.elkcorp.com™

ELK
The Premium Choice®
www.elkcorp.com



©2002, Elk Premium Building Products, Inc. All trademarks, ®, are registered trademarks of Elk Premium Building Products, Inc., an ElkCorp company. All trademarks, ™, are trademarks pending registration of Elk Premium Building Products, Inc.

FOR THE FIFTH YEAR
2002-2001

EXCITING SHELF SUPPORTS



SH7—hamburger cut in half;
2 sizes, 7/8", 1 1/2" protrusion



SH13—perforated pattern in
2 sizes, 7 7/8" or 11 3/4"

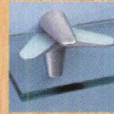

SH2—"Bird's Foot" design,
2 1/2" protrusion



SH8—massive bracket
protruding 5 1/8"

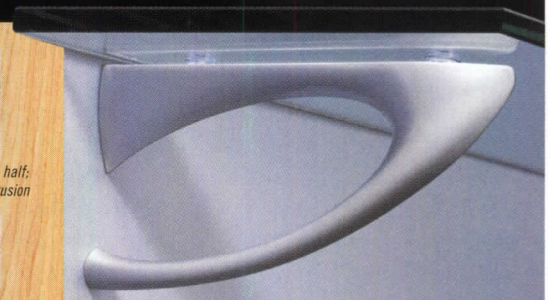

Out-of-this-world lines of our SH-12 "Galaxy" radiate elegance and good design. Clear rubber bumpers raise shelf above support; maximum 11" shelf width. Available in Satin Nickel and Matte Chrome.

See all 15 of our contemporary shelf supports at www.mockett.com. For our "New Concepts 2002" Catalog call 800-523-1269.

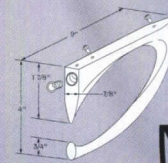

MOCKETT
MOCKETT & COMPANY, LTD.

BOX 3333, Manhattan Beach, CA 90266 USA • Fax: 800-235-7743

"Fine Architectural Hardware for Your Fine Furniture.™"

CIRCLE 44 ON READER SERVICE CARD
OR GO TO WWW.LEADNET.COM/PUBS/MHAR.HTML

CIRCLE 45 ON READER SERVICE CARD
OR GO TO WWW.LEADNET.COM/PUBS/MHAR.HTML

Looking in the rearview mirror to see more than just the style of last century's Modernists

Books

By Kenneth Caldwell

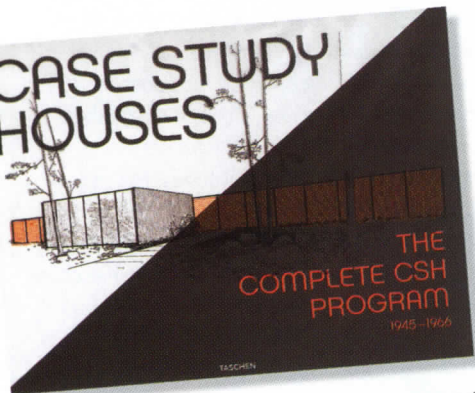

Case Study Houses: The Complete CSH Program, 1945–1966, edited by Elizabeth Smith. Taschen, 2002, 440 pages, \$150.

California Modern: The Architecture of Craig Ellwood, by Neil Jackson. Princeton Architectural Press, 2002, 208 pages, \$50.

A. Quincy Jones, by Cory Buckner. Phaidon, 2002, 272 pages, \$60.

Paul Rudolph: The Florida Houses, by Christopher Domin and Joseph King. Princeton Architectural Press, 2002, 248 pages, \$40.

Why the growing fascination with mid-20th-century Modern domestic architecture? Perhaps the appeal lies in nostalgia for the apparent sweetness and optimism before Vietnam,

Kenneth Caldwell is an Oakland-based communications consultant to architects and a contributor to San Francisco and California journals.

Watergate, and domestic terrorism. Perhaps it is a reaction to the visual clutter of Postmodernism. Pristine black-and-white photographs from the late 1940s and '50s suggest a lifestyle simpler than our own and seemingly available to everyone.

Book publishers have responded by unearthing photographic and architectural archives and producing scores of titles about midcentury Modernism. But renewed interest risks grouping architects from this period into a single style, which trivializes their individual accomplishments. They were not creating backgrounds for fashion shoots; they were developing different ideas for an honest and humane architecture.

Of the new books about mid-century residential Modernism, Smith's *Case Study Houses* is the most lavish, offering large color photographs and brief descriptions of each project, along with original texts from *Arts & Architecture* magazine, sponsor of the program. At 10-plus pounds and 18 by 13 inches, the book is also the most awkward to hold and read. Smith's essay in it places the program in a larger context by showing how it tried to develop low-cost, Modern housing prototypes. A more critical analysis, including an examination of why the program failed to meet its goals, can be found in the 1989 exhibition catalog *Blueprints for Modern Living: History and Legacy of the Case Study Houses* that Smith edited. However, the black-

and-white "projects" section of that book was overly spare, and this volume is a needed supplement, however ungainly.

Covers of *Arts & Architecture* issues in which the homes originally appeared offer a glimpse into the graphic design of the period, and a few contemporary photographs, most without captions, show the houses' current condition. In assembling this collection of material, much of it never seen before, Smith has made a significant contribution to the literature on midcentury Modernism. But the book relies almost entirely on presenting beautiful old photographs,

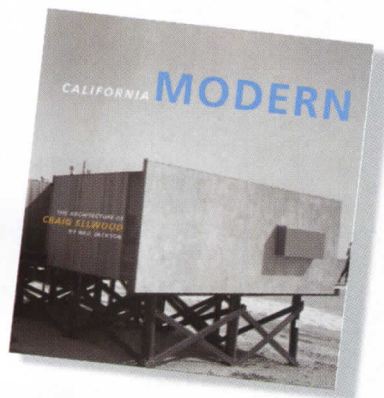

and although Smith mentions that different architects favored different materials, she offers little comparative analysis of their varied paths, values, and approaches.

Telling too much

Craig Ellwood's biography is the stuff of Hollywood: Born in 1922 in the Texas Panhandle, he married a Hollywood actress, rose to cultural stardom in Los Angeles, where he drove expensive, fast cars, and retired to Italy to paint. However,

Ellwood was in fact born Johnnie Burke, was mostly self-taught, and never passed the architect's registration exam. Neil Jackson's broadly researched biography, *California Modern*, should make fascinating reading. And at times it does—too much so. The prologue, entitled "Johnnie Burke," reads like fiction. Although it fleshes out missing details, it muddles truth and conjecture and gives gossip too much credence. It suggests, for example, that Ellwood's frequent coverage in John Entenza's *Arts & Architecture*, and his inclusion in the Case Study Houses program, was the result of a flirtation—a suggestion, however delicious, that diminishes the integrity of both men. The book would have benefited from extensive pruning and the use of more sources to support controversial points.

Moreover, the biography meanders and is burdened with too many long quotes and irrelevant details. Jackson presents three different threads without weaving them together: Ellwood's life, the difficulty of determining who actually designed Ellwood's buildings, and the buildings themselves.

Perhaps because of Ellwood's self-aggrandizement and his limited training, Jackson focuses on the question of design authorship. Disputes over credit for designs are frequent in offices headed by stars. But Jackson suggests that Ellwood's contributions to the office were largely limited to architectural details and self-promotion. Although Ellwood may have been self-invented, the vision needed to establish and sus-

Books

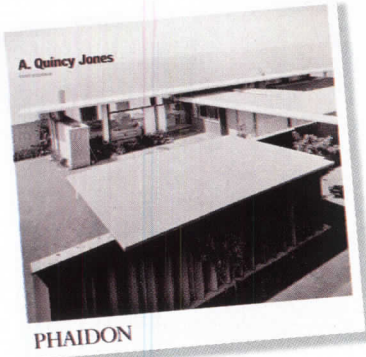

tain his office was his.

Jackson's strength lies in the clarity with which he writes about Ellwood's buildings. He gets behind the photographs and the style and analyzes what was original and what was not. His description and quotes about the "shadowline," the thin space between a building's components or materials, and about Ellwood's "chasing the gaps" to make sure there were no clumsy or unplanned connections, gives the

reader a good feel for the young architect and his office. Perhaps Ellwood's fondness for a reductive Modernism grew, in part, from his experience as a cost estimator on early Modern houses in Los Angeles; it may also have been a strategy to conceal his lack of education and training.

Jackson connects Ellwood's evolving designs to his frequently repeated lectures and occasional writings, which moved from relatively simple ideas about "visual expression," using form and structure, to those for using more sophisticated prefabricated components and steel. In the chapter "Californian Mies," Jackson traces Mies's influence on Ellwood and shows that he reinterpreted Miesian details, as when he used a redundant H column on either side of the exposed corner at the Daphne House in Hillsborough, California.

In describing this complex man, Jackson equivocates between accepting Ellwood as an impostor and viewing him as an innovator. As a result, the author leaves us wondering who Ellwood really was as a man or as an architect. But Jackson's insightful explanation of the buildings nevertheless makes the book a valuable resource for serious students of the period.

A forgotten Californian

If some of Jackson's assertions are a reach, Cory Buckner's new book, *A. Quincy Jones*, does not reach far enough. Perhaps because Jones was not interested in the building as isolated object or monument, he was largely neglected after his

death in 1979. He has returned to the architectural spotlight only with the recent resurgence of interest in midcentury style.

Although Jones is often grouped with other midcentury practitioners, he was more eclectic than his peers, including his southern California colleagues and fellow Case Study House architects Ellwood, Ed Killingsworth, Pierre Koenig, and Raphael Soriano. Jones's architecture was not reductive; he employed a rich variety of materials, layers, textures, plant materials, and often vivid color, and he seemed less obsessed with the building's image than others in this group.

A friend of Jones, Ratan Tata, wrote in the 1983 Japanese publication *Process No. 41* that "Quincy's architecture never sought attention through visual drama. His work reflects spatial sensitivity, great recognition of nature and natural materials as well as plant life, and a great feeling for integrating indoor and outdoor spaces. The

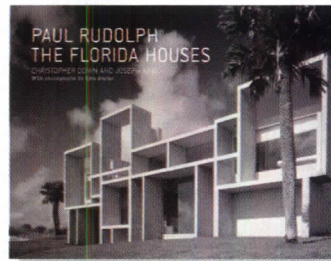

Residential & Commercial Water Sculptures

For inquiries
please call toll
free 866.293.3840.

These custom
designed water
sculptures come
in any size, all
materials, and are
ideal for interior
or exterior from
home to business.



ART N' MOTION

WWW.ARTNMOTIONDESIGN.COM

1223 Wilshire Blvd. #601
Santa Monica, CA 90403
310.319.7652

Maximum VALUE through Superior SERVICE



AVOID BACK INJURIES



INCREASE PRODUCTIVITY

EVERY DOCK NEEDS A LIFT

An Advance dock lift is the
only equipment that can
service all trucks. Full line of
dock lifts including:

- Portable
- Top Of Ground
- Pit Mounted

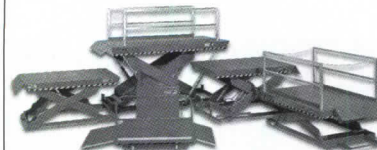

Call
1-800-THE-DOCK
or visit our web site
www.advancelifts.com for a
FREE CATALOG.

 ADVANCE LIFTS

DOCK LIFTS



PROJECT OF THE YEAR

Winners

New Construction



1st PLACE

RESIDENCE, TUNKHANNOCK, PA

Distributor: Bradco Supply, Binghamton, NY

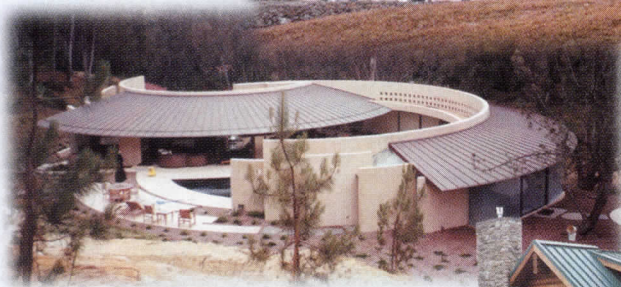

2. BILL'S RESIDENCE, RANCHO SANTA FE, CA

Architect: Wally Cunningham, San Diego, CA
Distributor: Coast Heating & A/C, San Diego, CA
Installer: Coast Heating & A/C, San Diego, CA



3. GLAZEBROOK RESIDENCE, FREDERICKSBURG, VA

Distributor: The Roof Center, Fredericksburg, VA
Installer: Drewry Construction, Fredericksburg, VA



4. NICHOLS RESIDENCE, HARDWICK, NJ

Distributor: Alamco Aluminum, Allentown, PA
Installer: Architectural Developers, Northampton, PA

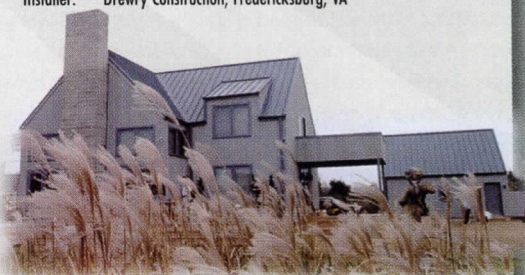

5. LEAR RESIDENCE, BRIDGEHAMPTON, NY

Distributor: Marjam Supply, Farmingdale, NY

To see additional projects and obtain detailed product specifications

Visit us at

www.atas.com

Re-Roof



1st PLACE

MEDITERRANEAN MISSION, LEXINGTON, KY

Distributor: Corken Steel Products, Covington, KY
Installer: J. D. Harper and Sons, Lexington, KY



2. ROCCO BALDO RESIDENCE, MANTUA, NJ

Distributor: Universal Supply, Hammonton, NJ



3. COLE RESIDENCE, ONTARIO, CANADA

Distributor: Met-R.O.C., Innisfil, Ontario
Installer: Ken Docherty Construction, Barrie, Ontario



4. RESIDENCE, NEW WINDSOR, NY

Distributor: Strober King Bldg. Supply, Wappingers Falls, NY
Installer: AOK Construction, Wurtsboro, NY



5. MELLOUL RESIDENCE, WATERLOO, ONTARIO

Distributor: Met-R.O.C., Innisfil, Ontario
Installer: Ken Docherty Construction, Barrie Ontario

ATAS Congratulates Its Residential Winners

From classic standing seam to metal tiles, shingles and shakes, ATAS offers the products to complement any home's style.

ATAS International, Inc.

Email: info@atas.com

Allentown, PA
610-395-8445

Mesa, AZ
480-558-7210

Maryville, TN
800-468-1441

CIRCLE 125 ON READER SERVICE CARD
OR GO TO WWW.LEADNET.COM/PUBS/MHAR.HTML

Books

success of circulation within his architecture often gets taken for granted." Sometimes Jones's exterior designs bordered on the plain; the focus was always on the plan and the human experience within that plan.

Buckner, picking up on this idea, quotes from noted historian Esther McCoy: "He seemed to be profoundly present in his floor plans, bound kinetically to them, like someone who walked them in his mind as he drew." Yet only a fourth of the projects presented by Buckner include plans of any kind.

The book's Minimalist graphic style, while attractive, is inappropriate. The volume includes more than 60 of Jones's projects, but several are shown with just one or two images. Some images seem to have been chosen for style only, not substance. And in some cases, visual information is too spare. For exam-

ple, the campus of Cal State Dominguez Hills' greatest strength lies in its pedestrian and garden experiences, but Buckner shows only its library. Additionally, some project descriptions, including those for the Daphne Funeral Home in San Francisco and UCLA's Research Library, are inaccurate or imprecise.

If Buckner's book, the first on Jones since the 1983 *Process No. 41*, sparks renewed interest in the architect, perhaps future volumes will examine his plans and architectural thinking more critically.

Early Rudolph

Drawing on the Library of Congress's archive of Paul Rudolph material, Christopher Domin and Joseph King have produced a book that strikes the right balance of criticism, biography, and a visual catalog of projects. It reviews Rudolph's early development in

Florida and makes a strong connection between regionalism and Modernism.

The introduction by Robert Bruegmann, a professor in the art history department at the University of Illinois at Chicago, stresses the importance of Ezra Stoller's photography and how it contributed to Rudolph's visibility in the architectural press and beyond. King's essay introduces a young man fresh out of Harvard who was rapidly promoted to partner in Ralph Twitchell's small regional practice in Sarasota, Florida. King gives us a sense of the ambition that propelled Rudolph beyond the confines of Sarasota and notes that Rudolph's early houses were so simple that he developed an elaborate rendering style to attract publicity before a building was completed. King, an architect who understands the materials and construction methods of Rudolph's unusual beach houses, writes about them clearly and accessibly.

Domin charts Rudolph's path after he left Twitchell's practice and

moved to New Haven. Domin shows how Rudolph—a restless experimenter—wanted to go beyond a rigid Modernism, articulated an interest in history and issues of urban design, and evolved into the "sensualist" whom Ellwood later criticized. Domin also points out that the introduction of affordable residential air-conditioning gave Rudolph freedom to explore new forms and spatial organizations and that he moved toward increased monumentality in his later, widely publicized houses. Success took Rudolph away from a humble but splendid achievement—the modest Modern house that responded to climate and culture.

What emerges from each of these four books is the crucial role of photography in our perception of midcentury Modernism. An essential but imperfect tool, photography has simplified and often distorted history. Telling the larger story of this era will require more focused investigations into its individual architects. ■

varia™ is a material, a tool, and a full palette of creative opportunity. Translucent, frosted and opaque panels consisting of form, texture and color offering complete design freedom.

form
texture
light

varia™

3form™

www.3-form.com 1.800.726.0126

CIRCLE 50 ON READER SERVICE CARD
OR GO TO WWW.LEADNET.COM/PUBS/MHAR.HTML

SEIHO INTERNATIONAL, INC.
120 W. COLORADO BLVD.
PASADENA, CA 91105
TEL: (800)248-0030
(626)395-7299
FAX: (626)395-7290
www.seiho.com
info@seiho.com



PK

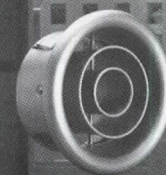

NT

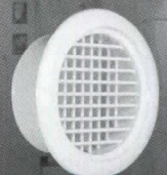

RHV

Our Human Environments Often Require Directed
Tempered, Clean Airflow with Energy Savings

SEIHO

has the Solutions.

CIRCLE 51 ON READER SERVICE CARD
OR GO TO WWW.LEADNET.COM/PUBS/MHAR.HTML

Snapshot



By Naomi Pollock

Located midway between Tokyo and Osaka, the city of Nagoya is a major intersection on the Bullet train's main artery. From there local train lines branch out in all directions, up to the Japan Alps, down to the Japan Sea, and all around the immediate metropolitan area. Because of the large volume of people who traverse Nagoya's extensive transportation network each day, retail outlets and restaurants have cropped up above, below, and around each node, turning many underground train and subway plazas into subterranean shopping malls. Teeming with activity, these underground labyrinths of boutiques, bookshops, bars, and bakeries inhabit their own world, completely cut off from the external environment.

Though a very efficient way to utilize space in a country where buildable land is a precious commodity, the two-tiered system isolates pedestrians from ground-level activities and cuts off contact between people and parks, as well as other civic facilities. Situated between Nagoya Castle and the city's main shopping district, Obayashi Corporation's Oasis 21, a 219,483-square-foot, multilevel urban park, attempts to bridge this gap. "Following the

Intergalactic design at a Japanese urban park

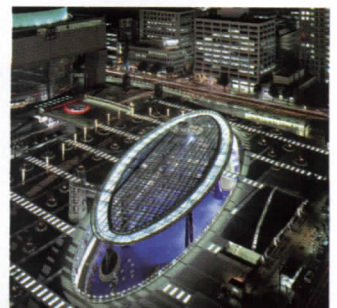



Oasis 21's water-covered roof soars above the plaza (above and right). A 9-foot pedestrian path rings the "Aqueous Starship," allowing visitors to beam up and enjoy the view.

philosophy of traditional Chinese treatment, an acupuncture of a therapeutic point can improve the whole circulation of blood," says Obayashi principal Hideki Kasai.

The winning entry in a closed competition held in 1997 among Japan's five leading construction companies, Obayashi's park design forges a direct connection between the lower level, the ground plane, and the sky above. It consists of three main elements: Galaxy Platform, an 80,729-square-foot, ovoid sunken plaza; Aqueous Starship, a soaring steel frame supporting an oval, water-covered glass roof above the plaza; and a 150,694-square-foot grassy park at grade abutting a bus terminal. While wheelchair-friendly slopes, stairs, and elevators connect Platform and park, a separate elevator and stair beam visitors up to the top of the Starship, 46 feet above grade, where a 9-foot-wide pedestrian path rings its water-covered glass roof.

The scene of concerts, open-air markets, and other civic events, Galaxy Platform is a welcome escape hatch in the vortex of existing underground shops that spin out from its perimeter in every direction. But the main purpose of the development is to reconnect the underworld with the natural world by letting fresh air, daylight, and sky views filter down, underscoring seasonal change with the park's pink cherry blossoms in spring and maple trees' autumnal hues, and drawing attention to ever-changing daylight with the Starship's water-covered glass roof. ■

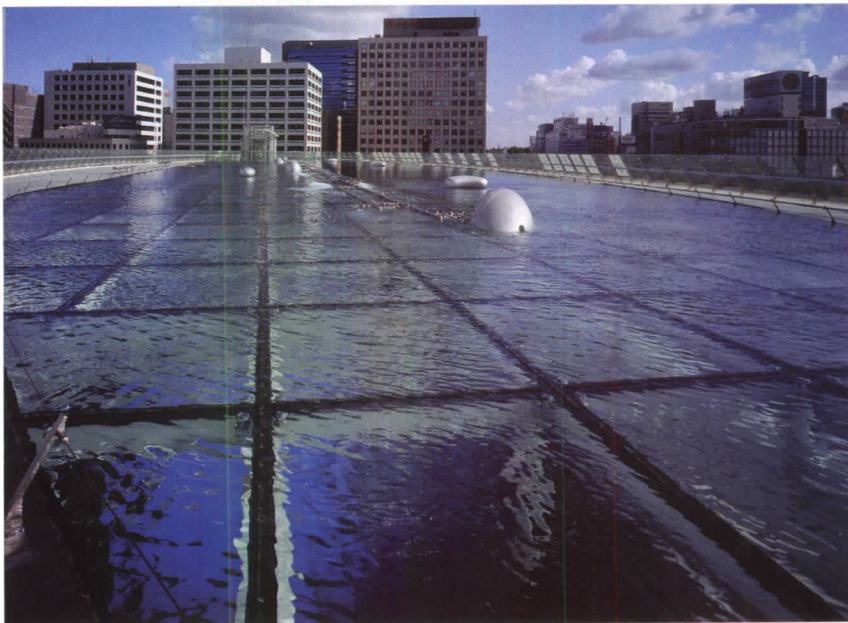



G-P Gypsum 
a Georgia-Pacific company



DensArmor Plus™ features a glass mat surface on *two* sides for the ultimate in interior protection. And, at G-P, we think that's a healthy change that will be appreciated for generations to come.



 **DENSGUARD**



DENSARMOR
Interior Guard

 **DENSGUARD**



DENSARMOR PLUS
Interior Guard



Protect what you create.™

WWW.GP.COM/GYPSUM

G-P TECHNICAL HOTLINE: 1-800-225-6119

© 2002 G-P Gypsum Corporation. All rights reserved. DensGlass Gold, DensArmor and DensArmor Plus are registered trademarks of Georgia-Pacific Corporation.

When tested in accordance with ASTM D 3273.

CIRCLE 54 ON READER SERVICE CARD OR GO TO WWW.LEADNET.COM/PUBS/MHAR.HTML



Architecture as image-maker: Wise clients work with

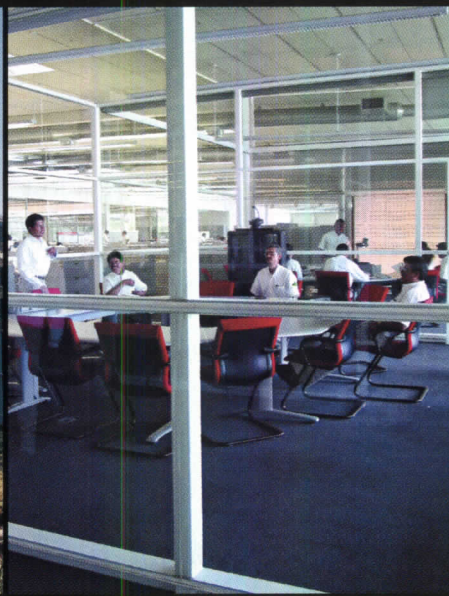

"At Valeo, we are convinced that architecture is a component of productivity, and we strive to give personnel the best conditions to achieve excellence."
—Jacques Tillement, director, Valeo Group Property.

By Jane F. Kolleeny

What fuels the engine that powers the architect's world? Clients do. Even so, architects fail to understand that the primary objective of their clients is rarely design itself, but the use of design to further their product, service, or domestic goals. In a survey conducted by AIA this year entitled "The Client Experience," two definitions of design were offered in the summary: "To clients, *design* is a noun; it's the tangible thing that architects create. To architects, *design* is a verb; it's a process and mindset." Understanding this fundamental difference of perspective is key to the client/architect relationship.

Winners of the Business Week/Architectural Record (BW/AR) awards seem to have a talent in bringing together these two definitions of design. Indeed, how architecture promotes or fulfills the stated goals of a client is the single most important criterion for winning the award, and the unique collaboration of architect and client is the process that fuels it. The goals of clients vary. They can be economic, demanding a building

that increases production and translates into increased profits. They can be iconic, used to convey a message about the client either to the public, the workforce, or both. We see that one corporate goal usually spills into another—they are not discrete. A better environment leads to increased production because employees are happy.

BW/AR award winners must provide tangible evidence, such as measurable change, that illustrates the ways such goals were accomplished through architecture. Such positive outcomes don't simply arise by magic. We usually find that a notably harmonious relationship between architect and client underlies these results. Stan Askew, president of Allsteel, a winner of this year's BW/AR award, says, "Designers who tell you they know the answer don't have the answer. It's been our experience that the designers who take time to listen to you and be part of the team are successful."

Using architecture to convey a new story to the public

BW/AR finalist Ing Direct, a European banker, used architecture as a pow-

architects to build success

Clients fuel
the engine that
powers the
architect's world

FEATURES

erful tool to reinforce its brand. Being virtually unknown in North America, the company knew it would go unnoticed if it launched in the conventional way. Highlighting its differences from traditional banking, in its first Midtown Manhattan bank Ing replaced the expected row of tellers with an upbeat café featuring coffee, drinks, and food, free Internet access, and branded merchandise in a modern, trendy setting. The scale and feel of the café and the colorful orange neon exterior sparks the curiosity of potential customers, drawing them inside. There visitors discover an entirely new way to conduct banking. They sit down, order a latte in the familiar ambience of a coffee bar, and discuss banking with the friendly banking/wait staff. An enticing environment, designed with meticulous care by Gensler, becomes a showcase for selling banking services.

In the first quarter of the year, retail sales in the café boomed, exceeding projections by 73 percent, and business grew from \$4 billion to \$7 billion. Underlying this success is a highly effective relationship that evolved between Ing and Gensler. According to Jim Kelly, executive V.P. for sales, “We needed someone to interpret our vision. Gensler listened and listened, then listened some more. They got under our skin. They probed our tastes for

colors, design, furniture, merchandising, and brands. Then they presented their ‘Big Idea,’ and we knew we had partnered with the right firm.”

While architects are known to be great problem-solvers and innovators, they also have a reputation of being ego-driven and not cooperative team players. Architects that “stop doing what they do and think about what their client does,” says Frank Stasiowski of PSMJ Resources, can open the door of opportunity. In this case, Gensler knew that design would pay off if they tuned in clearly to the business goals of the client, rather than imposing a fixed view.

Putting the employees first

Most call centers are like dungeons—they are often converted warehouses—windowless, impersonal. Cellular Operations knew they needed a call center that would keep its young and restless workforce gratified. What to do? Through the clever architecture of Richard Hywel Evans in London, the firm created an environment that is irresistible to its employees. According to company chairman Richard A. Lee, “Inside, the open-plan layout, with a large breakout area, gives a buzz to the atmos-

“As a start-up brand with zero name recognition in the crowded U.S. market, Ing Direct had to make a refreshing new statement. The café arose out of that thinking.”
—Jim Kelly, executive vice president of sales, Ing Direct.



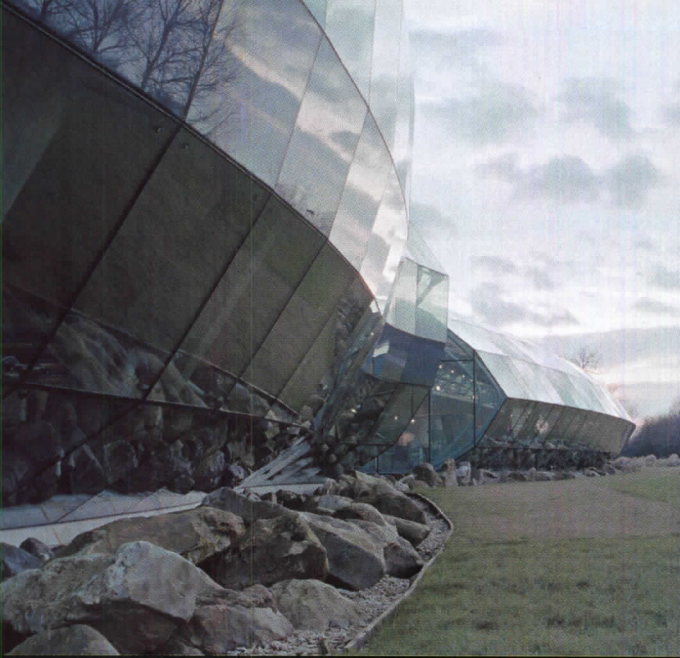

“We set out to create an extraordinary building for the price of a shed. We didn’t succeed totally, but we delivered something extraordinary for 20 percent more than a warehouse.”
—Richard A. Lee, chairman, Cellular Operations.

FEATURES

phere. We deliberately put in features to make the staff smile. There are no indicators for the elevator to tell you what floor it is on, unless you look at the height of the fountain outdoors, visible through a glazed wall, which follows the elevator’s movement up and down. The elevators themselves respond to the presence of a body like a burglar-alarm sensor, the stairs look like the skeleton of a dinosaur, there are tea trollies with real tea servers to serve employees, and themed toilets are available for use, so you can pick the one that suits your mood.”

While the company’s focus was on pleasing employees, the concept caught on with potential distributors, dealers, suppliers, and business partners, who became keen to work with them. Celebrated in the national press as the happiest work place in the country and utilized by the government to promote progressive environments, Cellular Operations is now the second-largest independent cellular service provider in England.

Good design wins when in the final analysis it brings more value. “The corporate client is likely to measure value in terms of specific productivity and revenue generation and subjective things like image enhancement and attraction of talent,” says Hugh Hochberg, partner in The Coxe Group,

marketing and management consultants to the design professions.

Cellular Operations did all these things for sound economic value—to keep their employees happy. “You can hear if someone’s smiling when they answer the phone, and that makes a good impression with the customer. If your staff is happy, it’s far more likely to stay, which cuts down recruitment and training costs and provides a stability and continuity for business,” explains Lee. And cut costs they did—staff turnover decreased by 50 percent.

Using architecture to enliven a name

A leading retailer of merchandise for children, Toys “R” Us turned the tide on what was a fairly utilitarian approach to the marketplace when they opened their flagship in Times Square, New York City, in 2001 and used architecture to reposition themselves. Allowing the store to resonate with the prevailing flash of 42nd Street was an audacious approach. Designed by Gensler, it has become a display case for conveying a new direction, complete with celebrity appearances, new product launches, and author and product signings. Using an unprecedented combination of innovative

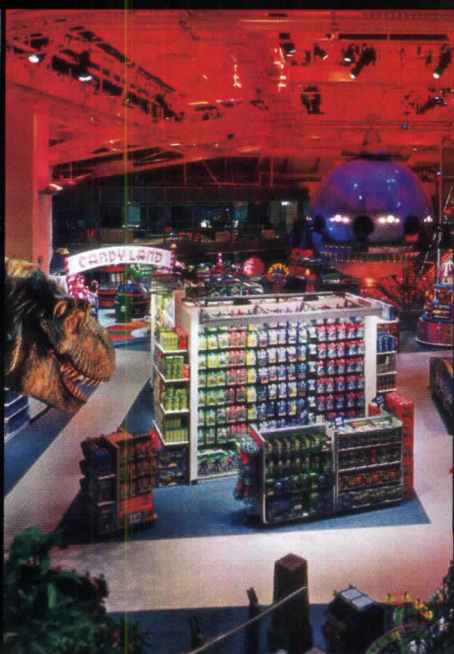

“The planning process involved formulating special interior, exterior, and scroller teams to attack those aspects of the design. Each team shared their progress in a weekly project meeting.”
—David Picot, V.P., real estate, design, and construction, Toys “R” Us.

retail design, entertainment architecture, and groundbreaking graphic communication, the store has become a premier destination for visitors, exceeding 5 million since opening. Its product sales are also up, and every major news outlet has covered the store. Its success has evidently awakened its executives to the power of place, because they intend to refocus their stores nationwide in a like-minded fashion.

For architecture to take such a central role in branding, “you need a client who believes in the project goals and objectives from both a business and design perspective,” says David Picot, Toys “R” Us V.P. of real estate, design, and construction. On this project, architects, engineers, and designers were part of the client team from the beginning. “Pride of authorship must be set aside to demonstrate flexibility and response to the client’s overall program,” says Williston Dyre in his article “Activity vs. Solutions: What Matters to Your Client?” in the June 2002 issue of *Design Intelligence*.

So, too, clients must understand and convey their needs. “Clear communication is necessary on the client’s part, not only regarding the program requirements, but all the other factors that are important to the

firm’s facilities during a period of phenomenal growth. The understanding and shared aspirations of both parties were in place long before the current project was undertaken, which was the largest to date for both of them.

In these cases, architects have become trusted advisers, instrumental in their clients’ strategy during the planning stages. Architects are not often involved in the predesign stages of projects, which are usually handled in boardrooms among client executives, well before an architect joins the team. “The skill sets that make architects flourish during the design phase would enhance the project as a whole if architects could apply them during other phases,” concludes AIA in their survey—but, typically, clients perceive architects as designers, not strategists.

Till death do us part

“It costs six to eight times more to obtain a new client than it does to keep one. If service firms evaluated the cost of losing clients, they would concentrate more on keeping their current clients,” noted Theresa M. Casey as early as October 1996, in “Client Relations Programs,” *SMPS Marketer*. Indeed,

“This is the third and largest set of kitchens we have designed over our twelve-year history with the architect, and our collective experience has resulted in a layout that is enormously efficient and productive.”
—Gael Towey, creative director, Martha Stewart Omnimedia.



final decision maker(s)—image, style, maintenance, philosophy, culture, and so on—and then ongoing feedback between the client and design team during the conceptual phase,” advises Kerry Harding of Talent Bank, the architecture business consultants.

Architect as a trusted adviser

Second-time BW/AR finalist Valeo Electrical Systems had already worked with its architect, Davis Brody Bond, on a technical center in Auburn Hills, Michigan [RECORD, October 2000, page 88]. So, while this latest project—Valeo Production Facility in Mexico—was quite different in scope, the firm had a prior, established relationship with the designer. As part of the initial design process, the architects attended a series of brainstorming and design workshops at corporate headquarters in France with the client team leaders, user groups, and budget personnel.

Martha Stewart Living Omnimedia, another finalist, had been working with its architect, Daniel Rowan, since the company’s inception in 1989. Rowan had been integrally involved in the strategic planning of the

architects are well aware of the value of repeat clients but don’t always know what it takes to keep them. If architects remain steady with clients through thick and thin, accepting less interesting commissions between larger ones, being available during construction and post-occupancy, becoming client-centric in outlook rather than project-centric in their business development overtures, they can learn the client’s business and gain their trust over time. Certainly, the examples used above provide positive models to emulate.

Each architect/client relationship we have explored takes its own evolutionary journey, arriving at a final, unique solution. The collaborative process itself is at the heart of successful outcomes. It’s not that the architect or the client dictates an answer, but an organic process evolves where every step along the way contributes to an eventual outcome that goes beyond the dictates of architecture and relates to the fundamental *raison d’être* of the client’s existence. In “Understanding Client Relationships,” in the August 2000 *Design Intelligence*, Robin Ellerthorpe, FAIA, stated, “The winners are those firms that looked out for the long-term relationships, who performed every task as an opportunity to excel in working with their client.” ■

Give Us Measurable Business Results

AN AWARD
THAT ASKS
HOW GOOD
DESIGN
CONTRIBUTES
TO THE
BOTTOM LINE

This is the sixth year of the Business Week/Architectural Record awards program. As has been true from the beginning, the award is about how architecture enhances business strategy. In the words of juror Chee Pearlman, "Architecture becomes part of the business plan, necessitating intimate collaboration between architect and client at the very top levels of decision making."

Other trends became evident this year. The jurors reviewed 164 applications, honing that list down to about 20 comprising the winners and finalists, all of which were visited by members of the jury. While winning projects are not necessarily offices, this year the majority were—11 of the 18 finalists. One important theme among winners was the role of community in the workplace. This sense of community is evident in the emphasis on horizontal organiza-

6th Annual Business Week/Architectural Record Awards

This unique awards program judges entries on the basis of their architectural excellence and the degree to which they advance the owners' goals. Entries include information on the

results realized by each project. The jury is selected by Business Week, RECORD, and AIA (the sponsor) and includes architects, academics, critics, and business leaders. After the jury

narrows the entries to about 20, at least one juror visits the sites. For more coverage, see the November 4th issue of Business Week or go to www.architecturalrecord.com.

2002 AWARDS JURY

- **Lawrence Edge**, President, World Development Federation
- **Steven Goldberg**, FAIA (chair), Partner, Mitchell Giurgola Architects
- **Dr. Michael Hammer**, President, Hammer & Company
- **Jon Jerde**, FAIA, Chairman, Founder, The Jerde Partnership
- **Toshiko Mori**, AIA, Toshiko Mori Architect
- **Tim O'Brien**, Vice President, Real Estate, Ford Motor Company
- **Chee Pearlman**, Chee Company
- **Cathy Simon**, FAIA, Principal, SMWM
- **David A. Thurm**, Vice President, Real Estate Development, New York Times
- **Robert Vanech**, Principal, ETF Group

JURY DESIGNATES

- **John D. Rees**, Principal, The Rees Group

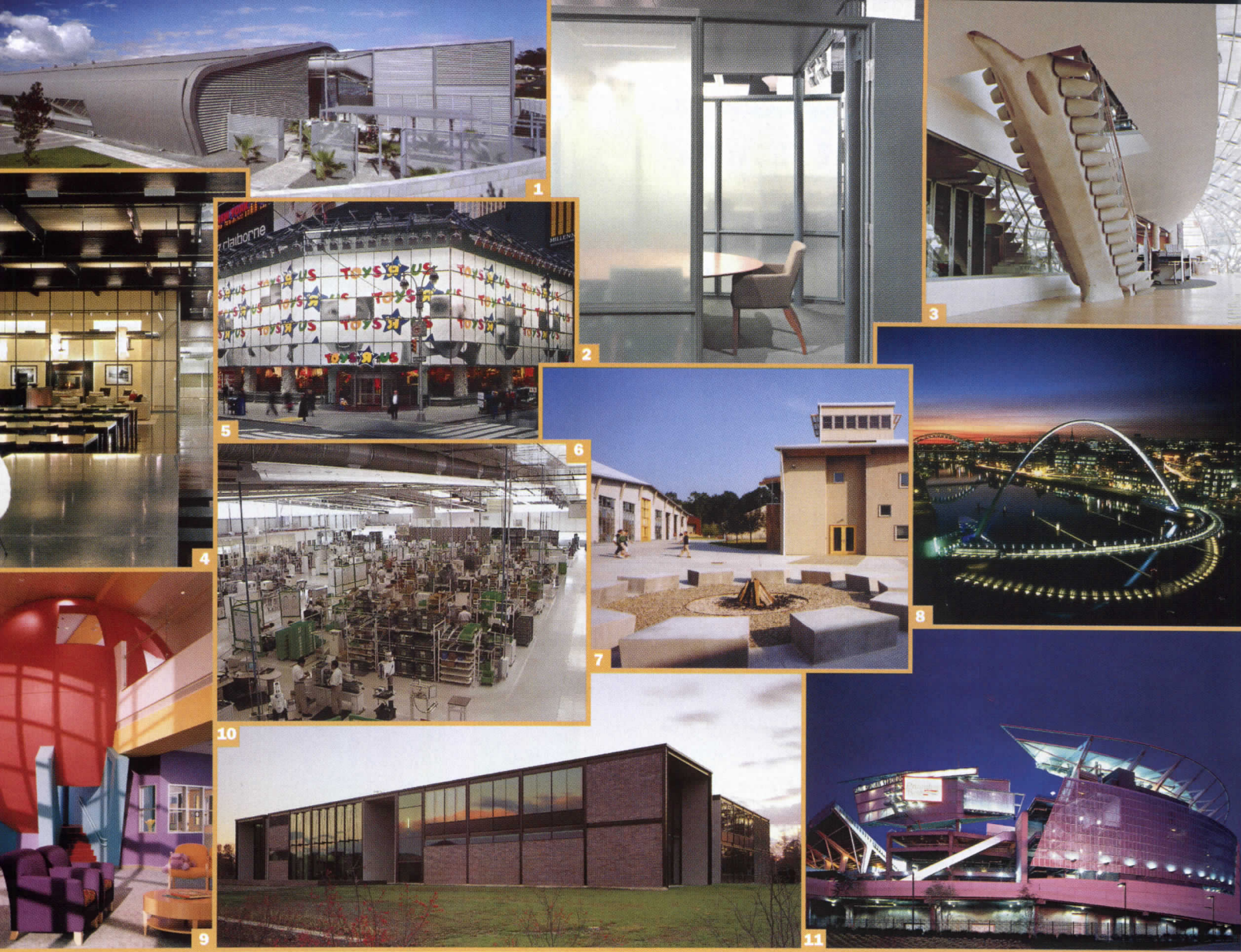

tion, where segregation and hierarchy are minimized and employee empowerment and lifestyle enhancement are encouraged. Juror Cathy Simon remarked that “in a world where more and more employees can work independently, the need for community is ever stronger. Every project is about visibility and transparency, which is also a metaphor for the companies that built these buildings. It seems to me a wonderful affirmation of the need that people as social creatures have to come together, now more than ever.”

Branding was often at the forefront of winning projects. On this topic, Robert Vanech remarked: “It isn’t one size fits all, but each project captured something special—like Allsteel, which captured an honest Midwest manufacturing environment.” And what made the winners stand apart this year? In Toshiko Mori’s words, it was “the degree of aspiration that both client and architect displayed and the risk they shared. They actually dreamed a dream and shared a vision; they became personally accountable, took chances, made a commitment.” The winners, as if by sheer force of nature, rose to the top effortlessly. Coverage of winners, finalists, and unbuilt-project-award winners follows.—*Jane F. Kolleeny*

1. **Multi-Use Centre**
Photo: © Kim Christensen
2. **University of Pennsylvania Dept. of Facilities and Real Estate Services**
Photo: © Barry Halkin
3. **Cellular Operations Headquarters**
Photo: © John Mclean
4. **Allsteel Headquarters**
Photo: © Chris Barrett/Hedrich Blessing
5. **Toys “R” Us**
Photo: © Peter Paige Photography
6. **Valeo Electrical Systems**
Photo: © Jaime Navaro
7. **Abercrombie & Fitch Headquarters**
Photo: © Anderson Architects
8. **Gateshead Millennium Bridge**
Photo: © Graeme Peacock
9. **Texas Children’s Hospital Clinical Care Center**
Photo: © Craig Dugan/Hedrich Blessing
10. **Trumpf Customer and Technology Center**
Photo: © Paul Warchol
11. **Paul Brown Stadium**
Photo: © Tim Griffith

AN OPEN ENVIRONMENT FOSTERS CONNECTIVITY AMONG STAFF

Program: The client wished to create an innovative office environment that would respond to the workplace, as well as the recreation and leisure needs, of its employees, while fostering interdepartmental communication, increasing production, breaking down hierarchies, and providing gathering areas to stimulate creativity. The architects worked closely with the client to bring new ideas to a traditional multiuse environment that includes a 24/7 call center, software development operations, and IT infrastructure. Concepts were researched, developed, and tested. The team held charrettes, brainstormed, and critiqued. User focus groups were convened for feedback and ideas.

Solution: The resulting design is based on an open-plan office to engender comfort, good cheer, productivity, and inspiration. The plan organizes teams around a central common area for meeting, work, and social gathering. This central “park” idea and café are the hub for the office community. The solution is fun, captures the spirit of the place, and is being used with considerable enthusiasm. Traditional hierarchies are physically broken down to reflect the new image and culture. Post-occupancy evaluation has shown an increase in verbal communication (less e-mail by 30 percent), staff turnover reduction of 50 percent, and a 10 to 15 percent faster software development delivery.

“What stands out about this project is the collaborative effort undertaken among all disciplines involved, including the end users.”

—LAWRENCE EDGE, PRESIDENT, WORLD DEVELOPMENT FEDERATION



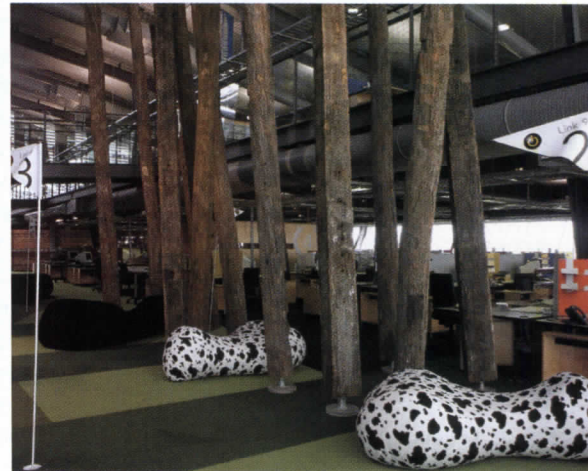

PHOTOGRAPHY: © KIM CHRISTENSEN PHOTOGRAPHER

Project: Multi-use
Centre, Albany, Auckland,
New Zealand
Architect: JASMAX
Limited, in association
with Blich Voller Nield
Client: Dominion Funds
Key players: Jacob
Consulting (structural);
Lincolne Scott New
Zealand (building services)

A PIONEERING MOVE ENLIVENS A MARGINALIZED CAMPUS AREA

Program: Facility departments at universities typically inhabit uninspiring spaces, and the University of Pennsylvania facilities was no exception. Overcrowded and dispersed among several buildings, the department needed to reshape its image and improve its function. It underwent a major restructuring, intending to demonstrate with its new quarters the value of good architecture and planning in an academic environment. Utilizing the track level of a massive abandoned 1929 railroad warehouse on the eastern end of the campus, the client consolidated the scattered parts of the department into this industrial facility. Additionally, the project revived a vacant industrial quarter of the city, extending the campus boundary eastward toward downtown, providing a center for future development.

Solution: The architecture of this new space is a celebration of the industrial character of the warehouse. The project has brought positive energy to what was previously an undesirable edge of campus, and the perception of the department by the architectural, university, and business communities has significantly improved. The project's success is evident on many levels: A post-occupancy survey revealed increased morale and improved communication, and administrators report greater ease in recruiting and retaining personnel.

“This rather humble and modest project makes many, many inventive moves, with an amazing facility as a cumulative result.”

—TOSHIKO MORI, ARCHITECT



Project: University of Pennsylvania, Department of Facilities and Real Estate Services, Philadelphia
Architect: MGA Partners, Architects
Client: University of Pennsylvania
Key players: CVM Engineers (structural); Marvin Waxman Consulting Engineers (mechanical)

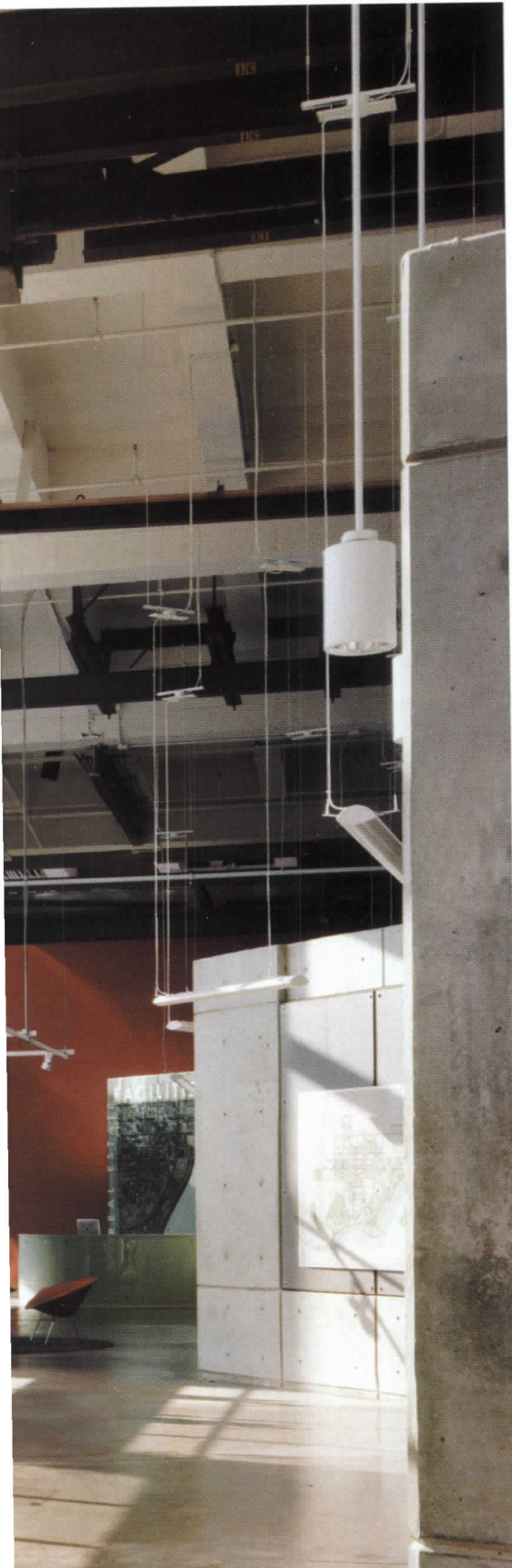

PHOTOGRAPHY: © BARRY HALKIN

FANCIFUL DESIGN MAINTAINS THE INTEREST OF THE YOUNG AND RESTLESS

Program: Cellular Operations' staff were overcrowded and spread out among four buildings, making communication difficult. In addition, a youthful workforce in a fast-changing industry created huge staff turnover. The company wanted an exciting place where employees enjoyed their work, and an open office plan that encouraged information dissemination and serendipitous meetings. Lastly, the firm wished to exceed its place as fourth- or fifth-largest in its industry in England. Knowing that architecture could help to achieve these goals, the company sought a building of exceptional design.

Solution: An open-plan layout with a large breakout area was designed to add a buzz to the atmosphere of the offices. Whimsical features in the design cheer up the staff, including stairs that look like the skeleton of a dinosaur, tea trolleys with real tea servers, elevators that operate with a sensing device, and themed toilets. If your employees are happy, they're far more likely to remain on staff and respond in a friendly fashion to customers, cutting down on recruitment costs and providing stability for the business. The building has also had a major effect on potential distributors, dealers, and suppliers, now keen to work with the firm. Lastly, since the redesign, the company has dwarfed the competition, becoming the second-largest provider of cellular phone technology in England.

“The building has lighthearted elements as relief and as a sign that employees are important and the building is for them.”

—DR. MICHAEL HAMMER, PRESIDENT, HAMMER AND COMPANY

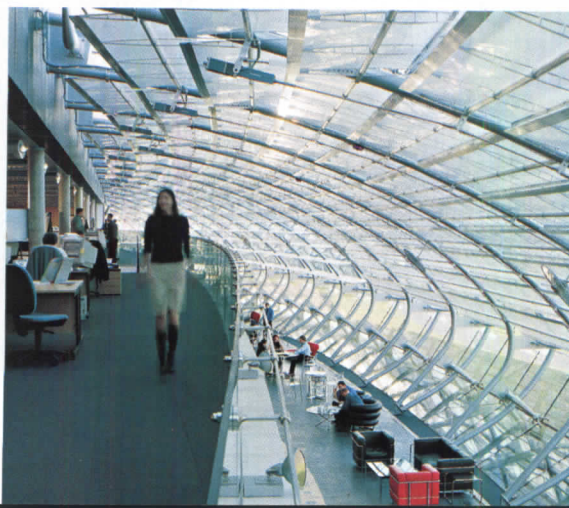

Project: Cellular Operations Headquarters, Swindon, England
Architect: Richard Hywel Evans Architecture and Design
Client: Cellular Operations
Key players: Buro Happold and Curona Design (engineers); Tilbury Douglas (general contractor)

I live in a colorful world with VPI.

Let's face it...sometimes a standard color line is just a starting point. It's nice having a company like VPI that works with me to make the base and tile blend into the space. VPI treats me like a person, not a purchase, and they handle my business with care and attention to detail. The same way I design my environments.

Free your imagination and quench your thirst for color with VPI. We have 41 delicious wall base colors in our designer palette and 17 standard colors in our ESD tile line. Plus we'll custom match any other color. So why go anywhere else?

Architects who care about detail spec VPI.

Karen Glaser
Senior Professional Associate, HDR

Precision Design to Last a Lifetime

3123 South 9th St.
Sheboygan, WI 53082-0451

800-874-4240
Tel: 920-458-4664
Fax: 920-458-1368



CIRCLE 55 ON READER SERVICE CARD
OR GO TO WWW.LEADNET.COM/PUBS/MHAR.HTML

www.vpiflooring.com



MIDWESTERN VALUES ARE THE HEART OF THE ALLSTEEL MESSAGE

Program: Seeking to reestablish a century-old identity separate from a new parent corporation, this office-furniture manufacturing company wanted a facility representative of a new company mission. In addition, the client wished to create a collaborative work environment that reflects its brand and communicates design sensitivity to the architecture and design community, while expanding its existing client base. The company's core midwestern values—honesty, fairness, and respect—formed a strong foundation from which to build the new business culture, but it realized that dramatic innovations were needed to effect substantive change.

Solution: The company purchased a 65,000-square-foot abandoned factory with the intention of uniting its scattered employees (referred to as "members") into one headquarters facility. Through signage, office-plan layout, and display, a nonhierarchical culture evolved that was transparent both to the staff and to the public while capturing the essence of the new brand and helping the company establish direction. Since opening in 2000, the firm has had 364 visits from dealers and potential end users—compared to 15 in the prior year—and 90 percent of all such visits resulted in new business. Corporate accounts have grown from 3 to 15 percent of the company's business in the past year, and product delivery time has been cut from 24 months to 16 months.

"I was deeply struck by the humility of the message throughout the company—one of warmth and community."

—CHEE PEARLMAN, DIRECTOR, CHEE COMPANY





Project: Allsteel Headquarters, Muscatine, Iowa
Architect: Gensler
Client: Allsteel
Key players: KJWW Engineering Consultants, and Martin & Whitacre Surveyors & Engineers (engineers); Knutson Construction Services (general contractor)



ENTERTAINMENT RETAILING IS THE NEW BUZZ WORD AT TOYS "R" US

Program: In an effort to increase its recognition in a highly competitive field, Toys "R" Us decided to reposition itself with the introduction of a flagship store smack in the middle of glitzy Times Square, New York City. The company wished to have a landmark store that would serve as an exciting geographic and emotional destination for customers and products, a "Center of the Toy Universe," as the firm put it, that would pull out all the stops to create an exciting experience for customers and new opportunities for vendors to display and launch products.

Solution: The site consisted of two older theaters requiring extensive renovation. Billboards on the roof that generate significant income for the landlord had to remain intact. To meet a completion goal set for the following year's holiday season, design and construction had to occur in 18 months. Making a splash in media-rich Times Square was a challenge. A high-tech signage system covers the entire facade of the building. Lining translucent windows, 165 scrolling panels display up to eight changing images. Through an unprecedented combination of innovative retail design, entertainment architecture, and groundbreaking graphic communication, this store has become a premiere destination. Media coverage, visitors to the store, and revenue from advertising have all exceeded expectations.

"I go to Manhattan every year with my kids and take them to F.A.O. Schwartz. This year I'm going to Toys 'R' Us." —ROBERT VANECH, PRINCIPAL, ETF GROUP

Project: Toys "R" Us, New York City
Architect: Gensler
Client: Toys "R" Us
Key players: J. Newbold Associates (interior them-
 ing); Gilsanz, Murray, Steficek (structural); FMC Associates (mechanical, electrical); Show & Tell (scroller system technology); Focus Lighting (lighting)

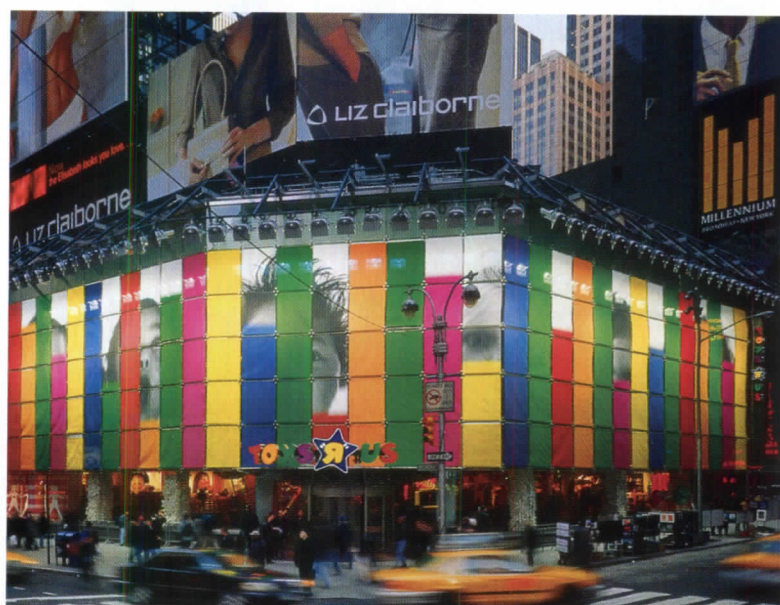

Beauty and protection. Acrovyn® Wall Panels gives you both.

For years, Acrovyn Wall Panels have been the brand of choice. Today, we offer more than just Acrovyn!

C/S Renaissance Panels offer the beauty and warmth of real wood, or the high tech look of stainless steel. All panels can be mounted permanently, or on our demountable track systems.

No other system can match the versatility of Acrovyn Wall Panels. For free literature call 888-621-3344.

Acrovyn Panels available in a wide array of colors and finishes. Acrovyn Metal Panels offered in a variety of textures and finishes.

C/S Acrovyn Wall Panels

CIRCLE 56 ON READER SERVICE CARD
OR GO TO WWW.LEADNET.COM/PUBS/MHAR.HTML

What's New

Check out the all new www.c-sgroup.com

It's the most comprehensive web tool for the A&D community.

THE BUILDING AS A METAPHOR FOR THE OWNER'S PHILOSOPHY

Program: One of the world's largest suppliers of automotive equipment, Valeo saw an opportunity to enhance its production by responding to a major shift in auto production in Mexico and locating a plant in close proximity to its clients there. The company's decentralized structure, consisting of nine industrial operating units and more than 100 autonomous divisions, has created a unique corporate philosophy of equality and communication among workers by eliminating hierarchies and integrating departments.

Solution: A new, 178,000-square-foot facility for the design, fabrication, and testing of electric motor parts for automobile manufacturers was created to foster and maintain the company's horizontal philosophy, to integrate previously separate divisions, and to accommodate expansion that has already doubled the size of the facility. The project was designed and constructed in 10 months at a cost of \$66 per square foot. Featuring a long-span, column-free structure using a modular tensile exoskeleton, the architects demonstrated that the increased cost of such a structure would be offset by the resulting efficiency. The plant has allowed the company to grow and consolidate its operations and has supported its mission to find innovative methods to increase production and reduce costs. Also, its 1 percent turnover rate for employees is considered a benchmark in Mexico.

"It's a clean plant, it's well-organized, exceedingly flexible. The architecture really feeds off that and then reinforces it."

—DAVID THURM, V.P., REAL ESTATE DEVELOPMENT, NEW YORK TIMES



Project: Valeo Electrical Systems, San Luis Potosi, Mexico

Architect: Davis Brody Bond

Client: Valeo

Key players: Arup (engineers); Lidxi Biaani (lighting); Contreras y Asociados (general contractor)



Even the outside of Dean and Deluca® is appetizing.



Sunbrella Firesist® and GLEN RAVEN are registered trademarks of Glen Raven, Inc. • SEF+ is a trademark of Solutia.
Dean & DeLuca® is a registered trademark and is used with permission. Awning fabrication by Plastex, Charlotte, NC.



The culinary masters at Dean & DeLuca® feel that choosing the finest ingredients, even for building design, is vital. That's why Sunbrella Firesist® fabric was the obvious choice. It's woven from SEF+ self-extinguishing modacrylic fibers giving superior flame retardancy. So it meets the strictest fire codes. It also resists fading, because the colors are locked-in. And, with over 25 styles and colors to choose from, you're sure to find one that suits your taste.

To find out more, contact your local awning dealer or Glen Raven Custom Fabrics, LLC, Glen Raven, NC 27217. Or visit our website at www.sunbrella.com. Insist on Sunbrella, there is no substitute.



Awnings & Canopies • Patio & Deck Furniture • Boat Tops & Covers

CIRCLE 57 ON READER SERVICE CARD
OR GO TO WWW.LEADNET.COM/PUBS/MHAR.HTML

A BUCOLIC CAMPUS CATERS TO YOUNG TRENDSETTERS

Program: The original offices for Abercrombie & Fitch were generic and nearly windowless; their identity was not expressed beyond a sign in the lobby and a few images placed around the interior. Both client and architect wished to create an environment for employees where they would experience a world that both reflected the brand and would play a significant role in shaping it. They sought a workplace to stimulate interaction and innovation, a place of natural beauty that could be used to recruit talent.

Solution: A rural site in Ohio with 300 acres of woodland was selected for the new headquarters. Its natural beauty was the perfect setting for offices that could mingle with the landscape and offer scenic views to the outside. From the parking lot to the offices, employees weave their way on narrow wooded paths that lead to a boardwalk and wood-trussed entry. At the entrance, one experiences the character of the new headquarters' brand. Open workstations promote interaction among staff and encourage collaboration. Work areas are designed as an easily adapted kit of parts. Areas for work and play coexist throughout the campus. The offices are open-ended, informal, hip, and democratic. The project has enabled the client to grow and has become a sought-out place to work among young trendsetters.

“Abercrombie & Fitch epitomizes the trend of capturing the brand—which here is clearly a youth brand—in the design work.”

—TIM O'BRIEN, V.P., REAL ESTATE, FORD MOTOR COMPANY

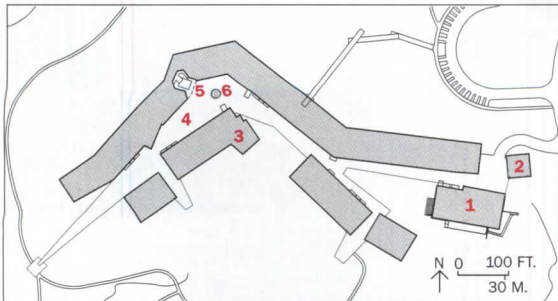
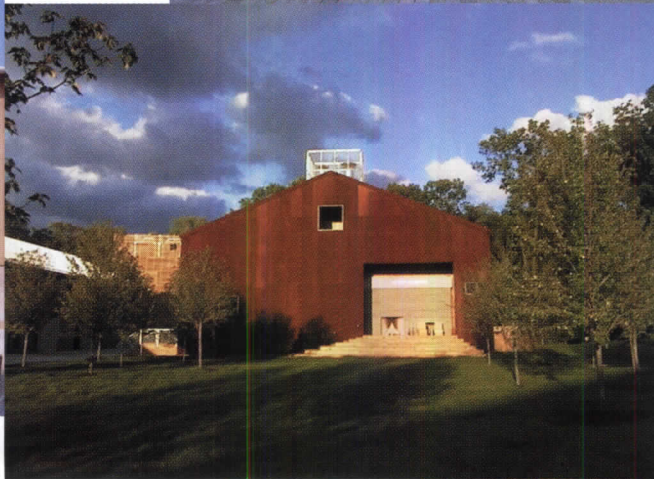

- 1. Rusty barn/dining
- 2. “Tower of Power”
- 3. Tree house
- 4. “The Street”
- 5. “The Bite”
- 6. Fire pit

Project: Abercrombie & Fitch Headquarters, New Albany, Ohio

Architect: Anderson Architects; NBBJ (associate architect)

Client: Abercrombie & Fitch

Key players: M-Engineering (mechanical, electrical)





Team power.



Designed for high performance and reliability. Tested and proven by leading CAD-ISV partners, an Evo Workstation W8000, from the new HP, with the latest Intel® Xeon™ Processor simply makes things happen. These powerful Microsoft® Windows® platform machines will give your engineers some concurrent quality time. Now fully functional prototypes, more efficient 3D design, and Web-based project management and collaboration stand at-the-ready. For CAD solutions, put an HP Evo Workstation on your team. It will be high fives all around.

**To equip your team for victory,
visit www.hp.com/go/evoworkstations
or call 1-800-888-0414**



The Power of
MACROPROCESSING



HP PCs use genuine Microsoft® Windows®
www.microsoft.com/piracy/howtotell

©2002 Hewlett-Packard Company. During the HP/Compaq product transitions, some HP workstation products and packaging may be labeled with the Compaq brand. Intel, the Intel Inside logo and Xeon are trademarks or registered trademarks of Intel Corporation or its subsidiaries in the United States and other countries. Screen image courtesy of EDS PLM Solutions. EDS and Unigraphics are trademarks or registered trademarks of Electronic Data Systems, Inc.

BEAUTY AND INNOVATION ARE UNIFIED IN THIS GRACEFUL BRIDGE

Program: Through an international competition, an architect/engineer team was chosen with the specific intent of making a bridge that would attract worldwide attention. The city of Gateshead, England, sought an enduring image to regenerate the area, attract local support and media coverage, and embody something unique and innovative to raise its profile on the international stage. The solution needed to fulfill the complex functional, operational, contextual, and visionary aspirations of the client, who was driven by the need to succeed over competing projects for essential and limited national funding.

Solution: Linking Newcastle with Gateshead over the River Tyne, this bridge provides a footpath and cycle way joining ambitious new arts and cultural developments on the south bank of the Tyne, called Gateshead Quays. Gateshead Millennium is the world's first rotating bridge and has generated worldwide interest because of its unique design. It has also received significant media coverage and was noted as one of the innovations of the year in *Time Magazine*. Local pride and continued international interest have caused the client to state that the bridge has unequivocally fulfilled and even surpassed each of its established objectives. But the ultimate measure of appreciation is that thousands of people cross the bridge each week despite the present lack of any obviously compelling destination on the other side.

“As an act of kinetics, it’s quite extraordinary; and as a thing sitting in place, it’s absolutely beautiful.”—JON JERDE, FAIA, CHAIRMAN, THE JERDE PARTNERSHIP

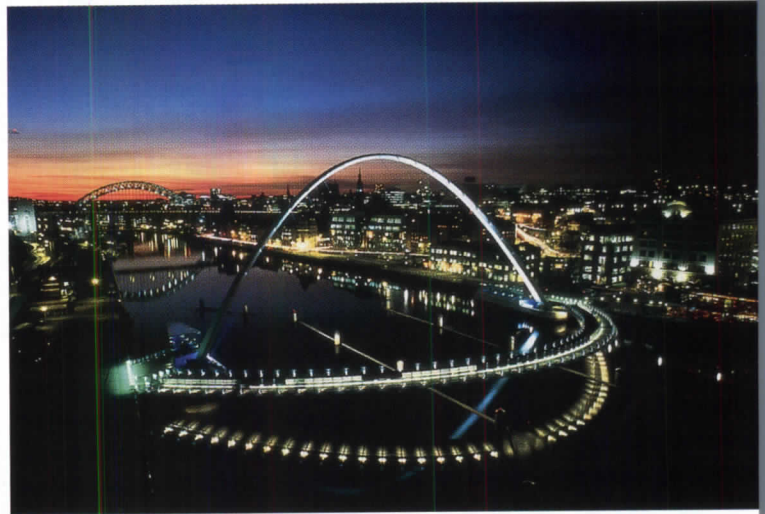

Project: Gateshead Millennium Bridge, River Tyne, England
Architect: Wilkinson Eyre Architects
Client: Gateshead Council
Key players: Gilford and Partners Consulting Engineers (engineers); Kvaerner Markham (mechanical, electrical, and hydraulic); Harbour & General/Volker Stevin (general contractor)



DISCOVER THE
ARTISTRY BEHIND
EVERY DOOR.

IWP crafts exceptional solid wood doors to complement many architectural styles. In addition, we offer a variety of options and custom capabilities to suit your needs. Please visit us to learn more.



World's Finest Doors
Part of the JELD-WEN family

(800) 877-9482 ext. IWP 3
www.iwpdoor.com

CIRCLE 58 ON READER SERVICE CARD
GO TO WWW.LEADNET.COM/PUBS/MHAR.HTML

A HOSPITAL CELEBRATES CHILDREN WITH PLAYFUL, COLORFUL WHIMSY

Program: This 41-year-old pediatric institution realized it needed a new facility to meet its business goals in a changing health-care environment. In addition, it wished to improve conditions for its young patients. The client sought increased space flexibility for growth and efficient use, easy conversion of space to accommodate future needs, better wayfinding, an increase in the productive use of staff, and satisfied customers. Five distinct groups were instrumental in the decision-making process—the administrators, physicians, user groups, parents, hospital trustees, and architects.

Solution: Clinic floors are organized around a two-story, color-coded play area, featuring bold geometric shapes, which assists with wayfinding and also serves as the central check-in and recreation area for children. The team redefined work groups and reengineered staff roles to improve efficiency. Flexibility for incremental growth is incorporated into the design. Offices are on the floors above or beneath clinics, allowing caregivers ease of movement among them. Clinical spaces work like time-shares, with several physicians utilizing the same rooms during different periods. Overall exam-room utilization increased from 41 to 60 percent in the new facility. The percentage of patients completing check-in/out in less than 15 minutes increased from 69 to 94 percent, and annual growth has exceeded 9 percent in the first six months after opening.

“This project represents a tremendous effort to make a difference; to celebrate the kids who are the patients.”—CATHY SIMON, FAIA, PRINCIPAL, SMWM



Project: *Texas Children's Hospital Clinical Care Center, Houston*

Architect: *FKP Architects*

Client: *Texas Children's Hospital*

Key players: *Facilities Design International, and McCoy (interior designers); Walter P. Moore, and Burns DeLatte McCoy (engineers); W.S. Bellows Construction (general contractor)*

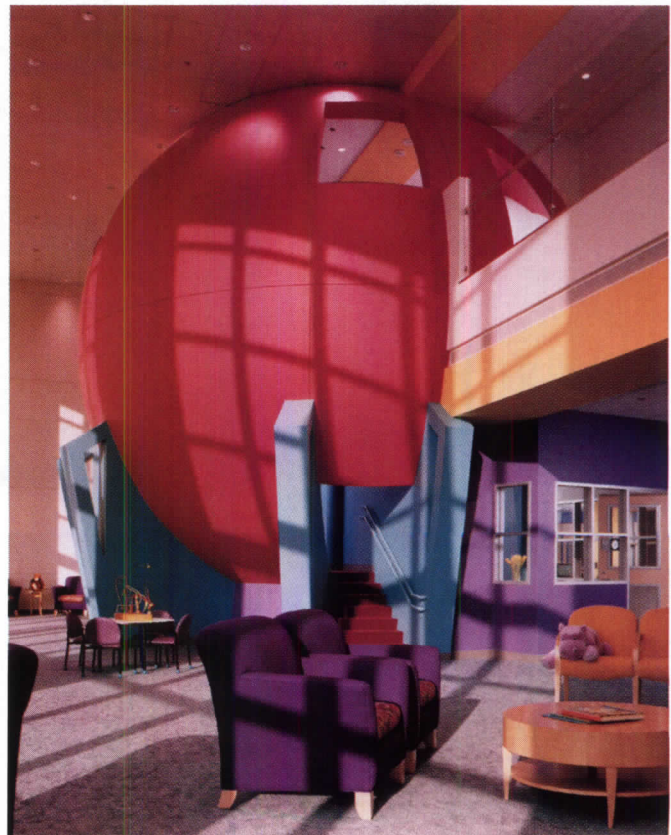

SONY

MAKING BUSINESS PLEASURE

THE PROFESSIONAL EDGE

THE PROS OF BUYING A SONY PROFESSIONAL FLAT PANEL MONITOR

Sure, flat panel displays are all the rage, but professionals insist on high performance monitors... like Sony's PlasmaPro™ Series.

Whether you choose the 32", 42" or the 50" (viewable area measured diagonally), the PlasmaPro Monitors will add style and impact to any visual. But remember, these are no ordinary flat panels. The PlasmaPro Series' non-glare, high resolution panels feature a built-in high performance scan converter using high-speed sampling that optimizes picture quality whether from standard composite video, HDTV or UXGA computer signals. Plus, selectable aspect ratios let you choose from letterbox to normal, full and widescreen.

PLASMA  **PRO**
MONITORS

Most models also feature Sony's Real Digital System, bi-pixel interlace-to-progressive circuitry, CineMotion™ function to create astounding picture quality and built-in amps that let you place (optional) speakers where they look and sound the best. Or, you can use an existing sound system for stereo or surround sound.

The Sony PlasmaPro Monitors. For a purchase as important as a flat panel, it pays to be professional.



COMPOSITE/S-VIDEO*

RS-232C

RGB/YUV/UXGA (x2)

(NTSC/PAL/HD COMPUTER FORMATS TO 140kHz)



FOR MORE INFORMATION AND A FREE CD-ROM ON SONY'S PROFESSIONAL DISPLAY PRODUCTS, CALL OR VISIT

1-800-472-SONY EXT **PRO**
WWW.SONY.COM/DISPLAYSYSTEMS

CIRCLE 59 ON READER SERVICE CARD
GO TO WWW.LEADNET.COM/PUBS/MHAR.HTML

©2002 Sony Electronics Inc. All rights reserved. Reproduction in whole or part without written permission is prohibited. Features and specifications are subject to change without notice. *The PFM-42B1 requires a BKM-B13 Option Board for S-Video. Sony, PlasmaPro and CineMotion are trademarks of Sony.

A BUILDING THAT PROCLAIMS THE SPIRIT OF ENTERPRISE

Program: Trumpf Customer and Technology Center is the American subsidiary of a European-based manufacturer of high-tech laser machine tools. Originally intended as a training center for machine operators, the acceleration of sales in the U.S. prompted the decision to change the program to include client demonstration and sales. The new building lies within a suburban industrial office park, where a large pond and extensive natural wetland areas are maintained. To serve a customer center, it was imperative to improve the pedestrian circulation from the existing buildings to the new one.

Solution: The building is large enough to demonstrate the company's entire range of products and services and includes a presentation theater, employee cafeteria, dining for clients, a lobby, conference rooms, and offices. A new central walkway that terminates in a terraced stair to the pond's shore unites the separate buildings of the site into a campuslike assemblage and improves circulation. A hierarchical office structure has been replaced by a design that emphasizes collaborative work and maximizes a larger cross section of the company's talent. Each month, more than 20 groups of customers visit the center, and three out of every four purchase a machine or service from the client—a 50 percent increase from the time prior to construction of the facility.

“The building is a classical Miesian pavilion, surrounded by support space, brought into the 21st century.” —STEVE GOLDBERG, FAIA, PARTNER, MITCHELL GIURGOLA ARCHITECTS

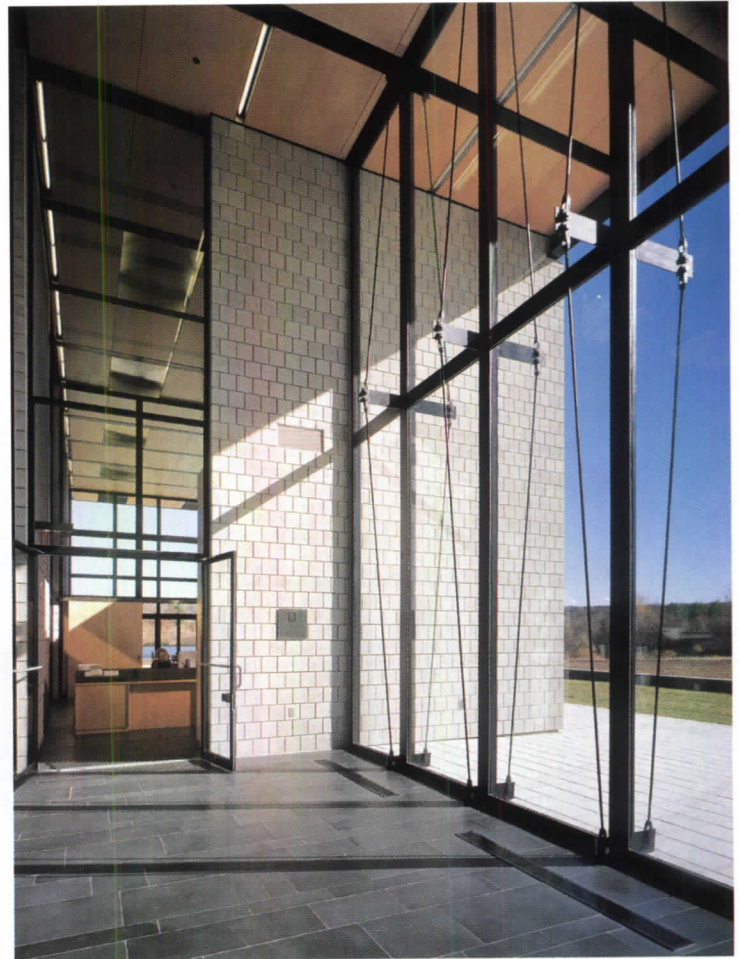

Project: Trumpf Customer and Technology Center, Farmington, Conn.
Architect: Barkow Leibinger Architects; Casle Corporation (associate architect)

Client: Trumpf America
Key players: Szewczak Associates (structural); Quinlan, Giannoni and Livingston (mechanical); Casle Corporation (general contractor)



**REGARDLESS OF HOW MANY
EXITS YOUR BUILDING HAS SEEN,
YOU ONLY NEED ONE ENTRANCE.**



Times change. Businesses change with them. But the welcoming appeal of a Kawneer entrance endures. Engineered with details such as welded Dual Moment corner construction and dependable operating hardware, these are entrances with the durability to stand sentinel for years and the craftsmanship to offer a firm, confident greeting every time. It's a level of quality that allows Kawneer to include a limited lifetime warranty.

The Kawneer entrance. It never wears out its welcome.



Kawneer
An Alcoa Company

A STADIUM SERVES AS A CENTERPIECE OF COMMUNITY DEVELOPMENT

Program: The client owned a professional sports team whose existing home facility in Cincinnati was among the smallest and least financially viable in its league. Retrofitting the old stadium was ruled out, so a new one was proposed that would meet current operational and economic needs, provide flexibility to accommodate future changes, and be architecturally significant, serving as a cornerstone of the city's economic and community well-being.

Solution: A team consisting of the client, their government partner, the construction manager, and the architect worked closely together over a two-year period leading up to construction. The remarkable building that resulted from this process provides the functions necessary to support events of all sizes, accommodates the team's year-round programs, and includes offices for the owner. The design incorporates 116 suites and six party suites, as well as a number of clubs, which serve as spectacular gathering places for the hundreds of events hosted each year. Sight lines within the 67,000-seat stadium are excellent, and there are no bad seats. Visible from afar, the stadium's striking cantilevered, steel-structured roof, clad with translucent fabric that covers the upper deck, is visually awesome.

“The stadium is a cornerstone of economic development and community activity in Cincinnati.”

—TIM O'BRIEN, V.P., REAL ESTATE, FORD MOTOR COMPANY

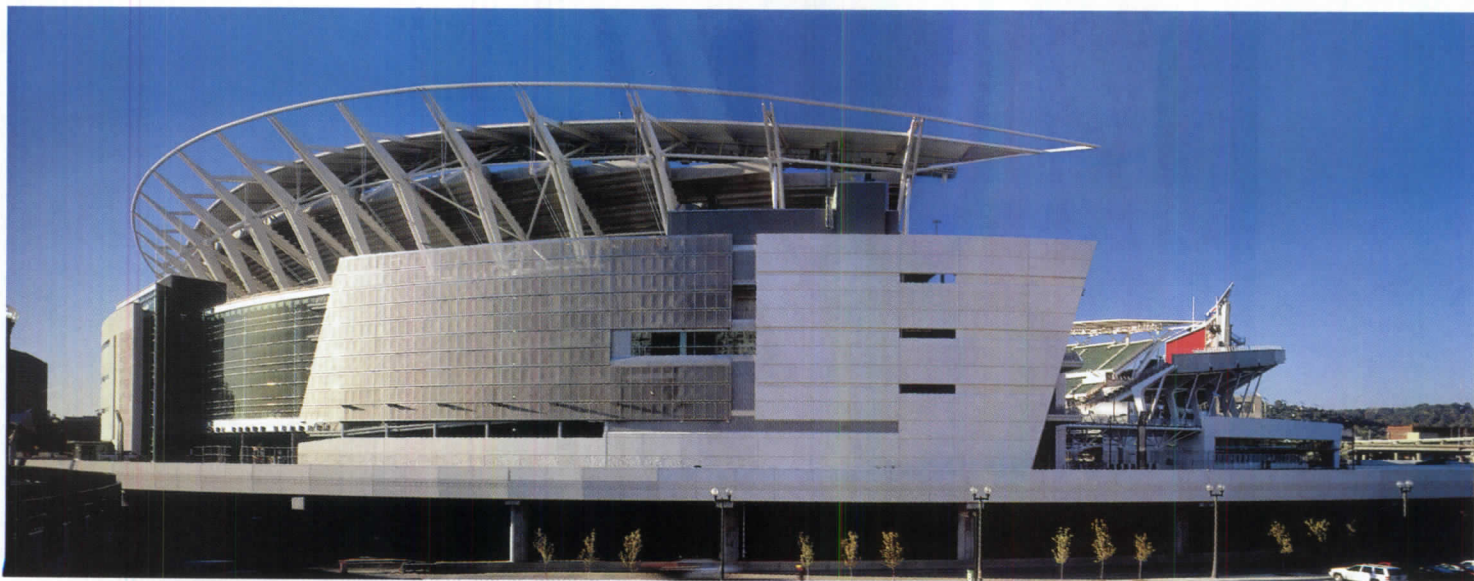
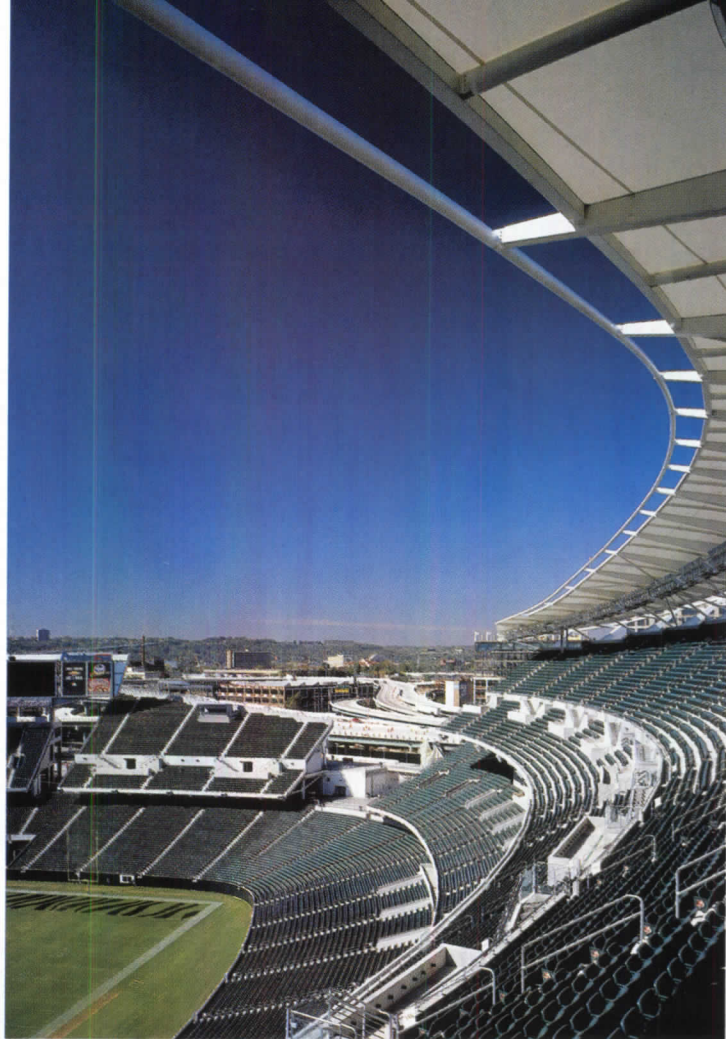

Project: Paul Brown Stadium, Cincinnati
Architect: NBBJ; Glaser Associates (associate architect)
Client: Cincinnati Bengals

Key players: Arup (structural); Flack & Kurtz (mechanical, electrical); Acoustic Dimensions (acoustics)



TODAY

Encourage our engineers
to push the boundaries

TOMORROW

Cars without limits

TOYOTA



A surfboard you can ride on land.

A car driven by sound.

A vehicle powered by hamsters.

At Toyota, we value ideas no matter how silly they may seem. Like the inventions generated by our annual Idea Expo — a unique competition that encourages serious technological innovation from our employees through the use of good old-fashioned fun.

For example, recent winners ranged from a whimsical robotic Santa's sleigh to a wheelchair that can be driven virtually anywhere — even up and down stairs.

One day, advances made through our Idea Expo may be applied to Toyota's vehicles. So we'll keep encouraging our engineers to be a little bit out there. That way, the car as we know it may go a lot further.

www.toyota.com/tomorrow

CIRCLE 60 ON READER SERVICE CARD
OR GO TO WWW.LEADNET.COM/PUBS/MHAR.HTML

Seven outstanding finalists prove that good design pays

THEIR PROGRAMS VARY, THEIR LOCATIONS ARE DIVERSE, BUT EACH FINALIST CONVEYS IN A UNIQUE WAY HOW DESIGN ENHANCES BUSINESS

THIS WAREHOUSE ATELIER IS CAST IN LIGHT AND AIRY TONES

Phenomenal growth has occurred over the 12-year existence of this well-known international media company. All of its facilities in New York City were designed by its architect, Daniel Rowen, fostering a rare, collaborative spirit. The team was faced with the challenge of consolidating a group of disparate offices into one location—a former warehouse building occupying a full city block. Since suitable contract furniture was unavailable, 400 workstations were imaginatively designed by the architect, in shades derived from the client's paint products. This extraordinary solution comprises bays of workstations that function like ateliers for the company's various design groups. The photographic studios are considered among the best in the city. Visitors are always impressed by both the scale of the place and the space itself—the light, the openness, and its unencumbered views of the river and city.



For the second year, RECORD is featuring finalists in its awards program, recognizing their significant merit in fulfilling the award criteria. The seven projects featured here join the 11 winners in providing a portrait of effective design for business. The criteria include components of path and result—each finalist participated in a distinguished architect/client collaborative process and achieved definable goals of excellence through fulfillment of the clients' objectives. Most awards programs focus solely on the merits of design in their selection process. This one is different: It leans heavily on how design promotes measurable business results in a variety of definable ways relevant to the clients, for whom architecture becomes a means to their success. Juror David A. Thurm, V.P. of real estate development at The New York Times company, says, "The award was hardwired from the very start that the business objective would be an important factor as to why the award was given."—Jane F. Kolleeny



Project: Martha Stewart Living Omnimedia, New York City

Architect: Daniel Rowen Architects; Berger Rait Design Associates (associate architects)

Client: Martha Stewart Living Omnimedia

Key players: Ambrosino DePinto & Schmieder, and Severud Associates (engineers)

Play

VT INDUSTRIES

Compose. Be imaginative with a vast array of design options, from classic wood veneer to the jazziest of laminate. Select from a full array of door options that meet your life safety as well as aesthetic needs. VT Architectural Doors turn any work into a masterpiece.

Call 1-800-827-1615 ext. 210 or visit www.vtindustries.com/doors

CIRCLE 61 ON READER SERVICE CARD
OR GO TO WWW.LEADNET.COM/PUBS/MHAR.HTML

VT Architectural
Wood Doors
INDUSTRIES



SPECULATIVE OFFICES SUCCEED ON THE BANKS OF THE SEINE

The client sought to develop a high-end speculative office complex from four previously disparate but adjacent buildings, that would become an identifiable unit for an international developer and its tenants. The introduction of green elements such as natural lighting, sustainable materials, and temperature-regulating curtain walls ensure tenant satisfaction. Amenities such as a restaurant, cafeteria, and conference facilities attract and retain tenants and, in turn, their employees. A bold landmark on the banks of the Seine, the complex was redefined and unified through an arch and the reskinning of the building's walls with glass printed with images of the river's waters. All of the space was leased to premium tenants before occupancy permits were granted, spelling a huge success for the client. Users are unilaterally satisfied with the fine quality of their new home.



Project: Arcs de Seine, Paris

Architect: Skidmore Owings & Merrill; Alexandre et Sandoz (associate architect)

Client: HRO Group
Key players: Severud Associates, and Cosentini Associates (engineers); Fougerolle (general contractor)



A TRENDY INTERNET CAFÉ ENTICES NEW BANK CUSTOMERS

In an effort to be noticed, ING Direct entered the competitive U.S. banking market with an innovation: In their first Midtown Manhattan bank, they replaced the expected row of tellers with an upbeat café staffed by trained bankers and featuring coffee, soft drinks, and food, with free Internet access, newspapers and magazines, and branded merchandise in a modern, trendy setting. The scale and feel of the café and the colorful neon orange exterior draws potential customers inside. The success of the approach is measurable—in the first quarter of the year business grew from \$4 billion to \$7 billion. Underlying this achievement is a highly effective relationship that evolved between client and architect.

Project: Ing Direct, New York City

Architect: Gensler

Client: Ing Direct

Key players: Marino

Gerazounis & Jaffe Associates (engineers); CIC Construction (general contractor); Showorks (audio-visual consultant)



DIVIDING SPACE WITH LIGHT AND GLASS



A.D. Fiorella Radice - Foto: Romano Fotografie

Made in Italy

PAVILION
design Antonio Citterio

TRE-P&TRE-Più

TRE-Più NEW YORK • Architects & Designers Building • 150 East 58th Street, New York, N.Y. 10155
Phone 212-935-5955 • Fax 212-421-1600 • www.tre-piu.com • info@tre-piu.com

CIRCLE 62 ON READER SERVICE CARD
OR GO TO WWW.LEADNET.COM/PUBS/MHAR.HTML



THIS STADIUM BREATHES NEW LIFE INTO HISTORIC CONEY ISLAND

Sited next to Coney Island, a seasoned seaside amusement park in Brooklyn, New York, this stadium captures the informal, whimsical, and festive spirit of the early-20th-century architecture of the area in a state-of-the-art, 21st-century sports facility. Key to success was the high degree of project coordination among the public/private members of the design team. Completed on schedule and within budget, the facility was treated as an instant landmark in the neighborhood. Fans have repeatedly applauded the convenience and comfort of the stadium, and its street-level retail space is almost fully leased. Through bold graphics, access to the boardwalk, and concessions on the concourse level, the surrounding area has been reinvigorated.



Project: KeySpan Park Stadium, Brooklyn
Architect: Jack L. Gordon Architects
Client: New York City Economic Development Corporation and Brooklyn

Baseball Corporation.
Key players: Ysrael A. Seinuk (structural); Keyspan Energy Management (mechanical, electrical); Turner Construction (general contractor)



A FLEXIBLE FACILITY WHERE MANAGERS LEARN TO LEAD

Realizing that managers do not necessarily make leaders, this Fortune 500 company sought to provide an institution to cultivate leaders of the future. Employees at all levels in the company come to this campus to build better networks, forge stronger relationships, trade ideas, and share experiences. The design team toured several of the best leadership centers in corporate America and planned a flexible building that could morph over time as the curriculum evolved. A former Harvard Business School faculty member acted as the team's learning-environment consultant. Success was instantaneous—when the center opened, the company's earnings, stock price, sales, and backlog all went up. Employee satisfaction increased, and the center has been benchmarked by other companies around the world. Demand is so high that a new addition to the facility is under way.

Project: The Boeing Leadership Center, St. Louis
Architect: Hellmuth, Obata & Kassabaum
Client: The Boeing Company

Key players: Ross & Baruzzini (mechanical, electrical); David Mason & Associates (civil); J.S. Alberici Construction Company (general contractor)



www.norcowindows.com/simple

888-476-6726, ext. N9

Bringing the outside in is beautifully simple.

Norco® wood windows add beauty to any home. Their energy efficiency, durable performance and easy availability are also attractive. Our windows are available in thousands of standard shapes and sizes and can be enhanced with 3-1/2" flat casing, eight clad colors (**including new Architectural Bronze and Black**), multiple divided lites and grille patterns. We offer prefinished interiors in four stains, four shades of white and clear coat lacquer, as well. You'll appreciate our uncomplicated electronic quoting and ordering system, complete, on-time deliveries, and warranted reliability. Working with Norco is simple. And that's beautiful.



Part of the JELD-WEN® family

© 2001 JELD-WEN, inc. JELD-WEN and Norco are registered trademarks of JELD-WEN, inc., Klamath Falls, OR.

CIRCLE 63 ON READER SERVICE CARD
OR GO TO WWW.LEADNET.COM/PUBS/MHAR.HTML

VIENNA'S HISTORY IS PRESERVED AND A NEW URBAN CENTER BEGUN

When four industrial gasometers (storage tanks for Vienna's gas supply) became obsolete, they left huge masonry shells behind. In this project, the landmark shells were converted into a new urban center that includes apartments, a youth hostel, a performance hall, shopping mall, movie center, and more. Utilizing complex technical solutions, the architect devised an entirely separate concrete structure within the restored masonry cylinder to support 13 stories of apartments, shops, and offices, and a massive circular foundation wall enclosing a 3,000-seat auditorium. All housing units were rented by the completion of the project, and there has been only positive feedback from tenants. In addition, the event hall has been commended for its functionality. But most notably, the exceptionally beautiful and unusual architecture of this project spells success, putting this small town 10 minutes from the center of Vienna distinctly on the map.

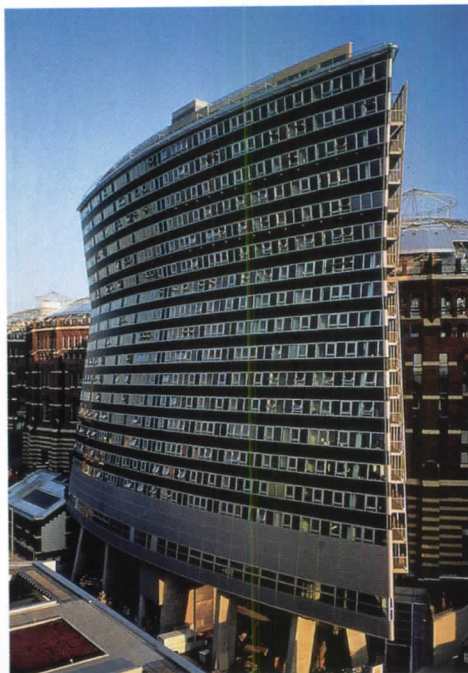

Project: *Gasometer B, Simmering, Vienna*

Architect: *Coop Himmelb(l)au; Prix & Swiczinsky GmbH*

Client: *GPA/WBV,*

Wohnbauvereinigung der Privatangestellten

Key players:

Voitl/Gerstl/Habau (general contractor)



Project: *Hansen Construction Office, Aspen, Colo.*
Architect: *Harry Teague Architects*
Client: *Hansen*

Construction
Key players: *Harry Cole and Steve Peightal (engineers); Hansen Construction (general contractor)*

FINELY HONED OFFICES USED AS A SALES TOOL FOR BUSINESS

This high-end residential construction company near Aspen, Colorado, sought to provide a quality workplace that reflects its stature as one of the finest construction firms in the area. As a result of the client's industry, an unusually close collaboration among design team members occurred. With client Hansen included at the design table, providing fabrication expertise and instant samples, mock-ups, and cost evaluation, many of the encumbrances to innovation were removed and the team was able to concentrate on fresh solutions. Because the space being created was for the business of construction, every aspect of the project was subjected to an unusual level of professional scrutiny from both the design team and the client. Functionally, the new space accommodates the frequent arrival of subcontractors and the inquisitive visits of clients, successfully balancing openness and privacy.





Trex® decking and railing has endless features that turn your vision into reality. Our unique products provide limitless design flexibility, code-compliance and advanced weather-resistance. Experiment with new colors. Bend boards. Choose from a full complement of decking and railing profiles. Take your project to the next level. To learn all you need to know about building with Trex® decking and railing, visit www.trex.com or call 1-800-BUY-TREX ext. 731.

Trex

The DECK of a Lifetime®.



DESIGN IDEAS ARE COMING

a mile a minute.

ONLY ONE DECKING COMPANY

CAN HANDLE THE PACE.



©2002 Trex Company. All rights reserved. TREX, the TREX logo, Easy Care Decking® and The DECK of a Lifetime® are federally registered trademarks of Trex Company, Winchester, Virginia.

**CIRCLE 64 ON READER SERVICE CARD
OR GO TO WWW.LEADNET.COM/PUBS/MHAR.HTML**

Editors' choice: **Two unbuilt projects** that reach into the future with innovation

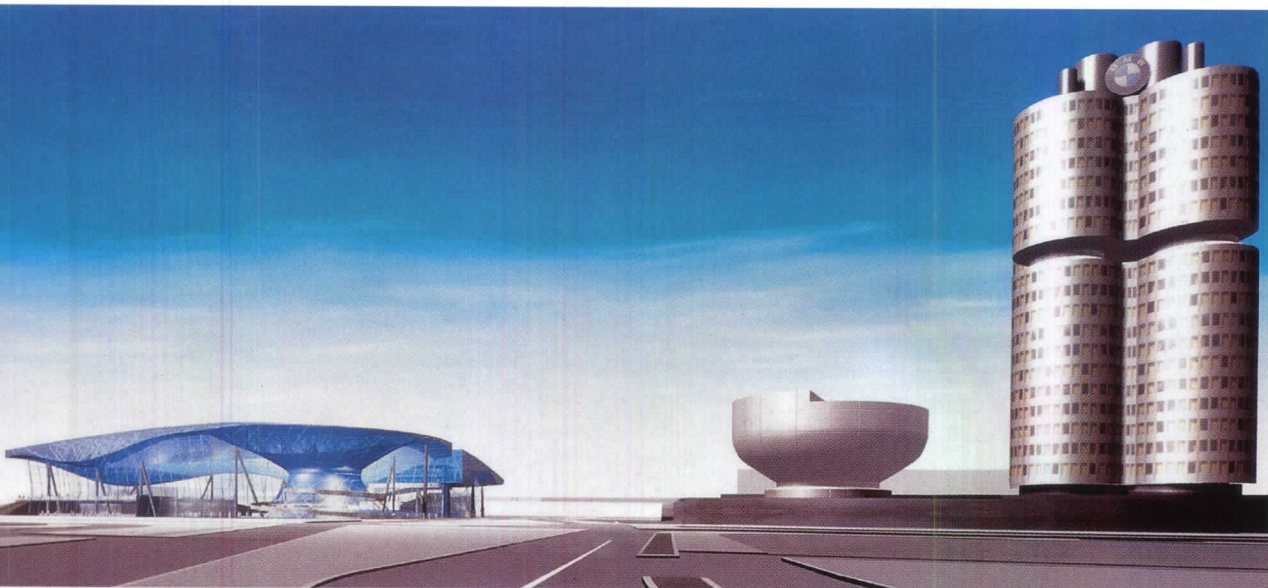

Project: BMW Event and Delivery Center, Munich, Germany

Architect: Coop Himmelb(l)au; Prix & Swiczinsky GmbH

Client: BMW Group



“This remarkable structure promises to envelop visitors in a rich spatial experience that should help the client project itself as a company with its eyes on the future.”

A DRAMATIC SCULPTURAL ELEMENT DISTINGUISHES THE BMW BRAND

Scheduled to open in 2004, this event center and showroom for BWM will serve as a focal point for vehicle delivery. Through its design, the building unifies the nearby BWM Headquarters tower and the adjacent Olympic Park into a cohesive whole. Its distinguishing features include a sculptural roof element floating over a flexible marketplace, creating a remarkable landmark of unique, undulating forms. The shape of the roof is influenced by the functions below, forming a stage with changing heights for the varied uses of the building. The roof itself is anchored to the ground at the south-east edge of the site and is transparent, mitigating sunlight and energy. The center contains a multifunctional event hall, exhibition spaces, shops, restaurants, and cafés.

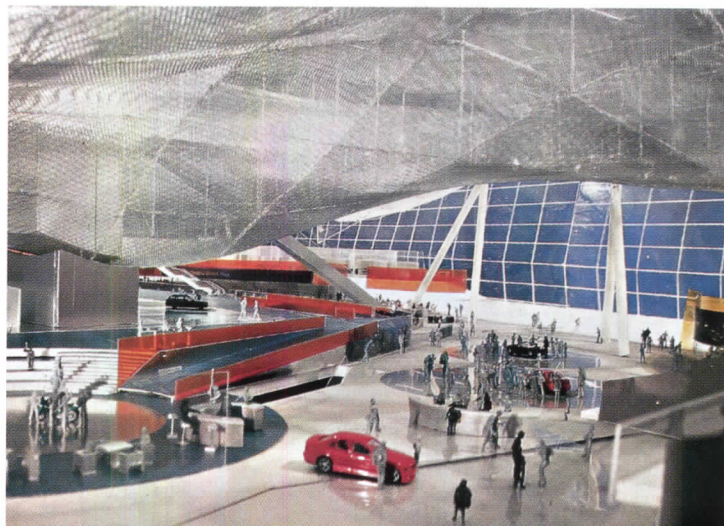

The following two unbuilt projects constitute the Editors' Choice, an unbuilt-project category that was begun in 2001 to coincide with the Business Week/Architectural Record awards program. This is the first year RECORD is publishing works in this category, which is so named since editors of both magazines decide which entries to publish. By disseminating these selections, we give our readers an early look at some of the excellent projects in the pipeline for tomorrow. Since these projects cannot be measured in the same way that built projects can, the emphasis here is on innovative design. Both projects selected are clearly innovative, and each contributes strongly to the corporate image of the client, a theme that was evident in many of the winning entries. —Jane F. Kolleeny

“While offering an elegant, modern interpretation of the industrial shed, this design provides office workers with plenty of access to daylight and outdoor spaces.”



A UTILITARIAN WAREHOUSE CONVEYS A SPORTSMAN'S AESTHETIC

This proposed warehouse building will serve as a headquarters for a new easy-lifestyle brand owned by clothing manufacturer Abercrombie & Fitch and will be added to the company's existing office campus (featured as a BW/AR awards winner on page 102). Although connected to the campus visually and in terms of materials, the new building is quite different. In the same manner that stables, sheds, barns, and other outbuildings help shape the landscape of large estates, this 110,000-square-foot structure will serve as a background element. Light will filter inside through a perforated metal scrim, and the building will feature exterior courtyards and second-floor porches. Exterior materials include a metal roof and corrugated-concrete-panel skin; interiors will reflect the retail store's palette of dark woods and metals.



Project: Hollister
Headquarters, New Albany,
Ohio
Architect: Anderson
Architects
Client: Hollister
Key players: BBC&M

Engineering (geotechnical);
EMHT (civil); Lantz, Jones,
Nebraska (structural);
M-Engineering (mechanical,
electrical); Elford
Construction Services
(general contractor)



IMPACT RESISTANT WINDOW & DOOR SYSTEMS



Even at
150 mph,
there are few
limits
to what
you can
create.

LIFE  GUARD™
BY WEATHER SHIELD

If you think the new building codes are tough, you're right. But new LifeGuard™ windows and doors from Weather Shield® are even tougher. They're certified to withstand winds up to 150 mph* with a combination of strength and beauty that no other impact resistant products can offer. New LifeGuard windows and doors are available in a multitude of sizes. With styles, shapes, colors and options to complement any home, they're engineered to blow you away. Want to learn more?

Call 1-800-477-6808 ext. 1398 or visit
www.weathershield.com.

FEATURING

Keep Safe®
GLASS
MAXIMUM

CIRCLE 65 ON READER SERVICE CARD
OR GO TO WWW.LEADNET.COM/PUBS/MHAR.HTML

©2002 Weather Shield Mfg., Inc. *Based on laboratory testing, which is for comparison purposes only. Actual performance of windows and doors after installation may differ because of factors beyond Weather Shield's control, such as installation details, building construction details, maintenance, etc. See written warranty for further information. Size and style limitations apply.



McGraw-Hill Construction's Architectural Record and Weather Shield Windows & Doors

2002 Learning Series

Please join *Architectural Record* and Weather Shield Windows & Doors for a half a day educational program in beautiful Charleston, SC.

DATE: Thursday, December 12, 2002
TIME: 2:00 p.m. to 7:00 p.m.
PLACE: Renaissance Charleston (Marriott)
68 Wentworth Street
Charleston, SC 29401
Phone: 800-468-3571
For room reservation & special rate refer to McGraw-Hill Group.

Scheduled Program

2:00 P.M. **Welcome and Opening**

Robert Ivy
Editor-in-Chief, *Architectural Record*

2:15 P.M. **AIA/CES Program: Code Demands for
Impact-Resistant Glass**

Sponsored by Weather Shield Windows & Doors

3:30 P.M. **Guest Speakers**

Orrin H. Pilkey, Director "Program for the Study of Developed Shorelines," Division of Earth and Ocean Sciences, Duke University, along with renowned batik artist, **Mary Edna Fraser**. Discussion will focus on barrier island research and coastal management. Mr. Pilkey & Ms. Fraser have a Columbia University Press book due out in April titled: "A Celebration of the World's Barrier Islands."

4:30 P.M. **Walking Tour of Charleston**

Tour Subject: Charleston – Past and Present
Christopher Rose, AIA/ASID
Christopher Rose Architects

5:30–7:00 P.M. **Cocktail Reception at Old Charleston Jail**

Sponsored by Weather Shield Windows & Doors

RSVP TO: Mamie Allegro, *Architectural Record*
Phone: 312.233.7400
Fax: 312.233.7403
E-mail: mamie_allegro@mcgraw-hill.com



Earn two continuing education learning units.

Space is limited! So please make your plans to attend, ASAP!

Look forward to seeing you in Charleston.

McGraw Hill
CONSTRUCTION Architectural Record



Weather Shield
Windows & Doors

The entrance to the poured-in-place concrete church (below), on its southeast corner, opens onto the plaza. The church's north side, marked by a campanile, abuts the Hollywood Freeway (opposite).



CRITICISM What makes a religious structure awe-inspiring? Rafael Moneo's design for the CATHEDRAL OF OUR LADY OF THE ANGELS provides a partial answer

By Suzanne Stephens

We often hear that the museum has replaced the church as the architecturally "sacred" space of contemporary times. Now it looks as if the church—at least the Catholic church—is trying to make a comeback. Not only has the Cathedral of Our Lady of the Angels in Los Angeles, designed by Pritzker Prize winner Rafael Moneo, just opened, but other high-profile churches are in the works, such as the Cathedral of Christ the Light, in Oakland, California, by Santiago Calatrava, and Richard Meier's Jubilee Church, in Rome.

All of these monumental endeavors to embody spirituality in stone (actually concrete) come at a critical moment in the Catholic church. Apart from the sex-abuse scandals and attendant money-draining lawsuits, there is the ongoing debate within the church about designing houses of worship to be welcoming to parishioners. Since the Second Vatican Council's recommendations in the mid-1960s that the church become more of a communal space, many have taken this to mean that a church should look like a Quaker meetinghouse. In the case of the Los Angeles cathedral, the client, Cardinal Roger Mahony, voiced a concern that the building embrace its constituency of 4.1 million, which includes the poor and uneducated. But how do you make something awe-inspiring without being intimidating? Unlike advocates in the Catholic faith who argue the church should have a dome, or a spire, or at least a sense of verticality, Moneo has made it his mission to show that a transcendent aura can be embodied in earth-centered, Modernist, abstract forms. Moneo's efforts have been partially successful in certain areas, and naggingly unsuccessful in others. The cruelest irony is that some of the strongest aspects of his scheme are undermined by the religious art commissioned for the building.

Working with executive architect Leo A Daly and Morley Builders, Moneo came up with a monumentally scaled, skillfully crafted concrete aggregate of squat blocks and single-pitch roof elements, some of which are 128 feet high. Geometrical chunks coalesce, horizontally articulated by an overlapping shingling effect of the concrete walls creating shadow lines, and serrated glazed carapaces over the alabaster windows. From certain angles, the forms yield a forceful, calm drama; from others,



however, the exterior appears deadeningly clunky in its massing. Similarly, the hue of the concrete depends on the time of day. In the intense noontime sun, the evenly tinted tan concrete is drably monochromatic; in the morning or late afternoon, it can take on an effulgent, pinkish hue. In spite of its impressive scale, the church does not sufficiently proclaim its symbolic role as a cathedral for the largest archdiocese in the nation. Having a campanile and a cross limned against a projecting alabaster bay is not enough to imbue the building with a sense of being a powerful, sacred space. Probably for this reason, the comments by the public (and some critics) that it looks like a fortress, a power plant, or one of the city's chunky retail malls, is relevant: The question is, what should a cathedral look like?

The issues raised are typological, something that Moneo, the chair of architecture at Harvard's School of Design from 1985 to 1990, has addressed before. In 1978, writing in *Oppositions*, Moneo argued that an

Project: Cathedral of Our Lady of the Angels, Los Angeles

Client: Roman Catholic Archbishop of Los Angeles, Cardinal Roger Mahony

Design architect: Jose Rafael Moneo Arquitecto—Jose Rafael Moneo, principal; Hayden Salter, David Campbell

Executive architect: Leo A Daly—Roy Follmuth, principal in charge; Nick

Roberts, project manager; John Williams, senior project architect;

David Arredondo, project architect

Engineers: Nabih Youssef & Associates (structural); Arup (m/e/p, fire)

Consultants: Francis Krahe & Associates (lighting); Reginald D. Hough (concrete)

General contractor: Morley Builders

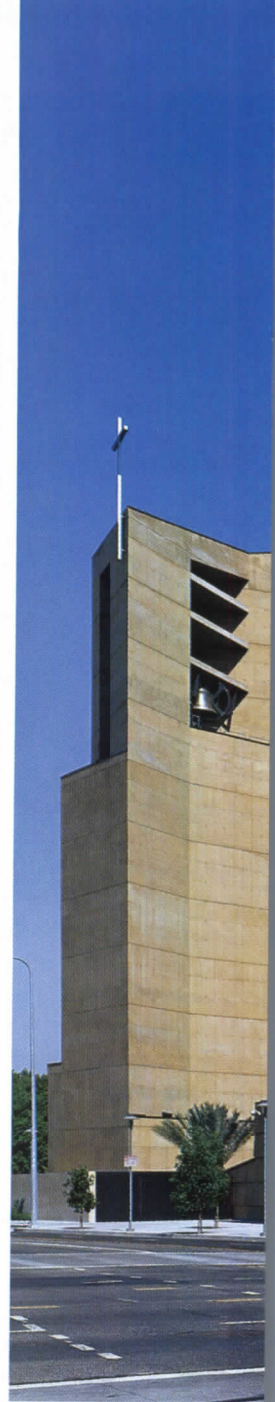
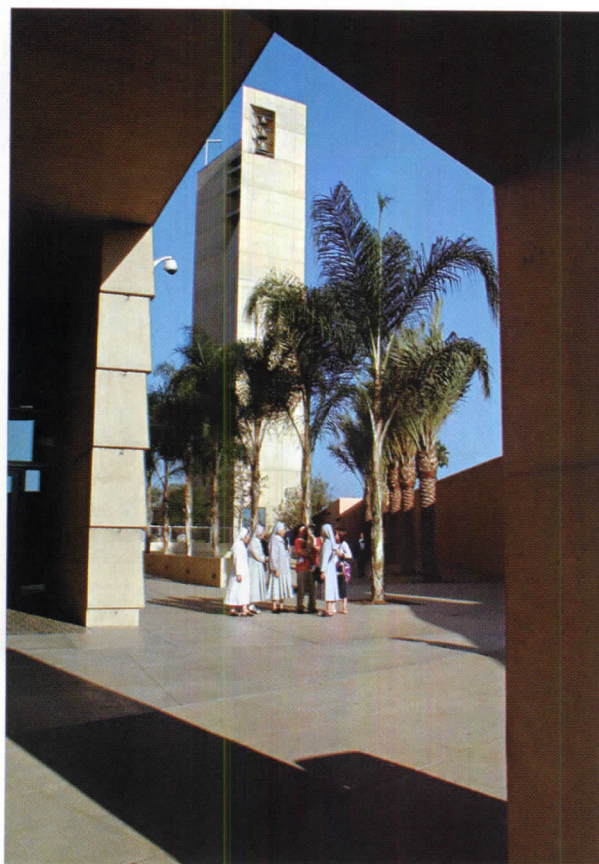
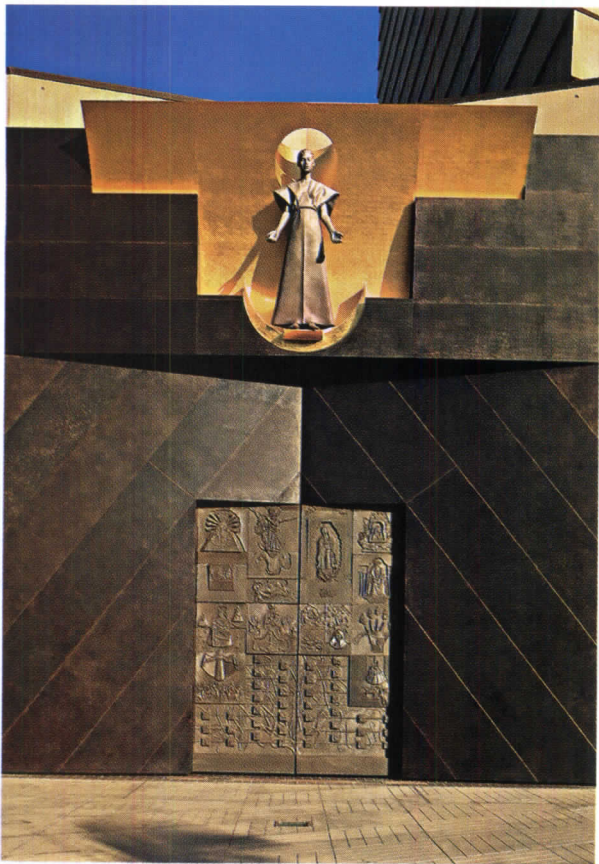

The cathedral's bronze entrance doors (above left), designed by sculptor Robert Graham, overlook the parking garage and stuccoed community center at the opposite end of the plaza (below). The campanile (above and opposite) occupies a small northwest courtyard. Serrated glazing covers the nave's alabaster panels (exterior view, opposite).

OPUS IN CONCRETE The desire of the Catholic church that the cathedral would stand for centuries, some say 500 years, led to fabricating the building of concrete. The adobe-tan pigmented concrete used for the church is a triumph in mixing, curing, and construction; not only is it beautifully crafted, there is no cracking and spawling (so far). To withstand cracking, a Danish white cement (Lehigh Aalborg) was mixed with pozzolan fly ash [RECORD, September 2001, page 175; ENR, September 10, 2001, page 42]. Then a number of methods were used to make sure the heat generated by the mixture of water and cement was controlled. Using Aalborg cement helped, since it warms up more slowly than others. To slow up the process further, Morley did the pours with cooled water at about 3 A.M., before the sun came up. In addition, the rebar were positioned at least 3 inches from the exterior surface to reduce rusting and, with that, further possibilities of cracking and spawling. Since the church sits close to the Elysian Park Fault, it is designed to withstand a quake of 8.5 on the Richter scale. Structural engineer Nabih Youssef devised a sophisticated seismic-base-isolation system below the church's main floor and its subterranean mausoleum: Load-bearing concrete walls are positioned on 149 isolators laminated of rubber and steel, 18 inches high. For lightly loaded areas, the interior concrete columns rest on 47 Teflon slider bearings only 3 inches high.





architectural object's formal structures are defined by its construction and use. As a type, it retains a continuity with forms of the past, which in turn provide "a frame within which change operates." External events, such as a new program or new construction techniques, however, can push the architect to create a type with new formal relations, something Moneo seemed to attempt with the \$189 million Los Angeles cathedral.

While the geometries of the planar, concrete shapes evoke the vernacular mien of Spanish Mission churches in the Southwest, the design is closer to the formalist Modernism of the 1960s nonliturgical architecture of Paul Rudolph, Kevin Roche, and I.M. Pei. Just emulating Mission-style architecture would have been cloyingly historicist. Yet Moneo's adherence to a late-Modernist blocky heftiness results in a non-communicative angular assemblage of quiet, leaden (albeit well-crafted) forms. Moneo didn't have to be faithful to the Gothic, Renaissance, or Baroque church traditions to make a strong religious statement. But abstract geometries can radically symbolize the content of such a pro-

gram, as Daniel Libeskind's Jewish Museum in Berlin demonstrates.

Although the exterior doesn't go far enough in creating a powerful expression of a transformed typology, Moneo's approach with regard to the plan does. He has provided a dramatically different kinesthetic experience to entering the church and arriving at the expansive nave and sanctuary that heightens the sense of being in a holy place. Moneo has brilliantly taken the traditional procession sequence and altered it so that one moves through a series of vertical and horizontal, contracting and expanding spaces, emphasized by the play of light and shadow.

Instead of having the visitors enter through the narthex, into the nave with the apse and transept of the cruciform at the far end, Moneo has worshipers enter the church from the same (eastern) side as the altar. As visitors pass through the blackish-bronze entrance doors on the southeast corner of the building, they step into a dark vestibule softly lit from the side by a large alabaster window. They then walk along the Spanish limestone floor of the ambulatory, which is edged by a narrow, linear sky-

Natural light penetrates the 100-foot-high nave and sanctuary through large alabaster panels. The stalwart concrete walls that frame the windows and chapels

are 4 feet thick. The ceiling of the nave, of cedar plank and Douglas fir plywood, emphasizes the arklike shape of the 58,000-square-foot hall.





The roof structure is composed of nine steel trusses that span 90 to 115 feet in a north-south direction between concrete girders. A roof slab about a foot thick acts as a diaphragm and stabilizes the tall walls.

1. Sawtooth curtain wall
2. Alabaster interior panels
3. Base isolation crawl space
4. Mausoleum
5. Nave
6. Attic
7. Service chase for curtain wall
8. Copper roof
9. Shingled concrete wall

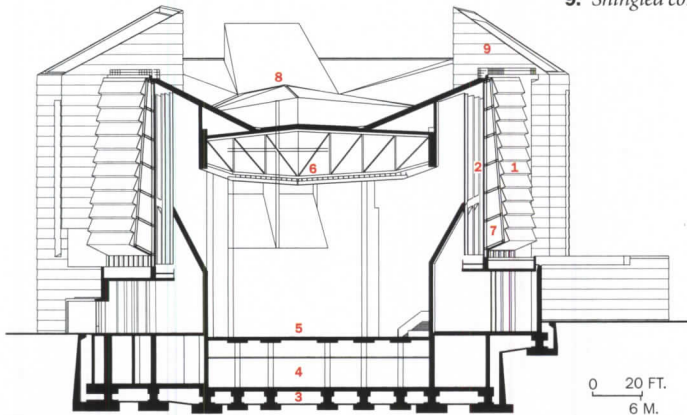

MAIN FLOOR PLAN

1. Entrance
2. South ambulatory
3. Baptistry
4. Chapel of the Blessed Sacrament
5. Nave
6. Altar
7. Organ/choir
8. Sacristy
9. North ambulatory
10. Cathedra
11. Reconciliation chapel



TRANSVERSE SECTION

light. The angle of the interior walls and the gentle upward climb heightens the sense of procession. The church's chapels, held within 4-foot-thick concrete walls, are arranged along the inner edge of this ambulatory; every now and then a space between them permits a glimpse into the nave and sanctuary.

In a deviation common to recent changes in church design, Moneo has located the tabernacle in its own Chapel of the Blessed Sacrament, rather than have it placed behind the altar. This striking chapel, a powerful and surprisingly vertical shaft, soars up to a height of about 85 feet, emphasized by a large alabaster-clad protrusion illuminated from the back by natural and fluorescent light sources.

As visitors continue to the west end of the south ambulatory, a 17th-century Spanish Baroque retablo, or altarpiece, asymmetrically placed, terminates their path and guides them into the nave. In making this right turn, visitors all of a sudden find that space and light open up dramatically in a hall that seats 2,600, where large alabaster windows, instead of stained glass, suffuse the interior with a soft glow. In walking the 333.5-foot-long nave toward the altar and sanctuary, visitors are aware of a slight downward incline. A sense of vertical expansion is augmented by the 100-foot-high nave, and transepts that rise another 20 feet inside. In this major space, the poured-in-place concrete walls, the slightly angled ceiling of cedar plank and Douglas fir plywood, plus the cherry wood pews and the altar of red Turkish marble, create an understated setting. Dominating one's attention is the 6,019-pipe organ, also of cherry wood, that soars to an 85-foot height. From the altar area, visitors can gain access to the north ambulatory, which contains confessional booths. Farther along this walk, a striking 90-foot-long glass wall faces onto an open courtyard and affords glimpses of the 156-foot-high campanile.

While the kinesthetic qualities of Moneo's solution augment the church's architectonic power, the art selected by the church, and the surfeit of overly lighted suspended chandeliers, do much to fight it. Most of the art is on a level of figurative kitsch that suggests the church got nervous about the extent of Moneo's use of abstraction. In spite of all the press attention, Robert Graham, the sculptor for the bronze entrance doors, is no Ghiberti, as the studied muscularity of his WPA-proletarian-style *Our Lady of the Angels* and other religious images too well attest. But his doors

THE KINESTHETIC QUALITIES AUGMENT THE CHURCH'S ARCHITECTONIC POWER, BUT THE ART AND CHANDELIERS FIGHT IT.

are almost avant-garde compared to the poster realism of the tapestries by painter John Nava. Here photos of "normal" people were digitally rendered onto the 25 woven panels for a strikingly inauthentic effect. Even the muted palette doesn't tone down the cloying quality.

The lighting, with fixtures that Moneo did design, is a series of inverted trumpets holding acoustic speakers and surrounded by translucent globes, with transparent half-globes over them. The design of the fixture itself is lyrical. But there are too many of them, and they hang so low in the space that, because of the incline of the floor, they block the view of the altar and organ from the rear of the nave. Also, they are too bright. The sophisticated computerized dimmer system was not in evidence during the 4-hour dedication services on a bright, sunny September day. Any sense of mystery owing to the beauty of shadows was sorely missing. It would also help if the translucent round globes were thicker and slightly yellow, so you couldn't see the light bulb inside.

As visitors leave the cathedral, they pass from a small courtyard between the north ambulatory and the campanile into a large, 2.2-acre open plaza, facing the community center and the residence house. Moneo's



The focus of the sanctuary (above) is the Moneo-designed cherry wood facade of the 6,019-pipe organ built by Dobson Pipe Organ Builders, with Manuel Rosales, the archdiocese consultant. The altar (near right) is Turkish marble, and the floors are limestone, as seen in the south ambulatory (far right).



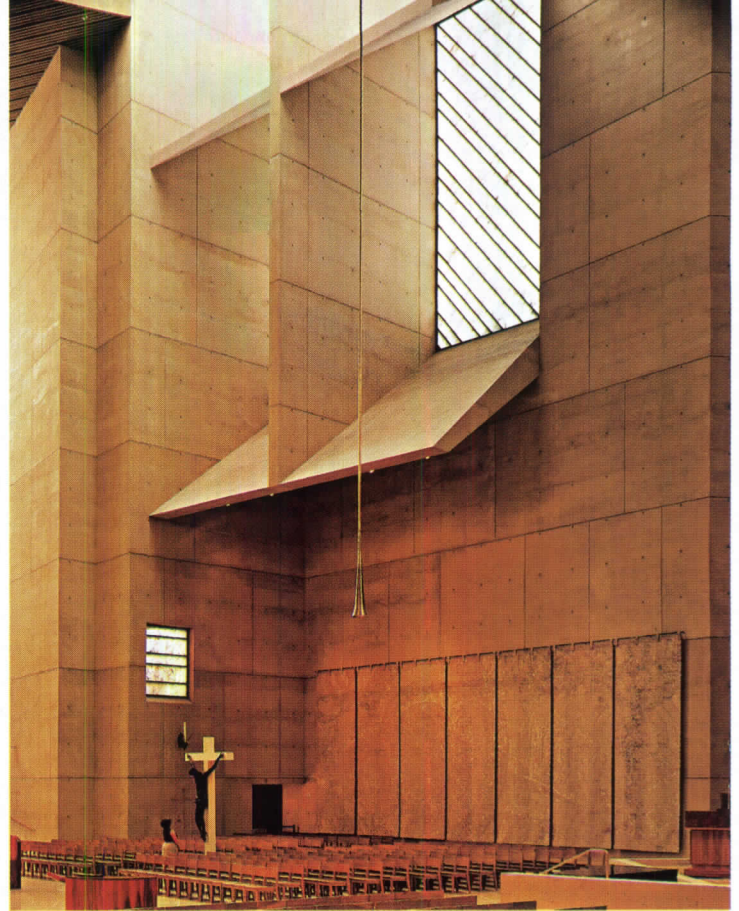

outbuildings along the eastern edge of the plaza—which are, respectively, steel framed and wood framed, with a stucco coating—are unspectacular, but they do provide an inoffensive background for the church. And here on the open plaza it is easy to see that the entire site, some 5.5 acres, occupies a hill rimmed on the north by the Hollywood Freeway. To the south is Grand Avenue, where a couple of blocks away the arrestingly sculptural Disney Hall is now taking shape; farther south along Grand’s “cultural corridor” is the Colburn School of Performing Arts by Hardy Holzman Pfeiffer’s Norman Pfeiffer, and Arata Isozaki’s Museum of Contemporary Art.

The site, at least symbolically, attests to the larger role of the church, with its diocese of more than 4 million people spread out through Los Angeles, Ventura, and Santa Barbara counties. Formerly, the cathedral was located in the Mission-style St. Vibiana, a masonry structure dating to 1876 in a skid-rowish section of downtown. When the 1994 Northridge earthquake damaged St. Vib’s, as it is called, Cardinal Roger Mahony wanted to demolish it and build anew. Lawsuits by the Los Angeles Conservancy discouraged him from this course of action, and eventually St. Vib’s was sold to the developer Thomas Gilmore, who is working with architect Brenda Levin to convert it into a performing arts center for Cal State L.A. and other groups. Meanwhile, Cardinal Mahony negotiated with the county to buy the current site for \$10.85 million, and raised money for the new cathedral.

A selection committee, formed of Sylvia Lavin, chair of UCLA’s department of architecture and urban design; Stephen Rountree, the Getty Trust executive vice president; Adele Chatfield-Taylor, president of the American Academy in Rome; and the late Ira Yellin, a developer, among others, drew up a list of architects to be interviewed. The short list came down to Moneo, Thom Mayne, and Frank Gehry.

Of those on the short list, Moneo, a Jesuit-trained Catholic, would arguably be quite familiar with the rituals and beliefs behind the church’s architecture. Yet even he could not come up with an external architectural presence that communicates the sense of religion, power, and

mystery. Scale is difficult with abstract forms: a small-scale chapel can be powerful, but a large, mammoth structure often looks just like that. The tan color of the concrete could mitigate the massiveness, but not as much as the drenched polychromy of Luis Barragan or Ricardo Legorreta.

In addition, the richly sensual association with past Catholic religious structures is hard to forget: in contrast, for instance, to the quiet formalism that Louis Kahn brought to the Unitarian Church in Rochester, New York (1961–69), which seems perfectly appropriate for its astringently simplified religious program. Even if the Catholic church wants to be simpler, its historically symbolic baggage demands more.

The church needn’t go quite as far as critic Michael Rose urges, in his recent book *Ugly as Sin, Why They Changed Our Churches from Sacred Places to Meeting Spaces and How We Can Change Them Back Again*, to revert to highly traditional solutions somewhere to the right of Ralph Adams Cram. Replicating the old is not the answer. Indeed, Moneo’s most powerful sacred space—the entrance procession—flies in the face of tradition. An emerging typology for the Catholic church needs to be forceful, dramatic, and innovative, while maintaining its continuity with the past. It must work within the frame, as Moneo once wrote, and yet break out of the frame. In the case of the Los Angeles cathedral, it does not quite happen. Instead, the sense of ambivalence hovers over its mute forms. ■

Sources

Concrete: Morley Construction

Concrete sealers: Prosoco

Metal and glass curtain wall and skylights: Benson Industries

Structural steel: Plas-Tal (cathedral); Columbia Steel (conference center)

Expansion joints: C/S Group

Glass: Viracon

Steel windows, entrance doors:

Hopes System (cathedral)

Wood ceiling: Pacific Woods and Hutchison Group

www For more information on the people and products involved in this project, go to Projects at architecturalrecord.com.





The architects floated their multilevel addition within the renovated shell of the library's South Court, maintaining a 4- to 5-foot slot between new traylike floors and the marble facades. Before the transformation, the courtyard was used as a parking and loading dock (opposite).

Davis Brody Bond gives new life to a Beaux-Arts grande dame, with the modern new **SOUTH COURT** of The New York Public Library

By Raul A. Barreneche

Manhattan architects Davis Brody Bond have enjoyed a long and fruitful relationship with a dowager, the main branch of The New York Public Library, the Beaux-Arts icon on Fifth Avenue and 42nd Street in Manhattan designed by Carrère and Hastings. Over the past 20 years, the firm has helped bring the landmark library up to date with a subtle combination of meticulous preservation and seamless technological upgrades. Davis Brody Bond's involvement began in 1982, when partner Lewis Davis headed the creation of a master plan to restore the library's musty public rooms to their original 1911 grandeur. Throughout the '80s, the firm renovated rooms bearing the names of New York's philanthropists past and present—the Astor Hall, McGraw Rotunda, and the Celeste Bartos Forum—as well as the Public Catalog Room. They also designed a new stack wing buried beneath adjoining Bryant Park before its restoration as New York's most urbane public space. In the 1990s, the architects renovated landmark interiors including the Main Reading Room and the Rare Book Room. When the library decided to relocate its science, business, and industry collections and staff from the main library in the early 1990s, Davis Brody Bond prepared a second master plan to rethink expansion plans in light of newly available square footage. That's when they began to look at the library's underutilized South Court in a whole new light.

The courtyard at the library's southern end was originally designed as a drop-off for horse-drawn carriages; since 1950, it had languished as a loading dock, parking lot, and general dumping ground, even though its articulate marble elevations suggested a far grander purpose. An ad hoc, trailerlike bungalow had also been erected within the courtyard to house overflow space for staff offices. The only unbuilt open space within the library, the South Court seemed the perfect site for a much-needed expansion, as a new structure could be built within the void without altering the building's profile. "The idea of adding onto the building had been kicking around for a long time, though nothing had been built above ground since 1911," says Paul LeClerc, the library's president and C.E.O. "There was a huge amount riding on the success of this intervention. My sense was that Lew Davis was so familiar with the vocabulary of Carrère and Hastings and the function of this building that we felt we could entrust it to him."

Davis and his colleagues developed a simple parti of a new free-standing box—or "trays of space," as Davis suggests—floating within the

Contributing editor Raul A. Barreneche is currently at work on a new book about tropical Modernism, to be published next fall by Rizzoli/Universe.



South Court, never really touching the original building but continuing its floor levels at key junctures to keep circulation between the two structures fluid. The strategy made sense on many levels. But fitting 40,000 square feet of program—including a 178-seat auditorium, two classrooms, an orientation theater, collections and acquisitions staff offices, and a staff lounge—within the courtyard void proved challenging. The New York City Landmark Preservation Commission stipulated that the addition could not be seen from the street; the new insertion essentially had to remain invisible. Given the height restriction, there was simply no way to shoehorn in the necessary square footage. So the architects dug 40 feet beneath the existing ground level to scoop out enough space for the auditorium and a new mechanical basement. They stabilized the existing foundations and poured new concrete footings beneath, while the library remained opera-

Project: South Court of The New York Public Library, New York City

Architect: Davis Brody Bond—Lewis Davis, FAIA, partner in charge; Nathan Hoyt, AIA, associate partner; Ernesto Bachiller, AIA, project architect; Anne Asher, Ian Ferguson, Robert

Halverson, Bennie Johnson, Pam McGirr, Anthony Sieveding, AIA, Don Nicoulin, Bruce Dole, project team

Engineers: Weidlinger Associates (structural); Atkinson Koven Feinberg (m/e/p); Langan Engineering and Environmental Services (geotechnical)



tional. Fortunately, none of the library's walls cracked or settled irregularly during the delicate operation. Once the ground was excavated and the new foundations poured, steel for the new structure had to be hoisted over the existing building and into the courtyard by tall cranes.

Visitors enter the new South Court, which became fully operational in September, without much fanfare, through glass doors inserted within an enlarged marble window frame along the library's monumental main hall. As they cross a glass bridge and enter the reclaimed courtyard, they leave behind the library's dark brooding halls for a luminous world of crisp, polished materials and daylight pouring in from ribbon skylights around the perimeter. The sparkling, freshly scrubbed walls of the old courtyard, hidden from view of the general public for nearly a century, become internal facades for the open "trays" that comprise the six-level insertion.

The public's first contact with the new addition is a small theater on the first floor showing a 12-minute film that introduces users to the library's resources. Adjoining the orientation theater are two state-of-the-art classrooms for instruction on using the library's electronic indexes and other research tools, with 15 interactive workstations each.

The only other public space in the addition—the auditorium—is located two levels down from the classrooms and theater via a translucent

structural-glass staircase. (Between the first floor and the submerged auditorium is a vast new main loading dock at street level.) Descending the glowing staircase, visitors pass layers of building fabric revealed by the excavation: the courtyard's old *piano rustica*, the exposed rubble foundations, and the expanded concrete footings below, wrapped in gleaming white marble matching the courtyard facades. In fact, the walls, like the floors throughout the addition, are clad in marble drawn from the same quarry in Danby, Vermont, as the original library cladding. The auditorium itself is a large room made warm and more intimate by roped beech paneling and a beech-backed Finnish seating system. The architects installed golden-hued acoustical absorption panels behind walls of stainless-steel mesh to pick up the honey tones of the beech cladding and seat backs.

The library's acquisition and catalog staff now enjoy sleek new offices on the mezzanine, second, and third floors, and a comfortable lounge on the third floor. In the open workspaces, Davis Brody Bond's strategy of stacked trays within the courtyard is most clearly visible: The floor plates stop 4 to 5 feet from the restored marble facades, seemingly close enough to touch. Aluminum-leafed coves along the undersides of the exposed floors draw the eye outward to the articulated lintels and corbels of the courtyard walls and cast a flattering light on the freshly

From the library's marble halls (opposite, left), the renovated South Court appears as a glowing high-tech insertion, accessed by a translucent structural-glass bridge (opposite, right). Behind the flush-mounted rear projection screens (opposite, right, and this page) is the orientation theater.





Directly beneath strip skylights, a structural-glass stair leads down two levels from the main floor to the auditorium (left), passing beneath the glass entry bridge (opposite, top).

The stair descends past exposed rubble footings and terminates in a marble basin defined by new foundations (bottom left and right).



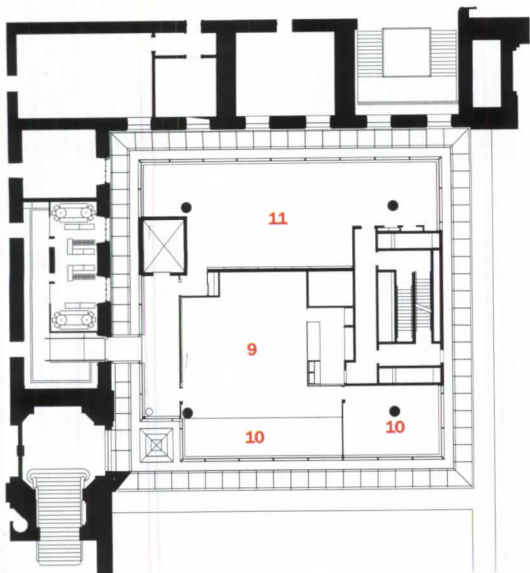

THIRD FLOOR

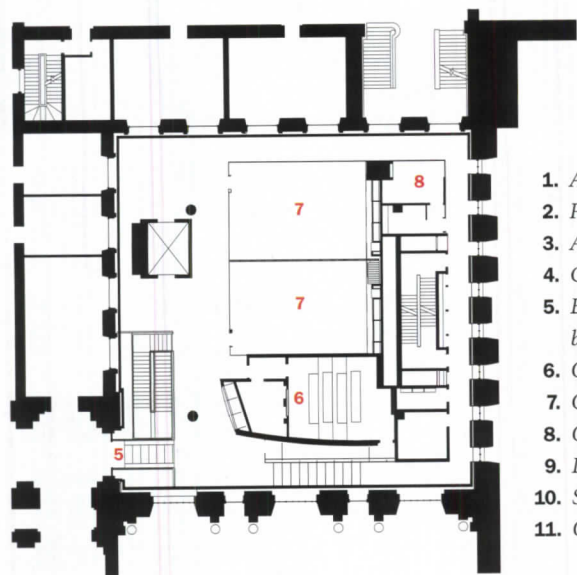

FIRST FLOOR

1. Auditorium
2. Projection
3. Audio-visual
4. Greenroom
5. Entry from existing buildings
6. Orientation theater
7. Classroom
8. Office
9. Dining
10. Staff lounge
11. Open offices

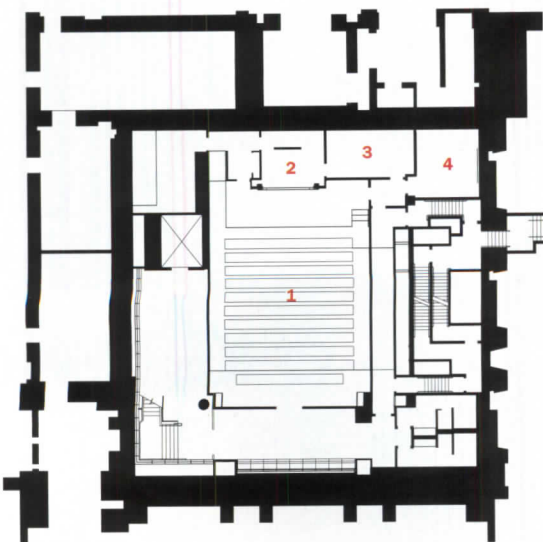

AUDITORIUM FLOOR / BELOW STREET LEVEL

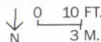

scrubbed elevations. “It’s amazing that Carrère and Hastings did these facades for a service yard instead of using brick,” suggests associate partner and director of interiors Nathan Hoyt. “It shows their commitment to the design.” Hoyt and his colleagues concealed core functions within the open offices behind bright red walls that strike a harmonious chord between the slick workstations and the graceful white marble facades.

The architects inserted strip skylights around the perimeter of the addition just above a continuous cornice that wraps the original courtyard above the second floor. Above this skylight datum, the glass-enclosed addition becomes a self-contained pavilion. Internal walls defining offices, a staff lounge, and a much-needed quiet zone on this level are veiled in beaded stainless-steel curtains that echo the metallic mesh panels found throughout the addition, including elevators.

Hoyt says that one of the driving forces behind the design was keeping the intervention as light as possible. The strategy has paid off handsomely: The new South Court is a graceful, seemingly effortless addition that stakes out a strong modern presence within the library’s marble halls, frescoed walls, and carved plaster ceilings. It uses both light and a lightness of touch to convey a sense of transparency that more accurately reflects the essence of the contemporary library than grand, gilded interiors. It has just enough character not to fade into the background, but lets the surrounding historic architecture become an active part of its composition. In that sense, it’s reminiscent of I.M. Pei’s monumental, but discreet, additions to the Louvre, or Norman Foster’s sleek but sensitive alteration of the British Museum’s Great Court.

LeClerc says he thought it would be “disingenuous” to mimic the library’s landmark structure. “I thought we needed something that was very ‘today,’ something that would stand alone proudly without bowing and scraping and paying homage to Carrère and Hastings,” explains LeClerc. For Davis, however, the revamped South Court is both forward-minded and deeply reverential of the original architects, whom he admires as great innovators. As Davis explains, “We did everything to make Carrère and Hastings proud. In fact, we feel like we created a Carrère and Hastings building.” ■

Sources

Concrete: RCC Concrete
Glass: W & W Glass Systems (curtain wall); ASF Glass, Super Sky (skylights)
Paneling: Bauerschmidt & Sons
Resilient flooring: Armstrong
Carpet: Bentley; Stark
Wood flooring: I.J. Peiser

Office furniture: Knoll

Lighting: Zumbobel; Linear; Edison Price; Elliptipar; LSI; Artemide; Lutron

www For more information on the people and products involved in this project, go to Projects at architecturalrecord.com.



Woven stainless-steel mesh panels, a recurring motif throughout the South Court, define the back wall of the auditorium (above and opposite, top). Inside the auditorium, acoustical panels behind the mesh echo the warm color scheme of beech walls and seat backs. On the addition's third floor, a comfortable staff lounge offers veiled views of the original courtyard facade through glass walls (center right). Translucent glass encloses one of two interactive high-tech classrooms on the main level (below right).



Foreign Office Architects blurs the line between landscape and building in its undulant, dunelike **YOKOHAMA PORT TERMINAL**



Precisely cut and positioned, wood-planking follows the terminal's complex curves (this page). The low-lying structure provides a transition between land and sea (opposite).

By Naomi Pollock

For an island nation, Japan is surprisingly good at pretending its waterfronts do not exist. Throughout the country, shorelines and harbors tend to be undeveloped, at best, or marred by industrial complexes or ill-conceived master plans, at worst. But the completion of Yokohama International Port Terminal, designed by London-based Foreign Office Architects (FOA), is bound to raise those standards. Casting conventional typologies overboard, FOA created a building that blurs distinctions between architecture and landscape. Here, beneath—and above—a long, wavy, “topographical” roof, a transportation node and civic gathering space meld into one.

This highly ambitious project is one of the first large-scale realizations of a new generation of cyber-influenced architecture, distinguished by its fluidly irregular, curvilinear geometry. It is the final result of an open competition held in 1995 by the Yokohama Port and Harbor Bureau. Hoping to create a significant work, the jury—composed of city officials and the renowned architects Arata Isozaki, Toyo Ito, Yoshinobu Ashihara, and Rem Koolhaas—selected FOA’s scheme from a pool of 660 submissions from 41 countries.

By pouring money into public works projects, Japanese government agencies were trying to jumpstart the economy. But the winning team was apparently not quite what the competition organizers had envisioned. FOA partners Farshid Moussavi and Alejandro Zaera-Polo were only 29 and 31 years old, respectively, and had completed just a handful of projects, primarily interiors and renovations. The firm had yet to build a public facility on its own turf, let alone in Japan, making Yokohama city officials nervous, at first, about hiring this young practice from abroad. Complicating matters, a Japanese recession, coupled with routine shifts in the governing bureaucracy, soon put the project on hold and threatened to capsize it. But in 1999, when Yokohama geared up to host 2002 World Cup events, work on the terminal finally began in earnest.

Although FOA’s design was a gutsy choice, the selection of a foreign firm was fitting since Yokohama had been one of the first ports in Japan to open to trade with the West. Still in use today, the Osanbashi Pier, originally erected during the Meiji period in the late 19th century, was expanded with landfill to create a site for the International Port Terminal.

Jutting 1,411 feet into Yokohama Bay, the new construction extends almost seamlessly from the existing pier. The building rises from

Naomi Pollock is RECORD’s Tokyo-based correspondent.

Project: Yokohama International Port Terminal, Yokohama, Japan
Architect: Foreign Office Architects—Farshid Moussavi, Alejandro Zaera-Polo
Associate architect: GKK
Engineers: Structure Design Group (structural); PT Morimura (services)
Consultants: Kado Lighting Design Laboratory; Negata Acoustics; Akeno Fire Research Institute; Urban Traffic Engineering
General contractors: Shimizu; Kajima; Toda

PHOTOGRAPHY: © SARTORU MISHIMA, EXCEPT AS NOTED

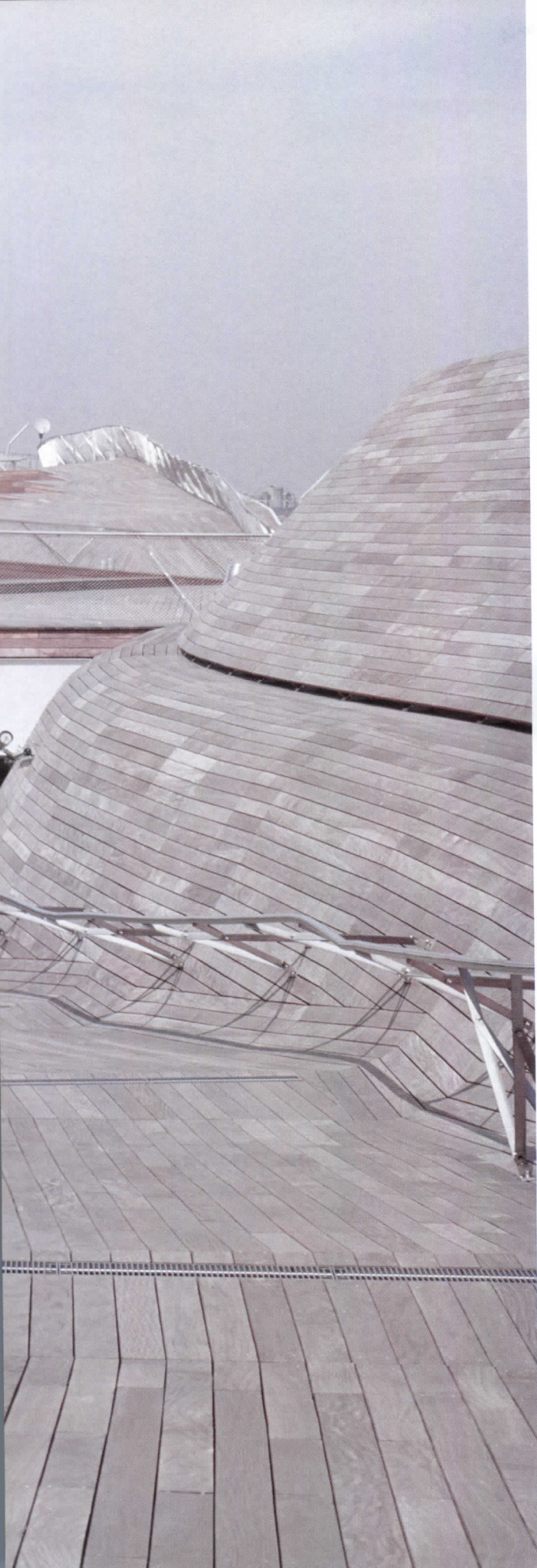

Flanking the roadway, two wooden boardwalks ramp up gradually from the ground to become the terminal's rooftop promenade, offering 360-degree views of the city and sea.

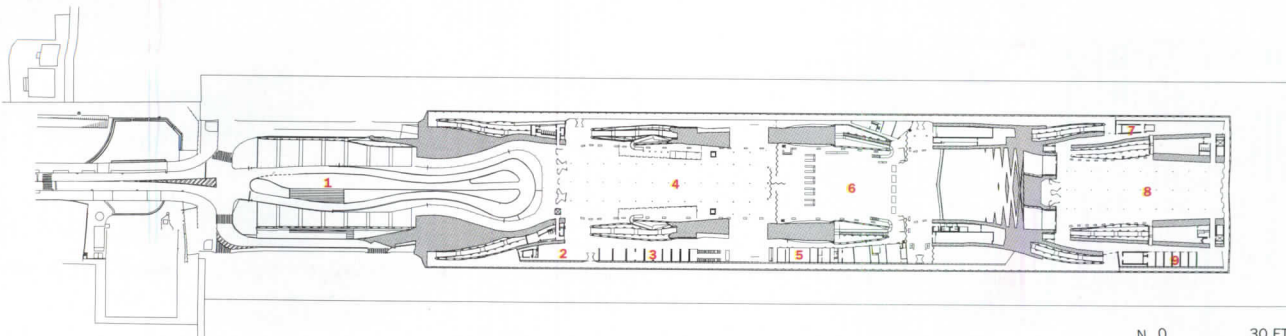

1. Traffic plaza
2. Café
3. Shops
4. Departures/arrival
5. Offices
6. Customs/immigration quarantine

N 0 30 FT.
9 M.



- 7. Restaurant
- 8. Multipurpose
- 9. Dressing room
- 10. Green space
- 11. Amphitheater

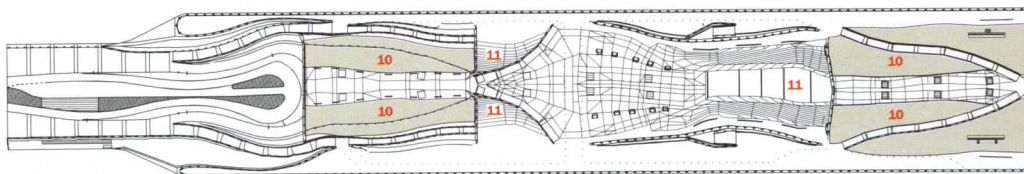

UPPER LEVEL

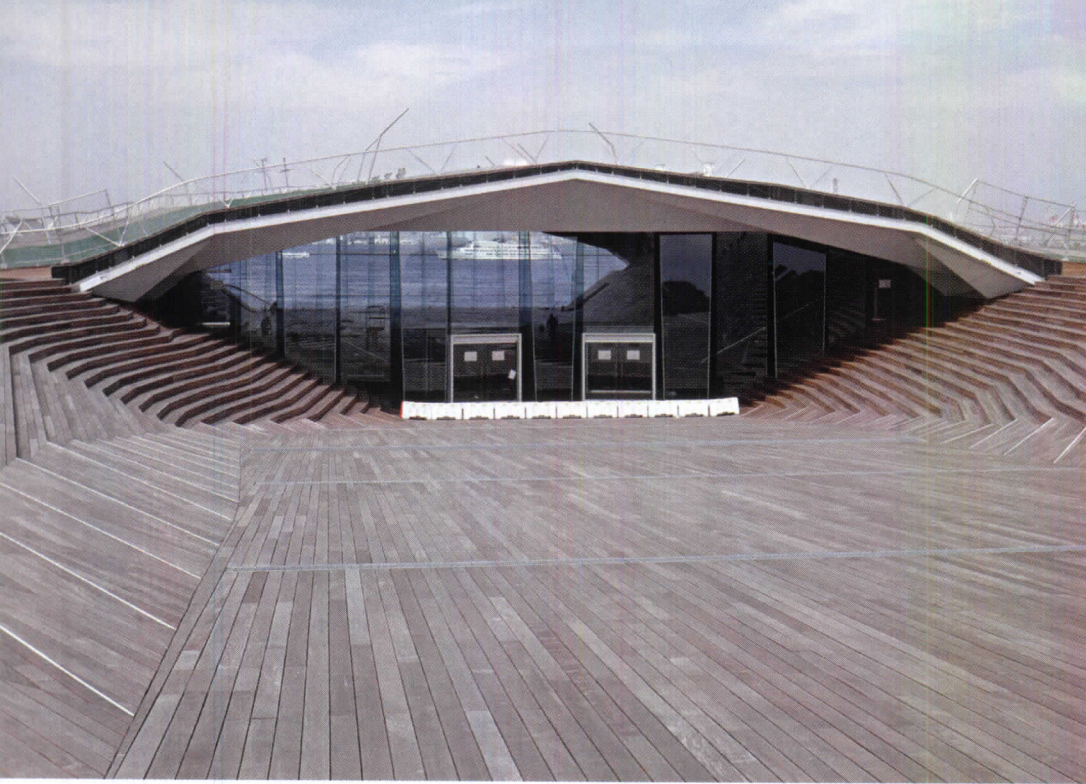

Some of the roof topography steps down to provide raked seating for spontaneous performances, public events, or casual people-watching (left and opposite). In wet weather, the decking's many facets become reflective (center left).



Pedestrians, ships, bicyclists, and automobiles all converge at the port terminal (above). A complex steel substructure (bottom left and right) supports the seemingly gentle flow of the building's sculptural, wood-clad roofscape.

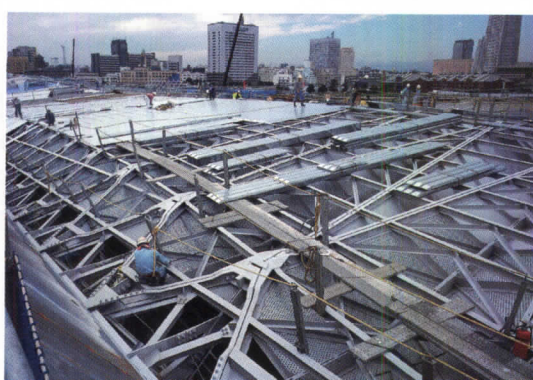



two wooden boardwalks that ascend gradually from the ground to become the rooftop, where a promenade offers 360-degree views of the city and sea. At grade, the terminal's keyhole-shaped traffic plaza culminates at the glazed main entrance. This entry flows into a waiting area for local and international travelers, and then into the customs, immigration, and quarantine plaza. Serving as a passenger-processing area for international cruise ships 25 times a year, the plaza is available for public events on other days. At the terminal's tip, a multipurpose hall with floor-to-ceiling glazing overlooks the water. Flanking these spaces are ramps leading up to the roof or down to service areas and parking for 400 cars. Ship boarding occurs along exterior decks at the building's perimeter.

It was challenging, however, to reconcile the spatial requirements for ship boarding with the site conditions. Though basically symmetrical around its long axis, the terminal is not centered on its newly constructed pier, a 162-foot-wide landfill strip, surrounded by an apron with ship moorings. Because the architects had to retain an existing extension of the Osanbashi Pier, the apron is 16 feet wider on one side than the other. Yet, to accommodate a uniform gangplank size, all decks needed to be equidistant from boats anchored at the apron edges. FOA resolved the discrepancy by cantilevering the terminal level 10 to 16 feet on one side and up to 56 feet on the other. Providing visual balance, they placed boxy offices and shops beneath the inboard ends of the longer cantilevers, while manipulating structural elements to equalize lopsided loading conditions.

The terminal's column-free structural system consists of essentially two parts: folded steel plates for transverse loads and bridgelike steel girders for longitudinal loads and support of the cantilevers. The transverse component was initially designed as two flat plates sandwiching steel webbing, but as the project developed, the bottom plate was eliminated and the webbing replaced with triangulated folds of sheet steel. The entire transverse system evolved from a composite resembling corrugated cardboard (insofar as it held a wavy material between two thin, flat layers) to an assemblage more akin to origami. "The girders are basically large-scale folds," explains FOA partner Alejandro Zaera-Polo. Trough-shaped and hollow in cross section, these members house a network of ramps. But achieving the necessary combination of structure and function was no easy feat: As load-bearing elements, the girders had to be anchored to piles in the landfill, while the ramps within the girders had to mediate between two levels of spatial and programmatic needs. Still another parameter was the required slope for wheelchair access, which set the ramp lengths. The solution, satisfying all these criteria, resulted in a system of wood-lined ramps, each with its own range of twists and curves and girders, all varying in section constantly along the building's length.

Given this geometric complexity, the architects designed the building with computer-generated local vector systems similar to those used routinely by naval architects. But the move from design to construction introduced other complications. To begin with, building

technology typically relies on a more straightforward Cartesian system to position objects in space. And the city complicated the coordination of the construction process when it divided the 97,846-square-foot building longitudinally into thirds, assigning each chunk to a different contractor. Every builder had to piece together its own section and join it with the others, as if assembling segments of a roller coaster. Fortunately, the site's waterfront location eased the task, allowing components to arrive by boat from 15 different steel fabricators and ship builders in Japan and Korea. "What is remarkable is the amount of technology used in this building," says Zaera-Polo. "I don't think ship welding and assembly techniques have

ever been used to this extent in architecture before."

Spreading the work among many manufacturers and contractors may have benefited the economy and kept the project on a tight, two-year construction schedule, but it also placed unusual demands on the architect's ability to maintain consistency. Clean details and a limited palette—glass, steel, and planks of Brazilian Ipe, or ironwood—helped, yielding uniform interior and exterior surface treatment and reinforcing spatial flow. Although the undulant, wood-clad building may seem laden with references to dunescapes and seaside boardwalks, the formal qualities are rooted in the terminal's program and functions, as well as the architects' desire for visual continuity. To achieve such a strong sense of unity, FOA had to keep close tabs on the project. So the London-based firm set up a Tokyo office and followed the work throughout construction.

Working overseas had its trying moments for FOA, but the project has been well received in both Japan and England. Though relatively few Europeans have had a chance to visit Yokohama, the building is making waves around the globe. In this year's Venice Biennale, it constituted Britain's entire entry. With the Yokohama terminal, the still-young firm of FOA has put itself on the map—and navigated international waters with remarkable skill. ■



Sources

Steel: *Kawasaki Heavy Industries; NKK*

Nail fastenings: *Hilti (stainless steel)*

Glass: *Asahi Glass Building Component Engineering*

Handrails: *Kanematsu Devices*

Wood: *Isolite Insulating Products; Maeda Environmental Art*

www For more information on the people and products involved in this project, go to Projects at architecturalrecord.com.

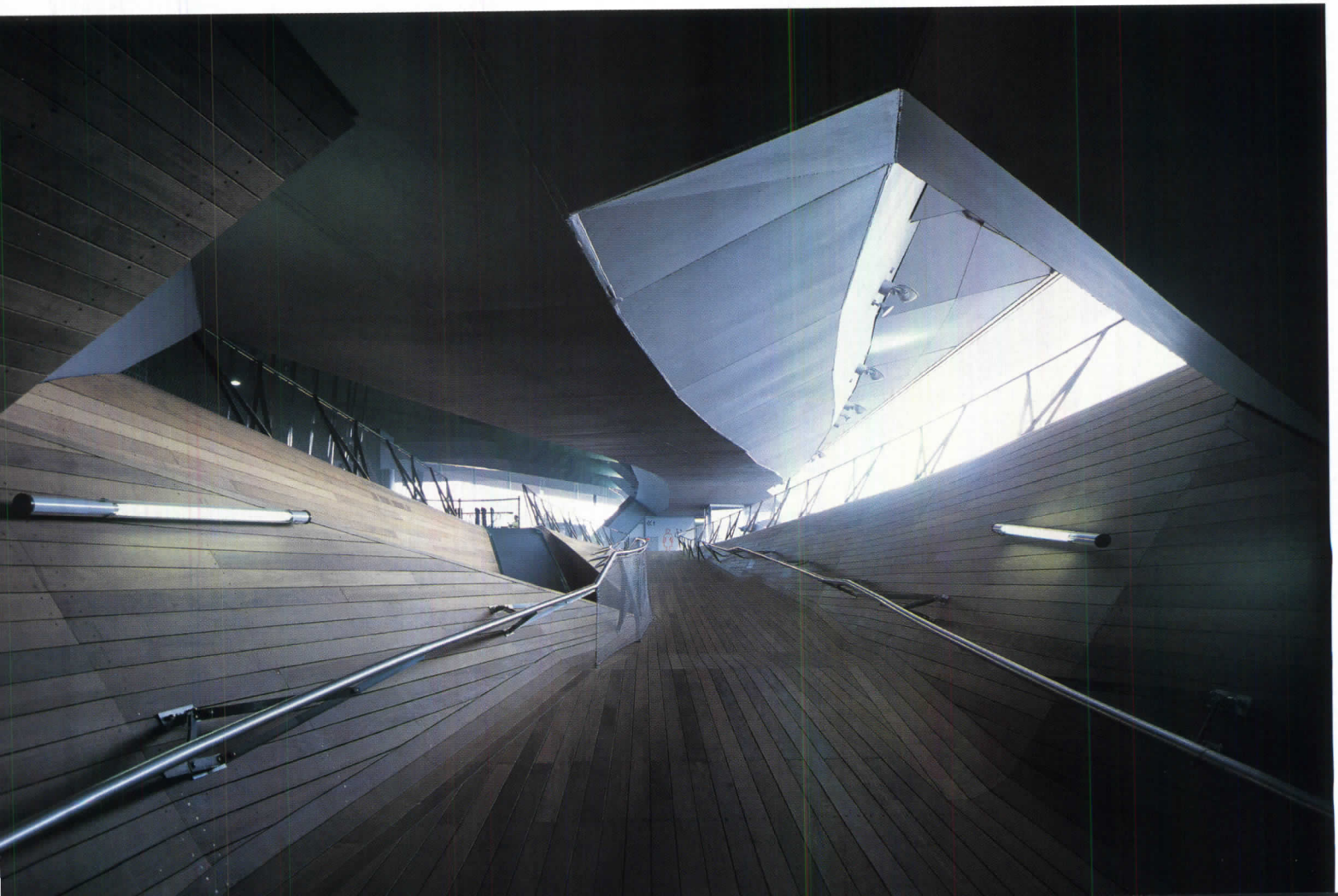

Inside the terminal, the origami-like structural system has a powerful presence (this page and opposite, top). Interior ramps, lined in wood planks, connect the building's two levels (opposite, bottom).



Mack Scogin Merrill Elam mediates deftly
between the man-made and the natural in its
Herman Miller **CHEROKEE OPERATIONS** plant



Set amid the rolling hills of north Georgia, the plant is clad in standard tilt-up concrete panels—but with surprisingly subtle and poetic results (this spread and opposite, inset).

By Christine Kreyling

In Cherokee County, Georgia, north of Atlanta, the Appalachian Mountains relax into hills that roll with vigorous contours reminiscent of a Thomas Hart Benton painting. From certain vantage points, the hills read as a series of layered planes receding into the horizon. A similar language of layering emerges in the Herman Miller Cherokee Operations plant by the Atlanta firm of Mack Scogin Merrill Elam Architects.

At the outset, furniture manufacturer Herman Miller presented a straightforward program—to merge, under one roof, the operations of its three separate Georgia facilities for office-system production and distribution. One of those facilities, located in Roswell, had been designed nearly 20 years earlier by Mack Scogin, AIA, and Merrill Elam, AIA, then working in the offices of Heery & Heery [RECORD, January 1983, page 122]. But subsequent changes in property values and land use, coupled

Christine Kreyling is Nashville Scene's architecture and urban-planning critic.

Project: Herman Miller Cherokee Operations plant, Canton, Georgia

Architect: Mack Scogin Merrill Elam Architects—Mack Scogin, AIA, principal in charge; Lloyd Bray, AIA, and

Merrill Elam, AIA, collaborating principals; Tim Harrison, project architect

Landscape architect: Michael Van Valkenburgh Associates—Matthew Urbanski, principal







PHOTOGRAPHY: © TIMOTHY HURSLEY, EXCEPT HELEN HAN/MACK SCOGIN MERRILL ELAM ARCHITECTS (TOP RIGHT)

Tilt-up concrete slabs screen the entry route into the building (opposite, bottom). Openings within the slabs and thin slots between them create a pattern of repetition and variation that evokes the rhythm of the assembly line (this page, photos at right). Truck containers, used for storage, occupy a yard bound by concrete walls (bottom right). Trucks, extending out from the loading docks, accentuate the long, low character of the building (opposite, top). A state highway along the site's northwest edge provides the main access to the plant, while to the site's southeast, views open up toward the Etowah River and some of its tributaries (above left).

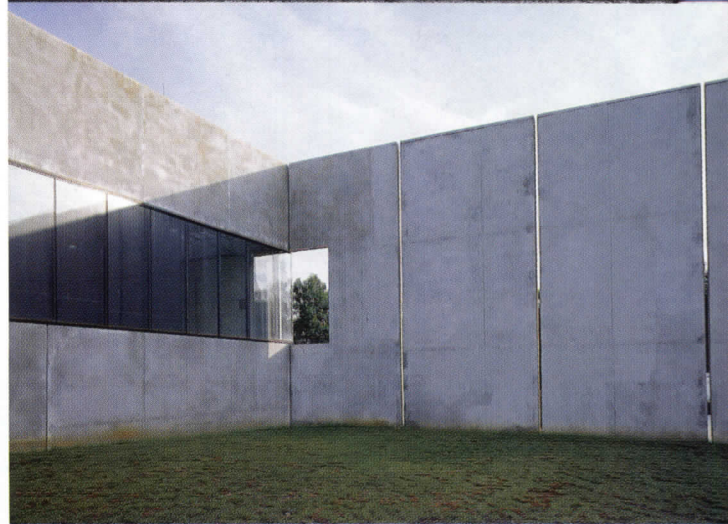
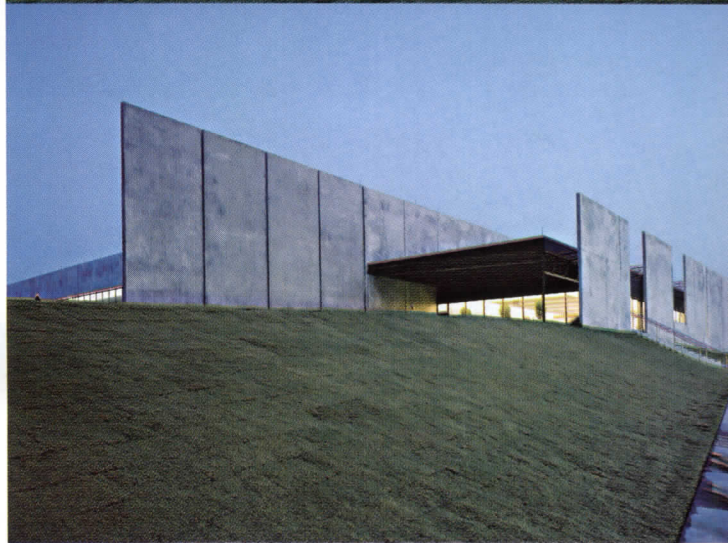
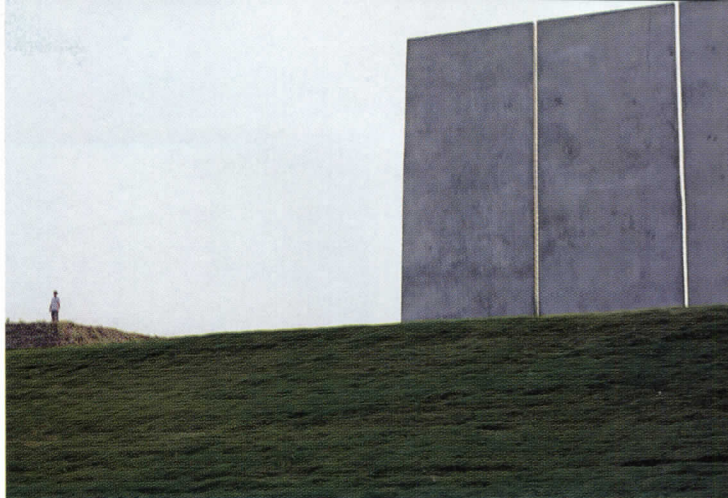

A forest of telephone poles, some holding lighting, punctuates the parking lot (this page and opposite), mediating between the building and surrounding hills. Wildflowers bloom in the meadows (right). Ivy will eventually cover the inside of the concrete screening walls (below), “greening” close-range views from within the glazed office areas.





with the inefficiencies and costs of decentralization, prompted the company to consolidate. The new plant, as Herman Miller engineers calculated, called for a 330,000-square-foot space all on one level.

The solution required the precision of smoothly meshing gears. In transforming a manufacturing flow diagram into architecture, the designers had to efficiently and economically shelter the path leading from raw materials, through fabrication and assembly, to trucks poised for product delivery to the world. Large parking aprons would accommodate truck containers—an inexpensive means of inventory storage. Minimal showroom and office space were needed. And a lean budget of \$17.9 million set a cap of \$55 per square foot.

For such a large footprint, rolling terrain is not the obvious choice. In fact, Herman Miller selected a site in Cherokee County only after receiving inducements, such as local tax abatements, job-training assistance, and infrastructural improvements. In Canton, the county seat, the company found a reasonably flat site: 70 acres of open pasture that required some grading but no removal of dirt or trees.

The massing and site plan—with landscape design by Matthew Urbanski of Michael Van Valkenburgh Associates—open the building's sight lines to the rear, away from the road and toward the property's southwest edges, licked by the Etowah River and its tributaries. "The idea was to retain the feel of the original promontory, to take advantage of the views of

hills and river," explains Elam. The forms and style, however, are decidedly not suburban picturesque. As she puts it, "We chose not to domesticate."

Instead, architecture and landscape speak a complementary idiom of simple materials shaped into severe, consciously manipulated forms. A major goal was to distinguish human from machine space. "This is a big place," Elam explains. "You have to be selective about making 'moments,' surprises—detailed human encounters with site and building."

The final results reveal appropriately huge, boxlike sheds for fabrication and assembly. Adjacent, but slightly staggered in plan, they have tilt-up concrete walls with corrugated metal ceilings and a steel truss system overhead. Perimeter skylights articulate the shed walls and provide balanced illumination for the truck-loading docks that flank the assembly zone. Within the great scale of the manufacturing processes, glazed doors signify access for people. Similarly, a transparent layer of offices—forming a thin, L-shaped zone along the assembly and fabrication sheds—defines with storefront glazing the project's most intimately scaled spaces. Twelve-foot-high picture windows open up views between offices and manufacturing. At the front of the building, large, thin tilt-up concrete slabs form two parallel screening layers, connected to the building core by steel joists. Penetrating these layers, the entry route is democratic, welcoming the arrival of both white- and blue-collar workers, as well as visitors, through a central door.

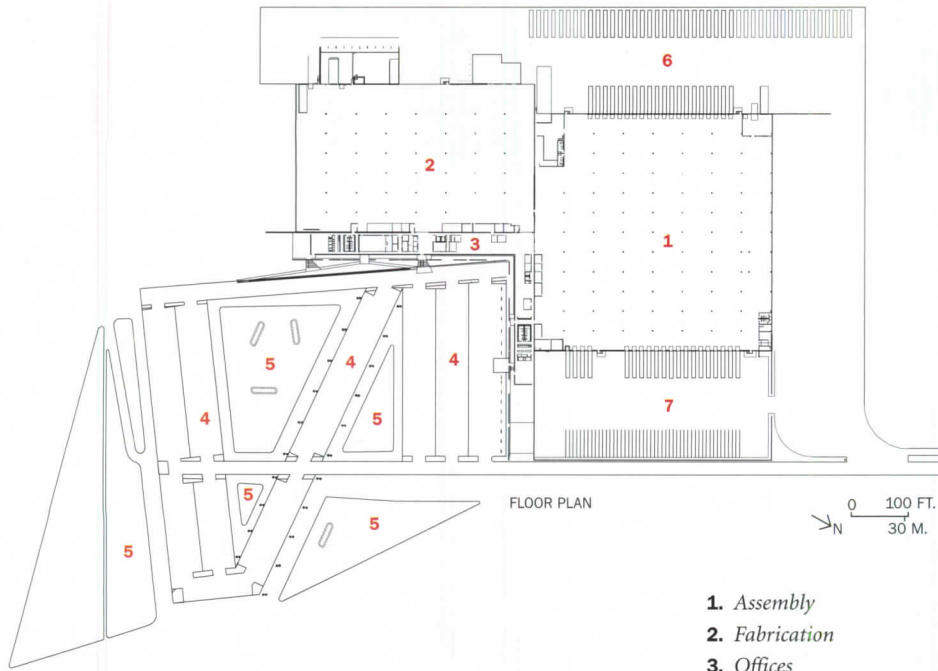

1. Assembly
2. Fabrication
3. Offices
4. Parking
5. Water filtration
6. Receiving
7. Shipping

The manufacturing areas (opposite) evoke a huge, finely tuned machine. Glass walls inside the offices (below right) yield views into assembly and fabrication zones. Herman Miller products furnish the offices and a lounge (below left).



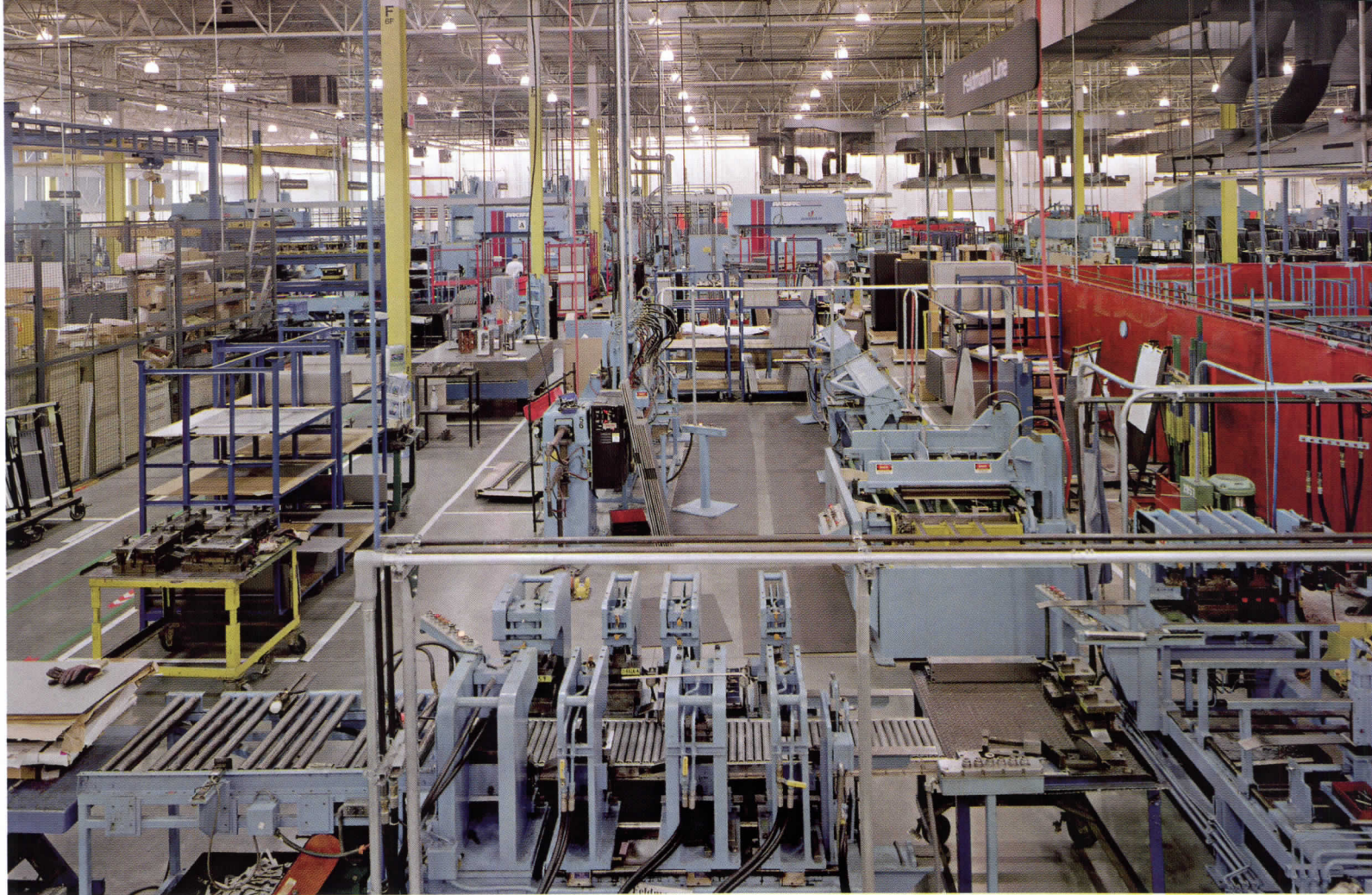

Openings in the tilt-up slabs create a pattern of repetition and variation that evokes the assembly-line process. The fenestration frames views from within, while thin slots between the panels allow the sun to cast precise slashes of light—examples of what Elam calls “moments.” Outside, the rhythm of apertures turns a simple box into an exploration of geometry—a play of light and shadows worthy of a De Chirico painting.

The architects selected tilt-up concrete in part for its economy—but this method also holds a more-than-respectable place in the history of American architecture. Irving Gill and then Rudolph Schindler used it to pioneer concrete construction in southern California in the early 20th century. In more prosaic applications, the technique is ubiquitous in north Georgia today. “Tilt-slab is a local custom for warehouses and transportation facilities—it’s a method tried and true,” Elam says. “But the concrete is usually painted. We were going for honesty of materials.”

The need for economical solutions, done with style, influenced not only the building, but also the landscape design. The challenge, according to Urbanski, entailed storm-water management on a site with rivers and streams on three sides. Water quality had to be maintained, even where impervious surfaces tend to concentrate the runoff. “The normal solution,” Urbanski says, “is to jam parking close to the building, and then link both by piping, with fairly deep storm-water retention ponds farther away.” Instead, the landscape designer devised a more mutually beneficial way to recombine the same three components: building, traffic infrastructure, and storm-water filtration.

Urbanski made what he describes as a “collage” of shallow ponds distributed across the asphalt parking area. The shallowness, he says, helps prevent “a violent change in pond ecology when it rains—so you can put

plantings in them and create marshland.” By eliminating the need for curbs, drain inlets, and extensive piping, this strategy reduced infrastructure costs—and, as the landscape architect suggests, “added visual interest by breaking up the scale of parking with a variety of shapes.”

Those shapes include hedgerows of trees bordering the marshland. A “forest” of phone poles, some of which support lighting, also punctuates the parking lots. The poles are taller and more numerous than the lighting required, but they give the space vertical definition, providing a transition between the building and the surrounding hills and valleys.

Roof and truck-apron runoff flows to the front of the site. “Such a giant pulse of water is too violent for marshes,” Urbanski explains—so, in front of the building, he created a large pond, excavated down to the bedrock. The pond’s organic shape contrasts with the building’s geometry, reinforcing tension among natural, apparently natural, and explicitly constructed elements. While the green infrastructure and its processes mimic nature, the orthogonal concrete forms are clearly man-made.

“We haven’t invented anything here,” says Elam. “All the materials are standard off-the-shelf. What we were looking for was not experimentation, but a different way of assembling things.” ■

Sources

Tilt-up concrete: *T & M Tilt-Up*

Zinc cladding: *VM Zinc*

(preweathered Anthra-Zinc)

Exterior paint: *Tnemec*

Skylights: *Naturalite Skylight*

Systems; Polygar Solar Grade

Fabric wall panels: *Herman Miller*

Glazing system: *Trainor Glass*

(storefront)

www For more information on the people and products involved in this project, go to Projects at architecturalrecord.com.

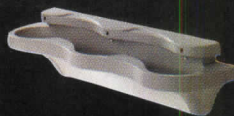

**WANT TO KNOW WHICH WASHROOM FIXTURES
AND ACCESSORIES TO CHOOSE?
ASK SOMEONE AS PICKY AS YOU ARE.**

As an architect or designer you embrace a look that's different. And nobody gives you more styles and colors to choose from in washroom fixtures and accessories than Bradley. Your reputation depends on the quality of the products you specify, which is why we rely on an old-fashioned principle of making products that are built to last. For 80 years, Bradley has been the leader in both quality and innovation. Break away from the ordinary and give yourself better choices for better results. Specify Bradley. To learn more about what Bradley can offer you, visit us at www.bradleycorp.com, or call 1-800-BRADLEY.

CIRCLE 126 ON READER SERVICE CARD
OR GO TO WWW.LEADNET.COM/PUBS/MHAR.HTML

Bradley 

Better choices. Better results.

© 2002 ALL RIGHTS RESERVED.

RESTAURANTS

This Year's Models

ARCHITECTS AND INDUSTRIAL DESIGNERS ARE CREATING DINING PLACES THAT CAN COMPETE WITH OTHER FORMS OF ENTERTAINMENT FOR THE CONSUMER'S ATTENTION.

By Clifford A. Pearson

1.

New York City

As designed by Andre Kikoski, a dining platform hovers above a frame of water in the cellar of what had been a neighborhood bodega.



2.

Philadelphia

Karim Rashid combined the logic of the Cartesian grid with the sensuality of soft, swirling forms at a restaurant for Iron Chef Masaharu Morimoto.



3.

Los Angeles

Richard Cutts Lundquist, AIA, designed a modern oasis that sets this spacious Korean restaurant apart from all of its competition.



4.

Reykjavik, Iceland

Colorful lighting, sleek furniture, and high-tech materials give a slightly surreal spin to a club designed by British expatriate Michael Young.



The life of most restaurants is nasty, brutish, and short—just like that of humankind, according to Thomas Hobbes. Even the places lucky enough to earn praise and attract hordes of patrons tend to lose their appeal after a few years, then quietly disappear. It's a tough business that rewards the new and the beautiful. While such conditions put enormous pressures on restaurateurs, they create great opportunities for architects. The need to catch the public's eye pushes owners to invest in design, and the fleeting nature of a restaurant's existence encourages experimentation. Don't try designing for the ages here, just make it fresh and engaging. Restaurants reflect the moment. They are now or they are gone.

Once upon a time, dining out was a special event to be treated with aristocratic reserve and fine manners. Today it is entertainment—high, low, and everything in between. Restaurants must compete with movies and plays for consumer dollars. Do we go out for a nice dinner or do we see a Broadway show? How does the interior design of that hip new Asian restaurant compare with the set design of David Henry Hwang's new production of *The Flower Drum Song*? Which is more fun? It's no coincidence that David Rockwell, one of the country's busiest restaurant designers, recently did the sets for the play *Hairspray*.

If restaurant design offers a mirror to the latest trends, what does the current crop of dining places tell us? From the four projects shown in this Building Types Study, we can see a number of ideas and tools in play. One is a bold use of color. Both Karim Rashid at Morimoto, in Philadelphia, and Michael Young at Astro, in Reykjavik, wield vibrant palettes of electric hues. Indeed, they've literally plugged in their designs, making colored light a featured part of the performance and creating a show in which colors change while customers eat and drink.

Andre Kikoski at Suba, in New York City, and Richard Cutts Lundquist, AIA, at Chosun Galbi, in Los Angeles, take approaches that rely more on shaping space than manipulating surface and color. And instead of creating environments that seem to float outside of the everyday realm, they ground their designs in the particulars of place—either the old brick walls of a Lower East Side tenement building or the dancing sunlight of southern California.

It's interesting to note that both Rashid and Young are industrial designers, while Kikoski and Lundquist are architects. Such blurring of professional boundaries isn't surprising in a society that sees dining as a subset of entertainment and treats restaurants as products with spin-off potential and cross-marketing opportunities. ■

www For additional restaurant projects, and more information on the people and products involved in the following projects, go to Building Type Study at architecturalrecord.com.

Suba

New York City

1 **ANDRE KIKOSKI HAD TO DIG BELOW THE SURFACE (AND INTO THE CELLAR) OF AN OLD TENEMENT TO CREATE A HIP NEW PLACE TO BE SEEN.**

By Elizabeth Harrison Kubany

Architect: Andre Kikoski Architect—Andre Bassim Kikoski, AIA, partner in charge and designer

Owner: Suba

Engineers: Gilsanz Murray Steficek (structural); Sharon Engineering (m/e/p and structural)

Lighting consultant: Ann Kale Associates

General contractor: Suba

Size: 4,000 square feet

Cost: \$1.98 million

Sources

Storefront system: Kawneer

Glazing: Corona Glass

Structural steel for stair and ramp: Colonial Steel

Stainless-steel bar grating: McNichols Metals

Millwork: Custom by Heights Woodworking

Bar lighting: Light Solutions

Track lighting: Halo

Submersible lighting: Hydrel

Step lights: LucePlan

www For more information about the people and products involved in this project, go to Building Types Study at architecturalrecord.com.

The New York City restaurant scene sometimes seems borderless. On any block, in any neighborhood, at any time of day or night, wonderful discoveries—both culinary and architectural—can be made. Located on a desolate block of Manhattan's Lower East Side, a neighborhood in the throes of gentrification, Suba offers one such surprise.

Program

When he first saw the 1909 tenement building that is now Suba's home, New York City architect Andre Kikoski needed to use all his imagination to envision what might be. A childhood friend, attorney-turned-real-estate-entrepreneur Whitney Quillen, had purchased the property and wanted Kikoski to transform it into a restaurant. The place was "horrific," he says. The two bodegas at ground level had been forced to close by the Drug Enforcement Agency, and a rear apartment and backyard were filled with trash and vermin.

Solution

Kikoski slipped the restaurant within the brick shell of the tenement, designing a ground-level lounge as a dark and intimate space with a bar crafted of walnut and industrial metal and fitted with sleek furniture that he designed. The lounge, though, turns out to be just one of

Elizabeth Harrison Kubany is a contributing editor to RECORD.



Suba's three main spaces, a teaser for what is hidden below.

Behind the bar, patrons descend a staircase of stainless-steel bar grating suspended over an 18-foot-long illuminated reflecting pool. The staircase is a microcosm of the entire restaurant: raw, industrial, and meticulously detailed. The architect even measured the width of his wife's Manolo Blahnik stilettos so the stair's metal grating would be tight enough to prevent fashionistas from losing their heels as they walk up or down.

At the bottom of the stair, a small bridge leads to the dining "grotto," the Lower East Side's answer to the Four Seasons Pool Room—albeit somewhat grungier and turned inside out. Instead of



The main dining area (this page) occupies what had been the cellar of the old bodega. A narrow channel of water wraps around the floor, giving it the feeling of floating. From the street (opposite, top), visitors see only a small bar and lounge (opposite, bottom).





GROUND FLOOR

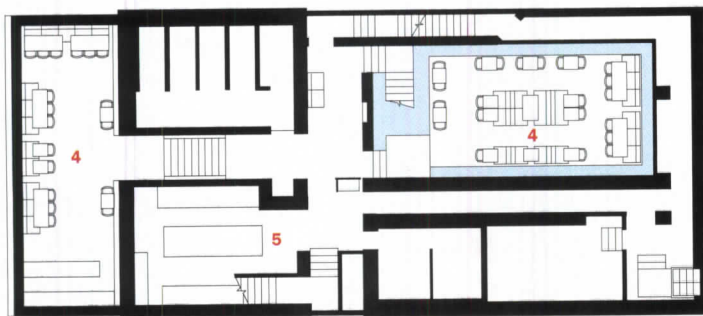

LOWER LEVEL

1. Bar/lounge
2. Storage
3. Office
4. Dining
5. Kitchen

While industrial materials, such as brick, steel, and concrete, set the tone for most of the restaurant, “Frida Kahlo and Diego Rivera” colors provide a different accent to the skylight lounge on the lowest level (below and bottom). Lights in the water in the grotto (opposite) cast moving shadows on the wall.



dining tables surrounding a pool, the water at Suba (7,000 gallons of it) surrounds the tables. Fifty underwater lights (designed by Anne Kale Associates, the firm that relit the Four Seasons’ pool) shine through the gently moving water to cast shimmering ripples of light across the room’s exposed brick walls and ceiling vaults.

Half a level below the grotto, in a space excavated from what had been the rear yard, is the skylight lounge—ironically, the only room in the restaurant with views to the sky. Although not large, the lounge has 14-foot ceilings and graceful proportions, which give it an expansive feel.

To create this subterranean playground required expensive preparation. In fact, almost three quarters of the project’s budget went for excavation, structural design, and mechanical/electrical/plumbing work. Workers removed more than 8 feet of earth for the grotto and 10 feet for the skylight lounge. They inserted steel beams throughout the building and tied these new members to the existing structure.

While most of Suba is new—including its systems, spaces, and structure—Kikoski retained the old building’s brick fabric to create a

seamless blending of past and present. Even when he had to move a wall, he reused the old brick as much as possible. To embellish this simple materials palette, he added a few contemporary flourishes, such as tinted concrete floors polished with automotive wax and “Frida Kahlo and Diego Rivera” colors on a few of the surfaces in the skylight lounge.

Commentary

These days, when restaurants often resemble the sets of Broadway shows, Kikoski set out to create a restaurant that was all about space and architecture rather than surface and flash. Suba is defined by the architect’s reverence for New York City. New York, he says, “is all about things that became other things.” So he tried to respect the original tenement as much as possible. While cleaning and restoring the old fabric, he inserted contemporary furnishings and a modern sense of space. As a result, the restaurant seems to be of and about Manhattan’s Lower East Side while serving as a magnet for a less rooted, more global culture of pretty young things sipping trendy cocktails and grazing on tapas. ■



Morimoto Philadelphia

2

KARIM RASHID BRINGS AN INDUSTRIAL DESIGN AESTHETIC TO A BOLD RESTAURANT THAT'S HANDMADE—JUST LIKE THE SUSHI ROLLS.

By Clifford A. Pearson

Designer: Karim Rashid—Karim Rashid, principal; Jalan Sahba, project manager; Lisa Rusakova, Aurelie Brunet, architects
Client: Stephen Starr
Lighting designer: Focus Lighting

Size: 10,800 square feet
Cost: \$1.3 million
Completion date: November 2001

Sources

Curtain wall: Paul Rabinowitz Glass Company
Booth and sushi-bar seating: Galerkin Design
Lobby seating and lounge ottomans: Nienkamper
Glass tables: Curvet USA
"Candle" table light: Custom by Karim Rashid

Take three oversized personalities, shake well, and pour into a long, tight space. Sounds like a recipe for disaster. But somehow it created the very hip, very successful restaurant Morimoto. Like one of those Hollywood films with a cluster of big names, the project brought together a powerful producer—Stephen Starr, Philadelphia's restaurant mogul; a strong-willed director—designer Karim Rashid; and a popular star—chef Masaharu Morimoto, of Nobu and *Iron Chef* fame. While all three admit they didn't always get along, their collaboration produced a restaurant that has pleased both food and design critics.

Program

A former rock-concert promoter and club owner, Starr reinvented himself in the 1990s as a restaurateur. Having hit it big with a martini bar called Continental; a pan-Asian restaurant, Buddakan; a Parisian bistro, Blue Angel; and other themed establishments, he decided Philadelphia was ready for a modern Japanese restaurant that would break free of stereotypes. "I wanted a place that reflected the new Japan, not Western ideas of old Japan," he explains. He hired New York City-based industrial designer Rashid to find an architectural expression for chef Morimoto's inventive fusion cuisine. Just as Morimoto's cooking crosses national boundaries, Rashid's work



blurs distinctions between product and architectural design.

When Starr showed Rashid two locations for the restaurant—one conventionally proportioned and the other just 21 feet wide and 240 feet long—the designer recommended the more difficult, narrow property. "It's an amazing space," exclaims Rashid. "It forces you to be creative."

Fitting a dining room with 122 seats and a sushi bar with 13 stools onto one level was a challenge. But a 19-foot-high ceiling relieves any sense of claustrophobia and allowed Rashid to tuck a small bar and lounge onto a mezzanine overlooking the dining room. Rest rooms and food-preparation spaces occupy a basement level.

www For more information about the people and products involved in this project, go to Building Types Study at architecturalrecord.com.

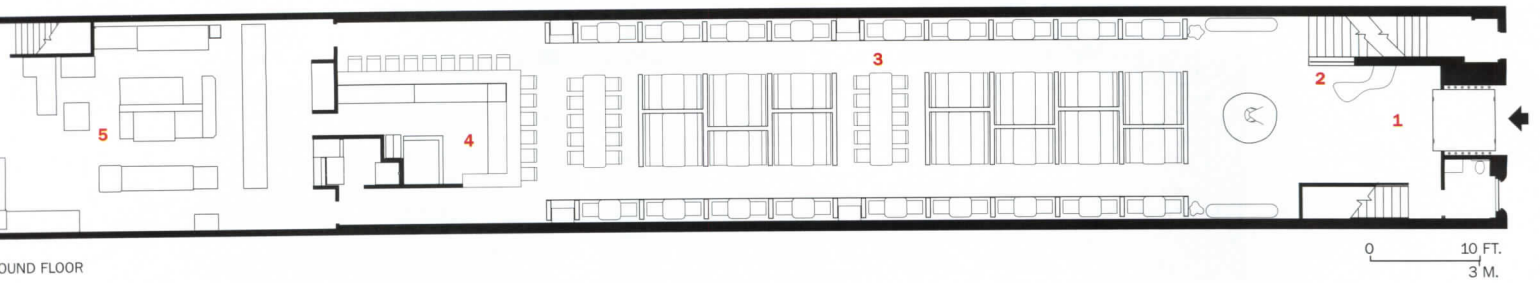

GROUND FLOOR

ashid wrapped the
doors and rolling ceil-
ing with narrow strips
of bamboo and ani-
mated the walls with

a snaking relief made
of a semigloss stucco
on top of metal lathe.
Chairs and benches
are leather clad.

1. Lobby
2. Reception
3. Dining
4. Sushi bar
5. Kitchen



A mezzanine lounge (bottom) looks onto the dining room (right and middle), where a Cartesian grid of booths and tables marches between bio-morphic walls. LED fixtures within the glass partitions change the color of light emitted every 12 to 15 minutes.



Solution

Rashid's design strategy was to wrap the restaurant's interior with soft, organic forms, then anchor it with a rigid grid of seating booths. Using the same computer modeling he employs when developing furniture and other manufactured objects, he designed walls that bulge out as much as 18 inches at mid-height to form a wiggling strip running the length of the restaurant. He animated the ceiling, as well, creating a rolling surface made of bamboo.

For the seating area, though, he took a more Cartesian approach, lining the two long sides of the restaurant with fixed, two-person tables and running a procession of glass booths with alternating four- and six-person tables down the middle of the floor. Set within the 6-inch-wide glass partitions are light-emitting diodes (LED) that slowly, continuously change color and intensity. Clear green glass tables and off-white leather seating offer neutral keys to the pulsating visuals. In the back of the restaurant, an L-shaped, glass sushi bar provides another calming element.

While Rashid used the same design methodology for this project as he would for a chair or a watch,

he wasn't able to build it as a manufactured object. In the end, the biomorphic walls were made the old-fashioned way: with plywood, metal lathe, and hand-applied Japanese semigloss stucco.

During the design process, chef Morimoto made just two requests: that he be visible when working and that customers be able to use the bathrooms without having to touch anything. Excited by the first request, Rashid tried placing the sushi bar in the middle of the restaurant. But the narrow space made this scheme unworkable. So he put the sushi bar in the back but kept it open to view. Downstairs, he eliminated doors to the rest rooms by tucking stalls behind a freestanding partition and specifying automatic faucets and hand dryers.

Commentary

At first glance, Rashid's design seems to rely on one big gimmick: light that changes color. But it works because he couples the trick with a crisp, clean plan, elegant materials, and a bold use of a very long space. While color grabs your eye to begin with, eating at the restaurant turns out to be a more calming experience than you might expect. ■

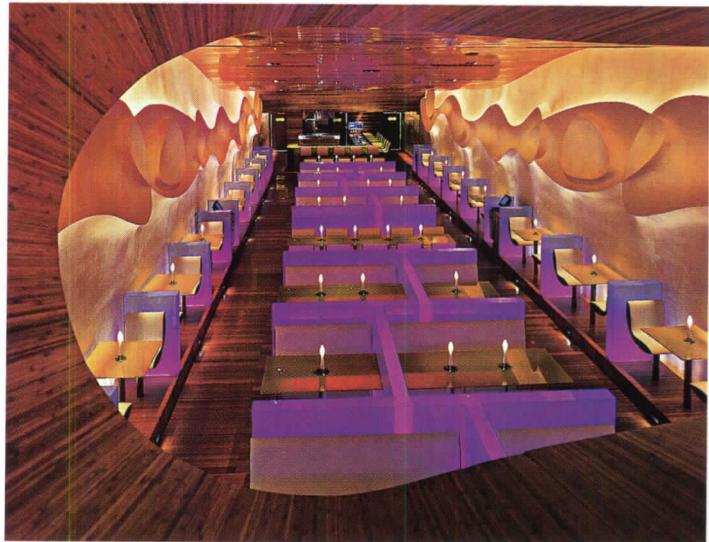



Rashid says the morphing colors “change the phenomenological sense of the space,” creating different impressions over time.

CHOSUN GALBI

Los Angeles

3

RICHARD CUTTS LUNDQUIST, AIA, CREATES A VARIED MENU OF DIFFERENT SPACES TO MATCH THE PIQUANCY OF KOREAN CUISINE.

By Suzanne Stephens

Architect: Richard Cutts Lundquist, AIA—Richard Cutts Lundquist, principal; Sookja Lee, David Takacs, project team

Client: Kyong M. Ji

Consultants: Paul Francheschi Engineering (structural); Yoomi Yoon (lighting); Glen C. Drake (landscaping); Henry Park (kitchen)

Size: 8,000 square feet

Cost: Withheld

Completion date: Fall 2001

Sources

Steel structural system: Young Star Steel and Iron Work

Metal work and chairs: Deco Welding & Sheet Metal Works

Cabinetwork, custom woodwork, fixed seating, and reception furniture: Bamboo World

www For more information about the people and products involved in this project, go to Building Types Study at architecturalrecord.com.

Aficionados of Korean barbecue don't usually expect much in the way of design ambience. Pure function—where grilling and dining take place simultaneously around a table—has a way of focusing all thoughts on the savories at hand. However, at ChoSun Galbi (literally "Korean Barbecue"), in Los Angeles, architect Richard Cutts Lundquist, AIA, boldly demonstrates that these dual activities can be enhanced by a rich and varied architectural expression.

Program

The owner, Kyong M. Ji, a well-known restaurateur in the Korean community, owned two restaurants before opening ChoSun Galbi with her husband, who is the chef. This time she wanted to create a venue with a strong design presence that would differentiate itself from the slew of eateries in the Koreatown section of L.A. The site itself was a challenge: a corner lot on busy four-lane Olympic Boulevard noted for a cacophony of noise and visual clutter. Mrs. Ji wanted the restaurant to be a soothing oasis seating about 250 people, with private dining rooms for large groups of families or business people. Her lighting designer, Yoomi Yoon, recommended Lundquist, a former architecture professor of hers, who had worked previously for both Morphosis and Michele Sae, before opening his own office in 1990.

Solution

Originally the restaurant was to occupy a renovated brick storefront building. Once the design was under way, however, it became clear that this building had structural problems. So Lundquist replaced it with an economical, low-key, concrete-block structure, while adding more formally active spaces at the rear, where he could place the entrance adjacent to parking for cars.

Guests arriving at the rear enter the restaurant along a path that skims by an outdoor dining patio framed by a steel pergola, which is planted with lush vegetation that blocks the view of the cars. The pergola is created from rolled I-beams employed as both curved columns and flying arches, and it carries a trellis of steel fins covered by thick vines of bougainvillea.

Immediately inside the restaurant, two private dining rooms enclosed in basketlike forms of bamboo and steel create a buffer zone between the patio dining area and the restaurant proper. Here, four arches of steel, 4 feet wide and 40 feet long, are placed in a staggered configuration every 20 feet, so that a structure of 80 feet is generated. This formation yields two discrete dining rooms, 20 by 16 feet, with two areas, also 20 by 16 feet, left over for circulation and additional dining. To give the rooms a

PHOTOGRAPHY: © MARK LUTHRINGER (TOP TWO); BENNY CHAN (BOTTOM)

The entrance from the parking lot takes guests past open-air dining under the pergola, and past private dining rooms enclosed in bamboo (below), to the interior (near right), where the bar is located (far right).

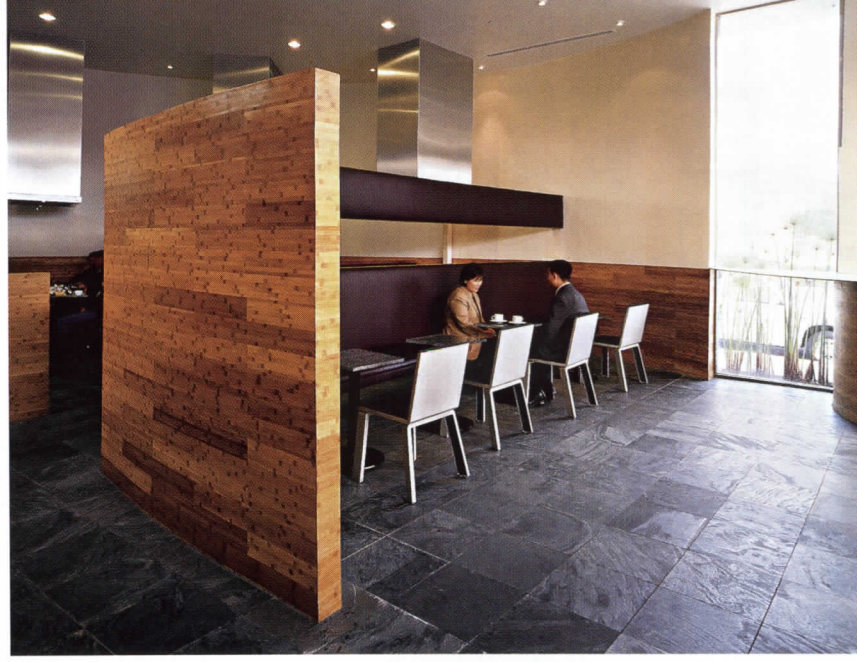



1. Water garden
2. Lobby
3. Reception
4. Bar
5. Private dining
6. Main dining
7. Kitchen
8. Patio dining

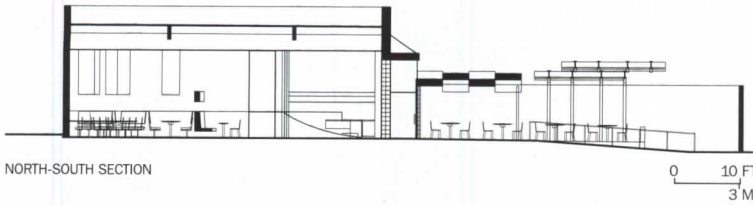

NORTH-SOUTH SECTION

sense of warmth, Lundquist wrapped the ceiling and screen walls with bamboo.

As guests come into the main section of the restaurant, they find themselves at a central reception area and bar, where aluminum countertops mimic the soft curves of the arches in the outer region. From here they enter the main dining room, which, while it may not have a fancy rolled-steel roof or bamboo-screen walls, has a strong architectonic quality by virtue of the cluster of stainless-steel hoods placed over the dining tables. The suspended rectilinear volumes for venting fumes and the banquette seating help subdivide the group of dining tables with barbecue grills into semiprivate alcoves.

A bank of private dining rooms partitioned by plastic mesh screens runs along the perimeter (Olympic Boulevard) wall to accommodate parties of 10 or larger groups of 30 or more. Another room with five tables provides a quasi-private space for diners in the curved corner of the building.

All this interior activity is not very visible from the street, along



The reception area and bar tops (left) are covered in aluminum plate, while the floor is honed slate. Stainless-steel hoods are the dominant design motif of the main dining area (opposite, top); while bamboo-wrapped steel arches and bamboo-screen walls in the private dining rooms afford privacy with views out (opposite, bottom left). Rolled-steel beams form a pergola over the outdoor dining area (opposite, bottom right).

Olympic Boulevard. Here the facade is quite opaque, with the exception of three high windows and creeping fig planting, which offers, as Lundquist puts it, "an architectural surface."

Commentary

Although the restaurant turned out to be an idiosyncratic hybrid of timber-frame roofing and concrete block combined with arcing structures of sculptural, steel-rolled I-beams, Lundquist has developed a series of dining spaces with varying degrees of privacy and openness to the outdoors.

The use of cool and glossy steel, with the warm sheen of bamboo and the luxuriant tropical vegetation, plus the creation of a strong architectural component in the ceiling (whether rolled-steel arches or suspended steel hoods), imparts a forceful character to the interior. The bar off the reception area, which is brightly lit and rather small, is the only element that seems to be an afterthought. But, then again, it probably is. You're not going there just for the martinis. ■



ASTRO

Reykjavik, Iceland

4

MICHAEL YOUNG BROUGHT A BIT OF ARTIFICIAL NATURE INSIDE A 90-YEAR-OLD BUILDING TO CREATE A SEXY NEW HANGOUT FOR THE WITH-IT CROWD.

By Clifford A. Pearson

Designer: M.Y. Studio—Michael Young, principal; Katrin Petursdottir, graphic design principal; Bill Holding, design team

Client: Isfoss

Lighting designer: Jeremy Lord

General contractor: Isfoss

Size: 5,400 square feet

Cost: Withheld

Completion date: April 2000

Sources

Bar counter and shelves: Corian

Lighting: Eurolounge

Light clock: E&Y

Stick light: Eurolounge

Sofa: Twentytwentyone

Red-button cushions: Cappellini

Custom furniture: Sawaya & Moroni

A combination of glaciers, volcanoes, quirky musicians, and cheap airfares from the U.S. and Europe has helped make Iceland an unusual hotspot on the international travel scene. Take your backpack and check out the thermal springs that provide clean energy for the entire country. Or bring your guitar case and roam the clubs of Reykjavik, where design is becoming an important way of attracting a crowd.

British industrial designer Michael Young moved his base of operations to Reykjavik in 1998 after meeting Katrin Petursdottir, an Icelandic graphic designer who became his wife. Having started his own firm in London in 1994, Young made a name for himself designing curvaceous furniture with a vaguely futuristic, slightly pop sensibility. Molded plastic “stick lamps” created for a Japanese company, for example, look like they could have been taken from Woody Allen’s *Sleeper* or inspired by the podlike forms of seaweed.

Program

The owners of a nightclub with a fake Victorian design asked Young to give it a completely new identity. Set in a 90-year-old building with rotting wood, the club needed a radical makeover. Though 90 years may not seem a particularly historic age for architecture in other parts of Europe, the local authorities made it

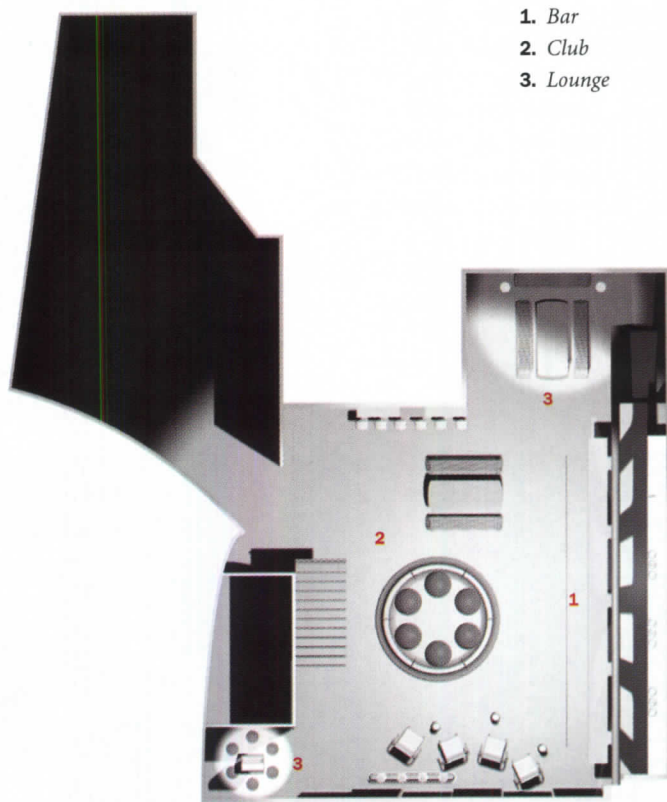

1. Bar
2. Club
3. Lounge

clear they considered the building an important piece of Reykjavik’s architectural legacy. The new two-level establishment would be more club than restaurant—with four bars and two dance floors—but food would be part of the mix.

Solution

Young decided to treat the club as a “shell within an outer shell.” Instead of engaging the old architecture, Astro creates its own world inside the existing fabric—like a Hollywood

diva bringing glamour (and her own entourage) to a bar on the wrong side of the tracks. Required to keep an old fireplace, for example, Young preserved the relic but sealed it off so no one could see it.

Understanding that a design is only as good as it’s built, Young decided to leverage to the fullest local skills in steelwork and concrete construction. So, bent steel tubes support the bar on the main level and concrete elements such as floors and a circular “swimming

www For more information about the people and products involved in this project, go to Building Types Study at architecturalrecord.com.

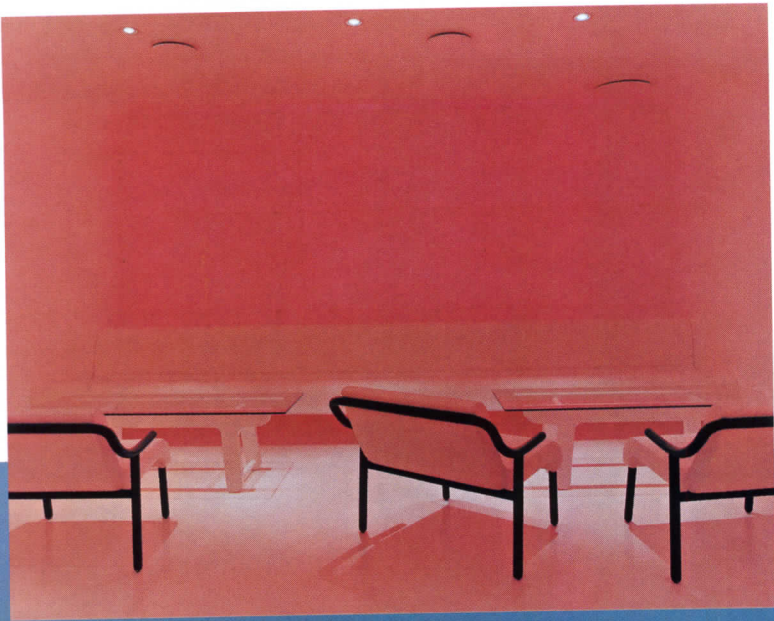

In the Red Room (left), lighting designer Jeremy Lord created walls that change color in response to the body heat of people in the space. On the main floor (below), a “swimming pool” serves as a lounging area.

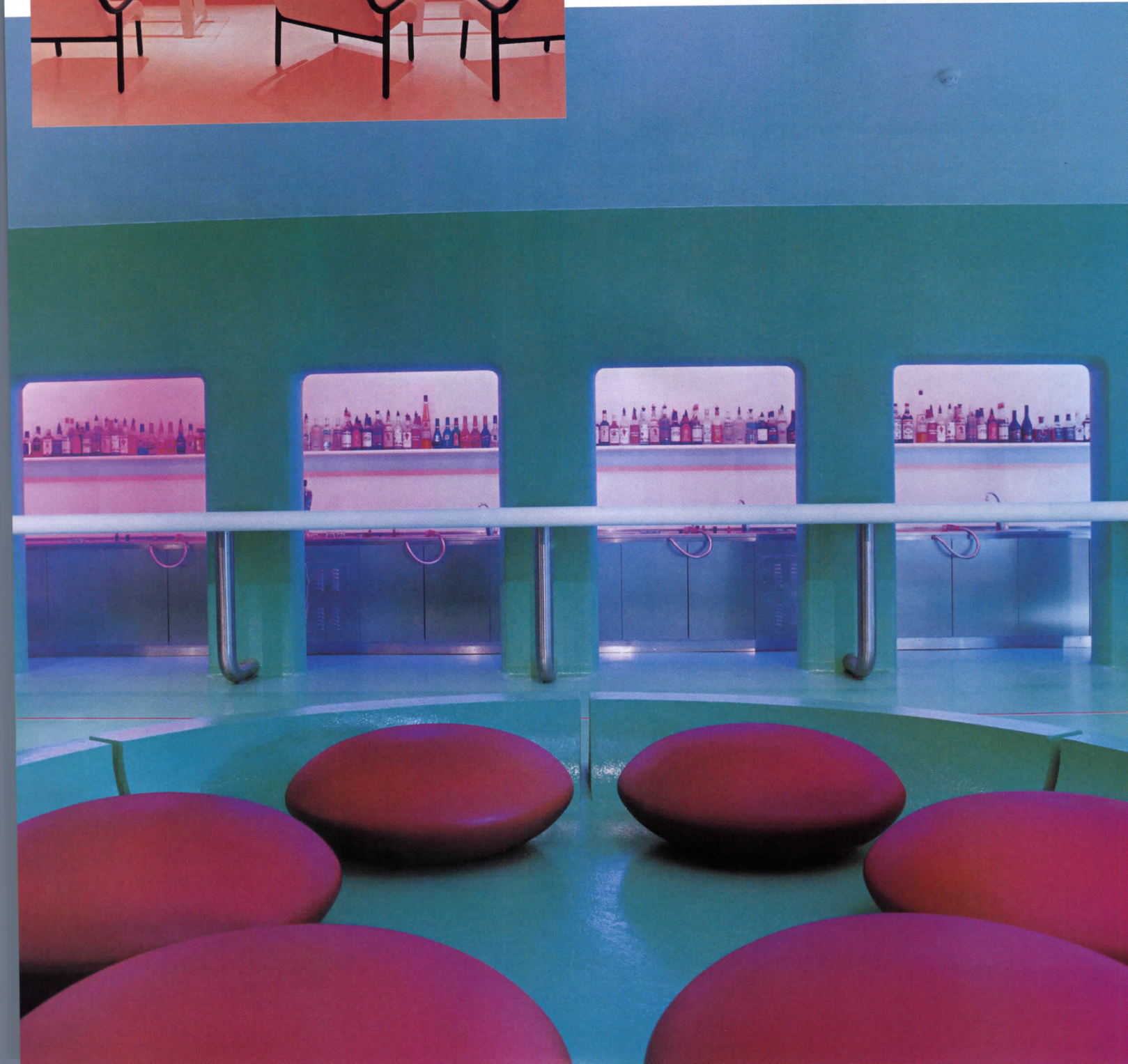

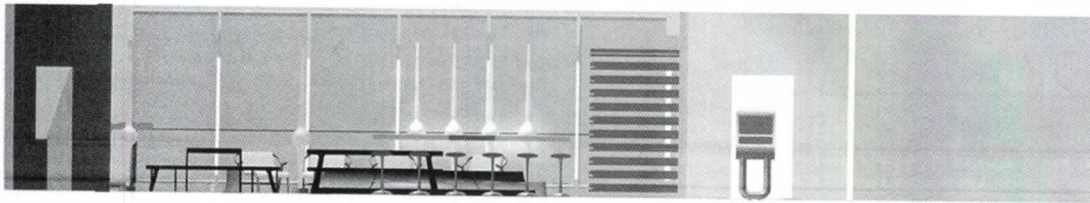

CROSS SECTION

Young designed the yellow “lighting stick” and “magazine” couch in the Red Room (below left). A picnic table in the main space brings the notion of the outdoors inside (bottom).

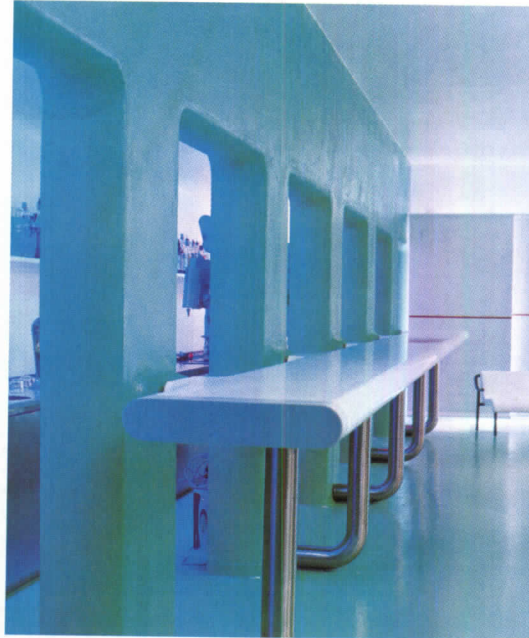
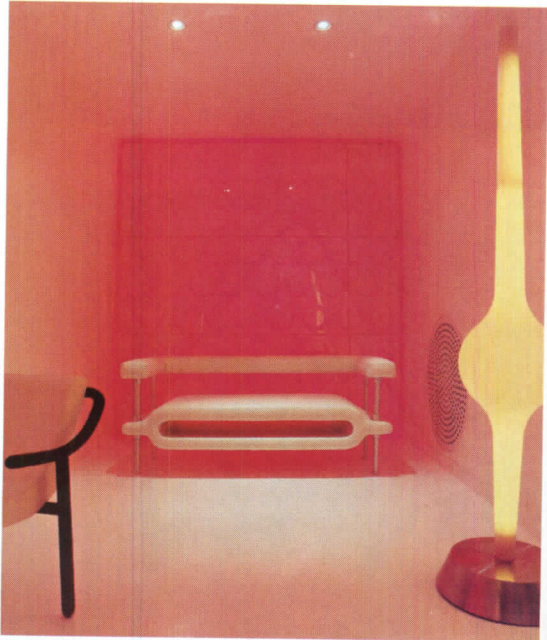

pool” help define the look of the place. “Because it can be so cold and windy in Iceland, I thought it would be fun to bring the outdoors inside,” says the designer. That explains the “swimming pool” decked out with enormous red-button cushions and the picnic table in a lounge area.

To give Astro a sleek, almost slippery, appeal, Young coated walls and floors with a resin-based compound and scattered his own sexy furniture throughout the two stories. Some of the furniture—including a “magazine” couch and chairs—exemplifies the “lounging” style that Young started honing in the mid-’90s, and most of it shows off his penchant for white.

Color, however, plays a big role in setting the mood at Astro. Lighting designer Jeremy Lord created a system for the wall behind the bar that slowly changes the color of light being emitted. Upstairs in the Red Room, where a more relaxed atmosphere holds sway, Lord designed thermo walls with lights that respond to body movements. As a result, the color here goes from a pale pink to deeper tones of red as guests become more active.

Commentary

Like many of the patrons at Astro, Young is part of a new generation of global nomads who feel equally comfortable in Tokyo, Paris, and Reykjavik. They’ve stayed at Philippe Starck hotels and expect every hip place to offer a new sensation, a new spin. Astro delivers the goods, but at the expense of seeming a bit glib, a tad superficial. Sipping a cosmopolitan on a giant button cushion, a guest at Astro could be anywhere in the world of cool. ■



Designers Get More Information Earlier and Faster via Affordable Rapid-Prototyping Tools

CREATION OF 3D ARCHITECTURAL MODELS IS INCREASINGLY BEING APPLIED IN SCHEMATIC DESIGN

By Michael Bordenaro

One Monday morning, Denver-based OZ Architecture sent CAD files of a resort project it was designing to a model maker. The technician fed the files into a computer-driven machine, which built up layers of self-adhesive powder to create a 3D site model. The architect had his 1/200 scale model on Wednesday. This process of machine-made model making is just one of the emerging technologies—generically called rapid prototyping (RP)—that is gaining popularity among architects. Approximately 30 processes are now available and are generally classified according to the methods and materials used.

Architectural model shops have long been equipped with 3-axis milling machines that can be used for rapid prototyping. But it is the increasingly affordable use of 3D printing and stereolithography (SL) that is making rapid prototyping more applicable to architectural design. In stereolithography, a computer-controlled laser etches models out of liquid synthetic materials, such as resins. A thin layer of the liquid synthetic is poured into a chamber. The laser etches the shape of the model into the layer by hardening the liquid on contact. More synthetic is then introduced to the chamber and the process is repeated, fusing one layer to the next until the model is completed.

Additional 3D modeling processes include Selective Laser Sintering (SLS), which is similar to stereolithography, but fuses powder

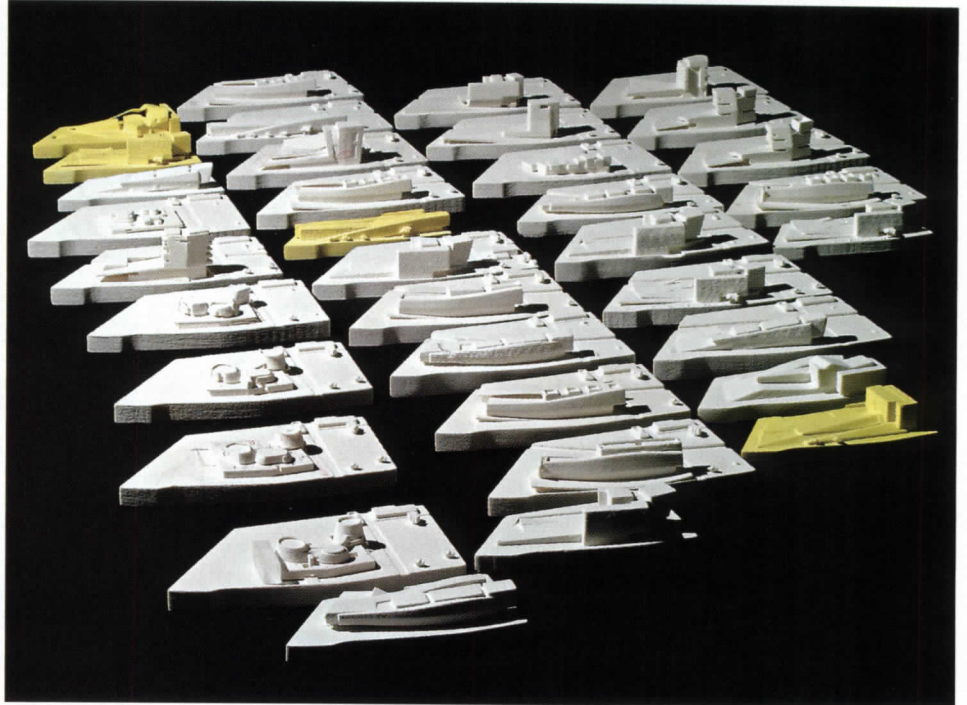

Rapid prototyping allowed the designers at Morphosis to quickly produce dozens of schematic massing models for a courthouse, which could be easily plugged in to a site model for closer examination.

instead of resin; and Fused Deposition Modeling (FDM), which fuses material as its deposition head passes over the model bed. But it is stereolithography and 3D printing that are currently being investigated most often by architects.

Introduced commercially in the late 1980s, the auto industry used rapid prototyping to stimulate a renaissance of affordable design and predictable manufacturing. Unlike other industries, where full-size, working prototypes are made, the architectural profession currently uses it mainly as automated model building. Observation of the physical models is used to refine CAD drawings that are, in turn, used to create and assemble mock-ups of structural sections, curtain-wall samples, and other building elements for further investigation. Eventually, rapid prototyping will be increasingly extended to automated manufacturing for architecture, as in other industries, but currently its main use in architecture is as a model-building process.

“Rapid prototyping will get to be like color plotting, which was commonly outsourced but is now an in-house process,” says Charles Overy, president of architectural model builder Laser Graphics Manufacturing, in Minturn, Colorado. In a few years, architects will be able to show clients dozens of detailed schematic designs in model form, which will be far more sophisticated and accurate than the handmade models typical today.

The size of the 3D printing bed and the stereolithography cham-

Michael Bordenaro is a Chicago-based business writer who focuses on architectural technology.



CONTINUING EDUCATION

Use the following learning objectives to focus your study while reading this month's ARCHITECTURAL RECORD/AIA Continuing Education article. To receive credit, turn

to page 200 and follow the instructions.

LEARNING OBJECTIVES

After reading this article, you should be able to:

1. Explain how architects are using rapid prototyping
2. Describe various types of 3D computer model rapid prototyping
3. Discuss future improvement of 3D computer modeling for architecture

www For this story and more continuing education, as well as links to sources, white papers, and products, go to architecturalrecord.com.

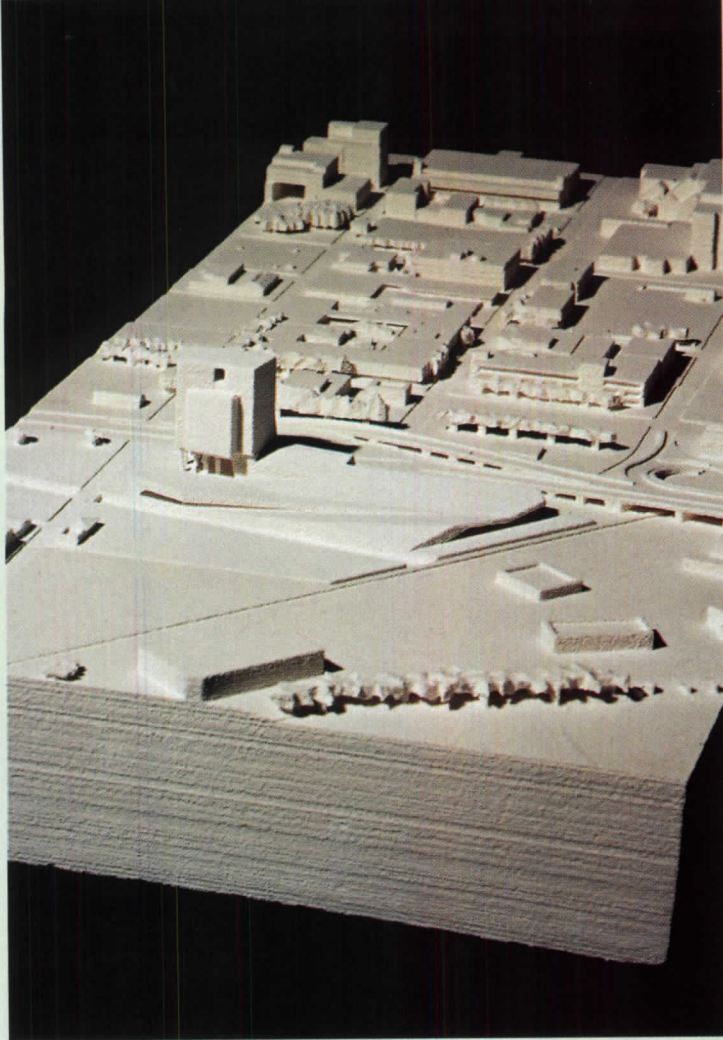

In-house capability

Designers at Santa Monica-based Morphosis used its in-house 3D-printing technology and stereolithography extensively to create a site model (left) for a new courthouse

commission with a complex program. Then they created a larger model of the entire building (below). They then studied one of the courtroom pods (bottom) with yet a larger model.

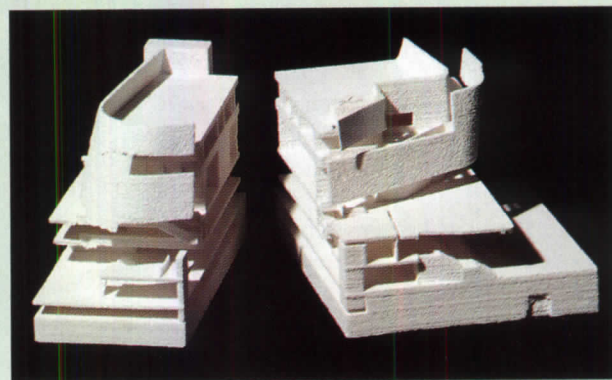
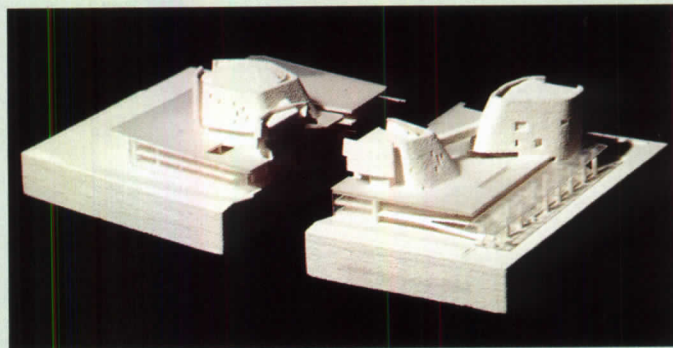

ber limit the size of models that can be created in one process. However, it is possible to use software to divide a building into interlocking segments. While 3D printing produces a less stable model out of powder than stereolithography does out of resin, the cost of equipment and materials is generally less. Because of price competition, 3D printers are now available for under \$40,000, which is considerably less expensive than \$200,00 for new stereolithography equipment (\$80,000 for a refurbished machine).

“I BELIEVE MOST EARLY ADOPTERS WILL USE THE TECHNOLOGY TO MAKE QUICK ITERATIONS OF DESIGN CONCEPTS.”

New York-based architect Kevin Rotheroe has been investigating rapid prototyping since the mid-1990s and teaches rapid prototyping to graduate architecture students at Harvard and the University of Illinois at Champaign. “If a building design is primarily orthogonal, it will often be difficult for even inexpensive rapid-prototyping processes to compete with interns that build models by hand,” explains Rotheroe, president of the Freeform Research Studio, in New York City. “To capture the full potential of rapid prototyping to enable creativity, you must be interested

in quickly considering many conceptual design iterations than would otherwise be unreasonable. For this reason, I believe most early adopters in architecture will use the technology to make quick, tangible iterations of design concepts.”

In-house capability

Santa Monica, California-based Morphosis Architects is one of the first firms to have an in-house 3D printer, which it uses for quick production of schematic models and a variety of other uses. According to Ben Damron, a Morphosis designer who is largely responsible for operating the 3D printer, one highly effective use of the machine has been to create a context model with a space prepared for various schematic design models.

“For a GSA [General Services Administration] courthouse project that has multiple key tenants, we sent context base models to the different department heads and were able to ship them schematic building models that easily plugged in to the site,” Damron said. The firm has calculated the cost of building the models at \$1 per cubic inch for all powders, sealant, and the consumables involved in making the 3D models. The plug-ins for the courthouse project were 8 cubic inches, estimates Damron. Z Corporation manufactures a printer with 8-by-8-by-10-inch



A revolutionary new concept in commercial skylighting.

Now Solatube® provides the exceptional benefits of natural light to ceiling grids.

Solatube introduces the SolaMaster® Series a revolutionary new concept that brings radiant, natural lighting to places skylights have rarely been an option.

The flagship product for the SolaMaster® Series is a 21-inch unit designed for a wide range of commercial applications, creating work areas that enhance employee comfort and productivity.

Perhaps equally important in an era of dramatically rising energy costs, the SolaMaster® Series delivers genuine cost savings, while bathing interior environments in soothing, natural light.



- Quality daylighting reduces electricity costs and increases productivity
- Modular design is easily reconfigured to accommodate future interior layout changes
- Produces over 12,000 usable lumens of light depending upon tube configuration, building location, and climate
- Ideal for retail environments, warehouses, office buildings, schools and healthcare facilities
- Quick, simple installation requires no structural modifications

From installation flexibility to superior performance, the SolaMaster® Series presents a whole new dimension of affordable lighting solutions for discerning architects and building occupants. *For more information, call 1-800-966-7652 Code 846.*



SOLATUBE®
The Miracle Skylight®

2210 Oak Ridge Way, Vista, CA 92083-8341

www.solatube.com



Designing in 3D

Many small maquettes (above) of NBBJ's building at 505 Union Street were created early in the design process. This one is about 3 inches by 5 inches. A 3D digitizer captured the best ideas in the maquette and fed them to the



computer, which generated new computer models (center) using SGI Alias Maya software. Larger scale study models were made by

hand. Finally, a full-size two-story prototype was built in Florida for wind and water testing. This model is about 25 feet tall (right).



printing-bed capability.

Jena Yoo, a principal with OZ Architecture, says that the firm also pays approximately \$1 per cubic inch for materials when it outsources 3D prints. Additional charges are required for computer-file manipulation. But printing 3D models is not always a matter of money. "We don't have time to make this quality of study models or massing models in-house anymore," she says.

With the equipment in-house, Damron says that practice has made 3D printing as easy to output as traditional printing. He adds,

"WE DON'T HAVE TIME TO MAKE THIS QUALITY OF STUDY MODELS OR MASSING MODELS IN-HOUSE ANYMORE."

"Because of size limitations, it can't replace all other forms of models, but when trying to convey schematic design information to the client and to the rest of the team, the value is immeasurable."

Yoo agrees that schematic designs are well-suited to output in 3D printing. "The color of the material, which makes the model look sugar frosted, is monochromatic, which means to us [and the client] that it is still schematic," says Yoo. The "sugar frosted" look is a result of the claylike compound used to create models. Yoo notes that the printed

models are not as adaptable as paper models, which can be easily altered. Damron points out that a complication of having the equipment in-house is the amount of dust produced in the printing process. Morphosis relegated its printer to a model-building studio adjacent to its main office.

Damron adds that finishing the claylike models can become a scientific experiment that requires the right combination of sandable automotive primers and heavy paints, which the material won't absorb. For the Los Angeles County Museum of Art competition, Morphosis glued and pasted together 28 pieces—the entire site—and then sanded and painted them to appear as a seamless whole.

Yoo also notes the convenience of using the printer to make a site model and then placing schematic building models in context. An additional benefit is the ability to print a model to any scale within the limitations of the printer. Clients have requested "desktop" versions of larger site models and buildings, according to Yoo. She adds one caveat, however—the printed models do not have the color or detail refinement for use as marketing tools.

Construction assistance

For Seattle-based architect NBBJ, rapid prototyping has already contributed significantly to the construction of a complex curtain-wall system. "We have been interested in using rapid prototyping for going



© 2002 PPG Industries, Inc. All rights reserved. Caribia, PPG and the PPG logo are trademarks of PPG Industries, Inc.

There's something new on the horizon – a lush aqua green glass whose beauty is exceeded only by its performance. Caribia™ is a new spectrally selective tinted glass that combines high visible light transmission (60%) and low Solar Heat Gain Coefficient (.38). But even with this kind of performance, looks are still everything. To see a sample of Caribia glass for yourself, call the PPG Solutions Hotline today: 800-377-5267. Or email us at caribia@ppg.com.

PPG Glass Technology
Since 1883

PPG Industries, Inc., Guys Run Road, Pittsburgh, PA 15238-1305 ppgglazing.com

CARIBIA™
Spectrally Selective Tinted Glass

CIRCLE 78 ON READER SERVICE CARD OR GO TO WWW.LEADNET.COM/PUBS/MHAR.HTML



From tiny maquette to detail renderings to full-size prototype to finished product (above and right), NBBJ's Union Street building's "waterfall" curtain-wall system of multiple, sloping angles was made

buildable with 3D technology. Stereolithography and other modeling devices helped the fabricators understand the complex connection details and allowed contractors to submit accurate bids.



through design iterations and understanding how components come together in a fuller manner," says Patrick Mays, AIA, a principal with NBBJ. The firm's 505 Union Street building in Seattle has exterior components sloping at multiple angles to create a curtain-wall "waterfall." Even though NBBJ has in-house milling, laser cutters, and digitizers for model building, the complexity of the curtain wall made it appropriate to

"WHEN WE FIRST BID THE CURTAIN WALL [WITHOUT THE MODEL], THE BIDS WERE ALL OVER THE PLACE."

use an outside vendor for the stereolithography model. "Because of the complicated connection details, we wanted to make sure we understood how the curtain wall went together," Mays says.

In true rapid-prototyping fashion, the company built cardboard models that they digitized in-house and fed back into the computer. "We used the digitized information to refine our computer models, which were then sent out to make the physical stereolithography model," Mays says. "When we first bid the curtain wall [without the model], the bids were all over the place," he continues. Then they gave the contractors access to their stereolithography model and other information and construction bids were closer in range. (The stereolithography model was even sent to the

curtain-wall manufacturer to serve as a reference during the fabrication of a full-scale sample section used for wind and water penetration testing.)

Watertight models

Mays indicates that in order to ensure a proper model is made from a 3D printer or stereolithography process, a 3D computer model has to be created that has a continuous exterior surface. This is called a "watertight" model in rapid-prototyping industry speak. Mays says that traditional architectural CAD programs, such as AutoCAD and Bentley's MicroStation, are not known for easily creating the stereolithography files that describe a series of triangles (STL) and are necessary to output 3D physical models. IronCad and ProEngineer are two programs Mays says are used by many architects and engineers to make consistent 3D computer models needed for automated model building. If a computer model is not "watertight," it is unlikely that the physical model will be structurally sound, and consequently it could collapse in the rapid-prototyping machine.

Morphosis's Damron mentions that form•Z from auto•des•sys and AutoCAD's 3D Studio Max are effective programs for creating watertight 3D computer model STL files. Rotheroe has found that although most conventional architectural software can now generate STL files at some level, the capacity of most programs to accommodate complex geometry is very limited. "My practice now primarily uses Studio Tools by

■ Proven products.

■ Proven services.

■ Proven people.

■ Proven integrity.

■ Proven dependability.

THEY'VE BEEN OUR BUILDING BLOCKS SINCE 1955.

ROPPE.
Proven ■ Flooring ■ Experiences ■

When you're talking resilient flooring,
there's only one name that can claim
a quality-rich heritage for nearly
50 years – Roppe.

Today, our look is new ... our ideas are fresh ...
and our corporate ideals continue to make us
the leading flooring company for those who want
proven performance.

But don't take our word for it. Walk the walk for your-
self, and enjoy the confidence that comes with nearly
a half century of flooring expertise.

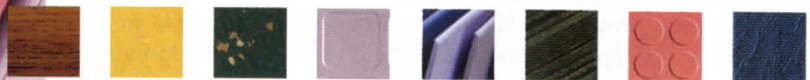

1-800-537-9527 www.roppe.com



rubber wall base, tile, treads, accessories ■ vinyl wall base, treads, accessories ■ solid vinyl tile ■ esd flooring systems

CIRCLE 79 ON READER SERVICE CARD OR GO TO WWW.LEADNET.COM/PUBS/MHAR.HTML

composite models to take advantage of the most cost-effective processes.

Growth through universities

In his 10th annual state-of-the-industry presentation at this year's Rapid Prototyping and Manufacturing Conference in Cleveland, Terry Wohlers mentioned the architectural market for rapid prototyping for the first time. Wohlers, president of the Fort Collins, Colorado-based consulting firm Wohlers Associates, studies rapid-prototyping developments around the world. He speaks annually at the Rapid Prototyping Association of the Society of Manufacturing Engineers, which currently serves medical, packaging, tooling, transportation, toy, electronics, and a host of other industries.

The two biggest obstacles to rapid prototyping in architecture are the software used and the cost, according to Wohlers. "Architects tend to produce floor plans, details, and 2D cross sections—not solid models. This is the biggest roadblock to widespread use of rapid prototyping in architecture," Wohlers said. "The second issue is cost, which will be overcome in the next three to five years," Wohlers predicts.

In order for rapid prototyping to reach its full potential in archi-



Z Corporation makes 3D printers for creating physical prototypes from CAD drawings. The Z810 System is shown here.

itecture, Rotheroe says, universities will have to play a large role. "I spoke at the panel discussion on "The Future of Rapid Prototyping" in Cincinnati and emphasized that I feel RP will penetrate the architectural market from the ground up via higher education," says Rotheroe. "From my own experience teaching rapid prototyping, only 10 or so of the 126 schools of architecture in North America formally teach the subject. Recent graduates will continue to bring this knowledge into firms and this, I feel, will be the primary path by which rapid prototyping will be widely introduced to the profession," Rotheroe says.

Manufacturers realize this and are making services available to students at schools that do not have rapid-prototyping machinery in place. Two architecture graduate students had rapid-prototype models that were donated by manufacturers for their

year-end design critique at the University of Illinois at Chicago last spring.

Doug Garofalo, acting director for the University of Illinois at Chicago School of Architecture, said, "Architecture firms will be hiring students specifically for their knowledge of rapid-prototyping techniques." As with many technology evolutions, this shift may be occurring more rapidly than you think. ■



AIA/ARCHITECTURAL RECORD CONTINUING EDUCATION

INSTRUCTIONS

- ◆ Read the article "Designers Get More Information Earlier and Faster via Affordable Rapid-Prototyping Tools" using the learning objectives provided.
- ◆ Complete the questions below, then fill in your answers (page 280).
- ◆ Fill out and submit the AIA/CES education reporting form (page 280) or download the form at www.architecturalrecord.com to receive one AIA learning unit.

QUESTIONS

1. The main use for rapid prototyping currently is which?
 - a. a model-building process
 - b. making mock-ups of structural sections
 - c. making working prototypes
 - d. a schematic design process
2. In a few years, schematic design models will be used in place of which?
 - a. structural section mock-ups
 - b. schematic drawing presentations
 - c. construction drawings
 - d. shop drawings
3. What is the reason rapid prototyping is just now being used in architectural design?
 - a. hand model building is no longer available
 - b. 3D printing has recently become available
 - c. 3D CAD has recently come into widespread use
 - d. 3D printing has recently become affordable
4. Stereolithography uses which material to make models?
 - a. fused powder
 - b. liquid resin
 - c. fused deposition
 - d. solid synthetic
5. According to Rotheroe, rapid prototyping is best used for which application?
 - a. orthogonal designs
 - b. complex designs
 - c. accommodating changes in design
 - d. reiterations of the design concept
6. The advantage of having a 3D printer in-house is which?
 - a. cost
 - b. time
 - c. convenience
 - d. cleaning
7. What is meant by the term "watertight" model?
 - a. made of a material impervious to water
 - b. made without joints, seamless
 - c. made with a continuous exterior surface
 - d. made from a series of triangles
8. Why does a computer model need to be watertight?
 - a. to prevent collapse in the rapid-prototyping machine
 - b. to look for weak joints
 - c. to handle the paints and epoxy
 - d. to handle the laser graphics
9. The major time consumer of printing a 3D model is which?
 - a. uploading the program on the Internet
 - b. running the STL file
 - c. configuring the computer model
 - d. laser printing of the model
10. Overly's software will do all except which?
 - a. take any type of 3D computer model via the Internet
 - b. run the computer model through his proprietary software
 - c. produce an STL file
 - d. print the rapid prototypes

Digital Architect

In tough times, maintain a technical edge

By Alan Joch

For Rob Fortin, today's downtrodden economy sometimes has an upside. As director of IT for Arrowstreet, a 100-person architectural firm in Somerville, Massachusetts, Fortin provides the design staff with necessary technology tools while trying to keep costs under control. That job got a little easier when Fortin bought two high-end servers late in the summer and found their prices were significantly lower than what he had budgeted for last January. "We saw a 20 percent savings that was due just to the state of the economy," he says.

Fortin isn't alone. Technology officers at other architectural firms are also finding ways to take advantage of a slow economy. The key, they say, is to resist attempts to slash IT budgets and use these resources to prepare for better times. "In a down economy, we do have to tighten our belts," says Jill Rothenberg, AIA, chief technology officer at ADD in Cambridge, Massachusetts, which specializes in corporate architecture and multi-unit residential projects. "Nevertheless, this is a time to keep putting money into technology, as well as the people to support it, so you can continue to develop."

Outsourcing strategies

Moving forward means different

Alan Joch is a technology and business writer based in New England.

Contact him at ajoch@monad.net.

www For more information on technology for architects, including reviews, vendor lists, and links, go to Digital Architect at architecturalrecord.com.

things to different IT managers. Rather than maintaining a business-as-usual approach, some firms are now overhauling their IT infrastructure to make it more efficient.

One such company is Manhattan-based Davis Brody Bond, where a bare-bones, three-person IT staff serves a 100-person design firm. Paul Seletsky, AIA, director of technology, is aggressively moving to off-load as many of the firm's technology services as possible, including the phone and e-mail systems, to third-party outsourcers. "My philosophy is that the company should focus on its core competency—design—and not make the IT department the tail that's wagging the dog."

Seletsky believes that most firms, in both good economic times and bad, have trouble providing a complete range of IT needs with an in-house staff. Instead of fighting for more people, Seletsky is opting to stay small and tap outside expertise. "I wouldn't build an electrical system to provide the firm with power, so why should I even attempt to do that with the phone or e-mail systems?" he reasons.

Part of Seletsky's vision was shaped in 1993, when he worked in the World Trade Center. He saw firsthand how the bombing that year disrupted IT infrastructures. "I experienced what business continuity really means," he says. One of the advantages of outsourcing is that a large portion of critical technology and company data reside off-site, protected from internal problems or disasters.

Outsourcing is also saving the firm money. Seletsky pays a



At Davis Brody Bond, Paul Seletsky, AIA, has invested in IT despite the recession. A new IP telephony system lets staff manage calls through their PCs.

Manhattan-based e-mail service, M18 Corporation, \$20 per person per month to deliver the resource. He estimates this arrangement is saving him about \$1,000 a month compared to managing e-mail in-house, which would require one person dedicated to the job.

Similar savings are accruing from outsourcing the phone system to M5 Networks, of New York City. M5 provides a new type of telecommunications platform called IP telephony that sends voice traffic over the Internet rather than long-

distance telephone lines. Because each call is billed only as a local charge to the firm's Internet service provider, the system is saving the company about \$2,000 a month that they'd otherwise pay in long-distance charges. In addition, the silicon brains of the new phone system reside at M5's headquarters, fulfilling Seletsky's goal of protecting key technology in a remote location. "If a fire broke out in our office, I could redirect incoming calls to the home phones of employees," he says, adding that calls and voice

mail would be lost if the old, in-house phone system were damaged.

The company is even outsourcing some of the specialized tools of the design trade. ABC Imaging, based in Washington, D.C., now installs and maintains all of the firm's printing and plotting equipment. "We have color plotters, high-end black-and-white production plotters, and three new multifunction printers, which we can swap out [with new equipment] as our needs change," Seletsky says. He estimates the firm saves between \$4,000 and \$5,000 a month by using a service contract versus buying and maintaining the same equipment. An on-site manager from ABC keeps all the printers and plotters supplied with toner cartridges, paper, and other consumables. "He provides better service than I could expect from an employee," says Seletsky.

Finally, leasing rather than buying PCs shields the firm from IT obsolescence. All of the computers at Davis Brody Bond are part of a three-year lease agreement with Dell Computers. The arrangement allows the firm to standardize on a common platform, which reduces networking and application software conflicts. "You don't save money by leasing, but it makes us better able to manage expenses," Seletsky says. "We understand the costs better each month, compared to buying equipment in bits and pieces."

Another firm that has seen the benefits of outsourcing is The Office of Michael Rosenfeld (OMR), of West Acton, Massachusetts, a 42-person residential, commercial, and municipal architecture firm. Paul Woyda, AIA, the firm's IT manager, is the sole person dedicated to the company's IT needs. To help him provide necessary services, he outsources LAN and telecommunications services. The firm has also recently hired financial software vendor Intuit to provide secure, Web-based database services using a product called QuickBase.

"Our focus is the real-time sharing and tracking of construction administration information," Woyda says. Currently, the company is using QuickBase in a \$73.9 million high school project under construction for two Massachusetts towns. All modifications to construction documents, meeting reports, submission status, and construction progress photography are available via the Web at any time to authorized people, including the client and contractors. "The result is significant time and cost savings for the project owner and all project participants," Woyda says.

But not everybody embraces outsourcing. Arrowstreet's Fortin takes comfort in having in-house experts who can tackle problems as they arise, rather than relying on service technicians who juggle the needs of numerous customers. He's devoting more time to staff training and what he describes as a move toward greater self-sufficiency. "We're giving our network administrator all the training he can get," Fortin says. "The need for people to have the best possible tools is more important than ever." And one of the key advantages of outsourcing—the storage of critical information off-site—also makes firms vulnerable to unexpected downtime, system crashes, or other problems experienced by the companies they do business with.

Selective do-it-yourself

With a relatively large IT staff of eight, ADD has traditionally followed a do-it-yourself approach, choosing to let in-house talent manage technology tools. But that stance has become less rigid in the past year as the firm began to consolidate disparate data sources, including separate human resources and financial databases, into a central system with reduced redundancy and fewer opportunities for errors. "A year ago, we saw some applications coming onto the market that would allow us to bring our data together under one umbrella," Rothenberg says.

Committing to a new off-the-shelf product called Deltek Vision for practice management represented a break from the past, when the IT staff would develop software in-house to enhance its various databases. Although this gave the firm exactly the capabilities it staff needed, there was an expensive downside. "When you develop [software] internally, it can become a never-ending process. Everyone wants this or that tweak," Rothenberg says. "When you get a shrink-wrapped package, that can end those discussions."

Rothenberg's new philosophy is

stream of new hardware and software that characterized the past decade, and IT departments have barely time to install an application and learn its features before the next release hits the market. In addition to constantly shuffling installation disks, Rothenberg's staff felt they rarely mastered an application's capabilities in depth, she says. Today, her staff spend more time fully evaluating new technologies, like the parametric modeling program Revit from Autodesk, or revisiting existing programs. "We can now look at our current infrastructure and see how we might get more out of it," she

The screenshot shows a web browser window displaying the 'Project Tracker' application. The main heading is 'Due in the next 30 days' with a sub-heading '4 deliverables matched (out of 8)'. Below this is a table with columns: Deliverable, Description, Duration (days), Functional Category, Resource, and Status. The table is divided into sections: Client Management (1 Deliverable), Contractors (1 Deliverable), and Procurement (2 Deliverables). A 'TOTALS' section at the bottom summarizes the data by Functional Category.

Deliverable	Description	Duration (days)	Functional Category	Resource	Status
Client Management (1 Deliverable)					
Client design meeting #2	Review interior plans with client. Focus on placement of 2nd floor baths.	2	Client Management	Mark	Planned
TOT		2			
Contractors (1 Deliverable)					
Interview electricians	Review 3 candidates for the electrical work.	27	Contractors	Joe	At Risk
TOT		27			
Procurement (2 Deliverables)					
Rent Hauling Equipment	Rent 5-piece trucking set to haul debris away from job site.	26	Procurement	Kim	Started
Purchase Lumber	Submit order to purchase studs and framing materials. Special order, expect delays.	43	Procurement	Kim	Planned
TOT		69			
TOT		98			
TOTALS					
Functional Category	Deliverables	Duration			
Client Management	1	2			
Contractors	1	27			
Procurement	2	69			
TOTALS (3 groups)	4	98			

Intuit's QuickBase helps OMR manage and share information on the progress of a school construction project with the client and contractors.

to devote IT resources to developing programs that aren't available commercially, while buying off-the-shelf yet customizable solutions whenever possible. "Why reinvent the wheel?" she says. The firm is currently using its in-house staff to expand its intranet beyond being a clearinghouse for company news and policies—it's now becoming a resource for the design process itself, with archives of model templates and project documentation.

ADD will also use the months ahead to catch its breath. The pace of technological innovation has slowed compared to the constant

says. "We're looking for unused features within [Microsoft] Outlook or [Bentley Systems] Microstation that we can now use to our advantage."

Stay strong

IT managers say the biggest lesson today is to stay focused on the goal of using technology to boost productivity. "Don't let management try to stop computer purchases to save costs," Fortin maintains. "That just gives you frustrated architects who don't have the tools they need to take on a fast-turnaround project. It's more important than ever to maintain your technical edge." ■



JELD-WEN, INC.
PRESENTS

Window Walls: Bringing the World Into Your Living Room

Bozeman, Montana
Photo courtesy Pozzi Wood Windows®

The client of Bozeman, Mont., studio head Bayliss Ward, AIA, was a nine-time Professional Golfers' Association winner and former U.S. Open champ who moved from Phoenix to Bozeman, Mont., his wife's childhood home. The client

Use the learning objectives below to focus your study as you read **Window Walls: Bringing the World Into Your Living Room**. To earn one AIA/CES Learning Unit including one hour of health safety welfare credit, answer the questions on page 207, then follow the reporting instructions on page 278 or go to the Continuing Education section on www.architecturalrecord.com and follow the reporting instructions.

Learning Objectives

- understanding the variables, including some of the structural issues, associated with creating "window walls."
- envisioning stacking and grouping traditionally independent windows to create energy efficient view walls.
- exploring how exposure issues affect your selection of glass.

chose as a home site a 20-acre parcel of land atop a knoll, with a panoramic view of the Gallatin Valley and the distant Bridger Range.

"There is little in the way of artwork in this guy's life. The site becomes the artwork, and we worked with different window sizes to frame the views," says Ward, head of 14-member Bayliss Architects.

Eighteen-foot vaulted ceilings provide the "canvas," if you will, and

a 14-ft.-wide centerpiece window wall, an unusual combination of traditional window types, sizes and shapes, completes the breath-taking effect.

Through computer-aided design and automated manufacturing, window manufacturers now offer a vast selection of window types, styles and sizes at affordable prices. Designers have been quick to adopt the new products to create dramatic visual effects, and at the same time provide comfort with relative energy efficiency.

Residential window walls combine window shapes and styles typically not seen in combination. The ability to mix and match, and the ability of manufacturers to fill almost any architectural need, creates unprecedented design opportunities.

In lieu of custom windows, in the Bozeman home, Ward—aside from a nearly 10-ft. high central picture window—opted for standard windows in standard sizes, then combined them to create an unusual effect. "Ninety percent of the work we do starts with standard, off-the-shelf units," says Ward. "I've never been unhappy with what we can get out of the book."

In grouping units to create window walls, there are a number of critical considerations, including load factors, mullion support systems and the effects of exposure. This continuing education section will explore the process of creating window walls and discuss some of the factors designers must take into account when creating view walls.

Bayliss' Bozeman project is instructive because it is built under seismic codes (Zone 3), at a latitude where tremendous snow loads are commonplace, and

where wind loads can be critical. There were other lessons learned in Bozeman, and they apply to all climates: heat gain was greater than expected and demanded attention three years after the client moved into the home. We'll get back to that in a moment, let's first look at some of the structural issues.

Panoramic window wall combinations are likely to include these window types:

- **Casement windows** lend an air of elegance; they also deliver the most unobstructed viewing areas, the greatest structural integrity and ventilation of all operating windows. Certified casement windows offer superior thermal performance. Use them as a foundation for a grouping of windows, and you can dream up a multitude of designs that include complementary or contrasting window types.
- **Awning windows** are versatile, and compatible with a variety of architectural styles. They're especially pleasing when combined with other windows, large or small. You can achieve a flexible range of ventilation, and operators let you set openings at fractions of full venting, while allowing windows to close securely without shaking or rattling.
- **Fixed or operating geometric windows** are a distinctive alternative to more commonly expected designs. They let you emphasize a home's architecture or your own particular style. Use a custom-designed window, or a standard geometric window to add the ambiance you're after.

Casements, awnings and geometric windows can be combined in a virtually unlimited number of ways. Manufacturers' catalogs, despite their apparent breadth, suggest only some of the possibilities. Combining windows to create a window wall, however, creates some specific support problems of which designers must be wary.

There are three basic types of joined window combinations:

- combinations of ribbons or stacks.
- combinations with T-corner intersections.
- combinations with four-corner intersections.

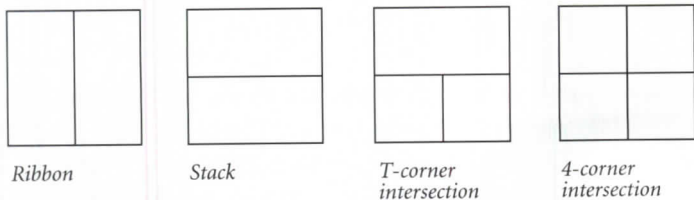

Generally speaking, joined casements, awnings and spandrels supported on all sides by the building structure are the most stable, since all four corners of each individual unit are firmly anchored into the wall opening. Such is the case with ribbon and stack combinations.

T-corner intersections and four-corner intersections, however, will require load-resistant mullions sufficient to withstand wind loads. Two rules of physics determine the design pressure capability (DP) of mullions:

- wind load, measured in pounds per square feet (psf) increases as the surface area of the combination increases.
- wind load capacity of the mullion decreases as its span increases.

The design pressure rating diminishes as the area of the windows and/or the span of the mullions increases. Note that, in the case of ribbons and stacks, the design capability does not begin to fall off until the dimensions of the adjacent window units exceed roughly five feet—or the mullion length exceeds six feet (we try hard not to exceed 50 square feet, and in high-load areas even that number will decrease, says the technical manager for one manufacturer. It is heavily dependent upon the configuration. For example, a window three feet

wide by 12 feet tall will perform much differently than a window six-feet-by-six-feet, though the square footage is the same).

"Most states requiring DP ratings will call out ratings up to a given roof height (generally 33 feet) regardless of the size of the fenestration," says one industry source.

"Florida requires that DP ratings be determined by the architect or engineer of record based upon the size and location of the structure, according to ASCE 7-98. This means that every home has to be engineered."

The new codes have created considerable confusion. A single-story home next to a two-story home, for instance, will have a different DP requirement for the same size opening. "When it comes to the size of the opening, a factor called tributary area is applied. The result is that a 3-0 x 5-0 may need to be DP-50, while a larger window or door, say an 8-4 x 8-0, may only need to be DP 45—on the same side of houses."

In the case of T-corner intersections or four-corner intersections, the windows are especially susceptible to lateral loads, such as wind, because not all of the units are fastened to the building structure on their opposing sides. A combination with a T-corner intersection offers some resistance to wind load since a continuous jamb spans and supports the intersection. A combination with a four-corner intersection, however, is particularly susceptible to wind load and may deflect at the intersection. If the deflection is severe enough, it may compromise the integrity of windows joined at the four-corner intersection.

As shown below, the more four-corner intersections that occur in a combination, the more susceptible the configuration is to deflection.

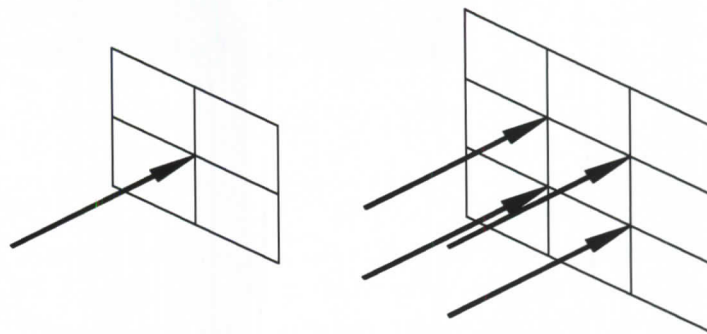

Generally speaking, two types of mullion support systems are available to resist wind loads at these four-corner intersections:

- wood mullion stiffeners (for smaller combinations and lighter lateral loads).
- metal mullion reinforcement (for larger combinations and heavier lateral loads).

Manufacturers will generally supply mullion stiffeners to all factory-assembled casement/awning combinations unless metal mullion reinforcements are specifically requested.

It should be noted that mullion reinforcements may add to the overall unit dimension as shown in the illustration below. For instance, the manufacturer's mullion reinforcement in this illustration requires the rough opening to be increased by 1/4" for every mullion requiring reinforcement.

For greatest strength, both mullion stiffeners and reinforcements should span the shortest distance, either vertically or horizontally, as shown in the illustrations on page 205.

Note that wood mullion stiffeners are not recommended for spans of over six feet. Longer spans require either metal mullion reinforcement or lateral support elements within the building structure, such as studs or columns.

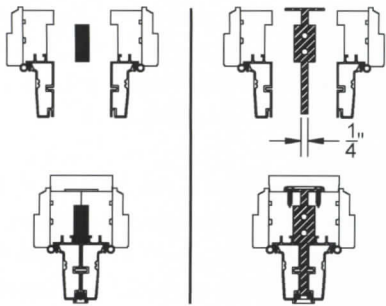

Mullion Stiffener

Mullion Reinforcement

The wall area of the 6,600 sq. ft. Bozeman home (the client spends much of his time in the separate 3,600 sq. ft. “barn,” complete with indoor driving range, putting green and kitchen) is 7,570 sq. ft.—nearly 1,000 of it glazed. “One of the pitfalls in using so much glass,” says Ward, “is that you take away your shear in the building.”

Ward relied on moment frames and “a lot” of hold-downs, both at the bottom plate and at mid-wall to compensate for the lack of shear. Two 3.5-ft-deep box beams carry the roof load, the roof ridge is in a near-cantilevered condition, and Ward relied on steel where necessary for reinforcement. Corners are plywood shear panels inside and out.

The largest of the panes—the central picture window—is 9 x 6, mullioned to about 10 feet. Overall, the window wall is 14 ft. wide and 16 feet from the top of the sill to the top of radiused transoms. Casements, in combination, bring in fresh air. Simulated divided lites allowed Ward to reduce the scale of the south window wall. “We used simulated divided lites because we wanted an aluminum-clad exterior and a wood interior,” he says. “But it is difficult to tell at a glance that they are not true divided lites.”

To meet egress requirements in bedrooms, Ward used casements in concert with double-hung windows, again using a simulated divided lite with 1 1/2-in. horizontal members and 3/4-in. verticals. “The horizontals are at a height to match the double-hungs. The 1 1/2-in. horizontal elements look like the check rail on the double-hungs.”

Ward chose low-E glass for north and east exposures, but the client eschewed tinted glass for the window wall because they found the tint disconcerting.

“That has come back to bite us,” Ward says. Despite three-and-a-half-foot overhangs around the house, the heat gain from the southern window wall is occasionally uncomfortable. “We’ve gone back and are now installing a retractable shutter device to control the heat gain—and we added air conditioning, although that is a rarity where we are located.”

Accommodating Loads on the Windows

Windows are designed to support their own internal weight. When downward vertical loads are transferred to the head of the window frame, deflection will occur and loads can inadvertently be transferred to sashes, or worse, the glass itself. These load transfers will affect ease of operation or induce stresses on the glazing unit. Therefore, vertical loads above the head of a window frame must be transferred to a lintel or other structural system that limits deflection to an acceptable amount. The deflection must be



Klamath Falls, Oregon Photo courtesy Willmar® windows

accommodated when calculating the joint width between the head of the window frame and the lintel above.

To limit vertical load transfer between lintel and frame head, the seal at the top of the window must be compressible using very little force. This is done by using an elastic sealant with a low modulus of elasticity. The window anchor points should allow vertical movement of the window frame head, while minimizing the vertical load component being transferred to the frame.

Window anchorage systems must transfer substantial wind loads (positive and negative) to the adjacent wall, accommodate structural deformations such as creep, and allow for thermal expansion between materials. As window units get larger the design of anchorage systems become more critical.

To restrict the displacement of the window versus the wall, several anchor points are required to prevent vertical displacement, to accommodate wind loads and to account for thermal expansion and contraction.

Designers must accommodate a variety of loading conditions on windows with full awareness of dimensional inaccuracies introduced by site construction techniques. Rough opening dimensions may vary from working drawings and are often out of square. Vertical loads that could be introduced by building creep in the first few years after construction must be accommodated. Anchorage systems must transfer wind loads to the wall structure, yet allow differential expansion between the window and wall.

Divided Lites: Accent Your Design

A key to personalizing the window wall is designer divided lites, which give the window the appearance of having individual panes without sacrificing the energy efficiency of insulating glass.

The look of authentic divided lites can be achieved by permanently attaching wood or metal-clad muntins to the glass—inside and out. Spacer bars between the muntins give windows the look of true divided lites. Exterior



Chesterfield, Missouri. Photo courtesy Norco® wood windows and patio doors

bars can be constructed of either wood or extruded aluminum, and to increase the sense of authenticity, champagne-colored internal aluminum shadow bars are available in varying widths and profiles.

There are a number of divided lite choices to consider:

- simulated divided lites, with or without internal shadow bars, are available for windows with either wood or clad exteriors in a number of widths and profiles and provide an authentic divided lite look.
- full-surround wood grilles, which fit securely into the window interior, are an economical way to simulate the look of divided lites.
- between-the-glass muntins require no maintenance and are available in either flat or profiled bars.

Wind Load Data

ASTM International (formerly the American Society for Testing and Materials) has established wind load standards. In 1989, ASTM established standard E1300-89 "Standard Practice for Determining the Minimum Thickness of Annealed Glass to Resist a Specified Load." ASTM has subsequently proposed criteria for other glass types: heat-strengthened, tempered and insulating glass are referenced in ASTM E1300-98 and E1300-02.

Considering Exposure

As Ward learned in the Bozeman project, the many advantages of natural sunlight, especially solar radiation in winter, can be diminished by the discomfort of summertime heat gain.

Heat transfer across the cavity of insulating glass units occurs through two separate mechanisms: thermal radiation from glass surface to glass surface, and conduction through molecules of air. In a two-pane clear window unit, over 60 percent of the total heat transfer is by thermal radiation.

In winter, when heat loss is the overriding issue, incorporating a low emissivity (low-E) coating on one surface facing the airspace blocks enough radiation transfer to reduce the total heat loss from 34 to 22 Btu/hr/ft². By adding a low-E coating, heat loss by thermal radiation is reduced to only 14 percent of total heat transfer.

Heat loss in winter can be further reduced by filling the airspace with an inert gas, in most cases argon (the conductivity of argon is 30 percent lower than that of air). But at high altitudes, gas-filled insulating units may be

impractical. The air in the sealed cavity of a double glazed unit expands as the unit is raised in altitude due to the change in the atmospheric pressure. This expansion results in stress on the glass which can cause the glass to break. To allow the air pressure in the cavity to acclimate to the change in altitude, a breather tube (or capillary tube) is installed so that air can escape during transit. If argon gas were included, this tube would allow the argon gas to escape, which would greatly depreciate the thermal performance of the unit. Ward notes, for instance, that argon-filled insulating glass was considered, then dismissed, because of the likelihood of damage to the units that would occur in shipping due to changes in altitude.

In summer, heat gain occurs both as a result of direct transmission of solar radiation and air-to-air heat gain from high outdoor temperatures. Low-E units can reduce summertime heat gain by nearly 50 percent.

How to Select an Energy Efficient Window?

The website www.efficientwindows.org provides a good guide to selecting energy efficient windows: plug in the geographic location of the building site and you get a list of window types, coatings and a bar-chart illustrating the annual energy savings associated with each. It will give you U-factors, solar heat gain coefficient (SHGC) and visible transmission (VT) numbers for a range of recommended window types.

The National Fenestration Rating Council (NFRC) has developed a window energy rating system based on product performance. The label that appears on all NFRC certified windows allows direct energy property comparisons.

You've been through this drill before, but let's review. Here are some of the terms you will need to be familiar with when specifying windows:

- **Solar Heat Gain Coefficient:** The fraction of solar radiation entering a home through the windows. The lower the number the better the window is at preventing solar gain—critical to reducing summer cooling costs.
- **Shading Coefficient:** The ratio of solar heat gain through a glazing to the solar heat gain through a single lite of 1/8" glass. The smaller the number, the better the glazing is at preventing solar gain.
- **Relative Heat Gain:** The total amount of heat gain through a glazing system expressed in terms of Btu/hr/ft².
- **U-Factor:** The amount of heat transmitted by the window. The lower the number, the more efficient the window is in resisting the transfer of heat, thus reducing winter heating costs. Look for windows with a low U-factor. A U-factor of 0.35 or lower is considered very good by the EnergyStar program.
- **Visible Light Transmittance:** In the visible spectrum, the percentage of light that is transmitted through the glazing.
- **Visible Light Reflectance:** In the visible spectrum, the percentage of light that is reflected from the glass surface(s).
- **Solar Energy Transmittance:** In the solar spectrum, the percentage of ultraviolet, visible, and near infrared energy from the sun that is transmitted through the glazing.
- **Solar Energy Reflectance:** In the solar spectrum, the percentage of ultraviolet, visible, and near infrared energy that is reflected from the glazing surface(s).
- **Emissivity:** A measure of a surface's ability to emit long-wave infrared radiation or room temperature radiant heat energy. The lower the emissivity, the lower the resultant U-value.

As a rule, in northern climates select windows with a U-factor of 0.35 or less. Some windows with double-pane insulating glass, low-E coating and inert gas have a U-factor below .30. Some windows with triple-pane insulating glass, low-E coating and inert gas have values below .20.

In southern climates, the solar heat gain coefficient is the critical factor. Look for windows with a solar heat gain coefficient less than 0.40.

Click for Additional Information

As part of this CES learning activity, you are required to read some additional material. Some of the test questions below will relate to the additional reading material. Go to www.architecturalrecord.com/CONTEDUC/ConteducC.asp to access the material online. To request a faxed copy of the material, please send an email to joycer@jeld-wen.com.

Learning Objectives

- understanding the variables, including some of the structural issues, associated with creating “window walls.”
- envisioning stacking and grouping traditionally independent windows to create energy efficient view walls.
- exploring how exposure issues affect your selection of glass.

Instructions

Refer to the learning objectives above. Complete the questions below. Go to the self report form on page 278. Follow the reporting instructions, answer the test questions and submit the form. Or use the Continuing Education self report form on *Record's* website—architecturalrecord.com—to receive one AIA/CES Learning Unit including one hour of health safety welfare credit.

Questions

Q: 1. Which of the following is a basic type of joined window combination:

- A: a. Combinations of ribbons or stacks.
b. Combinations with T-corner intersections.
c. Combinations with four-corner intersections.
d. All of the above

Q: 2. T-corner intersections and four-corner intersections will require load-resistant mullions sufficient to withstand wind loads.

- A: a. True
b. False

Q: 3. Which type of mullion support systems available to resist wind loads at these four-corner intersections is best for larger combinations and heavier lateral loads:

- A: a. wood mullion stiffeners
b. metal mullion reinforcement

Q: 4. Mullion reinforcements will ____ to the separation between units.

- A: a. add to
b. subtract from

Q: 5. Window anchorage systems must:

- A: a. Transfer substantial wind loads to the adjacent wall
b. Accommodate structural deformations such as creep,
d. Allow for thermal expansion between materials.
d. All of the above

Q: 6. In a two-pane clear window unit, over ____ percent of the total heat transfer is by thermal radiation.

- A: a. 30
b. 40
c. 50
d. 60

Q: 7. Incorporating ____ on one surface of glass, heat loss by thermal radiation is reduced.

- A: a. low emissivity (low-E) coating
b. breather tube
c. clear glazing
d. tinted glazing

Q: 8. As a rule, in northern climates select windows with a U-factor of:

- A: a. 0.35 or less
b. 0.35 or more

Q: 9. According to the Lawrence Berkeley National Laboratory, double pane windows tinted on one glass surface will reduce the level of discomfort by about what percentage?

- A: a. 20 percent
b. 34 percent
c. 18 percent
d. more than 50 percent

Q: 10. Wind load, measured in pounds per square feet (psf) increases as the surface area of the combination increases.

- A: a. True
b. False

About JELD-WEN, inc.

Founded as a small millwork plant in Oregon in 1960, JELD-WEN® today is one of the world's largest manufacturers of doors, windows and millwork. Several JELD-WEN divisions manufacture wood and clad wood windows; some of these include: Pozzi Wood Windows®, Norco®, Caradco®, and Willmar Windows®.



(800) 877-9482, ext. CEUD
www.jeld-wen.com or www.doors-windows.com

CIRCLE 84 ON READER SERVICE CARD OR GO TO WWW.LEADNET.COM/PUBS/MHAR.HTML

THE EVOLUTION OF CLADDING

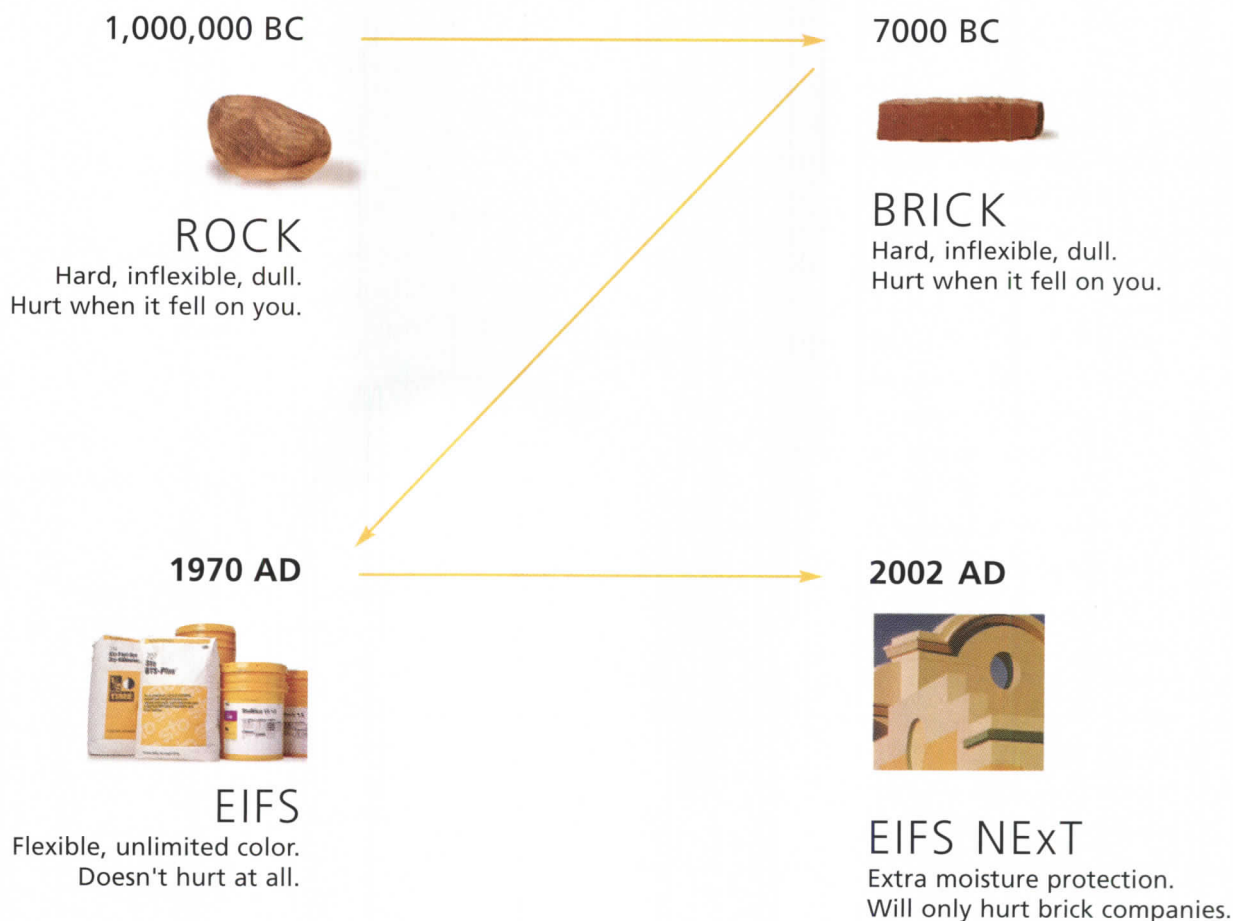

Introducing Sto EIFS NEXt. A New Exterior Technology that combines the unlimited design flexibility of EIFS with unbeatable protection against moisture intrusion. We've taken the best from the past to create the future of cladding and building design. Find out more about Sto EIFS NEXt. Call 1-800-221-2397 or visit www.stocorp.com

100% ACRYLIC POLYMERS

CIRCLE 85 ON READER SERVICE CARD
OR GO TO WWW.LEADNET.COM/PUBS/MHAR.HTML



STO CORP. PRESENTS

Fluid Applied Air/Moisture Barriers for Moisture Control and Mold Prevention in Wall Construction



Fluid applied air/moisture barriers are effective and economical means of controlling moisture in wall assemblies. Moisture control assists in preventing mold growth in wall assemblies. Fluid applied air/moisture barriers also offer performance advantages over building wraps and traditional asphalt impregnated felt or paper moisture barriers. They can be used in all types of wall construction over wood, gypsum and cement based sheathings. They can also be used over prepared concrete and concrete masonry units. They generally consist of three components (*Figures 1a and 1b on page 210*):

1. A trowel applied *joint treatment* for filling sheathing joints, spotting fasteners, and protection of rough openings, corners and other changes of plane in sheathed wall construction.
2. A *reinforcing* mesh or tape used in conjunction with the joint treatment to reinforce sheathing joints, corners, and changes of plane, and for repair of minor cracks in concrete or concrete masonry wall construction.
3. A *waterproof coating* applied by trowel, spray, roller or brush to prepared sheathing, concrete or concrete masonry wall surfaces.

When properly applied to sound supporting construction, these components function together as an air barrier and seamless moisture barrier in the wall assembly. Some of the advantages of a fluid applied air/moisture barrier include:

Effectively blocks air leakage	Increases occupant comfort, Reduces energy costs by reducing heating and cooling loads, Reduces risk of condensation caused by air leaks through the wall construction
Seamless moisture barrier	No tears, holes, or lap joints that can compromise performance in service, Reduces risk of installation errors
Protects sheathing and rough openings from weather damage during and after construction	Minimizes risk of weather damage to sheathing and associated repair or replacement costs
Simple installation procedures	No special tools or skills required, reduces labor costs
Durable	Does not tear or lose its effectiveness with exposure to weather during construction or while in service
Structural/fully adhered	Rigid and stable under air pressure loads, does not tear or blow off the wall with wind
Distinct color	Facilitates job site inspection and quality control
Water based	Safe to use, easy clean-up, VOC compliant
Provides opportunity for pressure equalized or pressure moderated wall design	Minimizes risk of rain water penetration through wall assembly
Doubles as air barrier and moisture barrier in wall assembly	Efficient use of materials

Use the learning objectives below to focus your study as you read **Fluid Applied Air/Moisture Barriers for Moisture Control and Mold Prevention in Wall Construction**. To earn one AIA/CES Learning Unit including one hour of health safety welfare credit, answer the questions on page 213, then follow the reporting instructions on page 278 or go to the Continuing Education section on www.architecturalrecord.com and follow the reporting instructions.

Learning Objectives

- Know the components of fluid applied air/moisture barriers
- Compare the advantages of fluid air/moisture barriers with building wraps and other moisture barriers
- Identify design considerations when incorporating fluid applied air/moisture barrier systems into wall assemblies

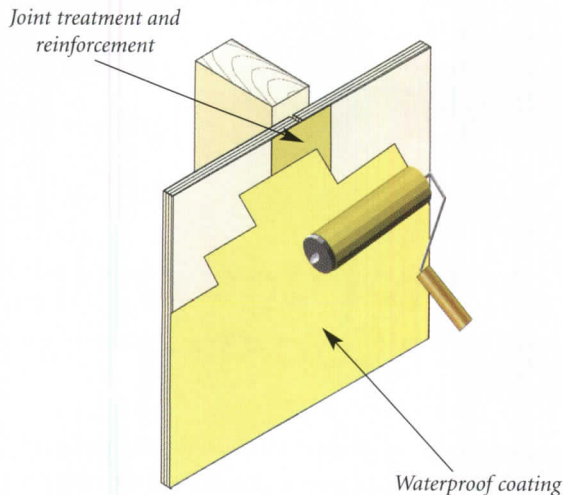

Figure 1a: Fluid Applied Air/Moisture Barrier applied to sheathing by roller



Figure 1b: Fluid applied air/moisture barrier applied to sheathing by spray application

In the last decade studies (CMHC, *Commissioning and Monitoring the Building Envelope for Air Leakage*, Odom, David J. III, *Preventing Indoor Air Quality Problems in Educational Facilities: Guidelines for Hot, Humid Climates*) have shown *air leakage* to be a significant potential source of condensation and moisture accumulation in building envelope assemblies. By constructing an airtight building envelope the risk of moisture problems—decay, corrosion, loss of insulation value, mold growth and IAQ (Indoor Air Quality) problems—that can occur because of air leakage and condensation are minimized. At the same time airtight construction is likely to be less capable of drying than “air-porous” construction in the event of water leakage or other unforeseen circumstances that cause water to enter into a wall assembly. The designer then must strive to prevent rain water penetration into the wall assembly, to construct an airtight building envelope assembly of compatible air barrier materials, and to enhance the drying potential of the wall assembly in his/her overall design strategy. When incorporating fluid applied air/moisture barriers in wall assemblies, the following considerations are important to effectively control condensation and prevent moisture penetration:

Design Considerations

- Air permeability
- Continuity with other air barrier materials
- Structural integrity
- Durability
- Water penetration resistance
- Water vapor permeability
- Mechanical ventilation
- Construction details and sequencing
- Code compliance
- Climate

Air Permeability

The layers of material that make up a wall assembly have different air permeability. Figure 2 provides a comparison of typical materials used in wall assemblies and their air permeability values.

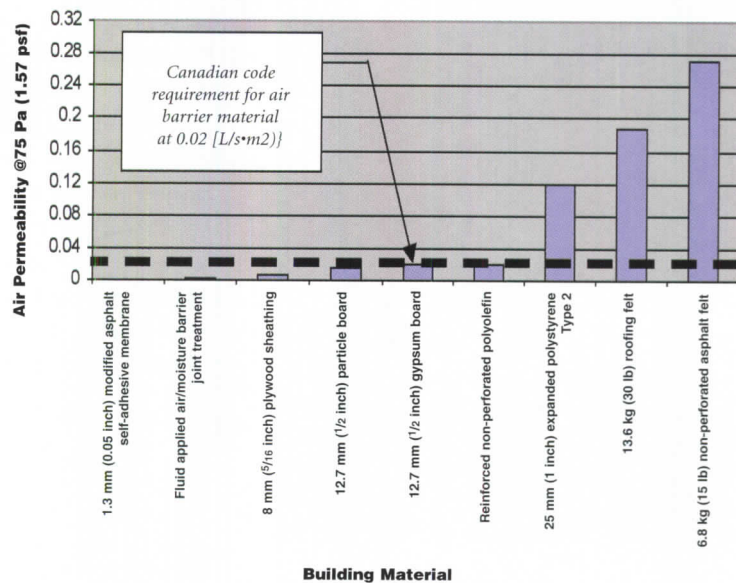

Figure 2: Air Permeability [L/(s·m²)] of Fluid Applied Air/Moisture Barrier and Common Building Materials

Sources of Data: Canada Mortgage and Housing Corporation and Sto Corp.

Energy codes in the United States have begun to require air tightness of the building envelope, but they are not specific about levels of air permeability for air barrier materials. The generally accepted level based on National Building Code of Canada requirements is 0.02 L/(s·m²) at 75 Pa pressure [0.004 cfm/ft² at 1.57 psf]. While many common building materials like plywood and gypsum wallboard meet this standard, a sheathed wall assembly will not perform well as an air barrier unless the joints are treated with an air barrier material. The sheathed wall assembly with treated joints then becomes an air barrier sub-system of the total building envelope air barrier system. The total building envelope air barrier system consists of all the interconnected air barrier materials—for example, treated wall sheathing, roof membrane, foundation waterproofing, windows, and doors, and the air barrier connection materials between them.

Air Barrier Continuity

The overall design concept of air barriers in building construction is the creation of a continuous airtight membrane around the building envelope. Therefore air barrier materials in wall assemblies, to be effective, must be *continuous*. Breaks in air barrier continuity cause air leaks. In cold climates the breaks can allow significant amounts of warm moisture laden air to escape from the interior environment and condense on a cold surface in the wall assembly. Conversely, in hot humid climates, breaks in the air barrier permit moisture laden air from the exterior environment to infiltrate the building envelope and potentially condense on a cold surface in the wall assembly. Any penetration through the wall assembly or termination of the wall assembly must therefore be detailed to maintain the continuity of the air barrier materials to effectively create an air barrier system. *Without continuity of the air barrier materials in the wall assembly air barrier system performance is less effective.* The design/construction professional must take material compatibility and construction sequencing into account when designing an airtight assembly to ensure *continuity*. A number of connecting air barrier materials exist that are compatible with fluid applied air/moisture barriers to make transitions from one material to the next, for example, rubberized asphalt membrane tapes to connect from wall sheathing to foundation, or low expanding urethane foam sprays for use between windows and rough openings.

Air Barrier Structural Integrity

Structural integrity of air barriers is important because wind loads are transferred to the most airtight components in a wall assembly, the air barrier materials, and in turn, are transferred to the structure. Negative and positive wind loads stress air barrier materials. If the materials tear or displace with loading they lose their effectiveness as air barriers. Some building wraps have low air permeability, but they do not perform well as commonly installed, not only because they have many seams that reduce their effectiveness against air leakage, but they are non-structural. If the seams in building wraps are not taped they do not perform well as air barrier materials. Because building wraps are non-structural they are susceptible to displacement and tearing with negative wind gusts in cavity wall construction. This compromises their performance in service.¹

Fluid applied air/moisture barriers are fully adhered. Adhesion to sheathing exceeds the strength of the sheathing. Tensile adhesion tests show that the paper or glass mat facing fails in gypsum based sheathings, while unfaced sheathings like plywood show adhesive failure at loads in excess of 344 kPa (50 psi, could equate to more than a 2560 km/hr [1600 mph] wind speed). The structural strength of the fluid applied air/moisture barrier in effect equates to that of the sheathing. Deformation while in service is limited to the deformation of the sheathing. *This means no tears and no compromise in performance caused by structural loading, provided the sheathing and supporting frame are adequate to resist loads.*

Air Barrier Durability

While capable of resisting wind loads without compromise in performance, air barrier materials must also demonstrate durability in a number of other ways, particularly if the air barrier is concealed and inaccessible for maintenance.

Durability criteria include:

- Resistance to puncture
- Resistance to pests—rodents, termites, carpenter ants, and other insects

- Resistance to low but sustained negative pressures from building stack effect and HVAC fan effect
- Ability to withstand stress from thermal and moisture movement of building materials, and stress from building creep
- Resistance to UV degradation (during the construction period)
- Resistance to mold growth
- Resistance to abrasion

Fluid applied air/moisture barriers generally do not provide a food source for insects or other pests. By virtue of their excellent adhesion to sheathing and prepared concrete or masonry substrates, they are resistant to puncture and they resist loads imposed by stack effect and fan effect, as well as wind loads. Their resistance to stresses imposed by thermal and moisture movement, and building creep, is mainly dependent on the ability of the joint treatment material to span gaps in sheathing without cracking. This performance, in turn, is dependent on the physical properties of the specific joint treatment material. Similarly, the UV resistance, resistance to mold growth, and abrasion resistance are dependent on the physical properties of the joint treatment and waterproof coating materials.

Water Penetration Resistance

The traditional moisture protection used in wall construction is asphalt saturated felt or kraft waterproof building paper. The terms weather-resistive barrier or moisture barrier are often used to describe these components in wall construction. They are generally installed over sheathing by lapping them shingle style and fastening with nails, screws or staples to the sheathing. Their general purpose in walls is to protect against ingress of incidental water into the building and to protect moisture sensitive components like gypsum sheathing in the event of a breach in the outer wall covering, such as a crack in stucco. Building wraps are often used in place of asphalt felt in wall construction, often with the same perceived purpose. The water resistance, air infiltration resistance, and vapor permeability characteristics of building wraps vary widely, depending on the brand of wrap selected (See references, PHRC Report No. 59). Seamless fluid applied moisture protection provides a significant improvement over traditional moisture protection and building wraps. *In fact, they can be 10 times more resistant to water penetration than building wraps and nearly 200 times more resistant to air leakage than asphalt felt* (refer to Figures 2 and 3).

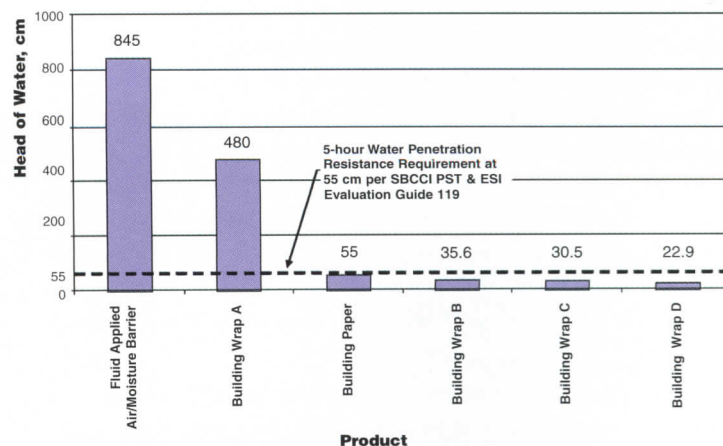

Figure 3: Water penetration resistance of fluid applied air/moisture barrier material compared to building wraps and building paper. Check online material for figure 3 notes.

Water Vapor Permeability

A fluid applied air/moisture barrier may or may not be a vapor retarding material. The generally accepted definition of a vapor retarding material is one that has a water vapor permeance of 57.4 ng/(Pa·s·m²) [1.0 perms] or less. In table 1 the fluid applied air/moisture barrier components are not vapor retarders. The joint treatment has a vapor permeance of 994 ng/(Pa·s·m²) [17.3 perms] and the waterproof coating has a vapor permeance of 327 ng/(Pa·s·m²) [5.7 perms], about the same as Type 15 building felt.

Building Material	Water Vapor Permeance (Perms)	Water Vapor Permeance ng/(Pa·s·m ²)
4 mil Polyethylene ¹	0.08	4.60
6 mm (1/4 inch) Plywood ³ (ext glue)	0.7	40.2
101 mm (4 inch) Brick ³	0.8	46.0
203 mm (8 inch) Concrete Block ³	2.4	138
25 mm (1 inch) Expanded Polystyrene ¹	5	287
Type 15 Building Felt ²	5.6	322
Fluid Applied Air Moisture Barrier Waterproof Coating	5.7	327
19 mm (3/4 inch) Plaster on Metal Lath ³	15	862
Fluid Applied Air Moisture Barrier Joint Treatment	17.3	994
9.5 mm (3/8 inch) Gypsum Wallboard ⁴	50	2873

Table 1: Water Vapor Permeance of Fluid Applied Air/Moisture Barrier Materials and Common Building Materials. Check online material for Table 1 notes.

The purpose of a vapor retarder in wall construction is to minimize water vapor diffusion through the wall assembly and thus reduce the risk and the amount of condensation on cold surfaces in the wall assembly. Whether or not a vapor retarder should be placed in a wall assembly and where it should be placed must be carefully evaluated in relation to climate, the physical characteristics of other components of the wall assembly, and interior relative humidity conditions. In cold climates the predominant water vapor diffusion direction through most of the year is from the inside to the outside, as warm humid air from the interior environment moves in the direction of cold dry outside air. Conversely, in hot humid climates the predominant water vapor diffusion direction through most of the year is from the warm humid outside environment towards the cooler, dryer conditioned interior environment. Based on these general conditions a vapor retarder is customarily placed on the interior of wall construction in cold climates and on the exterior in hot humid climates. A vapor retarder should not be placed on the interior in hot humid climates, since it will potentially cause condensation by restricting vapor diffusion to the interior. The use of interior vapor retarders has been shown to be a contributing cause in many cases of moisture problems and IAQ problems in buildings in hot humid climates. One tool that is available to assist in making decisions about whether a vapor retarder is needed and where to place it in the wall assembly is a water vapor transmission analysis that can be performed manually (see ASHRAE Handbook—Fundamentals, chapters 21 and 22) or by computer (Treichel, *Moisture Analysis and Condensation Control in Building Envelopes*).

Mechanical Ventilation

A properly functioning air barrier system will limit the influence of air infiltration and exfiltration on the heating and cooling loads of the interior environment. This can increase the efficiency of the HVAC system which translates into energy cost savings. However the mechanical ventilation system must still perform its basic functions of:

- Ventilation and exhaust
- Proper distribution of makeup air to interior spaces
- Dehumidification of air
- Filtration of outdoor air

Wind effects, stack effects, fan effects and space configuration and partitions influence how the mechanical ventilation system must be designed to perform adequately. ASHRAE handbooks provide guidance on mechanical ventilation, and design and control of interior relative humidity conditions to control microbial growth, to minimize condensation potential, and to provide occupant comfort, in relation to air leakage.

Construction Details and Sequencing

“As much as 90 percent of all water intrusion problems occur within 1 percent of the total building exterior surface area. The 1 percent of the structure’s façade contains the terminations and transition detailing that all too frequently lead to envelope failures.”³

Construction detailing is a critical component for the success of any wall assembly. The designer must create details that effectively:

Control rain water penetration that may occur via:

- Gravity flow—water that flows down and to the interior if surfaces are sloped towards the interior, for example, an improperly sloped brick ledge
- Kinetic energy—rain water, for example, being blown directly into large openings
- Capillary action—the tendency of water to travel through narrow openings or cracks in materials toward dryer surfaces, for example, a crack in a mortar joint
- Pressure differentials—the effects of wind pressure, stack effect or mechanical ventilation that create pressure differences across the building envelope, and drive water through cracks or openings

Control condensation that may occur via:

- air leakage
- diffusion

The contractor must in turn coordinate and sequence work so that details are properly constructed. Given that today’s buildings are generally “tighter” than they were fifty years ago, the importance of eliminating water intrusion into wall assemblies increases substantially, since water in walls may not readily dry. Some details are fundamental such as the proper sloping of sills and ledges to the exterior, use of drip edges at soffit returns, capillary breaks in construction joints, or lapping of the air/moisture barrier over flashing at the base of a wall (Figure 4) to direct water to the exterior. Other details are more complex, such as maintaining the continuity of the air barrier at a window penetration (Figure 5) and integrating the air/moisture barrier with sill flashing. Whatever the detail, whether straightforward or complex in nature, the development and execution of details is vital to the long term success of the wall assembly, regardless of how well the air/moisture barrier system performs. An important advantage of a fluid applied air/moisture barrier in the wall assembly is that it can mitigate or eliminate one of the major forces that cause water infiltration into walls: pressure difference. The fluid applied air/moisture barrier, in combination with venting and compartmenting, can effectively enable the pressure behind the cladding material to equalize with the pressure outside, and prevent rain water penetration caused by pressure differentials (pressure equalized rainscreen).

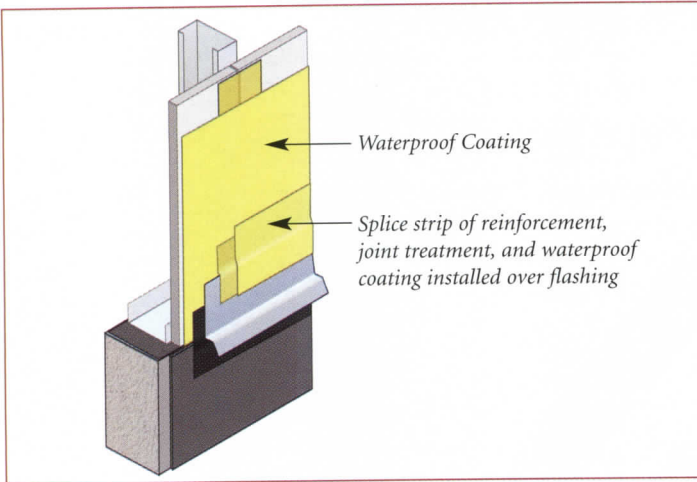

Figure 4: Fluid applied air/moisture barrier lapped onto flashing at the base of the wall to “splice” the two materials and shed water onto the flashing and to the exterior.

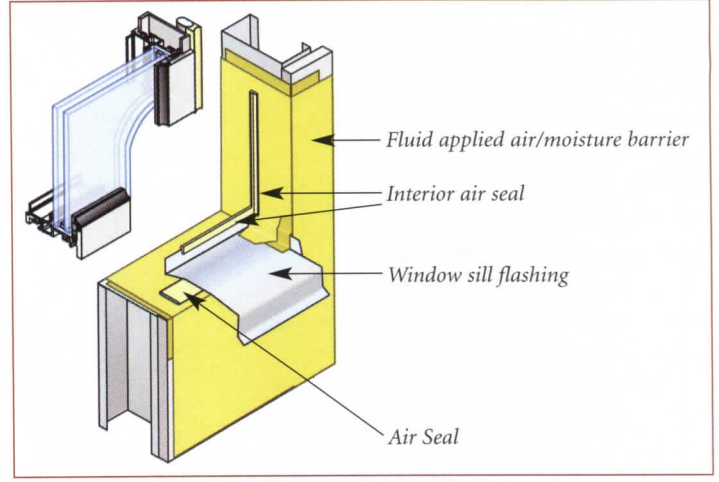

Figure 5: Integration of the fluid applied air/moisture barrier at the rough opening with interior air seal and sill flashing beneath the window.

Click for Additional Information

This continuing education section is continued at www.architecturalrecord.com/CONTEDUC/ConteducC.asp. You need to read the entire section to answer the questions and receive credit.

Learning Objectives

- Know the components of fluid applied air/moisture barriers
- Compare the advantages of fluid air/moisture barriers with building wraps and other moisture barriers
- Identify design considerations when incorporating fluid applied air/moisture barrier systems into wall assemblies

Instructions

Refer to the learning objectives above. Complete the questions below. Go to the self report form on page 278. Follow the reporting instructions, answer the test questions and submit the form. Or use the Continuing Education self report form on Record’s website—architecturalrecord.com—to receive one AIA/CES Learning Unit including one hour of health safety welfare credit.

Questions

- Q:** 1. United States energy codes are always specific about the levels of air permeability for building materials.
- A:** a. True
b. False
- Q:** 2. Fluid applied air/moisture barriers’ excellent adhesion to sheathing and prepared concrete or masonry substrates makes them resistant against:
- A:** a. Wind loads
b. Insects or other pests
c. Mold growth
d. UV degradation
- Q:** 3. Seamless fluid applied moisture protection is nearly _____ times more resistant to air leakage than asphalt saturated felt.
- A:** a. 100
b. 150
c. 200

- Q:** 4. A fluid applied air/moisture barrier is also always a vapor retarding material.
- A:** a. True
b. False
- Q:** 5. In cold climates, a vapor retarder is customarily placed on which?
- A:** a. the interior side of the wall
b. the exterior side of the wall
- Q:** 6. “As much as 90 percent of all water intrusion problems occur within _____ percent of the total building exterior surface area.”
- A:** a. 1
b. 5
c. 10
- Q:** 7. Rain water blown directly into large openings is an example of which mechanism of rain water penetration?
- A:** a. Gravity flow
b. Kinetic energy
c. Capillary action
d. Pressure differentials
- Q:** 8. One of the major forces that causes water infiltration into walls is:
- A:** a. Kinetic energy
b. Gravity flow
c. Pressure difference
- Q:** 9. Fluid applied air/moisture barriers are proprietary materials and are not listed in model codes.
- A:** a. True
b. False
- Q:** 10. In which climate should you use a low permeance rigid insulation on the exterior to resist vapor diffusion to the interior?
- A:** a. Hot humid climates
b. Cold climates



Phone: (800)221-2397
Fax: (404)346-3119
marketingsupport@stocorp.com
www.stocorp.com

CIRCLE 86 ON READER SERVICE CARD OR GO TO WWW.LEADNET.COM/PUBS/MHAR.HTML

**Conservationists
wanted to plant more trees.**

**The Forest Products Industry
wanted to plant more trees.**



(After much debate, they decided to plant more trees.)

In fact, the participants in the Sustainable Forestry Initiative® program are planting more than 1.7 million trees every day. That's over 650 million a year. It's a marriage of environmental responsibility and sound business practices. And that provides us with the wood and paper products we need, while helping to ensure the future of our forests and wildlife for generations to come.



www.aboutsfi.org

CIRCLE 87 ON READER SERVICE CARD
OR GO TO WWW.LEADNET.COM/PUBS/MHAR.HTML



Hy-Lite® Products presents:

Acrylic Block Offers Privacy and Light

Why do glass and acrylic block products inspire creativity? Because of the many ways they can be incorporated into residential and commercial designs ... and because of their attributes. Blocks

allow light to flow into an area while protecting privacy. Whether used as a partition in a dental office or as a radius wall shower surround in a master bathroom, blocks help set architectural designs apart.

As many architects know, heavy glass blocks have been incorporated into building designs throughout the twentieth century. Mortared individually on the job site, glass blocks require special craftsmanship and load-

bearing capacity to be incorporated into designs. During the past several decades a popular alternative to glass block—acrylic block—has captured the attention of architects worldwide.

Acrylic block products generally come in pre-fabricated modular units—either as fully-framed windows or as panels that can easily be assembled on the job site. Gone are the days when special crews are needed to individually assemble block projects. Now, a general contractor can just as easily install an operable acrylic block window as any other window in a project.

When it comes time to specify acrylic block products, architects find that the weight factor is a significant consideration. Acrylic block products can weigh up to 70 percent less than installed glass block units, thus reducing concerns about load-bearing areas and extra support systems. Acrylic blocks still allow in light while protecting privacy, but they also offer fewer job site concerns.

Understanding Acrylic Blocks

What projects best lend themselves to incorporating acrylic blocks? Every project. That's because acrylic block windows (both operable and fixed) and panels can be specified in a wide array of standard and custom size configurations. Whether you're looking for a large octagon-shaped window, a stair-stepped partition panel or an arched window, they can all be created using acrylic blocks.

The use of acrylic blocks is a flexible design element for residential and commercial projects—and for both new construction and retrofit applications. In homes, acrylic block windows allow for privacy in bathroom areas above tubs and around showers. Casement, awning and hopper windows can be

Use the learning objectives below to focus your study as you read **Acrylic Block Offers Privacy and Light**. To earn one AIA/CES Learning Unit including one hour of health safety and welfare credit, answer the questions on page 219, then follow the reporting instructions on page 280 or go to the Continuing Education section on www.architecturalrecord.com and follow the reporting instructions.

Learning Objectives

- Know features and benefits of acrylic blocks compared to glass blocks
- Know ways to incorporate acrylic blocks into residential and commercial settings
- Understand options for various configurations of acrylic blocks in designs

This dentist office gains privacy and light by incorporating acrylic block radius walls and panels into its design.

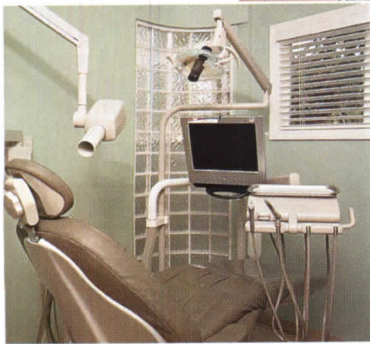

incorporated into kitchens, basements and laundry rooms that are oftentimes physically close to neighboring homes. The

translucence of the blocks protects privacy while allowing for the transmission of natural light.

In commercial applications, acrylic block panels can be specified in medical office spaces, schools and retail settings. Many restaurants, airports and health spas incorporate acrylic block partitions into their designs for both functional and decorative purposes. In recent years, acrylic block panels have been used in everything from television show settings (including in the set designs of *Jeopardy* and *ER*), as passenger area designations at various Southwest Airlines airport gates and even incorporated into exterior signage.

One of the areas architects appear to appreciate acrylic block's features most, is in dealing with renovation and historic restoration projects. Oftentimes existing restrictions on weight make it difficult to bring glass block walls into an existing project when it's time to renovate. Those concerns are lessened with acrylic block panels. Because the panels and windows weigh far less than installed glass block, acrylic block products have become the product of choice for architects working on restoration projects.

Looking for inspiration on how to incorporate acrylic blocks in projects? Consider these ideas:

- When redesigning existing warehouse-type space into offices, cubicles or privacy areas, use acrylic block partitions of varying heights and lengths to promote light flow, privacy and assist with sound control.
- If you're creating a clubhouse, pool area, spa or health facility, specify acrylic block windows and partitions to protect privacy.
- Looking to bring light into a hotel room or medical facility that overlooks an unsightly rooftop or other unappealing view? Acrylic block windows can transform even the most unattractive outdoor areas into obscure images of light and color.
- Create a logo or decorative design using different colored acrylic blocks in a feature wall for either a residential or commercial application.
- Release "trapped light" in the home by specifying doorlight inserts for interior doors. The translucent acrylic blocks protect homeowner privacy while allowing light to flow from room-to-room. Exterior doorlight inserts are also available for creating unique entryways.
- Add light under kitchen cabinets against exterior walls by specifying staggered acrylic block fixed units just above the countertop.
- Create a unique room divider or under-counter partition in a retail or

restaurant setting with an acrylic block radius wall. Available in an assortment of sizes and heights (up to 86 inches tall), radius walls come in a variety of arcs from below 90-degrees (quarter circles) up to 180-degrees (half circles).

- Need an extra burst of light in a project? Try specifying tube lighting within acrylic block panels. Low-voltage tube lighting is ideal for blocks surrounding mirrors in homes, beauty salons and other high-end settings. The fixtures can be installed either horizontally or vertically in panels made with three-inch thick blocks.
- Eager to add even more light? Try fiber optic lighting set inside a structure made out of acrylic block—located, for example, at the base of a bathtub, table or wall partition.
- Create a combination of acrylic block and clear glass by designing a square or rectangular glazed panel inserted into an acrylic block wall. In the application, a framed "doughnut" window is created using acrylic blocks leaving the center portion open for installation by a local dealer of a center glass panel.

Specifics of Acrylic Blocks

Appreciated mostly for their ability to encourage light flow while promoting privacy, acrylic block panels and windows have many appealing features and benefits. The blocks are joined together with a clip system internally and then sealed together with an innovative caulking compound specially formulated to spread and dry evenly, sealing to the block on all sides.

Mechanically applied for even distribution, the caulking is cured and systematically air-dried—resulting in consistently smooth, straight caulk lines. Unlike mortaring of glass blocks, which is field-applied and dependent upon the skill of individual applicators, the caulk will not crack, flake, chip or discolor. The durable caulk is water resistant, and offered by some manufacturers with a mold inhibitor. Some manufacturers also offer a 10-year warranty against the discoloration of the caulking or block, against seal breakage and against failure of the units due to workmanship.

Along with being lightweight and easy to install, acrylic block products require only minimum long-term maintenance. Both vinyl frames on acrylic block units (which come in white and tan generally) and aluminum frames (in



Waist-high acrylic block panels at the Southwest Airlines gate area at the Providence, RI airport help passengers line up for their flights.



The artist owners of this historic home transformed their attic by using acrylic block walls and panels to define office and living spaces.

white, tan, bronze and clear anodized) usually wipe clean with a damp cloth. Even the low-profile frame options, which maximize visibility of the acrylic blocks, can be cleaned easily. Acrylic-safe cleaners should be used on the blocks. Scratch and gouges can usually be restored with a polishing compound.

When specifying acrylic block products, there are many product options available that architects need to be aware of. Most manufacturers offer both six- and eight-inch square blocks—and some offer thicknesses ranging from one to three inches. Triangle-shaped blocks are also available, allowing for the construction of diamond configurations.

One of the most popular aspects of acrylic blocks is the variety of colors and patterns. While clear, frosted and green are the most widely specified colors, other options, including peach, blue, gray, amber and pink are also available from many manufacturers. Architects can also combine several of the color combinations to create customized designs. Surface patterns—such as clear wave, frosted wave, and clear cross rib—can also be combined. Similar to selecting from an ala carte menu at a restaurant, architects are offered an impressive amount of choices for creating customized and standard designs using acrylic block products.

Another way architects can accent a room is to specify that decorative muntins cover the caulk lines in the interior of an acrylic block product. Available in metallic finishes, woodgrain and paintable/stainable versions, the muntin covers (and matching perimeter trim) add a decidedly upscale look to a project, allowing the units to complement other room elements.

Acrylic Blocks Pass the Test

By the numbers, acrylic block products are a solid addition to any project design. Window units from major industry manufacturers offer similar thermal benefits to traditional, dual-glazed units and are safety glazing approved and AAMA certified for use in Wind Zones II and III.

Safety glazing is required in bathrooms, entryways and other locations throughout projects depending on local building codes. Most acrylic block windows are qualified to be used in applications where tempered glass is

required. Both aluminum and vinyl framed windows have passed the ANSI Z97.1-1984 tests.

The weight of acrylic block window units is substantially less—up to 70 percent less—than that of installed glass block units. For an aluminum-framed window constructed of six-inch blocks, two-inches thick, the weight of the unit is just 4.1 pound per square foot. A vinyl-framed window using similar materials weighs approximately 3.7 pounds per square foot. When comparing to a similar glass block configuration weighing in at a hefty 12 pounds per square foot, it's easy to see the benefits of acrylic block.

How do acrylic block windows perform as thermal barriers? The National Fenestration Rating Council (NFRC) rates the U-Value for residential in a range of .51 to .55 depending on the size and depth of the block for products with aluminum frames. With vinyl frames, the rating is .46 to .49. In non-residential applications, the range for aluminum-framed windows is .50 to .54 and .46 to .49 for vinyl windows. These numbers are similar for an energy efficient acrylic block window as they would be for a dual-glazed glass window.

Shape and Size Options

Architects specifying acrylic block products in their designs find them a creative and versatile way to add a striking design element to commercial and residential settings. Configurations and designs are almost limitless based on creativity.

Geometric shaped windows are available in octagons, triangles and even roundtop styles. Large picture windows, archtop windows and stair-stepped designs can be created by many manufacturers. Combining these shapes and styles with stair-stepped partitions, radius wall shower surrounds and interior doorlights allows a project to take on a style all its own—while protecting privacy of the occupants.

When the challenge is unleashing trapped space in bathrooms, laundry rooms and closet areas while protecting privacy, acrylic block windows offer a unique solution.

From a one-block window unit to a massive wall of acrylic blocks, architects have the capability of using acrylic block configurations in a wide variety of ways.

A stunning accent in an entryway for a commercial or residential project is an acrylic block insert unit. In this piece, a glass unit is surrounded by an acrylic block “frame” to combine both traditional glass and the lightweight acrylic block. The glazing insert option



Geometric-shaped windows, including this octagon, can serve as a focal point in both commercial and residential settings.

allows for the customization of a center glass panel surrounded by the acrylic blocks. In the application, a framed “doughnut” window is created using acrylic blocks leaving the center portion open for installation by a local dealer of a glass panel.

The glazing insert option is especially appreciated in applications where a home or business owner may wish to have a window unit of an engraved glass panel surrounded by acrylic blocks. The glazing insert option provides the flexibility to allow for acrylic block products to be combined with glass panels to create a striking showpiece window.

Available for both new construction and retrofit windows, the glazing insert option is available in either a square or rectangular shaped glass panel. The inner opening must be surrounded on all four sides by at least one row of acrylic block. The size of the glass must be the equivalent of the blocks removed from the overall pattern minus three-quarters of an inch.

The acrylic block manufacturer provides the complete inner glazing frame in aluminum, plus the glazing tape, making it easy for a dealer to install the selected glass panel. The exterior frame is available in either aluminum or vinyl. As long as the inner opening is surrounded by at least one row of acrylic blocks on all four sides, the size options are endless.

Whether creating a signature design, such as a decorative Southwestern style window in a master bedroom, or a stair-stepped shaped window in a hallway,

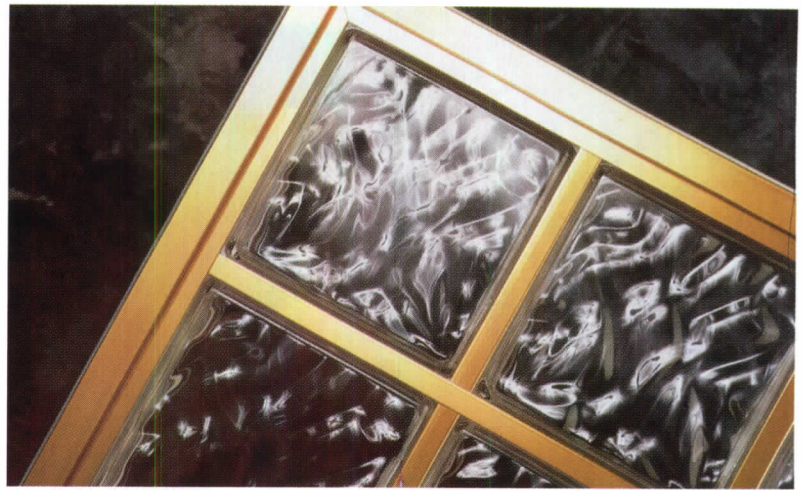

Acrylic block windows can be transformed to match any room décor with decorative muntin and trim coverings. This unit shows a bright gold covering.

architects find an abundance of design and product options available from acrylic block manufacturers. These unique products—coupled with the creativity of designers and architects—allow projects to gain strong design and privacy enhancements with unique fixed and operable acrylic block window units, partitions, walls and shower surrounds.

Attention to Detail

Different than glass blocks that are mortared together on site, acrylic block components are assembled at the factory.

Acrylic block windows and panels can range in size from a fixed unit containing just a single block to a massive picture window stretching eight feet

by eight feet to fill an entire wall opening. No matter the size, at the majority of acrylic block manufacturers, each unit is subjected to the same high levels of quality control in the factory.

The step-by-step construction process for many manufacturers includes:

1. Verification of order details, including size and style of units; block size, pattern and color to be used; frame selection; special options (i.e.: perimeter and muntin trim, combination of different colored blocks, etc.).
2. Construction of a custom made aluminum or vinyl frame as specified by the customer. Aluminum frames are thermally-broken for increased thermal performance and have a stream-lined design. Vinyl frames are fusion-welded and never need painting. New construction products include integral nailing fins for fast, easy installation. (photo A)
3. Hand placement of individual blocks in frame. Blocks are tightly assembled into

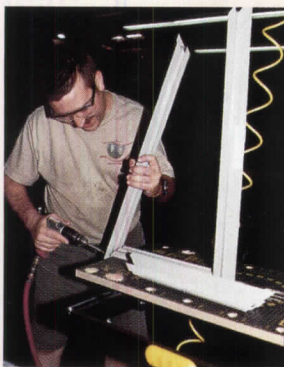

A



B



C

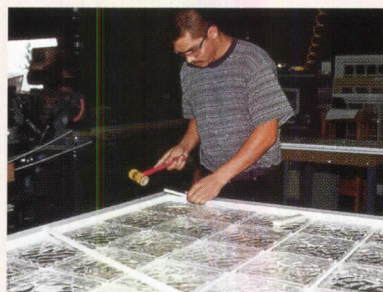

D



E

- complete units using rugged polymer clips. (photo B)
4. After laying the units flat, an exclusive, fade-resistant synthetic caulking compound is applied to permanently seal the blocks together. Once the unit has cured for 24 hours, it is turned and caulking compound is applied to the reverse side. Another 24-hour cure time follows. (photo C)
 5. Frame elements are affixed to each unit, including weather stripping and operating hardware. (photo D)
 6. Following careful inspection and application of optional muntin and trim covering, the unit is packaged for shipment. (photo E)

Some manufacturers use blocks that are hermetically sealed to help prevent condensation. The high-quality durable acrylic blocks stand up against harsh weather conditions and resist discoloration and scratching.

Click for Additional Information

As part of this CES learning activity, you are required to read some additional material. Some of the test questions below will relate to the additional reading material. Go to www.architecturalrecord.com/CONTEDUC/ConteducC.asp to access the material online.

Learning Objectives

- Know features and benefits of acrylic blocks compared to glass blocks
- Know ways to incorporate acrylic blocks into residential and commercial settings
- Understand options for various configurations of acrylic blocks in designs

Instructions

Refer to the learning objectives above. Complete the questions below. Go to the self report form on page 280. Follow the reporting instructions, answer the test questions and submit the form. Or use the Continuing Education self report form on *Record's* website—architecturalrecord.com—to receive one AIA/CES Learning Unit including one hour of health safety welfare credit.

Questions

- Q: 1. Acrylic block products can weigh up to ___ percent less than installed glass block units,
A: a. 40
b. 50
c. 60
d. 70
- Q: 2. The blocks are joined together internally with a:
A: a. Caulking compound
b. Clip System
c. Muntins
- Q: 3. Caulking of acrylic blocks are field-applied.
A: a. True
b. False
- Q: 4. Most acrylic blocks are qualified to be used in applications where tempered glass is required.
A: a. True
b. False
- Q: 5. The weight of an aluminum-framed window constructed of six-inch acrylic blocks, two-inches thick is:
A: a. 4.1 pounds per square foot
b. 6.2 pounds per square foot
c. 12 pounds per square foot
- Q: 6. The U-Values for an energy efficient acrylic block window are similar for a dual-glazed glass window.
A: a. True
b. False
- Q: 7. The best way to remove light scratches from acrylic blocks is by using:
A: a. Comet
b. Bleach
c. Furniture polish
d. Windex
- Q: 8. Acrylic block windows come in which versions:
A: a. Operable Casements
b. Fixed Picture
c. Basement Hopper
d. All of the above
- Q: 9. An anti-fungicide in the caulking of some manufacturer's products prevents the spread of mildew in acrylic block products.
A: a. True
b. False
- Q: 10. The glazing insert option available from some acrylic block manufacturers
A: a. Allows acrylic blocks to be glazed
b. Provides the flexibility for acrylic block products to be combined with glass panels
c. Offers builders and remodelers a way to sandwich together glass blocks and acrylic blocks in one project

ABOUT HY-LITE® PRODUCTS

With manufacturing facilities in California, Georgia, Canada, Japan and Australia, Hy-Lite Products is the industry leader in the production of acrylic block panels, fixed and operable windows, partitions, radius walls, shower surrounds and doorlight inserts. The company's award-winning products are specified and installed in both new construction and retrofit applications for commercial and residential projects. Hy-Lite offers a QuickShip(SM) program providing standard-sized units in two days. Other products are available within seven business days. For more information on Hy-Lite Products and to locate a dealer, call 877-712-4013 or visit the company's web site at www.hy-lite.com on the Internet.



101 California Avenue
Beaumont, CA 92223
1-800-827-3691
Fax 1-800-827-4920
www.hy-lite.com
e-mail: productinfo@hy-lite.com

CIRCLE 88 ON READER SERVICE CARD OR GO TO WWW.LEADNET.COM/PUBS/MHAR.HTML

THE BEST CONTRACT DOCUMENTS JUST GOT EASIER TO USE.

The leading contract documents are now easier to use than ever before, thanks to AIA Contract Documents 3.0 PLUS. It's a free upgrade for current electronic format 3.0 users, featuring:

AIA Contract Documents release **3.0 PLUS**

- 11 new or revised documents
- Faster-printing "DRAFT" watermark for clean, readable copying and faxing
- Multi-seat licenses
- Improved navigational aids and formatting

AIA Contract Documents were created from a consensus of contractors, attorneys, architects and engineers. They've been finely tuned through 110 years of legal precedent. And now they're easier to use than ever before.

- **To order AIA Contract Documents software, or to obtain your free upgrade, visit www.aia.org or call 1-800-365-2724.**



**THE AMERICAN INSTITUTE
OF ARCHITECTS**

www.aia.org

The American Institute
of Steel Construction, Inc. presents:

Building Tomorrow's Parking Structures Today with Steel Frames

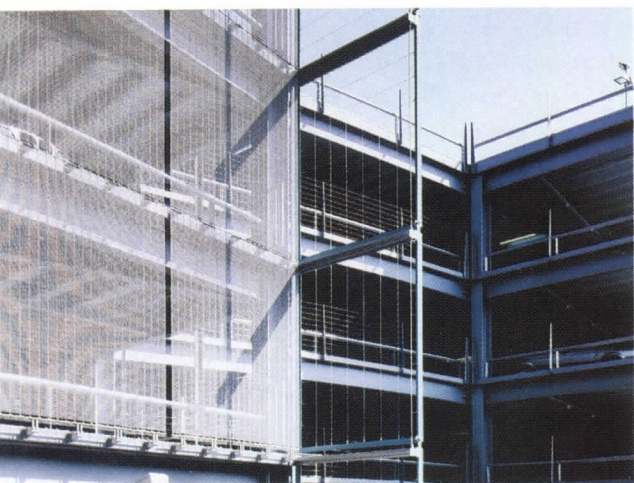

“Steel Parking Structures Making a Comeback!” reads the headline

in a recent issue of *Parking Today*, the leading independent trade publication of

the US parking industry. Steel framed parking structures today are radically different than their predecessors. New high performance paint systems and modern galvanizing techniques have satisfied corrosion concerns and provide a protective, attractive finish that lasts for decades. Choosing a steel framing system will improve the return on your investment through benefits that concrete cannot provide including:

- lower construction costs
- greater parking density providing more parking spaces
- bright, open interiors enhancing patron security and comfort
- earlier occupancy from reduced construction time and simplified construction practices
- reduced maintenance costs as opposed to escalating restoration costs
- superior long-term durability
- unlimited opportunity for aesthetic expression
- greater design flexibility
- simplified maintenance procedures
- adaptability to irregular sites
- reduced foundation requirements resulting from a lighter structure
- convenience and ease of future vertical expansion

Open Deck Parking Structures

During the past several decades, the open, above-ground, multi-level parking structure has been increasingly dotting the country's urban and suburban landscape. The scarcity and cost of urban sites for inefficient grade-level parking lots together with the growth of large suburban malls and office parks have propelled structured parking to a prominent position in the nation's building inventory.

Use the learning objectives below to focus your study as you read **Building Tomorrow's Parking Structures Today with Steel Frames**. To earn one AIA/CES Learning Unit including one hour of health safety welfare credit, answer the questions on page 225, then follow the reporting instructions on page 280 or go to the Continuing Education section on www.architecturalrecord.com and follow the reporting instructions.

Learning Objectives

- Understand the current design parameters for open deck parking structures
- Know the benefits of steel framing for open deck parking structures
- Explore the use of different coating technologies to provide long term corrosion resistance
- Know how design elements can impact the long term maintenance of open deck parking structures.

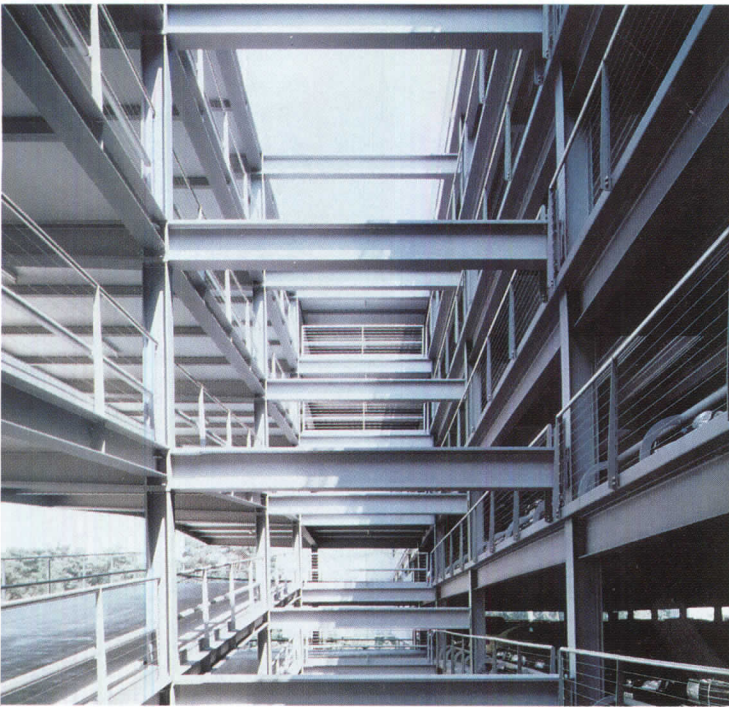

Cologne-Bonn Airport & Car Park; Murphy/Jahn Inc.

Open deck parking structures typically provide multi-level parking for at least 150 vehicles and have at least two sides that are a minimum 50% open to the outside. The open parking structure is preferable to enclosed structures in that it does not require mechanical ventilation and specialized fire protection systems. Open deck structures also create an increased sense of security for the patron and are easier and less expensive to construct. A vehicle is designed to be exposed to weather conditions and is ideally suited to the environment of an open deck structure.

Open deck parking structures have two major structural systems: the framing system which forms the skeleton of the structure and the deck system upon which the vehicles drive and park.

There are three basic material choices that owners and developers have for the framing systems:

- Fabricated structural steel framing (beams, girders and columns) supporting a concrete deck
- Cast-in-place concrete framing (concrete formed, poured and cured on the construction site), conventionally reinforced or post-tensioned
- Precast/prestressed (manufactured off-site) concrete framing using long span double tees for deck

Three deck options are generally utilized:

- Precast systems utilizing long span double tees (40 to 60 foot long concrete sections that have two "T" stems extending down from the deck)
- Cast-in-place floor slabs with conventional steel reinforcing utilizing stay-in-place steel deck
- Cast-in-place post-tensioned floor slabs utilizing steel cables to compress the slab after curing by placing the cables or tendons in tension

Unlike the concrete framing systems, only the steel framed parking structure provides the opportunity to use any of the three concrete deck systems. This is one major advantage in choosing structural steel for a parking structure.

Evaluating Costs

The initial costs of an open deck parking structure are determined by the selection of a site, subsurface conditions, the choice of a framing and deck system, local labor and material prices, and financing costs during the construction period. The speed of design and construction is particularly critical to revenue generating parking structures or in situations where an adjacent office building or similar structure cannot be fully leased until adequate parking is provided. The parking designer should take each of these factors into account in the original budget provided to the owner. Cost reductions can be accomplished through:

- the choice of structural systems that may minimize overall structure weight reducing the foundation requirements
- optimizing bay sizes for maximum parking capacity within the structure's footprint (or minimizing structure size for a given parking requirement)
- the evaluation of various façade options

The expenses of ownership of a parking structure do not end when the first car is parked. Ongoing maintenance programs are critical to the long-term life of the parking structure. A regular program of preventive maintenance at a reasonable annual cost can avoid the future expense of major renovation. The cost of these preventive maintenance programs and the anticipation of future remedial actions must be taken into account when evaluating the true cost of ownership, the life cycle cost of the structure. Items to be considered for maintenance and remedial action are:

- the expected life of the concrete system including the quality of the wearing surface and joints
- the replacement of concrete sealers and membranes
- the structural integrity of the concrete deck, columns and beams
- the performance of the coating system on steel members
- the integrity of the drainage system
- the condition of rails and facades

The choice of framing system can greatly impact the life cycle cost of a parking structure. A comprehensive life cycle cost study was recently performed by an outside consultant of a steel-framed parking structure at Newark Airport for the Port Authority of New York and New Jersey. The findings of that study verified that their steel framed structure was the most cost-effective solution both in terms of construction and life-cycle costs (*Modern Steel Construction*, April 2001).

Closely related to life cycle costs is the evaluation of the long-term durability of the structure. Concrete decks and structural members deteriorate as a result of chloride migration compromising the structural integrity of the parking structure. This may necessitate the removal and replacement of deck slabs or the need to structurally reinforce concrete columns and beams through the use of steel bands or concrete encasement techniques. Addressing these structural concerns is a costly, time-consuming process that will take the structure out of operation and often results in reduced parking capacity. When a concrete deck on a concrete framed structure requires replacement, the entire structure may have to be demolished while in a steel framed structure, the original framing system can be cleaned, repainted and reused in the rehabilitated structure.

Maintenance or "life-cycle" costs are directly impacted by the ease of maintenance of the parking structure. Ease of maintenance should be considered in the initial design of the structure, including:



Harvard Square Parking Garage, Cambridge, MA; Maguire Group

- drains should be located at points of easy access
- structural connections should be exposed for inspection
- expansion joints should be laid out for easy replacement of seals
- storm water discharges should be accessible and direct flow away from the structure
- a defined procedure simplifying upper deck snow removal should be included
- visual inspection opportunities should be optimized
- areas of the structure should be able to be easily catalogued for tracking progressive deterioration.

For many parking structures, the ease of construction will have a direct bearing on the construction costs of the project. Issues to evaluate should include:

- availability of storage space on the site for material delivery
- foundation conditions
- the ability of structural materials to be placed in winter conditions
- crane setup locations
- tight erection clearances
- the ability of trucks to deliver components in congested areas
- the erection sequence of components
- the ability of the partially erected structure to be self supporting
- the need for shoring and bracing

In seismic regions the design of the parking structure must take into account lateral forces due to seismic (earthquake) loading. In seismic design, the dead load, full live load and the seismic loads are combined and the structure is designed for combinations of these effects. Common lateral load resisting systems used in steel parking structures are:

- Braced frames where the lateral load is resisted by diagonal members
- Flexible moment connections or semi-rigid frames designed to distribute the lateral load through controlled displacements
- Moment frames where the lateral load is resisted in the stiffness of the connections between the steel members

Concrete framed structures typically require the use of large concrete shear walls or complex moment frames. Shear walls disrupt the openness of the parking structure's design and create security concerns. Concrete moment frames require a high degree of field expertise and may extend outside the footprint of the structure requiring additional site area.

The selection of the façade treatment on a parking structure is important from a security, aesthetic and cost stand point. Parking structure owners and developers are now realizing that the first impression a visitor receives of their organization is often conveyed by the parking structure. Many municipalities are now requiring that parking structures blend into the architectural aesthetics of the neighborhoods in which they are located. For these reasons the choice of a façade treatment can be a critical choice for the structure. Façade systems are available to create literally any exterior treatment desired by the owner. A steel framing system provides the design flexibility to allow the architect to conceive an exterior façade system that is at once

economical, attractive, compatible with the surroundings, acceptable to reviewing agencies and "open" to eliminate a fire resistance requirement. Even in cases where a desired façade may not contain the required amount of openness to allow the structure to qualify as an open deck parking structure, the desired façade may be used on one side of a structure while a more open façade can be used on the other sides allowing the structure to meet the openness requirements.

Economical, detached, above-ground steel framed parking structures have been typically built for \$5,000 to \$10,000 per space depending on the region of the country (costs are from the year 2000). Cost-per-space of a structure can escalate rapidly if the façade itself is very elaborate, difficult to fabricate and install, especially if the perimeter-to-floor area ratio is high. A massive, heavy facade can add substantial load to the perimeter foundation and require more costly design, detailing, fabrication and erection for seismic resistance. The most economical façade is simple, serves as a structural safety barrier, and is easily attached to the steel frame.

Safety, security and patron comfort issues have a necessary influence on parking structure design. The brightness of interior finishes and smoothness of the ceiling impact the type and quantity of illumination. From a safety perspective, 90 degree parking with wide aisle widths may be preferred. The "over-cut basement", in which earth is removed from around below-grade levels, provides an opportunity to eliminate structural fire protection,



Burlington International Airport, Burlington, VT; Hybrid Parking Solutions

introduce natural light and eliminate totally enclosed levels. External glass-enclosed elevator and stairwell cores improve visibility and increase the sense of security for patrons. Video monitoring and emergency call systems improve security and help patrons with car trouble to obtain assistance.

Functional Design Parameters

In establishing the feasibility, size, design concept and cost of a parking structure, the average floor area to be occupied by one parking space must be determined. This figure is obtained by dividing the total square footage of the structure (all levels) by its capacity, in total number of cars to be parked. The area-per-space ratio depends on many factors: size and shape of the buildable area; stall size, aisle width and ramp design; ratio of small to full-size cars; short or long span module; traffic flow system; mixed-use occupancy requirements (above or below); and local ordinances. The average area per space can vary from about 280 square feet to 400 square feet. For planning purposes 320 square feet to 350 square feet is typically used. When comparing average cost per space (i.e., cost per car) for design alternatives the design efficiency (area/space) must be considered. Steel columns are substantially smaller than corresponding concrete columns allowing for an increase in the number of spaces per floor.

In recent years, angle parking has become a popular stall design for self-parking structures, primarily because it is easier for drivers to maneuver and less driving aisle is needed than for 90° stalls. Angle parking, typically 50° to 70°, consumes a larger floor area per space than 90 degree parking with two-way aisles but the parking module, and perhaps even the over-all width of the structure, can be narrower. Angle parking uses one-way aisles, which may reduce congestion, but the narrower aisle may be perceived to be less secure for patrons walking to and from their cars. The 90° stall pattern allows a more uniform grid and appears to simplify ramp design.

For a "one-size-fits-all" design, assuming a 70/30 ratio of large to small cars and 90° parking, an 8 foot 6 inch. space width and a 60 foot wall-to-wall module may be used for planning purposes.

Bay sizes and interior spans in a parking structure are often dictated by factors other than parking efficiency. Framing for parking below steel-framed multi-story office or residential space having a 25 foot by 27 foot bay size will probably be more economical if the steel columns continue directly down through the parking levels to the foundation, avoiding structural transfers to longer bays at the transition floor. Long span modules, typically 55 foot to 65 foot, may be heavier, but cost 10% less due to fabrication and erection efficiencies. The number of stalls within the structure can be increased or the overall size of the structure can be reduced through the use of long span design. Advantages of long spans in parking structures include:

- column-free areas that simplify maintenance and improve illumination
- less opportunity for damage to automobiles
- more openness and improved psychological effect on patrons (safety, comfort)
- greater flexibility to re-stripe stalls in the future
- fewer spaces lost to careless parkers in three-car bays

In parking structures with 55 foot to 65-foot spans, total floor depth will depend largely on the steel beam depth. Depending on the bay size, these spans are typically made with W24 to W30 composite design beams of A992 (standard 50 ksi) steel. It would appear that for the long span parking structure,



Allegheny General Hospital, Pittsburgh, PA; Mulach Parking

a minimum total floor depth of around 30 inches must be expected. If shallower floors are required, shorter spans have to be considered. Thus, the designer should determine very early if there is a limitation on the depth of floor construction in the parking structure, because such a restriction can have a significant impact on the column grid and on selection, design and cost of the floor system to be used.

Depth of floor construction has emerged as an important factor governing the selection and design of floor systems for many types of buildings. Restriction of floor construction depth arises from local zoning (either total height or headroom), matching floors of an existing connected building, ramp grade requirements, and, for below-grade levels, shallow bedrock or a high water table. The minimum recommended clearance or headroom for parking structures is 7 foot 2 inches. (sometimes codified), but clearances as low as 7 foot 0 inches may be used. (The designer should consider detailing for a clearance that is 2 inches greater than the minimum required to allow for tolerances in beam camber and construction.) Where van access by disabled patrons is required, the minimum clearance to the lowest overhead obstruction is 8 foot 2 inches. To determine story height the designer should factor in the thickness of any mechanical and electrical services and fire protection that will run below the structural framing systems. Consideration should be given to running these services through web openings in steel framed structures.

Astute structural engineers have been successful in condensing steel beam floor construction to acceptable depths by the use of high-strength steel, LRFD (load and resistance factor design), cambering, composite beams, beam web penetrations, castellated beams and innovative steel beam/concrete floor systems.

In parking structures, as in all buildings, greater floor-to-floor height translates directly into increased cost of facade and other vertical building elements. With a simple and economical facade, the impact of this element on total cost is minimal. Decreasing depth of floor construction, below that of the most economical framing, may increase floor framing cost to some threshold that will exceed the savings accrued through lower total building height.

Depending on the length of horizontal run available, desired ramp grades may influence depth of floor construction. Generally, straight-run ramps with no parking stalls or pedestrian traffic on either side have 10% to 15% grades

(slopes); a 12% maximum slope is suggested for long ramps. Any ramp with a slope greater than 14% will require a transition slope at the end of the ramp. Single lane ramp widths are usually 12 feet curb-to-curb, but 15 feet to 16 feet is advised if approaches or turns are particularly sharp. For the parking ramp itself, a 5% grade is preferred under ADA guidelines, although a 6% slope is generally acceptable.

Structure Height and Fire Safety Requirements

Under all of the model building codes, no fireproofing is required for structural steel members in an open deck parking structure less than 75 feet in height as long as any point on any parking tier is within 200 feet of an open side. It should be noted that the height of a parking structure is measured to the top of the deck for the top parking tier, not to the top of any facades or parapet walls (this is based on the treatment of the top tier as the "roof" of the parking structure with parking allowed on the roof). When parking is being provided on the lower floors of a mixed use structure, the lower parking floors must be fire separated from the upper floors and be fire rated.

It is possible for a steel framed parking structure to exceed the 75 foot limitation based on the square footage of each tier and the number of open sides. The prospective owner of a parking structure should consult with local building code officials to determine any local modifications of the relevant code provisions.

When evaluating tier area and structure height the impact of any future vertical expansion should be taken into account. Properly designed steel framed parking structures provide a readily expandable structure.

Click for Additional Information

As part of this CES learning activity, you are required to read additional materials. Some of the test questions below will relate to the additional reading material. Go to www.architecturalrecord.com/CONTEDUC/Conteduc.asp to access the material online. To obtain a faxed copy of the materials, contact the Steel Solutions Center at 1-866-ASK-AISC or email solutions@aisc.org.

Learning Objectives

- Understand the current design parameters for open deck parking structures
- Know the benefits of steel framing for open deck parking structures
- Explore the use of different coating technologies to provide long term corrosion resistance
- Know how design elements can impact the long term maintenance of open deck parking structures.

Instructions

Refer to the learning objectives above. Complete the questions below. Go to the self report form on page 280. Follow the reporting instructions, answer the test questions and submit the form. Or use the Continuing Education self report form on *Record's* website—architecturalrecord.com—to receive one AIA/CES Learning Unit including one hour of health safety welfare credit.

Questions

- Q: 1. Typically, the average area allocated in a parking structure per space is:
- a. 250 sq ft
 - b. 400 sq ft
 - c. 320 sq ft
 - d. 200 sq ft
- Q: 2. The following is not a viable structural option for an open deck structure:
- a. Structural steel frame with a pre-cast double tee deck
 - b. Cast-in-place beams and columns with a post-tensioned concrete deck
 - c. Structural steel frame with a post-tensioned concrete deck
 - d. Pre-cast concrete frame with a cast-in-place concrete deck
- Q: 3. The Achilles' heel of an open deck parking structure is:
- a. concrete deck cracks
 - b. parking control equipment
 - c. corrosion on protected surfaces
 - d. façade attachments
- Q: 4. Steel framed parking structures are:
- a. less durable than concrete structures
 - b. more expensive than pre-cast parking structures
 - c. 10% to 20% less costly than concrete structures
 - d. more complex to erect
- Q: 5. Effective corrosion protection in parking structures can be obtained by the use of:
- a. acrylic paint
 - b. galvanizing
 - c. weathering steel
 - d. spray membrane coating
- Q: 6. Foundation requirements for a steel framed parking structure:
- a. are greater than a comparable concrete structure
 - b. prohibit vertical expansion
 - c. are less than for a comparable concrete structure
 - d. require short span construction
- Q: 7. The minimum recommended headroom clearance for a parking structure is:
- a. 7 foot 2 inches
 - b. 6 foot 8 inches
 - c. 8 foot 6 inches
 - d. 6 foot 10 inches
- Q: 8. Fire protection is not required for steel framed parking structures:
- a. less than 30 feet in height
 - b. less than 75 feet in height when the maximum distance to an open side is 200 feet
 - c. that are sprinkler equipped
 - d. less than 100 feet tall
- Q: 9. Typically the most efficient layout for parking bays is:
- a. 70 degree angle parking with one way aisles
 - b. parallel parking
 - c. 90 degree parking with two way 60 foot bays
 - d. 90 degree parking with one way aisles
- Q: 10. Life-cycle costs for steel framed parking structures:
- a. are less than for comparable concrete structures
 - b. with post-tensioned decks average \$1.00 per sq ft per year
 - c. cannot be estimated
 - d. are dependant on the type of vehicle parked in the structure



866-ASK-AISC
www.aisc.org
Email: solutions@aisc.org

CIRCLE 89 ON READER SERVICE CARD OR GO TO WWW.LEADNET.COM/PUBS/MHAR.HTML

n e w c a t a l o g

light

of louis poulsen

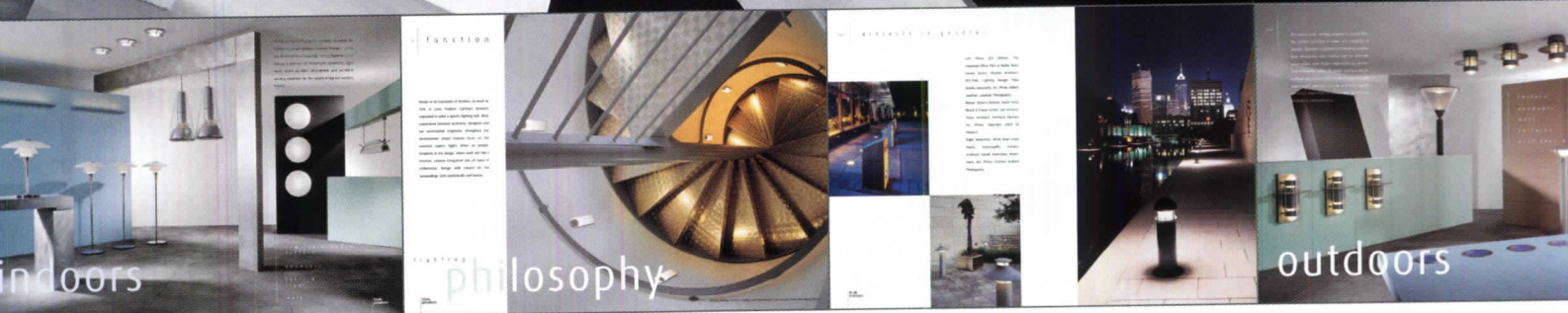

A brand new catalog with 480 pages of inspiration and information. A book conceptually bound by the three basics in our lighting philosophy – Function – Comfort – Ambience.

We present a product program suited for all kinds of applications. Products, which not only give light but create atmosphere. Products, which adapt to all types of architectural surroundings, yesterday, today and tomorrow.

Visit our website www.louis Poulsen.com or contact your local agent to register for the new catalog.

**louis
poulsen**

Louis Poulsen Lighting, Inc. · 3260 Meridian Parkway · Fort Lauderdale, FL 33331
Tel.: +1 954 349 2525 · Fax: +1 954 349 2550 · info@louis Poulsen.com · www.louis Poulsen.com

**CIRCLE 90 ON READER SERVICE CARD
OR GO TO WWW.LEADNET.COM/PUBS/MHAR.HTML**

LIGHTING

Eat, drink,
shop, **sightsee:**
Sharp, inventive
illumination
leads the way



Everything Is Illuminated is the title of a wonderful new book by Jonathan Safran Foer. No, it's not the nostalgic memoirs of a veteran lighting designer pontificating about a lifetime's work with klieg lights, filaments, and foot candles, but a remarkable first novel by a precocious

young writer. Though lighting is not the novel's central theme, the title has become a kind of mantra for me. As both a fiction writer and journalist covering lighting design, I find that my dual interests rarely converge. Oh, there is the book-list genre sometimes dubbed "light fiction," of course, which calls to mind the latest Jackie Collins summer beach read ("Will Lucky remain head of the film studio, marry her true love, the Count de Fortbrasso, or fall head over heels for the on-set lighting technician?"), but how often does literature put lighting in the spotlight? In our more William Safire-like semantic moments at *RECORD*, we editors often debate the best choice of descriptive term that will translate the specific quality of a project's certain ethereal glow or moonlight-dusted backdrop. Good writing, like good lighting design, only *looks* easy.

Illumination is the key word around our office. Though we try to avoid "preaching the gospel" of good lighting design, we often find that an architectural installation, when accurately and thoroughly documented, can "illuminate" the technical specifications, and perhaps artistry, behind designing with electric light.

The projects and profiles in this issue indeed demonstrate that everything is illuminated. From a sophisticated restaurant and a jewelry boutique in New York City to the globetrotting "light magic" of Frenchman Yann Kersalé, plus stops along the way to check in with our Canadian colleagues, our tour displays the spectrum of styles, approaches, and applications possible with today's new sources. Charles Linn also updates us on some new twists in fiber optics. And what lies ahead? For February 2003, we're working on a lighting-education report, to survey how our readers came to be so "enlightened." Please forward your insights to me at: bill_weathersby@mcgraw-hill.com. I might see the light. *William Weathersby, Jr.*

229 Creative Uses

230 Profile: Lighting designer Yann Kersalé

238 D'Fly, New York City
3deluxe

244 Craft, New York City

Bentel & Bentel Architects

253 Lighting Technology: Fiber-optic advances

255 Lighting Resources

TECHNOLOGY BREAKTHROUGH:

The Look of Low Voltage at a Fraction of the Energy.

Energy issues can keep designers from specifying the lighting they want. Take halogen fixtures, for example. They're small, attractive and produce focused accent and downlighting. But because halogen isn't energy efficient, compact fluorescent often gets specified instead, even when it's inappropriate.

Enter Fiberstars EFO™, a major breakthrough in fiber optic lighting combining energy efficiency with the small fixture size and focused distribution of halogen. Our new, six-fixture EFO downlighting system delivers MR16-like performance using a single 68-watt lamp instead of six 50-watt lamps.

DELIVERED LUMENS PER WATT

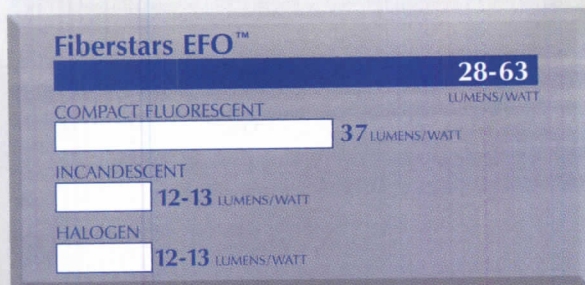

Independent tests show that a single 75-watt Fiberstars EFO™ system can deliver MR16-like performance from a fraction of the energy.

It's all made possible by CPC Optics™, a patented system that transmits light to fiber in an entirely new way, redefining fiber optic lighting performance. There's still no local heat, electricity or harmful U.V. And because one lamp powers six fixtures, EFO is exceptionally easy to install and maintain.

It's a breakthrough so impressive it's hard to believe. So don't take our word for it—ask your Fiberstars representative for a demonstration.



Fiberstars EFO™ is an energy-efficient solution for highlighting and area downlighting in offices and other commercial applications.

JAY GRAHAM PHOTOGRAPHY



www.fiberstars.com

800/327-7877

efo@fiberstars.com

FIBERSTARS EFO™ The first lighting revolution of the 21st Century.

CIRCLE 91 ON READER SERVICE CARD
OR GO TO WWW.LEADNET.COM/PUBS/MHAR.HTML

Creative Uses

Designers now working in Canada explore light in interior environments: In Montreal, a designer raised in Morocco wraps a fashion house in light, and Toronto sees light-filled furniture

The showroom of a denim company is bleached with light

Montreal-based architect Jaime Bouzaglo has been fascinated by the effects of shadow and light since childhood. Born in Alcazar, Morocco, and raised in Barcelona, Spain, he grew up watching the play of daylight and nightfall amid classic Mediterranean architecture. Those childhood perceptions continue to inform how he integrates lighting into design projects such as the Buffalo Jeans headquarters and showroom in Montreal.

When asked by a friend, clothing designer David Bitton, to design the 13,000-square-foot base of operations for the popular line of jeans, the architect knew lighting would help define his plan. "I saw the floor plan as a mega city," he explains. "A place where many things happen at once. In some spaces people are working, elsewhere they're walking or examining merchandise."



Indigo blue jeans cue the color of the ceiling at Buffalo Jeans in Montreal, offset by bright white lighting, like a "3D acid wash."

Bouzaglo envisioned the corridors between offices, design studios, and showrooms as vital passageways connecting people with each other and their environment, "like a paseo or promenade in Spain." Imbuing the main corridor with warmth, fluorescent lighting is camouflaged by translucent white

stretch-fabric-covered fixtures suspended from the ceiling. The 8-foot-diameter fixture is lit by 6-foot lengths of fluorescents installed at 6-inch intervals. Reflective metal flooring is a counterpoint to the soft, fabric-covered fixture. An additional run of translucent, fabric-covered lighting is

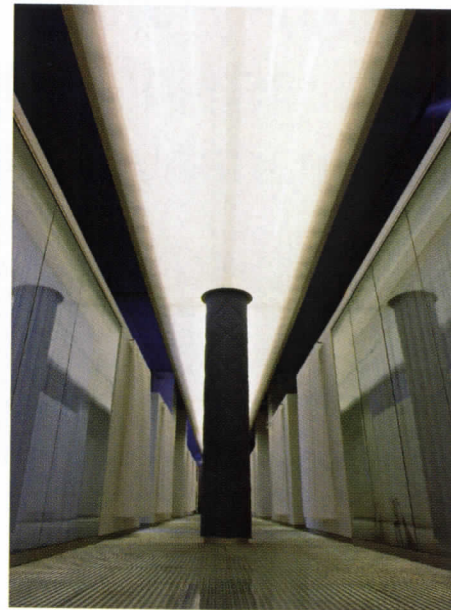

suspended from the ceiling and supported by columns dressed in denim, rising toward the blue-painted ceiling. Bare 150-watt incandescents are suspended individually to recall the past within the modern context. *Leanne B. French*



Illuminated by fluorescents, Mr. Grayson's Cabinet of Wonder teamed a filmmaker client with an inventive architect/designer, Johnson Chou.



An illuminated cabinet beckons the curious

Dr. Caligari had his famous cabinet in the classic German film, and now so does Canadian filmmaker John Grayson. Titled *Mr. Grayson's Cabinet of Wonder*, the inventive storage credenza anchors the office of the director/producer's loft, sparking the curiosity of virtually everyone who stands before it. Appearing like a ghostly distant cousin of the black monolith that looms in the landscape at the outset of *2001: A Space Odyssey*, the credenza features a Minimalist black melamine base whose face is infused with mystery via translucent acrylic compartments backlit by fluorescents. Both elegant and functional, the piece, designed by Toronto architect Johnson Chou, incorporates a working light table, computer base, and archival storage

compartments of various sizes.

The design challenge for the cabinet was issued by organizers of the Toronto Arts Awards. Part of the prize, which Grayson received, includes a design commission granted to a protégé (younger architect or artist) to design an object or artwork in tribute.

"John collects specimens from around the world that inspire his projects, so the cabinet functions as his personal treasury," Chou says. Also a graphic designer and art curator, Chou here explores the notion of transformation. But the mystery does not end with the light show; the unit's drawers must be opened in sequence from a "secret" starting point. Mr. Grayson's wondrous cabinet requires no lock and key. *William Weathersby, Jr.*

In the City of Light and beyond, Parisian lighting designer **Yann Kersalé** turns acts of illumination into narrative works of art

By **Claire Downey**

Like a photographer who waits for the perfect play of light and shadow to fall across a building, Yann Kersalé sees electric illumination as an integral part of architecture. True, applied electric light is an artificial enhancement, and often a functional necessity, but with the possibility of becoming much more. “As people sleep less,” says Kersalé, “remaining more active and even working through the night, lighting has become more important to defining architectural and urban landscape projects. Illumination can be more than a technical specification; it can tell an expressive story.”

The narrative thrust of Kersalé’s work as a lighting designer is often expressed by light that changes, or “pulsates,” with the environment. There is a bit of the poet in the 47-year-old Kersalé, as well as sculptor, explorer, and showman—a result of years spent lugging around sound and lighting equipment for several popular French bands. According to Kersalé, he learned the basics of electricity, lighting, and even computer technology “on the road.” The technical knowledge that he has mastered has never, he says, been the catalyst of his design work. Yann Kersalé approaches the challenges of working with light as an artist.

Born just outside of Paris, Kersalé has an art degree from the Ecole de Beaux Arts de Quimper, in Brittany. His early school projects already incorporated photographic projections generated with slides and a Kodak carousel. To earn money for school, Kersalé worked on the local docks transferring the night’s tuna catch onto refrigerated trucks while immersed in the changing nightscape of the harbor. Years later, in 1991, Kersalé was approached by the city of Saint-Nazaire on the Atlantic coast to help revitalize its industrial port. Among other things, Saint-Nazaire is famous for an enormous, abandoned concrete bunker built by the Germans to house submarines during World War II. Kersalé created a virtual ballet of red and green light—as well as static white illumination—on cranes, silos, and even the bunker, which the city found was cheaper to rehabilitate than to destroy. At Saint-Nazaire today, a computer program collects data during the day, then translates that data into the evening’s choreography of light. One element that plays a role in the play of light is

Claire Downey is ARCHITECTURAL RECORD’s correspondent based in Paris.

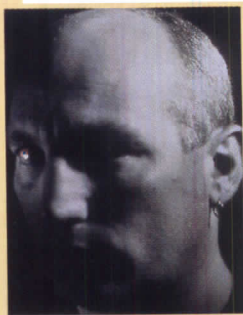

Yann Kersalé



PHOTOGRAPHY: © COOP HIMMELB(L)AU/GERALD ZUGMANN; ILLUSTRATION: COURTESY YANN KERSALÉ



**Swiss Expo
Biel, Switzerland**

Collaborating with architectural firm Coop Himmelb(l)au, Kersalé washed the metal-mesh towers with computer-controlled spotlights

fitted with color changers. Kersalé begins each lighting project by studying the architect's material choices and the site's weather and light conditions. Then he sketches in color.

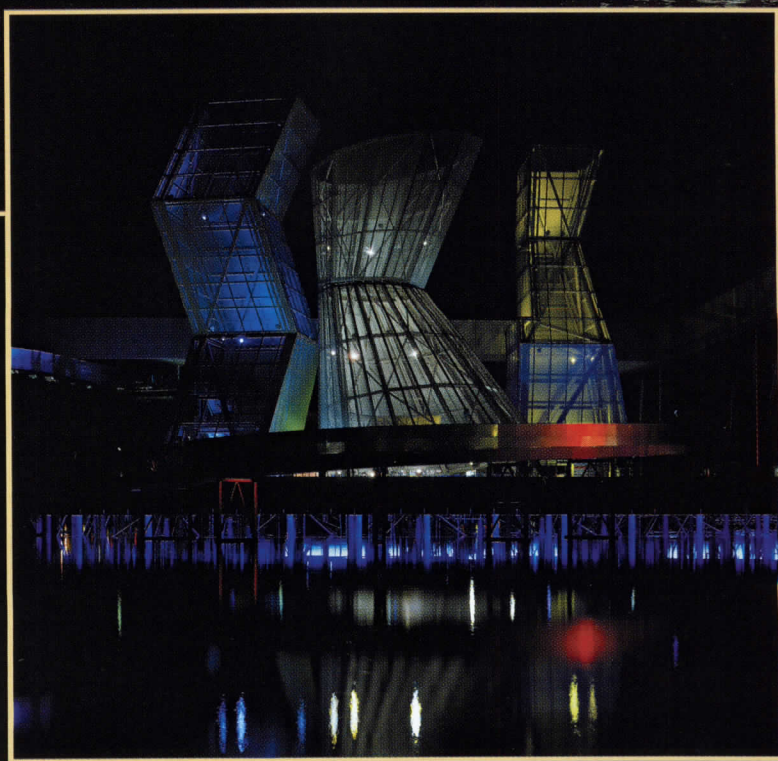

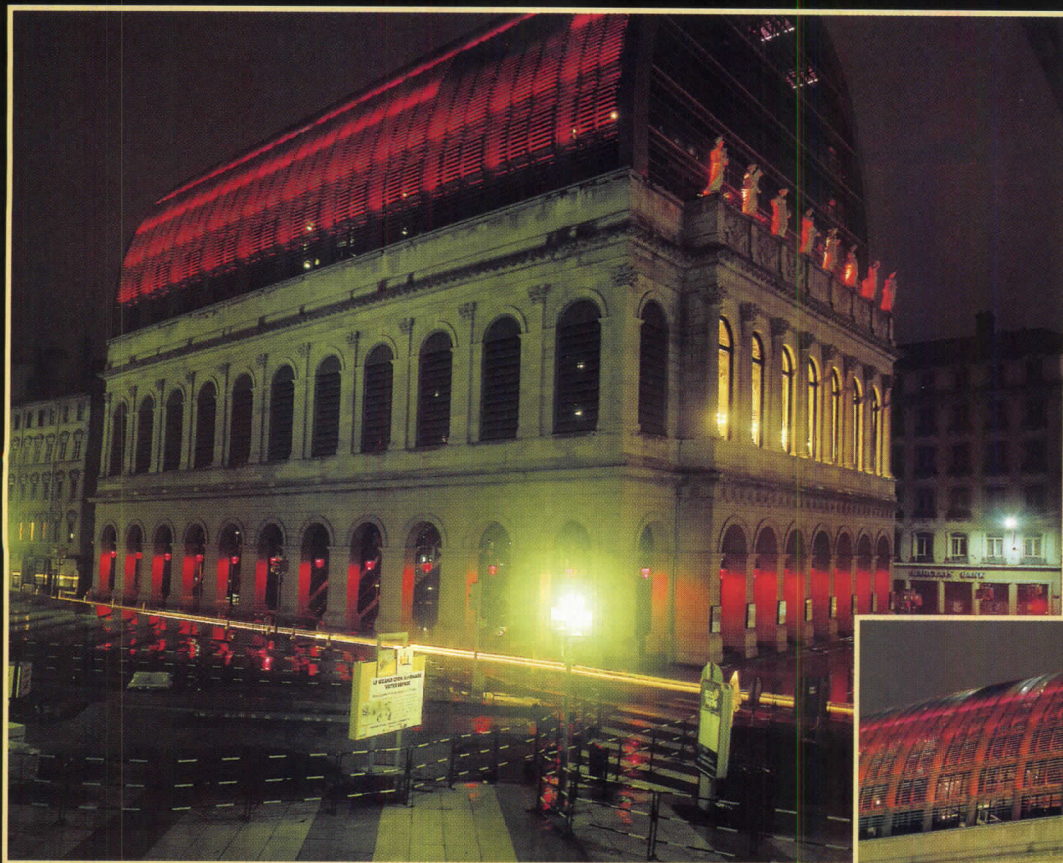

Théâtre Temps Lyon, France

Completed in 1993, the theater is one of several public venues Kersalé has illuminated in Lyon, with light in shades that call to mind French wines, from Beaujolais to Côtes-du-Rhône.



the ocean itself. As Kersalé describes the process, “a tube was placed in the harbor with a ball floating inside. The ball rises and falls, and so do the light levels.” According to the designer, such control technology is readily available, yet it is not often considered when specifying controls for architectural illumination. “The same electric eye that tells a door to open can activate a light source, immediately or hours later,” Kersalé says.

The concept of illumination that flows with time, rather than fluctuates in sharp, aggressive flashes, is central to his work, Kersalé says. Such an effect wasn’t lost on architect Jean Nouvel, who invited Kersalé to

LIGHTING BY KERSALÉ IS INSPIRED BY THE EBB AND FLOW OF TIDES, OR THE CONFLUENCE OF CROWDS AT THE OPERA.

collaborate on the Lyon Opera House, which opened in 1993. Kersalé lit the barrel-vaulted roof in red, a hue that intensifies as the concert hall and the stage fill up. Kersalé, who has known Nouvel for 20 years, is also teaming with the architect on a tower in Barcelona and a new museum of art and civilization to be built along the Seine in Paris.

Kersalé’s input begins in the earliest design stages of a project, and

the end result “should melt into the work of the architect,” he says. “It’s a process that requires the acceptance of a certain ambiguity in terms of where one person’s work ends and another’s begins. Yet the architects with whom I work are all established enough in their careers to accept this. We are all working as part of the same family.”

For architect Helmut Jahn’s Sony Center in Berlin, a project that encompasses restaurants and movie theaters, Kersalé conceived the light as a kind of giant jelly fish, white in the daytime, then coming alive at night with a concentration of color at the center and a fine net spreading out in all directions. The designer also just completed lighting Jahn’s postal headquarters in Bonn.

Another project, which opened last summer, is the Arteplage towers designed by Coop Himmelb(l)au for Swiss Expo 2002. The light-filled, metal-mesh towers are meant to represent “Power and Liberty.” Kersalé focused on the transparency of the tower skin until he “felt the towers swelled and waned like a living organism.” Kersalé also designed the Expo’s street lamps, and settled upon the perfect gray light to lend an ethereal magic to Diller + Scofidio’s “Cloud” project at Yverdon-les-Bains.

Currently Kersalé is working on a series of street lamps to line what was once the route of kings, winding through the Paris suburbs to

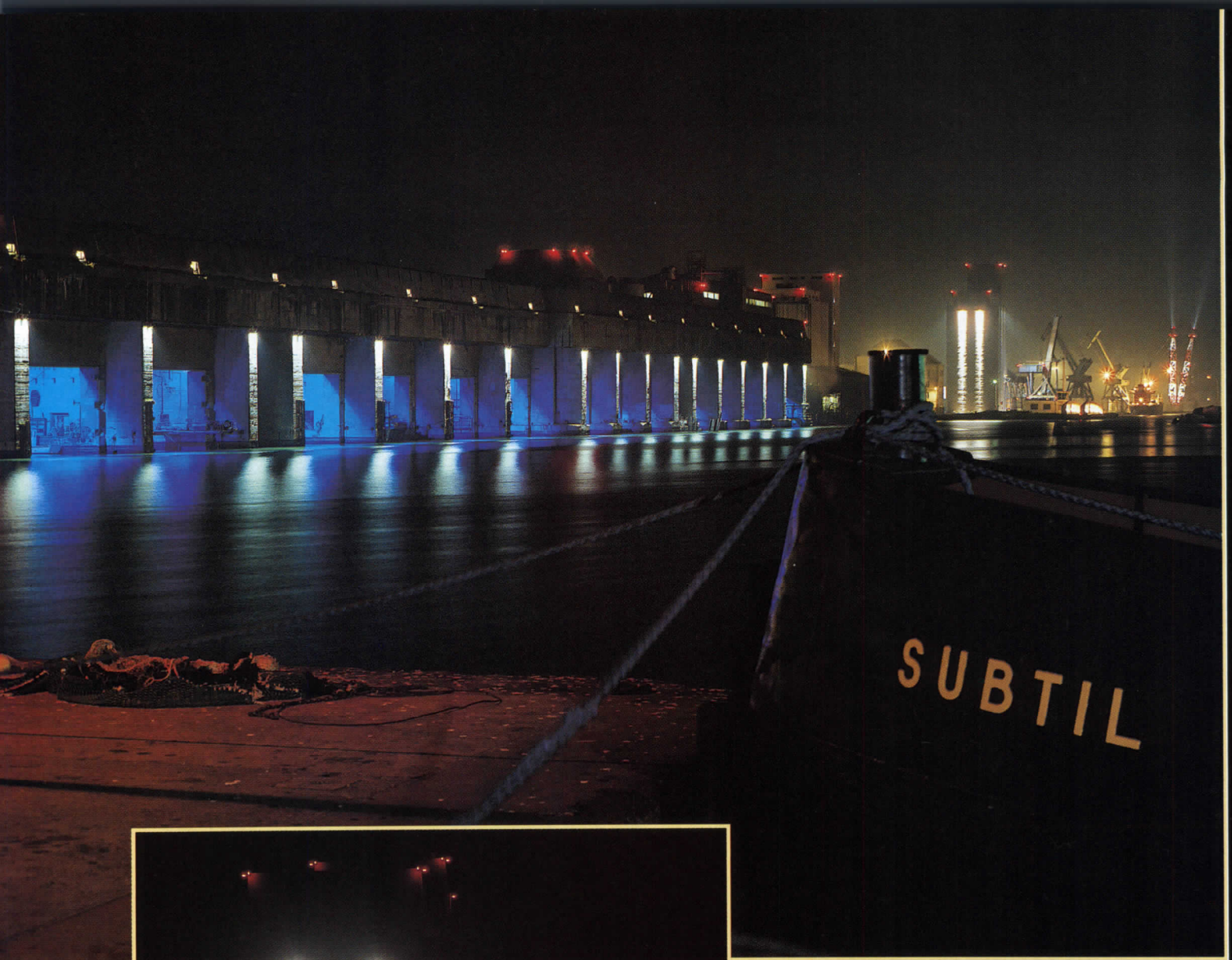

**Nighttime Docks
Saint-Nazaire,
France**

A project begun in Kersalé's hometown in 1991, the *Nuit des Docks* illuminates the waterfront where submarine bunkers abandoned by the Germans after World

War II remain standing. Many light sources—halogen, metal halide, and airstrip runway lights—graze metal towers and cranes. Lighting is choreographed in synchronicity with the flow of tides.

Sony Center Berlin, Germany

For an entertainment complex of cinemas and shops designed by Helmut Jahn, the lighting designer created an amorphous,

jelly-fishlike membrane of light. Occupancy sensors within the complex are linked to computer-controlled color changers that create an ebb and flow of light and movement.

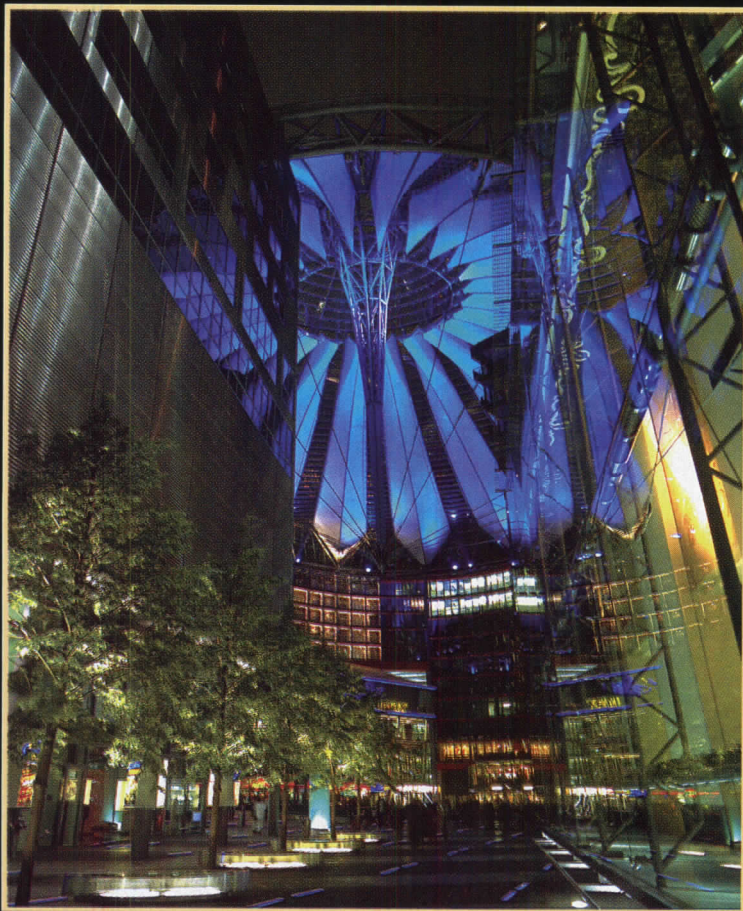

Cactus of Light South of France

When designing illuminations set within a landscape, such as the explosion of color in *The Cactus* (right), a new work, the site inspires Kersalé to “think big.”

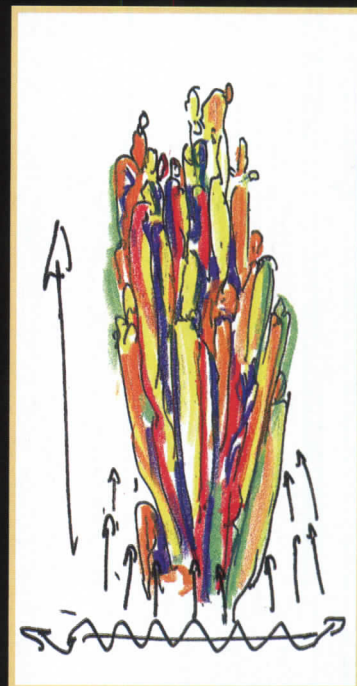

Versailles. Today the ancient road is bordered by parking lots, with little room to replant the original trees. The designer’s concept is to recreate the idea of an arbor, with arcs of light emanating from the lampposts that will

THE ARTIST AND DESIGNER TRAVELS TO AREAS AS FAR AFIELD AS THE ARCTIC TO “CAPTURE” NEW QUALITIES OF LIGHT.

change from green to aqua. Sensors embedded in the road will record the traffic flow, then trigger the subtle changes in illuminated color. The street lamp is a piece of urban furniture that fascinates and frustrates the artist. “They are found universally in cities and even in the countryside—until science finds a better solution—but I would like to develop the street lamp beyond its functionality. It should become an extension of the history of a place and the history of the road itself.”

Kersalé photographs every lighting environment he encounters, even traveling as far as the Arctic on what he calls “lighting expeditions.” His

photography is shown in galleries and museums and might seem far removed from, say, illuminating the Champs-Élysées (which he has done). Each facet of his workday is linked. By studying how light and color can shape our surroundings, he avoids the trap of light as decoration, or repeating his designs so each city resembles another. “My work begins when the sun sets and daylight gives way to artificial light. Yet the world continues to breathe.” To architects and observers, his illuminating installations are captivating because they grow from existing sites, rather than by sterilizing an area with brightness. Yann Kersalé is not afraid of the shadows. ■

Projects: *Swiss Expo; Théâtre Temps; Docks at Saint-Nazaire; Sony Center; French Landscapes*

Lighting designer: *Yann Kersalé, with a variety of teams of electrical contractors and lighting-board operators*
Architects: *Coop Himmelb(l)au;*

Helmut Jahn; Jean Nouvel, among other collaborators

www For more information on the people and products involved in this project, go to Lighting at architecturalrecord.com.

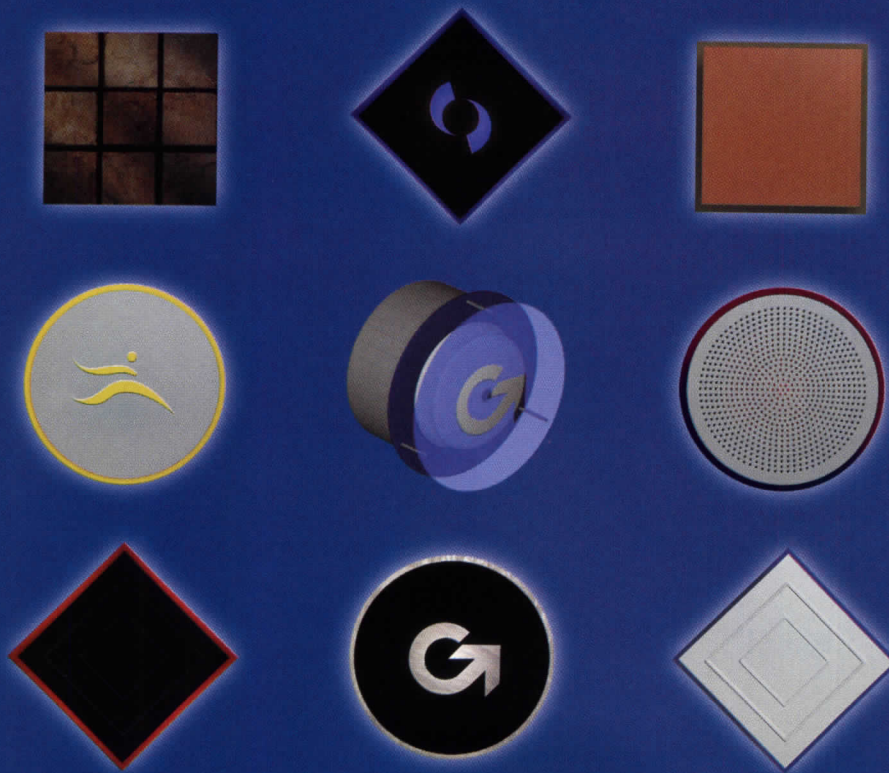

Fascia Plates are part sconce, part architecture, part decoration, part identity system and completely unlike any lighting system ever invented. You can select from one of many standards or use your own imagination to create a custom Plate. Custom versions can range from your client's logo to your unique idea. Architectural, practical, decorative, illuminating, inspirational and endlessly versatile, Fascia Plates are among all else... Gardco.



GARDCO
LIGHTING

CIRCLE 93 ON READER SERVICE CARD
OR GO TO WWW.LEADNET.COM/PUBS/MHAR.HTML

www.sitelighting.com

At the shop entrance, a custom luminaire casts light on a vitrine that appears to float in midair. "Genetic structure" forms, tailored from bi-elastic fabric, create a sense of flow through the space.



Nuanced lighting at D'Fly in New York City casts a glow upon jewelry in a sleek setting fit for James Bond



Sixteen custom-designed vitrines are internally illuminated with custom lighting that is dimmable via remote control. The glass panels were fastened with stainless-steel elements to leave a small gap, allowing heat generated by the internal lighting to escape.

By Leanne B. French

Jeff Shi says he approaches his work as a jeweler as “a commitment to design.” With the recent opening of D’Fly, his new shop with wife/partner Jennifer Lin in New York’s SoHo district, Shi’s dedication takes the sculptural form of a glass and steel interior jewel box. Equal parts boutique, art installation, and high-tech showcase, the new store, conceived with the German design firm 3deluxe, elevates the simple act of shopping for accessories into an architectural experience. “We’re not concentrating on brand names,” Shi affirms. “We’re selling nontraditional jewelry to individuals with an affinity for interesting designs. Buying jewelry should be like buying art.”

A former designer for Harry Winston, Shi also owns Dragonfly Gallery, an interior design store, and two jewelry galleries in his native Taipei. At D’Fly (shorthand for *dragonfly*), showcasing the jewelry, like presenting a work of art, was paramount, yet Shi resisted the traditional approach of overlit shelves and vitrines. “Standard retail lighting makes the jewelry in cases look different than when it is shown to a customer in daylight,” he explains. “I wanted to avoid that standard look, along with the procedure of keeping vitrines under lock and key. I thought it might be interesting if our display cases opened like garage doors.”

Designer Nik Schweiger and his team at the avant-garde 3deluxe studio worked with Shi to turn his “garage door” concept into a high-tech design solution fit for a James Bond film. Via remote control, D’Fly staff can elevate 16 custom-made steel and glass vitrines so they appear to float in midair. The technology behind the high-tech magic is a Fluidic Muscle membrane-contraction system, traditionally used by car manufacturers, which was adapted as individual lift systems for each vitrine.

Nuanced lighting works in tandem with the custom display design. Shi sought a high level of lighting control for each vitrine. Although he considered fiber optics, which light his galleries in Taipei, it proved cost-prohibitive for the 2,200-square-foot New York store. Instead, vitrines are lit by a combination of four 50-watt halogen lamps and two 54-watt fluorescent tubes. The lamps were fitted inside custom-made steel and tempered-glass light boxes installed within each vitrine. Both sets of lamps are dimmable to adjust color temperature and lighting levels so that the jewelry maintains a consistent appearance in and outside of the vitrines. To prevent damage to the jewelry from heat generated by

Leanne B. French is a freelance writer and documentary filmmaker based in New York City. She frequently contributes to the quarterly lighting section of *RECORD*.

Project: D’Fly, New York City

Owner: Yaoer USA—Jeff Shi, Jennifer Lin

Architect of record: Kevin C. White Architects

Designer: 3deluxe—Nik Schweiger, principal designer

Lighting designers: 3deluxe; OSRAM Lighting Consulting GMBH

Engineer: Wolf Elektroanlagenbau GmbH

General contractor: Winter Tuffy Construction



Each vitrine is lit by a combination of halogen and fluorescent lamps fitted inside steel and tempered-glass light boxes (above). Avoiding the use of keys to unlock displays, glass doors can be lifted via remote control (left), using individual Fluidic Muscle membrane-contraction systems.

the lamps, the glass panels of each vitrine are fastened with stainless-steel parts instead of glass epoxy. The design leaves a small gap between panels, allowing heat to escape from the vitrines and air to circulate inside.

Beyond illuminating the vitrines, lighting here also functions as art. "Light showers," custom luminaires designed by 3deluxe, project flickering light patterns that paint the walls at the entry and rear of the store. Beneath the kaleidoscope of light near the entrance, customers are invited to sit on a sofa ergonomically designed with cushions made from Tempur foam, a product originally developed for NASA. The seats mold to the shape of the shopper, as one views the light show and baubles.

Shi and Schweiger extended the use of industrial-grade materials to the recycled rubber flooring, a forgiving surface if jewelry is dropped. The front counter and try-on table are made from wood finished in white lacquer and topped with tempered glass. Hidden within the try-on table is more high-tech wizardry. Three internal lifts raise mirrors

ARC

Die-Cast Curvilinear Luminaire
Vertical or Horizontal Lamp
150 - 1000 Watt



KIM LIGHTING

16555 East Gale Avenue
City of Industry, CA 91745
626/968-5666

www.kimlighting.com



Lighting, Inc.



CIRCLE 94 ON READER SERVICE CARD OR GO TO WWW.LEADNET.COM/PUBS/MHAR.HTML



A bamboo garden (above) is a serene backdrop to the high-tech try-on table, which features hidden mirrors that can be raised by remote control. A tailored fabric form intersects the space above the front counter (left), illuminated by recessed track lighting.

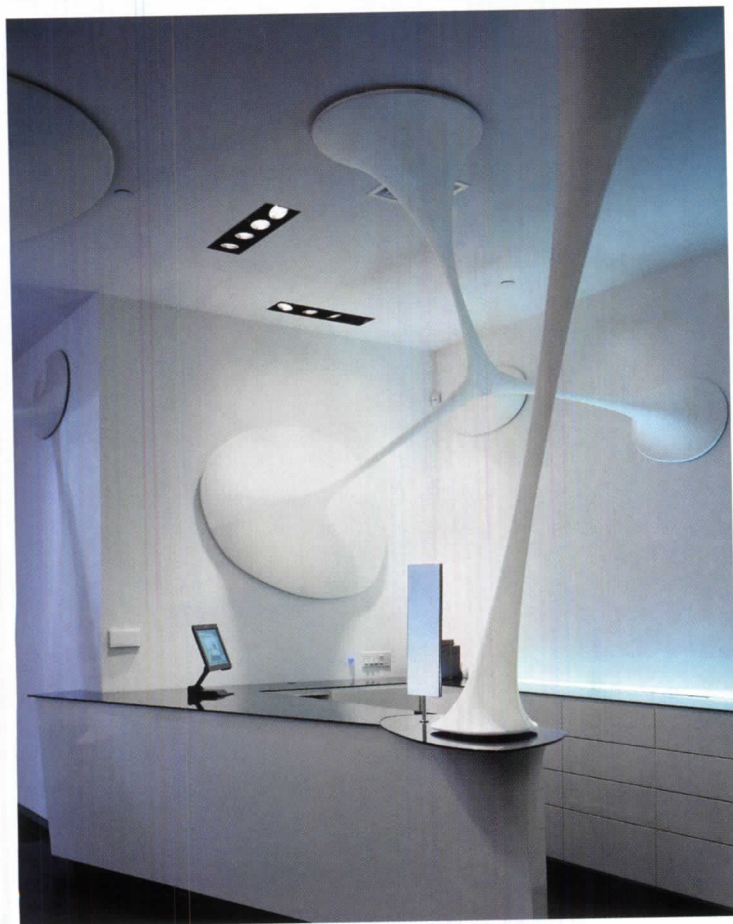

via remote control to allow customers to view their jewelry selections. Shi's inspiration: watching the movement of a car's power windows.

Organic-inspired elements, both natural and man-made, balance the austerity of the surroundings. The 3deluxe team's signature "genetic structures," 3D tailored fabric forms, are suspended from the walls and ceiling. The forms follow computer-generated templates that simulate natural growth. And as a nod to his Asian heritage, Shi incorporates his favorite plant, bamboo, as an element in all his shops. At the rear of D'Fly, a Zen-like bamboo garden is set behind commercial glass, which minimizes reflection and is lit by track fixtures. A mirrored back wall creates the illusion of depth and makes the garden appear expansive. ■

Sources

Ambient, downlight, task fixtures: OSRAM Lighting Consulting GmbH

Glass: Glas Schröder (vitrines and counters)

Seating: GECCO Scene Construction

Displays, vitrines: Space4a; Festo AG & Co.

Woodwork: Klunderschmid

Steel: Steelworks

www For more information on the people and products involved in this project, go to Lighting at architecturalrecord.com.

B

O

Y

D

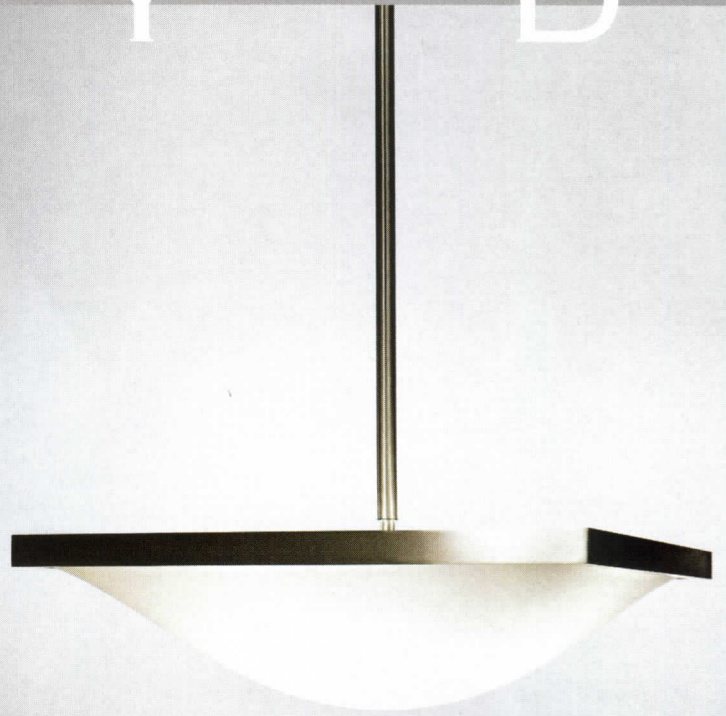
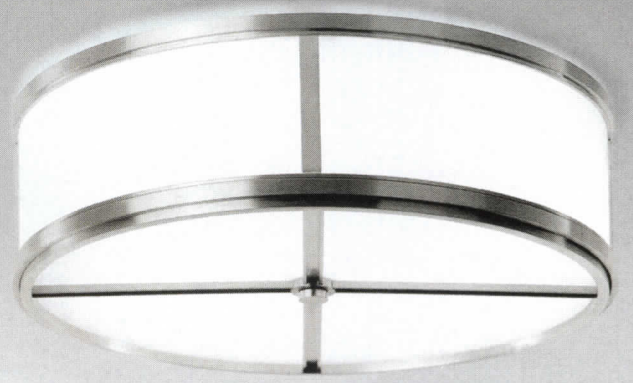

BOYD LIGHTING 944 FOLSOM STREET SAN FRANCISCO CALIFORNIA 94107 TELEPHONE 415 778 4300 WWW.BOYDLIGHTING.COM
GORGEOUS NEW CEILING FIXTURES BY BARBARA BARRY, BELSCHNER AND VINCENT AND MICHAEL VANDERBYL

MR11 uplights graze the wall above a banquette, while fiber-optic pinlights supplied by 16 MR11 projectors lend a sheen to custom steel wine coolers.



A modern-day tandem recalling Greene and Greene, Bentel & Bentel imbue **Craft** with remarkable details

By William Weathersby, Jr.

Right up there with form and function, “craft” is a well-worn term circulating within architecture circles. Many architects today laud the craftsmanship of their work and that of their peers, but it’s the rare occasion when a 21st-century space—particularly a restaurant—showcases a level of careful design execution that calls to mind the top-to-bottom attention to detail championed by *The Craftsman* and ARCHITECTURAL RECORD at the outset of the last century.

Craft is such a place. Tucked into the quiet block of 19th Street at Park Avenue South in New York City, the restaurant is rich in texture and spatial complexity, befitting the multilayered food-service concept it supports. Commissioned by star chef Tom Colicchio, whose culinary style favors “crafting” meals from fresh ingredients and unadorned natural flavors, the interior mise-en-scène dovetails nicely with the menu, functionally and metaphorically. Subtle, layered lighting brings out Craft’s burnished wood tones, adds sparkle to its copper and steel fittings, and casts a becoming glow upon both patrons and bountiful meals.

The palette of materials and concentration of custom design details (here, even the wine bottle coasters are cast bronze) call to mind a modern-day interpolation of handsome work by the leading American Arts and Crafts Movement architects Greene and Greene. Nearly 100 years ago, Gustav Stickley lauded the Greene brothers’ “solid yet picturesque walls, the frank use of structural beams ... and the quiet loveliness” of their interiors. Those lines could have been coined for a recent restaurant review of Craft.

In fact, this project is also the work of a brother team, Peter and Paul Bentel. Their design work here recalls Greene and Greene’s, yet they are actually the legacy of another partnership, their architect parents, Frederick and the late Maria Bentel, who founded the firm in 1956.

“The chef/owner of this restaurant firmly believes that cooking of any kind is a craft, not an art,” explains Peter Bentel. “He planned to pursue uncomplicated culinary craftsmanship, explore the full flavor of each ingredient on the seasonal menu, and serve these unadorned on separate plates placed at the center of each table for all to share. His approach motivated us to experiment with a limited set of architectural materials and the most suitable craftsmanship required to join the elements.”

The architects addressed Colicchio’s requirements for 130 seats, a 3,500-bottle wine storage, and a 2,200-square-foot kitchen, spread over a 2,975-square-foot first floor and a 2,450-square-foot cellar. Five discrete

Contributing editor William Weathersby, Jr., recently moved back to Manhattan. He edits RECORD’s quarterly lighting and interiors sections.

Project: *Craft*, New York City

Owner: Tom Colicchio, Foodcraft

Architect and lighting designer:
Bentel & Bentel, Architects/Planners—
Peter Bentel, AIA, principal in charge;
Thomas O’Connor, Christopher

Hinchey, Boone Lo, Paul Wise, Raffaele
Razzano, project team

Electrical engineer:

Altieri Sebor Wieber

General contractor: Jadum
Construction



Craft is the reworking of the wreck of a former department store built in 1886 in what was then called the Ladies Mile shopping

district, which more recently was a warehouse/copy shop. Lighting includes a layering of incandescent and fiber-optic sources.





Suspended Tesla lamps give Craft a warm, ambient glow. (Nikola Tesla was a contemporary of Thomas Edison's whose early work with incandescent lamps was overshadowed by Edison, the more publicity-savvy inventor.)

The geometry of the phalanx of Tesla lamps works well against the steel grid of the wine coolers, and above the rows of wood tables (top left and right).

The curved, leather-paneled wall is lit with 500-watt MR16 narrow-flood spots (bottom right). A side wall is illuminated at top and bottom by recessed striplights (bottom left).



elements define the space: a rectilinear steel and bronze wine vault, a curved Brazilian walnut-and-leather-paneled wall, an expansive oil-on-canvas triptych, existing terra-cotta-clad columns, and bare, amber-hued Tesla bulbs grouped as chandeliers. These elements create a progression through the 14-foot-high room, “a spatial compression and release,” as the Bentels call it, that provides varying degrees of intimacy for diners while preserving the feeling of a communal “single-room refectory” that the proprietor envisioned. As patrons feast upon Colicchio’s banquet, their sensual appreciation of the surroundings deepens. The cold-steel rigidity of the two-story wine vault accentuates the warm, curved softness of the leather-paneled wall facing it. The rough, matte texture of the wood-fiber ceiling panels intensifies the reflective surface of the bronze reveals and column capitals. Every surface is lit to showcase artistry.

All furnishings and fittings, from cherry dining tables to bronze bathroom sinks, were designed to celebrate their materials and straightforward construction. The absence of any protective coating (other than beeswax) on any surface promotes their natural ability to age with grace.

With such a wealth of detail, how can lighting seem like much of the story here? That seems to be one of the Bentels’ main accomplish-

ments. Though the lighting appears simple and functional—with the array of exposed filament lamps marching through the space—the layered lighting plan is actually rather sophisticated and complex. More than 512 fiber-optic cables light the custom wine cooler alone, while halogen uplights and downlights team with striplights and floods to counterbalance the amber-hued ambient chandeliers. “Craft,” it appears, can also describe the workmanship that is required to orchestrate the essential, experiential design element called light. ■

Sources

Downlights:

Prescolite; Hess America; Lightolier

Recessed sconces:

Engineered Lighting Products

Surface sconces:

Modular

In-floor uplights:

Designplan

Recessed art lighting:

Alkco

Exterior downlights:

Ardee

Striplights:

Creative Lighting

Systems; Starfire; Roberts

Fiber-optic lighting: *Nouvir*

Custom pendants: *Rejuvenation*

Tesla bulbs: *Aamsco*

Dimming system: *Lutron*

www For more information on the people and products involved in this project, go to Lighting at architecturalrecord.com.

Fiber-optic lighting's efficiency breakthrough

A PAIR OF TECHNICAL INNOVATIONS ALLOWS THE EFFICIENCY OF TWO NEW FIBER-OPTIC PRODUCTS TO RIVAL THAT OF TRADITIONAL COMPACT FLUORESCENT AND INCANDESCENT SYSTEMS

By Charles Linn, FAIA

Scientists have been trying to develop high-efficiency fiber-optic lighting (FOL) systems for decades. The concept is simple: transmit light from a centrally located lamp through light-transmitting cables and put it where it's needed. The advantages over using individual electric lights are numerous. Because fiber-optic cables don't conduct electricity, they're safer in wet locations, easier to install and maintain, and fixtures are free of heat and UV radiation. Color can easily be changed, and the fixture size at the destination end of the cable can be kept small. Fiber-optic lighting systems have found acceptance where efficiency is not as great a concern as dealing with maintenance, difficult wiring conditions, fixture size, and heat.

The technical problems involved in making an FOL downlight bright enough to directly replace one with an electric lamp are complex. The most difficult challenge has been getting more than a small fraction of the light from the source lamp into the end of the fiber-optic cable. Researchers have tried refining the shape of the source lamp, changing the chemical composition of the fibers, and reengineering the large reflectors that focus light into the ends of the cables. A second major problem is the limited amount of light energy that can be focused on the end of a fiber-optic cable of the type used for lighting before it begins to melt. Until now, this has meant that it was probably impossible for FOL to ever approach the efficiency of electric lighting, unless fragile, and prohibitively expensive, glass fiber was used.

The compound-parabolic collector solution

John Davenport, who leads a team of scientists at Fiberstars, a Fremont, California-based lighting company, approached the problem in a counterintuitive fashion. He was convinced that the solution to the heat and efficiency problems lay in defocusing the light and distributing it more evenly across the surface of the fiber cable's end. He also felt that there must be a way to dissipate heat from the light source without sacrificing optical efficiency.

Davenport's team developed two devices. One is a double-ended reflector called a compound-parabolic collector (CPC). The device is only 10 percent of the size of the traditional reflectors used by the fiber-optic industry. The interior surfaces are coated with a special material, which, when combined with the CPC's geometry, helps direct the source light to the fiber in a fundamentally unfocused condition. The CPC uses a special 68-watt metal-halide lamp that is located between a pair of back-to-back parabolic reflectors (diagram, lower left). Half of the lamp's output is collected and redirected by each reflector. Test results showed that the CPC collected close to 97 percent of its source light. The larger FOL reflectors typically in use throughout the fiber-optics industry only collect about 50 percent of their source's light. From the CPC, the unfocused light enters the second device developed by Fiberstars' scientists, a component known

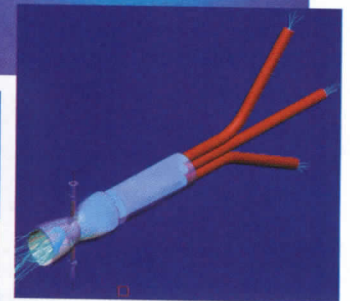
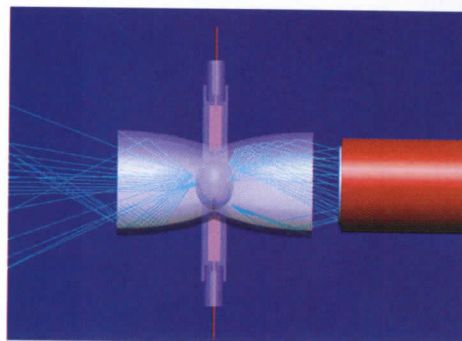
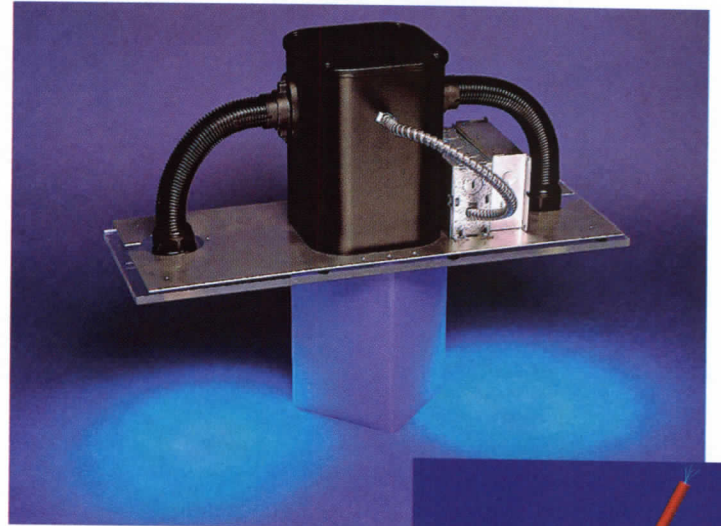

A proprietary compound-parabolic reflector allows a fiber-optic lighting system's efficiency to rival that of low-voltage incandescents.

as an integrating rod. This component dissipates enough heat to allow the light to pass through to the fiber cable without damaging it.

The first self-contained, two-light downlighting system (photo, top) to use these components shows that Davenport's theories work. An Independent Testing Laboratories report indicates that Fiberstars' two-light fixture has a system efficiency of over 75 percent, more than double the efficiency of any FOL system ever offered commercially. A more recently developed CPC-based product illuminates six downlight fixtures using the same type of 68-watt lamp (diagram, lower right). This luminaire is capable of powering accent lighting systems that match six 50-watt MR16s but uses 232 fewer watts. While this early example of the six-way system performs far better than any comparable FOL system, its use of first-generation integrating rods keeps its 44 percent efficiency less than the comparable 75 percent efficiency of the two-light system. Fiberstars predicts that improvements in the system will allow it to reach between 50 and 54 percent efficiency early next year.

According to Terry McGowan, who recently retired as General Electric's long-time lighting-applications manager, this system exceeds the efficiency of some traditional compact fluorescent lamps and incandescent systems, not by a little bit but by a lot. He notes, "It's going to change the game as far as those lighting applications are concerned." ■

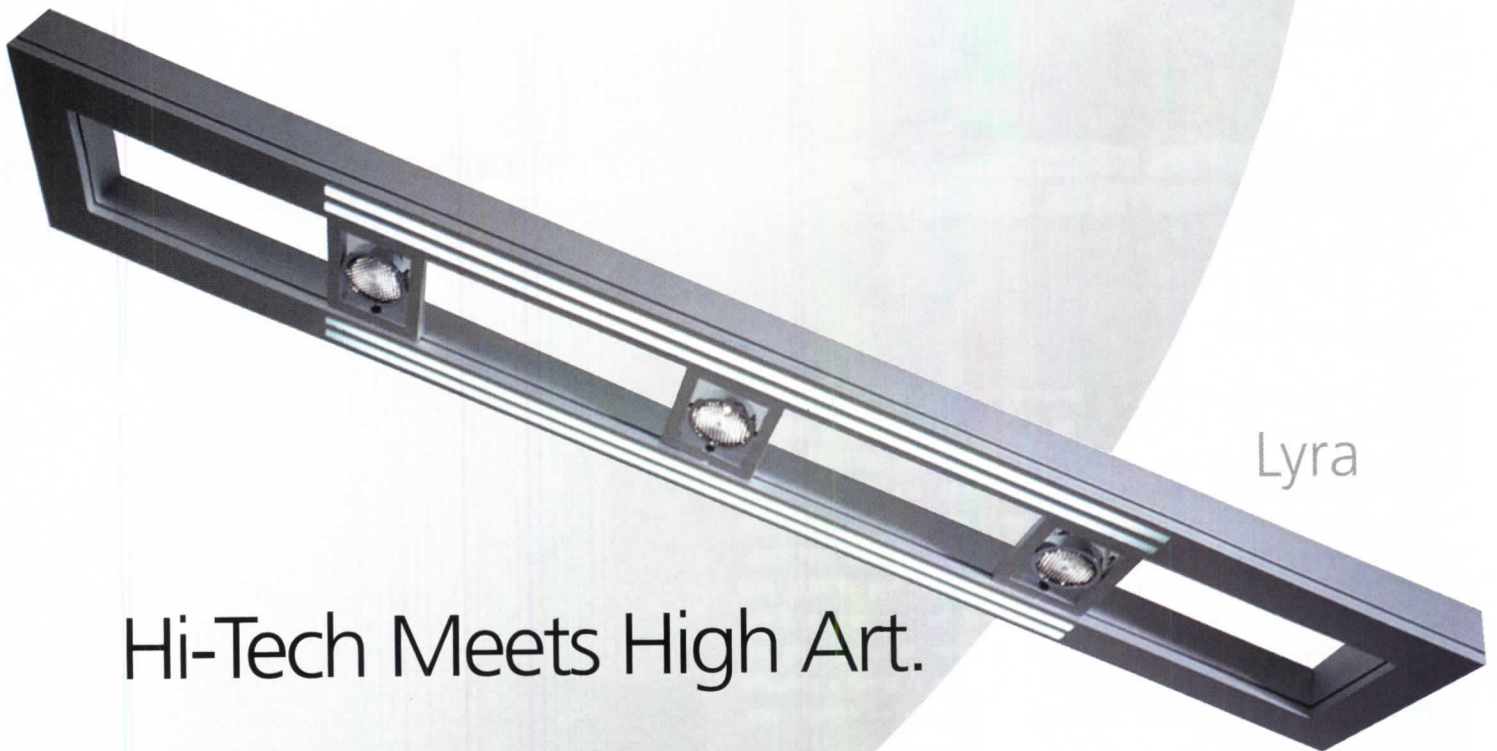

Lyra

Hi-Tech Meets High Art.



Loft

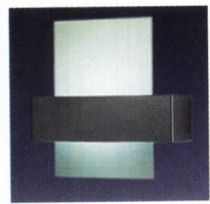

Shift Glass



Espace



Contour

Exclusively ours, the stylish and versatile Lyra fixture combines sleek lines with the ultimate in utility by providing both diffused direct and indirect light. Ideal for office or kitchen, Lyra features fluorescent and adjustable, low-voltage halogen down lighting and is available in four dimensions to perfectly suit your space.

Visit our new showroom to view the largest and most progressive collection of contemporary lighting in North America!

SHOWROOM HOURS
M, T, W, Sat: 10-6
Th, F: 10-7

CIRCLE 97 ON READER SERVICE CARD
OR GO TO WWW.LEADNET.COM/PUBS/MHAR.HTML

Lightology

215 W. Chicago Ave.
Chicago, IL 60610
312.944.1000
www.lightology.com

Lighting Briefs



▲ Clunky wooden lamp shapes

Penta's Wood shades for tabletop and floor lamps match the material of the lamp base: lacquered woods in a variety of rich finishes. Illuminated, the lamps glow like dark-shaded light boxes; turned off, they are Minimalist sculptures. The choice of wood includes oak, wengé, and cherry, and the shades are also available with patterned hemp and linen fabrics. A suspended Wood ceiling lamp is also available. 954/924-4880. Casa Bella, Dania Beach, Fla. **CIRCLE 200**



► Classical pendant

The Sunscape pendant's half-moon shape features a pleated bronze wire cloth or a stainless-steel wire-cloth diffuser. The pendant shown has a polished chrome finish with a bronze wire cloth. Sunscape is also available as a drop pendant in the same materials. Both lamps come with incandescent or fluorescent lighting. 425/822-1292. Architectural Details, Kirkland, Wash. **CIRCLE 203**



◀ Sliding spotlight

The Bungee lamp features a transparent ceiling-mounted cable with a low-voltage transformer suspended from it. The lamp is protected by an anodized aluminum and polycarbonate casing. The actual light consists of a polycarbonate ring fitted with steel springs that allow it to slide and rotate, and a halogen bulb with a narrow beam. Bungee has a foot-operated on/off switch. 39/0423-4848. Fabbian Illuminazione, Treviso, Italy.

CIRCLE 204

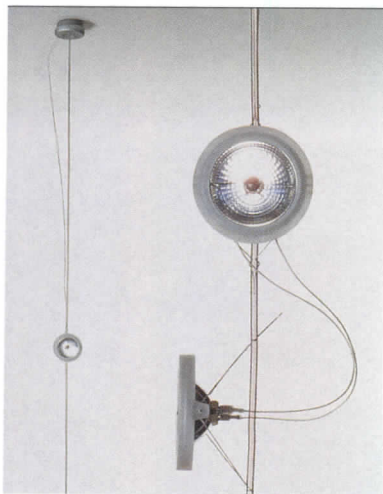

◀ Billowing glass

The free-flowing form of the Logico light fixture could be mistaken for fabric, but it is actually glass with a satined crystal finish. Shown is a combination of three single fixtures, with a chandelier/curtain effect. Logico offers a table, floor, ceiling, or suspension model. Michele De Lucchi was inspired to design Logico by the translucent weightlessness of clouds in the sky. Supporting cables are required, however, and come in stainless steel. 631/694-9292. Artemide, Farmingdale, N.Y. **CIRCLE 201**

▼ Plane of light

Plane, a 6" square casting, is only 1.9" deep and mounts directly to a 4" octagonal junction box. The perimeter glow effect, which provides the illusion that the plane is floating, is achieved by mounting linear LED strips within a clear polycarbonate back plate. The light can be used outdoors for a building or bridge, or as a step light, wall sconce, or signage. 847/626-6000. io Lighting, Skokie, Ill. **CIRCLE 202**

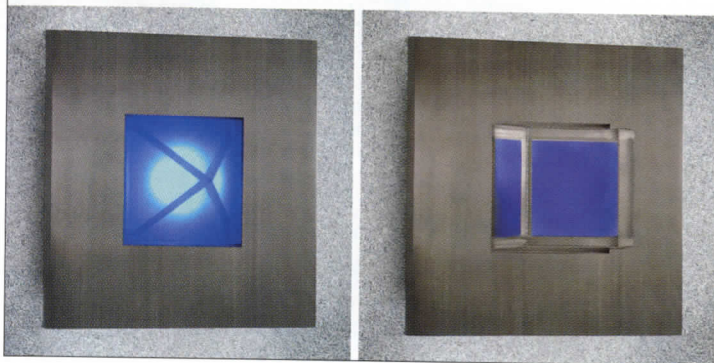

◀ Shimmering rain fountain

The Light Shower Fountain System is a water and light sculpture in the lobby of the American Board of Radiology headquarters in Tucson. The fountain consists of an array of vertical ribbons coated with an optical surface that refract a full spectrum of color when illuminated from a metal halide spotlight recessed into the ceiling. The ribbons shimmer as droplets of water flow downward. 520/884-4844. Light Ray Studios, Tucson. **CIRCLE 205**

Lighting Briefs

► Mite-y large light

Don't be fooled by the size of the fixtures shown here; these floor lights from Foscarini are actually 6' tall. Illuminated from the halfway point up, the Mite housing gives spaces a strong vertical emphasis. The fiberglass fabric material with a carbon thread starts opaque at its base and graduates in degrees of translucence to reach 100 percent light at the opening on top. Resembling overgrown champagne flutes, these lights are functional sculptures that illuminate a full 360 degrees—a feature also found in Supernova, a spherical pendant fixture also available from Foscarini. 800/713-2182. North American Light Spectrum, Danbury, Conn. **CIRCLE 206**



► Pod lights for the future

The Pod lens collection includes a ceiling, floor, and table fixture. Designed by Ross Lovegrove for either indoor or outdoor use, the injected molded polycarbonate lamps feature prismatic sides and a choice of muted colors, including sage green, sand, and gray. The color is resistant to ultraviolet rays and the electric cable is sheathed in neoprene. 212/989-6265. Luceplan USA, New York City. **CIRCLE 207**



◀ For the mathematician

The patterns in lighting fixtures from OVO are either directly observed in nature or found in the work of mathematicians, engineers, or scientists. The form of Scott Winslow's Archimedean pendant is based on a fractal iteration of the truncated octahedron—15 individual octahedra form the complete pendant. The pendant is available in white PETG (shown), wood veneer, or cork. The overall diameter is 28". 917/741-5778. OVO, Los Angeles. **CIRCLE 208**

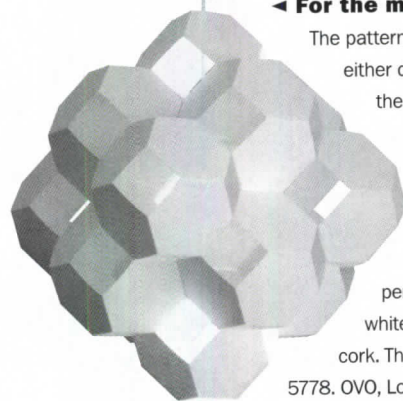

For more information, circle item numbers on Reader Service Card or go to www.architecturalrecord.com Advertisers & Products info.

A New Spin On Performance!



Mantra™



Echelon™



Nexus™



Scion™



Inde-Pendants™

Individual Pendant-Mounted Fluorescent Fixtures

- A new alternative in architectural lighting
- 21 different product choices
- Indirect or Indirect/Direct distribution
- Large and small fixture sizes

Ask for the "Inde-Pendants" brochure.

CIRCLE 98 ON READER SERVICE CARD OR GO TO WWW.LEADNET.COM/PUBS/MHAR.HTML

NEW METAL CRAFTS



Custom Architectural
Lighting Worldwide

ny Belluschi Architects, Ltd.
ct:
West Jackson Blvd., Chicago

Our expert design staff can assist you in all aspects of your custom project.
Visit our showroom/warehouse to see our vast collection
of fine antique, vintage, and reproduction lighting fixtures.

812 N. Wells • Chicago, IL • 312.787.6991 • Out-of-State 800.621.3907 • Fax 312.787.8692
www.newmetalcrafts.com • inquiries@newmetalcrafts.com

CIRCLE 99 ON READER SERVICE CARD
OR GO TO WWW.LEADNET.COM/PUBS/MHAR.HTML

Lighting Briefs



◀ Full of energie

The Limit cylindrical wall sconce features a housing that can be rotated 360 degrees within its rectangular base to adjust brightness. An optional tempered-glass shielding is easily added or removed to adjust light. Limit has less than a 4" recessed depth and is fully ADA-compliant. The Pen/Pendel line is available in single-, double-, or triple-head versions and features stepped specular reflectors to control brightness.

The larger Pendel shares Pen's industrial look and may be specified with either compact fluorescent or metal halide lamplighting. 720/963-8055. Energie, Lakewood, Colo.

CIRCLE 209

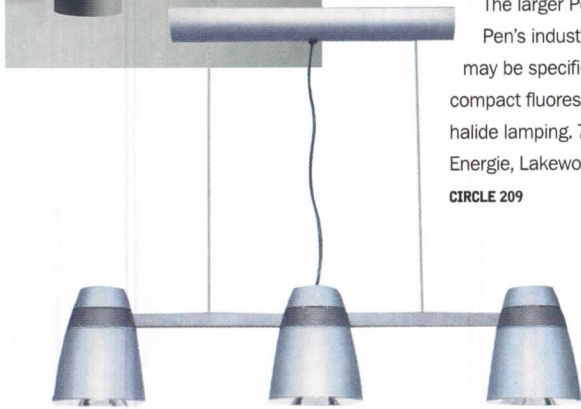

▼ 19th-century streetlights

Hinkley offers outdoor lantern families made of 100 percent cast aluminum in a finish range that includes forest green, gold, bronze, and pewter. They also offer a solid brass grouping with a variety of finishes, a full line of interior lighting including chandeliers and bath fixtures, and a new line of bollards. 216/671-3300. Hinkley Architectural, Cleveland. **CIRCLE 210**



▲ Stone cold shades

Alfa's Quick Jack low-voltage pendants are now offered in natural onyx shades, including white marble, natural amber, and natural stone green. All of the company's fixtures have the flexibility for various track and system configurations, with a wide choice of forms, styles, and decorations. 415/346-8181. Alfa Lighting, San Francisco.

CIRCLE 211

For more information, circle item numbers on Reader Service Card or go to www.architecturalrecord.com Advertisers & Products info.

BARTCO

lighting

Leading the Way...and Lighting It

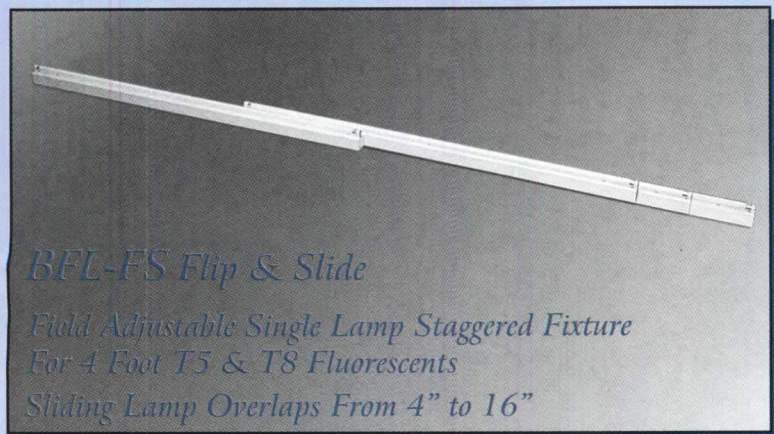

BFL-FS Flip & Slide
Field Adjustable Single Lamp Staggered Fixture
For 4 Foot T5 & T8 Fluorescents
Sliding Lamp Overlaps From 4" to 16"

Specializing in Luminaires for Architectural Applications



Phone 714/848-0892 Fax 714/848-6843 Web www.bartcolighting.com

CIRCLE 100 ON READER SERVICE CARD OR GO TO WWW.LEADNET.COM/PUBS/MHAR.HTML

patent pend

New Products

The gates, screens, railings, door hardware, and sculpture shown here are just a few examples of the possibilities of **architectural metalwork**. Whether an architect is looking for a partner to reproduce cast-metal ornamentation or to create modern pieces in **bronze, iron, aluminum, or stainless steel**, there is no doubt that a skilled metal craftsman can have a great influence on a project's success. *Rita F. Catinella*

Firm restores and reproduces architectural cast-metal ornamentation

For nearly 30 years, Historical Arts & Casting has been restoring and replicating metal ornamentation for restoration and new commercial and residential projects across the country. The Utah-based firm works with bronze, aluminum, and iron and is actively involved in historic-restoration consulting. As part of their consulting service, they conduct extensive surveys that involve research, documentation, drawings, and metal analysis.

Historical Arts & Casting offers a full catalog of proposal drawings for light fixtures, railings, roof cresting, gates, canopies, doors, storefronts, grilles, cornices, moldings, columns, fountains, and mailboxes.



Bronze entrance gates, Palm Beach, Fla. (left); bronze canopy entrance, Providence (middle); cast-iron railing, N.Y.C. (right).

For a recent project, the firm worked with Smith Architectural Group of Palm Beach, Florida, to design a pair of bronze entrance gates and a service gate area for a Palm Beach private residence. For the Union Trust Building in

Providence, the firm worked with Granoff Associates of Providence to design a cast-bronze canopy for the building's entrance. For another project, they worked with Sciama Construction of New York to design a 40' long, cast-iron railing and an



81' long, mounted steel railing with a wood cap for the Invest Corporation's corporate office building in New York City. 800/225-1414. Historical Arts & Casting, West Jordan, Utah. **CIRCLE 212**

From shingles to sculpture: high-profile architectural metalwork

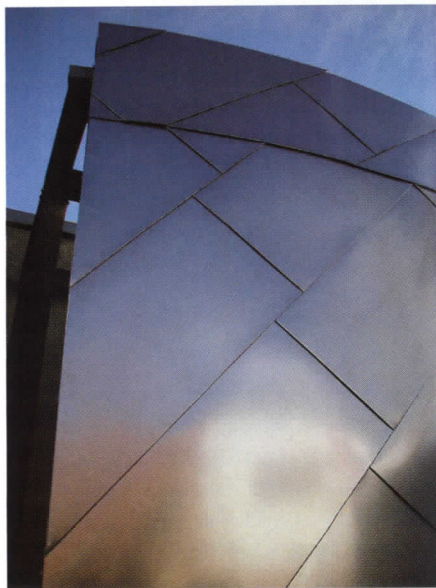

MIT's new lab will feature metal shingles.

A. Zahner Company produces custom architectural and ornamental metalwork for commercial and institutional projects. In collaboration with Karas & Karas Glass Company of Boston, A. Zahner is providing the metal and glass exterior sections of MIT's new Frank Gehry-designed artificial intelligence laboratory, the Ray and Maria Stata Center. A. Zahner is fabricating two different shingle types on the project; the substructure will be made in Kansas City (with the window boxes built right in) and the complete

assembly will then be shipped to the job site and installed. A. Zahner also fabricated a sculpture in the Issey Miyake store in Tribeca for Gehry and for Gordon Kipping. The sculpture has a titanium skin suspended from a steel subframe with a custom-made, stainless-steel articulated mounting bracket.

The firm is currently working on an array of projects with high-profile architects, such as the Austin City Hall and Tacoma Museum of Art by Antoine Predock; a stainless-steel skin system for the Lake Whitney Water Treatment Plant by Steven Holl; an aluminum-plate system with a blackened finish for Cincinnati's



A titanium-skin sculpture for a Tribeca store.

Rosenthal Center for Contemporary Art by Zaha Hadid; the de Young Museum in San Francisco (which features a copper roof and custom wall-panel system) by Herzog & de Meuron; and the Modern Art Museum of Fort Worth and the Pulitzer Foundation for the Arts, in St. Louis, by Tadao Ando. 816/474-8882. A. Zahner Company, Kansas City, Mo. **CIRCLE 213**

New Products



► Designing for the real world

Featured on MTV's *The Real World*, the Veyko pivoting and rolling screen (right) has stainless-steel and translucent polycarbonate panels that rotate in unison. The 6'6" tall, freestanding screen can be used as an office divider, sunscreen, or privacy partition. Veyko's hand-polished metal finish complements wood, glass, stone, and textiles. In addition to designing and producing furniture pieces, Veyko is also a high-end metal fabricator and design firm; a balcony they designed is shown above. The Philadelphia-based firm has also recently completed retail fixtures for Barneys New York. 215/928-1349. Veyco, Philadelphia. **CIRCLE 214**



► Screens and covers

The third in a collection of city-themed Valve Cover Tables, New York joins San Francisco and New Orleans in recreating the look of these long-lost covers, which guarded the access holes to water and gas valves and meters beginning in the mid-1800s. Newly introduced lines of fire screens include the Rectangle Collection, the Oval Series, and the Bronze Firescreen, all constructed from hand-forged steel and available in a variety of sizes. 415/550-9328. Jefferson Mack Metal, San Francisco. **CIRCLE 217**

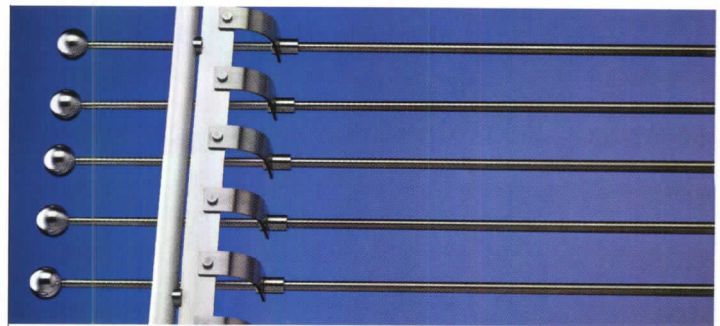

▲ Railings rally

Livers Bronze Company's new railing systems include Ballo (above), which is supported by stainless-steel pickets with a side-mounted handrail, and Strata, a stainless-steel, post-supported railing system with a tempered plate-glass infill. Also new from Livers is a line of commercial grade door pulls in bronze and chrome-plated bronze. 816/300-2828. Livers Bronze Company, Kansas City, Mo.

CIRCLE 215

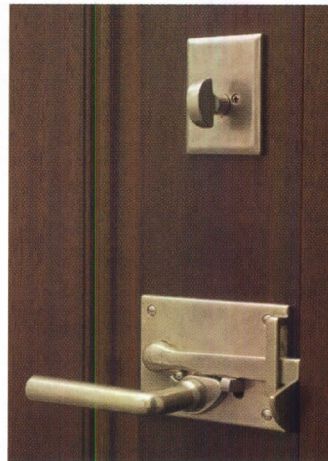

◀ Solid bronze hardware

Sun Valley Bronze designs and manufactures a complete line of original handcrafted and hand-finished solid bronze door, window, kitchen, bath, and cabinet hardware. The collection is offered in either silicon or white bronze patinas and in a variety of finishes. All entry sets are available with a choice of levers or knobs and arch or rectangular plate designs. Sun Valley offers door knockers, doorbells, door stops, and other accessories. 208/788-3631. Sun Valley Bronze, Bellevue, Idaho. **CIRCLE 216**



▲ Full-color glossy

Moz Designs produces column covers, room dividers, canopies, and wall-panel systems of metal and translucent plastics. Their aluminum laminates can be applied to ceilings, walls, privacy screens, signage, and display units. Wall systems, including wall panels, reveals, and corner and base components, are engineered to make installation efficient and are available in many different configurations. Products are designed and manufactured in-house, allowing for a variety of custom work, such as the signage for the Singapore Turf Club in Emery, California, shown above. 510/444-0853. Moz Designs, Oakland. **CIRCLE 218**

Product Briefs

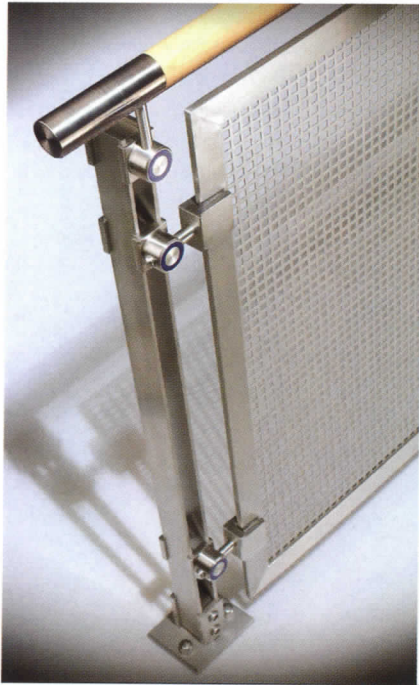

◀ Stainless and nylon

Handrail Design announces their continued distribution of railing systems formerly marketed by HEWI. Railing systems include inox and Circum stainless steel and HEWI's nylon system made of colored nylon with steel inserts throughout. Infill options include glass or perforated stainless-steel panels, or horizontal rails of 15-mm-diameter solid stainless steel. The stainless-steel systems may be combined with components of the nylon system and with straight top rails made of natural wood in several finishes. Railings are designed to meet all building codes and standards. 717/285-4088. Handrail Design, Lancaster, Pa. **CIRCLE 219**



◀ Portable prep

Constructed of solid walnut, the Vatelier by La Cornue makes food preparation possible in almost any room, from the kitchen to outdoors. The countertop features a small sink, cutting board, and a compact work surface in the center. Also included are 12 spice drawers, an integral knife rack, and two shelves beneath the counter that come with two wooden baskets. 800/892-4040. Purcell Murray, Brisbane, Calif. **CIRCLE 221**

▶ Hand-tufted rugs

Martin Patrick Evan Limited is a Chicago-based company specializing in exclusive custom rugs and carpets. Handmade in Asia, the rugs and carpets feature materials ranging from traditional wool and silk to fibers such as linen, cashmere, mohair, and chenille. Projects range from corporate headquarters to private homes. 800/734-8214. Martin Patrick Evan, Chicago. **CIRCLE 222**



Product of the Month NYIT Design



New-York based NYIT Design represents Italian home furnishings brands that have previously had little or no exposure in the United

States. Designed by Luigi Giabardo, Flower (below) allows for countless configurations of sofa (up to 114"), armchair, ottoman, and extensions. Handcrafted in Italy by Models, Flower will be targeted for use in hotel lobbies and retail spaces; a smaller version will be scaled for apartments. The



frame is in solid and multi-layered wood with spring systems of interwoven and reinforced elastic belts. Covers in fabric and Alcantara are completely removable and available in a range of colors; a leather version has nonremovable covers. Feet come in several wood finishes, including natural cherry and bleached maple, as well as an alu-

minum version with line relief. The Blob (top right) is a new take on the "beanbag," combining an old concept with new technology. Made in Italy by Antidiva, a series of internal cords allows the shape of the lounger to conform to the body, making a variety of sitting and sleeping positions possible. 866/499-6948. NYIT Design, New York City. **CIRCLE 220**



▲ Crystal clear

The Sica line of furnishings, lighting, and wall systems can be curved, colored, or sandblasted. The furnishing line includes tables, mirrors, a computer console, and accessories. The Visan glass system (shown above) is made of 8-mm-thick, extra-clear tempered glass. Visan features a height-adjustable shelving system and an optional sliding-tempered-glass door that hangs from a stainless-steel runner. Visan can be used residentially as a partition wall or open bookcase or as a display system for a retail environment. Sica is a division of the Italian company Curvet. 814/663-0704. Curvet USA, Corry, Pa. **CIRCLE 223**

Product Briefs

▼ Seal the deal

The Sealed system from Citterio was one of the office-furnishing solutions on display at this year's Milan Furniture Fair. Sealed is a new system for dividing space that is able to meet both the existing needs for space division and any future expansion or reuse. These qualities have been achieved through the basic characteristics of the Sealed range—in particular its modular design, free-standing metal structure, ability to support a wide array of accessories, and its compatibility with other Citterio products. Sealed is easy to erect and dismantle and can serve multiple uses and specifications thanks to its double panels and spacers. 39/031-853545. Citterio, Sirone, Italy. **CIRCLE 224**



◀ Tough enough for New York

Marvin's StormPlus Wood Ultimate Double Hung is certified for use under New York State Building Codes that will go into effect January 1, 2003. It features two panes of glass and a tempered exterior and laminated interior to reduce energy costs and provide enhanced structural protection during violent weather. The StormPlus line will eventually include a wide variety of windows and doors. 888/537-8266. Marvin Windows and Doors, Warroad, Minn. **CIRCLE 225**

► Spa upgrade

In response to more hotels and resorts adding spa-like amenities to attract travelers, the Best Western Siesta Beach Resort in Sarasota has upgraded its guest rooms with therapeutic air-jet baths. The Sensation, a corner tub with a removable skirt, was chosen because of its size (54" x 54" x 20") and completely pipeless design. The tub blows air instead of water, improving the quality of the massage and providing a quieter bath. 800/463-2187. Ultra Baths, Saint-Nicolas, Quebec. **CIRCLE 226**



For more information, circle item numbers on Reader Service Card or go to www.architecturalrecord.com Advertisers & Products info.

“Reward helps me give clients a more comfortable home.”

Satisfying customers is key to success.

That's why Cliff Taylor designs with Reward Wall Systems. Reward's insulating concrete forms (ICFs) let him create inviting and attractive structures that provide:

- Creative freedom
- Virtually soundproof interior
- Stable temperature regardless of outside elements
- Energy efficiency and durability

Learn how the industry leader provides your customer with a better building.



Visit www.rewardwalls.com or call us at 800-468-6344 ext. 801

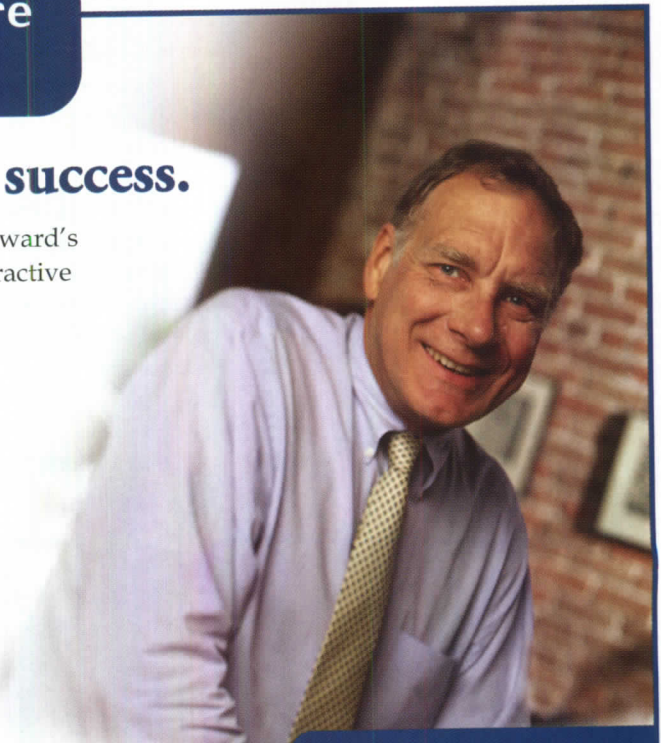

Cliff Taylor
Clifford Taylor Architects
Colorado Springs, Colorado

Sun Healthcare
Albuquerque, NM

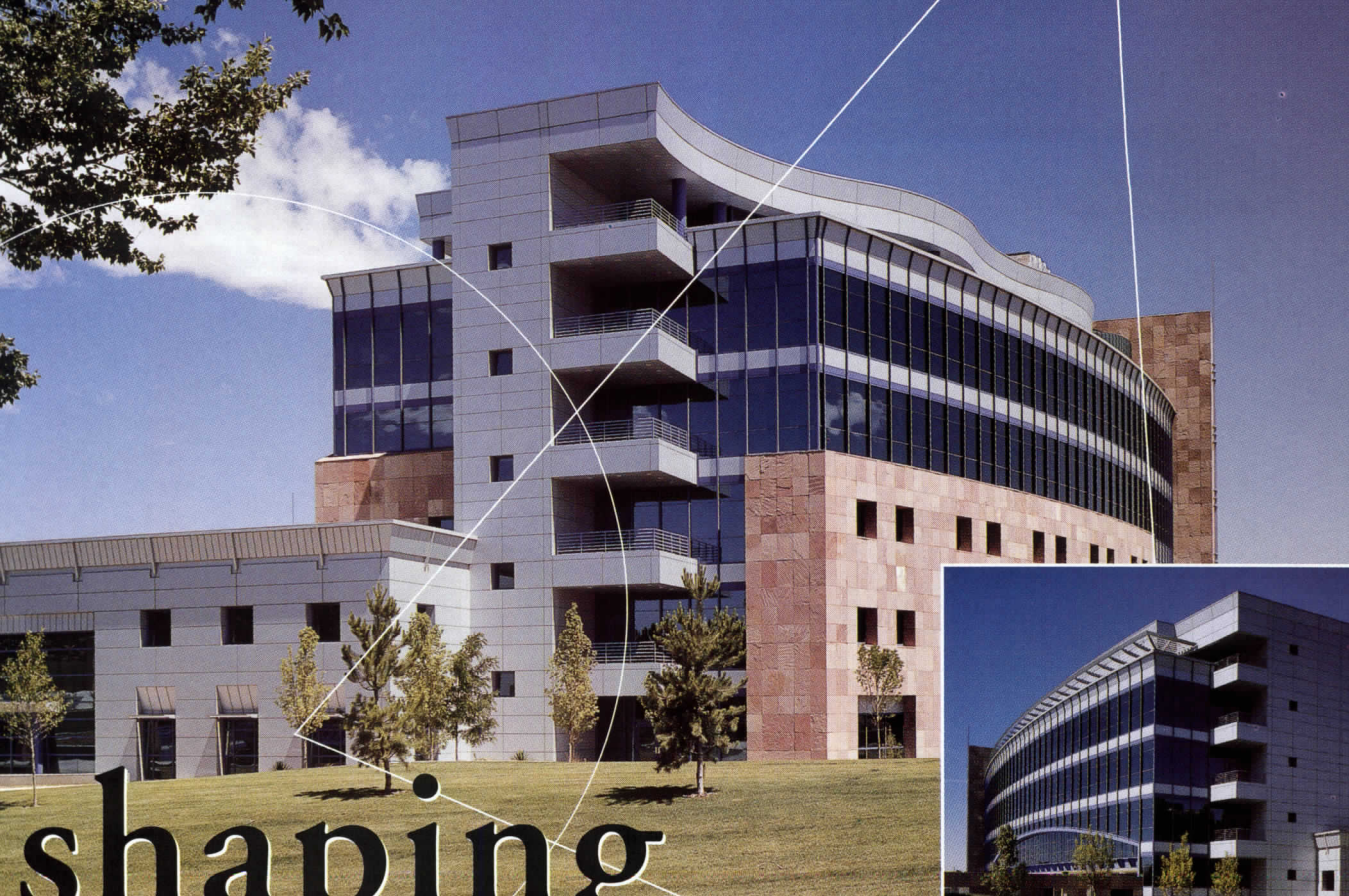

shaping
the future

A L U C O B O N D

It's a challenging task. Because the images we create today reflect a lasting attitude. Enter Alucobond Material... a refreshing combination of architectural beauty and efficiency, designed to adapt to our ever-changing world. Shaping it, in fact. As the original aluminum composite material, Alucobond delivers almost unlimited forming and shaping capabilities. Served on an extensive color palette, Alucobond Material's versatility goes well beyond its physical properties. With an eye to the future, Alucobond creates a sleek contemporary look. With its respect for the past, Alucobond provides the perfect marriage of traditional design with modern flavor. Whatever image and attitude you seek, Alucobond Material offers unlimited inspiration to fuel innovative designs for years to come.

Alcan Composites USA Inc.

P.O. Box 507 • 208 W. 5th Street • Benton, KY 42025-0507

800-382-6445 • 270-527-4200 • Fax 270-527-1552

www.alucobond.com

A member of the ALCAN group of companies

**ALUCOBOND**
MATERIAL

ALCAN COMPOSITES

CIRCLE 107 ON READER SERVICE CARD OR GO TO WWW.LEADNET.COM/PUBS/MHAR.HTML

Product Briefs

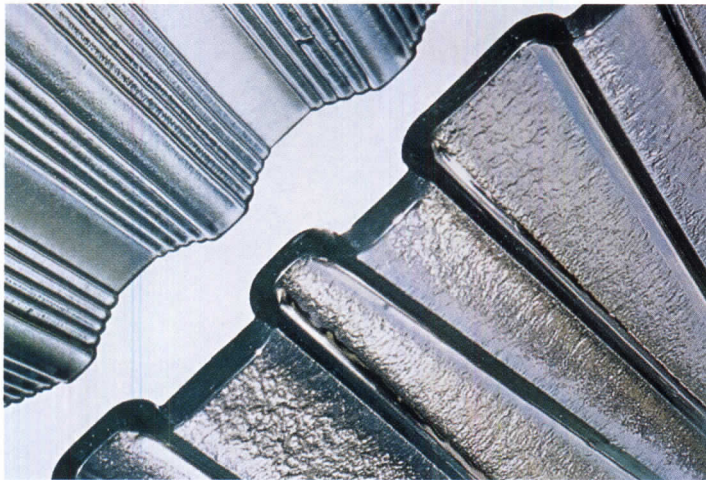

▲ Textured, shaped, and smudge-free

Originally produced by Nathan Allan Glass Studios for an architectural office that was concerned about cleaning a clear, shaped product, the Venetian Series retains the texture throughout the glass surface while also forming a curvy shape. Retaining full texture in the glass creates full privacy, allows light to travel through, and eliminates concerns over fingerprints. Venetian glass can be tempered to meet safety requirements and can be produced in sheet sizes up to 135" x 77". 604/277-8533. Nathan Allan Glass Studios, Richmond, British Columbia. **CIRCLE 227**

▼ Floating framework

The new office for Swiss RE Germany AG in Munich features a facade design based on X-Tend stainless-steel netting from German manufacturer Carl Stahl. A floating wall of Virginia creeper and wisteria is supported by a framework of X-Tend stainless-steel cable netting. The netting can withstand enormous loads and stress without losing its original tensioning. 49/7162-4007184. Carl Stahl GmbH, Süssen, Germany.

CIRCLE 228



▲ On your trail

The CM993 computer-managed exit trim from Von Duprin is a battery-powered, stand-alone exit trim designed for use with Von Duprin's 98/99 series exit devices. It can manage up to 1,000 users and provides an audit trail for the last 1,000 events. 800/348-2263. Access Hardware Supply, San Leandro, Calif. **CIRCLE 229**

For more information, circle item numbers on Reader Service Card or go to www.architecturalrecord.com Advertisers & Products info.

TURNING GRAY CONCRETE *Green*

These microscopic, glassy spheres are fly ash – and at ISG Resources, we sell millions of tons of them every year.

Produced by burning coal at electric power plants, fly ash might be destined for disposal in a landfill. But when added to concrete, fly ash makes concrete easier to work with, stronger and more durable.

Fly ash also allows concrete producers to reduce the amount of cement that they use. That means less energy is consumed to manufacture cement and there are less greenhouse gas emissions from the process – almost a ton of CO₂ saved for every ton of cement that's not produced. In addition to concrete, fly ash is used in mortars, stuccos and a variety of other building materials.

That's an improvement worth specifying.

ISG RESOURCES
A HEADWATERS Company

1.888.236.6236
www.isgresources.com

Contact ISG for free technical literature and information on how fly ash use benefits the environment.



Member

AIA/CES Registered Provider



LEED 2.0 Gold Certification

Vancouver Island Technology Park Wins Gold!

They used....

Grasspave²

Gravelpave²

What do you use?

800-233-1510
www.invisiblestructures.com

CIRCLE 108 ON READER SERVICE CARD
OR GO TO WWW.LEADNET.COM/PUBS/MHAR.HTML

CIRCLE 109 ON READER SERVICE CARD
OR GO TO WWW.LEADNET.COM/PUBS/MHAR.HTML

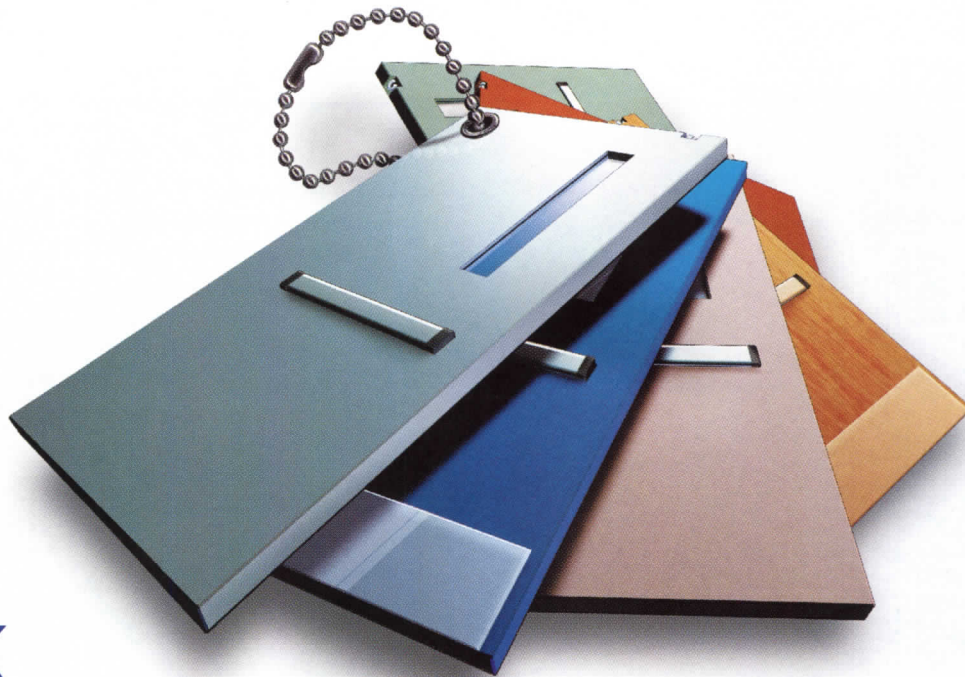

Pick The RITE Door

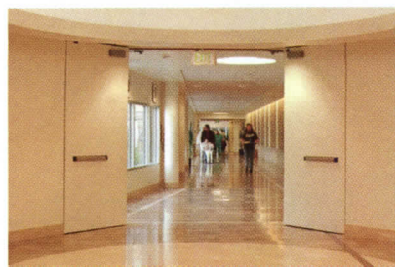

Commercial projects require code-compliant openings, so choosing The RITE Door[®] is important. As a fully integrated system, incorporating the door and associated hardware, The RITE Door is designed to work flawlessly. Smooth, quiet operation, dramatically reduced installation time and trouble-free performance are the result. The RITE Door satisfies the strictest requirements for building safety and security, without sacrificing your desire for clean lines and unobtrusive openings. With a designer's selection of finishes, accessories and hinge options, you'll have your pick of just the right door.

Just pick The RITE Door.

The RITE Door[®]



For additional information contact Adams Rite:
1-800-87-ADAMS or visit www.adamsrite.com

CIRCLE 110 ON READER SERVICE CARD
OR GO TO WWW.LEADNET.COM/PUBS/MHAR.HTML

Modified Sydney Bench with Concrete Legs Model A1



Modified Sydney Bench Model A2
Steel, stainless steel or aluminum.
Contoured metal seat

Vega Bench
Steel slats 2" wide x 1" with 3/4" x 2" frame.
Option: wood seat.



Canterbury International
5632 West Washington Boulevard
Los Angeles, California 90016
toll-free 800-935-7111
323-936-7111
fax 323-936-7115
canterburyintl@earthlink.net
www.canterburyintl.com

CIRCLE 111 ON READER SERVICE CARD OR GO TO WWW.LEADNET.COM/PUBS/MHAR.HTML

Product Literature

Luminaire literature

Holophane recently released brochures on two of their lines of luminaires. The CrystalGlo line offers 2 x 2 high-intensity discharge lighting for commercial, retail, and academic applications. The Bantam 2000 line features low-profile luminaires for heavy industrial and low-ceiling applications. Also new from Holophane is the *College and University Lighting Guide*, which provides recommendations for illuminating various indoor and outdoor areas on campus. 740/345-9631. Holophane, Newark, Ohio. **CIRCLE 230**

Artistic applications

The new brochure by Metallon takes readers through the step-by-step process of applying Metallon finishes to create decorative metal accents on vinyl, wood, polyurethane, aluminum, and other building-product surfaces. 304/485-1937. Metallon, Parkersburg, W.Va. **CIRCLE 231**

Downlight trims

The new four-page brochure from Ardee Lighting features information on Varianti and Focus, the company's collection of coordinating trims for adjustable and fixed recessed downlight fixtures.

NEW SITES FOR CYBERSURFING

Ranked among the best business-to-business Web sites, this site offers information on all National Gypsum

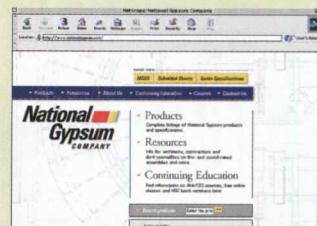

products as well as numerous case studies www.nationalgypsum.com

You can now find a kitchen gallery and interactive product information for all Jenn-Air products www.jennair.com

Redesigned site for professionals and consumers with projects, data sheets, and products www.tecspecialty.com

704/482-2811. Ardee Lighting, Shelby, N.C. **CIRCLE 232**

Hardwood building guides

The *Finishing Touch* specifying guide offers valuable tips and tools on working with hardwood floors, cabinets, moldings, and millwork. The 32-page booklet and interactive CD-ROM contain information on hardwood properties, as well as a finishing guide and a "smart specifying" guide. 412/281-4980. The Hardwood Council, Oakmont, Pa. **CIRCLE 233**

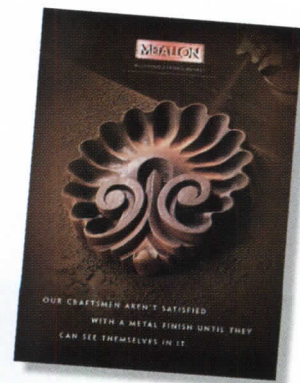

For more information, circle item numbers on Reader Service Card or go to www.architecturalrecord.com Advertisers & Products info.



LAV^{ish}



When it comes to conforming to ADA requirements, the aesthetics of your accessible lavatory finish should not be compromised.

The TRUEBRO *Lav Shield*[®] is designed to meet all federally mandated lavatory accessibility regulations—and exceed them. It covers vulnerable plumbing and electrical sensor faucet connections—while offering a clean, attractive appearance.

Lav Shield can be factory cut to fit your specified lavatory, and is engineered to ensure easy installation, commercial-grade durability, and affordability to fit every budget.

FREE Specification Guide

Complete with all TRUEBRO product specifications, your FREE Guide will detail how easy it is to be totally compliant with TRUEBRO. To get yours, simply circle the number indicated below on your *Inquiry Card* and mail today. There's no obligation!



7 Main Street • P.O. Box 440
Ellington, CT 06029
Tel 800-340-5969 • www.truebro.com



LAV GUARD Classified by Underwriters Laboratories, Inc.[®]
in accordance with ADA ARTICLE 4.19.4 22FF

CIRCLE 112 ON READER SERVICE CARD
OR GO TO WWW.LEADNET.COM/PUBS/MHAR.HTML

Product Literature

Kitchen catalog

The new catalog from Snaidero contains more than 50 color pages. The five European-styled kitchens featured—Sistema ES, Ola, Viva, Idea, and Gioconda—are shown with various finishes and options. 310/516-8499. Snaidero USA, Los Angeles. **CIRCLE 234**

Windows and doors

Champion's new color brochure contains all of their products with updated data to help with specifications. The brochure highlights their tilt double-hung and terrace doors and casement and side-load double-hung windows. 516/921-6200. Champion Window and Door, Syosset, N.Y. **CIRCLE 235**

Cabinet hardware

New product photos and kitchen scenes are among the featured items in a 96-page color catalog detailing Amerock's complete cabinet hardware program. Over 1,400 hardware pieces are featured, including new styles such as Cyprus, Village Classics, Divinity, Funzie'Z, and other recent additions. A finish guide and comprehensive index with product dimensions are also included. 815/969-6308. Amerock, Rockford, Ill. **CIRCLE 236**

Ceiling systems

The newly updated 2002/2003 *Ceiling Systems* catalog from USG Interiors provides comprehensive product specification information on the company's complete line of acoustical ceiling panels, suspension systems, and specialty ceiling systems. 888/874-2450. USG, Chicago. **CIRCLE 237**

Lighting navigator

Universal Lighting Technologies recently updated its *Ballast Navigator*, which includes all the company's product lines, with catalog numbers, wiring diagrams, and reference dimension drawings on one page. The product lines included are electromagnetic, electronic, dimming, compact fluorescent, high-intensity discharge, and sign. 800/BALLAST. Universal Lighting Technologies, Nashville, Tenn. **CIRCLE 238**

Outdoor living

Now available from Weyerhaeuser Building Materials is a 12-page brochure featuring product photos, deck design ideas, information on product standards, and details on Western Red Cedar. 877/235-6873. Weyerhaeuser, Federal Way, Wash. **CIRCLE 239**

Modern Masters of Architectural Timbers ■ ■ ■

The G.R. Plume Company sets the standard for integrating the beauty of natural wood into today's architecture. Our masterful architectural timbers grace distinctive homes and businesses around the world. We provide beautiful and ingenious solutions, insightful collaborations, and a thorough understanding of wood and its applications. Our twenty years of creative and technical woodworking expertise can help you realize your architectural vision. For more information, call (360) 384-2800.



THE
**G.R. PLUME
COMPANY**
ARCHITECTURAL TIMBER DIVISION

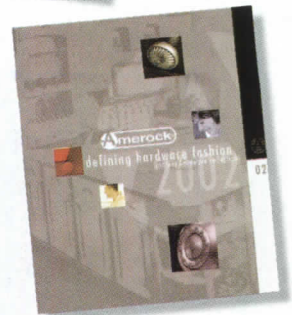
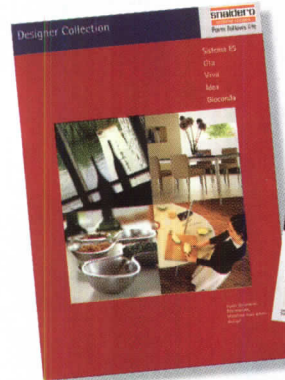

For more information, circle item numbers on Reader Service Card or go to www.architecturalrecord.com Advertisers & Products info.

Tile & Stone Waterproofing & Anti-Fracture INSURANCE

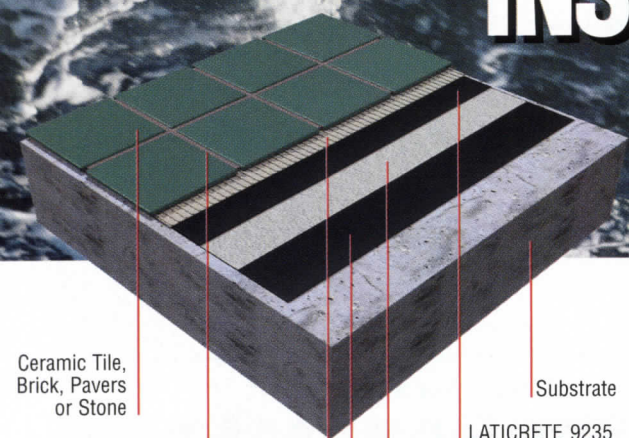

Ceramic Tile,
Brick, Pavers
or Stone

Substrate

LATICRETE 9235
Waterproofing Membrane

LATICRETE Reinforcing Fabric

LATICRETE 9235
Waterproofing Membrane Liquid

LATAPOXY® SP-100
Stainless Epoxy Grout

A LATICRETE® Floor N' Wall Thin-Set
Mortar with LATICRETE 333 Super
Flexible Additive

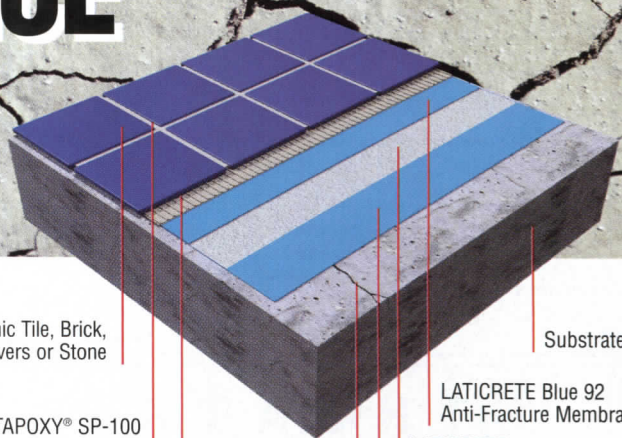

Ceramic Tile, Brick,
Pavers or Stone

Substrate

LATAPOXY® SP-100
Stainless Epoxy Grout

LATICRETE Blue 92
Anti-Fracture Membrane

LATICRETE
Reinforcing Fabric

A LATICRETE® Floor N'
Wall Thin-Set Mortar with
LATICRETE 333 Super
Flexible Additive

Non-Structural
Crack

LATICRETE Blue 92
Anti-Fracture Membrane

LATICRETE® 9235 Waterproofing Membrane

"The Architects' Choice for RISK FREE Installations"

- Guaranteed not to leak or crack*
- Dual purpose – for waterproofing and anti-fracture applications
- IAPMO, ICBO approvals
- Meets rigid DIN standard for anti-fracture membranes
- Full fabric application
- Extra Heavy-Duty Floor Service Rating
- Approved for continuous submersion in pools and fountains

LATICRETE Blue 92 Anti-Fracture Membrane

"When you only need anti-fracture protection"

- Guaranteed against cracking*
- Easy to install liquid applies like paint
- Full fabric application
- Meets rigid DIN standard for anti-fracture membranes
- Extra Heavy-Duty Floor Service Rating

*See DS700.12 Hassle Free Lifetime Warranty for Additional Details.



**Globally proven.
Professionally endorsed.**

LATICRETE INTERNATIONAL, INC.

LATICRETE PARK NORTH • BETHANY, CT 06524-3423 USA
EL: (203) 393-0010 • (800) 243-4788
AX: (203) 393-1684 • FAX ON DEMAND: (800) 359-3297
www.laticrete.com • support@laticrete.com

LATICRETE MIDDLE EAST

EL: (971) 4-286-2627 FAX: (971) 4-286-2123

LATICRETE ASIA PACIFIC

EL: (65) 262-4237 FAX: (65) 262-3701

LATICRETE EUROPE

EL: (39) 0585-856-159 FAX: (39) 0585-856-160

LATICRETE LATIN AMERICA

EL: (203) 393-0010, EXT. 218 FAX: (203) 393-1684



**For an actual
sample of these
membranes
absolutely
FREE call
800-243-4788,
Ext. 265.**

Please specify 9235 or
Blue 92 Swatch Card.



Program title: "Designers Get More Information Earlier and Faster via Affordable Rapid-Prototyping Tools" (11/02, page 187).

AIA/CES Credit: This article will earn you one AIA/CES LU hour of health, safety, and welfare credit. (Valid for credit through November 2004.)

Directions: Select one answer for each question in the exam and completely circle appropriate letter. A minimum score of 70% is required to earn credit.

- | | | | | | | | |
|------|---|---|---|-------|---|---|---|
| 1. a | b | c | d | 6. a | b | c | d |
| 2. a | b | c | d | 7. a | b | c | d |
| 3. a | b | c | d | 8. a | b | c | d |
| 4. a | b | c | d | 9. a | b | c | d |
| 5. a | b | c | d | 10. a | b | c | d |

Last Name _____ First Name _____ Middle Initial or Name _____

Firm Name _____

Address _____ City _____ State _____ Zip _____

Tel. _____ Fax _____ E-mail _____

AIA ID Number _____ Completion date (M/D/Y): _____

Check one: \$10 Payment enclosed. (Make check payable to *Architectural Record* and mail to: Architectural Record/Continuing Education Certificate, PO Box 682, Hightstown, NJ 08520-0682.) If you have any questions, call 877/876-8093.

Charge my: Visa Mastercard American Express **Card#** _____

Signature _____ **Exp. Date** _____

Check below:

To register for AIA/CES credits: Answer the test questions and send the completed form with questions answered to above address.

For Certificate of Completion: As required by certain states, answer test questions, fill out form above, and mail to above address. Your test will be scored. Those who pass with a score of 70% or higher will receive a certificate of completion.

Material resources used: Article: This article addresses issues concerning health and safety.

I hereby certify that the above information is true and accurate to the best of my knowledge and that I have complied with the AIA Continuing Education Guidelines for the reported period.

Signature _____ **Date** _____

THEATRE CONSULTANTS

since 1972

ARCHITECT: MILTON POWELL & PARTNERS

IMAGE: BLACKMON WINTERS © 1992



NOVITA

307 JANE STREET, TORONTO, ONTARIO
CANADA, M6S 3Z3
WWW.NOVITA.ON.CA / CONSULTANTS@NOVITA.ON.CA
(416) 761-9622 (FAX) 761-9616

CIRCLE 115 ON READER SERVICE CARD
OR GO TO WWW.LEADNET.COM/PUBS/MHAR.HTML

The First Step To A Dry Concrete Masonry Building

Mortar Net Block™

Properly constructed single wythe unit walls are one way to ensure that your concrete masonry walls are dry and free from water damage and mold. During construction, mortar droppings can block weep holes trapping water inside the walls, creating long-term moisture problems.

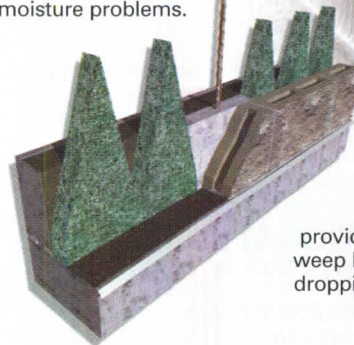

Mortar Net™, the inventor of the mortar dropping collection device, provides the solution for clogged-weep holes by breaking up mortar droppings, thereby allowing water to freely drain to the weeps.

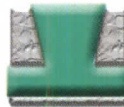

Mortar Net™
The Difference is in The Cut

800 664 6638 www.mortarnet.com

Patent Reissue #36676

CIRCLE 116 ON READER SERVICE CARD
OR GO TO WWW.LEADNET.COM/PUBS/MHAR.HTML

Wausau Tile

Always Go With a Winner

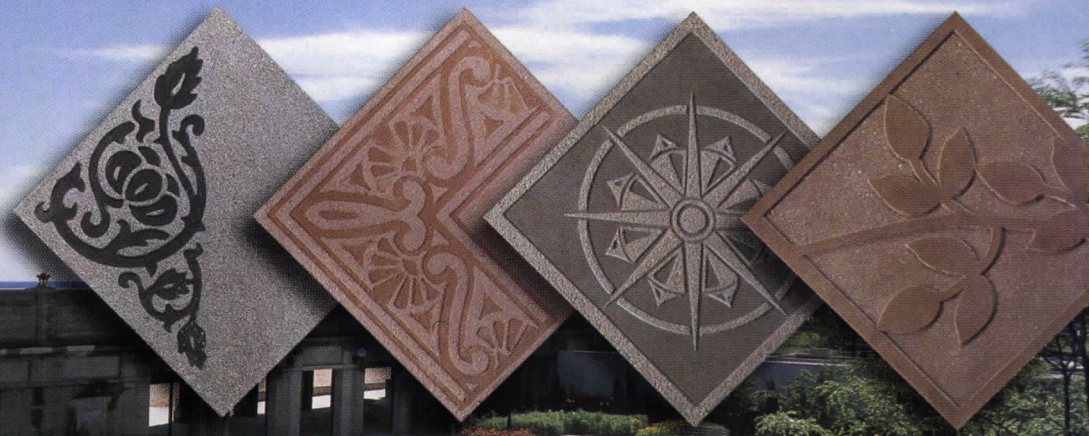

- Precast Concrete Pavers and Precast Accessories
 - Terrazzo Tile and Precast Accessories
 - NEW - Epoxy Terrazzo Accessories
- Call today for catalogs filled with products and ideas - 1-800-388-8728 or visit our new website at www.wausautile.com

WAUSAU TILE

P.O. Box 1520 Wausau, Wisconsin 54402-1520
(800) 388-8728 (715) 359-3121 FAX (715) 359-7456

www.wausautile.com
CIRCLE 119 ON READER SERVICE CARD
OR GO TO WWW.LEADNET.COM/PUBS/MHAR.HTML

Program title: **"Window Walls: Bringing the World Into Your Living Room" (11/02, page 203)**

11YSPONU

AIA/CES Credit: This sponsored section will earn you one AIA/CES LU hour of health safety welfare credit. (Valid for credit through November 2004)

Directions: Select one answer for each question in the exam and completely circle appropriate letter. A minimum score of 70% is required to earn credit.

- | | | | | | | | | | | | |
|------|---|---|---|------|---|---|---|-------|---|---|---|
| 1. a | b | c | d | 5. a | b | c | d | 9. a | b | c | d |
| 2. a | b | | | 6. a | b | c | d | 10. a | b | | |
| 3. a | b | | | 7. a | b | c | d | | | | |
| 4. a | b | | | 8. a | b | | | | | | |

Last Name _____ First Name _____ Middle Initial or Name _____

Firm Name _____

Address _____ City _____ State _____ Zip _____

Tel _____ Fax _____ E-mail _____

AIA ID Number _____ Completion date (M/D/Y): _____

For customer service, call: 877-876-8093.

Check one: \$10 Payment enclosed. (Make check payable to *Architectural Record* and mail to: *Architectural Record/Continuing Education Certificate*, PO Box 682, Hightstown, NJ 08520-0682.)

Charge my: Visa Mastercard American Express Card# _____

Signature _____ Exp. Date _____

Check below:

To register for AIA/CES credits: Answer the test questions and send the completed form with questions answered to above address or fax to 212-904-3150.

For Certificate of Completion: As required by certain states, answer test questions, fill out form above, and mail to above address. or fax to 212-904-3150.

Your test will be scored. Those who pass with a score of 70% or higher will receive a certificate of completion.

Material resources used: Article: This article addresses issues concerning the health and safety.

I hereby certify that the above information is true and accurate to the best of my knowledge and that I have complied with the AIA Continuing Education Guidelines for the reported period.

Signature _____ Date _____

Program title: **"Fluid Applied Air/Moisture Barriers for Moisture Control and Mold Prevention in Wall Construction" (11/02, page 209)**

11YSPONV

AIA/CES Credit: This sponsored section will earn you one AIA/CES LU hour of health safety welfare credit. (Valid for credit through November 2004)

Directions: Select one answer for each question in the exam and completely circle appropriate letter. A minimum score of 70% is required to earn credit.

- | | | | | | | | | | |
|------|---|---|---|------|---|---|---|-------|---|
| 1. a | b | | | 5. a | b | | | 9. a | b |
| 2. a | b | c | d | 6. a | b | c | | 10. a | b |
| 3. a | b | c | | 7. a | b | c | d | | |
| 4. a | b | | | 8. a | b | c | | | |

Last Name _____ First Name _____ Middle Initial or Name _____

Firm Name _____

Address _____ City _____ State _____ Zip _____

Tel _____ Fax _____ E-mail _____

AIA ID Number _____ Completion date (M/D/Y): _____

For customer service, call: 877-876-8093.

Check one: \$10 Payment enclosed. (Make check payable to *Architectural Record* and mail to: *Architectural Record/Continuing Education Certificate*, PO Box 682, Hightstown, NJ 08520-0682.)

Charge my: Visa Mastercard American Express Card# _____

Signature _____ Exp. Date _____

Check below:

To register for AIA/CES credits: Answer the test questions and send the completed form with questions answered to above address or fax to 212-904-3150.

For Certificate of Completion: As required by certain states, answer test questions, fill out form above, and mail to above address. or fax to 212-904-3150.

Your test will be scored. Those who pass with a score of 70% or higher will receive a certificate of completion.

Material resources used: Article: This article addresses issues concerning the health and safety.

I hereby certify that the above information is true and accurate to the best of my knowledge and that I have complied with the AIA Continuing Education Guidelines for the reported period.

Signature _____ Date _____

Innovation and durability are hallmarks of Bradley's Express Lav System.

Bradley Corporation based in Menomonee Falls, Wis., has advanced the concept of group handwashing and proves a well-designed lavatory system can be both visually appealing and durable. Bradley has developed the Express® Lavatory System for high-traffic washrooms, keeping the personal space of users in mind. While having the look and feel of individual lavs, each is a complete handwashing system that can accommodate up to three users at once.

The Express Lavatory System reduces installation problems, requiring one-third of the connections used in three single lavs. The units are shipped in pre-assembled modules, and need only standard supplies and one waste outlet for installation, reducing labor and maintenance costs.

The Express is made of Terreon®, Bradley's exclusive solid surface material that is vandal-resistant. Graffiti, burns, stains or scratches damage can

be easily removed using everyday cleaners or fine-grit abrasives. A choice of 18 inviting colors is available, along with a range of options and accessories such as "no touch" infrared sensors or mechanical push-button controls for convenient operation.

Routine cleaning and maintenance of the Express Lav System are also easy, as the bowl and sprayhead are designed as continuing surfaces with smooth flowing lines, rounded edges and no crevices for dirt build-up. Excess soap drips right into the bowl, not onto the counter or floor.

Specify Bradley Express Lav Systems with confidence – the company is the only lavatory system manufacturer with both Canadian Standards Association and National Association of HomeBuilders certification.



**AS FAR AS WE'RE CONCERNED,
WHITE CHINA IS FOR DINING.**

Available in an array of colors and configurations to fit any need, the Express® Lavatory System is the exciting alternative to everyday white china lavs. The contemporary design that architects prefer and the durability that building owners demand are hallmarks of Bradley's product innovation. Designed with fewer connections and rough-ins, the Express Lav is faster and easier to install. Express Lav units come in pre-assembled modules from a single source - requiring only a single specification. Express Lavatory Systems are made from Terreon®, a solid surface material that resists stains, burns, chemicals, impact and vandalism, providing longer lasting value than white china lavs. For the best selection and design in lavatory systems, call Bradley. www.bradleycorp.com or call 1-800-BRADLEY.

Bradley 
Better choices. Better results.

Program title: "Acrylic Block Offers Privacy and Light" (11/02, page 215)

11YSPONW

AIA/CES Credit: This sponsored section will earn you one AIA/CES LU hour of health safety welfare credit. (Valid for credit through November 2004)

Directions: Select one answer for each question in the exam and completely circle appropriate letter. A minimum score of 70% is required to earn credit.

- | | | |
|---------------------------|---------------------------|---------------------|
| 1. a b c d | 5. a b c | 9. a b |
| 2. a b c | 6. a b | 10. a b c |
| 3. a b | 7. a b c d | |
| 4. a b | 8. a b c d | |

Last Name _____ First Name _____ Middle Initial or Name _____

Firm Name _____

Address _____ City _____ State _____ Zip _____

Tel _____ Fax _____ E-mail _____

AIA ID Number _____ Completion date (M/D/Y): _____

For customer service, call: 877-876-8093.

Check one: \$10 Payment enclosed. (Make check payable to *Architectural Record* and mail to: *Architectural Record/Continuing Education Certificate*, PO Box 682, Hightstown, NJ 08520-0682.)

Charge my: Visa Mastercard American Express Card# _____

Signature _____ Exp. Date _____

Check below:

To register for AIA/CES credits: Answer the test questions and send the completed form with questions answered to above address or fax to 212-904-3150.

For Certificate of Completion: As required by certain states, answer test questions, fill out form above, and mail to above address, or fax to 212-904-3150. Your test will be scored. Those who pass with a score of 70% or higher will receive a certificate of completion.

Material resources used: Article: This article addresses issues concerning the health and safety.

I hereby certify that the above information is true and accurate to the best of my knowledge and that I have complied with the AIA Continuing Education Guidelines for the reported period.

Signature _____ Date _____

Program title: "Building Tomorrow's Parking Structures Today with Steel Frames" (11/02, page 221)

11YSPONO

AIA/CES Credit: This sponsored section will earn you one AIA/CES LU hour of health safety welfare credit. (Valid for credit through November 2004)

Directions: Select one answer for each question in the exam and completely circle appropriate letter. A minimum score of 70% is required to earn credit.

- | | | |
|---------------------------|---------------------------|----------------------------|
| 1. a b c d | 5. a b c d | 9. a b c d |
| 2. a b c d | 6. a b c d | 10. a b c d |
| 3. a b c d | 7. a b c d | |
| 4. a b c d | 8. a b c d | |

Last Name _____ First Name _____ Middle Initial or Name _____

Firm Name _____

Address _____ City _____ State _____ Zip _____

Tel _____ Fax _____ E-mail _____

AIA ID Number _____ Completion date (M/D/Y): _____

For customer service, call: 877-876-8093.

Check one: \$10 Payment enclosed. (Make check payable to *Architectural Record* and mail to: *Architectural Record/Continuing Education Certificate*, PO Box 682, Hightstown, NJ 08520-0682.)

Charge my: Visa Mastercard American Express Card# _____

Signature _____ Exp. Date _____

Check below:

To register for AIA/CES credits: Answer the test questions and send the completed form with questions answered to above address or fax to 212-904-3150.

For Certificate of Completion: As required by certain states, answer test questions, fill out form above, and mail to above address, or fax to 212-904-3150. Your test will be scored. Those who pass with a score of 70% or higher will receive a certificate of completion.

Material resources used: Article: This article addresses issues concerning the health and safety.

I hereby certify that the above information is true and accurate to the best of my knowledge and that I have complied with the AIA Continuing Education Guidelines for the reported period.

Signature _____ Date _____

15	6	Tango Lighting
71	46	⑤ Timely timelyframes.com
111	60	Toyota toyota.com
115	62	TRE-Più tre-piu.com
119	64	Trex trex.com
271	112	⑤ Truebro truebro.com
66	41	⑤ Trus Joist trusjoist.com
185, 4cov	⑤	USG Corporation usg.com
33	18	Visa Lighting Corp visalighting.com
68	43	⑤ Vistawall Architectural Products vistawall.com
95	55	⑤ VPI vpiflooring.com
113	⑤	VT Industries vtindustries.com
22-23	10	⑤ Vulcraft, A Division of Nucor Corp nucor.com
277	119	⑤ Wausau Tile wausautile.com
8-9	3	Weather Shield Windows & Doors weathershield.com
122, 123	65, 66	Weather Shield Windows & Doors weathershield.com
77	52	⑤ Whirlpool whirlpool.com
24	11	⑤ Wiremold wiremold.com
260	103	World Exposition of Ceramic Tile italytiles.com
111	60	www.toyota.com/tomorrow toyota.com

EXECUTIVE OFFICES

James H. McGraw, IV, Group Publisher
(212) 904-4048 Fax: (212) 904-3695
jay-mcgraw@mcgraw-hill.com

Laura Viscusi, VP, Associate Publisher
(212) 904-2518 Fax: (212) 904-2791
lviscusi@mcgraw-hill.com

ONLINE SALES

Paul Cannella, Manager
(312) 233-7499 Fax: (312) 233-7490
paul_cannella@mcgraw-hill.com

INSIDE SALES

Janet Kennedy, Director
(212) 904-6433 Fax: (212) 904-2074
janet_kennedy@mcgraw-hill.com

NORTHEAST / MID-ATLANTIC

Ted Rzempoluch
(212) 904-3603 Fax: (212) 904-4256
rzempoluch@mcgraw-hill.com

MIDWEST

Mike Gilbert (AR, IL, IA, MN, MO, OH, W.PA, WV)
(312) 233-7401 Fax: (312) 233-7403
mike_gilbert@mcgraw-hill.com

Annette Moore (IL, IN, KS, MI, ND, NE, OK, SD, TX, WI)
(312) 233-7402 Fax: (312) 233-7403
annette_moore@mcgraw-hill.com

Assistant: Mamie Allegro

SOUTHEAST / MID-ATLANTIC

Susan Shepherd
(404) 843-4770 Fax: (404) 252-4056
sshepherd@mcgraw-hill.com

Assistant: Pam Crews

WEST (AZ, CA, CO, NM, NV)

Bill Hague
(253) 858-7575 Fax: (253) 858-7576
(760) 340-5575 Fax: (760) 340-0439
bill_hague@mcgraw-hill.com

WEST (BRIT. COLUMBIA, ID, OR, S. CA, UT, WA)

Bill Madden
(503) 224-3799 Fax: (503) 224-3899
bill@maddenandassociates.net

CANADA (EXCEPT BRITISH COLUMBIA)

Frank A. Spangenberg
(905) 939-0653 Fax: (905) 939-0654
spang@sympatico.ca

CLASSIFIED ADVERTISING / MANUFACTURERS' SPOTLIGHT / POSTCARD SERVICE

Tracey Hall
(212) 904-2010 Fax: (609) 426-7136
tracey_hall@mcgraw-hill.com

Editorial

(212) 904-2594 Fax: (212) 904-4256
www.architecturalrecord.com

Subscriber Service

(888) 867-6395 (USA only)
(609) 426-7046 Fax: (609) 426-7087
p64cs@mcgraw-hill.com

Back Issues

(212) 904-4635
phyllis_moody@mcgraw-hill.com

Reprints

(212) 512-4170 Fax (212) 512-6243
Architecturereprints@Businessweek.com

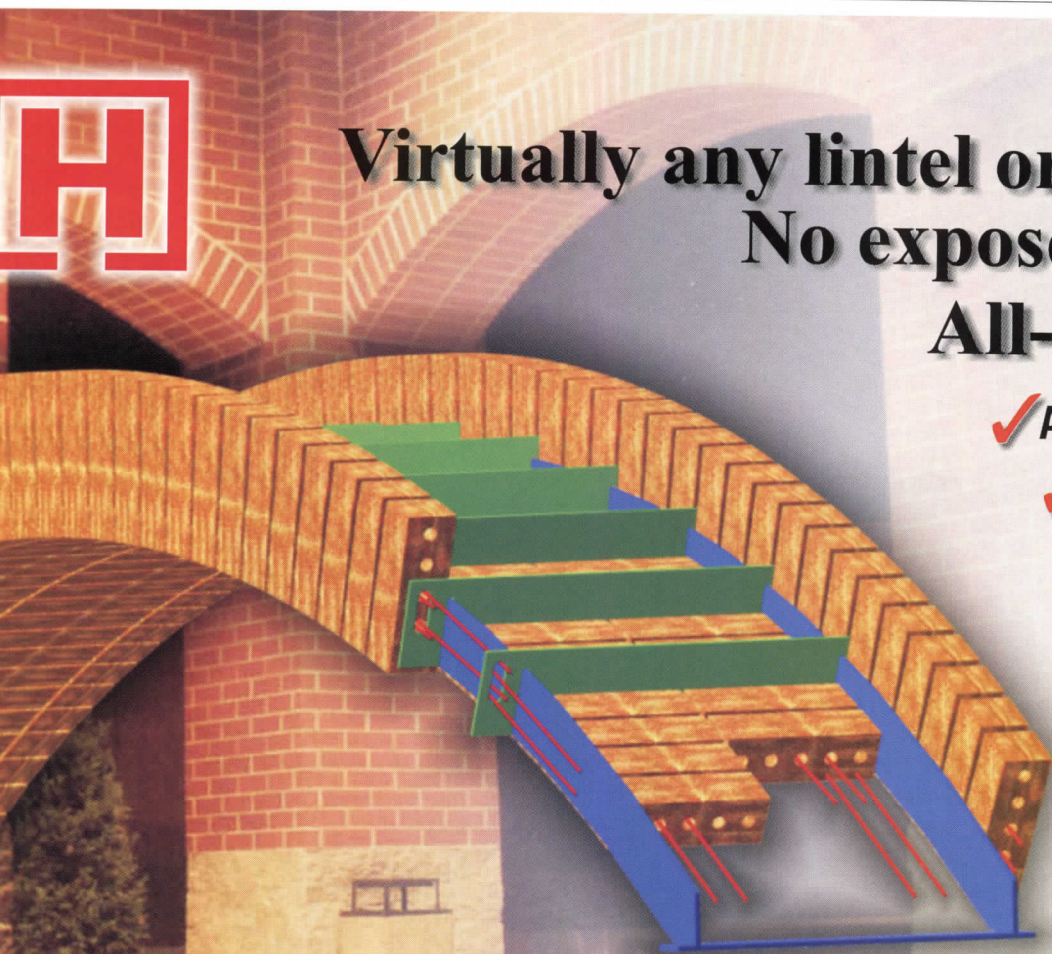

Virtually any lintel or arch
No exposed steel
All-brick soffit

- ✓ Aesthetically Pleasing
- ✓ Engineered to match conceptual design
- ✓ Endless Possibilities



Meadow Burke Products
P. O. Box 547 Converse, TX 78109
Tel: (800) 323-6896
Fax: (888) 277-1695
website: halfenusa.com
email: tbg@texas.net



Ayala Sefarty: A designer by nature

Interviewed by Randi Greenberg

Initially an artist who worked in the humble mediums of dust and rice paper, Ayala Sefarty's multihued, multifaceted design career started while she was snorkeling in the Red Sea. Back on the beach, Sefarty immediately began to sketch the designs that would launch Aqua Creations, her nature-influenced furniture and lighting company. Almost 10 years later, Sefarty has an extensive product line and has branched out into designing casino and hotel interiors, as well as a 2,400-square-foot underwater restaurant in Eilat, Israel. Her latest installation is an enormous futuristic chandelier, composed of 50 lamps hung in the main entrance of an aquarium in Valencia, Spain.

Q: You studied fine art in Jerusalem and in London. What led you to furniture design? Ten years ago I was a fine artist, and making props to earn money. After my trip to the Red Sea, something happened to me. I realized that I was bored with my artwork. I began to design organic-shaped lamps and furniture and never stopped. Your work doesn't seem to fit the "form follows function" credo. My designs are definitely functional, but for me, form follows fantasy. I'm trying to create something alive, humorous, and colorful—objects with texture and movement. So much of what one sees tends to be minimal or flat or square, so when I design I am not thinking in terms of everyday styles.

What materials do you prefer to work with? With lighting projects I tend to work in silk, felt, or glass wrapped in fabrics. My newest lighting projects will involve a new material whose technology we've been working on for more than a year to develop. For the furniture, I use hand-dyed fabrics, and I am starting to use more wool. If you could pick any building in the world to feature your designs, what would it be? One of Gaudí, or a building that is very Japanese. In the Gaudí building, my designs would be natural, and in the Japanese, a harmony of oppositions.

What is your relationship with architects? Architects are my best clients, because they often challenge me with unusual projects. I think they like to work with us because we can do custom work to suit their fantasy. When it's a relationship of trust, as it has been working with the architect in the aquarium project in Valencia, it's like a birthday party. It's just so easy.

What are the pitfalls for designing an underwater restaurant? There is the necessity to design the indoors to coexist with the aquatic outdoors. When diners are looking out the window, I didn't want the reflection of the interior to clash with their view, so it was important to me to design pieces that would enhance their underwater experience.

How have your designs changed over the years? The work is more cellular in structure, more refined, not as brightly colored, and more about topography. As a whole, I am more conscious of other pieces in the design of the room. In the past, I thought of each piece as a sculpture.

Who would you like to see sitting in your Satala chair [pictured]? David Bowie. Or Eric Clapton.

Photograph courtesy of Aqua Creations

To see more by Ayala Sefarty and Aqua Creations, go to www.aquagallery.com.

Unleash the power of 10

Get ready to shift your business into high gear with VectorWorks 10. **The basics just got better:**

We've made dramatic improvements in fundamental drawing efficiency. **Maneuver through deadline**

congestion: We've added features that help you work faster with fewer mouse clicks, and enhanced

the compatibility with other CAD/CAM programs. Plus, we've designed remarkable new tools to help

you create cleaner, more attractive plans. **Power through presentations:** New features help you

visualize and present your ideas in 3D. Discover a better way to design.

VectorWorks10. Take a test drive and unleash the power for yourself.

A Product of Nemetschek North America
Vectorworks[®] 10
ARCHITECT • LANDMARK • RENDERWORKS

CAD for the smart-sized company

888.646.4223 • www.vectorworks10.com

CIRCLE 123 ON READER SERVICE CARD
OR GO TO WWW.LEADNET.COM/PUBS/MHAR.HTML



They had fifteen tough questions about my design.

I needed only one answer.

No challenge is impossible when your creativity teams up with USG's innovative products and systems, responsive service and proven industry leadership. Contact your USG sales rep today.



Ceilings
Substrates
Drywall
Systems

WORKING FOR YOU.

1-800-USG-4YOU www.usg.com

SHEETROCK
BRAND PRODUCTS

FIBEROCK
BRAND PANELS

DUROCK
BRAND CEMENT BOARDS

DONN
BRAND GRID

USG CEILINGS