

# ARCHITECTURAL RECORD

**JAKOB + MACFARLANE IN LYON**

**GEHRY IN MIAMI BEACH  
FOSTER IN ABU DHABI**

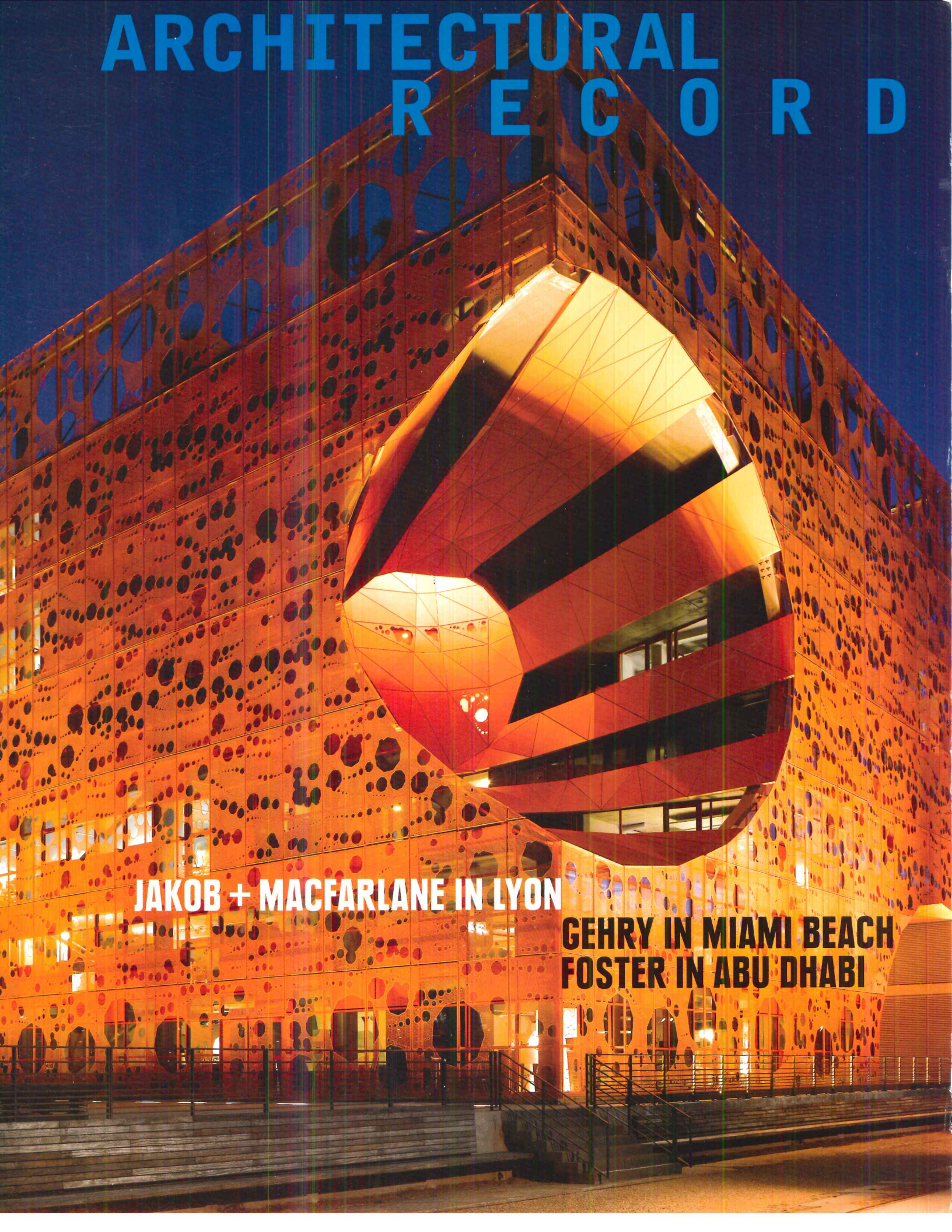

# CEILING&WALL SYSTEMS

Between us, ideas become reality™

WoodWorks® Tegular Custom 1' x 8' in Bamboo Patina with W2 perforation on Prelude® XL grid in Silver Satin with 4" Axiom® Classic in Silver Satin;  
WoodWorks® Walls Custom 4' x 8' in Bamboo Patina / Chandler City Hall, Chandler, AZ / Architect: The Smith Group, Phoenix, AZ

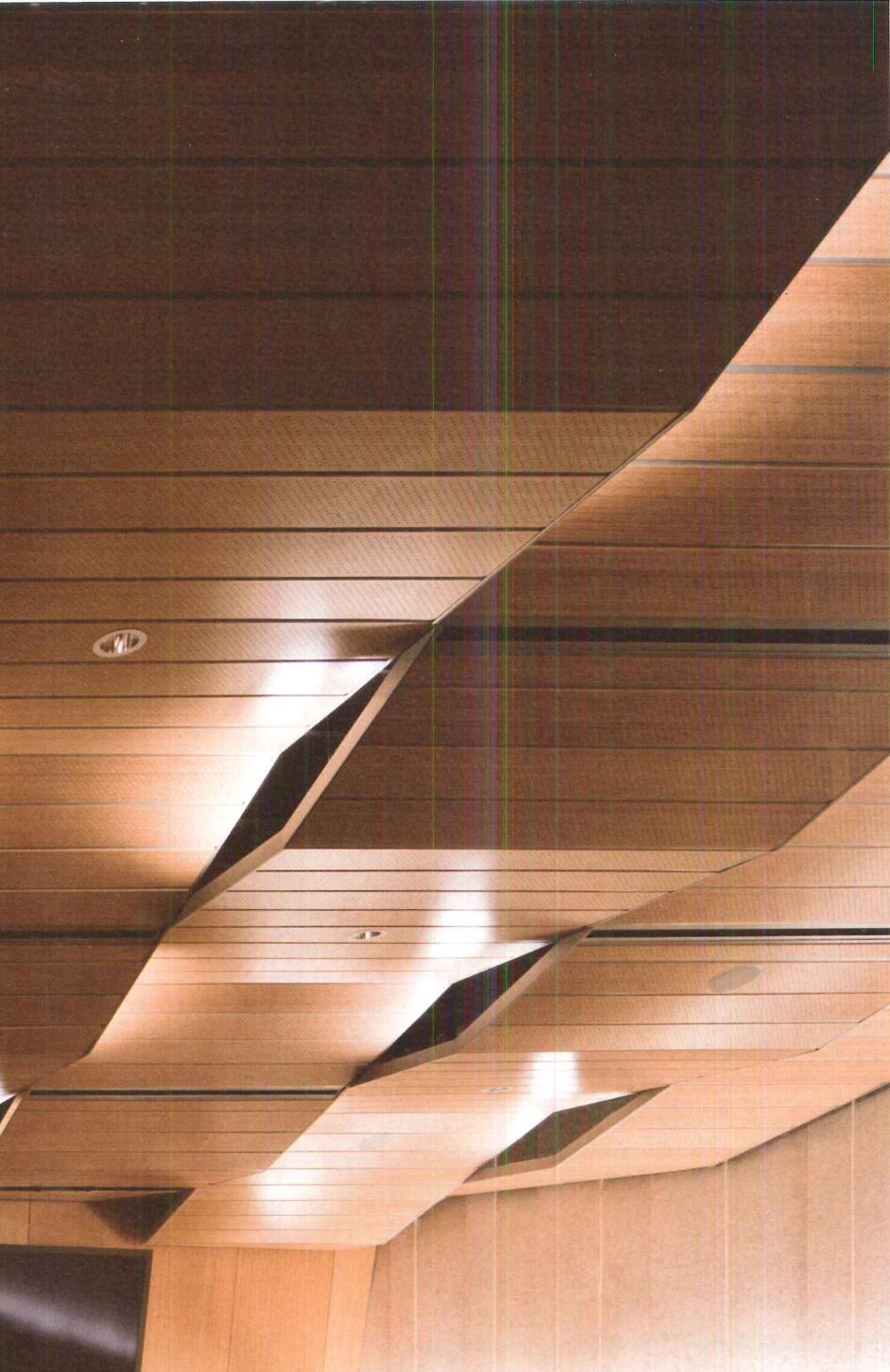

## unanimous board approval

Whether the boards are planks, panels, clouds or canopies, everyone approves of the warmth and sophistication of WoodWorks® Ceiling & Wall Systems. Choose from a broad range of standard and custom veneers, perforations, channels and acoustical options – all made from FSC®-certified wood. Visit our website to learn more about how WoodWorks can help you earn high approval ratings.

[armstrong.com/unanimous5ar](http://armstrong.com/unanimous5ar) 1 877 ARMSTRONG

**Armstrong**®

CIRCLE 10

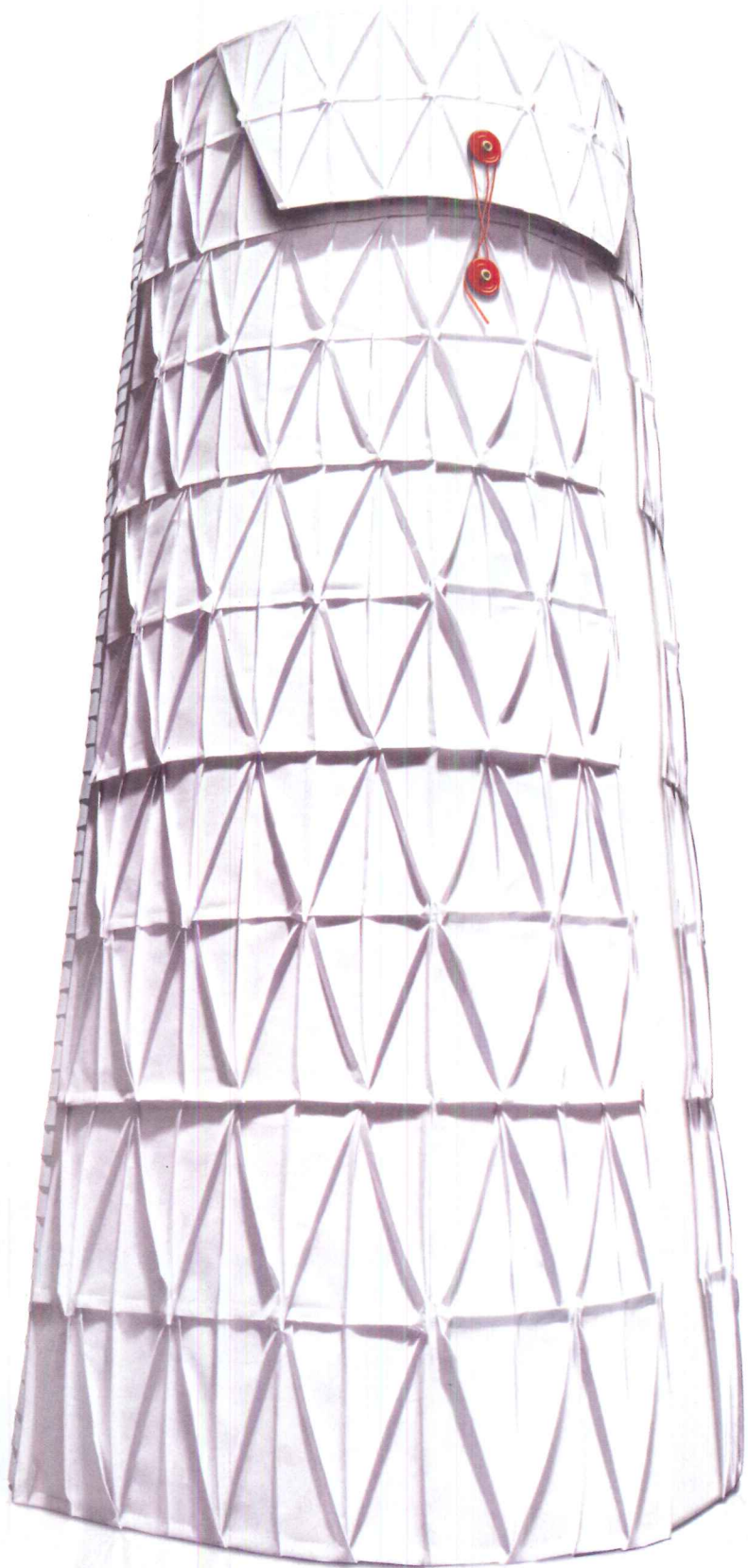

*The Bow  
Origami  
by Artist  
Robert Lang*

# this envelope changes everything

## **Oldcastle Glass® is now Oldcastle BuildingEnvelope™**

More than a name change, this is a sea change in how the building envelope is realized. Like an envelope created from a single piece of paper, we approach the building envelope the same way. Not as pieces and parts—instead—we design, engineer, test and manufacture curtain wall, windows, storefronts, skylights and glass as one seamlessly integrated unit. Why do we do it? Everyone in the design and construction chain is asking for it—from visionary architects to owners, engineers, consultants and construction managers. To see the future of the building envelope, call 866-OLDCASTLE (653-2278) or visit us online at [oldcastlebe.com](http://oldcastlebe.com). See us at the AIA Convention, booth #2825.



*Finally there is one integrated system where all the elements necessary to enclose the building are engineered to work together seamlessly.*

*The Bow by  
Foster + Partners  
Building envelope  
by Oldcastle  
BuildingEnvelope™*



**Oldcastle BuildingEnvelope™**

*Engineering your creativity™*

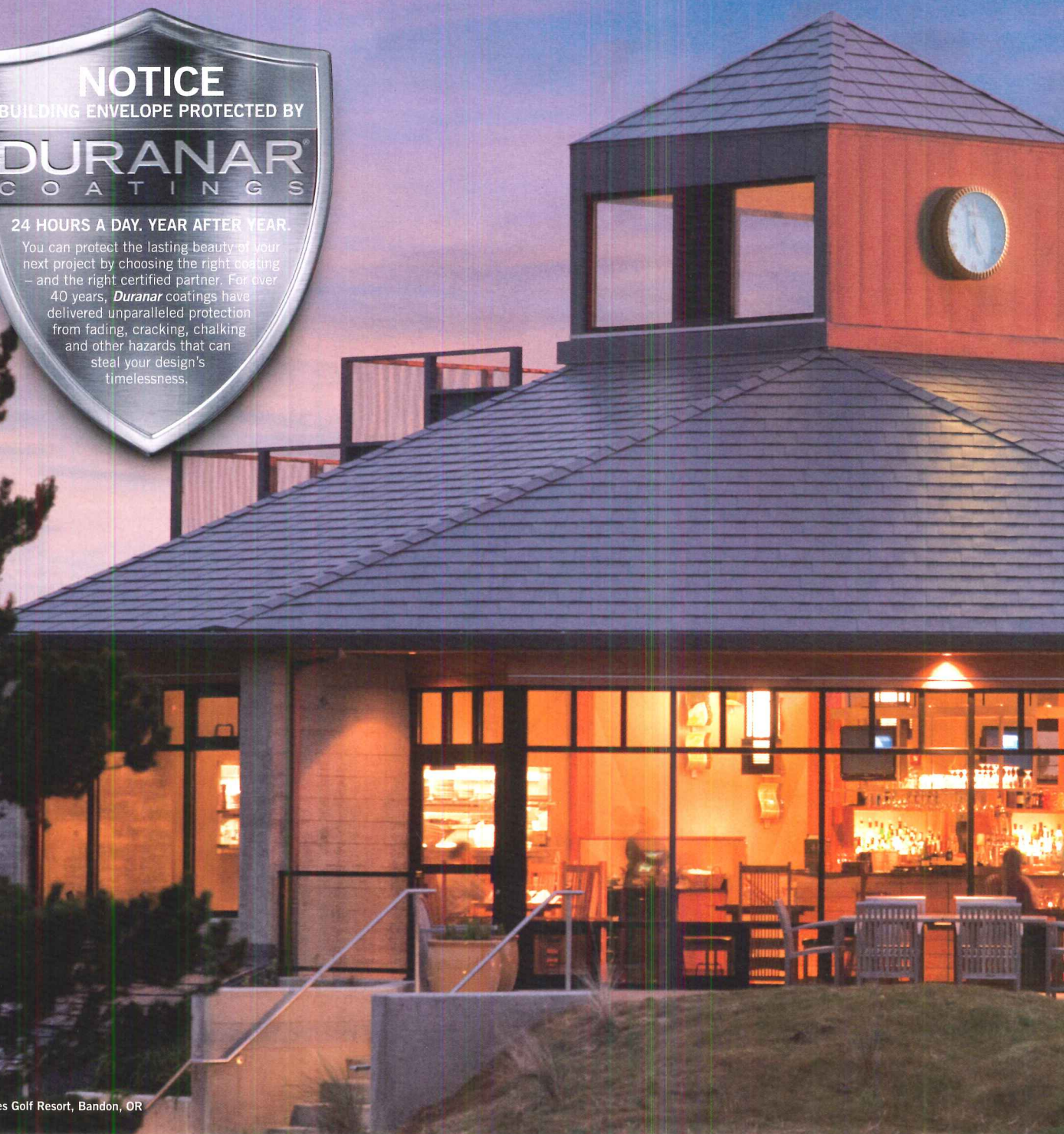
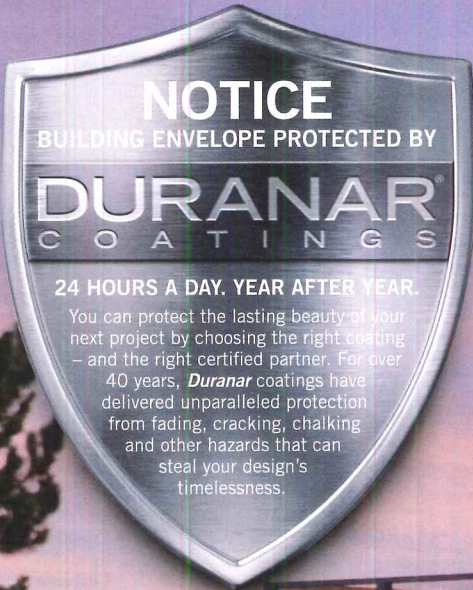

Bandon Dunes Golf Resort, Bandon, OR

**To serve and protect, choose Duranar® coatings – and a certified partner.**

When you work with members of the PPG Certified Applicator Program® or Certified Metal Painter Program®, you get the best people, practices and products. Which give you consistent, durable color. And a whole lot more. To learn more, call 1-888-PPG-IDEA. Or visit [ppgduranar.com](http://ppgduranar.com).



All trademarks are marks of PPG Industries Ohio, Inc.



# ARCHITECTURAL RECORD

**MANAGING EDITOR** Beth Broome, [elisabeth\\_broome@mcgraw-hill.com](mailto:elisabeth_broome@mcgraw-hill.com)  
**SENIOR GROUP ART DIRECTOR** Francesca Messina, [francesca\\_messina@mcgraw-hill.com](mailto:francesca_messina@mcgraw-hill.com)

**DEPUTY EDITORS** Clifford A. Pearson, [pearsonc@mcgraw-hill.com](mailto:pearsonc@mcgraw-hill.com)  
Suzanne Stephens, [suzanne\\_stephens@mcgraw-hill.com](mailto:suzanne_stephens@mcgraw-hill.com)

**SENIOR EDITORS** Jane F. Kolleeny, [jane\\_kolleeny@mcgraw-hill.com](mailto:jane_kolleeny@mcgraw-hill.com)  
Joann Gonchar, AIA, LEED AP [joann\\_gonchar@mcgraw-hill.com](mailto:joann_gonchar@mcgraw-hill.com)

**PRODUCTS EDITOR** Rita Catinella Orrell, [rita\\_catinella@mcgraw-hill.com](mailto:rita_catinella@mcgraw-hill.com)  
**NEWS EDITOR** Jenna M. McKnight, [jenna\\_mcknight@mcgraw-hill.com](mailto:jenna_mcknight@mcgraw-hill.com)  
**SPECIAL SECTIONS EDITOR** Linda C. Lentz, [linda\\_lentz@mcgraw-hill.com](mailto:linda_lentz@mcgraw-hill.com)

**PRODUCTION MANAGER** Juan Ramos, [juan\\_ramos@mcgraw-hill.com](mailto:juan_ramos@mcgraw-hill.com)  
**EDITORIAL PRODUCTION** Rosa Pineda, [rosa\\_pineda@mcgraw-hill.com](mailto:rosa_pineda@mcgraw-hill.com)

**ART DIRECTOR** Helene Silverman, [helene\\_silverman@mcgraw-hill.com](mailto:helene_silverman@mcgraw-hill.com)  
**CONSULTING ASSOCIATE ART DIRECTOR** Donna Agajanian, [donna\\_agajanian@mcgraw-hill.com](mailto:donna_agajanian@mcgraw-hill.com)

**EDITORIAL SUPPORT** Monique Francis, [monique\\_francis@mcgraw-hill.com](mailto:monique_francis@mcgraw-hill.com)

**EDITORIAL ASSISTANT** Laura Raskin, [laura\\_raskin@mcgraw-hill.com](mailto:laura_raskin@mcgraw-hill.com)

**CONTRIBUTING EDITORS** Sarah Amelar, Robert Campbell, FAIA, Andrea Oppenheimer Dean,  
Martin Filler, C.J. Hughes, Blair Kamin, Jayne Merkel, Robert  
Murray, B.J. Novitski, David Sokol, Michael Sorkin, Ingrid Spencer

**SPECIAL INTERNATIONAL CORRESPONDENT** Naomi R. Pollock, AIA  
**INTERNATIONAL CORRESPONDENTS** David Cohn, Tracy Metz

**WEB EDITOR** William Hanley, [william\\_hanley@mcgraw-hill.com](mailto:william_hanley@mcgraw-hill.com)

**ARCHITECTURAL RECORD:** (ISSN 0003-858X) May 2011. Vol. 199, No. 5. Published monthly by The McGraw-Hill Companies, 1221 Avenue of the Americas, New York, N.Y. 10020. **FOUNDER:** James H. McGraw (1860-1948). Periodicals postage paid at New York, N.Y. and additional mailing offices. Canada Post International Publications Mail Product Sales Agreement No. 40012501. Return undeliverable Canadian addresses to: DHL Global Mail, 355 Admiral Blvd-Unit 4, Mississauga, ON L5T 2N1. Email: [arhcustserv@cdsfulfillment.com](mailto:arhcustserv@cdsfulfillment.com). Registered for GST as The McGraw-Hill Companies. GST No. R123075673. **POSTMASTER:** Please send address changes to ARCHITECTURAL RECORD, Fulfillment Manager, P.O. Box 5732, Harlan, IA 51593. **SUBSCRIPTION:** Rates are as follows: U.S. and Possessions \$70.30; Canada and Mexico \$79 (payment in U.S. currency, GST included); outside North America \$199 (air freight delivery). Single copy price \$9.95; for foreign \$11. Subscriber Services: 877/876-8093 (U.S. only); 515/237-3681 (outside the U.S.); fax: 712/755-7423. **SUBMISSIONS:** Every effort will be made to return material submitted for possible publication (if accompanied by stamped, self-addressed envelope), but the editors and the corporation will not be responsible for loss or damage. **SUBSCRIPTION LIST USAGE:** Advertisers may use our list to mail information to readers. To be excluded from such mailings, send a request to ARCHITECTURAL RECORD, Mailing List Manager, P.O. Box 555, Hightstown, N.J. 08520. **OFFICERS OF THE MCGRAW-HILL COMPANIES, INC:** Harold W. McGraw III, Chairman, *President and Chief Executive Officer*; Kenneth M. Vittor, *Executive Vice President and General Counsel*; Jack F. Callahan, *Executive Vice President and Chief Financial Officer*; Elizabeth O'Melia, *Senior Vice President, Treasury Operations*. **COPYRIGHT AND REPRINTING:** Title ® reg. in U.S. Patent Office. Copyright © 2011 by The McGraw-Hill Companies. All rights reserved. Where necessary, permission is granted by the copyright owner for libraries and others registered with the Copyright Clearance Center (CCC), 222 Rosewood Drive, Danvers, Mass. 01923. To photocopy any article herein for personal or internal reference use only for the base fee of \$1.80 per copy of the article plus ten cents per page, send payment to CCC, ISSN 0003-858X. Copying for other than personal use or internal reference is prohibited without prior written permission. Write or fax requests (no telephone requests) to Copyright Permission Desk, ARCHITECTURAL RECORD, Two Penn Plaza, New York, N.Y. 10121-2298; fax 212/904-4256. For reprints call 800/360-5549 X 129 or e-mail [architecturalrecord@theygsgroup.com](mailto:architecturalrecord@theygsgroup.com). Information has been obtained by The McGraw-Hill Companies from sources believed to be reliable. However, because of the possibility of human or mechanical error by our sources, The McGraw-Hill Companies or architectural record does not guarantee the accuracy, adequacy, or completeness of any information and is not responsible for any errors or omissions therein or for the results to be obtained from the use of such information or for any damages resulting there from.

**EDITORIAL OFFICES:** 212/904-6667. Editorial fax: 212/904-4256. Email: [monique\\_francis@mcgraw-hill.com](mailto:monique_francis@mcgraw-hill.com). Two Penn Plaza, New York, N.Y. 10121-2298. **WEB SITE:** [ArchitecturalRecord.com](http://ArchitecturalRecord.com).



The McGraw-Hill Companies



PRINTED IN USA

15 Certified partners.  
One goal: yours.



[www.ppgcmpp.com](http://www.ppgcmpp.com)

## Roof Panel Manufacturers

Custom-Bilt Metals

Ryerson Building Products

## Wall Panel Manufacturers

Alcoa Architectural Products

Alucobond®

Kingspan Benchmark  
Architectural Systems



[www.ppgcap.com](http://www.ppgcap.com)

## Extrusion Applicators

Anacolor Inc.

Architectural Window

Keymark Corporation

Linetec

Sapa, Inc.

Southern Aluminum  
Finishing Co. (SAF)

Spectrum Metal Finishing, Inc.

Tecnoglass S.A.

Windsor Metal Finishing

YKK AP America, Inc.



Glass • Coatings • Paint

CIRCLE 93



ENTER  
myMarvin  
**ARCHITECT'S  
CHALLENGE**

**WIN** the chance to showcase  
your most inspired work.

This is your opportunity to inspire and be inspired. And to see how you measure up with your peers in the architectural community. Submit your best work that includes Marvin® Windows and Doors, and our esteemed judging panel will evaluate each entry on a number of attributes. If your submission is singled out for excellence, it will be showcased amongst the winning entries in this prestigious annual event.

Get details at  
[marvin.com/inspired](http://marvin.com/inspired)



Built around you.®

©2011 Marvin Windows and Doors. All rights reserved.  
®Registered trademark of Marvin Windows and Doors.  
1-800-236-9690

CIRCLE 72

# ARCHITECTURAL RECORD

**VICE PRESIDENT, PUBLISHER** Laura Viscusi, [laura\\_viscusi@mcgraw-hill.com](mailto:laura_viscusi@mcgraw-hill.com)

**SENIOR DIRECTOR, MEDIA OPERATIONS** Brenda Griffin, [brenda\\_griffin@mcgraw-hill.com](mailto:brenda_griffin@mcgraw-hill.com)  
**DIRECTOR, CREATIVE SERVICES** William Taylor, [william\\_taylor@mcgraw-hill.com](mailto:william_taylor@mcgraw-hill.com)  
**PRODUCTION MANAGER** Stephen R. Weiss, [stephen\\_weiss@mcgraw-hill.com](mailto:stephen_weiss@mcgraw-hill.com)

**SENIOR DIRECTOR, MHC MEDIA PRODUCT DEVELOPMENT** Michael McNeerney, [michael\\_mcneerney@mcgraw-hill.com](mailto:michael_mcneerney@mcgraw-hill.com)  
**MANAGER, CONTINUING EDUCATION** Marissa Wyss, [marissa\\_wyss@mcgraw-hill.com](mailto:marissa_wyss@mcgraw-hill.com)

**VICE PRESIDENT, BUSINESS SERVICES** Maurice Persiani, [maurice\\_persiani@mcgraw-hill.com](mailto:maurice_persiani@mcgraw-hill.com)  
**DIRECTOR, CIRCULATION** Brian McGann, [brian\\_mcgann@mcgraw-hill.com](mailto:brian_mcgann@mcgraw-hill.com)

**SENIOR MARKETING MANAGER** Marybeth Whited, [marybeth\\_whited@mcgraw-hill.com](mailto:marybeth_whited@mcgraw-hill.com)

**FINANCE DIRECTOR** Ike Chong, [ike\\_chong@mcgraw-hill.com](mailto:ike_chong@mcgraw-hill.com)  
**FINANCE MANAGER** Tom Maley, [tom\\_maley@mcgraw-hill.com](mailto:tom_maley@mcgraw-hill.com)

**ASSISTANT TO MEDIA DEPARTMENT** Pina Del Genio, [pina\\_delgenio@mcgraw-hill.com](mailto:pina_delgenio@mcgraw-hill.com)

## ADVERTISING SALES

**NORTHEAST:** Joseph Sosnowski  
(610) 278-7829 Fax: (610) 278-0936, [joseph\\_sosnowski@mcgraw-hill.com](mailto:joseph_sosnowski@mcgraw-hill.com)

**SOUTHEAST:** Susan Shepherd  
(859) 987-9913 Fax: (404) 252-4056, [susan\\_shepherd@mcgraw-hill.com](mailto:susan_shepherd@mcgraw-hill.com)

**MIDWEST:** Martin McClellan  
(312) 233-7402 Fax: (312) 233-7430, [martin\\_mcclellan@mcgraw-hill.com](mailto:martin_mcclellan@mcgraw-hill.com)

**SOUTHWEST/CENTRAL:** Bret Ronk  
(972) 437-7877 Fax: (972) 437-7876, [bret\\_ronk@mcgraw-hill.com](mailto:bret_ronk@mcgraw-hill.com)

**NORTHWEST:** Bill Madden  
(503) 557-9000 Fax: (503) 557-9002, [bill\\_madden@mcgraw-hill.com](mailto:bill_madden@mcgraw-hill.com)

**PACIFIC:** Sherylen Yoak  
(760) 568-0465 Fax: (720) 559-9818, [sherylen\\_yoak@mcgraw-hill.com](mailto:sherylen_yoak@mcgraw-hill.com)

**TECHNOLOGY:** Roy Kops  
(415) 357-8191 Fax: (415) 357-8005, [roy\\_kops@mcgraw-hill.com](mailto:roy_kops@mcgraw-hill.com)

**SPOTLIGHT SALES:** Risa Serin  
(212) 904-6041 Fax: (212) 904-4652, [risa\\_serin@mcgraw-hill.com](mailto:risa_serin@mcgraw-hill.com)

**WORKFORCE/ RECRUITMENT:** Diane Soister  
(212) 904-2021 Fax: (212) 904-2074, [diane\\_soister@mcgraw-hill.com](mailto:diane_soister@mcgraw-hill.com)

## INTERNATIONAL

**GERMANY:** Uwe Riemeyer  
(49) 202-27169-0 Fax: (49) 202-27169-20, [riemeyer@intermediapartners.de](mailto:riemeyer@intermediapartners.de)

**ITALY:** Ferruccio Silvera  
(39) 022-846716 Fax: (39) 022-893849, [ferruccio@silvera.it](mailto:ferruccio@silvera.it)

**JAPAN:** Katsuhiko Ishii  
(03) 5691-3335 Fax: (03) 5691-3336, [amkatsu@dream.com](mailto:amkatsu@dream.com)

**KOREA:** Young-Seoh Chin  
(822) 481-3411/3 Fax: (822) 481-3414

## McGRAW-HILL CONSTRUCTION

**PRESIDENT** Keith Fox  
**SENIOR VICE PRESIDENT OF SALES, MHC** Robert D. Stuono  
**VICE PRESIDENT, OPERATIONS** Linda Brennan, [linda\\_brennan@mcgraw-hill.com](mailto:linda_brennan@mcgraw-hill.com)  
**VICE PRESIDENT, MHC PRODUCT DEVELOPMENT** Kathryn E. Cassino, [kate\\_cassino@mcgraw-hill.com](mailto:kate_cassino@mcgraw-hill.com)  
**VICE PRESIDENT, TECHNOLOGY** Isaac Sacolick, [isaac\\_sacolick@mcgraw-hill.com](mailto:isaac_sacolick@mcgraw-hill.com)  
**VICE PRESIDENT, STRATEGIC MARKETING** Patricia France, [patricia\\_france@mcgraw-hill.com](mailto:patricia_france@mcgraw-hill.com)  
**SENIOR DIRECTOR, FINANCE** John Murphy, [john\\_murphy@mcgraw-hill.com](mailto:john_murphy@mcgraw-hill.com)

**WEB SITE:** [ArchitecturalRecord.com](http://ArchitecturalRecord.com) **SUBSCRIBER SERVICE:** 877/876-8093 (U.S. only). 515/237-3681 (outside the U.S.). Subscriber fax: 712/755-7423. E-mail: [arhcustserv@cdsfulfillment.com](mailto:arhcustserv@cdsfulfillment.com). If the Post Office alerts us that your magazine is undeliverable, we have no further obligation unless we receive a corrected address within one year. **INQUIRIES AND SUBMISSIONS:** Letters, Beth Broome; Practice, Suzanne Stephens; Books, Clifford A. Pearson; Products, Rita Catinella Orrell; Lighting and Interiors, Linda C. Lentz; Residential, Jane F. Kolleeny; Architectural Technology, Joann Gonchar; Web Editorial, William Hanley. **REPRINT:** [architecturalrecord@theygsgroup.com](http://architecturalrecord@theygsgroup.com). **BACK ISSUES:** Call 877/876-8093, or go to [archrecord.com/backissues/](http://archrecord.com/backissues/)



The McGraw-Hill Companies



PRINTED IN USA



SIMPSON  
Strong-Tie  
**Strong Frame**  
ORDINARY MOMENT FRAME

SIMPSON  
Strong-Tie

SIMPSON  
Strong-Tie

SIMPSON  
Strong-Tie

SIMPSON  
Strong-Tie

SIMPSON  
Strong-Tie

We provide the frame,  
you frame the view.

If your client comes to you with waterfront property, you definitely want to take advantage of the natural view. And with the Strong Frame™ ordinary moment frame, you can do just that by creating wall openings up to 20 feet wide and 19 feet tall. In fact, there are 368 pre-engineered steel frame configurations to choose from as well as custom sizes. So whether you're designing a custom home on the lake, retrofitting a multi-story building or creating an "open" floor plan, Simpson Strong-Tie has a frame to frame your design.

For additional information, call (800) 999-5099 or visit [www.strongtie.com/strongframe](http://www.strongtie.com/strongframe).

**SIMPSON**  
**Strong-Tie**





# Clean air. Created by science and **Nature.**

She's a powerful life force; a transforming figure. And she can dramatically improve your outlook with a single touch. No wonder architecture has forever drawn from nature. Though many have incorporated, manipulated or simply decorated with her, none have replicated nature's profound impact. But like the breath of fresh air they're creating, Nedlaw Living Walls is doing just that.

Inspired by nature; perfected through science, Nedlaw Living Walls is creating better indoor spaces everywhere by improving air quality — naturally. Using our patented biofilter technology and a building's own air-handling system, a Nedlaw Living Wall captures, breaks down and removes airborne pollutants. Off-gases. Odours. Chemicals. They aren't just filtered, they're quantifiably eliminated. It's the same biological processes used by nature outdoors, brought indoors. Beautifully.

**Give your projects the natural advantage. Talk to Nedlaw Living Walls and put science and nature in your corner.**

[www.NedlawLivingWalls.ca](http://www.NedlawLivingWalls.ca)

**NEDLAW**  
LIVING WALLS ™  
Clean air, naturally.™

REIMAGINE METAL



## HIGH STAKES. NO GAMBLE.

The beauty of choosing metal for your building envelope enclosure these days is you can't lose on aesthetics, sustainability or value. CENTRIA simply offers the most advanced thermal and moisture protection technology. Coatings, textures and colors. Performance and style. There have never been more options in form or truly integrated components. CENTRIA innovations are capturing imaginations - and contracts - and awards - all over the world. Learn more about the possibilities at

[centria.com/reimaginemetal](http://centria.com/reimaginemetal)  
**800.229.5427**

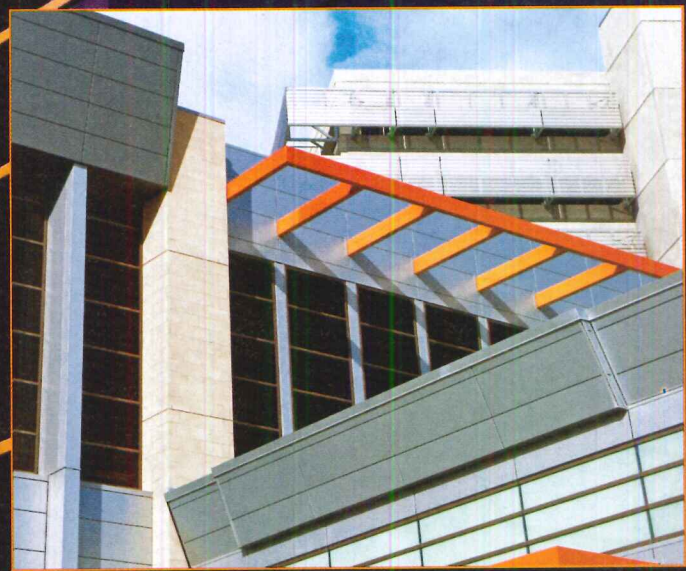

Scan the QR Code with your smart phone to view the River's Casino project gallery and learn about the CENTRIA products chosen.



**REIMAGINING THE BUILDING ENVELOPE**

© 2011 Technical Glass Products. FireLite is a registered trademark of Nippon Electric Glass Co., Ltd. Technical Glass Products, One Source, Many Solutions, and FireGlass are registered trademarks of Technical Glass Products.



**FireLite**<sup>®</sup>  
Family of Products

For a beacon of clarity in the otherwise cloudy landscape of fire-rated glazing, choose the FireLite<sup>®</sup> family from Technical Glass Products. Our new ultraHD™ Technology is clearly superior when compared to other brands. In fact, our website shines a light on the competition. See for yourself at [FIREGLASS.COM/HD](http://FIREGLASS.COM/HD)

The Clear Path to Safety.



- Fire ratings up to 3 hours
- High impact safety ratings
- UL listed and labeled

**TGP**  **FIRE RATED**  
one source. many solutions.®  
CIRCLE 112

**ultraHD™**  
**TECHNOLOGY**

# Beautiful, well-built furniture looking for beautiful, well-built spaces.

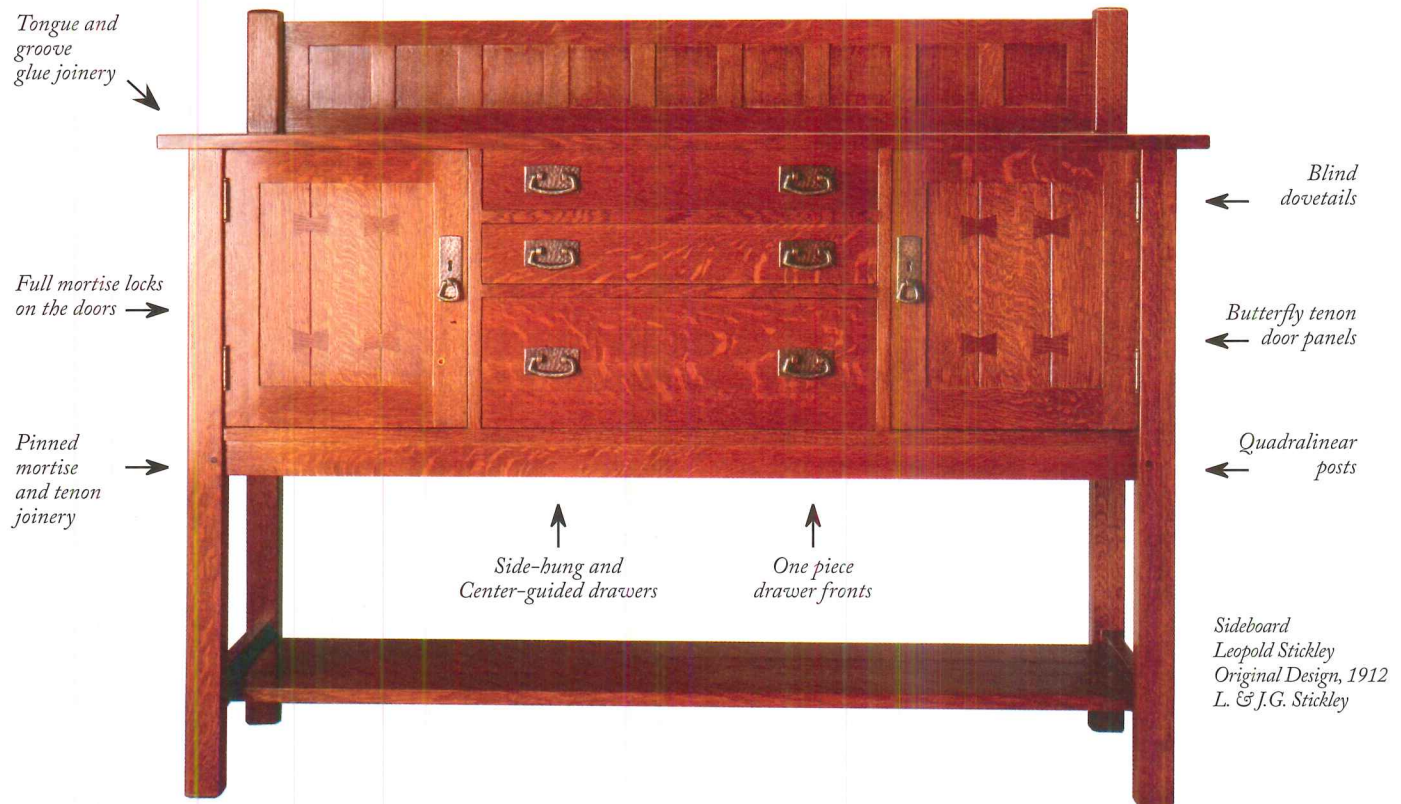

For more than 100 years, L. & J.G. Stickley has been setting the standard for furniture design, quality and craftsmanship.

Taken individually, Stickley's construction features are impressive. When they are combined into one remarkable piece of furniture, you begin to understand the real meaning of enduring value. Stickley's unique construction methods, superior materials, and timeless design combine to create furniture that's always stylish. ***That's the Stickley Difference.*** Learn more at our website: [www.stickley.com/difference](http://www.stickley.com/difference).

Stickley furniture is built to order, and many items can be customized to suit specific spaces and needs.

# STICKLEY®

SINCE 1900

FOR THE LOCATION OF THE STICKLEY DEALER NEAREST YOU, CALL 315.682.5500 OR VISIT STICKLEY.COM.  
L. & J.G. STICKLEY, INC., STICKLEY DRIVE, P.O. BOX 480, MANLIUS, NEW YORK 13104-0408



# ARCHITECTURAL RECORD



## 05 2011

### NEWS

- 34 **Why Souto de Moura won the Pritzker**
- 36 **Shigeru Ban offers aid to Japan**
- 38 **New Orleans redevelopment**
- 40 **On the Boards**

### DEPARTMENTS

- 22 **Community**
- 25 **Editorial: Being There (Virtually)**
- 45 **Commentary: The Future of Criticism**  
*By Christopher Hawthorne*
- 46 **Update: Make It Right** *By Shawn Kennedy*
- 58 **Books: Heroes & Villains**
- 63 **House of the Month: Horizon Houses**  
*By Ingrid Spencer*
- 69 **Product Focus: Walls** *By Rita Catinella Orrell*
- 72 **Products in Brief: 2011 Buckminster Fuller Challenge** *By Rita Catinella Orrell*
- 223 **Dates & Events**
- 240 **Snapshot: reOrder** *By Laura Raskin*

### FEATURE

- 83 **Good Design Is Good Business**  
The nine recipients of our annual awards program demonstrate how design can help boost revenue, minimize operational costs, increase sustainability, and improve employee morale.

### BUILDING TYPES STUDY 912

#### PARK PAVILIONS

- 147 **Ruth Lilly Visitors Pavilion, Indianapolis**  
MARLON BLACKWELL ARCHITECT *By Cheryl Kent*
- 152 **Dhoby Ghaut Green, Singapore**  
SCDA ARCHITECTS *By Clifford A. Pearson*
- 156 **Playa Vista Park, Los Angeles**  
MICHAEL MALTZAN ARCHITECTURE *By Sarah Amelar*

### LIGHTING

- 164 **Uniqlo, Shanghai**  
BOHLIN CYWINSKI JACKSON *By Clare Jacobson*
- 168 **Marc Jacobs, Tokyo**  
JAKLITSCH/GARDNER ARCHITECTS  
*By Naomi R. Pollock, AIA*

- 173 **LAPD Main Street Parking, Los Angeles**  
JOHN FRIEDMAN ALICE KIMM ARCHITECTS  
*By Linda C. Lentz*

### 176 Lighting Products

### PROJECTS

- 114 **New World Center, Miami Beach**  
GEHRY PARTNERS *By Victoria Newhouse*
- 122 **Orange Cube, Lyon, France**  
JAKOB + MACFARLANE *By Jenna M. McKnight*
- 130 **Masdar Institute, Abu Dhabi, UAE**  
FOSTER + PARTNERS *By Sona Nambiar and Joann Gonchar, AIA*
- 232 **Reader Service**

ABOVE: New World Center, Miami Beach, by Gehry Partners. Photo by Robin Hill.

ON THE COVER: Orange Cube, Lyon, France, by Jakob + MacFarlane. Photo by Roland Halbe.

Expanded coverage of Projects and Building Types Studies, as well as web-only features, can be found at [architecturalrecord.com](http://architecturalrecord.com).

This symbol denotes that enhanced content is available in our iPad edition.

# SEE ARCHITECTURE FROM A NEW PERSPECTIVE – YOURS

THE NEW *ARCHITECTURAL RECORD* iPhone APP

BROWSE OUR IMAGES.

UPLOAD YOUR OWN.

DOWNLOAD THE FREE APP AT THE ITUNES STORE.

Sponsored by

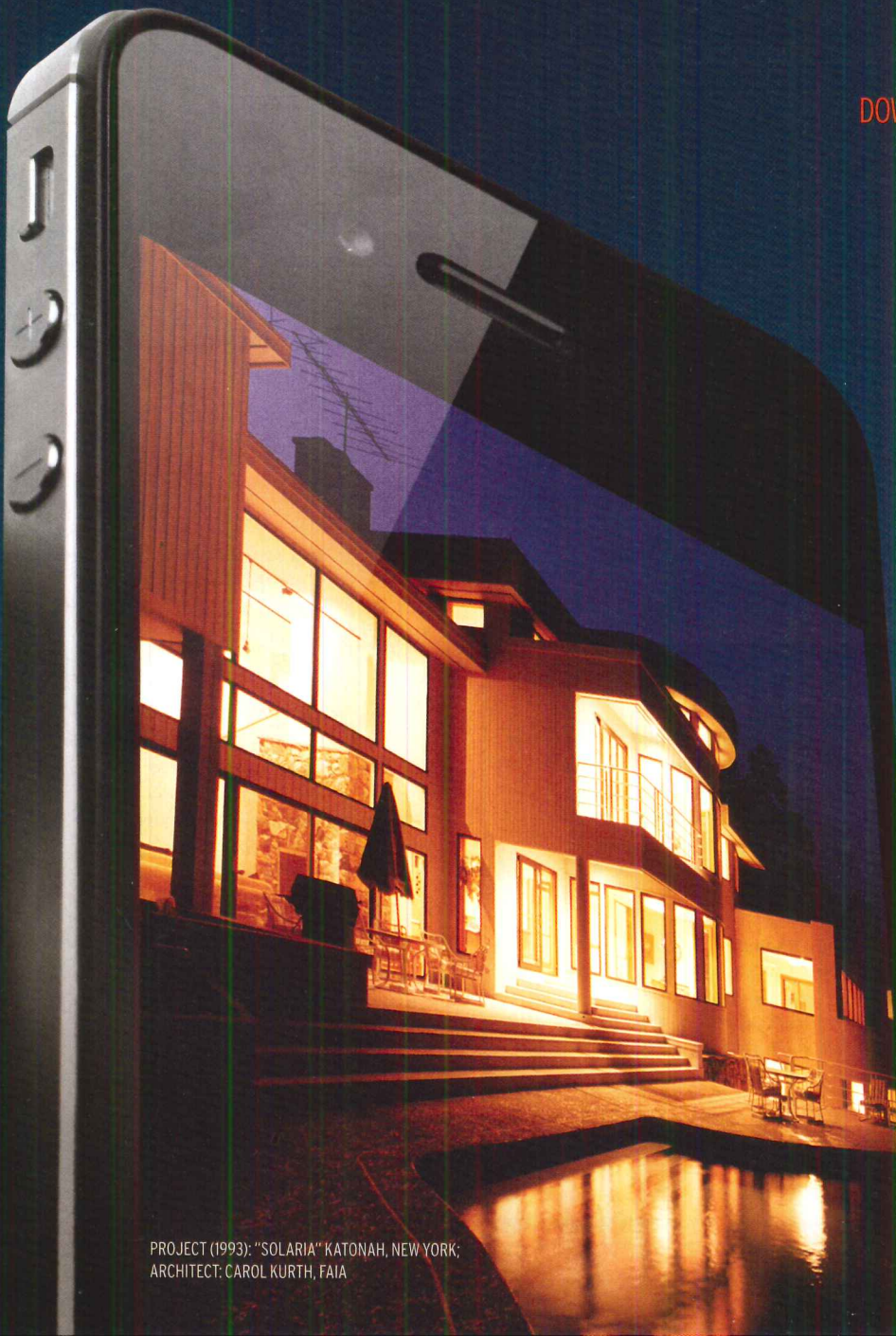

PHOTOGRAPHY: MARC JAFFEE

PROJECT (1993): "SOLARIA" KATONAH, NEW YORK;  
ARCHITECT: CAROL KURTH, FAIA

ARCHITECTURAL  
RECORD

The McGraw-Hill Companies

FINE INCHES

# ARCHITECTURAL RECORD

## Cocktail Napkin Sketch Contest 2011

# OFFICIAL ENTRY FORM

**Deadline July 21, 2011**  
**Enter now**

## Call for Entries

If you are a licensed architect or related professional who practices in the United States, you can enter this remarkable contest.

All you need is a white cocktail napkin and pen to demonstrate that the art of the sketch is still alive. Two grand prize winning submissions will be published in the October issue of Architectural Record and winners will receive a box of napkins with their sketch printed on it.

Grand prize winners will also receive a collection of **Pentel Arts writing instruments** valued at more than \$200. Up to ten finalists receive a collection valued at more than \$100. Winners and finalists will be seen in the online Cocktail Napkin Sketch Gallery.

### HOW TO ENTER:

- For Cocktail Napkin sketch, think about unleashing your creative genius within about 20 minutes.
- Sketches are to be drawn specifically for this competition.
- Sketches should be architecture oriented.
- Create a sketch on a 5-inch-by-5-inch white paper cocktail napkin.
- Use ink or ballpoint pen.
- Include the registration form below or from the website.
- You may submit up to 6 cocktail napkin sketches, but each one should be numbered on the back and include your name.
- No digital entries and no digital files accepted!
- No entries will be returned.
- The architect maintains the copyright for the drawing.
- Judges for this contest are Architectural Record Editors.
- All materials must be postmarked no later than July 21, 2011

## TWO Grand Prize WINNERS!

For more information and official rules visit [www.architecturalrecord.com/call4entries](http://www.architecturalrecord.com/call4entries)

Competition sponsored by



### CENTRIA

Architectural Metal Wall  
and Roof Systems

Prizes sponsored by



**SEND ALL SUBMISSIONS  
IN ONE ENVELOPE TO:**

Cocktail Napkin  
Sketch Contest  
Architectural Record  
Two Penn Plaza, 9th Floor  
New York, NY 10121-2298

For more information,  
email: [ARCallforEntries@mcgraw-hill.com](mailto:ARCallforEntries@mcgraw-hill.com)  
with the subject line: Cocktail Napkin



NAME OF ARCHITECT

FIRM

ADDRESS

NUMBER OF YEARS IN PRACTICE

TELEPHONE

EMAIL

### What is your job function? (check one)

- ARCHITECT       DESIGNER       FACILITIES MANAGER  
 SPECIFICATION WRITER       CONTRACTOR       OTHER

**Are you registered?**       YES    NO

**Are you an AIA member?**       YES    NO

When you register for the contest, your personal contact information provided on the registration form is added to an electronic mailing list so that we can select the winner. We may share the data collected about entrants with other units within The McGraw-Hill Companies and with companies whose products or services we feel may be of interest to you.

For more information on McGraw-Hill Construction's privacy policy see:  
[www.construction.com/privacypolicy.asp](http://www.construction.com/privacypolicy.asp)

*The winning designs may be used for promotional purposes.*

The McGraw-Hill Companies



The  
Clear  
Solution

Visit us at Booth 1634 at the AIA Convention

www.aia.com

1-800-368-5848

1-800-368-5848

1-800-368-5848

1-800-368-5848

1-800-368-5848

1-800-368-5848

1-800-368-5848

1-800-368-5848

1-800-368-5848

# SuperLite

F I R E R A T E D G L A S S

Advanced fire rated glass with superior clarity and performance for every application.



SuperLite II-XL 60-120



SuperLite II-XL 45



SuperLite I-XL



SuperLite I

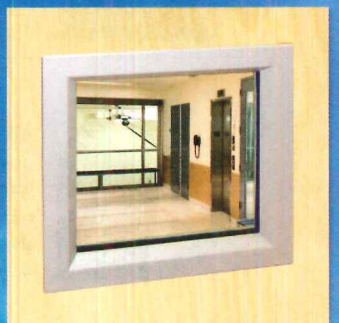

SuperLite X-90

 **SAFTIFIRST™**



Register online for "Designing with Fire Rated Glass" and receive 1 AIA LU/HSW credit



Proudly made in the USA.

WWW.SAFTI.COM • 888.653.3333

CIRCLE 102

# LEARN & EARN

Earn all your continuing education credits free online at Architectural Record's Online Continuing Education Center!\*

## IN THIS ISSUE



Photo courtesy of Modernus

### Room For Luxury and Energy Efficiency: Hospitality Goes Green

Credit: 1.00 HSW/SD

**MODERNUS**

**Henry**  
#1 CHOICE OF PROFESSIONALS

**THE SLIDING DOOR COMPANY**  
The signature choice for today's architect

PAGE 205



### Fire-Rated Glass and Framing Deliver Design Goals

Credit: 1.00 HSW

**TGP** FIRE RATED  
one source. many solutions.™

Photo courtesy of Technical Glass Products

PAGE 183



### Nature & Nurture

Credit: 1.00 HSW/SD

**NanaWall**  
Grand Transformations

Photo courtesy of NanaWall Systems Inc.

PAGE 189

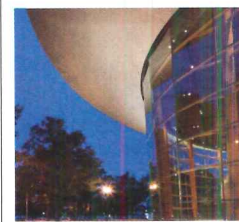

### Materials In Action

Credit: 1.00 HSW/SD

**naturally:wood**

Photo by Nic Lehoux, courtesy of Bing Thom Architects

PAGE 195



### Cool Roofs for Hot Projects

Credit: 1.00 HSW/SD

**CRRC**  
COOL ROOFING RESEARCH CENTER

Photo by Sam Fentress, courtesy of HOK

PAGE 201

## ON ARCHRECORD.COM



### Integrating Solar Electric Systems into Roofing Design

Credit: 1.00 HSW/SD

**JMEco.**  
The JMEco-Leadership™ Company

Photo courtesy of Johns Manville Corporation



### NEW Touchless and High Capacity Dispensers: Healthier, more efficient source reduction restrooms with a wave of the hand

Credit: 1.00 HSW/SD

**GP** Georgia-Pacific Professional

Photo courtesy of Georgia-Pacific Professional



All exams are available at no charge and are instantly processed. You will know immediately if you have earned credits and you will be able to print out your certificate of completion instantly. **You can access these and many other continuing education courses for free online at archrecord.com.**

Earn Free Health Safety Welfare (HSW) and Sustainable Design (SD) credits with Architectural Record

\*All Architectural Record articles and presentations count toward the annual AIA continuing education requirement



**LIMBURG** Collection

LED Downlights  
surface, semi-recessed and pendant mounted

**BEGA** sets the standard

[www.bega-us.com](http://www.bega-us.com)  
(805) 684-0533

No. 149

## COMMUNITY

FEEDBACK, CONTRIBUTIONS, AND COMMENTARY FROM OUR READERS  
[ARCHITECTURALRECORD.COM](http://ARCHITECTURALRECORD.COM)

### CALL FOR ENTRIES UPDATES

- > 2011 RECORD INTERIORS
- > 2011 RECORD KITCHEN & BATH PORTFOLIO

SELECTED PROJECTS WILL BE FEATURED IN THE OCTOBER 2011 ISSUE. ENTRIES MUST BE POSTMARKED BY JUNE 1.

TO DOWNLOAD A SUBMISSION FORM: VISIT [ARCHITECTURALRECORD.COM](http://ARCHITECTURALRECORD.COM) AND CLICK ON "CALL FOR ENTRIES" AT THE BOTTOM OF THE HOME PAGE.

#### [ READER PHOTOS ]



Commenters were largely positive about this year's Pritzker Prize going to 58-year-old Portuguese architect Eduardo Souto de Moura, rather than to one of his better-known contemporaries, but a few questioned why the high-profile award went to a comparatively low-profile designer.

A few recent submissions to our residential gallery have shown designers working with unusual programs – including a 9th-floor lobby and communal space in a multifamily New Orleans project by Eskew+Dumez+Ripple (left) and Prentiss Architects' weaving studio adjacent to a residence on a rocky site on Washington's San Juan Island (bottom).

#### [ COMMENTS AND LETTERS ]

The architecture of Souto de Moura...engages the soul and the senses without the contemporary rhetorical trickiness of spectacle and ornamentation.

—Anonymous

A visit to the Braga Soccer Stadium is on my bucket list.

—Robert A. Harris

If you are unfamiliar with his full body of work, study his book in the Ten Houses series. The "intimacy and poetry" mentioned in the Pritzker jury's citation abounds in the images published there. The prize is most certainly well deserved.

—Anonymous

It's so encouraging to see the Pritzker go to an architect of substance (again)! Some people like it loud and boisterous, but I love the nuances this architecture gives us.

—Anonymous

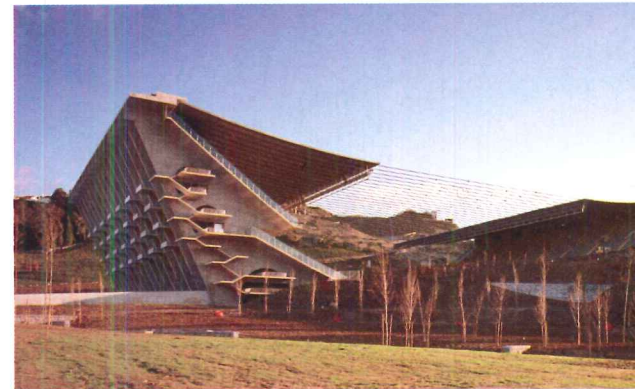

Eduardo Souto de Moura's Braga Stadium in Portugal

With the possible exception of the stadium, his work looks as if it came directly from the mid-20th century. Considering the man is not even 60, the architecture doesn't look fresh at all. I'm not looking for "flavor of the month" — I just want to see stuff that looks era-appropriate rather than prematurely aged.

—Anonymous

If 18 slides of his work don't do it justice, I think the wrong selection was made. You could show 10 slides of Holl or Chipperfield and feel it was a justified decision.

—"jmorschl"

Seems to me he won the world's most prestigious prize for one beautiful stadium, one pretty good museum, and a bunch of utterly mundane structures.

—Anonymous



The Etch-A-Sketch product name and configuration, and the Etch-A-Sketch product, are registered trademarks owned by The Ohio Art Company.

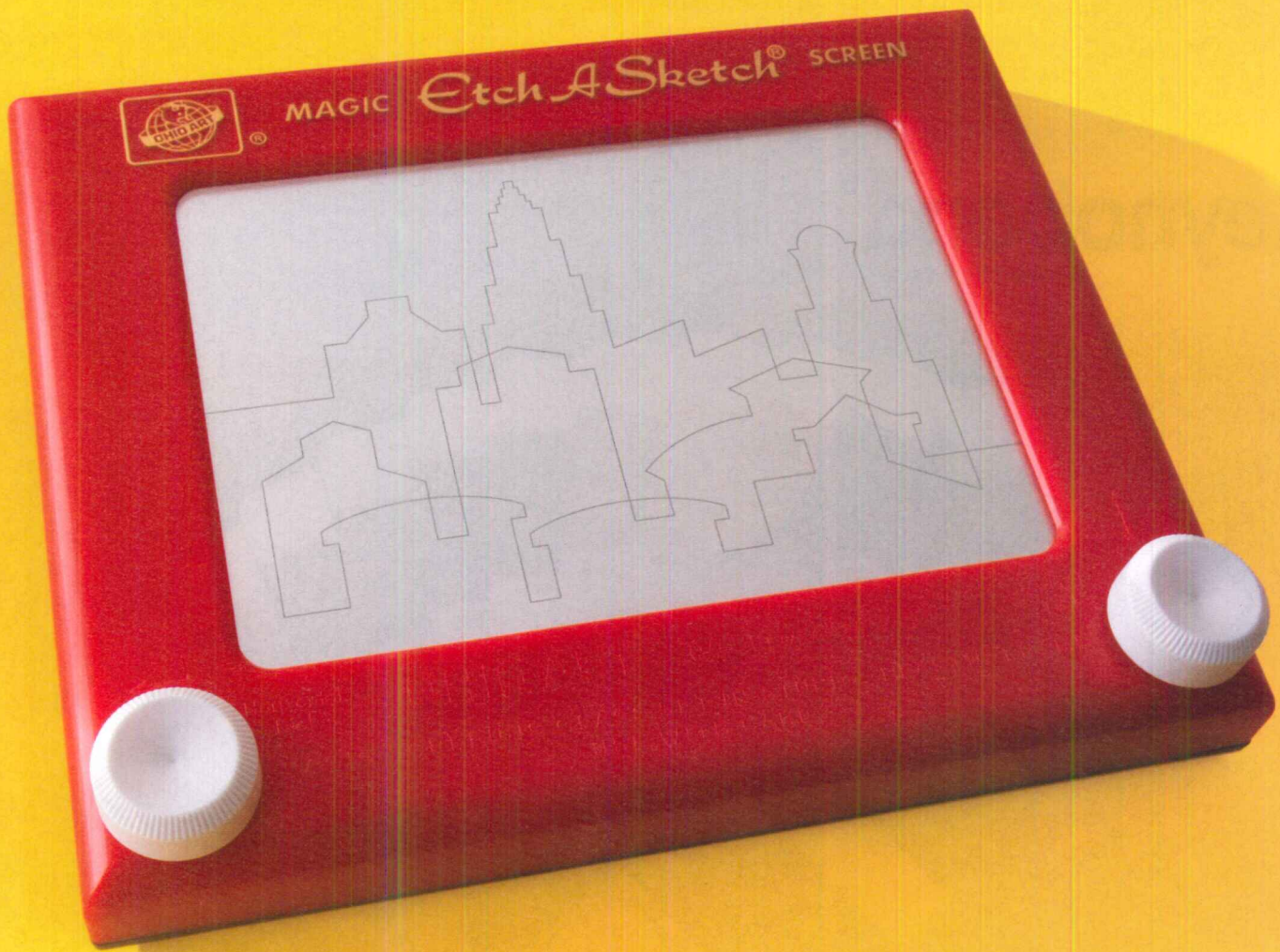

**PELLA ADVANTAGE NUMBER 204:**  
A LONG LINE OF COMMERCIAL SUCCESS.



Draw from Pella's generations of commercial fenestration expertise. Call **888-217-3552** to request your **FREE** *Pella Commercial Products Guide*, or visit [pellacommercial.com/cpg](http://pellacommercial.com/cpg) and see how we've helped leading commercial architects and general contractors meet their project, application and budget needs since the 1940s. The wood, fiberglass and vinyl products, plus the technical support you need to make your mark. That's **The Power Of Yellow.**<sup>®</sup>



COMMERCIAL

# Reynobond® Architecture



## Nature. Now available in aluminum.

At first glance you'd swear it's really mahogany. Or granite. Or copper patina. Reynobond® Design Line is a breakthrough line of Colorweld® DL paint finishes so realistic they're virtually indistinguishable from nature's own creations. Each finish provides environmentally sensitive architects with the ability to incorporate eco-friendly, cutting-edge materials without sacrificing style or quality. It's another example of Excellence in Innovation from Alcoa that can help you make an impact on our world.



## Being There (Virtually)

Techniques for conveying the experience of architecture are more sophisticated. Can they supplant the act of visiting a building?

**WITH ALL THE** available means to see buildings – through printed publications and images on the web, tablet (iPad, Android), or even better, videos, it may seem as if you don't need to actually visit a building to know what it's about. At the same time that electronic media enhance the visual experience, of course, digital advances allow more complicated buildings to be constructed. Architects such as Zaha Hadid, Steven Holl, and UNStudio, to name a few, have been enabled by certain clients and circumstances to experiment frequently with ceiling, wall, and floor planes that tilt, volumes that rotate, and spaces that swell and shrink dramatically. Architectonic results that engage a variety of senses – the kinesthetic, the haptic, as well as the optical – have always existed in architecture. But the new crop of buildings makes a strong argument why it's essential now, more than ever, to visit the site.

Obviously, experiencing architecture firsthand is best. Nevertheless, since ARCHITECTURAL RECORD started publishing in 1891, it has tried to come as close as possible to being there, through words and photos in print, and now also on the web and with video. And not only photographers and videographers visit the buildings. RECORD's writers and editors also need to see the work of architecture in person to better convey through words what it is like to be in and move through its spaces over a period of time. We go there not to conduct a functional checkup – just as important – but because spaces worth living in and looking at go beyond function.

The actual experience isn't easy to approximate, since it involves a kinesthetic perception, where your muscles in your feet and legs send messages about perceiving space to your brain, and where your haptic sense allows you to mentally measure yourself in relation to objects, as if you were touching them. Needless to say, they both enhance the optical sense data forming your visual perception of the built work.

That said, today the recreation of the actual experience is much closer to the real thing than it was when RECORD first started. In its early years, the magazine's critics, such as Montgomery Schuyler and Russell Sturgis, wrote about buildings as visual experiences, and, more often than not, as if looking at two-dimensional compositions, like paintings on a wall. Schuyler, for example, critiqued New York's Bayard Building by Louis Sullivan (1899) seemingly standing across the street, gazing at the front of the 13-story high-rise embedded in the middle of a crosstown block.

As architecture began to radically change, and buildings grew to astonishing heights, Schuyler's point of view changed as well. It was no longer so fixed. In the early 20th century, skyscrapers looming over the rest of the city could be seen from all sides. In writing about New York's 57-story Woolworth Building by Cass Gilbert (1913) for RECORD, Schuyler analyzed it

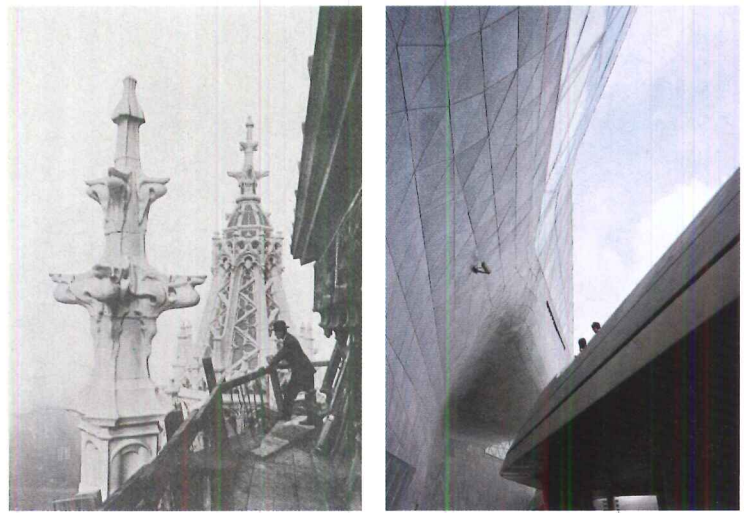

The view from the 51st floor of Cass Gilbert's Woolworth Building in New York, seen in RECORD in 1913, was riveting (left). The view from Zaha Hadid's Guangzhou Opera House in China is arresting for different reasons.

from afar, mid-distance, and even close-up. The critic argued that the Gothic-style ornament of the balconies projecting into space provided a sense of human scale in relation to the overall size of the tower. The photographs by Tebbs-Hymans published alongside Schuyler's story captured the three-dimensional quality of the work. They illustrate how printing techniques constantly improve the representation of architecture: In fact, RECORD's first editor in chief, a young poet, Henry W. Desmond, brought innovations in photographic reproduction to our publication.

Writing, in addition to photos and video, clearly helps tell the story. Although the spatial experience of architecture is hardly new, theorizing about it didn't get underway until the Modern era, particularly in 19th-century Germany. The ideas on empathy of Robert Vischer, spatial perception of August Schmarsow, and later the phenomenology of Edmund Husserl offer a few salient examples of this orientation. Did any of these theorists, particularly the earlier ones, influence RECORD's critics way back when? Hard to know. But ideas could have been in the air. Already architects, such as Frank Lloyd Wright, were emphasizing spatial concepts in buildings and essays. (Wright began writing for RECORD in 1908.)

By the early 20th century, building technology was making possible a more expressive form of architecture that brought together the connection between building and theory: Erich Mendelsohn's Einstein Tower in Potsdam (1921) may not have used reinforced concrete, but its swirling forms held the promise of a spatial potential we could later find in the concrete of Frank Lloyd Wright's Solomon R. Guggenheim Museum in New York (1959), or Eero Saarinen's TWA Terminal at JFK (1962), both blatantly kinesthetic, haptic, and visual architectural experiences.

The computer has certainly allowed that process of design and construction to go further, as have the improved techniques for making glass, steel, concrete, and plastic. The structural glass balconies at the Ledge at Skydeck at Chicago's Willis Tower by Skidmore, Owings & Merrill (page 98) offer a modern-day counterpoint to the Woolworth Tower balconies, enabling visitors to survey the city in a more immersive (or vertiginous) way. Hadid's Guangzhou Opera House in China provides an example of today's experiments in shifting and tilting planes and volumes. RECORD still seeks to represent that feeling of being in these environments by all the means at its disposal. It can't be a substitute for being there. But in a global age, it's a worthwhile supplement. – *The Editors*



**New Solarban® R100 solar control, low-e glass.  
A better glass for a better environment.**



Clean lines. Clean look. Clean conscience. It's a lot to expect from an ordinary piece of glass. Then again, Solarban® R100 solar control, low-e glass is about as far from ordinary as you get – thanks to a Solar Heat Gain Coefficient of .23 and a neutral-reflective appearance that lets your building put its best face forward. And you'll really be surprised by the extraordinary energy savings you can expect with Solarban R100 glass. To get your copy of the white paper, go to [ppgideascales.com/SBr100](http://ppgideascales.com/SBr100).



CIRCLE 94

*IdeaScapes*<sup>™</sup>  
Glass • Coatings • Paint

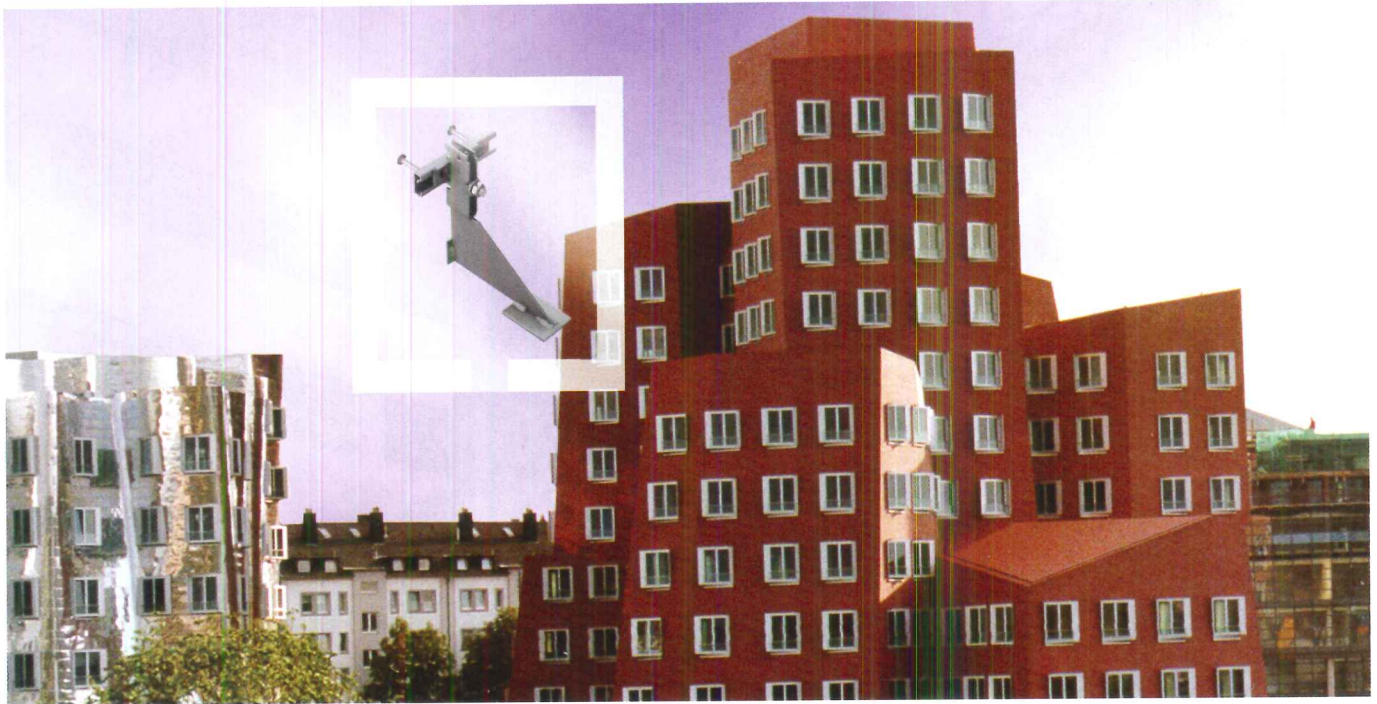

# Makes anything look good.

With the proven HALFEN HK4 brickwork supports, your brickwork façade will look its best for a long time to come.

**H**ALFEN HK4 brickwork supports transfer the dead load of the outer skin of brick to the building load-bearing structure: a modern and efficient construction principle developed with the experience from over 70 years of fastening technology.

#### Adjustment

The HALFEN HK4 brickwork supports have continuous height adjustment of  $\pm 1\frac{3}{8}$ " and are therefore perfectly suited for compensating existing tolerances of the structure or installation inaccuracies of wall anchors.

#### Economical

Through the classification into load levels 785 lbs, 1,570 lbs and 2,360 lbs, the HALFEN HK4 brickwork supports allow extremely efficient anchoring of brickwork façades in connection with HALFEN cast-in channels.

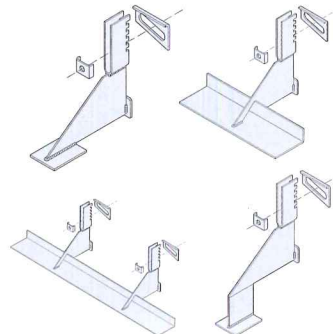

#### Quality

By using HALFEN HK4 brickwork supports, you profit from a type-approved anchoring, excellent adjustment options and a complete product program covering all aspects of facing brickwork.

*Many advantages with one result: HALFEN provides safety, reliability and efficiency for you and your customers.*



Halfen Anchoring Systems · Meadow Burke Products · PO Box 547 Converse, TX 78109 ·  
Phone: 800 323 68 96 · [www.halfenusa.com](http://www.halfenusa.com) · [info@halfen.com](mailto:info@halfen.com)

# EPIC Metals Roof and Floor Deck Ceiling Systems

EPIC Metals' structural roof and floor deck ceiling systems are designed to maximize architectural possibilities and creative potential. Long span capabilities of 10–55 feet are intended to define a building's envelope with unique appearance options and a high degree of interior acoustical control.

**EPIC**<sup>®</sup>  
METALS CORPORATION

877-696-3742 Toll-Free  
[www.epicmetals.com](http://www.epicmetals.com)

San Jose Airport Terminal B, San Jose, CA  
Architect: Gensler, in association with  
Steinberg Architects, San Francisco, CA



CIRCLE 42

Wideck<sup>®</sup> WPA





## Ceramic Tiles of Italy. A natural beauty.

Choosing Italian tiles is a question of style. Beauty alone is no longer enough, you have to create harmony which is beauty and respect together. The beauty of a product of superior technical quality along with respect for working conditions and the environment.



## Ceramic Tiles of Italy

*For more information, please contact: Italian Trade Commission – Ceramic Tile Department – 33 East 67<sup>th</sup> Street – New York, NY 10065-5949 – ph (212) 980-1500 – fax (212) 758-1050 – newyork@ice.it*  
Ceramic Tiles of Italy, promoted by Confindustria Ceramica, is a registered trademark of Edl.Cer. S.p.a., the organizer of CERSAIE,  
International Exhibition of Ceramic Tile and Bathroom Furnishings – Bologna, Italy, September 20-24, 2011 – www.cersaie.it





SURFACE  
MOUNTED  
DISPENSER



AUTOMATIC,  
CONVERTIBLE  
MODULE



BUILDING VALUE SINCE 1906

## Automatic, convertible, universal... very green.

New B-3974 automatic, universal roll towel dispenser eliminates long-term proprietary paper purchasing contracts, saving 30% or more. Adjustable towel length, time delay, second activation and stub roll utilization reduce paper consumption and waste. Complies with US EPA Reduce & Reuse Resource Conservation Initiative. Surface-mounted and semi-recessed models available. Removable towel dispenser module allows conversion to folded towels. [www.bobrick.com](http://www.bobrick.com).

# DRIVABLE GRASS®

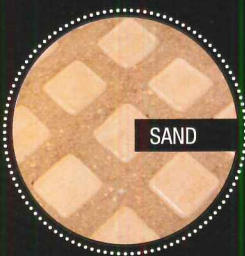

SAND



SOD

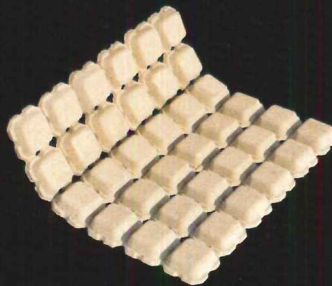

SEED

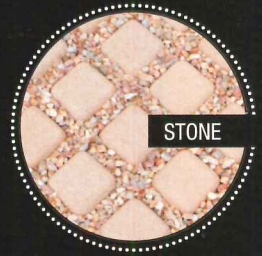

STONE

Drivable Grass® offers a simple and reliable solution to **storm water management** through **bio-filtration**, **infiltration**, and **storage** while not sacrificing valuable site area. The thin-profile, permeable, and flexible concrete paving system promotes superior **root penetration** and **moisture containment** beneath the product resulting in **healthy turf**. Drivable Grass® is designed to **flex** and **conform**. It does not crack and break like rigid concrete or pop up and wear like plastic paving.



## SOIL RETENTION

Plantable concrete systems®

[www.soilretention.com](http://www.soilretention.com)

8 0 0 - 3 4 6 - 7 9 9 5

CIRCLE 109



## The next generation of fire-rated glass is clearly beautiful. Fingerprints not included.

PYRAN® Platinum fire-rated glass-ceramic has pushed beyond fire and safety requirements for a truly beautiful look and feel.

It's in a class by itself. PYRAN® Platinum glass-ceramic is the only fire-rated glass that's as clear, as colorless and as smooth as window glass. It's also the only fire-rated glass-ceramic to be Cradle-to-Cradle® silver certified by MBDC. PYRAN® Platinum meets UL requirements and is fire-rated for 90 minutes in windows and 180 minutes in doors. PYRAN® Platinum is easy to get your hands on through our distributors, local fabricators and glaziers. To learn more about PYRAN® Platinum fire-rated glass-ceramic, call us at 502-657-4417 or visit us at [www.us.schott.com/pyran](http://www.us.schott.com/pyran).



**SCHOTT North America, Inc.**  
Phone: 502-657-4417  
[pyran@us.schott.com](mailto:pyran@us.schott.com)  
[www.us.schott.com/pyran](http://www.us.schott.com/pyran)  
©2011 SCHOTT North America, Inc.

© PYRAN Platinum is a registered trademark  
of SCHOTT AG, Mainz, Germany

CIRCLE 104



**SCHOTT**  
glass made of ideas

BY DAVID COHN

## [ AWARDS ]

## Why Souto de Moura Won the Pritzker

## THE PORTUGUESE ARCHITECT

Eduardo Souto de Moura has won the 2011 Pritzker Prize. While he is largely unknown in the United States and has built little outside of Portugal, his understated Modernist works have been widely published in European journals, and he has been an influential teacher at the University of Porto, among other schools. The selection of Souto de Moura confirms the Pritzker's commitment in recent years to the more subtle values of craft, local scale, and sensibility over architectural extravagance.

Based in the northern city of Porto, Souto de Moura, 58, was overshadowed in his early career by Alvaro Siza, the 1992 Pritzker winner, for whom he worked for five years and with whom he remains close (the two have collaborated on several projects and their studios share a Siza-designed building in Porto). But over the last decade, Souto de Moura's work has evolved from a Miesian vocabulary into a distinctive style of his own.

His Courtyard Houses in Matosinhos, near Porto, completed in 1999, with their high walls and interior courts and gardens, look like closed warehouse blocks from the outside and adhere to the

severe restraint of Mies van der Rohe's court-house typology. But in more recent works, including the 2004 Braga Soccer Stadium, the 2007 Burgo Tower in Porto, and the 2009 Paula Rego Museum in Cascais, all in Portugal, he has broken free from a strictly Miesian model without renouncing the strong, closed geometric forms, the honest use of materials, especially concrete, and the innate restraint of his early work, which allows his buildings to enter into dialogue with their surroundings.

Pritzker jury describes the architect's work as follows: "It is not obvious, frivolous, or picturesque. It is imbued with intelligence and seriousness. His work requires an intense encounter, not a quick glance. And like poetry, it is able to communicate emotionally to those who take the time to listen."

In giving the prize to Souto de Moura, the Pritzker jury, headed by Lord Peter Palumbo and including previous laureates Renzo Piano and Glenn Murcutt, continues the trend marked by the two previous years,

**The 58-year-old architect works primarily in Portugal. His notable projects include the Paula Rego Museum (2009) in Cascais.**

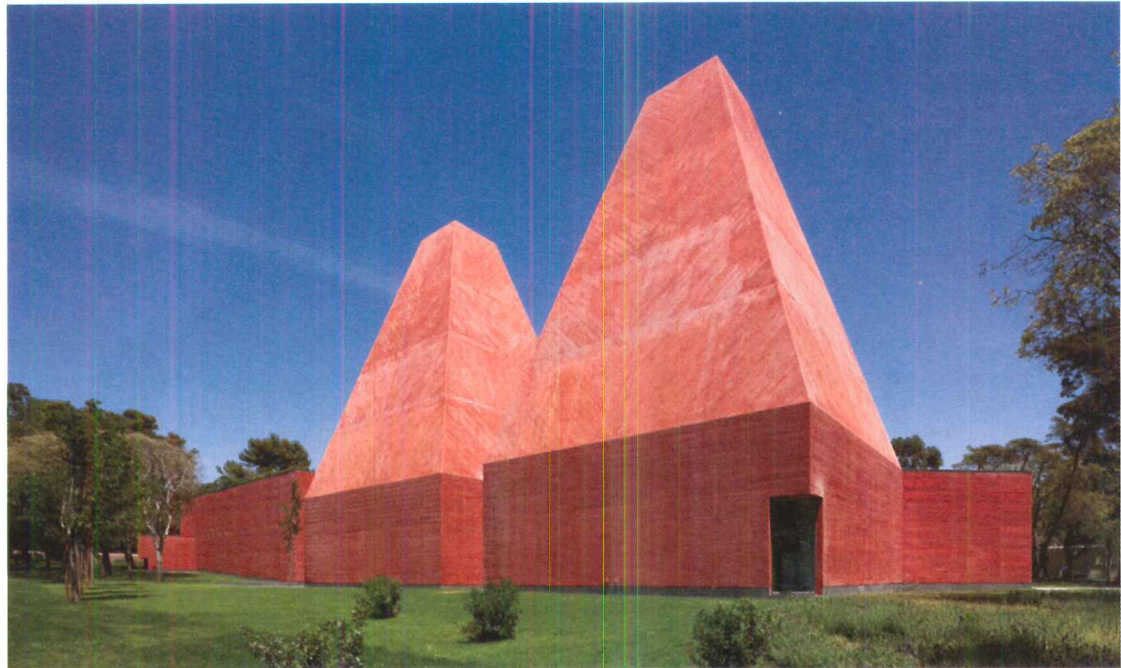

One of the first projects in which this expressive silence finds a powerful voice is his 1997 conversion of the ruined Portuguese monastery of Santa María do Bouro into a state hotel [RECORD, November 1998, page 120]. The finished building, I wrote at the time, "is full of echoes of its former abandon: the flat roofs overhung with bits of vegetation, the roofless cloister, the dark window openings, some with their sky-blue blackout shades drawn as if bits of sky could still be seen through the structure."

In a formal statement, the

when the award went to Swiss architect Peter Zumthor (2009) and the Japanese team of Kazuyo Sejima and Ryue Nishizawa (2010). The selection of Souto de Moura confirms the jury's promotion of architects who explore the more intimate and poetic qualities of architecture, as opposed to the extroverted formal experimentation that has marked the most conspicuous world architecture leading up to the financial crisis of 2008.

The jury's choice has surprised many, as it should if the Pritzker aspires to have any impact on the

public's perception of architecture or on the direction of the profession globally. The award also catches Souto de Moura at a crossroads in his development, at a time when he has begun to open his work to new dimensions, as the formal variety of his most recent projects demonstrates. It thus finds him at an ideal moment to make positive use of the worldwide attention it brings. ■

*David Cohn is RECORD's Madrid-based international correspondent and author of Young Spanish Architects (Birkhäuser).*

## WEB HIGHLIGHTS

- Weese Building in Aspen to Be Razed
- Serie Architects Finds New Use for Old Chinese Factory
- Nicholas Clark Architects Designs Haiti Hospital

## DAILY UPDATES

[archrecord.com/news](http://archrecord.com/news)  
[twitter.com/archrecord](https://twitter.com/archrecord)

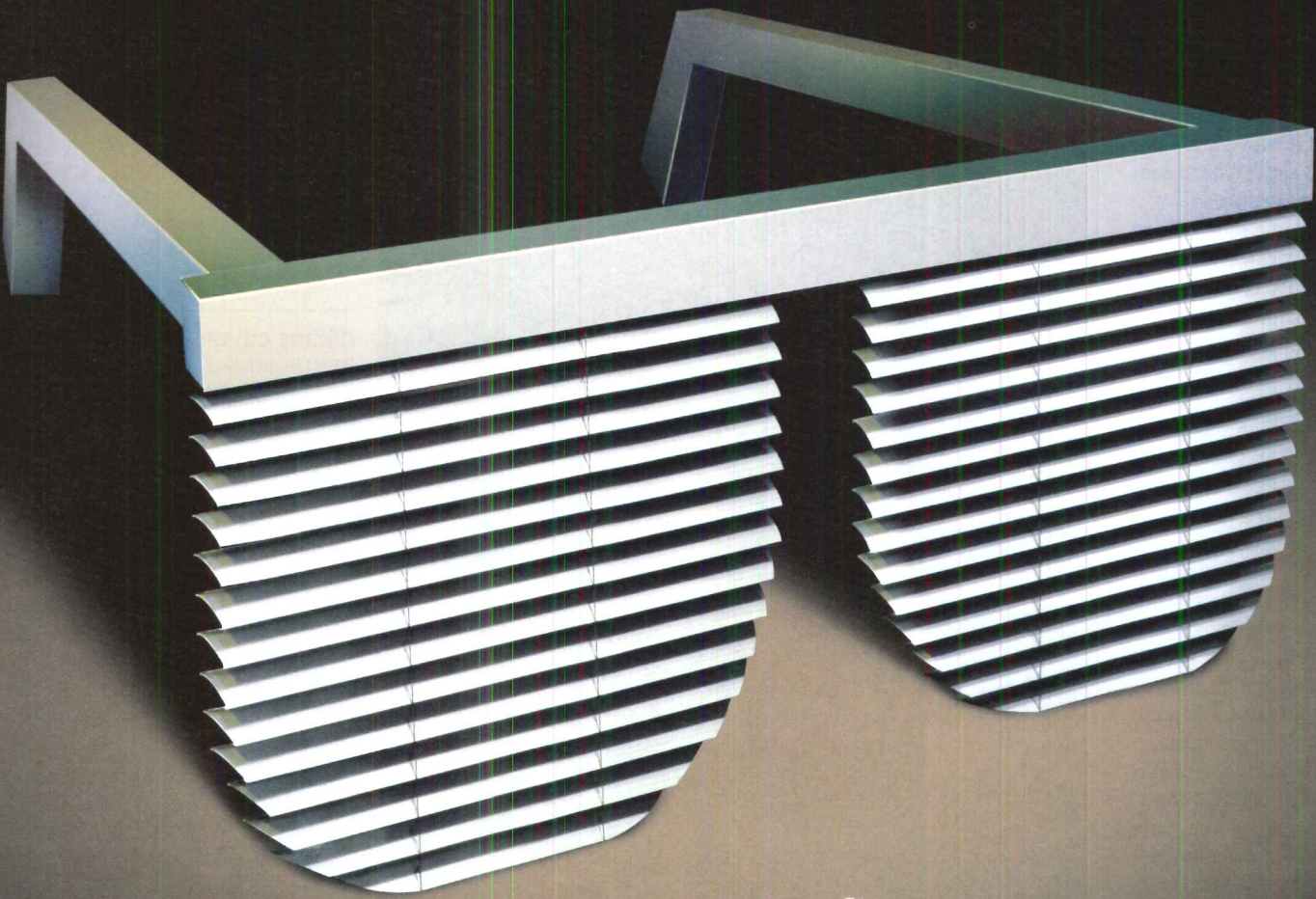

## Outfit your building with the latest solar heat gain reduction technology



**Introducing C/S Solarmotion® Architectural Blinds.** All the rage in Europe for decades due to traditionally high energy costs, C/S is pleased to bring this advanced technology to North America through an exclusive agreement with Warema, Europe's leading manufacturer. This system can reduce your building's solar heat gain coefficient by up to 90%, drastically lower your energy consumption and have a stunning effect on the look of your facade. The time is right. To learn more, visit [www.c-sgroup.com](http://www.c-sgroup.com), call 800-631-7379 or find Construction Specialties on [f](#), [in](#) or [t](#).

**See us at the AIA Convention, booth #1427.**

**CS**™ **Solarmotion**  
Architectural Blinds

CIRCLE 25

## [ DISASTER RELIEF ]

## Shigeru Ban Offers Aid to His Native Japan

For quake and tsunami victims left homeless, simple shelters help ease discomfort.

"I HAVE BEEN to disaster areas all over the world," says Shigeru Ban. But never had the Japanese architect and veteran relief worker seen the degree of devastation that struck his homeland on March 11, 2011. The 9.0-magnitude earthquake, followed by the massive tsunami that crashed down on 311 miles of coastline, left thousands of people dead or missing and many more homeless. "This tsunami was incredible," says Ban. "It came nine minutes after the earthquake, so there was no time to escape."

As in Haiti, Sri Lanka, and other countries where he has helped out, Ban immediately went to the disaster site and identified a need that was not being met by government agencies or nonprofit groups. While evacuation centers quickly sprang up in gymnasiums and other large structures throughout the blighted region, many were crowded and had little provision for much-needed privacy – a condition that will continue for months, until the government completes temporary homes for the victims. In response, Ban devised a curtained partition system to shield individual families.

Ban's first foray into partition design followed the 6.8-magnitude Kobe earthquake that shook neighboring Niigata Prefecture in 1995. His latest partitions, a simplified version of his original system, are made from paper tubes of three different diameters – large for columns, medium for beams, and small for joints – that fit together without any additional parts, aside from tape to seal the connections. White canvas sheets attached to the frame and held together with safety pins provide coverage. Though adjustable, each unit easily conceals the 161-square-foot area typically allotted per family.

Ban, paired with his students from Tokyo, loaded the disassembled parts into a van and headed north to several evacuation centers



in late March. Their mission was to demonstrate how the system works and convince authorities of its value. Manufactured and sourced in Japan, the units can be delivered quickly and directly to the relief centers, where Ban's students work with local residents to assemble the partitions. Though authorities at some shelters placed orders to cover nursery and changing rooms only, others, such as the mayor of Yamagata City, requested one

apiece for each of the 250 families currently staying in the municipal sports center.

Funded exclusively by donations from around the world, each unit costs \$300. But Ban isn't concerned about financing at the moment. "I have to continue to build [partition systems], as many as are needed," he says. "The money will come later." For more information and to make a donation, visit [www.shigerubanarchitects.com](http://www.shigerubanarchitects.com). ■

**ONLINE COVERAGE:  
REBUILDING JAPAN**

- ▣ Urban Planner André Sorensen Discusses Rebuilding Challenges
- ▣ Foreign Designers Mobilize to Help Devastated Country
- ▣ Japanese Architects Comment on Aftermath

1. Emergency centers set up in gymnasiums and other large structures offer little privacy.
2. Ban conceived a partition system made of paper tubes and canvas sheets. It is a simplified version of the system he designed in 1995.

*Naomi R. Pollock, AIA, is RECORD's Tokyo-based international correspondent and coauthor of New Architecture in Japan (Merrell).*

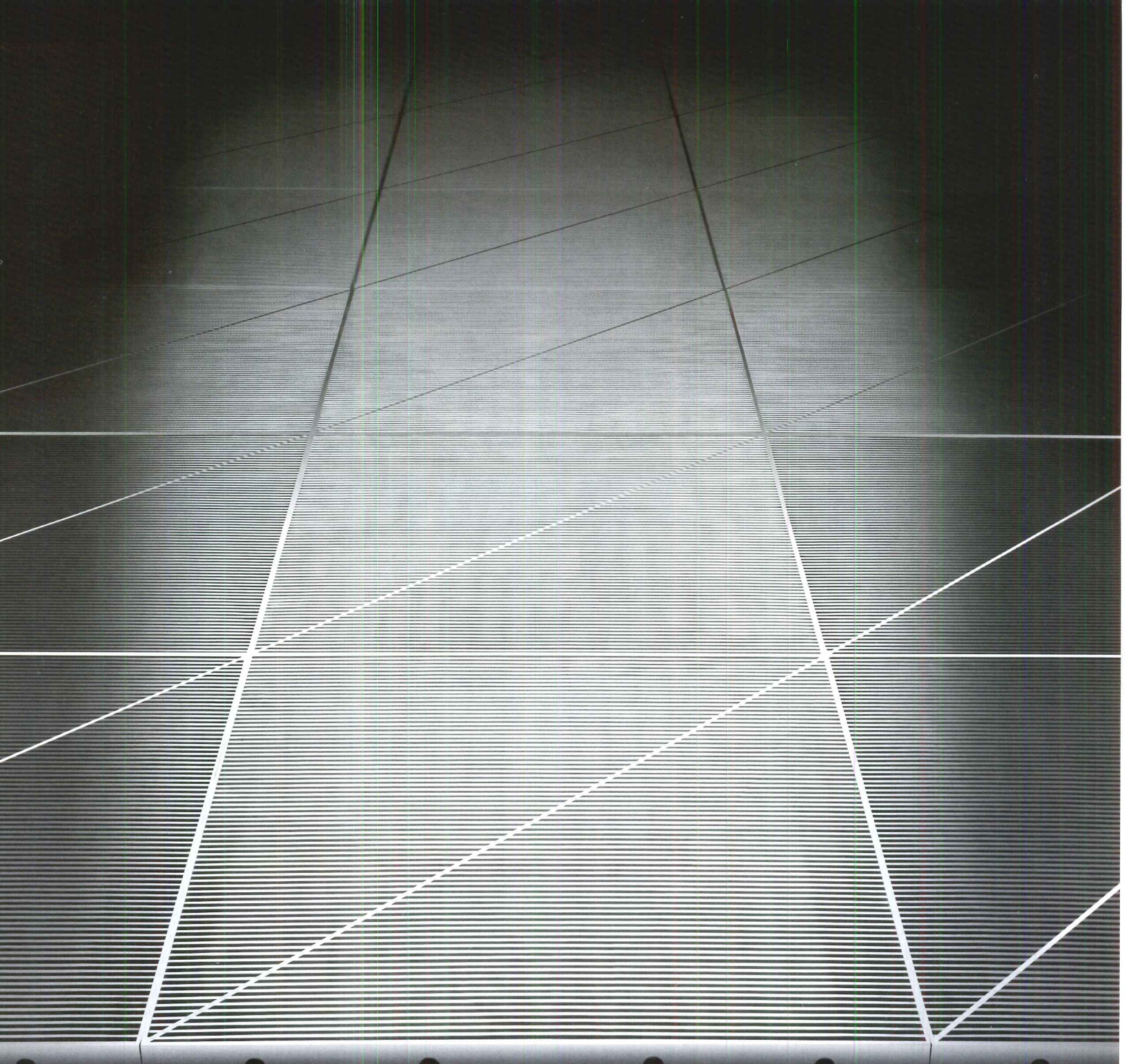

**We've changed  
the rules**

Architects asked us to develop new flooring options for their entrances. **New Floorometry® 101 entrance flooring** takes the stainless steel entrance grid to a whole new level by adding geometric accents that provide visual interest while aiding in the removal of water and debris from shoes. Choose from dozens of geometric designs or work with us to create your own. Call 888-621-3344, visit [www.c-sgroup.com/floorometry](http://www.c-sgroup.com/floorometry) or find Construction Specialties on [f](#), [in](#) or [t](#).  
**See us at the AIA Convention, booth #1427.**

 **Floorometry®**

CIRCLE 24

## [ REBUILDING ]

## Do-It-Yourself New Orleans

**EVEN BEFORE HURRICANE** Katrina's floodwaters were pumped out of New Orleans, the nation's top urban planners started weighing in on the devastated historic city's future.

Their motives were generous, but not exclusively so. The August 2005 catastrophe offered the planning community an unprecedented opportunity: Here was a chance to redesign a city from the ground up, in accordance with the most current thinking on livability, walkability, and sustainability. Post-Katrina New Orleans, the theory went, would be a laboratory for testing out big ideas.

Then came the green dots.

The green-dot map, as locals still call it, was a draft plan developed by Mayor Ray Nagin's Bring New Orleans Back Commission, under guidance from the Urban Land Institute. One of its central tenets was that New Orleans should be rebuilt for a reduced population, with homes and services grouped together, and some areas converted into flood-retaining parks and ponds. Green dots indicated zones that might not get rebuilt (most were low-lying districts prone to severe flooding). When the map appeared on the front page of the *Times-Picayune* in January 2006, it incited a furious backlash from people who saw their homes covered by those dreaded dots – written off, they felt, by insensitive out-of-towners and city officials who hadn't sought their opinions.

Nagin, who was up for re-election that spring, changed tack and decreed that no area would be off-limits from reconstruction, that development would follow the people, not the other way around, and that private property rights would rule. He called himself a "free-market guy," a philosophy that fit the new public mood, and also a convenient excuse for avoiding painful choices. The green-dot plan was never adopted.

There would be other plans over the years, some written specifically to unlock federal funding, some idealistic visions that the market couldn't support. Nagin was narrowly re-elected in 2006, and his most specific second-term attempt to guide recovery was a \$1.1 billion blueprint identifying 17 key redevelopment zones. Unveiled to tremendous fanfare in 2007 by outspoken recovery director Ed Blakely (who, in 2009, would resign), the plan suffered from a lack of funding and follow-through and quickly dissipated. Then there was the citizen-driven Unified New Orleans Plan (UNOP), also from 2007, which outlined various principles – that all neighborhoods have a right to exist and be protected from flooding, for instance, and that citizens should decide their communities' fate.



Retaining the essence of New Orleans' charismatic vernacular architecture, as seen above, has been a component of many post-Katrina redevelopment initiatives in the city.

UNOP carries no official weight, but it has informed much of what has happened in recent years, including the clustering of schools, community centers, and health clinics, and even the insertion of bike lanes along rebuilt roads.

There's no question that Nagin's free-market approach has left out many residents. Some have found themselves isolated amid blight, without the choices or information that a more formal plan might have provided. Yet many neighborhoods have thrived in the do-it-yourself environment.

Certain areas have gotten a major boost from outsiders. One such example is a development by Project Home Again, a nonprofit organization established by Barnes & Noble founder and chairman Leonard Riggio. The group didn't wait for the city's input. Instead, it started acquiring land in the Gentilly area in 2007 and enlisted local architect John Schackai and his firm, Sustainable Architecture, to design energy-efficient homes in a traditional bungalow style for displaced, moderate-income residents. Riggio's goal, says executive director Carey

Shea, is to "create a community." It appears he is succeeding: His organization has completed about 70 homes and aims to finish 30 more by this summer.

By the time Nagin's successor, Mitch Landrieu, took office in 2010, the redevelopment landscape had been set, so the new mayor's policies have focused more on problem solving than ground-up planning. Nearly six years after Katrina, the results of decentralized decision making can be seen all over the still-recovering city, in empowered neighborhood associations, in independent-run charter schools, even on those bike paths.

Steven Bingler, president of the planning and architecture firm Concordia and coordinator of UNOP, argues that the Nagin administration's laissez-faire approach to redevelopment actually worked out for the best. It allowed more organic planning to flourish, he says, and it "spawned a democratic revolution in New Orleans."

*Stephanie Grace, a political columnist at the Times-Picayune, has written extensively about rebuilding efforts in New Orleans.*



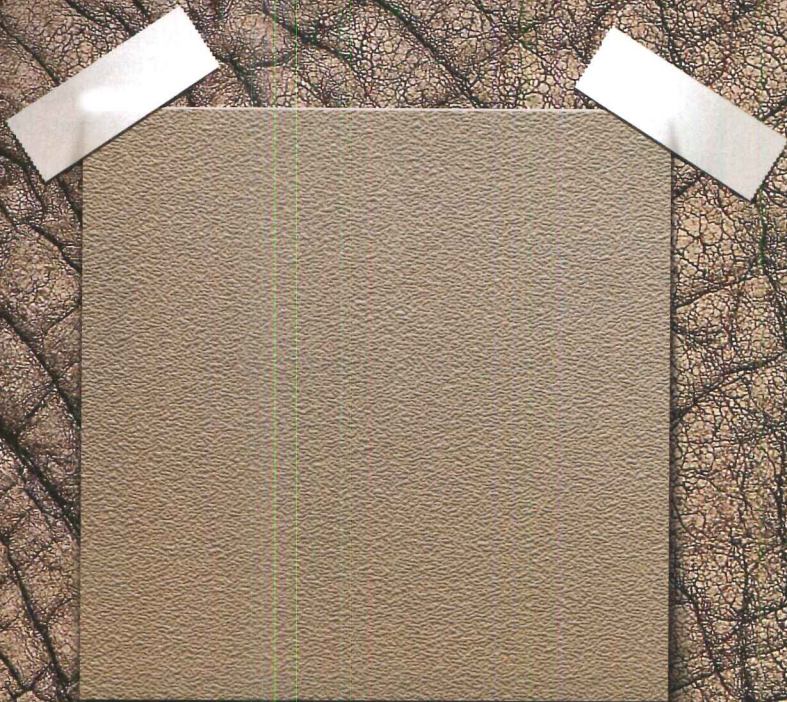

**Tough  
has a  
new look**



**Acrovyn® 4000.** Everyone knows Acrovyn Wall Protection is as tough as an elephant's hide, but it doesn't have to look like one. We've reengineered our entire line to create a contemporary new texture that designers and owners overwhelmingly prefer over original Acrovyn, not only for its good looks, but also for its ease of cleaning. And, our entire line is now free from PVC, PBTs and all chemicals of concern as certified by MBDC. To learn more about Acrovyn 4000, visit [www.c-sgroup.com](http://www.c-sgroup.com), call 888-621-3344 or find Construction Specialties on [f](#), [in](#) or [t](#) [twitter.com/acrovyn](https://twitter.com/acrovyn).  
**See us at the AIA Convention, booth #1427.**

**CS**™ **Acrovyn®** *Protection for tomorrow's environment*

CIRCLE 23

## ON THE BOARDS

**Project** Indian School of Business  
**Location** Chandigarh, India  
**Architect** Perkins Eastman

The Indian School of Business has hired Perkins Eastman, working with the local firm RSP Design Consultancy, to create its new 725,000-square-foot campus in Mohali, located on the edge of the rapidly developing Chandigarh metropolitan area. Designed to achieve LEED Gold, the complex comprises academic blocks and small courtyards covered by a canopy superstructure, with separate clusters of residential buildings. The project broke ground in April; an opening is slated for 2012.



**Project** Golden Dream Bay  
**Location** Qinhuangdao, China  
**Architect** Moshe Safdie

Moshe Safdie Architects has been tapped to design a 2,400-unit housing development in Qinhuangdao, a coastal city 200 miles east of Beijing. Inspired by Safdie's landmark 44-year-old Habitat 67 project in Montreal, the new complex is composed of large, stacked volumes that frame 20-story "windows." Construction is now under way and should be finished by 2014.

**Project** Liberty Plaza  
**Location** Mexico City  
**Architect** Richard Meier

Richard Meier & Partners has unveiled plans for Liberty Plaza, a complex of three 15-story towers in Mexico City's Santa Fe section, which is both a business and university district. One of the towers will serve as a 132-room W Hotel with a 50-foot-long rooftop pool. The other two towers will contain offices, with stores and restaurants at their base, and will be joined at ground level by a conference center. The project is set to break ground this summer, with an expected 2013 completion.



# DEFYING

## New Architects Enlisted for Languishing Sagaponac Development



LEFT TO RIGHT: Designs by Di Cicco Vinci Architects, Hanrahan Meyers Architects, and David Biagi Architect.

**HOUSES AT SAGAPONAC** was a project for a robust economy. In 2001, the late Harry Brown Jr. recruited Richard Meier to help lure architects, many of them famous, to design 32 modern, high-end residences for a 72-acre plot of land in the town of Southampton, on Long Island, New York. Brown was hoping to beat back the traditional, shingle-style mansions cropping up in the area.

But one decade and one recession later, only eight have been built (by Tsao & McKown, Keenen/Riley, Shigeru Ban, and others) and seven of those have sold, with prices ranging from \$2.5 to \$4.5 million. Brown died in 2005, and the property is now owned by the general contracting firm Reinhardt, O'Brien, Oza + Company (R,O'B,O,Co) and the developer Millennium Partners, along with David Hamamoto, CEO of NorthStar Realty Finance Corporation.

Hoping to reinvigorate the project, the owners have hired

a new batch of firms to conceive fresh and less costly schemes (although the original designs are available if a buyer is willing to pay for them). The 16 firms include Brooklyn-based Thread Collective, Los Angeles-based XTEN Architecture, and New York-based Cook + Fox Architects.

The new designs will be marketed only until September before the owners move on to Plan B: host an open competition and invite architects from around the globe to upload concepts for the vacant lots. The competition website is scheduled to launch on September 21.

While details have yet to be worked out, a group of jurors will select a collection of designs. Buyers will then be able to choose a scheme and work with (and pay) the architect, explains Nilay Oza, project architect and R,O'B,O,Co partner. "We are at a place where either this project dies," he says, "or it pivots to face a new reality." *Laura Raskin*

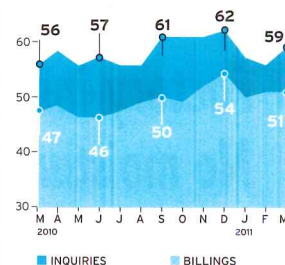

## ABI Hovers at 50

The Architectural Billings Index has barely moved in recent months, hitting **50.0 in January, 50.6 in February, and 50.5 in March.** Kermit Baker, the AIA's chief economist, says market conditions across the country vary, "with some firms reporting an improving business environment and even ramping up staffing, while others continue to operate in survival mode." The March inquiries score was 58.7.

# LONGSPAN

Working with leading architects worldwide to design, engineer and construct the finest examples of long span tensioned membrane structures, since 1956.

BIRD AIR

birdair.com

# GRAVITY

**SLENDERWALL**® a 30 lbs/sf *award-winning* architectural precast and steel-stud exterior panel system

**Factory-installed windows and R-42 foam insulation**  
**No moisture or air infiltration - Guaranteed!**

**The Most Technologically Advanced  
Performance-Oriented Exterior Cladding Available**

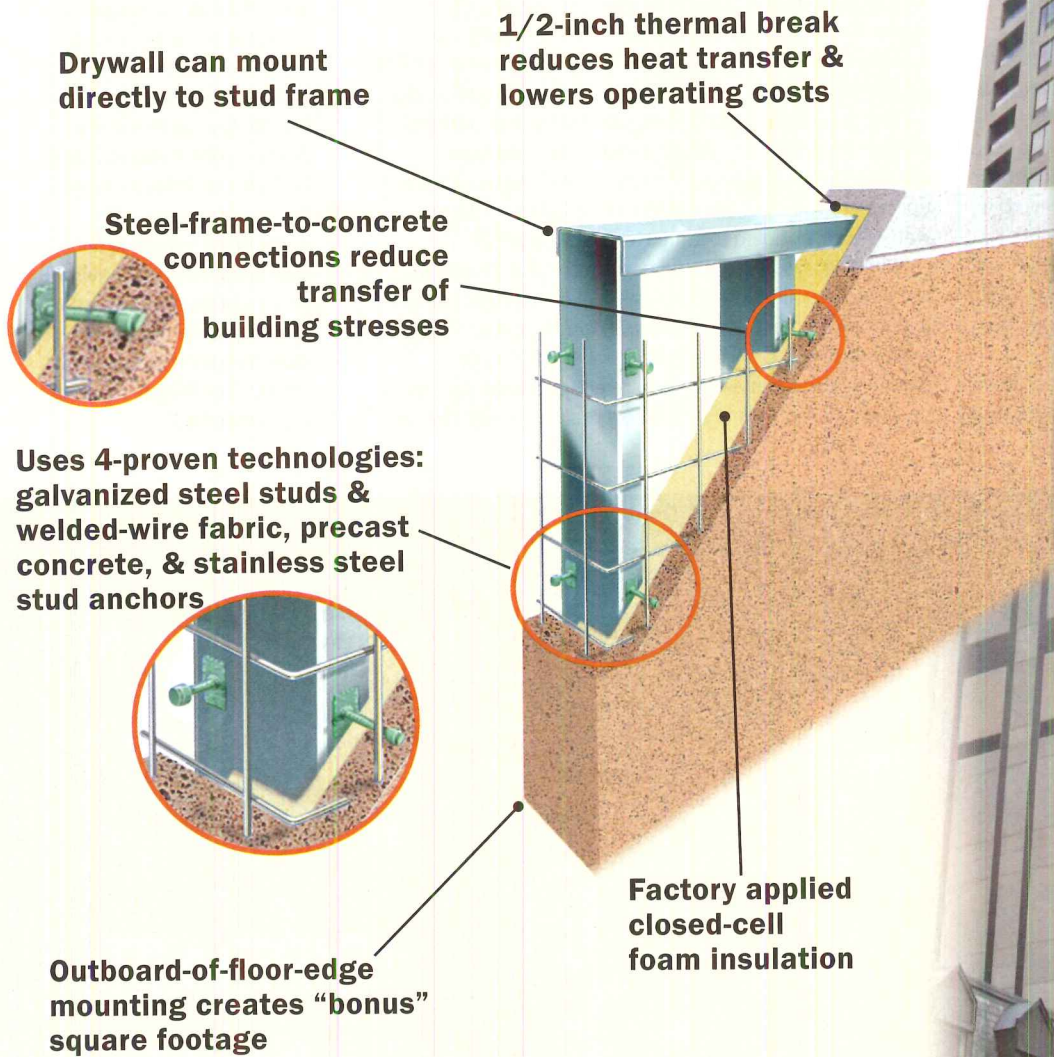

See our portfolio of projects online...

**AR.slenderwall.com**

800.547.4045 infoar@slenderwall.com

Hilton Garden  
Montreal, Canada

Architect: Geiger & H



SLENDERWALL® is a product of Easi-Set® Worldwide, licensor of precast products and a wholly-owned subsidiary of publicly traded Smith-Midland (DE). ©2011 CIRCLE 39

**SLENDERWALL**



Enhance Your **CREATIVITY**

## Eco-ficient™ Grand H Series

Our newest offering, the Eco-ficient™ Grand H Series, provides both flexibility and function with its attractive aesthetic appeal and energy efficiencies. This horizontal insulated wall panel is available in a variety of colors and panel widths and, when desired, can be used with Eco-ficient™ vertical panels to achieve an architectural masterpiece. To learn more about how the Eco-ficient™ Grand H Series can enhance your design, visit [www.mbc.com/enhancing](http://www.mbc.com/enhancing).



**MBCI**  
Metal Roof and Wall Systems  
[www.mbc.com/enhancing](http://www.mbc.com/enhancing)

Houston, TX (Corporate) 877-713-6224 | Adel, GA 888-446-6224 | Atlanta, GA 877-512-6224 | Atwater, CA 800-829-9324 | Dallas, TX 800-653-6224 | Indianapolis, IN 800-735-6224  
Jackson, MS 800-622-4136 | Lubbock, TX 800-758-6224 | Memphis, TN 800-206-6224 | Oklahoma City, OK 800-597-6224 | Omaha, NE 800-458-6224 | Phoenix, AZ 888-533-6224  
Richmond, VA 800-729-6224 | Rome, NY 800-559-6224 | Salt Lake City, UT 800-874-2404 | San Antonio, TX 800-598-6224



## INTRODUCING ALUCOBOND® COOL

From the makers of the world's leading ACM comes a new, cool paint finish technology offered in a broad spectrum of colors that provides higher solar reflectivity, potential energy savings and reduced air conditioning costs.

With proven environmental advantages over non-cool finishes and products, cool technology already qualifies for LEED credits in roofing applications, and similar certifications are expected for its use in vertical applications.

For more information or to request samples, call your Alucobond representative or visit [AlucobondUSA.com](http://AlucobondUSA.com).

### ALUCOBOND®

Alucobond® is a registered trademark of 3A Composites USA, Inc.  
©3A Composites USA, Inc. 2011. All rights reserved.

800.626.3365  
[AlucobondUSA.com](http://AlucobondUSA.com)



## COMMENTARY CHRISTOPHER HAWTHORNE

### WHAT HAPPENS TO ARCHITECTURAL CRITICISM WHEN DAILIES SHRIVEL AND BLOGGERS TAKE OVER?

**IN 1998, THE** British critic Martin Pawley rather dramatically announced what he called “the strange death of architectural criticism.” Pawley lamented the disappearance of an aggressive, “take-no-prisoners” approach to critical writing about architecture, which he felt was being replaced by “wall-to-wall testimonials of praise.”

I wonder what Pawley, who served as architecture critic for both the *Guardian* and *Observer* newspapers and died in 2008, would say about the state of the field today, particularly in this country. If the praise, at least for certain celebrity architects, has grown even more over-the-top, the number of critics has also dramatically declined since his piece appeared.

The years since 1998 brought wave after wave of consolidation, buyouts, and layoffs in the newspaper business. At American dailies, there are fewer than a dozen writers covering architecture with any regularity, and perhaps just four or five full-time critics.

As a member of that shrinking fraternity – I joined the *Los Angeles Times* as architecture critic in late 2004 – I can attest that the field is undergoing a radical transformation keenly felt even by those of us whose official titles haven’t changed. It is not just that our numbers have fallen, but that the way we go about our jobs has been reconfigured by the digital age. There was no Twitter in 1998, no Facebook, and no iPad; newspaper websites were a mere shell of the overstuffed catalogue of links, video, ad banners, and breaking-news alerts they are today.

At the same time, our deadlines are tighter now than ever, thanks to the split-second demands of Internet culture, which can make the cycle of daily journalism appear leisurely. The result is that our critical attention is now scattered across several platforms, as we write pieces for blogs and for the print edition

and then promote them via social networking, TV, and radio. And we find ourselves competing with bloggers, historians, videographers, and practicing architects, all of whom have taken advantage of these new conditions to produce a sort of criticism that didn’t exist even five years ago.

The quality of that criticism, as you might guess, is wildly uneven: for every blogger whose prose voice seems to have emerged fully formed, like Geoff Manaugh of BLDGBLOG, there are 10 others whose work – overlong, prone to self-absorption, and still struggling to get a handle on the it’s/its dilemma – appears to exist only to prove the old adage that it’s the editor who makes the writer.

And yet as much as this brave new multi-platform world can seem dizzyingly unpredictable, it has also brought with it new kinds of freedom and critical range. The truth is that American architecture critics – even, and perhaps especially, at beleaguered big-city dailies – are today writing about a richer variety of subjects and, thanks to the Internet, reaching more readers, than has ever been the case. Those readers, for their part, can now choose from a wide range of online criticism, from brief Twitter alerts to annotated photo galleries to long, carefully considered essays. And compared with architecture and design magazines, which – apologies to present company – rarely say a negative word about an architect or a building, most newspaper criticism remains quite pointed.

It helps, of course, to have forward-looking editors, or at least open-minded ones. My higher-ups at the *Times* have encouraged me to define my job in broad terms, to write about architecture proper but also about planning, green design, preservation, landscape architecture, real-estate power plays, and mass transit. In many ways my beat



is not simply architecture but the lives of cities. In a place like Los Angeles, which is still a fairly young and maturing metropolis and faces a series of fundamental questions in the coming years about just what kind of city it desires to be, that often feels like one of the most vital beats at the paper.

But is there such a thing as too much freedom? If any building can be assessed as a work of architecture, as Reyner Banham taught us decades ago, and if every platform is now capable of carrying criticism, from a video tour of a new museum to an old-fashioned 1,500-word essay in the Sunday arts section on the legacy of James Stirling, how does a critic decide?

If the critic does happen to generate a semi-novel, even potentially useful idea about an architect, a building, a stylistic movement, or a zoning change, where should that idea go, exactly? What form should it take? If you’re on Twitter, after all, that means you’re not working on that blog post you promised your editor, to say

nothing of that Stirling essay, now two days overdue.

As surprising as it might sound, I don’t know if I would trade our uncertain, fragmented world of criticism for the old one, which provided stability, to be sure, but also allowed critics a certain untouchable, privileged isolation.

As much as the blogosphere often turns crucial issues into soap-operatic fodder, it also keeps us honest to a degree that didn’t exist before. What has emerged is an architecture criticism less contemplative, perhaps, but more nimble – and better attuned to its audience, in ways good and bad. Martin Pawley might not recognize this new criticism right away, but even he, I think, would have to admit its heartbeat is plenty strong. ■

*Christopher Hawthorne is architecture critic for the Los Angeles Times, and coauthor, with Alanna Stang, of The Green House: New Directions in Sustainable Architecture, now in paperback.*

## UPDATE MAKE IT RIGHT

THE AMBITIOUS OPERATION INITIATED BY BRAD PITT IS GOING ON, WITH MORE HOUSES IN CONSTRUCTION. BY SHAWN KENNEDY

IT'S BEEN NEARLY three years since homeowners were given keys to the first group of new houses built in their storm-ravaged New Orleans neighborhood by actor Brad Pitt's Make It Right (MIR) foundation. But the project's architects and builders are still pushing the boundaries of modern residential design with cost-effective, sustainable, and storm-resistant construction techniques.

With 80 of the 150 houses planned now completed or being built, the neighborhood has evolved from a cluster of edgy architectural experiments that stood out—mirage-like—against their desolate surroundings, into a real neighborhood, with flags flapping in the breeze, flower beds, and toys on porches. To be sure, the new designs are as eye-popping as their predecessors. Their often-lively Caribbean-inspired colors add a layer of local tradition to the decidedly nontraditional look of this part of town.

The modern designs have taken their hits—mostly from outsiders. But even to New Orleanians who have never seen the houses in person or don't share the actor's taste in forward-thinking design, Pitt is a local hero. The actor did what government would not or could not do: He resuscitated a working-class neighborhood engulfed by water from a break in the Industrial Canal wall. Before Katrina, homeowners were underinsured or didn't have insurance at all. Now the houses have earned a celebrity following of their own. The MIR houses are even part of some commercial, post-Katrina sightseeing tours.

The project, in the city's Lower Ninth Ward neighborhood, has spurred more homeowners to rebuild without MIR's help. Still, the numbers are not yet high enough to bring badly needed retail development and services to the area, which



The Make It Right area after Katrina (top) has been transformed by new houses, shown in a June 2010 aerial photo (above).

seems like a city satellite.

In 2007 Pitt presented owners who lost their homes with a portfolio of designs by leading architects, saying, in essence, "Choose a design and your house will be built." With the architects providing designs free of charge and Pitt's foundation subsidizing the reconstruction, MIR hoped to build them for about \$150,000 each. They average 1,400 square feet and most have three bedrooms. While the first generation exceeded that budget, economies of scale have brought the costs down to about \$150 per square foot.

An original mandate for the designs was for vastly improved safety, with the highest LEED standards the budget would allow. To begin with, the houses were raised at least 3 feet. The first generation of structures (13 prototypes) included solar photovoltaic systems and groundwater heat pumps for both heating and cooling.

Among this group were those designed by Billes Architecture and Concordia, both New Orleans firms, along with KieranTimberlake of Philadelphia and GRAFT of Berlin and Los Angeles. Because of the narrow lots, most houses, such as ones by Billes and KieranTimberlake, resemble the shotgun-type

**Some Make It Right houses, designed by local and out-of-town architects, have been criticized for their modern designs. But the community is still growing, with first-generation houses embraced by occupants.**

indigenous to the region. However, Concordia and GRAFT also took visual and spatial cues from the deep porches and pitched roofs common to New Orleans architecture.

The blueprints for the second round include some duplexes, and innovations, such as SIP modular construction and advanced framing techniques, that have reduced materials, costs, and time.

Buyers had the option of tweaking the designs, and tweak they did. Some changes reflect personal taste, but more often they have been dictated by family circumstances or because the bells and whistles the architects envisioned cost too much.

John C. Williams, principal of the New Orleans firm Williams Associates, who is guiding the project, acknowledges that they have walked a fine line melding the architects' concepts with the buyers' needs and building costs.

"We've been talking to the architects as often as possible and I think we've been good stewards of their designs," Williams says.

KieranTimberlake, for instance,

designed its house to have elaborate metal art pieces fronting the porch and at the banister. But a less expensive railing was used.

The two-story house designed by Byron Mouton of Bild Design in New Orleans was to be among the first duplexes built. But the owners opted for a single-family residence with a small artist's studio replacing the second unit. Mouton's design, in step with the neighborhood's contemporary silhouettes, has a roofline that swoops dramatically from a single level in front to two stories in the rear. A side porch is sheathed with a metal screen providing shade and visual interest. Mouton's house was built by second-year students at Tulane University's School of Architecture, where he is a professor.

The duplex by Atelier Hitoshi Abe of Japan, constructed largely as designed, is inspired by the double shotgun, an iconic side-by-side residential style of the area. Departing from the design of the traditional static facade, Abe has carved a space out of the middle that dramatically distinguishes each unit and allows a front porch.

The tradeoff for the straightforward, boxy design by Adjaye Associates of London is a top level that serves as both a luxurious outdoor room as well as a rescue place in a worst-case scenario.

"We're improving our technique and cost savings with every house constructed here," says Williams. "But we are demonstrating that affordable, sustainable houses can be built anywhere." Indeed, Williams claims MIR houses now form the largest LEED-Platinum community in the country. Overall, the housing project initiated by Brad Pitt is still proceeding along its intended path. ■

*Shawn Kennedy is a former reporter for the New York Times who is now a freelance writer based in New Orleans.*





1. So far, 80 of the planned 150 houses in the Make It Right (MIR) development in New Orleans' Lower Ninth Ward have been built. A recently finished duplex by Hitoshi Abe of Japan has a double shotgun form common to the area. The two volumes are melded for this duplex, but carved out in the middle for the separate entries.
2. All houses are lifted at least 3 feet off the ground. For the first round of prototype schemes, KieranTimberlake of Philadelphia created a house layered with trellises for vines.



3. Houses average about 1,400 square feet in size. David Adjaye's London firm Adjaye Associates included a covered roof loggia in its design.



4. Concordia, a New Orleans firm, created a bungalow with peaked roof and wraparound porch typical of the vernacular.
5. Byron Mouton of Bild, a New Orleans firm, collaged two wedge-shape forms for a single-family house. The larger wedge slopes up to two stories at the rear and the smaller one provides a side porch enclosed by a meal screen.
6. GRAFT, an architectural firm with offices in Los Angeles and Berlin, created a prototype in the first round that refers in a nontraditional way to the shotgun-type house familiar to the region.



# VIVIDGLASS



VIVIDglass  
A FORMS+SURFACES<sup>®</sup> COMPANY

## Let Your Imagination Run Wild.

Enliven a space with color. Add pop with backlit displays. Make a dramatic opening statement. Let the look of stone surround you. Whether you're turning a conference room into a showplace or refreshing a restaurant lounge, VividGlass gives you countless ways to shape your creative vision.

Simply choose the VividGlass product that's right for you then let your imagination run wild. ViviChrome brings solid color to life. ViviGraphix gets your message across with color graphics. ViviForm takes a dimensional approach with textural patterns. And ViviStone unites the beauty of stone with the convenience of glass. Specify VividGlass on its own or incorporate it into a variety of F+S products, including LEVELe Walls and Elevator Interiors, Silhouette Railings, and Doors.



USE YOUR  
SMARTPHONE  
OR CODE  
READER TO  
LEARN MORE.

*Clockwise from top left: Backlit bar front in ViviStone, Honey Onyx; Office partitions in ViviChrome Scribe, Bright White, Magnetic; Room divider in ViviChrome, Chromis, custom color; Backlit wall panels in ViviGraphix Spectra, custom graphics; Partition door in ViviChrome Chromis, White, with Comet door pull.*



Member of the USGBC | Member of the EGBC  
LEED<sup>®</sup> Accredited Professional on Staff  
FSC Certified Supplier | SCS-COC-001461  
© 1996 Forest Stewardship Council A.C.

**FORMS+SURFACES**

offices worldwide | 800.451.0410 | [www.forms-surfaces.com](http://www.forms-surfaces.com)

Sign up for F+S new product announcements at [www.forms-surfaces.com/news](http://www.forms-surfaces.com/news)



Castore  
design Michele De Lucchi

**Artemide<sup>®</sup>**

*design innovation architecture*

Contact your local Artemide sales office for more information.

Toll free: 1-877-Art-9111 • [contractsales@artemide.net](mailto:contractsales@artemide.net) • [www.artemide.net](http://www.artemide.net)

CIRCLE 11

## Heroes and villains who have shaped our world over the years

**Architecture's Evil Empire? The Triumph and Tragedy of Global Modernism**, by Miles Glendinning. *Reaktion, 2010, 208 pages, \$28.*

Help! The sky is falling! Large ego-driven, eccentric, metaphoric buildings are raining down! Chicken Little? No, Miles Glendinning, director of the Scottish Centre for Conservation Studies, fretting about global capitalism and its effects on architecture.

In this picture-less polemic, the culprits are those buildings that many critics find superb, including

Glendinning's original sinner, the Sydney Opera House, and its evil cousin, the Guggenheim in Bilbao. These projects prove that domineering architects (and their clients) have no regard for users, cost, context, or social decorum. But I doubt Australians would feel better without the Opera House or Spaniards without the Guggenheim, no matter the cost overruns or troubles these buildings incurred.

The author laments the loss of a "hierarchy of decorum," and "values of collective cohesion," exacerbated by self-promoting "starchitects." As

with all polemics, there is some truth to this – for what would Wright's Guggenheim be without the consistency of Fifth Avenue? But I see little danger of being stampeded by a few excesses. Furthermore, Glendinning gives far too much credit (or blame) to those with star power. You cannot build without the acquiescence of many: building officials, zoning boards, funders, clients, and community. I am far more concerned with the proliferation of Kentucky Fried Chicken or McDonald's outlets than a few fantastic buildings.

While I'm not a fan of the most egregious examples in this book, I feel there must be room for the fringe designers, trendsetters, and intelligentsia who come with each new era. We have heard it all before. Tom Wolfe ranted against Modern architecture in his 1981 book *From Bauhaus to Our House*. The sky didn't fall. *Sam Davis*

**Triumvirate: McKim, Mead & White: Art, Architecture, Scandal, and Class in America's Gilded Age**, by Moseette Broderick. *Knopf, 2010, 608 pages, \$40.*

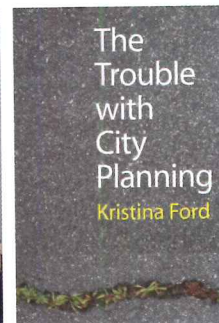
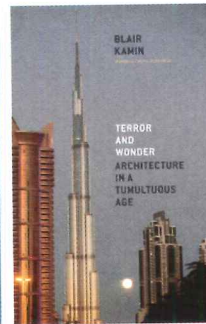
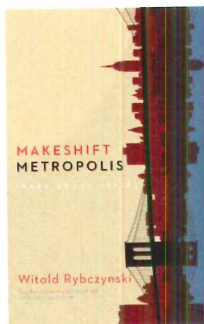
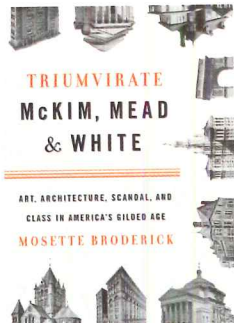
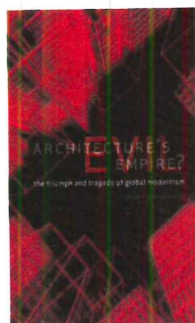

# Jump™

We just raised the bar. Again.

McKim, Mead & White changed American architecture at the turn of the last century, helping to usher in a renaissance of Beaux Arts public buildings and Colonial Revival houses. The firm dominated the so-called Gilded Age from the early 1880s until well into the 1920s, even though the major designers, Stanford White and Charles McKim, died in 1906 and 1909, respectively.

Since the firm has been extensively studied (including by this reviewer), with lots of attention focused on White's women and escapades, one might ask what more can be said. The author revisits the firm's scandals and brings up questions about White's sexual orientation and that of McKim, who suffered at times from severe depression. Also important for Broderick is the partners' social striving and the firm's patrons. In the end, *Triumvirate* is a social history of America's perhaps most famous architectural partnership.

Oddly, William R. Mead, the

business manager, is relegated to an appendix. More critical, many buildings are treated without illustrations or plans, a sad omission given the firm's spatial innovations. An important contribution, however, is the focus on forgotten members of the office, such as Joseph Morrill Wells and Sidney Stratton, who did lots of the design work and who, Broderick argues, helped change the stylistic orientation of the firm.

*Richard Guy Wilson*

**Makeshift Metropolis: Ideas About Cities**, by Witold Rybczynski.

*Scribner, 2010, 256 pages, \$24.*

It may be obvious where Witold Rybczynski is headed in *Makeshift Metropolis*, but it's a journey no less worth taking. Rybczynski's writing is erudite, entertaining, and engaging. It's the destination that leaves us wanting more.

Running through more than a century of urban planning philosophies, Rybczynski begins with the

Garden City and City Beautiful movements, then tackles Le Corbusier and Jane Jacobs. Finally, it's the Bilbao Effect – or, as he prefers, the Bilbao Anomaly – revitalized waterfronts, shopping centers, and suburbia. Though it's a long way from Ebenezer Howard and his quaint pronouncements to the exhaust-tinged environs of 21st-century sprawl, Rybczynski connects the dots admirably. Given that most North Americans now inhabit some form of suburb, it's not surprising he devotes much attention to the nonurban. But if this is reality today, it's one that depends entirely on the car. Which is why one can't help but wonder whether contemporary planning hasn't become above all a question of transportation. Even if we didn't face the unprecedented crisis of climate change, getting around by car has become more difficult than ever.

Rybczynski argues that the answer lies in alternate fuel sources. "If automobile manufacturers can

produce an affordable car that does not require gasoline – or uses considerably less," he writes, "the suburbs would get a new lease on life." That simply isn't true. Traffic volumes have reached the point of no return. Still, Rybczynski insists, "Effective planning should recognize that while the market is not always right, an aggregation of individual decisions is generally closer to the mark than the plans of willful urban visionaries." Perhaps, but wasn't it the market that created the problem in the first place? *Christopher Hume*

**Terror and Wonder: Architecture in a Tumultuous Age**, by Blair Kamin.

*University of Chicago Press, 2010, 304 pages, \$30.*

For Blair Kamin, Pulitzer Prize-winning critic for the *Chicago Tribune* and *RECORD* contributing editor, the story of architecture between 2001 and 2010 parallels and illuminates the story of the decade itself. In *Terror and Wonder*,

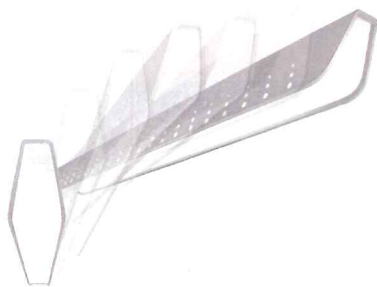
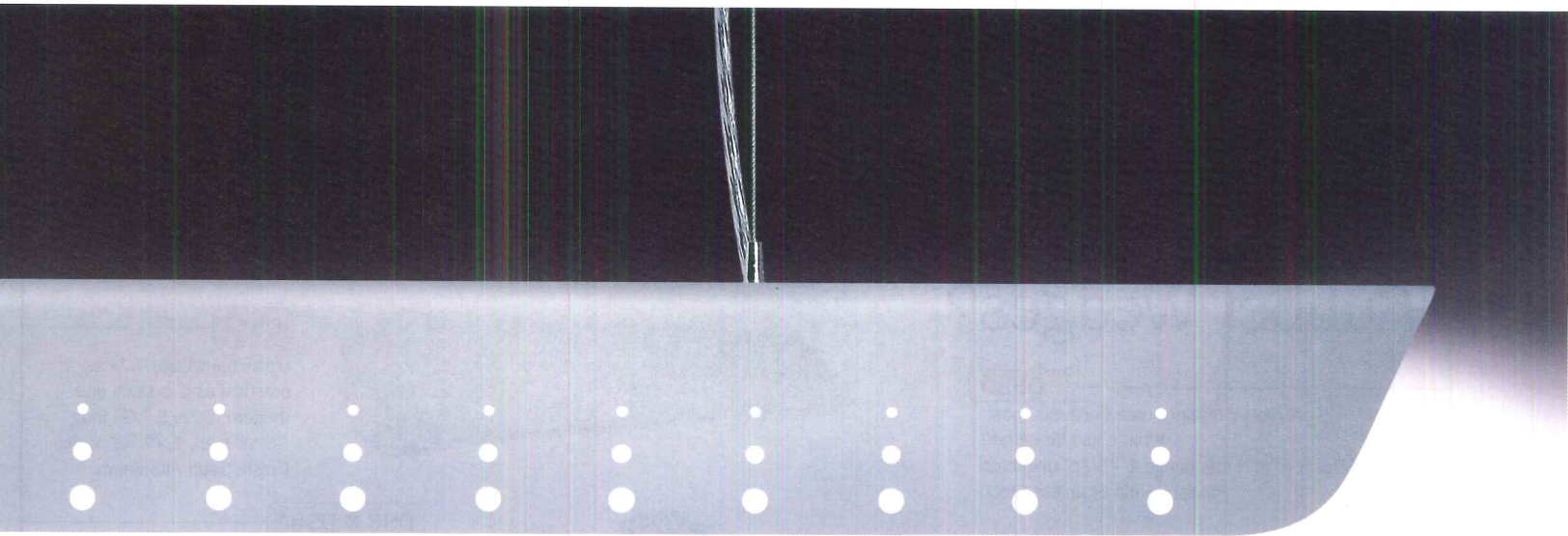

## Are you ready to make the leap?

**Jump™** is the first high performance architectural luminaire to integrate LEDs with innovative optics and advanced controls. Subtle textures and rhythmic patterns combine with revolutionary technology to create a seamless continuum of luminance.

[areyoureadytojump.com](http://areyoureadytojump.com)

CIRCLE 65

**PHILIPS**  
 **LEDALITE**  
 sense and simplicity

he spotlights architecture's central role in the decade's main events and trends: the devastating consequences of 9/11 and Hurricane Katrina; the emergence of energy conservation and green concerns; the real-estate boom and bust; growing nervousness about America's crumbling infrastructure.

Kamin brackets his essays with two mind-shifting events: the destruction of the Twin Towers and the completion in 2010 of the world's tallest tower, Dubai's Burj Khalifa. Both had enormous consequences on the public realm. He writes that overreaction to 9/11 and the terrorist threat resulted in measures that drained vitality from public spaces. But cities also attempted to duplicate the Bilbao Effect of Gehry's Guggenheim Museum, producing many wonderful public places, including Chicago's Millennium Park. We will always need iconic buildings, Kamin believes, but as a lover of cities, his focus is more on the everyday, background structures

that shape metropolitan areas.

Kamin ends his book by contrasting the sudden violence of 9/11 with the long-term neglect of America's infrastructure and public buildings – two very different sets of ruins. Repair, he believes, requires a new mind-set, one that grasps afresh that architecture isn't "just about aesthetics. It's a social art." Kamin, author also of *Why Architecture Matters: Lessons From Chicago* (2001), is, in the end, our most deeply humane critic. *Guy Horton*

**The Trouble with City Planning: What New Orleans Can Teach Us**, by Kristina Ford. Yale University Press, 2010, 288 pages. \$30.

Here's an interesting fact: virtually every New Orleans neighborhood that flooded after Hurricane Katrina happened to be built after the city had established a planning commission nearly a century ago.

This is mentioned in passing in Kristina Ford's *The Trouble With City*

*Planning*. But you have to admit, it puts a central question in stark relief: What exactly is it that city planners do?

Ford's answer is an engaging hybrid – part historical overview of the practice of planning nationwide, part case study of New Orleans, and part prescription for crafting what she calls, a little uninspiringly, "A Good City Plan." Ford brings considerable frontline experience to her task: she served as the director of New Orleans city planning for eight years in the 1990s, and she authored the well-regarded *Planning Small Town America* (American Planning Association, 1990).

Perhaps most compelling in her new book are the sections that look behind the curtain drawn across New Orleans' planning process, both pre- and post-Katrina. The city engaged in a sort of Planapalooza following Katrina, with as many as five city plans being trotted out in rapid succession. (Federal funds couldn't start flowing in earnest until the city

had approved a workable plan.)

Post-flood planning, Ford notes, basically came in two flavors: those with vision but no plan for carrying it out, and practical plans without a vision. Compounding these flaws was the fact that planners spoke one language (general) and the public and city council spoke another (specific). That is, non-planners pay attention to plans only when a neighborhood-changing project looms and supporters and opponents start swarming, each waving documents in support of their cause.

Ford suggests that for plans to be effective, they need to find a niche between vision and practicality, influencing leaders while reflecting the will of the people. Planners aren't the message. They're the medium. And Ford's book takes helpful first steps in outlining how that can be conveyed, and how the next generation of planners might guide us toward safer, saner, and more sustainable cities. *Wayne Curtis*

## Why Should Door Stops Be Boring Rubber Wedges?

Fine little finishing details are what we are known for, and door stops are no exception. Enjoy these well-designed pieces.

### DS3

Stylish bumper design with raised top for added flair. Size: 1 5/16" tall, 1 3/4" diameter including bumper. Finishes: Satin Aluminum, Satin Stainless Steel.



### DS14

Ultra-cool wedge. It is as practical as it is sleek and modern. Size: 5 1/8" long, 15/16" high, 1 25/32" wide. Finish: Satin Aluminum.

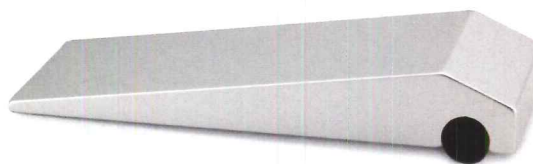

### DS6 & DS6A

Stylish bumper design with raised top for added flair. Size: 1 5/16" tall, 1 3/4" diameter including bumper. Finishes: Satin Aluminum, Satin Stainless Steel.



### DS20

A rubber bumper on a horizontal post. What could be better? Size: 5 3/16" long, flange 1 27/32" diameter. Finish: Satin Stainless Steel.



"FINE ARCHITECTURAL HARDWARE FOR YOUR FINE FURNITURE"®

Doug Mockett & Company, Inc. • Manhattan Beach, CA • 800-523-1269

**MOCKETT**  
DOUG MOCKETT & COMPANY, INC.



Timely then.



Timely now.

# Timely frames forever.

The beauty and strength of Timely steel door frames have endured for 40 years.

In fact they have only improved and evolved over time. Now, with six attractive casings and an unsurpassed anchoring system, they'll set the industry standard for years to come. Each one comes prefinished . . . so you just paint the wall and then install. This saves a lot of time in preparation . . . which means you can save a lot of money over the

**next** four decades. [TimelyFrames.com](http://TimelyFrames.com) | 800-247-6242



MADE IN THE USA SINCE 1971

TIMELY DOOR FRAMES CELEBRATING 40 YEARS OF STRENGTH

CIRCLE 116



## Lindner – Metal Ceiling Systems.

When building owners and architects are planning a new project they need a strong partner.

When designing a metal ceiling system, Lindner is that partner.

Our strength is "Building New Solutions"

Lindner USA | 5126 South Royal Atlanta Drive | Tucker, Georgia 30084 | USA  
 Phone +1 770 / 414-5054 | Fax +1 770 / 934-3384 | info@LindnerUSA.com | www.LindnerUSA.com



USGBC and related logo is a trademark owned by the U.S. Green Building Council and it is used by permission.



**Lindner**

Building New Solutions



## HOUSE OF THE MONTH **INGRID SPENCER**

TWO BRIDGELIKE HOUSES DESIGNED BY UNDURRAGA DEVES  
ARQUITECTOS SIT ATOP A ROCKY CLIFF NEAR SANTIAGO, CHILE.

**WITH CHILE'S CAPITAL**, Santiago, a two-hour drive away, and the vibrant seaport city of Valparaiso just down the coast, the onetime shipping village of Zapallar has become a chic resort destination. Located in the central part of the country's 4,000 miles of coastline, its white sand beaches and wooded hills provide much of the region's allure. But the rocky bluffs above the Pacific Ocean appealed most to architect Cristian Undurraga, principal of the Santiago-based firm Undurraga Deves. Inspired by the strength and persistence of the crashing waves, as well as the wide view afforded from the architect's chosen 1.5-acre site, some 82 feet above sea level, Undurraga designed two narrow "Horizon Houses" with panoramic views of the water and sky.

The two similar concrete-and-glass dwellings – one for Undurraga and his family, the other for a friend and his family – share a common garden, courtyard, and reflecting pool. "My friend thought as I did, that the two houses need to equal one single gesture capable of a dialogue with the extraordinary landscape," says the architect. Undurraga designed both houses as two-story bridge pavilions that would each span two large cavities excavated into the stone cliff. These cavities were dug so that patios and living/dining areas could be accommodated within them and still have views out of each of the long sides of the houses. The upper levels, devoted to bedrooms and sitting areas, occupy the glazed void under the post-tensioned, reinforced-concrete beams, 150 feet in length. These beams are supported on three piers in each house: One at the center accommodates the fireplace and staircase; the other two, at either end of each house, rest on stone walls or (in the case of the lower levels) merge with them. The concrete floor slabs separating the two levels hang by steel posts from the beams.

The two houses, one with seven bedrooms and the other, shorter

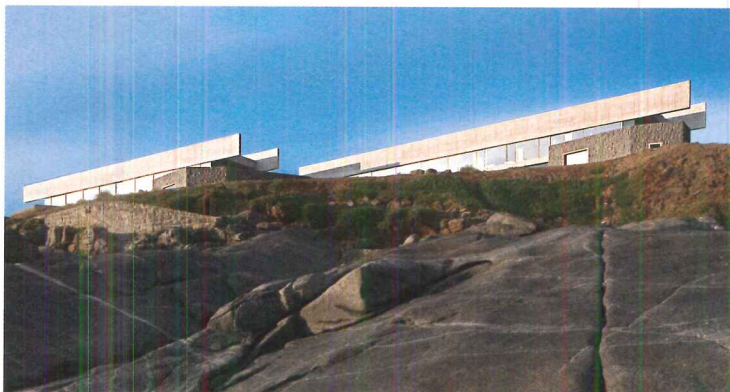

LEFT: The two concrete bridge houses, one for the architect, the other for a friend, overlook the Pacific.



one with four, total 9,950 square feet. Details differ in the two, but they do share passive ventilation and radiant floor heating. And they both feature unadulterated views to the south, showing the sea and the town of Zapallar three miles away. On a clear day you can see Valparaiso. To the north, mobile lattices shield the houses' interiors from bright sun, or reveal views of the protected courtyard space.

For Undurraga, the house is the perfect escape from the office. "During a Christmas lunch, two whales came from the inner sea toward our house," he says. "They swam close to the shore and suddenly jumped in an incredible way, right in front of us. Nature welcomed." ■

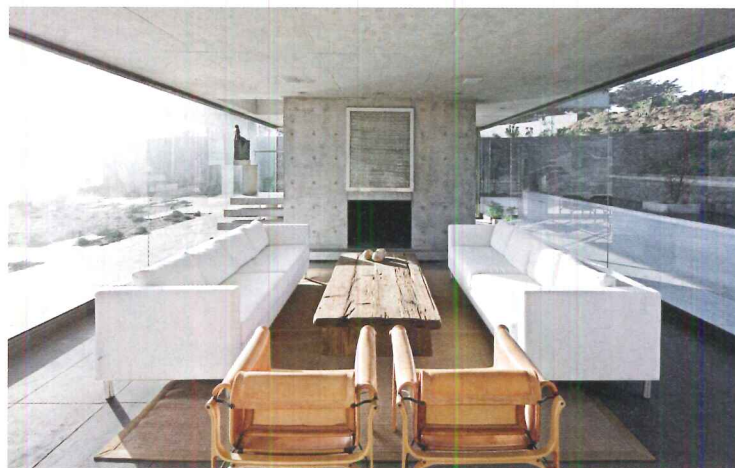

CENTER: Long post-tensioned, reinforced-concrete beams cantilevered at the ends shield second-level sitting areas and bedrooms of the houses.

BOTTOM: On the first floor, Cristian Undurraga excavated the rocky promontory to give the living area breathtaking views on both sides.



Photo courtesy of Estuardi Bonnell

**BOCCI**

14 by Omer Arbel

Standard Fixtures and Custom Chandeliers  
LED | Xenon | Halogen

**BOCCI** Vancouver

+ 1.604.639.5185  
[www.bocci.ca](http://www.bocci.ca)  
[sales@bocci.ca](mailto:sales@bocci.ca)

**BOCCI** Berlin

+ 49.151.2406.1212  
[www.bocci.ca](http://www.bocci.ca)  
[infoeu@bocci.ca](mailto:infoeu@bocci.ca)

**BOCCI** London

+44 (0)779.458.7325  
[www.bocci.ca](http://www.bocci.ca)  
[info@bocci.ca](mailto:info@bocci.ca)

# Introducing SunGuard SNX 62/27.

The next generation of high-performance glass.  
For the next generation of buildings.

The newest entry in Guardian's SuperNeutral Series has our highest light-to-solar-gain ratio (LSG) ever. SNX 62/27

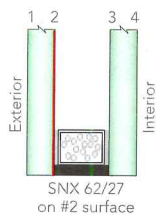

delivers 62% visible light transmission and a low 0.27 solar heat gain coefficient, for an impressive LSG ratio of 2.30. This performance means SNX 62/27 lets in lots of natural light but still blocks solar heat, saving on energy costs and helping

projects qualify for LEED credits. SNX 62/27 is available on five float-glass substrates (Clear, UltraWhite low-iron, CrystalGray, Green and TwilightGreen). To order a sample, call 866-GuardSG (482-7374). To compare energy costs across multiple glazing configurations, **use our new Building Energy Calculator at SunGuardGlass.com.**

**GUARDIAN  
SUNGUARD®**  
ADVANCED ARCHITECTURAL GLASS

BUILD WITH LIGHT®

CIRCLE 50

  
**GUARDIAN**  
Glass • Automotive • Building Products

© 2011 Guardian Industries Corp.  
SunGuard®, Build With Light®, SuperNeutral®, Crystal Gray®, UltraWhite™  
and TwilightGreen™ are trademarks of Guardian Industries Corp.

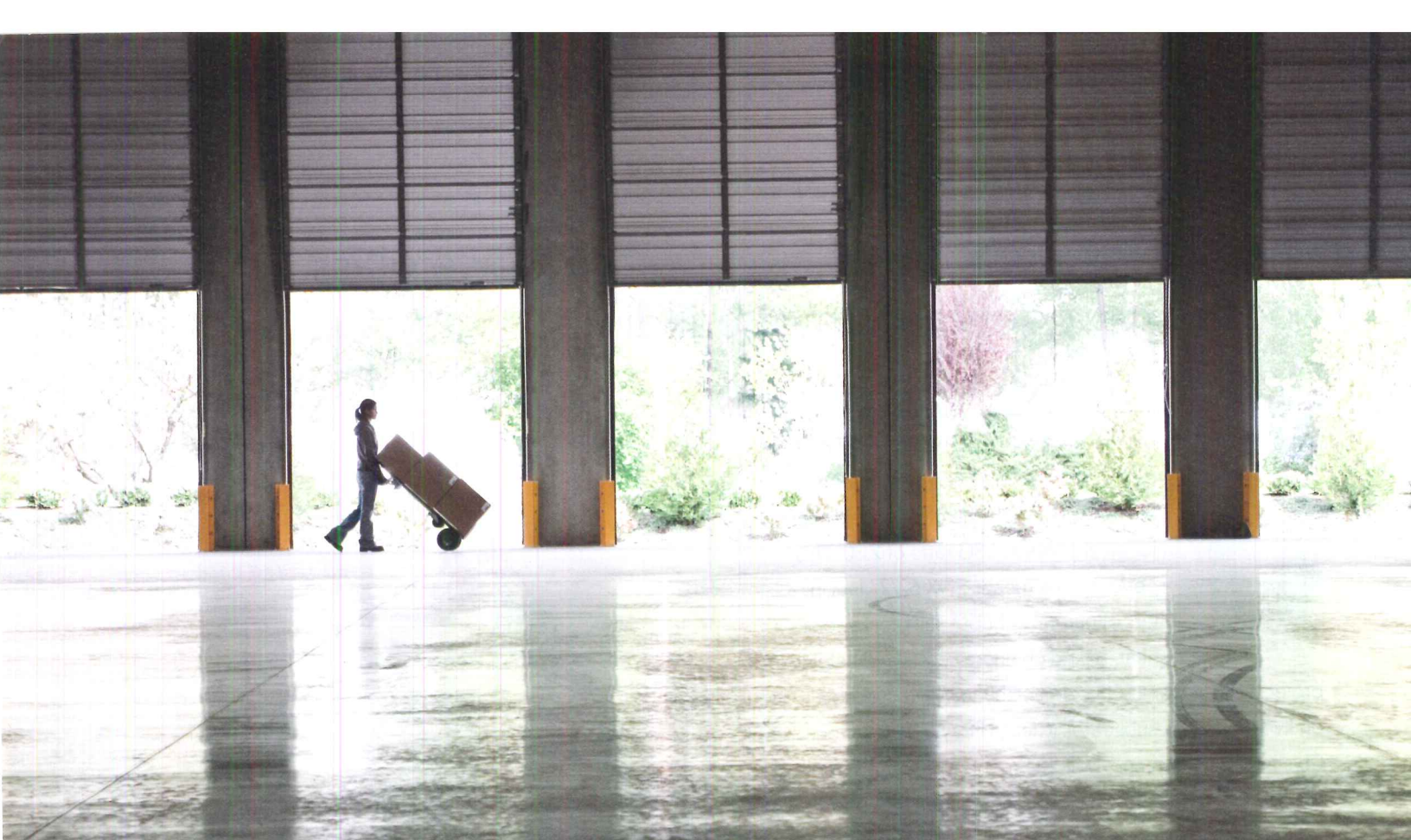

## The safest installation meets the smartest innovations.

**Next-generation LiftMaster® door operators lead the way with groundbreaking innovations that protect your clients.**

Our new line of door operators protects your clients' employees and property with continuously monitored entrapment protection and state-of-the-art safety features, making it easier than ever to incorporate warning lights, bells, and timers.

Plus, they meet tough new UL325-2010 standards, which is critical in complying with state and local building codes. It's all what you'd expect from the #1 brand of professionally installed door operators. There's no smarter way to protect what matters most...your reputation.

**Specify safe. Specify smart. Specify LiftMaster.**  
To learn more, visit [liftmaster.com](http://liftmaster.com) or call 800-323-2276.

Residential Garage Door Openers • Commercial Door Operators • Access Control  
Residential and Commercial Gate Operators • Telephone Entry Systems

[liftmaster.com](http://liftmaster.com)

**LiftMaster®**  
Commercial Door Operators

eventscape®

PHOTOGRAPHY: BILL EVANS/STEWART

# Build the extraordinary.

A fully contained corporate boardroom structure for the mezzanine level of Canada's premier sports and entertainment venue. Designed to reflect aspects of the Canadian landscape, the structure is built of high strength 3" diameter structural steel with 13mm tempered glass walls on 3 sides, making the most of the access to natural light. Aluminum ceiling coves, doors and walls and fabric membrane ceilings with HVAC, sprinklers and lighting complete the space. Maple Leafs Sports and Entertainment Boardroom in Toronto, ON. Design: Eventscape Inc. and Straticom Planning Associates Inc.

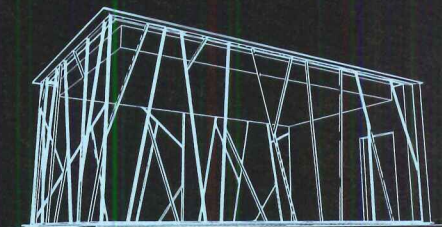

Want more? Scan this QR code to access our In-Depth video. (Download a QR reader for free at ScanLife.com)

+1 416.231.8855 • E: info@eventscape.us • www.eventscape.us

CIRCLE 145

# SUSTAIN

NPPD's Norfolk Operations Center  
HDR Omaha, Architect  
Featuring dri-design panels made with VMZINC ANTHRA

Dri-Design dry joint, maintenance-free architectural panels are not a composite, so no oil is used in the manufacturing process. Instead you'll find only solid metal skins made with recycled material that is 100% recyclable. Making dri-design good for the environment **and those who live in it.**

## ADDITIONAL BENEFITS

- Made with VMZINC, Kynar painted aluminum and a variety of other metals
- Surprisingly affordable due to automated manufacturing and easy installation
- Not laminated, so they will never delaminate
- No sealants, gaskets or butyl tape, means no future maintenance
- Miami-Dade Approved

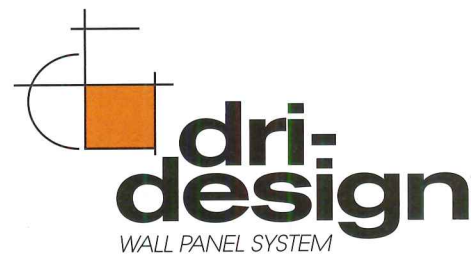

616.355.2970 | [www.dri-design.com](http://www.dri-design.com)

VISIT US IN BOOTH 1653 AT THE NEW ORLEANS AIA NATIONAL CONVENTION

CIRCLE 37

## PRODUCT FOCUS WALLS & WALL COVERINGS

A RANGE OF NEW MATERIAL OPTIONS, FROM CONCRETE TO LUMINOUS WOOD VENEER. RITA CATINELLA ORRELL

# High-Performance Concrete Gets a Makeover

**SIX YEARS AGO**, when Carpinteria, California-based Forms+Surfaces wanted to develop products in ultra-high-performance concrete (UHPC), it ran into a problem – research on commercial applications of the material was not available outside of university settings. Rather than throw out the concept, the company chose to develop its own UHPC specifically for commercial architectural, landscape, and urban applications – and TAKTL was born.

“The closest commercially available material to TAKTL in the architectural products we’re making would be GFRC [glass fiber reinforced concrete], but the base concrete in GFRC is not UHPC,” says Jason Flannery, TAKTL’s head of design. “TAKTL outperforms GFRC in compressive, tensile, and flexural strength and, unlike GFRC, TAKTL can be cast in virtually any shape, texture, or pattern.” These improvements, along with the capability to custom-color the material, have transformed UHPC from a technical construction material into a group of multidimensional interior and exterior wall elements and panels, as well as urban furnishings such as benches, receptacles, and planters.

Although it is a new design material, it should feel familiar, says Flannery. “TAKTL is for the most part made up of similar components to conventional concrete; this was an essential part of its development,” he says. “The magic, if you will, is in the precisely controlled relationship between these components.” For proprietary reasons, the company will not disclose the complete list of ingredients, but it may utilize glass fibers or mesh, polyvinyl acetate, or steel fibers, depending on the project’s needs.

Beyond its design potential, the most innovative thing about TAKTL is its approach to manufacturing – if the project is big enough, they will come to you. “We have made a substantial investment to develop a manufacturing process that is modular and mobile,” says Flannery.

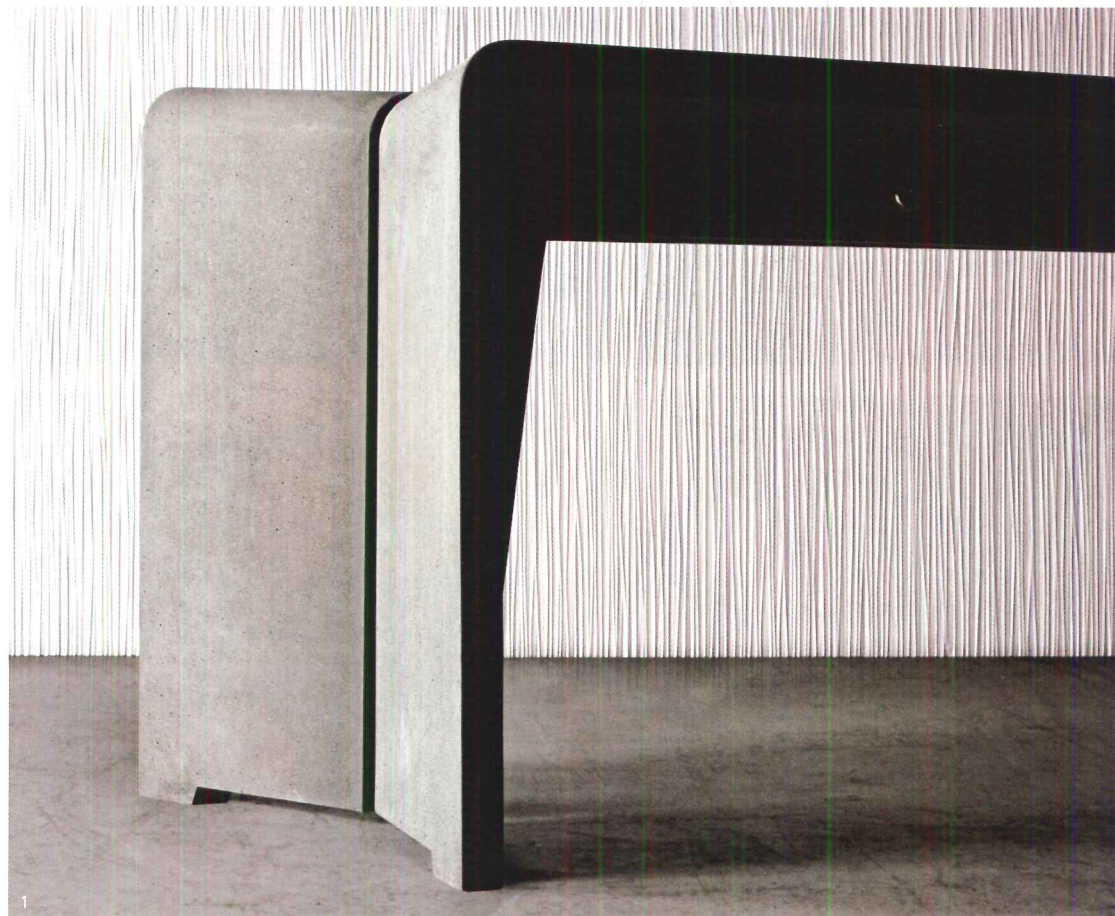

“For large-scale projects more than 500 miles from Pittsburgh, we could set up a manufacturing facility near the project – anywhere in the world – and source all of the material and much of the labor locally.” This process virtually eliminates shipping costs, lowers the carbon footprint, and contributes to the local economy. “We are not aware of any other companies making building products for large-scale architectural projects operating in this way,” he adds.

The company anticipates installations to begin in fall 2011, with more unexpected product types, including louvers and canopies, coming soon. “The profile thickness depends entirely on the project, the size of the panel or piece, and the structural requirements of the particular situations,” says Flannery. TAKTL, Pittsburgh. [taktl-llc.com](http://taktl-llc.com)

CIRCLE 200

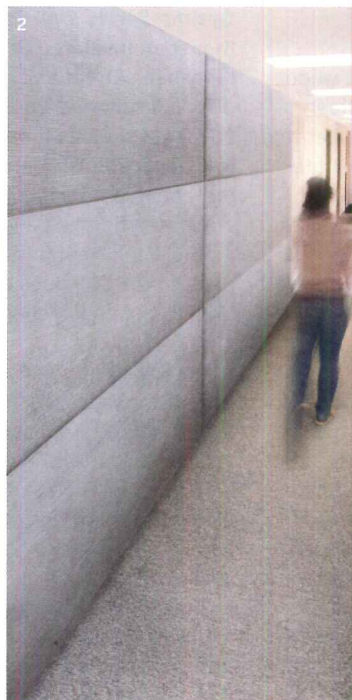

1. TAKTL ultra-high-performance concrete is shown here both on the back wall (in the Grass pattern) and in the manufacture of the Bevel Bench, part of the company’s Situ Urban Elements collection.
2. TAKTL has both outdoor and indoor wall-panel applications.
3. A range of standard colors is available, along with custom-color-matching capabilities.

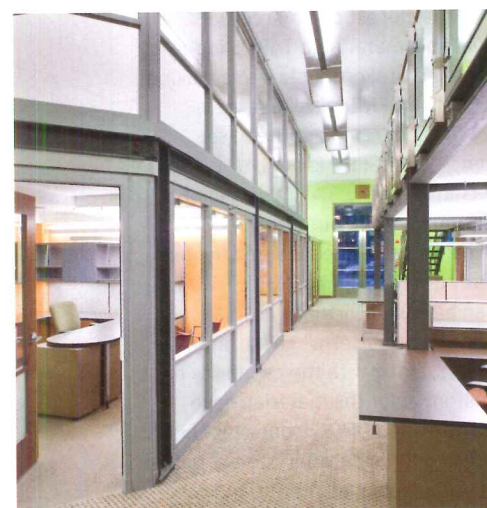
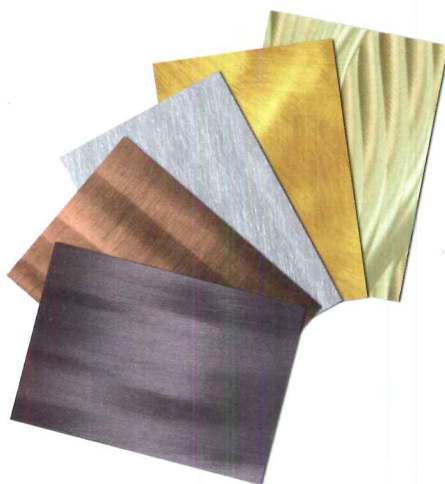
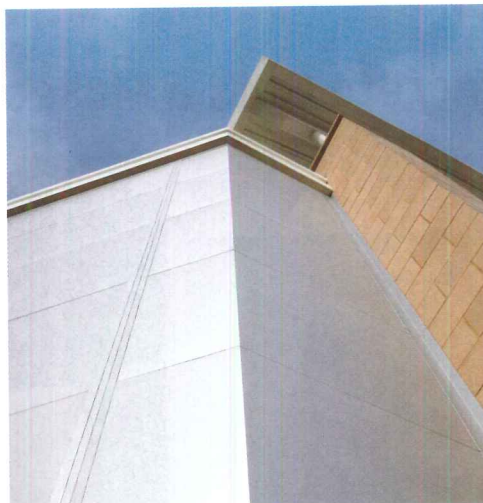
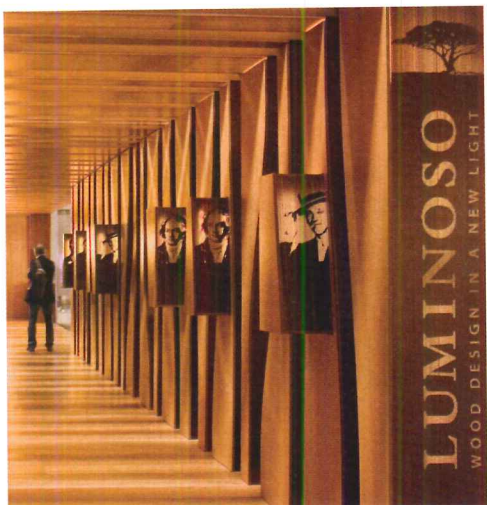

### Luminoso Wood Composite

Luminoso [luminoso.at](http://luminoso.at)

Luminoso (top) is a specially developed wood composite panel featuring high-grade fiber optics embedded between layers of veneer that allow light sources to pass through the material. Luminoso works with all common wood types: black cherry, oak, Sipo mahogany, teak, wenge, hard maple, and black walnut are standard. Panel sizes are approximately 12" x 20", 11" x 20", and 118" x 39". **CIRCLE 201**

### Bookshelf Ceramic Tiles

Imagine Tile [imaginatile.com](http://imaginatile.com)

Anurag Nema, of New York City-based *nema-workshop*, designed the D'Espresso coffee shop in Manhattan (bottom) to look like an upended reading room. To create the sideways "bookshelf" of ceramic tiles that wrap around the floor, wall, and ceiling, Nema collaborated with Imagine Tile, a company known for producing tile with high-resolution graphics. Based on a sepia-tinted photo, the 16"-square ceramic tiles feature a textured, nonslip surface. **CIRCLE 202**

### Optimo Series Wall System

Kingspan Insulated Panels [kingspanpanels.us](http://kingspanpanels.us)

Kingspan's Optimo Series wall system (top) offers designers a comprehensive range of building solutions for vertical and horizontal wall applications. Featuring a flat profile, the pre-engineered panel is available in smooth or embossed finishes, a variety of module widths, multiple color options, and trimless ends. The panels offer R-Values up to 30, superior airtightness, and low thermal bridging. **CIRCLE 203**

### Metal Panels

MóZ Designs [mozdesigns.com](http://mozdesigns.com)

Manufactured from recycled aluminum and brought to life with hand-etched patterns, MóZ surfaces (bottom) are used in wall panels, elevators, and other applications in hospitality, health care, and commercial installations. MóZ's new tones include the Minerals Collection with vivid accents and cool neutrals (shown). The metals are available in any thickness, but standard laminates are .04". Sheet sizes include 4' x 8' and 4' x 10'. **CIRCLE 204**

### 180fx Laminate

Formica [formica.com](http://formica.com)

Formica is expanding its 180fx laminate to the commercial market with seven new designs featuring color variations of natural stone slab and petrified wood (shown, top) in a believable 5' span. Ideal for vertical and horizontal applications that require dramatic scale, such as conference tables, islands, countertops, wall panels, fixtures, and displays, Formica laminates are both FSC- and Greenguard-certified. **CIRCLE 205**

### Genius Movable Walls

KI [ki.com](http://ki.com)

A double-decker stacked configuration of KI's Genius movable walls helped transform an unfinished storage space at the Brooklyn Law School (bottom) into a functional, transparent, and flexible administration space. All of the ground floor and mezzanine area common corridor walls of the 7,000-square-foot space are entirely composed of Genius movable walls, which were also selected for their acoustical privacy. **CIRCLE 206**



# Tessellation, Wood and BIM Transform Ceilings

“If you can draw it, we can probably build it.”

That's the philosophy underlying innovations by Ceilings Plus, the leading producer of specialty ceiling and wall panels. BIM-driven equipment allows them to custom fabricate almost any panel shape with extraordinary precision and speed. Their surprisingly affordable panels are lightweight, acoustical, and can be integrated with lighting, HVAC and other building services.

No longer limited by rectangular grids, panels can form elaborate tessellations, curved surfaces

and 3D polyhedral shapes. The location, size and shape of each hole is controlled, allowing perforations to be used for design elements as well as acoustical control.

Ceilings Plus offers beautiful wood finishes in addition to anodized and painted aluminum. Now, even large wood panels are lightweight and easy to install, with Class A ratings and noise reduction up to NRC=.95. Arboreal® has real wood veneers bonded to aluminum and protected with a zero VOC coating. Saranté™ has dimensionally-simulated wood-grain that is wear-resistant and warranted for exteriors. Panels have no added formaldehyde and can be FSC certified.

For more information, see [www.CeilingsPlus.com](http://www.CeilingsPlus.com)

**Barz™** is a unique system of lightweight dimensional elements, panelized for easy installation and maintenance. It can be fabricated in virtually any size, and in the full range of wood species.

Reader Service Number 18

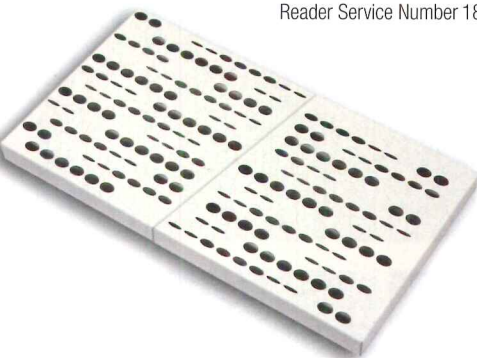

**BIM-driven.** Using high speed equipment, each perforation can have a unique size and shape, and be placed for optimum acoustics and visual impact. Panels can be fabricated with any angles required.

Reader Service Number 137

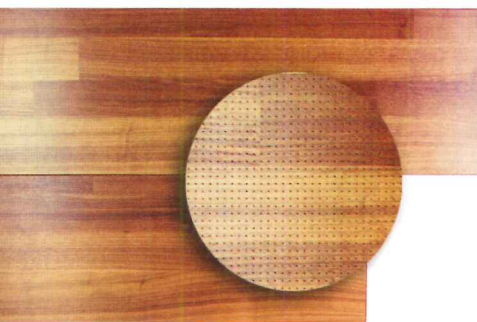

**Arboreal®.** Even exotic wood veneers can now be used on panels that are lightweight and have outstanding acoustics.

Reader Service Number 138

## Any shape.

Triangle, pentagon, rhombus, trapezoid, hexagon and freeform panels invite designers to explore the aesthetics of tessellated surfaces.

Reader Service Number 139



Location: The Orchard  
Architect: TFO Architecture

## INTEGRATED. EFFORTLESSLY.

Lighting, ventilation, and mechanical systems are all beautifully integrated into the ceiling.

(And btw, it's lightweight, acoustical, and FSC-certified wood.)

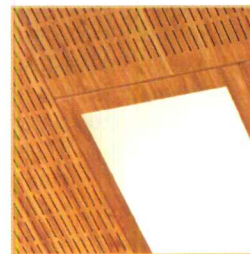
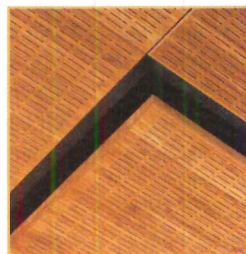

**CEILINGS PLUS®**

+1 323.724.8166 [www.ceilingsplus.com](http://www.ceilingsplus.com)

Reader Service Number 140

## PRODUCTS IN BRIEF 2011 BUCKMINSTER FULLER CHALLENGE

WE PRESENT A FEW OF THE 21 SEMIFINALISTS OF THIS YEAR'S CHALLENGE. THE WINNER OF THE \$100,000 PRIZE WILL BE ANNOUNCED AT A CEREMONY IN NEW YORK IN JUNE. RITA CATINELLA ORRELL

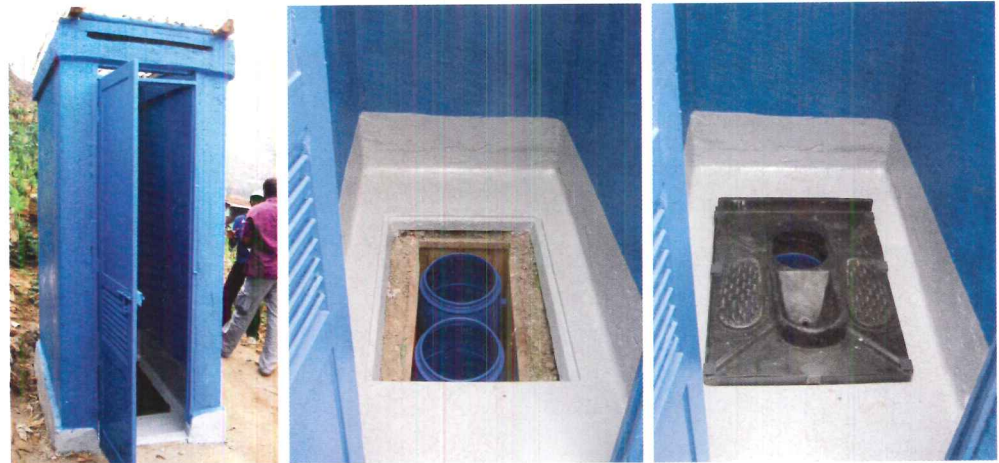
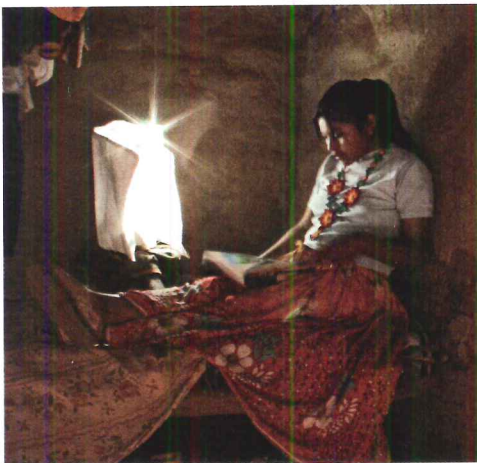
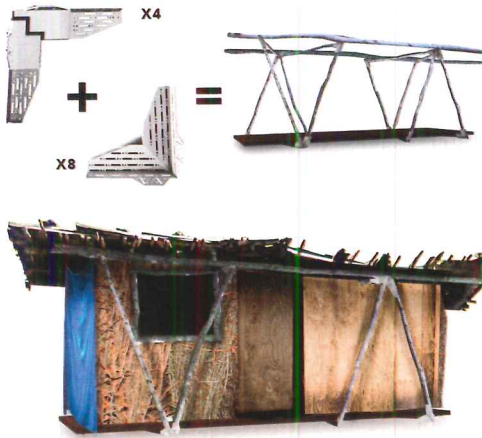

### QuaDror Homes

Studio Dror [quadorr.com](http://quadorr.com)

The QuaDror Home kit (top), which includes instructions, tools, and a set of QuaDror universal joints, could help upgrade existing slums and provide more resilient structures for emergency housing. The joints are designed so structural members in the form of local and found materials can be attached. If Studio Dror wins, the prize money would be used to deploy the first prototypes in Sierra Leone.

### The Portable Light Project

Portable Light Project [portablelight.org](http://portablelight.org)

This nonprofit research, design, and engineering initiative was established by KVA MATx to create new ways to deliver decentralized renewable power and light to the developing world. Its core product is a flexible, lightweight, thin-film PV cell that can be woven onto goods such as bags or clothing (bottom). The PV cell stores solar energy in a battery pack that can power items such as LEDs, cell phones, radios, and medical devices.

### Macrophyte Lagoon Water Purification System

Ecosistema Urbano [ecosistemaurbano.com](http://ecosistemaurbano.com)

An architectural firm located in Madrid, Ecosistema Urbano has developed a water purification system that works by natural processes; lagoons clean the wastewater of buildings for reuse in their surrounding communities while reducing city CO<sub>2</sub> emissions. The low-tech, low-cost system is supported by a social software platform, providing opportunities for community members on a local and global level to become involved in water conservation efforts. The firm has constructed a prototype installation for a public park space known as Plaza Ecopolis (top). Linked to a kindergarten, a macrophyte lagoon purifies both gray and black wastewater from the nearby building; the water is then reused for the irrigation of the entire park. The firm would like to apply more macrophyte lagoon design initiatives throughout urban and suburban areas.

### Sanergy

Sanergy [saner.gy](http://saner.gy)

Sanergy produces electricity and fertilizer by providing safe, affordable sanitation in urban slums. It begins with the design of a prefabricated ferrocement toilet (bottom, center and right), which allows for easier and more sanitary removal of waste compared to open dumping and pit latrines. Sanergy's innovative business model has a for-profit and nonprofit side. On the nonprofit side, creditworthy entrepreneurs obtain financing to build and install the toilets. Once installed, haulers are hired to move the waste to local collection points in the slum. It is processed before being taken to a larger facility, where the for-profit side takes over and the waste is placed in anaerobic digesters and turned into biogas and fertilizer for distribution. Sanergy's pilot program is operational in two of Kenya's largest slums, Kibera and Lunga Lunga, where local youth groups have been engaged to build and operate the centers.

# full court

Action® covers every athletic and multi-use floor system application.

See our full selection of products at  
[actionfloors.com/fullcourt](http://actionfloors.com/fullcourt)

Lake Forest College  
Lake Forest, IL USA

Serving the  
**global**  
marketplace.

Activity meets creativity.™

[actionfloors.com/fullcourt](http://actionfloors.com/fullcourt) | [info@actionfloors.com](mailto:info@actionfloors.com)  
Call us at 800.746.3512

CIRCLE 02

**Action**  
FLOOR SYSTEMS LLC

# IN RETAIL

## Steel

**POINT OF VIEW** "We don't build buildings. We sell merchandise and use buildings to do that. If you are going to understand us as an owner of buildings, you have to shed the idea of the core function of a building. For us, it's selling merchandise. That shift completely changed the way I looked at buildings as an architect."

*Crate & Barrel. A company that began with a dream, one employee, and no cash register. Today, the company has 7,500 employees and 60 stores in markets across the U.S. John Moebes, AIA, NCARB is one of them. Architect, contractor, he saw an opportunity open up with Crate & Barrel and hasn't looked back since. As Director of Construction for the company, he offers a unique point of view about his world.*

## Crate&Barrel

**BUILDING OWNER** Crate & Barrel

**STRUCTURAL ENGINEER** Moore Lindner Engineering, Inc.

**FABRICATOR** SteelFab, Inc.

**ECONOMICS.** "An architect or engineer typically has a brief relationship with a building – maybe 2% of its lifespan? How does 'economic performance' fit that involvement? What I learned is that the 2% can have a huge economic performance impact that's not always positive for the business. Architects believe the building will be there forever. That can lead to incorrect decisions from the business point of view."

**LIFE CYCLE** "If you looked to an architect or engineer and say, well, think of what you are doing in relation to lasting only 15 years, they would feel concerned. They are not trained to think of a building as a short-term commodity. However, we may not be able to stay in the building. What if the market shifts? For us to be paying for a 50 or 100 year building would be a disaster. This kind of thinking impacts decisions we make with structures."

**STEEL** "Steel matches our core business philosophy. It is the industry standard in retail for many reasons. It's the fastest material to erect; it's always cost competitive. A school opening early doesn't mean much to the bottom line. But a retail store? Steel is at the top of the list for speed to market."

**FORGIVENESS** "Steel is like my grandmother: it is always forgiving. You can fix steel; you can subtract and add in a way you cannot with other materials. There is no construction formula for our stores as in some retailers. At one point – pretty far along on this one building – we saw it was wrong. You don't want fifteen years of regret behind you. We made a decision to change it. With steel, you can do that, there is no penalty to make such changes."

**STRATEGY** "We don't have prototypes; our buildings are unique because of our real estate deals. We want to be in the best markets, which could be urban, suburban, maybe a historic building in New York, a lifestyle center in Charlotte. When I put together the strategy for a store, I would initially look for local experience. Steel changed that. We have developed an extremely effective relationship with a structural engineer and fabricator. For us, it is more cost effective to ship steel and have them travel to our sites than using local resources."

**COLLABORATION** "It's complicated. There are certain mind sets in the industry practices that don't benefit an owner. For example, the industry says there shouldn't be direct collaboration with fabricator and structural engineer. It's a kind of chain of command that we grew up with. Now we call them roadblocks. We go around them. Whether or not you believe it, the world is flat; there is a leveling of how people work and without collaboration, you always pay more."

**FABRICATORS** "A general contractor selected SteelFab on one project when we were building a tough structure. It was overly complicated from a construction perspective. SteelFab hurried to show us how we could save money in the future. That was a magic moment. Over the next year and a half, they were awarded two more stores, under two different contractors. We soon realized they were working together throughout the U.S."

**STRUCTURAL ENGINEERS** "SteelFab introduced us to Moore Lindner Engineering. It was another magic moment, because Moore Lindner understood we wanted a relationship – not just a dialog going back and forth. You have to find people who want to talk to each other. We are fortunate."

**CORE VALUES** "We have to have a building that is adaptable. Our deals are all different. From a branding perspective, we don't see our brand as static. We sell change; we bring in new product every year. Our floors shift continually. We want an ever-developing relationship with our customers. If we had a static building in every city, it wouldn't reinforce change as our concept, would it?"

**FUTURE** "The next fifteen year period will bring more change to buildings than anything we have seen. There is increasing pressure on all of us because no one has the money to build what we have to build. It will be on the AEs and owners to figure out how to get the next generation of buildings built. Steel, as an industry, thinks differently than other industries; it is progressive. It is the most innovative material we build with, far away above other materials when it comes to recycled content. It isn't publicly seen as green, but it is the most strategically green. It will be integral to the future."

Steel  
**SolutionsCenter**

Your connection to  
ideas + answers



[www.aisc.org](http://www.aisc.org)

866.ASK.AISC

*There's always a solution in steel.*



# Let's Discoh!

Far-out shapes, groovy stainless steel trim options,  
and lighting performance that rocks.

Check out the whole Discoh family at [manningltg.com](http://manningltg.com)  
and visit us at AIA in New Orleans, booth #2317



CIRCLE 71

See Discoh and **all our latest products** at the new [manningltg.com](http://manningltg.com)

MANNING LIGHTING INC 920.458.2184 SHEBOYGAN, WI USA



# Cardinal Red, Weathered Zinc...LEED Gold



Animal Care & Protective Services - Jacksonville, FL  
 Architect: Ebert Norman Brady Architects  
 Panel Contractor: Thorne Metal Systems  
 Profile: 7.2" Rib & Perforated Panels  
 Finish: Cardinal Red, Interstate Blue & Weathered Zinc

*LEED Gold Certified*



Register to win a Honda Hybrid CR-Z!  
 2011 AIA Expo, Booth 2817

## PAC-CLAD® Panels in 29 Energy Star® Colors!

Sustainable materials and eye-catching design. The PAC-CLAD 7.2 Panels offer heavy horizontal shadow lines that are appealing for this LEED® Gold Certified project.

"We selected metal panels to give us the contemporary state-of-the-art look we wanted for the high profile site"

—Tom Norman, Project Manager + Designer with Ebert Norman Brady Architects

See all of our Corrugated Panels at [www.PAC-CLAD.com](http://www.PAC-CLAD.com).



WWW.PAC-CLAD.COM | IL: 1 800 PAC CLAD  
 MD: 1 800 344 1400 | TX: 1 800 441 8661  
 GA: 1 800 272 4482 | MN: 1 877 571 2025



# SHOW US YOUR RECORD COLLECTION WE KNOW YOU HAVE ONE!

*Architectural Record* readers have been subscribers for an average of 18 years.  
65% of them save their copies for future use.\* Show us YOUR Record Collection.



Robert A.M. Stern, FAIA,  
has been saving his  
*Architectural Records*  
for decades.

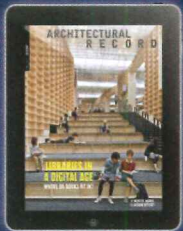

ENTER the *Architectural Record* COLLECTION COMPETITION  
For your chance to **WIN** an iPad!

Sponsored by



#### TO ENTER:

Photograph your collection or your firm's collection of *Architectural Record* and upload at [archrecord.com](http://archrecord.com). Digital editions count. **Submission deadline: June 30th**

Three winners selected, one in each of the following categories:  
Oldest Collection, Largest Collection and Most Creative Presentation.  
Winners will be seen in the *Architectural Record* Collection Photo Gallery.

#### FOR MORE INFORMATION AND OFFICIAL RULES VISIT:

[www.architecturalrecord.com/call4entries](http://www.architecturalrecord.com/call4entries)

**ARCHITECTURAL  
RECORD**

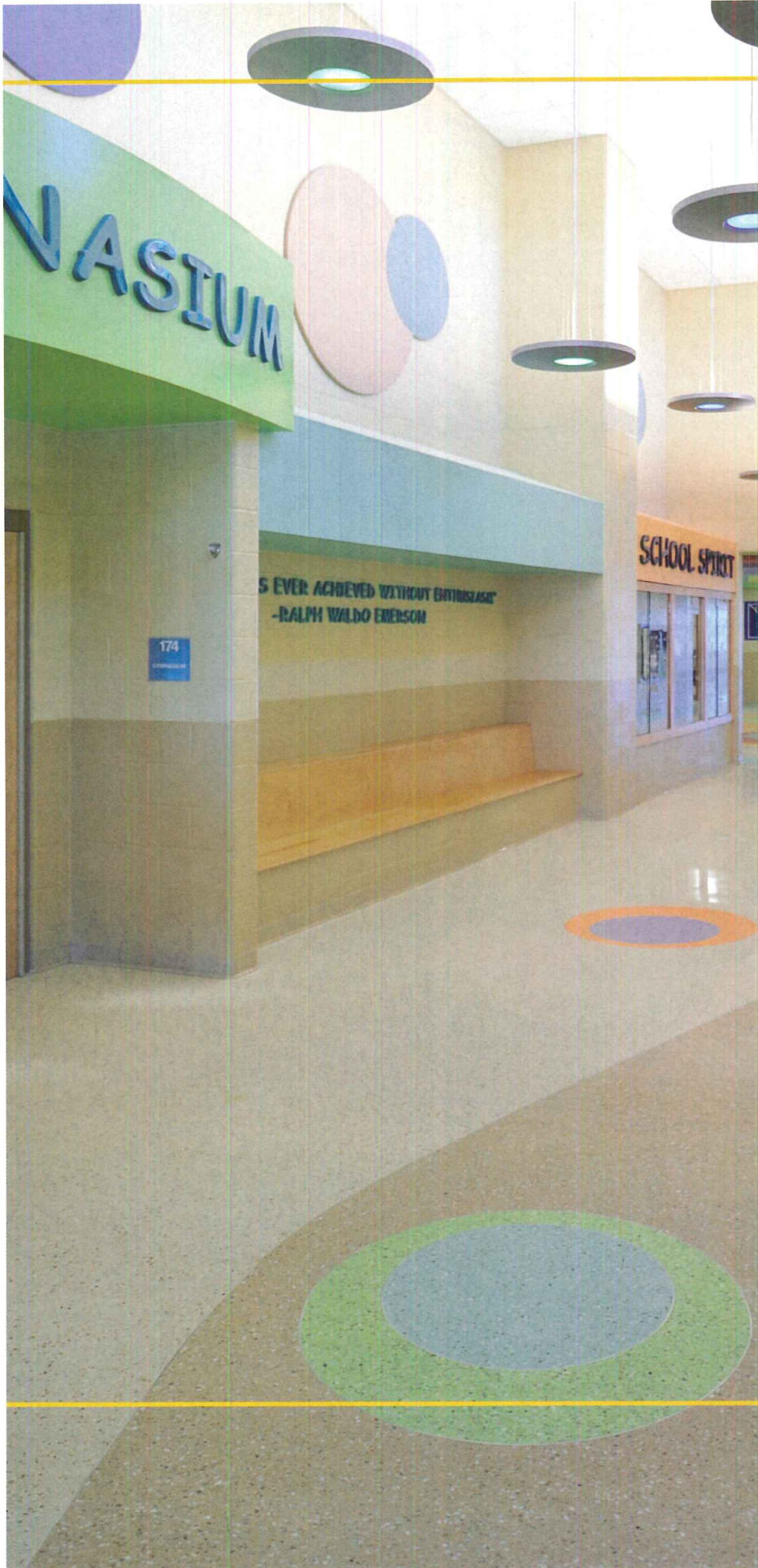

TERRAZZO tops the class at Northern Elementary School.



“When designing educational environments, our goal is to design spaces that inspire learning. The flexibility of terrazzo enabled us to create a playful and enjoyable environment that will excite students about learning for years to come.”

SILKE N. BECKER, IIDA, CID,  
LEED AP ID+C  
Interior Designer  
RossTarrant Architects  
[www.rosstarrant.com](http://www.rosstarrant.com)

Photo courtesy of David Laudadio



[www.ntma.com](http://www.ntma.com)  
800.323.9736





# Next Generation Green Restroom Design

## LEARN ABOUT:

- Facts about water use in the U.S.
- Green restroom applications, including performance testing
- Environmental benefits
- Financial and maintenance savings

# REDUCE

WATER



UP TO  
50%

COST



OVER  
90%

CARBON



OVER  
70%

TAKE THE COURSE NOW  
at [www.aecdaily.com](http://www.aecdaily.com)

(search by "Sloan" or "Excel")

**SLOAN**<sup>®</sup>

866-663-2289  
[www.sloanvalve.com](http://www.sloanvalve.com)



800-255-9235  
[www.exceldryer.com](http://www.exceldryer.com)

# FACADE? CHALLENGES?

BUDGET  
PROBLEMS?

UNRESOLVED  
DETAILS?

SCHEDULING  
NIGHTMARE?

CODE  
COMPLIANCES?

COMPLEX  
PROFILES?



OVERALL  
COST SAVINGS  
GUARANTEE

IN-HOUSE  
STRUCTURAL  
ENGINEERING

SIGNIFICANT  
SCHEDULE  
REDUCTION

25 YEARS  
DESIGN ASSIST  
EXPERIENCE

CREATIVE  
INSTALLATION  
METHODS

WE OFFER FACADE!  
SOLUTIONS!

**KEPCO+**  
Architectural Cladding Systems

[WWW.KEPCO.US](http://WWW.KEPCO.US)

Call for a **FREE CONSULTATION** with our experienced staff:

**1.800.495.9127**

# JuliusBlum&Co.Inc.

Stock Components For Architectural Metal Work

100 years and counting...  
introducing **Catalog 19**

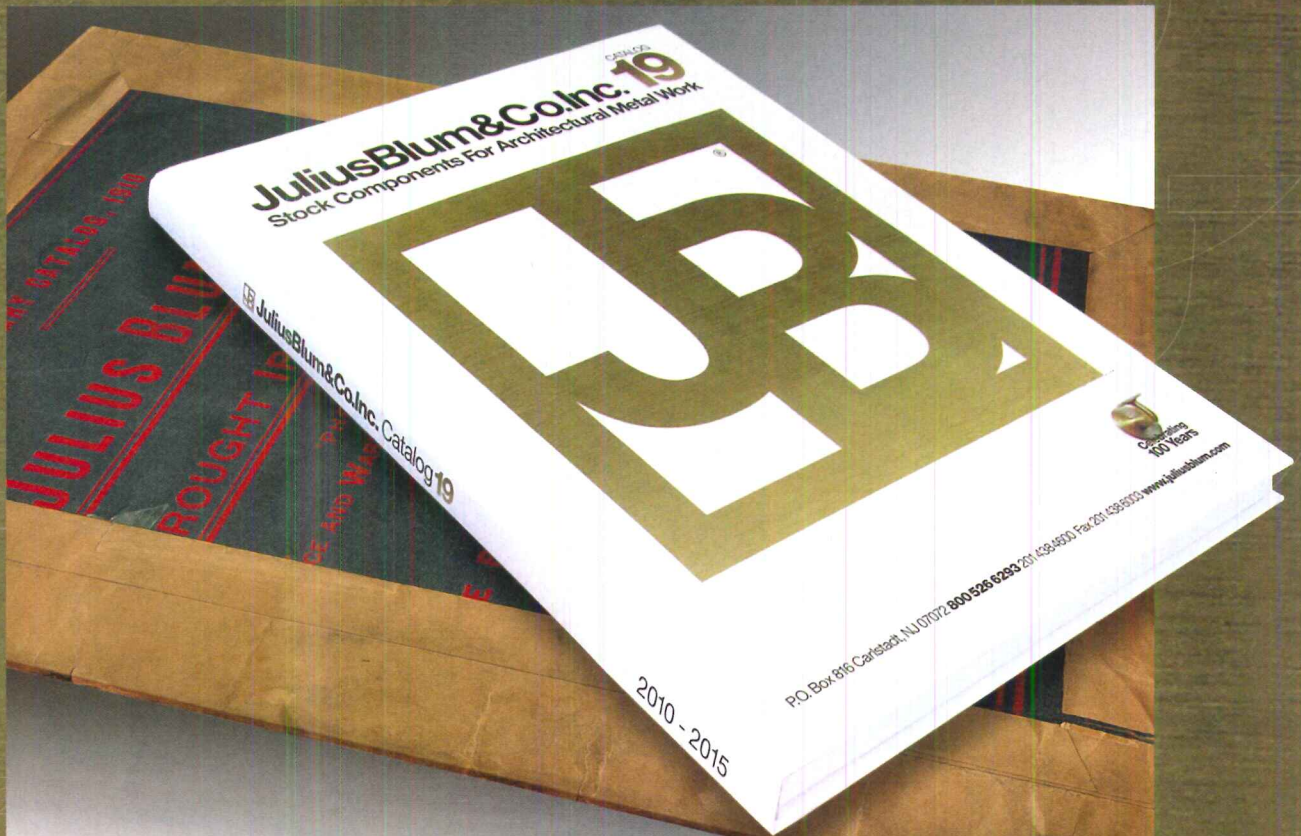

**Request your copy, email [catalog19@juliusblum.com](mailto:catalog19@juliusblum.com)**

Julius Blum & Co. Inc. is the nation's largest supplier of architectural metal products. For complete information on all components, visit [www.juliusblum.com](http://www.juliusblum.com) or email [bluminfo@juliusblum.com](mailto:bluminfo@juliusblum.com).

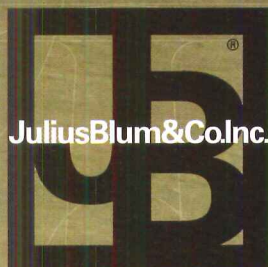

P.O. Box 816  
Carlstadt, N.J. 07072-0816  
800.526.6293  
201.438.4600  
fax 201.438.6003  
[bluminfo@juliusblum.com](mailto:bluminfo@juliusblum.com)  
[www.juliusblum.com](http://www.juliusblum.com)

Private Residence  
Los Angeles California  
Andrew Liang / Studio 0.10  
Recipient of the MCA President's Award  
and VMZINC ArchiZinc Trophy Award

# AWARD WINNING ARCHITECTURE AWARD WINNING PRODUCTS

Booth #253 at 2011 AIA Convention in New Orleans



Umicore Building Products USA, Inc.  
phone: 919.874.7173  
[www.vmzinc-us.com](http://www.vmzinc-us.com)  
[www.ZINCsense.com](http://www.ZINCsense.com)



ARCHITECTURAL RECORD | 2011 AWARDS

# good design IS GOOD BUSINESS

Nearly three years into the economic slump, businesses and governments continue to struggle with tight budgets exacerbated by volatile markets, natural disasters, and crises around the world. All the more reason to honor the winners of the 13th ARCHITECTURAL RECORD Good Design is Good Business Awards (formerly the BusinessWeek/Architectural Record Awards). Without exception, the projects that follow demonstrate how thoughtful architecture, cohesive collaborations, and sustainable resource management benefit a client's bottom line, productivity levels, and preparedness for the future. The editorial jury was especially impressed with the winning architects' integration of innovative strategies and materials into pragmatic solutions – an auspicious upshot of the time's prevailing restraints. *Linda C. Lentz*

**Barkow Leibinger**  
Trumpf Campus, Stuttgart, Germany

**Earl Everett Ferguson Architect**  
Eileen Fisher, New York City/Irvington, NY

**Office of Architecture in Barcelona (OAB)**  
Roca Gallery, Barcelona

**Pickard Chilton**  
300 North LaSalle, Chicago

**Roth + Sheppard**  
Denver Art Museum Shop, Denver

**Skidmore, Owings & Merrill**  
The Ledge at Skydeck, Chicago

**Bohlin Cywinski Jackson**  
Mills College, Lorry I. Lokey  
Graduate School of Business, Oakland

**Cannon Design**  
Cannon Design Regional Office, St. Louis

**THA Architecture**  
Mercy Corps, Portland, OR

"UNDERGROUND TUNNELS AND INFRASTRUCTURE CONNECT THE ENTIRE CAMPUS AND ALLOW PEOPLE AND GOODS TO MOVE AROUND IN ALL WEATHER." – BARKOW LEIBINGER, TRUMPF CAMPUS, STUTTGART



PROJECT **TRUMPF CAMPUS**  
 ARCHITECT **BARKOW LEIBINGER**  
 LOCATION **STUTTART, GERMANY**

**FROM 1997 TO 2010**, Berlin-based Barkow Leibinger Architects worked on the master plan and architecture of an industrial campus that breaks down the traditional divide between "blue"- and "white"-collar workers and establishes a flexible blueprint for future growth. Located in Ditzingen, outside of Stuttgart, the expanded and reorganized campus has helped the Trumpf Group become "the world's leading machine-tool manufacturer" and grow to 7,000 employees around the globe, state the architects. In addition, the company's recent success at exporting its products has allowed it to

weather the current economic storm without laying off any employees, says Barkow Leibinger.

Instead of applying a single corporate identity to the entire campus, the architects imbued each phase in the master plan with a degree of "autonomy" based on its programmatic needs and design expression. They also developed a "soft master-planning" approach that allows the company to adapt to changing needs and future acquisitions while enjoying a holistically conceived complex.

The first two phases, in the late 1990s, involved building a new laser machine-tool factory and then a technical systems facility on the west side of the campus. The new buildings brought together production halls, offices, and laboratories, eliminating the usual hierarchies of corporate rank. In the first part of the 21st century,

Barkow Leibinger designed a new Customer and Administration Building, a gatehouse with a dramatically cantilevered canopy, and then a campus restaurant with an attention-grabbing ceiling made of polygonal cells set within a triangular steel frame. The firm also renovated an existing spice factory on the east side of the campus and expanded it.

Underground tunnels connect the entire campus and allow people to move around in all weather. By converting old buildings to new uses, incorporating energy-saving technologies, and applying sustainable design strategies, the architects say they help the company reduce operational costs. And by creating a workplace that instills pride in employees, they improve performance and help the company attract and retain the best talent. *Clifford A. Pearson*

ALLOWS TRUMPF TO ADAPT TO CHANGING NEEDS AND FUTURE ACQUISITIONS WHILE ENJOYING A HOLISTICALLY CONCEIVED COMPLEX.



1. A gatehouse completed in 2007 features a dramatic cantilever that alerts visitors to the innovative architecture on the campus.
2. The laser machine-tool factory from the 1990s and a Development Center from 2009 occupy former farmland on the west side of the campus.
3. North light helps animate spaces inside the Development Center.
4. For the campus restaurant, the architects used digital fabrication technologies that they learned from TrumPF itself.



#### CREDITS

**ARCHITECT:** Barkow Leibinger Architects – Frank Barkow, Regine Leibinger, principals; Heiko Krech, project architect/development center; Carsten Kraft and Caspar Hoesch, project architects/gatehouse; Lukas Weder, project architect/restaurant

**ENGINEERS:** Boll und Partner (structural/development center); Werner Sobek (structural/restaurant and gatehouse)

**CLIENT:** TrumPF GmbH & Co.

**SIZE:** 964,100 gross square feet (campus); 371,400 square feet (development center); 58,100 square feet (restaurant); 1,400 square feet (gatehouse)

**COST:** \$194 million

**COMPLETION DATE:** January 2009

#### SOURCES

**METAL PANELS:** ThyssenKrupp; VMZINC (development center)

**TILES:** NBK (restaurant)

**CERAMIC CLADDING:** Architectural Terracotta (restaurant)

**WOOD CEILING CELLS:** Holzbau Amann (restaurant)

**STEEL FRAME:** Winterhalter Stahlbau (restaurant)

**METAL WINDOWS:** Schüco International (development center)

**GLASS:** Glaszentrum Schweikert (gatehouse)

## GOOD DESIGN IS good business

"HAVING A BEAUTIFUL OPEN SPACE TO WORK ALLOWS FOR INCREASED COLLABORATION AND CREATIVE THINKING. EMPLOYEES CAN CONNECT WITH EACH OTHER, AND AS A RESULT, THE PRODUCT IS BETTER." – EILEEN FISHER



## CREDITS

**ARCHITECT:** Earl Everett Ferguson Architect – Earl Ferguson, principal in charge  
**CONSULTANTS:** Dunne & Markis (structural); Antonucci & Assoc., Gabor M. Szakal (mechanical);  
**CLIENT:** Eileen Fisher, Inc.  
**SIZE:** 43,000 square feet (NYC); 40,000 square feet (Irvington)  
**COST:** \$15 million  
**COMPLETION:** 2008 (NYC); 2009 (Irvington)

## SOURCES

**CEILINGS:** Armstrong  
**LIGHTING:** Belfer, Elliptipar, Zumtobel Staff, Holophane, Metalux, Lightolier, Juno

PROJECT **EILEEN FISHER, INC.**  
 ARCHITECT **EARL EVERETT FERGUSON ARCHITECT**  
 LOCATION **NEW YORK CITY/IRVINGTON, NEW YORK**

**LAUNCHING HER APPAREL** line in 1984 with \$350 and a degree in home economics, Eileen Fisher started small. But her modest beginnings belie the power of her brand – a line of elegant, comfortable clothing sewn with natural materials that has resonated with America's professional women. As she does with her clothing, Fisher brings a holistic sensibility to the workplace, fostering people-centric environments in her Irvington, New York, headquarters north of New York City, and her Manhattan design studio/showroom, or Creative Center.

To achieve her goals, Fisher tapped Irvington-based Earl Everett Ferguson Architect to create sustainable facilities for both locations. The architects – who also designed Fisher's home and some of her stores – incorporated eco-sensitive materials, daylighting strategies, and energy-efficient systems, deftly adapting older structures. They expanded the Creative Center from 20,000 to 43,000 square feet by relocating it to three floors of a historic department store on lower Fifth Avenue – maintaining the open quality of the space with high ceilings and glass-enclosed meeting rooms. For Fisher's Irvington headquarters, the design team updated the company's existing offices in a former Lord & Burnham greenhouse factory, expanding it by 19,000 square feet into a light-infused, loftlike adjacent space in sync with its city counterpart.

Design principal Earl Ferguson's strategies support the company's operational recycling program and energy-saving policies, observed by all employees. He also programmed spaces for wellness activities and impromptu gatherings within work areas. "Department leaders and managers are located adjacent to each other, with their teams surrounding



them in peripheral areas," says Ferguson. "This fosters creative collaboration, and affords natural light and views for more than 90 percent of occupants." According to the company, the design contributes to a sense of health and well-being among staff, evidenced by the turnover rate of 8 percent, much lower than the industry average.

By 2010 Eileen Fisher had grown to 900 employees, generating over \$300 million in sales. Today the company ranks among the best medium-sized companies to work for, according to the Great Place to Work Institute. Fisher aims to foster a workplace dedicated to nurturing employees and reflecting holistic sensibilities. Ferguson's design supports that directive with ease and simplicity. *Jane Kolleeny*

TOP: At the Eileen Fisher headquarters in Irvington, New York, Ferguson replaced existing monitors in the shed roof of a former Lord & Burnham warehouse along the Hudson River.

BOTTOM: Inside, the open, daylight-filled space features 23-foot-high ceilings supported by exposed steel trusses and glass-enclosed pods for private meetings.



# CONSIDER THE POSSIBILITIES



AN AMERICAN COMPANY SINCE 1868



For more information on our complete line of architectural concrete masonry or to locate a dealer near you please contact us at (800)234-8970 or visit our website [www.edillon.com](http://www.edillon.com)

CIRCLE 38



PROJECT **ROCA BARCELONA GALLERY**  
 ARCHITECT **OAB**  
 LOCATION **BARCELONA**

**THE BARCELONA-BASED ROCA**, one of the world's top producers of bath furnishings and tile, wanted to increase its visibility. So the company approached Carlos Ferrater's Office of Architecture in Barcelona (OAB) in 2008 to transform a small 1960s office building it occupied into a brand showroom. Although the timing was precarious — right when the financial crisis hit — design architect Borja Ferrater developed a successful stage for

Roca's products and services, thanks to scale, materials, and public allure.

Gutting the structure, the OAB team worked with Spanish glass manufacturer Cricursa to develop an iconic facade made of aquamarine panels that reflect, refract, and deflect light. "In the day it looks solid like a rock, and at night it looks liquid," says Ferrater of the glass box, which is lit by 4,200 computer-controlled LEDs.

The resulting interior features dramatic volumes with installations that invite visitors to browse the company's products and explore its bath solutions through state-of-the-art interactive displays. An additional exhibition

space accommodates business and consumer events, often in conjunction with collaborating companies. "[Roca] wants to erase the detachment that companies have from society," explains Ferrater.

According to Roca brand and communications director Xavier Torras, the gallery has received thousands of visitors since it opened in fall 2009. He estimates that business gleaned just from the buzz generated by the building amounts to \$1.2 million. Awareness and positive perception of the company have also grown. "This is the first time in our communication history that we have had results like these," says Torras. *Laura Raskin*

THE PUBLIC. ROCA WANTS TO ERASE THIS DETACHMENT THAT COMPANIES HAVE FROM SOCIETY." – BORJA FERRATER, OFFICE OF ARCHITECTURE IN BARCELONA

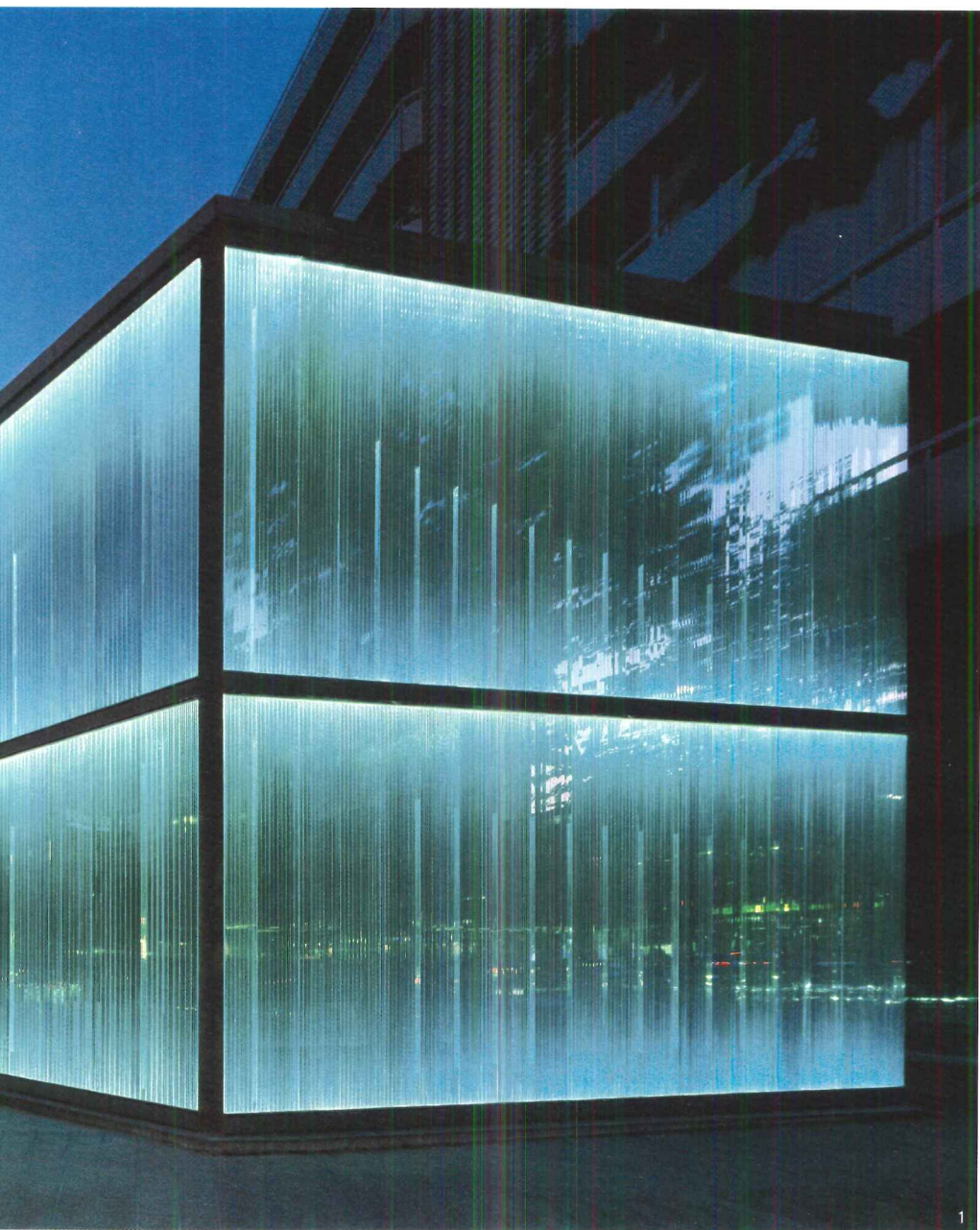

#### CREDITS

**ARCHITECT:** Office of Architecture in Barcelona (OAB) – Carlos Ferrater, Borja Ferrater, Lucía Ferrater, principals

**CONSULTANTS:** JG Consulting, Jordi Bernuz (engineers); Artec3 (facade lighting)

#### GENERAL

**CONTRACTOR:** EMPTY SA

**CLIENT:** Roca Corporación Empresarial

**SIZE:** 27,000 square feet

**COST:** \$14.6 million

**COMPLETION DATE:**

October 2009

#### SOURCES

**FACADE:** Cricursa (glazing); Talleres Inox (steel frame)

**ROOF:** Iraco

**LIGHTING:** Tronics 2000 (exterior); Davide Groppi (interior downlights)

#### INTERIOR FINISHES:

Euroslot (suspension grid); Roca (floor tile); Aschi de Mas (carpet); Carpintería y Ebanistería Construmad (wood paneling, acoustical ceiling and wall)



1. A system of 4,200 computer-controlled LEDs illuminate the Roca Barcelona Gallery at night.

2. The glass facade refracts, deflects, and reflects light, creating optical illusions for those inside the building. People, cars, and other buildings seem to appear where they are not.

3. The gallery's ground floor includes 10 interactive installations devoted to subjects that are important to the company, such as design, water, and technology. Motion sensors detect visitors' locations, triggering an increase in light when someone stops in front of a particular product. A video installation shows people looking at themselves in a bathroom mirror – a window into intimate behavior.



## GOOD DESIGN IS good business

PROJECT **300 NORTH LASALLE**  
 ARCHITECT **PICKARD CHILTON**  
 LOCATION **CHICAGO**

**BUILDING HIGH IN** the Windy City is not a charge to be taken lightly. New Haven-based Pickard Chilton has risen to the challenge with this 1.3 million-square-foot, 60-story tower on the north bank of the Chicago River that emphatically states its presence.

In devising the scheme, the architects worked closely with Chicago developer Hines and anticipated anchor tenant, the international law firm of Kirkland & Ellis (K&E), which previously occupied Edward Durell Stone and Perkins and Will's Aon Center. With a new home for K&E, the team hoped to create a visible identity as well as a high-performance transparent building that connected with the waterfront, attracted talent, and enabled K&E to use less square footage more efficiently while maximizing perimeter offices.

"The design of 300 North LaSalle was instrumental in securing the anchor tenant K&E," says Hines vice president Jim Walsh. "The building needed to create an image of quality. Pickard Chilton's selection of materials, from the curtain wall's stainless steel to material choices in the lobby and the public plazas, as well as their detail in the overall design, achieved that goal." This and flexible, efficient floor plans were also instrumental in attracting tenants for the 25,000-square-foot rentable floor plates. "In many cases," points out Walsh, "these tenants will be paying more per square foot but taking less square footage."

To maximize daylighting and views, the team raised the ceilings to about 10 feet and employed floor-to-ceiling low-E glass (with stainless steel shade fins). And to achieve LEED Gold CS

**CREDITS**

**ARCHITECT:** Pickard Chilton – Jon Pickard, William D. Chilton, Anthony Markese, principals

**ARCHITECT OF RECORD:** Kendall/Heaton

**CONSULTANTS:** Magnusson Klemencic (structural); Alvine (m/e/p); Epstein (civil); Wolff (landscape); BVM (sustainability); CDC (curtain wall)

**CLIENT:** KBS Real Estate Investment Trust

**SIZE:** 1.3 million gross square feet

**COST:** \$480 million (construction)

**COMPLETION DATE:** May 2009

**SOURCES**

**CURTAIN WALL:** Permasteelisa

**METAL PANELS:** Centria (penthouse)

**PRECAST CONCRETE:** Gate Precast

**GLAZING:** Viracon

**ENTRANCES:** Kawneer

**CEILING:** Armstrong

**PAINTS:** Sherwin-Williams



An articulated steel crown defines 300 North LaSalle on its prominent site. To maximize the southern exposure of the garden and limit solar gain on the east and west facades, the team placed the tower on the plot's northern limit.



# SOFTER LIGHT FOSTERS SHARPER IDEAS

CREATING ENVIRONMENTS WHERE PEOPLE CAN SHINE™

It's an undisputed fact - a well-designed daylighting strategy lifts performance in everything from student test scores to retail sales\*. But harsh direct sunlight, when left unchecked creates glare on monitors, raises room temperatures and pushes human performance downward. Translucent skylights and curtainwall from Major soften light, moderate temperatures and keep buildings and occupants alike performing at peak levels.

## SKYLIGHTS AND TRANSLUCENT CURTAINWALL



\* Heschong Mahone Group, Inc. 1999  
© Major Industries, 2011

888-759-2678 | [www.majorskylights.com](http://www.majorskylights.com)

"THE TEST OF A GREAT BUILDING IS IN THE MARKETPLACE. THE MARKETPLACE RECOGNIZES THE VALUE OF QUALITY ARCHITECTURE AND ENDORSES IT IN THE SALES PRICE IT IS ABLE TO ACHIEVE."  
 — JON PICKARD, PRINCIPAL, PICKARD CHILTON



ABOVE: The building's grand, three-story public lobby continues a long Chicago tradition.

LEFT: The team created a pedestrian connection to the building by dedicating a half-acre of the 1.2-acre site to two public plazas bridged by a stair.

certification and an Energy Star rating, they diverted 98 percent of demolition and construction waste and specified a green roof and condenser water supplied by the river, among other things.

"The building opened 90 percent leased in a tough leasing market and quickly leased to over 96 percent," says Walsh. As a further testament to the building's success, Hines sold it in 2010 for a record \$655 million – at \$503 per square foot, the highest price ever paid for a downtown Chicago office building, claim the architects. "You can achieve your business objectives by simply doing a box," says Pickard Chilton principal Jon Pickard. "However, 300 North LaSalle transcends that. It contributes to the city at many levels – it has a dignity that goes beyond a bottom-line commercial focus and a refinement that is consistent with the history of Chicago." *Beth Broome*

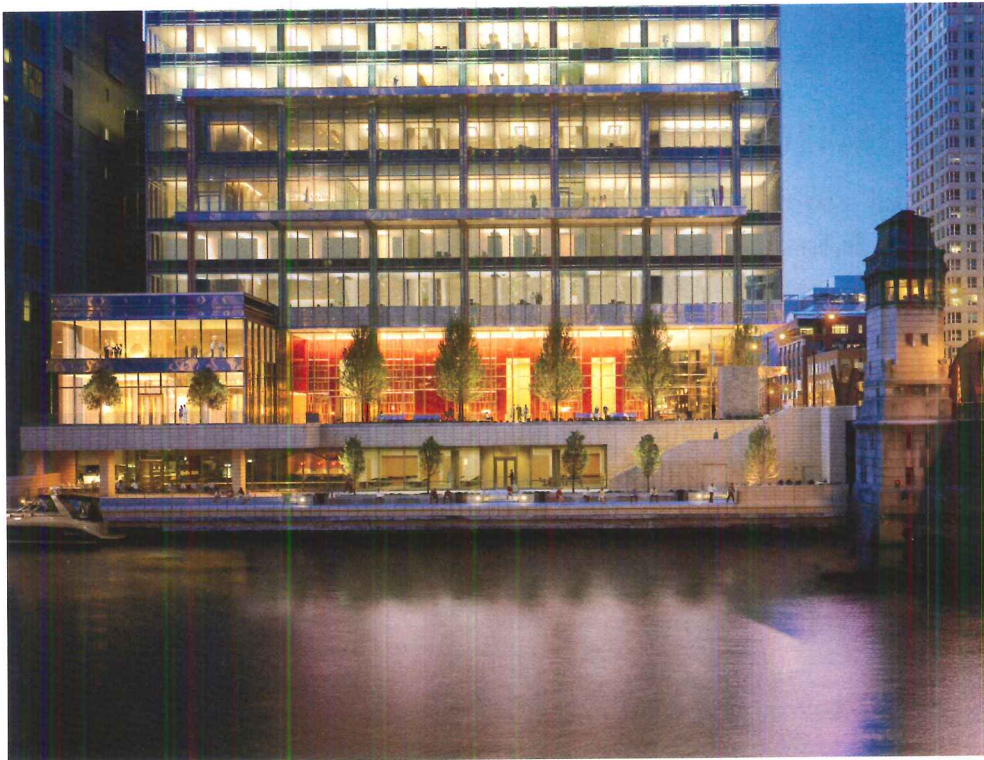

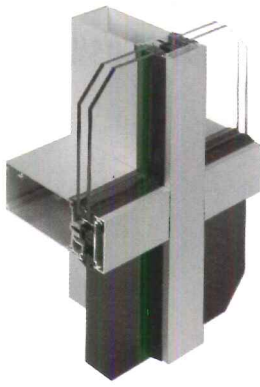

It's ultra thermal and ultra innovative.

It's ultra condensation resistant and ultra flexible.

It's ultra trusted and an ultra value.

**Kawneer's new 1600UT Curtain Wall System™ is**

# ULTRA

Setting the standard in thermal innovation.

See us at AIA 2011 National Convention and Expo Booth #2641.

Architectural Aluminum Systems  
Steel + Stainless Steel Systems  
Entrances + Framing  
Curtain Walls  
Windows

[kawneer.com](http://kawneer.com)  
[kawneergreen.com](http://kawneergreen.com)

 **KAWNEER**  
AN ALCOA COMPANY

## GOOD DESIGN IS good business

PROJECT **DENVER ART MUSEUM SHOP**  
 ARCHITECT **ROTH + SHEPPARD ARCHITECTS**  
 LOCATION **DENVER**

**ESTABLISHED MORE THAN** 26 years ago, Roth + Sheppard Architects have a bunch of retail projects in their portfolio – “just cool spaces that seemed to work,” says Jeff Sheppard, coprincipal of the Denver-based firm. His design of the gift shop at Daniel Libeskind’s Denver Art Museum wasn’t based on a gut sensibility, though. Instead, he and his team took a scientific approach to the design in order to directly impact sales. According to consultant Andoniadis Retail Services, the museum store’s sales were substantially lower than those of other museums’, says Sheppard. “That was an indicator that maybe something wasn’t working right.”

After conducting a relocation analysis process, the firm determined that visitors were ignoring the store because it was hidden under the stairs in the lobby that led to the museum’s galleries. The spot where the shop would get the most attention appeared to be an empty space adjacent to the museum’s entrance, where a café had been planned but never installed.

Sloping, sculptural Libeskind-designed walls slice through this dynamic space, forcing the architects to buck the prevailing strategy, which is to put as much merchandise as you can on the walls. “We had to rethink that to figure out ways to make the merchandise look like art,” says Sheppard. “[But] we want you to touch it and buy it, even though it looks like art.”

With Paco Underhill’s *Why We Buy: The Science of Shopping* (Simon & Schuster, 2000) serving as inspiration, the architects made deliberate choices every step of the way – and achieved their goal. The project was completed in November 2009. According to data compiled by the museum, revenues increased 25 percent between calendar years 2009 and 2010, and, in the first quarter of fiscal year 2011, 29 percent of the museum’s visitors entered the museum shop, an increase over the national “capture rate” of 17 to 22 percent.

Visitors now pass through a doorless threshold next to



The store’s backlit “color wall” displays a regularly updated supply of glass vases.

## CREDITS

**ARCHITECT:** Roth + Sheppard Architects – Jeff Sheppard, principal in charge; Tim Politis, project architect; Christopher Keast, Adam Harding, designers  
**CONSULTANTS:** Studio NYL (structural); BCER (electrical); Beaudin Ganze (mechanical); Andoniadis (retail); High Country (millwork); Urban Fabrication (custom lighting)  
**GENERAL CONTRACTOR:** NCI Norkoli Construction

**CLIENT:** Denver Art Museum  
**SIZE:** 4,936 gross square feet  
**COST:** Not available  
**COMPLETION DATE:** November 2009

## SOURCES

**GLAZING:** Cricursa; C.R. Laurence; 3M  
**WINDOWS:** Manko  
**HARDWARE:** Häfele; Futura Industries; Marlite Visplay

**CEILING:** Litelab  
**INTERIOR FINISHES:** US Surface Warehouse (LivingStone); Sherwin-Williams; Pionite  
**FLOORING:** Ryan and Co. Flooring Solutions; Johnsonite  
**LIGHTING:** Fawoo (LED panels); Litelab (track lighting); Urban Fabrication (custom yellow line fixture)  
**PLUMBING:** Advance Tabco



**Reynobond**<sup>®</sup>  
Architecture

# Smog-Eating Buildings?

It's not science fiction. It's the innovative science behind Reynobond<sup>®</sup> with EcoClean<sup>™</sup>  
Powered by HYDROTECT<sup>™</sup>

For decades, scientists have recognized that, when exposed to sunlight, titanium dioxide acts as a catalyst to break down organic matter, while also creating a superhydrophilic (water-loving) surface.

Now, Alcoa Architectural Products has developed a proprietary process that leverages HYDROTECT<sup>™</sup> technology from TOTO<sup>®</sup> to apply a titanium dioxide coating, called EcoClean, to the pre-painted aluminum surface of Reynobond. The result is the world's first coil-coated aluminum architectural panel that cleans itself – and the air around it.

From bird residue to diesel fumes, architectural building panels are constantly exposed to organic material that makes surfaces dirty. Yet there's another organic material constantly bombarding buildings: NOx (nitrogen oxides). As the primary component of smog, it threatens the quality of the air we breathe.

But when NOx molecules float near the surface of Reynobond with EcoClean, they are attacked by free radicals generated from the titanium dioxide reacting with water and oxygen in the air – oxidizing the NOx molecules and converting them to a harmless nitrate.

In this way, Reynobond with EcoClean actively works to remove pollutants by using sunlight and the water vapor and oxygen in the air to clean the air itself.

And because the EcoClean coating is superhydrophilic, it makes the surface of the Reynobond super slick in the presence of water. So when it rains, water collapses and runs evenly off the building, taking most of the broken down organic matter and nitrates with it.

Reynobond with EcoClean creates cleaner air and a cleaner building – while lowering maintenance costs. It's another example of Excellence In Innovation from Alcoa that can help you make an impact on our world.



 **excellence in innovation**

[ecoclean.com](http://ecoclean.com)

ALCOA  
Alcoa Architectural Products • 50 Industrial Boulevard • Eastman, GA 31023-4129 • Tel. 800 841 7774 • [ecoclean.com](http://ecoclean.com)  
©2011 Alcoa Architectural Products. EcoClean<sup>™</sup> is a trademark of Alcoa Inc. HYDROTECT<sup>™</sup> is a trademark of TOTO USA, Inc.

"WE HAD TO . . . FIGURE OUT WAYS TO MAKE THE MERCHANDISE LOOK LIKE ART. NOW MANY PEOPLE WALK INTO THE LOBBY AND THINK THE STORE IS THE FIRST GALLERY."  
 — JEFF SHEPPARD, ROTH + SHEPPARD ARCHITECTS



1

1. The architects designed a small café at the back of the store to lure visitors all the way through and entice them to linger near the books.

2. Visitors enter the museum shop through the lobby. There are no doors because the shop is only open when the museum is open.

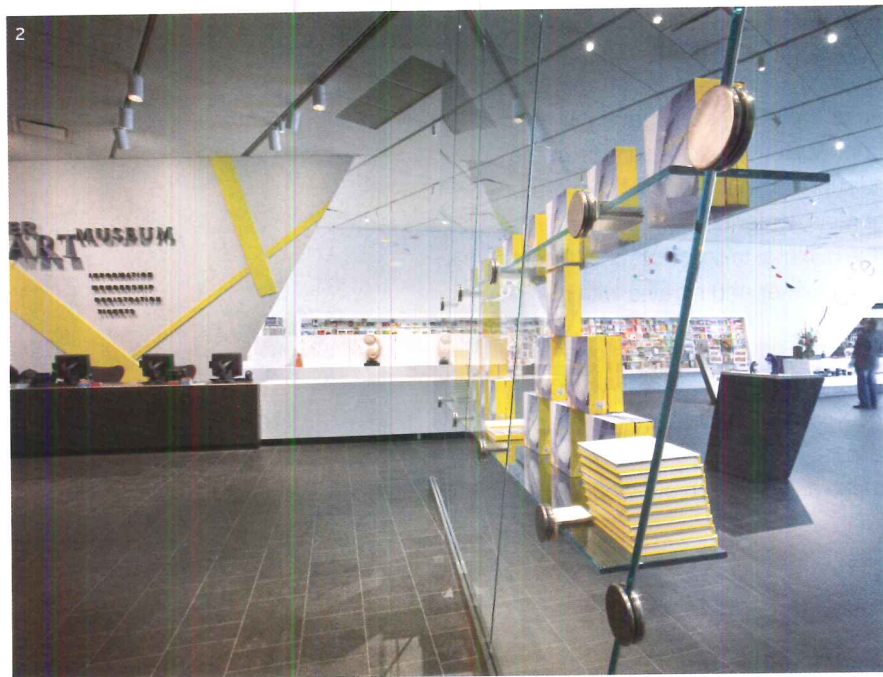

2

the ticket counter, where they are given space to get a sense of the store without being bombarded by merchandise. The most profitable item – jewelry – is at a striking, centrally located counter opposite the children's area. Columns of merchandise, only one of them structural, inspire a procession through the shop, where even gift cards are arranged on a sloping wall like a mosaic.

When the unused room was initially tapped for the new location of the store, Sheppard was wary. "In a Libeskind building, there's a lot going on with the structure and geometric interplay," he says. Maybe this was an intentional void, a place for people to rest their eyes? But the museum insisted that this wasn't the case. Now, says Sheppard, "many people walk into the lobby and think the store is the first gallery." *Laura Raskin*



# 1,413 SAFETY STANDARDS

Trust UL

A million code requirements, thousands of standards, every day you see new technologies and new applications. How do you keep track of it all? Trust your gut and trust the knowledge leader—the one who developed 1,413 standards and the one contractors and specifiers have relied on for 117 years. Ask one question and be done with it—**IS IT UL OR ISN'T IT?**



Need help with fire resistance rated designs? Go to [ul.com/firewizard](http://ul.com/firewizard)  
For technical help call **1.877.UL.HELPS** or go to [ul.com/architects](http://ul.com/architects)

## GOOD DESIGN IS good business

AFTER THE LEDGE AT SKYDECK CHICAGO AT THE WILLIS TOWER OPENED IN 2009, ATTENDANCE ROSE FROM 1.09 MILLION IN 2008 TO A PROJECTED 1.4 MILLION FOR 2011.



PROJECT **THE LEDGE AT SKYDECK CHICAGO**  
ARCHITECT **SKIDMORE, OWINGS & MERRILL**  
LOCATION **CHICAGO**

**BEFORE YOU GO** to the Ledge at Skydeck Chicago at the Willis Tower (formerly the Sears Tower), you may want to get in the mood by seeing *Vertigo* (1958), Alfred Hitchcock's famous thriller. Or maybe not. The thrill, panic, and fear so memorably portrayed in the film is present in real life at the Ledge. Skidmore, Owings & Merrill (SOM), which designed the tower in 1973, came up with these subtle additions to a renovated Skydeck when the new owner wanted to revamp its image after the tower's name change. SOM and engineer Halcrow Yolles created four five-sided glass balconies about 4 feet deep, 10 feet high, and 10 feet wide. They are formed by laminating three layers of 1/2-inch clear, no-iron, specially coated glass panels and mounting them on steel frames. The assembly slides on rails so the outdoor glass rooms can be retracted into the building for maintenance. The frames' hollow tubes bring conditioned air to the ledges and provide air flow to mitigate condensation. Needless to say, the scheme has been wildly popular. The renovation of Skydeck and the addition of the Ledge have upped attendance from just over from 1.09 million in 2008 (before its completion in 2009) to a projected 1.4 million by the end of 2011. While the 3,500-square-foot multimillion-dollar renovation is not cheap, the building owner, U.S. Equities Realty, expects income and attendance to keep soaring. *Suzanne Stephens*

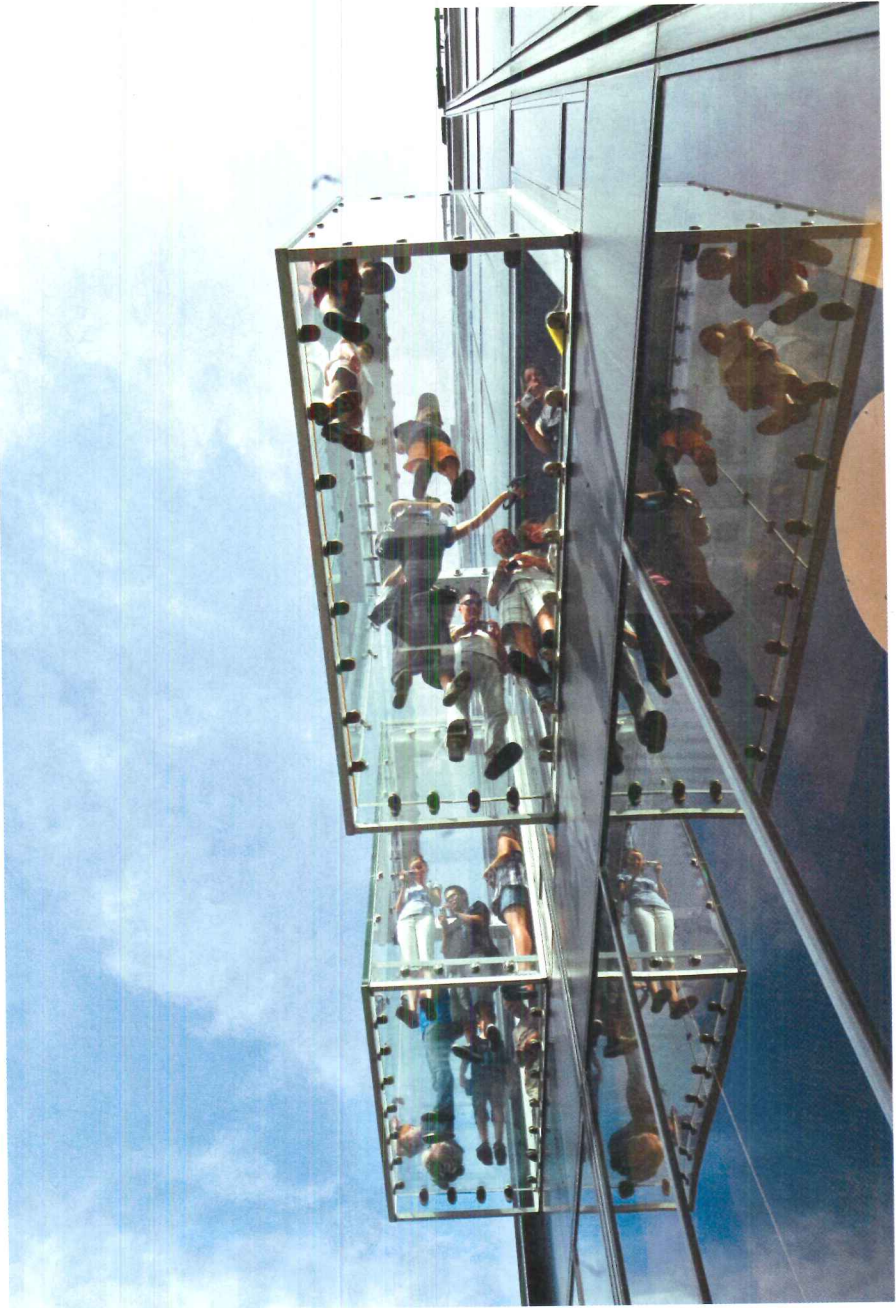

LEFT: The Willis Tower, formerly the Sears Tower, was designed in 1973 by Skidmore, Owings & Merrill. Since its change of name, the new owners decided that Skydeck on the 103rd floor needed renovating, which led to the addition of four glass balconies with glass floors. RIGHT: Each of the balconies can accommodate 5 tons and wind pressure of 125 pounds per square foot.

## CREDITS

ARCHITECT: Skidmore, Owings & Merrill – Thomas Kerwin, managing partner; Ross Wimer, design partner; William Baker, structural partner; Charles Hasbrouck and Darren McKinnon, project managers

ENGINEERS: Halcrow Yolles, (structure, glass boxes)

GLAZING CONTRACTOR: MTH Industries

CONSULTANTS: Environmental

Systems Design (m/e/p); Schuler Shook (lighting)

CLIENT: U.S. Equities Realty

SIZE: 3,500 square feet

COST: withheld

COMPLETION DATE: July 2009

## SOURCES

STRUCTURAL GLASS: PPG;

Prelco (fabrication)

GLASS INTERLAYER: Solutia;

DuPont SentryGlas Plus

# Every time our coating goes on a building, so does our reputation.

When it comes to architectural coating, the specs always call for durability and beauty. But you know that a coating that applies as beautifully is just as important. For over 40 years, Fluropon® has been the first choice of architects, builders and applicators. Why? Because Fluropon coatings are field proven with outstanding resistance to UV rays, exceptional color retention and resistance to chalking and chemical degradation. Just as important, we don't miss deadlines. We back up what we sell and Fluropon is a name you can trust. Fluropon coatings are available in a variety of energy-efficient solar-reflective colors, so you'll find exactly what you want. Check out Fluropon today because when your project looks good, you look good. **Fluropon PVDF. 100% trusted.**

Maple Grove Hospital, Maple Grove, Minnesota  
Product: Formawall Dimension Series  
and Concept Series by CENTRIA  
Finish: Fluropon Classic II  
Architect: BWBR Architects



© 2011 Valspar Corporation

Visit [valsparcoil.com](http://valsparcoil.com)

**Fluropon**<sup>®</sup>  
by valspar

CIRCLE 122

## GOOD DESIGN IS good business

ENROLLMENT IN THE MBA PROGRAM IS UP 45 PERCENT FROM THREE YEARS AGO – GROWTH THAT THE CLIENT ATTRIBUTES TO THE NEW BUILDING'S VISIBILITY.



PROJECT **LORRY I. LOKEY GRADUATE SCHOOL OF BUSINESS, MILLS COLLEGE**

ARCHITECT **BOHLIN CYWINSKI JACKSON**

LOCATION **OAKLAND**

**RED TILE ROOFS** and stucco facades dominate the leafy grounds of Mills College, in Oakland. But for the new home of its now-10-year-old MBA program, the women's liberal arts college and coeducational graduate institution asked architects Bohlin Cywinski Jackson (BCJ) to depart from the campus's characteristic Spanish Revival style.

The firm responded with a decidedly modern building made of crisp volumes clad in stone, zinc, and glass. Completed in the fall of 2009, the Graduate School of Business houses classrooms, faculty offices, and areas for collaboration and impromptu meetings. The largest of these interactive zones is the double-story lobby, which opens to a covered linear porch and a lawn defined by the building's L-shaped plan. These indoor and outdoor spaces function like a campus "living room," says Greg Mottola, a BCJ principal.

A vegetated roof visible from the second floor is the most readily identifiable green feature, but the LEED Gold-certified building deploys several other tightly coordinated sustainable strategies, including daylighting, rainwater harvesting, and natural ventilation. These systems help maintain a comfortable learning environment and conserve resources and money, confirming the business school's commitment to "people, planet, and profit," or the so-called "triple bottom



TOP: A green roof, visible from the second floor offices, shelters a linear porch that serves as an outdoor extension of the lobby.

BOTTOM: The lobby, which has splashes of color and is full of daylight, is connected to the second floor with an open-riser grand stair.

line," explains Rosa Sheng, BCJ's project manager.

Enrollment in the MBA program is up 45 percent from three years ago – growth that the client attributes to the new building's visibility. The project has also proved to be an important faculty-recruitment tool. In fact, it was one reason Deborah Merrill-Sands elected to join the business school as dean this past fall. The facility, says Merrill-Sands, "demonstrates a dedication to advancing women of all backgrounds and to socially responsible business." *Joann Gonchar, AIA*

**CREDITS**

ARCHITECT: Bohlin Cywinski Jackson – Peter Q. Bohlin, principal for design; Gregory R. Mottola, principal in charge; Rosa Sheng, project architect

CONSULTANTS: Rutherford & Chekene (structural); Integral Group (m/e/p); BKF (civil); Lutsko Associates (landscape); Silverman & Light (lighting); Charles M. Salter Associates (acoustical)

CLIENT: Mills College

SIZE: 28,000 square feet

COST: \$21.4 million

COMPLETION DATE: August 2009

**SOURCES**

CURTAIN WALL: KAWNEER

GLAZING: Oldcastle BuildingEnvelope

GREEN ROOF: American Hydrotech

METAL PANELS: Rheinzink

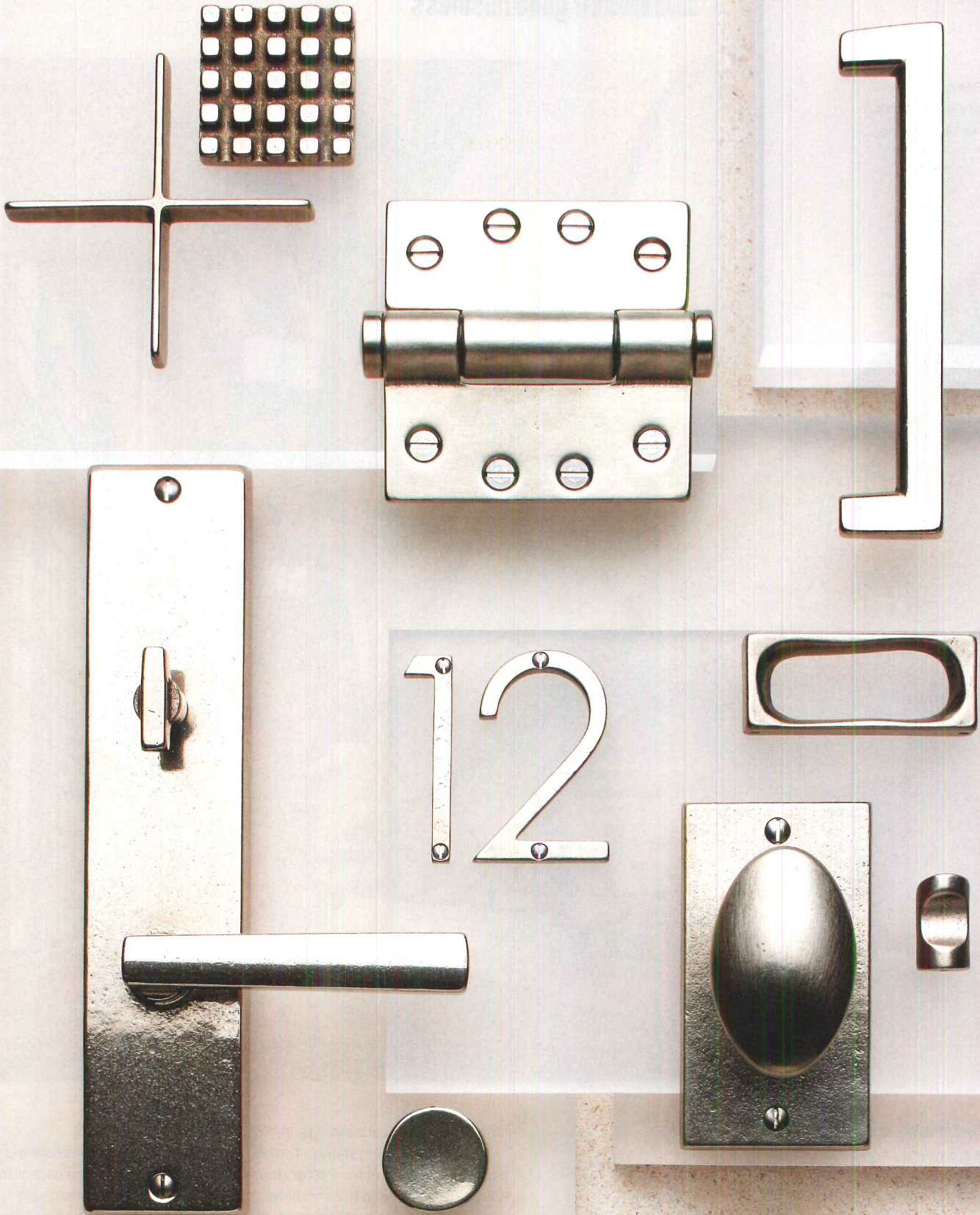

ROCKY MOUNTAIN®  
H A R D W A R E  
HANDCRAFTED BRONZE HARDWARE

VISIT US IN BOOTH #765  
888.552.9497  
rockymountainhardware.com



90% RECYCLED CONTENT  
50% Post-consumer  
40% Pre-consumer

## GOOD DESIGN IS good business

Cannon Design created a three-story gallery inside the shell of the building.

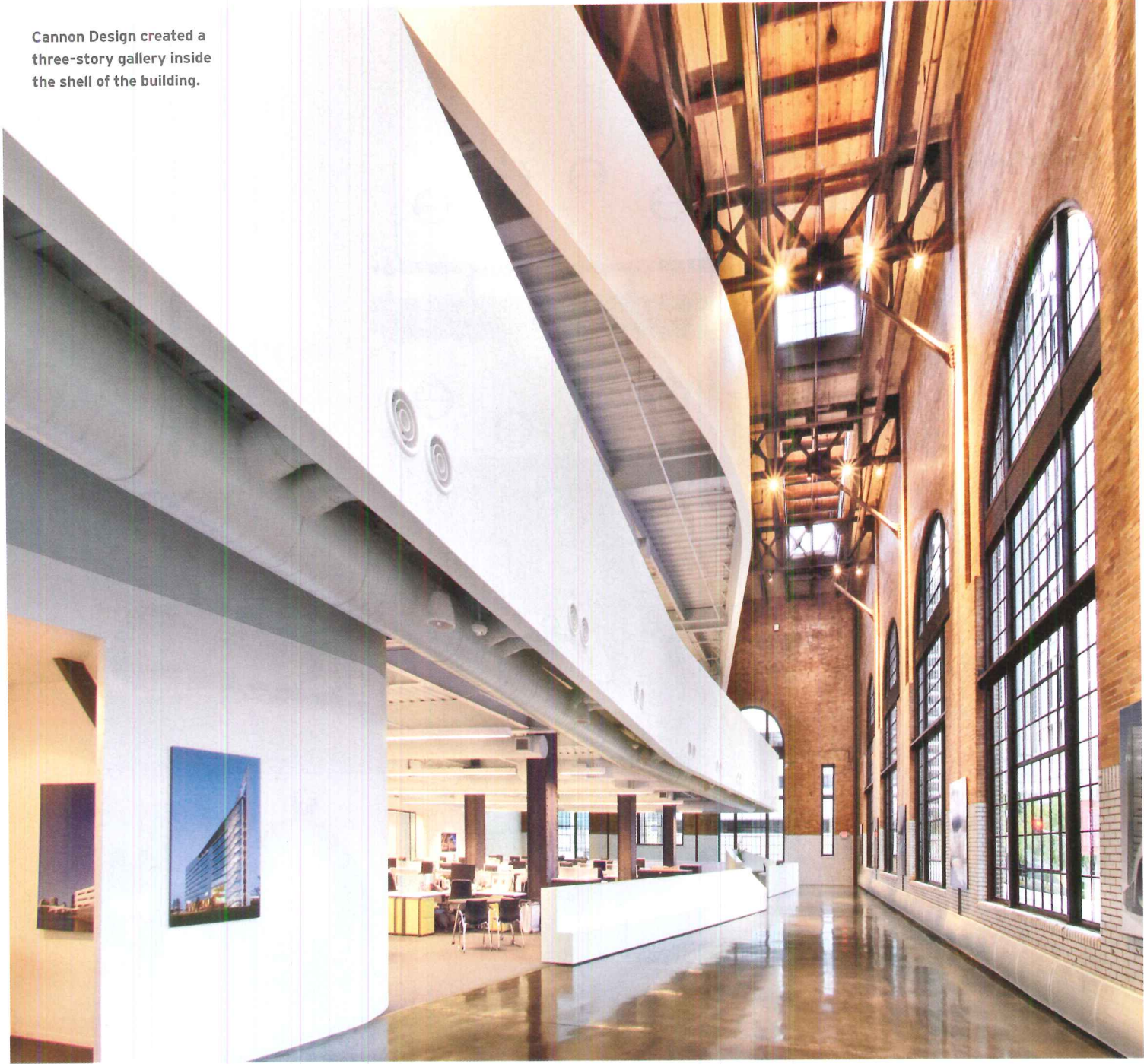

PROJECT **THE POWER HOUSE RESTORATION**  
 ARCHITECT **CANNON DESIGN**  
 LOCATION **ST. LOUIS**

**ARCHITECT THOMAS BERGMANN, MANAGING PRINCIPAL** of the Cannon Design St. Louis office, had walked past the Power House many times. The 1928 Revival-style building was a derelict landmark, listed on the National Register of Historic Places, just off the interstate – a sign of different and more prosperous times. The building began its life as a courthouse. Then the city turned it into a coal-fired power plant to heat

about a dozen local buildings. In 1980 it was decommissioned.

It wasn't until Bergmann's firm was in the market for a new office that he saw the potential of the Power House. Even though it had been vacant for 30 years, "the light and the character and the feel of the space were very powerful to me," says Bergmann. "It was a postindustrial cathedral." And since Cannon Design's lease was up on its office, it was the right time to leap. The firm analyzed the market and determined that if it utilized state, national, and Brownfield tax credits, purchasing the Power House from the developer/owner would make financial sense. So they bought it in 2007.

The subsequent renovation maintains the integrity of the original structure. To begin, the architects held an office-wide charrette that resulted



The strange disappearance of 300 chairs in just six minutes.

Discover the enigma at [www.figueras.com/mutaflex](http://www.figueras.com/mutaflex)

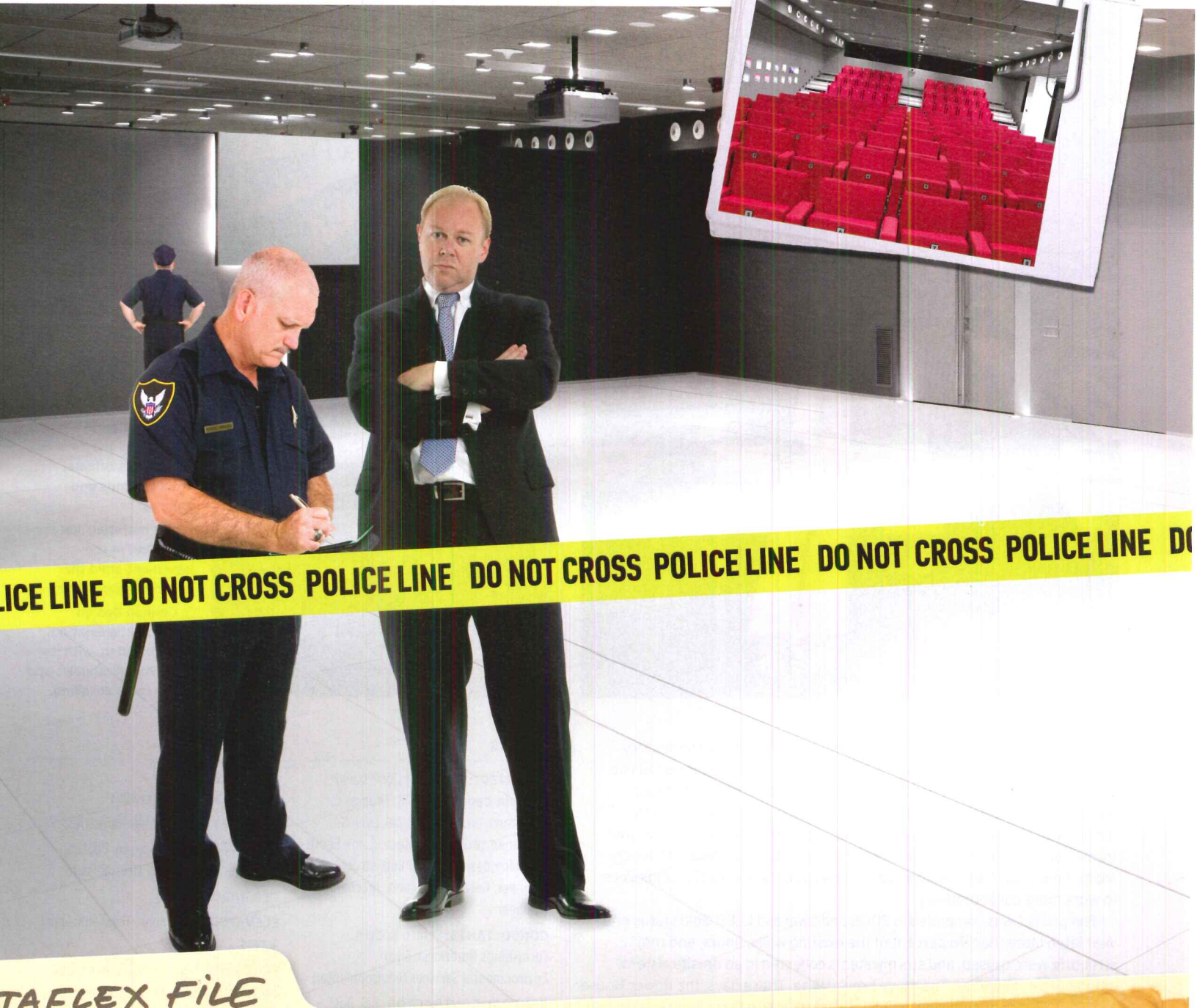

MUTAFLEX FILE

[www.figueras-usa.com](http://www.figueras-usa.com)  
W. 84th Avenue, Miami, FL 33126  
figueras-usa.com · Phone 1-786 331 9433

green  
attitude

CIRCLE 44

 **FIGUERAS**  
seatingUSA  
INNOVATION FOR YOUR PROJECTS

"[CANNON DESIGN STAFF] ARE NOW LIVING IN A WORLD WHERE THEY CAN TALK WITH EACH OTHER AND SHARE IDEAS, AND IT MAKES OUR PROJECTS STRONGER AND OUR TEAM STRONGER."  
 — THOMAS BERGMANN, CANNON DESIGN



1. The architects maintained the structure's original steel columns and trusses.
2. The materials library is located in the basement amid the concrete foundation.
3. Cannon Design restored the existing 1928 building, with its tall, arched windows and terra-cotta detailing.

in a "ship in a bottle" design. The interoffice team created a three-story gallery within the massive volume of the building. Then they inserted two separate floor plates that float above the ground floor to create extra balcony-like levels with meeting and work spaces. They also tucked the model shop, materials library, and boardroom in the basement and transformed an old storage structure into another boardroom and staff lunchroom. Ample open and flexible space allows approximately 120 employees to work more collaboratively.

The project was completed in 2008 and awarded LEED Gold status one year later. More than 98 percent of the existing walls, floors, and roof structure were reused, and stormwater is collected in an on-site cistern, among other initiatives. The move proved wise. These days, the Power House is part of a block of municipal buildings that the city has recently invested in, says Bergmann. Besides Cannon Design, advertising and creative agencies are moving to the area. More important, clients are wowed when they visit — as is the staff. "Almost immediately, the productivity and employee happiness were 'real,'" says Bergmann of the revived building's effect on Cannon Design's St. Louis team. "They are now living in a world where they can talk with each other, share ideas, and it makes our projects stronger — and our team stronger." *Laura Raskin*

#### CREDITS

**ARCHITECT:** Cannon Design — David M. Polzin, design principal; Thomas C. Bergmann, project principal; Lynn S. Grossman, project architect; J. Joe Scott, plumbing design; Ruofei Sun, structural engineer; Gerald G. Williams, mechanical engineer

**CONSULTANTS:** Centro Modern Furnishings (interiors); Sitex Environmental Services (environmental)

**GENERAL CONTRACTOR:** R.G. Ross — Kevin Bohnenstiehl, project manager

**CLIENT:** Cannon Design

**SIZE:** 32,000 square feet

**COST:** \$8 million

**COMPLETION DATE:** August 2008

#### SOURCES

**WINDOWS:** Quaker Windows

**WINDOW FILM:** Guardian Industries

**HVAC:** Kees, Trane, Indeco, Dayton, Lochinvar, Loren Cook, Titus, Ruskin

**CEILING:** Armstrong

**ELEVATOR/LIFT:** Kone, ThyssenKrupp Access

**FLOORING:** Desco, HTC, Diamond Clad, Expanko, Nora, Roppe, Johnsonite

**CARPET:** Lee's, Interface, Tandus

**LIGHTING:** Cooper Lighting, Focal Point, Architectural Lighting Works, Louis Poulsen, FineLight

**BUILDING CONTROLS:** Delta

**PAINT/COATINGS:** Sherwin-Williams, Walltalkers

TOTO®



*I want*

DESIGN WITH A CONSCIENCE.

The days of pretty for pretty's sake are over. Now, more than ever, bathrooms need style with substance. TOTO bath fixtures save money and water with every use without losing an ounce of performance. Or sacrificing their good looks to do it. That's world-class design with something more – real human value.

*you + water*

TOTOUSA.COM | 800.451.1111

## GOOD DESIGN IS good business

"I OFTEN HAVE THE FEELING THAT WHAT I WANT TO ACHIEVE IS UNATTAINABLE, BUT THE PROJECT THAT THA DELIVERED IS EVEN MORE THAN I DREAMED I COULD ACHIEVE."  
— NEAL KENY-GUYER, CEO MERCY CORPS



## CREDITS

**ARCHITECT:** THA Architecture – Thomas Hacker, design principal; Will Dann, principal in charge; David Keltner, project designer

**CONSULTANTS:** David Evans and Assoc. (civil); ABHT (structural); Glumac Int. (m/e/p); DECA (interior design); Peter Meijer Architect (historic)

**CONTRACTOR:** Walsh

**CLIENT:** Mercy Corps

**SIZE:** 83,032 gross square feet

**COST:** \$21.3 million

**COMPLETION:** Summer 2009

## SOURCES

**CLADDING:** Moeding (clay tile); Mutual Materials (masonry)

**GLASS:** Kawneer (curtain wall, monitors); Sage (electrochromic)

**INTERIORS:** Armstrong (acoustic panels, ceiling); MechoShade (shades); Benjamin Moore (paint)

PROJECT **MERCY CORPS WORLD HEADQUARTERS**  
ARCHITECT **THA ARCHITECTURE**  
LOCATION **PORTLAND, OREGON**

**COMMAND CENTRAL FOR** a global team of 4,000 professionals who run disaster relief and community development programs in over 40 countries, Mercy Corps needs an efficient base of operations. But its Portland, Oregon, "headquarters" was scattered in six leased locations around the city. "We were ready to build a home that would consolidate the different aspects of the organization and reflect our values," recalls CEO Neal Keny-Guyer. Inasmuch as these values include accountability, sustainable resource management, and the wise allocation of funds, the 30-year-old nonprofit agency negotiated the affordable acquisition of a blighted riverside landmark, the Packer-Scott building (circa 1892), from the Portland Development Commission – part of an urban improvement initiative for the economically challenged downtown neighborhood it occupied.

Charged with the sensitive renovation, the Portland firm THA Architecture worked with Mercy Corps to create a scheme that would qualify for LEED certification, as well as the tax credits and grants needed to bolster the reasonable purchase price and fund-raising profits. Maintaining the integrity of the existing 42,000-square-foot masonry structure, the architects nearly doubled its footprint and mass with a terra-cotta-clad addition that integrates with the historic property without mimicking it. Then the design team worked with engineers to cut a wide opening in the connecting wall for a free flow between the old and new sections.

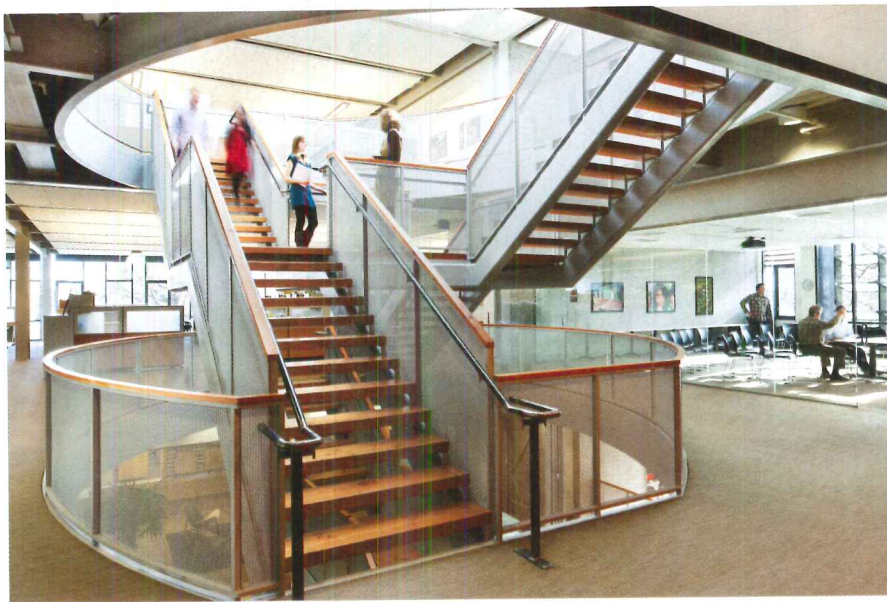

Their flexible strategy includes a ground-floor community center, bike racks, and an office for another nonprofit foundation that bought a small piece of the building.

Adjacent to the Saturday market, and near public transportation, the new headquarters has been a catalyst for both Portland and Mercy Corps. "Employees from different divisions now work side by side, and the building presents the right impression to visiting donors," says Keny-Guyer. Delivered on time and on budget, he concludes, "The project is more than I dreamed we could achieve." *Linda C. Lentz*

**TOP:** A dramatic east-facing curtain wall and operable windows bring daylight and fresh air into the building interior with its glass-enclosed meeting rooms.

**BOTTOM:** A skylight-topped, open stair, just east of the old structure in the new wing, fosters staff interaction.

# For personal patterns, think Trespa

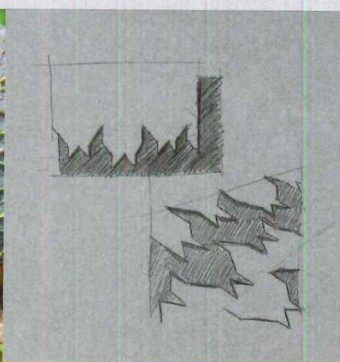
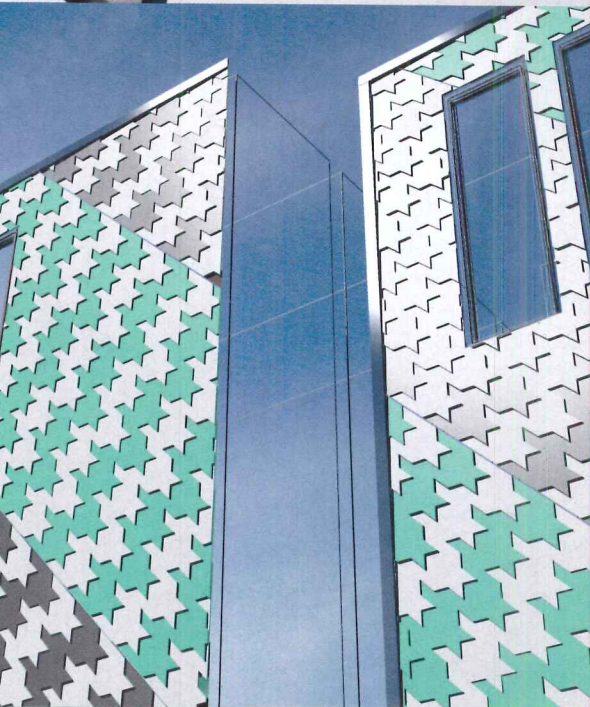

## Design a new Rhythm to create the unexpected

Fascinating rhythms in shapes, lines and patterns can portray a range of emotions. These patterns change as light plays across a facade . . . highlighting an unexpected array here, a surprising texture there.

Intricate patterns and thoughtful color choices amuse the eye and help connect with people on an emotional level. The Rhythm concept from Trespa fosters an exciting diversity of possibilities leading to classic and timeless design that will last forever. For more information: [www.trespa.com/na](http://www.trespa.com/na)

**Trespa**  
North America Ltd.  
12267 Crosthwaite Circle  
Poway, CA 92064  
Tel.: 1-800-4-TRESPA  
Fax: 1-858-679-9568  
[northamerica@trespa.com](mailto:northamerica@trespa.com)



# TRESPA®



# The beauty of a 10 Built for a Category 4

**Sentrigard™ is the perfect combination of beauty and beast.** Each of our 30 versatile colors comes with a 30-year warranty and our panels meet the strictest building codes in the country including Miami-Dade Product Control and Green Sustainable Certifications. Sentrigard panels can be incorporated into LEED specified architecture and have earned Energy Star® designation.

MIAMI-DADE COUNTY  
APPROVED

Sentrigard is exclusively distributed through N.B. Handy and Morris Ginsberg, market leaders in architectural sheet metal products and machinery for more than 100 years.

Offered exclusively through  
**NBHANDY**  
The Preferred Choice



**Morris  
Ginsberg**  
an N.B. Handy Company

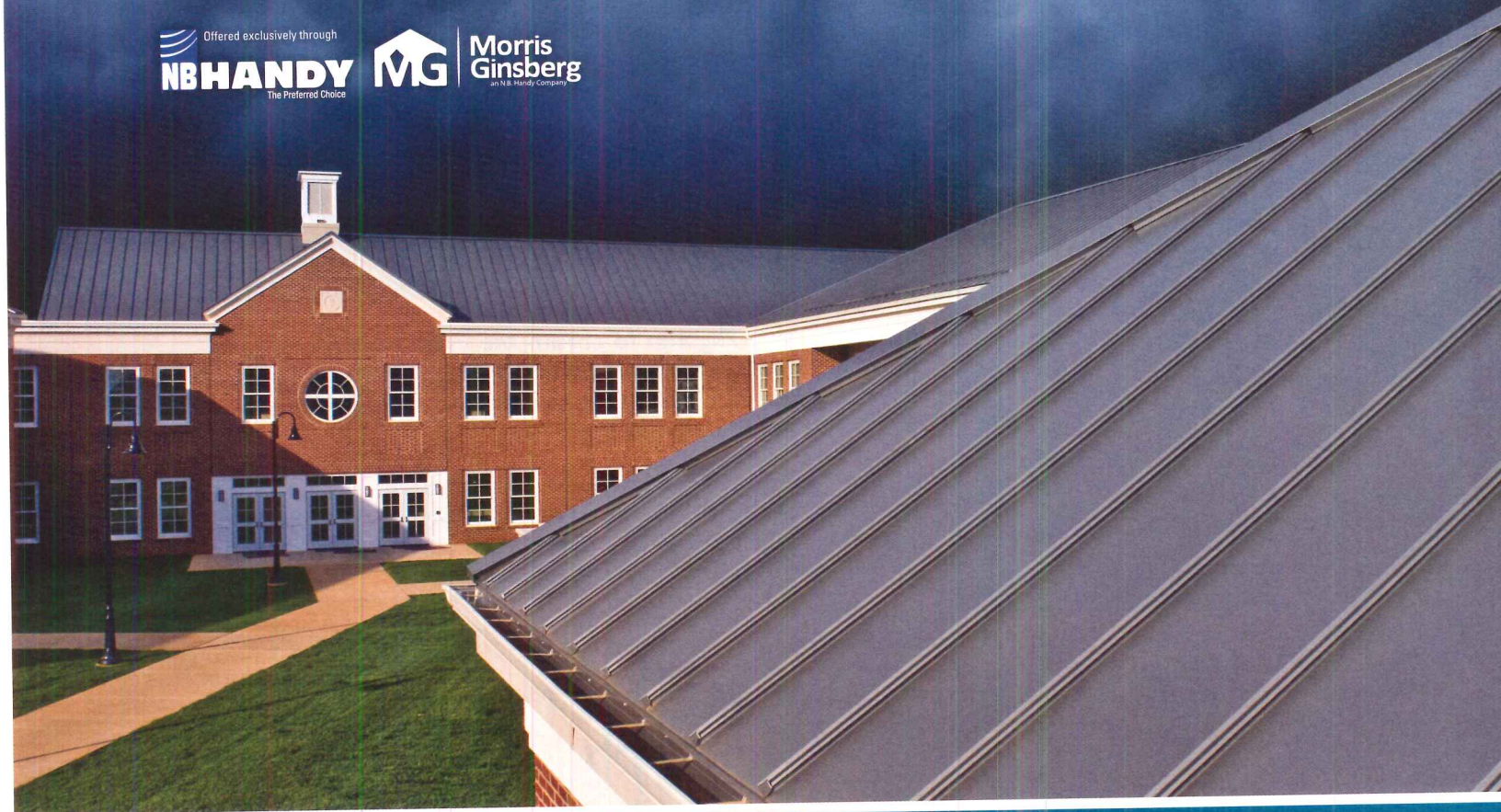

[www.sentrigard.com](http://www.sentrigard.com) • 877-495-7663

CIRCLE 82

# Blending Aesthetics & Energy-Efficiency

VRF solutions from Mitsubishi Electric Cooling and Heating helped the Lance Armstrong Foundation fulfill its vision for a dynamic new headquarters while earning prestigious LEED® Gold certification.

Lance Armstrong — international cycling star and well-known cancer survivor — has built an unparalleled legacy of achievement. His LIVESTRONG™ movement, along with the Lance Armstrong Foundation, is dedicated to improving the lives of the 28 million people around the world living with cancer.

After years based in a generic office space in downtown Austin, Texas, the seven-time Tour de France winner decided to seek a new permanent home for his operations that would better reflect and enhance the dynamic LIVESTRONG™ culture.

## The Mitsubishi Electric Solution

The foundation discovered a 30,000-square-foot former warehouse near Austin. The loft-like space offered the openness, youthfulness and sense of energy that Armstrong sought.

At the same time, he wanted the new headquarters to highlight the foundation's concern for the environment. He turned to San Antonio-based Lake/Flato Architects to fulfill his vision of this becoming one of Austin's first LEED® Gold-certified facilities.

Designing an inspiring, collaborative, free-flowing space was just the beginning. To achieve LEED® Gold, the architects knew they needed an HVAC system that could earn LEED® credits in the Energy 7 Atmosphere (EA), Indoor Air Quality (IAQ), and Innovation and Design categories.

That's where Mitsubishi Electric Cooling and Heating came in. The first two systems the architects looked at — DX (direct expansion) and chilled water — were rejected for being inefficient or too expensive. But Mitsubishi Electric's VRF solution offered lower energy costs while fitting smoothly within the space's aesthetics.

## Exclusive Two-Pipe Efficiency & Performance

There was one key driver — make that two. Mitsubishi Electric offers the industry's only two-pipe system that can simultaneously deliver heating and cooling to different zones within the same building. The two-pipe system requires many fewer fittings, plus a smaller investment for installation and labor and equipment.

Mitsubishi Electric's low-profile, energy-efficient indoor units were ideal for the demands of the new facility's open design:

- Ultra-quiet operation
- Shorter defrost cycle
- Little or no ductwork
- Simple controls
- Versatile locations
- Easy to expand
- Two-pipe configuration

In the end, Mitsubishi Electric was able to provide precise cooling and heating without interrupting or compromising the design aesthetics of the space. And that was vitally important to the designers.

Additionally, Mitsubishi Electric was the leading factor in the foundation earning LEED® Gold certification. According to Greg Lee, chief financial officer for the Lance Armstrong Foundation, "In less than two years, we already know that our new building uses 30 percent less energy than a conventional office building, and much of the savings can be attributed to (Mitsubishi Electric's) intelligent HVAC system."

Superior energy efficiency. Unobtrusive design. Mitsubishi Electric's VRF solutions met all of the foundation's needs. And they have the industry-leading technology and products to handle your next project.

**To get more information about this and other projects utilizing Mitsubishi Electric solutions, visit [mitsubishipro.com](http://mitsubishipro.com).**

## SOPHISTICATED ELEVATOR ENVIRONMENTS KONE DESIGN COLLECTION

Experience the KONE Design Collection and its 70 specially designed alternatives. KONE's FourSeasons™ concept combines different colors and shades reflecting the seasons, making it easier and faster to select a sophisticated and stylish design.

KONE was the first elevator company to receive the prestigious GOOD DESIGN award for their innovative elevator design concept.

Visit us at the 2011 AIA National Convention in New Orleans May 12-14 in booth #819 to learn more about our KONE Design Collection, BIM Tools, and see our Destination Control display.

[www.us.kone.com](http://www.us.kone.com)  
[us.communications@kone.com](mailto:us.communications@kone.com)  
1-800-956-KONE (5663)



# CHANGING THE WAY YOU SEE THE WORLD

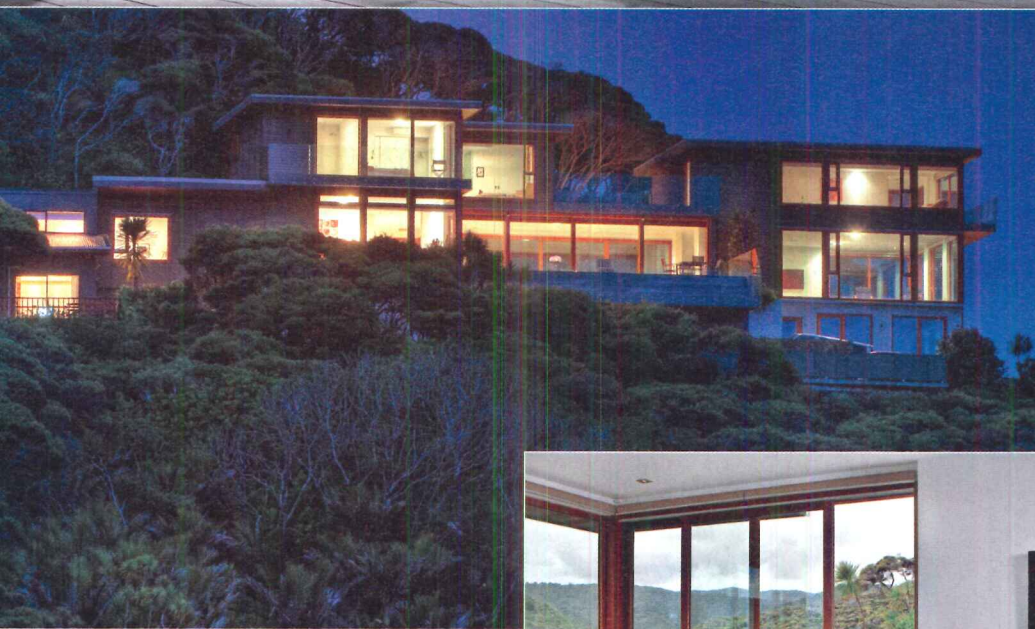
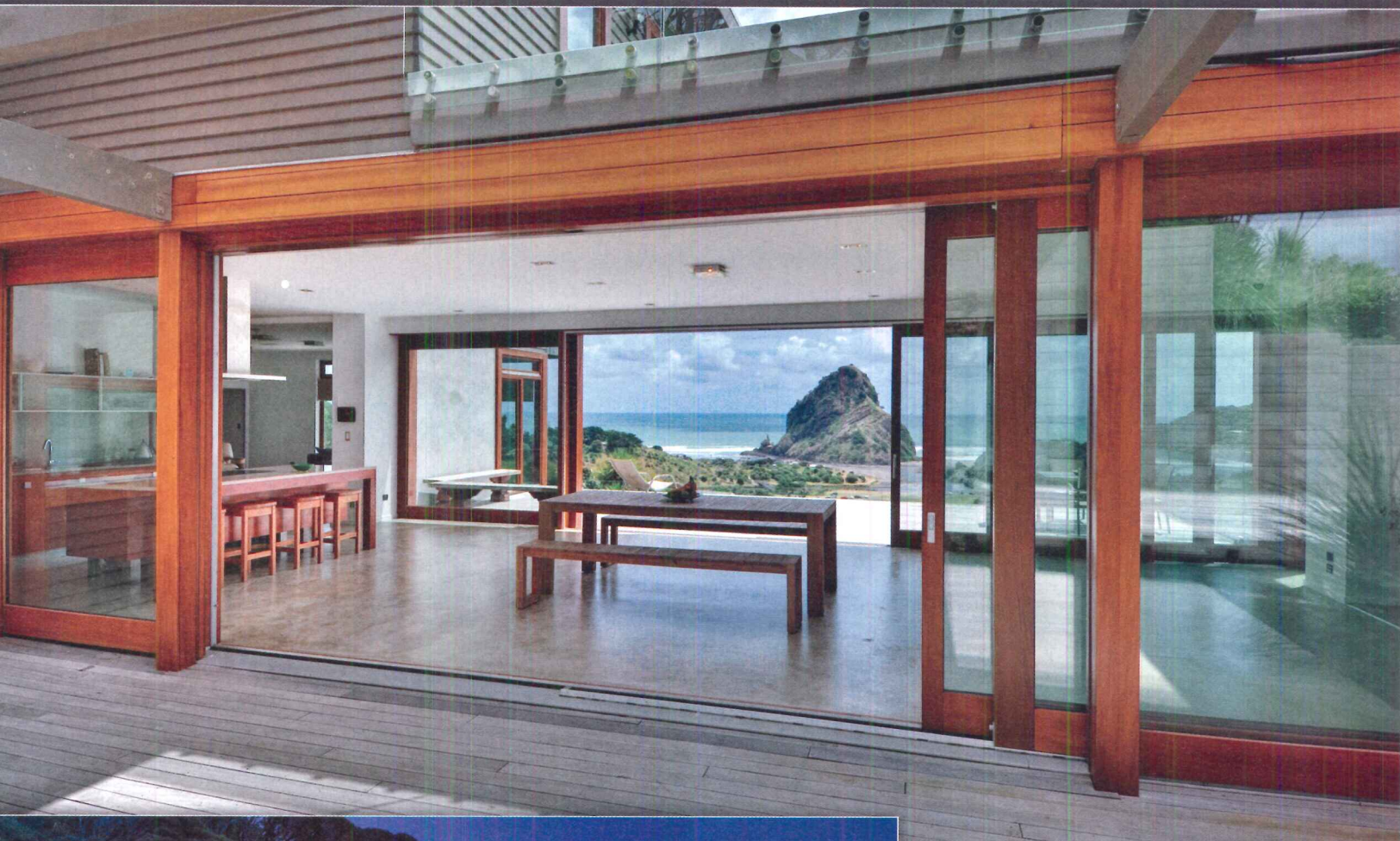

Every window and door that leaves our facility is custom made to order. Meeting our customers precise needs is what allows us to constantly innovate and modify our product line, thus preserving our reputation as the industry leader. Visit us online to see all the products we currently offer.

702.643.5700

[panda@panda-windows.com](mailto:panda@panda-windows.com)

[www.panda-windows.com](http://www.panda-windows.com)

 **PANDA**  
WINDOWS & DOORS



# CPI

DAYLIGHTING  
*Quality Comes to Light®*

Phone (800) 759-6985

[www.cpidaylighting.com](http://www.cpidaylighting.com)

# 2010 WINTER OLYMPIC RICHMOND SPEED SKATING OVA

Everyone deserves a medal during these difficult economic times. We at CPI Daylighting are just trying to offer a little **translucent panel daylight** at the end of this tunnel.

Diffused Glare-free Daylight | Significant Energy Savings | Proven System Longevity

**Highest Ratio of Light Transmission to Solar Heat Gain on the market**

Can meet DoD Blast Resistance and Forced Entry Requirements | Wide Range of Light Transmissions & Colors

Suitable for **LEED or Green Construction** projects

**Visit us at AIA Booth #737!**



SKYLIGHTS | CANOPIES | WALKWAYS | CURTAINWALLS

CONTROLLED DAYLIGHTING

CIRCLE 28



## Pilkington Pyrostop® Fire Resistance Glass

### Product Features

- Optical clarity of clear glass
- High visible light transmittance
- Human impact safety rated to Cat II
- Classified by Underwriters laboratories
- 45, 60, 90, 120 minute products available

Contact Technical Glass Products (TGP) at 800.426.0279 or visit [www.fireglass.com](http://www.fireglass.com)

Pilkington Fire Protection Glass North America • [www.pilkington.com/fire](http://www.pilkington.com/fire)



**PILKINGTON**  
NSG Group Flat Glass Business

LOCATION **MIAMI BEACH**  
ARCHITECT **GEHRY PARTNERS**  
BY **VICTORIA NEWHOUSE**

# NEW WORLD CENTER





**FRANK GEHRY'S NEW** World Center (NWC) in Miami's South Beach, and Walt Disney Concert Hall in Los Angeles [RECORD, November 2003, page 134], are at once similar yet quite different. While the sculptural stainless steel Disney Hall remains a landmark of the 21st century, nearly every guiding principle of that hall is overturned in the more reserved, white-stuccoed concrete New World Center in Miami. Yet both the Los Angeles and the Miami Beach performing arts spaces feature single halls with no proscenium.

In contrast to the painful birth of Disney Hall, the Miami project offered Gehry the opportunity to work with a lifelong friend, the esteemed conductor and composer Michael Tilson Thomas. A big difference between the two designs was Gehry's creation in Los Angeles of "a nice room in which nothing changes," as he says, and, conversely, his willingness for the Miami Beach auditorium to accommodate a dazzling array of transformations.

Thomas founded the New World Symphony (NWS) in 1987 as an orchestral academy for gifted graduates of major music conservatories. Attentive to the wishes of the late Ted Arison, the founder of Carnival Cruise Lines, who spearheaded NWS's \$75 million endowment, Thomas chose Miami for the symphony's home, originally in a retrofitted 1930s movie palace. Two nearby parking lots offered a site for the three-part project: a new NWC building, a 557-car garage, and the 2.5-acre Miami Beach Soundscape park from which the public can view free simulcasts of concerts projected on part of the center's facade. All three components were to be developed by NWC – with Gehry as the architect – for the city, which leased the land to NWC for \$1 a year for 90 years. The Dutch landscape architects West 8 took over the park's design after a budget reduction prompted Gehry to resign.

The NWC and its predominantly white walls harmonize with the heart of South Beach's Art Deco redevelopment district located a few blocks away on Lincoln Road. A wavy canopy marks the entrance, while the walls framing the atrium's glazed facades inflect slightly, drawing



OPPOSITE: An 80-foot-high by 180-foot-long unitized aluminum glazing system with low-iron glass mounted on a secondary steel frame marks the front entrance. This curtain wall is repeated on the west elevation.

1. The center's entrance facade overlooks Miami Beach Soundscape, a park designed by West 8. To the side of the entrance is a 7,000-square-foot projection wall of smooth plaster on metal studs that displays live concerts.
2. The atrium, featuring Frank Stella's bent tube sculpture *Taboehan* (2003), includes a lobby with a box office marked by a 17-foot-long plasma wall that announces the center's programs.
3. On the center's north wall, a white plastered shotcrete sunshade shields the performance hall from glare. Two layers of laminated insulated glass separated by a 3-foot air space eliminate outdoor noise.

attention to the interior where the activities within some workrooms are visible from the outside. After dark, the opaque auditorium facade next to the transparent atrium lights up with video projections.

Floating within the six-story atrium are volumes in the architect's signature sculptural style that house classrooms, rehearsal spaces, and offices. Traversed by a spiraling stair, the space is bathed in natural illumination from a skylight and east and west glazed facades. "The volumes are built," says Gehry, "like a multistory village, like a city on a stage." The top floor of the NWC contains a music library and the patrons' lounge, plus a rooftop garden designed by landscape architect Raymond Jungles.

Views into and around the concave, convex, and tilted forms perceptually expand the lobby's space and allow glimpses of musical activities in these rooms. Two low, narrow corridors snake from the east and the west parts of the lobby into the center of the 7,000-square-foot auditorium, where tiers of seats rise steeply on all sides in an arena configuration. The arrangement of the 756 seats varies according to the performance. Thomas's commitment to experimental ways of presenting music encouraged Gehry to devise 14 different stage configurations within the hall's trapezoidal container. Additionally, 247 seats can retract to make a flat floor and four satellite platforms allow musical programs in areas other than the stage.

Concerts feature theatrical, immersive lighting; specially commissioned videos; and contextual information (instead of program notes) projected onto the five huge, curved, acoustic, saillike wall panels, suspended below the ceiling. Simultaneous projections on these "sails" surround the audience and can, with the appropriate videos, create images that reinforce the musical experience. No seat in the auditorium is more than 13 rows from the stage. The sails swooping down the walls' upper halves lower the ceiling visually and intensify the space's feeling of intimacy, a quality that has become as important as acoustical excellence to the performance arts.

Ample daylight is admitted through a window behind the stage and a skylight, both constructed of multilayered laminated glass to mitigate outside noise. The concert hall is also protected from intrusive sound by massive concrete walls isolated from the interior ones. The soft absorptiveness of the stage's Alaskan yellow cedar and the plaster system for the ceiling baffles offer other acoustic features. The room's 50-foot height (the same as Disney Hall's) and its boxlike shape also produce acoustics that are clear and enveloping no matter what size group is performing. As NWS flute fellow Matthew Roitstein remarks, "In contrast to our old hall, the musicians can hear themselves and each other." The ensemble's adjustment to the more balanced acoustics of their new home should counter criticism by some of the symphony's excessive loudness.

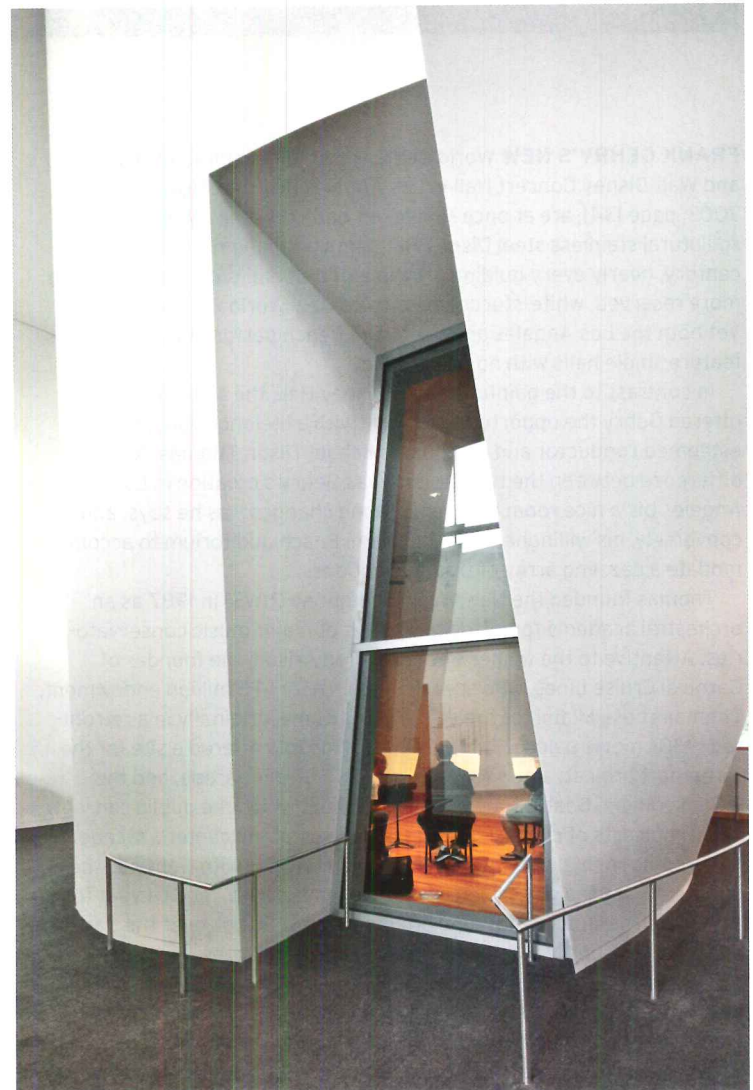
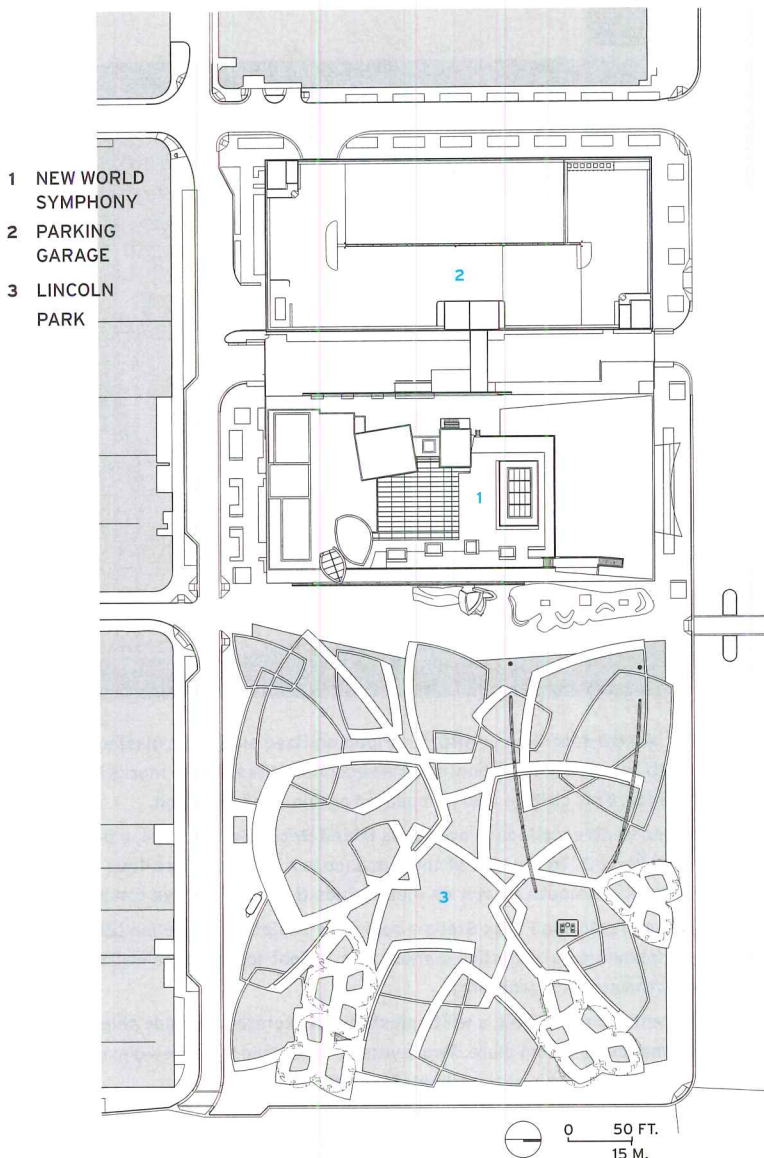



OPPOSITE: In the six-story atrium, Gehry stacked geometric forms for various functions. Most contain rehearsal rooms where viewers can glimpse musicians at work.

THIS PAGE: The clustered volumes are constructed from a curved steel stud track system surfaced with as many as five layers of drywall.

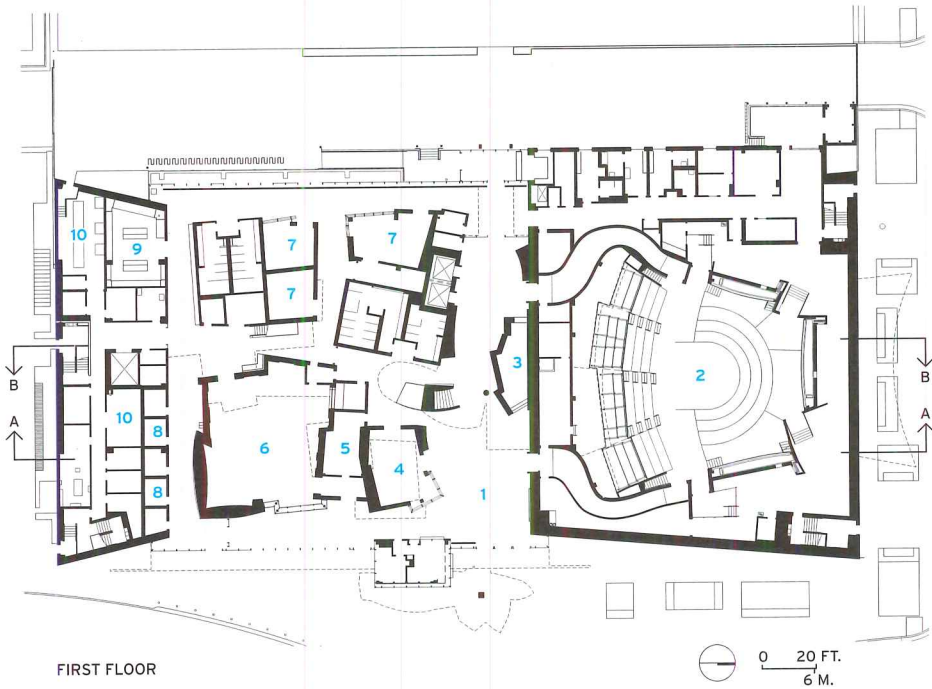

FIRST FLOOR



THIRD FLOOR

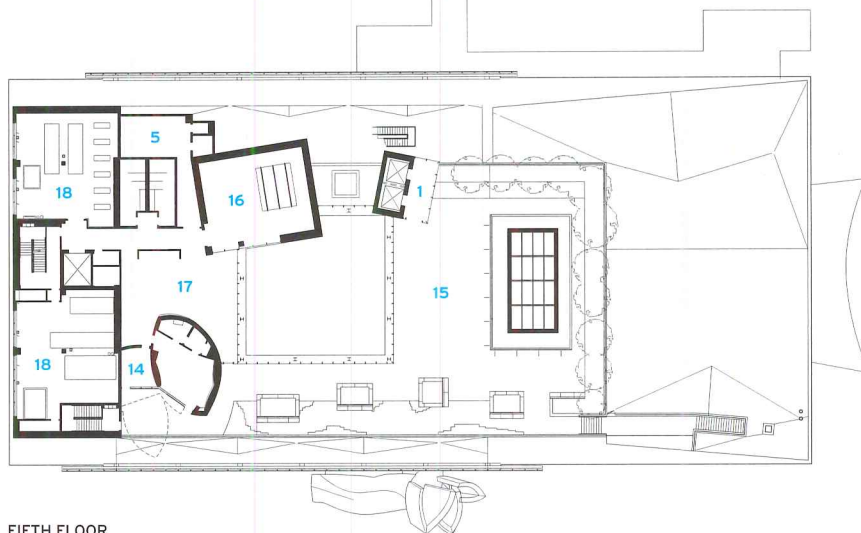

FIFTH FLOOR

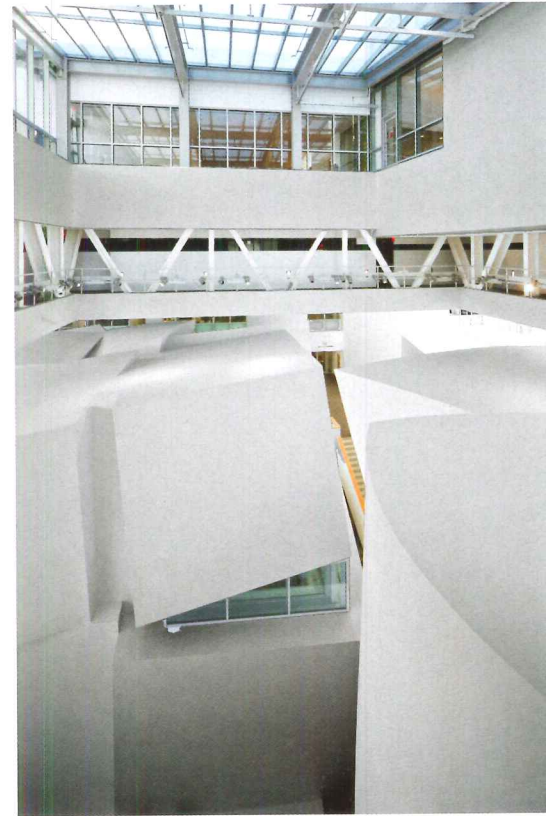

ABOVE: Fissures in the lids of the atrium's volumes containing chamber ensemble rooms allow daylight to filter from above to the interiors.

OPPOSITE: Daylight can enter the performance hall from the north window behind the 50-foot-high stage. "Sails" of curved, layered drywall over 2-inch shotcrete create a surface mass and add to the luminous ambience. In addition, slanted acoustical hardwood slats resembling garden trellises, seatbacks of Douglas fir, and blue upholstery evoke outdoor informality.

- |                     |                     |
|---------------------|---------------------|
| 1 LOBBY             | 10 SERVICE          |
| 2 PERFORMANCE HALL  | 11 CONTROL ROOM     |
| 3 BAR               | 12 VIDEO EDIT       |
| 4 CHAMBER ENSEMBLE  | 13 AUDIO STUDIO     |
| 5 PANTRY            | 14 OFFICE           |
| 6 MULTIPURPOSE      | 15 ROOF GARDEN      |
| 7 PERCUSSION STUDIO | 16 MUSIC LIBRARY    |
| 8 PRACTICE          | 17 ARTIST RECEPTION |
| 9 LOCKER            | 18 MECHANICAL       |



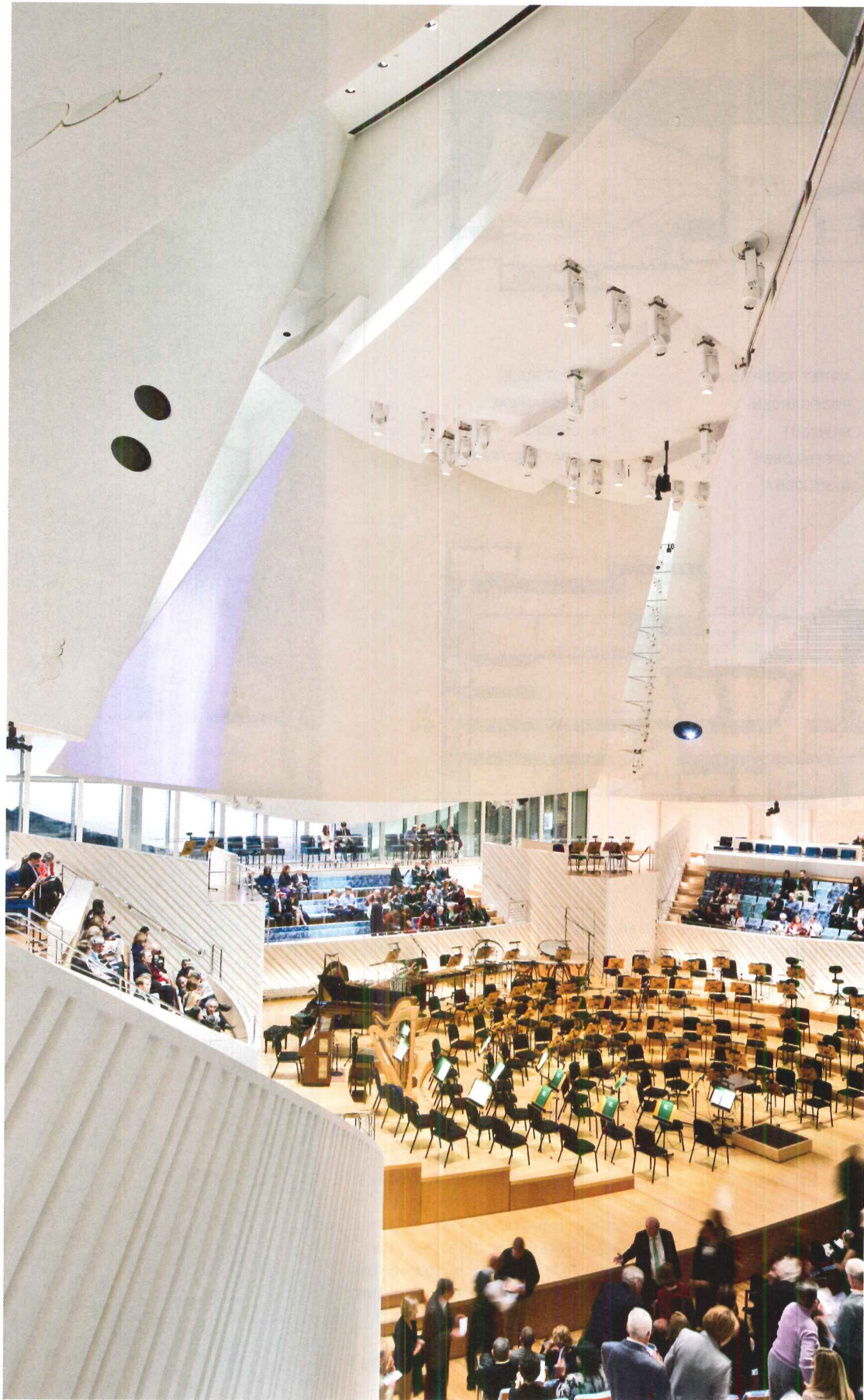

#### CREDITS

**ARCHITECT:** Gehry Partners – Frank Gehry, design partner; Craig Webb, project designer; Terry Bell, managing partner; Brad Winkeljohn, project architect; Kristin Ragins, project manager

**ENGINEERS:** Gilsanz, Murray, Steficek (structural); Cosentini Associates (m/e/p); Kimley-Horn and Associates (civil)

**CONSULTANTS:** Yasuhisa Toyota, Nagata Acoustics (acoustical); Theatre Projects Consultants (theatrical); Lam Partners (lighting); Acoustic Dimensions, Sonitus (sound and projection); Raymond Jungles Associates (landscape architect)

**CLIENT:** New World Symphony

**SIZE:** 100,641 square feet

**COST:** \$160 million

**COMPLETION DATE:** January 2011

#### SOURCES

**GLASS CURTAIN WALL:** Harmon

**GLASS:** Viracon

**SKYLIGHTS:** Super Sky

**ACOUSTICAL CEILINGS:** BASWAphon; Ecophon Focus D1

**DOWNLIGHTS:** Edison Price

**EXTERIOR LIGHTS:** Color Kinetics, Bega, BK

**FIXED SEATING:** Poltrona Frau

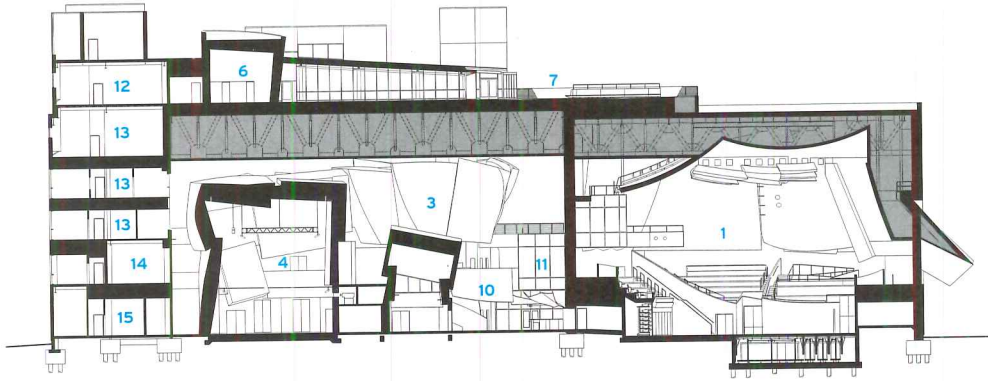

SECTION A-A

- |                    |                    |                      |
|--------------------|--------------------|----------------------|
| 1 PERFORMANCE HALL | 6 ARTIST RECEPTION | 11 VESTIBULE         |
| 2 CONTROL ROOM     | 7 ROOF GARDEN      | 12 MECHANICAL        |
| 3 CHAMBER ENSEMBLE | 8 SKYLIGHT         | 13 OFFICES           |
| 4 MULTIPURPOSE     | 9 UPPER LOBBY      | 14 COACHING/PRACTICE |
| 5 MUSIC LIBRARY    | 10 BAR/LOBBY       | 15 SHOP              |

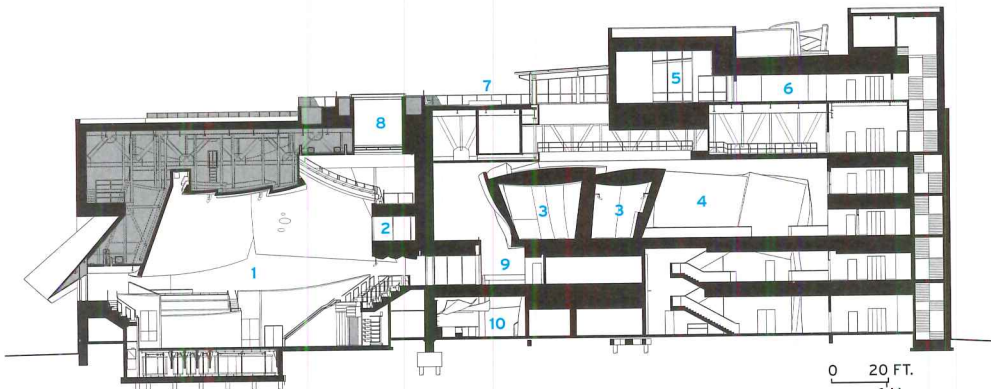

SECTION B-B

The flexibility in the 756-seat hall is accomplished by 14 configurations of the stage, 247 seats that retreat to a flat floor, 10 mechanical stage lifts, and four satellite platforms. Five "sails," some 40 feet by 65 feet, are supported on curved steel tubes, studs, and box beams, supplemented by acoustical "clouds" coated with seamless, sound-absorbing plaster that hang from steel pipes.

Connections to the university-based, broadband Internet2 network allow NWS students to take part in online projects and receive instruction from musicians elsewhere – in addition to the now-standard means of streaming a concert in Miami around the globe. The hall's acoustician, Yasuhisa Toyota, says, "The equipment is not new, but increasing the technological possibilities to this extent is." Another technological feature aimed at a larger public was in evidence during the center's opening week. Over a thousand people filled West 8's park to attentively watch "Wallcasts" of each concert being played inside. These simulcasts zoomed in on musicians as well as showed the 80-some orchestra members, relaying sound via 167 speakers embedded in large metal tubes.

The NWC achieves many of the goals that are being sought for today's concert halls, and which are more prevalent abroad than in the United States. A welcoming openness to the exterior is provided by the atrium and reinforced by the Wallcasts, and the auditorium combines intimacy with remarkable physical and acoustical flexibility. The magic sparked by the collaboration of Gehry and Thomas just might fulfill their hope to turn around a perceived faltering interest in classical music by the young. ■

*Victoria Newhouse is the author of the forthcoming Site and Sound: The Architecture and Acoustics of New Spaces for Music (Monacelli).*

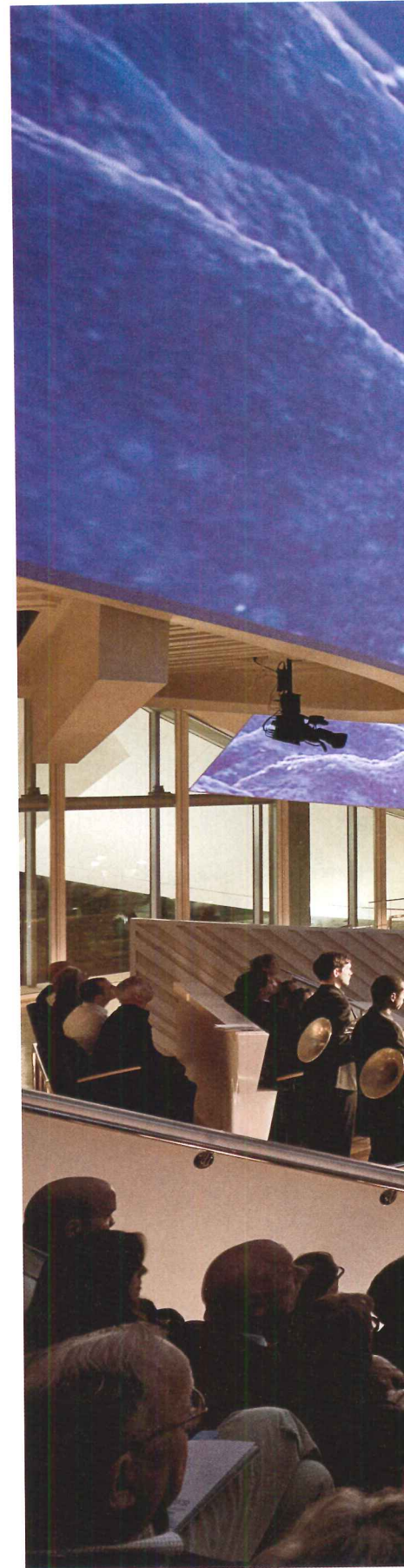



# ORANGE CUBE

LOCATION **LYON, FRANCE**  
ARCHITECT **JAKOB + MACFARLANE**  
BY **JENNA M. MCKNIGHT**

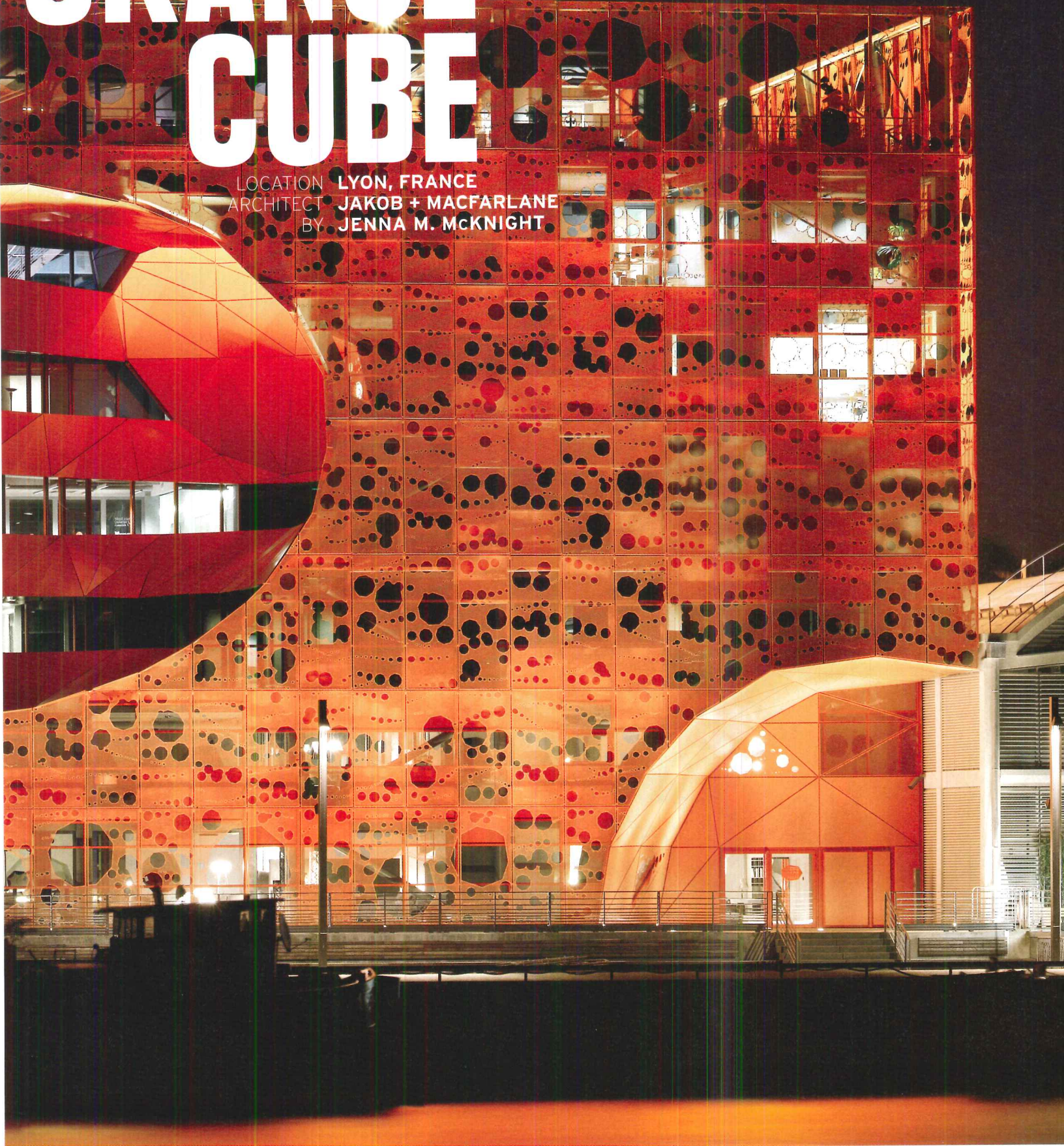



**OPPOSITE:** Located in a former dockland, the new commercial building is clad in an aluminum scrim whose pattern was inspired by the movement of water.

**THIS PAGE:** A faceted concrete frame supports the 43-foot-wide rim of a conical, west-facing void. Balconies look out toward the River Saône.

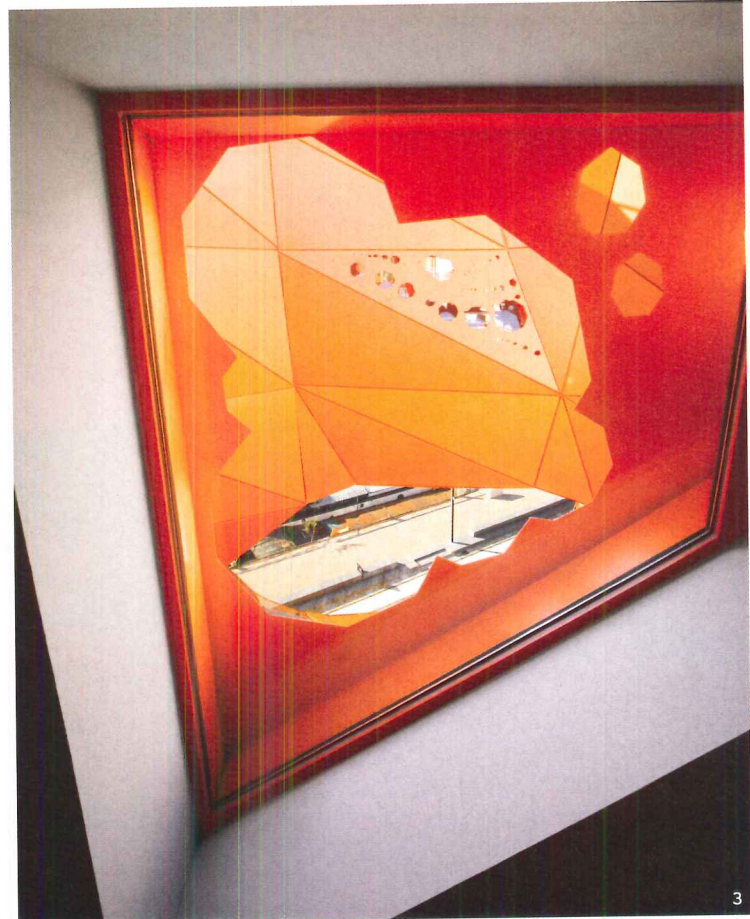
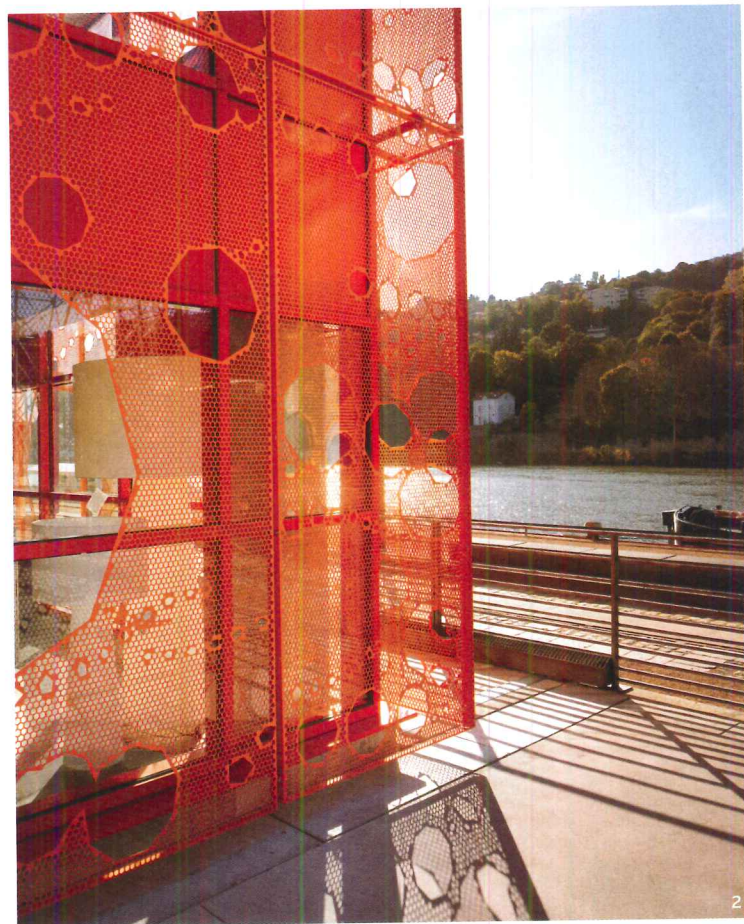
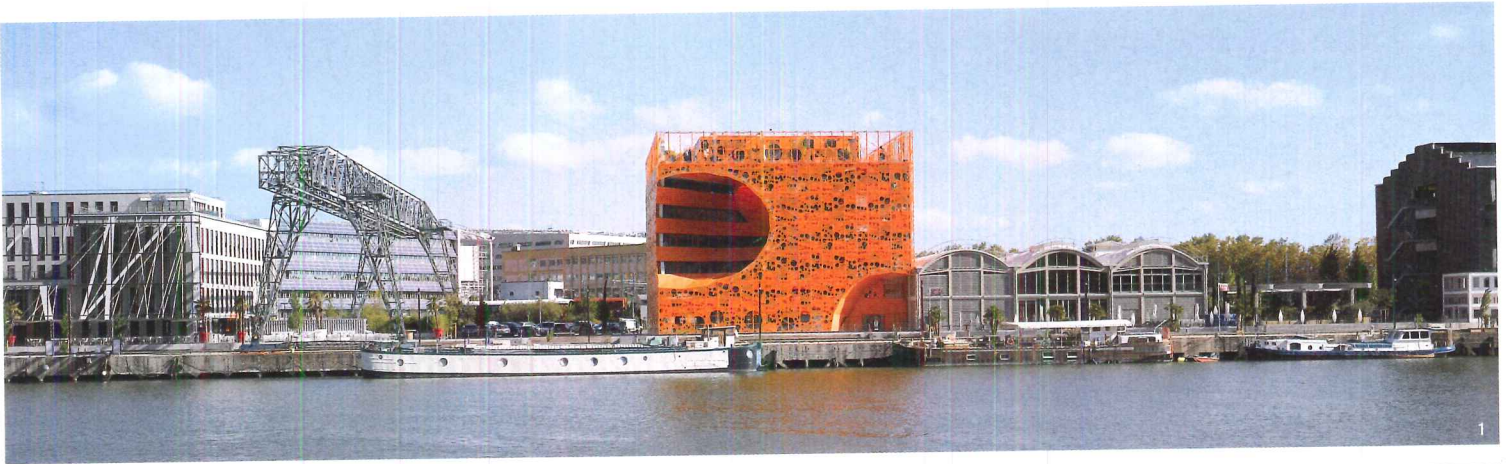

**SINCE LAUNCHING THEIR** eponymous Paris-based practice in 1992, Dominique Jakob and Brendan MacFarlane have produced a series of exuberant projects that wouldn't look out of place in a sci-fi film. For their first notable commission, Restaurant Georges, they inserted four large, aluminum-clad blobs into a stripped-down space in the Pompidou Center [RECORD, September 2000, page 128]. Years later, for their design of the Docks de Paris, they wrapped tubes of bright-green-fritted glass around a warehouse-turned-fashion center on the River Seine [RECORD, June 2009, page 110]. Employing digital design tools to cleverly manipulate materials and form has become a signature for the 19-employee firm.

With the Orange Cube, Jakob + MacFarlane has shown once again that it likes to push the envelope. Completed last fall, the 67,640-square-foot

building, which contains a ground-floor furniture showroom and offices above, is perched on a river's edge in a converted industrial zone in Lyon, France. Surrounded mostly by gray, modern structures, the six-story box, with its conical gashes and pulsating orange veil, is the life of the party. On any given day, you'll find locals and tourists alike gathering outside the building, studying its unusual features and snapping photos.

It's a brazen work of architecture for any city, particularly Lyon. While one of the most progressive industrial centers in the 19th century and home of the visionary urbanist Tony Garnier (1869-1948), Lyon has become fairly subdued in recent decades. The city has, however, embarked on various endeavors to boost its cosmopolitan character. In the 1990s, it opened Cité Internationale, a 37-acre mixed-use project by Renzo Piano. More recently, it



4

1. The budding “Lyon Confluence” mixed-use district, which eventually will encompass 370 acres, features new and repurposed buildings. The curved void in the Orange Cube’s lower southwest corner responds to the arched roof of a neighboring structure, a 1920s warehouse converted into a restaurant. To the north of the cube, an old dock crane rises from an expansive concrete courtyard – a formidable reminder of the area’s history.

2. There is a 10-inch gap between the cube’s perforated metal screen and inner curtain wall.

3. The building’s bold color was inspired by the site’s past: orange “safety” paint is often used in industrial zones. Irregular cutouts lend a whimsical touch to the building.

4. Ringed by bands of aluminum panels, the west-facing void cuts deep into the cube. This elliptical opening not only provides striking views; it also brings ample daylight into the facility and channels hot air to a rooftop opening, thus lowering energy costs. It is one of the project’s many sustainable features.

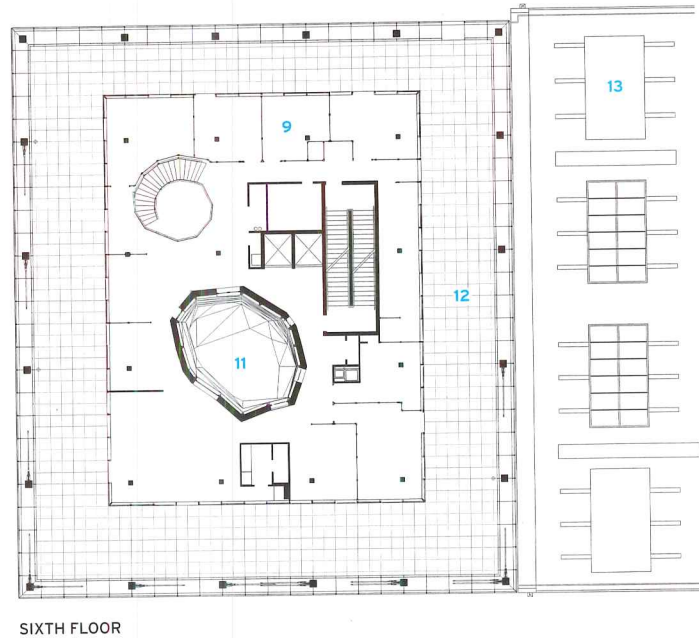
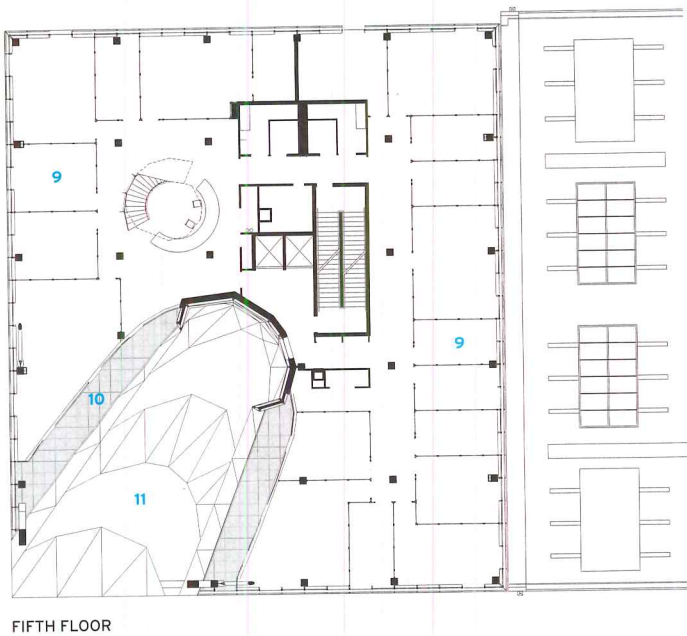
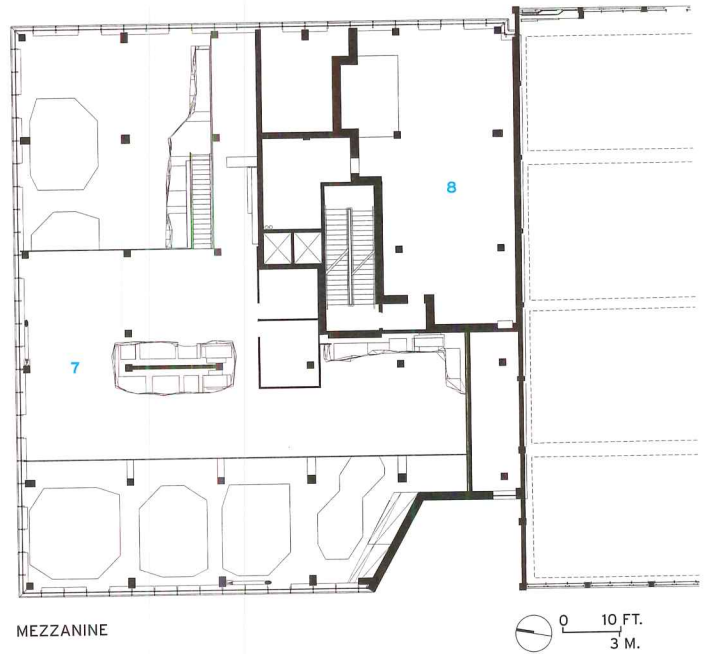
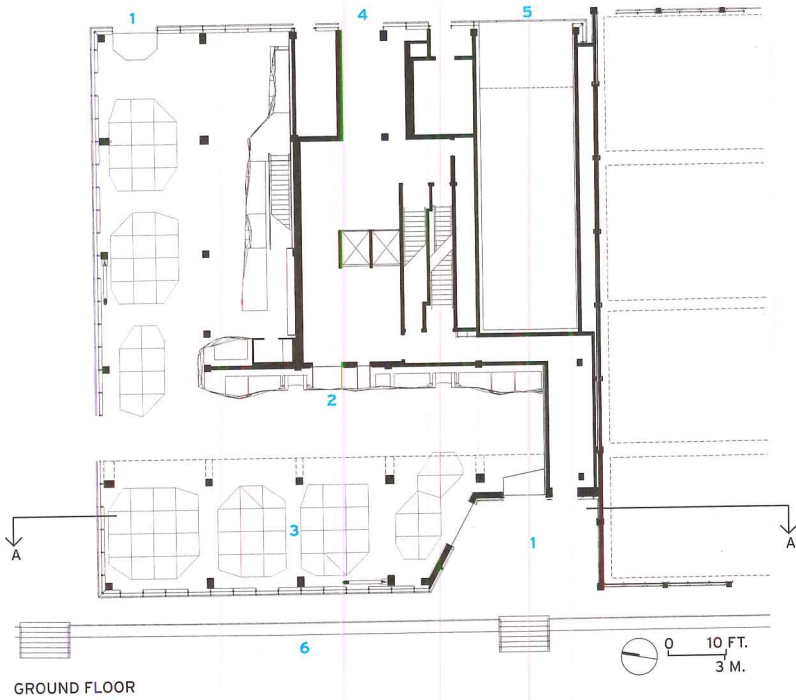

OPPOSITE TOP: Hot air escapes out of a 33-foot-wide rooftop opening.

OPPOSITE BOTTOM: The architects were charged with designing a building with a certain amount of negative space. In response, they inserted three cone-shaped voids into a cube. Two of the cavities converge at the center of the building, forming a four-story atrium, while the third occupies the lower southwest corner of the box.

- |                        |                      |
|------------------------|----------------------|
| 1 ENTRY, SHOWROOM      | 8 MECHANICAL         |
| 2 DISPLAY WALL         | 9 OFFICES            |
| 3 DISPLAY ISLANDS      | 10 BALCONY           |
| 4 ENTRY, OFFICES       | 11 VOID              |
| 5 ENTRY, PARKING       | 12 ROOFTOP TERRACE   |
| 6 WATERFRONT PROMENADE | 13 EXISTING BUILDING |
| 7 SHOWROOM             |                      |



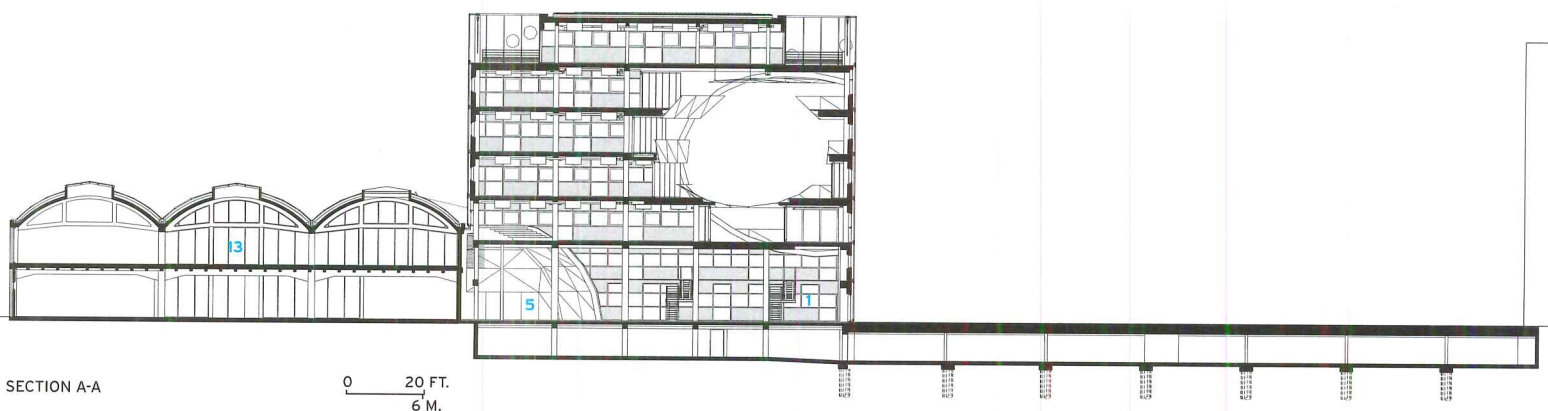

set out to redevelop a run-down harbor district dominated by warehouses. It is here, in the new "Lyon Confluence" district – so named because it occupies the tip of a peninsula where the Saône and Rhône rivers meet – that the Orange Cube enlivens the landscape.

Designed to encompass 370 acres, the Confluence development will double the size of Lyon's urban core. The original master plan, by architect François Grether and landscape designer Michel Desvigne, calls for a mix of commercial, residential, and cultural facilities designed by a roster of international architects, including a museum by Coop Himmelb(l)au. The public-private venture recalls that of HafenCity in Hamburg, where a 390-acre port area is being transformed into a hip district studded with buildings by design luminaries.

In January 2006, Jakob + MacFarlane won a competition to design the building that would become the Orange Cube. No tenants were lined up at the time; the brief simply called for an eye-catching structure on a half-acre site. "The idea was to have a competition, get iconic buildings, and, through this interesting architecture, get someone to pay for it all," explains MacFarlane. The building's first two floors had to accommodate cultural programming, while the upper levels would house offices. The brief also stipulated that the building envelope not fill the entire site, that it have a certain amount of negative space.

That last requirement inspired the architects to create a box pierced by three large voids oriented toward the water. "The most obvious solution, from our point of view, was to take the negative space and treat it as a cutout from the whole," says MacFarlane. "It seemed like a good way of making something interesting out of the project."

At first glance, the building's anatomy looks frenetic, but it quickly comes into focus. Supported by a poured-in-place concrete frame, the cube contains two cone-shaped voids: one drops down from the roof, the other angles up from the river, and they converge at the center of the building, creating a four-story atrium. Balconies line the roughly 43-foot-wide, west-facing opening, providing workers a peaceful retreat. This void creates "an extraordinary dialogue with the river, almost bringing it inside," says MacFarlane. Moreover, it ushers in daylight and channels hot air to a rooftop opening, thus reducing energy costs.

A third void, located in the cube's lower southwest corner, connects with a promenade and adjoins a neighboring structure: a salt warehouse – now a restaurant – built in the 1920s. The void's curvature elegantly responds to the restaurant's undulating, arched roof. "How do you pull up next to an existing condition? In this case, we decided to treat it like a child's block. It slides alongside the old building," says MacFarlane.

The cube's vibrant and high-performance building envelope constitutes another remarkable feature. The architects sheathed each facade in a perforated aluminum screen whose pattern is based on the movement of water. The color refers to the site's past (orange "safety" paint

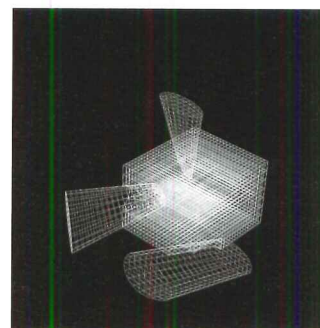
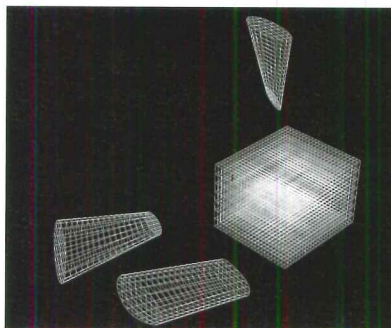



is often used in industrial zones). "Our role was to energize a very burnt-out, depressed area in the city. Color gave us a chance to do that," says MacFarlane. Aesthetics aside, the scrim reduces heat gain, while external shades on the inner curtain wall afford additional solar protection.

Given all the razzle-dazzle on the outside, the facility's interior shows fitting restraint. The ground-level tenant, RBC Mobilier, ended up hiring Jakob + MacFarlane to design its furniture showroom. For this loftlike space, the architects conceived a dramatic display wall with cutouts that refer to the exterior screen. They also helped design the offices on the upper levels, which feature concrete floors and contemporary furnishings. Tenants include a law office, an online media company, a lighting manufacturer, and the real estate firm Cardinal Group, which developed the building and now shares ownership with two public entities.

There's no doubt the Orange Cube adds considerable verve to the Confluence district. Soon, it will have some friendly competition: a 107,000-square-foot headquarters for Euronews, another project in the neighborhood by Jakob + MacFarlane. As they did with the Orange Cube, the architects intend to puncture the rectilinear building with two giant holes, but this time paint it bright green. Construction is slated to begin in 2012. "The idea of perforated buildings and cones is starting to excite me quite a bit," says MacFarlane. "This is just the beginning." ■

ABOVE: A 9,690-square-foot furniture showroom occupies the ground floor and mezzanine. The loftlike space features a dramatic, 184-foot-long display wall with various shaped holes; its design refers to the building's exterior screen.

OPPOSITE: Smaller holes in the brise-soleil were punched out, while larger ones were numerically laser-cut.

#### CREDITS

**ARCHITECT:** Jakob + MacFarlane – Dominique Jakob, Brendan MacFarlane, principals; Sébastien Gamelin, Grégory Bismuth, project team

**ENGINEERS:** RFR (structural); Alto Ingénierie (electrical)

**CONSULTANTS:** Avel Acoustique (acoustics); Bureau Michel Forgue (cost planning)

**OWNER:** Cardinal Group, Caisse des Dépôts, Voies Navigables de France

**SIZE:** 67,640 square feet

**COST:** \$17 million

**COMPLETION DATE:** September 2010

#### SOURCES

**METAL PANELS:** RMIG

**CURTAIN WALL SYSTEM:** Wicona

**GLAZING:** Soliver

**ACOUSTICAL CEILINGS:** Ecophon Saint-Gobain

**INTERIOR AMBIENT LIGHTING:** Philips  
**ELEVATORS:** Otis

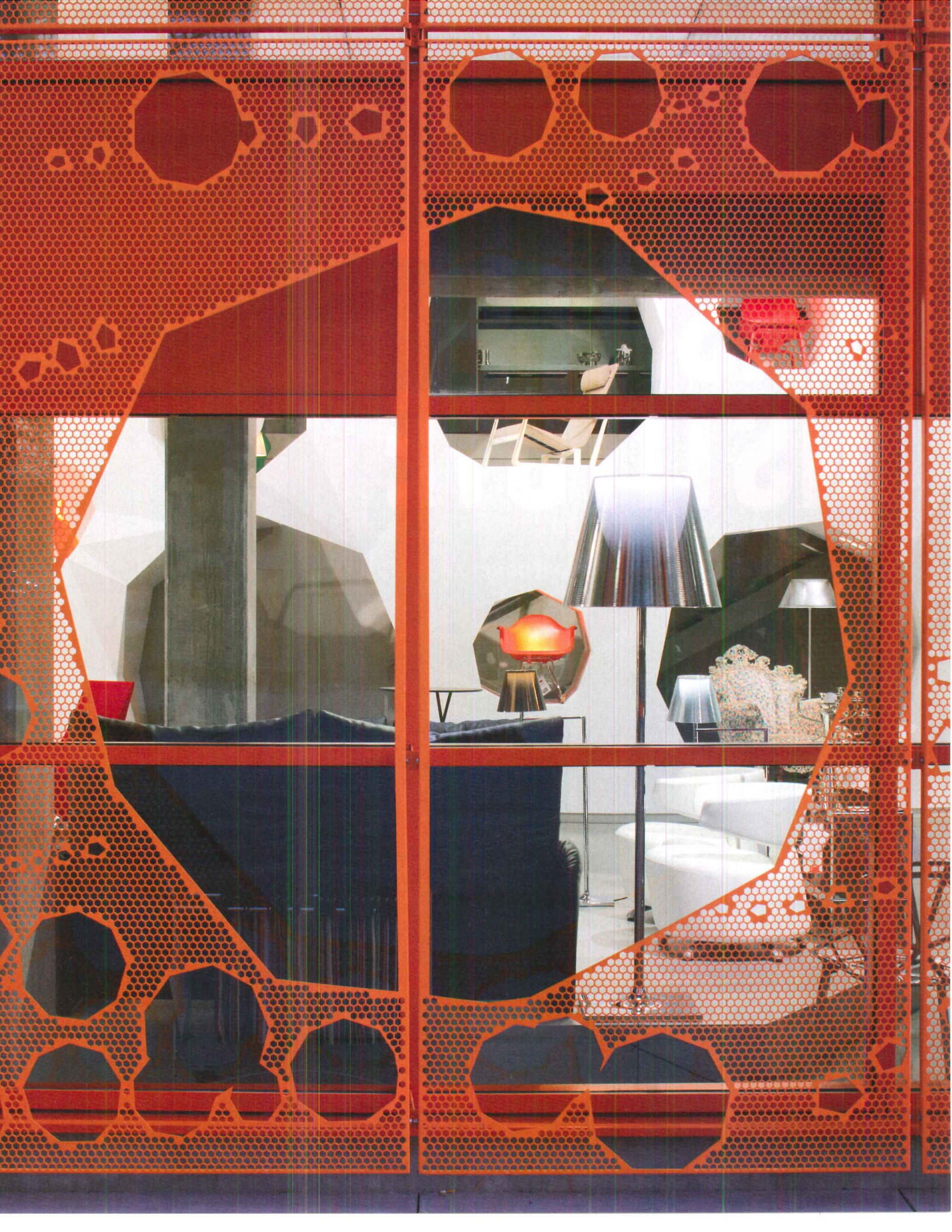

# MASDAR INSTITUTE

LOCATION **ABU DHABI**  
ARCHITECT **FOSTER + PARTNERS**  
BY **SONA NAMBIAR AND JOANN GONCHAR, AIA**

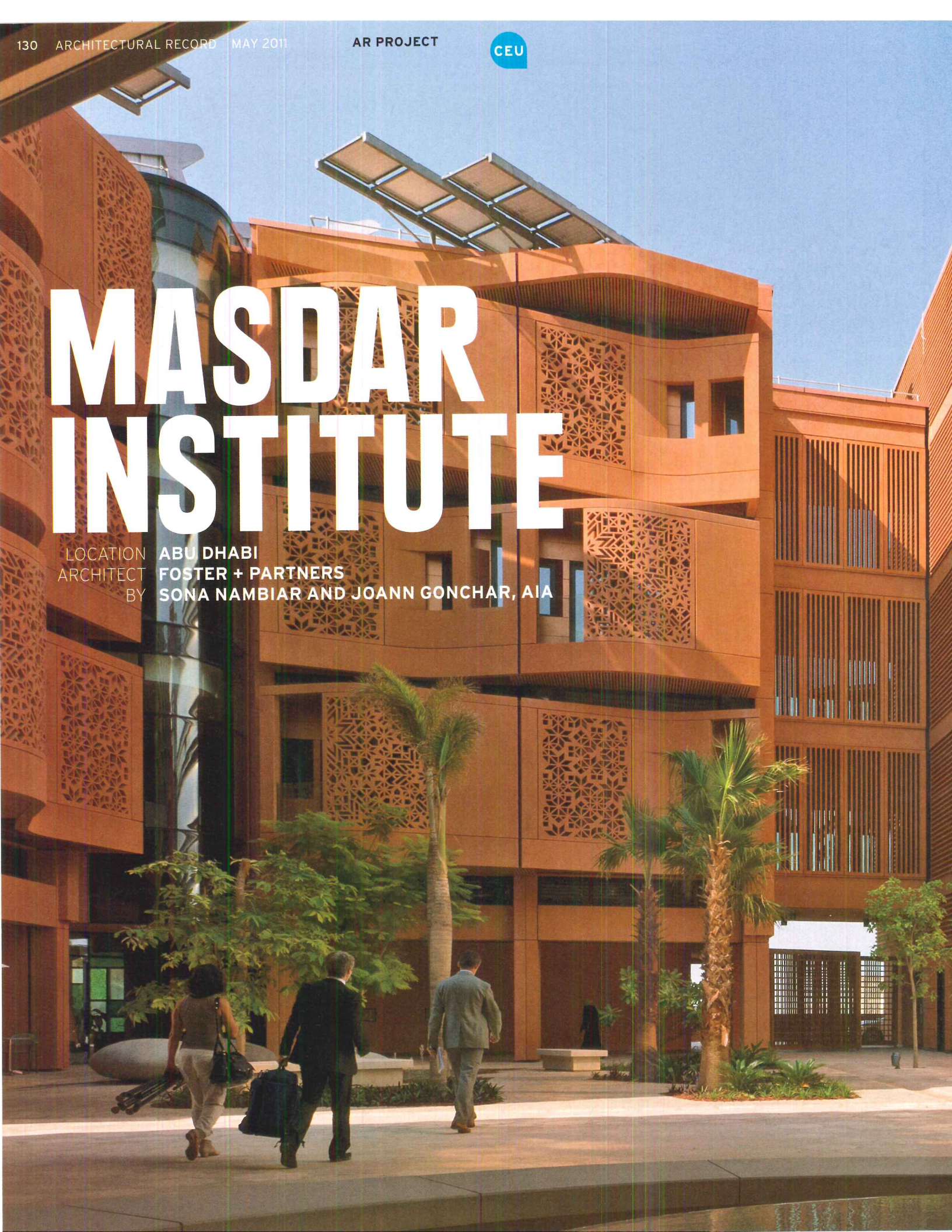



Masdar Institute's campus combines high-tech materials and technologies, like ethylene tetrafluoroethylene (ETFE) cladding for the laboratory buildings, with features that take their cues from the region's vernacular, such as glass-reinforced concrete *mashrabiya* screens that shield the residential buildings' balconies.

**THE GLOBAL FINANCIAL** crisis has derailed construction all over the world – even in the oil-rich United Arab Emirates. But certain megaprojects continue to march ahead, though with tighter budgets, more pragmatic goals, and less ambitious schedules. One such project is Masdar City, in Abu Dhabi. In 2007, the government-owned Abu Dhabi Future Energy Company chose a consortium led by London-based Foster + Partners to design the master plan for the 2.3-square-mile development it touted as the world's first zero-carbon city. Originally slated for completion by 2016, plans for Masdar included housing, cultural institutions, educational and research facilities, and space for tenants focused on the development of advanced energy technologies. The developers envisioned that the city, located about 20 miles from central Abu Dhabi, would eventually have a daytime population of 90,000 people.

However, Masdar officials have reevaluated their plans. The original \$22 billion budget has been reduced by 15 percent and completion pushed back to 2025. Alan Frost, director of Masdar City, maintains that the drawn-out schedule has a silver lining. "The slowing [of construction] means we can improve the project as we go along," he says.

Among the changes is a revised power-generation strategy. Initially, Masdar was to have its own grid and depend only on renewable power generated on-site. But the development is now grid-connected. And though it includes its own 10 MW photovoltaic (PV) field that generates considerably more electricity than is consumed by current operations, the city will likely require power from additional renewable sources located outside the project boundary as the population grows.

Despite such adjustments, the development's core principles have not been sacrificed, insist members of the project team. "Masdar is still a compact, high-density, mixed-use development, with well-integrated public transport and a street design that enforces walkable communities and neighborhoods," says Jurgen Happ, a Foster associate partner.

The planning principles that Happ cites are evident in the first piece of the development – 680,000 square feet of a 3.7 million-square-foot campus designed by Foster for the Masdar Institute of Science and Technology. Occupied since November, the completed portion of this graduate-level university dedicated to the study of sustainability comprises a laboratory, a library, and student housing. The mostly concrete framed buildings, all under four stories, are elevated 25 feet above the desert floor on a podium and define narrow pedestrian streets and intimately scaled courtyards.

**1. Masdar Institute's first 680,000 square feet, along with the remaining 3 million square feet of the university yet to be built, are raised 25 feet above the desert floor on a podium.**

**2. A corkscrew stair connects the podium's undercroft to the institute's reception area.**

**3. The buildings are configured to create narrow, colonnaded urban spaces that are in shade for much of the day.**

**4. Photovoltaic panels project from the roofs over the edges of the courtyards and streets, providing shade and energy generation.**



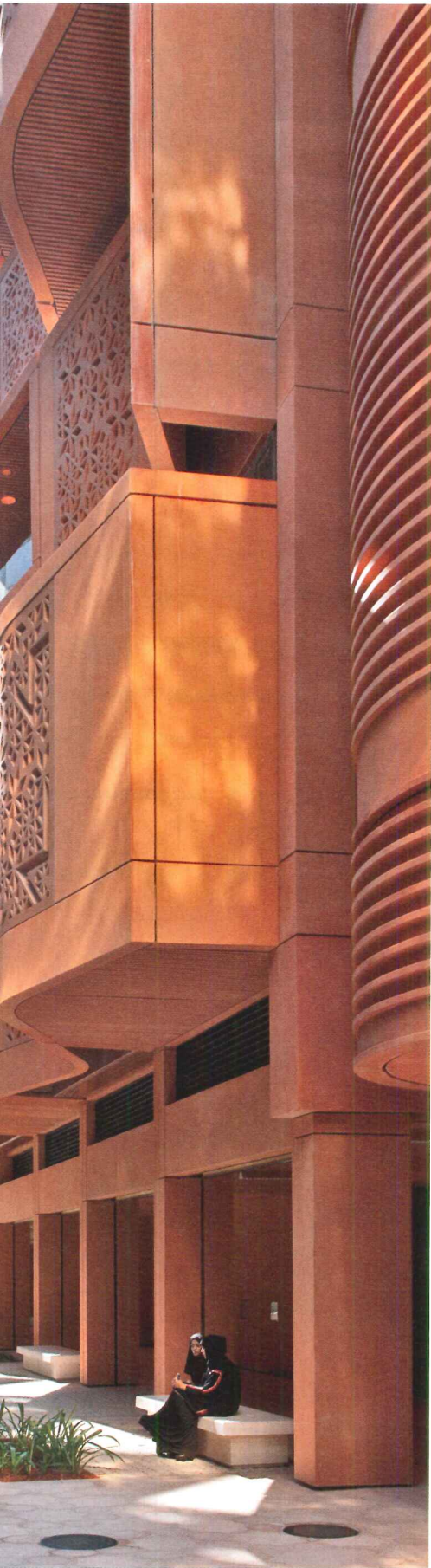



SECTION A-A

- 1 RECEPTION
- 2 LABORATORY
- 3 HOUSING
- 4 LIBRARY
- 5 WIND TOWER
- 6 PODIUM UNDERCROFT



SECTION B-B

0 20 FT.  
6 M.



SECOND FLOOR



0 30 FT.  
9 M.



**RIGHT:** Designers have treated the residential buildings' atria as "climate lobbies." The temperature in these skylit circulation spaces is maintained, primarily through natural means, at a higher set point than the apartments beyond.

**BELOW BOTTOM:** Masdar officials envision that the city will cover 2.3 square miles, as depicted in this rendering, and have a daytime population of 90,000 by 2025.

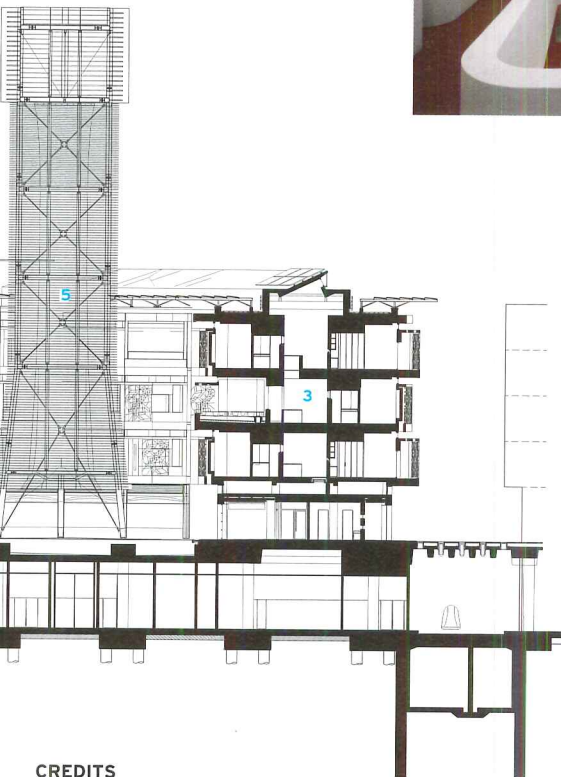

Vehicular traffic, segregated to the zone within the podium's undercroft, is limited to an electric-powered fleet of 13 driverless "personal rapid transit" cars, or PRTs. Visitors and commuters park their own cars at the edge of the development before boarding one of the podlike, remotely controlled PRTs. Other transportation options are planned for the parts of the city beyond the institute's campus, including electric buses and other low-emissions vehicles. Eventually, a light-rail system and a metro line will connect Masdar to Abu Dhabi and surrounding developments.

For the structures that make up the completed section of the institute, as well as an adjacent 925,000 square feet of housing, lab space, and recreational facilities currently under construction, Masdar will not be seeking certification under any of the green building assessment tools, such as the U.S. Green Building Council's LEED or the U.K.-based BREEAM. Future phases will seek a rating from the emirate's own Pearl Rating System (see next page), required since late last year for all building projects that apply for a permit from the Abu Dhabi Urban Planning Council. But despite the lack of the imprimatur of certification, the goals for these first phases of the development can still be considered aggressive: The buildings are designed to use less than half of the energy of those that comply with the U.S. energy standard, ASHRAE 90.1-2004.

The scheme includes more than a few high-tech devices and materials. The research laboratories, for example, have an exterior envelope made of ethylene tetrafluoroethylene (ETFE) – a plastic with a high insulation value that is a cousin of Teflon. Inside the labs, a sophisticated network of sensors track carbon dioxide and particulate levels, humidity, and temperature, among other characteristics. The system helps maintain good indoor air quality while keeping air change rates to a minimum, reducing the considerable energy associated with ventilation in a typical lab. And in addition to the utility-scale power plant on the outskirts of the development, the roofs of the completed buildings are covered with PV panels providing 1,800 MWh of electricity each year and evacuated thermal collectors that satisfy about 75 percent of hot water demand.

But despite such bells and whistles, the completed institute buildings are most remarkable for their reliance on low-tech, passive strategies. The design team's first priority was to reduce energy loads by carefully configuring streets and other urban spaces and optimizing building form and orientation. "The question we constantly asked ourselves was, 'Can we avoid an active system?'" says Edward Garrod, previously a director at

**CREDITS**

**ARCHITECT:** Foster + Partners – Norman Foster, chairman; David Nelson, head of design; Gerard Evenden, design director; Ross Palmer, Austin Relton, partners

**ARCHITECT OF RECORD:** RW Armstrong

**CONSULTANTS:** PHA Consult (sustainability, m/e/p); Adams Kara Taylor (structure); Mott MacDonald (facades); Gillespies (landscape)

**CLIENT:** Masdar

**SIZE:** 680,000 square feet (phase 1a)

**COST:** withheld

**COMPLETION DATE:** November 2010

**SOURCES**

**ETFE PANELS:** Vector Foiltec

**ZINC ROOF CLADDING:** Mero

**AIR MONITORING SYSTEM:** Aircuity

**ROOF-MOUNTED PVS AND THERMAL COLLECTORS:** SunEdison





### Continuing Education

To earn one AIA learning unit, including one hour of health, safety, and welfare and sustainable design (HSW/SD) credit, complete the test online at no charge at [architecturalrecord.com](http://architecturalrecord.com). Upon passing the test, you will receive a certificate of completion and your credit will be automatically reported to the AIA. Additional information regarding credit reporting and continuing education requirements can be found online at [ce.construction.com](http://ce.construction.com) under "resources and requirements."

### Learning Objectives

- 1 Explain how passive strategies helped Masdar's designers reduce energy loads.
- 2 Explain how passive strategies helped Masdar's designers enhance occupant comfort.
- 3 Describe some of the elements drawn from vernacular architecture deployed at Masdar.
- 4 Discuss the goals and requirements of the Pearl Rating System.

AIA/CES Course #K1105A

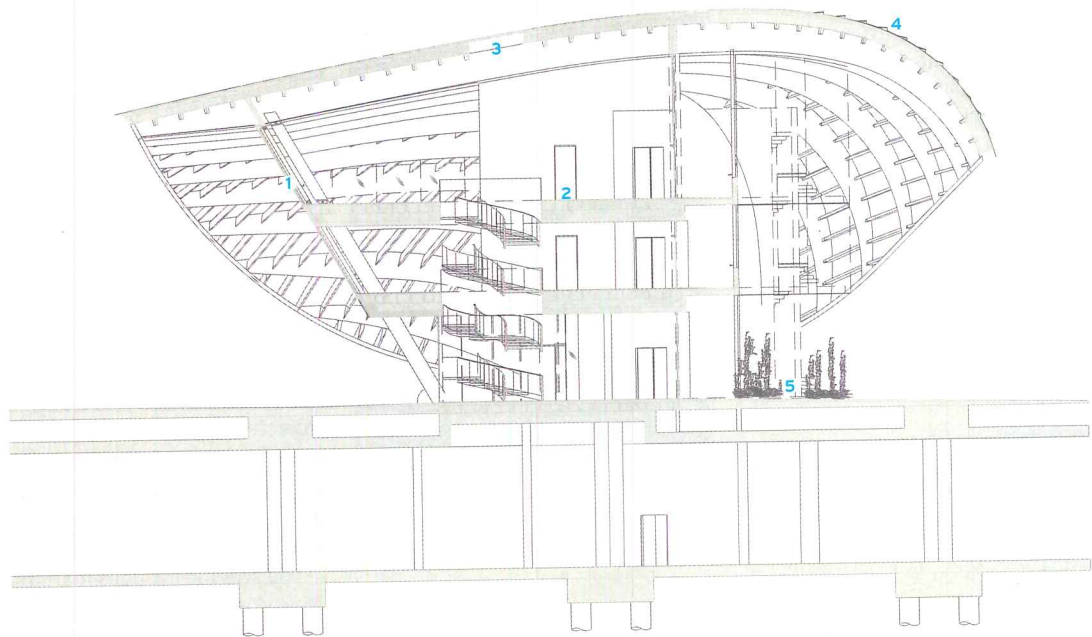

SECTION - LIBRARY

- 1 VIEWS TO PARK
- 2 DISPLACEMENT COOLING
- 3 SKYLIGHTS
- 4 VENTILATION OPENINGS
- 5 SHADED SEATING AREA

OPPOSITE TOP: The helmetlike form of the library roof was the result of the need to maximize PV energy production while shading an all-glass wall that provides students with views of a park. On the entry side (shown here), the roof is articulated with hat-shaped openings and shields an outdoor space.

OPPOSITE BELOW: The top floor of the library features a seating area directly under the roof's vaulted, glue-laminated structure.

## THE PEARL RATING SYSTEM: ABU DHABI'S BESPOKE ASSESSMENT TOOL

Masdar, the development designed by London-based Foster + Partners for a 2.3-square-mile plot of land not far from Abu Dhabi's airport, has ambitions to become one of the world's greenest cities. However, for the first completed 680,000-square-foot piece of the development, and another 925,000 square feet under construction, officials decided not to pursue certification under any green building rating systems. "The clients were keen for us to take a holistic approach using the best of LEED and BREEAM," says Foster partner Edward Garrod, referring to two of the most established assessment tools.

Future phases of the megaproject, slated for completion in stages by 2025, will comply with Abu Dhabi's own Pearl Rating System, launched last year and now required for any project that applies for a planning or construction permit from the emirate's Urban Planning Council (UPC). The new system is a key component of the UPC's Estidama initiative, a program intended to guide responsible development that takes its name from the Arabic word for sustainability.

Like the U.S. Green Building Council's LEED, the Pearl Rating System is point-based, but instead of earning a Certified, Silver, Gold, or Platinum certification, projects earn "Pearls." The minimum, one Pearl, is required for all privately funded projects, while those that depend on government funds must earn at least two Pearls. The highest possible rating, five Pearls, requires a level of performance that approaches that of the so-

called "beyond platinum" Living Building program established by the Cascadia Green Building Council. A five-Pearl building is one with limited reliance on grid energy and utility-supplied water, explains John Madden, senior planning manager on the Estidama team.

According to its creators, the Pearl standard is tailored to the emirate's climate and the culture. One example is the emphasis on water conservation, with almost 25 percent of available points geared toward the regionally important issue. The system, which encompasses communities, individual commercial and institutional buildings, and residential construction, also encourages well-planned and walkable neighborhoods that make use of vernacular forms and passive design strategies.

Certification requires an integrated design process, intended to ensure the early involvement of professionals from diverse disciplines. Project teams demonstrate their compliance by including documentation such as meeting-attendee lists as part of their project submittals. The requirement's goal is to help teams establish targets for land use, density, and performance, and realize potential synergies.

From the first stages of the assessment tool's development, the Masdar team has been providing feedback to the UPC. It continues to share information, especially in the area of sustainable building materials. "The intent," according to Madden, "is to use the information to help evolve the Pearl system and to ultimately transform the market." JG

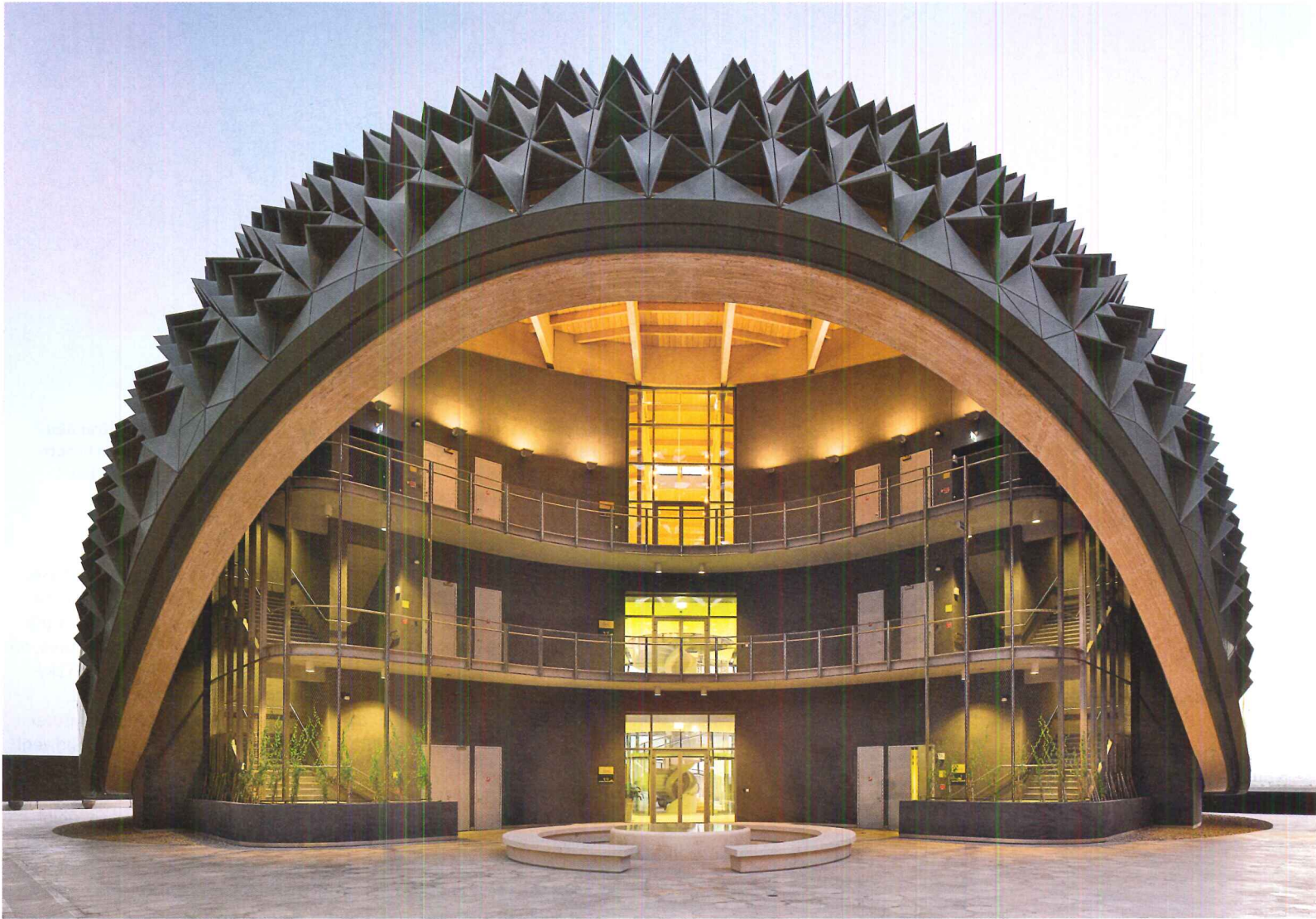

PHA, the project's environmental design consultant. Earlier this year, the London-based firm was acquired by Foster, where Garrod is now a partner.

The institute's buildings are the product of in-depth environmental analyses, including solar studies, wind tunnel testing, and energy simulation. Even the library, enclosed by a zinc-clad, glue-laminated structure shaped like a helmet, is the result of such investigation, rather than architectural caprice, say the designers. The form is the outcome of a desire to maximize energy collection from roof-mounted PVs while shielding the interior from direct sun but giving students a view of a linear park.

Except for undulant balconies, the other structures are rectilinear and set as close as 10 feet apart. Their ground floors step back under colonnades at the edge of short streets that turn and change direction. The configuration, common in traditional Arab settlements, helps accelerate the movement of air, explains Gerard Evenden, a Foster senior partner.

Other features also take cues from vernacular features, such as the glass-reinforced concrete latticework – a contemporary take on a *mashrabiya* screen – that shades the curvy balconies. Another reinterpretation of the region's traditional architectural devices is the 150-foot-tall, steel-framed wind tower in one of the courtyards. Foster's version has operable louvers that adjust to guide air downward, while mist is sprayed from the top of the structure. The combination of evaporative cooling and

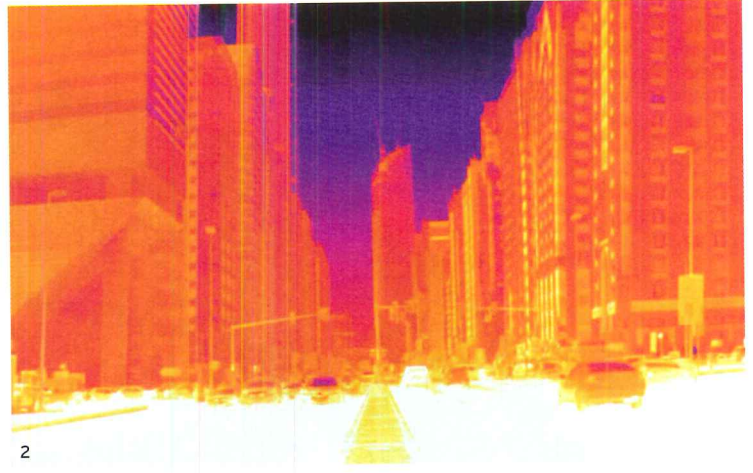
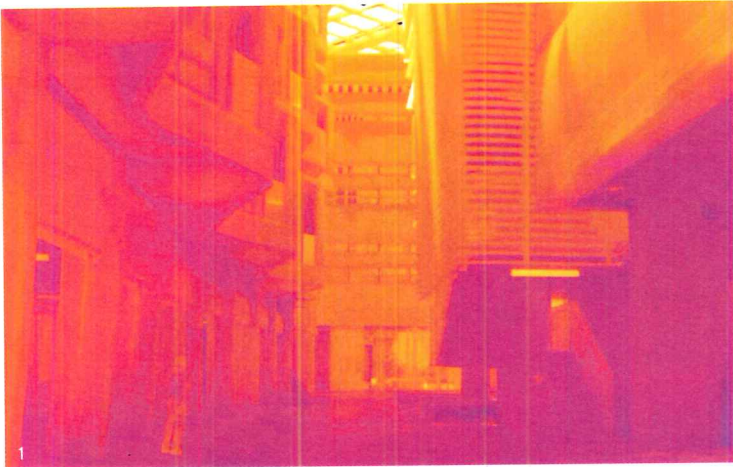

2

Designers documented the institute's outdoor space (1) and a central Abu Dhabi street (2) with a thermal imaging camera. The images, taken in both locations on October 1, at midday, show that the mean radiant, or "felt," temperature at Masdar was 20 degrees Fahrenheit cooler.

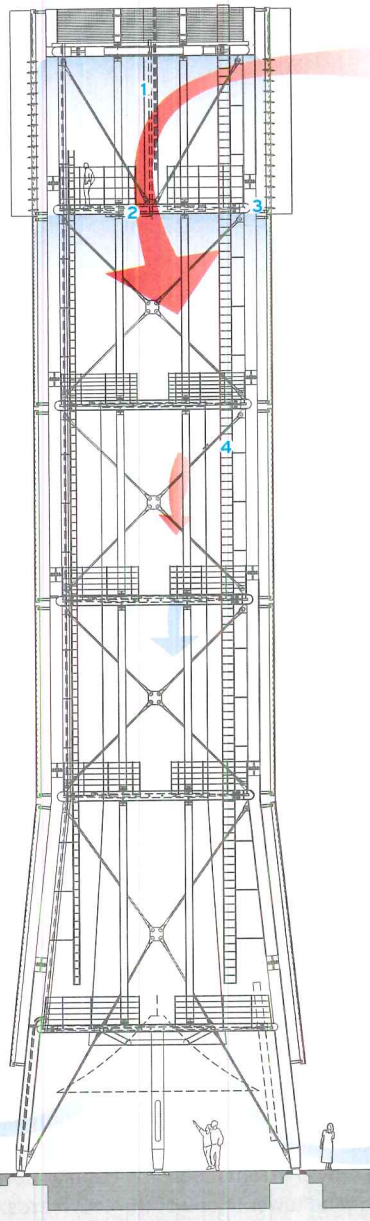

- 1 SENSOR-CONTROLLED LOUVERS
- 2 MIST JETS
- 3 WEATHER STATION
- 4 INNER SOCK

SECTION - WINDTOWER

moving air helps moderate perceived temperatures at the tower's base.

Within the buildings, designers have treated circulation areas as "climate lobbies" – transitional zones maintained at a warmer temperature than the regularly occupied interior spaces. The residential structures, for example, have central atria largely illuminated by daylight through skylights configured to prevent the penetration of direct sunlight and associated heat. For much of the year, the spaces are cooled by natural means with night air drawn into the lower floors through grilles, and vented, via the stack effect, through roof-level openings. The thermal mass of the surrounding walls helps modulate the temperature over the course of the day, keeping the space at around 86 degrees. This higher set point conserves energy and, somewhat counterintuitively, also increases occupant comfort: It helps prevent the "thermal shock" experienced when one walks into a very cool space from intense heat, explains Garrod.

In addition to energy and comfort, water is also a key issue at Masdar, as it is for the region. Strategies deployed at the completed part of the project should reduce consumption by 54 percent when compared to UAE standard practice. The buildings include low-flow fixtures, efficient appliances, and a graywater treatment system that receives condensate from cooling towers. The recycled water is used to flush toilets and for irrigation.

Masdar's sustainability objectives also influenced material choices. One example is the ground granulated blast-furnace slag that replaces a significant portion of the Portland cement in the structure's concrete mix – up to 80 percent in some places. The use of the slag, which is a byproduct of steel-making, reduced the carbon footprint associated with the structure. It also improved constructability by slowing the concrete's hydration and reducing the heat generated in the process, explains Albert Taylor, director of the project's structural engineer, London-based Adams Kara Taylor.

In the coming months, Masdar officials expect to award the construction contract for the city's headquarters building, designed by Chicago architecture firm Adrian Smith + Gordon Gill. And by 2015, they estimate that about 10 million square feet, or a quarter of the city, will be completed. But the pragmatic Frost is in no hurry to prove a point. "The timeframe from design and construction to completion," he says, "must result in a project on the leading edge, not one on the bleeding edge." ■

*Dubai-based journalist Sona Nambiar is a former architecture editor with Emirates Business 24/7, The Big Project, and Architecture+.*



The steel-framed wind tower that rises above one of the courtyards reinterprets a traditional Middle Eastern architectural element. The top of the 150-foot-tall structure has operable louvers and mist jets that help moderate perceived temperatures in the public space surrounding its base.

Project: Manitoba Hydro Place  
Design Architect: Kuwabara Payne McKenna Blumberg Architects  
Architect of Record: Smith Carter Architects and Engineers  
Energy/Climate Engineers: Transsolar Energietechnik

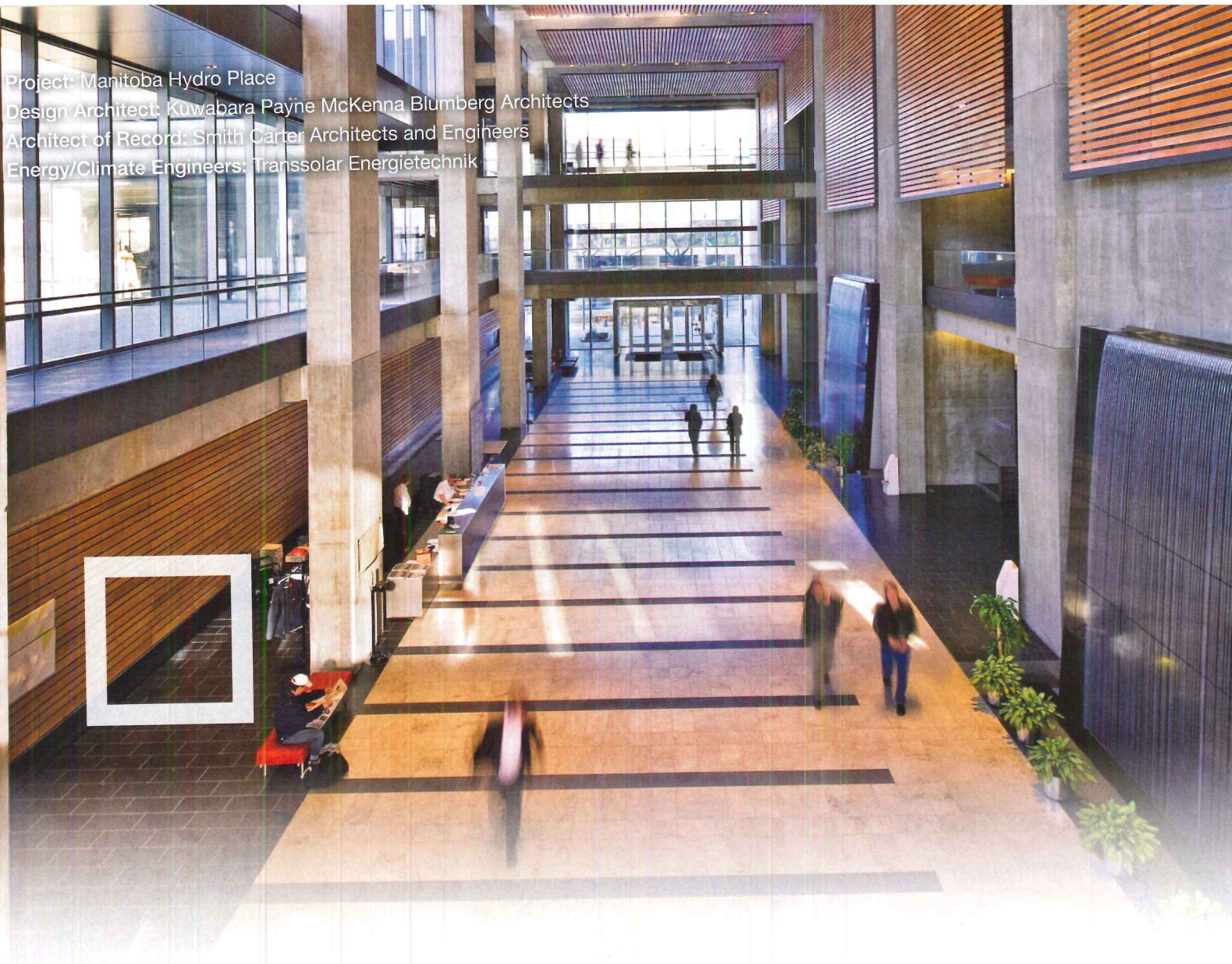

## Hidden in Plain Sight Displacement Ventilation by PRICE

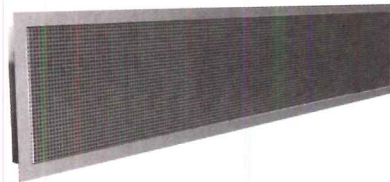

**Architectural Integration:** Customized diffusers can be applied almost anywhere.

**Energy Efficient:** Multiple opportunities for reduced energy consumption.

**Comfortable:** Provides you with a draft-free environment.

**Indoor Air Quality:** Increases ventilation effectiveness and reduces airborne contaminants.

See why we are the supplier of preference for air distribution.  
Visit [price-hvac.com/dv](http://price-hvac.com/dv) or call 1.866.430.0969 today.

CIRCLE 95

**PRICE**<sup>®</sup>

# BUILDING AT LIGHTSPEED

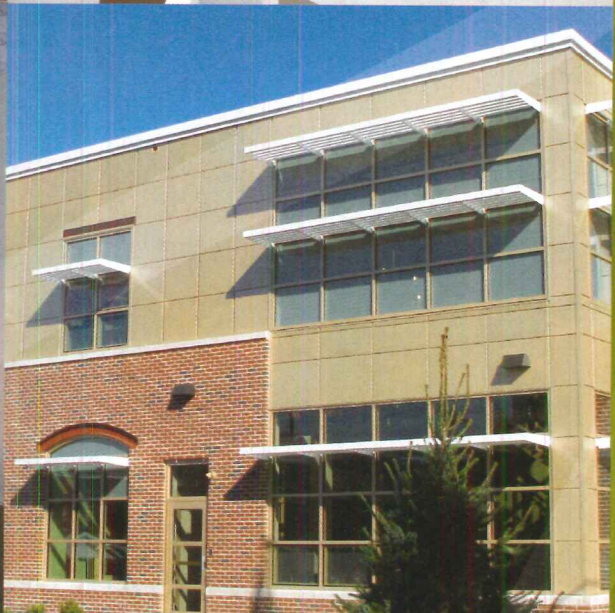
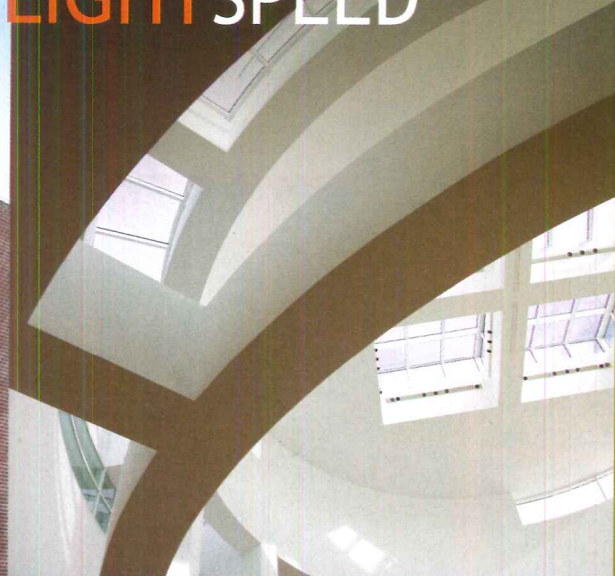

## *Light speed.*

The velocity of construction made possible by a reduction in weight for concrete forms, foundations, walls and deck systems.

**An innovation in rapid construction of building envelopes from SYNTHEON.**

Lightweight components, engineered with less mass to be more agile on site, easier to control, with less equipment and fewer specialized crew requirements.

SYNTHEON<sup>™</sup>  
ADVANCING THE BUILDING ENVELOPE

888-922-2353  
[www.syntheoninc.com](http://www.syntheoninc.com)

SYNTHEON and SYNTHEON logo are trademarks of SYNTHEON Inc., a NOVA Chemicals Inc. subsidiary.

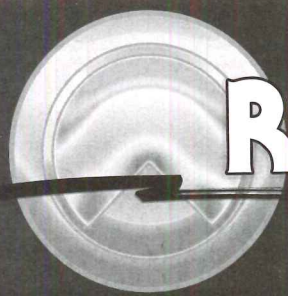

# REV·A·SHELF®

*Your Design.  
Our Products*



800.626.1126  
rev-a-shelf.com

*Products as unique as your customers!*





## Sustainability – it's serious business.

CertainTeed Gypsum is committed to preservation of natural resources, recycling, waste management, and reclamation in our operations.

We are part of Saint-Gobain, the world's largest gypsum wallboard manufacturer. Our innovative, sustainable building materials can contribute to the built environment's indoor environmental quality, acoustics management, fire resistance, and materials recycled content.

To see how sustainability suits you, visit: [www.CertainTeed.com/Sustainable](http://www.CertainTeed.com/Sustainable)



800-233-8990 • [www.certainteed.com](http://www.certainteed.com)

ROOFING • SIDING • TRIM • DECKING • RAILING • FENCE • FOUNDATIONS  
GYPSUM • CEILINGS • INSULATION • PIPE

**CertainTeed**  
SAINT-GOBAIN

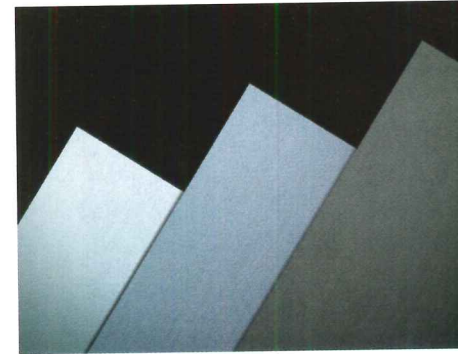
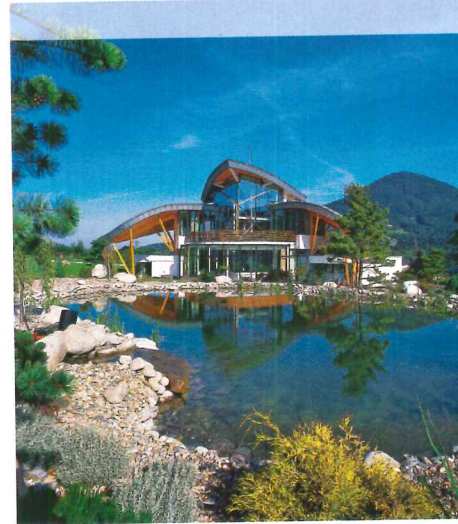

Project: Private Residence "The Bird" • Czech Republic  
Architect: Atelier Simona • Czech Republic

## RHEINZINK®- The Material with a Future

RHEINZINK® is an architectural-grade zinc with unmatched longevity and elegant appearance, making it an ideal building material. It complies with the strictest environmental standards and is 100% recyclable. For over 40 years, RHEINZINK® has been able to claim the

title 'sustainable' from 'cradle to grave'. Our material can be recycled infinitely without the loss of its chemical or physical properties.

RHEINZINK® is available in Bright Rolled, Pre-weathered Blue-Gray and Pre-weathered Graphite-Gray.

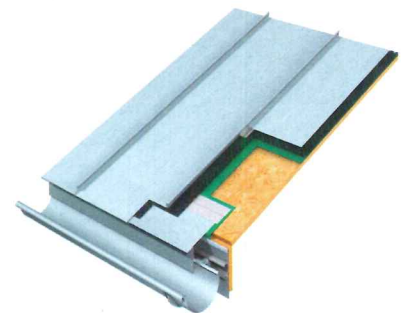

ood for you, good for the environment...

When installed in a permeable pavement system our permeable clay pavers allow rainwater to filter through and dissipate into the soil rather than carry excess pollutants into storm drains and waterways.

Strong - 12,000+ psi

Durable - life cycle of 100+ years

Colorfast - no pigments or dyes

LEED - can help qualify in five categories

[americaspremierpaver.com](http://americaspremierpaver.com)

800.334.8689



**Pine Hall Brick**

earth friendly...naturally green



**StormPAVE**

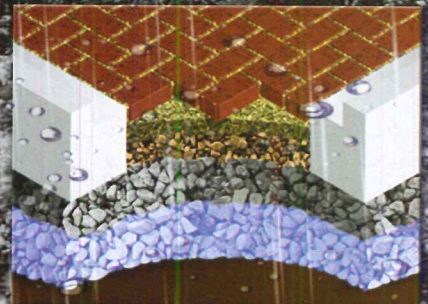

Aria Hotel & Casino, Las Vegas, NV  
Architects: Pelli Clarke Pelli  
Lighting Designers: Brandston Partnership,  
Photography: Dana Hoff

# The perfect light equation

From simple utilitarian structures to grand architectural masterpieces, The Lighting Quotient skillfully blends serious engineering performance with artistic elegance.

Indoor, outdoor, asymmetric, task/ambient and LED lighting solutions.



**elliptipar**   
there is no equal™

**tambient**   
green in any color\*

**fraqtir**   
shaping LED science™

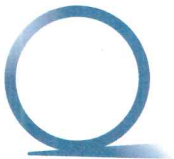

THE LIGHTING **QUOTIENT**™

[www.TheLightingQuotient.com](http://www.TheLightingQuotient.com)



## Ruth Lilly Visitors Pavilion

Indianapolis

Marlon Blackwell creates a carefully sited building that is both a retreat from and an extension of the woods around it.  
By Cheryl Kent

**The architect used wood slats and floor-to-ceiling glass to orchestrate a subtle medley of visual effects, ranging from the transparent to the shaded to the reflective.**

**AS COMMISSIONS GO**, only the folly offers an architect more liberty than the pavilion. Consider a Modern jewel, Mies van der Rohe's Barcelona Pavilion, built to represent Germany at the 1929 World Exposition and to formally receive the king and queen of Spain – once – at its opening in May of that year. Having served its purpose, it was demolished in January 1930. (It was rebuilt in 1986.)

**Program** In strictly functional terms, the Ruth Lilly Visitors Pavilion at the Indianapolis Museum of Art (IMA) required nothing more than a couple of Porta-Potties and a bench. The coarseness of that notion contrasts with the refined building designed by Marlon Blackwell, pointing up the real function of the pavilion as an expression of identity. "I look at it as a glorious place of



Located on the highest part of 100 Acres Art & Nature Park, the pavilion sits 30 inches above the ground to accommodate flood waters. Raised walkways and a 17-foot-long cantilevered canopy extend the building into the landscape.

respite," says IMA director and CEO Maxwell Anderson.

The 100 Acres Art & Nature Park, where the pavilion is located, lies in the floodplain of the White River. Abandoned by its previous owners, the land fell under the control of the state of Indiana, which donated it to the IMA in 1972. The property had been farmland and, later, a portion of it became a quarry – now a 35-acre lake. Just behind the museum, a canal runs north-south and, to this day, supplies drinking water to

Indianapolis. The White River enfolds the two remaining sides of the triangular park, curving from the west to the north. Hardly pristine, the land restored itself over the years. It encompasses a protected wetland and has become lightly and prettily wooded – perfect for a sculpture park coexisting with nature.

In its search for an architect, an IMA selection committee met Blackwell at Pinecote Pavilion in Picayune, Mississippi. There its

members picnicked on pulled pork at Fay Jones's open-air building with Blackwell and Ed Blake, the landscape designer who teamed with Blackwell for the IMA project and had landscaped Pinecote for Jones.

**Solution** For the Indianapolis project, Blake proposed clearing nonnative species from the park and carving out pathways in the woods. When he showed a scheme with a series of low berms radiating out from the pavilion like points of a star,

- 1 MULTIPURPOSE
- 2 OFFICE
- 3 KITCHEN
- 4 RESTROOM
- 5 VESTIBULE
- 6 STORAGE/MECHANICAL
- 7 DECK
- 8 TERRACE

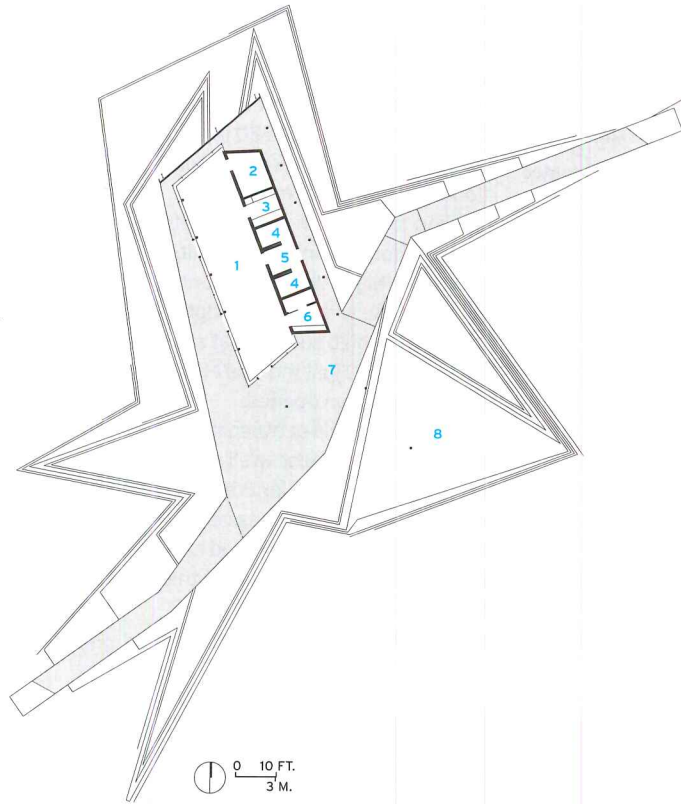

- 1 MUSEUM
- 2 PAVILION
- 3 WHITE RIVER
- 4 QUARRY LAKE
- 5 PARKING AND TRAILHEAD
- 6 CANAL



OPPOSITE: Tightly spaced wood supports on the north facade act as “Venetian blinds,” appearing solid when viewed from the side but more open when approached straight on.

BELOW: Overhead slats and elongated “peepholes” that run between them filter sunlight much the way a forest canopy does. Although just 1,300 square feet, the pavilion offers a variety of indoor and outdoor places to relax.

*Cheryl Kent is the author, most recently, of Millennium Park Chicago (Northwestern University Press).*

Blackwell was aghast. But ultimately the ingenuity of that move impressed itself on the architect, since the berms mask the fact that the building must be raised 30 inches above the ground to accommodate flooding. The berms marry the pavilion to the earth and eliminate the need for a railing. The pavilion sits on the highest point and only buildable site within the floodplain. Sadly, Blake died suddenly at age 63 in August 2010 just months after the park and pavilion opened.

The relationship between structure and nature drove Blackwell’s design. His pavilion sifts sunlight through wooden slats that form its ceiling and 17-foot-long cantilevered canopy in the same way, he suggests, that a tree canopy does. “[The pavilion] pulses with the rhythm of the day. A

cloud passes and it goes quiet,” he says. “It’s as though it inhales and exhales.”

Partly because the building is not orthogonal, it can seem animated, almost alive. As visitors walk around it, different features present themselves. The triangular tip of the cantilever tilts upward but isn’t visible from the principal approach. Similarly, the wooden ceiling slats veer off from straight parallel runs in some places to form elongated peepholes, creating an optical illusion that sometimes makes them appear inverted like a pleat and sometimes flat with the roof plane. The pavilion’s slightly canted north wall – composed of precisely spaced wood slats cut lengthwise as parallelograms – can appear, like old-fashioned Venetian blinds, solid

from some angles and open at others.

Although just 1,300 square feet, the pavilion is structurally complex. It has two layers of steel in its roof – one structural, the second a lighter-gauge steel T to which heavy and dense ipé wood is attached and tied back to the primary steel frame. A layer of glass above the wood forms the actual ceiling for the interior, extending the transparent, open-air quality of the deck into the interior.

**Commentary** Where the Barcelona Pavilion is an exquisite expression of formality and chilly beauty fit for royals, the Lilly Pavilion is a quiet creature revealing itself slowly and rewarding contemplation. That is as it should be for a pavilion in the woods. ■







#### CREDITS

**ARCHITECT:** Marlon Blackwell Architect – Marlon Blackwell, principal in charge; Jonathan Boelkins, project manager; Chris M. Baribeau, Gail Shepherd, Meryati Johari Blackwell, Mark Rukamathu, project team

**CLIENT:** Indianapolis Museum of Art

**ENGINEERS:** Guy Nordenson and Associates (structural); L'Acquis Consulting Engineers (m/e/p); Cripe Architects + Engineers (civil)

**CONSULTANTS:** Kate Kulpa (curtain wall); Ed Blake/The Landscape Studio, Eric Fulford and Ann Reed/NINebark (landscape)

**SIZE:** 1,300 square feet (enclosed); 6,625 square feet (deck and canopy)

**COST:** \$2.3 million (includes landscaping of area immediately around pavilion)

**COMPLETION DATE:** June 2010

#### SOURCES

**CURTAIN WALL:** Metal Art; Kawneer

**GLASS:** Viracon

**MILLWORK:** Trespa

**SKYLIGHTS:** LinEl

**RAISED FLOORING:** Versaroc by US Architectural Products; MegaJoist by TMCP Building Systems

**INTERIOR LIGHTS:** Juno

# Dhoby Ghaut Green

Singapore

Inserting a sinuous amphitheater and a rectilinear café pavilion into an existing park, Soo Chan brings new life to the public realm.

By Clifford A. Pearson

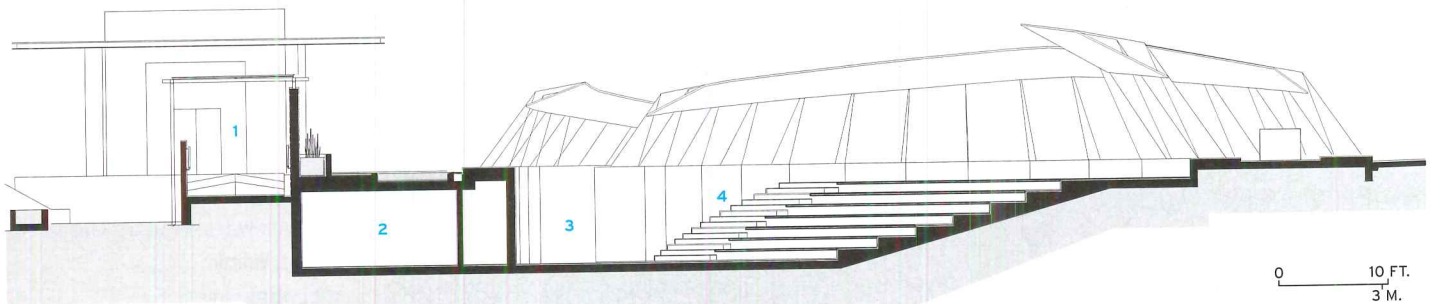
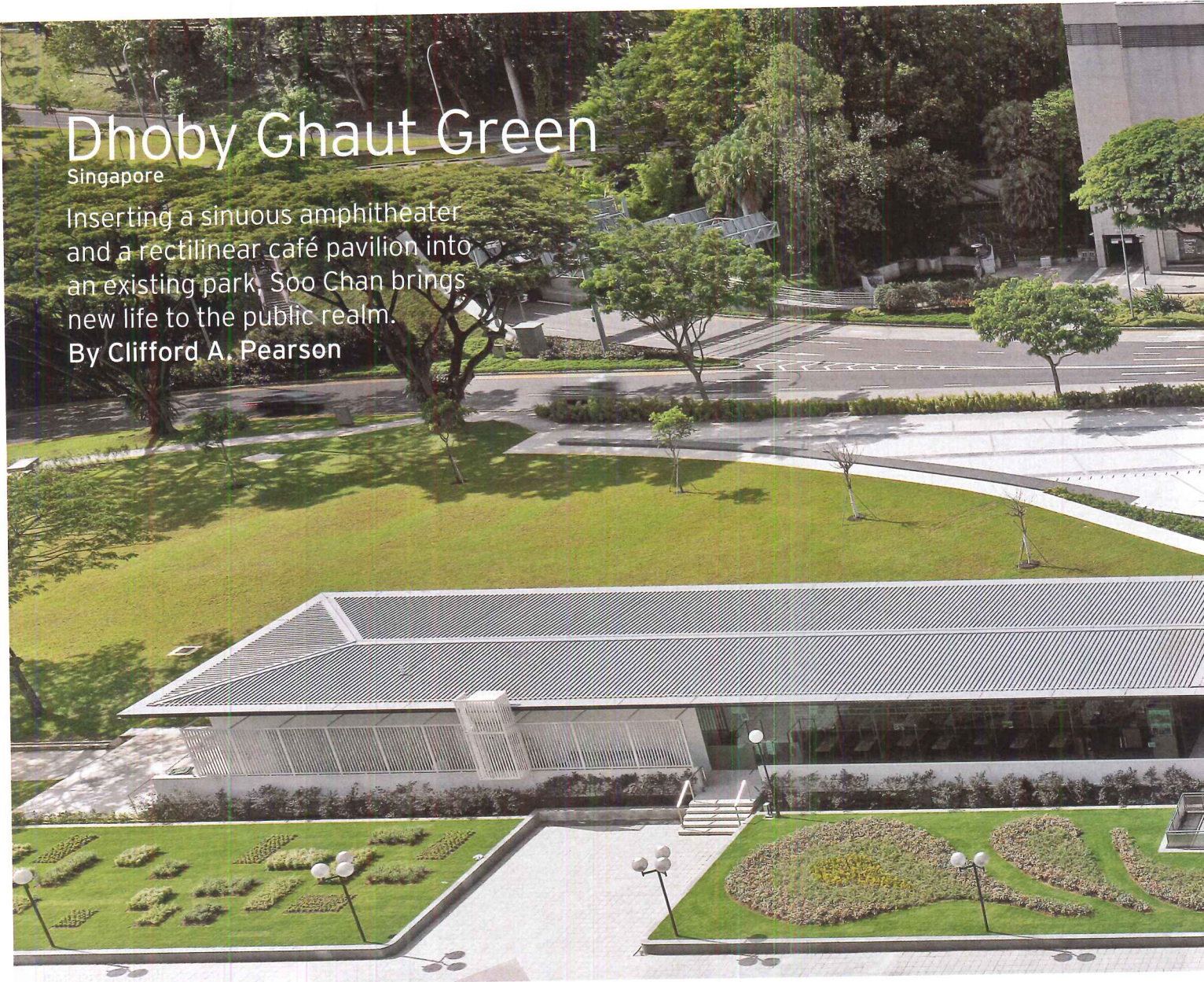

- 1 COVERED WALKWAY
- 2 DRESSING ROOM
- 3 STAGE
- 4 SEATING



**TO REVITALIZE A** three-acre park in a busy part of Singapore, Soo Chan and his firm, SCDA Architects, explored ways of knitting together architecture and landscape – an issue of growing interest to designers as they investigate sustainable strategies and break down traditional boundaries between disciplines. So Chan wrapped a small amphitheater with a canted, curving screen that provides a sense of definition and enclosure while letting breezes and light filter in. “We wanted it to be porous to connect with its surroundings and read less as an object,” explains the architect.

**Program** Singapore’s well-respected Urban Redevelopment Authority (URA) hired Chan for the job after he won the city-state’s first Designer of the Year award, in 2006. As part of an effort to improve public open spaces, the URA asked Chan to rethink a park called Dhoby Ghaut Green, which faces busy Orchard Road and leads to the Bras Basah/Bugis arts and entertainment district. Although thousands of people came to the site each day, the great majority of them immediately went underground to an existing subway station. In a hot, humid climate such as Singapore’s,

**In a busy part of downtown Singapore, the architects used the new amphitheater to shape outdoor spaces around it and created an ensemble of structures that connect to the surrounding streets and a subway station below grade.**

## CREDITS

**ARCHITECT:** SCDA Architects – Soo Chan, principal; Jin Oon, Winnie Ho, project team

**ENGINEERS:** Web Structures Singapore (structural); J. Roger Preston (m/e)

**LIGHTING CONSULTANT:** Lighting Planners Associates

**GENERAL CONTRACTOR:** Westtech Builders

**CLIENT:** Urban Redevelopment Authority of Singapore

**SIZE:** 3 acres (park); 5,400 square feet (amphitheater); 4,575 square feet (café pavilion)

**COST:** \$3 million

**COMPLETION DATE:** October 2009

## SOURCES

**GALVANIZED STEEL FRAME:** Green Star Products (amphitheater)

**ALUMINUM ROOF PANELS:** Bluescope Lysaght (café)

**HALOGEN UPLIGHTS:** iGuzzini

creating outdoor spaces where people want to linger is a real challenge. The URA and the National Parks Board, which operates the Dhoby Ghaut Green, figured that a new performance space and a café would give residents and visitors reasons to stay in the park.

**Solution** Chan realized that the amphitheater's location on the site would affect the way the park works. So he placed it near the transit station on a spot that divides the park into two zones. On the west side, where large trees provide shade, he added gravel and plantings to create a place where people could relax during the week and market stalls could pop up on weekends. To the east, he created a

grassy lawn for sports and other active uses. For the café pavilion, he incorporated a few small structures (elevator, mechanical, storage) servicing the transit station and added indoor and outdoor dining areas, and then tied it all together with a long, standing-seam roof.

In early schemes for the performance space, Chan envisioned a band shell or stage facing one way or another. But he eventually realized that a nondirectional structure would work better with the rest of the park. In the end, he developed a spiraling design with arms that reach out to the landscaped spaces on both the east and west.

To reduce the apparent mass of the amphitheater and create seating for 250 people, he pushed

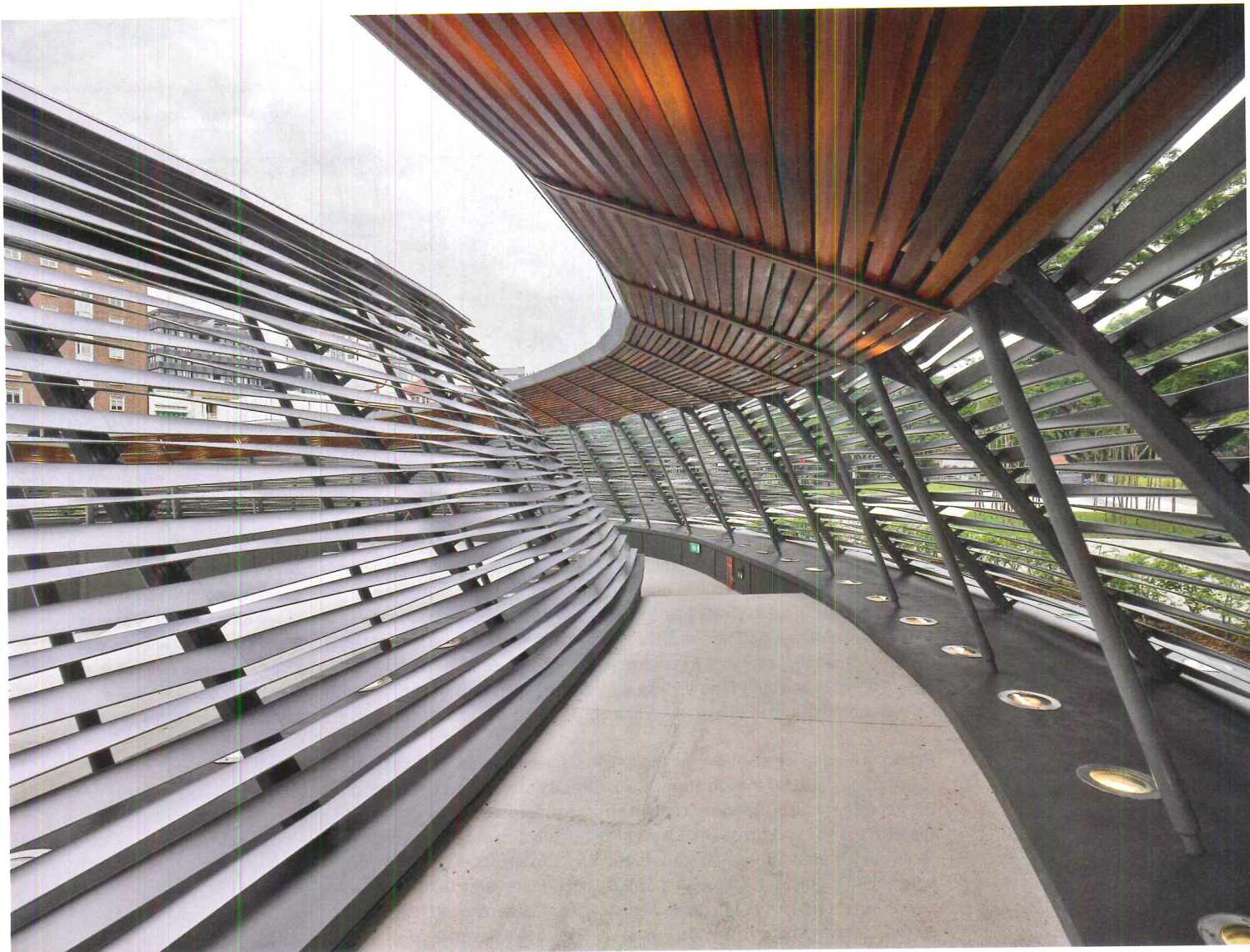

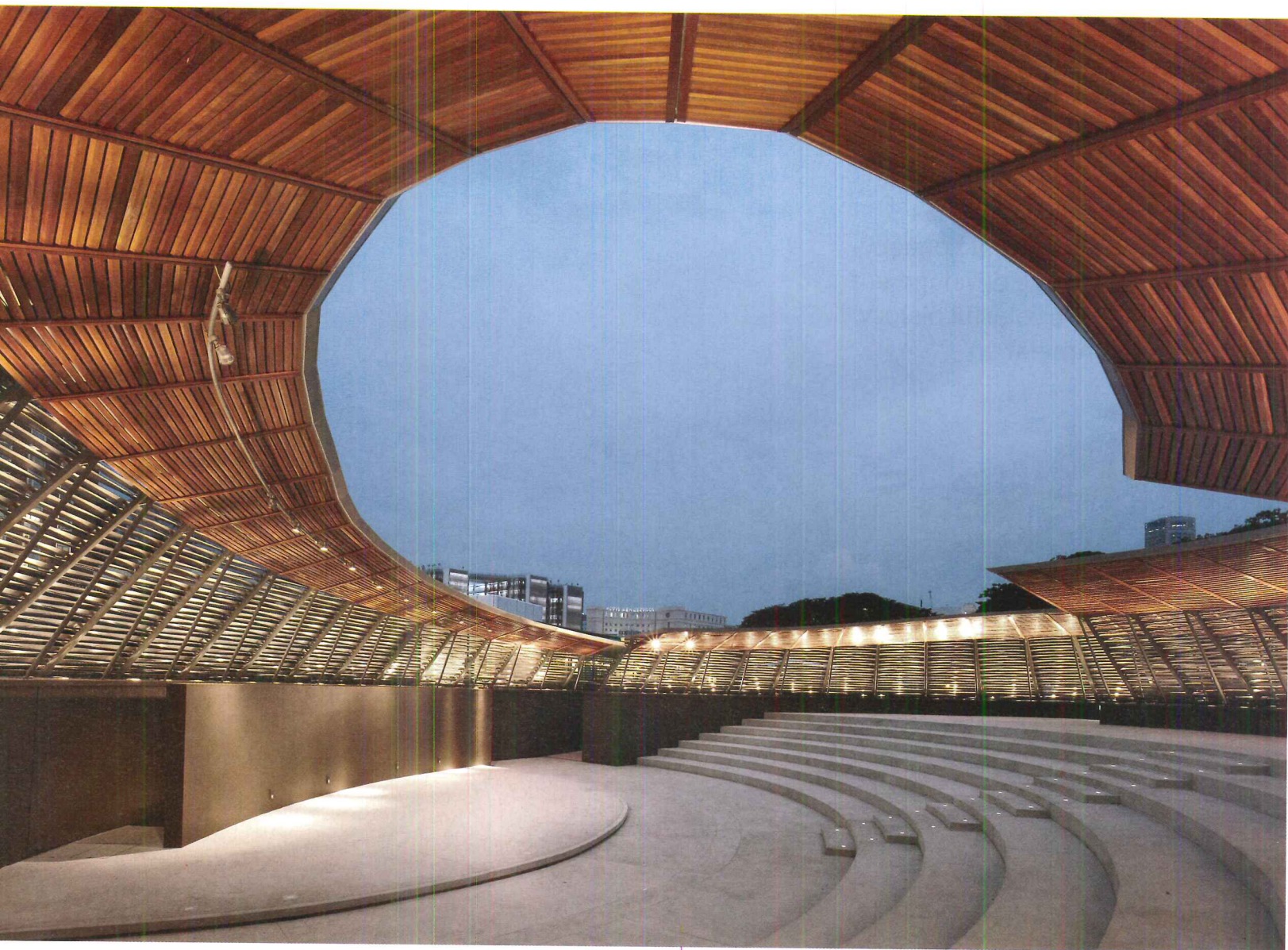

**ABOVE:** The designers used a combination of blue and white halogens to light the amphitheater from below. A dressing room behind the stage provides space for performers to change and prepare.

**OPPOSITE:** Workers manually twisted 0.11-inch-thick aluminum ribs and bolted them onto aluminum brackets attached to the amphitheater's angled-steel supports. Balau-wood planks help cover the walkways, adding a warm accent to the durable materials.

the concrete base of the structure into the earth. Above this, he designed a lacy metal screen that shades access ramps and the seating area and focuses attention on the performance space. "At first, I thought about weaving aluminum ribs around steel supports to create a basket effect," recalls Chan. But because the steel supports slant down and spiral around the central space, weaving the ribs in and out would have been expensive and made any errors stand out. So he attached the powder-coated gray ribs to the outside of the columns and twisted them to create an irregular pattern that is more forgiving of imperfections. The

twisted surfaces catch sunlight in different ways during the day and scatter light at night.

To provide protection from the rain, Chan placed aluminum panels on top of the arms embracing the performance space. Underneath these panels he installed planks of balau, a tropical hardwood that adds a warm note to the material palette.

For the dining pavilion the architect kept things simple; orthogonal metal-and-glass curtain walls enclose a small café and a sushi bar where a conveyor belt delivers the food. A long metal canopy reaches out to the vehicular drop-off circle, providing shaded access to the MRT station and the café.

**Commentary** Using sinuous geometry and an intriguing metal veil, Chan created an amphitheater that is both animated and calm, enclosed yet open. With the dining pavilion and redesigned landscaping in the park, he has given Dhoby Ghaut Green new meaning as a place for multiple groups and activities. At midday this past December, though, even the screened spaces of the amphitheater couldn't entice many people to sit down. In a city just a degree north of the equator, most people need air-conditioning at that hour. In the evening, the park and its stage become more alluring attractions. ■

# Playa Vista Park

Los Angeles

Where Howard Hughes once flew, Michael Maltzan has designed a park that connects a new mixed-use development with the site's colorful history.

By Sarah Amelar



**ABOVE:** A fiberglass/PTFE membrane wraps around the bandshell, bringing to mind a moored dirigible and the area's aeronautical history.

**OPPOSITE:** Maltzan envisioned the park as a series of programmatic "bridges" linking nearby commercial buildings and future development.

**ON LAND ONCE** inhabited by native Tongva people and, centuries later, by the Hughes Aircraft Company, the planned community of Playa Vista is gradually rising on Los Angeles's West Side. Here, in the 1940s, Howard Hughes built a private airfield and his famous wooden "Spruce Goose," an aircraft with the greatest wingspan in history. After a single flight, the Goose was permanently grounded, but controversy over the 1,086-acre tract hovered for decades following Hughes's death in 1976.

A series of developers, as early as 1978, tried to create a mixed-use, live-work community. But endless setbacks ensued. In the 1990s,

DreamWorks planned a movie studio, then pulled out. Opposition from environmentalists over wetlands protection and other obstacles followed. The final outcome: Hundreds of acres of wetlands will be protected, limiting the development parcel to 435 acres. Now partially complete, it will enfold the historic Hughes Aircraft buildings as movie-production facilities.

Back in 2007, Michael Maltzan was hired to design two office buildings here (now on hold). In the process, the master developer, Playa Capital, asked him to make studies for a park, part of the complex's public open space requirements. Maltzan's ideas – "bridges of program" connecting

the surrounding office buildings and future development – convinced Playa Capital to hire him to design the park with landscape architect James Burnett.

**Program** The resulting 7.9-acre public park, privately maintained by Playa Capital, includes a basketball court, soccer field, playground, bosque, bocce courts, berm gardens, and a bandshell with an amphitheater lawn.

**Solution** Aerial panoramas provide an apt – and telling – introduction to the former site of Hughes's airfield. As planes approach Los Angeles International Airport, Central Park

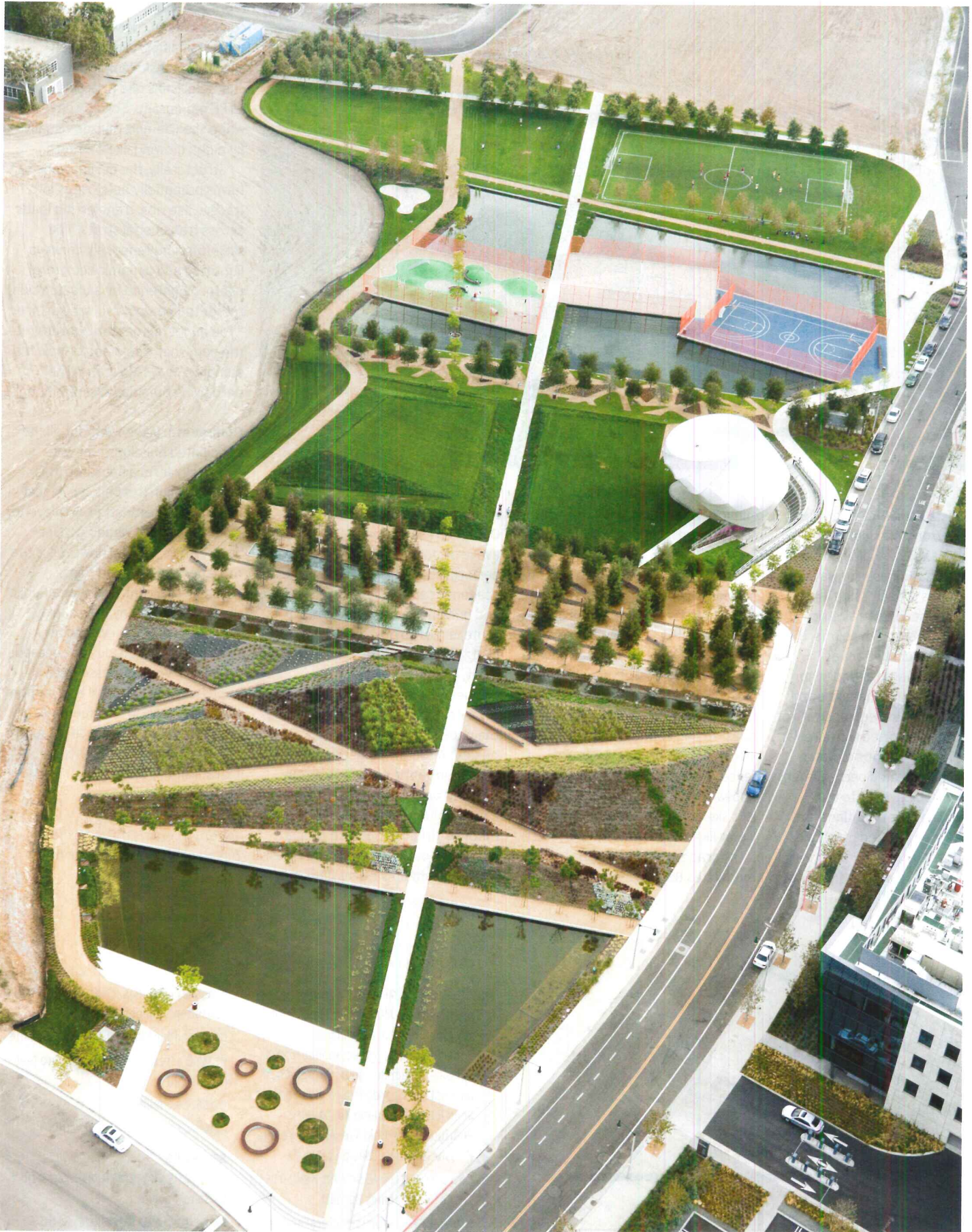



Working with landscape architect James Burnett, Maltzan used berms, paths, and different plantings to create a "constructed" nature.

at Playa Vista comes into view, just three miles from touchdown. The park's main axis, extending its entire length, recalls Hughes's runway, with diagonal paths crisscrossing it like taxiways intersecting an airstrip.

From the air or nearby bluffs, the park's graphic qualities are as striking and unreal as a rendering. Bands of contrasting materials and textures stripe this irregular swath of land with a plaza dotted with circular benches, two wide strips of water, allées of trees, faceted berm gardens, and a lawn sloping down to the bandshell. The berm plantings form swatchlike triangles and trapezoids of color and pattern, pieced together like a collage. "We weren't trying to

mimic nature," says Maltzan, "but to evoke the *spirit* of nature in a manifestly constructed place."

The design playfully manipulates not only the plantings, but also some of the standard-built features of a city park. Here, the "land bridge" over one band of water brings together a blue-surfaced basketball court, a volleyball area, and a candy-green playground – three elements in a quasi-zigzag configuration, behind a veil of vibrant orange chain-link fence. Varied as the transverse zones appear, they are united by the long axis skewering them and crossing the water like a causeway.

At grade, a range of scales modulates the experience of passing

from one "outdoor room" to the next. On this level, the diagonal paths that evoke airport taxiways from above perform like walkways in a classic academic campus, connecting people and buildings across a green. En route, a "bento box of activity," as Maltzan describes the programmatic array, animates the park.

The most traditionally architectural item here is the bandshell. Like the paths, it has an aeronautical quality. A roughly spherical, stretched-fabric object, stealthily perched on two steel feet, it conveys a sense of buoyancy, recalling a moored dirigible, but with ramps extending out, instead of guy wires. Though Maltzan says he finds most

fabric structures lacking in spatial complexity, he chose to investigate the possibilities, exploring, for example, translucent versus opaque characteristics of a fiberglass/PTFE membrane. Solid by day, the white shell dematerializes visually by night, glowing like a lantern.

Structurally, the design transforms potentially hefty rings into tracery-like ribs, transferring loads across transmodal struts. The skeleton simultaneously conveys lightness and dynamic sculptural depth, heightened by a pleated skin, rather than a single simple surface. "You might momentarily wonder if the bandshell's spinning or how it's standing," says Maltzan. "The perplexing qualities are intentional."

**Commentary** Even without all the anticipated buildings that will eventually form a backdrop, this iconic pavilion has become a local landmark, a destination, with events from concerts to weddings. One recurrent complaint, however, is the management's posted rules, exceptionally controlling for a public park, including "Any type of play other than designated sport is prohibited." Yet the design succeeds on other levels, addressing the mind through its formal abstraction, the body through its abundance of activities, and the place through roots tapping into the site's extraordinary history. ■

Sarah Amelar is a California-based contributing editor to ARCHITECTURAL RECORD.

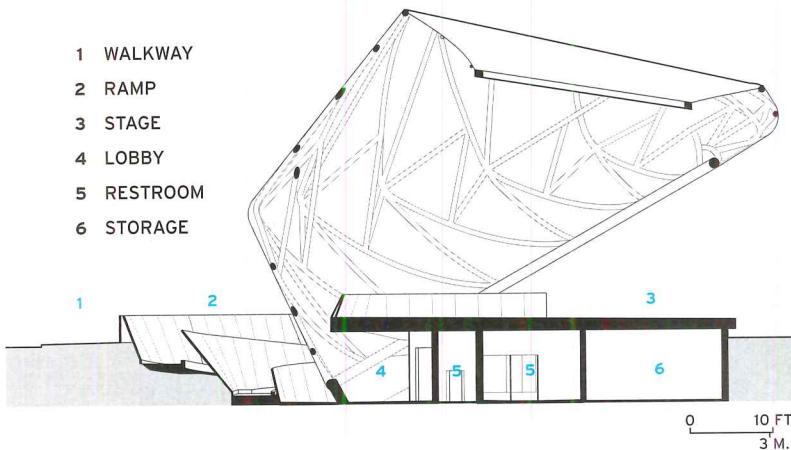

#### CREDITS

**ARCHITECT:** Michael Maltzan Architecture – Michael Maltzan, design principal; Tim Williams, project director; Robert Donnelly, project manager; Will Carson, project designer; Po-Wen Shaw, job captain; Ricardo Moura, Rob Shostak, Sean Ramseier, Guang Xu, David Rodriguez, Gee-Ghid Tse, Audrey Vuong, Hiroshi Tokumaru, design team

**EXECUTIVE LANDSCAPE ARCHITECT:** The Office of James Burnett

**ENGINEERS:** Arup (structural and m/e/p,

bandshell); Psomas (civil); Group Delta Consultants (geotech)

**CLIENT:** Playa Capital Commercial Land  
**SIZE:** 8 acres (park), 3,540 square feet (bandshell)

**COST:** \$9.6 million

**COMPLETION DATE:** July 2010

#### SOURCES

**BANDSHELL MEMBRANE:** Sheerfill V by Saint-Gobain

**PLAYGROUND SURFACE:** Goric





# Beautiful, versatile, sustainable western red cedar

Western Red Cedar has a low environmental footprint, proven performance and exceptional beauty that bring warmth, character and longevity to projects around the world. It is this bundle of properties that has made "Cedar" the natural choice of discerning architects, builders and homeowners alike.

In order to withstand the challenging climate and inherent termite presence, Western Red Cedar was chosen for the expressed roof framing as well as the vertical exterior siding on this residence on the Big Island of Hawaii. Careful thought and regard was given to the exposed pattern and detail, which surround the home, giving it a distinctly casual feel. Together with the warm character of the Western Red Cedar, Walker Warner Architects chose native materials such as natural ohia columns and wind screening, and carved koa slabs, to root the house in place-sensitive Hawaiian tradition.

To discover more about Western Red Cedar and assistance in sourcing it for your next project, please visit our website or call 1 866 778 9096.

[www.wrcla.org](http://www.wrcla.org)

1.866.778.9096



# DESIGN WITH CONFIDENCE

When you want to be sure about your manufacturer – Tubelite® is the clear choice

We begin with exceptional product quality and energy performance. Our benefits then extend into industry leading sustainability by producing all extrusions from Ecoluminum. Discover AIA-CES courses available and many more reasons for selecting Tubelite® by visiting our website.



More recycled content, eco-efficient finishes



KNOW WE'RE  
BEHIND YOU!

# TUBELITE®

**DEPENDABLE**

LEADERS IN ECO-EFFICIENT STOREFRONT,  
CURTAINWALL AND ENTRANCE SYSTEMS

[www.Tubeliteinc.com](http://www.Tubeliteinc.com) | 800.866.2227



RETHINK INNOVATION. RETHINK SUSTAINABLE.  
RETHINK THE BUILDING ENVELOPE.  
RETHINK QUALITY METAL WALL PANELS FROM ATAS INTERNATIONAL, INC.

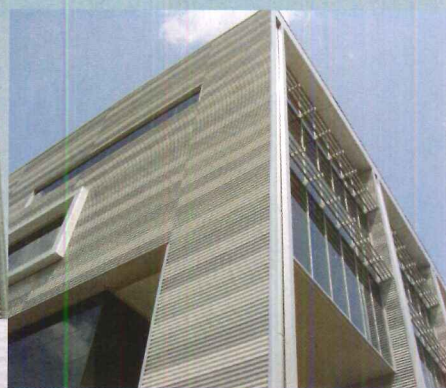

Ann Arbor Municipal Building, Ann Arbor, MI  
Architect: Quinn Evans Architects, Ann Arbor MI  
Distributor: Oakland Metal Sales, Inc., Auburn Hills, MI  
Metal Installer: CEI Michigan, LLC, Howell, MI

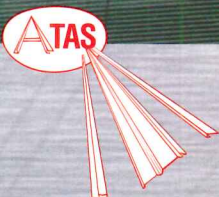

Rethink innovation with ATAS' variety of vertical and horizontal metal wall panels, offering mix and match profiles to produce visual impact with interesting patterns and designs. Wall profiles are available in ribbed, corrugated and smooth with exposed or concealed fasteners in a variety of color choices. Elite Trim can complement walls by creating crisp sight lines at areas of panel termination while perforated panels can add another dimension. Rethink sustainable with InSpire, the transpired solar collector, which utilizes precision perforated metal panels to preheat ventilation air via solar energy. Rethink your building envelope with ATAS' sustainable metal wall panels.

ATAS International, Inc. | [www.atas.com](http://www.atas.com) | 800.468.1441 | Allentown, PA | Mesa, AZ | Maryville, TN

CIRCLE 133

AIA 2011 Expo  
Booth #3737



Please come visit us at  
the AIA in New Orleans  
at **Booth Number 3505**

## *Turn Silver to Gold with CalQ*

Holcim's new CalQ Materials Assessment Calculator helps you maximize MR4 and MR5 LEED points as you work to achieve LEED certification. Concisely formatted in an easy-to-read report that's saved only to your computer, your assessment is available for quick referral on new projects saving you valuable time on future specifications.

At Holcim, we're committed to helping you reduce the environmental footprint of your projects with Envirocore™ products and time-saving tools. CalQ, it's just another way Holcim is working with you Perfecting Progress.

Don't leave LEED points on the table, visit [www.holcim.us/CalQ](http://www.holcim.us/CalQ)

# STANLOCK<sup>®</sup>

ARCHITECTURAL GASKET SYSTEMS  
A PRODUCT OF GRIFFITH RUBBER MILLS

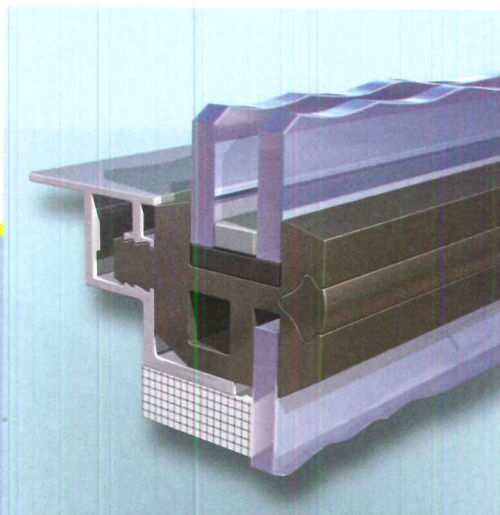

seal a curtain  
wall against the  
forces of nature,  
there is only one  
product that has  
stood the test of  
time. Since 1955,  
StanLock has been  
one of the most  
trusted and reliable  
curtain wall glazing  
systems in the  
industry. Properly  
installed, it will  
keep energy in,  
while keeping the  
elements out.

*Invest in the future*

*With proven performance*

*Invest in StanLock*

**Come see us at  
booth 3064 during  
the AIA show in  
New Orleans!**

visit us at [www.griffithrubber.com/stanlock](http://www.griffithrubber.com/stanlock) or call us at 800-321-9677

CIRCLE 49

**GRIFFITH**  
RUBBER MILLS  
PROVEN SOLUTIONS FOR AN EVOLVING WORLD



- UNIQLO Shanghai
- Marc Jacobs Tokyo
- LAPD Main Street Parking Los Angeles

### Bohlin Cywinski Jackson

By Clare Jacobson

Enlisted to craft an understated yet visible Shanghai flagship for Uniqlo, Bohlin Cywinski Jackson teamed with Candela Lighting Design to transform a quirky existing structure into a lustrous icon for the popular Japanese brand.

**SHANGHAI'S NANJING ROAD** is the center stage of the city's shopping culture. Its eastern end features a pedestrian zone with towers of neon signs competing for attention. Its western side has dramatic storefronts for high-end brands, including a brightly lit five-story suitcase for Louis Vuitton. In between, the Uniqlo global flagship store, designed by Bohlin Cywinski Jackson's (BCJ) Seattle office for the popular Japanese clothing retailer, is a subdued player, without flashy lights or multistory logos. Instead the building relies on restrained architecture and lighting to make a quiet statement amid the noise, like a supporting actor stealing the scene with a simple gesture.

"We were interested in differentiating this building from what was around," says Robert

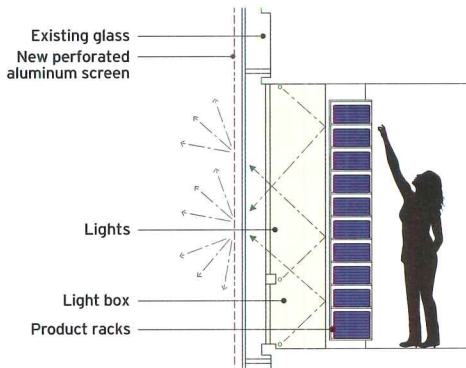

LEFT AND RIGHT: Backlit by fluorescent lamps and easily reached between the product walls and existing glazing (above), a new perforated metal skin reveals a pattern reminiscent of rippled fabric.

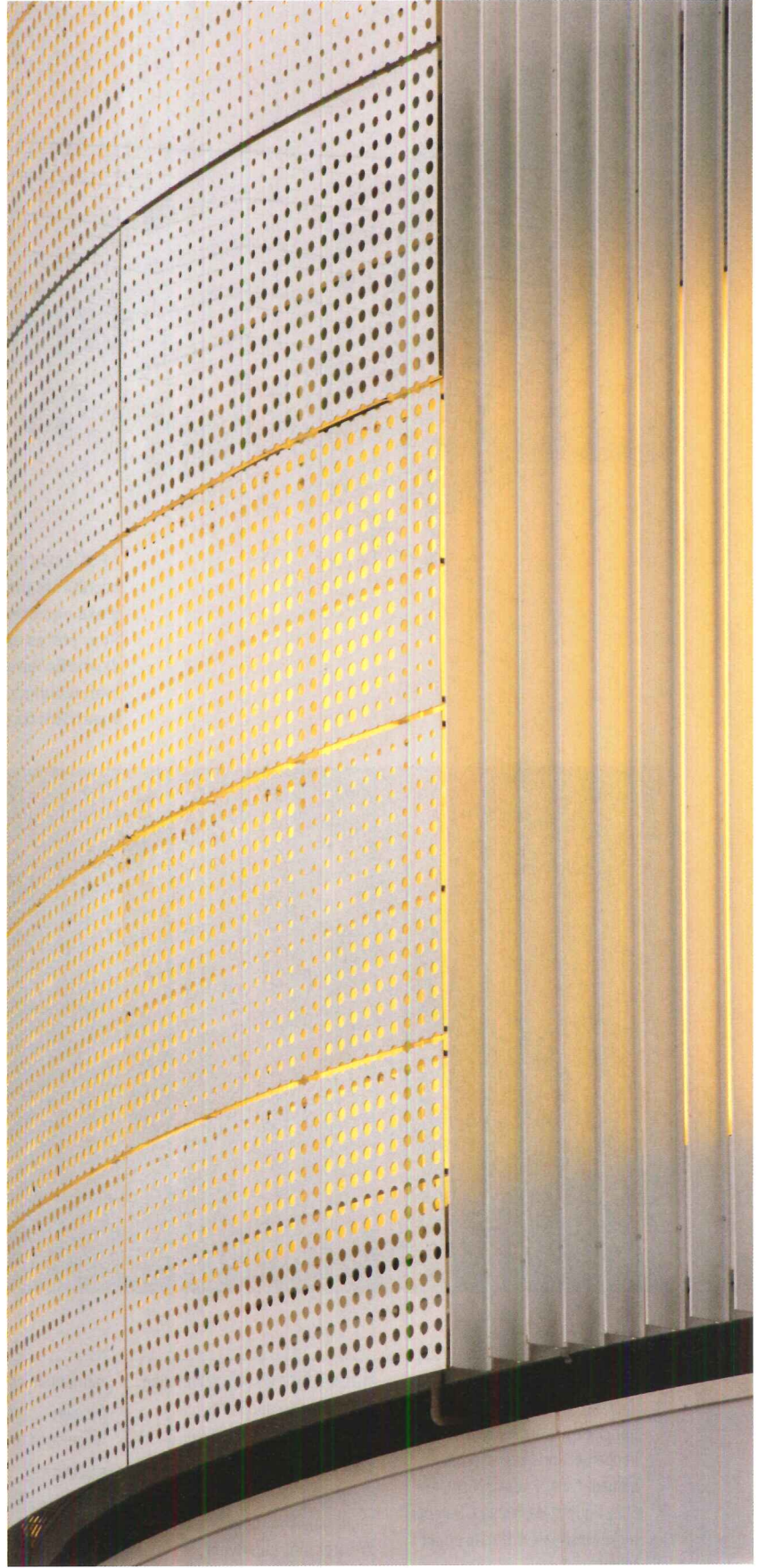



ABOVE AND BELOW: The architects inserted a shard of glass and steel through the floor plates as a conduit for dramatic lighting, views, and mannequins rotating on theatrical rigging.

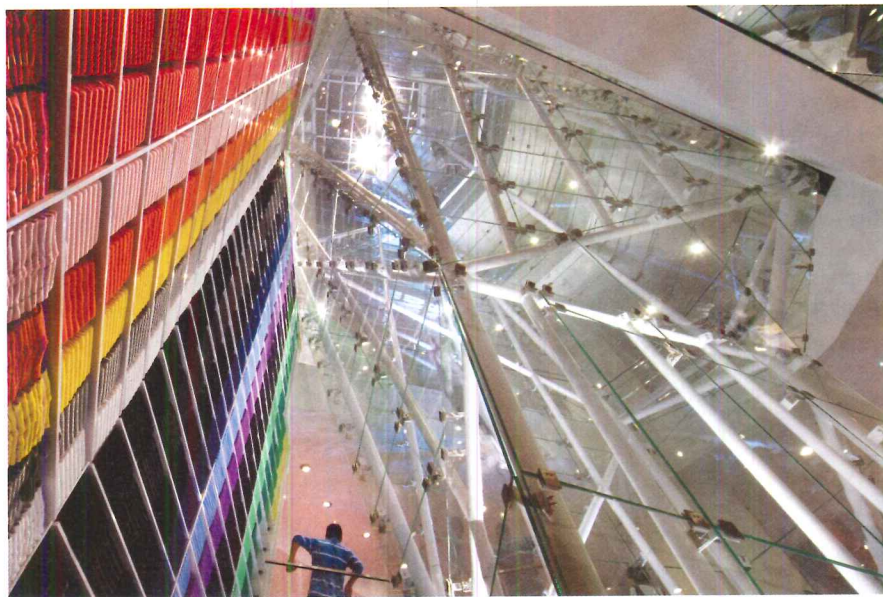

#### CREDITS

**ARCHITECT:** Bohlin Cywinski Jackson – Peter Bohlin, design principal; Robert Miller, principal in charge; Chris Evans, project manager; Mark Adams, Campie Ellis, Nguyen Ha, Michael Hatcher, Nick Hons, Matt Wittman, project team

**ARCHITECT OF RECORD:** Jian Architects & Engineers

**ENGINEERS:** PCS Structural Solutions (structural)

**CONSULTANTS:** Candela (lighting); Axis Facade (facade); ZFX (rotating and flying

mannequin consultant)

**GENERAL CONTRACTOR:** Tanseisha Co.

#### SOURCES

**LIGHTING FIXTURES:** ETC; Koizumi Lighting Technology

Miller, BCJ principal in charge. “I think people respond to subtle clues and discovery.” These subtle clues start at the new facade attached to an existing steel-reinforced concrete frame structure. A metal skin with a fluid pattern of perforations wraps the center three floors of the five-story building. By day, Shanghai’s typically gray sky gives the skin a solid appearance. By night, fluorescent lamps set inside the expanse of window frames reflect light off the back of display shelves and through the perforations. The reflected light produces a striated effect, suggesting the textiles of the clothing inside. This novel approach was created in part as a response to restrictions at the site that prohibited exterior lighting and mandated the original glass facade remain.

The building, said to be a former music school, brought additional challenges. BCJ addressed its triangular floor plan by arranging display areas and circulation into discrete lines and taking advantage of the rounded primary corner along Nanjing Road to create an entry rotunda with mannequins encased in clear cylinders that circulate on a track above. A white palette allows the colorful goods to “shine.” Such design choices were made to emphasize the Uniqlo brand. “Our product is very simple,” says Hiroshi Matsuoka, Uniqlo store design manager. “We asked the architect for a minimal design so that our product stands out.”

Lighting designed by Seattle-based Candela underscores the unpretentious scheme. Both ambient downlights and track lighting focused on display shelves are recessed into ceiling slots for an organized, clean look. A constellation of small LEDs, set into the ceiling at the ground level, continues out to a subway exit that runs through the building. Spotlights track the rotating mannequins at the rotunda entrance and radiate onto the street, while horizontal bars of translucent acrylic resin in the escalator’s metal wall panels reveal slits of white light, which draw shoppers up through the 32,292 square feet of retail space on three floors.

Within this quiet backdrop, the design does allow for a bit of drama. “Uniqlo was looking for 1,000 lux (or 100 foot-candles) for general lighting,” says Lauren MacLeod, Candela senior designer. “It’s a huge challenge when you start with that, because then when you want to really punch focal areas, your light levels have to be that much higher.” To help MacLeod achieve that punch, the architects inserted a hollow glass-and-steel “shard” through the floor plates, bringing the dramatic light and views to each level. Mannequins travel up and down through this jewellike tube on theatrical rigging, and directional spotlights at its base rotate, move to music, and change color and beam pattern.

With such varied lighting features, the architects thought they should be “green.” According to MacLeod, all of the lamp sources are energy efficient – ceramic metal halide, fluorescent, and LED – and come from a local manufacturer.

The combination of a Japanese client, an American design team, and a Chinese contractor working with a limited budget and a three-month construction schedule could be the plot for a tragedy. Instead, says Miller, the Uniqlo story ends with “a soft spot right in the heart of the neighborhood.” ■

*Clare Jacobson is a Shanghai-based writer and editor specializing in architecture and design.*





L101 - 2000K (92 CRI) with 2" spacing

## 2000K Linear LED

The look and feel of incandescent lighting. The design and technology of an LED lamp.

Introducing MP Lighting's NEW 2000K, high CRI (92 typ.), warm white color option. Available for select linear products.



**[M] MP LIGHTING®**

[www.mplighting.com](http://www.mplighting.com)

1 877 708 1184

# LIGHTING STRUCTURAL BEACONS



- UNIQLO Shanghai
- Marc Jacobs Tokyo
- LAPD Main Street Parking Los Angeles

## Jaklitsch/Gardner Architects

By Naomi R. Pollock, AIA

Making the most of a small footprint within a crowded, competitive shopping zone, architect Stephan Jaklitsch married textural layers of materiality with a creative lighting strategy to catch the eye of tony passersby, and to create a subtle yet unique visibility for the American fashion designer Marc Jacobs's Tokyo flagship.

**IN OMOTESANDO, TOKYO'S** fashion epicenter, only the most flamboyant of buildings stand out. Concentrated around the area's famous tree-lined boulevard, they aggressively vie for attention. But instead of competing head-on with its eye-catching neighbors, Jaklitsch/Gardner Architects' Marc Jacobs boutique wows shoppers with understated elegance and bold lighting effects. While the building's brightly lit, transparent base lures passersby, its translucent top beckons to the city.

Located on a side street between designer shops, including Prada and Cartier, and low-rise apartments, the site straddles commercial and residential zones. This condition legally limited the building to two above-ground stories, which inspired the boutique's layered look. Stacked horizontally, three wide swaths of different materials – glass, terra-cotta tile, and punched anodized aluminum panels – define the exterior of the 2,800-square-foot boutique.

Inside, the architects tucked menswear below grade, enclosed street-level accessories behind a glass skin, and used terra-cotta tile to mask women's wear upstairs. Crowning the occupied space is an uninhabitable aluminum box that nearly doubles the building's stature. Open to the sky, the enclosure reads like a third floor but has the legal status of the roof-mounted signs that abound in Japan. "I always wanted to design a billboard," jokes design principal Stephan Jaklitsch.

In lieu of logos, a continuous pattern of lozenge-shaped perforations adorns the box's silvery surface, made of six rows of rectangular panels. Evocative of richly woven fabric,

**Made of a translucent formable material supported by a polished stainless steel frame, the shop's oversize elliptical luminaire hovers above a glowing cash/wrap station and illuminates the accessories boutique and street at grade.**



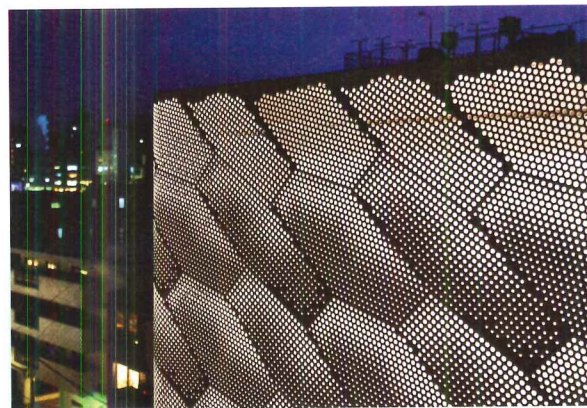
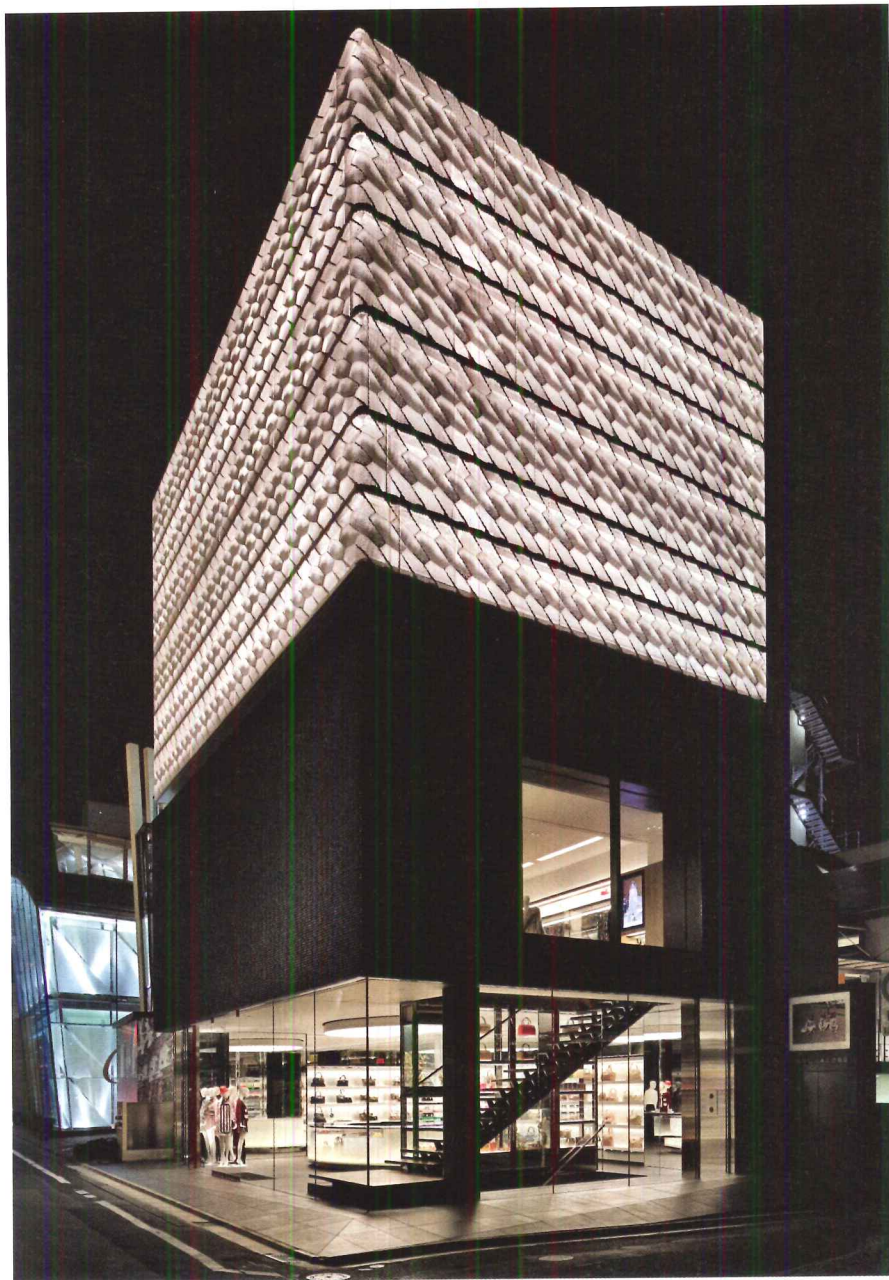

ABOVE: Illuminated panels of punched anodized aluminum transform the shop's hollow third layer into a lantern by night.

LEFT: Stacked horizontally, three levels of different materials – glass, terra-cotta, and punched anodized aluminum panels – define the exterior of the 2,800-square-foot boutique.

the intricate motif carries from panel to panel, wrapping the rounded corners. When the sun begins to set, each small dot emits a point of light from within, turning the metal box into a lantern. As darkness falls, the light intensity gradually decreases until the system shuts off after midnight.

The light source is a computer-controlled system of linear LED fixtures that line the top and bottom of each panel's back side. Instead of shining directly outward, the LEDs face away from the street and reflect off strips of plastic fabric mounted behind the panels. An additional color filter adds warmth to the 2,700-Kelvin color temperature of the lamps.

A shadowy 20-inch slot, deftly integrated with the stratified exterior, melds the metal with the tile below. Supported by metal clips and concrete panels, the rough-hewn terra-cotta plates stack vertically – an installation that adds texture and depth by day but goes mute at night.

In contrast, the interior lighting on the ground floor radiates a warm glow onto the street via an elliptical ceiling fixture, drawing attention to the entire room. Comprising fluorescent tubes contained within a translucent nonflammable stretch material supported by a polished stainless steel frame, it also echoes the oval cash/wrap, a counter with glazed and internally lit display cases below.

Throughout, built-in shelves – in white solid surfacing or sycamore – line walls and illuminate merchandise with LED strips embedded above frosted-glass diffusers on their undersides. "Like in a theater," says lighting designer Hervé Descottes. "Lighting the back wall gives the store depth."

Fortunately, the lighting was unscathed by the earthquake that struck Japan in March, and the building sustained only cosmetic damage. Because of the acute electricity shortage, however, the rooftop lantern will remain dark for a while. Yet even unlit, this clever adaptation of the vernacular sets this Marc Jacobs flagship apart from the pack. ■

*Naomi R. Pollock is RECORD's Tokyo correspondent and the coauthor of New Architecture in Japan (Merrell, 2010).*

#### CREDITS

**ARCHITECT:** Jaklitsch/Gardner Architects – Stephan Jaklitsch, Mark Gardner, principals; Jonathan Kirk, project architect; Bronson Fung, Toshi Hirai, Palmer Thompson-Moss, designers

**ARCHITECT OF RECORD:** Creative Designers International (core and shell)

**CONSULTANTS:** L'Observatoire International (lighting); D.Brain Co. (interiors)

#### SOURCES

**LIGHTING:** Winona (exterior LEDs); Moriyama Sangyo (interior LEDs); NIPPO (fluorescent lamps); Lucifer Lighting Company, FLOS (downlights); Axon (custom fixtures); Lutron (controls)

**STRETCH MATERIAL:** Barrisol

**GLASS:** Schott (LED diffuser)

**SOLID SURFACING:** Corian

**RAINSCREEN:** INAX (terra-cotta tile); EXP (panel and clip system)

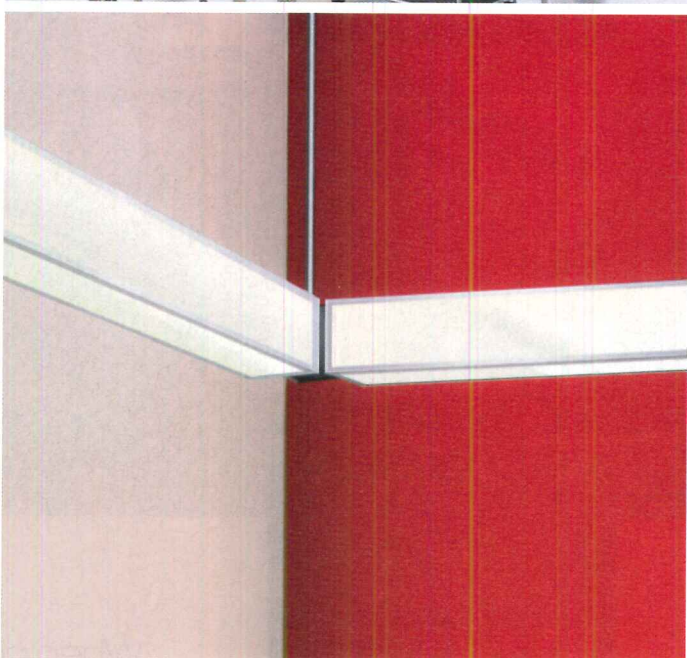
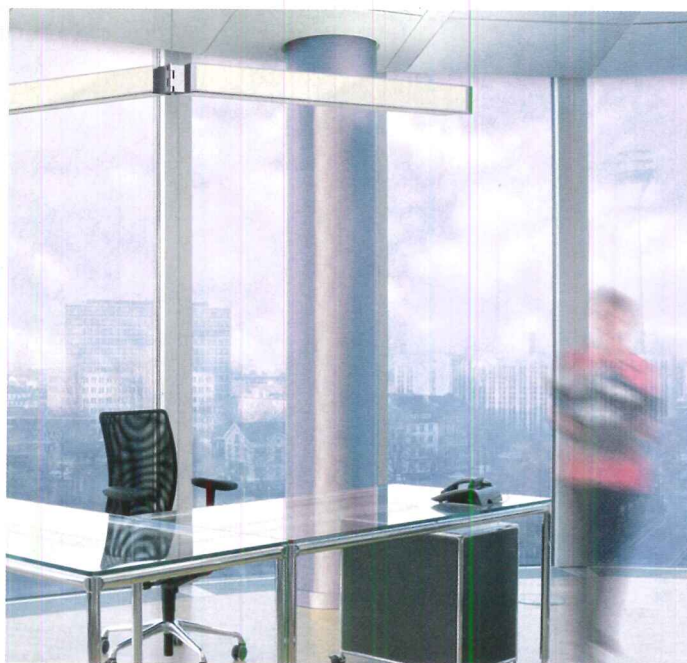

# neo®

The neo® is a new generation of luminaires constructed of glass and polished aluminum. The patented, award-winning design provides freedom with style and flexibility. The utilization of all visible light is the key to the neo® luminaire philosophy. It has pure aesthetics in design, material, and technology.

[selux.com/usa](http://selux.com/usa)  
(800) 735-8927



Scan here  
for neo video.

## se'lux®

Light. Ideas. Systems.



Uplight  
Downlight  
Decorative  
Restoration



When cost matters, experience pays.

For 110 years, Rambusch has provided the tools for illumination.

We welcome your inquiry.

^^ San Jose International Airport  
WSP Flack + Kurtz (phase I)  
Horton Lees Brogden Lighting  
Design (phase II)  
Gensler and Steinberg

A Marriott Orlando World  
Center Ballroom, Orlando, FL  
C.M. Kling & Associates  
TVS Design

> Taft School, Moorhead Wing  
Watertown, CT  
Ripman Lighting Consultants  
Gund Partnership

**RAMBUSCH**  
LIGHTING

160 Cornelison Avenue, Jersey City, NJ 07304  
T 201.333.2525 F 201.433.3355 info@rambusch.com www.rambusch.com

## LIGHTING STRUCTURAL BEACONS

- UNIQLO Shanghai
- Marc Jacobs Tokyo
- LAPD Main Street Parking Los Angeles

**John Friedman Alice Kimm Architects**

By Linda C. Lentz

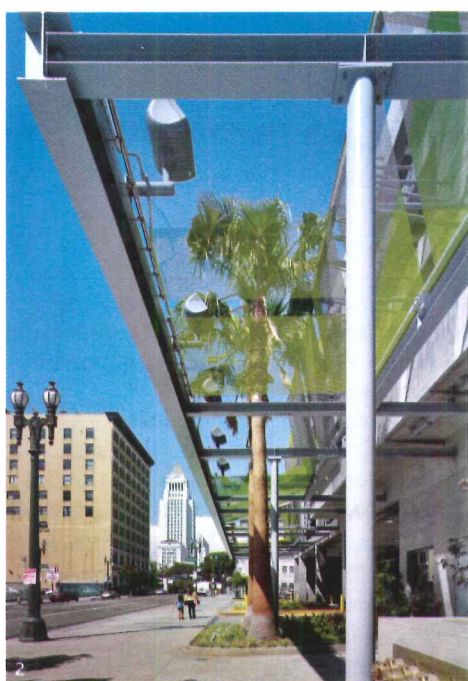

New to Downtown L.A.'s developing Gallery Row, John Friedman Alice Kimm Architects' Main Street Parking + Motor Transport Division building for the Los Angeles Police Department sets a glowing standard for utilitarian civic architecture.

**PART OF THE** three-stage master plan for the Los Angeles Police Department Headquarters (2009), spearheaded by an AECOM/Roth + Sheppard joint venture in the city's redeveloping Downtown, the Main Street Parking + Motor Transport Division is the kind of ancillary project that could sever a neighborhood by virtue of its sheer mass and typically unattractive aesthetic. Anticipating local concerns, the city's Bureau of Engineering charged John Friedman Alice Kimm Architects (JFAK) to devise a scheme that would both fulfill its need for a secure, rational building as well as illuminate the fragile urban revival.

The historic core of Downtown L.A. is on the upswing. Neglected commercial properties and

prewar buildings abandoned during the latter half of the 20th century are being converted into residential lofts and art galleries, and St. Vibiana, the city's former cathedral, which was damaged in the 1994 Northridge earthquake, has been restored and renovated into an elegant event space. Needless to say, the community was less than welcoming when they got wind of the LAPD's plans to build a vehicular parking and maintenance facility on Main Street, the burgeoning Gallery Row, adjacent to the revamped church.

Taking their cues from the area's cultural vibe, JFAK employed a whimsical combination of materiality, color, transparency, and light to minimize the impact of the 300,000-square-foot,



1. A series of 34 illuminated mesh screen panels veils the expanse of the LAPD garage, creating a playful illuminated relief visible across town.
2. The canopy is edged with 400-watt metal halide floodlights – one centered on each screen.
3. Braced by galvanized metal supports, the sheer mesh folds over a cantilevered catwalk, which provides access and egress for accessible parking.

- 1 STAINLESS STEEL MESH
- 2 METAL SUPPORT STRUCTURE
- 3 METAL HALIDE FLOODLIGHTS
- 4 FASCIA BEAM
- 5 CONCRETE CATWALK
- 6 CONCRETE STRUCTURE

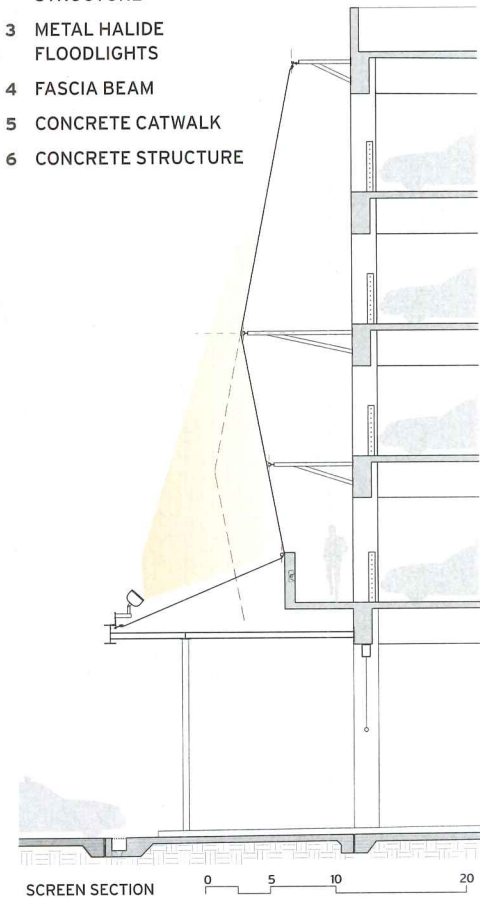

SCREEN SECTION

five-story concrete structure. And although the architects incorporated an 800-car employee garage in addition to a mechanics shop, car wash, and refueling station for official vehicles, the program is subliminal.

This is largely because of the glowing 300-foot-long screen that JFAK applied to camouflage the upper parking levels along the length of the Main Street elevation. According to design partner John Friedman, “We wanted to design the facade like a piece of public art or sculpture to acknowledge the high density of galleries here.”

Factory-painted, with a leaf graphic in two shades of green, this scrimlike facade comprises eight-foot-wide stainless steel mesh panels

draped and folded down over the building and across the canopy. Light filters through its perforations and reflects off the shimmering metal surface. The visual effect is transparent or diffuse, depending on the time of day or perspective of the viewer, says Friedman. To enliven the dynamic canvas in the evening, he and his team simply edged the canopy with metal halide floodlights, one centered on each panel, so that the image becomes the main event.

Visible from Frank Gehry’s Disney Concert Hall, JFAK’s humble building for the LAPD is luminous yet subtle, converting skeptics. Rather than the eyesore they feared, it is a vibrant lantern for a recharged Downtown L.A. ■

#### CREDITS

**ARCHITECT:** John Friedman Alice Kimm Architects – John Friedman, principal in charge; Robert McFadden, project designer; Claudia Kessner, project architect

**ARCHITECT OF RECORD:** AECOM/ROTH + Sheppard joint venture

**ENGINEER:** TMAD Taylor & Gaines (structural; m/e/p)

**CONSULTANTS:** HLB (lighting); Kaminski Kaneko Design (graphic design)

**SOURCES**  
**LIGHTING:** Cooper, McGraw-Edison, Allscape (exterior); Lutron (controls)

**CLADDING:** W.S. Tuler/Haver Boeker (screen)





Architectural  
LED Lighting



Roadway &  
Area Lights



Lamps for Post &  
Pendant Luminaires



# LEDtronics.com

The Future of Light. Today.



LED Tube Lights



LED Strip/String  
/Path Lighting



Miniature &  
Intermediate  
Based LED Bulbs



**LED**<sup>®</sup>  
**LEDTRONICS, INC.**<sup>®</sup>  
800.579.4875

*Designed in the U.S.A.*

[webmaster@LEDtronics.com](mailto:webmaster@LEDtronics.com)

See us at Lightfair Booth #2209

## PRODUCTS LIGHTING

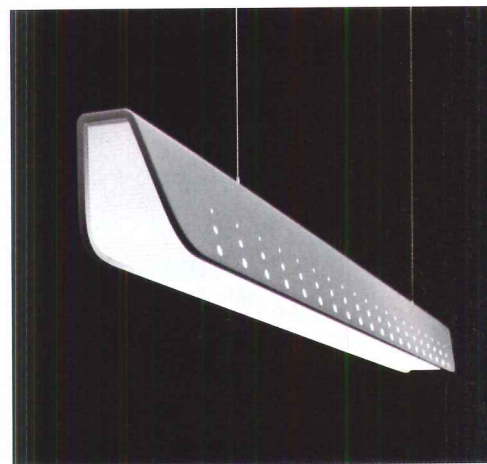
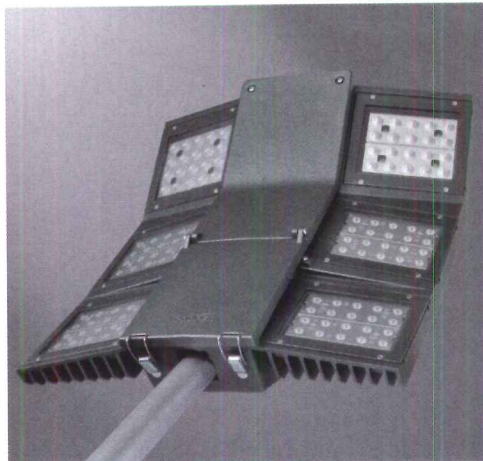
**NanoLED**

USA1 Lighting [usa1lighting.com](http://usa1lighting.com)

USA1 Lighting has combined the design features of its NanoLumen product with the performance of its BeveLED fixture to create NanoLED (top), a recessed lighting fixture that features impressive optics with a small, 2.5" aperture. It offers advanced thermal management, field-replaceable light engines, "Slide & Replace" LED driver sliding tray, and plug-and-play trim assemblies. **CIRCLE 207**

**RPD02 Collection**

Neidhardt [neidhardtinc.com](http://neidhardtinc.com)

The RPD02 Collection (bottom) is a geometric design based on linear extrusions supporting T5 lamps in 24" (14-watt), 36" (21-watt), 48" (28-watt), and 60" (35-watt) lengths. The stock octagon pendants range in overall diameter from 60" to 146". The T5s are lensed with a sanitized acrylic for a soft, even diffusion. The linear sections are cleanly joined with inner brackets, and coaxial cables supply power. Custom finishes are available. **CIRCLE 208**

**Marquis LED Sign Light**

Cooper Lighting [cooperlighting.com/led](http://cooperlighting.com/led)

According to Cooper Lighting, Marquis (top) is the first high-performance LED luminaire in the industry optimized for the stringent IESNA RP-19 Roadway Sign Lighting standards. The fixture's optical design produces even illumination, exceeding the IESNA standard, while providing a benchmark warm white light of 4000K with no sacrifice in lumen output or lighting performance. **CIRCLE 209**

**Kelvin LED**

Flos [flosusa.com](http://flosusa.com)

The Kelvin LED table lamp (bottom), designed by Antonio Citterio with Toan Nguyen, offers 30 2700K LEDs, producing a total of 270 lumens. An LED diffuser provides excellent duration and efficiency. The adjustable lamp head has a square polycarbonate body, and a double arm features a fixed pantograph, a mechanical linkage connected so the movement of one specified point accurately mimics the movement of another point. **CIRCLE 210**

**Lure Sconce by Alison Berger**

Holly Hunt [hollyhunt.com](http://hollyhunt.com)

One of the newest pieces from California-based glass artist Alison Berger is the Lure Sconce (top), which, like a fishing pole, uses a grommet and reel to hold a line in tension. The high-end, nearly 15"-tall fixture features bronze hardware and a delicate blown shade surrounding a 25-watt filament bulb. The sconce will be available exclusively through Holly Hunt showrooms across the country by June 1. **CIRCLE 211**

**Jump**

Philips Ledalite [ledalite.com/products/jump](http://ledalite.com/products/jump)

Philips recently received the prestigious Red Dot product design and innovation award for the Jump high-performance direct luminaire (bottom). Equipped with advanced LEDs or fluorescent light sources, it features a luminous end cap and is designed with MesoOptics holographic nanotechnology that blends light and color, controls high-angle glare, and creates a precise batwing distribution. Available with various mounting options. **CIRCLE 212**

inspire and de(light)

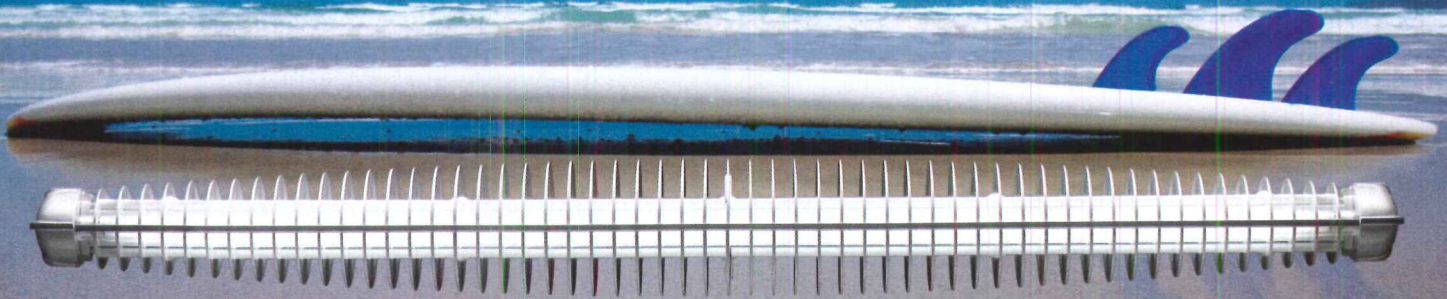

These are the emotions of innovation and change. Prudential's brand new, luminous homage to the cool design culture of the California coast and the rhythm of the ocean. Prudential shines with the new pulse of innovation. See the inspiration, Pulse fixture and facts online at [prulite.com/pulse](http://prulite.com/pulse).



PRUDENTIAL LTG.

pulse

# STONEPEAK

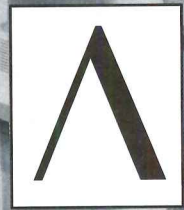

high tech porcelain

## MATERIA 3D

classic reinvented for today's spaces

[www.stonepeakceramics.com](http://www.stonepeakceramics.com)  
[info@stonepeakceramics.com](mailto:info@stonepeakceramics.com)





# BE GREEN. GO BLUE.

## BUILDING COMMUNITIES THROUGH GRANTS

If you have plans for a community-based green building project, your project may be eligible to receive a grant of UltraTouch™ Denim Insulation. The **Cotton. From Blue to Green.®** UltraTouch™ Denim Insulation Grant Program is dedicated to helping improve U.S. communities through the creation and development of such projects.

Tell us why your project should be awarded a grant from the **Cotton. From Blue to Green.®** program.

## HERE'S HOW IT WORKS

1. Visit the Grant Program tab on [CottonFromBlueToGreen.org](http://CottonFromBlueToGreen.org).
2. Create an account to register and begin your Grant Program Application.
3. Complete your application anytime between now and September 30, 2011. Grants will be awarded on a first-come, first-serve basis.

For more information visit [CottonFromBlueToGreen.org](http://CottonFromBlueToGreen.org) for Official Grant Application Guidelines.

**Deadline for completed applications is September 30, 2011.**



[CottonFromBlueToGreen.org](http://CottonFromBlueToGreen.org)

# Zero.



What's zero?

It's "net zero." That's the goal for NASA's Sustainability Base in California. This project is designed to use no more energy than it creates. And MechoSystems plays a key part in helping regulate daylight and lighting-energy use.

NASA chose MechoSystems for a project intended to be as self-sufficient as a lunar base. Imagine what we can do for projects a little more down to earth.

 **MechoSystems**  
Design with light.™

T: +1 (800) 437-6360

F: +1 (718) 729-2941

W: [mechosystems.com](http://mechosystems.com)

[media@mechosystems.com](mailto:media@mechosystems.com)

Design architect: William McDonough

+ Partners, architect of record: AECOM



# CONTINUING EDUCATION



*In this section, you'll find five compelling courses highlighting creative solutions for tomorrow's buildings—brought to you by industry leaders.*

*Read the courses and then go to our online Continuing Education Center to take the tests free of charge to earn AIA/CES credits at: ARCHRECORD.COM.*

Photo © Pilkington

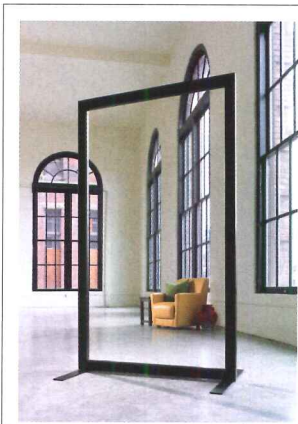

## Fire-Rated Glass & Framing Deliver Design Goals

SPONSORED BY: **Technical Glass Products (TGP)**

Aesthetic advances in fire-rated glazing help design professionals meet visual and life-safety design objectives. This course explores the latest solutions for commercial and institutional projects.

Credit: 1.00 HSW



Photo courtesy of Technical Glass Products **PAGE 183**



## Nature & Nurture

SPONSORED BY: **NanaWall Systems Inc.**

The sustainable benefits of all-glass operable double-wall systems include energy savings and access to nature. Discover how to meet high-performance values without sacrificing design goals for a “transparent building.”

Credit: 1.00 HSW/SD



Photo courtesy of NanaWall Systems Inc. **PAGE 189**

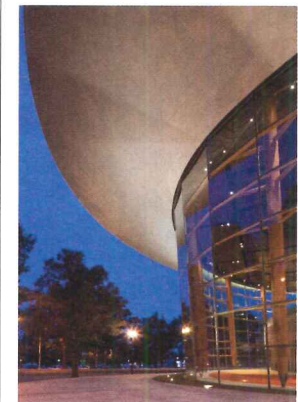

## Materials in Action

SPONSORED BY: **U.S. WoodWorks & Forestry Innovation Investment**

Wood, concrete, and steel each has its own unique environmental impact. This course addresses these differences in terms of basic properties, performance and end-of-life issues.

Credit: 1.00 HSW/SD



naturally:wood

Photo by Nic Lehoux  
courtesy of Bing Thom Architects

**PAGE 195**



## Cool Roofs for Hot Projects

SPONSORED BY: **Cool Roof Rating Council**

Innovative technologies are pushing the building envelope with cool roofs. Learn how designing with cool roofs can help save energy, address global warming and meet code.

Credit: 1.00 HSW/SD



Photo by Sam Fentress, courtesy of HOK

**PAGE 201**



## Room for Luxury and Energy Efficiency: Hospitality Goes Green

SPONSORED BY: **Henry Company, Modernus Doors + Office and THE SLIDING DOOR COMPANY®**

Hospitality goes green. This course examines how smaller footprints, energy consciousness, healthy interiors and flexible room configurations provide sustainable solutions for greening the hospitality industry.

Credit: 1.00 HSW/SD



Photo courtesy of Modernus

**PAGE 205**

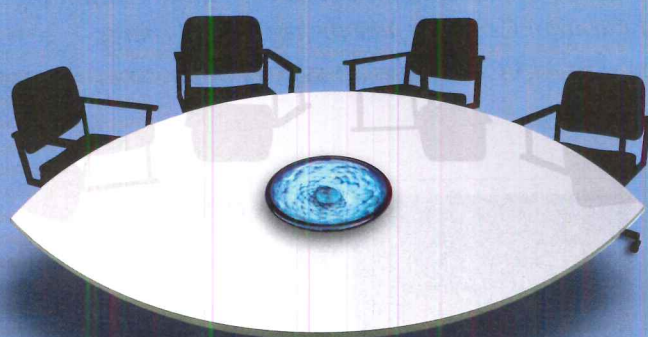

Come see.

2011

# NeoCon®

m | t | w

**June 13-15**

The Merchandise Mart  
Chicago

Pre-Register by June 11th & Save | Onsite Registration is \$25

neocon.com



PRODUCED BY M

CIRCLE 84



# FIRE-RATED GLASS AND FRAMING DELIVER DESIGN GOALS

Photo courtesy of Technical Glass Products



*New technologies deliver fire-rated ceramic glass with high clarity and smoothness.\**

## CONTINUING EDUCATION

EARN ONE AIA/CES HSW LEARNING UNIT



Use the learning objectives below to focus your study as you read **Fire-Rated Glass and Framing Deliver Design Goals**. To earn one AIA/CES Learning Unit, including one hour of health safety welfare credit, answer the questions on page 187, then follow the reporting instructions or go to [ce.architecturalrecord.com](http://ce.architecturalrecord.com) and follow the reporting instructions.

### Learning Objectives

After reading this article, you should be able to:

- Describe the ways fire-rated glazing can be used to support aesthetic goals similar to traditional window glass
- Discuss the range of product make-up options and visual treatments available with fire-rated glazing
- List examples of fire-rated glazing materials and their primary performance features
- Differentiate between appropriate applications for fire-protective and fire-resistive glazing

*Aesthetic advances in fire-rated glazing help design professionals meet both visual and life-safety design objectives.*

**Sponsored by  
Technical Glass Products (TGP)**

*By Karin Tetlow*

*\*Note: This frame was set at an angle to the natural light source to avoid capturing the reflection of the photographer, camera and equipment.*

Since the third century when the Romans began installing window glass in their most important buildings, glass technologies have evolved dramatically. A far change from that imperial novelty—it was thick and translucent and did not permit people to see out—today’s fire-rated glass and framing units not only comply with increasingly stringent life-safety code requirements, they also meet aesthetic goals for commercial and institutional projects that were hardly possible a decade or so ago.

One big change has been improvements in ceramic glass. Such materials can earn fire-ratings and be produced in transparent sheets that look like ordinary window glass. (See Sidebar “Why Ceramic Glass is Different.”) In earlier processing methods, the glass surface could become slightly distorted when it was drawn out between rollers. It also frequently had an earth tone tint compared with the blue-green tint of float glass. New manufacturing techniques have improved the color, clarity and surface quality of fire-rated ceramic glass. The result is that architects now have numerous options to meet virtually limitless design goals and are delivering wide-open light-filled spaces in a multitude of applications.

The level of fire protection required by codes differs depending on the specific glazing application, and in some cases, by building occupancy. In 2006, the International Code Council (ICC) adopted revisions to the fire-

rated glazing requirements of the International Building Code (IBC) that had a substantial effect on the types of materials suited for life and property safety. As more jurisdictions adopt the revised code—including populous states such as New York (August 1, 2007) and California (January 1, 2008)—design professionals increasingly need to be aware of changes and become familiar with fire-rated glazing systems that will meet both those requirements and achieve aesthetic design goals.

The first step is to understand fire-rating terminology, such as “hose stream test,” “impact safety” and “positive pressure.” But most important is appreciation of the distinction between “fire protection” and the more rigorous “fire resistance,” which will drive each choice of a fire-rated glazing product. (See below.)

#### FIRE-RATING TESTS AND TERMINOLOGY

Design professionals should check manufacturers’ product literature for fire-ratings. Common phrases in the fire-rated glazing field include:

#### Why Ceramic Glass is Different

Manufacturers produce ordinary float glass by heating a mixture of sand and modifiers until it melts; they then cool it quickly to become glass. It is named “float” glass because it is made by floating molten glass on a bed of molten metal. Because of the rapid cooling, the particles in the liquid state can’t return to their original crystalline arrangements. Instead, they settle randomly. The result is that glass is known as an amorphous (literally “without shape”) material. Amorphous glass is brittle because atoms cannot slip past each other to relieve stress from a surface flaw or crack.

Ceramic glass is manufactured by overheating glass so that its amorphous structure is transformed into a fine-grained crystalline arrangement. This crystalline material prevents cracks and can hold together under high heat. Glass-ceramics are at least 50

percent crystalline after they have been heated. In some cases, the final product is more than 95 percent crystalline.

While ordinary glass has the desired features of low color, high clarity, a smooth surface and ability to be manufactured in large sizes and shapes, it fails building codes that call for fire-rated glazing. It shatters at approximately 250 °F (tempered glass also cracks at relatively low temperature, about 500 °F)—well below temperatures of many fires—shatters on impact, transfers heat and will not block a fire’s spread.

Ceramic glass, however, has the hardness and fire protection of ceramics plus the close appearance of floatglass. Fire-rated glass can remain intact up to 1600 °F or hotter for varying periods depending on the specific product.

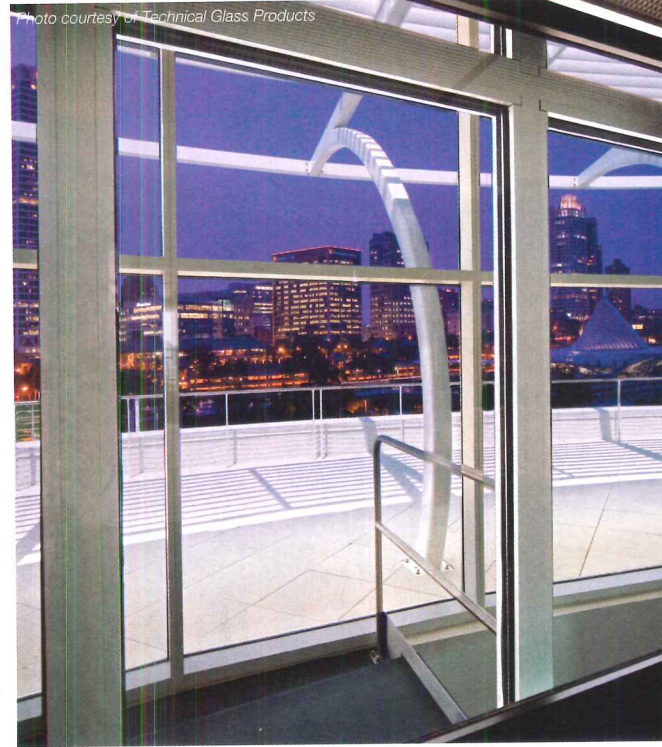

*Fire-rated, impact-safety rated transparent wall panels provide attractive glazing in highly visible locations.*

**Fire Protection Rating.** The designation indicating the duration of the fire test exposure to which a fire door assembly or fire window assembly was exposed and for which it successfully met all acceptance criteria as determined in accordance with test standards such as NFPA 252 / NFPA 257 / UL 9 / UL 10C.

**Fire-resistance rating or heat barrier rating.** Fire resistance is a more rigorous rating than fire protection and is generally required for wall assemblies such as transparent wall panels. Also known as a heat barrier, it is expressed as a unit of time, generally in minutes or hours, that materials or assemblies have withstood a fire exposure as established in accordance with the test procedures such as NFPA 251 / ASTM E-119 / UL 263. This rating tests a product’s ability to block the transfer of conductive and radiant heat from a fire.

**Fire ratings.** Fire-rated glazing is typically rated from 20 minutes to 3 hours. The rating reflects the amount of time the material is anticipated to remain in place to help stop the spread of fire and smoke. Fire ratings are determined by a series of tests conducted by independent testing facilities, such as

Underwriters Laboratories (UL.) The lab installs samples of the glass and framing in a wall assembly. This assembly is then subjected to specified test standards that include two required elements: a “fire test” and a “hose stream test.”

**Fire test.** In the fire test, the glass and framing assembly is heated in a furnace following a specified time-temperature curve. After five minutes, the temperature reaches 1,000 °F and increases to 1850 °F at 120 minutes. To earn a rating, the standard generally requires that: 1. the window or door assembly must not separate from the wall in which it was installed for the duration of the test; 2. flames cannot appear on the unexposed surface of the assembly; 3. the glazing material edges must not separate from the glazing frame; and 4. no openings shall occur in the door or window assembly.

**Hose stream test.** The fire hose stream test shows how hot glass will react when hit by water from a fire hose, or perhaps from just a sprinkler. If nearby sprinklers activate during a fire, the “shocked” glass could shatter and vacate the frame within only a few minutes, thus allowing the spread of deadly flames and smoke.

Within two minutes of completion of the fire test, the hot glass and framing is subjected to a hose stream test. The purpose of this test is to evaluate the integrity and overall reliability of the glazing unit.

In the United States, the hose stream test is required for all fire ratings of 45 minutes or greater. Canada requires the test for all fire ratings. The hose stream test is an integral part of many fire testing standards such as ASTM E 119.

**Impact safety.** Fire-rated glass in hazardous locations where it is susceptible to impact and breakage, such as doors, sidelites and windows near the floor must meet the Consumer Product Safety Commission (CPSC) *Safety Standard for Architectural Glazing Materials*, a federal standard (U.S. Code of Federal Regulations, Title 16, Part 1201) and ANSI Z97.1, which establishes voluntary tests for safety glazing materials. CPSC Category II is the highest level of required impact safety where glazing material must successfully pass an impact from a 400 lb weight dropped from a height of 48 in. Category II materials can safely withstand an impact similar to that of a fast-moving adult. Glazing material passing the 18-inch drop height, a 150 foot-pounds impact, is classified as “Category I” glass.

**Positive pressure.** Positive pressure test standards such as UL 10C, UBC 7-2 and

### Providing Fire and Life Safety While Preserving Historic Beauty

Recognizing the need to modernize New York City’s Brooklyn Engine Company 239 fire station, the city’s Department of Design and Construction hired Beyhan Karahan & Associates of SoHo, New York City, to renovate the 1895 building while preserving its historic character. The brief included restoring and upgrading the apparatus room for fire engines, dormitory, kitchen and lounge area, as well as refreshing the building’s detailed exterior.

One challenge was how to provide adequate fire and life safety protection between

the main staircase and the apparatus area, as well as between the main staircase and the upper floors where the firefighters live. The architects wanted to keep the main staircase open as in the original house, yet needed to meet strict fire and life safety codes. They also wanted to maintain visibility around each of the building’s fire poles, while providing a barrier against falls and protection against fire.

The architects’ solution was to specify a UL-listed glazing system that is fire-rated for up to two hours and meets the impact safety requirements of CPSC 16CFR1201

Category I and II. Not only does the system block the spread of fire and smoke, as well as protect against the transfer of radiant and conductive heat—essential to protecting firefighters and sensitive equipment in the firehouse—it is also an excellent alternative to solid walls. The transparent wall panels bring in large amounts of light, which helped the architects re-create the open environment found in the station’s original staircase design. The panels also allow for clear sightlines from inside the staircase and fire pole enclosures to the ground.



Photos courtesy of Pilkington®

UBC 7-4 simulate real fire conditions. As heat develops within the source area, pressure within an enclosed room can build relative to the pressure outside the room. The pressure tends to increase until the availability of oxygen relative to fuel causes the fire to reach equilibrium. For materials that fail the test, smoke and hot gases and flames might be forced through openings in the door or window assembly.

**Transparent wall panels.** Transparent wall panels are tested and classified as walls even though they are made of glass. They are tested to ASTM E119 *Standard Test Methods for Fire Tests of Building Construction Methods* and UL 263 *Fire Resistance Ratings*, among others. They carry fire ratings up to 120 minutes, are able to pass the fire and hose stream tests, block significant amounts of heat and offer up to Category II impact safety ratings. For police stations and other at-risk buildings, specifiers can select from glass panels with Level III bullet-resistance ratings.

## TYPES OF FIRE-RATED GLASS

Two main types of fire-rated glass currently on the market are fire-rated ceramic glass and transparent wall panels. A third type of fire-rated glass is wired glass that was used for years in institutional and commercial buildings to help hold glass together under high heat. It



*This school has a mix of different fire-rated ceramic glazing units.*

offered fire protection, but upon impact its wires could snag and cause injury. The 2006 code revisions specifically eliminate the use of traditional polished wired glass in hazardous locations where it is susceptible to impact and breakage, such as doors, sidelites and windows near the floor, in all types of buildings. Wired glass is now often used where budgets do not support higher performance and more aesthetic materials.

where viewers may come in close proximity to the glass. Design benefits of new fire rated ceramic glass include:

- High visible light transmission (VLT) of approximately 88 percent
- Low reflectivity of about nine percent
- May be lightly sand-blasted or etched on one side without affecting fire-rating
- Offered in translucent patterned surfaces for privacy
- Reduced visible color
- Available in large sizes generally up to 3-ft. x 8-ft
- Available in a thin profile, typically 3/16-in., weighs approximately 2.4 lb/sq in. (depending on product make-up)
- Can fit in a standard size fire-rated frame
- Surface condition similar to ordinary glass
- Fire ratings from 20 minutes to 3 hours.

Specific product capabilities may vary depending on the make-up and brand. Check with the manufacturer for details.

➤ **Continues at [ce.architecturalrecord.com](http://ce.architecturalrecord.com)**

See Quiz on the Next Page or  
Take the Quiz Free Online



*Photo courtesy of Technical Glass Products*

*Depending on the product, fire-rated glazing can be etched on one side without affecting its fire-rating.*

**Fire-rated ceramic glass.** This type of fire-rated glass carries fire protection ratings and protects against flames and smoke. But because ceramic glass transfers radiant and conductive heat, it should not be specified for installations where codes require a fire resistant or 'barrier to heat' rating. Fire-rated ceramic glass is, however, available in different products and product make-ups that meet many code requirements. For design professionals, modern fire-rated ceramic glass offers a number of aesthetic advantages. Since large glazed areas with no noticeable coloring and surface imperfections are now possible, it can be used in many more projects, especially

To receive AIA/CES credit, you are required to read the entire article and pass the test. Go to [ce.architecturalrecord.com](http://ce.architecturalrecord.com) for complete text and to take the test. The quiz questions below include information from this online reading.

Program title: “Fire-Rated Glass and Framing Deliver Design Goals” (05/11, page 183). AIA/CES Credit: This article will earn you one AIA/CES LU hour of health, safety and welfare (HSW) credit. (Valid for credit through May 2013). **Directions:** Refer to the Learning Objectives for this program. Select one answer for each question in the exam and fill in the box by the appropriate letter. A minimum score of 80% is required to earn credit. **To take this test online and avoid handling charge, go to [ce.architecturalrecord.com](http://ce.architecturalrecord.com)**

1. **Fire-rated ceramic glass has the following characteristics:**
  - a. Remains intact up to 1600 °F or hotter
  - b. Is amorphous because atoms cannot slip past each other
  - c. Blocks the transfer of heat
  - d. Has identical crystalline structure as ordinary glass
2. **Fire-resistance rating:**
  - a. tests a product's ability to block the transfer of conductive and radiant heat from a fire.
  - b. is expressed as a unit of time, generally in minutes or hours.
  - c. is generally required for wall assemblies such as transparent wall panels.
  - d. All of the above
3. **In the United States, the hose stream test is required for all fire ratings of 45 minutes or greater.**
  - a. True
  - b. False
4. **The typical upper-end rating for currently available fire-rated glazing is:**
  - a. one hour.
  - b. three hours.
  - c. three hours only if it passes an impact test.
  - d. three hours only if it blocks the transfer of heat during a fire.
5. **The 2006 revisions to fire-rated glazing requirements of the International Building Code (IBC):**
  - a. eliminate the use of traditional polished wired glass in hazardous locations.
  - b. permit the use of wired glass in all locations requiring a fire rating.
  - c. eliminate the use of ceramic glass in hazardous locations.
  - d. eliminate the use of traditional polished wired glass in all applications.
6. **A characteristic of fire-rated ceramic glass is it:**
  - a. cannot be specified in insulated glass units (IGUs).
  - b. is available in large sizes and thin profiles.
  - c. can be etched on both sides.
  - d. can be specified where codes require a heat barrier.
7. **Fire-rated insulated glass units (IGUs) are made up of:**
  - a. ceramic glass panels.
  - b. ceramic glass panels with translucent insulating material.
  - c. ordinary float glass with a dead air space.
  - d. ceramic glass, tempered float glass or annealed float glass and a dead air space.
8. **Unlike fire-rated ceramic glass, transparent wall panels:**
  - a. have air spaces that stay cool when exposed to heat.
  - b. defend against radiant and conductive heat.
  - c. cannot be used in door applications.
  - d. cannot be used in stairwells and elevator shafts.
9. **What fire-rated products may be suitable for doors in a hazardous location?**
  - a. Ceramic glazing with a surface-applied approved fire-rated film
  - b. Laminated fire-rated glazing that is rated for impact safety
  - c. Transparent wall panel that is impact safety-rated and tested as a heat barrier
  - d. All of the above.
10. **Fire-rated glazing framing materials should:**
  - a. carry a fire-rating at least half that of the glazing.
  - b. never be constructed from wood.
  - c. carry a fire rating at least equal to that of the glazing.
  - d. always be specified in aluminum or steel.

Last Name	First Name	
Job Title		
Firm Name		
Address		
City	State	Zip
Tel.	Fax	
E-mail		
AIA ID Number	Completion date (M/D/Y)	
Check one: <input type="checkbox"/> \$10 Payment enclosed. (Make check payable to McGraw-Hill Construction and mail to: Continuing Education Certificate, PO Box 5753, Harlan, IA 51593-1253.)		
Charge <input type="checkbox"/> Visa <input type="checkbox"/> Mastercard <input type="checkbox"/> American Express		
Card#		
Signature	Exp. Date	

To register for AIA/CES credits: Answer the test questions and send the completed form with questions answered to address at left, or fax to 888/385-1428.

For certificate of completion: As required by certain states, answer test questions, fill out form, and mail to address at left, or fax to 888/385-1428. Your test will be scored. Those who pass with a score of 80% or higher will receive a certificate of completion.

Material resources used: This article addresses issues concerning health, safety and welfare.

I hereby certify that the above information is true and accurate to the best of my knowledge and that I have complied with the AIA Continuing Education Guidelines for the reported period.

Signature \_\_\_\_\_ Date \_\_\_\_\_

K1105B

For McGraw-Hill Construction customer service, call 877/876-8093.



Technical Glass Products (TGP) is the recognized leader in the fire-rated glass and framing field, offering the FireLite® family of ceramic glazing, Pilkington Pyrostop® transparent wall panels, and Fireframes® fire-rated framing. The company provides AIA-registered continuing education, project consultation, product specifications, CAD drawings and rapid-response quoting. [www.fireglass.com](http://www.fireglass.com)

# The Leader in Opening Glass Walls

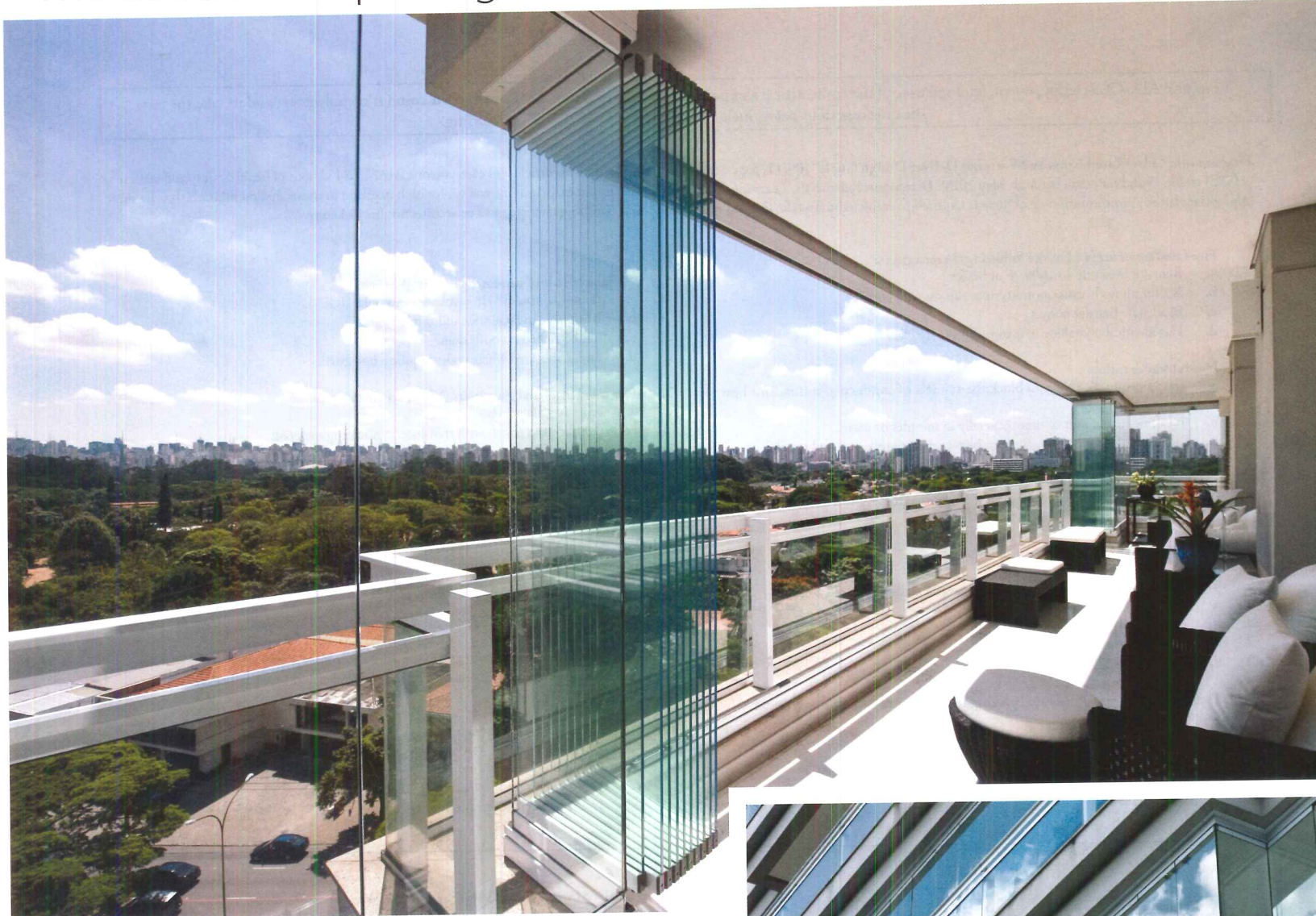

NanaGlass SL25 Operable Glass Wall System

## NanaGlass SL25:

- Transforms balconies into year-round usable living spaces
- Improves building aesthetic
- Preserves and modernizes building facades
- Increases overall energy efficiency
- Reduces urban noise pollution within each unit

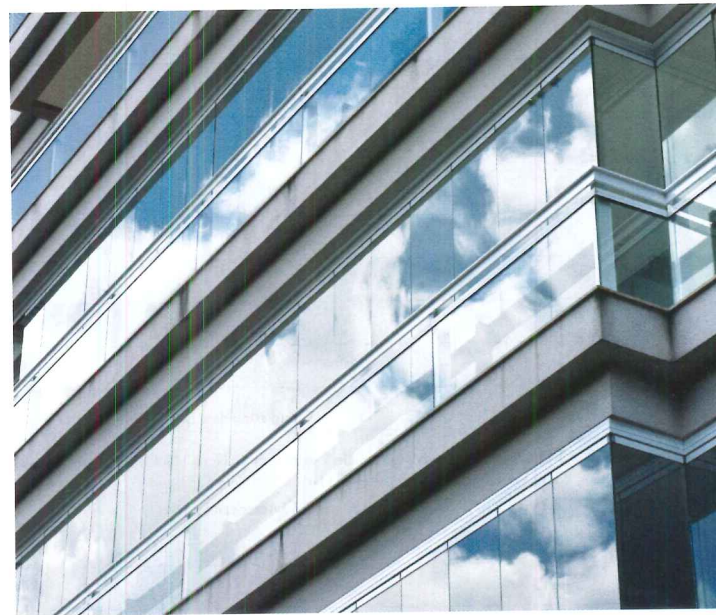

## Operable All-Glass Balcony Glazing System

With over a half million SL25 panels installed worldwide, rely on NanaWall's experience and custom-tailored solutions for your multi-level building project.



Showrooms Nationwide 888 868 6643 [nanawall.com](http://nanawall.com)

**NanaWall**<sup>®</sup>  
Grand Transformations  
CIRCLE 80

# NATURE & NURTURE:

## THE SUSTAINABLE BENEFITS OF ALL-GLASS OPERABLE DOUBLE-WALL SYSTEMS

### CONTINUING EDUCATION

EARN ONE AIA/CES HSW/SD LEARNING UNIT



Use the learning objectives below to focus your study as you read

**Nature and Nurture: The Sustainable Benefits of All-Glass Operable Double-Wall Systems.** To earn one AIA/CES Learning Unit, including one hour of health safety welfare and sustainable design credit, answer the questions on page 193, then follow the reporting instructions or go to [ce.architecturalrecord.com](http://ce.architecturalrecord.com) and follow the reporting instructions.

### Learning Objectives

After reading this article, you should be able to:

- Discuss how glass operable wall systems can be integrated into passive sustainable design strategies in new and old buildings
- Discuss the energy-saving benefits of all-glass operable wall systems
- Identify the components of all-glass operable wall systems used as double-skin façades
- Explain the relationship between buildings and human comfort based on access to nature and biophilic design principles

*Activated by users, passive operable double-wall systems and balcony retrofits provide energy savings and access to nature.*

Sponsored by NanaWall Systems Inc.

*By Celeste Allen Novak AIA, LEED AP*



*This light-filled, transparent office building at Nijverdal in the Netherlands uses all-glass operable wall systems and is a demonstration of climate-neutral design.*

**Architect Wolfgang Herich compares the design of his new office building in the Dutch town of Nijverdal to a sailing ship.**

Powered by the elements, this 27,000 sf three-story office, gallery and showroom can be actively controlled by its users. Completed in 2010, the designers and engineers targeted a goal of a climate-neutral sustainable building that uses less technology and more physics. By using an all-glass operable wall system, they created an intelligent, user-controlled building envelope that reduced energy consumption while increasing human comfort. According to Fred Mak, managing director, Solarlux, the Netherlands, “For us, sustainability is not an abstract term, it is something which is lived and breathed by our employees on a daily basis. In this building the focus is on the individual as the active party in a passive building.”

The architecture faculty at TU Delft University Façade Research Group, The Institute for Applied Energy, is monitoring this office building and Flow Simulation as well as the Ifes Institute in Frechen, Germany, as part of a large research project. Over the next three years, technical data on the ventilation, temperature daylighting and the reduction of CO<sub>2</sub> will be recorded to verify environmental performance. This project is an example of a new kind of passive solar all-glass operable double-skin façade. Through the integrated design of its building components and user education, this climate-neutral building has already reported as much as an 80 percent carbon reduction in carbon emissions when compared with other buildings of its size, occupancy and location. In addition to reducing CO<sub>2</sub> emissions, the use of this system as part of an integrated design strategy also reduced energy consumption, as well as increased the amount of fresh air providing natural ventilation.



*Photo courtesy of NanaWall Systems Inc.*

*To revitalize this building facade and capture more year round usable space, an all-glass operable wall system was installed behind the guardrail.*

Herich was inspired by the early modernist work of architect Jan Duiker in the initial design stages for this administration building. Duiker’s 1927 design for the First Open Air School for the Healthy Child was a forerunner for 21st century studies on the beneficial effects of daylight on learning. Duiker’s building and subsequent all-glass buildings promised that access to nature led to increased vitality, energy and health of building occupants. Biophilia is the distinctive bond that philosophers like E.O. Wilson and Erich Fromm believe humans have to nature. This concept has influenced

architects from the organic architecture of Frank Lloyd Wright to the biometrics of Dennis Dollens. The relationship between human comfort and the design of natural ventilation, orientation to views and daylight harvesting are components of most sustainable design metrics. The dilemma faced by most architects who are enamored of transparent buildings is that these glass structures may fail the high performance values necessary to reduce energy consumption.

According to studies by the Environmental Protection Agency (EPA), the building sector is responsible for 49 percent of all energy consumption and 47 percent of greenhouse gas emissions. Designers and engineers of buildings are both the source and the solution to the problems associated with climate change and the economics of scarce natural resources. The EPA estimates that between 2010 and 2030, building sector energy consumption will increase by 7.16 quadrillion Btus (QBtu). The EPA estimates that one QBtu is equal to the delivered energy of thirty-seven 1000-MW nuclear power plants or 235 coal-fired power plants at 200-MW each.<sup>1</sup> The American Institute of Architects (AIA), the Mayor’s Institute for Climate Change and Architecture 2030 are leading the call for the reduction of fossil fuels in buildings in the next twenty years. According to the 2030 Blueprint, a report written in 2008 by architect and founder of Architecture 2030, Ed Mazria, AIA, and co-author Kristina Kershner, design professionals need to reduce their use of fossil fuels by half. One strategy is to design more energy-efficient buildings.

Many high-performance building strategies encourage and sometimes require the reduction of the amount of glass in a building envelope. For example, the new American

### The 2030 Challenge

In January of 2006, Architecture 2030 officially issued the “2030 Challenge,” as an achievable strategy to dramatically reduce global greenhouse gas emissions and fossil-fuel consumption in the building sector by the year 2030.

Specifically, the Challenge calls for:

- All new buildings and developments to be designed to use half the fossil fuel

energy they would typically consume, i.e., half the regional or country average for that building type,

- At a minimum, an equal amount of existing building area to be renovated annually to use half the amount of fossil fuel energy they are currently consuming
- The fossil fuel reduction standard for all new buildings to be increased to 60

percent in 2010, 70 percent in 2015, 80 percent in 2020, 90 percent in 2025 and carbon neutral by 2030 (using no fossil fuel greenhouse gas emitting energy)

Architecture 2030 recommends that the fossil fuel reduction targets be achieved through design, the application of renewable energy technologies and/or the purchase of renewable energy (20 percent maximum).<sup>2</sup>



Society of Heating and Air-Conditioning Engineers (ASHRAE) 189.1, Standard for the Design of High-Performance, Green Buildings Except Low-Rise Residential Buildings, has been developed with the assistance of the U.S. Green Building Council (USGBC), the Illuminating Engineering Society (IES) and the American Institute of Architects as a basis for municipal codes in the United States. Prescriptive requirements are listed as well as guidelines and requirements for the building envelope that limit the amount of fenestration depending on climate and integrated design strategies.

This article will explore all-glass operable wall systems that can meet high performance values without sacrificing design goals for a “transparent building.” The design and planning of the office building in Nijverdal as a passive building with active users will be used as an illustration of how a high-performance building can also deliver high-performance buildings that increase human comfort and add to their well being.

In addition, this article will explore renovations of existing buildings that incorporate all-glass operable wall systems. Architects have been able to capture balcony space as a new vertical gardens or conservatories. The advantages of these facelifts include energy savings that can be as much as a 60 percent reduction in energy use for heating and the ability to provide natural cooling through cross ventilation. In this article, design professionals may discover new opportunities for the exploration of those transitional inside and outside spaces. They will see how a building can be modernized by the addition of an all-glass operable wall system, a facelift that can add to the building’s aesthetics as well as to its energy efficiency.

These new rooms add year round useable spaces that often were lost during inclement weather. The new glass enclosures reduce urban noise and pollution while providing more access to nature both through views

and the option of wide openings for fresh air and ventilation. They allow the occupant the freedom to enjoy the changing seasons and to work as though they are in the “open air.” Design professionals are finding both design and economic advantages to using all-glass operable wall systems to provide greater access to the outdoors in senior housing and for homeowners. As Scott Hommas, principal of Gelotte Hommas states about their use of all-glass operable wall systems, “People here in the northwest like to be connected to the outside, and the climate allows us to do so. These glass walls allow us to maximize the connection between indoor and outdoor in a really great way.”



*All-glass walls can make the transitions between inside and outside almost seamless.*

## DESIGN FOR CLIMATE

The Nijverdal project is located in a temperate climate zone in the northeast area of the Netherlands not far from Amsterdam. Temperatures range from just below freezing in January to the high-eighties in the summer. The design parameters were set for the project as an integration of heating, cooling, and ventilation to maximize the human comfort zone. From the beginning, the architects knew that they wanted to create a modern building that expressed lightness, transparency, openness and permeability. They aimed to design a comprehensive and integrated mechanical system reducing all technical components to

a bare minimum. The three key components to this design included the regulation of the atmosphere in the building by the massing and orientation of the structure, the development of a breathing, double-skin façade and an integrated mechanical system that responded to user comfort and seasonal change.

### The Basics: Orientation and Micro-climate

One of the first rules of any passive design strategy is to design to the macro- and micro-climate of the building’s location. As described in Victor Olgyay’s classic overview of the topic, “Design with Climate,” the successful design professional must know the solar aspect of the site, wind orientation, as well as the ground and air temperature swings. The Nijverdal project was oriented to take advantage of the prevailing winds and with an understanding of how wind could be directed through the building to provide natural ventilation through the operable façade. The building is oriented to achieve maximum solar gain in the winter. The balconies act as overhead sunshades and are extended to provide the most sun exposure in the winter and the least in the summer.

The geothermal heating and cooling system was based on providing a supply temperature of a maximum of 86 °F in the winter and a minimum of 59 °F in the summer. In the winter a heat pump raises the temperature from the ground source mean as well as from the waste heat recovered from the building. This warm water is piped into the ceilings and radiant floor slabs to provide the required temperature for each zone of the building. In the summer, the cooler ground water is piped from the geothermal field to cool the mass and structure of the building. Photovoltaic roof modules generate the energy for the electric heat pump. Additional electricity is purchased from renewable energy resources as needed in order to reduce the carbon footprint of this office building.

## DOUBLE SKINS AND DESIGN FOR FRESH AIR AND NATURAL VENTILATION

The skin is the largest organ in the human body. The skin protects humans from cold and heat, providing both a barrier and a transmitter of elements that make us well and comfortable. The building envelope is also a skin that encases an engineered indoor environment providing a thermal barrier from climate. The trend toward using a second skin in buildings has been driven by design aesthetics for transparent buildings, the improvement in acoustic properties of windows in urban settings, the reduction of energy loss from low U-Value portions of the façade and a desire to provide windows that open for cross ventilation and fresh air. An active double-skin façade was used at Nijverdal to create the opportunity for occupants to feel as though they were working outdoors for many days of the year.

Most double-skin systems are designed to separate the inside climate from the outside. Few have the flexibility to allow for a seamless transition between the inside to the outside. At Nijverdal, users can decide to open the windows to fresh air and breezes and are given generous views of the changing seasons and changes throughout the day of the variety of cloud and weather patterns. Studies have shown that rather than distracting occupants, views of the changing face of nature increases concentration and focus by the occupants of a building. The mind when engaged with a mental task can lose focus and become tired without stimuli. In 2001, an article in the *Journal of Environmental Psychology* described a study of inner city children and found that concentration, impulse inhibition, and delay of gratification, all forms of self-discipline “drew on a resource that was renewed by contact with nature and allowed for the capacity for deliberate or self-directed attention.

According to researchers, “The mechanism underlying directed attention appears to behave like a mental muscle. With prolonged or intense use, the capacity to deliberately direct attention becomes fatigued and performance declines (Cohen & Spacapan, 1978; Glosser & Goodglass, 1990). In *Attention Restoration Theory*, S. Kaplan proposed that stimuli that draw primarily on involuntary attention give directed attention a chance to rest. Further, he

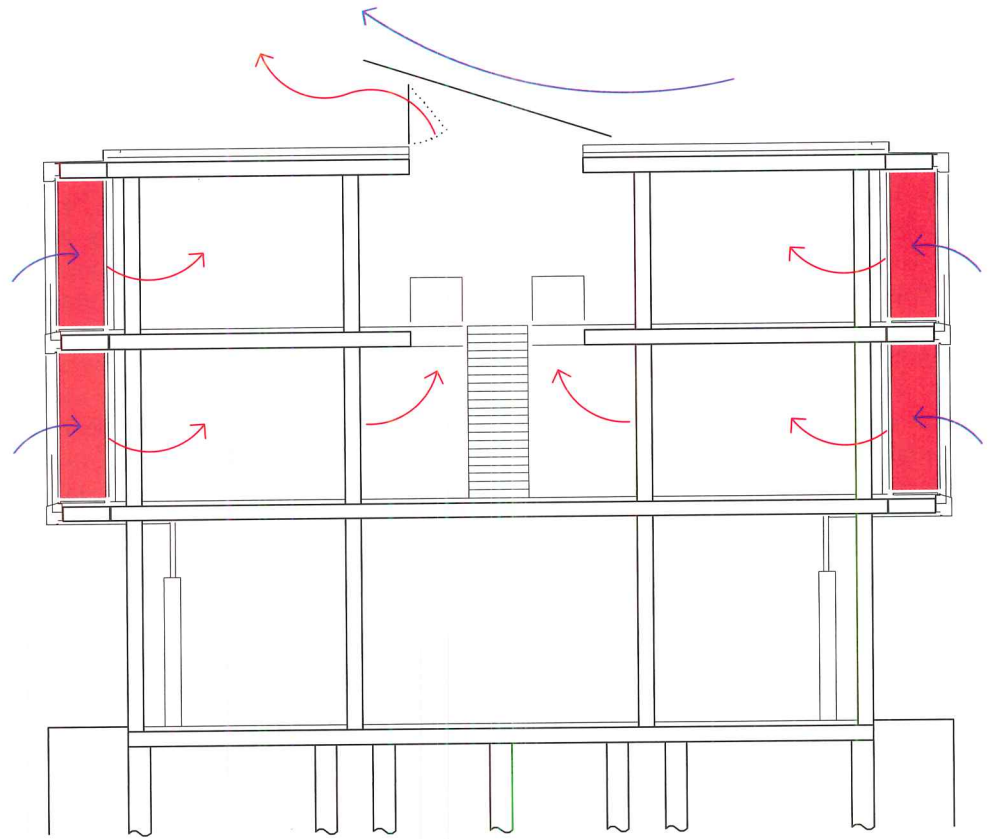

Ventilation strategy for all-glass operable wall system.

Courtesy of NanaWall Systems Inc.

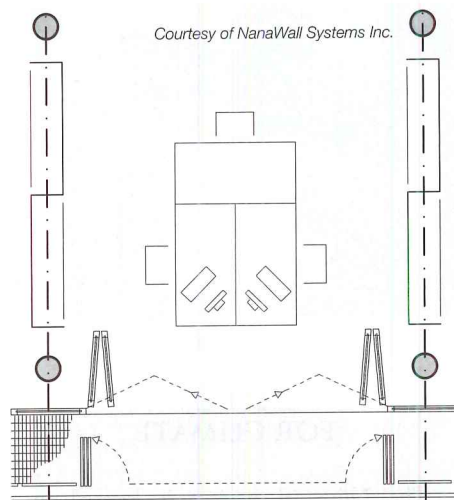

Users can open all of the sliding doors on summer days to maximize fresh air and views.

noted that natural settings and views appear to draw on involuntary attention; consequently, contact with nature should assist in recovery from the fatigue of directed attention.”<sup>3</sup>

In the summer, with limited airflow, heat and humidity rise within a building. Just opening a window will not create the airflow necessary to cool a typical office. The all-glass operable system used at Nijverdal involved the placement of two sets of operable walls that can be opened or closed by individual users. The

engineers at Nijverdal massed the structure to manipulate the air pressure by creating both the operable façade as well as designing part of the roof as an airfoil. The open plan of the building allows for easy airflow throughout the structure from wall to wall.

Individual users can open either one or both operable window walls to provide direct ventilation. Atrium roofs pitched against the direction of the prevailing winds are fitted with mechanically controlled ventilation windows. Like a wing of an airplane, wind passing over the roof creates negative air pressure drawing air from the building while fresh air flows in through the operable openings. The stack effect caused by temperature differentials in the building causes the air to rise toward the louvers. Air quality is measured using weather data and CO<sub>2</sub> sensors. Used air is extracted through controls in the ventilation louvers in the atrium roofs. The corridors that are created between the two glass facades provide solar gain in the winter, and a buffer and solar shade in the summer.

Continues at [ce.architecturalrecord.com](http://ce.architecturalrecord.com)

See Quiz on Next Page or  
Take the Quiz Free Online

To receive AIA/CES credit, you are required to read the entire article and pass the test. Go to [ce.architecturalrecord.com](http://ce.architecturalrecord.com) for complete text and to take the test. The quiz questions below include information from this online reading.

Program title: "Nature and Nurture: The Sustainable Benefits of All-Glass Operable Double-Wall Systems" (05/11, page 189). AIA/CES Credit: This article will earn you one AIA/CES LU hour of health, safety, and welfare/sustainable design (HSW/SD) credit. (Valid for credit through May 2013). **Directions:** Refer to the Learning Objectives for this program. Select one answer for each question in the exam and fill in the box by the appropriate letter. A minimum score of 80% is required to earn credit. **To take this test online and avoid handling charge, go to [ce.architecturalrecord.com](http://ce.architecturalrecord.com)**

1. **The all-glass operable wall system at Nijverdal accomplished a reduction in:**
  - a. energy use.
  - b. CO<sub>2</sub> emissions.
  - c. fresh air.
  - d. both a. and b.
  
2. **Philosophers call the distinctive bond that humans have to nature:**
  - a. biometrics.
  - b. biophilia.
  - c. bioptics.
  - d. biomimicry.
  
3. **Using all-glass operable window systems for balcony retrofits can provide:**
  - a. cross ventilation.
  - b. energy savings.
  - c. natural cooling.
  - d. all of the above.
  
4. **One of the first rules of any passive design strategy is to design to the:**
  - a. wind pressure.
  - b. solar aspect.
  - c. climate.
  - d. latitude.
  
5. **An active double-skin façade is:**
  - a. air-tight.
  - b. ventilated by integrated controls.
  - c. separated from the mechanical system.
  - d. managed at a central location.
  
6. **Enclosing existing concrete balconies with all-glass operable wall systems can reduce repair and maintenance by protecting the exposure of concrete on the balcony from moisture.**
  - a. True
  - b. False
  
7. **All-glass operable wall systems can be designed to fit any balcony because of:**
  - a. air monitors.
  - b. ENERGY STAR windows.
  - c. compensation channels.
  - d. ventilation fans.
  
8. **All-glass operable wall systems can be cleaned easily because they:**
  - a. rotate and stack.
  - b. are on top of balcony rails.
  - c. incorporate the guardrail.
  - d. are code compliant.
  
9. **All-glass operable double-skin wall systems can contain components that meet USGBC LEED® rating systems for regional materials and Forest Stewardship Council wood materials.**
  - a. True
  - b. False
  
10. **Environmental psychologists have documented that exposure to nature in building environments:**
  - a. reduces occurrence of illnesses.
  - b. hastens recovery from illness.
  - c. lowers blood pressure.
  - d. all of the above.

<b>Last Name</b>	<b>First Name</b>	
<b>Job Title</b>		
<b>Firm Name</b>		
<b>Address</b>		
<b>City</b>	<b>State</b>	<b>Zip</b>
<b>Tel.</b>	<b>Fax</b>	
<b>E-mail</b>		
<b>AIA ID Number</b>	<b>Completion date (M/D/Y)</b>	
Check one: <input type="checkbox"/> \$10 Payment enclosed. (Make check payable to McGraw-Hill Construction and mail to: Continuing Education Certificate, PO Box 5753, Harlan, IA 51593-1253.)		
Charge <input type="checkbox"/> Visa <input type="checkbox"/> Mastercard <input type="checkbox"/> American Express		
<b>Card#</b>		
<b>Signature</b>	<b>Exp. Date</b>	

To register for AIA/CES credits: Answer the test questions and send the completed form with questions answered to address at left, or fax to 888/385-1428.

For certificate of completion: As required by certain states, answer test questions, fill out form, and mail to address at left, or fax to 888/385-1428. Your test will be scored. Those who pass with a score of 80% or higher will receive a certificate of completion.

**Material resources used:** This article addresses issues concerning health, safety, welfare and sustainable design.

I hereby certify that the above information is true and accurate to the best of my knowledge and that I have complied with the AIA Continuing Education Guidelines for the reported period.

**Signature** \_\_\_\_\_ **Date** \_\_\_\_\_

For McGraw-Hill Construction customer service, call 877/876-8093.

See endnotes in online version of this course.



"The NanaWall is an operable glass wall system custom designed for large openings. The elegant, precision-engineered NanaWall meets the most challenging architectural specifications. The custom made NanaWall is available in aluminum, wood or clad frames with a selection of over two hundred colors. Independent testing confirms that many NanaWall systems meet or exceed industry standards for air infiltration, water penetration, thermal performance, forced entry, acoustic and hurricane requirements."

[www.nanawall.com](http://www.nanawall.com)



# In British Columbia, innovation really does grow on trees.

Of all the building materials you can use, nothing offers the beauty and innovation of B.C. wood. From simple structures to the strikingly complex, the design possibilities of wood are endless.

Innovation. It's built into B.C. wood and our standing as a world leader in sustainable forest management. Visit [www.naturallywood.com](http://www.naturallywood.com) and you'll see why wood is truly the renewable resource that can take your imagination — and your next project — to new heights.

## Highlights:

- Over 600 manufacturers of a wide range of structural, finishing and engineered products
- Technical expertise to answer questions on specific product information, installation inquiries and more
- Douglas-fir, western red cedar, pine beetle wood and many other species
- Case studies on sports and entertainment venues, schools and the latest innovations in wood technology
- Green building tools

Visit [www.naturallywood.com/ar](http://www.naturallywood.com/ar) for more information.

**naturally:wood**

British Columbia wood. Sustainable by nature. Innovative by design.

# MATERIALS IN ACTION

*Wood, concrete, and steel have an environmental impact on building construction, operation and end of life.*

Sponsored by U.S. WoodWorks & Forestry Innovation Investment

## CONTINUING EDUCATION

EARN ONE AIA/CES HSW/SD LEARNING UNIT



Use the learning objectives below to focus your study as you read **Materials in Action**. To earn one AIA/CES Learning Unit, including one hour of health safety welfare and sustainable design credit, answer the questions on page 199, then follow the reporting instructions or go to [ce.architecturalrecord.com](http://ce.architecturalrecord.com) and follow the reporting instructions.

### Learning Objectives

After reading this article, you should be able to:

- Evaluate the durability and versatility of wood, concrete, and steel
- Explain how current building codes permit the extended use of wood
- Articulate the importance of embodied and operating energy
- Discuss a building material's end-of-life issues

*Exterior of Arena Stage, Mead Center for American Theater, Washington, D.C.  
Hybrid wood, concrete, and steel structures are often good solutions in sustainable buildings.  
Photo by Nic Lehoux courtesy of Bing Thom Architects*



*Wood buildings have lasted for centuries.*

When an architect specifies a building material, that choice casts a long shadow. While most of the environmental effects from materials occur during the extraction and production phases, the building material influences a structure's environmental footprint well after, throughout the operations phase and beyond. What are the life cycle costs of the material? How durable is it? Is the material thermally efficient? Is it susceptible to moisture damage? Can it withstand seismic activity? What are the code considerations? Can it be recycled or reused, and at what cost to the environment? These are the kinds of questions that should be considered in the earliest project phases. The answers will determine, in part, a structure's sustainability quotient. This article will address, through research and facts, the differences between wood, steel, and concrete in terms of basic material properties as well as their performance during the building operations phase. Also discussed will be end of life issues, including the impacts of recycling versus reuse.

## DESIGN CONSIDERATIONS

Prior to specifying a material, certain issues should be thoroughly investigated.

### Durability

Good design and quality construction are important factors in a building's longevity, as is maintenance. "Any building of wood, concrete, or steel could last an indefinite period of time, provided there is proper maintenance," says Scott Lockyear, Technical Director for U.S. WoodWorks, an initiative of the Wood Products Council,

which is a cooperative venture of all the major North American wood associations as well as research organizations and government agencies. "The critical thing is moisture control. Without it, concrete will spall, wood will decay, and steel will rust."

Building materials do tend to deteriorate and fail via well-known mechanisms. Fungi are the major cause of wood deterioration when wood is exposed to constant wetting without preservative treatment or the ability to dry. However, wood is relatively resistant to high humidity

and many of the conditions and chemicals that adversely affect steel and concrete, such as corrosive salts, dilute acids and sea air. Provided its surface is protected from rust, steel can maintain its strength indefinitely. For construction steels, corrosion is the most common and expensive form of material degradation.

The most effective and common procedure for preventing or slowing corrosion is to eliminate contact with water, either by coatings or by protection within a building envelope. Steel studs and many other components are protected from water electrochemically by galvanizing, which does not eliminate contact with water. Although concrete itself does not corrode or decay, it almost inevitably cracks, and concrete cannot be used structurally without steel reinforcement. Cracking of concrete exposes concealed steel reinforcement to more moisture and corrosive chemicals which, in turn, further erodes the steel components and leads to further cracking and spalling of concrete.

Building materials can be durable but good design and consideration for future use are equally important. A study by the Athena Institute examined service lives of buildings in Minneapolis/St. Paul. The author investigated building demolition in 227 residential and non-residential buildings. Some 66 percent of non-residential wood structures were over 50 years old, while a similar percentage of concrete buildings were under 50 years old, and nearly 90 percent of steel buildings were under 50. However, the most common reasons for demolition were not related to material degradation, but to changing land values, lack of suitability for current use, and lack of

## Steps to Decades of Reliable Service

To enable wood to have a long service life, the following four factors are critical:

### Moisture control

Architects should fully understand moisture loading, including the source of water, how the water is transported, and how to control and remove it. Wood construction maintained at a moisture content of 20 percent or less will not decay. In fact, decay doesn't generally occur until the moisture content reaches 25 percent or more. Protected from water or vapor condensation, exposed to normal atmospheric conditions, wood has a moisture content that rarely exceeds 15 percent.

### Termite control

As termites thrive on water, controlling moisture goes a long way toward controlling termites. Soil and foundation barriers and bait systems can also help prevent infestation by insects.

### Use of durable materials

Wood that comes into contact with the ground or certain climates may need greater protection; naturally durable wood species, such as yellow-cedar or Douglas-fir, or pressure-treated wood may be necessary.

### Quality assurance

Where moisture and/or insects are an issue, quality control is critical in constructing building assemblies to resist negative effects, as is proper maintenance to keep the structure dry.

maintenance for non-structural components. The relative ease of expanding and modifying wood-frame structures may have contributed to their longer life.

---

“IN DEMOLITION, MATERIALS ARE NOT THE DRIVING FORCE,” SAYS LOCKYEAR. “AS A SOCIETY WE TEND TO OUTLIVE OUR BUILDINGS. WE WANT TO MODIFY THEM, ADAPT THEM TO CHANGING TASTES. THAT’S WHERE WOOD HAS A GREAT STORY TO TELL.”

---

Because of the unpredictability of future building needs, rather than trying to design structures with an infinite lifespan, experts advise that a design that lends itself to renovation or adaptation also extends a building’s life span and reduces waste.

Wood is particularly versatile and flexible, which makes it an easy construction material for renovations. For example, Arden Craig House in Vancouver, British Columbia, comprises four townhomes designed within the framework of an existing heritage home and garage. Over 90 percent of the wood in the original structure was retained in adapting the house. Salvaged materials from deconstruction of the garage were used to construct a coach house behind the main structure. Salvaged framing members were used to strengthen roof trusses and increase the space available for insulation.

### Strength

The strength of a building material refers to its ability to withstand an applied load without failure. Several types of load can be applied—tension, compression, torsion, bending, and shearing.

*Steel* is one of the strongest materials for tensile strength, the amount of stretching a material can take before breaking or failing. It is also one of the few materials that is equally strong in tension and compression. There are many different steel alloys, but they all have similar stress versus strain ratios. All steel alloys have the same modulus of elasticity, which refers to the material’s stiffness, or the ratio of the material’s allowable stress versus strain.



*Flexure test machine for testing full size panels for bending movement and stiffness*

Steel’s modulus of elasticity is 29 million pounds per square inch, compared to concrete’s 5 million and wood’s 2 million. However, every steel alloy represents a different yield strength, which is the highest force a material can take before it deforms. The most common alloy, carbon steel, or ASTM A36, has a yield strength of 36,000 pounds per square inch (psi); ASTM A441 has a yield strength of 40,000 to 50,000 psi; ASTM A572 has a yield strength of 42,000 to 65,000 psi. Building codes provide an allowable stress between 33 percent and 75 percent of steel alloy’s yield strength. The steel industry is creating new and stronger alloys. Common carbon steel, ASTM A36, for example, is slowly being replaced by ASTM A572 Grade 50, which is 77 percent stronger.

*Concrete* is one of the strongest materials for compressive strength; tremendous loads can be put on concrete without crushing it. Most concretes can handle 2,000 to 3,000 psi. The American Concrete Institute defines high-strength concrete as having a compressive strength greater than 6,000 psi, but the advent of high-strength concrete has pushed concrete’s compressive strength up to 19,000 psi. Making high-strength concrete involves optimizing the use of basic concrete ingredients. Fly ash and silica fume, commonly used admixtures, provide additional strength, as do superplasticizers which, when combined

with a water-reducing retarder, provide workability at low water-cement ratios, resulting in stronger concrete. Most often used in high-rise structures, high-strength concrete is specified where reduced weight is important, and because it carries loads more efficiently than conventional concrete, it can reduce the total amount of material needed, lowering overall building costs. On the other hand, high strength concrete may be more expensive than conventional concrete. According to the Portland Cement Association, one of the tallest concrete buildings in the United States is Chicago’s 311 South Wacker Drive, which at 969 feet, uses concrete with compressive strengths up to 12,000 psi.

However, concrete doesn’t have the same advantage when it comes to tensile strength. In building construction, rebar, or reinforcing steel bars, provides the tensile strength lacking in concrete. Concrete has a very low coefficient of thermal expansion, and as it matures, concrete shrinks. All concrete structures will crack to some extent, due to shrinkage and tension.

*Wood’s* strength is dependent on loading direction—it is strongest in tension along the fibers and weakest in radial and tangential directions. When loaded longitudinally along the grain, wood can have a strength-to-weight ratio advantage relative to steel of 2:1. However, when wood is loaded in other directions, including radial and tangential

to the grain, this advantage disappears. Wood's psi varies among species: western red cedar may have a psi of 7,500, Douglas-fir, a psi of 12,400, and mahogany, a psi of 25,400.

For decades, the wood industry has been evolving high-strength products in the form of engineered wood—plywood, oriented strand board, glulam beams, I-joists, and laminated veneer lumber, to name a few examples. Generally stronger than traditional lumber, engineered wood is also more consistent, easier to work with, and can be manufactured to precise specifications. Engineered wood is made with chips, wood waste, particles, fibers, veneers, and/or wood with defects or from small trees.

One innovative engineered wood product is cross laminated timber (CLT), a material widely used in Europe that is poised to significantly increase the possibilities for North American wood buildings. CLT is comprised of boards stacked together at right angles and glued over their entire surface, creating a product that retains its static strength and shape, and allows the transfer of loads on all sides. Besides being dimensionally stable, it can span long distances and be erected rapidly.

A 78-foot bell tower at Myers Memorial United Methodist Church in Gastonia, North Carolina, is the first non-residential structure in the U.S. to be built from CLT. The bell tower includes 70 feet of CLT over a 3-foot concrete foundation—which, because of CLT's light weight, is substantially smaller than would have been necessary to support a tower built in steel or concrete. It is made from 54 prefabricated panels of varying configurations, the largest of which is 4-feet wide, 24-feet long and just over 5-inches thick.

"The environment is something we consider for all of our projects," said Michael Devere of MDS10 Architects, who co-designed the tower. "However, with this particular client, being good stewards of the earth is part of their faith. In addition to its low carbon footprint, wood is the only major building material that's renewable. Plus, the process to manufacture CLT is energy efficient and low polluting, prefabricated panels eliminate waste, and CLT buildings are proven to maintain their ambient temperatures with less energy."



*A 78-foot bell tower at Myers Memorial United Methodist Church in Gastonia, North Carolina is the first non-residential structure in the U.S. to be built from cross laminated timber.*

▶ [Continues at ce.architecturalrecord.com](http://ce.architecturalrecord.com)

See Quiz on the Next Page

or

Take the Quiz Free Online



To receive AIA/CES credit, you are required to read the entire article and pass the test. Go to [ce.architecturalrecord.com](http://ce.architecturalrecord.com) for complete text and to take the test. The quiz questions below include information from this online reading.

Program title: **“Materials in Action” (05/11, page 195)**. AIA/CES Credit: This article will earn you one AIA/CES LU hour of health, safety, and welfare/sustainable design (HSW/SD) credit. (Valid for credit through May 2013). **Directions:** Refer to the Learning Objectives for this program. Select one answer for each question in the exam and fill in the box by the appropriate letter. A minimum score of 80% is required to earn credit. **To take this test online and avoid handling charge, go to [ce.architecturalrecord.com](http://ce.architecturalrecord.com)**

1. **What is the critical factor in building longevity?**
  - a. Building maintenance
  - b. Moisture control
  - c. Fire protection measures
  - d. Design
2. **Although concrete does not corrode or decay, it can:**
  - a. expand.
  - b. erode.
  - c. crack.
  - d. bleach out.
3. **Wood's strength is dependent on its:**
  - a. grain.
  - b. thickness.
  - c. loading direction.
  - d. age.
4. **One type of engineered wood that promises to be change how we build structures is:**
  - a. CLT.
  - b. glulam.
  - c. mid-ply.
  - d. OSB.
5. **The new IBC allows sprinklered buildings of wood-frame construction with NFPA 13 systems to contain:**
  - a. four additional stories.
  - b. 15,000 square feet of floor area.
  - c. 25,000 square feet of floor area.
  - d. one additional story.
6. **What is the moisture content of wood at which mold and decay begin to thrive?**
  - a. 19 percent
  - b. 28 percent
  - c. 50 percent
  - d. 60 percent
7. **Wood, concrete, and steel are all susceptible to mold.**
  - a. True
  - b. False
8. **One of the most earthquake-resistant building types is considered to be a:**
  - a. mid-rise concrete structure.
  - b. steel high-rise structure.
  - c. wood mid-rise structure.
  - d. wood low-rise structure.
9. **Wood's advantage on site stems from:**
  - a. its heavy weight.
  - b. its flexibility in enabling a contractor to make modifications on site
  - c. its grain.
  - d. its thermal properties.
10. **In terms of thermal properties, wood is:**
  - a. 400 times better than steel.
  - b. half as effective as steel.
  - c. 400 times better than concrete.
  - d. half as effective as concrete.

To register for AIA/CES credits: Answer the test questions and send the completed

Last Name	First Name	
Job Title		
Firm Name		
Address		
City	State	Zip
Tel.	Fax	
E-mail		
AIA ID Number	Completion date (M/D/Y)	
Check one: <input type="checkbox"/> \$10 Payment enclosed. (Make check payable to McGraw-Hill Construction and mail to: Continuing Education Certificate, PO Box 5753, Harlan, IA 51593-1253.)		
Charge <input type="checkbox"/> Visa <input type="checkbox"/> Mastercard <input type="checkbox"/> American Express		
Card#		
Signature	Exp. Date	

form with questions answered to address at left, or fax to 888/385-1428.

For certificate of completion: As required by certain states, answer test questions, fill out form, and mail to address at left, or fax to 888/385-1428. Your test will be scored. Those who pass with a score of 80% or higher will receive a certificate of completion.

Material resources used: This article addresses issues concerning health, safety, welfare and sustainable design.

I hereby certify that the above information is true and accurate to the best of my knowledge and that I have complied with the AIA Continuing Education Guidelines for the reported period.

Signature \_\_\_\_\_ Date \_\_\_\_\_

K1105C

For McGraw-Hill Construction customer service, call 877/876-8093.



WoodWorks provides education and technical support to architects and engineers on the use of wood in a wide range of building types, including commercial, institutional, educational, retail, public, recreational, and mid-rise/multi-family. WoodWorks is an initiative of the Wood Products Council, a cooperative venture of major North American wood associations.  
[www.woodworks.org](http://www.woodworks.org)

naturally:wood

An agency of the government of British Columbia, Canada, Forestry Innovation Investment is focused on promoting environmentally friendly certified wood products from British Columbia's sustainable forests.  
[www.naturallywood.com](http://www.naturallywood.com)

# Belden

## STANDARD OF COMPARISON

Belden Brick continues to meet your needs by creating new colors, sizes, textures, and special shapes. Belden Brick manufactures more than 20 different sizes of face brick and clay pavers, more than 300 colors, 10 different textures and hundreds of special shapes.

With more than 125 years of experience the Belden Brick Company has set the standard of comparison.



**BELDEN**  
THE BELDEN BRICK COMPANY

**The Standard of Comparison since 1885**

[www.beldenbrick.com](http://www.beldenbrick.com) / [info@beldenbrick.com](mailto:info@beldenbrick.com) / (330) 456-0031

An ISO 9001:2008 Registered Quality Management System

# COOL ROOFS FOR HOT PROJECTS

*Using cool roofs to save energy, address global warming, meet code, and have the coolest project on the block*

Sponsored by the Cool Roof Rating Council



*Co-written by Sherry Hao, Jessica Clark, LEED AP, Celeste Allen Novak, AIA, LEED AP, and Sarah Van Mantgem*

## CONTINUING EDUCATION

EARN ONE AIA/CES HSW/SD LEARNING UNIT

Use the learning objectives below to focus your study as you read **Cool Roofs for Hot Projects**. To earn one AIA/CES Learning Unit, including one hour of health safety welfare and sustainable design credit, go to [ce.architecturalrecord.com](http://ce.architecturalrecord.com) and follow the reporting instructions.

### Learning Objectives

After reading this article, you should be able to:

- Identify a cool roof and its energy performance benefits
- Describe resources to specify a cool roof
- Identify codes or green building programs that either require or offer credit for cool roofs
- Explain how cool roof technology is evolving



*The King Abdullah University of Science and Technology, designed by HOK, utilizes several types of cool roofing materials. The solar performance benefits of the roofing were combined with the passive cooling strategies of vernacular design for an energy-efficient building, recognized by the U.S. Green Building Council as the world's largest LEED Platinum project.*

Photo by Sam Fantress; courtesy of HOK; inset photo by JB Picoulet, courtesy of HOK

Imagine specifying a roof that is visually dynamic, yet also reduces cooling energy loads by 30 percent, combats global warming, and decreases roof maintenance costs. This miracle roof can meet all your expectations for comfort, cost and aesthetics and it is not some product from the future—it is a cool roof. Technological advancements and ecological awareness have evolved cool roof materials from the flat, white roofs of yesterday to the myriad colors, materials, and profiles of today. Because they are so versatile, cool roofs can be applied to all styles of projects, from pitched residential to flat commercial roofs. Innovative technologies are pushing the “building” envelope with cool roofs that self-clean, change color accordingly to the temperature, or are holographic, bringing countless design options to an architect’s table.

The extent of the energy benefits to be gained from cool roofing correlates to the building’s location, type and use, as well as to the specific radiative properties of the selected roofing product. Fortunately, there is a broad range of locations in which cool roofs are proving to be a viable energy efficiency measure. Simply put, cool roofs are roofing products that integrate materials with greater spectral reflectance than their traditional, non-cool counterparts, and thereby minimize the transfer of heat to the building below. This is true for a broad range of product types, colors, textures and roof slope applications.

### COOL ROOFS 101: DECIPHERING THE LANGUAGE OF COOL ROOFING

The energy performance properties of a roof can be determined by two characteristics of the surface layer: solar reflectance and thermal emittance (see diagram above). These radiative properties describe the roof’s ability to minimize the solar heat gain of a building by first reflecting incoming radiation and then by quickly re-emitting the remaining absorbed portion. As a result, the cool roof stays cooler than a traditional roof of similar construction.

When sunlight hits an opaque surface, some of the energy is reflected. The measured fraction of solar energy that is reflected by a roofing material’s surface is called solar reflectance, or albedo. Solar reflectance is measured on a scale of 0 to 1, where the

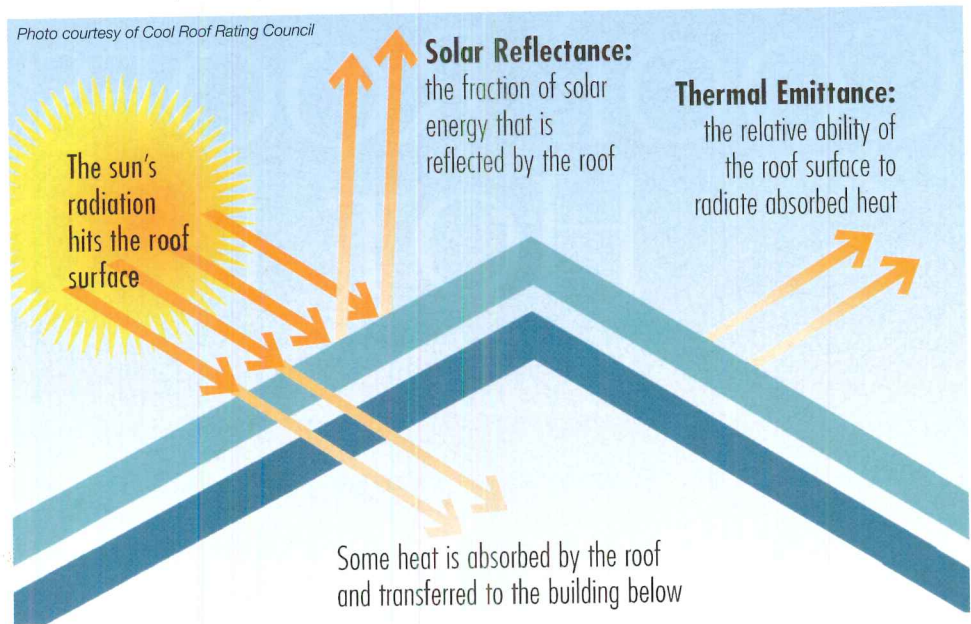

*This diagram shows how the radiative properties of a roof affect the solar radiation hitting the surface.*

higher the solar reflectance value the “cooler” the roof. High albedo, more reflective surfaces stay much cooler than low albedo, less reflective surfaces. Energy that is not reflected by the roof is potentially absorbed by it; this is where thermal emittance comes into play.

Thermal emittance is the relative ability for the roofing material to re-radiate absorbed heat as invisible infrared light (relative to a black body radiator). This absorbed heat will either be gradually or quickly re-radiated away from the roof; the quicker the better because the longer the heat is trapped at the surface of the roof the more likely it is to be transferred to the building below. Thermal emittance is also measured on a scale of 0 to 1, where a roofing material with a higher thermal emittance will re-emit absorbed thermal energy more quickly than a material with a low emittance and will result in a “cooler” roof.

Though most roofing materials have a fairly high thermal emittance, in order to accurately determine a roofing product’s “coolness,” or its ability to shield the building beneath it from heat, both solar reflectance and thermal emittance must be measured. It is possible for a roofing product to have mixed emittance and reflectance values ranging from very high to very low, although products with either a low reflectance or emittance would not typically be considered “cool” roofs. It is important to note that a high emittance value alone will not result in a “cool” roof

nor will a high reflectance value alone. The Solar Reflectance Index can be a useful tool for determining the overall thermal properties of a roofing product.

### SOLAR REFLECTANCE INDEX (SRI)

Codes, standards and programs that specify cool roofing requirements may also reference an additional calculated value, the Solar Reflectance Index (SRI). SRI allows actual measured solar reflectance and thermal emittance values to be combined into a single value by determining how hot a surface would get relative to standard black and standard white surfaces. In this manner, SRI measures a material’s ability to reject solar energy, based on a scale of 0 to 100.

The standard black roofing material has a high emittance value (90 percent) but a low reflectance value (5 percent). This creates a hot roof surface because even though the emittance is high, there isn’t enough reflectance to prevent excessive heat gain. As such, the standard black roof is given an SRI value of 0.

The standard white roofing material is highly reflective (80 percent) and has the same emittance as the standard black surface (90 percent). Its surface is much cooler and the standard white roof is assigned an SRI value of 100. It is important to note that materials

with particularly poor or good radiative properties can have a negative SRI value, or a value that exceeds 100. Like solar reflectance and thermal emittance, a higher SRI value is synonymous with a cooler roof.

**Calculating SRI**

Lawrence Berkeley National Laboratory (LBNL) hosts an easy-to-use SRI calculator on their website. All that is required is the solar reflectance and thermal emittance values and the tool will calculate the SRI. The calculator is located at [coolcolors.lbl.gov](http://coolcolors.lbl.gov).

**COOL ROOFING:  
A WIN-WIN FOR BUILDING  
OWNERS AND  
THE ENVIRONMENT**

When properly installed and maintained, cool roofs provide numerous benefits that contribute to the health of a community, to the occupants of the building and to the owner's pocket book.

Among the benefits to the building occupants and owner are:

- Improved comfort for occupants. The building's interior is subject to less thermal flux and stays cooler during the warm season.
- Energy savings from reduced cooling energy loads.
- Longer air conditioning unit life resulting from decreased use.
- Increased roof durability due to reduced thermal flux, as cool roofs can stay up to 70 °F cooler than dark roofs.<sup>1</sup>

Cool roofs are distinguished among energy conservation measures because of the many environmental benefits they can provide. A crucial benefit of cool roofs is their ability to help mitigate the urban heat island effect. The urban heat island effect is a phenomenon that is characterized by a measured increase in the ambient air temperature in cities over their surrounding rural areas. This is due to roofs and other non-reflective surfaces that absorb and trap solar radiation—or heat. Cities can be 2° to 8°F warmer than their surrounding areas because this trapped heat gradually warms the ambient air temperature throughout the day and nighttime hours warming the urban core without any opportunity for temperatures to drop at night.<sup>2</sup> Cool roofs help improve urban conditions by:

- Contributing to cooler ambient temperatures by immediately reflecting solar radiation back into the atmosphere before it can degrade to heat, as well as reemitting a portion of infrared light.
- Indirectly reducing air-conditioning use by lowering the ambient air temperatures.
- Improving grid stability and increasing peak energy savings by reducing the need for air-conditioning at the hottest times of the year.

**IMPROVING THE AIR  
WE BREATHE**

Through mitigation of the urban heat island effect with the reduction of ambient air temperatures, cool roofs also improve air

quality. Smog is created by photochemical reactions of air pollutants, and these reactions increase at higher temperatures. In Los Angeles alone, mitigation measures that reduce the average air temperature by 5 °F could yield a 12 percent reduction in smog (ozone) worth \$360 million/year.<sup>3</sup> Lower ambient air temperatures and the subsequent improved air quality also result in a reduction in heat-related and smog-related health issues, including heat stroke and asthma. In addition to the reduction of greenhouse gas emissions such as CO<sub>2</sub>, by conserving electricity for air conditioning cool roofs reduce the emission of nitrogen dioxide and sulfur dioxide particulates from power plants.

**COOL ROOFS ARE DISTINGUISHED AMONG ENERGY CONSERVATION MEASURES BECAUSE OF THE MANY ENVIRONMENTAL BENEFITS THEY CAN PROVIDE.**

**COOLING OFF THE PLANET**

A LBNL study found that world-wide reflective roofing has the potential to produce a global cooling effect equivalent to offsetting 24 gigatons of CO<sub>2</sub> over a 20 year use of the roofs. This is comparable to taking 300 million cars off the road over the same time period and equates to \$600 billion in energy savings.<sup>4</sup> The study recommends cool roofs as a geo-engineering mechanism to counteract climate change. The method by which cool roofing operates as a global cooling strategy is simple. Reflected sunlight effectively passes through the atmosphere, whereas sunlight that has been absorbed and then re-radiated from earth surfaces does not pass through easily, but is held within the atmosphere.

Continues at [ce.architecturalrecord.com](http://ce.architecturalrecord.com)

Go to [ce.architecturalrecord.com](http://ce.architecturalrecord.com) to  
Take the Quiz Free Online

See endnotes in online version of the course

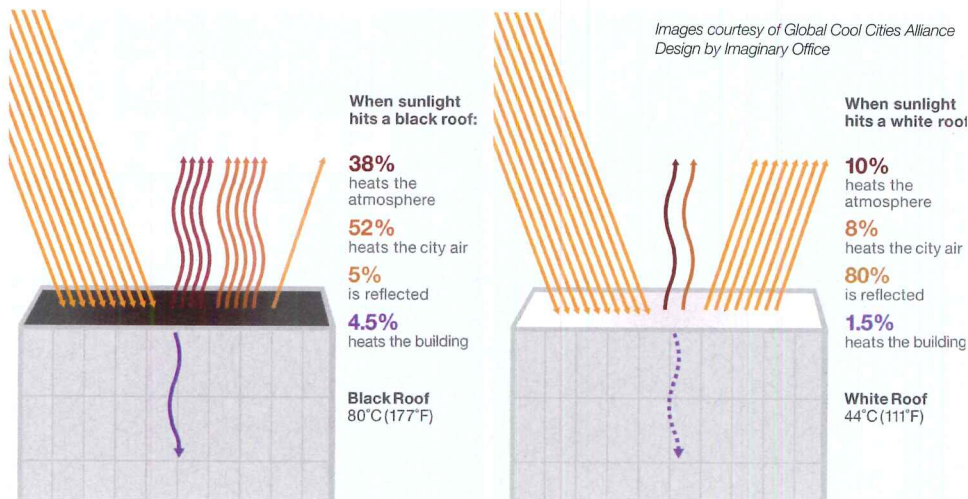

This diagram compares how solar radiation and heat are distributed on a black versus a white roof.

# Finding the Right Product Is a Must.

Wasting Time Searching For It Isn't.

Browse. Compare. Select.

**FIND IT AT**  
**SWEETS.COM**

84,000 Building Products - 80,000 Content Components  
BIM | CAD | SPECS | GREEN | 3D | CATALOGS

**McGraw Hill**  
**CONSTRUCTION**

[www.sweets.com](http://www.sweets.com)

The McGraw-Hill Companies

# ROOM FOR LUXURY AND ENERGY EFFICIENCY:

## HOSPITALITY GOES GREEN

By Celeste Allen Novak AIA, LEED AP

### Sponsored by

Henry Company

Modernus Doors + Office

THE SLIDING DOOR COMPANY.

*Smaller footprints, energy consciousness, healthy interiors and flexible room configurations provide sustainable solutions for greening the hospitality industry.*

### CONTINUING EDUCATION

EARN ONE AIA/CES HSW/SD LEARNING UNIT



Use the learning objectives below to focus your study as you read **Room for Luxury and Energy Efficiency: Hospitality Goes Green**. To earn one AIA/CES HSW/SD Learning Unit, including one hour of health safety welfare and sustainable design credit, go to [ce.architecturalrecord.com](http://ce.architecturalrecord.com) and follow the reporting instructions.

#### Learning Objectives

After reading this article, you should be able to:

- Discuss the meaning and metrics of green hospitality
- Identify the environmental advantages of air barriers that are fully adhered to the structure without mechanical fasteners
- Analyze sustainable strategies including the design of smaller spaces using sliding doors that can potentially decrease the new building's footprint
- Discuss green roofing that provides new views for hotel guests while increasing energy efficiency and longevity of the roof surface

*Flexible sliding glass walls can be used to enhance the minimalist design of a hotel lobby and allow for future renovations with the least amount of construction.*

Photo courtesy of Modernus



No dust  
No permit  
No hassle  
No limits

All of the above

[www.slidingdoorco.com](http://www.slidingdoorco.com)

ROOM DIVIDERS  
OFFICE PARTITIONS  
CLOSET DOORS  
WALL SLIDE DOORS  
SWING DOORS

LOS ANGELES  
NEW YORK  
SAN FRANCISCO  
HOUSTON  
CHICAGO

WASHINGTON D.C.  
SAN DIEGO  
LAS VEGAS  
MIAMI  
TORONTO

CIRCLE 115

 **THE  
SLIDING DOOR  
COMPANY®**

The signature choice for today's interior



**Recently, individuals booking a hotel reservation** on one of the major discount online travel services found a green leaf symbol attached to the hotel listings. This new label identifies an eco-friendly hotel to the traveler. Many hotel guests are following the links on these online sites to find out more about a hotel's or vacation spot's green practices. Eco-travelers are looking for hotels that meet sustainable initiatives, such as providing alternatives for those with chemical sensitivities, saving energy and water, or providing operable windows and healthy finishes. Even the most luxurious chains of hotel properties are greening their image to capture this market.

The Green Hotel Association has hundreds of member hotels worldwide and encourages travelers to rate their experiences. Guests are choosing to stay at facilities that promote sustainable practices extending beyond linen services. They are looking at how a hotel saves energy and conserves water. To meet this demand, hotels are rebranding themselves as vacation destinations that will provide environmental stewardship of the planet, as well as healthy places to stay. Green hotels save water and energy, favor environmentally friendly materials and reduce waste. Owners are striving to meet the triple bottom line of sustainability defined in the 1987 Brundtland report as development that meets the needs of the present without compromising the ability of future generations to meet their own needs. Sustainability proponents in the hotel industry promote the interaction of the three fundamentals of sustainable development: economics, equity and the environment. A recurring measurement in many of the major environmental checklists for hotels is the fourth "e"—educating their guests on their green initiatives.

The hotel industry is finding that being green means increased business returns both for sales and for operating costs. The American Hotel & Lodging Services Association (AH&LA) conducted a survey in 2008 and compiled responses from 217 hotels. The results showed that motivations to go green included environmental benefits that increased guest loyalty, pre-empted governmental regulations, provided financial savings, increased market share and provided new revenue opportunities.<sup>1</sup> While many travelers are looking for green hotels, hotel owners are finding cost savings in this new initiative. Driven by economics, as well



*Photo courtesy of The Sliding Door Company*

*Space-saving sliding doors allow for the reduction of overall square footage at the Ravel Hotel in New York City.*

as green branding, hotel owners are requesting energy-efficient buildings and building interiors that convey the sustainability message. Hotel chains are advertising their new environmental consciousness and achieving green ratings from organizations like the U.S. Green Building Council (USGBC). However, as Todd Schwarz, sales manager, commercial division of The Sliding Door Company notes, "Sustainability is not just a checklist of materials, healthy finishes or certified products. It is problem solving that affects design in a cost-effective manner. Often a design solution that allows for a smaller building footprint is one of the most sustainable attributes of a hotel room, even though it may not achieve a point on a green rating system."

---

**THE HOTEL INDUSTRY IS FINDING THAT BEING GREEN MEANS INCREASED BUSINESS RETURNS BOTH FOR SALES AND FOR OPERATING COSTS.**

---

This article will explore products for the exterior and interior of hotel buildings as illustrations of a few of the ways hotels are making themselves more sustainable and energy-efficient. From wrapping buildings with efficient air barriers to expanding small spaces with sliding doors, design professionals

will be provided with a snapshot of integrated design solutions that can help their clients in the hospitality industry.

The particular challenge to hotel design is that projects need solutions that can be applied across identical buildings in many different parts of the world. Exterior products that can be specified for installation and performance in any climate are cost-effective. Interior products that can be installed or removed on a three- to five-year cycle have added benefits. Durability and easy maintenance are important factors to add to the cost analysis for this market.

When it comes to interiors, the actual design of guest rooms has the largest impact for a green hotel project. In addition to paying attention to air quality and finishes, the design professional should maximize the use of space to reduce construction and associated environmental impacts. Eco-friendly hotels need to be stylish and provide a sense of luxury as well as maintaining a connection to the local environment. Designers are looking at ways to make a statement by using materials that as Matteo Baceda, principal of Modernus, states, "are functional as well as have a large visual impact like the doors in a room. User and tactile experience are important to the aesthetics and branding of a hotel room design." To meet this challenge, design professionals are using more finishes



*Green roofs save energy and also provide new views from hotel windows.*

that are natural and they pay a lot of attention to the technical specifications of the products they use. To increase air quality, they are using materials that have low VOCs or are formaldehyde-free. They are also exploring strategies to provide greater access to daylight and fresh air, such as daylight harvesting and the use of operable windows and all-glass door systems.

This article will also look at green product choices, such as sliding doors, and their impact on hotel aesthetics. Glass sliding doors, for example, allow the designer to take advantage of daylight harvesting while maximizing space in small rooms. One case study will show how manufacturers can use integrated problem solving and solutions-based design to develop durable, fashionable products scaled and multiplied for many installations. Doors are just one of many products that can be specified with components made of recycled or recyclable materials, and with low-VOC finishes to protect air quality.

On the exterior of buildings, products discussed in this article include an innovative and highly efficient air barrier that uses no mechanical fasteners. On the roof, cool and green roofs demonstrate a means to reduce the effect on the building's energy consumption from the heat island effect. Green roofs can also provide new views for guests who are looking out at lower roofs of hotel facilities adding value to once less marketable hotel rooms. From the exterior to the interior, this

article provides a quick snapshot of how to add to your green hospitality toolkit.

## HOTEL EXTERIORS: BUILDING THE GREEN ENVELOPE

### Air Barriers

In the 1990s, a few high-profile cases highlighted the problem of mold in hotel chains. An increase in mold caused by air and water penetration led building scientists to examine the science behind hotel construction practices. According to a study by the Air Barrier Association of America, air leakage

has been found to be the real problem behind the transmission of moisture into buildings, rather than vapor pressure. An estimated range from 30 to 200 times more moisture transport occurs via airflow than vapor diffusion.<sup>2</sup>

According to Marc Tropper, P Eng, director of product management and marketing, air barriers and waterproofing, of Henry Company, "Studies show that buildings account for 48 percent of U.S. energy consumption and generate far more greenhouse gas emissions than any other sector. Although there is a lot of talk about the reduction of energy in buildings by 2030, there are not enough discussions as to how to make the changes in construction practices necessary to achieve these goals." One method to save energy is to design buildings that do not leak air uncontrollably. Buildings are more energy-efficient when the structure of a building is wrapped with an air barrier. An air barrier should form a continuous plane around a building to prevent uncontrolled air movement in and out of a building envelope.

Air barriers save energy, reduce utility costs, improve air quality and protect buildings. According to the EPA, commercial buildings are subject to larger infiltration rates and air leakage is a measurable problem. Infiltration in commercial buildings including hotels can have many negative consequences, including:

- Reduced thermal comfort
- Interference with the proper operation of mechanical ventilation systems

*Photo courtesy of Henry Company*



*Air barriers with no mechanical fasteners are able to seamlessly wrap a structure for additional energy savings.*

- Degraded indoor air quality—causing sick building syndrome
- Moisture damage of building envelope components
- Increased energy consumption

An EPA study revealed that the right air barrier can help improve building performance by reducing heating and cooling costs by as much as 36 percent.<sup>3</sup>

In the past, weather-resistive barriers have been mechanically fastened to a building structure. Air barriers can now be specified that are peel and stick allowing the application of an air barrier with no mechanical penetrations. This means that the air barrier will provide a fully adhered wrap around the structure to prevent air and water leakage in order to optimize building performance. The advantages of the air barrier being fully adhered to the substrate versus being mechanically fastened in place include:

- Fully adhered membranes do not require staples or screws to install thereby reducing the amount of penetrations or holes through the air barrier which are sources of air or water leaks.
- Fully adhered membranes can provide a continuous plane of air and water tightness throughout the building envelope without having to rely on tapes or sealants.
- They prevent lateral air and water migration between the substrate and the air barrier.
- Wind loads can be transferred directly to the bonded substrate without causing a billowing or pumping effect on the barrier.
- They are less prone to wind cycling damage from sustained winds when exposed during construction.

By wrapping a building in a seamless air barrier, the added advantage is the ability to reduce the size of HVAC systems due to fewer air leaks in the building envelope. For a hotel chain that may have projects in many climate zones, these barriers are designed to function in even the most extreme environments as shown in the case study on the Hurst Conference Center at the

end of this article. They can also be adhered with products that emit low volatile organic compounds (VOCs).

## HOTEL INTERIORS: SPACE PLANNING

While discussing sustainability with their clients, some architects point out that strategic planning includes the understanding of building programs and prioritizing spatial requirements. They encourage their clients to reduce their proposed building footprints as an energy-saving strategy for sustainable design.



*Tall, frameless doors can create visual illusions in a small hotel room.*

Designing a small space that is both efficient and interesting requires that the designer pay attention to all of the details. One space-saving strategy that is becoming more popular as a design solution for hotel rooms, spas and restaurants is the use of sliding doors. Sliding doors can be durable and provide flexibility for room design. They also can meet universal design principles when used in renovations as well as new construction.

### Scale—Rightsizing

As part of an integrated design process, details do make a difference when part of a sustainable design solution. Doors are the first material that a hotel client touches in the room and that sensation of touch can convey aesthetic experience and emotional

feedback. Doors frame views and they help define the scale of a room. The relative visual size of any space is created by the size relationships between objects. Human scale is acknowledged as the average relationship of the height and reach of most people and the sense of space in a room can be dramatically altered by using visual techniques that affect the scale and proportion of a room space. Oversized door openings create an illusion of height even in small rooms and when the ceiling height can be as low as 8 feet. Tall frameless doors of the same size as a framed door make the room look taller and visually alter the proportion of the space. Door openings of the same size look larger without casings around the door opening. Even very small rooms or a tightly enclosed room like a bathroom can look or feel larger by manipulating the sense of scale in a room.

Small hotel rooms also feel bigger with sliding glass doors. The USGBC, The American Society of Interior Designers and The Hospitality Industry Network sponsored a sustainable suite design competition at the 2010 Hospitality Design Expo. The award-winning hotel room highlights many strategies that presented “luxury redefined as effortless sustainability.”<sup>4</sup> Sliding glass walls and doors were used as just one way to add value to the

aesthetics of this space. Sliding glass doors in the bathroom or on closets increases the apparent usable square foot area in a small space.

### Daylight Harvesting

Glass doors allow for interior daylight harvesting from exterior windows as well as shared lighting between rooms. Increasing natural light in an interior is recommended by numerous green building rating systems. Access to daylight and shared illumination between rooms reduces the use of electricity. Exposure to natural light also has been shown to increase occupant well being.

A typical hotel room is narrow and deep with an end window. Natural light usually provides enough daytime lighting to eliminate the need to turn on electric lights.

Photo courtesy of Modernus

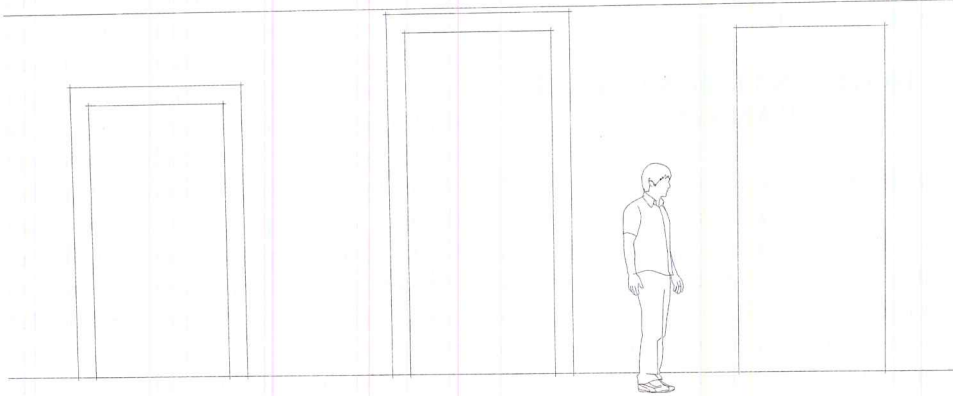

This sketch compares flush frames used to extend space visually.

If there is natural light or electric light in an adjacent room additional electrical energy can be saved by using glass doors.

#### Materials Durability and Healthy Finishes

Frosted glass, highly polished finishes and natural wood veneers can reinforce a design statement that can be carried over into the rest of the interior finishes. Modern hotel

designers are also finding that sliding glass doors are easy to maintain as well as durable. Today, floor-mounted tracks have features that prevent doors from leaving the track and have low profiles to meet barrier-free requirements. New sliding door technology allows designers to create spaces that are unencumbered by

floor tracks in hotels. Top-hung doors can be easier to install, they facilitate room cleaning and they do not introduce physical or visual barriers. The lack of a floor track makes them friendlier for people with disabilities. For these reasons top-hung sliding doors are often the preferred choice by hospitality designers.

A criterion for healthy indoor air quality by most green rating systems includes the avoidance of VOCs. VOCs are a component of many building products, usually in the form of some adhesives, primers and paints that emit harmful chemicals into the air. Green professionals are choosing low-VOC paints and finishes for hotel properties. They can now find door products that also meet low-VOC requirements. New doors are available with low-VOC finishes as well as zero formaldehyde content.

According to the EPA, most pressed-wood building products have adhesives that contain urea-formaldehyde. In large doses, this product can cause watery eyes, burning sensations in the eyes and throat, nausea,

#### Value Engineering: Solutions-based Manufacturing

In July of 2010, TVS Design Group in conjunction with Hilton Hotels approached a doors office design and manufacturing group to value engineer a door that would be part of the design of a re-brand of the Hilton Corporation. The problem was that the mirror-clad doors in the hotel rooms were warping. The wood mirrored closet doors were dated and needed a facelift to be part of the room's new contemporary design. As part of a solutions-based manufacturing process, this company analyzed the issues stemming from the differences in the materials between two panel faces. The solution had to prevent mirror cracking and protect the sides of the door. The new doors had to be able to be reproduced at a large scale for thousands of doors across the entire hotel portfolio. The technology needed to reflect the latest sliding door hardware technology, meet the latest codes and provide universal design access. In addition, the contractor needed to meet a tight budget and timeline

To stabilize the differences in materials between the two panel faces, tension bars were designed into the doors to re-adjust

relative tension parameters between the two faces of the door. The new doors were constructed with a solid wood frame and a no-warp panel core. Tempered glass mirrors were installed for safety and durability. Hardwood backing support for the ADA hand pull was built into the door. This provision resulted in a 60 percent cost savings for the contractor over other means of hardware selections. A steel band was placed on the perimeter of the doors to protect the door edges as well as adding a sleek surround and finish to the casing.

The new door slides like a barn door, away from the wall. This sleek solution is a modern interpretation of a traditional barn door. The door was mounted on a slot in the ceiling away from the wall. This meant that the doors could be easily installed in new construction or as part of a renovation. By meeting with the owner, the designer and the contractor the communication and early involvement by the manufacturer enabled a solution-based manufacturing process. The manufacturer designed, tested and developed a prototype door that was delivered within seven days of the order.

Photo courtesy of Modernus

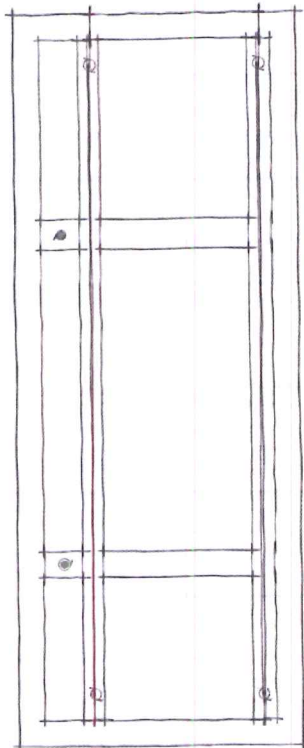

Solving the problem of mirror cracking required a solutions-based manufacturing process.

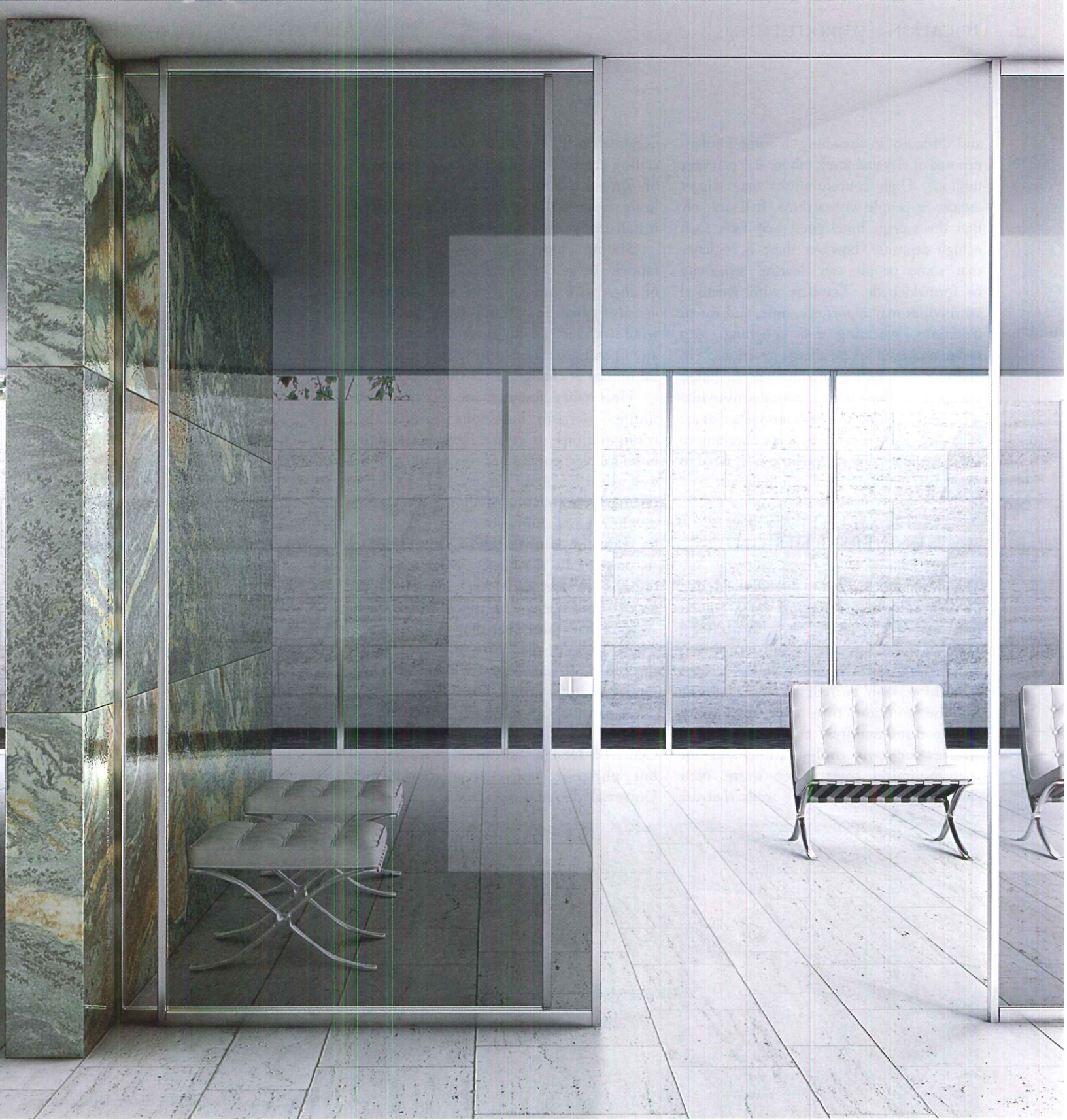

We know doors and it shows.

**MODERNUS**  
DOORS + OFFICE

[www.modernus.com](http://www.modernus.com)  
800 755 8940  
[info@modernus.com](mailto:info@modernus.com)  
CIRCLE 76

and difficulty in breathing in some humans exposed at elevated levels (above 0.1 parts per million). High concentrations may trigger attacks in people with asthma. It is unlikely that the average hotel guest may have such a high exposure, however there is evidence that some people can develop sensitivity to formaldehyde. Travelers with chemical sensitivities may report eye, nose, and throat irritations, wheezing and coughing, skin rashes and even severe allergic reactions.<sup>5</sup> In addition to building products, green hotels that cater to those with chemical sensitivities also select cleaning and bath products that are fragrance-free. Eco-travelers are checking to see if the air quality in hotel rooms is rated to meet their environmental requirements.

### FLEXIBILITY AND UNIVERSAL DESIGN

Most hotel chains need to refresh the design of their interior architecture on a regular basis in order to reduce the churn rate of their clientele. Customers will return to a hotel based on its branding and as it stays in fashion with current trends. Planning for the constant turn over of interior architecture requires a flexible design strategy for room configurations and one that minimizes construction waste. New sliding doors can be entire walls that are

designed to fill the openings from floor to ceiling creating the option for a multitude of room configurations. They can be hung from ceilings for easier and faster installations and renovations.

Sliding doors can be mounted in tandem or stacked to slide into a pocket or align with other panels. Manufacturers are also providing sliding door walls and windows that can be plugged into almost any opening or room configuration with a minimum of changes to existing openings.

Hospitality designers are incorporating sliding doors in numerous finishes and configurations to create flexible space in hotel lobbies, conference rooms and spas as well as for hospitality suites. Derived from the Japanese practice of sliding screens to divide rooms, sliding door engineering is far different from the sliding closet doors so popular in the fifties. New hardware options include doors that are pre-hung on overhead tracks with rollers and locking systems that assure that they stay on track. These systems maximize the speed and flexibility of installations for new and renovated hotel properties.

According to Barbara Knecht, the director of The Institute of Human Centered Design, accessibility is the law but universal design is a movement.<sup>6</sup> Universal design principles and practices

### ADA Requirements

Accessible doors must have a minimum of a clear opening width of 32-in., measured from the face of the door opened to 90 degrees to the surface of the latch sided door stop. If no latch side doorstop exists, then measure to the latch side jamb surface.

- Doorways deeper than 24-in. must have a minimum clear opening width of 36-in.
- When an existing building is altered, the clear opening may be reduced 5/8-in., if it is structurally or technically impossible to provide a minimum 32-in. clear opening.
  - ▶ Doorway approaches for manual sliding doors are 48-in. for a front approach and 42-in. for a side approach.
  - ▶ Adjacent flooring shall have smooth surfaces. Horizontal or vertical joints in these surfaces shall be within 1/16-in. (1.6 mm) of the same plane as the other. Cavities created by added kick plates shall be capped.
  - ▶ Door thresholds should be no taller than 1/2-in. tall.<sup>7</sup>

are important to an industry that houses everyone, from children to seniors and those with differing abilities. According to the ADA Standards for Accessible Design, accessible doors can be either sliding or swinging. A sliding door requires similar approach distances from the front or side as does any other door opening but by using a sliding door, the designer does not have to accommodate the area of the door swing. Swinging doors need more clear floor area than sliding doors. For example, in a bathroom, more clearance to fixtures and furniture is required to accommodate the swing of a door.

Continues at [ce.architecturalrecord.com](http://ce.architecturalrecord.com)

Architect Celeste Allen Novak AIA, LEED AP specializes in sustainable design and planning in Ann Arbor, Michigan.



Space-saving sliding doors reminiscent of Japanese screens can be specified with low VOC finishes.

Go to [ce.architecturalrecord.com](http://ce.architecturalrecord.com)  
Take the Quiz Free Online

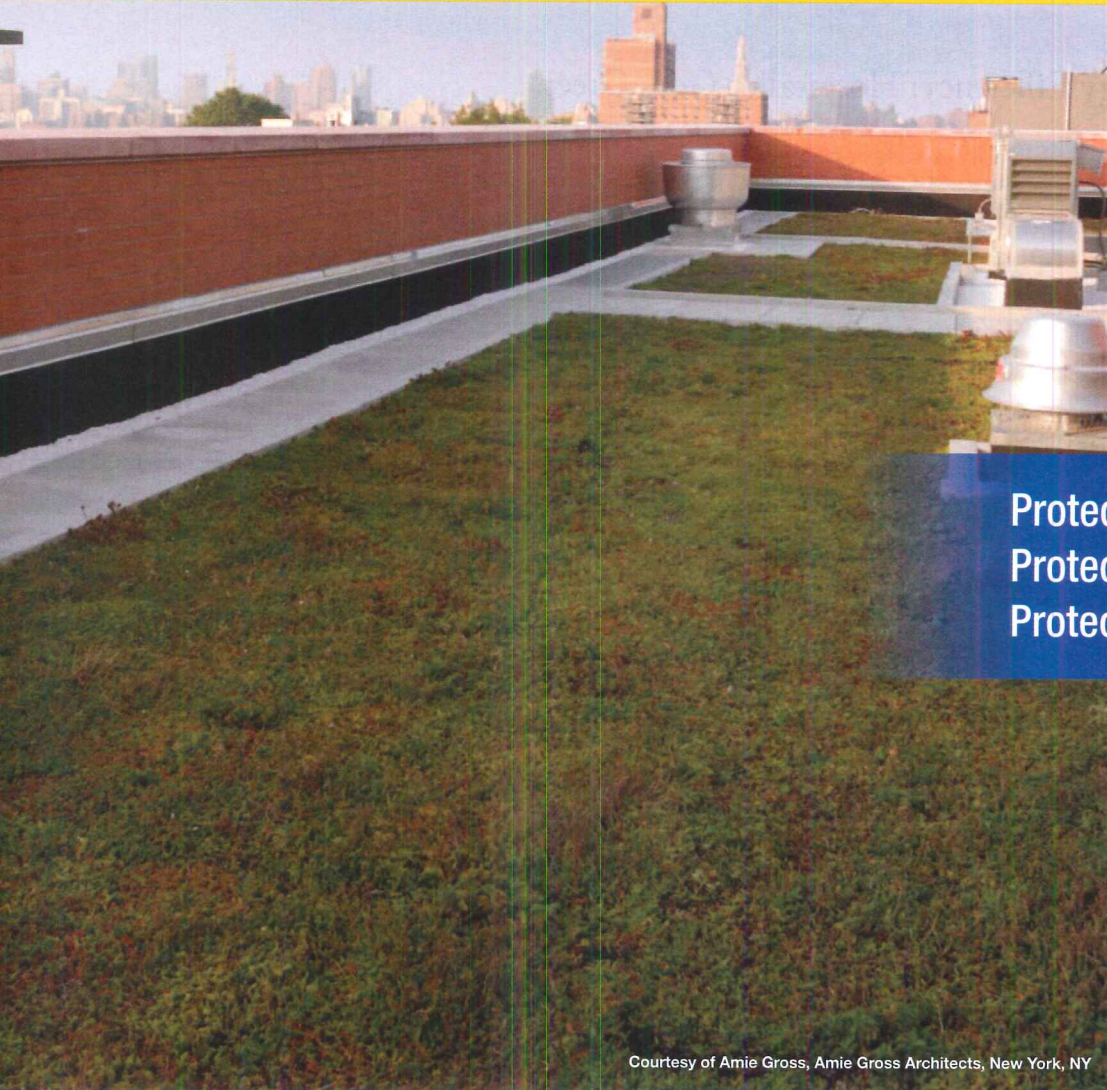

Protect your building.  
Protect your environment.  
Protect your reputation.

The Vegetative Roof Assembly® from Henry – proven technology, single-source warranty.

Courtesy of Amie Gross, Amie Gross Architects, New York, NY

The benefits of a vegetative roof are many – from reduced building maintenance and energy consumption to reduced storm water runoff and urban heat island effect. But they are quickly diminished by a roofing system that fails to keep water out.

The Henry Vegetative Roof Assembly® is a proven system that provides building owners with the confidence to “go green,” as well as a single-source warranty that includes complete waterproofing membrane and vegetative roof assembly coverage in one agreement.

At the core of Henry's Vegetative Roof Assembly® is our high performance, hot rubberized 790-11 roofing and waterproofing membrane, proven in more than 40 years and 75 million square feet of successful installed roofing throughout North America and Europe.



Henry's unmatched experience and expertise in enabling trouble-free, water-tight roofing is your assurance that your building will not only stand out, but stand the test of time. For more information about our products and experience, contact a Henry representative or visit [www.henry.com](http://www.henry.com)

- Possible LEED credits: 1. Storm water management  
2. Urban heat island 3. Water efficient landscaping  
4. Improved building energy performance

See [www.usgbc.org](http://www.usgbc.org) for more information

# Henry®

Room for Luxury and Energy Efficiency: Hospitality Goes Green

# PRODUCT REVIEW

①



## 1. Modernus Doors + Office

### CUSTOM-BUILT SLIDING DOORS

Modernus Sliding Doors are custom built and feature a top-hung track system with shock-absorbing sliding hardware. Doors can be produced in recycled aluminum, stainless steel and wood. Doors do not require a floor track and sliding hardware is 100% concealed within the track system—making for the most minimal system available.

[www.modernus.com/products/sliding](http://www.modernus.com/products/sliding)

circle 48

②



## 2. THE SLIDING DOOR COMPANY®

### WALL SLIDE/BARN DOORS AND ROOM DIVIDERS

Wall Slide (Barn) Doors, as well as Room Dividers, are a sliding door system separating one part of a room from another using a proprietary panel-clamp smooth-glide system. Design is customizable with choice of finishes and with highly safe glass types (tempered or laminated).

[www.slidingdoorco.com](http://www.slidingdoorco.com)

circle 135

③

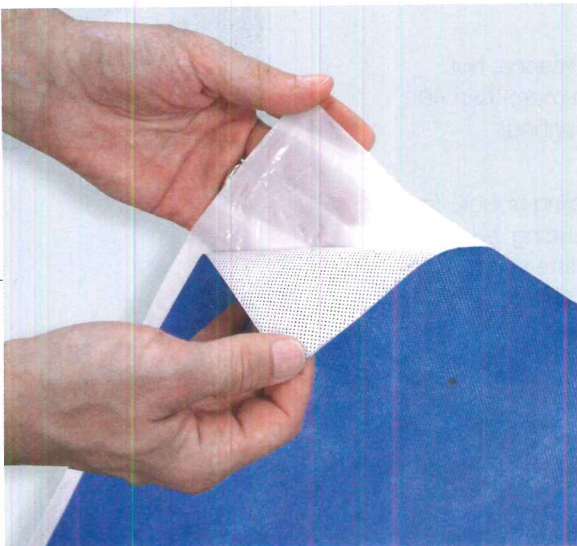

## 3. Henry Company

### FULLY ADHERED POLYMERIC WRAP SYSTEM

BlueskinVP™ picks up where traditional polymeric wraps leave off. This fully adhered system functions not only as a water-resistant barrier but also as an air barrier, eliminating uncontrolled air leakage created by various mechanisms, such as stack effects, wind effects and mechanical air handling effects.

[www.henry.com](http://www.henry.com)

circle 136





Found on some of the best addresses in the world

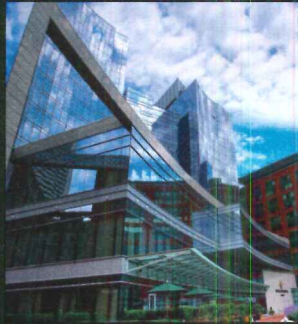

Design Meets Innovation

DORMA Americas is a leading global manufacturer of premium access solutions that enable better buildings. Our full range of products and services provides safety and security as well as convenience and comfort. DORMA features a design-oriented portfolio of architectural door hardware, specialty hardware for glass door and wall applications, door automation systems including Crane Revolving Doors, and operable wall systems featuring Modernfold.

See us at **AIA 2011 – Booth 3843**, visit us at [www.dorma-usa.com](http://www.dorma-usa.com), or call our Architectural Support Desk at **866.401.6063**

**CIRCLE 35**



*The key to our Garden Roof® is our Monolithic Membrane 6125®, a seamless rubberized asphalt membrane with a 45+ year track record for critical water-proofing and roofing applications world-wide.*



## From concept to completion

American Hydrotech's Garden Roof® Assembly has set the standard by which all other green roofs are measured. Our Total Assembly Warranty provides owners with single source responsibility from the deck up. This is peace of mind that only American Hydrotech can offer.

To learn more about the American Hydrotech Garden Roof Assembly, please call **800.877.6125** or visit us online at [www.hydrotechusa.com](http://www.hydrotechusa.com).

American Hydrotech, Inc. | 303 East Ohio | Chicago, IL 60611 | **800.877.6125** | [www.hydrotechusa.com](http://www.hydrotechusa.com)

© 2010 Garden Roof is a registered trademark of American Hydrotech, Inc.

**CIRCLE 08**



When a hole in your ceiling or wall...  
*is a good thing!*

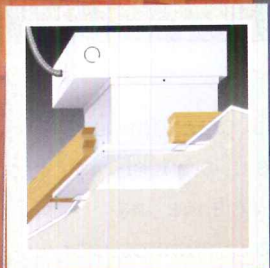

"Hole In The Ceiling"  
 HITC Series Fixtures



"Hole In The Wall"  
 HITW Series Fixtures



**ELP**

ENGINEERED  
 LIGHTING  
 PRODUCTS

CIRCLE 41

Our "HITC" & "HITW" fixtures are plaster/glass-fiber castings. When installed, they blend into the surface and appear to be a custom built drywall "light niche." They efficiently illuminate your space without calling attention to themselves.

Call us now for more information  
 626 579-0943

Visit our website today:  
[www.elplighting.com](http://www.elplighting.com)

## Specifier ALERT

# Mortar Net<sup>®</sup> with Insect Barrier

**Change Your Spec Today!**

**All 0.4", 1" & 2"  
 Mortar Net<sup>®</sup> now  
 has Insect Barrier**

Simply insert  
 "with Insect Barrier"  
 into your Mortar Net<sup>®</sup> specs

Call today for more information and samples.



**Mortar Net<sup>®</sup>**  
 USA LTD.

*The Future of Flashing in Cavity Walls*

### TotalFlash<sup>®</sup>

- **EVERY** Moisture control element built into each lightweight, easy to install panel.
- Everything arrives assembled in one order. Just open the carton and start installing.
- Available in sizes for new construction & restoration.

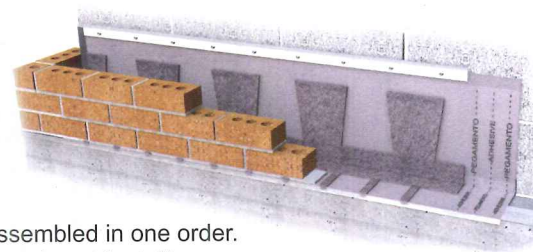

*The Future of Flashing in CMU*

### Blok-Flash<sup>®</sup>

- Tough, lightweight, embeddable Blok-Flash<sup>®</sup> flashing system
- **Surest, most cost effective control of moisture and mold growth** in exterior single-wythe CMU wall systems.



**800.664.6638**

**MortarNet.com**

See our complete line of Masonry Moisture Control Products, including HouseNet<sup>®</sup>, BlockNet<sup>®</sup>, Stone&StuccoDrain & Weep Vents

CIRCLE 77



**ZAHNER®**

We design, engineer, and build works for  
intelligent architects, artists, and designers.

Pictured above: The Zahner Campus, designed by Crawford Architects, engineered by Zahner.

**CIRCLE 129**

cool by

de-

sign

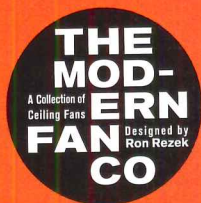

modernfan.com | 888.588.3267

CIRCLE 114

Don't just go green  
go Emerald.

emerald  system

**CUSTOM'S COMPLETE SYSTEM  
OF ENVIRONMENTALLY  
RESPONSIBLE TILE AND STONE  
INSTALLATION PRODUCTS**

- Guaranteed to comply with all leading environmental agencies: LEED®, ANSI, TCNA and more
- Eligible for up to a Lifetime Installation Systems Warranty
- First tile installation system to offer Carbon Offset Credits

**RESPONSIBLE. CONVENIENT. COMPLIANT.**  
**WE'RE CUSTOMER FOCUSED.**



www.customemeraldsystem.com  
800-282-8786

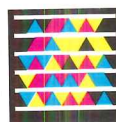

To learn more about Emerald System,  
get the free mobile app for your phone  
<http://gettag.mobi>

CIRCLE 32

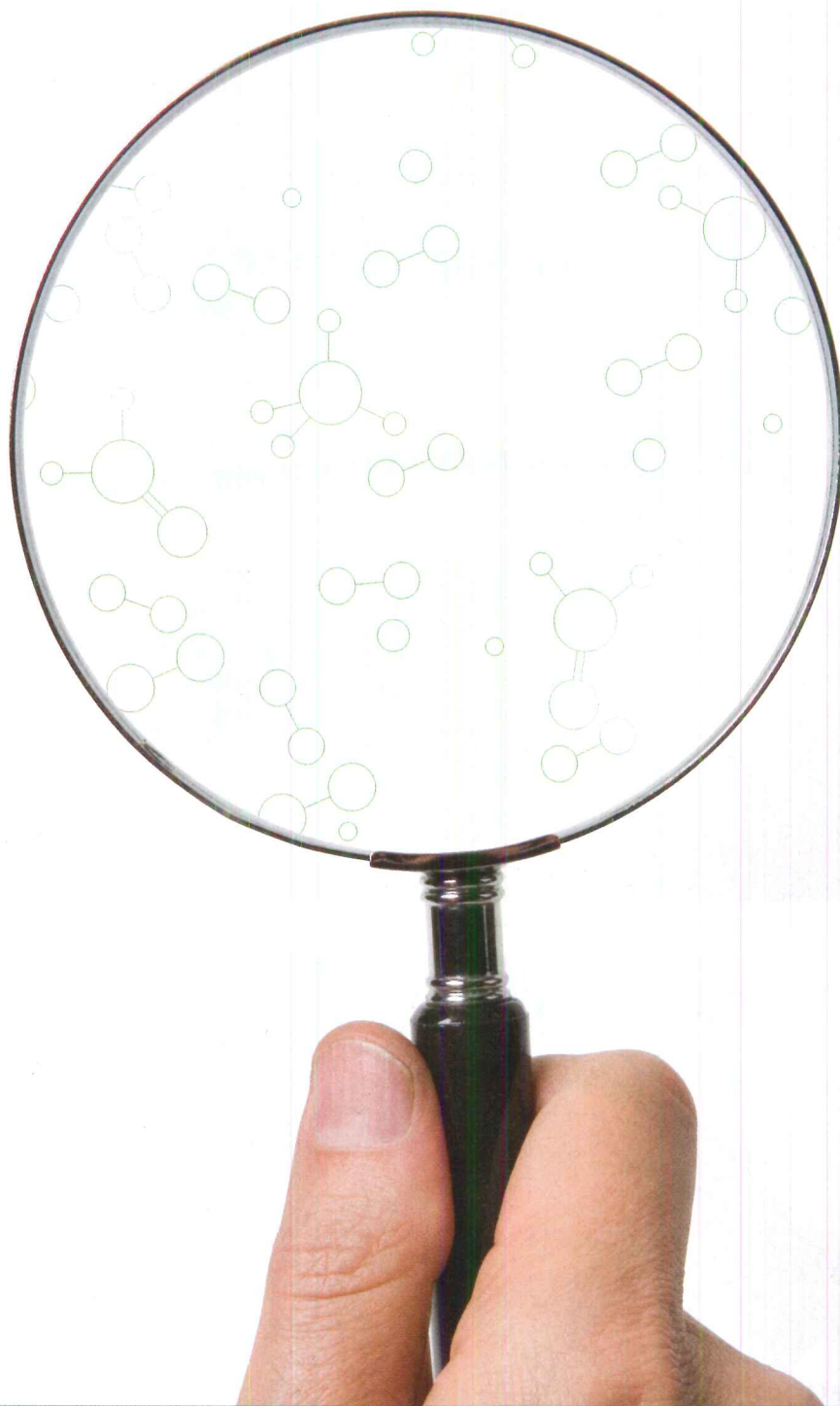

## LOOK CLOSER.

Many pollutants can be in the indoor air you breathe. The largest source of these pollutants is chemical emissions from everyday products such as flooring, paint and furnishings. Keeping indoor air healthy is GREENGUARD's objective. We take a close look at products and certify only those that meet our stringent chemical emissions standards. Visit our free online product guide for a complete list of certified products to help you create healthier indoor environments.

[greenguard.org/greensource](http://greenguard.org/greensource) | 800.393.7025

CIRCLE 131



# Got Protection?

Don't let your steel get sacked by corrosion.

**PROTECT YOUR STEEL**

**PROTECT YOUR ENVIRONMENT**

**GALVANIZE IT!**



American Galvanizers Association

CIRCLE 07

[www.galvanizeit.org/protection](http://www.galvanizeit.org/protection)

## Diamond Spas

CUSTOM STAINLESS STEEL, COPPER & BRONZE AQUATIC PRODUCTS

RESIDENTIAL • COMMERCIAL • SUSTAINABLE

- Spas • Swim Spas • Swimming Pools
- Cold Plunge Pools • Waterfeatures • Kitchen & Bath
- BUILT TO CLIENT SPECIFICATIONS
- DURABLE • ARTISTIC

**DIAMOND  
SPAS**

1-800-951-SPAS (7727) 720-864-9115 FAX 720-864-9120  
[www.diamondspas.com](http://www.diamondspas.com) [spasales@diamondspas.com](mailto:spasales@diamondspas.com)

CIRCLE 34



CASCADE COIL DRAPERY

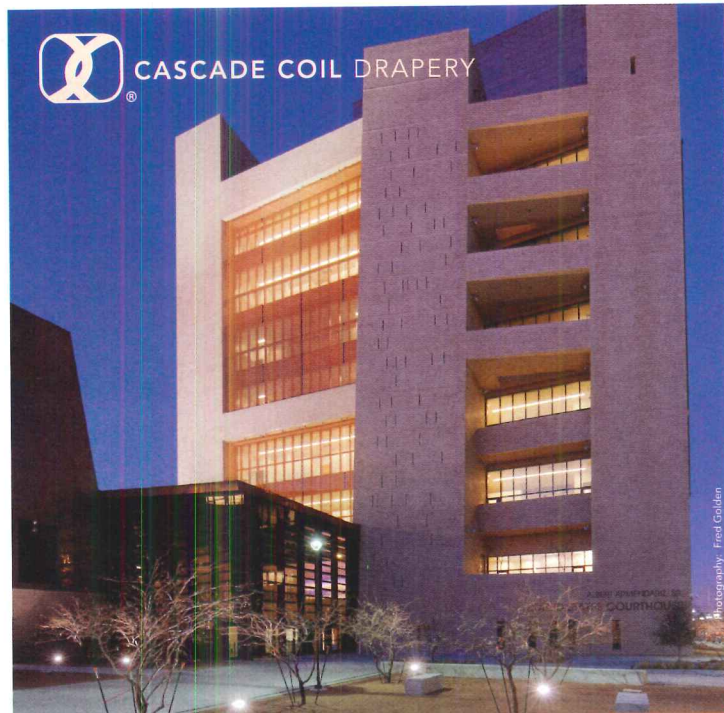

### Building Shading & Cladding

Cascade Coil Drapery is proud to showcase its new offerings for building cladding and shading with the spectacular El Paso Courthouse project. Panels of copper clad steel mesh as tall as 150 feet provide shading to moderate the intense El Paso sun.

Projects include multi-story wire mesh draperies for hotels, auditoriums, and casinos; curved dividers for visual merchandising; window treatments for private homes; safety screening for industrial settings; sculptural forms for urban gardens; decorative interior/exterior wall coverings for buildings and parking garages; aviary round weave screening for animal habitats, and see-through appealing barriers for commercial security. Whatever the application, let us help you realize your creative vision.

[www.cascadecoil.com](http://www.cascadecoil.com) | 800-999-2645

CIRCLE 17



Enhance your landscape with the natural elegance of Cavawood wood poles. Wood is a renewable resource and an energy wise alternative to metal poles. Cavawood poles are made with Alaskan Yellow Cedar wood which is naturally resistant to decay and insects without the use of any chemical preservatives. The poles are tapered, laminated beams for exceptional strength. The aluminum base incorporates an anchor base and wiring compartment for a trouble-free installation.



# CAVAWOOD

ARCHITECTURAL WOOD POLES

Manufactured in Colorado of locally sourced materials  
389.6618 CIRCLE 132 [www.cavawood.com](http://www.cavawood.com)



# Specify and forget.

Peace of mind.  
Isn't that what we all strive for?

Specifying **Horton Automatics** door systems brings you that. With our design and specification assistance on the front end and our professional certified independent distribution network on the back end, all you have to do is specify and forget. We'll do the rest.

To learn more, visit [hortondoors.com](http://hortondoors.com) or call 800.531.3111.

CIRCLE 55



[www.hortondoors.com](http://www.hortondoors.com)



People Helping People Build a Safer World™

## ICC Plan Review Services: Imagine what we can accomplish together

To learn more about the **ICC Plan Review Services**, visit [www.iccsafe.org/planreview](http://www.iccsafe.org/planreview).

To speak with an expert, call **(888) ICC-SAFE (422-7233)** and talk to **Chris Reeves at x4309** or **Doug Connell at x5226**.

10-04042

ICC helps building departments review plans for high-rises, retail facilities, schools, and residential developments. Our qualified staff delivers comprehensive and accurate code-base plan reviews—on schedule and on budget.

Choose a complete review or just one aspect of a plan, including building (structural and nonstructural), mechanical, plumbing, electrical, accessibility, energy, and fire protection systems (including sprinklers). We also offer evaluations of specific code topics or special studies of building components, characteristics, or applications. Just ask!

No job is too small or too large for the ICC Plan Review Services. ICC Plan Review fees are based on the scope of work requested.

CIRCLE 57



## DATES &amp; EVENTS

## New and Upcoming Exhibitions

**The Worms**

New York City

May 7, 2011

Winner of the Streetfest Tent Design Competition, "The Worms" exhibition takes the most functional aspects of the typical street fair tent and advances them, making the result more adaptable, sculptural, and interactive, while accommodating a wider and more engaging variety of programs. Built from common and inexpensive materials, these new tent typologies are designed to be as efficient in cost and assembly as the ubiquitous white farmer's market tent. Visit [www.storefrontnews.org](http://www.storefrontnews.org).

**Lucite 75th Anniversary**

New York City

May 10–June 10, 2011

Lucite International, maker of the eponymous material, is celebrating 75 years with an exhibition at Material ConneXion, showing off vintage accessories as well as the many current applications of the material, from architecture and furnishings to industrial design and retail merchandising. The exhibition will present the entire history of Lucite, from its early days as a DuPont innovation and its use in World War II in airplane canopies and submarine periscopes to its widespread postwar use in handbags, jewelry, and furniture. For more information, visit [www.materialconnexion.com](http://www.materialconnexion.com).

**Daniel Buren: Echos, Work in Situ**

Paris

May 16–September 12, 2011

Contemporary artist Daniel Buren created a site-specific installation at the Centre Pompidou-Metz, which will take up the entire exhibition space in Galerie 3. This commission was initiated in collaboration with Mudam - Musée d'art moderne Grand-Duc Jean, Luxembourg, where Buren created another installation, "Architecture, contrearquitecture: transposition." The project at the Centre Pompidou-Metz will echo this installation with a new intervention that responds to the space and architecture of the museum. Visit [www.centrepompidou-metz.fr](http://www.centrepompidou-metz.fr).

**Sol LeWitt: Structures, 1965-2006**

New York City

May 24–December 2, 2011

The first-ever outdoor career survey of Sol LeWitt's sculptures, or "structures," as he called his three-dimensional works, will be on view at City Hall Park. The exhibition will include 27 works from the seminal artist's modular, serial, geometric, and irregular structures series attesting to his lifelong engagement with the medium and showcasing his most important ideas about

sculpture. Two works will be installed inside City Hall and accessible by tour. For more information, visit [www.publicartfund.org](http://www.publicartfund.org).

**Florence Architecture**

Florence

June 1–30, 2011

This unique four-week architectural learning experience for aspiring and professional architects will usher students through different architectural periods to discover the key to the evolution of Italian architecture. The course will be held mostly in the form of walking tours combined with on-site discussions and photometric analysis as well as sketching by hand. Classes will be also held in

the Florence Institute's elegant Baroque-style palazzo. For more information, visit [www.florence-institute.com](http://www.florence-institute.com).

**Talk to Me**

New York City

July 24–November 7, 2011

This exhibition at the MoMA investigates the communication between people and objects and features a wide range of objects from all over the world, from interfaces and products to diagrams, visualizations, and furniture by designers, students, and scientists – all designed in the past few years or currently under development. For more information, visit [www.moma.org](http://www.moma.org).

# PROSPEC®

Floor Preparation • Concrete Repair • Tile Setting



## Total Confidence.

Have your floors foundation be just the beginning of your beautiful floors. Our complete line of Level Set underlayments and toppings is engineered for superior performance and outstanding workability, giving you the beautiful finish you expect from a premium brand. It's the material you don't see that matters most.

ProSpec is a trademark of Bonsal American, an Oldcastle Brand



For product specification and information go to [www.prospec.com](http://www.prospec.com)

## Ongoing Exhibitions

### Reappearing Act: The Star-Spangled Banner at the Smithsonian

New York City

Ongoing

This exhibition documents the renovation by SOM Skidmore, Owings & Merrill of the Smithsonian National Museum of American History in Washington, D.C., one of the last buildings by McKim, Mead & White. All images were photographed by Eduard Hueber of Archphoto. For more information, visit [www.archphoto.com](http://www.archphoto.com).

### Neutra VDL House

Los Angeles

Ongoing

Seventy-five years ago, Viennese-American architect Richard Neutra built a radical "glass house" with rooftop and balcony gardens, a project that has since grown into a modern marvel of the architectural world. Saturday tours of the house – a place that saw the beginning of the careers of architects Gregory Ain, Raphael Soriano, and Donald Wexler, among others – are given by Cal Poly Pomona architecture students and offer a unique chance to stay as long as you want to see the entire house. For more information, visit [www.neutra-vdl.org](http://www.neutra-vdl.org).

### Counter Space: Design and the Modern Kitchen

New York City

Through May 2, 2011

This exhibition explores the 20th-century transformation of the kitchen and highlights MoMA's recent acquisition of a complete example of the iconic "Frankfurt Kitchen," designed in 1926-27 by the architect Grete Schütte-Lihotzky. In the aftermath of World War I, thousands of these kitchens were manufactured for public-housing estates being built around the city of Frankfurt-am-Main in Germany. Visit [www.moma.org](http://www.moma.org).

### Silent Disco

Los Angeles

Through May 15, 2011

Architecture students are the imagined client for this temporary disco installation at the SCI-Arc Gallery. "Silent Disco" aims to support social and communal experiences. This architectural project is not limited to the execution of a design and its special effects but acts as a framework to encourage visual, physical, and social pleasure. For more information, visit [www.sciarc.edu](http://www.sciarc.edu).

### Frank Lloyd Wright: Organic Architecture for the 21st Century

Milwaukee

Through May 15, 2011

Experience more than 150 objects designed by Frank Lloyd Wright. This exhibition features 33 never-before-shown drawings by the Wisconsin legend as well as rare home movies. Examining every type of project that Wright designed, along with his plans for suburban communities and American System-Built Homes, the exhibition includes drawings, models, photographs, and more. Visit [www.mam.org/frank-lloyd-wright](http://www.mam.org/frank-lloyd-wright).

### Palladio at Work

Montreal, Quebec

Through May 22, 2011

The extraordinary drawings presented in this exhibition are annotated to show the Italian Renaissance master architect Andrea Palladio as a draughtsman working on a blank sheet of paper. It considers a life sustained by drawing, the process by which Palladio's design was developed, argued, and communicated. The exhibition includes early drawings for books as well as unfinished publication efforts on the Roman baths and on arches, evidence of setbacks and failures that have been ignored by the gloss of history. Visit [www.cca.qc.ca](http://www.cca.qc.ca).

### You Are Here: Architecture and Experience

Pittsburgh

Through May 29, 2011

In this exhibition at The Heinz Architectural Center, the Carnegie Museum of Art presents the powerful work of two contemporary artists – Candida Höfer and Cyprien Gaillard – who explore architectural

## ARCHITECTURAL 'ALL-GLASS' ENTRANCE SYSTEMS

DESIGNED, ENGINEERED AND MANUFACTURED BY C.R. LAURENCE COMPANY



- Door and Sidelite Rails
- Patch Hardware
- Commercial Door Pulls
- Access Control Handles
- Headers and Channels
- Stacking Partition Systems
- Sliding Glass Doors
- Door Closers

CRL IS PROUD TO ANNOUNCE  
THREE NEW ACQUISITIONS!

**Tajima**

**jackson**

*Thumcraft*  
OF PITTSBURGH



**CRL** C.R. LAURENCE COMPANY

[crlaurence.com](http://crlaurence.com) | Worldwide Supplier

Phone (800) 421-6144 ext. 7700 | Fax (800) 587-7501

environments and how they influence experiences and perceptions of the world. Both artists express the formative power of architecture in different but complementary ways. For more information, visit [www.cmoa.org](http://www.cmoa.org).

#### **John Portman Art & Architecture**

Beijing

*Through June 12, 2011*

The exhibition features architecture, furniture, paintings, and sculpture from renowned architect-developer-artist John C. Portman, Jr.'s five decades of work. Portman has a long history of involvement in China's architectural landscape and was one of the first American architects invited to China by the former vice premier Deng Xiaoping in 1979 when China opened its doors to the West. The exhibition kicks off in Portman's hometown of Atlanta, Georgia. Visit <http://capitalmuseum.org.cn/en>.

#### **Vertical Urban Factory**

New York City

*Through July 10, 2011*

The Vertical Urban Factory at The Skyscraper Museum features innovative architectural design, structural engineering, and processing methods of significant factory buildings from the turn of the 20th century to the present. Divided into four major sections – Modern Factories, Contemporary Factories, New York Factories, and Future Factories – the installation dissects more than 30 projects, including canonic examples of Modernism. For more information, visit [www.skyscraper.org](http://www.skyscraper.org).

#### **Charlotte Perriand: De la Photographie au Design**

Paris

*Through September 18, 2011*

This exhibition examines the photography of French architect and designer Charlotte Perriand (1903-1999). Much of Perriand's work focused on the nature of living spaces and how good design can contribute to the betterment of society. She worked with Le Corbusier and Pierre Jeanneret, and her design work ranged from European embassies to model kitchens and distinctive-yet-functional furniture. Much of Perriand's furniture designs are currently being manufactured by Cassina, which is one of the sponsors of this exhibition. For more information, visit <http://petitpalais.paris.fr>.

## **Lectures, Conferences, and Symposia**

#### **Architecture and Design Film Festival**

Chicago

*May 5–9, 2011*

More than 40 films from 11 different countries will be screened at the Art Institute of Chicago. Highlights include *How Much Does Your Building Weigh, Mr.*

*Foster?*, *Studio Gang Architects: Aqua Tower*, and *My Playground* with Danish Architect Bjarke Ingels, who will be on hand for a Q&A and book signing. For more information, visit [www.adfilmfest.com](http://www.adfilmfest.com).

#### **The Art of Citizenship in African Cities**

New York City

*May 6–7, 2011*

This conference presents research at the cutting edge of African studies and seeks to re-conceptualize the nature and contours of citizenship in African cities. The conference advances budding scholarship that reframes urban citizenship by showcasing the emergent and historical practices through which urban Africans enact and reconfigure their cities,

while asking hard questions about the implications of these strategies and their limits. The conference has been convened by Mamadou Diouf and Rosalind Fredericks. For more information, visit [www.arch.columbia.edu](http://www.arch.columbia.edu).

#### **AltBuild Expo and Conference**

Santa Monica, California

*May 6–7, 2011*

AltBuild provides the best opportunity of the year for professionals – designers, architects, and the building trades – and the public to explore everything that's new and on the horizon in green building, design, and operational practices. The event features public demonstrations, accredited

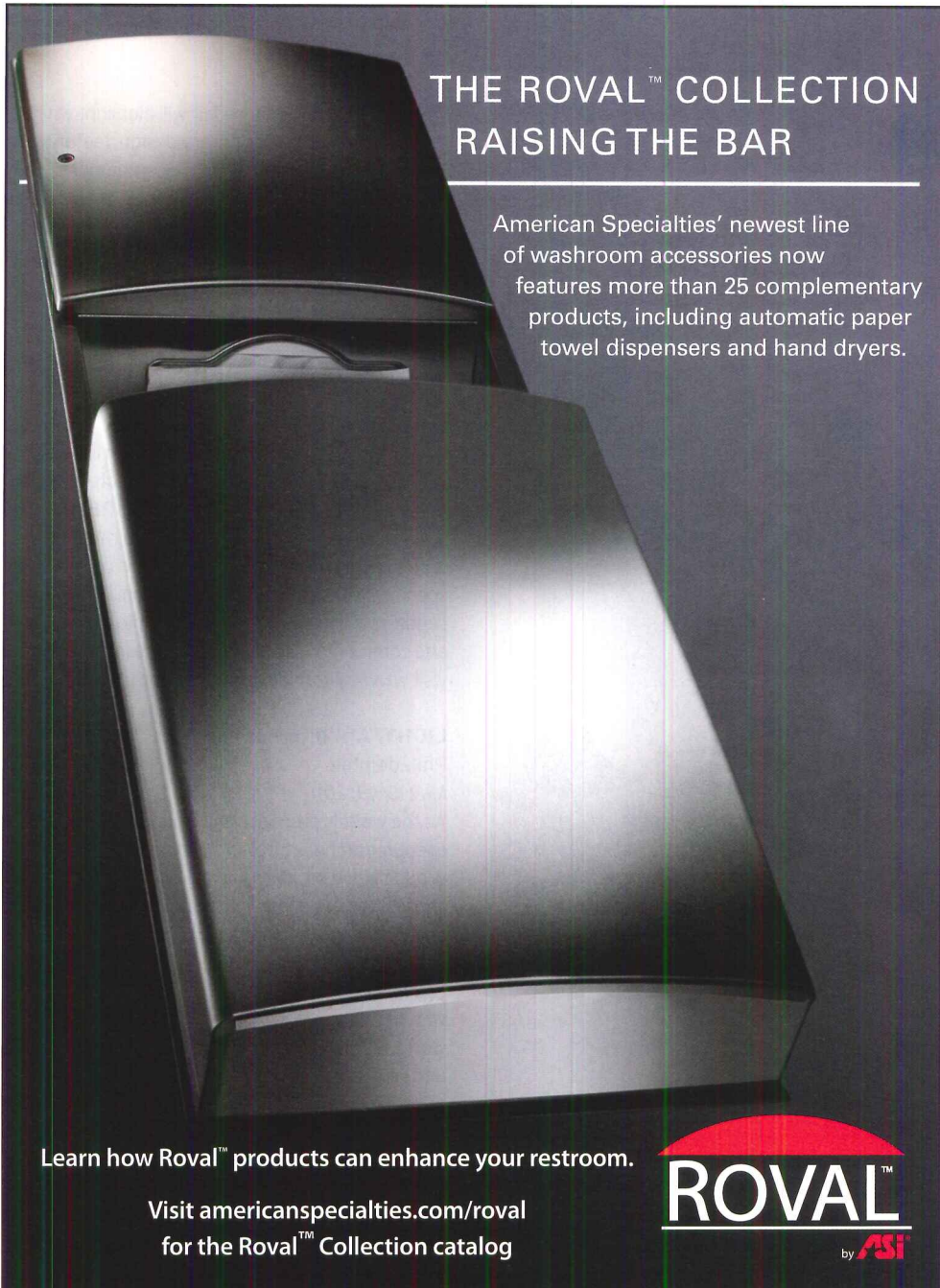

**THE ROVAL™ COLLECTION  
RAISING THE BAR**

American Specialties' newest line of washroom accessories now features more than 25 complementary products, including automatic paper towel dispensers and hand dryers.

Learn how Roval™ products can enhance your restroom.

Visit [americanspecialties.com/roval](http://americanspecialties.com/roval) for the Roval™ Collection catalog

**ROVAL™**  
by ASI



brand new!

### InterlockingRock® BuildingBloks™

Modular wall blocks work with standard steel studs to create rock-solid, full-round sculptural walls of any size.



**modulararts®**

modulararts.com | 206 788 4210

Quincy™ ©2011, Deano™ ©2010 Modular Arts, Inc.  
Patent pending. Made in the USA, sans hubris.

## DATES & EVENTS

educational programming for professionals, and small group discussions led by area green building experts. For more information, visit [www.altbuildexpo.com](http://www.altbuildexpo.com).

### Parsons Festival

New York City

May 7–23, 2011

Parsons The New School for Design presents its first art and design festival, with more than 100 public events taking place across its campus and around the city as well as a daylong block party on May 21. Highlights of the festival include student work and an MFA Fine Arts exhibition at The Kitchen. There will also be several symposia and panel discussions. Visit [www.newschool.edu/parsonsfestival](http://www.newschool.edu/parsonsfestival).

### International Contemporary Furniture Fair

New York City

May 14–16, 2011

The 23rd annual furniture fair will highlight what's next and best in contemporary design, featuring 500 global exhibitors displaying contemporary furniture, seating, carpet and flooring, lighting, outdoor furniture, materials, wall coverings, accessories, textiles, and kitchens and bathrooms for residential and commercial interiors. May 17 is the ICFF Public Day. For more information, visit [www.icff.com](http://www.icff.com).

### Preservation on the Edge

Santa Monica, California

May 15–18, 2011

The California Preservation Foundation invites sustainability professionals and advocates to help define the future of preservation at its 36th annual statewide conference. It will explore a range of topics under the theme "Preservation on the Edge," specifically the future of preservation and its essential role in sustainability, economic development, and community character. For more information, visit [www.californiapreservation.org](http://www.californiapreservation.org).

### LIGHTFAIR International

Philadelphia

May 15–19, 2011

As the world's premier annual lighting industry event for architectural and commercial lighting products and services, the LIGHTFAIR International Trade Show & Conference is the gathering place for the lighting industry. LIGHTFAIR brings top international and domestic architectural, design, engineering, and lighting professionals together with more than 500 exhibitors from around the world. LIGHTFAIR offers 200-plus hours of CEU, LU, and HSW accredited courses. Free admission for architects. Visit [www.lightfair.com](http://www.lightfair.com).

### SOLAR 2011: National Solar Conference

Raleigh, North Carolina

May 17–21, 2011

This 40th annual conference, sponsored by the

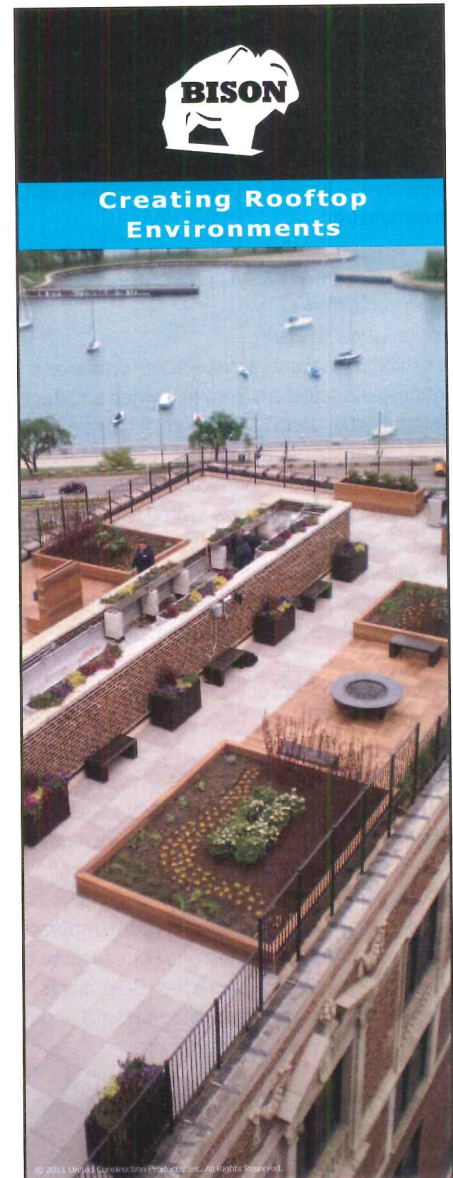

**BISON  
DECK SUPPORTS**  
Supports paving materials for level decks on rooftops



**BISON CUBE**  
Standard & Custom Sizes  
Many Colors Available  
Aluminum, Ipê & Steel



**BISON  
WOOD TILES**  
Custom Sizes Available  
Standard in Ipê & Massaranduba  
FSC® Certified  
(FSC-C013454)

**AIA BOOTH #2701**

Request your free samples and swatches at [www.BisonIP.com](http://www.BisonIP.com)

**BISON INNOVATIVE PRODUCTS**

[www.BisonIP.com](http://www.BisonIP.com) | 800-333-4234

## FORESIGHT ENABLES SUCCESS

- *What economic and business trends are relevant to my firm?*
- *What new opportunities can we take advantage of?*
- *Is our strategy sound?*

*If you're asking yourself tough questions, you're not alone.*

The Design Futures Council is an interdisciplinary network of architecture and design leaders intent on discovering what's ahead. Joining this prestigious body puts you in touch with a network that understands the challenges you face and can offer data, ideas, and experience.



With membership, you'll receive an annual subscription to *DesignIntelligence*, which provides original research, insightful commentary, and instructive best practices you won't find anywhere else.

Design Futures Council membership is the most economical way to get exactly what your firm needs to succeed.

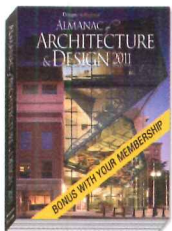

### **BONUS**

*The Almanac of Architecture & Design, 2011 edition*

*Hundreds of pages of essential resources*

*"I've been in profession for a long time, but I carefully read each issue of DesignIntelligence, and I still find new ideas and information of value."*

—M. ARTHUR GENSLE JR., CHAIRMAN, GENSLE

Learn how to become a member of the Design Futures Council today:

[www.di.net/about](http://www.di.net/about)

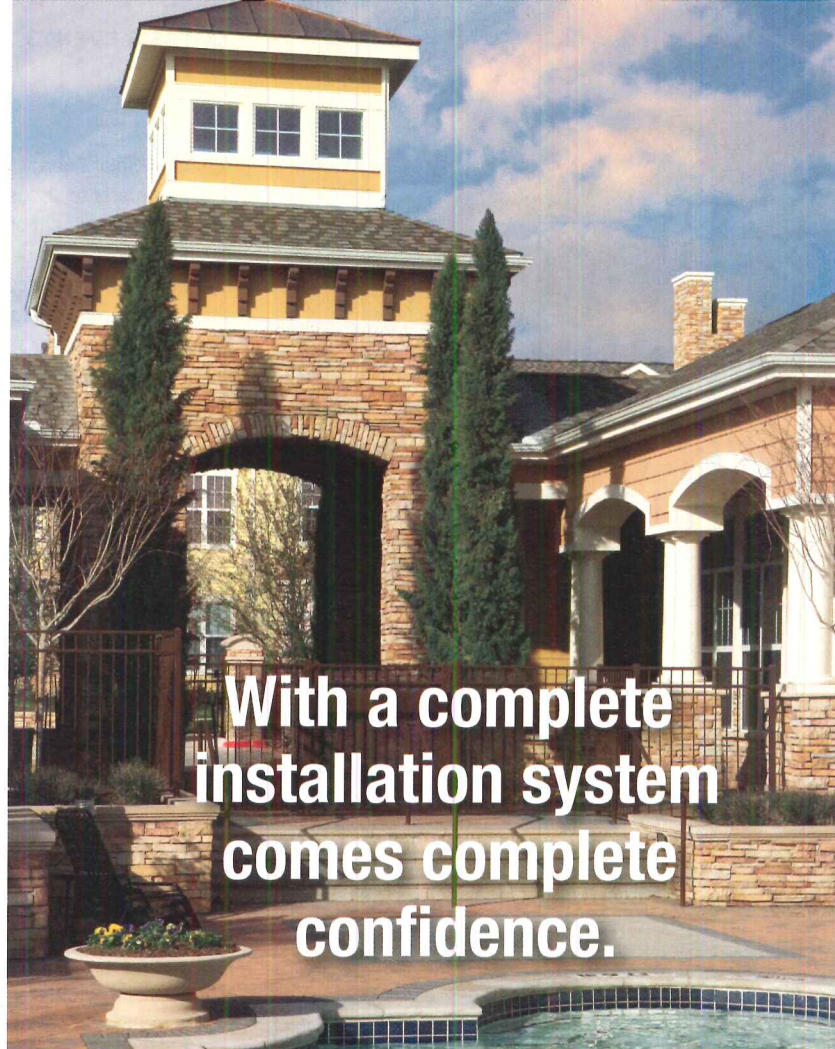

With a complete installation system comes complete confidence.

Introducing new installation solutions for: Manufactured Stone, Masonry Veneer, Veneer Panels, Division 4

For over 40 years, Custom Building Products has been manufacturing high quality, innovative building materials for the commercial and residential markets.

TVIS features:

- 4 premium mortars
- 7 pointing mortar colors
- Veneer waterproofing membrane
- Masonry mortar admix
- Penetrating masonry sealer

ELIGIBLE FOR  
**15**<sup>YR</sup>  
SYSTEMS  
WARRANTY



# TVIS™

Thin Veneer Installation System

www.customTVIS.com  
800-272-8786



ARCAT BOMI

# THE FRP PANELS YOUR PROJECT DEMANDS

Since 1954

**GLASBORD** protected by Surfaseal has been the industry standard for frp wall and ceiling panels.

*Surfaseal provides extra protection against mold, mildew and stains.*

Durable, cleanable, easy to install **GLASBORD** is the FRP panel your project demands backed by the service you deserve.

## GLASBORD®

The Only FRP panel with



CIRCLE 30

 **CRANE** Composites

www.cranecomposites.com  
1.800.435.0080



WHAT IF FRP  
DIDN'T LOOK LIKE FRP

www.DESIGNSFRP.com

## DATES & EVENTS

American Solar Energy Society, will bring together leading experts to discuss advances in technology and mass deployment of renewable energy and efficiency as well as the benefits for national security and jobs creation. The conference will include sessions on "Green Careers," "Greening Your Home or Business," and "Understanding Renewable Energy Technology, Policies, and Incentives." For more information, visit [www.ases.org](http://www.ases.org).

### NeoCon

Chicago

June 13-15, 2011

NeoCon features the latest design trends, products, and concepts in office, health care, hospitality, residential, institutional, and government interior environments from more than 700 exhibitors. Thousands of commercial furnishings products and services will debut, including architectural products, building products, and more. For more information, visit [www.neocon.com](http://www.neocon.com).

### CTBUH 2011 World Conference

Seoul, Korea

October 10-12, 2011

This conference will focus on the significant value of high-rise buildings in modern society from three perspectives: sustainability, safety, and livability. The goal of the conference is to provide an opportunity to share information with top industrial and academic experts in the field of high-rise buildings as well as experience dynamic aspects of Seoul. For more information, visit [www.ctbuh2011.org](http://www.ctbuh2011.org).

## Competitions

### Changing the Face: Pushkinsky Cinema

Submission Deadline: May 15, 2011

This competition offers architects a chance to give Moscow's Pushkinsky Cinema a design befitting its position at the center of Russia's cultural life. It is also an opportunity to rethink how the theater engages with the public from its prominent position in Pushkin Square. The competition aims to prove that changing the facade of once-great buildings is not a mere superficial change but one that can revitalize landmarks and change the dynamics of public space. Visit [www.architizer.com](http://www.architizer.com).

### Life at the Speed of Rail

Submission Deadline: May 21, 2011

How will high-speed rail change American life in the coming decades? At this critical moment for American infrastructure, Van Alen Institute's Projects in Public Architecture has announced an open call for design ideas that envision the cultural, environmental, and economic impact of a new rail network in the U.S. This multimedia competition seeks the visions of the architectural design community, planners, graphic designers, artists, and

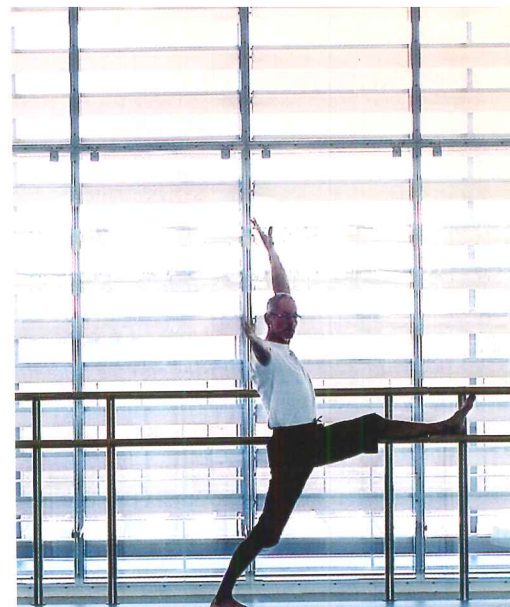

## Grace under fire.

Aluflam offers true extruded aluminum doors, windows and walls which are fire-rated for up to 60 minutes. These systems blend perfectly with non-rated storefront and curtain wall systems with clear glass and extruded aluminum profiles. Specifying Aluflam allows you to provide fire safety while reaching for your design goals.

Visit [www.aluflam-usa.com](http://www.aluflam-usa.com)



**aluflam**

architectural fire-rated solutions

Fire-rated aluminum window and door systems

15551 Industry Lane  
Huntington Beach, CA 92649  
Ph: 714.899.3990  
Fax: 714.899.3993  
E-mail: [info@aluflam-usa.com](mailto:info@aluflam-usa.com)

CIRCLE 06

Supporting your designs.



*In the material your customers want*

Walpole is the largest, most experienced fabricator of advanced solid cellular vinyl fence and outdoor structures in the U.S. Working from your designs, we use time-honored methods to handcraft fence, railing, gates, pergolas, arbors, planters, lantern posts and more. To direct buy prefinished wood and wood alternative products, call 800-343-6948.



**Walpole Woodworkers.**

CIRCLE 126

800-343-6948 • walpolewoodworkers.com

**Grasspave<sup>2</sup>**



Environmentally Friendly  
100% Grass Coverage  
Strong - 5721 psi

grasspave2.com  
800-233-1510



CIRCLE 58

# Reusable. Reliable. Remarkable.

## Introducing VELCRO® Brand Carpet Protection

Today's aggressive construction schedules are causing trades to overlap, with finishes installed sooner than you would like. Minimize risk, make job sites more environmentally friendly by reducing waste and adhesive use, and avoid costly last minute delays and claims.

**Specify VELCRO® Brand Carpet Protection** for your next project.

**Make it part of your plans.**

- **Reusable**—less waste and more environmentally friendly
- **No adhesives**—no risk of residue or damaged carpeting
- **Easy to install,** reposition and reuse—saves money
- **Breathable**—allows carpet adhesives to cure properly

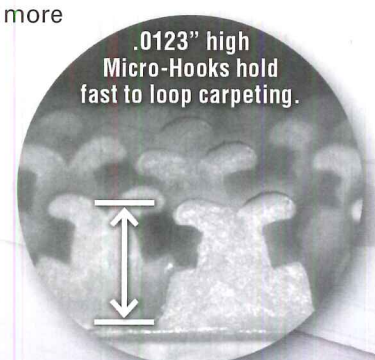

.0123" high Micro-Hooks hold fast to loop carpeting.



Velcro Industries B.V. owns VELCRO and other marks. ©2011



800-225-0180 ■ marketing@velcro.com  
velcroconstruction.com/architects  
CIRCLE 123



[kalwall.com](http://kalwall.com)  
[daylightmodeling.com](http://daylightmodeling.com)

Since 1955  
**Kalwall**  
 ...is the way.

**Building with daylight.**

- Sustainable/LEED®
- The most highly insulating
- Museum-quality daylight™
- Maintenance-free
- Vandal resistant
- Shatterproof
- DoD, anti-terrorism compliant



Kalwall Corporation  
 800-258-9777 (N. America)



THE AMERICAN INSTITUTE  
 OF ARCHITECTS  
 Committee on Architecture for Education

Follow us on  
[facebook.com/Kalwall](http://facebook.com/Kalwall)

**DATES & EVENTS**

anyone who wants to contribute to the discussion surrounding high-speed rail. Entrants are asked to produce projects and narratives picturing the wide-ranging impacts that a new transportation network will have on the nation's communities. Ten winning submissions will be awarded \$1,000 each. A selection of additional submissions will receive honorable mentions. Visit [www.vanalen.org/lifeatthespeedofrail](http://www.vanalen.org/lifeatthespeedofrail).

**The Leicester B. Holland Prize**

*Submission Deadline: May 31, 2011*

This annual competition recognizes the best single-sheet measured drawing of a historic building, site, or structure prepared by an individual or a group to the standards of the Historic American Buildings Survey, Historic American Engineering Record, or the Historic American Landscapes Survey. The prize is intended to increase awareness, knowledge, and appreciation of historic sites, structures, and landscapes throughout the United States. Visit [www.nps.gov](http://www.nps.gov).

**Architectural Record  
 Cocktail Napkin Sketch Contest**

*Deadline: July 21, 2011*

All you need is a white cocktail napkin and a pen to demonstrate that the art of sketching is still alive. Licensed architects and related professionals who practice in the United States are invited to enter this contest. Two grand-prize winners will be published in the October issue of ARCHITECTURAL RECORD, and winners will receive a box of napkins with their sketch printed on it. The grand-prize winners and up to 10 finalists will also receive a collection of Pentel Arts writing instruments. Winners and finalists will be exhibited on the online gallery. To enter, go to [www.architecturalrecord.com/call4entries](http://www.architecturalrecord.com/call4entries).

**Show Us Your Record Collection**

ARCHITECTURAL RECORD readers have been subscribers for an average of 18 years. Sixty-five percent of them save their copies for future use. Photograph your collection or your firm's collection of ARCHITECTURAL RECORD and upload at [archrecord.com](http://archrecord.com) (digital editions count) for a chance to win an iPad. Three winners will be selected, one in each of the following categories: Oldest Collection, Largest Collection, and Most Creative Presentation. The winning collections will be exhibited in a photo gallery. For more information, visit [www.architecturalrecord.com/call4entries](http://www.architecturalrecord.com/call4entries).

*E-mail information two months in advance to [recordevents@mcgraw-hill.com](mailto:recordevents@mcgraw-hill.com). For more listings, visit [architecturalrecord.com/news/events](http://architecturalrecord.com/news/events)*

- 100% vertical grain cedar
- Overlocking end joint
- Concealed nailing
- Traditional shingle butt
- Unlimited pre-finish options
- Fire resistant
- Rain screen technology

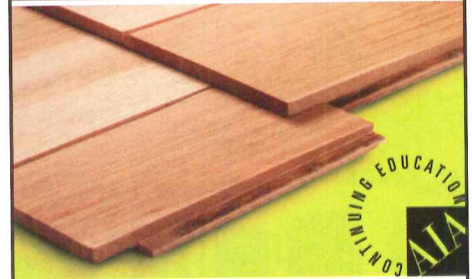

**Tradition meets  
 Innovation**

Shakertown's Craftsman shingle panels combine the appeal of traditional cedar shingles with innovative features that improve performance and reduce onsite costs.

The panels offer fire resistance, a built in rain screen system and a significantly lower environmental footprint than man materials. They install up to 10 times faster than individual shingles.

Add the beauty and performance of Shakertown's Craftsman shingle panels to your next project. Call **1-800-426-8970** or go to [www.shakertown.com](http://www.shakertown.com) for more information on our AIA Lunch & Learn, "Fire Resistive Construction Using Western Red Cedar Shingles."

**SHAKERTOWN**  
 CEDAR SHINGLES SIMPLIFIED



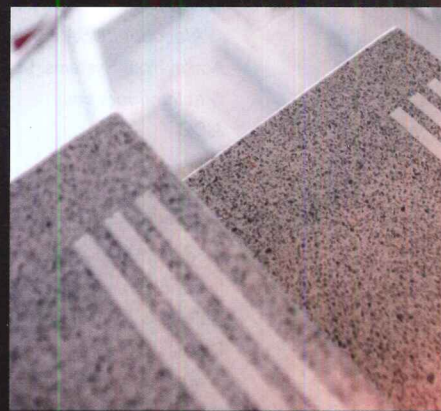
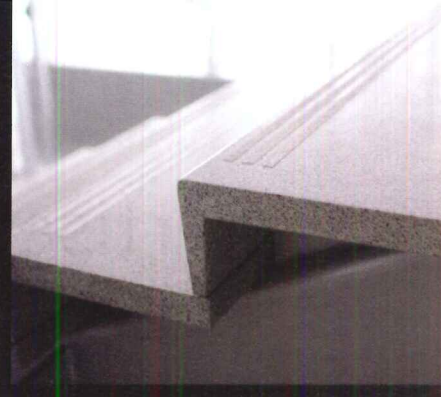

**PRECAST TERRAZZO DESIGNS**  
 TERRAZZO *and* EPOXY STAIRS, BASES, SILLS, WALL *and* LANDING PANELS  
 Free shop drawings & samples

MADE IN  
**WAUSAU**<sup>®</sup>  
 www.wausautile.com  
 800-388-8728

CIRCLE 127

**HOW TO**  
 combat  
 global warming,  
 reduce the  
 production of  
 greenhouse gases,  
 and **build a**  
 stronger infrastructure.

**SPECIFY FLY ASH**  
 (a recovered resource)  
 as a replacement for cement  
 in concrete.

When you specify fly ash as replacement for cement in concrete, you help reduce CO<sub>2</sub> emissions from cement production, conserve landfill space, and decrease water usage. You also enhance workability and chemical attack resistance, increase strength and produce more durable concrete.

Contact Headwaters Resources for free technical literature and information on how fly ash use benefits the environment and produces better concrete.



**HEADWATERS**  
 RESOURCES

www.flyash.com | 1-888-236-6236

CIRCLE 52

**HUNZA**<sup>™</sup> PURE  
 OUTDOOR  
 LIGHTING



**PURE ENGINEERING**

The Hunza Path Lite is machined from solid metals, such as 316 stainless steel or natural copper, to provide the perfect combination of durability and performance. At Hunza we take pride in making the finest outdoor lights in the world, engineered in New Zealand from the best materials to provide a lifetime of pure enjoyment.

www.hunzausa.com

Ph: +1 888 578 6005 Toll Free  
 sales@hunzalightingusa.com



PURE NEW ZEALAND LIGHT<sup>™</sup>

CIRCLE 56

# Get Free Information

from our advertisers! Fill out this Reader Service Card and send back today or go to [ArchRecord.com](http://ArchRecord.com) > Products tab > Reader Service

## Advertisers Index

Reader Service #	Advertiser	Page	Reader Service #	Advertiser	Page	Reader Service #	Advertiser	Page
1	3A Composites USA, Inc. <i>AlucobondUSA.com</i>	44	18,137-140	Ceilings Plus <i>ceilingsplus.com</i>	57	145	Eventscape <i>eventscape.net</i>	67
2	Action Floor Systems, LLC <i>actionfloors.com</i>	73	19	CENTRIA <i>CENTRIA.com</i>	10,11	43	Excel Dryer, Inc. <i>exceldryer.com</i>	235
3	AISC <i>aisc.org</i>	74	20	CertainTeed Gypsum <i>certainteed.com</i>	143	44	Figueras Seating USA <i>figueras-usa.com</i>	103
4	Alcoa Architectural Products <i>alcoaarchitecturalproducts.com</i>	24	21	Chamberlain Group, Inc. <i>liftmaster.com</i>	66	46	Forestry Innovation Investment Ltd. <i>naturallywood.com</i>	194
5	Alcoa Architectural Products <i>ecoclean.com</i>	95	22	Charles Loomis <i>charlesloomis.com</i>	235	45	Forestry Innovation Investment Ltd. <i>naturallywood.com/ar</i>	195-199
	ALPOLIC / Mitsubishi Plastics Composites America, Inc. <i>alpolic-northamerica.com</i>	32A-B	23,24	Construction Specialties <i>c-sgroup.com</i>	37,39	47	Forms & Surfaces <i>forms-surfaces.com</i>	48
6	AluFlam USA <i>alufлам-usa.com</i>	228	25	Construction Specialties <i>c-sgroup.com</i>	35	131	GreenGuard Environmental Inst. <i>greenguard.org</i>	219
7	American Galvanizers Association <i>galvanizeit.org/protection.com</i>	220	26	Cool Roof Rating Council <i>coolroofs.org</i>	201-203	49	Griffith Rubber Mills <i>griffithrubber.com/stanlock</i>	163
8	American Hydrotech, Inc. <i>hydrotechusa.com</i>	215	27	Cotton Incorporated <i>CottonFromBlueToGreen.org</i>	179	50	Guardian Industries Corp. <i>SunGuardGlass.com</i>	65
9	American Specialties, Inc. <i>americanspecialties.com</i>	225	28	CPI Daylighting <i>cpidaylighting.com</i>	112	51	Halfen Anchoring Systems <i>halfenusa.com</i>	28
	Architectural Record <i>architecturalrecord.com/call4entries</i>	16,17	29	CR Laurence <i>crlaurence.com</i>	224	52	Headwaters Resources <i>flyash.com</i>	231
	Architectural Record <i>architecturalrecord.com/call4entries</i>	20,77	30	Crane Composites <i>cranecomposites.com</i>	228	53	Henry Company <i>henry.com</i>	213
10	Armstrong World Industries <i>armstrong.com</i>	1,Cov2	31,32	Custom Building Products <i>custombuildingproducts.com</i>	227,218	54	Holcim (US) Inc. <i>holcim.us</i>	162
11	Artemide <i>artemide.us</i>	71	33	Design Intelligence <i>di.net/about</i>	227	55	Horton Automatics <i>hortondoors.com</i>	222
133	ATAS International, Inc. <i>atas.com</i>	161	34	Diamond Spas <i>diamondspas.com</i>	220	56	Hunter Douglas Contract <i>hunterdouglas.com</i>	16A-L
149	BEGA <i>bega-us.com</i>	21	35	DORMA <i>dorma-usa.com</i>	215	57	Hunza Lighting <i>hunzausa.com</i>	231
134	Belden Brick <i>beldenbrick.com</i>	200	36	Doug Mockett & Company Inc. <i>mockett.com</i>	60	58	International Code Council <i>iccsafe.org/planreview</i>	222
12	Birdair <i>birdair.com</i>	40,41	37	Dri-Design <i>dri-design.com</i>	68	58	Invisible Structures Inc. <i>invisiblestructures.com</i>	229
13	Bison Deck Supports <i>BisonDeckSupports.com</i>	226	38	E Dillon & Company <i>edillon.com</i>	87	59	Julius Blum & Co. Inc. <i>juliusblum.com</i>	81
14	Bobrick <i>bobrick.com</i>	31	39	Easi-Set Industries <i>AR.slenderwall.com</i>	42	60	Kalwall Corporation <i>kalwall.com</i>	230
15	BOCCI <i>bocci.ca</i>	64	40	EDICER s.p.a. (Ceramic Tile of Italy) <i>italiantiles.com</i>	30	61	Kawneer <i>kawneer.com</i>	93
16	Boston Architectural College <i>the-bac.edu</i>	239	41	Engineered Lighting Products <i>elighting.com</i>	216	62	Kepeco+ <i>kepecoplus.com</i>	80
17	Cascade Coil Drapery <i>casca decoil.com</i>	220	42	EPIC Metals Corporation <i>epicmetals.com</i>	29	63	KONE INC. <i>kone.com</i>	110
132	Cavawood Architectural Wood Poles <i>cavawood.com</i>	221						

# Get Free Information

from our advertisers! Fill out this Reader Service Card and send back today or go to [ArchRecord.com](http://ArchRecord.com) > Products tab > Reader Service

# Advertisers Index

Reader Service #	Advertiser	Page	Reader Service #	Advertiser	Page	Reader Service #	Advertiser	Page
64	L. & J. G. Stickley, Inc. <i>stickley.com</i>	14	87	🇸 Panda Windows & Doors <i>panda-windows.com</i>	111	108	🇸 Sloan Valve Company <i>sloanvalve.com</i>	79
65	Ledalite, Division of Philips Lighting <i>areyoureadytojump.com</i>	58,59	88	🇸 Pella Corporation <i>pella.com</i>	23	109	🇸 Soil Retention <i>soilretention.com</i>	32
66	LEDtronics Inc. <i>ledtronics.com</i>	175	89	🇸 Petersen Aluminum <i>pac-clad.com</i>	76	130	Stonepeak <i>stonepeakceramics.com</i>	178
67	Lighting Quotient, The <i>thelightningquotient.com</i>	146	90	🇸 Pilkington <i>pilkington.com</i>	113	111	SYNTHEON <i>syntheoninc.com</i>	141
68	Lindner USA, Inc. <i>LindnerUSA.com</i>	62	91	🇸 Pine Hall Brick Co. <i>americaspriempaver.com</i>	145	97	Tamlyn <i>tamlyn.com</i>	234
69	Lutron Electronics Co., Inc. <i>lutron.com</i>	Cov4	92,93	🇸 PPG <i>ppgideascape.com</i>	4,5	112	Technical Glass Products <i>fireglass.com/hd</i>	12,13
70	🇸 Major Industries, Inc. <i>majorskylights.com</i>	91	94	🇸 PPG Industries, Inc. <i>ppgideascape.com</i>	26,27	113	Technical Glass Products <i>fireglass.com</i>	183-187
71	Manning Lighting <i>manningltg.com</i>	75	95	Price <i>price-hvac.com/dv</i>	140	116	🇸 Timely <i>timelyframes.com</i>	61
72	Marvin Windows & Doors <i>marvin.com</i>	6	85	ProSpec <i>prospec.com</i>	223	117	Toto USA <i>totousa.com</i>	105
73	🇸 MBCI <i>mbci.com</i>	43	96	Prudential Lighting <i>prulite.com</i>	177	118	Tournesol Siteworks <i>tournesolsiteworks.com</i>	234
	McGraw-Hill Construction <i>construction.com</i>	49-56	98	Rambusch <i>rambusch.com</i>	172	119	Trespa <i>trespa.com/na</i>	107
	McGraw-Hill Construction <i>construction.com</i>	204	99	Rev-A-Shelf, LLC <i>rev-a-shelf.com</i>	142	120	🇸 Tubelite Inc. <i>tubeliteinc.com</i>	160
74	MechoShade Systems, Inc. <i>MechoShadeSystems.com</i>	180	100	RHEINZINK <i>rheinzink.com</i>	144	124	🇸 Umicore Building Products USA Inc. <i>vmzinc-us.com</i>	82
75	🇸 Mitsubishi Electric <i>mitsubishiipro.com</i>	109	101	Rocky Mountain Hardware <i>rockymountainhardware.com</i>	101	121	Underwriters Laboratories Inc. <i>ul.com</i>	97
114	Modern Fan Co., The <i>modernfan.com</i>	218	102	🇸 SAFTI FIRST <i>safti.com</i>	18,19	122	Valspar Corporation <i>valsparcoil.com</i>	99
76	Modernus <i>modernus.com</i>	211	103	Salsbury Industries <i>mailboxes.com</i>	235	123	Velcro USA Inc. <i>velcroconstruction.com</i>	229
143	modularArts <i>modulararts.com</i>	226	104	SCHOTT North America, Inc. <i>us.schott.com/pyran</i>	33	125	🇸 VT Industries, Inc. <i>vtindustries.com</i>	Cov3
77	🇸 Mortar Net USA, Ltd. <i>mortarnet.com</i>	216		🇸 Scranton Products, Inc. <i>scrantonproducts.com</i>	72A-B	126	Walpole Woodworkers <i>walpolewoodworkers.com</i>	229
78	MP Lighting <i>mplighting.com</i>	167	105	Selux <i>selux.com/usa</i>	171	127	🇸 Wausau Tile, Inc. <i>wausautile.com</i>	231
79,80	🇸 NanaWall Systems, Inc. <i>NanaWallSystems.com</i>	188-193	82	Sentrigard Metal Roofing Systems <i>sentrigard.com</i>	108	128	Western Red Cedar Lumber Association <i>realcedar.org</i>	159
81	🇸 National Terrazzo & Mosaic Assn., Inc. <i>ntma.com</i>	78	106	Shakertown <i>shakertown.com</i>	230	129	Zahner <i>azahner.com</i>	217
83	Nedlaw Living Walls <i>NedlawLivingWalls.ca</i>	8,9	107	Simpson Strong Tie <i>strongtie.com/strongframe</i>	7			
84	NeoCon <i>neocon.com</i>	182		Skyscraper Museum, The <i>skyscraper.org</i>	234			
86	🇸 Oldcastle BuildingEnvelope® <i>oldcastlebe.com</i>	2,3	115	Sliding Door Company, The <i>slidingdoorco.com</i>	206			

# THE SKYSCRAPER MUSEUM

# VERTICAL URBAN FACTORY

through July 2011

Visit [www.skyscraper.org](http://www.skyscraper.org) for a full list of programs, including upcoming factory tours

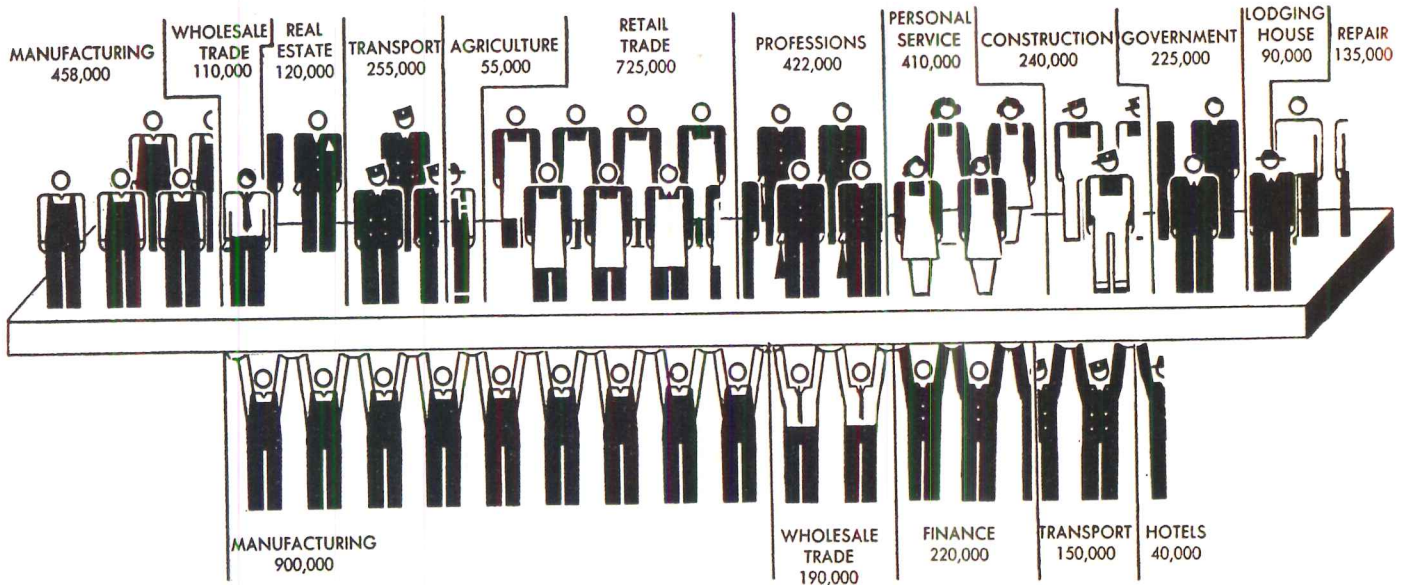

Labor Force in the NY Metropolitan Region, 1940. Each figure = 100,000 people

39 Battery Place, NY, NY 10280 | [www.skyscraper.org](http://www.skyscraper.org) | Wed - Sun 12 - 6pm

RPA Economic Status of NY Region, 1944

Building Science Innovations®

## XTREME TRIM™

For use with fiber cement siding and soffit

Versatile Design Options . Aesthetically Pleasing  
Sustainable . Durable . Lightweight

- Xtreme Trim™
- PVC Trim
- Color Flashing
- Color Sealant
- Fiber Cement Blades

**TAMLYN**  
www.tamlyn.com

CIRCLE 97

## BETWEEN LANDSCAPE + ARCHITECTURE

**Tournesol**  
SITEWORKS

- Complete Hanging Planter Systems
- Living Walls
- Pots & Planters

Learn more about our complete solutions for the urban environment at [tournesolsiteworks.com](http://tournesolsiteworks.com), or call 800.542.2282 for a 100-page catalog.

CIRCLE 118

# NEXT GENERATION GREEN RESTROOM DESIGN

(Featured USGBC CEU Course @ [www.usgbc.org/virtualltour](http://www.usgbc.org/virtualltour))

## REDUCE

WATER

COST

CARBON



UP TO  
50%

OVER  
90%

OVER  
70%

## TIME TO THROW IN THE TOWEL®

Excel Dryer inc. • 1.800.255.9235 • [www.exceldryer.com](http://www.exceldryer.com)

CIRCLE 43

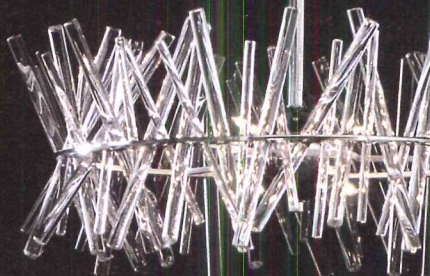

"Stiletto Collection"  
by

*Loomis*

CHARLES LOOMIS, INC.  
P: 800.755.0471  
[www.charlesloomis.com](http://www.charlesloomis.com)

CIRCLE 22

### Mailboxes

[mailboxes.com](http://mailboxes.com)  
1-800-MAILBOX



Contact us today for a **FREE** quote or catalog!

1010 East 62nd Street • Los Angeles, CA 90001-1598  
Phone: 1 800 624 5269 • Fax: 1 800 624 5299

**SALSBURY**  
INDUSTRIES  
People Committed to Quality Since 1936

CIRCLE 103

## PRODUCT SPOTLIGHTS

Advertisement

### DOORS, WINDOWS

#### LIFT & SLIDE SLIDING DOOR SYSTEM

\$\$\$ | G | NEW

##### Panda Windows and Doors

▲ Panda manufactures and distributes some of the finest custom windows and doors in the world today.

##### Product Application:

- High-end custom residential; luxury high-rise condos, hotels, world-class resorts
- Restaurants, lounges, and nightclubs

##### Performance Data:

- Available in aluminum, wood clad, thermally broken, and all wood
- Pocketing available
- Low-profile track at 3/16 in. above finished floor

www.panda-windows.com  
702.643.5700



Circle 150

### DOORS, WINDOWS

#### CONCEALED DOOR CLOSER

\$\$\$

##### Samuel Heath

▲ Perko Power™ concealed door closers deliver benefits in aesthetics, performance, and safety for hotel, healthcare, education, and other applications.

##### Product Application:

- Aria Resort, Las Vegas, NV
- Hilton Hotel
- Godolphin and Latymer School

##### Performance Data:

- UL10B/10C/228
- ANSI/BHMA A156.4

www.perkopower.com  
212.599.5177



Circle 151

### DOORS, WINDOWS

#### CUSTOM DOORS & FRAMES

\$\$ | WR | G

##### Tubelite® Inc.

▲ Make Tubelite your supplier of choice for doors with custom hardware and special sizes.

##### Product Application:

- Schools
- Retail
- Office

www.tubeliteinc.com  
616.301.0056 | Contact: Walt Lutzke



AIA Booth #2228

Circle 152

### DOORS, WINDOWS

#### TOTAL DESIGN SYSTEM

G | NEW

##### Azon

▲ MLP™ (mechanical lock profile) and Warm-Light® warm-edge spacer for insulating glass—energy efficiency and high strength for aluminum fenestration products.

##### Product Application:

- Storefront and curtain wall applications
- Commercial aluminum, windows, doors, skylights; thermal barriers for framing, glazing

##### Performance Data:

- Intelligent technologies reduce overall U-factor
- Higher CRF (condensation resistance factor)

www.azonintl.com  
800.788.5942



1 WARM-LIGHT®  
Insulating glass spacer

2 MLP™  
mechanical lock profile

Circle 153

### DOORS, WINDOWS

#### OVERSIZED UNIT SKYLIGHTS

##### CPI Daylighting Inc.

▲ CPI MegaSky Oversized Unit Skylights provide extra daylighting with more than double the insulation of acrylic units. Complies with OSHA standards.

##### Product Application:

- Fits conventional 4- or 5-ft. bar joists with skylight lengths of 10, 12, or 14 ft.
- Warehouses, distribution centers, supermarkets, etc.
- Green construction requiring LEED certification

##### Performance Data:

- No obstructive metal cage required
- Anti-glare matte finish

www.cpidaylighting.com  
800.759.6985 | Contact: Talia Vinograd

MEGASKY  
Oversized Skylights



AIA Booth #737

Circle 154

### DOORS, WINDOWS

#### ICONIC, REFINED HARDWARE

WR

##### Specialty Doors

▲ Make a statement with sliding doors. Wide selection of styles, sizes, and finishes. Enhance offices, lofts, homes, and more with hardware that can transform any room. For fast, friendly, old-fashioned service, give them a call. Mention this ad for a dealer discount. Guaranteed lowest price.

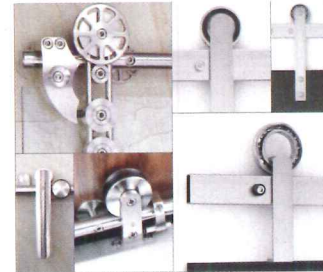

www.barndoorhardware.com  
866.815.8151

Circle 155

### MATERIALS

#### ARCHITECTURAL NATURAL STONE

\$\$\$ | G

##### Vermont Structural Slate Company

▲ Quarrier and fabricator offering select slates, quartzites, sandstones, limestones, marbles, granites and basalts.

##### Product Application:

- Private residence
- Semi-Weathering Gray-Green and Heathermoor slate roof
- Sanford Strauss Architects

www.vermontstructuralslate.com  
800.343.1900 | Contact: Craig Markcrow



Circle 156

### MATERIALS

#### FIRE-RATED GLASS CERAMIC

##### Technical Glass Products

▲ FireLite® with ultraHD™ Technology is a clear choice when you don't want to compromise on aesthetics to meet fire-safety codes.

##### Product Application:

- Post Road Elementary, White Plains, NY
- Seattle-Tacoma International Airport, Seattle, WA
- Shaklee Headquarters, Pleasanton, CA

##### Performance Data:

- Fire ratings up to three hours
- Impact safety options, passes hose stream test

www.fireglass.com  
800.426.0279 | Contact: sales@fireglass.com



Circle 157

PRODUCT SPOTLIGHTS

Advertisement

MATERIALS

QUARTERSAWN HARDWOODS

\$\$\$ | G

Frank Miller Lumber Company, Inc.

Frank Miller Lumber Co. produces high-quality quartersawn and rift hardwoods. White oak, red oak, Walnut, cherry, and hard maple also available.

Product Application:

- Interior millwork, cabinetry, flooring, furniture
- Hotels, museums, offices, high-end residential
- High Museum, Atlanta, GA; Getty Museum, Los Angeles, CA; Lodge at Torrey Pines, Del Mar, CA

Performance Data:

- Quartered white oak and red oak are durable, stable, and sustainable; FSC certified available



www.frankmiller.com

765.964.3196 | Contact: Criswell Davis

Circle 158

MECHANICAL SYSTEMS, HVAC, PLUMBING

ARCHITECTURAL CEILING FANS & LIGHTING

G

G Squared Art

San Francisco ceiling fan—a GOOD DESIGN Award winner. Whisper quiet, powerful, reliable energy saver.

Product Application:

- Suitable for sloped ceilings up to 30°, can be used on 8-ft. ceilings or on cathedral ceilings

Performance Data:

- Light kit and other finishes available
- Lifetime warranty



www.g2art.com

877.858.5333 | Contact: info@g2art.com

Circle 159

MECHANICAL SYSTEMS, HVAC, PLUMBING

LINEAR DRAIN SYSTEMS

WR | NEW

Infinity Drain

Infinity Drain offers linear drain systems for the shower, pool, patio or driveway, providing an architectural aesthetic and infinite possibilities.

Performance Data:

- Site sizable, cut to desired length
- Locate outlet anywhere on channel run
- Any type waterproofing, including hot mop
- 316 wedge wire stainless steel grate
- Available in kits or individual components

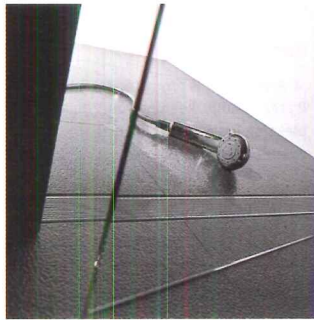

www.infinitydrain.com

516.767.6786 | Contact: info@infinitydrain.com

ICFF Booth #1339

Circle 160

ROOFING, SIDING, THERMAL & MOISTURE PROTECTION

ARCHITECTURAL TERRA COTTA

\$\$\$ | G

Boston Valley Terra Cotta

The TerraClad™ product line is a ceramic material formed into high-performance rainscreen panels, baguettes, and louvers. Potential 10 LEED™ credits.

Product Application:

- North Carolina Biotechnology Center - Research Triangle Park, NC (shown)
- Urbanica 691, Boston, MA
- Harrah's Ak-Chin Hotel & Casino, Maricopa, AZ

Performance Data:

- Miami-Dade NOA No. 08-1014-03; NYC MEA 1220-07M



www.bostonvalley.com

888.214.3655 | Contact: Patricia Aubrecht

AIA Booth #3823

Circle 161

ROOFING, SIDING, THERMAL & MOISTURE PROTECTION

NATURE. NOW AVAILABLE IN ALUMINUM.

\$ | G | NEW

Alcoa Architectural Products

Reynobond® Design Line finishes, inspired by Mother Nature, offer a variety of striking design choices with all the benefits of Reynobond aluminum composite material.

Performance Data:

- 39 distinct color choices
- Lightweight
- Offers strength and flexibility



alcoaarchitecturalproducts.com

800.841.7774 | Contact: Customer Service

AIA Booth #1935

Circle 162

ROOFING, SIDING, THERMAL & MOISTURE PROTECTION

VEGETATIVE ROOF ASSEMBLY

WR | G

Henry Company

Proven technology and single-source warranty from waterproofing membrane, hot rubberized liquid asphalt, and vegetation—all in one agreement.

Performance Data:

- Single-source warranty from membrane to vegetation
- 790-11 SBS-modified leak-proof asphalt membrane
- Hot rubberized, liquid asphalt seals penetrations
- Henry waterproofing proven for 40 years
- 75+ million square feet of installed roofing



www.henry.com

800.486.1278 | Contact: Pete Friedli

AIA Booth #2501

Circle 163

ROOFING, SIDING, THERMAL & MOISTURE PROTECTION

INNOVATIVE METAL WALL SYSTEMS

WR

ATAS International, Inc.

ATAS offers a variety of horizontal and vertical wall panels; mix & match profiles for visual impact with interesting patterns and designs.

Performance Data:

- Profiles: ribbed, corrugated, smooth, structural panels with exposed or concealed fasteners
- Mix & match profiles
- Complementing Elite trim for crisp sight lines
- Perforated panels
- 30 standard color choices and custom colors



www.atas.com

800.468.1441

AIA Booth #3737

Circle 164

ROOFING, SIDING, THERMAL & MOISTURE PROTECTION

OPERABLE SKYLIGHTS & RETRACTABLE ROOF ENCLOSURES

WR | G

OpenAire Inc.

Beautiful custom structures that open up to the sun, air, and stars. Retractable roof provides year-round usage, lower energy and operating costs, reduces HVAC needs, improves daylighting, and draws crowds.

Product Application:

- Restaurants, hotels, shopping malls, aquatic, office atriums, community centers, waterparks, and more

Performance Data:

- Custom designs open up 100%
- Clearspans from 150 ft. - 300 ft.
- LEED, lower life-cycle costs



www.openaire.com

800.267.4877 | Contact: sales@openaire.com

Circle 165

## PRODUCT SPOTLIGHTS

### ROOFING, SIDING, THERMAL & MOISTURE PROTECTION

#### SPECIFIER ALERT

\$ | G

#### Mortar Net® USA

▲ Include Mortar Net® with insect barrier protection in your specifications. Now Mortar Net® with insect barrier adds another layer of defense—inside the wall cavity.

#### Product Application:

- For traditional brick cavity wall construction

#### Performance Data:

- Simply insert “with insect barrier” into Mortar Net specs
- Patented masonry drainage products



www.mortarnet.com

800.664.6638 | **Contact:** Jerry Combs

| Circle 166

### SPECIALTY PRODUCTS

#### ARCHITECTURAL COLUMNS, BALUSTRADES & CORNICES

#### Architectural Columns & Balustrades by Melton Classics

▲ Melton Classics provides the design professional with an extensive palate of architectural columns, balustrades, cornices, and millwork. They invite you to call their experienced product specialists to assist you with the ideal products for your design, application, and budget. Columns are available in fiberglass, synthetic stone, GFRC, and wood. Their 80+ durable maintenance-free balustrades feel substantial yet have reduced weight. Also, ask about their low-maintenance fiberglass and polyurethane cornices and millwork.



www.MeltonClassics.com

800.963.3060 | **Contact:** Mike Grimmert

| Circle 167

### SPECIALTY PRODUCTS

#### ARCHITECTURAL METAL

\$\$ | G

#### Gage Corporation, Int.

▲ GageMetal® is an innovative collection of 23 designs suitable for walls, elevators, column covers, and other architectural fabrication. Standard sizes 48 in. x 96/120 in. with available thicknesses from .025-in. aluminum to 16-gauge stainless steel. GageMetal® is one component of Gage Vertical Surfacing. Custom design and collaboration is available. Contact the Gage factory for literature and sample requests.



www.gagecorp.net

800.786.4243

Circle 168

### SPECIALTY PRODUCTS

#### PRIMED WHITEWOOD TRIM

\$ | G

#### Belco Forest Products

▲ Armor Coat is protected from the inside out by P3 technology, keeping your trim aesthetically pleasing for years to come.

#### Product Application:

- Residential construction
- Commercial construction

#### Performance Data:

- Protection against termites, fungal decay, and mold
- 20-year limited warranty



www.belcofp.com

800.426.7214 | **Contact:** belcosales@belcofp.com

| Circle 169

### SPECIALTY PRODUCTS

#### CUSTOM-MADE ROLLING LADDERS

#### Putnam Rolling Ladder Co., Inc.

▲ Since 1905 Putnam Rolling Ladder Co. has been manufacturing custom-made rolling ladders.

#### Product Application:

- Library rolling ladder
- Loft ladder
- Decorative office ladders and stools

#### Performance Data:

- Numerous hardwood species, stains, and hardware metal finishes



www.putnamrollingladder.com

212.226.5147 | **Contact:** Sales

Circle 170

### SPECIALTY PRODUCTS

#### HANDRAIL MOUNTING BRACKETS

\$

#### Rangine Corporation / Rakks

▲ Rakks handrail mounting brackets reduce the cost and improve the quality of railing installation. This two-piece system consists of heavy-gauge cast aluminum parts, one that is attached to the wall and the other to the handrail. The unique design compensates for a wide margin of installation error and wall irregularities. Serrated surfaces lock together to eliminate slippage. Available in two sizes for 5-in. and 7-in. nominal height railings. Meets or exceeds OSHA and ADA standards. Contact Rangine Corporation for information.



www.rakks.com

800.826.6006

| Circle 171

### SPECIALTY PRODUCTS

#### BRACKET

\$\$ | G | NEW

#### The Wagner Companies

▲ Wagnerail Slip-Fit™ System.

#### Performance Data:

- Eliminate welded and glued joints
- Simplify installation—complete system in minutes
- Lumenrail® Ipe wood and laminated bamboo options

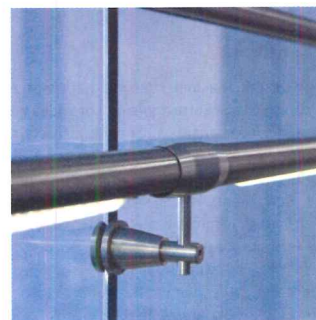

www.wagnercompanies.com

888.243.6914 | **Contact:** Sales

AIA Booth #2719

| Circle 172

### SPECIALTY PRODUCTS

#### SUN CONTROLS

WR | G

#### Airolite

▲ Produced to your custom design and specification, marrying aesthetics and energy efficiency.

#### Product Application:

- Koll Airport Professional Park, Irvine, CA
- Univ. of Colorado Hospital, Anschutz Inpatient Pavilion, Aurora, CO

#### Performance Data:

- Comprehensive system to filter up to 80% of the sun's heat and glare
- All-welded connections withstand intermittent windloading



www.airolite.com

715.841.8757 | **Contact:** Leight Murray

Circle 173



## PROFESSIONAL SERVICES

## Security Consulting & Engineering Worldwide

[www.MinieriAssociates.com](http://www.MinieriAssociates.com)

## SEMINARS

[WWW.ADAWEBSTUDY.COM](http://WWW.ADAWEBSTUDY.COM)

Updated 5-Hour online coursework on ADA. Meet CAB licensure req'tms and AIA/CES HSW credit.

## POSITIONS VACANT

INTERIOR DESIGNER NY, NY

Utilize knowl of rlted technologies to work on all phases of various interior dsgn projects. Bachelor's deg or foreign equiv in Interior Dsgn or in rlted fld + rlted exp. RES: SR Gambrel Inc., 55 Grove St., NY, NY 10014

MAGNET FOR TALENT

JR Walter Resources, premier A/E/C recruiting firm, can help you grow your company and your career. Review current opportunities at [www.jrwalters.com](http://www.jrwalters.com) or call 269-925-3940.

[WWW.SMPS CAREERCENTER.ORG](http://WWW.SMPS CAREERCENTER.ORG)

Find marketing/BD professionals with A/E/C experience. Call 800-292-7677, ext. 231

To view Architectural Record online visit:  
[www.architecturalrecord.com](http://www.architecturalrecord.com)

# ARCHITECTURAL RECORD

Employers, recruiters, colleges and universities look to our Career Center for recruiting solutions

- **Promote your firm** as a great place to work
- **Recruit top faculty** for your college or university

Use our Classified Advertising section to promote your product or service

- **Promote** to categories including official proposals, software, special services, seminars/training & business opportunities
- **Target coverage** of owners, engineers, specialty consultants, design team members and international professionals
- **Increase your visibility** combine your ad in Architectural Record with online recruitment

To obtain information or to reserve space contact:

Diane Soister at Tel: 212-904-2021/Fax: 212-904-2074

Email: [diane\\_soister@mcgraw-hill.com](mailto:diane_soister@mcgraw-hill.com)

Ruthann Lubrano at Tel: 212-904-2815/Fax: 212-904-2074

Email: [ruthann\\_lubrano@mcgraw-hill.com](mailto:ruthann_lubrano@mcgraw-hill.com)



**BOSTON  
ARCHITECTURAL  
COLLEGE**

Architecture  
Interior Design  
Landscape Architecture  
Design Studies

*The BAC welcomes  
transfer students.*

CIRCLE 16

[the-bac.edu](http://the-bac.edu)  
320 Newbury Street  
Boston MA 02115  
(617) 585-0123

## SNAPSHOT

PROJECT reOrder  
LOCATION BROOKLYN, NY  
DESIGNERS SITU STUDIO



WHEN BROOKLYN-BASED DESIGN and fabrication shop Situ Studio was installing reOrder at the Brooklyn Museum in late February, it looked as though their team was fashioning enormous Victorian skirts for the classical columns in the McKim, Mead & White-designed Great Hall. Up on scaffolding and scissor lifts, they fussed with plywood hoops and precise folds of canvas. Each unique form emits a glow from rectangular LEDs, and the bases of 11 of 16 columns are fitted with exaggerated molding.

"We wanted to break away from the symmetry and the grid of the space," says Westley Rozen, one of Situ Studio's five founding partners. The partners met at Cooper Union and started the firm in 2005. reOrder continues the museum's transformation of the early-19th-century Great Hall, located at the center of the ground floor, into a space that is better suited for exhibitions, performances, and hanging out. Ennead Architects led the design of the renovation, which includes four freestanding gallery walls. *Laura Raskin*



## IMAGINATION IS A DRIVING FORCE

Creativity is always about perspective—being alert, noticing what others don't. At VT, if it lives in your mind, we can help give it life. VT custom wood and laminate doors offer exceptional performance and design, produced with our exclusive edge-before-face method, creating a continuous flush appearance. VT stile and rail can be completely customized by panel configuration, sticking, and veneer. VT Heritage and Artistry doors offer virtually endless options for design expression. With VT as your partner, you'll discover that when inspiration hits, we're there.

**VT**  
INDUSTRIES **Architectural  
Wood Doors**

VTDoors.com 1-800-827-1615 (ext. 512)



The mark of  
responsible forestry

©2011 VT Industries, Inc. All rights reserved.

CIRCLE 125

# Lutron® — save energy and reduce operating costs

**NEW Quantum®** light management solutions can **SAVE 60%** of lighting energy used in your building, respond to **peak pricing** and **demand response** signals, **AND** improve comfort and productivity by utilizing dimming, occupancy sensing, automated shading and daylighting.

## Fluorescent dimming

- Light level is proportional to energy use
- Dim your lights and you'll use less energy
- Dimming lights by 50% uses only 60% of the energy—saving 40%

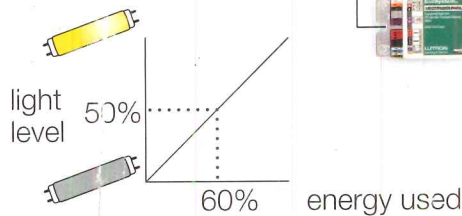

## Occupancy sensors

- Sensors automatically turn lights off when a room is vacant
- Easy to retrofit with wireless communication and 10-year battery life
- Can provide up to 20% lighting energy savings

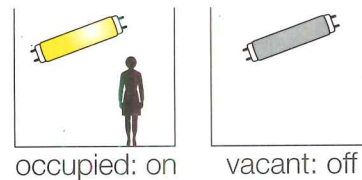

## Automated shades

- Hyperion™ solar-adaptive shading can save 10% on HVAC

**Summer days:** close shades to keep heat out and provide soft, even light, for an enjoyable work environment

**Winter nights:** close shades to keep heat in

**Year round days:** close shades to reduce glare and increase employee productivity



## Smart Grid integration

- Automatically or manually reduce energy usage to avoid peak pricing penalties by adjusting lights and shades
- Allows your facility to easily participate in demand response or peak pricing programs

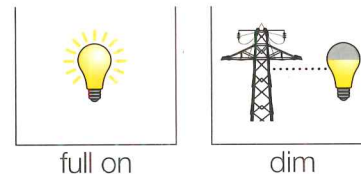

Visit us  
at AIA  
Booth #2253  
and LIGHTFAIR  
Booth #501

For more information on what Lutron Quantum solutions can do for you—or to schedule an on-site lighting energy assessment—call **1.888.LUTRON1** or visit [www.lutron.com](http://www.lutron.com)



©2011 Lutron Electronics Co., Inc.

