

BUILDING NEWS

Profiting by European trial and error, Asia takes the lead in capital-building. Four new cities make Eastern wastelands "blossom like the rose."

But don't go near the water. When all New York a-bathing goes, city fathers are hard put for parking space—mechanical and human.

Pittsburgh places the last Gothic touch on its 42-story Cathedral of Learning, enshrining the memory of Stephen Foster of Sewanee River fame.

Architects on wheels. While Paul Cret interprets the Navajos, Minnesota's Gaarder designs a roving dentist's office.

Decentralized prefabrication from architects' plans may be a tongue twister but it's one of the latest developments on the housing front.

Health Center. Science shorts. New product news. New Literature. Announcements.

ARCHITECTURAL

Record

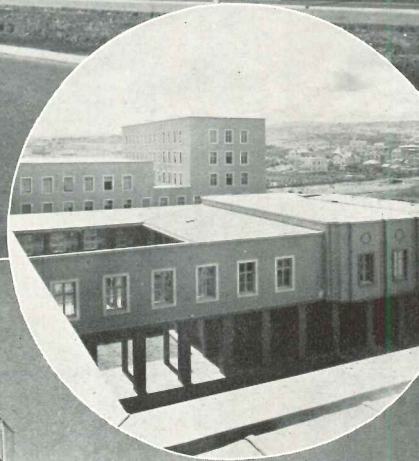
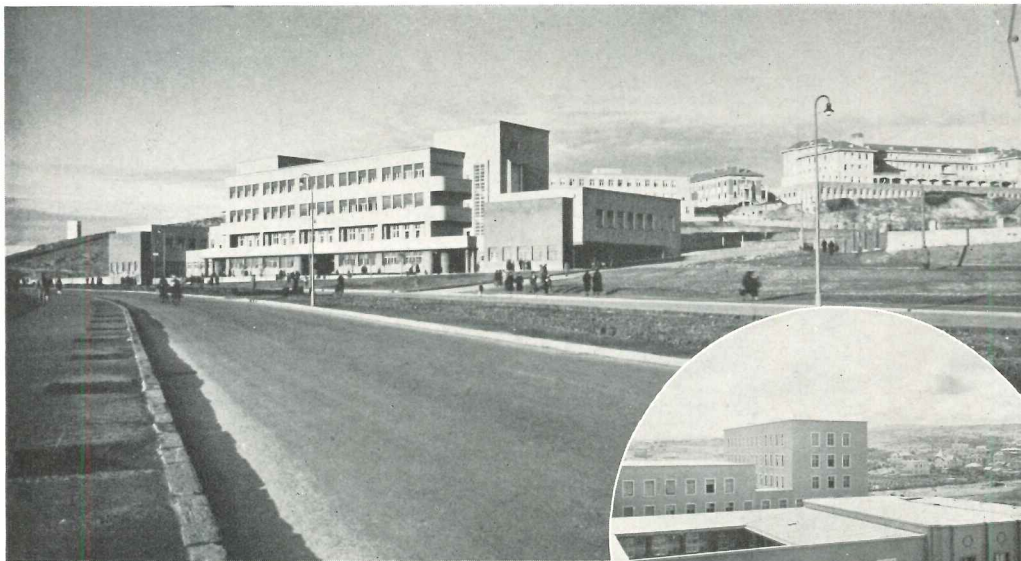
FAR-OFF LANDS BUILD MODERN CAPITALS



Sorfoto

AT ULAN-BATOR, CAPITAL OF THE Mongolian People's Republic, severe flat surfaces of modern architecture furnish a striking background for camel's hair tents of wandering native tribes. In this industrial "combinat,"

built in 1934, are leather, shoe and felt factories, and sheepskin-curing and fur-dressing plants. Ninety thousand pairs of "gutuli"—shoes to the Mongolian—are turned out annually in one of these establishments.

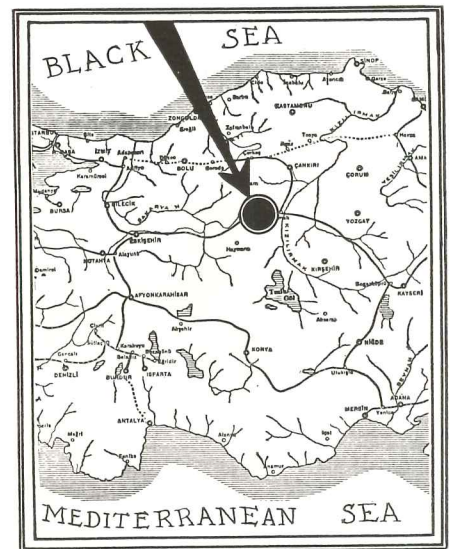


Press Topics Photos

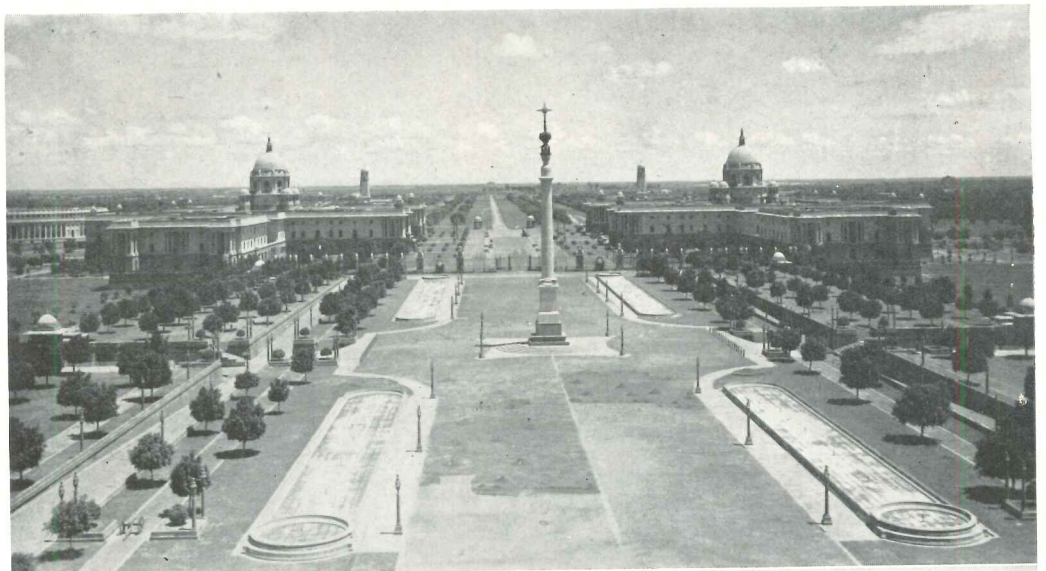
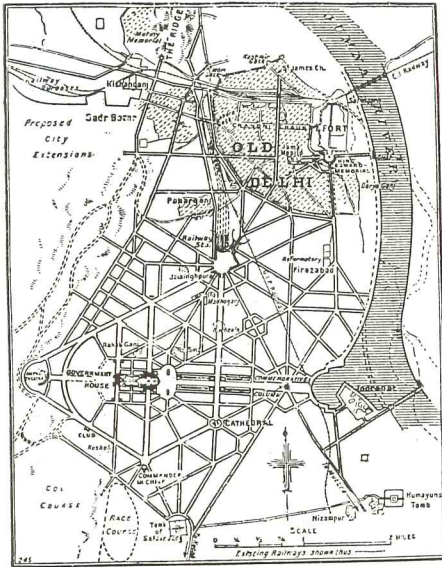
ON ANKARA'S NEWLY LAID-OUT streets stand modern official buildings (top). At the ministry of Public Works (below) is one of the many gardens in-

roduced in the plot plan of the new city. The Ministry of the Interior (inset) was designed by the Austrian architect Holzmeister.

TWENTY-THREE CENTURIES AGO, Ancyra, situated in mid-desert, was the chief city of Galatia. Rebuilt by Kemal Ataturk, and now known as Ankara, this ancient town is the new capital of the new Turkey. Its wide, double-track avenues are lined with buildings of the most modern and up-to-date design. Separate quarters of the city contain embassies, government offices, official residences, shops, stores, and sports.

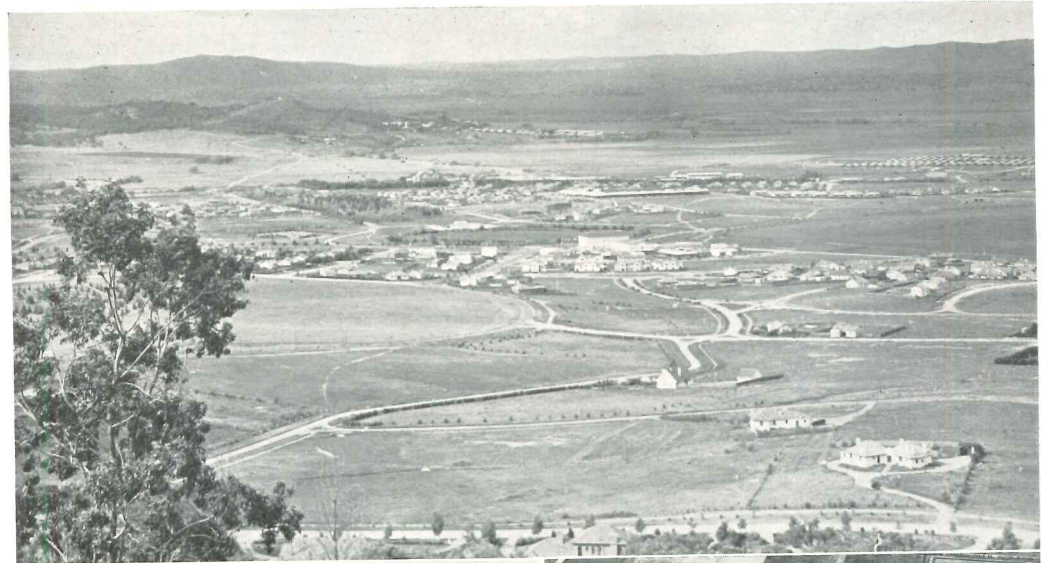
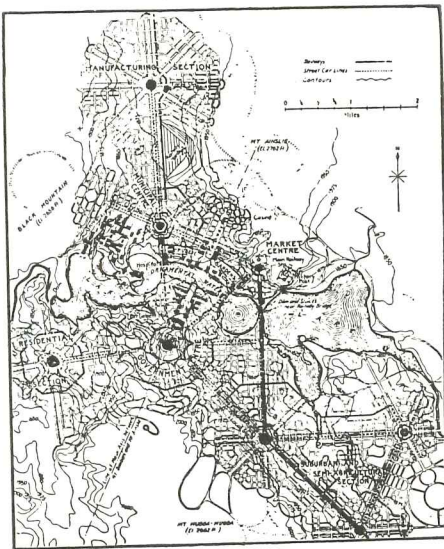


WHERE SHAH JEHAN ONCE HELD his gorgeous court, the British government is constructing a new capital for India. More suited to the kind of government now maintained in India than what passes as indigenous Indian architecture, is the type used, which, though derived from Classic forms, is modified with Saracenic detail.



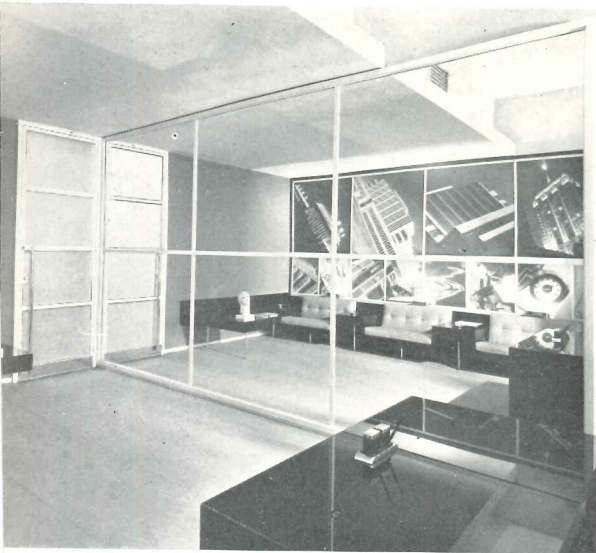
DELHI'S NEW SECRETARIAT (above), seen from the top of the Viceroy's House (below, left), consists of two buildings, similar in design, with a wide esplanade between them. The Legislative Councils Chamber (below, right) has 148 Corinthian columns on its periphery.

THE MOST DELIBERATELY PLANNED of these projects is Canberra, capital of Australia. On what was an absolutely barren plain, the city is under construction according to the plan of W. B. Griffin, Chicago architect, chosen in competition held in 1912. Changes in government control have somewhat altered the original plans, and curtailment of the building program has retarded completion of the city. (RECORD, July 1933.)



THE SEVEN SECTIONS OF AUSTRALIA'S capital city (top) stretch across a plain which lies between two mountains. The Federal Parliament Building (below, left) is in the Government Center. Typical of the city's sectional layout is the aerial view of the Federal Capitol (below, right).

GLASS-CONSCIOUS ARCHITECTS WIN PRIZES

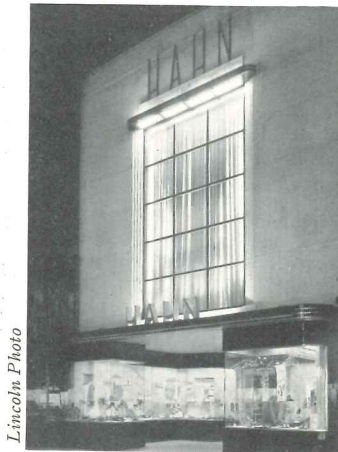


Grand Prize: Office Interiors

FOR OUTSTANDING examples of the use of glass as an architectural or decorative material, Pittsburgh Glass Institute awarded thirteen prizes and twenty-four mentions in its first annual competition. RECORD readers will be familiar with five of the prize-winning designs and eight of the mentions which appeared in the RECORD in the past year and a half covered by the contest. The award originally offered was a glass medal designed by Sidney Waugh, but cash prizes totaling \$3,200 in addition to the medal were subsequently announced. The grand prize winner received \$1,000, first prize in each classification \$100, and mentions \$50. Architects, decorators and designers from all parts of the country submitted photographs of their work. These photographs will be exhibited this fall at museums throughout the country under auspices of the American Federation of Art.

Winners in the various classes are:
GRAND PRIZES

Abel Faigy, Chicago, for Hedrich-



Lincoln Photo

1st Prize: Stores 3 stories or more

Blessing Studio, Chicago.

HOUSES costing under \$12,000

Prize: Harwell Harris, Los Angeles, for house in Fellowship Park, Los Angeles.

Mention: Richard J. Neutra, Los Angeles, for house in N. Hollywood (Barsha).

Mention: Richard J. Neutra, Los Angeles, for house in Palm Springs, Calif. (Mensendieck, RECORD, pp. 29-34, May 1937).

HOUSES costing over \$12,000

Prize: Morris B. Sanders, New York City, for city house in New York City (RECORD, p. 174, March 1936).

Mention: Harrison & Foulhoux, New York City, for exhibition house, Madison Sq. Garden (RECORD, p. 37, June 1937).

Mention: John P. Gerald, New York City, for exhibition house at B. Altman's store, New York City.

SHOPS not more than two stories in height

Prize: J. A. Hardesty, Los Angeles, for



1st Prize: Domestic Interiors

Pennzoil Co., shop front, Los Angeles.

Mention: Reinhard & Hofmeister, New York City, for jewelry shop, New York City.

Mention: Earle Webster and Adrian Wilson, Los Angeles, for store building, Glendale, Calif.

STORES three stories or more in height.

Prize: Pioso & Peterson, Chicago, for Wm. Hahn Co. store, Washington, D. C. (RECORD, p. 132, August 1936).

Mention: Barney Sumner Gruzen, Newark, N. J., for Star Electric Building, Newark, N. J.

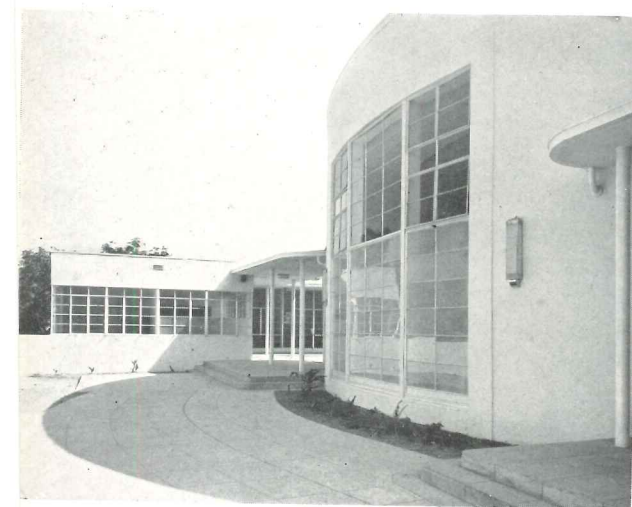
Mention: Earl Giberson, San Diego, for Santa Fe Railroad office building, San Diego, Calif.

THEATERS

Prize: Robert Law Weed, Miami, Fla., for Royal Palm Club, Miami.

Mention: Michael Meredith Hare, New York City, for Nordic Theater, Marquette, Mich.

Mention: Mark D. Kalischer, Chicago, for Adelphi Theater, Chicago, Ill.



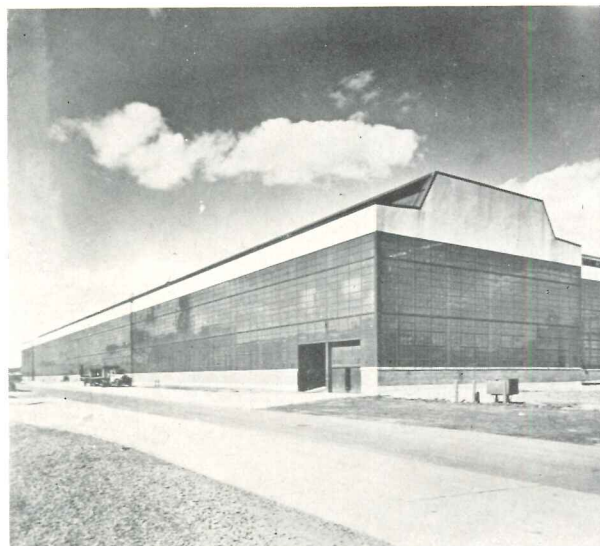
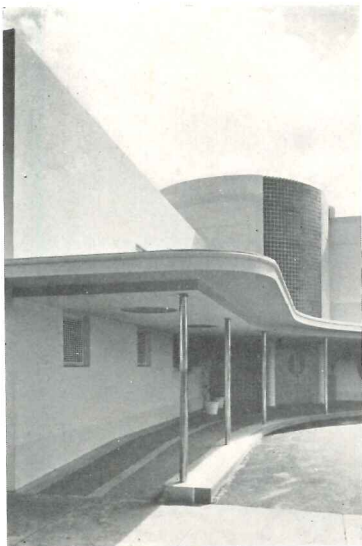
1st Prize: Institutional Buildings



1st Prize: Shops not more than 2 stories



1st Prize: Hotels and Apartments



1st Prize: Theaters

1st Prize: Schools and Colleges

1st Prize: Manufacturing Plant

HOTELS, APARTMENTS

Prize: Harrison & Fouilhoux, New York City, for Rockefeller Apartments, New York City (RECORD, pp. 302, 303, October 1936).

Mention: Richard J. Neutra, Los Angeles, for Landfair Dwellings, Westwood, Calif.

Mention: Strawbridge & Clothier and Leslie Stuart Geisert, Philadelphia, Pa., for bar in club, Philadelphia.

MANUFACTURING PLANTS

Prize: Albert Kahn, Inc., Detroit, Mich., for Press Shop, DeSoto Plant, Detroit (RECORD, p. BT34, February 1937).

Mention: Childs & Smith and Frank D. Chase, Chicago, for Campana Sales Co., plant, Batavia, Ill.

Mention: Abbott, Merkt and Co., New York City, for Hecht Company Warehouse, Washington, D. C. (RECORD, pp. 78-81, June 1937).

SCHOOLS, COLLEGES, ETC.

Prize: Lyndon & Smith, Detroit, Mich., for Grade School, Northville, Mich.

(RECORD, pp. 16-23, April 1937).

Mention: Lyndon & Smith, Detroit, Mich., for High School, Flint, Mich. (RECORD, pp. 24-27, April 1937).

Mention: Richard J. Neutra, Los Angeles, for Experimental School, Bell, Calif. (RECORD, pp. 453-456, June 1936).

INSTITUTIONAL BUILDINGS

Prize: Georgious Y. Cannon, Pasadena, Calif., for Church of Jesus Christ of the Latter Day Saints, Glendale, Calif.

Mention: Smith, Carroll and Johanson, Seattle, Wash., for addition to surgeries, Swedish Hospital, Seattle, Wash.

Mention: Chester Lindsay Churchill, Boston, Mass., for Mapparium, the Christian Science Publishing Society Building, Boston (RECORD, p. 6, May 1937).

PUBLIC BUILDINGS

Prize: John Matthews Hatton, New York City, for swimming pool pavilion, Astoria, New York.

Mention: Alfred Kastner, Washington, D. C., for sewage disposal plant, Hightstown, N. J. (RECORD, p. BT 36, February

1937).

Mention: Wm. C. E. Becker, Saint Louis, Mo., for floral conservatory, Saint Louis (RECORD, p. 31, June 1937).

DOMESTIC INTERIORS

Prize: Donald Deskey, New York City, for roof terrace, Chicago, Ill.

Mention: Donald Deskey, New York City, for apartment interior, New York City.

Mention: Joseph Aronson, New York City, for dining room, New York City.

ACCESSORIES

Prize: Francis Vicovari, New York City.

Mention: Dorothy C. Thorpe, Glendale, Calif.

Mention: Gustav Jensen, New York City.

On the jury were architects Maurice Fatio, Palm Beach, William Wilson Wurster, San Francisco, Philip Brooks Maher, Chicago, and Edward D. Stone, New York; interior decorators William R. Moore and Francis Lenygon; and industrial designer Walter Dorwin Teague.

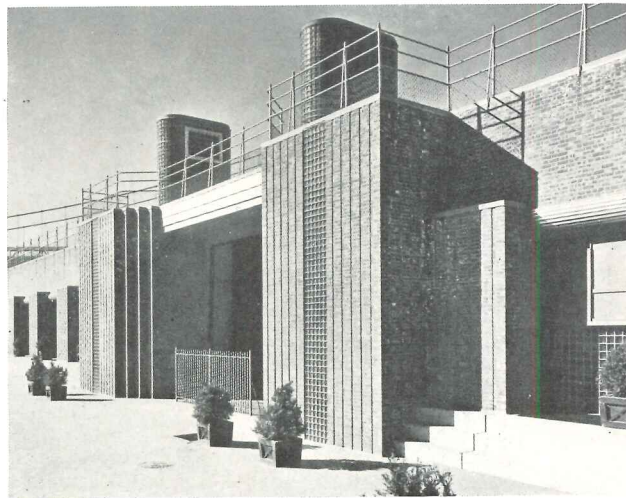


Garrison Photo

1st Prize: Houses over \$12,000

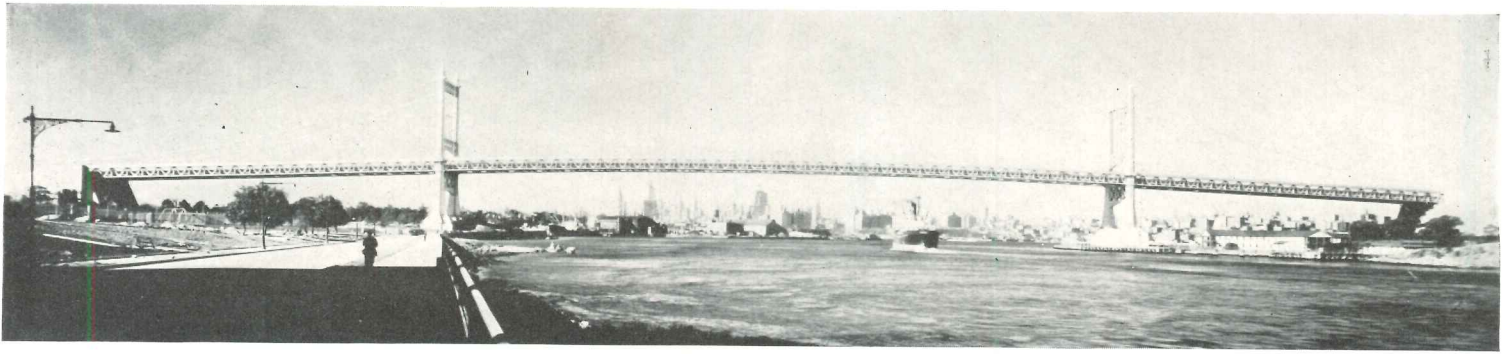


1st Prize: Houses under \$12,000

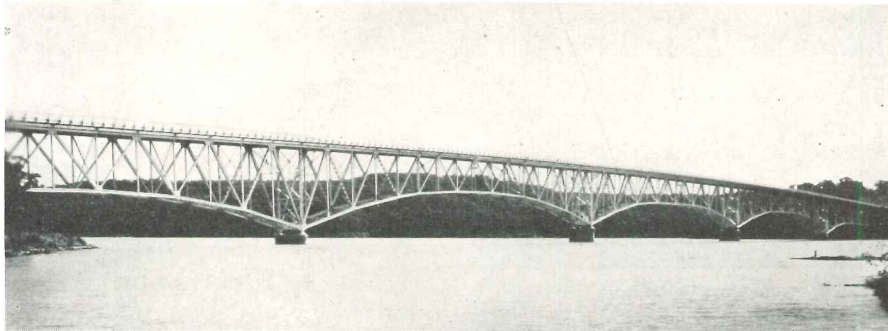


1st Prize: Public Buildings

THREE BRIDGES WIN BEAUTY PRIZES IN STEEL CONTEST



NEW YORK: East River Crossing, Triborough Bridge. 1st place, Class A.



MISSOURI: Hurricane Deck Bridge, Lake of the Ozarks. 1st place, Class B.



NEW YORK: Astoria Crossing, over Grand Central Parkway. 1st place, Class C.

SELECTED by the American Institute of Steel Construction as the most beautiful bridges built during 1936, these three bridges will receive the stainless steel plaque of the Institute.

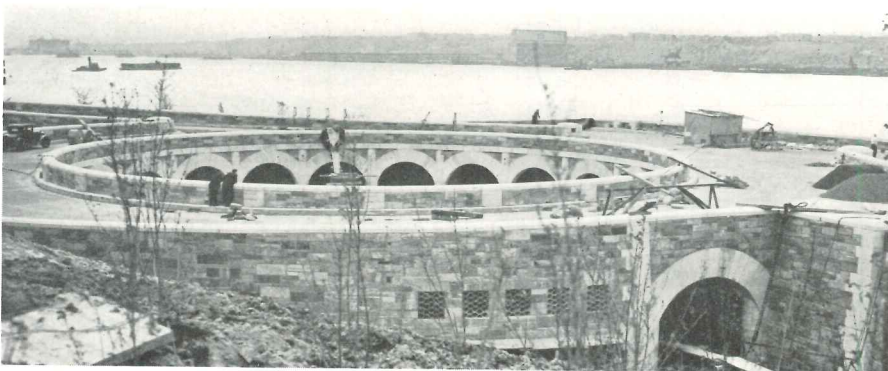
In charge of construction for the East River Crossing of the Triborough Bridge were: The Triborough Bridge Authority, O. H. Ammann, Chief Engineer; Allston Dana, Engineer of Design; Leon S. Moisseiff, Consulting Engineer; Aymar Embury II, Architect. Span length, 1,380 feet; width, 113 feet; total cost, \$8,500,000.

Engineers for the Hurricane Deck Bridge across Sage Arm of the Lake of the Ozarks on Missouri Route No. 5, Camden County, Missouri, were Sverdrup and Parcel. Span lengths, three central spans each 464 feet, two side spans each 377 feet; total cost, \$656,204.89.

The Astoria Crossing over Grand Central Parkway extension was designed by engineers of the Long Island State Park Commission and Triborough Bridge Authority. Span length, on skew, 92 feet, square, 74 feet 8 inches; total cost, \$114,000.

On the jury for the Institute's ninth annual award were architects Harvey Wiley Corbett and Leonard Schultze; engineers Clarence W. Hudson and Robert Ridgway; and A. Lawrence Kocher, editor of ARCHITECTURAL RECORD.

NEW YORK RECLAIMS ITS WEST SIDE RIVER FRONT



Wide World Photo

THIS IS THE ENTRANCE TO ONE of the parks which are part of the program for reclamation of the Hudson River waterfront. Approach ramps to the three-level grade separation are incorporated in a building which houses a garage, river lookout and promenade.

GOTHAM'S SWELTERING HORDES COOL OFF AT TWO NEW BEACHES

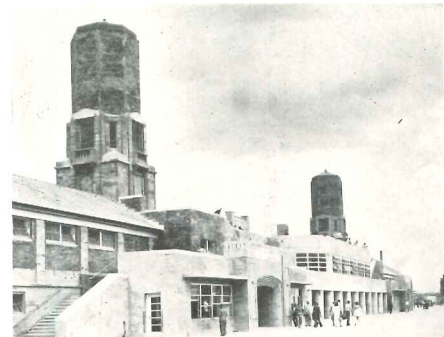


ONE MILE OF WHITE IMPORTED sand covers what was mostly water in Pelham Bay Park, Bronx, up to November, 1935. Orchard Beach is New York City's newest recreation area. The brick pavilion (above, right) contains, in addition to bathhouses, a cafeteria with a terrace on the second floor overlooking the water. Lockers and dressing rooms are pro-

vided for 5,400 persons, and the parking area accommodates 8,000 cars. Nine baseball diamonds, seven football fields, 32 tennis courts and a fully-equipped children's play area have been laid out. A lagoon for boating will be connected with the bathhouses by a mall 250 ft. wide and 1,400 ft. long lined with benches and trees.



Photos courtesy N. Y. Park Department



RECONSTRUCTED AND ENLARGED, Jacob Riis Park, named for the New York journalist, will rival Jones Beach (RECORD, Dec. 1933 and May 1935). Bathhouses and lockers can accommodate 10,000 persons. The beach has been more than doubled in width, and a mile-long, 40-ft. wide boardwalk has

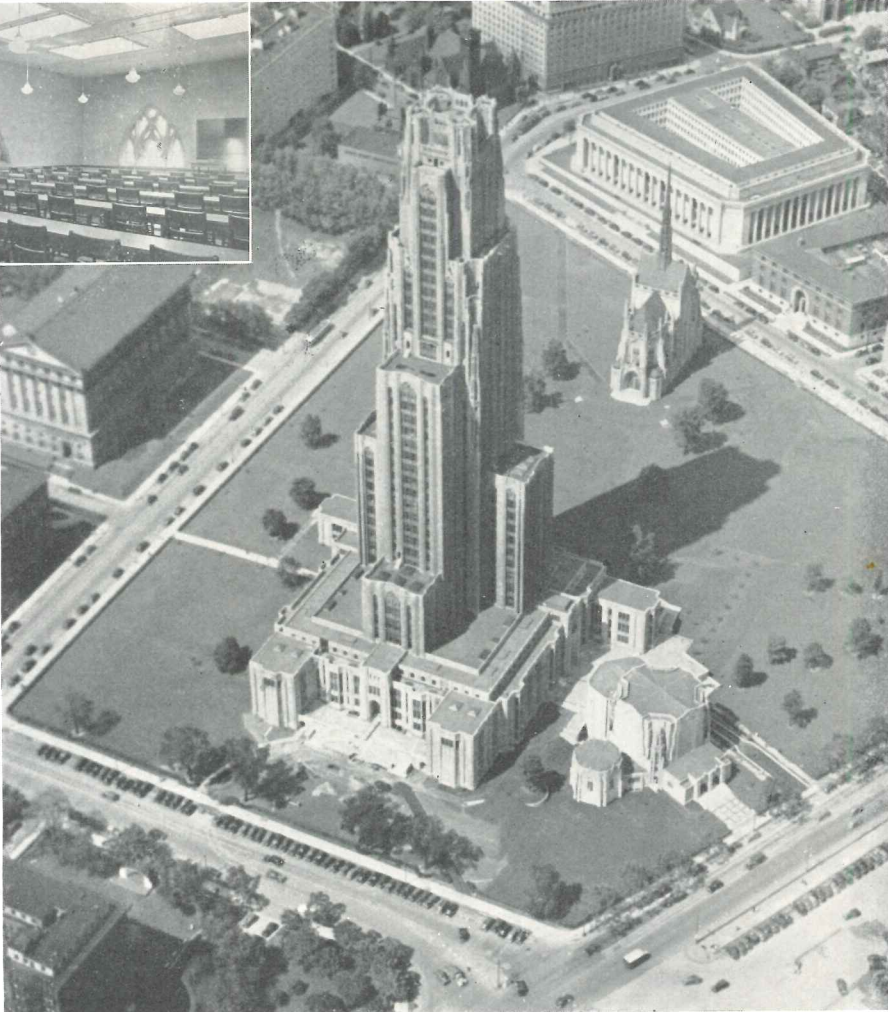
been built. Play areas for children and adults have been laid out and include facilities for pitch and putt golf, shuffleboard, and deck tennis. The parking area, described by New York Park Department officials as the largest single unit parking space, has provision for 14,000 cars.



ON THE CAMPUS: PITTSBURGH AWAKENS LATENT IDEALISM



Photos courtesy University of Pittsburgh
Aerial View by Newman-Schmidt Studios

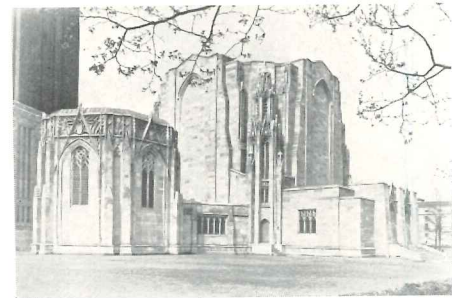


FROM JOHN RUSKIN CAME THE inspiration for Pittsburgh University's 42-story Gothic tower of learning. Conceived by Chancellor John G. Bowman of the University, the idea of a tall structure to symbolize the hopes and aspirations of education took form under the direction of Charles Z.

Klauder, Philadelphia architect. The building, now 85% complete, was begun in 1926 and has cost so far \$8,000,000. In the classrooms (inset) Gothic tracery vies with modern skylighting. Across the street from the campus is the Mellon Institute's new building.



GIVEN BY THE CHILDREN OF THE late "Pickle King," H. J. Heinz, the Heinz Memorial Chapel is reminiscent of the Sainte Chapelle. Interior and exterior are of limestone; the floor is of crab orchard stone except in the chancel where Vermont green slate is used.



TO THE MEMORY OF PITTSBURGH-born Stephen C. Foster, writer of Southern songs, stands this combination auditorium building and shrine. It is to be the center of student musical activities and permanent home of Pittsburgh's Tuesday Musical Club.

UNIVERSITIES RESUME BUILDING AS COLLECTIONS PICK UP

INDICATIVE of the general improvement of business conditions are the extensive building programs now under way at universities throughout the country.

At California Institute of Technology, Pasadena, four new laboratories are being added to the \$10,000,000 group of buildings already on the campus. Architects are Mayers, Murray and Phillip of New York who succeeded the late Bertram Grosvenor Goodhue as architects for the Institute. That science is not regarded by Caltech's undergraduates as alpha and omega of education was made vocally manifest at ground breaking ceremonies for the new buildings. The chant of "We want a gym" had to be silenced by a statement that

funds were given specifically for scientific laboratories.

George Horace Lorimer, former *Saturday Evening Post* editor, presented a \$200,000 chapel to his alma mater, 100-year old Colby College, Waterville, Maine. J. Frederick Larson is architect for the chapel which will be erected on Colby's new campus. Construction will not begin until funds for at least twelve new buildings have been promised. Already pledged are two academic halls and one wing of the library. Alumni now are campaigning for funds for a men's union building.

Proposed structures at Wells College, Aurora, New York, include a dormitory to house 200 students, a Fine Arts Building, an Infirmary, and enlarge-

ments to the Library and Chapel. Dwight James Baum of New York is architect for the new buildings.

Alumni of Colgate University at Hamilton, N. Y., have given a \$250,000 student union in honor of James C. Colgate. The building, now under construction, was designed by W. B. Chambers, New York architect.

Women students at Pennsylvania State College will occupy in 1938 a new dormitory, to be erected at an estimated cost of \$1,000,000. C. Z. Klauder, Philadelphia, is the architect.

Recently finished at the University of Alabama are the Girls' Dormitory and the Dining Hall for which Miller, Martin and Lewis, Birmingham, were architects.

FAIRS: NEW YORK HAS PLANS, PARIS HAS NEW BUILDINGS

SIXTEEN THOUSAND SPECTATORS can sit in this marine amphitheater (right) to be built by New York State for the New York World's Fair in 1939. Combined with the amphitheater is an exhibit pavilion and auditorium. First to sign a contract for exhibit space in the Electrical Products Building (right, below) was Westinghouse Electric and Manufacturing Company. In N.B.C.'s television studio at Radio City, signing of the World's Fair television contract was televised (below) and broadcast.

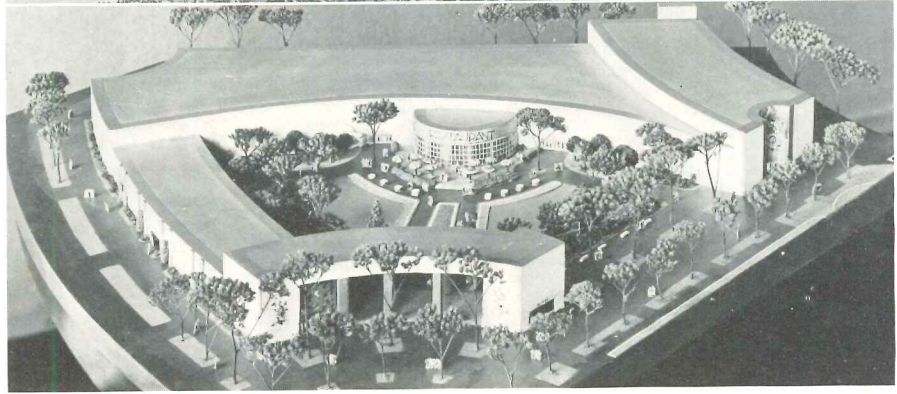
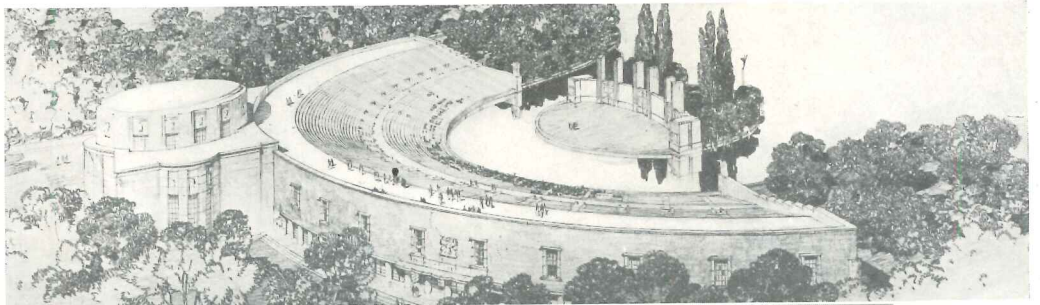
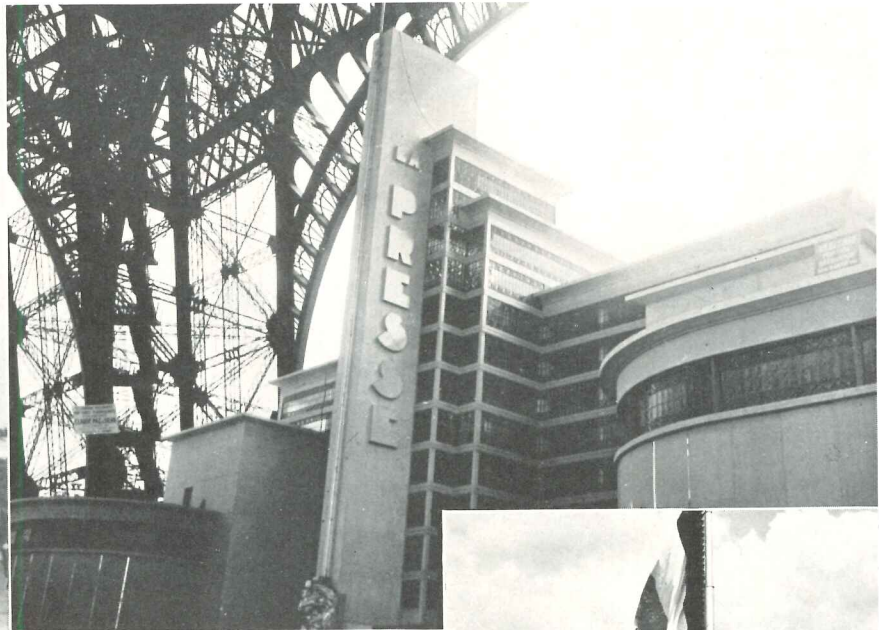


Photo: A. Arttagy



Photos by Bomney

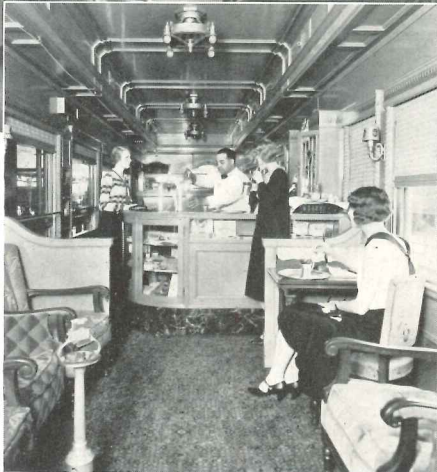
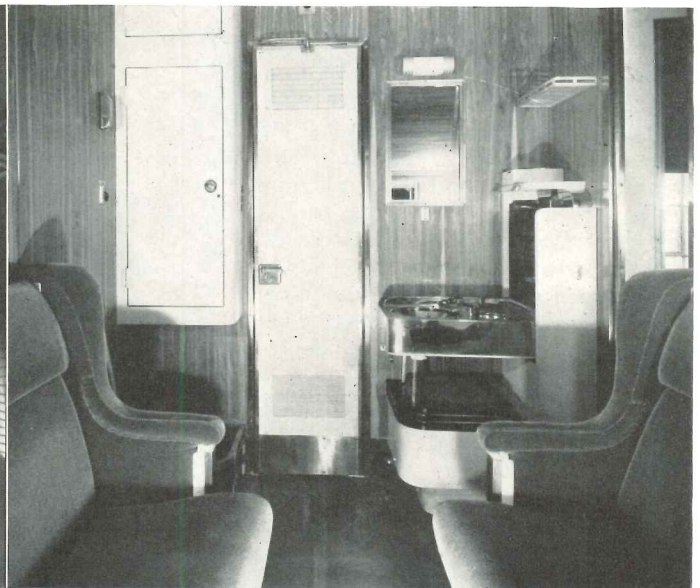
THE EIFFEL TOWER, SURVIVOR OF several fairs, looks down on the Paris Exposition. Its newest rival is the Soviet pavilion with its stainless steel figures. In the foreground is the group of Industrial Arts Buildings. Just under the Eiffel Tower stands the Press Building (right, above). Belgium finished its building (right, below) so far ahead of other exhibitors that it lent workmen

to the United States pavilion. The red, yellow and black of Belgium was the first flag to fly at the Exposition. Housed in this pavilion are exhibits of national and colonial arts, destined to demonstrate Belgium's belief in the "liaison intime" of art and utility. In the hall of honor are walls of black marble, a floor of black and brown marble, and a ceiling of gold and silk.



ARCHITECTS DESIGN MODERN TRAIN, TRAVELING OFFICE

Richard T. Dooner photos, courtesy Edward G. Budd Co.

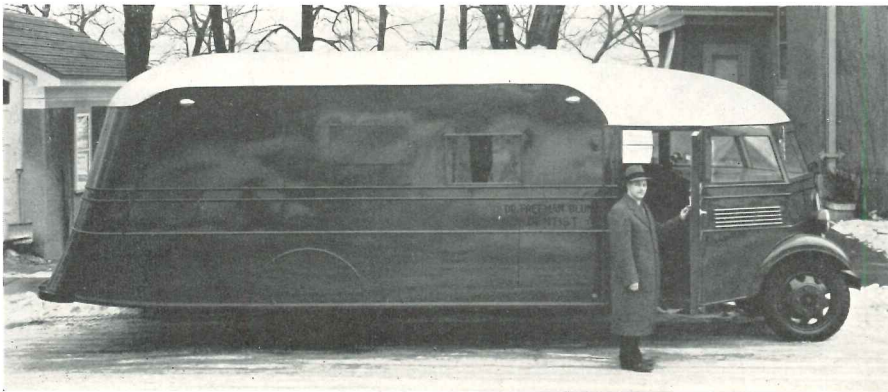


Courtesy Missouri Pacific

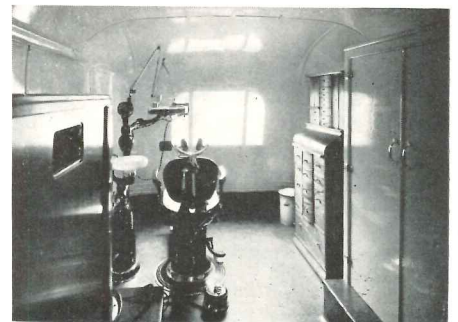
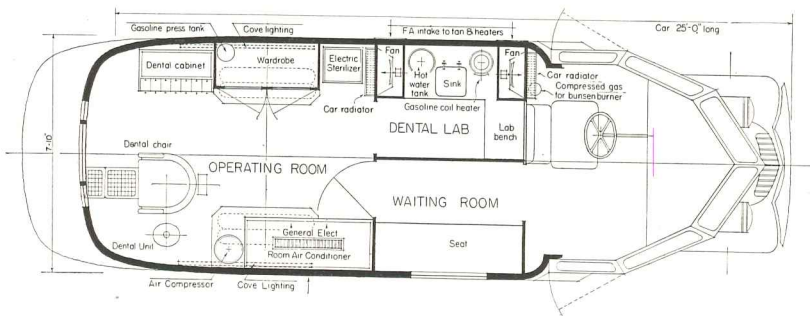
Jernigan Photo Service

PAUL CRET HAD A HAND IN DESIGNING Santa Fe's new Super Chief train, which runs through the Southwest desert. The cocktail lounge (above, left) relies on Indian motifs for decoration; back of the bar is an in-laid wood panel inspired by an Indian "sand painting." Side walls are of Bird's Eye Cypress; upper walls and ceiling are finished with Primavera veneer. The compartment (above, right), paneled in rare wood, has a fold-

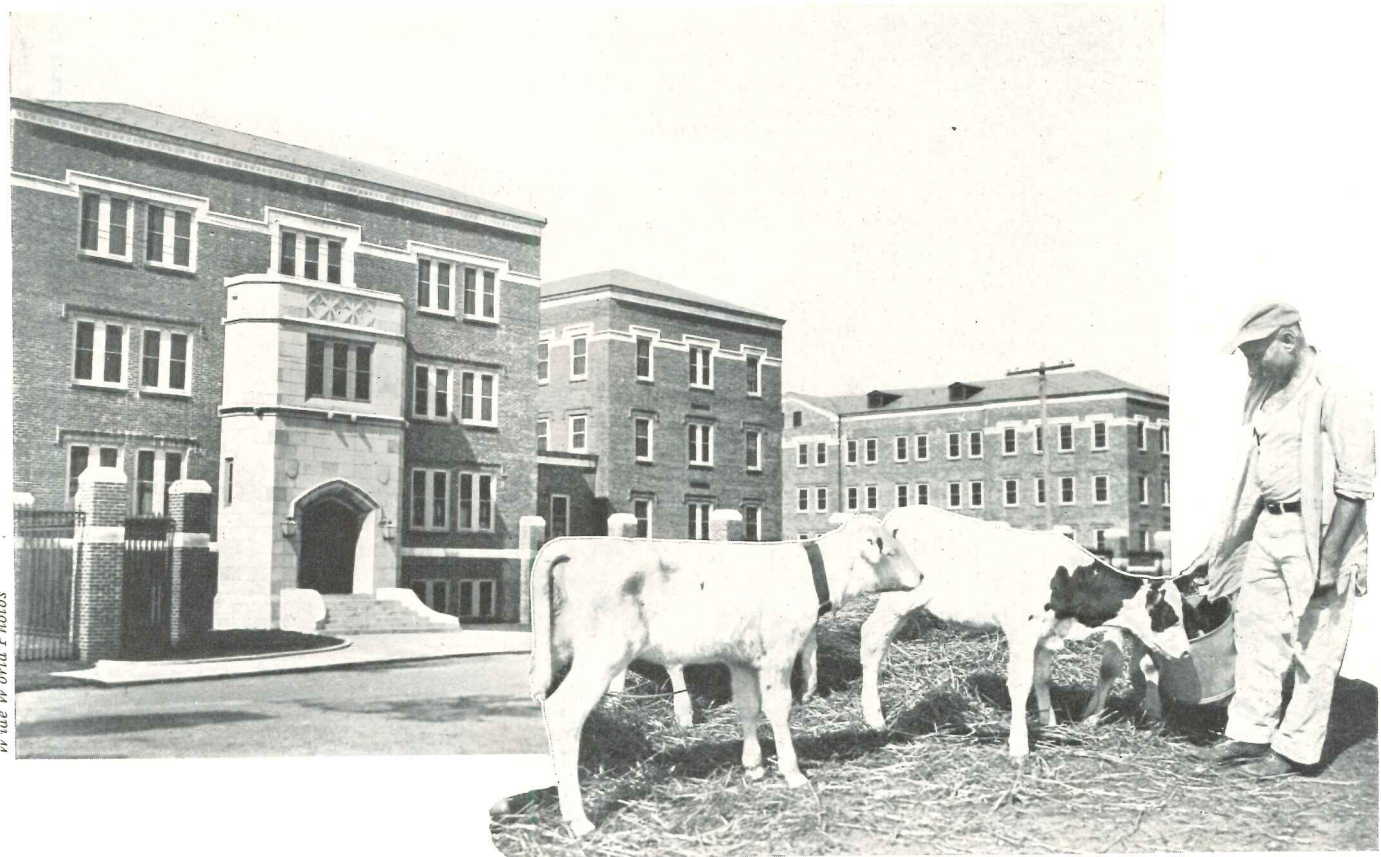
ing basin. Upper sleeper sections, each with two windows, are flat on the bottom, and in the "day position" give greater headroom. The train, nine cars long, is of stainless steel, and was built by the Edward G. Budd Company. Six years ago, Missouri Pacific's dry era soft drink bar (inset) was the last word in luxury. Interiors of the newest trains on this line are Spanish in design, reflect new standards of travel comfort.



IN HIS OFFICE-ON-WHEELS THIS dentist goes to his patients. Le Roy Gaarder, Albert Lea, Minn., architect, designed the Dental Car for Dr. Freeman Blunt, who serves five towns in a radius of 23 miles from Albert Lea. In subzero weather, the car is kept at a comfortable temperature by equipment (designed by the architect) which consists, in essence, of two regular car radiators, with circulating hot water lines from a 10-gal. storage tank heated by a gasoline coil heater.



SEVENTY YEARS MAKE A DIFFERENCE IN PRISON PLANNING



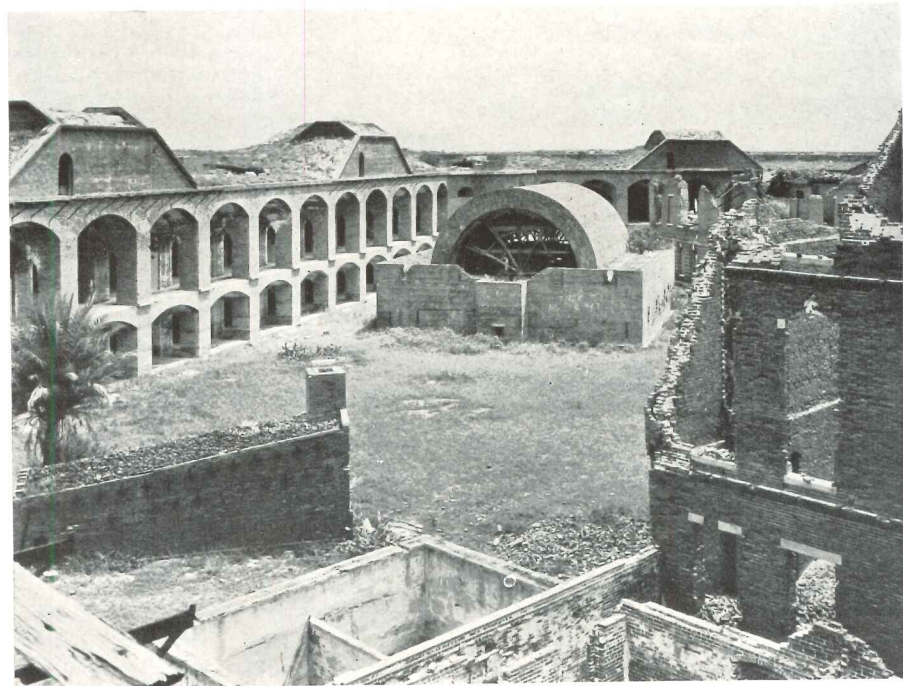
BY THE W. OTTIE F. HODGINS

FOR THE FIRST TIME IN 100 YEARS, New Jersey has a new state prison. More like a hospital than a penal institution, cells in the Bordentown prison are all outside rooms. Corner rooms have two windows and cross ventilation. A library and twelve

recreation rooms, one for each floor in the four wings, are provided for the 537 inhabitants. Minimum custody prisoners will sleep in dormitories and enjoy considerable freedom of movement within their quarters. Inmates obsessed with the idea of escape will

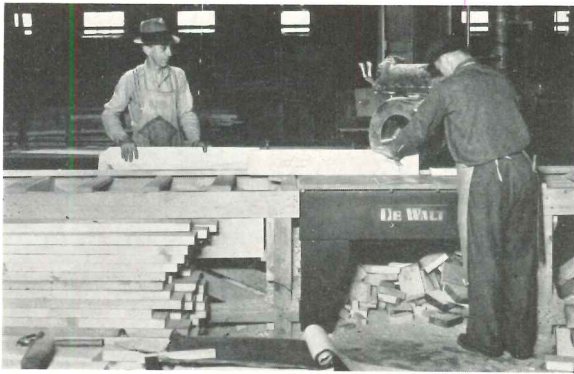
be kept in maximum custody quarters. Tool-proof steel bars are features of all windows, and an eight-foot industrial wire fence surrounds the 800 acres of farm land. The majority of prisoners will work in industrial shops, while 200 will do farming.

ONCE AN ISOLATED PRISON ON an island off the southwest coast of Florida, Fort Jefferson is now a National Monument. Here Dr. Mudd, the physician who attended John Wilkes Booth after the assassination of Lincoln, was imprisoned for four years. When an epidemic of yellow fever struck the prison, Dr. Mudd was taken from his dungeon and made active medical officer during the illness of the prison physician. When he was released, although still fairly young, his health was broken. WPA workers are cleaning up the Fort to attract tourists. At lower left is the hot shot furnace; beyond, with curved roof, is an unfinished powder magazine.



Wide World

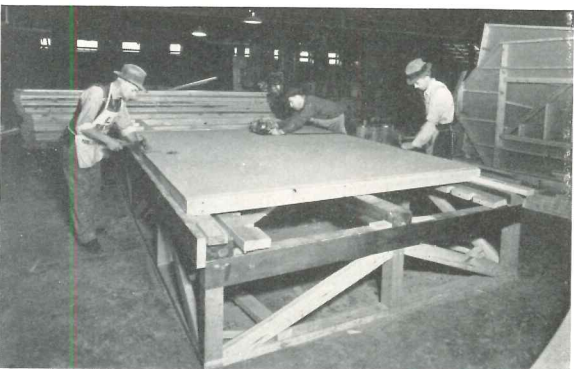
ON THE HOUSING FRONT



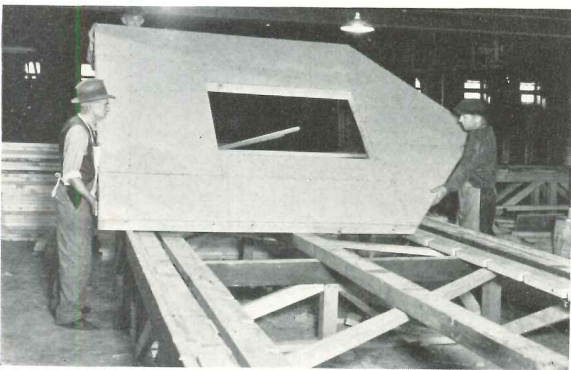
IN THE SHOP: "Precision-built" houses begin in the local mill, where all lumber is pre-cut.



Fabrication of wall and partition units are framed from working drawings, doors and windows integral.



To both sides of units Homasote is fixed by means of special glue, special nails.



Finished unit is ready for delivery. Under controlled shop conditions, a 20% saving in labor.

Prefabricators ordinarily use not only new materials, but out of them frequently evolve new systems. Advanced though these may be technically, they are often of only academic interest to most building designers, since they are not commercially available throughout the country at prices which compete with conventional construction. But when a building material manufacturer subsidizes an architect's research into the possibilities of partial prefabrication of conventional houses, and when his research results in a system that works—then it's worth talking about. W. Henry Neubeck, Trenton (N. J.) architect, describes the system he evolved for The Homasote Company, also of Trenton.



Architect Neubeck

Shop Fabrication from Architects' Plans

"THE GREATEST difficulty with the 'package' idea as applied to houses is that prospective owners want the home to conform not only to their aesthetic taste, but also to the particular requirements of their individual families. Thus, a problem is presented which contains many variables. After a more than two-year study, it was found that a satisfactory solution to the problem lay in the development of a system of construction that involved the use of standard parts and standard details, and yet was sufficiently flexible so that it could be readily adapted to any design in any price range.

"The development of the Precision-built (trade-marked) system of construction came after an exhaustive study of the various parts of a house. This study revealed that no matter what the particular type of construction was—all wood, wood frame and stucco, brick, concrete, or steel—the walls and partitions represented the biggest single item of the total cost, namely 23% on the average. The next largest item was millwork, which averaged 17%.

This figure was arrived at on the cost analysis of many homes, and work done last year at Purdue University supports it. For four different types of houses built, Purdue found the wall and partition costs to be:

Type of House	Walls and Partitions
Wood frame and stucco.....	23.4 %
Steel house	23.94%
All wood	21.5 %
Concrete	22.9 %
Average	22.93%

"It seemed logical, therefore, to first develop ways and means of reducing cost of walls, partitions and millwork. The word 'prefabrication' immediately jumped into the picture. Wall sections could evidently be shop fabricated, sent to the job and erected; but to what extent could prefabrication be applied to other parts of a house and still be economically feasible? From the first it seemed apparent that further development of standard carpentry practice would lead to the solution much more

directly than a radical departure from conventional construction methods. Hence, a system was developed, based on 16" centering of studs. Wall sections in multiples of 16" could be used, but it was found that flexibility in design could be increased by employing multiples of 8". Even with 8" multiples it was necessary to design carefully so that intermediate walls and partitions did not effect an inequality in the overall dimensions of the opposite sides, and restriction still laid a heavy hand on design.

"We now realized that a modular system was the correct solution—also that the correct module was yet to be discovered. Upon inspection, the chief troublemaker for the 8" module was found to be the intermediate partition. If wall sections could be made to increase or decrease the exact thickness of a partition when an intersection occurred, the condition would be corrected. From this it became obvious that the *only correct module for any system of modular planning is the thickness of its interior partition.* (In our particular instance, a 3 $\frac{3}{8}$ " stud—the American Standard depth of a dressed 2"x4"—plus one thickness of Homasote on each side gave a module of 4 $\frac{5}{8}$ ".)

In dismissing the vertical modulus, Architect Neubeck has this to say: "If a vertical modulus is used for wall sections, fractional rises will occur in roof pitches other than multiples of the $\frac{1}{2}$ " rise which it is very practical and necessary to use. While rafter cuts may be determined mathematically for fractional rises, the whole system becomes so cumbersome it loses its workability from a practical standpoint."

"With a definite modular system established, the next step was to design window and door sections. These sections had to fit both the module and stock sizes of windows and doors. The width of the stud opening was therefore made variable by means of blocking and, as heights were not governed by the module, it was thus possible to build window or door sections to take any stock or special size.

"It was possible to build doors and windows into each wall section, but to do so would make every section a special fabrication job. However, it was observed that wall, window and door sections could be fabricated either individually or in combination. For instance, if the side of a room was 12' 4" long with a window in the center, the wall sections on either side can be joined to the window section before *Homasote* is applied. In this way the *Homasote* can cover the entire side of the room without a single joint. It thus became necessary to differentiate on the plan between a connection of sections in combination at the shop and a connection of finished sections on the job. The connection within a combination was defined as a *construction joint*; the connection of sections made during their erection was defined as an *erection joint*.

"Problems of other parts of the house were in general readily solved. It was obvious that, until lighter weight structural units were developed successfully, floor and roof could not be con-

Logic of this is clear when it is remembered that Mr. Neubeck is striving for a system which requires no special material, equipment or trades—in other words, the lowest common denominator of American house construction. As a matter of fact, research was carried on in prefabricated roof sections, dormers and floors, dropped because it was impractical in any but metropolitan areas.

sidered as panels. Even if this were possible the units would be too unwieldy if an unbroken surface was desired.

"For many years lumber has been precut for joists and rafters, but this was always done from details of a special design. In Precision-built construction the cuts of joists or rafters can be readily and quickly determined for any floor or roof condition. Framing plans are easily laid out and the lengths of members quickly found because of the modular system employed. In order to eliminate the necessity of detailing joists and rafters, standard work sheets were drawn for the architect's use.

"Plumbing and heating layouts are easily prefabricated and installed in the wall sections at the shop: a substantial saving is usually resultant. However, it has been found that the conventional method of electrical wiring is most satisfactory to date. Developments in the field may bring about the prefabrication of many exterior and interior finish materials, but at present it seems advisable to cut and fit such items as finish woodwork, brick veneer, etc. Because of the fact that *Homasote*

may be easily applied to form a curved surface, circular or semi-circular rooms as well as curved ceilings may be very satisfactorily built.

"It may be readily seen from a brief inspection of the Precision-built Method of construction that, although plans of a building designed by this method are in more detail than conventional drawings usually are for a residence, the architect is not burdened with extra work. Because of the ease with which the system works, drawings that are complete in every detail are turned out in less time than the usual job. We already know from experience that the contractor benefits greatly by more complete drawings and that the owner is certain to get a better job for less money."

Within the limits of frame construction, the architect who wants to design P-B houses is offered certain definite

In its theory, the P-B module differs from others in three important respects:

- (1) It applies only to horizontal dimensions.
- (2) It makes no attempt to coordinate joist, stud and rafter spacing to the module—an arbitrary limitation which has been the death knell of many a modular theory.
- (3) It makes a clear distinction between the unit and its component sections—that is, the maximum size of the unit is determined by job conditions whereas that of the section is determined by shop conditions.

advantages, especially in the field of small houses. At no cost (only the obligation to design one house within 90 days) he can use the trade-marked system for plans and construction. It reduces total cost (claimed by the company is an average saving of approximately 10%), is completely flexible as far as planning goes, and permits any type of exterior finish. It is said to reduce likewise the time involved in production of working drawings. From the company he receives a service which includes standard details, free consultation on plans, etc. On the basis of the standard details, and using a special modular scale, which the company provides, the architect produces drawings which serve as *shop-drawings* in the mill, *working-drawings* on the job. At the same time, it is not necessary for him to detail most of the structural problems since both he, the mill and the contractor use in common the standard details of the company. Houses erected under this principle have received FHA approval for insured mortgages. (In the *Design Trends* section of this month's RECORD, pp. 86, 87. *Homasote's* vice president F. V. Wilson, Jr., gives the merchandising theory behind this development.)



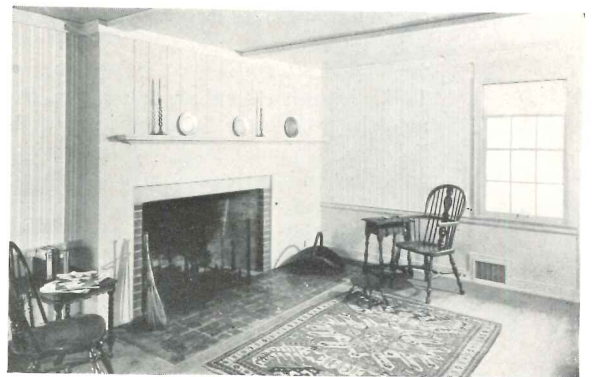
ON THE JOB: Foundations are put in, pre-cut joists set in place.



And 4 hours labor sees all partitions up, job ready for roof framing with precut rafters.



When finished a P-B house looks like any other. Only the cost-sheet indicates savings.



P-B eliminates wet-work but imposes limitations on interior design—14 ft. maximum wall length without joints, battens on ceiling.

NEW YORK OPENS FIRST HEALTH CENTERS IN 10-YEAR PLAN

Photos courtesy N. Y. C. Board of Health



MOTT HAVEN HEALTH CENTER (above) will serve the Bronx District. Like East Harlem Center, it is administered by a full-time district health officer.

CITY OWNED AND CITY BUILT, East Harlem Health and Teaching Center replaces the first general health center built in 1921.



FIRST in a program of eight such buildings, East Harlem Health and Teaching Center opened recently in New York City. Dedication of Mott Haven Center, in the Bronx, followed soon after. Because preventable diseases are still a problem, in spite of available medical services, the city will open health centers in eight different sections during 1937. Health education and preventive medicine are prime factors in the establishment of these centers, which provide facilities and personnel to evaluate the nature of the health problem in any given district, and to prescribe the steps necessary to protect the health of the people of that district. The plan allows for the provision in any district of whatever special facilities the health conditions of that district require.

The program provides for the organization of 30 health center districts by 1945, to serve the City's approximate

7,500,000 people living in an area of more than 300 square miles. In the 30-district plan, each administrative unit would serve a population area of approximately 250,000. The program contemplates a policy of close practical working relationship with voluntary medical, dental, health, social welfare and allied agencies. Space is provided in the health center for co-operating voluntary agencies working in the district.

The typical New York City district health center building provides space on the ground floor for functional services in health education and the control of communicable diseases. On the second floor is located the administrative unit with the district health officer in charge, Health Department nurses and a visiting nurse unit. A station for the distribution of departmental supplies and biologicals is established in the administrative office for the convenience of phy-

sicians in the district. A basement auditorium provides a meeting room for approximately 200 to 250 persons. Quarters are provided in the building for a health education staff and exhibit material.

A \$1,000,000 building at the New York World's Fair 1939 will show the wonders of the human body, the common ills to which it is subject, and the means made available by science for protection against them. A heroic transparent figure of man will reveal the internal anatomy, circulatory, digestive and nervous systems, and the glands of internal secretion. The building, designed by Mayers, Murray and Phillip, New York architects, will have an area of 81,871 square feet, and will occupy a triangular plot on Theme Plaza.

SCIENCE SHORTS: NEW AIDS TO BUILDING

Metals grow "fatigued" and "creep"

METALS, like human beings, are subject to fatigue, when worked at too high a rate. Although the first sign of fatigue can be detected by the magna-flux method, devised by Professor A. V. deForest of Massachusetts Institute of Technology, failure occurs without warning when stresses are imposed beyond a prescribed limit. At this limit nominally ductile metals, such as most steels used in construction work, will fracture just like brittle materials. The strength of steel at high temperatures depends on duration as well as amount of stress. In a test lasting six minutes, the tensile strength of medium carbon steel at 500 degrees Centigrade was 54,000 pounds per square inch. But when the time was increased to 240 minutes, the strength of the steel, at the same temperature, decreased to 4,000 pounds per square inch. The phenomenon of the decrease in strength of metals when subjected to high temperature effects over a long period of time is called creep. That further knowledge of fatigue and creep in metals is necessary is evidenced by the recent conference on these subjects held at Massachusetts Institute of Technology.

Paris Fair has electric display

OIL and metal shavings cast on the, untroubled waters of the Seine, flooded with light from projectors, form a shimmering moat for the Paris Fair. Rainbow colors illuminate fountains from beneath and above the water, and "fountain boats" carry visitors to points of display. The veteran Eiffel Tower undergoes nightly a chameleon-like change of colors from head to foot, and displays in lights the flags of many nations. All this electrical show is controlled by one man at a switchboard.

Air conditioning problems studied

EXPERIMENTAL air conditioning equipment recently installed at the University of Illinois is designed to handle either outdoor air, recirculated air from the main laboratory, or both. The laboratory is 135'x 120', and operation of equipment has at present little effect on air conditions of the space. A system of supply and return ducts between the plant and a 100-seat lecture room and several adjoining rooms, is planned. This will afford a more satisfactory means of putting a load on the plant. The apparatus can be used for study of the problems of air cleaning by filters or washers; humidification;

cooling and dehumidification; hot blast heating by steam or hot water; precision measurements of dry and wet-bulb air temperatures, etc. The restricted sections of recirculating, outside air and discharge air ducts permit determination of air velocities with more accuracy than is possible with larger cross-sectional areas.

Telephones warn of air raids

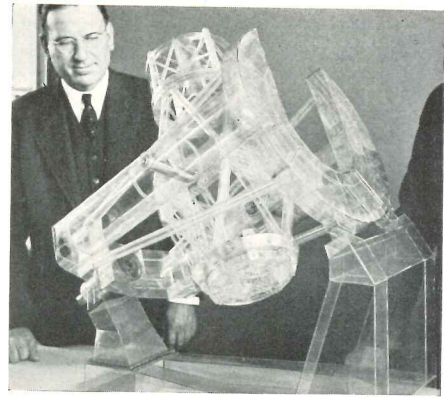
PARIS telephone subscribers will receive personal warnings of air raids as a result of the recent passive defense maneuvers when the noise of sirens was found to be insufficient. Each telephone exchange is to be fitted with a special switch, so that the alarm can be given at a moment's notice. The warning signal will be either a series of long and short rings, or a regular ring followed by a phonograph record which will give the alarm as soon as the receiver is taken off.

California's sun heats water

SOLAR water heaters, several thousand of which are now in use in California, can provide two or three hot showers per tank (where inclosed 30-gallon hot-water boilers are used) in the late afternoon of a bright sunshiny day. High temperatures are not maintained overnight, and cloudy weather lowers the temperature. To overcome weather difficulties, the hot outlet pipe from the solar heater storage tank can be connected to the cold inlet of an automatic auxiliary heater. This will then operate to raise the temperature to the desired point.

Old eyes need more light

OLD people can see as well as young people if the proper intensity of illumination is provided for them, says Dr. Morris Fishbein, editor of Journal of the American Medical Association. A 63-year old person can see at 27 foot-candles what a young person sees at 2.5 foot-candles, and 70-year old eyes can see as well at 100 foot-candles as young eyes at 1 foot-candle, according to recent investigations. More light is required for the eyes of old people, because their pupils have grown smaller, the transparency of materials through which light passes to the retina has diminished, and the tissues involved in adjusting the eye to light and images of various sizes have decreased.



CONSTRUCTED ENTIRELY OF pyroxylin sheets welded together with acetone, this model of the 200-inch telescope at Mt. Palomar, California, was made for testing angular deflection under load. Although transparent models offer possibilities for studying stresses by polarized light, no attempt to do this was made in this model because of initial strains in the material. Distortions caused in pyroxylin by cementing the sheets with acetone are similar in nature, although much exaggerated in degree, to distortions in welded steel structures.

Plate glass protects flowers

HEAT-ABSORBING plate glass protects flowers in a Boston florist shop. The new glass absorbs the sun's infrared rays, so that flowers can be displayed in full view of passers-by. In home construction, this product can be used for outer panes of double windows to reduce the heat load on air conditioning equipment.

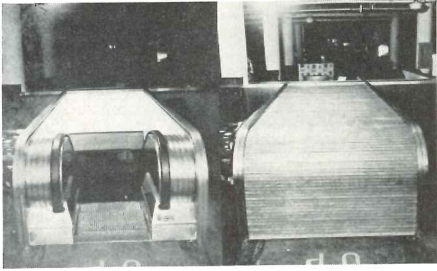
India uses new road surface

MOLASSES mixed with surface soil and water is used as a highway stabilizer on roads in the Indian province of Mysore. Taken as a waste from sugar factories, the molasses is mixed with water and spread over the road. In a half hour's time it has soaked into the road sufficiently to be coated with coarse sand. Fifty miles of this new surfacing are now in use.

Scientists test gravity changes

TESTS to determine how much the force of gravity changes in relation to the height above the earth's surface were completed recently at the Empire State Building. Three scientists, Lieutenants Albert J. Hoskinson and Carl I. Aslaksen of the United States Coast and Geodetic Survey, and Dr. Maurice Ewing of Lehigh University, made observations with instruments devised by Dr. Felix Vening-Meinesz of the Netherlands Geodetic Commission, using a freight elevator for the tests.

NEW PRODUCT NEWS



Inclosure for escalators

FIREPROOF steel shutters for escalators close automatically in case of fire by means of a fuse link which releases a closing weight. This cover also operates electrically or by hand. When open it coils on a horizontal shaft in the rear.

Cornell Iron Works, Inc., Long Island City, N. Y.

Insulating compound for cable

A SYNTHETIC insulating compound for cable is similar to rubber in characteristics but contains no rubber. "Flamenol" can be made either a soft and flexible compound, or a rigid celluloid-like one, can be put into solution for coating or impregnating, and can be compounded, filled, calendered and extruded. It is said to be highly resistant to moisture, alkalies, acids and oils. Flamenol-insulated cable is recommended for power and control circuits of 600 volts and less, for operation at a maximum copper temperature of 60° C. It can be used without protective finish except where subject to extreme mechanical abuse.

General Electric Company, Schenectady, N. Y.

Timbers in knock-down form

PREFABRICATED timbers ready for erection, now on the market, include roof trusses, oil derricks, walking beams, pipe tracks and bridges. The manufacturing company is prepared also to design and erect special structures.

Western Timber Structures, Inc., 85 Second St., San Francisco, Calif.

Steel road surface

SUBWAY grating as a road surface was used for the first time in New York City on the recently opened Marine Parkway Bridge. The surface resembles a honeycomb, and is of prefabricated steel. Constructed of longitudinal bars, held parallel by diagonal

struts 2 1/4" on center, the grating is said to become less hot than ordinary road surfaces. It is only 30% as heavy as its equivalent in concrete base, and half as heavy as other types of paving. The design of the grating is such, it is claimed, that there will be no additional wear on tires.

Irving Iron Works Co., Long Island City, N. Y.

Self-opening garage doors

GARAGE doors can be opened by the flash of headlights on a photo-electric eye, which operates also by a switch mounted on a post at the side of the driveway, within reach of the driver. Another switch, located inside the driver's home, will open and illuminate, or close and lock, the garage. Known as the Seed Electric Garage Door Opener, the device can be attached to doors now in use.

R. W. Seed Manufacturing Co., Lawrence & Eagle Roads, Upper Darby, Pa.

Bottle storage



A NEW storage cabinet for beverages holds 23 bottles in a honeycomb section and a circular rotating board. In addition there is space for siphons, cocktail shakers, etc. The door locks securely.

Kitchen Maid Corporation, Andrews, Indiana.

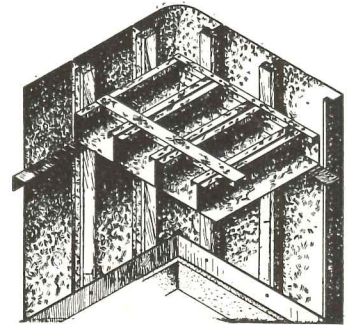
Outdoor electric current supply

AN ELECTRIC spigot, complete in one piece with self-binder for cables, supplies electric current for outdoor use. The device places a weatherproof hood and a hinged cover over the outlet. It is secured to the wall with two screws.

National Electric Products Corporation, Fulton Bldg., Pittsburgh, Pa.

Wall unit and roof deck

THIS 18-gauge TRUS-STEEL wall or partition unit is so constructed that wall surface and metal stud are one with a hard wood nailing strip. Made on 16-inch centers so that any conventional type of interior finish can be applied, and any type of insulation material installed, these sections come complete with slab angles, roof deck angles and all necessary fastenings, and can be had in lengths of one to fourteen feet.



The same company manufactures a long span metal roof deck which requires no beam or center supports. It is constructed of 18-gauge steel sheet, with 18-gauge channel bridging every four feet. The deck can be had in spans of six to twenty-four feet. The whole structure allows 100% salvage if the building must be moved and rebuilt.

The Edwards Manufacturing Company, 492 Culvert Street, Cincinnati, Ohio.

Paint compound for damp surfaces

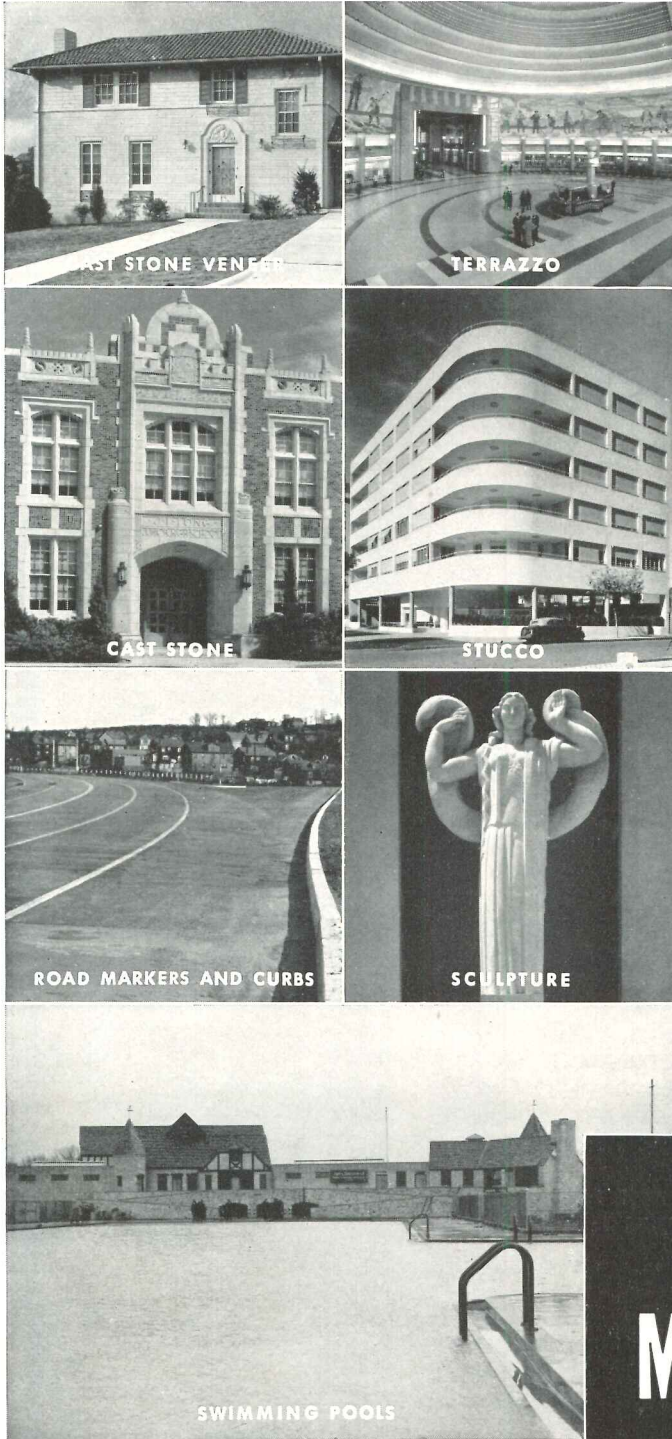
A NEW compound permits painting of damp surfaces with ordinary paint, varnish or lacquer, according to the manufacturer. The compound combines with water to form a substance which rises to the surface of the paint film, decomposes, and then evaporates.

U. S. Industrial Chemical Co., Inc., 60 E. 42 Street, New York City.

Quick-drying enamel

A NEW enamel made on a synthetic resin base and giving a surface that is actually whiter than white tiling, has been developed for interior woodwork. This new finish, claims the manufacturer, retains its whiteness, dries much quicker than orthodox enamels and has an extremely tough, elastic film which can be washed like a china dish when it becomes soiled. It has successfully withstood more than 200,000 "scrubs" in a specially designed machine, whereas films of orthodox enamels are usually worn through by 10,000 to 40,000 "scrubs."

E. I. du Pont De Nemours and Company, Finishes Division, Wilmington Del.



At the left are shown seven ways in which Medusa White Portland Cement (Plain or Waterproofed) can be used to improve construction.

STUCCO Medusa White Portland Cement stucco gives an almost unlimited variety of color and texture combinations with which to create individuality, charm and character in stucco homes. Waterproofed Medusa White Portland Cement repels all moisture, protecting the stucco against staining and the deteriorating action of frost and freezing of absorbed water.

CAST STONE Medusa White is internationally used in cast stone building trim. This use of Medusa White gives the architect or builder almost unlimited possibilities for ornamenting brick, stone, concrete or stucco buildings because it can be cast to meet specifications. Medusa White cast stone is also used as a veneer for houses or buildings.

TERRAZZO Many of the most colorful and magnificent terrazzo floors in this and other countries are made with Medusa White Portland Cement (Plain or Waterproofed) white or tinted, used as a matrix for beautiful colored marble chips. No matter how colorful or how intricate the design, a terrazzo contractor using Medusa White, Plain or Waterproofed, can meet the requirements.

SCULPTURING, ROAD MARKERS, CURBS AND SWIMMING POOLS Medusa White is widely used for making magnificent pieces of sculpturing, for white road markers and curbs and for the finishing coat in outdoor swimming pools.

Send the coupon below for complete specifications.

Use
MEDUSA WHITE
THESE 7 WAYS

- Medusa White cast stone veneer house. John Hagy, builder.
- Terrazzo floor in the Cincinnati Union Terminal. Architects, Fellheimer and Wagner.
- Medusa White cast stone trim on Dallas, Texas, modern school. Architects, Bryant and Sharp.
- Medusa White stucco apartment house, Buenos Aires. Architects, Sanchez, Lagos, De La Torre.
- Medusa White road markers and curbs on Route 6 near Palisades, New Jersey.
- Sculpturing in Medusa White, 1937 Pan American Exposition. Sculptor, Raoul Josset.
- Swimming pool with a lining made with Medusa White Portland Cement. Architect, Eric E. Hall.

MEDUSA PORTLAND CEMENT COMPANY
 1015 Midland Building, Cleveland, Ohio

Gentlemen: Please send me complete specifications on the use of Medusa White Portland Cement.

Name.....
 Address.....
 City..... State.....

MARKETING NEWS



HERE MEET OFFICIALS OF NEW York World's Fair, 1939. The board room was executed by W. & J. Sloane, Contract Division, New York City.

Brick and tile houses

DEMONSTRATION homes of brick and tile for FHA financing are now sponsored by Structural Clay Products Institute. Planned in accordance with FHA's principles for frame construction, the houses are designed to be built in a price range of \$3,000 to \$4,500. To make the designs suitable for brick and tile, some changes from the frame house were necessary, but floor plans are essentially the same as those of the demonstration houses now being erected throughout the country. The Institute estimates that the difference in materials will add \$2 per month to the total monthly payments to be made by the home owner.

NEW LITERATURE

ELECTRIC POWER AND LIGHTING

Brown Electric CO₂ Meters. Catalog 3005. The Brown Instrument Company, Philadelphia, Pa.

Durax, Non-Metallic Sheathed Cable. Anaconda Wire and Cable Company, 25 Broadway, New York City.

Lighting by Century. Century Lighting Inc., 419 W. 55 Street, New York City.

Service Cables. Anaconda Wire and Cable Company, 25 Broadway, New York City.

Sodium Lighting on San Francisco-Oakland Bridge. General Electric Company, Schenectady, N. Y.

Window Lighting with Fresnelites. Century Lighting, Inc., 419 W. 55 Street, New York City.

HEATING AND AIR CONDITIONING

Auer Register Book. The Auer Register Company, Cleveland, Ohio.

Clarage Multitherm Conditioning Units. Bulletin 107. Clarage Fan Company, Kalamazoo, Mich.

Gorton High Pressure Air Eliminator. Gorton Heating Corporation, Cranford, N. J.

Mercoid Automatic Controls. The Mercoid Corporation, 4201 Belmont Avenue, Chicago, Ill.

Permutit Household Water Conditioning. The Permutit Company, 330 W. 42 Street, New York City.

The Facts About Convection Heat, Catalog 4037. Young Radiator Company, Racine, Wis.

HANDBOOKS

Sheet Copper Handbook. New York: Copper and Brass Research Association, 420 Lexington Avenue. May 1937.

Standard Code for Testing and Rating Steam Unit Heaters, adopted January 1930. Detroit: Industrial Unit Heater Association, 5-208 General Motors Building.

WINDOWS

Astrup Awning Hardware, for Modern Store Front Construction. The Astrup Company, 2937 West 25 Street, Cleveland, O.

Insulated Windows—Double-Hung and Casement. Curtis Companies Service Bureau, Clinton, Iowa.

The Metal Awning of Distinction. Sunvent Metal Awning Company, 3712-18 Bronx Blvd., New York City.

Corrections • June Issue

EDITOR, ARCHITECTURAL RECORD
CORRECTION CURRENT NUMBER OF
RECORD STOP W C E BECKER ENTIRELY
RESPONSIBLE FOR DESIGN OF STLOUIS
QUOTE JEWEL BOX UNQUOTE STOP WITH
CUSTOMARY THOROUGHNESS BECKER
CONSTRUCTED MODEL OF DESIGN ON
A TILT TABLE AND MADE SIMUL-
TANEOUS PHOTOMETER READINGS
INSIDE AND OUTSIDE MODEL BEFORE
BEGINNING CONSTRUCTION STOP I
ONLY FURNISHED INFORMATION HOW
AT ANY TIME TO TILT TABLE TO SIMULATE
INSOLATION AT ANY TIME OF YEAR AND
ANY TIME OF DAY

H R GRUMMANN ASST PROF MATH
WASHN UNIV STLOUIS MO.

Word received from the Truscon Laboratories explains that through an error in advertising records the wrong photographs were shown in their advertisement which appeared in the June 1937 issue of the Architectural RECORD.

CALENDAR OF EXHIBITIONS AND EVENTS

- **September 1**—Closing date, National Alliance of Science and Industry Competition for Cemetery Memorial, Barre Granite Association, Barre, Vermont.
- **September 20**—Closing date, Structural Clay Products Institute Competition, 1427 Eye Street, Washington, D. C.
- **October 4-9**—Chicago Exposition of Power and Mechanical Engineering, International Amphitheater, Chicago, Illinois.
- **October 27-29**—Annual convention of American Institute of Steel Construction, Greenbrier Hotel, White Sulphur Springs, West Virginia.

MANY FACTORS
CONTRIBUTE TO
BEAUTY

BUT THE EFFICIENCY
OF PLUMBING
RESTS ON THE
**INTERNAL
DESIGN**
OF THE
Metal FIXTURES

Select
**SPEAKMAN
FIXTURES**

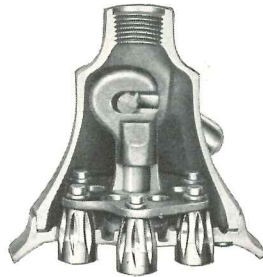
*For both
fine performance
and
lasting beauty*



WHAT'S INSIDE?

In a watch, it's not the beauty of the outer case, but the precisely machined springs and balances that assure split-second accuracy in time-keeping.

Beauty ALONE IS NOT ENOUGH



WHAT'S INSIDE?

In the Anystream Shower Head, it's the precision-tooled movement of six slotted plungers that determines the type of shower you get. A flood shower when they are fully extended and a fine-spray needle shower when retracted.

Performance—as well as appearance —will determine your clients' satisfaction one year and many years from now



Of course your clients expect their shower equipment to have beauty, but even more important are such questions as—What about its internal construction? . . . How does it work? . . . Will it clog up easily? . . . Does it adjust to the satisfaction of every person who uses it?

When you specify Speakman showers, you can be sure of high quality standards and faultless operation to safeguard your reputation for years to come. Consider the Speakman Anystream Shower Head* for instance. Here you have a shower that meets every requirement—satisfies every member of the family—and is sturdily built to give years of satisfactory service. Turn a small lever and instantly the shower is changed from a flood to a fine needle spray. And what's more, it's *self-cleaning*—just can't clog up.

For more than 67 years, the Speakman name has been identified with quality. In schools, clubs, hospitals, office buildings, apartment houses, homes and institutions of every kind, you find Speakman showers and Speakman fixtures giving the kind of satisfactory service that merits your confidence.

Whether your immediate job be new construction or remodeling . . . whether it be a public or private building, in the complete Speakman line with its wide price range, you have a choice of many types and trim to please every taste—to fit every purse—and to give the comfort and efficient service your client expects you to provide.

In Sweet's 1937 Catalog File you will find details of many types of shower installations; also the Mixometer, the Si-Flo Flush Valve, the Graceline Sink Fixture and other popular items of the Speakman Line. If you wish, we will gladly send you literature covering any or all of these items. **SPEAKMAN COMPANY, WILMINGTON, DEL.** Quality fixtures since 1869.

*Pat. No. 1,880,694

SPEAKMAN

SHOWERS • SHOWER HEADS • BATH FIXTURES • SI-FLO (SILENT) FLUSH VALVES
LAVATORY FIXTURES • SINK FIXTURES • INSTITUTIONAL AND INDUSTRIAL FIXTURES

SHOWERS AND FIXTURES



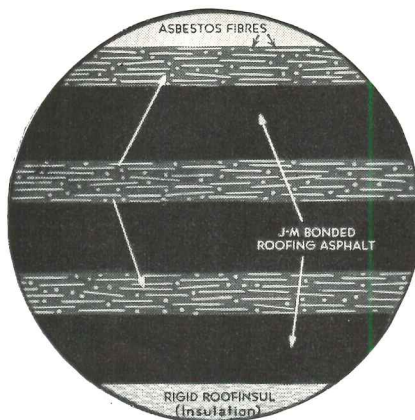
...and still Good in 1937!

PROMISES about roofing life make "strong words". . . yet the 1910 belief of a large mid-western farm-equipment company in the permanence of J-M Asbestos Roofs is very much a fact in 1937!

Nor can this be dismissed as just "one case." Too many J-M Asbestos Roofs applied before and shortly after 1910 have borne out that same promise—and are still in excellent condition today.

The conclusion, therefore, is an obvious one—and highly pertinent to the present or future roofing problems of your clients. J-M Asbestos Roofs offer lasting protection against the 3 major enemies of roofing life . . . fire, weather and sun.

This last is important, for the intense drying-out action of the sun is responsible for a large percentage of ordinary roof failures. How J-M Asbestos Felts prevent it is explained



below. And if you wish complete data on all phases of built-up roof construction, be sure to get our free handbook, "Specifications for J-M Bonded Built-up Roofs." Simply write to Johns-Manville, 22 E. 40th Street, N. Y. C., for your copy.

*How J-M Asbestos Felts
Protect the Waterproofing Asphalts
from the Sun . . .*

As this enlarged cross-section of a 3-ply J-M Asbestos Roof shows, each asbestos fiber is solid, non-capillary. The asphalt cannot penetrate into these fibers, or be drawn up through them by the sun. Hence, the asphalt—both within the felts and between the plies—retains indefinitely the lighter oils so essential to effective waterproofing. And asbestos, being imperishable and rotproof, insures a long length of roof service at minimum upkeep.



Johns-Manville

**SMOOTH-SURFACED
BONDED**

ASBESTOS ROOFS

STURTEVANT INDUSTRIAL AIR CONDITIONING



LIFE SAVERS, INC., Port Chester, N. Y., have made certain that this famous candy will get to the consumer hard, "handleable", and palatable—by cutting, packing and wrapping these confections under ideal air conditions.

A Sturtevant Air Conditioning System—installed by Cooling and Air Conditioning Corporation, Division of B. F. Sturtevant Company—maintains these conditions. Its use assures a better product, facilitates wrapping, prevents spoilage and production delays—saves money.

Scores of well-known names in industry are served by Sturtevant Air Conditioning. Merely a few of the many are Libbey-Owens-Ford, DuPont Rayon, Philip Morris, General Cigar, Crowell Publishing, and Calco Chemical.

B. F. STURTEVANT COMPANY
HYDE PARK, BOSTON, MASS. *Branches in 40 Cities*

THE COOLING AND AIR CONDITIONING CORPORATION
Division of B. F. Sturtevant Company

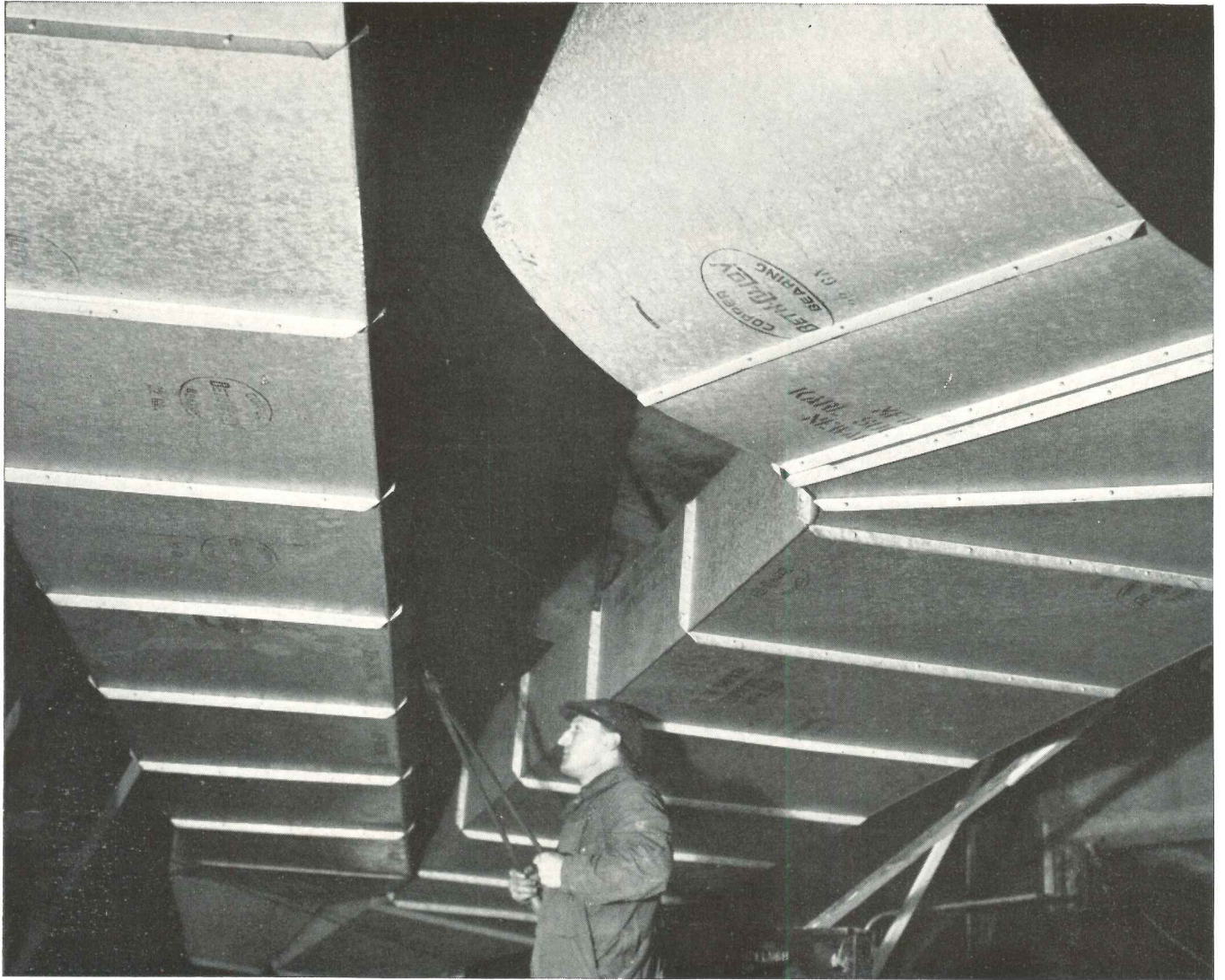
Sturtevant

REG. U. S. PAT. OFF.

Puts Air to Work



WORLD'S LARGEST MAKERS OF AIR HANDLING AND CONDITIONING EQUIPMENT



SPECIFY A *double defense* AGAINST RUST

***Beth-Cu-Loy* galvanized sheets offer
it at negligible increase in cost**



BETH-CU-LOY galvanized sheets have two separate lines of defense against rust. They have a sound, uniform coating of good, clean zinc. Underneath this galvanizing, they have a base of rust-resisting copper-bearing steel.

Atmospheric-corrosion tests on copper-bearing steel—identical to the composition of Beth-Cu-Loy—indicate that it will outlast standard open-hearth steel by two to three times (four times, in one test). These same impartial tests show that copper-bearing steel has about twice the life of open-



hearth iron, and outlasts even copper-bearing iron by 20 per cent or more.

Beth-Cu-Loy is not expensive. It costs only 4½ to 5 per cent more than ordinary steel—an increase that will be hardly noticeable in the cost of the completed job. Beth-Cu-Loy actually costs considerably less than open-hearth iron—either plain or copper-bearing.

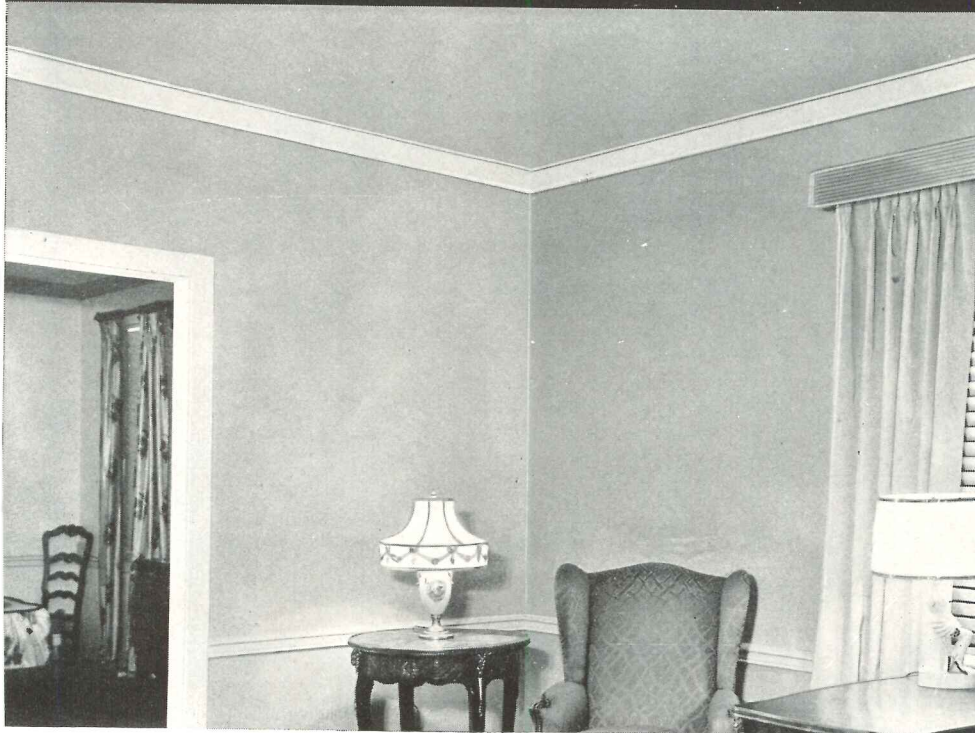
In specifications for sheet metal—duct-work, eaves and gutters, roofing—specify Beth-Cu-Loy copper-bearing steel. It adds so much in life; it costs so little more.

BETHLEHEM STEEL COMPANY

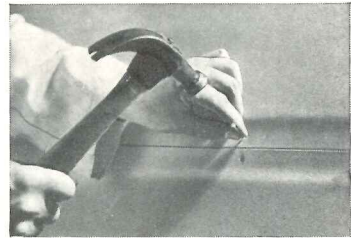
Wallboard Joint Concealment *Perfected!*

with **PERF-A-TAPE** and **RECESSED-EDGE SHEETROCK**

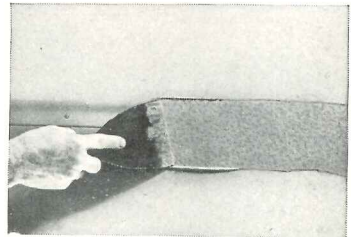
THE FIREPROOF WALLBOARD



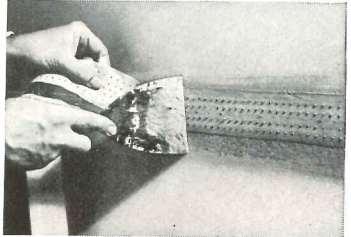
SEE HOW IT WORKS



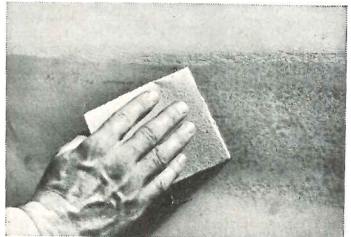
When the sheets are nailed in place, the recessed edges form a channel at each joint.



This channel is filled with a special cement, which is quickly and easily applied.



Perf-A-Tape, a strong perforated fiber tape with chamfered edges, is embedded in the cement.



Cement is applied over Perf-A-Tape and sanded evenly, assuring a smooth surface for any decoration.

Thoroughly Tested, Proved and Patented— Ideal For Modernization and Repair

Through the use of Recessed-Edge Sheetrock* and the new, patented Perf-A-Tape*, walls and ceilings free of "joint trouble" can now be secured in wallboard construction at low cost.

Perf-A-Tape provides a unique type of joint concealment which is easily and quickly applied. As the ½-inch thick boards go up on the studding—horizontally, for greater rigidity—the recessed edges of the board form a shallow channel at the joint. This channel is filled with a special cement, in which is embedded Perf-A-Tape, a patented strong fiber perforated tape. The cement is then

smoothed off evenly, as illustrated. This patented construction can be had with Recessed-Edge Sheetrock and Perf-A-Tape. It assures strong, reinforced joints completely hidden by any decoration your clients desire.

Recessed-Edge Sheetrock is not expensive. It is suitable for any interior. Smooth to work upon, it offers an excellent surface for textured wall finishes made with USG Textone* and for painted walls done in USG Texolite*. And, best of all, it is fireproof!

FOR YOUR PROTECTION, USG PRODUCTS
BEAR THIS TRADE-MARK IDENTIFICATION 

**SPECIFY USG PERF-A-TAPE AND RECESSED-EDGE
SHEETROCK CONSTRUCTION**

Patented by and Exclusive with

Registered Trade-marks

UNITED STATES GYPSUM COMPANY



United States Gypsum Co.
Dept. F-8, 300 W. Adams St.
Chicago, Ill.

Please send me a copy of the
"Sheetrock Book" with information on Recessed-Edge Sheetrock and Perf-A-Tape.

Name.....

Address.....

City.....State.....

UNITED STATES POST OFFICE, ST. PAUL, MINN.
LAMBERT BASSENDALE, ARCHITECT
GRAHAM, ANDERSON, PROBST AND WHITE, ASSOCIATE
HARRIS BROS. PLUMBING CO., PLUMBING AND HEATING CONTRACTORS

BRIDGEPORT BRASS PIPE



In the construction of this beautifully designed and appropriately planned Post Office Building, the architects and engineers looked far into the future and specified materials of lasting value. Modern in every respect, its veins and arteries are modern too, and will stay modern as time rolls by, for Bridgeport 85% Plumrite Brass Pipe was used throughout for the plumbing system.

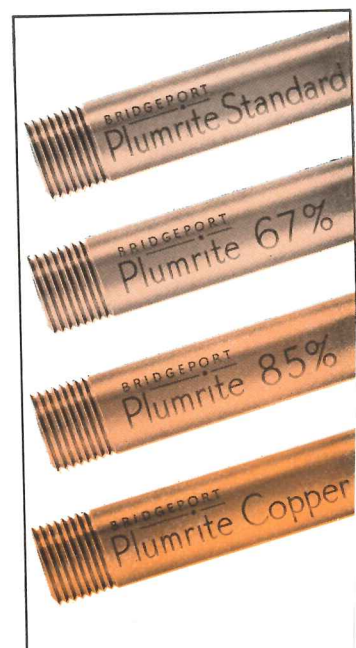
The permanence and economy of Plumrite is a proven fact. Its value as an asset that survives the years has been demonstrated again and again...through more than five decades in a wide variety of buildings. The qualities that recommended its use in this important structure recommend it for other buildings where trouble-free economical service is demanded.

Bridgeport engineers offer the architect and builder the full benefits of their seventy years of experience in selecting the *right* Plumrite brass or copper pipe or copper water tube for any purpose—plumbing, heating, refrigerating or air conditioning.



BRIDGEPORT BRASS

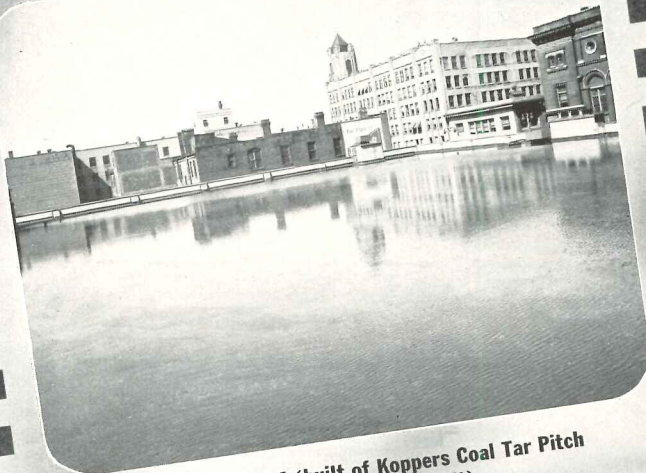
BRIDGEPORT BRASS COMPANY • BRIDGEPORT, CONN. • ESTABLISHED 1865



BUSINESS WEEK

J. C. Penney Co. is reported to be discovering that water on the 30,000 sq.ft. roof of its new air-conditioned department store in Milwaukee is saving a full 25% on estimated cooling costs.

Here is "Business Week's" report on the effectiveness of a water-cooled roof.



Here is the Roof (built of Koppers Coal Tar Pitch and Koppers Tarred Felt).

KOPPERS COMPANY KOPPERS SPRAY POND AND WATER-COOLED ROOFING SPECIFICATIONS

No waterproofing is necessary and will greatly increase the amount of water used in cooling buildings. In some instances it is necessary to let rain water collect on the roof, evaporating and the water in the air also is not absorbed by the building. The air of the building is cooled by the evaporation of water on the roof and also by the evaporation of water from the building. The evaporation of water from the building is controlled by the water on the roof. The water on the roof is controlled by the water on the roof.



KOPPERS COMPANY Spray Pond or Water-Cooled Roof Over Wood Deck or Precast Gypsum Slab

15-YEAR BUILT UP ROOFING SPECIFICATION KOPPERS SPECIFICATION NO. 22

(Preferably Dead Level. Maximum Incline Two (2) Inches Per Foot)

SECTION OF SPECIFICATIONS TO BE FURNISHED—This shall be general cover the entire area which, while laid, there shall be applied a second layer of two (2) coats of Koppers Coal Tar Pitch and Koppers Tarred Felt. The thickness shall be as specified in the specifications. If the roof deck is inclined it shall be made level to the outside.

THICKNESS OF FINISHING MATERIAL—The thickness of the finishing material shall be as specified in the specifications. The thickness shall be as specified in the specifications. The thickness shall be as specified in the specifications.

PREPARATION OF SURFACE—The surface shall be prepared as specified in the specifications. The surface shall be prepared as specified in the specifications. The surface shall be prepared as specified in the specifications.

INSTALLATION OF ROOFING MATERIAL—The roofing material shall be installed as specified in the specifications. The roofing material shall be installed as specified in the specifications. The roofing material shall be installed as specified in the specifications.

TESTING—The roof shall be tested as specified in the specifications. The roof shall be tested as specified in the specifications. The roof shall be tested as specified in the specifications.

WARRANTY—The roof shall be warranted as specified in the specifications. The roof shall be warranted as specified in the specifications. The roof shall be warranted as specified in the specifications.

NOTES—The specifications shall be read in conjunction with the specifications. The specifications shall be read in conjunction with the specifications. The specifications shall be read in conjunction with the specifications.

REFERENCES—The specifications shall be read in conjunction with the specifications. The specifications shall be read in conjunction with the specifications. The specifications shall be read in conjunction with the specifications.

APPENDICES—The specifications shall be read in conjunction with the specifications. The specifications shall be read in conjunction with the specifications. The specifications shall be read in conjunction with the specifications.

EXPLANATIONS—The specifications shall be read in conjunction with the specifications. The specifications shall be read in conjunction with the specifications. The specifications shall be read in conjunction with the specifications.

GENERAL—The specifications shall be read in conjunction with the specifications. The specifications shall be read in conjunction with the specifications. The specifications shall be read in conjunction with the specifications.

NOTES—The specifications shall be read in conjunction with the specifications. The specifications shall be read in conjunction with the specifications. The specifications shall be read in conjunction with the specifications.

REFERENCES—The specifications shall be read in conjunction with the specifications. The specifications shall be read in conjunction with the specifications. The specifications shall be read in conjunction with the specifications.

APPENDICES—The specifications shall be read in conjunction with the specifications. The specifications shall be read in conjunction with the specifications. The specifications shall be read in conjunction with the specifications.

EXPLANATIONS—The specifications shall be read in conjunction with the specifications. The specifications shall be read in conjunction with the specifications. The specifications shall be read in conjunction with the specifications.

GENERAL—The specifications shall be read in conjunction with the specifications. The specifications shall be read in conjunction with the specifications. The specifications shall be read in conjunction with the specifications.

NOTES—The specifications shall be read in conjunction with the specifications. The specifications shall be read in conjunction with the specifications. The specifications shall be read in conjunction with the specifications.

REFERENCES—The specifications shall be read in conjunction with the specifications. The specifications shall be read in conjunction with the specifications. The specifications shall be read in conjunction with the specifications.

APPENDICES—The specifications shall be read in conjunction with the specifications. The specifications shall be read in conjunction with the specifications. The specifications shall be read in conjunction with the specifications.

EXPLANATIONS—The specifications shall be read in conjunction with the specifications. The specifications shall be read in conjunction with the specifications. The specifications shall be read in conjunction with the specifications.

GENERAL—The specifications shall be read in conjunction with the specifications. The specifications shall be read in conjunction with the specifications. The specifications shall be read in conjunction with the specifications.

NOTES—The specifications shall be read in conjunction with the specifications. The specifications shall be read in conjunction with the specifications. The specifications shall be read in conjunction with the specifications.

REFERENCES—The specifications shall be read in conjunction with the specifications. The specifications shall be read in conjunction with the specifications. The specifications shall be read in conjunction with the specifications.

APPENDICES—The specifications shall be read in conjunction with the specifications. The specifications shall be read in conjunction with the specifications. The specifications shall be read in conjunction with the specifications.

EXPLANATIONS—The specifications shall be read in conjunction with the specifications. The specifications shall be read in conjunction with the specifications. The specifications shall be read in conjunction with the specifications.

GENERAL—The specifications shall be read in conjunction with the specifications. The specifications shall be read in conjunction with the specifications. The specifications shall be read in conjunction with the specifications.

NOTES—The specifications shall be read in conjunction with the specifications. The specifications shall be read in conjunction with the specifications. The specifications shall be read in conjunction with the specifications.

REFERENCES—The specifications shall be read in conjunction with the specifications. The specifications shall be read in conjunction with the specifications. The specifications shall be read in conjunction with the specifications.

APPENDICES—The specifications shall be read in conjunction with the specifications. The specifications shall be read in conjunction with the specifications. The specifications shall be read in conjunction with the specifications.

EXPLANATIONS—The specifications shall be read in conjunction with the specifications. The specifications shall be read in conjunction with the specifications. The specifications shall be read in conjunction with the specifications.

GENERAL—The specifications shall be read in conjunction with the specifications. The specifications shall be read in conjunction with the specifications. The specifications shall be read in conjunction with the specifications.

NOTES—The specifications shall be read in conjunction with the specifications. The specifications shall be read in conjunction with the specifications. The specifications shall be read in conjunction with the specifications.

REFERENCES—The specifications shall be read in conjunction with the specifications. The specifications shall be read in conjunction with the specifications. The specifications shall be read in conjunction with the specifications.

APPENDICES—The specifications shall be read in conjunction with the specifications. The specifications shall be read in conjunction with the specifications. The specifications shall be read in conjunction with the specifications.

EXPLANATIONS—The specifications shall be read in conjunction with the specifications. The specifications shall be read in conjunction with the specifications. The specifications shall be read in conjunction with the specifications.

GENERAL—The specifications shall be read in conjunction with the specifications. The specifications shall be read in conjunction with the specifications. The specifications shall be read in conjunction with the specifications.

NOTES—The specifications shall be read in conjunction with the specifications. The specifications shall be read in conjunction with the specifications. The specifications shall be read in conjunction with the specifications.

REFERENCES—The specifications shall be read in conjunction with the specifications. The specifications shall be read in conjunction with the specifications. The specifications shall be read in conjunction with the specifications.

APPENDICES—The specifications shall be read in conjunction with the specifications. The specifications shall be read in conjunction with the specifications. The specifications shall be read in conjunction with the specifications.

EXPLANATIONS—The specifications shall be read in conjunction with the specifications. The specifications shall be read in conjunction with the specifications. The specifications shall be read in conjunction with the specifications.

Here are the Koppers Specifications for water-cooled roofs.

KOPPERS COMPANY,
Pittsburgh, Pa.

Send me your roofing specifications which include water-cooled roofs.

Your Name _____

Address _____

Here is a coupon which will bring you these specifications.

KOPPERS ROOF CUTS AIR CONDITIONING COSTS

KOPPERS ALSO PROVIDES

KOPPERS DIVISIONS SUBSIDIARIES AND AFFILIATES

- American Hammered Piston Ring Division
- Bartlett Hayward Division
- Engineering and Construction Division
- Gas and Coke Division
- Tar and Chemical Division
- Western Gas Division
- Boston Towboat Company
- Eastern Gas and Fuel Associates
- The Koppers Coal Company
- Koppers-Rheolaveur Company
- The Maryland Drydock Company
- Mystic Iron Works
- Mystic Steamship Company
- National Lumber & Creosoting Company
- New England Coal and Coke Co.
- The White Tar Company of New Jersey, Inc.
- The Wood Preserving Corporation



Pressure-treated lumber from the Wood Preserving Corporation (creosoted or salt-treated) will resist termites and decay.

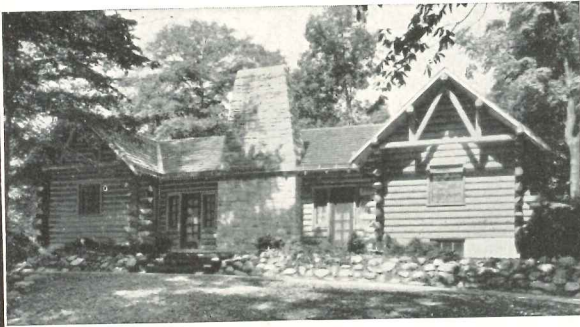


Tarmac road tars for paving private drives, walks, tennis courts, playgrounds, etc.



Aluminum (bituminous-base aluminum paint) to make masonry and waterproof and to stop "spalling" of concrete.

**"P & H" Service Helps you to
sell REAL LOG HOUSES**



WE supply properly seasoned Western Red Cedar logs, frames, built-ins, and other material . . . all accurately cut, fitted and numbered to meet your individual plans and specifications.

"P & H" soundly-developed, specialized log construction simplifies for you the planning, handling and erection of log houses, and protects your reputation and responsibility for the dependability of the completed job. Readily adapted to any need . . . comfortable, year 'round homes or vacation retreats, large or small. Easily combined with other building materials.

Complete, confidential service to architects . . . full cooperation in the preparation of plans in your office, with Chilson D. Aldrich, our staff architect, as consultant. See 1937 Sweet's Catalog File for the Building Market for structural details and other information. Write for illustrated booklet.

PAGE AND HILL CO.

1354 Northwestern Bank Bldg., Minneapolis, Minn.
New York Office: 50 Church Street

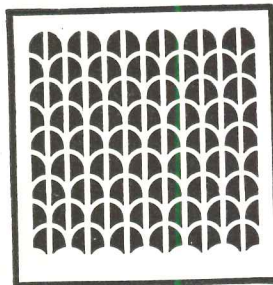
CLINTON

PERFORATED METAL



GRILLES

Arrive on Time



Metals in standard sheets, sizes and gages are kept in stock. Dies are always in condition for use. Wickwire Spencer has the facilities for and realizes the importance of closely following the customers' schedules. In extreme cases, grilles have been shipped within twenty-four hours after all information was in the shop. The buyer of grilles needs this type of service.

WICKWIRE SPENCER STEEL COMPANY

41 East 42nd Street, New York

Buffalo Worcester Chicago San Francisco

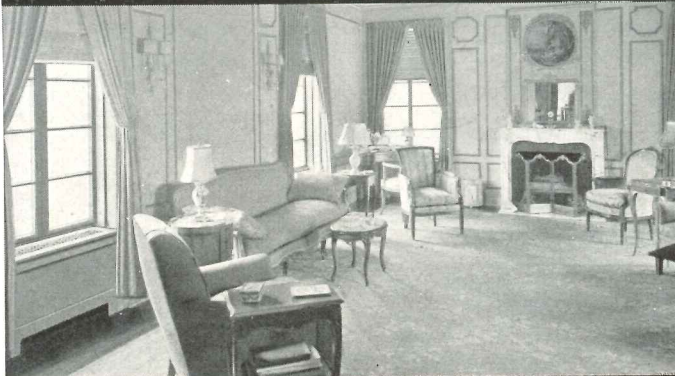
Clinton Grilles are regularly made in various gages of steel, brass, bronze, monel and Wissco Bronze, and are available up to 60" x 156" in all finishes. Send for the new GRILLE FOLDER that gives full information.



**WICKWIRE SPENCER
perforated metals**

YOUNG

Streamaire



A NEW COMPLETE LINE

Modern — beautifully appearing designs to blend with any scheme of interior decoration. Many outstanding features of construction. Free Standing Cabinets — Wall-Hung Cabinets — Partially Recessed Cabinets — Fully Recessed Cabinets — Plastered-In and Bathroom Convectors for homes and industrial buildings. The most complete line in the industry today.

COPPER CONVECTORS

SEND FOR THE NEW CATALOG

A handsome, 24-page, fully illustrated book, printed in color, showing interesting installations and mechanical details—giving capacities and performance tables. Drawings illustrating the best ways of installing and piping convectors. See this beautiful, newly engineered line. Use the coupon below. There is no cost, no obligation.

CLIP THE COUPON

Please send your NEW CATALOG illustrating young STREAMAIRE Copper Convectors.

COMPANY
ADDRESS
SIGNATURE

YOUNG RADIATOR COMPANY
RACINE, WISCONSIN



Now comes **MULTILAYER AIRCOWELDING**

*A new
welding
technique for
heavy wall pipe*

developed
by **AIRCO**

1. Assures welds of markedly superior physical characteristics.
2. Simplifies the making of both rolling and position welds.
3. Saves from 15 to 20% in oxygen and acetylene.
4. Cuts welding time by 15 to 20%, with corresponding reduction in labor costs.



*Get the
facts about*
**MULTILAYER
AIRCOWELDING**

**write for the
new bulletin**

**AIR REDUCTION
SALES COMPANY**

General Offices: 60 East 42nd Street, New York, N. Y.
DISTRICT OFFICES IN PRINCIPAL CITIES

*An 8 inch extra heavy
steam pipe, all joints
Aircowelded by the
MULTILAYER process,
in the plant of the
USIA Co., Newark, N. J.
Jaehrig & Peoples,
Newark, N. J., Contr's.*

A NATION-WIDE WELDING and CUTTING SUPPLY SERVICE



BUILD WITH GLASS—TODAY



Again the stage is set for pioneers among architects—for trail blazers who will dare to be leaders.

Glass—in its many forms and varieties—is at hand for the progressive architect to shape into the complete modern structure.

For facing the solid parts of the modern building, Vitrolite—the colorful structural glass—adds beauty and character, tying together in a sparkling unity the other types of glass that are indispensable—and providing a surface that will retain its luster undiminished through the parade of years.

Only an occasional washing is needed to restore its original newness, thus eliminating the extra expense of steam treatments, waxing, or sandblasting.

Our cities are eager for buildings of modern structural glass. Methods of installation now available make Vitrolite entirely practical for the exacting requirements of fine buildings—no matter how high or how large.

The rewards of tomorrow await the architect who—with vision and courage—can interpret the needs of today in terms of the most suitable materials. The Libbey-Owens-Ford Technical Staff will gladly cooperate in supplying construction details for the use of Vitrolite and other modern types of glass. No obligation, of course. Address Libbey-Owens-Ford Glass Company, 1307 Nicholas Building, Toledo, Ohio. (Member of Producers Council.)

VITROLITE
Colorful Structural Glass

Make certain that your Vitrolite installation is made by an L·O·F authorized dealer

For windows, specify L·O·F quality glass. For interiors, mirrors of L·O·F polished plate glass, clear or in colors, offer unlimited architectural possibilities.

DESIGN TRENDS

Did the Jefferson Memorial controversy foreshadow the fate of government architecture in the United States?

Registration laws now exist in 39 states but the emphasis has been on requirements for securing a license, not on who may and may not supervise or erect buildings.

Not only should the architect be an important factor in the design of "packaged" houses, thinks Vaux Wilson, Jr., a manufacturer, but he should be an important factor in the distribution set-up as well.

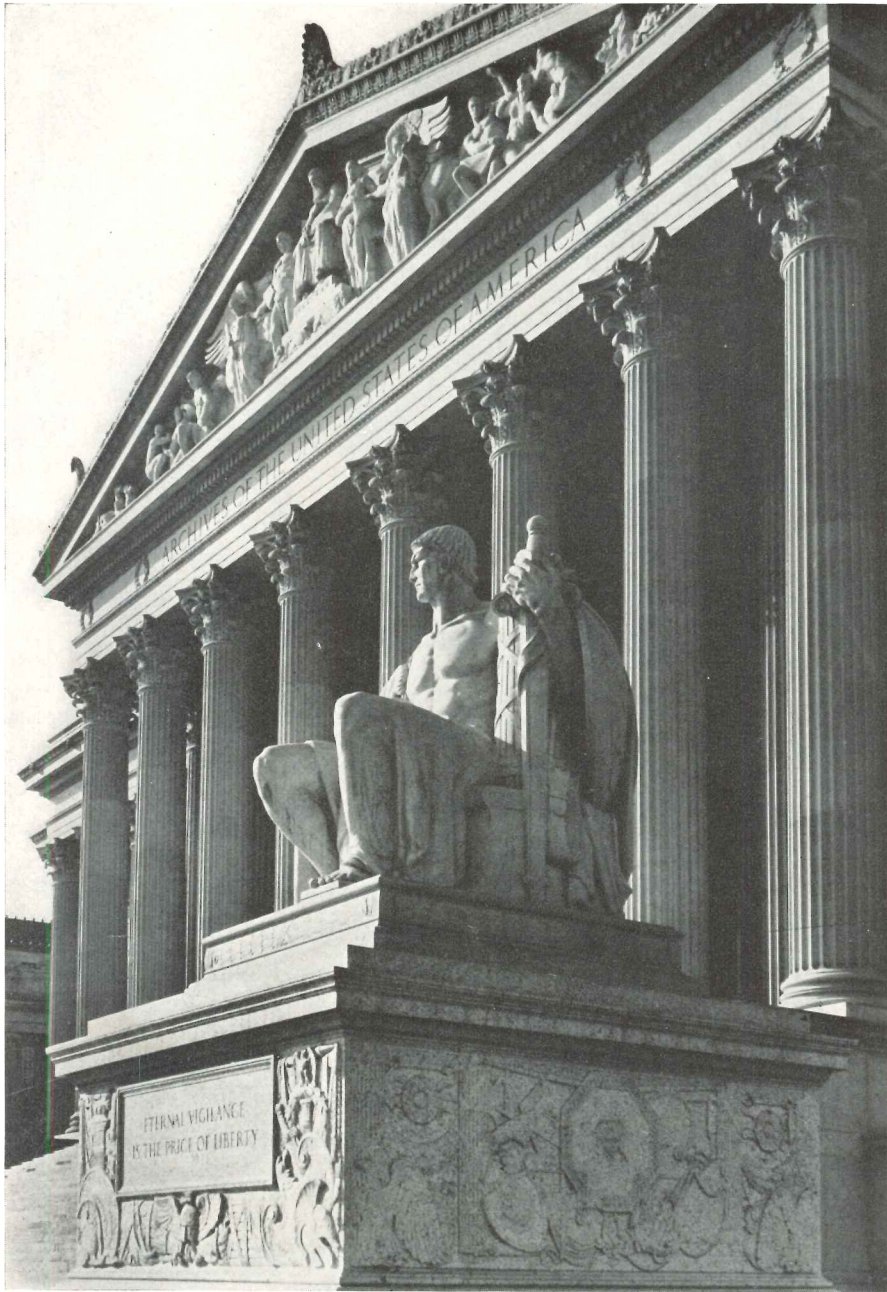
Part II of Frederick J. Kiesler's thumbnail history of photography brings the subject nearer to the architecture of tomorrow.

Pictorial Record: Week-End Houses; and the Coronado Beach Development.

Book Reviews: Small Houses (£500 to £2500). Degree-Day Handbook. Modern Architecture in England. Electric Service with Safety (booklet).

ARCHITECTURAL

Record



The Public

SYMPOSIUM ON PUBLIC

MASKS AND FACES WASHINGTON, D. C.

Exterior of Archives Building, at left. Below shows card-punching section in new U. S. Treasury Building.

Photographs by Ewing Galloway



Discussion of Public Architecture

DESIGNS AND MONUMENTS CONDUCTED BY THE AMERICAN FEDERATION OF ARTS

If we were to measure comment on architecture appearing in the press in recent months we would recognize either an increase in news interest supplied by current architectural events, or that the average citizen **AND THE ARCHITECT** are "speaking out" more frequently than heretofore. Much of this comment has been beside the point. Much of it has been bitter, as for example the squabble over the Jefferson Memorial which one writer characterized as the "betrayal of the **ARTISTIC** integrity of our people." At the same time open discussion of buildings, their desirable or stupid form, their ugliness of appearance or attractiveness

are indications of hope on the architect's horizon. Better architecture arises from discussion provided that the "talk" is reasonably thoughtful and, one should add, "temperate."

As an aftermath to the conflict of opinion on the Jefferson Memorial, The American Federation of Arts devoted a session of its annual meeting to the subject of Public Buildings and Monuments. Questions were raised such as "What constitutes a government public building or monument? What factors are to be considered in its design?" The following papers were extracted from the addresses at the annual convention of the Arts Federation:

Civic Art in the American City—Today and Tomorrow

By **CARL FEISS**, *Professor of Planning and Housing, School of Architecture, Columbia University*

"CIVIC ART," to the layman, means higher taxes and great civic expenditures of all sorts. It implies to this layman great buildings—always classic or Renaissance because to him nothing can be really monumental or magnificent unless it embodies the classic orders. It implies marble or granite columns, complicated ornament and sculpture, flights of stairs that are long and hard to climb, great slippery halls, flags and eagles, squat domes, tall domes. It implies great open squares without sufficient islands on which to jump while a puzzled motorist is careening across the broad open spaces like a ship on an uncharted sea. It implies to him wind-swept squares, filled with blinding sun and dust, a fountain perhaps, but certainly a monumental piece of sculpture which he is told is beautiful because it commemorates some particular event in the city's history, but which he instinctively feels isn't really as fine as its purported symbolism.

I always feel sorry for this poor layman who, being faced with a complicated combination of realism and symbolism denoting "civic progress" or "civic virtue" or "civic pride," must perforce justify the expenses incurred by this puzzling marble or bronze exhibit of bare bodies, horses, artillery, and flagpoles on the grounds that it is beautiful and the thing to show the country cousin on his yearly trip to town. But "civic art" must remain a puzzle to the layman. He stands before the public buildings and knows that they are beautiful because he has been told ever since he can remember that the flights of stairs and the colonnades and the sculptured pediments and the domes are beautiful and that he must consider all public monuments such as city halls, courthouses, railway

stations, libraries, memorials, museums, etc., as being the ultimate that the architect can design for these purposes if they embody such fundamental architectural elements. If he is occasionally puzzled to find that movie theaters, banks, department stores, Christian Science churches, and sewage disposal plants often embody these same architectural elements, the ingenuity of the architect in adopting these tried and true architectural features against great odds may be pointed out to him. Or perhaps it might be just as easy to indicate the subtle differences in intercolumniation and cornice height that differentiate a railway station from a public library. But the layman can not always find an architect handy to help him understand "Civic Art," so that all these fine distinctions are lost and all the poor man sees is a mounting line of little figures on his tax duplicate and a thinning pocketbook. And very often when the country cousin comes to town, this country cousin may turn away from the fine new city hall in high rural disdain with "Fer all thet thar marble and doo-dads, t'aint much different from the Goshen County Poor Farm."

But for the architect and the landscape architect, Civic Art is "nirvana." What do they do when they get a commission to design a group of public buildings or arrange for a public square? The answer is simple. They go to their office libraries and they pull down all the books on the orders of architecture and all the books on Italian and French gardens and all the back numbers of "The Concours of the Beaux Arts Institute of Design." Then they take a city map and they look for the place where the most roads come together in the most con-

gested part of the city and they find an axis and a place for an "etoile" or a fine big square crossed by a lot of very important streets and, with Gromort and the Grand Prix Drawings for thirty years scattered around, they lay out the "Grand Plan." The Grand Plan is a very fine thing. It occupies a large sheet of heavy paper of the best kind. Mosaic pavement patterns, the "poche" of the building plans, the spots indicating statues and fountains, the great smudges of "entourage" denoting formal planting and clipped trees (which, incidentally, in America, seldom get clipped), and the fine lettering, make the Grand Plan worthy of being an overmantel in the finest home. Also it is less of a nuisance as an overmantel than as a civic center.

There is something inherently awkward about the Grand Plan in the modern American City. The busy humming and buzzing of city traffic, the clatter of the

street car, the lumbering of a behemoth of a bus, shatter the classic calm of the colonnades. The tinkling of a fountain seems foolish when a truck comes bumping by. Of course, I may be uncharitable. The fine buildings may very successfully screen the slums behind them. They may completely conceal row after row of shoddy storefronts, of parking lots, of treeless streets. They may attempt to hide for a very brief moment a few of those many things which add up to make the American city the most incredibly ugly and dismal place in which to live that now exists. I challenge any one to tell me that the St. Louis or the Cleveland Malls, the Chicago Lake Front, or Fairmount Parkway in Philadelphia, despite the wholesale application of Art with a capital "A," and despite the millions of dollars spent upon them, make those cities beautiful or add one whit to the art of living within them.

In Defense of the Jefferson Memorial

By **ARTHUR UPHAM POPE** (*From American Magazine of Art, June 1937*)

ALL the questions protesting against the Jefferson Memorial, as now planned, seem to have ready answers drawn from current theories that are now much in vogue but which have not yet been subject to any searching scrutiny: architecture must express the materials of which it is composed, and it must express its own age, both statements partly true and both wholly insufficient. That form must respond to material and express rather than violate its inherent qualities needs no argument; that architecture records an age is true. But that the values that architecture has to express are primarily local and temporary, and that each age must reject what has gone before, and that tradition is a constriction, are plausible fallacies that are refuted by the whole history of art. The present age may be too ambiguous, incoherent, and transitory to find valid expression—its techniques may be well adapted to special and immediate concerns and not yet competent to the creation of a monumental style adequate to those universal qualities which civilized people share with all mankind—past as well as future.

Besides expressing its material and its milieu, archi-

ture, if it is to be permanently effective, must express and realize certain qualities that reside permanently in man's own constitution, in his ways of perception and response. All the mechanism of vision and comprehension is involved—the visceral and muscular apparatus, the brain and nervous system, qualities of mind which are as permanent and as legislative as logic itself, and the slowly accumulating mass of human experience; all these make their inescapable demands and they are hardly special to any one age. Democracy, for example, is not an affair of the moment as dictators would have us believe, and it ought to be symbolized in forms that have proven their capacity to endure, in forms deeply grounded in human nature and human experience, and which carry world-wide conviction.

Indeed the cry about imitation and adaptation is much overdone. Every great building has ample and detailed antecedents. The Jefferson Memorial is Roman in the same sense that the Pythagorean theorem is Greek and the sonata form is Italian. Roman law is still a valuable ingredient in modern jurisprudence. The State, War and Navy Building expressed its own age very well.

Classical Architecture Not Essential

By **JOSEPH HUDNUT**, *Dean, Graduate School of Design, Harvard University*

THE IDEA that only classic architecture is possible in Washington is one which has been held only in very recent times. The principle was first expressed in the report of the McMillan Commission and was undoubtedly a consequence of the architectural standards engendered by the Chicago World's Fair. Washington was to be made into a huge and permanent Fair in which all the parts should have a common measure and a consistent character. All growth and all development was to take place strictly within a firm framework adopted once and for all by the men of the late 1890's who were

thus to impress their concepts of form upon their posterity.

Such a program, if carried out, would prevent, or at least greatly restrict, all growth. A living organism would be compressed into a rigid mold, just as the feet of Chinese ladies were compressed in iron shoes. At the same time such a scheme would prevent that expression of history—of a succession of varied periods, impressing themselves, one after the other—from which all the great capitals of Europe have derived their dramatic individualities and enduring architecture.

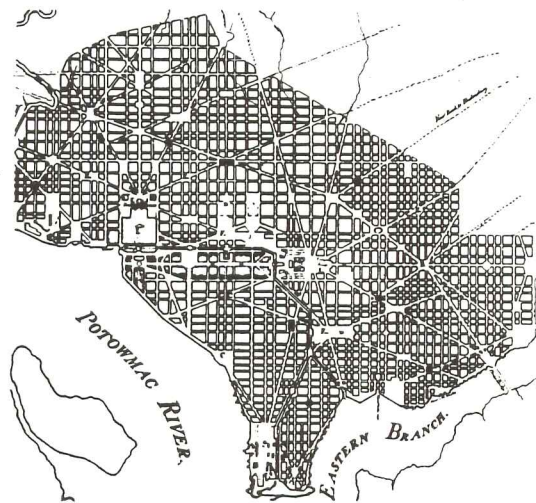
In the great traditions of architecture no such standardization was ever contemplated. In the heart of Venice there are buildings of every period—the Byzantine Basilica, the Gothic Palace, the Baroque Library, and the Renaissance Campanile—and yet these form a harmonious group, and taken together present a complete and satisfying harmony. This is because Venice has impressed on each of them her specific and continuing character.

In the great cathedrals of the Gothic period, each architect built in the manner of his own day, and yet these buildings, as a whole, present complete harmonies. Indeed, they have gained infinitely through this process. It should be the same with Washington. We should not be afraid of our history, nor should we fear that the coming generations will destroy our work even if they dare to be men of their own day. L'Enfant seems to have made his plan in such a way as to permit the greatest variation in types of architecture.

I feel, therefore, no reason for believing that L'Enfant intended a great monument on the axis south of the White House, nor did he intend to impose upon the city of Washington a perpetual classicism.

The third argument made in favor of the Memorial as proposed, namely, that Jefferson would have desired this type of memorial, is more plausible than either of those which I have discussed. There can be no doubt but that Jefferson admired Roman architecture and, if a memorial to some great statesman had been erected in his day, I am confident that he would have approved the construction of a Pantheon.

But suppose Jefferson were living today. Is it not far more likely that he would yield himself to the currents of progressive thought of our day? Since his sympathies in architecture during his own life were consistently with the advanced wing of his profession, since he was indeed an originator of architectural ideas, since his mind was



THE HISTORIC L'ENFANT PLAN was drafted in 1791. There is much in the present city map of Washington which is not L'Enfant's.

always alert to new expressions in architecture, is it not safe to assume that were he living today he would be found in the ranks of the progressives? A visit to Monticello will, I think, confirm this thesis.

But we need not make Jefferson into a modernist to find reasons for believing that he would wish his memorial to take some useful form. All we know of his character seems to confirm the belief that a facility dedicated to the welfare of mankind or to the happiness of the people would please him infinitely more than an archaeological monument. And, if an expression of his life and character is desired, surely such a dedication would be the more eloquent.

America's Outgrowing Imitation Greek Architecture

By **WILLIAM LESCAZE**, Architect

WHILE public buildings do not make up the complete story of architecture, they do constitute, as a rule, a very large part of it and during the past years that part has grown in larger and larger proportion to other types of building.

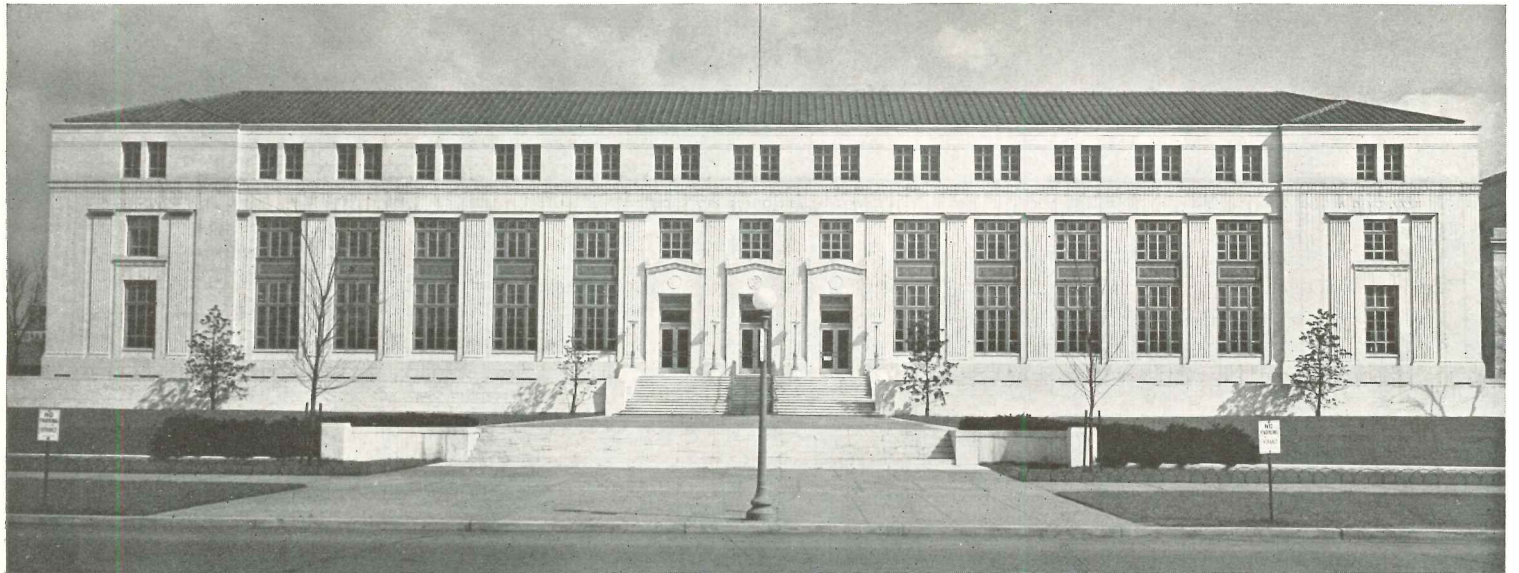
Unfortunately, little if any attention is usually paid by the general public to the kind of public buildings and monuments which our government erects. It is gratifying, therefore, that the announcement of the proposed Jefferson Memorial should have evoked so many comments. It is a healthy sign. Architecture, since we live either in it or surrounded by it, should always be a matter of great concern to all of us. I share the hurt surprise of many citizens at the thought that our Japanese cherry trees may be mutilated. Yet I cannot help feeling that what has really been brought to trial today before American public opinion is not so much the fate of the trees, charming as they are, as the fate of government architecture in the United States. I have no doubt about the outcome. America has definitely outgrown the imitation of Greek or Italian architecture. America is quite capable of developing its own architecture.

But let us go back a few months: let us assume that no

drawings have yet been made for the Jefferson Memorial, that no architect has been selected. A Thomas Jefferson Memorial Commission has been appointed by Congress, composed of honest, serious men. They come from different states, from different occupations. But one thought holds them together; they want to do their share and help to create the best monument possible for Jefferson. As they sit together and discuss and analyze their task, they soon realize that the very first thing to be decided on is: what type of structure will it be? The second thing is: what kind of surroundings, what location?

The location affects somewhat the type of structure. However, without closing their minds to any possibility, they begin an analysis of a few suitable locations which they are told are available. Still there is no idea of the type of structure. The amount of the appropriation which has been voted is the only defined factor.

Each one tries to imagine something. Some of the suggestions sound pretty good. But soon, as good sensible men would—after all, they are Congressmen, they are not philosophers or city planners—they reach the conclusion: let's have (1) a competition for an Idea,



Photographs by Ewing Galloway

PUBLIC HEALTH SERVICE BUILDING

open to all. We'll offer two sites, perhaps, and we will see what ideas we'll get. We'll ask for a description in words mostly and for just a little sketch. Then when we have the results of that first competition, we will decide ourselves on the type of structure. There has been talk of an auditorium for Presidential inaugurations. It might be a good idea to make it a useful structure. Wouldn't that be a fine and intelligent way to honor Jefferson? At any rate we will get some good suggestions of ideas and by that time the location will be determined and we'll be able to write a definite program.

Then let's have (2) a real architectural competition, open to all. We hear that there is still some unemployment among architects. There is a good chance to get quite a few responses and some very original drawings. Some might even capture the democratic spirit of Thomas Jefferson and yet carry it out in a modern—1937—manner.

However, things did not go that natural, democratic way. What happened instead makes a strange tale. Stranger still are the consequences of the proposed design:

- 1—Thomas Jefferson, simple man in his manner of living and in his own work, hater of pretense, would be immortalized with the very pomp and pretense he always fought.
- 2—The traffic circulation, already far from ideal at the 14th Street Bridge, would be further needlessly complicated.
- 3—The Japanese cherry trees that each spring draw thousands of tourists to the Capital would be mutilated.
- 4—In all likelihood the appropriation of \$3,000,000 would be exceeded. Cost of foundations alone would be abnormally great, due to difficult soil conditions.
- 5—If you will allow a "human interest" touch—the President of the American Federation of Arts has finally succeeded, as Director of the Brooklyn Museum, in removing the 47 steps which adorned the entrance of his museum. It might take 50 directors at least, of 50 museums, to remove the 67 steps of the proposed design.

I, for one, do not believe that the proposed Jefferson Memorial, as soon as we have seen it published, will be built. I, for one, find a great deal of encouragement in the critical reception with which the press, almost unanimously, greeted the announcement. Thanks to the ill-fated Jefferson Memorial, coming as a last straw, a serious, genuine interest in our public buildings has been re-awakened. Such an interest from the public is essential to all of us. We as architects can advance only as far as the public will demand, or rather, as I would prefer to have it; we as architects can advance only a little bit further than public opinion does let us.

Up to now only a few isolated voices had been heard in protest against Greek buildings, Roman buildings, or what have you. Back in 1926 Lewis Mumford had uttered the following warning:

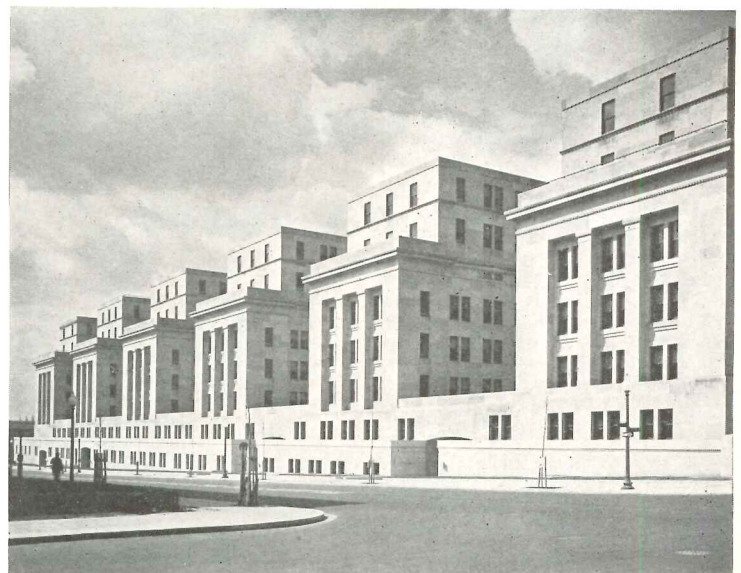
"In America we have fallen roughly between two misguided views of architecture: barracks architecture (factories, warehouses, office buildings) and picture-book architecture. Our picture-book architecture characterizes most of our schools, colleges, churches and municipal buildings. It aims to counterfeit the beautiful architecture of the past; and while its plumbing, its elevators, its lavatories, may belong to the Twentieth Century, everything else has the form of some other culture, some earlier age."

More recently, in the April 1934 issue of *Harper's Magazine*, William Harlan Hale published a thorough study of the buildings in Washington, which every Congressman, every Senator should read. I can't resist quoting one passage, at least here. This one is apropos of the Department of Commerce Building:

"How did they go about it? They sank concrete foundations and went ahead just as they would have done on any normal office building. They ran up steel girders and hung the traverse beams. But then, instead of attaching a light masonry mantle to the steel, they got to work with heavy rock. The lower two floors, clear around the building, they sheathed in rusticated stone in the old Florentine manner . . ."



FOLGER SHAKESPEARE LIBRARY.
PAUL PHILIPPE CRET, ARCHITECT.



DEPARTMENT OF INTERIOR BUILDING.
LOUIS A. SIMON, ARCHITECT.

No less than 700,000 cubic feet of limestone, at a total cost of \$2,700,000! No less than 135,000 cubic feet of granite, at a cost of \$450,000. Now let me say, so that these figures may be appreciated: when we speak of cubic feet of construction, available cubic feet of space is usually meant, including the walls, of course, but none the less, mostly cubic feet of free space, space which can be used for circulation, for work, etc. But here the figures mean cubic feet of solid, dense rock; in other words, unusable volume and weight. If the limestone is added to the granite, there is a total of 835,000 cubic feet for \$3,150,000, or \$3.77 per cubic foot of rock. Compare this with from 60 cents to 75 cents cost per cubic foot of any good quality construction!

Or, if you please, compare the total of 835,000 cubic feet of solid rock with a total 800,000 cubic feet of construction (walls and space) which we found were necessary to house 700 students in a public high school. In other words the bulk of limestone and granite alone in the Department of Commerce building equals the size of a public high school for 700 students!

Now to go to another warning, issued right in Washington, as an editorial of the *Washington Post* of October 1, 1934, under the appropriate title, "Is It Architecture?" The writer describes the Triangle and then outlines what he rightly thinks are the functions of an architect:

" . . . The architect must take into account the people the building is to serve, what it is to be used for, its relation to the community, its accessibility, what effect it will have upon traffic and a hundred and one other important items. Then he builds his structure from the inside, letting its shape and design depend upon its use; design that does not grow out of its use is extraneous and silly.

"On these premises the Government buildings in Washington are not good architecture. They are foreign to the form of government they were built to serve. They were designed from the outside and, as thousands of government workers complain, they may be classically beautiful to look at, but have little relationship in their design to their obvious function."

Some friends explained to me that the Triangle had

to be, because it is part of Major L'Enfant's plan. Now the same defense is made of the proposed Jefferson Memorial. Frankly, what if it is! Why should it matter? Is it or is it not true that Major L'Enfant mapped his plan in 1792? I should like to be shown anything in the field of science or medicine which was extremely good in 1792 and is still so good today, almost 150 years later, that we can still use it as is? Is it not generally conceded that L'Enfant's plan was extremely formal, as it is natural that it should have been at that time? Are we still as formal as people were then? How could L'Enfant foresee such changes in our habits? How could he prepare and plan for the automobiles?

Other cities have also had plans; other cities have also grown. But then they have readjusted, revised, their original plans to growing needs. I can recall countless instances. That is real planning, of the kind we need.

It might be of interest that quite a few public buildings were erected as the result of competitions. I quote from the *Journal of the American Institute of Architects*, April 1936, the names of the buildings, and the names of the architect winners of the competitions, and the age of the architects at the time they won the competitions:

	Age
U. S. Capitol, William Thornton.....	33
Pan American Building, Paul Cret.....	31
Washington Monument, Baltimore, Robert Mills.	33
New York County Court House, Guy Lowell....	43
Tribune Tower, Raymond Hood.....	41

and I could go on.

There can't be any doubt about it—the best method of obtaining designs for, and the architects to supervise, the erection of all buildings and monuments where the expenditure of public funds is involved, is the architectural competition. Our British colleagues know it: at a glance in their *Journal* of April 22, 1937, I counted over 12 competitions being announced, ranging from a modest bandstand to a church and a town hall.

Now, as I see it, beyond the question of a Jefferson Memorial or no Jefferson Memorial, beyond the question of the Triangle buildings looms the larger issue: what kind of architecture are we to have, what do we think architecture is, really?

Does Registration Protect Life, Health, Property?

By THOMAS S. HOLDEN*

IT SHOULD be only a matter of a few years before the title and status of architects are recognized and protected by law in all the 48 states of the country. Registration laws now exist in 39 of the states, as well as in the District of Columbia, Hawaii, Puerto Rico and the Philippine Islands.

Before 1910 only four states had registration laws. By the end of 1919 there were twenty; in the following decade the number grew to twenty-nine; from 1930 to the present time ten more states came into line, the latest being Nebraska and Texas, whose laws have been enacted this year.

The nine states which have not yet established any legal standards for architectural practice are Arkansas, Kansas, Maine, Massachusetts, Missouri, Nevada, New Hampshire, Vermont and Wyoming. Five of these nine states (Arkansas, Kansas, Maine, Nevada and Wyoming) already require registration of professional engineers, and four of them (Maine, Massachusetts, Missouri and New Hampshire) are actively engaged in an effort to pass architectural registration laws. The proposed Missouri law, covering registration of architects and professional engineers, is being urgently pushed by the Missouri Construction League, which has made this law one of the principal objectives of its very active development program.

Registration Approved by the Profession

It would appear that members of the profession generally have grown to recognize the advantages of registration laws. While there was some opposition and a considerable amount of indifference in earlier years, practically all recently enacted laws have been initiated or actively supported by the professional societies.

A very considerable preponderance of satisfactory experience with the workings of registration laws is expressed in a set of 32 letters recently received by the writer from officers of American Institute chapters and state registration boards in 21 states.

Letters from 15 of the 21 states say without qualification that general professional standards have been graded up very considerably by reason of registration requirements, and a like number report a continual stiffening

* Vice president, F. W. Dodge Corporation.

of registration requirements. Of the six states reporting no progress in this respect, only three had registration laws before 1920 and the other three have had registration only since 1930. One state law enacted in 1915 is reported as not having been amended since that date, though there is now a movement under way among the architects for strengthening the law.

As to the state registration boards, general satisfaction was expressed in the letters, nearly all stating that the boards are made up of men truly representative of the profession. Several letters expressed the wish that boards might be elected by the profession instead of appointed by the governor of the state, and one stated that the writer's state board was made up of political appointees. Practically all reported that registration fees are moderate and registration is economically administered; some even stated that fees were too low and administration too economical to secure effective enforcement. A number of letters mentioned the desirability of greater reciprocity between state registration boards. The Committee on Registration Laws of the American Institute of Architects and the National Council of Architectural Registration Boards are actively promoting reciprocity arrangements.

We may fairly conclude from this partial survey that the history of state registration laws is one of progressive recognition of the profession, and that their effectiveness has been measured by the extent to which members of the profession and professional societies have taken an active interest in enforcement and improvement of the laws. This appears to be equally true of the registration laws governing professional engineers.

Protecting Life, Health, Property

In spite of progress in this respect, however, it appears that little has been accomplished in carrying out the primary purpose of the laws, which, as generally stated, is to protect life, health and property. Emphasis has been placed almost exclusively upon requirements for securing a license and assuming the title of architect or professional engineer, without any accompanying restrictions as to who may supervise or erect buildings.

A dramatic illustration of this anomalous situation was afforded last year in the widely publicized collapse of a

partially constructed apartment building in the Bronx, New York City, in which eighteen lives were lost.

In this case plans and specifications were prepared and filed by a registered architect, in accordance with the law. Six men involved in the building project, including the architect, were convicted of second-degree manslaughter. The architect and the plan examiner for the building department, *neither of whom had seen the building during the process of erection*, were given suspended sentences. (The architect may get a reversal of the decision on appeal.) Thus the New York practice, rather general in speculative building projects, of employing a registered architect merely for filing plans and specifications, and trusting to the conscience of owners and builders and the perfunctory inspection of understaffed building departments to see that plans and specifications are carried out, was by implication severely condemned by the court.

Strengthening Laws for Safety

The Bronx tragedy quite naturally initiated country-wide discussion as to means of strengthening the laws in the interest of safe construction. Particularly in New York, a wide variety of legislative proposals has been discussed in the professional societies, other organized groups and volunteer committees.

A New York City ordinance was drawn up by a special committee of architects appointed by Mayor LaGuardia which would require supervision of practically all building projects by licensed architects or professional engineers. Other factors of the industry protested that the ordinance as drawn tended unduly toward a too rigid control by the professional men and at the same time put upon them such complete responsibility that they might be likely to suffer extreme penalties for mistakes made by others whom they could not control. A Building Safety Committee, representative of the various elements of the industry, was appointed by the New York Building Congress to hold open-forum discussions and formulate a substitute ordinance that would reconcile all differences of opinion. (Charles D. Butler, president of the National Council of Architectural Registration Boards, and a member of the New York State Registration Board, served as a member of this committee.) The Building Safety Committee's substitute ordinance contained the following principal provisions:

"Before beginning the erection or the alteration or conversion of any building or structure in the City of New York involving any structural changes or any other changes that may affect its safety, the owners or lessees of the real estate involved shall furnish satisfactory evidence of their legal ownership or leaseholdship and either personally or through legally authorized agent or representative, shall employ a licensed architect or a licensed professional engineer to prepare the design, drawings and specification for such improvement; affix or stamp his seal thereon; file them with the Building Department having jurisdiction and secure its approval; check and approve all shop drawings; and supervise the construction

thereof in person or through an authorized deputy to its completion. Should there be any subsequent changes made in the approved drawings, he shall furnish the said Building Department with such additional drawings and computations as it may require and secure its approval.

"The architect or engineer shall report the general progress of the work to the owner and the Building Department monthly in writing, stating that the materials used and workmanship performed are to the best of his knowledge and belief, in substantial conformity with the drawings and specifications as approved by the Building Department, or describe specifically in detail any variation therefrom and clearly state the reasons therefor. He shall present a final statement to the Building Department in his application for a certificate of occupancy that the work has been performed in compliance with all requirements of this law.

"In case of any change or substitution of a new owner, licensed architect or licensed professional engineer, they shall each file copies of all papers pertaining to such change or substitution with the original papers in the Building Department within 10 days and from that time each shall assume the obligations required of him in this article."

It will be noted that the substitute ordinance, concurred in by contractor members of the Building Safety Committee and approved by the New York Building Congress, which includes many general and special contractors in its membership, retained the provision for supervision by architects or professional engineers. It was not found possible to include, as some builders demanded, provision for supervision by builders in the absence of any registration law setting up standards defining competent builders.

Proposed New York Legislation

Latest reports are that this ordinance, prepared by representatives of the industry and introduced before the Board of Aldermen of New York City, may not pass and may be superseded by another one providing that building operations must be supervised by licensed supervisors, who shall be selected by civil service examinations. It is also reported that the professional societies will next year seek an amendment to the New York State law requiring supervision by licensed architects or professional engineers of construction operations larger than certain defined minimum projects. There was passed in the closing hours of the last session of the New York legislature a hastily drawn bill for licensing builders, which was vetoed by the Governor. It provided no adequate definitions or standards and was criticized as defective in other ways. This was not the first proposal for registration of contractors, nor is it likely to be the last.

Thus, the nature of any further legal enactment to assure safety for buildings in New York is still a matter of uncertainty. One of the states in which the registration laws have worked most effectively in grading up standards of professional competence is still struggling with the problem of assuring safety for life, health and property.

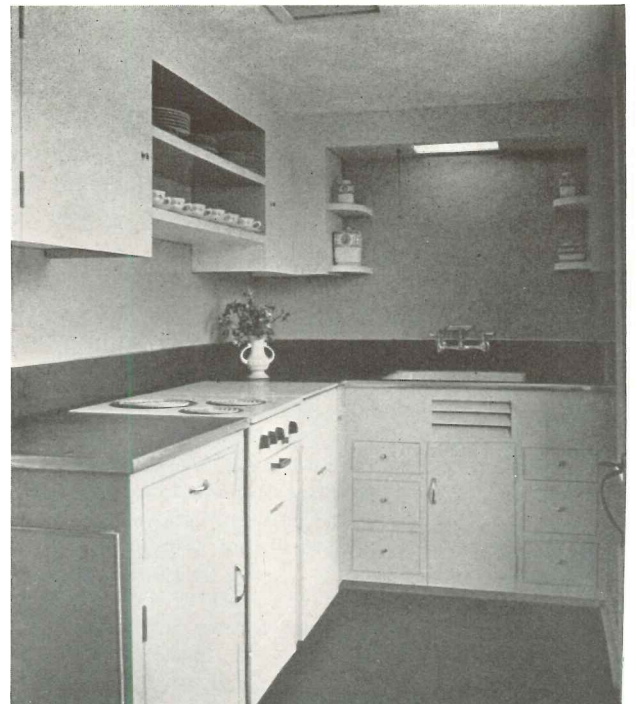


COLOR of house is putty color with blinds a soft gray. Roof is a similar gray.

HILLSIDE HOUSE AT SOUTH KENT, CONNECTICUT

DESIGNED BY ALLAN McDOWELL

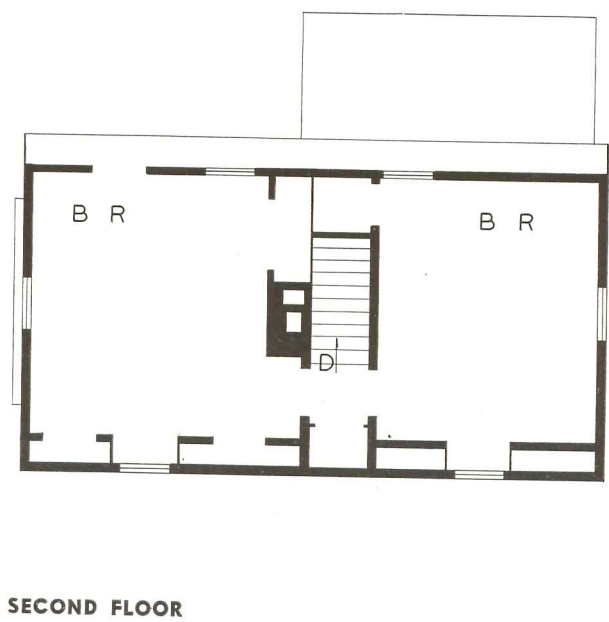
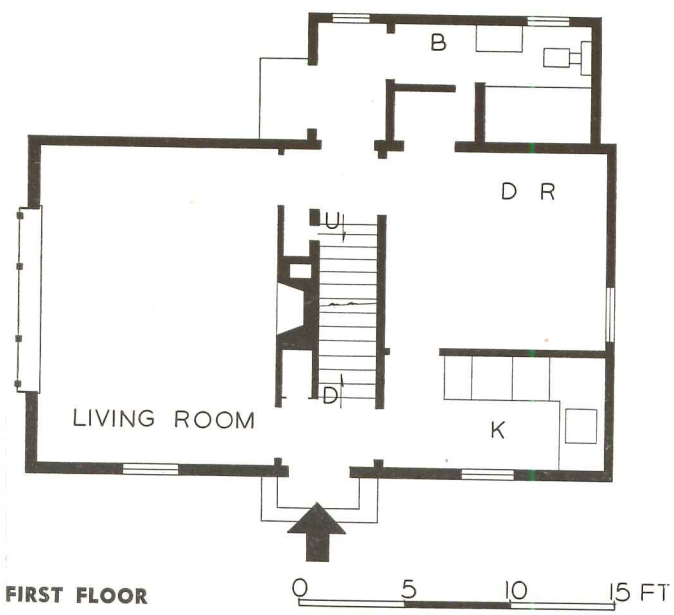
CONSTRUCTION SUMMARY: Foundation, concrete; full depth cellar under half of house; frame construction; wall studs with sheathing, building paper and clapboards; three coats plaster on sheet rock lath; 4" rockwool insulation; double-hung windows by Curtis; finished floors are red oak Minwaxed; in bath and kitchen walls are enamel painted and floors are black linoleum; T.V.A. unit range and refrigerator in kitchen; kitchen cabinets shown at right are of Presdwood; metal moldings by Wooster Products Co.; Fitzgibbons steel boiler, Ray oil burner; one-pipe steam job; complete cost, about \$4,500.

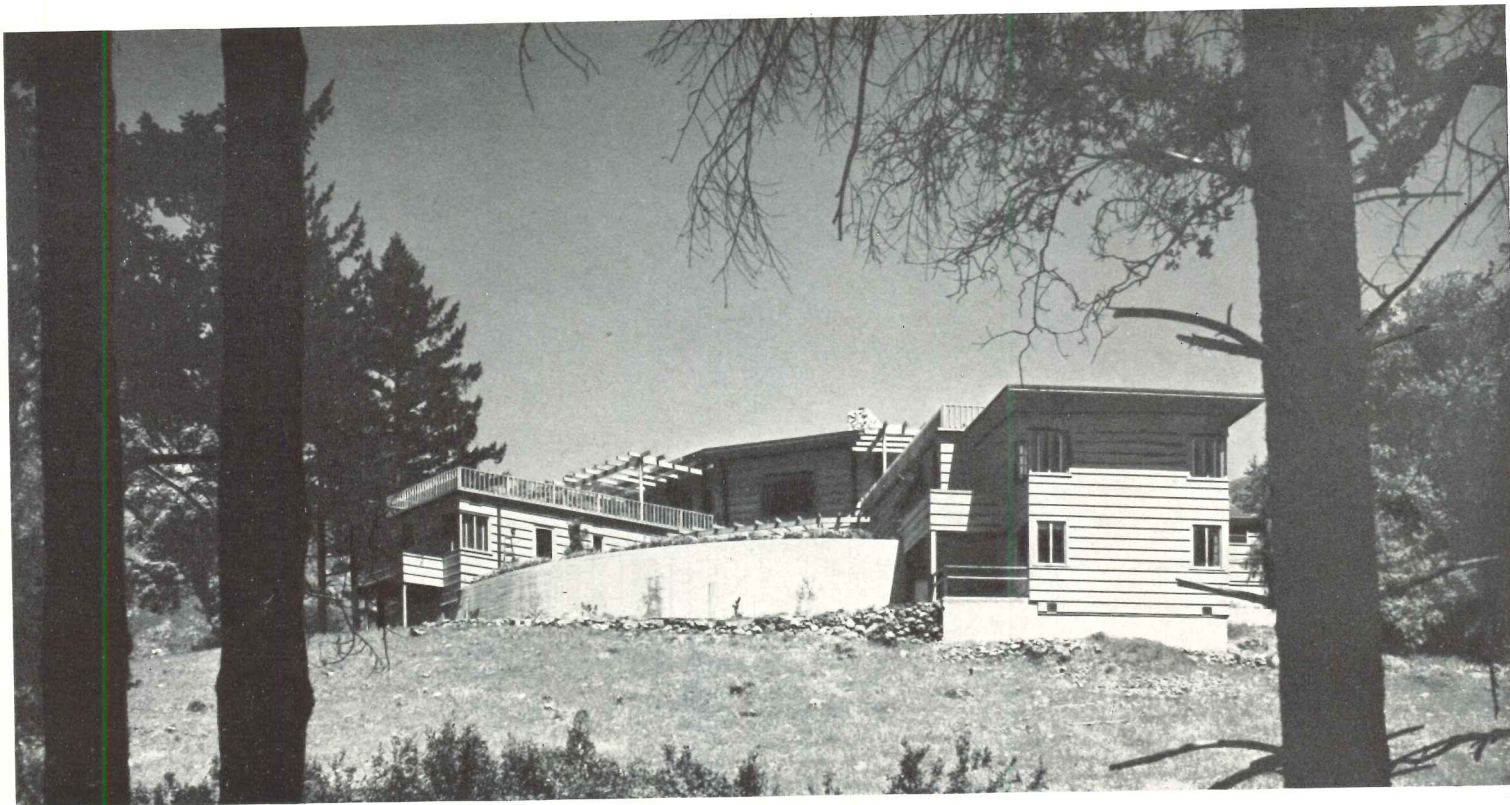


WALLS are of 10" redwood boards, beaded at edge. All interior trim is ivory. Walls downstairs are a soft old rose with exception of kitchen which is soft greenish gray - blue. Upstairs bedrooms are a lighter rose.



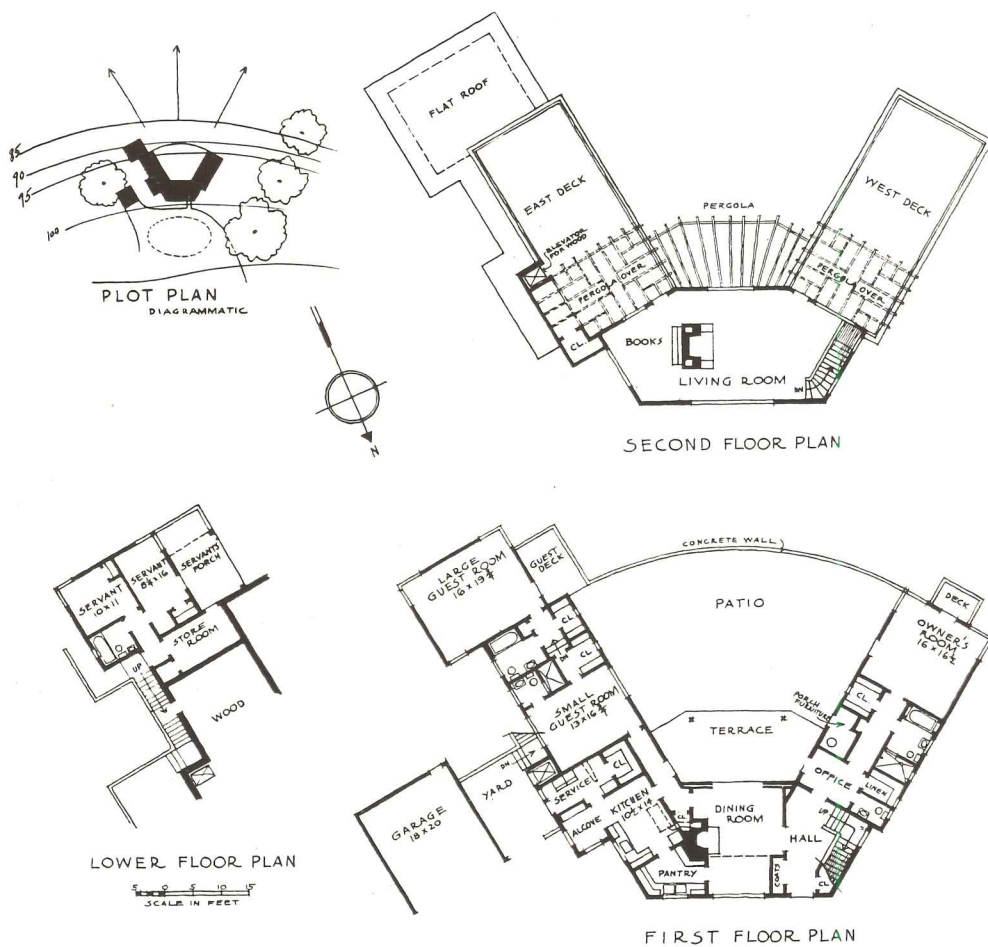
Photos by George H. Van Anda



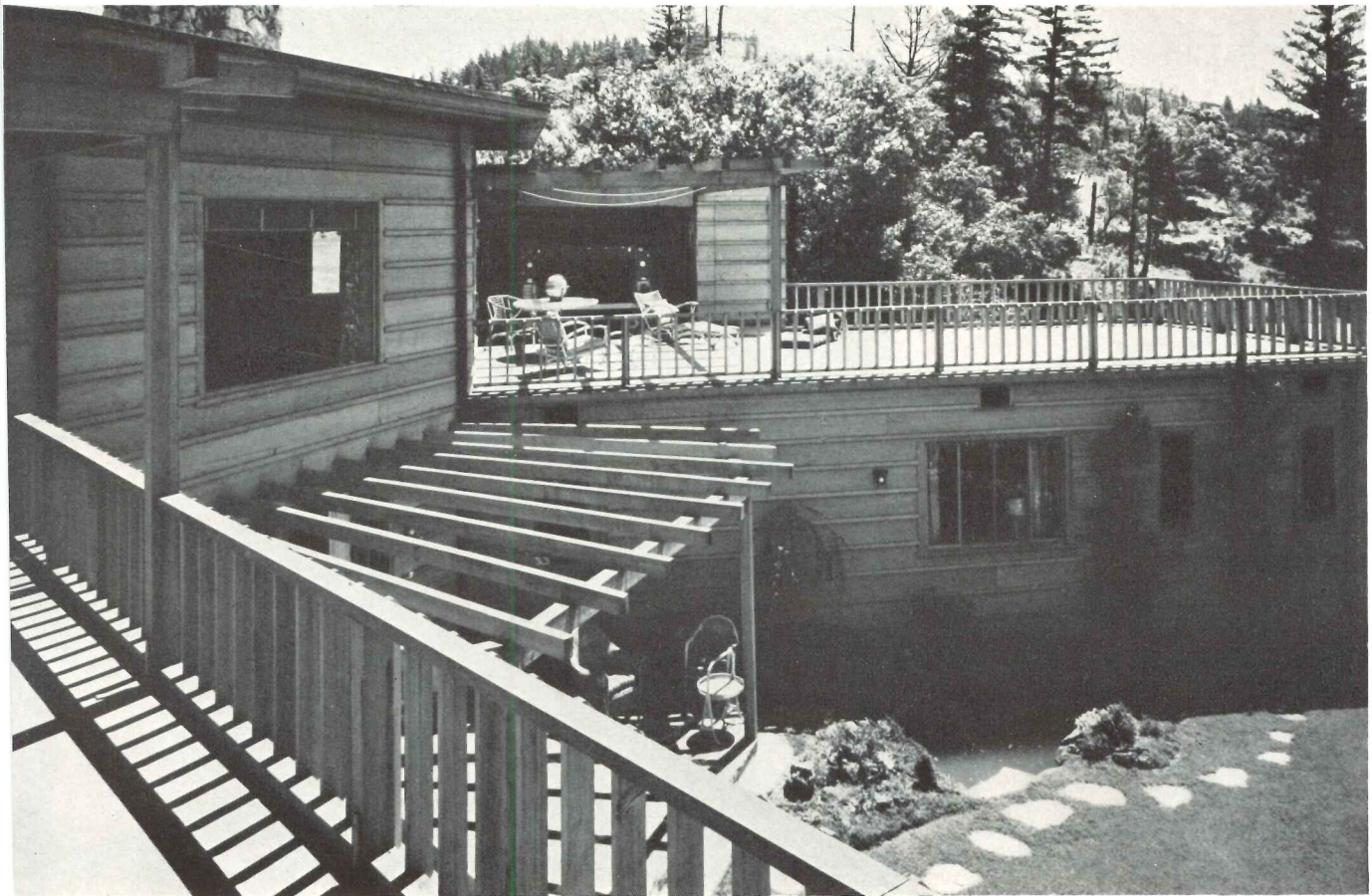
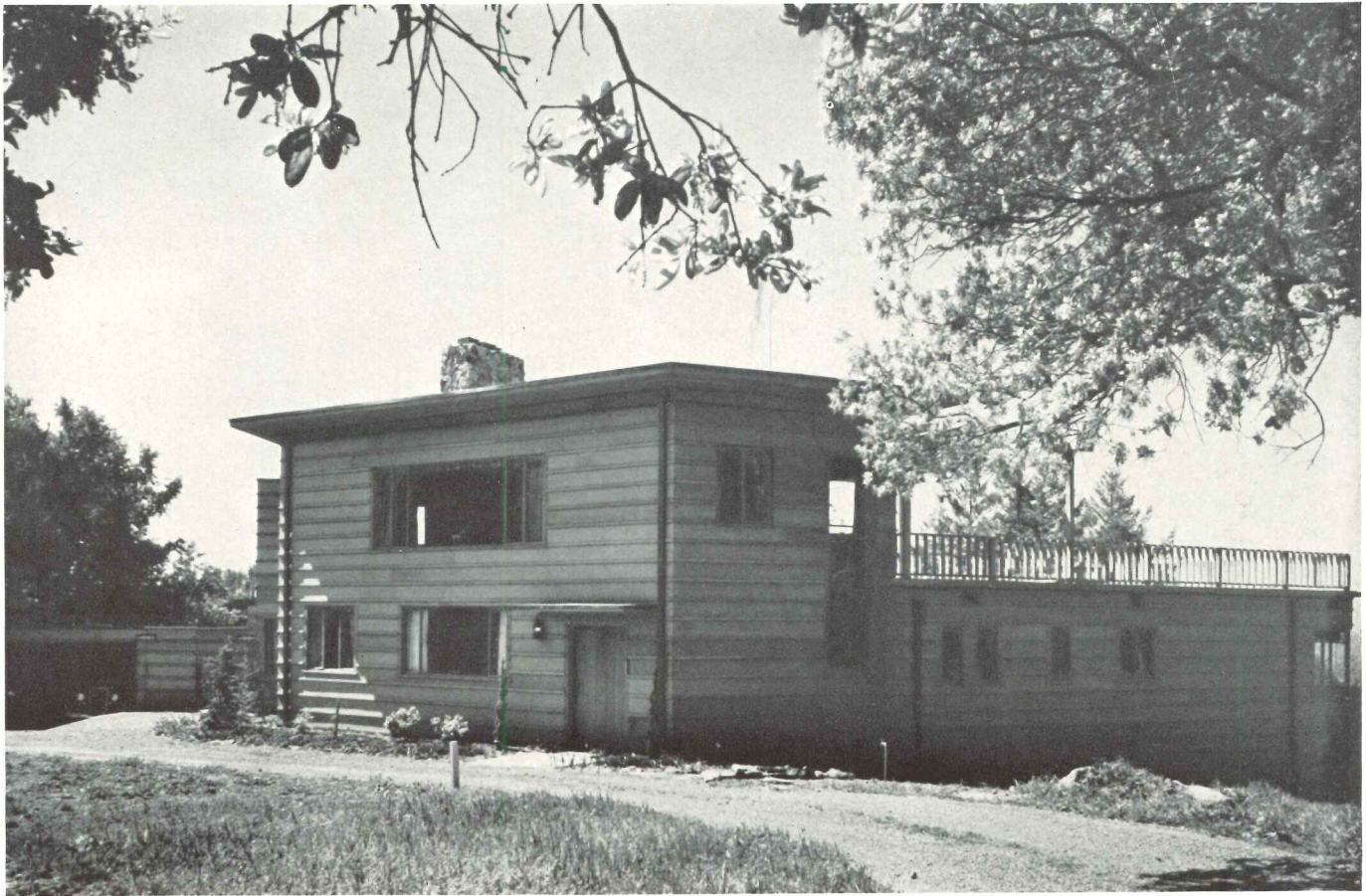


VACATION HOUSE IN CALIFORNIA

WILLIAM WILSON WURSTER,
ARCHITECT



THE HOUSE for Amelia Jarvie was built on the slopes of Mount St. Helena near Calistoga, California. The owner comes seasonally to California to this house on the Yellow Jacket Ranch, built high on a slope and commanding a breath-taking view toward which the house wings extend as open arms.





LIVING AND DINING ROOMS shown on this page; note separation of living room and library by location of fireplace.

VACATION HOUSE IN CALIFORNIA

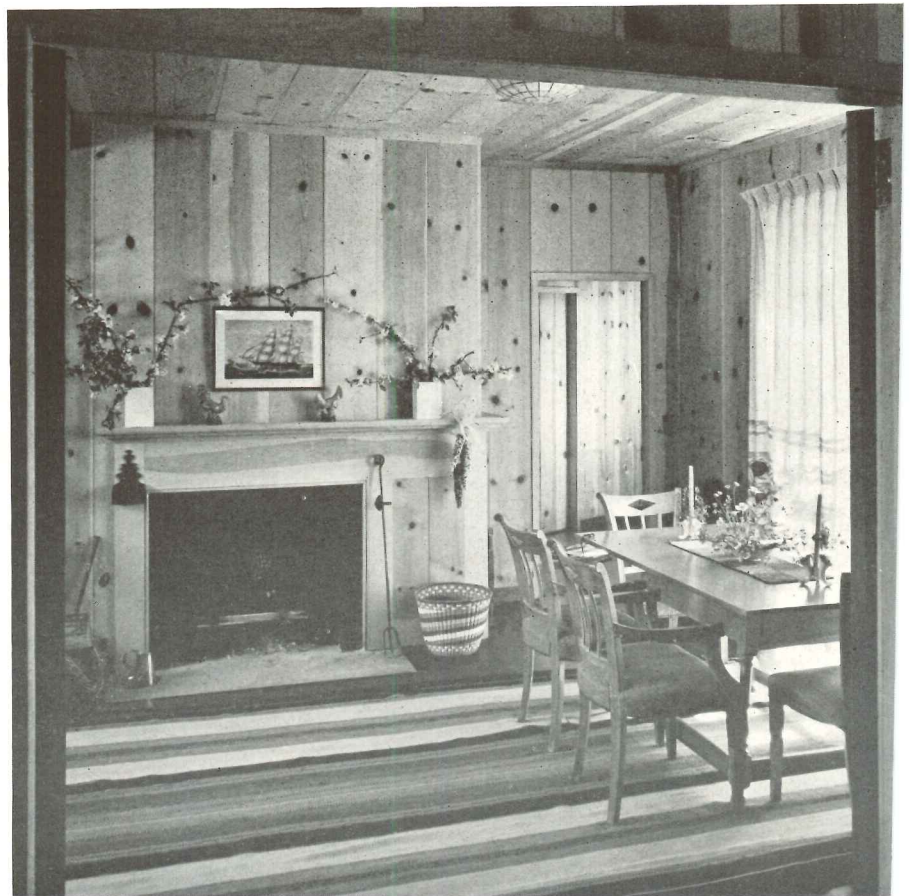
WILLIAM W. WURSTER,
ARCHITECT

CONSTRUCTION AND MATERIALS: The exterior boarding, railing and pergola are of redwood left dark; the sash are steel. The used roof decks are canvas covered; other roofs have built-up roofing with tar and gravel; the curved retaining wall is concrete; the terrace paving is a local stone; interior walls are of pine throughout; floors are Douglas fir T. & G. stained dark.

PLAN: The living room was conceived with the idea that the east end would be devoted to books and separated from the main sitting space only by the huge fireplace of rough local stone.

The dining room has a pair of doors which slide into the wall on the terrace side.

Heating is by electric wall units supplied with electric power from the owner's private power plant.



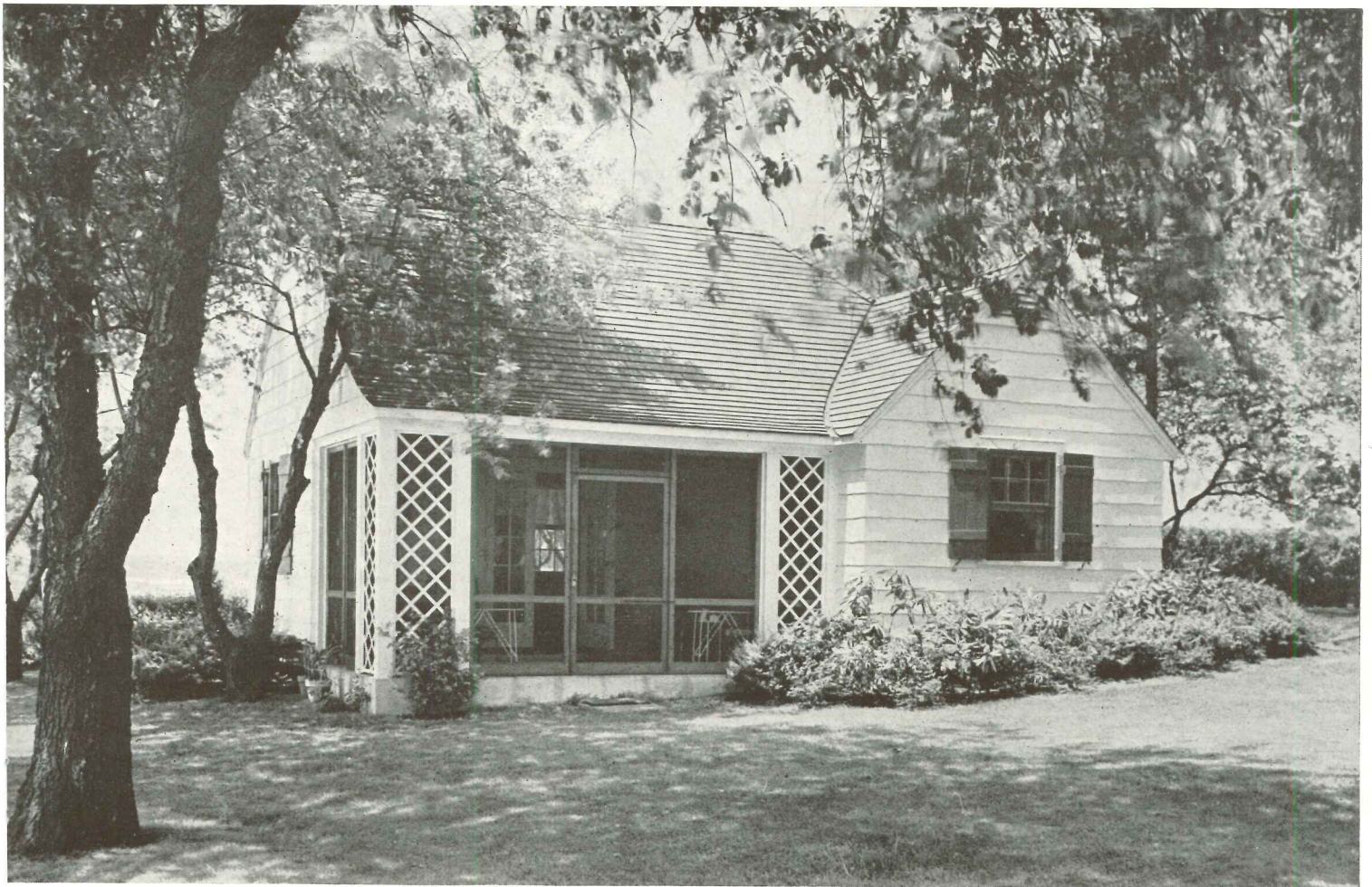
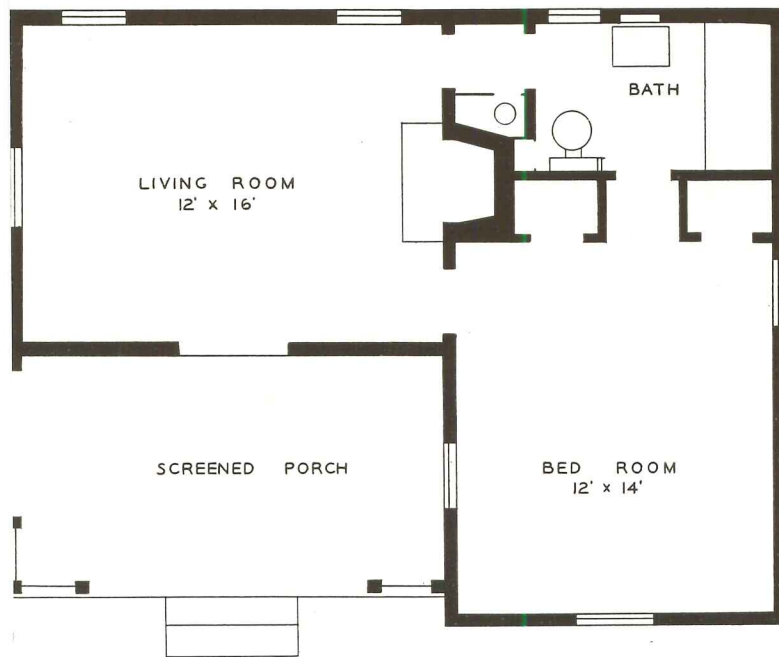


Photo by Murray M. Peters

COTTAGE No. 1 FOR SEAWAVE CLUB, HEWLETT HARBOR,
LONG ISLAND

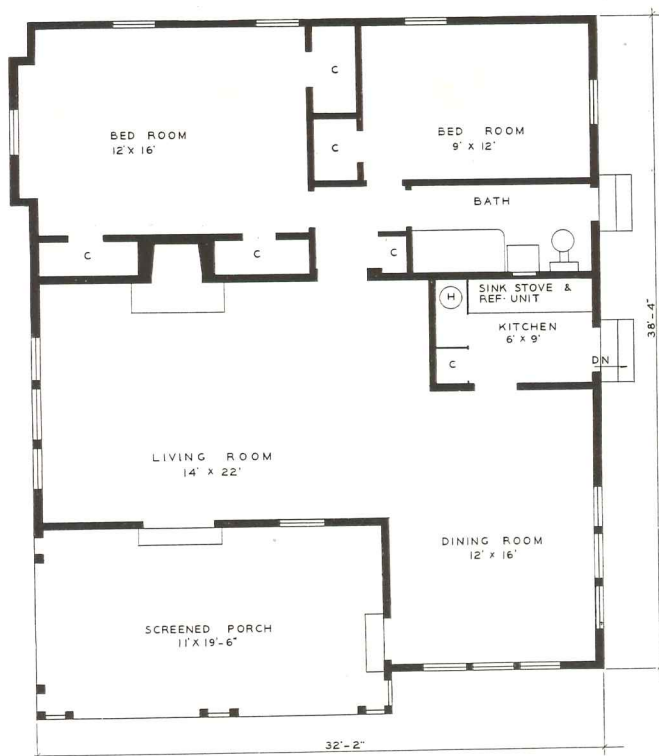


O. F. TJADEN, ARCHITECT



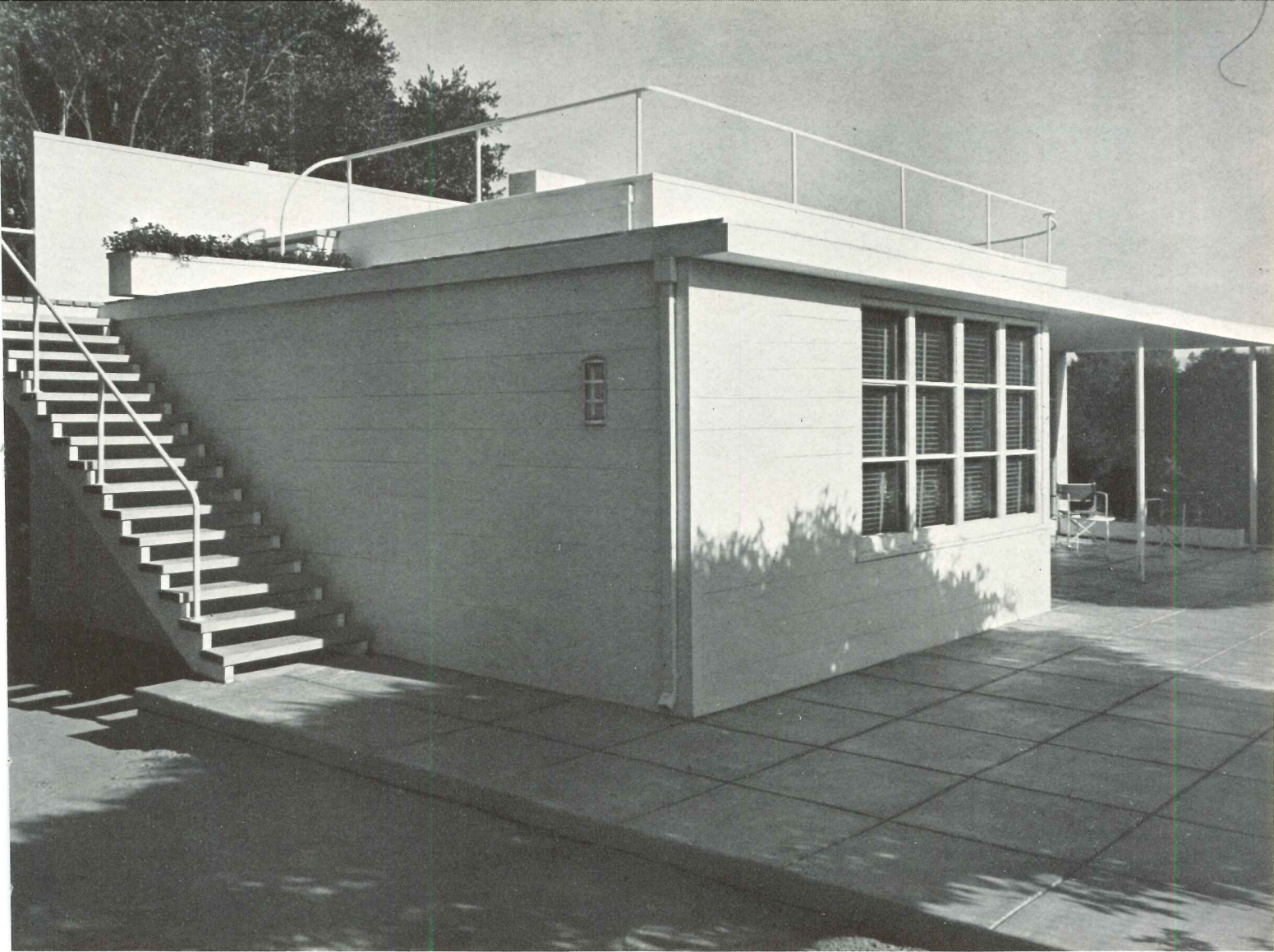
Photo by Murray M. Peters

COTTAGE No. 2 FOR SEAWAVE CLUB, HEWLETT HARBOR, LONG ISLAND



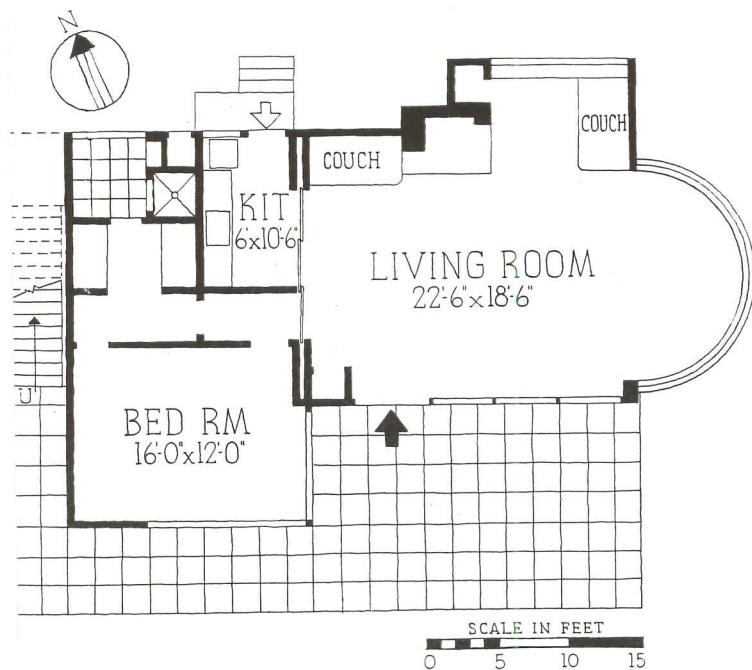
O. F. TJADEN, ARCHITECT

THESE cottages were designed for summer use by Seawave Club members. The construction of the two in this series is frame, faced with shingles or clapboards; stock doors, trim and windows; interior walls of insulation board, joints painted and papered; doors and windows screened with 16-gauge copper; roof, cedar shingles.



COMPACT WEEK-END HOUSE FOR WILLIAM LOWE, JR.

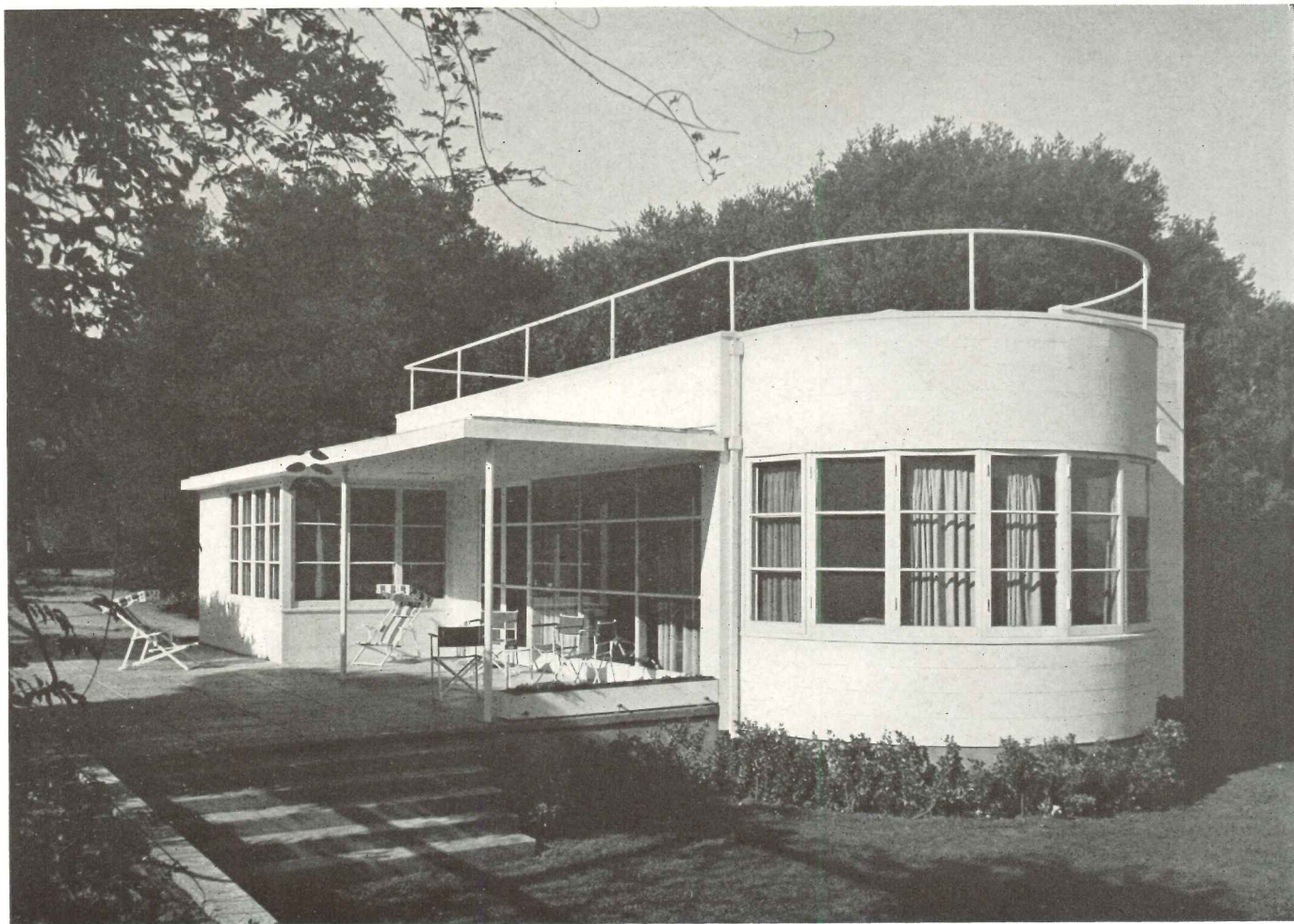
GARDNER A. DAILEY, ARCHITECT



THIS HOUSE was placed on an almost level area adjacent to a tennis court. The main rooms were faced south and west. A swimming pool has been planned on the axis of the living room at the south.

Although compact, the house has a spacious living room which in turn may be used for living, dining, or sleeping. The sliding panel doors that conceal the kitchen may be opened for buffet style meals and for drinks or they can be kept closed for more serious cooking or when the kitchen is not in use.

The built-in sofas in the living room are really comfortable beds which can be uncovered for the unexpected guest and the passage to the dressing room gives both the bedroom and the living room independent access to the bath.



COMPACT WEEK-END HOUSE FOR WILLIAM LOWE, JR.,
WOODSIDE, CALIFORNIA

GARDNER A. DAILEY, ARCHITECT



Having large window area, it was necessary to control light and reduce glare which was done by curtains, venetian blinds, projecting "fins" and by coloring all exterior paving gray-black.

A new method was employed in the installation of insulation board—so as to eliminate the usual cracks or unevenness which develop when building boards are used without some type of battens covering the joints. The studding and joist were placed at 2'-0" centers to accommodate the 4'-0" widths of the material. To the studding and joist were then nailed strips 4" wide of $\frac{1}{4}$ " tempered hardboard to come exactly on all joints where the sheets of insulation board joined. These strips were then "battered" with linoleum cement and the wallboard carefully joined with butt joints and held in place by 1" x 4" wood strips temporarily nailed over the joints to keep the wallboard firmly pressed against the cement. Twelve hours later, after the cement had "set," the temporary wood presses were removed, leaving the walls perfectly smooth and flush with no sign of a joint, and leaving the wall boarding continuous with no possibility of separating.

PENNSYLVANIA
FARMHOUSE
WITH MODERN
ADDITION

DR FRANK B. FOSTER,
ROADWATER FARMS,
HOENIXVILLE, PA.

CAR STONOROV,
ARCHITECT



Photo by F. S. Lincoln

THE PROBLEM: Before alterations and additions to the house consisted of an original Pennsylvania farmhouse to which a two-story porch was added some twenty years ago. Before the house was altered the farmhouse was used for week ends and occasional house parties. Roadwater Farms in which the house is situated is a 100-acre estate with full agricultural activities such as breeding Percheron horses, dairy farming, and so on. The owner wanted to retire to his farm from the suburbs and facilities had to be provided for his large family. The architectural problem was twofold. The owner wanted to have his own part of the house developed with respect for tradition. His children, on the other hand, wanted their part completely modern.

THE PLAN: The accommodations to be provided, in addition to the existing ones, were a new stair hall, a library, a large dining room, new kitchen and pantry. The requirements for the second floor were: master's bedroom and bath, bedroom, dressing room and bath for

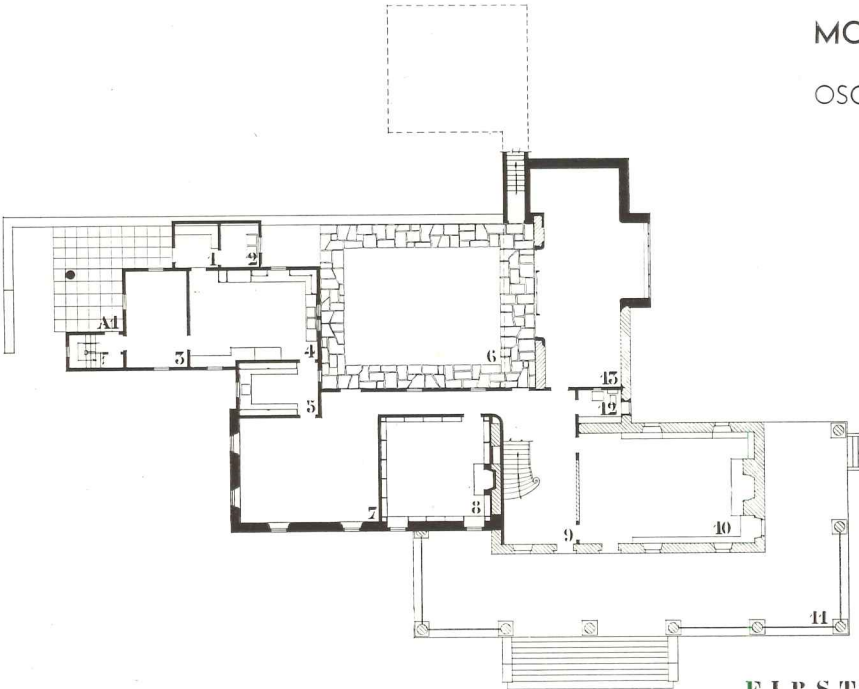
the younger daughter and for four maids' rooms and bath. These rooms were designed in a traditional way to carry out the character of the farmhouse.

The modern wing consists of an apartment for the owner's daughter consisting of a living room, a bedroom, dressing room, bath and sleeping porch. A son's apartment has similar elements. There is, in addition, a large music room with two pianos and an organ. This music room opens on to a patio to which the dining room also has access. The living room is a common meeting place of the two tastes. Here, over the mantel, there is an air map of the entire estate.

The traditional addition is built in a traditional manner, partly in stone and partly of frame. The stonework is stuccoed and painted. The frame construction is likewise stuccoed and painted over 1" Thermax and Steeltex. The modern construction is steel frame with 1" Thermax. Windows in the traditional wing are double-hung. In the modern wing the windows are heavy steel casements.

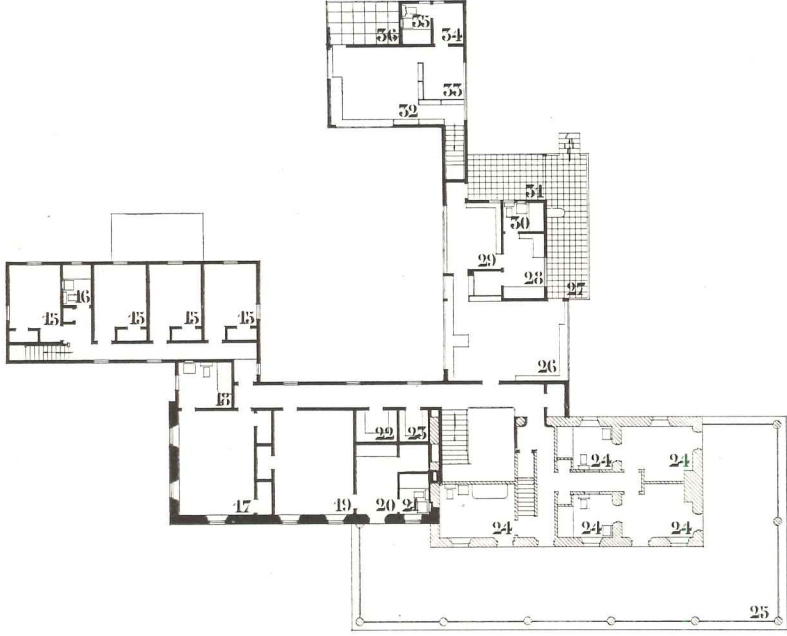
A FARMHOUSE WITH MODERN ADDITION

OSCAR STONOROV,
ARCHITECT



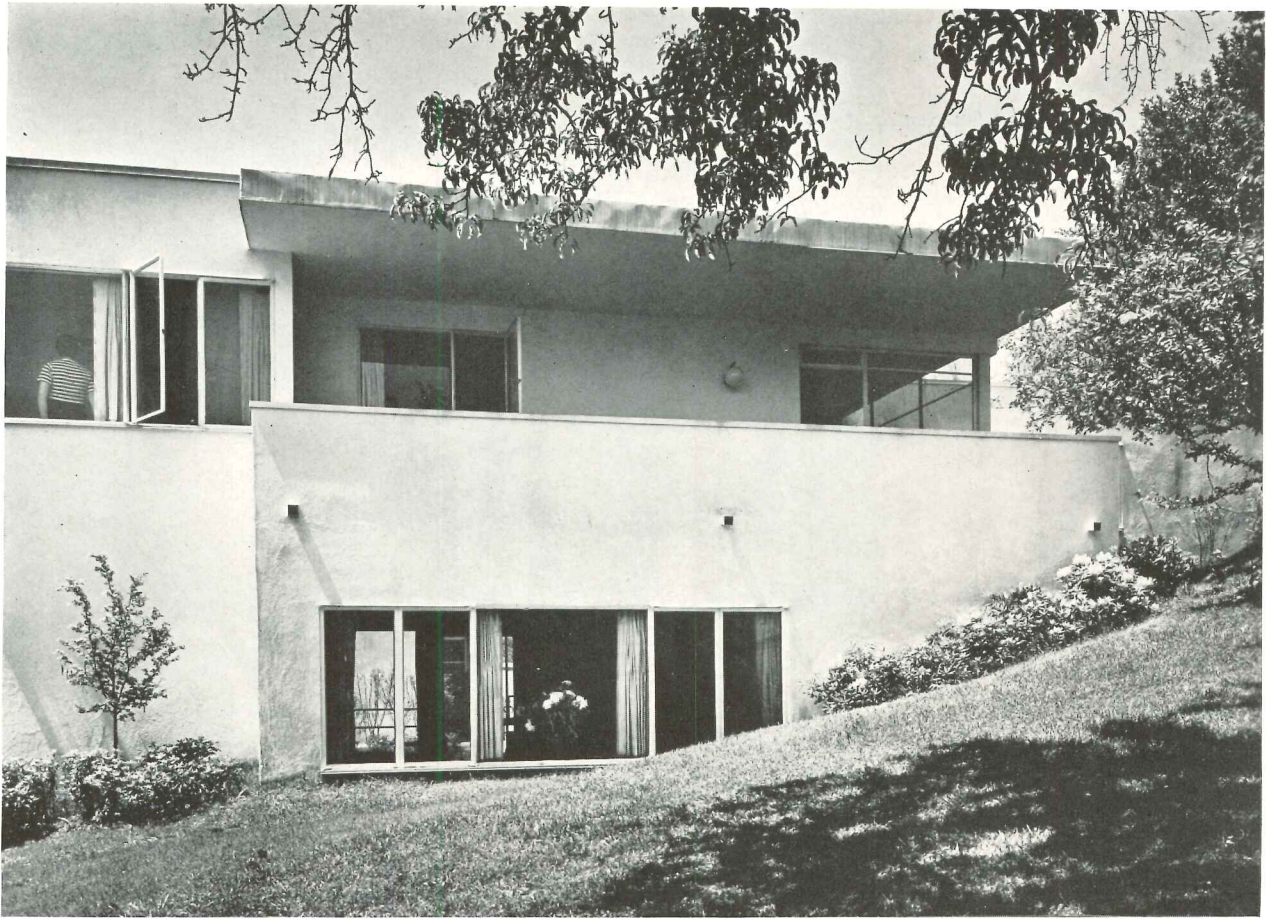
- LEGEND**
- A1 MAIDS PORCH
 - 1 GOLD ROOM
 - 2 LAUNDRY
 - 3 MAIDS SITTING ROOM
 - 4 KITCHEN
 - 5 PANTRY
 - 6 SUNKEN COURT
 - 7 DINING ROOM
 - 8 LIBRARY
 - 9 STAIR HALL
 - 10 LIVING ROOM
 - 11 PORCH
 - 12 POWDER ROOM
 - 15 MUSIC ROOM

FIRST FLOOR PLAN
SCALE 0 5 10 20



- LEGEND**
- 15 MAIDS BEDROOMS
 - 16 BATH
 - 17 MASTERS BEDROOM
 - 18 BATH
 - 19 DAUGHTERS BEDROOM
 - 20 DRESSING ROOM
 - 21 BATH
 - 22 LINEN CLOSET
 - 23 STORAGE CLOSET
 - 24 GUEST ROOMS & BATHS
 - 25 SLEEPING PORCH
 - 26 DAUGHTERS SUITE
 - 27 LIVING ROOM
 - 28 LIVING PORCH
 - 29 DRESSING ROOM
 - 30 BEDROOM
 - 31 BATH
 - 32 SLEEPING PORCH
 - 33 SONS SUITE
 - 34 LIVING ROOM
 - 35 BED ALCOVE
 - 36 DRESSING ROOM
 - 37 BATH
 - 38 SLEEPING PORCH

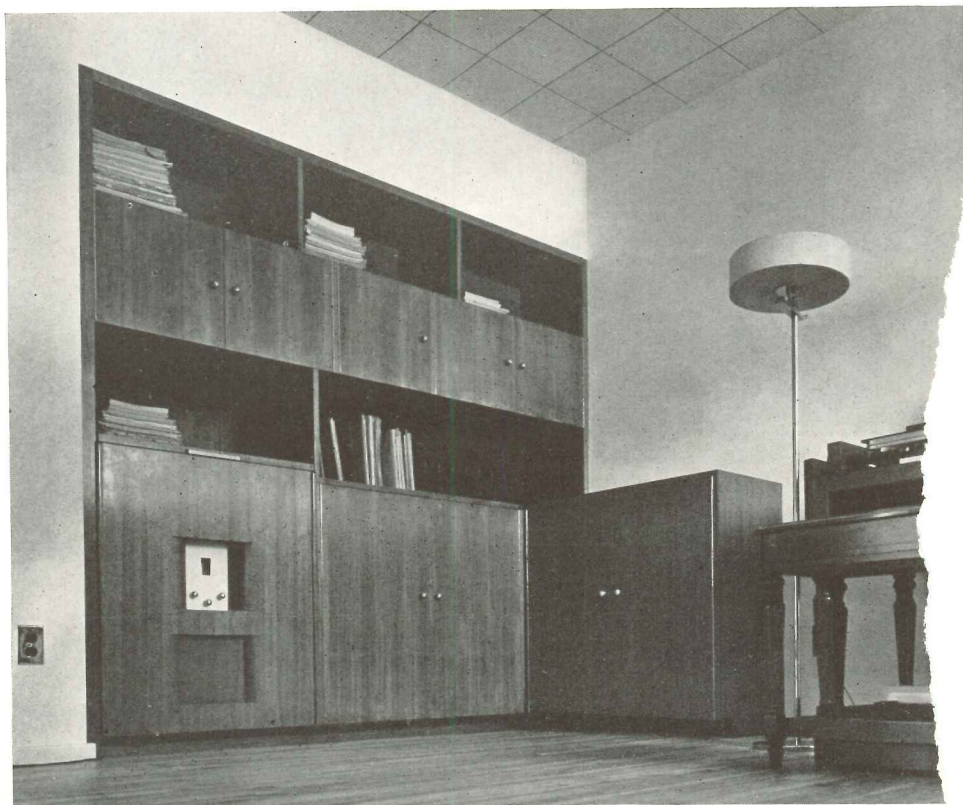
SECOND FLOOR PLAN
SCALE 0 5 10 20



Photos by F. S. Lincoln

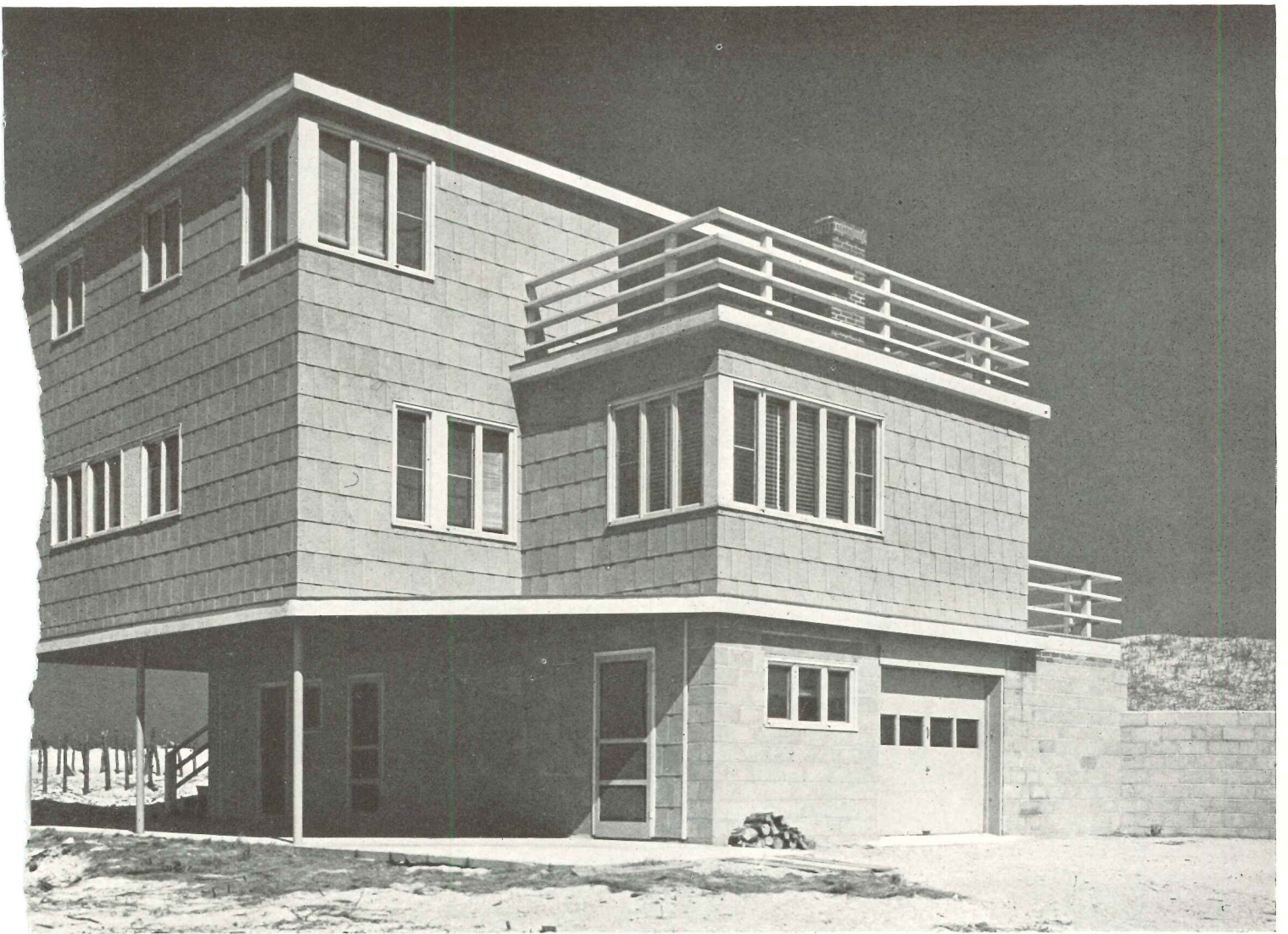
A FARMHOUSE
WITH MODERN ADDITION
OSCAR STONOROV,
ARCHITECT

At right, END OF MUSIC
ROOM; cabinets mahogany,
acoustical ceiling. Below,
DRESSING ROOM.



Photos by F. S. Linc



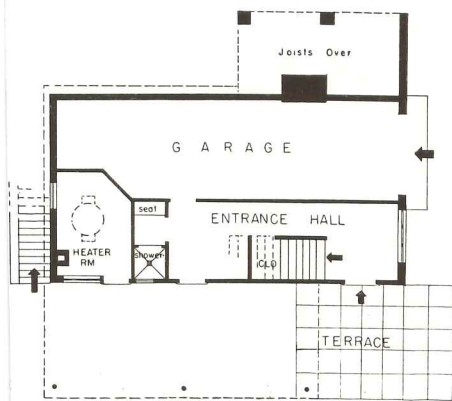


Photos by Imandt

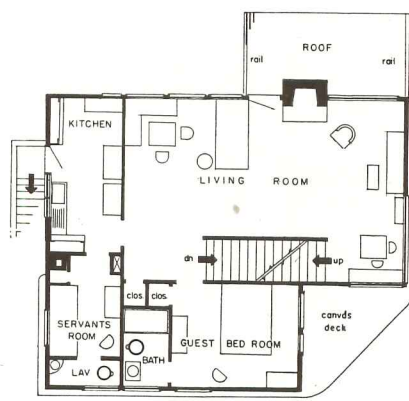
WEEK-END HOUSE ON SEASHORE

FOR WILLIAM BUTLER, AT HARVEY CEDARS, OCEAN COUNTY, NEW JERSEY

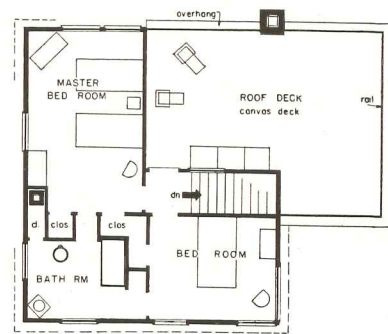
WILLIAM LESCAZE, ARCHITECT; GEORGE DAUB, ASSOCIATE



BASEMENT



FIRST FLOOR



SECOND FLOOR

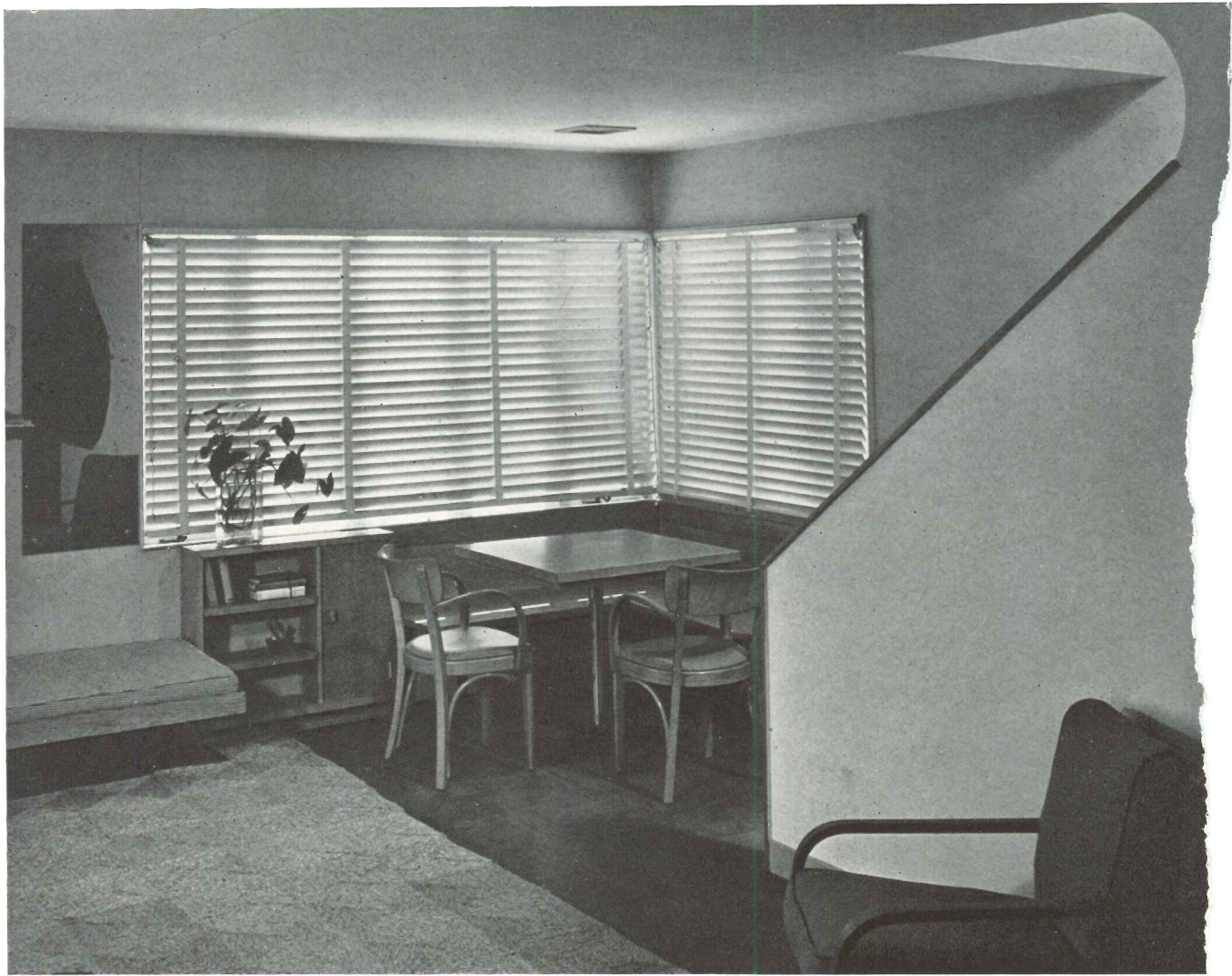
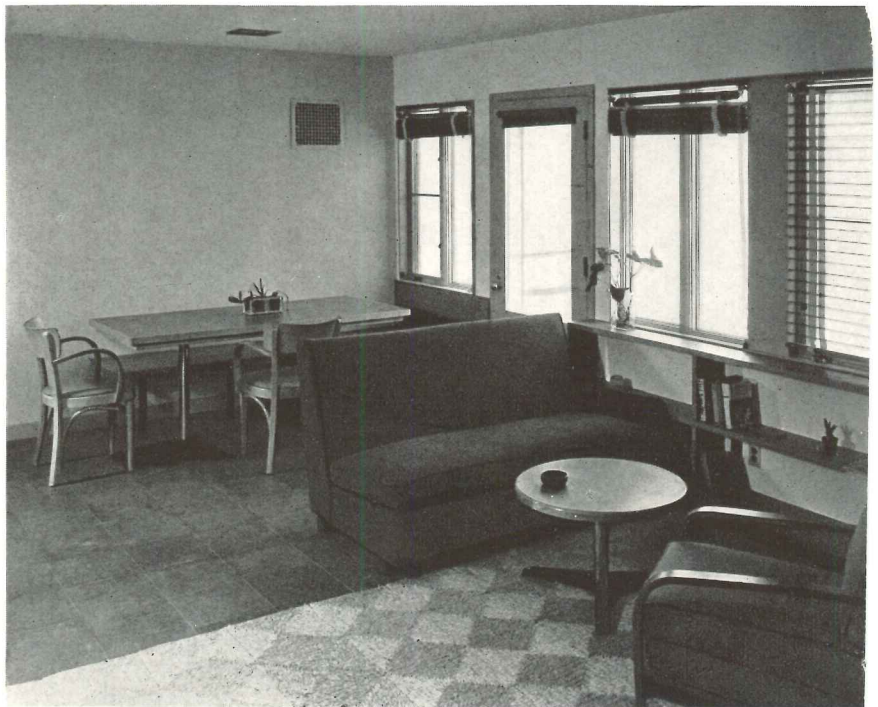


Photo by In

WEEK-END HOUSE
ON SEASHORE
FOR WILLIAM BUTLER
AT HARVEY CEDARS,
OCEAN COUNTY, NEW JERSEY

WILLIAM LESCAZE, ARCHITECT
GEORGE DAUB, ASSOCIATE

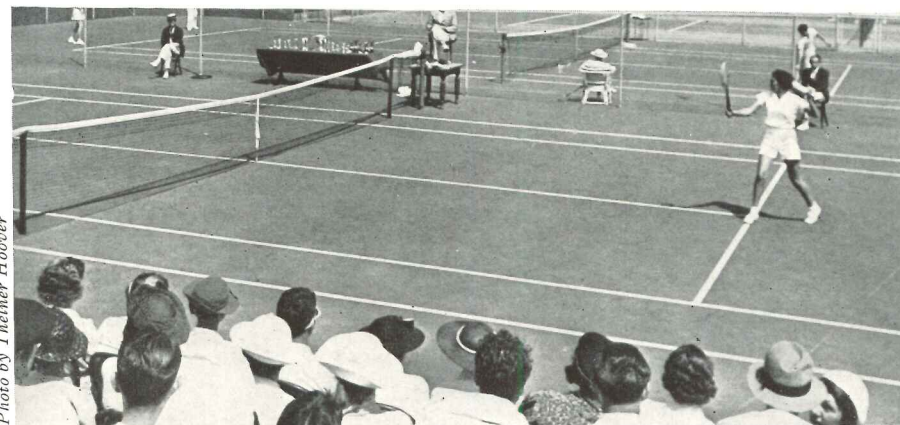
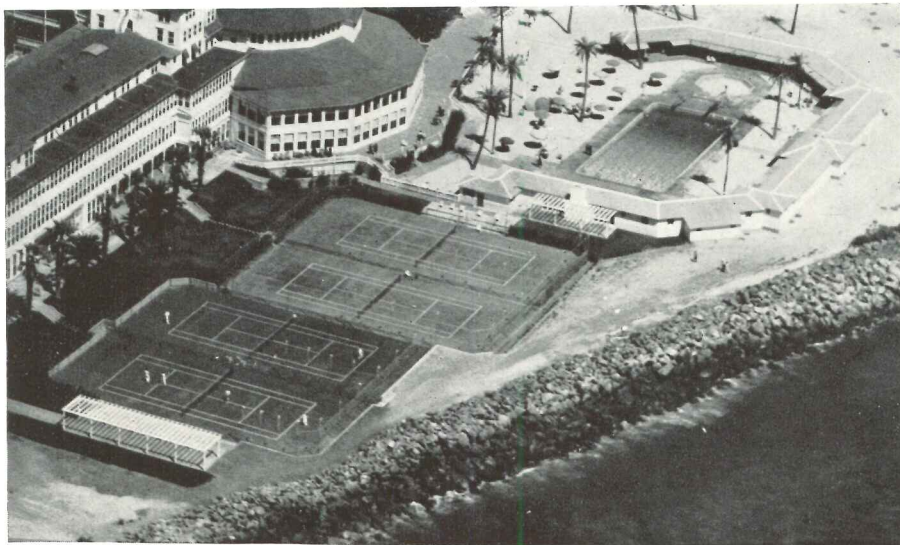


INTERIORS show dining space in living room and side of living room.

BEACH AND TENNIS CLUB

TO ATTRACT PATRONAGE TO HOTEL DEL CORONADO,
CORONADO BEACH, CALIFORNIA

DONALD D. McMURRAY, ARCHITECT



PROBLEM. The general scheme was to locate on a part of unoccupied beach an installation which would serve as a playground for the members of the club and guests of the hotel. It was intended as one of the steps taken to bring back patronage to the Coronado Hotel. The hotel itself was started in 1886 and completed in 1888. It had been a popular California resort.

CONSTRUCTION OF POOL. The entire shell of pool was poured as a monolithic basin. Anti-hydro was used throughout, both in concrete of pool and in backing and grout for tile.

All pipe used for the pool is red brass with the exception of the 12" cast-iron drain to the ocean. All water for pool is obtained from a well sunk beneath the machinery room floor at deep end of pool. This water is salt and so clear, due to filtering through sand, that it is used directly in the pool and then recirculated in the filters. The filter tanks are of reinforced concrete and not of metal. They are pressure filters and all connections to them are of red brass.

There is a grill for serving luncheon at end of pool toward the hotel, also service at night to give encouragement to night parties which receive attention from bar and hotel dining room.

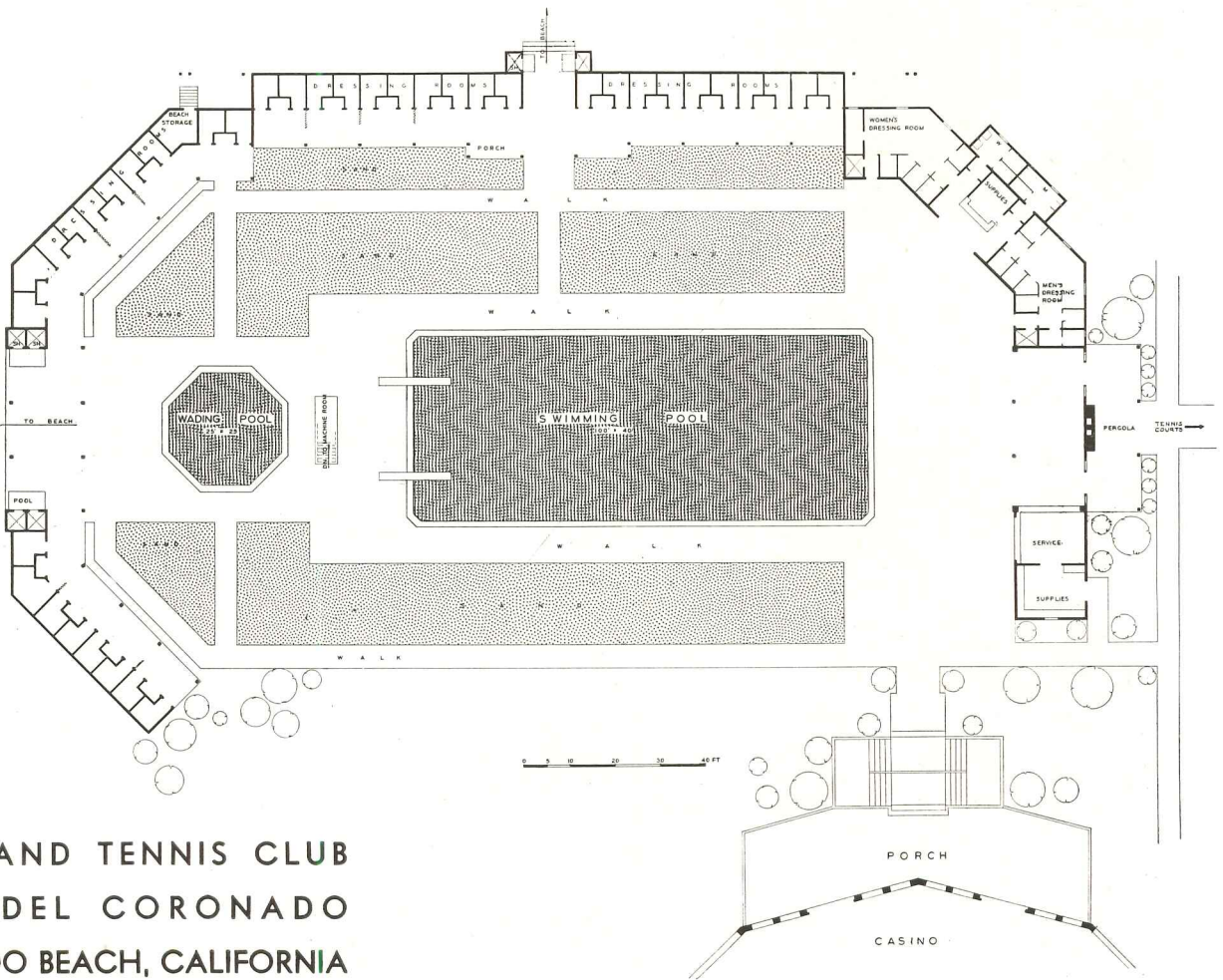
Owing to the fact that this installation is located in beach sand, the planting was somewhat limited. Dirt was brought in and palm trees planted. Around the courts and various buildings top soil was filled in, lawn and bushes were planted.

Photo by Thelmer Hoover

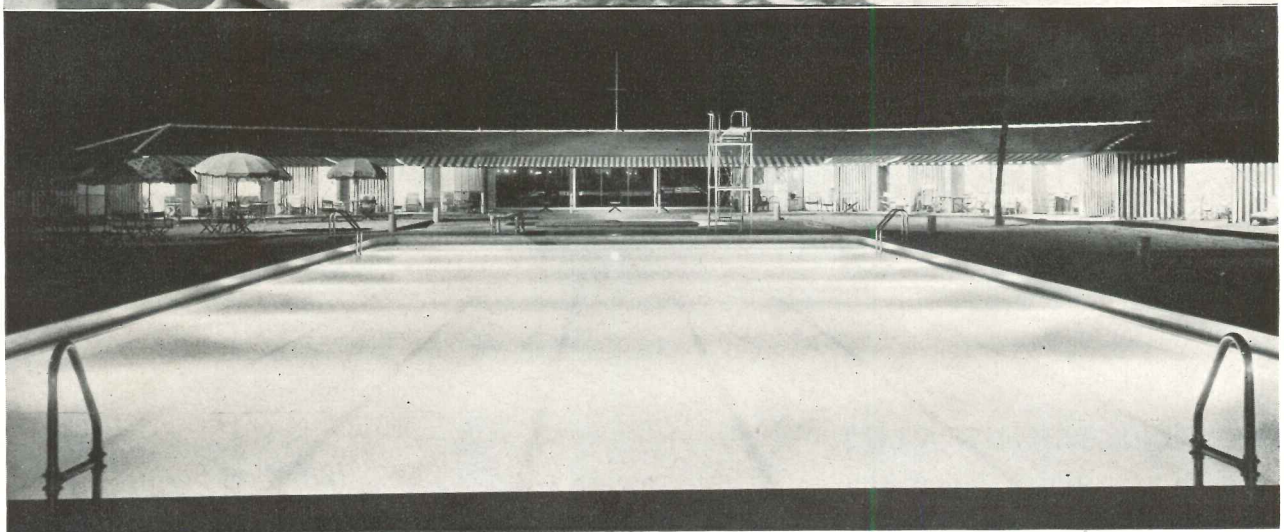




Photo by Thelmer Hoover



BEACH AND TENNIS CLUB
HOTEL DEL CORONADO
CORONADO BEACH, CALIFORNIA



BEACH AND TENNIS CLUB, CORONADO BEACH, CALIFORNIA

DESIGN-CORRELATION

By FREDERICK J. KIESLER

CERTAIN DATA PERTAINING TO THE GENESIS OF DESIGN BY LIGHT (PHOTO-GRAPHY)

PART 2

Part one appeared in the preceding (July) issue, tracing the development of the optico-chemical as well as the social aspect up to the end of the Eighteenth Century. Part two concludes this study of biotechnical reproduction.

Prior to the reproductions of drawings by woodcuts starting with block initials (13th century), the only method of transmitting pictorial messages was by hand-painting them again and again (illuminated papers). When Gutenberg, about 1438, invented movable printing type (typo-graphy), illustrations could only be done in woodcut, and color had to be added by hand. Printing text was already mechanized and the time required for setting up the text-design was shortened by having movable types stored and ready for composition. But any illustrations had still to be designed by hand, then to be cut into wood by hand, which delayed work and was not in conformity with the progress made through text printing of movable types. It was still a highly individualistic task and required artists rather than machines. The same principle of movable printing types stored and ready for use was never applied to illustrations. A standardization of illustration type-units (imago-graphy) was too diversified in its

scope to be standardized in movable parts. Synchronization of type and illustration set-up was lacking.

At the beginning of the 16th century metal engraving permitted, because of its harder constitution, a greater number of prints from hand drawings. By the middle of the 16th century we see the beginning of the mechanization of the following processes of delivering multiplied prints: First, design. Second, permanent impress. Third, inking. Fourth, printing. The engraving part of the hand drawing was now accomplished by an acid solution, which corroded the design into the metal (intaglio). Inking and printing had still to be done by hand. These processes permitted only line drawing. With the invention of lithography by Senefelder, 1796, stone with its regularly grained surface permitted the use of a crayon instead of a stylo (relief-printing). Line drawing was dissolved into gray areas, which suggested a still more "natural" illusion of the

scenes which were portrayed.

At the beginning of the 19th century, photography mechanized the method of design, replacing the artist's hand by the action of light; it retained the mechanization of fixing the design by chemical means. Inking was also mechanized by prefabricated paper that was emulsioned, but the fourth state of multiplied printing was still done by hand. Complete mechanization was achieved by the electro printing press in 1880. When, finally, optical lenses and chemical emulsions replaced the artist, speed in production approached speed in text printing and with the electro printing press, their production time became almost equal.

By these processes production time was increasingly reduced. Speeding up these techniques of transmitting pictorial messages led finally to the elimination of points two (plate-impress), three (inking), and four (printing), when television was achieved.



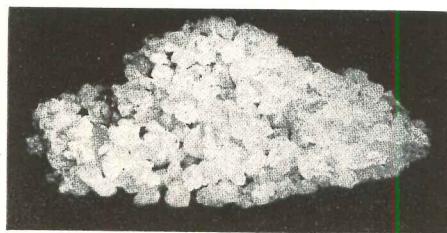
End of 18th century. Camera Lucida. A mechanism with prism which projects a view onto the drawing board. The picture is then traced

by the designer. The **camera lucida** is another device to facilitate the re-production of natural images.

1796. Lithography invented by Senefelder for multiplying drawings to make them available to many was furthered.

1800. Alessandro Volta invented the electric battery founded on a chance discovery made by a fellow countryman, Luigi Galvani of Bologna. It was electricity produced and controlled by chemism. That gave rise to the phenomena of the electric current—which later were to be used as inherent units in the development of photography (artificial illumination, mechanical dynamics, vision of the invisible).

1816. Joseph Nicéphore Niépce succeeded in fixing nature's image with a camera obscura on a "piece of pewter covered with bitumen of Judea dissolved in Dippel's Oil." It was a "negative" only. Wrote he to his brother, Claude, on April 1, 1816, ". . . but I must succeed in fixing the colors; . . . and it is most difficult."



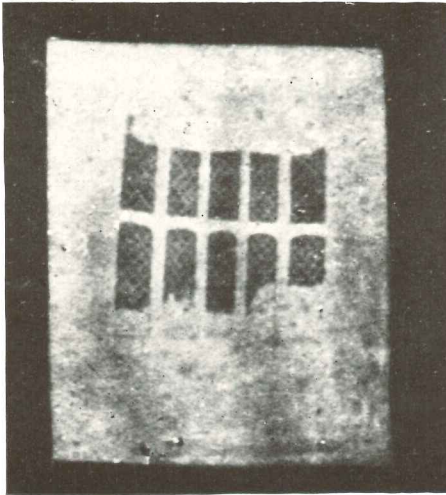
1819. Sir John Herschel discovered **hypo**, a solution of sodium thiosulphate, which is used as a fixing agent. It rendered the imprint on the emulsion permanent. Until then the print had darkened continuously in light; a most important contribution to photo-graphy from an outsider.

1827. Niépce made a direct "positive" photograph on glass (bitumen process), which now showed images in tones of black, white and grays, achieving a truer "effect" of nature. But his plate-print was still monoform—no multiplication could be obtained directly from it.

Courtesy Museum of Modern Art

Niépce, however, achieved multiplication through heliogravure, a method which used the activated metal plate for further etching. Photography was applied here only in preparing the metal plate for the etching process. No print could be made by photographic means. The transparency of the material and the sensitivity of the bitumen to the agency of light would have made it possible for him to print the picture from this master negative on a light-sensitive paper, already invented by Wedgwood and Davy in 1802; but Niépce, unfamiliar with their experiment, missed completing the cycle of "positive-negative." He is, however, to be credited with the achievement of heliography and heliogravure.

1833 until 1841. Calotype. William Henry Fox Talbot years before had occupied himself as an amateur, in designing landscapes with the help of the camera lucida and had also photographed with the camera obscura. He used Wedgwood and Davy's experiments and perfected them. He was able to make "photogenic drawing" permanent by bathing it in a solution of salt, or iodine of potassium. By

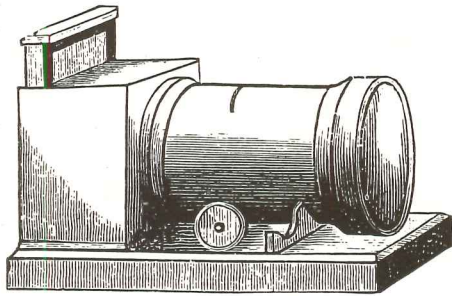


First negative on paper taken with a camera obscura by Talbot, August 1835.

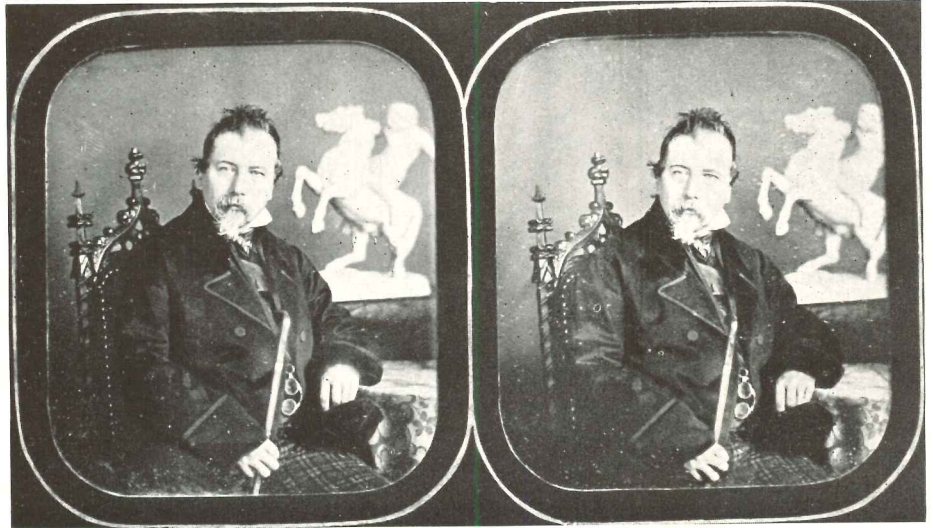
waxing his paper imprint, he rendered it translucent and succeeded in making other prints from his "negative," through the action of sunlight, producing a "positive" copy. The "negative-positive" process of photography was thus established. After further improvements he patented this process as calotype, 1841.

1837. Daguerre perfected the process of Niépce and thus entered the field of photography through having been himself a painter of dioramas. His first photograph was on metal, of the corner of his studio, 1837. These metal plates were not master negatives from which prints could be made. Each photograph was unmultipliable. The combination of artist and business man made Daguerre more widely known than Talbot, who had achieved more progressive photography at that time than Daguerre. The importance of Daguerreotype is not its process, but its acquisition by the French Chamber of Deputies on the 19th of August, 1839, when the process was purchased by the French government as a gift to its public at large. This social act was fostered

Courtesy Museum of Modern Art



Daguerre's Camera and A Double Daguerreotype, hand tinted, for stereoscopic illusion (mechanical imitation of miniature-paintings.)

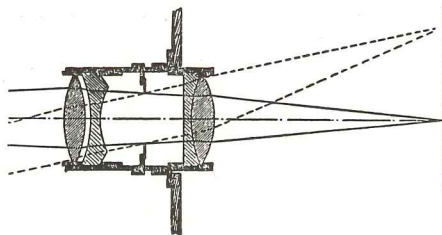


by the scientist Arago. The government purchased the secret technique to present it to the citizens of France, in return for an annuity of 2,000 francs paid to Daguerre and double that amount just paid to Isidore Niépce, the son of Joseph Nicéphore Niépce, whose photographic principles had been adapted and adopted by Daguerre. He advanced photography by "bringing the latent image 'slowly out' through mercury vapor treatment." This process reduced the exposure time considerably, and the whole act of photography to seventy-two minutes. Daguerre had also adopted the hypothesis of Sir John Herschel to his metal plate photography.

1839. Alexander Woollcott and John Johnson of the U. S. A. constructed a new type of camera obscura which used a concave mirror instead of a lens after the principle of telescopes.

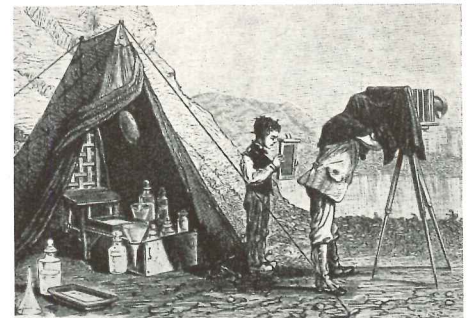
Bayard discovered the possibility of direct paper positives.

1840. Josef Petzel and Voigtländer designed



and constructed double lens which concentrated light sixteen to one, cutting down exposure time of the original Daguerre lens.

1851. Collodion wet plate process. To bind the emulsion better to the glass plate with unobstructed transparency, Frederick Scott Archer used Collodion, which Gustave Le Gray had previously suggested. This emulsion is a solution of gun cotton in ether or alcohol; and more sensitive to light. Record time for portraits required fifteen seconds, and interiors and landscapes approximately ten seconds.



Coating of the glass plate with the emulsion and the development meant continuous work in a dark tent. The dry plate was not yet available.

1851. Henry Fox Talbot used a brilliant high-voltage electric spark to illuminate a disk that was in motion. By that he arrested the motion optically, reducing exposure time to a fraction of a second.

1855. Roger Fenton was one of the earliest users of movable camera and tent equipment to photograph scenes of Crimean War.



1862. Matthew Brady's photographic Buggy.

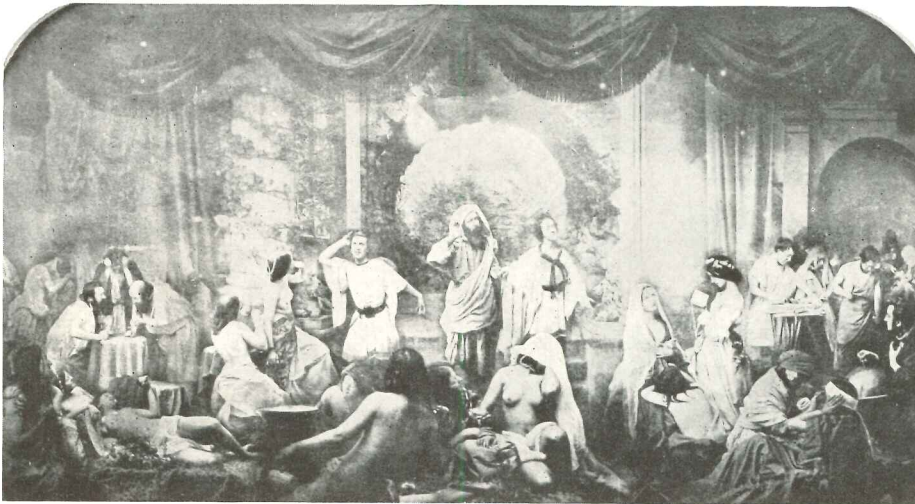
1862-1865. Photographic atelier on wheels. Photograph from National Photographic Collection of War Views: "The views were taken on

Photos Courtesy Museum of Modern Art



the spot during the progress of hostilities, by Mr. Brady and his assistants, and represent 'grim-visaged war' exactly as it appeared." (Civil War picture, 1863.) Authenticity of

recording vanishing events gives photography superiority over hand-drawn "sketches after life" by artists, hitherto the only means of "candid" portrayal.



Courtesy Museum of Modern Art

1860. Thomas Skaife constructed the "Pistol-graph," a miniature camera for candid shots. **1860.** Gaspard Félix Tournachon (Nadar) took the first photographs by flashlight in the Catacombs in Paris.

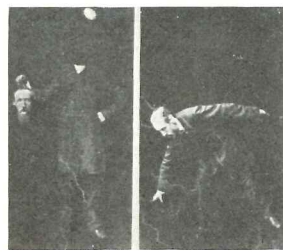
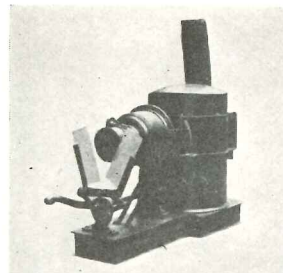
Adam Salomon and Nadar used the advanced techniques of photography to rival the art of painting. They draped background, posed portraits "artistically." By special lighting effects and hand retouching of negatives and prints they created an artificial appearance of person or scene, pleasing to the public as well as to amateur photographers. Carefully mounted prints of Salomon showed the following legend: "Composed and photographed by the sculptor, Adam Salomon." Photography was thus diverted into competing with "art," and led photographers to go so far as to imitate genre-painting. These false ambitions are typified by O. G. Rejlander of Wolverhampton, England, who published "The Two Ways of Life" from thirty combined negatives (1857). It is a forerunner of the trick printing and photography of today.

1869. The theory of subtractive color photography was published by Louis Ducos du Havron. But he lacked the necessary sensitive materials at that time to realize it himself.

1871. Sir R. L. Maddox experimented in binding sensitive silver salts to the plate glass support by gelatin. In cooling off the gelatin, the plate dried. The photographer was free from the cumbersome wet plate process. Photographic plates could be pre-fabricated and sold in packages. It meant that the photographer was free from his darkroom while photographing from his tripod. It speeded up the whole action of photography as well as the re-loading with plates. Photographs could now be taken in quick succession.

1874-1920. "Orthochromatic" plates or films. Started by H. W. Vogel of Berlin. These films are true to all colors except red (therefore are developed in the darkroom with red light).

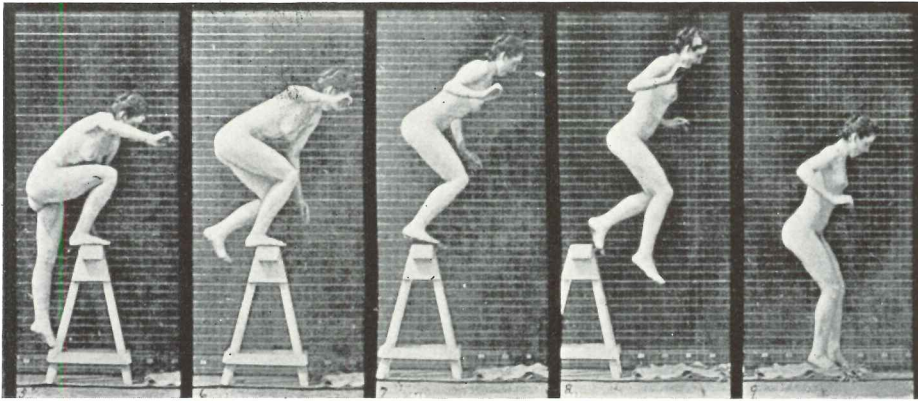
1875. "Biophantoscope" of Arthur Roebuck Rudge showed photos-in-motion in a lantern slide machine. Seven slides turn around the lantern by means of a handle. The shutters



obstruct the light until the next slide comes into position. It was the progenitor of cinematography.

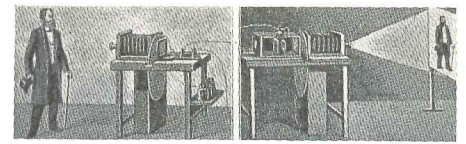
1881. W. Friese Greene substituted a band of paper for the gallery of slides, and later a band of celluloid film; he was granted Patent No. 10,131 for the first English machine to project "animated photography."

1882. Etienne-Jules Marey constructed a photographic rifle. Twelve exposures were taken in one second through a revolving plate.



1884. Eadweard Muybridge published 781 plates of Body Locomotion. An electric shutter control took pictures of objects in motion continuously as long as the machine was

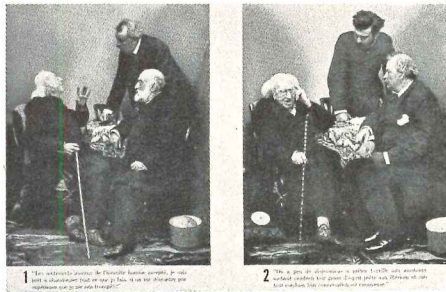
fed by plates. He also constructed a mechanical device for projecting these moving images. Jumping woman photographed by Muybridge (dry plate photography).



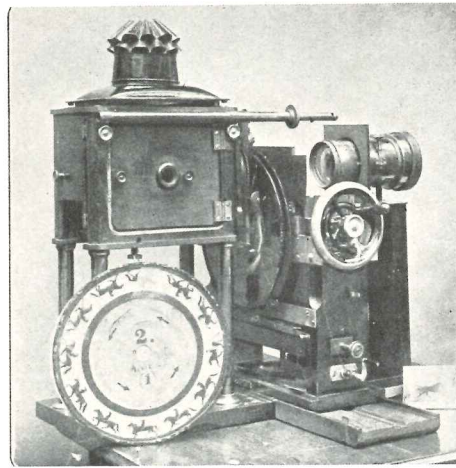
Receiver

Projector

1885. The telephone reproduces sound; the telegraph speech, by means of graphic signs. The tele-vision apparatus of Dussard tried to "transmit action at a distance" directly. (Bell's similar "Photophon," 1880.) The range was too short to be of general interest or service.

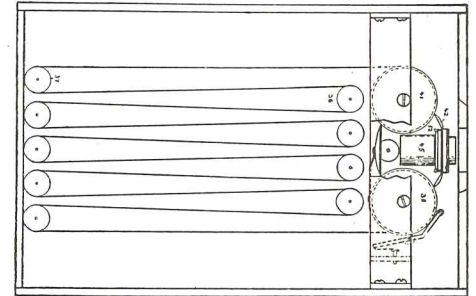


1886. Candid camera-shots by Paul Nadar. First: Coordination of voice and action. Second: Attempt to photograph informally, with subject unaware of being photographed, therefore "true to nature." Third: A photographed narrative in place of a designed one, like the earlier "cartoon" illustrations (woodcuts, lithos).
1886. Paul Nadar, the son of Gaspard Nadar, made good his father's ambition in photographing for the first time, a "Continuous Narrative."



1887. The original "Zoopraxiscope" for the projection of a series of horses photographed by Muybridge on a transparent glass-disk.

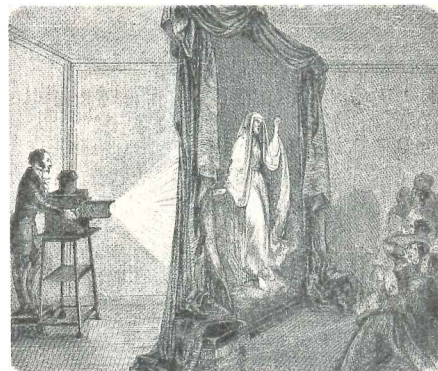
1887. Ottomar Anschuetz introduced high-speed photography replacing the click of the shutter of a camera by the illumination of an electric spark.



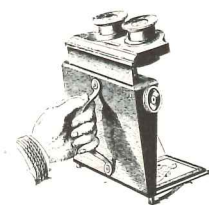
THE EDISON KINETOSCOPE PATENT DRAWING

1887. Thomas A. Edison conceived the idea of combining the motion picture and phonograph so as to produce speaking motion pictures.

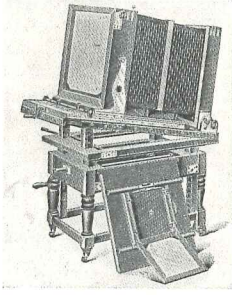
1889 is assigned as the date for the construction of the Kinetograph, an instrument for recording objects in motion. The photographs were on a long strip of celluloid, as at present, and were at first exhibited in a closed box to a single observer at a time. The box was then called the Kinetoscope. Today the motion-picture-camera permits a continuous portraiture of nature (16 pictures a second without sound, and 24 pictures a second with imprinted sound). This capacity constitutes an important step towards reproducing nature realistically. It intrudes on an event and arrests its flow. From its long record the one picture can be singled out that seems to resemble nature most truly, and copies made from it. The technique of photography has finally achieved the permanent visual image of the first camera obscura: where scenes of nature appeared on a screen in actual motion and colors, and first suggested the possibility of fixing them permanently for survival.



1890. Cameras obscura turned into Phantascope were in use to perform visionary images by enlarged projection.



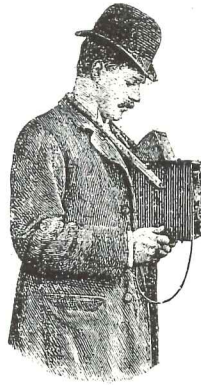
1890. Portable Stereopticon for prints; also in use was the Wheatstone tele-stereopticon for viewing nature directly through an arrangement of mirrors and prisms.



1890. Studio table-camera. The camera is a distinct descendant of the big original camera obscura, cumbersome, immovable.

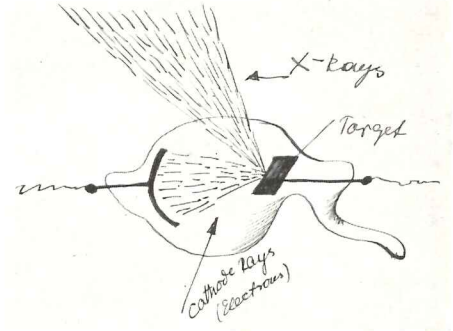
1891. The celluloid-film-band replaces single plates. Marketed by Eastman.

1891. Gabriel Lippmann of Paris recorded directly colors of nature by applying the optical phenomenon called "interference." But it did not enter into commercial use.



1892. Portable twin lens camera.

1893. John Joly of Dublin was first to make a colored photo through the additive process.



1895. Konrad Wilhelm Röntgen discovered x-rays emanating from a cathode-ray tube, thus being able to see invisible deep layers of matter, and to photograph them.

1903. Lunn Brothers used same method in their antochromes. Put on market 1907. But they were not prints, merely transparencies on glass or films.



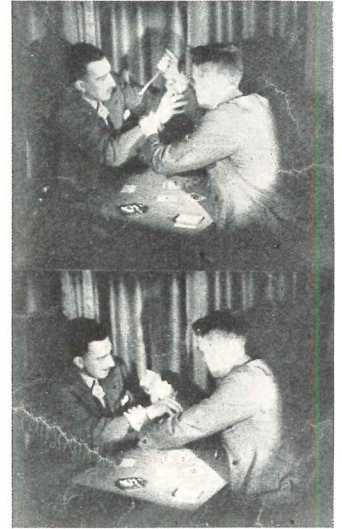
1925. Dr. Oskar Barnack, of the firm of E. Leitz, Weimar, Germany, constructed and marketed the first precise miniature-candid-camera. It represents mobility of the apparatus to a high degree. The possibility of enlarging small prints and loading with sixty feet of film made it the most compact synthesis of camera attempts since the beginning of the immobile camera obscura.

1925. Color filters (control of values). Panchromatic films about 1935. Requiring total darkness, they are best developed in sealed developers.

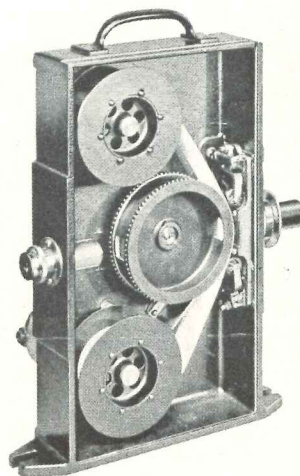


1926. Camera, artificial light-source, and its model in mobility.

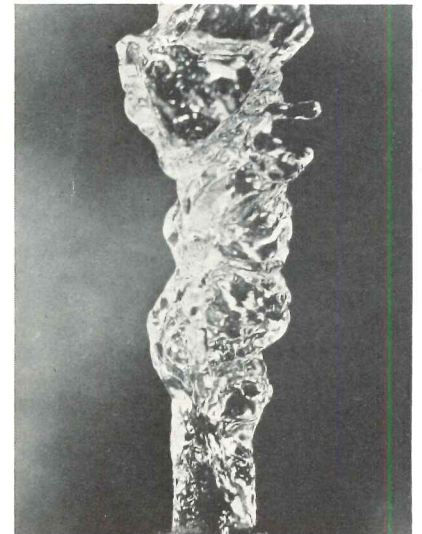
October 9, 1933. First infra-red cinematograph film taken in the dark with an ordinary camera lens by two 2,000-watt spotlights covered with infra-red filters. The scene was almost invisible to the human eye.



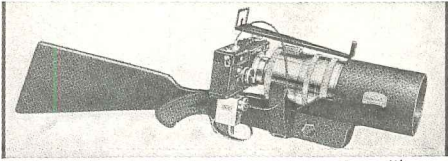
1935. Combining the Talbot principle of the experiment of 1851 (electric spark shutter) with a continuous moving film-band, high-speed-photograph was established by Edgerton, Germeshauser and Grier. Adapted from the motion picture camera is the rotating film band. The invisible correlation of motion-design is made visible: the flow of water from a faucet stroboscoped at an exposure of almost a millionth of a second appears in the form of a static crystal. A stroboscopic mercury vapor lamp, which is a cathode-ray oscillograph, must be used to activate the film emulsion. The film band rotates by electric motor at a speed of 85 miles per hour and takes 2,000 pictures per second. Another method of high-speed-photography is using a rotating optical system. Rotating lenses by Jenkins, Heape and Grylls and Thun; the rotating multi-sided mirror of Suhara; and the rotating prism of Tuttle. These two systems help to slow down motion to apparent standstill and thus permit the study of behavior of action "invisible" to the human eye.



Interior View of the High-Speed Camera

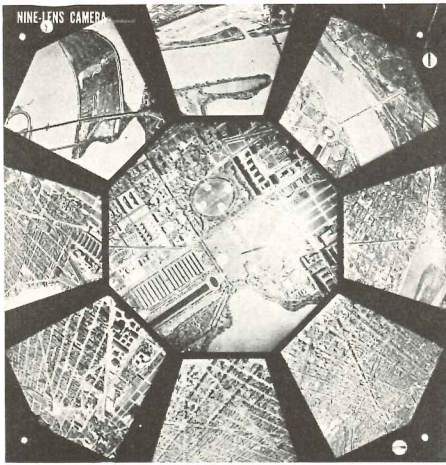


1935. Instant infra-red-photography was advanced by V. K. Zworykin. The image is focused by electrostatic means instead of optical means. This new electron optical system inverts the image, as in the case of a glass lens. In the electron-image-tube electrostatic lenses play the part of glass lenses.

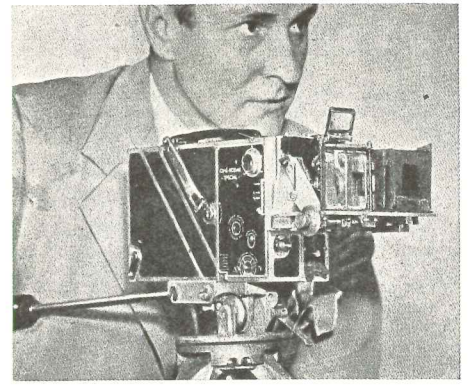


1936. Stop-motion-static-camera. For "long-range" action and rapid still-picture recording. The trigger clicks the shutter.

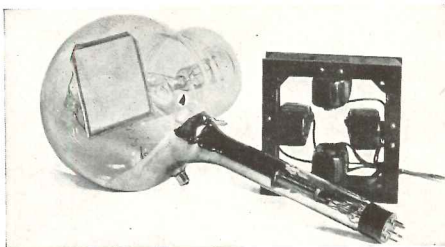
1936. Illusion of space. Drawings had interpreted illusion of space first through isometric perspective, then through horizontal perspective (Renaissance), then photography added vertical perspective and now attempts spherical perspective. (Nine-lens-camera records central image by the main lens and eight peripheral lenses. The camera's 130-degree photographic



angle gives it a spatial span four times greater than any single-lens camera. Designed by O. S. Reading.)



1936. Experimental three-dimensional camera which has in front of the lens a device permitting the two pictures, eye-distance apart, to be photographed simultaneously on a single film for the production of three-dimensional pictures, true in color, by means of Polaroid disk and panchromatic film.



A
Tele-vision. The Cathode-Ray-Tube generating X-rays of 1895 become the iconoscope (A) or "eye of infinite vision" of the television-camera. The deflection of the electron beam (as in the cathode-X-ray-tube) for scanning the mosaic of an image is accomplished by a magnetic field. This is the sender. It takes the place of the *negative* of the camera obscura. The Kinescope, (B), or cathode-ray-receiving-tube, takes the place of the *positive* (print). It reproduces the image through spot-scanning in 441 line definition. (C) This amount of grains permits a "smooth" picture. The pen-strokes of Dürer's



B
woodcuts and engravings, the dots of the stone-grains of Senefelder's lithography, the grains of the silver-crystals of the film-emulsion—have thus changed to a *controlled screen-of-lines* designed not manually, or chemically—slowly developed—but designed by light instantaneously, and projected at "a distance" beyond the reach and capacity of the human eye.

This recording applies to pictures of nature only. But if the theory of radiation and the interconvertibility of thought and matter is valid, then the recording of visions of the brain by arresting the energy emanation should one day become a reality, thus rendering concrete the subconscious image enigmatic to the lens of the human eye as well as to the lens of the camera obscura.

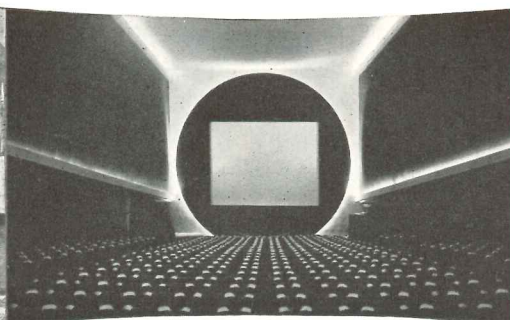


C
Industry will gradually adopt the progress made by the avant-garde. By manufacturing on a large scale, devices for "light-design-recording" will become available to a more popular public. Still-photography is already within the reach of every one. Ciné-machines are now available for amateurs. In not too distant a future tele-senders and receivers will become just as prevalent as radio amateurs. The cycle of technical creation terminates in reaching the masses. Photo-graphy is *pro-social*. Easel-Painting remains *a-social*. Trespassing from one field into the other is forbidden.

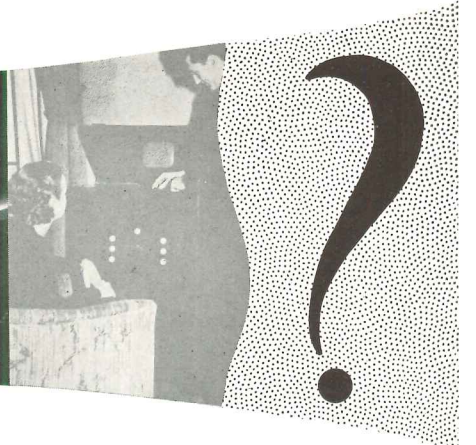
PHOTOGRAPHY AND ARCHITECTURE



End of 19th Century. Photography used as wall decoration. (Carbon Studio, 1889)



First Quarter of 20th Century. Photography in motion creates new architectural design in motion picture houses. (By Kiesler, 1927)



Middle of 20th Century. Television has produced movable tele-sets and will develop new schemes for light integration with shelter-structures. (By RCA, 1937)

Recovery Made Further Progress During First Half

By L. SETH SCHNITMAN, Chief Statistician, F. W. Dodge Corporation

WITH June at the highest point of the recovery, construction during the first half of 1937 reached a total not seen for any comparable six-month period since 1931, when the industry was in the declining phase of the previous cycle. The improvement has been general; virtually every major section of the entire country has shared in it. Of interest, too, is the fact that private projects started thus far in 1937 have not only exceeded in volume the totals for this class of work for every other comparable six-month period since 1931 but have exceeded, as well, the total for public projects started since the first of the current year.

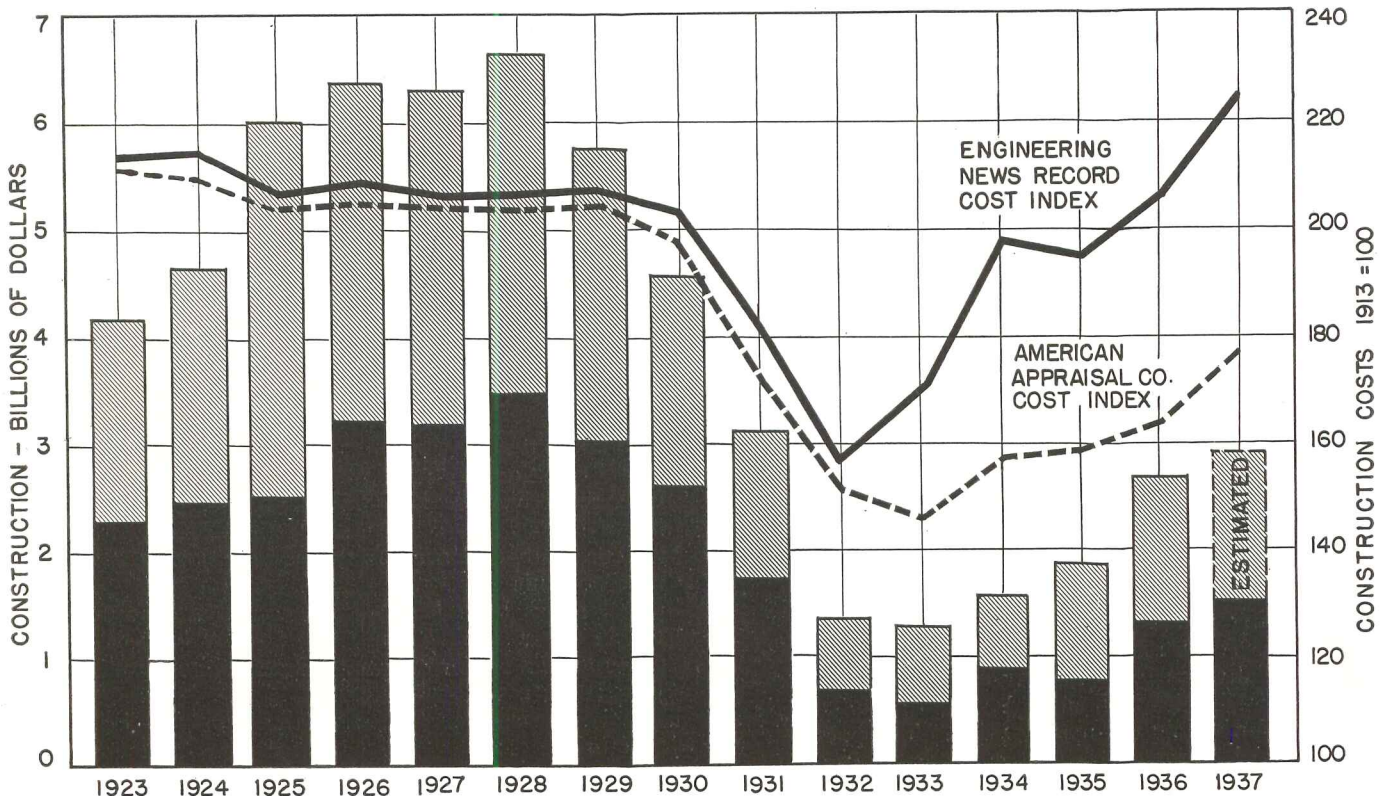
Of the private building, residential projects continue in the vanguard. The total volume of 1937 residential operations at midyear was about \$517,000,000 for the 37 eastern states; more than 90 per cent of this total represented private as distinguished from public housing. What is more, the residential total for the initial half of 1937, both private and public, was almost 55 per cent ahead of the volume reported for the corresponding period of 1936.

Commercial building—stores, warehouses, offices, pub-

lic garages and service stations—likewise have shown continued gains. For the first six months of 1937 all types of commercial building recorded an increase in construction over the like 1936 period of better than 38 per cent, with stores accounting for almost half of the total commercial building during the period. This is a natural result of an expanding consumer purchasing power and much improved conditions in retail trade.

Factory building has expanded by more than 75 per cent during the first six months of the current year, with the result that the half-year total has exceeded the figure for any other comparable period since 1929; this, likewise, in reflection of a substantially better rate of industrial operations.

Rising construction costs have paralleled the advance in construction activity. Further substantial increases in costs over the remainder of 1937, however, do not appear probable, for it is now apparent that the rate of gain in construction has begun to narrow—this largely because of declining influence of public projects—though the longer range prospects for continued recovery remain good.



CONSTRUCTION is rounding out the fourth year of recovery. At mid-1937 the total was greater than for any other comparative six-month period since 1931. On present indications the full year 1937 will closely approximate the 1931 volume. Construction costs, too, have increased materially and now are at levels much higher than they were in 1931. Black portions of bars denote construction totals for first six months; full bars represent annual totals. Cost indexes for 1937 are for April; for other years they represent monthly averages.

New Approach to "Packaged" Houses Recognizes Architects

By F. VAUX WILSON, JR.*

UNLIKE the other important sectors of industrial America, the building industry is not highly integrated—either technically or commercially. On the contrary, its integration has been conspicuously retarded; and nowhere has this disorganization been more apparent than in the house construction field. . . . In the chaos of the depression years many trends were set in motion, the full significance of which is only now becoming evident. Prefabrication, trailers and now "packaged" houses—all these have flashed across the sky. Each has been heralded by an uncritical audience expecting overnight returns as the "solution to the housing problem." The truth is, of course, that in so complex an organization as the house construction industry, no single development can "solve" the problems. The truth is also that too many of these developments are one-sided and fail to take sufficiently into account the contributions which such factors as the architect and contractor can make not only in solving technical shortcomings but in solving distribution problems. On the other hand, it would be foolish to dismiss such trends—prefabrication, trailers, packaging—as "failures." They are all straws in a wind blowing towards gradual reorganization and consolidation of the building industry. . . . Following its policy of covering all trends which seem likely to affect the future of building design and building designers, the RECORD this month begins a series of critical discussions on developments in the house construction field. This one is by a manufacturer whose activity in recent months (see page 34) qualifies him to speak. Other discussions will appear from time to time, presenting other viewpoints.—Ed.

DURING THE past depression there was a distinct slowing up in house construction, resulting for a period in a nearly complete stoppage of the heavy goods industry. This stagnation threatened an acute shortage in housing facilities and created a broad and tempting market. As a result many organizations—particularly those relatively new to the house construction field—saw profit possibilities in houses produced at sufficiently low cost to fall within the mass market. The possibilities of substantial savings which mass production might effect attracted many firms. Time and money were generously expended in the attempt to achieve low-cost houses through the medium of factory prefabrication. The emphasis of most of these experiments was almost wholly upon achieving low cost by turning out houses like automobiles. Unfortunately, the problem is not as easy as

* Vice president, The Homasote Company.

it seems. What if a house can be constructed on an assembly line at a slightly lower cost than conventionally-built houses? Can the parts be put on a flat car, or truck, and *economically* shipped around the country, or can wheels be attached to the house so as to roll it to destination? In short, can it be nationally merchandised to compete with traditionally-built houses?

Prefabrication, in itself, is not something to be condemned. On the contrary, repetitive operations in a shop, under controlled conditions, are conducive to better construction, greater speed and consequently lower cost. But—and here is the important point—prefabrication in a central shop immediately raises the problem of a distribution apparatus. Overlooking this point, or failing properly to analyze it, seems to have been prevalent among those who have interested themselves in prefabrication. Concentration on the *purely technical aspects* of complete prefabrication of houses led to a casual disregard of the problems of distribution, with the thought that "they would be solved when the time came." Unfortunately, this is anything but true. In modern industry there is an *interaction* between the product and its distribution system which cannot be ignored. A technical development in the product brings changes in its merchandising; and vice versa. Thus, both problems have to be faced simultaneously.

There are other aspects to prefabrication besides this necessity for a distribution apparatus. For example, at the present time, most prefabricated systems require for their assembly skilled labor not available except in metropolitan areas. This can, of course, be overcome either by simplification of the system or training of craftsmen or both; but meanwhile houses are needed. Then there is the question of "public taste"; while controversial at best, there has been and still is a strong desire among home buyers for conventional styles. And it is notorious, in this connection, that the lending agencies have reflected this conservatism. Loans on any but traditional styles have been very difficult to get; and only within the past few months has FHA been willing to underwrite a modern house. (See Architectural RECORD, July 1937; pp. 62-66—Ed.)

Briefly, these are some of the problems facing the prefabricators: they are by no means unsurmountable and the chances are that they will be solved sooner or later. So far, prefabrication is only one of several trends in the industry; but the degree to which it succeeds will be determined by what progress the rest—and by far larger part—of the house construction industry makes. How can this sector improve the quality and distribution of the conventional house, and at the same time lower its cost to meet competition?

Within this sector of the industry, the reverse is true. That is, it already has a nation-wide distribution apparatus but lacks the product. Thus one point appears clear: *it should have a product in packaged or unified form which can be nationally merchandised.*

Real merchandising has not been tried in any house field on any great scale, and the actual merchandising of homes which has been done is really insignificant as compared to the total possibilities. One of the main reasons for this is that to promote the sale of anything on a large scale it must be in *package form*, like a refrigerator, range (or the later "packaged kitchens," "packaged air conditioning"). If houses were available in a similar "package form" they, too, could be merchandised on a national scale. The problem of creating the "package" is, of course, not nearly so simple in a house as in a refrigerator. A house is a very complex thing, and personal tastes and family requirements play an exceedingly important part.

The "packaged" house implies that all possible economies in production (within the present distribution system of the industry) should be utilized to the fullest—i.e., those materials and processes which are already widely available. Thus it is possible to say of the "packaged" house:

(1) It should provide for use of conventional structural and finish materials.

This point does not require much elaboration. It is obvious that, at the present time, the distribution system of the house construction industry is largely geared to conventional structural and finish materials—i.e., wood, clay-products, cement, etc.; it is likewise obvious that a majority of American home builders demand and will continue for some time to demand these traditional styles. On the other hand, prefabrication will inevitably use the newer materials—plastics, metals, plywoods—for both commercial and technical reasons; and that part of the public which demands "modern" will get it.

(2) It should avoid the use of prefabricated elements which can be more economically produced on the job.

Some of the elements of every house can be and are today advantageously prefabricated. Others can be manufactured more cheaply by conventional methods. From actual experience in the field it has been demonstrated that walls, partitions, stairs, windows and doors should be prefabricated; while roofs and floors should be built conventionally. However, all framing lumber

should be pre-cut in the shop as experience demonstrates approximately a 20% saving over hand cutting on the job, and an approximate saving of 20% in erection time. The elements prefabricated in the shop are more efficiently and more accurately made than is generally found on the job, and at the same time no delays occur because of weather conditions. It is apparent also that considerable time is saved because all framing lumber can be pre-cut, all walls and partition sections, stairs, windows and doors can be assembled at the same time as the foundation is being put in, saving usually a week's time. Fabrication of wall and partition sections under controlled shop production methods means lower costs than with the haphazard methods found on so many conventionally-built jobs.

(3) Where prefabrication of elements is desirable, the fabrication should be decentralized to reduce transportation or distribution costs to a minimum.

It is obvious that prefabricated parts made on, or near, location of the job will be cheaper at the job than prefabricated parts manufactured at a great distance, since transportation and distribution costs will be reduced to the minimum. It seems logical that this decentralization can best be accomplished by prefabricating in the local lumber dealer's plant. Contrast this method with that of prefabricating parts in a shop in one part of the country and then adding heavy transportation costs to get the materials on the job. Obviously, decentralized prefabrication will show considerable savings over centralized manufacturing.

(4) The various factors in each locality—the architect, the lumber dealer, the various contractors, and the real estate broker—should be co-ordinated into a unit in each locality for the production and sale of "packaged" houses.

The development of a merchandising unit must parallel the technical development of the unified or "packaged" construction system; and this unit should naturally integrate—on a local basis—those factors already important in house construction—the architect, the building materials dealer, the contractor and the real estate broker. Each of these is already an essential part of the production of houses in a given locality. Integration of these factors, however, varies from one region to another; and it is clear that they must be much more closely coordinated if they are to take full advantage of the production and distribution of "packaged" houses.

(See page 34 in the *Building News* section of this month's RECORD for a story on how Mr. Wilson, in cooperation with W. Henry Neubeck, architect, has put his theories into actual practice.—Ed.)



Though there are many interpretations of "packaged" houses, Mr. Wilson submits the structure at the left as one example of what he refers to. It is one of many developed by a system which adheres to the 4-point plan outlined in his article.



NEW HEATING DATA AVAILABLE *to Architects and Builders*

Now ready . . . impartial performance records of approved Anthracite heating equipment. Also information of most recent developments in the heating field.

This service, and other information gained through many years of heating research, are available to you through Anthracite Industries, Inc.

It is a non-profit corporation, organized to focus all the experience and service of the principal factors interested in extending the economies and conveniences of Anthracite in home heating.

You may have the personal help of an extensive field force of trained heating men, with all the accumulated experience of the Anthracite industry at their command.

In addition, Anthracite Industries, Inc. maintains a fully equipped research and testing laboratory. Makers of Anthracite equipment have long relied on it for accurate testing of equipment. Its staff of engineers cooperates in improving existing equipment, and in developing new equipment.

● *Be assured, when you see the Anthracite Industries' seal of approval on any equipment, that it has passed the most rigid tests in the heating industry. Let Anthracite Industries, Inc. help you. Let its seal be your guide in selecting equipment.*

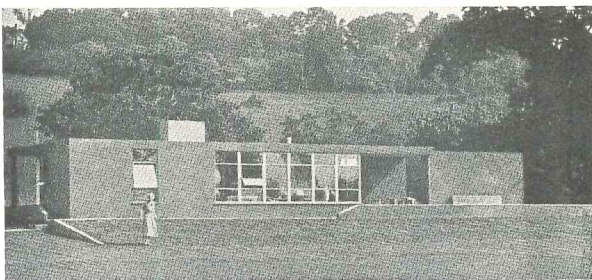
ANTHRACITE INDUSTRIES, Inc.
Chrysler Building New York, N. Y.

(SEE ADVERTISEMENT ON OPPOSITE PAGE)

Pennsylvania
ANTHRACITE
COAL

THE SOLID FUEL FOR SOLID COMFORT

Reviews of New Books



SMALL HOUSES £500-£2,500. Edited by H. Myles Wright. The Architectural Press, London. Price \$3.

In this book are collected together nearly eighty small houses recently built and designed by architects. Although the houses have been selected between the general limits of £ 500 and £ 2,500, the great majority are under the cost of £ 2,500 and the cheapest was built for £ 285. Each house is illustrated by exterior views and plans, and in a number of cases the interiors are shown as well. A few examples taken from recent housing schemes are also included. Notes appended to each house point out special features in the site and plan, and give particulars of construction, finishes and the building cost (exclusive of site unless otherwise stated). All of the houses shown are suited to the American as well as the English suburbs. Most of the houses are in design vernacular developed by the English architect since 1900. There are no half-timbered examples or manor house types—popularized by the American subdivider. As a matter of fact, most of the houses are of stucco on tile or straight unfussed brickwork. Some few (about one-quarter) of the designs are modern—perhaps in percentage equal to what occurs in actual building in the year 1937. These latter by F. R. S. Yorke, Maxwell Fry and others are included because of their excellence in planning and actual low cost.

In the introduction the editor deals with some of the problems that affect the building of the small house today—the lesson taught by the recent building boom in England, the evils of ribbon development along highways,

(Continued on page 91)

Now
**FOR MILLIONS
 OF HOMES**



Clean automatic Anthracite heating made possible the attractive modern basement shown here. Basements can also be dens, workshops or play rooms.

GREATLY ADVANCED

**AUTOMATIC ANTHRACITE HEATING AND AIR
 CONDITIONING WITH**

Pennsylvania
ANTHRACITE
COAL

(SEE ADVERTISEMENT ON OPPOSITE PAGE)



This seal appears on Anthracite equipment only after it has passed the most rigid tests in the heating field.

Tremendous advances have been made with automatic Anthracite heating and air conditioning. Moreover, its unmatched advantages are here for the millions of homes, small or large.

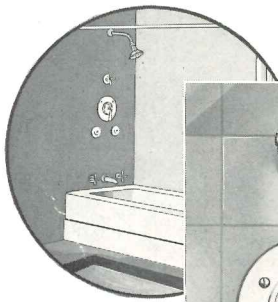
This new equipment is the most modern of all. It offers entirely new standards of efficiency and long life. With it comes cleanliness, absolute safety and dependability of Anthracite. Operating economies are even more pronounced, for the price of Anthracite has steadily gone down, while other fuels have gone up.

In addition, the broad range of automatic Anthracite heating and air conditioning enables you to fit any budget. You can install an Anthracite furnace, or boiler, and with a simple thermostat provide automatic heat. You can install a magazine feed boiler, or an automatic Anthracite burner that provides all-season firing and ash disposal.

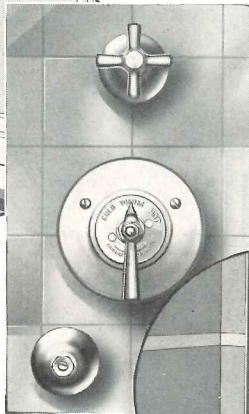
Write for bulletin listing approved equipment. Or, if you wish, avail yourself of the headquarters staff and the trained field men of Anthracite Industries, Inc. Call on them for any information you need on any problem affecting Anthracite heating. Write to ANTHRACITE INDUSTRIES, Inc., Chrysler Building, New York.

THE SOLID FUEL FOR SOLID COMFORT

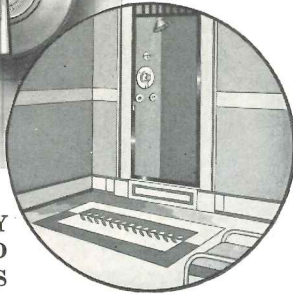
For SAFETY in the home SHOWER



SERIES R
CONCEALED
FOR BATH
SHOWER



SERIES R
CONCEALED
FOR BUILT-IN
SHOWER



THERMOSTATICALLY
CONTROLLED
WATER-MIXING VALVES

LEONARD VALVES

MANUFACTURED BY

LEONARD-ROOKE COMPANY, INC.
1360 ELMWOOD AVENUE, CRANSTON, R. I.



No RISK of
CONTAMINATION

There is no danger of contamination with Halsey Taylor Drinking Fountains; lips need never touch source of water supply. The Patented two-stream projector guards against that... and automatic stream control means that the drinking mound is always SAFE to drink from, regardless of pressure variation! Specify Halsey Taylor Drinking Fountains—for health-safety!



The Halsey W. Taylor Co.
Warren, O.

HALSEY TAYLOR

Drinking Fountains

6



Air Conditioned and Automatically Heated with **ELECTROL**

ELECTROL automatic oil heating and air conditioning equipment is being specified by architects and builders throughout the country because of its 18-year record for dependability, economy of operation and long life. ELECTROL provides time-proven quality and guaranteed efficiencies at a price any home owner can afford. Write for complete information.

One of the many modern homes in the Wilmot Woods Development, Scarsdale-Heathcote Section, Westchester County, N. Y., in which ELECTROL automatic oil heating and winter air conditioning has been installed. This seven-room house is heated and conditioned with an ELECTROL warm air furnace unit that heats, cleans, ventilates and humidifies the air. Architect, Charles Glaser. Builder, H. & B. Housing Corp.

ELECTROL Incorporated

934 MAIN AVE.



CLIFTON, N. J.

Local Installation and Service Organizations Everywhere

Reviews of New Books

(Continued from page 88)



"The gentle art of faking"

and the treacherous question of style. He also points out why it is essential to employ an architect, and explains the work that the architect does.

DEGREE-DAY HANDBOOK. By Clifford Strock and C. H. B. Hotchkiss. The Industrial Press, 148 Lafayette St., New York.

Temperature reference data for winter and summer air conditioning operation and design calculations, including the practical application of degree-day tables for checking heating plant efficiency and predicting or estimating fuel or steam consumption. Actual examples from various types of buildings show the solutions of operating problems and also the use of the degree-day in sales or other promotional work.

ELECTRIC SERVICE WITH SAFETY. General Electric Company, Bridgeport, Connecticut.

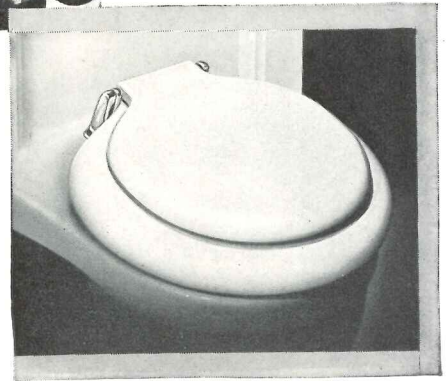
This booklet of 24 pages was prepared by the International Association of Electrical Inspectors to encourage safety in the use of electrical equipment in homes. It is common knowledge that electricity is perfectly safe when properly used but there are certain rules which should be observed to keep it safe at all times. This booklet reviews these rules.

MODERN ARCHITECTURE IN ENGLAND, with articles by Henry-Russell Hitchcock Jr. and Catharine Bauer. Allen & Unwin, Ltd., London, 104 pages.

The work of contemporary architects is analyzed with discussion of problems faced by the designers. Today in England the most advanced architectural ideas are being accepted. The book is similar to the recently published catalog of The Museum of Modern Art, New York, on the occasion of their exhibition of modern architecture in England. The book contains over fifty plates.



**STARTS
WITH
A**

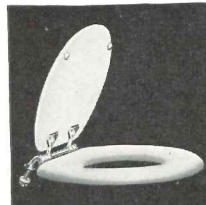


CHURCH *Sani* SEAT

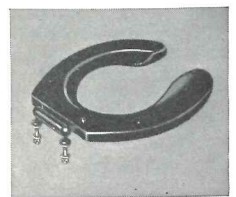
THERE ARE no limits placed on your decorative abilities when you plan bathrooms around CHURCH SANI-SEATS. From the wide range of colors in which they are furnished, select the seat you prefer. Key the other appointments to it. Then you'll achieve true harmony in bathroom color and design. And consider this: Your clients will like these seats for the *practical* advantages they offer—Low first cost. Durability. Absolute sanitation. Ease of cleaning.

CHURCH SANI-SEATS are available in a wide range of colors in pearl or plain finish. They are *sheet covered*—will not crack, chip, or peel. Soap and water keep them immaculate.

On your next job, build the bathroom around a CHURCH SANI-SEAT. Famous CHURCH quality and workmanship are present in even the lowest priced seats. Send today for the catalogue showing the complete line and for the new consumer booklet "Bathroom Magic" containing valuable suggestions on interesting bathroom designs. Write Dept. M8, C. F. CHURCH MFG. CO., HOLYOKE, MASS., *Division of American Radiator & Standard Sanitary Corporation.*

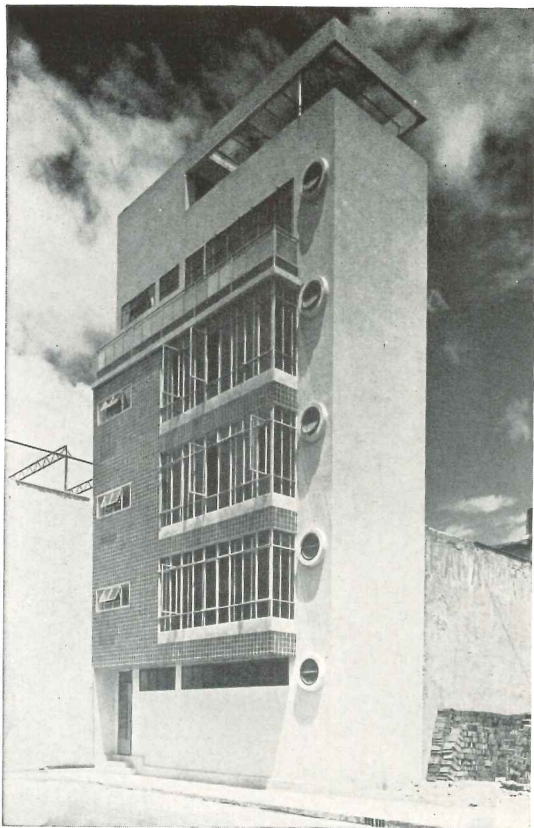


CHURCH SHEET COVERED SEATS for apartments, hotels, etc. Moderately priced, durable. *White or colors.*



CHURCH SANI-BLACK SEATS for offices, factories, stores; molded of hard rubber, outlast the building.

CHURCH *Sani* SEATS



The New Architecture in **MEXICO**

Modern architecture, painting and sculpture in Mexico, collected and arranged with photographs, by Esther Born.

Mexico, the land of mañana and siestas, has suddenly waked up and found itself in the midst of a wave of modern construction, a new kind of revolution, carrying with it a renaissance of the creative talent of the Aztecs and the Spanish Americans.

The new architecture in Mexico includes outstanding examples in practically every important class of building—office buildings, store groups, factories, hospitals, schools, apartments, workers' houses, town and country houses. In their own setting, the new structures with their straight lines and unornamented flat surfaces present a dramatic contrast with neighboring buildings heavily ornamented in the Spanish Colonial tradition; yet the new architecture has been perfectly acclimated to its background.

This new volume is a reference source for building designers everywhere, and contains a complete assemblage of the progressive thought of architects and engineers below the Rio Grande.

The New Architecture in Mexico, by Esther Born, in text, photographs and colored diagrams, including supplementary text on mural painting, sculpture, and pottery **\$3.50**

ARCHITECTURAL RECORD
119 W. 40 St., New York

Enclosed is \$3.50 for which please send me a copy of THE NEW ARCHITECTURE IN MEXICO.

Name

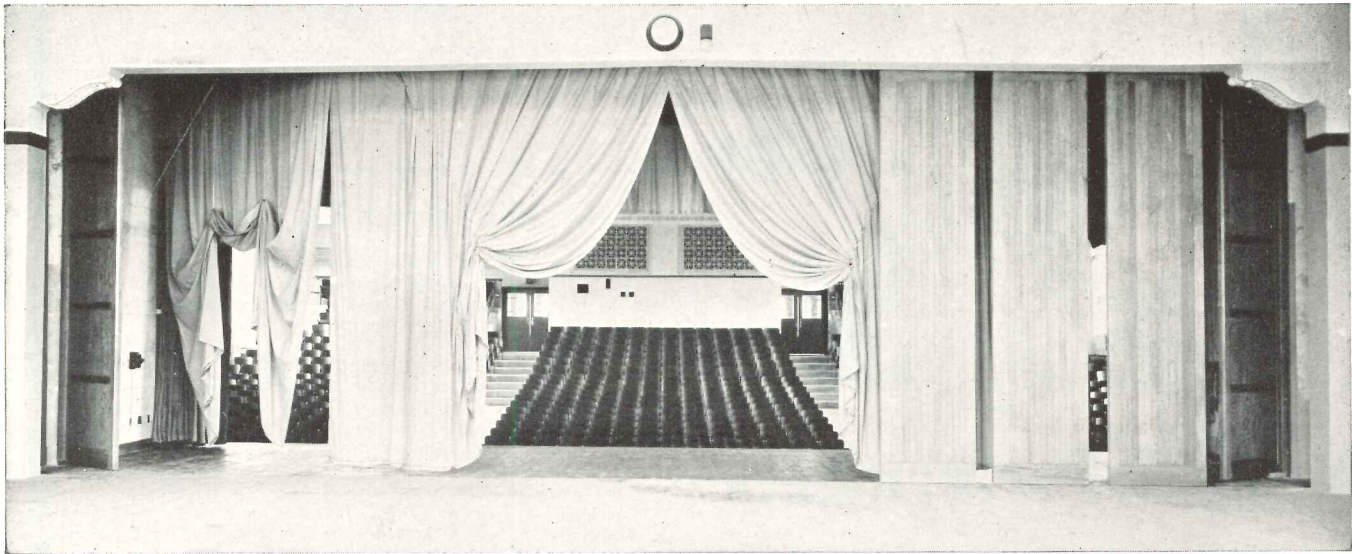
Address

.....

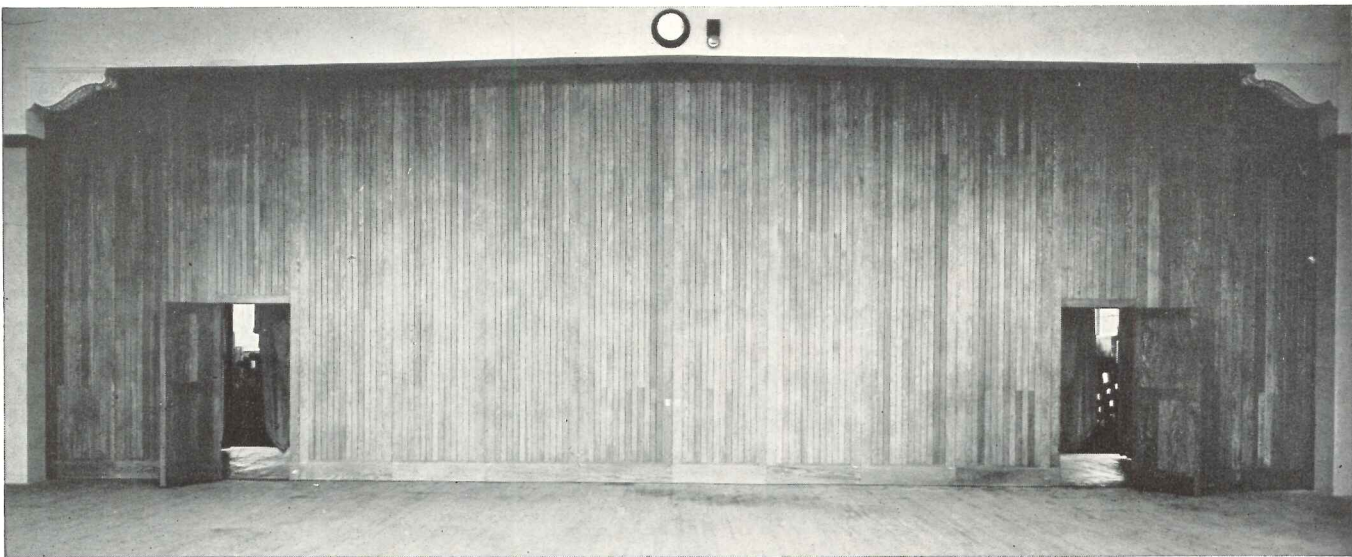
A.R. 8-37



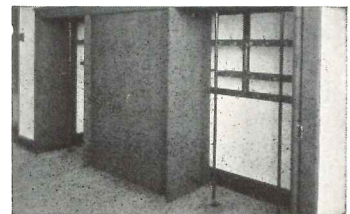
A. C. F.



FAIRHURST *folding* WALLS...



Any building in which flexibility of space is desirable will find the problem most satisfactorily solved by use of the Unitfold folding wall, manufactured by the American Car and Foundry Company under the well and favorably known Fairhurst patents. The illustrations above show the Fairhurst folding wall separating a gymnasium and an auditorium. The gym side of the wall is built of narrow beaded boards to provide a satisfactory wall for handball courts. The small wicket doors close flush, with invisible Soss hinges and flush cup handles. Fairhurst folding walls provide ample allowance for building settlement, floor or ceiling sag. Fine woodwork has been an American Car and Foundry Company specialty for years.



Also A. C. F. Fairhurst school wardrobes. Strong, sturdy, spacesaving. Widely used by leading schools.

AMERICAN CAR AND FOUNDRY COMPANY • 30 CHURCH STREET, NEW YORK, N. Y.
ALSO MAKERS OF FINE ARCHITECTURAL WOODWORK

Kindly send full particulars of A. C. F. Fairhurst Unitfold folding walls () A. C. F. Fairhurst school wardrobes ()

Name _____ Address _____

LCN



for Peak Performance

The result of 50 years' experience; many thousands in use throughout the country — and the only ones that have ever worn out were run down on the testing block! For power and full control, for silent, trouble-free service, for dollars-and-cents economy, there is nothing to touch the LCN surface type door closer. Make us demonstrate this. Call or write

NORTON LASIER COMPANY
466 West Superior Street, Chicago
Sales and Service Representatives in 21 Cities

YOUR CLIENTS CREATED THESE COURTS

because they demanded low maintenance.

YOUR clients will always continue to put their question mark alongside your tennis court specifications if minimum upkeep is not listed. But will they let you sacrifice quality? Never!

Tell these clients of yours about the En-Tout-Cas Domestic Green Court, which all but eliminates the time-killing roller.* Tell them we have a special change in formula for the famous En-Tout-Cas Red Court which cuts maintenance to the bone.*

Both these courts have the springy resilience and trueness of bound that En-Tout-Cas has always possessed. They give you low maintenance, but perfect tennis. The Green Court is slightly lower priced than the Special Red. Both are distinguished tennis surfaces.

*Write for specifications and prices for your file. Lowest maintenance costs of any fast-drying tennis courts means more easily satisfied clients.

GUY C. FOSTER INC.

American Agents  128-E Water Street
New York, N. Y.

SMARTLY RE-MODELED SHOPS ATTRACT TRADE TO THE NEW SHOPPING CENTER OF NEW JERSEY

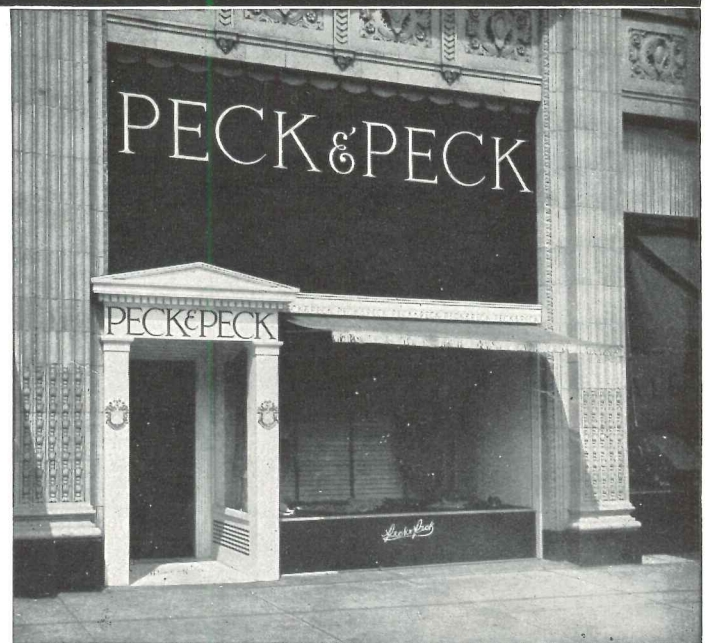
Virginia Black Serpentine was used for bulkheads for the Kress store on Central Avenue, near Harrison Street, East Orange, a little over five years ago. Today, this natural, quarried black stone decorates the facades of the following stores in this suburban shopping center: Peck & Peck (shown), Slater's, Black, Starr & Frost-Gorham, and Ethel Klein, Sportswear. On the next block a new group of stores, under construction, will use six hundred square feet of Virginia Black Serpentine for bulkheads.

These moderate-sized shops in E. Orange, N. J., are typical of the many in other cities, for which this durable, black stone has been chosen for reasons of economy as well as color. The polish on Virginia Black Serpentine is natural, and experience has shown that it will stand up almost indefinitely.

Inquiries will be answered promptly, and we will be glad to send you a set of samples, conveniently boxed, showing the range of stone from the Alberene Quarries, including mottled dark blues and greens.

Virginia Black SERPENTINE

ALBERENE STONE CORPORATION OF VIRGINIA
419 FOURTH AVENUE, NEW YORK, N. Y. Quarries and Mills at Schuyler, Va.



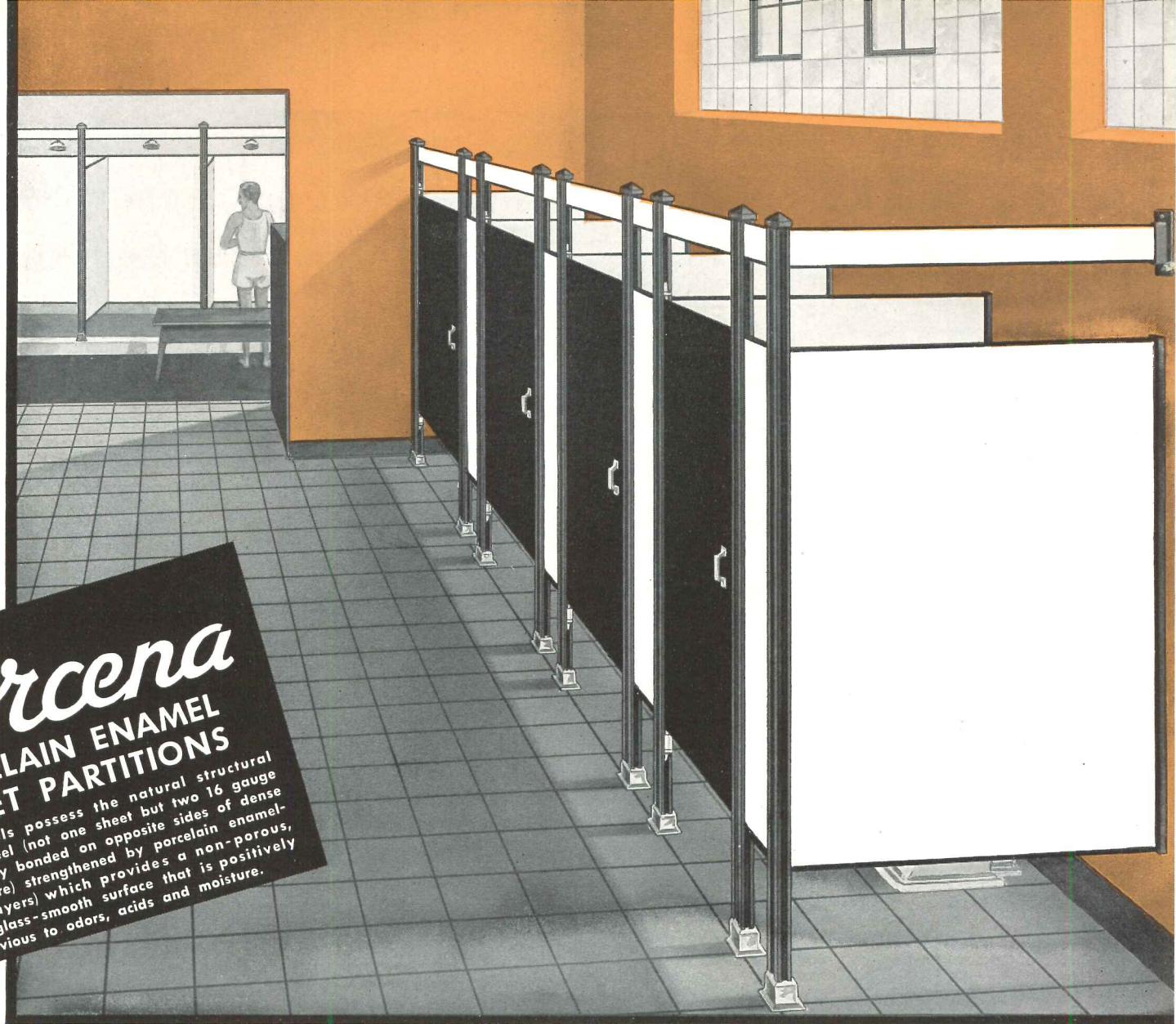
Above — Peck & Peck shop, East Orange, N. J. — one of the group of shops on which Virginia Black Serpentine was used.

To right — The Peck & Peck shop which was awarded the Prize for the outstanding re-modeling operation on Euclid Avenue, Cleveland, O., in 1936. Another Virginia Black Serpentine installation.



Porcena PORCELAIN ENAMEL TOILET PARTITIONS

Porcena Panels possess the natural structural strength of steel (not one sheet but two 16 gauge sheets securely bonded on opposite sides of dense insulating core) strengthened by porcelain enameling (four layers) which provides a non-porous, flint-hard glass-smooth surface that is positively impervious to odors, acids and moisture.



Toilet Room *Environments* Can Stimulate *a Sense of Well-Being* Among Employees

The first to originate and offer a definite style of toilet partition and wainscot panel utilizing porcelain enamelled panels, Sanymetal presents a wider scope for the creative talents of a patient profession and protects the building industry in the use of such materials by years of accumulated engineering and craftsmanship experience in the manufacture of certain exterior parts of porcelain enamelled metal.



Sanymetal's catalog is contained in Sweet's for 1937 identified

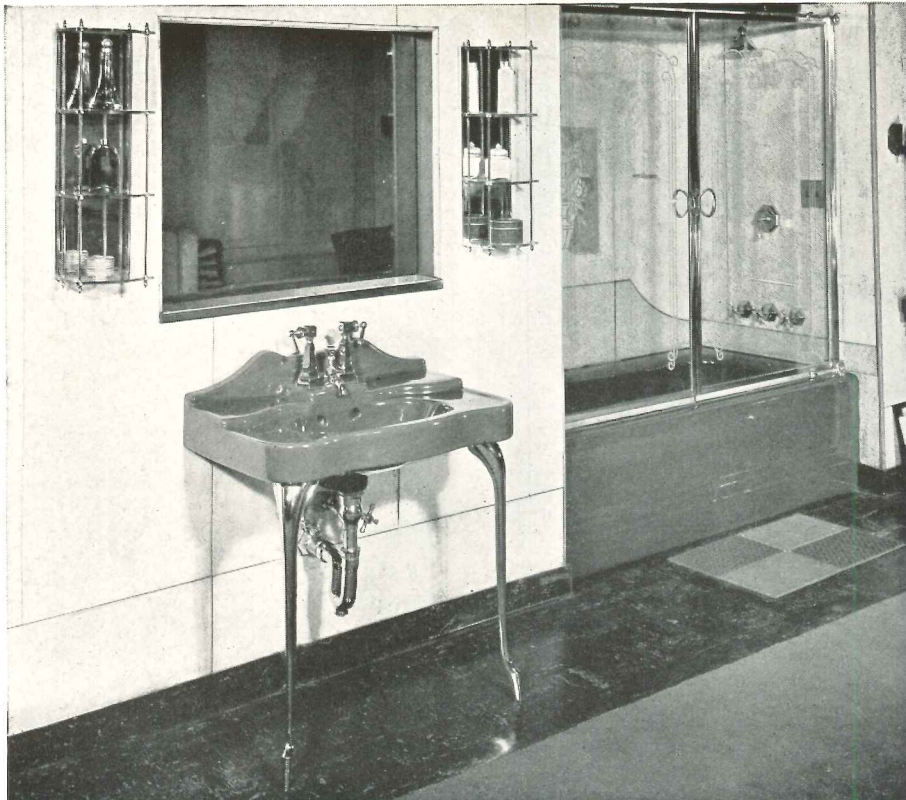
◆ In these days of industrial unrest, management overlooks no factor that will stimulate a sense of well-being among employees. In new plants or old, and in every industry, Sanymetal Porcena Toilet Partitions will remove one of the causes for resentment . . . create a more cheerful environment in toilet rooms. ◆ The simple design of Porcena Toilet Partitions encourages modernization of present toilet rooms. Their installation fosters new standards of sanitation. Their radiant cleanliness inclines the most slovenly to a desire for orderliness. Their porcelain enamel finish provides a flint-hard, glass-smooth surface that discourages the too common inclination to mar and disfigure toilet room equipment with degrading scribble. And, these flint-hard, non-porous surfaces absorb no odors; resist the effect of ordinary acids and are moisture proof and rustproof ◆ Sound, simple, exclusive construction features make for easier installation and years of faultless service for they are built to endure rough usage. The Sanymetal representative in your locality is prepared to help you plan modern toilet room environments for every type of building. ◆ Write for colorfully illustrated brochure featuring some of the most modern and sanitary of all present day toilet room environments.

Sanymetal

THE SANYMETAL PRODUCTS CO., INC.
1705 Urbana Road, Cleveland, Ohio

TOILET AND OFFICE PARTITIONS

MORE GLASS for the home . . . for example . . .



the Bathroom

Glass doors for the tub and shower bath . . . no wet, cold curtains. Glass shelf below mirror and glass shelves on either side of mirror for toilet articles. In bathrooms, as well as throughout the rest of the home, the trend is for a more generous use of glass. For the many applications of glass, Clearlite is being specified because of its uniform quality.



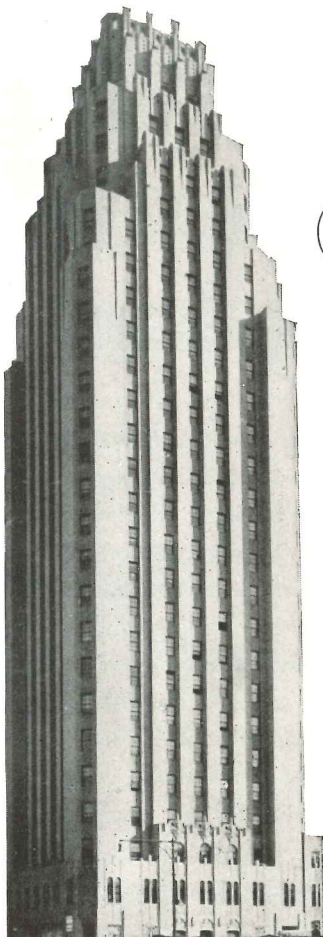
EASY ON THE EYES

FOURCO GLASS CO.

General Offices: CLARKSBURG, W. Va.

Branch Sales Offices:

NEW YORK • CHICAGO • FT. SMITH, ARK.



ANCIENT CASTLE - MODERN SKYSCRAPER

Both were designed with

A. W. FABER PENCILS

Strange, but we don't feel like a patriarch. In the 18th Century A. W. Faber pencils were used to design castles, fortresses and edifices of the time. In the intervening span of 176 years A. W. Faber pencils have been used for many of the great architectural and industrial projects of the world. Yet we feel young . . . amazingly young, because

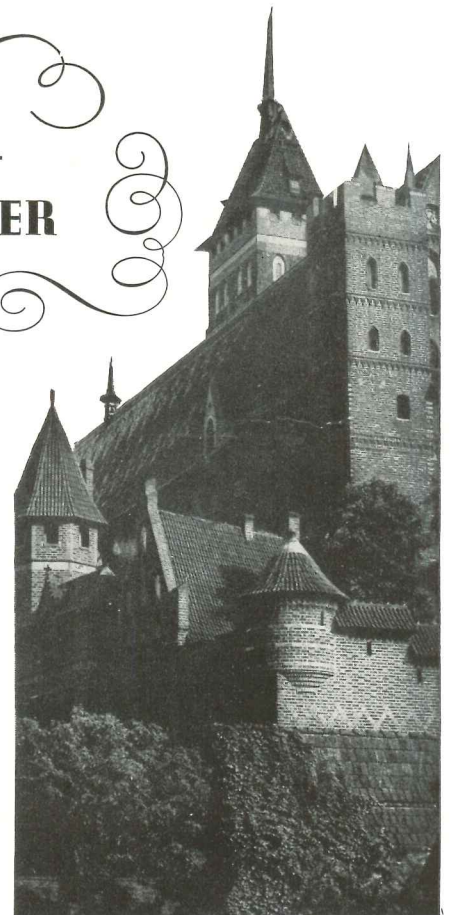
"CASTELL"

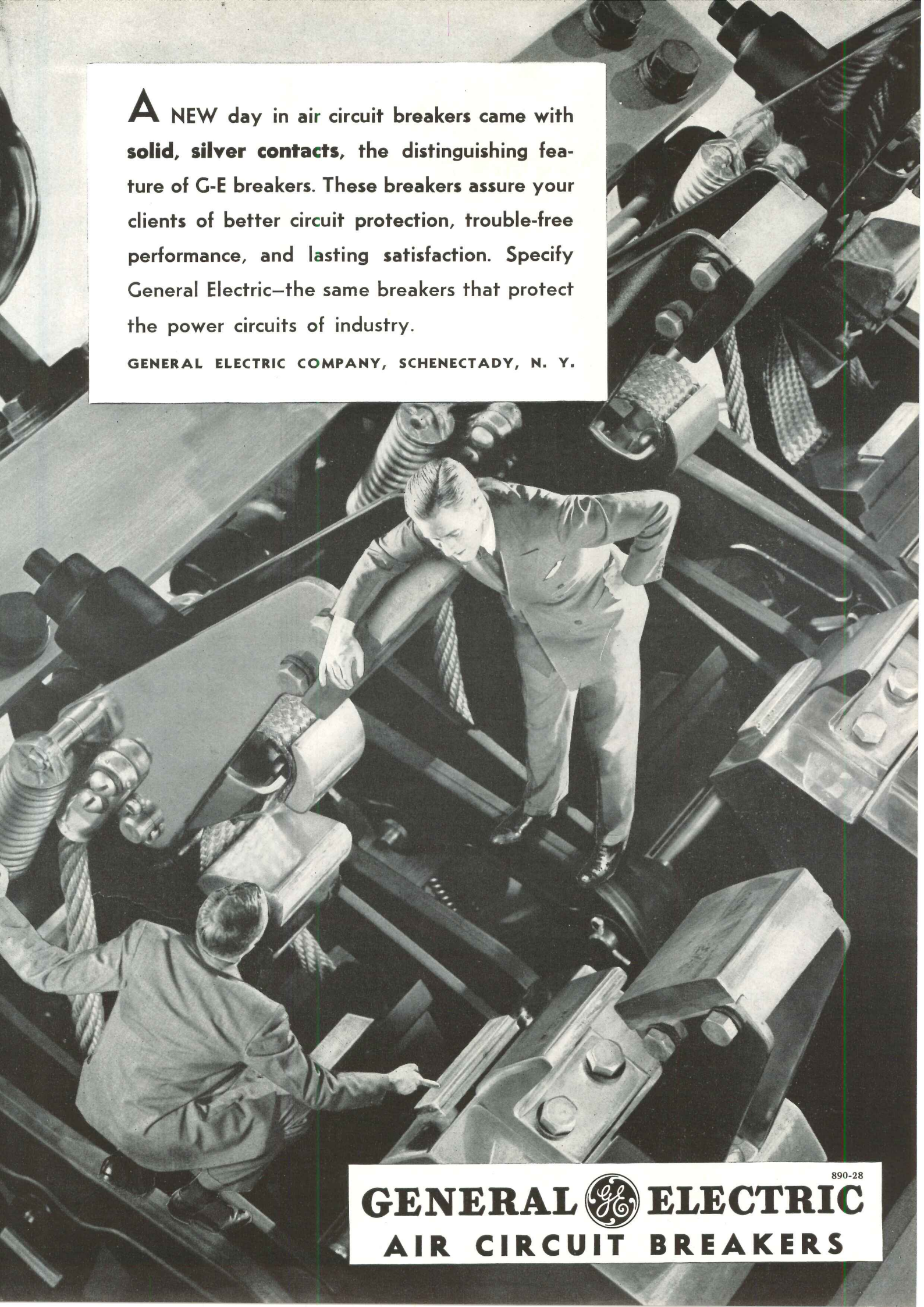
drawing pencils and drawing materials are still the quality standard of the world, the preferred tools of foremost architects, engineers, artists, designers and draftsmen. You, too, will do better work with "Castell". 18 accurate degrees.

MADE IN BAVARIA

AW. FABER, INC.

NEWARK . . . NEW JERSEY





A NEW day in air circuit breakers came with **solid, silver contacts**, the distinguishing feature of G-E breakers. These breakers assure your clients of better circuit protection, trouble-free performance, and lasting satisfaction. Specify General Electric—the same breakers that protect the power circuits of industry.

GENERAL ELECTRIC COMPANY, SCHENECTADY, N. Y.

890-28
GENERAL  **ELECTRIC**
AIR CIRCUIT BREAKERS

THROUGH
WINDOWS OF
ALUMINUM



Residence of Mr. L. P. Plym, Niles, Michigan—William Crane, Architect



U. S. Public Health Service Building, Washington, D. C.—J. H. de Sibour, Architect



A. O. Smith Building, Milwaukee—Holabird and Root, Architects



Pittsburgh Branch, Federal Reserve Bank of Cleveland—Walker and Weeks, Architects



Marshall Field Building, Chicago—Graham

★ Look to economies in construction and maintenance, to greater beauty. No matter what the type — double-hung, casement or industrial — whether frames or sash are large or small, an Aluminum window is available for your use.

Precise dimensions and advanced designs in extruded shapes of Alcoa Aluminum produce windows light in weight, sash easy to operate. No rusting, shrinking, warping or swelling to interfere with their smooth performance. Small, strong sections increase the effective glass area.

Not expensive. And annual costs are low, for Aluminum windows require surprisingly little attention. No need for painting. No streaking or staining of adjoining surfaces to be guarded against.

Leading manufacturers offer complete lines of windows fabricated from Alcoa Aluminum. Aluminum Company of America, 2167 Gulf Building, Pittsburgh, Pennsylvania.

★ ALCOA ★
ALUMINUM

BUILDING TYPES

FACTORIES

Recovery in Factory Building continues and architects design their share.

Two heads are better than one, so many authorities, including Secretary of Commerce Roper, outline briefly their views on how labor, raw materials, fuel and power, and other factors influence site selection.

Factories are flow lines within flow lines but number one is the production line around which the factory is built. Dr. Stepanek discusses and illustrates his views.

Make the factory safe for the worker, advises Donald F. McMurchy, and includes a detailed check list to help you do so.

The bibliography prepared by architect George Inglis is cross-indexed by industries.

Illustrated Case Studies: Metalworking, Printing, Newspaper, Ink Processing, and Milk Bottling Plants. Glass Factory Administration Building. Warehouse.

ARCHITECTURAL

Record

Factory Construction Traces a Recovery Outline

By **L. SETH SCHNITMAN**, Chief Statistician, F. W. Dodge Corporation

INDUSTRIAL production has rounded out another half-year of recovery. Whatever the causes—and the drawbacks—with it has come a collateral increase in factory building. There is nothing of the boom of earlier years, notably the 1920's. But a gain in factory construction of about 75 per cent, and that is the increase which has occurred thus far in 1937 over 1936, cannot be dismissed lightly; the more so since the gain is only part of a much broader swing that had its inception back in 1933.

New factories and expansion and modernization of existing plants during the first six months of 1937 are entailing an expenditure of upwards of \$150,000,000—this, for the 37 states east of the Rocky Mountains alone. In the like period of last year the total was only \$89,000,000. Were equipment and machinery to be included in the record the totals would bulk materially greater. But the comparison would be no less significant, such has been the impact of expanding demands for all manner of manufactured goods, a rising national income, and the pressure for increased efficiency in the processes of production.

Paper and pulp, food products, textiles and their manufactures, iron and steel and their manufactures, and vehicles, chiefly automotive—these are the industries which in 1937 have been making the largest expenditures for factory construction, modernization and rehabilitation. Miscellaneous, and, for the most part, lighter industries have recorded a volume of factory construction that also well reflects the strong industrial recovery of the past two years.

Much additional factory building is in the offing. The processes of decentralization and industrial shifts appear to have been somewhat accelerated. This, coupled with the remaining economic forces that continue to

underlie industrial revival, promises to provide a factory building volume for the final half of 1937 not much below the pace set during the first half. That would mean a total in excess of any shown since 1929. Much distance remains if we are to attain the level of that year—\$546,000,000 for the 37 states. But the direction is still forward and that seems to be the really important thing. A \$300,000,000 factory building year, on the basis of performance for the first half of 1937, means about \$175,000,000 of professionally-planned projects.



A FURTHER examination of the industrial work of the past six months reveals interesting facts and comparisons. Excepting miscellaneous and other unclassified operations, the greatest activity, as previously stated, has been in the planning and construction of factories for the fabrication of metal goods, small parts, machinery, electrical appliances, wires, and other such products. These together amount to fourteen per cent of the total number of architect-planned buildings and in cost represent slightly more than that relationship. Very few of these buildings were erected in the southern states, indicating that areas such as the Detroit, Pittsburgh, and New England sectors are not losing ground industrially in this field. Brick was used in the great majority of projects, not only in this group classification but also in every other, although reinforced concrete construction was employed to some extent, particularly in multi-storied structures. Less than half of the work represents alterations or additions to existing plants.

The next greatest activity seems to have been in the dairy plant development. This includes, besides milk depots and bottling or pasteurizing works, creameries, buildings for butter and cheese manufacture, and ice

cream plants (with quite a few of the latter). Ten per cent of the total, projects and money value, was devoted to work of this character. Where buildings were located in the larger cities, as more than a fourth of the total were, structures of two or more stories naturally prevailed; otherwise, one-story buildings were designed. In this field approximately one half of the jobs were either alterations or additions. Both additions and new work were most frequently of masonry construction although terra cotta was used extensively.

Laundries, dry cleaners, dyers, and kindred activities follow the milk industry in number of jobs (although not in money value). These accounted for more than nine per cent of all projects and were fairly distributed over the 37 eastern states. The average cost of sixteen or seventeen thousand dollars illustrates the small scale of this type of work, almost all of which was one-story brick and steel frame construction and the majority of which were additions to existing plants.

Next in order are food processing plants, which include candy manufacture and the bottling of beverages other than alcoholic ones. These bottling works, incidentally, reflect a considerably increased public demand for such products as well as the necessity for newer and improved plant and equipment. Seven per cent of all construction projects were food manufacturing plants, about half of which were new buildings and these were predominantly two or more stories, either brick and steel or reinforced concrete construction. Like laundries, these jobs were distributed evenly throughout the country; unlike laundries they represented an average cost of about forty thousand dollars.

Surprisingly, printing plants, newspaper plants, etc., stand sixth in the

breakdown of industrial expansion or alteration, amounting to something less than six per cent of the total projects; nearly all were additions to existing plants, New York City and Pittsburgh leading other sites. Undoubtedly the recent flood conditions in and around Pittsburgh gave rise to the necessity for new construction, particularly for newspaper plants, which were severely damaged.

Almost equaling the number of projects for the printing industry, the breweries, distilleries and other alcoholic beverage plants are considerably ahead of the former in average cost. These works, again like the printing plants, were mostly alterations or additions, structures of four stories being the average. Indications are that future work in this field may reasonably be expected to develop, particularly in the Philadelphia and Detroit areas.

The constantly maintained migration of the garment industries to the south, with the attendant need for

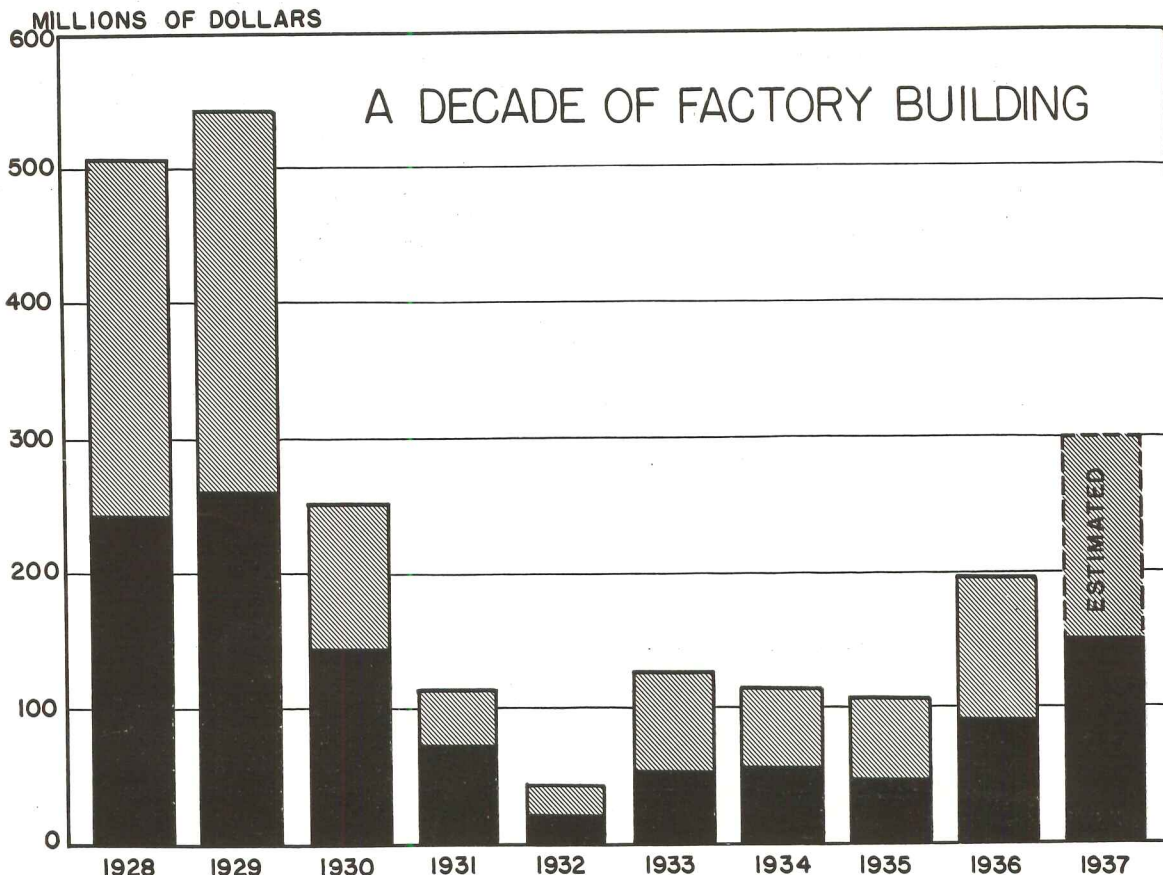
new housing of plants, places this industry eighth in line with a total of five and one-half per cent of the total jobs for this six month period (the cost factor is comparable here) and, as indicated, the work is largely new rather than additions or alterations which characterize the majority of other reportings. One-story masonry buildings predominate with an average cost of forty thousand dollars.

Meat packing houses, abattoirs, and the like show considerable new work to have been undertaken to the extent of five per cent of all jobs. Little is being done to shift the principal scene of such activity from the Chicago district, reports showing that half of the total was for that area. Two-story masonry and structural steel buildings represent the average design.

In number of projects the remaining classifications fall away rapidly from those previously mentioned. From bakeries, representing only three and a fraction per cent of the

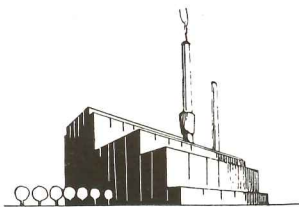
whole, the listing descends to canneries with a ratio of one-half of one per cent of the total. There are, between these two extremes, the following industries: house furnishings (furniture, housewares, etc.), iron and steel plants, textile plants, warehouses (including ice houses and mail order houses), chemical and drug manufacturing plants, paper and container manufacturing plants, and rubber factories (all rubber goods including tires). Although these classifications represent only small percentages of the total number of jobs, they are in some cases, notably in the iron and steel and rubber industries, works of considerable magnitude in terms of dollars.

Among the larger projects not classified are several new factories for the manufacture of trailers. This new field should beckon the attention of all architects interested in industrial work, representing as it does an opportunity for fresh and creative effort through the close study of a comparatively new product manufacture.



Excepting only 1936, the volume of factory building in the initial half of the current year (black portions denote totals for first six months) was greater than the full year totals for any year since 1930.

Some Site-selection Factors for the Architect's Working Files



FACTORY PLANNING begins with a multiplicity of tabular data, prepared especially for a projected factory development. Some of it may originate with the architect; all of it must be obtained from many sources if he comes properly equipped to assist and counsel in the primary step—namely, the selection of the factory site. Seldom are generalities possible in this analysis and determination of the factors involved. Each consideration, whether it be transportation, labor, governmental restrictions, or any of several other factors, relates by and large to the case in hand. One general premise, however, is possible. That is, no industry is static.

Not only does this imply that industry tends toward constant expansion of its activities and productions, and consequently its housing or structural shelter, but also it should be remembered that the very considerations which dic-

tate a factory location may undergo a change in values in regard to that particular factory. As an instance, the present low wages of a particular locality may be easily leveled with other sections at some future time. Or again, for example, raw materials essential to the production of a given product may be replaced with some new material—the world's laboratories are constantly developing new materials to supplant older ones of nature. Transportation which may be good or adequate today may be antiquated tomorrow. Markets may shift. Each and every factor is subject to change. The clear implication of this is that every factory planning program should incorporate that all-important element: *mobility*.

The ultimate of this factor would almost seem to indicate that a factory building was in reality no building at all, at least in the general sense of structure as an inde-

pendent element. Some steps have already been taken in this direction, notably in power-house developments, wherein the structure is integral with the equipment. The tops of the boilers, conveyors, etc., become the roofs; the sides become the walls. Obviously such units permit the greatest flexibility in rearrangement or even in reassembly at some new location. How far this type of design may be carried remains to be seen. Unquestionably it merits the architect's closest study to the end that he may play his part in the evolution of such new forms as will achieve greater economy as well as greater mobility for the factory building.

ARCHITECTURAL RECORD has requested several eminent authorities to contribute to a symposium which will indicate some of the more important present considerations relating to factory site selection. They present, in effect, a check list of possible determinates.

Civic Considerations and Responsibilities

By **DANIEL C. ROPER**, U. S. Secretary of Commerce

FACTORY site selection is a matter that should be decided on a basis of scientific research, conducted by its planners in co-ordination with supplementary studies by communities and regions. This is a matter worthy of the co-operative attention of the National Resources Committee.

It is timely that thought should be

given to decentralizing industry and to relieving urban congestion, thus promoting social progress. Under wise guidance to this end industry will be safeguarded and our social structure protected. It will bring a happier system of living among factory workers. To promote these purposes it is desirable that, where

economically sound and practicable, the factories be located in or near small towns having productive agriculture background. This would enable workers to enjoy the environment of the country where some members of the family could engage in the production of food articles and all can be kept in close touch with nature.

Whether locally- or foreign-owned, the enterprise needs to recognize definite obligations to the community. Some communities, in their zeal to acquire pay rolls to augment local business activity, have gone to the extreme of offering inducements in tax exemption, free rent, reduced power rates, etc. The site should be chosen purely on the basis of lasting natural and economic advantages rather than on such temporary inducements. Thus the necessary good will of the community and safeguard for the future will be best conserved. It is of course desirable that the factory buildings and associated structures be of high standard in appearance. Modern architectural treat-

ment of factory buildings and landscaping connected therewith should not only recognize attractiveness but depict as well the dignity and strength of the industry. Sufficient ground should be used as not to crowd the structures against the boundaries of the property. Parking space should be provided within the enclosure. Proper ground space is needed to afford ease and comfort. This together with appropriate landscaping will lend dignity and beauty to any industrial plant. Attention to these details will awaken community pride in the factory and thus promote safe business. Employees will be proud of it and their loyalty increased. Furthermore, the market value of neighboring prop-

erty will be enhanced. The factory will thus make its place in the community and prove to be a good neighbor.

We have all seen instances in which a factory has adapted itself so splendidly to this concept that we have asked with wonder whether it was not in reality some research or educational institution. We have only to compare our pleasurable impressions in such instances with those we get from factories forgetful of these cultural appeals. Life in industry and out of industry needs more than economic results and in fact, without these satisfying cultural additions, economic success is not safe or lasting.

Labor

By **M. ADA BENEY**, *Chief, Dept. of Labor Stat., National Industrial Conference Board*

ONE OF THE most important considerations is the labor factor. It may be examined from the point of view of labor supply, wages, living conditions, and trade union organization.

The manufacturer who is either opening up a new factory, or moving his plant from another location, must know whether or not there is an adequate supply of labor available locally. Is the labor supply sufficiently large in number? Is it of the steady, dependable type, or is it unstable? Is labor, whether skilled or unskilled, relatively efficient: that is to say, will the output per unit of measurement be as great as elsewhere? Do the men and women possess the necessary knowledge and skill that may be required for the company's operations? If not, are they the type that may be easily trained? Will it be necessary to import labor of specialized training into the community? Is there competition for such labor from other manufacturers?

While the question of wages is important at all times, it assumes added significance if the labor costs constitute a large proportion of total costs. Although there has been agitation toward equalization of wages throughout the country, wage rates at present differ widely. Certain general

tendencies are usually observed; for example, lower wage rates in the South than in the North and lower rates in smaller communities than in larger communities. Local peculiarities may at any time, however, offset these general tendencies. A dearth of certain types of skilled labor may send wage rates for such occupations above what they might normally be in a given community. Thus, while the general wage level in a given community might be comparatively low, the rates for some occupations might be comparatively high. The architect should, therefore, secure information not only concerning the general wage level, but also concerning the possible existence of peculiar conditions with respect to the wages of selected occupations. It should also be kept in mind that low wages have significance only if they mean low labor cost and, therefore, should be weighed against relative labor efficiency.

Not only the cost of living but also the standard of living which prevails in a given community should be carefully considered. These may vary widely between individual cities but not so much on a regional basis as is commonly believed.

Recreation, education, and health facilities may also be investigated,

since the lack of such public facilities may throw the burden of providing them upon the manufacturer.

Whether or not trade union organization should be taken into consideration depends on whether or not such organization appears desirable to the employer seeking a new site. In this connection, however, it should be pointed out that the non-existence of such organization in a given locality does not preclude its subsequent establishment. It often happens that employers move from one location to another to escape trade union domination, only to find that sooner or later organizers begin their work in the new location. Though it is true that some localities appear to offer more fertile ground for labor union activity than others, the escape often is merely temporary.

As a matter of fact, not only the question of labor organization but also the other labor factors should be viewed from their long-run possibilities. For example, a low wage differential enjoyed by a manufacturer may be wiped out sooner or later if other manufacturers attracted by the same consideration move into the locality and competition raises wages. What may appear as a definite advantage, therefore, may be of limited duration.

Raw Materials

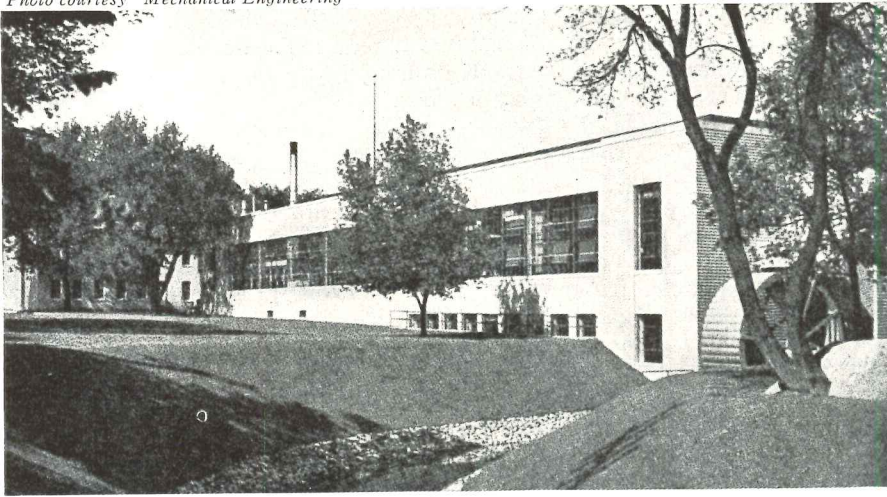
By **S. D. KIRKPATRICK**, *Editor, Chemical & Metallurgical Engineering*

"IF THE mountain will not come to Mohammed—then Mohammed must go to the mountain." This thousand-

year-old advice of the Arabian prophet has lately been taken to heart by American industry. Some indus-

tries have been forced to move because they have used up their old mountains of raw material and must

Photo courtesy "Mechanical Engineering"



Small village or country located factories are spreading rapidly.

seek new ones. Other large industries have long resisted the trend toward decentralization, only to find suddenly that smaller and more aggressive competitors have moved into the more desirable locations where worthwhile economies may be effected in the transportation of raw materials and finished products.

An executive in the chemical industry, for whose views I have the greatest respect, recently wrote me to the effect that it seemed to him producers have concerned themselves entirely too much with what it costs

to make goods and entirely too little with what the goods finally cost the consumer. Large production units have all too frequently been located without regard to new and cheaper raw material sources.

This is particularly true in the so-called heavy industries that make "producers' goods" rather than products for the ultimate consumer. Prior to 1934, a glass manufacturer in Shreveport, La., for example, had to pay as much as \$10.50 per ton in freight on one of his principal raw materials, soda ash, shipped from

Detroit or Syracuse. Today, as the result of an expenditure of approximately \$30,000,000 on the part of the chemical industry, he can secure his alkali requirements from two large plants in Louisiana, or from another around the Gulf Coast in Texas.

This new availability of basic chemical raw materials has given impetus to a great migration of the pulp and paper industry. Already \$150,000,000 has been invested in the Southern states as Northern producers suddenly awoke to the fact that the South had in its pine a self-perpetuating source of pulpwood for kraft paper. New processes of bleaching and refining promise to make great inroads into newsprint all of which has been imported in previous years. As the South discovers that "Cotton is no longer King" we may expect many other industries manufacturing such items as soap, food products, rayon, and ceramics to develop there, primarily because of available raw materials.

Fuel and Power

By **RUSSEL S. McBRIDE**, Consulting Engineer

FUEL AND POWER are so important to certain industrial establishments as to be dominant in determining factory location. The electrochemical or electrometallurgical enterprise, for example, must have very cheap electricity, or it has no chance to sell its products in an intensive competitive market. Those who carbonize coal for the manufacture of coke, gas, and various coal byproducts, must carefully consider the cheap delivery of their raw material in order that their costs, too, may not be prohibitive.

A very large share of chemical-process industry—that is, manufacturing enterprise in which chemical engineering is important—uses large blocks of power. Mechanical industries, which make sewing machines, typewriters, farm machinery, automobiles, and other mechanisms, are also big power users. But most of the chemical and mechanical groups find other considerations, such as skilled labor supply or cheap access to markets, more significant than this

question of geographic source of energy. This is more true today than it was ten or fifteen years ago. Interconnection of power systems has leveled out power prices surprisingly. One can purchase cheap energy in almost any municipal area, if his power requirements are not abnormally distributed in time or season.

Occasionally an industrial management must decide the important question as to whether it should buy electricity or should generate its own supply in an isolated power plant. Rarely, this question might be a determining factor between one site where cheap power is available and another where it is not. And still less frequently is it necessary for an enterprise to judge between one location and another because at one hydroelectric power is available, whereas at another steam electric energy must be generated. The answer as to the advantage of one site versus another is usually far more profound.

Far more important to the average factory owner than the question of

geography with reference to power, is the consideration of how his power requirements are distributed through the year or through the hours of the day and night. Some enterprises with large loads concentrated in the hours when everybody else wants energy are less desirable customers for the public utility company than are other users whose requirements are uniform. And if an enterprise can so arrange its business as to take electricity when the demand is small and the surplus great, the utility company finds them peculiarly advantageous customers, and they pay lower power rates.

In very few instances are power facilities of a community so poorly distributed as to make one section of a city advantageous as compared with another. The power line is ubiquitous. However, it is sometimes important to inquire of the utility company as to the limits of its power zones. By and large, there are few cases in which energy and fuel supply will dominate as to plant location.

Waste Disposal Factors

By **CHARLES P. WOOD**, *Lockwood Greene Engineers, Inc.*

A WASTE disposal problem exists wherever the residue discharged from a manufacturing plant is of such a nature that it pollutes air or water, or otherwise creates a hazard, damages property or obstructs traffic. There is a possible solution in almost every case. The expense and inconvenience involved explains why the nuisance has continued so often until prohibited by law. Provision for waste disposal should be included in the plans for all new plants. Where plants were built before waste disposal was a problem, it may be found that the location has made waste disposal more complicated and expensive than it would have been elsewhere.

Isolated industries, which produce harmful waste, have been tolerated because comparatively few people were affected and little damage done. The development of larger industrial units, congested industrial centers and more thickly-settled areas revealed hazards to human and animal life and damage to property which could not be allowed to continue.

Solid wastes, such as blast furnace slag and sludge from certain sedimentation processes, may be stable and harmless in themselves, but may be produced in such large volume as to make disposal a problem. Other solids, containing organic matter or unstable elements, may create hazards

or nuisances by spontaneous combustion or putrefaction when allowed to accumulate. Finely divided solids, in such form as dust, soot or fly-ash, escape to the air from many manufacturing, heating and power plants and cause trouble.

Liquid waste, or liquids carrying solids in suspension, may be harmless when discharged into a sewer or stream, but it is advisable to consult the chemists and engineers before taking anything for granted. Space does not permit going into details here about what might interfere with the operation of a sewage disposal plant or what might pollute a stream. There are state departments which have authority to pass on what is permissible and the chemists and engineers are co-operating with them to prevent stream pollution. Where there is any question about the harmful character of waste, a location at tidewater or on a large stream is generally preferable.

Gaseous waste, usually from chemical or metallurgical operations, can be dissipated and rendered harmless beyond limited areas. This indicates isolated locations in such cases. However, considerable areas may be affected, as illustrated by a copper smelter, where the fumes destroyed vegetation to such an extent that the state compelled the installation of a system to eliminate the harmful elements. The system not only

stopped the trouble but also produced a valuable byproduct, sulphuric acid.

Textile finishing plants, rayon plants, tanneries, oil refineries, garages, paper and pulp mills, dairies, hat factories, rubber plants and various metallurgical and chemical plants produce waste which requires treatment to render it harmless to sewers or streams. This treatment includes both mechanical and chemical operations and sometimes byproducts can be recovered. The byproducts of meat plants now account for all but a very small part of what was formerly objectionable waste. The gases which formerly escaped from coke ovens are now converted into salable products. Slag piles at blast furnace plants are being used to make Portland cement and for other purposes. Improved furnace and stoker design has eliminated smoke and dust which formerly characterized steam power and heating plants. Bagasse, the residue from sugar mills, is now converted into building material. The refuse from woodworking plants can be burned but byproducts also are possible. And so on; much has been done to solve the waste disposal problem but much remains to be done. America is still behind Europe in this respect and more attention should be given to waste disposal as an important factor in the selection of sites for manufacturing plants.

Selection of Industrial Sites—Case Studies

By **JOSEPH DOUGLAS WEISS**, *Architect*

IN THE LAST two decades the method for selection of industrial sites and the layout of plant expansion

programs has made just as much progress as the science of town planning. In many cases the two have

gone together. Careful studies are made of all factors involved and the industrial consultant architect has found his field of interest growing into economic and social spheres.

In order to illustrate the real forces which move or locate plants the following will describe actual case histories:

1. Textile Mill

Product:—Silk

Main sales office and administration office: New York.

Present plants: 11 in various parts of Pennsylvania; 1 in



Photo courtesy Jones & Laughlin

Fewer and fewer large industrial enterprises are being centralized in urban areas.

New York City; 1 in New Jersey.

Employees of each plant: approx. 380 girls, 30 men.

Average size of plant: 60 x 500, 4 stories high, plus auxiliary buildings.

The manufacturer needed a new plant to take care of approximately 10 per cent added production. The actual selection of a new site was dictated by the following considerations:

1. Raw materials come from Japan and from the various rayon plants in this country. Shipping of these high priced goods does not present an important factor.
2. Manufacturing costs are represented mostly by the wages paid girl employees. The labor cost, being a large percentage of production cost, was a very important consideration.
3. Plant costs.

Following surveys of the available locations within 24 hours of New York City, because it is nearly always desirable to have branch factories within easy reach of the supervision of the main office, the New York Metropolitan district and all of New England were eliminated mostly for reasons of labor cost and capital investment. All favorable factors pointed to the South. The ideal location would be a town with no industries, where the younger generation drifts to the large cities after school age unless there is employment available locally. Towns with this kind of population are glad to offer inducements to manufacturers in order to provide work for their youth. Towns which had industries employing men but leaving the female population without employment were also a possibility. A questionnaire was sent to railroads and Chambers of Commerce in towns of approximately 25,000 inhabitants as indicated. These questionnaires brought the following data:

1. population
2. established factories in town
3. number of men employed in factories
4. number of girls employed in factories
5. estimated unemployed labor
6. prevailing wages
7. crop conditions and seasonal workers

Each town was asked in addition for

concessions they would give in the way of lower taxes; if they owned the power plant, in lower rates, in free land, or in free building. If the town looked as though it could provide a satisfactory amount of labor and would offer some concessions, it was investigated further by a personal visit to check the character of the working population—their seasonal movements, etc. When the selection was narrowed to one town the manufacturer selected a site and the following plan was developed:

The town merchants formed a real estate holding corporation under the guidance of the Chamber of Commerce. The purpose of the corporation was to acquire land and erect a building, according to the plans and specifications of the manufacturer, which at its completion would be rented to the manufacturer for a rental based on 4 per cent of the cost of the land and building.

In addition to this, the town made concessions in city taxes and furnished the power and water at cost. The town also extended a bus line to the factory. The lease was made for a period of 10 years with a renewal privilege based on a reappraised valuation. An option of buying the plant at any time while the lease was in force was part of the terms.

A training school was established in the town to teach men and girls the operation of the looms under the guidance of the future manager of the new plant. The teachers were the foreman and a group of loom attendants from other factories, selected for their intelligence and efficiency. By the time the new plant was completed the town had enough trained workers to start production.

2. Tobacco Factory

Product: Cigars

Main sales office and administration office: New York.

Present plants: 10 in various parts of Kentucky and Tennessee.

Employees of each plant: 400 to 600 girls and 20 men.

It was decided to manufacture these cigars on automatic machinery. This required a large plant involving considerable capital investment both in buildings and machinery. Since this plant was to produce over a million cigars a day, its correct location, in a large town, was a very important matter. The output of the factory required about 1400 girls and about 100 men. As this is a nationally distribu-

ted product and the company had other plants taking care of the New York Metropolitan district, a mid-western town was to be selected.

Freight rates were studied from various mid-western towns to the consuming centers where the product was to be shipped; also from the plants and warehouses of the company where the tobacco was prepared and stored before it was shipped to the cigar plant.

Since the building was to be completely air conditioned and use a great deal of power, the power rates, water rates and coal prices of various towns were compared. After consideration of all the data, a town with two railroads was selected and the plant built without any concession on the part of the town. The tobacco comes to the plant in semi-finished form packed in cases and bales. While the raw materials or the finished product are not bulky, the output is large enough to make it necessary to locate this factory on a railroad siding. Once the town was selected, the site was established by locating the building on a railroad spur connecting to both railroads and on a street car line connecting it with the residential districts of the town.

The operation of automatic cigar machinery can be taught to intelligent girls of the labor class in approximately six weeks. A school was established in an old building and enough girls trained during a period of eight months, while the new building was under construction, to provide skilled hands to start the operation of the plant.

Careful studies were made of the amount of raw materials and supplies to be handled and the amount of fuel needed. The manufacturing process was laid out in a flow diagram establishing the logical method of laying out the building and its immediate vicinity in relationship to the railroad sidings.

The flow diagrams were the basis of architectural plans on which the location of each machine and all the conveyors were established. In this way the entire plant became a logical unit. In laying out the building great care was taken in routing the traffic within the factory and arranging the various auxiliary rooms, locker rooms, first aid hospital, and dining room in such a way that though they were near the working spaces and the independent entrances of the employees, they would not conflict with the flow of the manufacturing operations.

Look to the Flow Analysis for Effective Solutions

By DR. OTAKAR ŠTĚPÁNEK

INDUSTRIAL buildings were the first to escape from the useless application of historic detail to contemporary structure. In seizing the opportunities offered by modern construction methods, the factory designers re-discovered the essential relationship between exterior and interior design, and served to develop the contemporary concept of architecture.

Among the earliest examples, those which were most successful were often the result of a fortunate combination of circumstances, or bold planning by a designer who allowed himself freedom from tradition. During this period of transition, it was natural that even the best examples represented only a more or less successful attempt to reach a complete solution. This transition rested largely in the hands of engineers, who did not hesitate to make use of each technical invention in the evolution of structural science. Now, with the resources of scientific research at our disposal, it is clearly the responsibility of the architect to continue the development of industrial architecture by his comprehensive grasp of the problem.

In practice each individual factory presents its own distinctive problem due to the great diversity of manufacturing processes and the type of construction appropriate to each.

At the outset the architect must make himself familiar with all the technical details of his problem and then proceed to analyze these various requirements and resolve them into an organic solution. He will, of course, sit in conference with a number of technical experts, each of whom presents the requirements of his particular department and each requirement should find its answer in the final design.

The most important phase of the architect's work occurs when he, in consultation with the plant manager, determines the basic concept of the layout. The various factors which must be taken into consideration at this time may be conveniently included under the following headings:

- (1) Flow diagrams;
- (2) Economy of both building materials and space;
- (3) Architectural composition.

Flow Diagrams

After determining the location of the plant, the most important problem is the organization of an efficient flow of activities within the factory buildings. The factory manager will now place before the architect all the necessary information regarding the manufacturing processes and their arrangement in time and space—the Production Line. The architect must also become familiar with other related activities, not immediately connected with production, but which nevertheless are a factor in preparing the flow diagram.

All efforts to control the dynamic life of the plant find their

DR. ŠTĚPÁNEK shows how graphic representation of plant activities is an important phase of Factory Planning. The author, architect and assistant lecturer at the Polytechnic in Prague, Czechoslovakia, is at present at Cranbrook Academy under the auspices of the Institute of International Education.

Drawings by courtesy of "Česka Matice Technická v Praze"

reflection in the flow diagram, which includes all important movements of both materials and workers. It will show mechanical distribution systems and perhaps the limited and directed travel of groups of visitors through the factory. Traffic routes caused by movements of numbers of workers may later bring serious confusion if neglected at this point.

The component parts may form an extremely simple or a very complex picture, and the architect must now set to work to organize them for efficient operation.

The most important single element of the flow diagram is of course the production line. This is the

and some of their modifications.

1. Very often the best arrangement is a single straight line, giving rise to a very simple plan. Different departments may be housed in a single building or placed in separate units in line. Expansion is easily possible, for each department, at right angles to the production line and the architectural conception is very clear and simple.

2. Shows the production layout arranged in a circle, more or less closed according to the location of the receiving and shipping departments. This is a compact and economical plan, and the production line may connect at both ends to the same point

buildings. Connection between operations is often vertical and plays an important part in the architectural scheme. Expansion can be made vertically by the addition of extra stories or horizontally by wings. Where this type can be used it is very economical in coverage of the lot. The best plan is usually a simple rectangle.

4. This layout, on a slope, can often be used to advantage—especially if the materials handled are liquid or fluid ones. It proceeds by gravity from the receiving to the shipping platforms saving the power energy which might otherwise be necessary for the conveyance of materials. In-

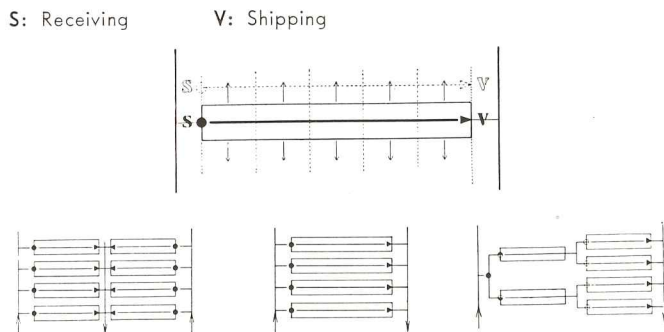


FIGURE 1

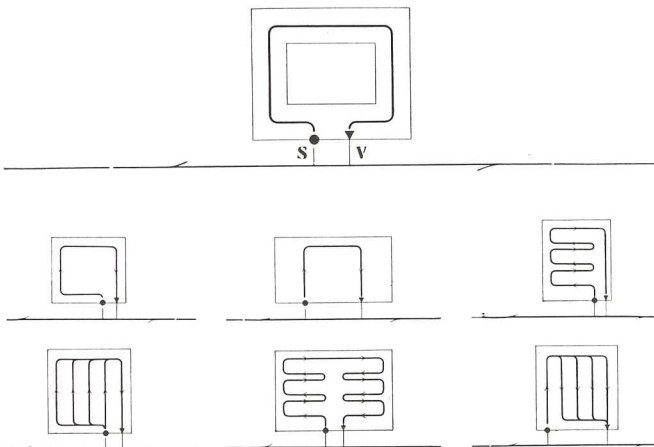


FIGURE 2

route traveled by the materials from the time they enter the factory as raw materials, to the point when they leave the shipping department as finished products. The production line may be single or compound according to the basic nature of the manufacturing processes.

As the production line is the real backbone of the plan, the architect must keep it always in mind as the starting point for his studies.

Illustrations 1, 2, 3 and 4 show the basic types of production lines

of departure. It lacks the freedom of the straight-line layout, but is sometimes desirable when compactness and close communication below the various departments are necessary. Expansion is possible only around the circumference. From the architectural point of view, it often leads to a complex solution, especially when the different departments are housed in separate buildings of various sizes and shapes.

3. Various modifications of the flow of production in multi-story

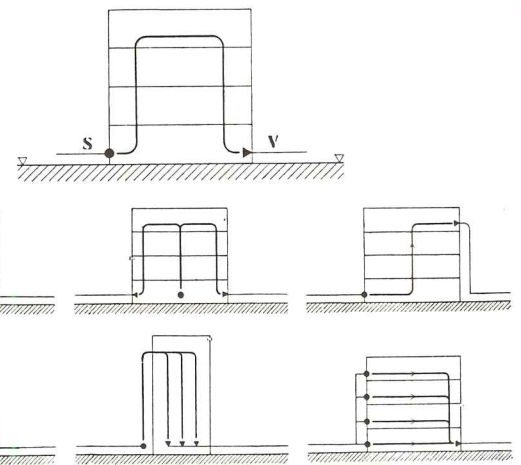


FIGURE 3

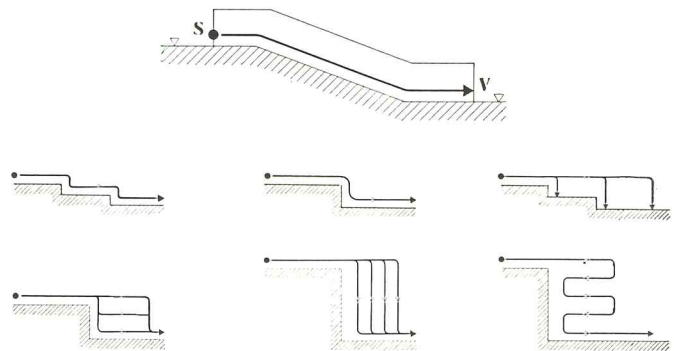


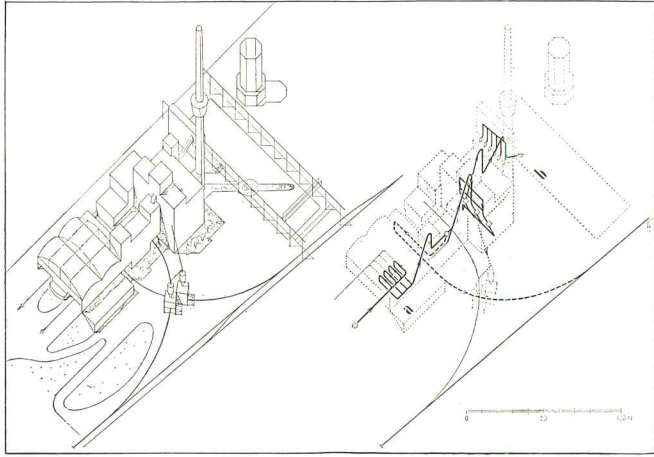
FIGURE 4

teresting possibilities in the architectural massing of the buildings are at once apparent in this arrangement.

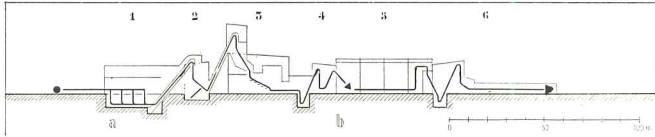
All production line arrangements will be found to be further developments of one or another of these basic schemes.

It is common practice to draw production line diagrams in two dimensions—plans and sections. This is satisfactory for simple layouts, but in many modern plants the flow is complicated by the nature of the manufacturing processes, and this

FIGURE 5 INCINERATOR, PRAGUE

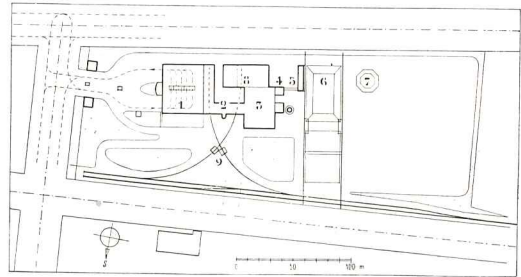
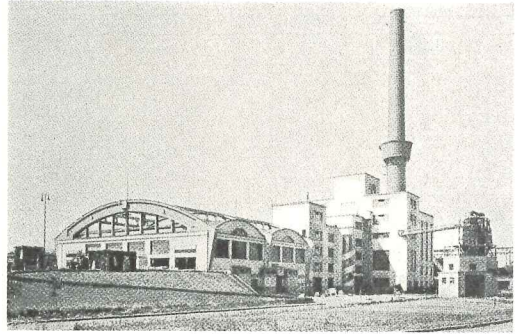


- ——— ○ refuse
- ——— ○ refuse unsuitable for burning
- ——— □ progress of refuse through incinerator
- ——— ▸ slag
- ash



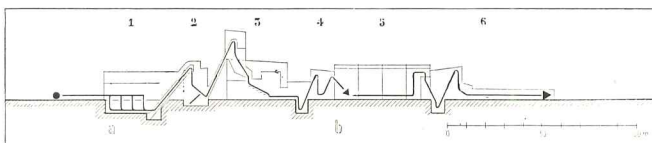
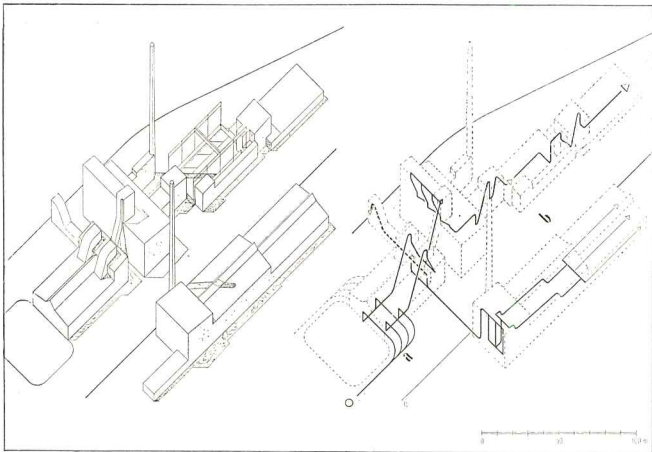
- 1. receiving and storage of refuse
- 2. screening
- 3. furnaces

- 4. slag storage
- 5. slag screening
- 6. slag storage



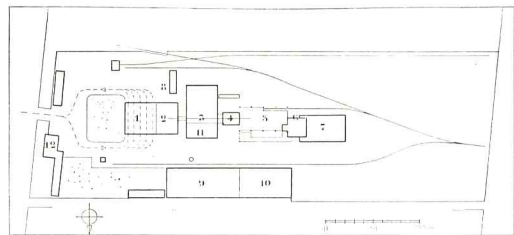
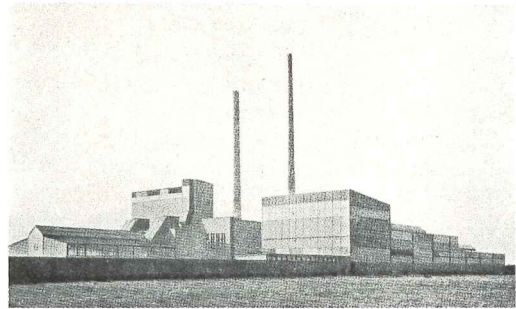
- 7. cooling tower
- 8. power-house
- 9. ash storage

FIGURE 6 INCINERATOR, COLOGNE



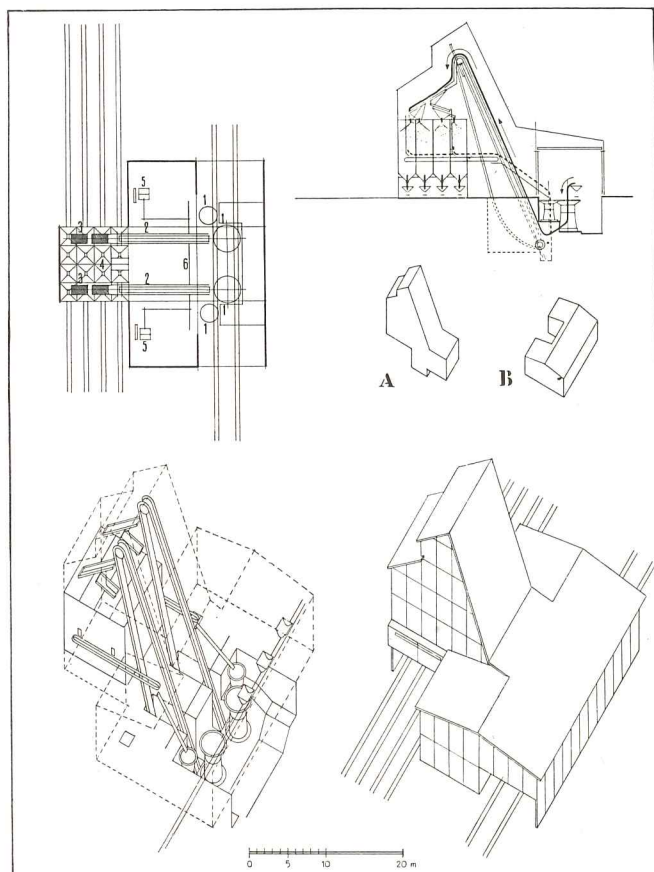
- 1. receiving and storage of refuse
- 2. screening
- 3. furnaces
- 4. slag screening

- 5. slag storage
- 6. brick factory
- 7. brick drying shed
- 8. scrap metal conveyor



- 9. rotary furnaces
- 10. tile factory
- 11. power-house
- 12. office

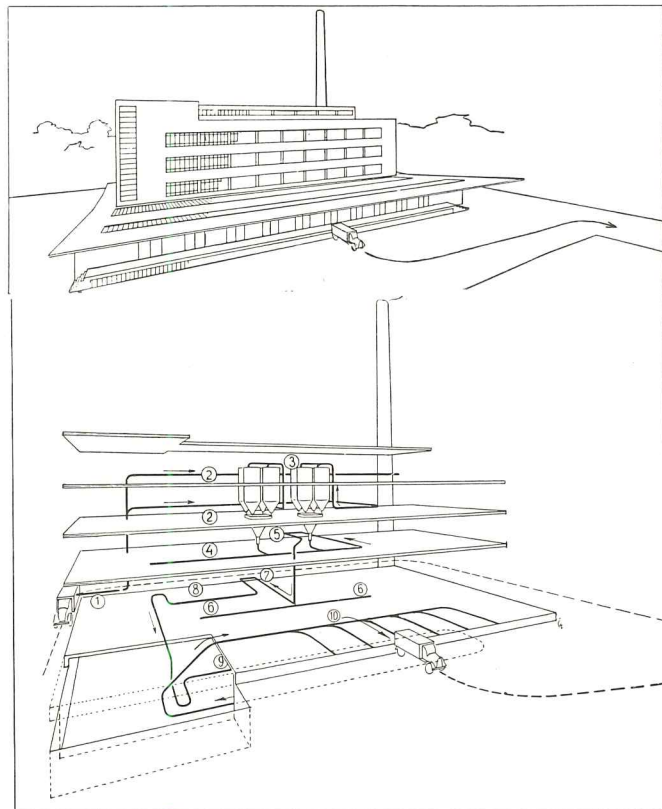
FIGURE 7 CRUSHING PLANT FOR ROAD MATERIALS



- | | |
|--------------|----------------------|
| 1. crushers | 4. gravel bins |
| 2. elevators | 5. motors |
| 3. screens | 6. main transmission |

FIGURE 8 BAKERY IN STUTT GART

K. ELSASSER ARCHITECT



- | | |
|---------------------------|---------------------------|
| 1. receiving platform | 6. cutting and shaping |
| 2. flour storage in sacks | 7. second raising |
| 3. flour storage in bins | 8. ovens |
| 4. mixing dough | 9. cooling |
| 5. first raising | 10. wrapping and delivery |

method fails to give a clear picture. It is then much better to draw it in axonometric or perspective form, in which the entire arrangement may be made clear in one drawing.

The principal architectural volumes are usually indicated by the general shape of the production line, and it is at this point that the architect must visualize the building as a shelter, more or less complicated by the form of the line and its tributary elements. This forms the basis of the first sketches.

In this stage the planning requires careful study, and presents a real opportunity of finding the best solution. The architect will bear always in mind the three-dimensional aspect of the whole, and here the axonometric diagram of the structure, with production lines indicated, is of the greatest aid.

Close co-operation between factory manager and architect is of vital importance. To their conferences the factory manager brings his intimate knowledge of the practical requirements of the manufacturing processes

and his familiarity with plant routine. The architect's planning ability may permit him to offer valuable suggestions with regard to possible reorganization of production to take more complete advantage of modern construction methods. He may find it possible to reduce the shape of the building to a simple block form. More often, perhaps, a complicated mass of structure shelters the factory equipment at this stage. The designer must then distinguish between the characteristic elements of the process schedule—analyze the units—and assign to each its proper value in the composition of the whole. A direct and simple solution will result only through careful study and if complexity is the outcome he may be sure that the final solution has not yet been achieved.

It is of primary importance to develop a clearly articulated and flexible plan which will allow the utmost freedom of expansion for each unit. Experience has shown that a plan of this character is best not only from a practical point of view, but also ad-

mits of clean architectural design. Unexpected demands made by technical changes may be met more easily. In any case the architect's important work is to keep the whole in good proportions, to carry a consistent rhythm and character throughout the entire project. This must naturally start with the design of the structural framework. Technical perfection and refinement of detail can never conceal bad proportioning of the structural elements. Disregard of this basic principle is a very common failing of many factory designers.

A truly organic solution will present a satisfactory appearance from all sides, equally well balanced in each part. But we see any number of factories in the design of which no attention has been given to the development of the plant as an organic unity. Except for a very superfluous treatment of the office building facades, usually in some derivative style, architectural possibilities have been completely neglected. A comparison between two buildings of similar purpose and capacity, but of

greatly contrasting architectural value, will serve to illustrate some of these principles.

Figs. 5 and 6 show two European municipal incinerators, at Prague and Cologne.

The system of treatment in the first example is as follows. Refuse is brought in covered trucks to the receiving room, where it passes into horizontal steel tubes, seven or eight feet in diameter. Within these tubes a screw conveyor carries the material to the inclined bucket elevators leading to the screening apparatus. Here the solid materials unsuitable for burning are separated from the rest by mechanical and hand selection. From here it passes into a second set of tubes which act as continuous feeders to the furnace grates. Slag is crushed and screened and remains in storage until sold. Ash is kept in a storage bin, to be removed periodically by railway cars or used in the subsidiary brick manufacturing plant.

The mechanical equipment and process layout of the plant is very good but, as the plans clearly show, the architect disregarded fundamental principles of architectural composition, resulting in a confused and poorly articulated massing.

The German incinerator has a very similar arrangement of equipment and process line. Between the points a and b, the incinerator proper, the problem is the same in both cases; but the architects have reached very different solutions.

The Cologne incinerator is a good example of the logical grouping of building units, in which each part has been studied both independently and

in its relation to the whole. The various elements are not the result of an arbitrary grouping, but are composed with a clear articulation of the three-dimensional aspect of the material flow. For example, the two sets of inclined conveyors are expressed in a simple but characteristic manner and form a powerful connection between the adjacent masses. In contrast to the Prague incinerator, that in Cologne is consistent in its structure—a light steel skeleton with reinforced concrete floor slabs. The proportioning of solids and voids is very good. In general, the merits of the Cologne plant are as follows:

(1) Clear distinction between the building units, according to their importance in the production plan.

(2) Free development of the plan.

(3) Unity and good proportions throughout.

Fig. 7 illustrates a design for a crushing plant for road materials, planned by the author. It is an example of a structure built around mechanical equipment and the drawings show how graphic analysis helped to solve the problem. Unit A contains the principal machinery and Unit B the motors and covered narrow-gauge railway line.

This analysis not only led to a logical architectural composition, but developed an economical form of construction in which no more space is provided than is absolutely necessary.

Fig. 8, a bakery in Stuttgart by K. Elsässer, is shown in perspective diagrammatic form, and illustrates the relationship of the flow line to the resulting structure.

Economy

Economy of both building materials and of space is of equal importance. A well-designed industrial building should be planned on lines of the greatest possible simplicity. A complicated layout will not render good service to the works manager nor reflect credit on the architect. An economical plan not only limits the building costs and future maintenance, but is one of the requisites of good architectural design.

Composition

The fundamentals of purpose, the regulation and direction of activities, and the all-encompassing expression of economy should result in an architectural composition both valid and direct.

Industrial architecture offers, by reason of its complete definition (in contrast to the sheltering of other activities), the fullest opportunity for the exposition of unity and rhythm. The very exactness of time and motion as well as the relationships of place and size conspire to these essential qualities. These qualities will be reflected not only in the component parts but also in the ultimate assembly in direct proportion to the integration and comparative values which have been established in the flow diagrams or analysis.

Fig. 9 shows a small portion of the industrial town of Zlin, Czechoslovakia. Standardized concrete construction has been used throughout and the unified effect is at once apparent. The buildings are a part of the Bata shoe factory, the largest of its kind in the world.

FIGURE 9 BATA SHOE FACTORY, ZLIN, CZECHOSLOVAKIA



Making the Factory Safe for the Worker

By DONALD F. McMURCHY

MR. McMURCHY, architect and safety engineer, is Director of Safety for the Tennessee Valley Authority as well as Technical Advisor to the Industrial Commission of Ohio. He has practised architecture in New York and Ohio and was formerly Director of Safety for the F.E.R.A. in Ohio.

BY ADDING safety to the list of essential elements of his designs the architect may not only protect his client's interests more adequately but may make an important contribution to the broad field of human security.

Modern methods of living have introduced hazards to human safety which past generations have never known. With the rapid mechanical development of the last three decades, accidents have come into increasing prominence as one of the greatest sources of human misery and economic loss. The importance of accidents as a major contemporary problem may be appreciated from information recently released by the National Safety Council that in the United States during 1936 accidents were responsible for 10,730,000 injuries, 400,000 of which were permanently disabling and 111,000 were fatal. Accidents ranked fifth among the causes of all deaths during 1936. Among males only, accidents caused 110.2 deaths per 100,000 population, a rate exceeded only by that of heart disease. The measurable economic loss to the American people attendant upon these accidents is estimated at \$2,600,000,000. Fire losses and damage to property from motor vehicle accidents raise the grand total to \$3,700,000,000 for the year.

There is scarcely need for calling attention to the human sorrow and suffering which attended this list of accidents. We can readily visualize the utter demoralization of a family by the loss of its breadwinner and can appreciate the grave social consequences of fatal accidents which leave children without the advantages of proper food, clothing, education and parental guidance.

Until means are devised to make an accurate estimate of the contribution a person may make to the national wealth, we have no way of estimating the total economic loss resulting from

his death. We can, however, estimate with a high degree of accuracy the *direct* losses which are incurred when a person is injured or killed in an accident. Of the \$2,600,000,000 accident cost during 1936, approximately 2 billion represents the loss of wages and the value of impaired services resulting from injuries. Four hundred million of the amount was expended for the medical treatment of these injuries and the balance of two hundred



million to pay the overhead costs of insurance, exclusive of compensation payments. This appalling waste of human and economic resources is entirely unnecessary. The so-called accidents responsible for these injuries are not accidents in a true sense, but represent the logical effects produced by definite causes in the form of hazardous physical conditions and unsafe practices, most of which can be foreseen and eliminated. Experience has shown that accidents can be controlled by a well-coordinated program of study and design to remove or control physical hazards, supplemented by extensive education to acquaint persons with the hazards to which they are exposed and with methods by which these hazards may be avoided.

Architects, as planning agencies, have a unique opportunity to foresee and eliminate most physical hazards

from their designs. Of the 111,000 accidental deaths in 1936, 35% occurred in homes and 16% in industry. Both homes and factories are within the architect's usual field of activity and offer a challenge to his ingenuity in removing those physical conditions which contributed to the fatal injury of more than 56,000 persons during the past year.

In addition to the far-reaching social aspects of the architect's contribution in the field of accident prevention, safety in factory design offers a more direct opportunity for him to protect his client's interests by improving his accident experience. Premiums on workmen's compensation insurance range from a fraction of one per cent to more than 30% of the employer's pay roll, depending upon the relation of accident losses to the total pay roll in the industry. Most compensation plans provide for reduced premiums when the accident losses of an individual employer are less than the average for the industry in which he operates. If, by eliminating those conditions which cause accidents, the architect can improve his client's accident experience, it is obvious that the employer is benefited directly by reduced premiums. Greater returns to the employer from an improved accident experience accrue in the form of increased plant and employee efficiencies and freedom from disrupted production schedules, damaged equipment, spoiled material and high labor turnover.

It is generally true that most hazards of a physical nature can be effectively and economically overcome while the project is in the design stage if sufficient thought is given to the conditions under which the structure will be used. Major hazards involving such items as structural arrangement, plant location and materials of construction do not lend themselves to correction after the structure is

completed and must of necessity be eliminated in the drafting room.

Building codes and ordinances generally find their basis in safety. Their essential inadequacy as reference manuals for safety in design lies in the practical impossibility of covering in sufficient detail the infinite number of physical arrangements and conditions which cause accidents. Codes are of particular value in providing against loss of life and property in emergencies but they do not generally cover the hazards of normal use. Various engineering societies and associations and several state and Federal establishments issue safety codes which represent the best practices current at the time of publication.

The architect's consideration of safety in factory design should begin with the preliminary discussions of the project. In gathering essential information from the client regarding the project, detailed information should be obtained on the hazards of each phase of the plant operations. If the client maintains a safety department this information will probably be available from the plant safety engineer; if not, consulting safety engineers and engineers from state labor departments, accident and fire prevention agencies and insurance carriers are usual sources of authentic information on the various hazards involved.

In the Tennessee Valley Authority, where both architectural and safety sections are maintained, safety engineers are in constant consultation with the designers. Upon completion of the drawings they are approved by the safety section before being released for construction.

Where safety consultation is not available to the architect, a large fund of information on accidents, their causes and methods for their preven-

tion, is contained in a series of Safe Practices Pamphlets published by the National Safety Council.

Each industry has its own methods of operation involving process hazards which must be considered individually. A review of plant operations with particular reference to the influence they may exert on the arrangement or structural characteristics of the building is not only essential for efficient production, but is also necessary for safety. Congestion as the result of inadequate clearance is a most prolific source of accidents.

For the guidance of safety engineers in checking plans and specifications for safety, the National Safety Council has recommended the use of a check list covering important hazards in the various subdivisions of a plant. The use of a safety engineer's check list by the architect as a guide to safety in design appears to be entirely feasible and desirable. For illustration there is appended to this article a check list published in the National Safety Council's Safe Practices Pamphlet No. 53. This list was prepared from the experience of various safety engineers in industry and contains a number of standards and recommended practices taken from recognized sources. It should be noted that the list is incomplete and that supplementary lists should be developed covering hazards peculiar to the industry for which the factory is being designed.

Analysis of accident causes indicates that approximately 85% of all accidental injuries sustained are due to conditions within the control of the injured person. All conditions which tend to divert the workman's attention from the particular work he is doing are potential accident sources. Eye strain caused by improper lighting has been shown to have a definite

effect on the accident rate as well as on the quality and efficiency of production. Fatigue, resulting from hard floor surfaces, drowsiness from improper ventilation, distracting noises and color combinations all affect the accident rate adversely and are within the scope of the architect's control. In this connection, late developments in air conditioning, scientific lighting and noise abatement warrant the architect's close investigation.

Mental preoccupation is a prolific source of accidents. Low morale and dissatisfaction with working conditions are common causes of temporary mental lapses which lead to accidents. Architects may influence this important factor by providing comfortable plant surroundings and adequate recreation and sanitary facilities.

Careful planning will generally overcome physical hazards at no additional cost. It is a generally accepted fact that the best solution to a safety problem does not hinder production but actually improves it so that substantial initial investments to achieve safety may be justified by increased production and freedom from expense caused by accidents.

Safety has a definite place among the essential elements of factory design and the architect who develops this phase of his designs makes the greatest contribution to his client and to the community.

Factories are production facilities. The major objective in their design is efficient production with a minimum of waste and delay. As accidents constitute a major source of waste and unnecessary expense, delaying production and detracting from efficiency, the elimination of hazards to safety should constitute one of the architect's prime considerations in factory design.

CHECK LIST

(References in parentheses are to sources of information listed at the end of this article. "SP-1" means Safe Practices Pamphlet No. 1, etc.) *Courtesy National Safety Council.*

General Plant Layout

(Refer to SP-17.)

- A. Use of natural topography to eliminate
 - 1. Grade crossing of important lines of travel—railroads, vehicular and pedestrian.
 - 2. Elevating of materials.
- B. Natural (and artificial) drainage, for avoidance of
 - 1. Muddy roadways and walkways.
 - 2. Icy roadways and walkways.
 - 3. Flow of hazardous liquids (e.g., gasoline in large tanks above ground, in case of failure of tank).

4. For proper disposal of industrial wastes.

- C. Location of drinking water wells (if any) with respect to sewerage or fumes, with respect to other plant buildings, also neighbors, considering the prevailing winds.
- D. Location and protection of buildings with serious fire or explosion hazard.
 - 1. Segregation of buildings having explosion and flash fire possibilities.
 - 2. Arrangement of equipment so that only a few employees are exposed to hazards.

Future Extension

The foregoing and also the following sections to be considered in the light of:

- A. Future buildings, yards, railroads, etc.
- B. Increase in height of present buildings.
- C. Change in use of buildings.

Railroads

(Refer to SP-17; SP-48.)

- A. Grades.
 - 1. Avoid runaway grades.
 - 2. Avoid cars rolling or being blown onto main track.
- B. Dangerous grade crossing of roadways or footways.
- C. Clearance from
 - 1. Buildings, platforms, etc.
 - 2. Other railroad tracks.
 - 3. Material piles (ample storage space—construct retaining walls if necessary).
 - 4. Overhead structures; tell-tales, light on structures, if insufficient clearance.
- D. Obstruction of engineer's view (place switch stands on engineer's side of train).
- E. Trestles over roadways and footways.
 - 1. Designed so as to prevent materials falling onto man below.
 - 2. Trestles have railed walkways.

- F. Raw materials bins.
- To be designed so that material will flow properly.
 - Provide means to work down material from outside of bins.

Roadways

For automobiles, tractors, and horse-drawn vehicles (SP-17).

- A. Drainage.
- B. Grade crossings.
- Keep down to minimum number.
 - Provide gates, watchmen, or automatic signals.
 - Provision for lighting.
- C. Proper width.
- D. Obstruction of driver's view by building, material pile, etc. (consider use of mirrors to view around corners) (SP-48).
- E. Clearance from overhead structures; tell-tales, and lights on structure, if insufficient clearance.
- F. Signals, markers, etc., to show center of road at curves and busy intersections.
- Provision for lighting.
- G. Proper railing or wall, on bridges and on slopes.

Footways

- A. Are safe footways provided along the shortest line between all important points where men must walk? (Men will follow shortest path, whether sidewalk is put there or not. If a railroad track is shortest line, footwalk should be provided alongside.)
- B. Dangerous grade crossings—possible use of subways or bridges—these will not be used unless grade crossing is fenced off (SP-17).
- C. Obstruction of view at grade crossings.
- D. Drainage.
- Do not locate footwalks under eaves of buildings (icicles; slippery walks).
 - Provide protection for doorways under eaves of buildings.
- E. Overhead clearance below pipe lines, etc.
- F. Railings.
- On bridges.
 - On steep slopes.
 - At slippery places.
 - To prevent walking directly onto railroad track or busy roadway.

Fences

- A. Gates not to swing onto sidewalks, i.e., set fence back.
- B. Fences not so high that drivers and pedestrians cannot see each other (or use open construction).
- C. Clearance of gates at railroad outlet.
- D. Strength against wind.
- E. Possibility of causing snowdrifts on road and walkways.
- F. Possibility of causing muddy road and walkways by keeping off sun and wind.
- G. Possibility of children climbing (as on large mesh wire fence).
- H. Fire hazard of wood fences touching or close to buildings.

Pipe Lines

Water, steam, oil, fuel, gas, acetylene, chemical, ammonia, etc.

- A. Frost.
- B. Mechanical injury.
- Excessive pressure from within.
 - Underground lines too close to surface— injury from loads on surface.
 - Overhead lines; injury by vehicles, etc., account insufficient clearance.
- C. Distinctive marking of lines and valves (Piping Systems Code).
- D. Clearance.
- Underground pipe lines not too close to roadway or walkway—danger of trench cave-in.
 - Lines and valves at or on surface—both outdoors and indoors—not to form stumbling hazard.
 - Overhead lines.

- Clearance at railroads, roadways, walkways.
 - Hot water or acid dripping.
- E. Location of valves, etc.
- Ladders or stairs, and platforms for safe access.
 - Shut-off valves accessible in case of fire or explosion.
 - In case of special hazard extend valve stem through wall to safe place.
 - Provide valve indicators.
- F. Valve pits.
- Good construction.
 - Ventilation (if possibility of explosive or noxious gases).
- G. Arrange so that high-pressure lines cannot communicate with apparatus not designed to carry high pressure, or provide reducing and safety valves.
- H. Automatic valves to shut off fuel lines to furnaces, etc., if fuel supply fails.
- I. Safe drainage in case of overflow.

Buildings—General

- A. Walls.
- Walks around building to be kept away from eaves.
 - Fire escapes (if required) on sunny side preferably, to melt snow and ice (Building Exits Code).
 - Outside stairways to be covered because of snow and ice.
 - Lighting of doorways and yard close to building.
 - Provision for cleaning outside of building and outside and inside surfaces of windows.
 - Sizes and location of windows.
 - Screens to prevent materials from being thrown out of building and for protection of windows—screens preferably on outside.
 - Clearances, railroad and other.
- B. Roofs and roof trusses.
- Pitch; considering snow, snowslides, icicles, protection from snowslides, repairs.
 - Strength considering
 - Snow and wind.
 - Suspended loads.
- C. Structures and floors.
- Dead loads, crane loads, moving loads and special loads.
 - Protection from injury by corrosive materials through installation of drip troughs and pans.
 - Possible deterioration by excessive heat or excessive vibration.
 - Floor surface—slipping and stumbling (SP-11).
 - Wear from trucks, falling objects, etc.
 - Slipping where oil, etc., is handled.
 - Tripping hazard from projecting valves, pipes, etc.
- D. Provision for cleaning floors if material handled is
- Poisonous (e.g., lead dust).
 - Dust-explosive (any flammable dust).
 - Any flammable liquid overflowing or dripping on floor.
- E. Avoidance of ledges of all sorts to catch dust.
- F. Exits.
- Number and size based on number of workers inside (Building Exits Code).
 - Location and style of door knobs and latches to avoid hand injuries and provide quick and sure exit.
 - Glass in doors to prevent collisions.
 - Size and location of doors to permit safe trucking.
 - Direction of swing to permit egress, especially where explosions, flash fires, steam or gas leaks may occur.
 - Passageway to exits to be free of permanent obstructions.
- G. Stairways (Building Exits Code, SP-2).
- At proper angle.
 - Treads and risers properly proportioned.
 - Non-slip surfaces.
 - Overhead clearance, especially from present or future pipe lines, breaching, etc.
- H. Rails (proper height and construction) (Building Exits Code, Floor Openings Code, SP-2).
- On stairways.

- At edges of floors and platforms.
- I. Permanent ladders and platforms to give access to out-of-the-way places (Ladder Code, Floor Openings, etc., Code, SP-1).

Heating and Ventilation

(Refer to SP-37, Ventilation Code.)

- A. Temperature and humidity control.
- B. Consider both artificial and natural heating and ventilation.
- Removal of hot air (especially in summer) from around heat-producing apparatus, or blowing cold air in on workers.
 - Removal of gases and fumes (see Section XVIII, Exhaust Systems).
- C. Effect of doors, elevator shafts, etc.—avoid drafts on persons.
- D. Effect of boilers: Boiler draft often decreased in winter by firemen closing all doors to keep warm; heat from engine room often wasted; latter can sometimes be passed into boiler room to advantage of both; but look out for fire protection.

Lighting of Buildings

Natural and artificial (Lighting Code, SP-22).

- A. Arrangement of windows and skylights for maximum natural light.
- Prism glass if needed.
- B. Employees not to face windows, especially prism glass.
- C. Proper arrangement and intensity of artificial light.
- Selection of equipment so as to require few local lights.
 - Avoidance of shadows, especially at operating point of machines.
- D. Light for out-of-the-way corners where valves, switches, etc., are located.
- E. Separate circuits for interior lighting, exit lighting (Building Exits Code).
- Storage battery or gas for emergency lighting, especially engine and boiler rooms.
 - Consider yard lighting from standpoint of emergency use in fire fighting.
- F. In presence of explosive dust or vapor, use vapor-proof globes, place switches outside, wires in conduit (SP-34.)
- G. Facilities for cleaning lights and reflectors with minimum personal risk (SP-29.)

Toilets, Lockers, Washrooms and Drinking Water

(Refer to SP-27, Sanitation Code.)

- A. General.
- Best location for all these facilities; central vs. distributed locations.
 - Heating and ventilation of rooms; higher temperature required than in factory.
 - Room layout to make best use of space—provision for more employees later.
 - Provision for cleaning; drainage; rounded corners.
- B. Toilets.
- Type of equipment: comfortable, easy to clean, durable.
 - Proper number of closets and urinals.
 - Suitable material for partitions and doors.
 - All operating mechanism for women's toilets to be placed on other side of wall accessible without entering toilet room.
- C. Locker and washroom.
- Proper type of equipment.
 - Facilities for heating wash water.
 - Guard against explosion from over-pressure.
 - Temperature control device to avoid scalding.
 - Provide showers.
 - Control valves at front (scalding hazard).
 - Slipping floor hazard.
- D. Drinking water.
- Central refrigerating plant vs. local refrigeration vs. underground cooling.
 - Proper source of supply.
 - If connected to nonportable water system use two valves with bleed pipe between.
 - Proper type of bubblers.

Power Supply

- A. Boiler room (Boiler Code, SP-3, SP-49).**
1. Double egress from every part of the room.
 2. Overhead clearance, especially from present or future pipe lines, breaching, etc.
 3. Prevent accumulation of combustible dust (explosion hazard).
 4. Ventilation (summer and winter).
 5. Ventilation of ash pit (carbon monoxide asphyxiation).
 6. Lighting, especially at gauges and gauge glasses.
 7. Low-voltage lighting system to avoid fatal shock to men in boilers and tanks (one company uses 28 volts).
 8. Space boilers to permit free use of tools.
 9. Traveling scaffolds at front and back of boilers for cleaning and repairs.
 10. Boilers constructed according to A.S.M.E. Code (or state code if more stringent).
 11. Automatic triple action steam valves.
 12. Steel vs. cast-iron piping and fittings, steel for high pressure and high super-heat).
- B. Engine room including air compressors (SP-9, SP-47).**
1. Install engines so that plane of wheel does not cross other buildings, steam lines, or switchboards.
 2. Flywheel speeds and design.
 3. Engine stops (SP-9).
 4. Guards for dangerous moving parts of engines and other machinery (SP-9).
 5. Air receivers.
 - a. Proper material and design for regular working pressure.
 - b. Guard against explosion from over-pressure (locate vent pipe where opening will not be clogged by snow, etc.).
- C. Dynamos and switchboards (Electrical Safety Code, SP-29).**
1. Clearances.
 2. Barriers or inclosures including inclosures for backs of switchboards.
 3. Recesses in floor for mats.
 4. Switches to be
 - a. Marked.
 - b. Provided with no voltage release (for D.C.).
 - c. Oil switches to be protected by disconnecting switches on both sides (door of disconnecting switch may be interlocked with oil switch).
 5. Grounds to protect against short circuits and lighting.
 6. Remote controls for high-voltage apparatus.
- D. Transformer station (Electrical Safety Code).**
1. Concrete inclosure for each transformer or for sets of three or four).
 - a. Depressed floor or pit large enough to hold oil or ample size drain from moderately depressed floor.
 - b. Separate, to avoid spread of trouble.
 2. Grounds.
 3. Warning signs (may be provided later).
- E. Transmission line (Electrical Safety Code).**
1. Clearance, or inclosures and barrier guards.
 2. Grounds.
 3. Warning signs (may be provided later).

Elevators

Passenger and freight (Elevator Code, SP-15, SP-43).

- A. Shaftway.**
1. Inclosure.
 2. Adequate penthouse with entrance from outside of shaftway.
 3. Strength of support for machine and/or sheaves.
 4. Platform or screen under machine and/or sheaves.
 5. Adequate over-travel, top and bottom.
 6. Pit watertight, if ground water is present.
 7. Wires, pipes, etc., not placed in pit or shaftway.
 8. Counterweight runway inclosure at bottom, and wherever exposed to contact.
 9. Counterweight over-travel stop at top.
 10. Doors or gates at landings.
 - a. Interlocks.
 - b. Lighting at landings.
 - c. Non-slip floor at landings.

- B. Car.**
1. Inclosure.
 2. Cover or top.
 - a. Front part hinged (freight elevators).
 - b. Trap door in top or escape door on side to adjacent car (passenger elevators).
 3. Car doors, especially if doors on more than one side of car.
 - a. Interlocks.
 4. Car control.
 - a. Cable control—cable lock in car.
 - b. Electric control—switch to return to "off" position when operator's hand is removed.
- C. Cables.**
1. Size, strength and material.
 - a. Provision for insuring use of same material when replacing.
 2. Inclosure for cables running outside of shaftway.
- D. Safety devices.**
1. Safety catch on car.
 2. Speed governor.
 - a. Balls to open halfway at full speed of car.
 - b. Bottom pulley of governor cable to be weighted.
 - c. Governor rope to hang clear in shaftway.
 3. Limit switches in shaftway.
 4. Limit stop on drum.
 5. Slack cable device.
 6. Bumpers in pit—for car and counterweight.
 7. Phase reversal protection.
- E. Hydraulic equipment.**
1. Automatic limit stop valves.
 2. Relief valves on pump.
 3. Pressure tanks.
 - a. Gauge glass and pressure gauge.
 - b. Constructed to permit inspection of inside.
 - c. If subject to vacuum, to have vacuum valve.
- F. Signal systems.**

Cranes

Including yard, O. E. T. in buildings, gantry, wall, etc. (SP-4).

- A. Footwalks with standard railings on**
1. Entire length of runway.
 2. Entire length of bridge, shaft side (preferably on both sides).
 3. Across ends of trolley, at right angles to bridge.
 4. Across ends of bridge.
 5. Provision for drainage, on outside cranes.
- B. Safe access.**
1. From floor to cage.
 2. From cage to walks mentioned above.
- C. Crane cage.**
1. Incombustible construction.
 2. Located so signals can be seen easily.
 3. Protection for operator if hot metal is handled (separate compartment).
- D. Overhoist limit stops.**
1. Phase reversal protection.
- E. Runway bumpers.**
1. To be at least one-half wheel diameter in height.
 2. To be fastened to girder and not to rail.
- F. Wheel guards.**
1. Attached to trolley and bridge frame.
 2. Shaped to push and raise objects off track.
- G. Brakes for all motors, preferably solenoid.**
- H. Clearance between.**
1. Crane and building structure so man will not be squeezed.
 2. Extremities of cranes on adjacent runways.
- I. Signals.**
1. Automatic block signals for cranes.
- J. Pilot lights for wall and jib cranes.**
- K. Protection against wind (overturning, running away).**

Derricks and Hoists

(Refer to SP-33, SP-Con-1.)

- A. Safety hooks (handles and latches).**
- B. Stops and catches on overhead rail system to prevent hoists from falling or derailing.**

- C. Inclosures for cables.**
- D. Anchor for foot of mast.**
- E. Hold down guys for top of mast.**
- F. Sufficient factor of safety for all cables, chains, drums, pulleys, fastenings, etc., based on greatest possible load.**
- G. Arrange so operator has clear view of hoist and signalmen.**

Conveyors

(Refer to SP-35 Conveyor Code.)

- A. Obstructions to prevent riding.**
- B. Roller guards.**
- C. Stop buttons at frequent intervals.**
- D. Guards where passageway is underneath.**
1. Bridges over, for passage where necessary.
- E. Covers.**
- F. Guards for head and tail pulleys.**

Mechanical Power Transmission

(Refer to Power Transmission Code, SP-5, SP-7, SP-8.)

- A. General layout so shafting will not cross passageways within 7 ft. of floor, or large belts at any height.**
- B. Tower controls.**
1. To shut down a department.
 2. To shut down individual machines.
 - a. Belt shifter locks or latches.
- C. Guarding of**
1. Shafts, couplings, clutches.
 2. Pulleys and sprockets.
 3. Belts, chains, and ropes.
 4. Gears, friction drives, etc.
- D. Oiling (SP-10).**
1. Advantages of self-oiling bearings (efficiency and safety).
 2. Oilers' runways.
 - a. Railing.
 - b. Ladder or stairway to.
 3. Extension pipes to oil cups.
 4. Arranged for oiling from floor.
- E. Protection against static electricity in pressure of flammable vapor or dust (SP-52).**
1. Grounding of shafts and belts.

Exhaust Systems

(Refer to SP-32, Exhaust System Code.)

- A. Catch dust and fumes at source and not permit handling of materials in the open, or handling poisonous substances unnecessarily.**
- B. Design of hoods.**
- C. Size and layout of pipes; avoidance of sharp bends.**
- D. Size of fan.**
- E. Collector or trap at discharge.**
- F. Discharge outside of workroom and where no nuisance created.**
- G. Protection against static or other sparks if combustible dust handled.**
1. Explosion doors in ducts (fire damper).
- H. Use of separate room or building for dangerous processes.**
- I. Provision for testing system.**

Abrasive Wheels

(Refer to Abrasive Wheel Code, SP-13.)

- A. Storage racks for wheels.**
- B. Adjustable rests to be provided.**
- C. Safety flanges to be attached.**
- D. Hood guards of material strong enough to hold wheel if it breaks.**
- E. Exhaust system connected to each wheel.**
- F. Belt and pulley guards.**
- G. Avoid excessive speed.**

Shop Layout and Machinery

(Plan for the typical manufacturing shop.)

- A. Locate all heavy machinery on first floor or provide extra strong floor.**
- B. Locate machines so as to minimize hazard of flying particles (especially such machines as drop hammers).**

- C. Ample aisle space for
 1. Trucking.
 2. Handling material at machines.
- D. Advantage of individual motor drives.
- E. Illumination at machines—natural and artificial (SP-22).
- F. Locate start and stop devices within easy reach of operator (SP-5).
 1. Latches on belt shifters to prevent creeping to tight pulleys.
 2. Locking arrangements when making repairs.
 3. Cone pulley belt shifters.
- G. Exhaust system (SP-32).
- H. Use conveyors, etc., for handling material (SP-35).
- I. Nonslip floor at machines (SP-11).
- J. Use machines for specific purpose where possible.
- K. Use automatic feeds where possible (guard feed rolls).
- L. Guard belts, gears, etc. (Power Transmission Code).
- M. Guard working machines—develop special check list for each industry such as
 1. Woodworking machines (Woodworking Code, SP-20).
 2. Metalworking machines (SP-39. Machine Tools Code, Power Press Code).
 3. For other industries or departments see list of codes and list of Safe Practices Pamphlets, at end of this article.
- N. Safe speed of machines.
- O. General layout and routing of work for maximum safety and efficiency.

Chemical Plant or Department

(Refer to SP-25), (develop similar special check list for other special industries or departments.)

- A. Possibility of explosions
 1. In tanks and portable containers for volatile liquids.
 2. In special apparatus wherein sudden violent reactions may occur.
 3. Because of close proximity to open flames or sparking electrical equipment.
 4. Because of static electricity in belts and flow of powdered material or liquid.
 5. Because of excessive pressure (in stills, blow cases and autoclaves).
- B. Control of chemicals or other hazardous materials.
 1. Valves and cocks to indicate open or closed.
 2. Pipe lines arranged so they can be easily traced.
 3. Pipe lines painted or marked distinctively.
 4. Adequate provision of indicators such as thermometers, pressure gauges, and sight glasses.
 5. Important control valves to be placed within reach of operator and not so widely separated that he must lose valuable time reaching them in an emergency.
 6. Sufficient number of valves where a single valve giving way would cause hazard.
 7. Safety cut-offs (pipe joints that may be easily disconnected) at points where the accidental introduction of a chemical would cause a violent reaction.
 8. Hoods or shields above valve stems conveying acids or other corrosive liquids under pressure.
 9. Catch-basin or drip for tanks or other containers holding corrosive liquids.
- C. Apparatus having explosion possibilities not placed too close to important structural supports.
- D. Showers for workers if burned.

Sources of Information

Following are the principal sources of detailed information as to standards and recommended practices:

- a. American Engineering Standards Committee, 29 West 39 St., New York City, under whose auspices a number of safety codes have been or are being formulated by joint committees. See reference to safety codes below.

- b. National Safety Council. See list of Safe Practices Pamphlets below. Also consult Annual Congress Transactions and National Safety News (magazine). Library and Information Bureau will furnish information on special subjects, to members, on request.
- c. Underwriters Laboratories, 207 E. Ohio St., Chicago, tests and labels approved devices and equipment for accident prevention as well as fire protection. List of approved devices sent on request.
- d. U. S. Bureau of Standards, Washington, D. C., in addition to producing certain safety codes, has published many technical papers, some of which contain safety information.
- e. U. S. Bureau of Mines, Washington, D. C., has issued many standards and other publications dealing with safety and sanitation.
- f. U. S. Bureau of Labor Statistics, Washington, D. C., in addition to its statistical reports, has issued pamphlets on health and accident hazards, principally the former.
- g. U. S. Public Health Service, Washington, D. C., has issued pamphlets on health and sanitation.
- h. The State Labor Department or State Industrial Commission of every important industrial state has regulations which should be consulted by industries located therein.
- i. Many insurance companies have issued books and pamphlets on various accident and health hazards.
- j. National Fire Protection Association, 40 Central St., Boston, Mass., has issued a large number of standards and regulations on fire prevention and protection including such subjects as exits and fire escapes, fire doors and windows, storage of flammable liquids and other combustibles, private fire protection systems, etc.
- k. National Board of Fire Underwriters, 76 Williams St., New York City, has other publications on fire prevention and protection including the "National Board Building Code."

The standard handbooks on fire protection and on mechanical, electrical, etc., engineering may be consulted for information in their respective fields. Some of these, as well as books and periodical references on accident prevention, may well be included in the safety engineer's library or, if not, may be obtained from any large library.

Safety Codes

Safe Practices Pamphlet No. 78, "Mathematical Tables and Data for the Safety Engineer," contains a complete list of the safety codes prepared under the auspices of the American Engineering Standards Committee.

Safe Practices Pamphlets

1. Ladders.
2. Stairs and Stairways.
3. Boiler Rooms.
4. Cranes.
5. Belt Shifters and Belt Shippers.
6. Knots, Bends, Hitches and Slings.
7. Belts and Belt Guards.
8. Shafting, Coupling, Pulleys, Gears, Sprockets and Chains.
9. Engine Guarding and Engine Stops.
10. Oiling Devices and Oilers.
11. Floors and Flooring.
12. Scaffolds (For Industrial Plant Use).
13. Grinding Wheels.
14. Goggles.
15. Freight Elevators.
16. Safe Clothing.
17. Yards.
18. Power Presses.
19. Exits, Fire Alarms and Fire Drills.

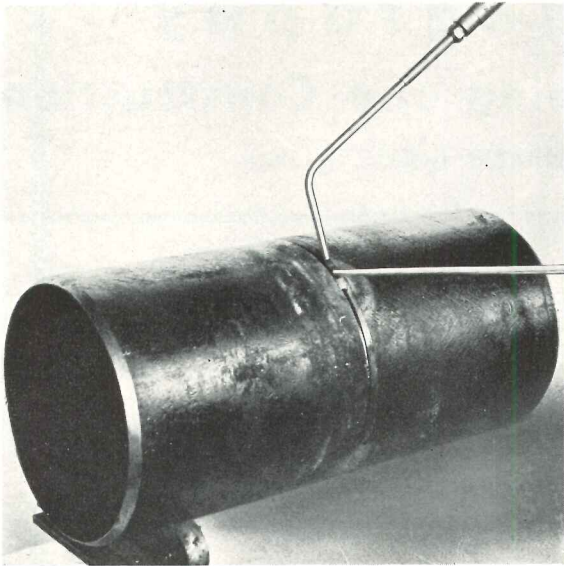
20. Woodworking Machinery and Equipment.
21. Accident Records.
22. Shop Lighting.
23. Gas and Electric Welding.
24. Fire Extinguishment.
25. Acids and Caustics.
26. Manila and Wire Rope.
27. Drinking Water, Wash and Locker Rooms and Toilet Facilities.
28. Commercial Explosives.
29. Electrical Equipment in Industrial Plants.
30. Trucks and Wheelbarrows.
31. Fire Causes and Prevention.
32. Exhaust Systems.
33. Hoisting Apparatus.
34. Industrial Explosion Hazards.
35. Conveyors.
36. Fire Brigades.
37. Industrial Ventilation.
38. Safety Posters and Bulletin Boards.
39. Machine Shop Machinery.
40. Suggestion Systems.
41. Hand Tools.
42. Industrial Safety Organization.
43. Passenger Elevators.
44. Skin Troubles From Cutting Oils and Emulsions.
45. Industrial Housekeeping.
46. Fuel Handling, Storing and Firing.
47. Compressed Air Machinery and Equipment.
48. Railroads in Industrial Plants.
49. Equipment and Operation of Steam Boilers.
50. Practical Methods for Reducing Fatigue.
51. Planning an Industrial Campaign.
52. Static Electricity.
53. Checking Plans and Specifications for Safety.
54. Handling Material (Part I) Handling by Hand and by Truck.
55. Handling Material (Part II) Handling with Mechanical Equipment.
56. Investigation of Accidents.
57. Health Service for Small Plants.
58. Construction of Machinery Guards.
59. Warehouses and Shipping Rooms.
60. Chemical Laboratories.
61. Refrigeration.
62. Motion Pictures in Educational Work.
63. Storage Tanks for Oils, Acids and Dry Materials.
64. Respirators, Gas Masks and Breathing Apparatus.
65. Teaching Safety to New Employees.
66. Pressure Vessels—Fired and Unfired (Part I). (Air receivers and not water tanks.)
67. Maintaining Interest in Safety.
68. Pressure Vessels (Part II).
69. Getting Safety Across to the Commercial Driver.
70. Safe Practices for Maintenance and Repair Men.
71. Safe Handling of Chlorine.
72. Safety Committees.
73. Foundries.
74. Competition as an Aid in Promoting Accident Prevention.
75. Safety Inspections.
76. Portable Electric Hand Tools.
77. Safety Meetings.
78. Mathematical Tables and Data for the Safety Man.
79. Engineering—A Factor in Accident Prevention.
80. Safety Rules—Their Formulation and Enforcement.
81. Warning Signs—Their Use and Maintenance.

Sectional Pamphlets

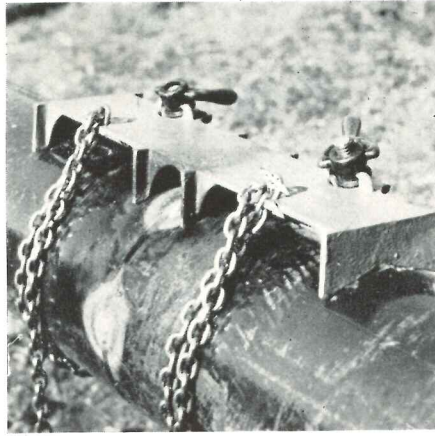
- Con.—1 Construction Work.
- P&P—1 Paper and Pulp Mills.
- Me—1 Cleaning and Finishing Rooms in Foundries.
- Me—2 Blast Furnaces.
- M—1 Underground Mine Cars and Haulage.
- M—2 Mine Rescue and Training.
- PS—1 Radio Hazards.
- PU—1 Protection of the Public (In Public Utilities Operations).
- PU—2 Grounding Practices.
- T—1 Cotton Mills.
- Safety Organizations for the Quarrying Industry.

WELDING STEEL PIPE by gas process

Photos Courtesy
Air Reduction Sales Co.



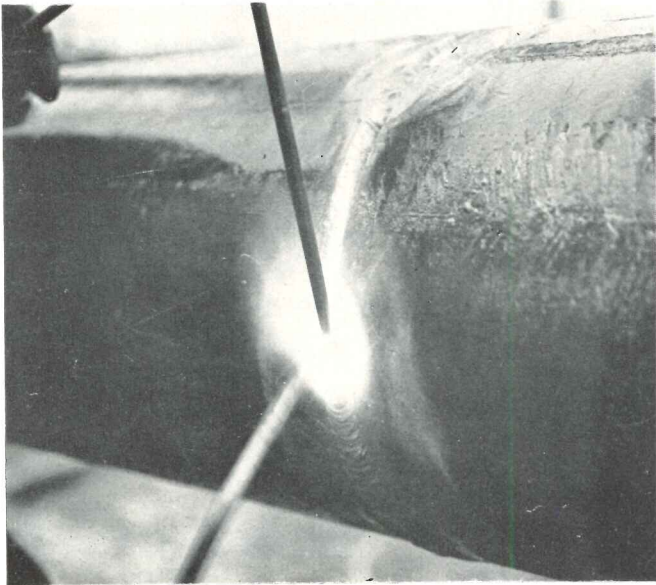
1. CORRECT POSITION OF TORCH, ROD, AND JOINT.



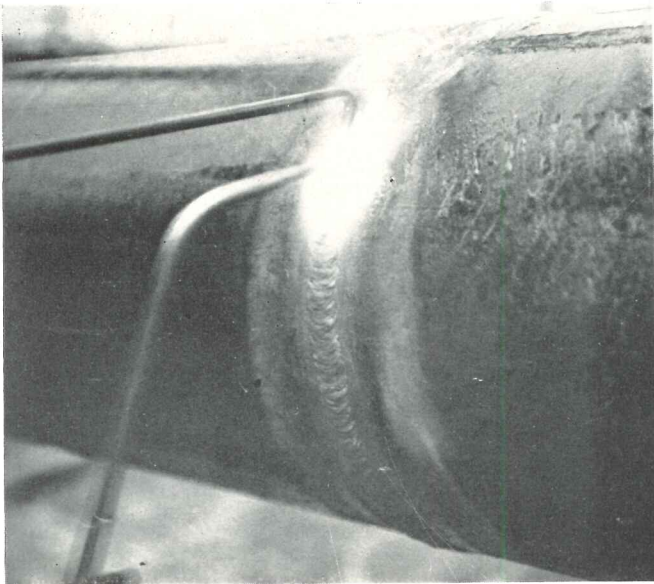
2. EXACTING CONDITIONS SPECIFY USE OF LOCKING DEVICE BEFORE WELDING. NOTE INITIAL TACKING OF PIPE.



3. WORK OF EACH WELDER IS TESTED BEFORE HIS EMPLOYMENT IS PERMITTED. COUPONS, 2" x 10", ARE CUT FROM TRIAL WELDS ON SMALLEST DIAMETER PIPE TO BE USED. THESE ARE FIELD-TESTED BY BEING BENT AT INSIDE OF WELD THROUGH 180°. NO FRACTURE SHOULD OCCUR WITHIN THE WELD. NO UNEVENNESS IN EVIDENCE. NO PROJECTION OF METAL INTO INSIDE OF PIPE. LABORATORY TEST FOR HYDROSTATIC AND TENSILE STRENGTH.



4. 5. WELD NEARING COMPLETION AND COMPLETE (below).



6. INSTALLATION CONSERVES SPACE, FACILITATES COVERING.

AUTOMOBILE—1 . . 12, 29, 60, 68, 69, 70, 71, 74; 4 . . 11, 34; 5a . . 1, 5, 6, 24, 48; 6 . . 19; 7 . . 20; 8 . . 12
 AIRPLANE FACTORY-HANGARS—1 . . 12, 32, 53, 65; 4 . . 32; 5a . . 1, 27, 28, 29, 30; 5b . . 30
 BAKERY—4 . . 38; 5a . . 1, 51; 7 . . 7
 BINDERY—5a . . 14
 BOTTLING—4 . . 7
 BREWERY—1 . . 9, 72; 5a . . 1, 20, 31; 5b . . 49; 7 . . 7, 31; 9 . . 26, 45, 46
 BRICK PLANT—1 . . 73
 CAN CO.—1 . . 8; 5b . . 9
 CANDY—5a . . 14; 7 . . 24
 CEMENT PLANTS—1 . . 55, 75, 79; 5a . . 55
 CHEMICAL PLANTS—1 . . 21, 43, 45; 2 . . 1, 10, 12, 16; 4 . . 4, 23, 35, 36; 5a . . 1, 26, 35, 36, 37, 41; 5b . . 16; 6 . . 25; 7 . . 15; 9 . . 1, 2, 3, 4, 13, 15, 17, 20, 22, 29, 44
 CLOTHING—5a . . 14; 6 . . 13, 18
 COLD STORAGE PLANT—5a . . 38, 53, 54; 5b . . 26; 9 . . 47
 COTTON MILLS—4a . . 30
 CREAMERY—5a . . 14
 DISTILLERIES—5a . . 1, 6, 7, 11; 9 . . 14
 DRUGS—1 . . 52, 76; 5a . . 56; 7 . . 29
 DYE WORKS—5a . . 1, 56
 ELECTRICAL PRODUCTS (Small)—1 . . 10, 30, 42, 48, 67; 5a . . 1, 7, 8, 14; 5b . . 13
 FLOUR MILLS—1 . . 12, 84, 85; 5a . . 1; 9 . . 31, 38
 FOOD PRODUCTS—1 . . 6; 4 . . 19, 23, 31; 5a . . 1, 14; 5b . . 36; 7 . . 15
 FOUNDRIES—1 . . 78; 4 . . 13, 33; 5a . . 19; 5b . . 12; 9 . . 16, 34
 FREIGHT TERMINAL—5a . . 50
 GLASS FACTORY—5a . . 43, 44
 GRAIN ELEVATORS (Silos)—1 . . 1, 57, 84; 5a . . 1, 57; 5b . . 34, 35; 9 . . 50
 GUM—5a . . 14
 HATS—5a . . 1
 ICE—5a . . 14
 ICE CREAM FACTORY—1 . . 58; 5a . . 3, 4
 INCINERATOR—1 . . 12
 LAUNDRY—1 . . 12; 5a . . 4, 14, 46; 9 . . 37
 METAL PLANT—6 . . 10
 MILK DEPOT—5a . . 1, 14; 5b . . 39
 MILL BUILDINGS—1 . . 17, 40; 5a . . 1; 5b . . 50
 OIL BULK STATIONS—1 . . 59; 5a . . 39, 52
 OIL REFINERY—1 . . 12
 PACKING PLANT—1 . . 12, 77; 4 . . 31
 PAPER-PULP MILLS—1 . . 18; 5a . . 3; 7 . . 14; 9 . . 20, 30
 PERFUME FACTORY—5a . . 12
 POWER PLANTS—1 . . 12, 56, 66; 4 . . 13; 5a . . 1, 5, 14, 33, 42, 47; 9 . . 25, 33, 38
 PRINTING—1 . . 36; 5a . . 1, 4, 14; 7 . . 14
 RESEARCH STATIONS AND LABORATORIES—1 . . 10, 70; 5a . . 1, 32
 RUBBER—2 . . 8; 4 . . 18; 5a . . 1, 14; 9 . . 39
 SAND, GRAVEL PLANT—1 . . 3, 62
 SHOES—4 . . 37; 5a . . 1; 5b . . 17; 6 . . 15; 9 . . 32
 SMALL-PARTS—1 . . 35; 4 . . 9, 25; 5a . . 3, 4, 5, 8
 SOAP—1 . . 33; 5a . . 1; 9 . . 41
 STEEL MILLS—ROLLING MILLS—1 . . 81; 4 . . 26; 5a . . 1, 5, 24, 25; 9 . . 18, 21, 36, 40, 52
 SUGAR—4 . . 12; 9 . . 53
 TEXTILE MILLS—1 . . 25, 26; 4 . . 30; 5a . . 14; 6 . . 24; 7 . . 13
 TIN PLATE MILL—1 . . 64
 TIRE FACTORIES—4 . . 18
 TOBACCO (CIGAR-CIGARETTE)—1 . . 39; 4 . . 3; 5a . . 1, 13, 14; 7 . . 23; 9 . . 49
 WAREHOUSES—1 . . 12, 83; 5a . . 1, 3, 14, 34; 5b . . 24, 40, 41; 7 . . 41
 WASTE TREATMENT—1 . . 32
 WIRE MILL—6 . . 11

Bibliography

Factory Planning and Construction

Compiled by **GEORGE ANDREW INGLIS, B. ARCH**

1. GENERAL
2. SITE
 - Urban
 - Suburban
3. GROUNDS
 - Traffic and Parking
 - Landscaping
4. PLANT LAYOUT (Material Transportation)
 - Heavy-Industries
 - Light-Manufacturing
- 5a. DESIGN and CONSTRUCTION
 - One-Story
 - Multi-Story
 - Mill Construction
- 5b. METHODS and MATERIALS
 - Struct. Steel
 - Reinf. Concrete
 - Brick, Stone, T. C., Concr.
 - Frame
- 5c. COSTS (Of Construction)
6. SERVICES (Internal)
 - El. L. & Power
 - Gas
 - Water
 - Oil
 - Sprinkler
 - Heating
 - Plumbing
 - Elevators
 - Conveyors
7. AIR CONDITIONING
8. WELFARE
 - Sanitary Accommodations
 - Cafeterias
 - First Aid and Ambulance
9. INDUSTRIAL ARTS (And Related Bibliographies)

List of Periodical References

NOTE: The prefix "m" indicates that reference is to a periodical.

1. GENERAL
 1. m "GIANT OF THE WEST." Saskatoon Plant of Robin Hood Flour Mills. Illustr. Pulp and Paper of Canada, Vol. 36, Sept. 1935.
 2. THE NEW WORLD ARCHITECTURE. By Sheldon Cheney. Tudor Publishing Co., New York, 1935. 389 Illustrations.
 3. m "SAND, GRAVEL PLANT IN TENNESSEE OF 125 TONS PER HOUR CAPACITY." Illustr. Rock Products, Vol. 38, Apr. 1935. See Oct. of same vol. for a plant in Louisville.
 4. INDUSTRIAL ENGINEERING AND MANAGEMENT. By R. M. Barnes. McGraw-Hill Book Co., New York, 1931. Part I includes:
 - I The Design and Construction of Factory Buildings.
 - II The Selection of Equipment.
 - III Plant Layout.
 - IV Materials Handling.
 - V Industrial Lighting (Daylighting).
 - VI Industrial Lighting (Artificial Lighting.)
 5. MODERN FACTORY MANAGEMENT; BUILDINGS AND MANUFACTURING EQUIPMENT. By Col. E. C. Peck. Lincoln Extension Univ., Inc., Cleveland, 1932.
 6. m "'PACIFIC COAST SHREDDED WHEAT FACTORY.'" Illustr. by H. J. Brunner. Architect and Engineer of California, San Francisco, 1916. Vol. 47, pp. 81-87.
7. m "INDUSTRIAL BUILDINGS, DETAILED INSPECTION CHART." Factory, Vol. 94, April 1936.
8. m "MANUFACTURING PLANT OF THE CONTINENTAL CAN CO., INC., CLEARING, ILL." Illustr. American Architect, New York, 1918. Vol. 113, pp. 253-259.
9. m "FACTORIES AND-OR ARCHITECTURE." Illustr. Arch. and Building News, London, 1936. Vol. 145, pp. 155-158. A review of some recent industrial buildings.
10. m "FACTORY FOR ALLOM BROS., LTD. (LIGHTING SPECIALISTS)." Illustr. Architect and Building News, London, 1935. Vol. 141, pp. 228, 229.
11. m "THE ARCHITECT IN INDUSTRIAL BUILDING." Illustr. by Albert Kahn. Architect and Engineer of California, San Francisco, 1918. Vol. 54, pp. 101-108.
12. m "INDUSTRIAL ARCHITECTURE." Feb. 1937 Issue of Building Types. ARCHITECTURAL RECORD, 119 W. 40 St., New York.
13. m "INDUSTRIAL RECOVERY MEANS MORE FACTORY BUILDING"—With charts. By L. Seth Schmitman. Building Types, Feb. 1937. ARCHITECTURAL RECORD, New York.
14. ARCHITECT AND ENGINEER. By Schupp and Kremmer. Berlin, 1929. A profusely illustrated work covering all phases of industrial building. (For a summary of this book see references 5a-14.)

15. m "NEW FACTORIES," London. Architecture, Illustrated, London, 1934. Vol. 9, pp. 130-135. Plans.
16. NEUZEITLICHE INDUSTRIEBAUEN. By Bruno Buch. Berlin, 1929. F. E. Hübsch Verlag, G. M. B. H. (Neue Werkkunst.)
17. m "MILL AND FACTORY BUILDINGS." Arkitekten Maanedshæfte, København, 1931. Bind 33, pp. 125-172. Illustrated with plans.
18. m "PAPER MANUFACTURE"—Denmark. Arkitekten, København, 1936. Aarg. 38, pp. 197-205. Illustr.
19. m "FRENCH FACTORY." Construction Moderne, Paris, 1933. Année 49, pp. 57-64. Illustr.
20. m "NATIONAL RADIATOR CO. (FRANCE)." Architecte, Paris, 1930. N. S. Année 7, March, pp. 26-28. Illustr.
21. m "SUPERPHOSPHATE PLANT (FRANCE)." Architecte, Paris, 1929. N. S. Année 6, pp. 23, 24. Plates.
22. m "THREE FACTORIES" (GERMAN). Baugilde, Berlin, 1933. Jahrg. 15, pp. 767-774. Illustr.
23. m "FACTORY AT COPENICK, BERLIN." Designed by Arthur Korn. Architect's Journal, London, 1934. Vol. 80, pp. 458-460. Illustr.
24. FACTORIES (GERMAN). By Hans Hertlein. Berlin. E. Wasmuth. A. G., 1930. 96 pp. Including diagrams, plans, tables.
25. m "ZUCKERFABRIK HEIDERSDORF IN SCHLESIEIN" by Hans Thomas. Baugilde, Berlin, 1937. Jahrg. 19, pp. 11-18. Illustr.
26. m "EIN SPENNEREI-NEUBAU." Baugilde, Berlin, 1937. Jahrg. 19, pp. 19-23. Illustr.
27. m "NEW BUILDINGS AT APSLEY MILLS, HERTS." Architect and Building News, London, 1935. Vol. 142, pp. 245-247. Illustr.
28. m "A FACTORY AT BRENTFORD." Architect and Building News, London, 1934. Apr. 27, p. 107. Illustr.
29. m "THE FORD MOTOR WORKS, DAGENHAM." Architect and Building News, London, 1932. Vol. 130, pp. 448-455. Illustr.
30. m "NEW RADIO FACTORY, ENFIELD (ENGLAND)." Architecture, Illustrated, London, 1932. Vol. 5, pp. 124, 125. Illustr.
31. m "THE ALADDIN FACTORY, GREENFORD (ENGLAND)." Architect's Journal, London, 1931. Vol. 74, pp. 203-207. Illustr.
32. m "AIRCRAFT FACTORY AT HATFIELD." Architect's Journal, London, 1935. Vol. 81, pp. 763-766. Illustr.
33. m "SOAP WORKS, IRLAM (ENGLAND)." Architect's Journal, London, 1937. Vol. 85, pp. 201, 202. Illustr.
34. m "NEW FACTORY, KNUTSFORD, ENGLAND." Architectural Design and Construction, London, 1933. Vol. 3, pp. 229-231. Illustr.
35. m "FACTORY FOR GILLETTE INDUSTRIES, LTD." Arch. Sir Banister Fletcher. Architect and Building News, London, 1936. Oct. 2, pp. 15-18. Illustr.
36. m "STATIONERY FACTORY AND BOOKBINDING WORKSHOPS." London. Architect's Journal, London, 1935. Vol. 81, pp. 220-223. Illustr.
37. m "AUTOPARCO. DEL MINISTERO DEGLI INTERNI A ROME." Architettura Italiana, Torino, 1931. Anno 26, pp. 13-19. Illustr.
38. m "MODERNE BOUWKUNST IN NEDERLAND." Rotterdam, 1932. No. 11, pp. 1-55. Illustr.
39. m "TOBACCO FACTORY (ROTTERDAM)." Architecte, Paris, 1930. N. S. Année 8, pp. 92-96. Diags. Plates. See also Architecture Vivante, Paris, 1933. No. 39. Plates 1-10.
40. m "THE ARCHITECTURAL SIGNIFICANCE OF THE RICE MILLS OF CHARLESTON, S. C." ARCHITECTURAL RECORD, New York, 1924. Vol. 56, pp. 158-184. Illustr.
41. m "BUILD TODAY'S PLAN FOR TOMORROW TOO" by F. C. Foltz. Factory Management. Vol. 94, pp. 40-42, Dec. 1936.
42. m "INDUSTRIAL PLANT OF NEW DESIGN." Penn Electric Switch Co. Iron Age. Vol. 139, p. 31, Jan. 21, 1937.
43. m "NEW HOME OF JOHNSON & SONS OF UNIQUE MODERN DESIGN." Oil, Paint and Drug Reporter, Jan. 18, 1937.
44. m "INDUSTRIAL PLANT BUILDINGS." Factory Management, April 1937, pp. 37-76.
45. m "BUILDING AND EQUIPPING A NEW FACTORY" by J. H. West. Chemical Age (London), Oct. 24, Nov. 7, 1936.
46. m "UP-TO-DATE FACTORY FOR GAS-HEATING APPLIANCES — WEMBLEY, ENGLAND." Illustr. Gas Journal (London), Jan. 8, 1936.
47. m "MAKE THE PLANT A PLACE MEN LIKE TO WORK IN." Superior Tube Co., Collegeville, Pa. By S. L. Gabel. Illustr. Factory Management, Vol. 93, Nov. 1935.
48. m "COOPERATIVE SOCIETY'S INCANDESCENT LAMP FACTORY, STOCKHOLM." Views and Plan. Arch. Forum. Vol. 59, Dec. 1933.
49. m "FACTORY BUILDING FOR MESSRS. BOOTS, NOTTINGHAM." Views and Plans. Arch. Forum, Vol. 61, Oct. 1934.
50. m "FACTORY BUILDING FOR THE OTIS ELEVATOR CO., TOKYO, JAPAN." Views and Plans. ARCHITECTURAL RECORD, Vol. 75, March 1934. See-Lamp Factory, Vol. 75, May 1934.
51. m "RURAL FACTORY INDUSTRIES." By Manny and Nason. Illustr. U. S. Agriculture Circular 3112, 1934.
52. m "NEW DRUG FACTORY"—Nottinghamshire, England. Illustr. plans. ARCH. RECORD, Vol. 73, Apr. 1933. See also Engineering News, Vol. 110, May 25, 1933.
53. m "PLANT OF BOEING AIRCRAFT CO." Seattle. Power Plant Engineering, Vol. 41, Feb. 1937.
54. m "SIMON PNEUMATIC COAL HANDLING PLANT." Illustr. Engineer, Vol. 163, Feb. 5, 1937.
55. m "MODERN CEMENT PLANT." Illustr. Rock Products, Vol. 40, Jan. 1937.
56. m "POWER AND THE MODERN WORLD." Views of steam and hydroelectric generating stations and equipment in foreign countries and in the United States. Public Utilities, Vol. 19, Feb. 4, 1937.
57. m "NEW TRANSFER GRAIN ELEVATORS" at Three Rivers, Quebec. By C. A. Culpeper. Illustr. The Canadian Engineer, Vol. 71, Dec. 1, 1936.
58. m "ICE CREAM FACTORY." General Ice Cream Corporation, Syracuse, N. Y. Views and Plans. Arch. Forum, Vol. 66, March 1937.
59. m "NEW MODERN OIL BULK-STATION." Midwest Petroleum Co. Illustr. Petroleum Age, Vol. 31, Jan. 1937.
60. m "INTERNATIONAL HARVESTER CO. TRUCK PLANT" by J. Geschelin. Illustr. Automotive Industries, Vol. 76, May 1937.
61. m "DAIL'S NEW ADMINISTRATION-DEMONSTRATION DEALER-TRAINING BUILDING." Illustr. Diag. Sheet Metal Worker, Vol. 28, March 1937.
62. m "GRAVEL HANDLING PLANT." Illustr. Mechanical Handling, Vol. 24, Mar. 1937.
63. m "PLANT FOR THE PRODUCTION OF PETROL" by the hydrogenation of bituminous coal. By F. E. Smith. Diag. Proceedings of The Institute of Mechanical Engineers, Vol. 133. See also—Engineer, Vol. 161, June 1936.
64. m "HUGE TIN PLATE MILL OPENED BY REPUBLIC IN NILES, OHIO." Illustr. Engineering News, Vol. 118, March 1937.
65. m "FACTORY, DOUGLAS AIRCRAFT CO." Santa Monica, Calif. Views. Arch. Forum, Vol. 65, Oct. 1936.
66. m "EXAMPLES OF PRIVATE ELECTRIC POWER PLANTS." Arch Forum. Vol. 66, March 1937.
67. m "WESTINGHOUSE ERECTS NEW TRIANGULAR BUILDING AT MANSFIELD, OHIO, WORKS." Refrigerating Engineering, Vol. 32, July 1936.
68. m "VAUXHALL WORKS." Illustr. The Automobile Engineer, London, Vol. 26, Aug. and Sept. 1936.
69. m "PACKARD'S 88 ACRES OF PRODUCTION EFFICIENCY" by J. Geschelin. Illustr. Automotive Industries, Vol. 74, May 1936.
70. m "FORD'S NEW LABORATORIES" by J. Geschelin. Illustr. Automotive Industries, Vol. 74, June 1936.
71. m "PONTIAC'S NEW AXLE PLANT" by B. Finney. Illustr. American Machinist, Vol. 80, Oct. 1936.
72. m "PROGRESSIVE ADVANCE IN BREWERY STOCK HOUSE FRAMING" by S. E. Berkenblit. Illustr. Engineering News, Vol. 117, Sept. 1936.
73. m "BRICK PLANT OF MOODY BROS. AT CARLINVILLE, ILL." Illustr. Brick and Clay Record, Vol. 88, Jan. 1936.
74. m "BUICK'S \$15,000,000 BID" by H. H. Cortice. Illustr. Factory Management, Vols. 93, 94, Dec. 1935-Feb. 1936.
75. m "MISSOURI PORTLAND CEMENT COMPANY'S MODERNIZED RAW MATERIAL PLANT." Illustr. Rock Products, Vol. 39, Jan. 1936.
76. m "NEW DRUG FACTORY OF GLAXO LABORATORIES, LTD." Illustr. Chemical Age (London), Vol. 34, Apr. 1936.
77. m "CUDAHY BUILDS A FACTORY AT ALBANY, GA." Illustr. Food Industries, Vol. 8, Nov. 1936.
78. m "BABCOCK AND WILCOX WORKS." (Foundry.) Illustr. Engineer, Vol. 161, June 1936.
79. m "PRODUCTION OF IRON AND CEMENT IN THE SAME ROTARY KILN" by D. Choffat. Plans. Rock Products, Vol. 39, July 1936.
80. m "FILTER PLANT FOR FORT SMITH TREATS NEW MOUNTAIN SUPPLY." Illustr. Diags. Engineering News, Vol. 117, Sept. 1936.
81. m "NEW STEEL MILL." Bethlehem Steel Co. Lackawanna Works. By W. Davis. Science, Vol. 84, July 1936.
82. m "TRADE WASTE TREATMENT PLANT AT BELTSVILLE RESEARCH CENTER, MD." To handle dairy and abattoir wastes. Illustr. Engineering News, Vol. 115, Dec. 1935.
83. m "COMPLETE LARGE SUGAR WAREHOUSE AT BALTIMORE FOR COCA-COLA COMPANY." Illustr. Manufacturer's Record, Vol. 105, May 1936.
84. m "CO-OPERATIVE FLOUR MILL AND SILO FOR SIFTED GRAIN AT VII-PURI, FINLAND." Views. Arch. Forum, Vol. 63, Sept. 1935.
85. HORIZONS. By Norman Bel Geddes. Little, Brown Co., Boston. Chap. 10.

2. SITE

1. m "BIBLIOGRAPHY ON PLANT LOCATION" by Perry & Cuno. Chemical and Metallurgical Engineer, Vol. 41, Aug. 1934.
2. m "MONEY MAKING LOCATIONS FOR SMALL INDUSTRIES" by J. G. Piquet. Illustr. Iron Age, Vol. 130, Dec. 8, 1932.

Bibliography

2. 3. **PLANT LOCATION.** By W. Gerald Holmes. McGraw-Hill, New York City.
4. m "INDUSTRIAL LOCATION AND THE HOUSING MARKET." *Annals of the American Academy of Political Science*, March 1937. Includes a bibliography on the subject.
5. m "INDUSTRY ON THE MOVE." *Business Week*, Feb. 27, 1937. Survey of migration, decentralization, new competition.
6. m "LOCATION OF INDUSTRIES, AND THE PLIGHT OF THE DEPRESSED AREAS." *Economist*, Nov. 21, 1936.
7. m "MEASUREMENT OF INDUSTRIAL LOCALIZATION." — Development of tools of analysis. By E. M. Hoover, Jr. *Review of Economic Statistics*, Nov. 1936. A bibliography on the subject is included.
8. m "NEW ORLEANS AS A MANUFACTURING CENTER FOR THE RUBBER INDUSTRY." *Rubber Age*, Jan. 1937, Vol. 40, p. 222.
9. m "WHY BUSINESS IS DECENTRALIZING" by E. Whitmore. *American Business*, March 1937.
10. m "SELECTING THE SITE FOR A FACTORY" by J. H. West. *Chemical Age (London)*, March 13, 1937.
11. m "WHERE TO LOCATE THE PLANT" by C. P. Wood. *Illustr. Factory Management*, April 1937.
12. m "SIGNIFICANCE OF LOCATION UPON PRODUCTION COSTS" by J. L. Warner. *Trans. Amer. Inst. Chemical Engineer*, June 1936.
13. m "FACTORY PLANNING" by H. Gutteridge. *Engineering*, Vol. 139, Jan. 11, 1935.
14. m "SELECTION OF A FACTORY SITE" by P. Dawson. *Engineer*, Vol. 159, Jan. 25, 1935.
15. m "SELECTION OF WORKS SITE" by E. T. Elbourne. *Engineering*, Vol. 139, March 15, 1935.
16. m "ECONOMIC AND TECHNICAL FACTORS IN CHEMICAL PLANT LOCATION" by Perry & Cuno. *Chemical and Metallurgical Engineering*, Vol. 41, Aug. 1934.
17. m "HOW ONE COMPANY CHOSE A HOME." *International Nickel Plant at Huntington, W. Va.* *Illustr. Nation's Business*, Vol. 22, May 1934.
18. **LOCATION OF MANUFACTURERS IN THE UNITED STATES. 1899-1929.** By Garver, Boddy, and Nixon. (Bull. 6.) 105 pp. Paper. Univ. of Minn. Employment Stabilization Research Institute, 1934.
- ### 3. GROUNDS
1. **BIBLIOGRAPHY ON LANDSCAPE ARCHITECTURE.** By K. McNamara, Compiler. \$2.50. 1934. Harvard Univ. School of Landscape Architecture, Cambridge, Mass.
2. m "BENEFITS RESULTING FROM PLANT BEAUTIFICATION. WATERWORKS, BLUEFIELD, VA." by E. A. Ruehl. *Illustr. Water Works and Sewerage*, Vol. 82, Jan. 1935.
3. m "BEAUTIFICATION OF SEWERAGE DISPOSAL WORKS SITES" by L. E. Burnside. *Illustr. Public Works*, Vol. 63, Dec. 1932.
4. m "WHEN THE WHISTLE BLOWS AT THE STOCK YARDS." *Nat'l Safety News*, Nov. 1933 and March 1936. Improving traffic conditions near plants in Chicago.
5. m "INVENTORY OF TRAFFIC NEEDS" by D. G. Mickle. Including flow chart. *Public Works*, Vol. 67, Jan. 1936.
6. m "HOW TO MAKE TRAFFIC PICK YOUR STATION SITES." *Petroleum Age*, Vol. 28, May and June 1934.
7. m "BIBLIOGRAPHY ON STREET TRAFFIC CONTROL AND RELATED SUBJECTS." 1920-1933. 223 pp. Erskine Bureau For Street Traffic Research, Harvard Univ., Cambridge, Mass. 1933.
8. m "PREVENTING SETTLEMENT OF PAVEMENT PATCHES" by R. J. Mayo. *Illustr. Roads and Streets*. Gillette Pub. Co., 400 W. Madison St., Chicago. Vol. 79, Nov. 1936. Also see—"Traffic Lines" by Edward N. Hines. Vol. 79, Dec. 1936.
9. **HIGHWAY ENGINEERING.** By H. J. Collins and C. A. Hart. \$18.50. Longmans, Green & Co., 114 Fifth Ave., New York City, 1937.
10. **ROAD MATERIALS.** Standard specifications for highway materials and methods of sampling and testing. \$2. Published by the American Association of State Highway Officials, 1220 National Press Bldg., Washington, D. C.
11. **ROAD AGGREGATES, THEIR USES AND TESTING.** By B. H. Knight. \$8. Longmans, Green & Co., 114 Fifth Ave., New York City.
12. **CONCRETE ROAD DESIGN.** Paper, gratis. Portland Cement Assoc., 347 Madison Ave., New York City.
13. m "YARDS." Floodlighting of Paper Mill Yards. By S. W. Stack. *Pulp and Paper of Canada*, April 1937.
14. m "POSITIVELY NO ADMITTANCE." Protection for Factory Yards. By C. F. Scheer. *Illustr. Nat'l Safety News*, May 1937.
15. m "NOT DUSTY ANYMORE." Use of Pebbles in Factory Yards. By H. W. Johnstone. *Illustr. Factory Management*, Vol. 93, March 1935.
16. m "UNIQUE LOW COST RAIL FACILITIES." Cut handling costs 50% for American Concrete Pipe Co., Los Angeles. By L. S. Flint. *Diags. Rock Products*, Vol. 39, Dec. 1936.
17. m "CASE STUDIES IN POWER ECONOMICS." Plant saves in fuel handling by utilizing R.R. siding. By Z. Kogan. *Diags. Power Plant Engineering*, Vol. 40, Feb. 1936.
- ### 4. PLANT LAYOUT (Material Transportation)
1. m "PLANT LAYOUT" by Allen H. Morgensen. Fifteenth in the series of the "Plant Operation Library." *Factory*, Vol. 94, 1936.
2. m "MATERIALS HANDLING CHECK-CHART." *Factory*, Vol. 93, July 1935, p. 321. Physical and economic factors governing preliminary and final choice of equipment.
3. m "FLOW-CHART." Philip Morris Cigarette Factory. By Cone, Hatcher, and Greenwald. *Illustr. Chemical and Metallurgical Engineer*, Vol. 43, March 1936.
4. **CHEMICAL ENGINEERING PLANT DESIGN.** By Frank C. Vilbrandt. McGraw-Hill, New York, 1934, \$4. An analytical presentation of a commercial size plant from the laboratory stage to the commercial size unit.
5. **FACTORY LAYOUT, PLANNING AND PROGRESS.** By W. J. Hiscox. Sir I. Pitman & Sons, London, 1924. 184 pp. Charts.
6. **FACTORY TRANSPORT.** By J. W. Parker. *Industrial Transport Pub. Ltd.*, 1931. *Illustr. Diags. Tables.* A guide to internal movement and works' handling appliances, hoisting and conveying machinery.
7. m "KEYING FACTORY DESIGN TO PRODUCTION REQUIREMENTS" by G. L. Howse. *Eng. News-Record*, Jan. 28, 1937. The Liquid Carbonic Bottle Washer Assembly Building.
8. m "PLANT EQUIPMENT"—Developments in 1936. by R. A. Fiske. *Iron Age*, Jan. 7, 1937.
9. m "WORKS OF KODAK, LTD." *Engineer*, Vol. 163, pp. 188, 192-3, 205-9, 246-8, 273-4. March 5, 1937.
10. m "THE PLANT'S NOT MODERN, BUT ITS LAYOUT IS" by D. C. Kickler. *Factory Management*, Jan. 1937. Plan.
11. m "CENTRALIZED MATERIALS HANDLING PLAN — FOLLOWED IN AUTOMOBILE PLANT." Buick Motor Car Co. Steel, March 15, 1937.
12. m "REDUCE HANDLING COSTS WITH MECHANICAL EQUIPMENT" by G. E. McNamara. *Sucrest Sugar Corp. Marine Eng.*, Dec. 1936.
13. m "PULVERIZED FUEL PLANT FOR FOUNDRY-FURNACES." *Illustr. Diags. Engineering*, Aug. 28, 1936.
14. m "BUILD A PLANT AROUND A LAYOUT." Hygrade Sylvania Corp., Salem, Mass. By F. J. Herly. *Illustr. Factory Management*, Vol. 94, Nov. 1936.
15. m "FACTORY LAYOUT AND MECHANICAL HANDLING" by N. V. Kipping. *Illustr. Plans. Mechanical Handling*, Oct. 1935-Jan. 1936.
16. m "PLANT LAYOUT" by A. H. Morgensen. *Illustr. Flow charts. Factory Management*, Vol. 94, May 1936. See also June 1936.
17. m "WORK ROUTING." Three dimension scale layout board. Easy Washing Mach. Corp. *Illustr. American Machine*, Aug. 12, 1936.
18. m "HOW GOODRICH CO-ORDINATES TWENTY-FIVE KINDS OF HANDLING EQUIPMENT." *Illustr. Factory Management*, Vol. 94, June 1936.
19. m "LOADING AND UNLOADING SYSTEMS FOR DELIVERY OF FOOD PRODUCTS" by J. H. Earle. *Diags. Plans. Food Industries*, Oct. 1936.
20. m "FACTORY PLANNING" by H. Gutteridge. *Engineering*, Vol. 139, Jan. 11, 1935.
21. m "SAFETY STARTS WITH PLANT LAYOUT" by G. A. Lang. *Illustr. National Safety News*, Oct. 1935.
22. m "MECHANICAL HANDLING SYSTEMS AT LARGE WORKS." Reckitt & Son, Hull. By G. L. Atkinson. *Illustr. Mechanical Handling*, Vol. 22, April 1935.
23. m "WHAT GOES UP MUST COME DOWN." Baking Powder Plant of the Rumford Chemical Works. Handles raw materials by gravity. *Illustr. Factory Management*, Vol. 93, April 1935.
24. m "FACTORY LAYOUT AND MECHANICAL HANDLING" by N. V. Kipping. *Illustr. Plans. Mechanical Handling*, Vol. 22, Oct.-Dec. 1935.
25. m "PLATING-PLANT LAYOUT." By A. J. Lupien. *Plans. Metal Industries*, Vol. 33, March 1935.
26. m "HANDLING DEVICES THAT MAKE STEEL MILLS MODERN." *Illustr. Blast Furnace and Steel Plant*, Vol. 23, Aug. 1935.
27. m "EFFECT OF MECHANICAL HANDLING ON PLANT LAYOUT" by A. H. Morgensen. *Mechanical Handling*, Vol. 21, Sept. 1934.
28. m "CHANGES IN PLANT LAYOUT." Abstract. By R. A. Fintz. *Iron Age*, Vol. 131, May 18, 1933.
29. m "PRODUCT CONTROL VERSUS PROCESS CONTROL" by A. H. Morgensen. *Illustr. Factory Management*, Vol. 91, May 1933.
30. m "BALANCING THE MILLS BY CALCULATION OF THE MACHINERY REQUIRED AT EACH COTTON-YARN MANUFACTURING PROCESS" by G. R. Merrill. *Textile World*, Vol. 87, Jan. 1937.
31. m "FOOD-PLANT ENGINEERING." At Armour's. By F. A. Lindberg. *Illustr. Food Industries*, Vol. 9, Jan. 1937.

32. m "PLANT LAYOUT AND PRODUCTION METHODS FOR MODERN AIRCRAFT ENGINES." Pratt and Whitney. By J. C. Ward, Jr. Illustr. Soc. Automotive Engineer's Journal, Vol. 40, May 1937.
33. m "FOUNDRY LAYOUT FACILITATES QUALITY CONTROL." Wilkening Mfg. Co. By J. Geschelin. Illustr. Automotive Industries, Vol. 76, May 1937.
34. m "ASSEMBLING M. G. CARS." Illustr. Automobile Engineering, Vol. 26, Oct. 1936.
35. m "RELATION OF RESEARCH TO CHEMICAL PLANT CONSTRUCTION" by H. S. Jacoby. Illustr. Transactions of the American Institute of Chemical Engineers, Vol. 32, March 1936.
36. m "MATERIAL HANDLING IN CHEMICAL PLANTS" by W. F. Schaphorst. Illustr. Industrial and Engineering Chemistry, Vol. 28, Nov. 1936.
37. m "CONVEYORS SPEED FOOTWEAR MANUFACTURE." Illustr. Rubber Age, Vol. 39, Apr. 1936.
38. m "WHERE BAKERY LAYOUT IS RIGHT." Wilkes-Barre Bakery. By L. K. Urquhart. Illustr. Factory Management, Vol. 93, May 1935.
- by D. T. Wallis. Architecture, London, 1929. N. S. Vol. 7, pp. 61-73. Illustr.
17. m "BROADER FACTORY AISLES." Design for single-story industrial buildings. Scientific American. Vol. 156, p. 130. Feb. 1937.
18. m "MODERN INTERNATIONAL PRACTICE IN FACTORY DESIGN." Journal of Royal Society of Arts, London. Illustr. Vol. 82, pp. 366-393.
19. m "MORRIS FOUNDRY AT COVENTRY." Illustr. Engineering, Vol. 140, Oct. 1935.
20. m "WHAT THE BREWERY OF THE FUTURE WILL LOOK LIKE" by V. Buhr. Flow-Sheet. Illustr. Food Industries, Vol. 5, Apr. 1933.
21. m "INDUSTRIAL BUILDINGS." Illustr. Engineering News, March 5-26, 1936.
22. m "PLANT BUILDINGS." Illustr. Factory Management, Apr. 1936.
23. m "VIEWS, PLANS, AND CONSTRUCTION OUTLINE." Arch. Forum, Vol. 65, Oct. 1936.
24. m "DESIGN OF ROOF FOR FORD MILL FOR MORE EFFECTIVE LIGHTING AND VENTILATION." Blast Furnace and Steel, Feb. 1936.
25. m "FLEXIBLE ROOF MONITORS USED IN CONSTRUCTION OF NEW STEEL MILLS AT RIVER ROUGE PLANT OF FORD CO." Diags. ARCHITECTURAL RECORD, Vol. 79, May 1936.
26. m "CHEMICAL PLANT CONSTRUCTION" by H. S. Jacoby. Illustr. Industrial and Chemical Engineer, Vol. 27, Sept. 1935.
27. m "DEHAVILAND AIRCRAFT WORKS." Illustr. Engineer, Vol. 162, Dec. 11, 1936.
28. m "SPECIALLY PLANNED MODERN BUILDING FOR FINAL ASSEMBLY." Boeing Aircraft Co. Illustr. Aero Digest, Vol. 30, Feb. 1937. See also—Steel, Vol. 100, Feb. 1, 1937.
29. m "ALL-STEEL HANGARS IN FRANCE HAVE SUSPENDED PLATE ROOFS." Illustr. Engineering News, Vol. 118, Jan. 14, 1937.
30. m "DESIGN AND CONSTRUCTION OF HANGARS." Integrated roofs. ARCHITECTURAL RECORD, Vol. 80, Nov. 1936.
31. m "NEW DESIGN FOR BREWERY STOCK HOUSES" by M. E. Smith. Illustr. Civil Engineering, Vol. 7, Feb. 1937.
32. m "DUPONT RESEARCH LABORATORY." The last word in efficiency. Illustr. Rayon, Vol. 18, Jan. 1937.
33. m "STEAM POWER PLANT." Plan. Electrician, Vol. 117, Oct.-Nov. 1936.
34. m "STORAGE BUILDING." New York City. View and plan. ARCHITECTURAL RECORD, Vol. 81, Feb. 1937.
35. m "NEW BUILDING OF GENERAL DYESTUFF CORPORATION AND GENERAL ANILINE WORKS, INC." Textile Colorist, Vol. 59, Jan. 1937.
36. m "SPRING STYLES IN CHEMICAL PLANTS" by E. B. Carter. Illustr. Chemical Industries, Vol. 40, Apr. 1937.
37. m "CHEMICAL PLANT (MONSANTO)." In North Wales. Illustr. Chemical and Metallurgical Engineering, Vol. 44, Apr. 1937.
38. m "COLD STORAGE PLANT OF PLACERVILLE FRUIT GROWERS ASSOC." by P. A. Sherer. Illustr. Power, Vol. 81, May 1937.
39. m "DESIGNING AND BUILDING A MODERN BULK-PLANT" by A. S. James. Illustr. Nat'l Petroleum News, Vol. 29, March 1937.
40. m "OPTICAL BUILDING." Richmond, Va. Illustr. ARCHITECTURAL RECORD, Vol. 79, March 1936.
41. m "CHEMICAL PLANT DESIGN AND CONSTRUCTION." Illustr. Chemical Industries, New Haven, Conn. 1936.
42. m "U. S. INDUSTRIAL ALCOHOL CO. BUILDS NEW POWER PLANT." Flow diag. Illustr. Power Plant Engineering, Vol. 40, May 1936.
43. m "OAKLAND GLASS FACTORY TO BE WORLD'S FINEST." Illustr. Glass Industry, Vol. 17, June 1936. See also—March 1936.
44. m "NEW BUILDING OF THE OWENS-ILLINOIS GLASS CO." Illustr. Engineering News, Vol. 116, March 1936. No windows but all glass.
45. m "WINDOWLESS BUILDING FOR NATIONAL ALUMINATE CORP." Illustr. Power-Plant Engineering, Vol. 40, Sept. 1936.
46. m "KNICKERBOCKER LAUNDRY CO. PLANT." L. I. City. Arch Forum, Vol. 65, Oct. 1936. See also Electrical World, Vol. 106, Apr. 1936.
47. m "DETERMINING THE ECONOMIC SIZE OF A POWER PLANT" by J. D. Lewin. Civil Engineering, Vol. 6, Apr. 1936.
48. m "NEW CHEVROLET ASSEMBLY PLANT." Baltimore. Illustr. Automotive Industries, Vol. 72, Apr. 1935.
49. m "DEVELOPMENT OF INDUSTRIAL BUILDINGS" by T. L. Condon. Illustr. Civil Engineering, Vol. 3, Aug. 1933.
50. m "INDUSTRIAL TERMINAL INNOVATIONS." Port of New York Authority's new inland freight station, New York. Illustr. Electrical World, Vol. 101, Feb. 1933. See also—Engineering News, Vol. 109, Dec. 1932. See also—ARCHITECTURAL RECORD, Vol. 73, Apr. 1933.

5d. DESIGN AND CONSTRUCTION

1. INDUSTRIAL ARCHITECTURE. By C. G. Holme. Introduction by L. H. Bucknell. The Studio Publications, Inc., New York City, 208 pp., \$10.
2. m "INDUSTRIAL PLANT BUILDINGS." Factory, Vol. 95, Part 2, April 1937.
3. m "INDUSTRY BUILDS." Arch. Forum, Vol. 66, March 1937.
4. m "FACTORIES, NEWSPAPER AND PRINTING PLANTS, LAUNDRIES." Arch. Forum, Vol. 65, Oct. 1936. Includes photographs, plans and construction outlines.
5. m "ENCLOSED ACREAGE." Engineering News-Record, Vol. 116, March 5-26, 1936.
6. m "PLANT BUILDINGS." Factory, Vol. 94, April 1936.
7. m "HISTORICAL DEVELOPMENT OF DISTILLING PLANTS." Transactions of the Institute of Chemical Engineers. Vol. 13, pp. 34-61. Illustr. Plans. Diags. Also contains bibliography on the subject.
8. m "THE SPERRY GYROSCOPE FACTORY, BRENTFORD." Illustr. Plans. Architect's Journal, London, 1931, Vol. 74.
9. m "INDUSTRIAL BUILDINGS." Illustr. Diags. Plans. Engineering News, Vol. 116, March 1936.
10. m "FACTORY DESIGN." Illustr. Architect's Journal, London, Vol. 75, Jan. 1932.
11. m "DESIGNING THE DISTILLERY" by J. H. Callender. Illustr. Flow charts. Diags. Plans. Arch. Forum, Vol. 59, Oct. 1933.
12. m "PERFUME FACTORY." Illustr. Plans. Nuestra Arquitectura, Buenos Aires. 1935, Agosto, pp. 32-40.
13. m "NEW CIGARETTE FACTORY." Illustr. Plans. By Peter Behrens and A. Popp. In Linz an Der Donau. Profil, Wien 1933. Jahrg. 1, pp. 158-162. See also—Architect's Journal, London, 1933. Vol. 77, pp. 277-279. See also—Profil, Wien 1936. Jahrg. 4, pp. 56-61.
14. m INDUSTRIAL BUILDING REFERENCE NUMBER OF THE ARCHITECTURAL FORUM. Sept. 1929. Vol. 51.
15. m "MODERN INTERNATIONAL PRACTICE IN FACTORY DESIGN" by Hal Williams. Journal of Royal Society of Arts, London, 1934. Vol. 82, pp. 366-393. Illustr.
16. m "MODERN FACTORY PLANNING"
51. m "AMERICAN BAKERIES CO. BUILDING, MIAMI, FLA." Illustr. American Architect, Vol. 146, Apr. 1935.
52. m "DESIGN AND ERECTION OF A BULK FUEL-OIL STORAGE PLANT" by K. Steiner. Illustr. Heating, Piping and Air Conditioning, Vol. 7, July 1935.
53. m "CREAMERY AND COLD STORAGE PLANT AT SIMCOE, ONT." by E. N. Darling. Illustr. Canadian Engineer, Vol. 68, Jan. 1935.
54. m "REFRIGERATION TERMINAL ON TIDEWATER; AT FT. PIERCE, FLA." by G. Perrine. Illustr. Civil Engineering, Vol. 5, August 1935.
55. m "WORLD'S NEWEST CEMENT PLANT." National Portland Cement Co., Brodhead, Pa. By G. M. Earnshaw. Illustr. Rock Products, Vol. 38, Aug. 1935.
56. m "IMPORTANCE OF THE DRUG-ROOM IN THE LAYOUT OF AN EFFICIENT DYE-HOUSE" by H. G. Price. Plan. American Dyestuff Reporter, Vol. 24, July 1935.
57. m "80,000 TON GRANARY AT BAHIA BLANCA." Illustr. Engineering, Vol. 135, Feb., March 1933.
58. m "DESIGNING BUILDINGS FOR FRUIT AND PRODUCE TERMINALS." Plan. Railway Age, Vol. 94, June 1937.
59. m "NIAGARA FRONTIER FOOD TERMINAL, BUFFALO." Illustr. ARCHITECTURAL RECORD, Vol. 74, ov. 1937.

5b. METHODS AND MATERIALS

1. m "BUILDING FEATURES IN THREE NEW PLANTS." Factory, Vol. 94, pp. S 214-S 223. A detailed discussion of construction, modernization, and maintenance. Illustrated. Chicago Cartoix Co., National Can Co., Sheffield Farms Co.
2. AMERICAN FACE BRICK ASSOCIATION: INDUSTRIAL BUILDINGS AND HOUSING. Edited and published by the Arch. Forum, New York, for the

Bibliography

5b.

- American Face Brick Association, Chicago—1926. 112 pp. Illustr.
3. m "CONSTRUCTION SYSTEMS ANALYZED" by Cobb, Lippman, and Root. Diags. Arch. Forum, Vol. 60, June 1934.
 4. CONSTRUCTION MATERIALS INDEX. By Const. Materials Research Co., 329 Minna St., San Francisco, 1936, \$5. This includes a bibliography on the subject.
 5. m "TYPES OF FLOORS FOR INDUSTRIAL BUILDINGS." Factory, Vol. 94, 1936, p. S 244.
 6. m "PICK FLOORS FOR THE JOB YOU ASK THEM TO DO" by J. F. Andrews. Factory Management, Vol. 94, pp. 59, 60. Dec. 1937. And Vol. 95, pp. 73, 74. Jan. 1937.
 7. m "WALKWAYS MUST BE SAFE." National Safety News, March 1937.
 8. m "ALL WELDED INTERMEDIATE FLOOR FOR HEAVY WORKSHOP LOAD." Illustr. Diags. Engineering, Apr. 2, 1937.
 9. m "CONCRETE CAN FACTORY." For the Continental Can Co. of Canada. Built in a steam-heated inclosure. Steel, Sept. 28, 1936.
 10. m "GLASS BLOCK WINDOWS AID FUNCTIONAL DESIGN OF FACTORY." —Owens-Illinois Glass Co. Illustr. Engineering News, Oct. 29, 1936
 11. m "FACTORY FLOORING FOR ROUGH USAGE." Illustr. Chemical Age (London), Feb. 15, 1936.
 12. m "FOUNDRY FLOORS." Illustr. Chemical Age (London), Feb. 1, 1936.
 13. m "CONCRETE IN FACTORY CONSTRUCTION." Eastman Kodak Co. American Concrete Institute Journal. Illustr. Vol. 6, Nov. 1934.
 14. m "RESURFACE HUGE INDUSTRIAL BUILDING WITH REINFORCED GUNITE." American Meter Building in Albany. Illustr. Concrete, Vol. 43, May 1935.
 15. m "TWENTY-FOUR MURALS." Ferro Enamel Corporation, Cleveland. Factory Management, Vol. 93, July 1935.
 16. m "CHEMICAL PLANT CONSTRUCTION" by H. S. Jacoby. Industrial and Engineering Chemical News, Vol. 27, Sept. 1935.
 17. m "ALL WELDED FACTORY ERECTED BY THE BATA SHOE CO. AT E. TILBURY." Illustr. Electrical Record (London), Vol. 112, June 23, 1933.
 18. m "WHAT IS THE PROPER FLOOR?" by A. E. Hansen. Illustr. Food Industries, Dec. 1932.
 19. m "WHITE PLANT'S A LIGHT PLANT." Illustr. Factory Management, Vol. 91, March 1933.
 20. m "CAST-IRON PLATES FORM PERMANENT PLANT ROOF" by W. G. Nutz. Illustr. Maintenance Engineering, Vol. 91, Feb. 1933.
 21. m "INDUSTRIAL PLANT SAVES BY ELECTRIC WELDING" by R. J. Collins. Illustr. Electric Welding, Vol. 101, Feb. 18, 1933.
 22. m "ACIDPROOF BRICK JOINED WITH SULPHUR CEMENT PROTECTS CONCRETE AND STEEL" by C. R. Payne. Steel, Vol. 100, Feb. 15, 1937.
 23. m "LOAD BEARING UNIT OF GLASS-FACED CONCRETE." Illustr. Concrete, Vol. 45, Jan. 1937.
 24. m "FACTORY AND WAREHOUSE FOR OWENS-ILLINOIS GLASS CO., GAS CITY, IND." Views. Arch. Forum, Vol. 66, March 1937.
 35. m "HOLLOW GLASS BLOCKS AS BUILDING MATERIAL." Owens-Illinois Glass Co.'s laboratory. Illustr. Engineer, Vol. 162, Nov. 13, 1936.
 26. m "ALL STEEL COLD STORAGE PLANT" by E. A. Griffiths. Illustr. Refrigerating Engineering, Vol. 33, Apr. 1937.

27. m "STRUCTURAL SYSTEMS." Illustr. ARCHITECTURAL RECORD, Vol. 81, March 1937.
28. m "NATCO INTRODUCES NEW ALL-CLAY PRE-FABRICATED ROOF BEAM." Illustr. Brick and Clay Record, Vol. 90, Apr. 1937.
29. m "BUILDING MATERIALS." Illustr. Architectural Record, Vol. 80, Dec. 1936.
30. m "LONG SPAN STEEL ARCHES INCORPORATE SAW TOOTH ROOF." Douglas Airplane Ass'y. Plant, Calif. Illustr. Engineering News, Vol. 117, Oct. 1936.
31. m "MATERIALS OF CONSTRUCTION IN THE BUILDING INDUSTRY." Illustr. Industrial and Engineering Chemistry, Vol. 27, Aug.-Nov. 1935. Also includes a bibliography on the subject.
32. m "STRUCTURAL ANALYSIS, BRICK AND MORTAR" by W. C. Voss. Illustr. ARCHITECTURAL RECORD, Vol. 79, May 1936.
33. m "BUILDING A REINFORCED BRICK MASONRY KILN SHED" by E. F. Gallagher. Illustr. Brick and Clay Record, Vol. 89, Sept. 1936.
34. m "CONSTRUCTING CONCRETE SILOS BY THE MOVING FORM METHOD." Illustr. Engineer, Vol. 161, May 1936.
35. m "60,000 TON GRAIN SILO AT LIVERPOOL." Illustr. Engineer, Vol. 161, June 1936.
36. m "CORROSION PROOF, SANITARY FLOORS FOR FOOD FACTORIES." Food Industries, Vol. 7, Dec. 1935.
37. m "GLASS PLATES FOR GAS STATION EXTERIOR WALLS." A. A. Curry Petroleum Corp. Illustr. Nat'l Petroleum News, Vol. 28, Sept. 1936.
38. m "STRUCTURE IN GLASS" by G. K. Geerlings. Illustr. Architecture, Vol. 73, Feb. 1936.
39. m "HOW TO KEEP CEILINGS DRY IN WINTER." Milk Bottling Plant. By W. A. Dean, Jr. Illustr. Food Industries, Vol. 8, Aug. 1936.
40. m "CONCRETE ROOF OF NOVEL DESIGN FOR SAN FRANCISCO WAREHOUSE." Illustr. Engineering News, Vol. 116, Apr. 1936.
41. m "TIMBER ROOF TRUSSES OF 111 FT. SPAN" by N. S. Perkins. Illustr. Engineering News, Vol. 117, Nov. 1936.
42. m "CONCRETE SLABS REINFORCED WITH WELDED WIRE FABRIC" by T. D. Mylres. Illustr. Journal of the American Concrete Institute, Vol. 7, Nov. 1935.
43. m "ADVANTAGES OF WOOD FOR MORE COMPLETE FACTORY FABRICATIONS." Architecture, Vol. 72, Dec. 1935.
44. m "RUG-CLEANING PLANT IS CONCRETE" by J. R. Arnold. Illustr. Concrete, Vol. 43, Aug. 1935. This issue includes bibliography on subject.
45. m "MANAGEMENT OF HAULING IN CONSTRUCTION" by J. L. Harrison. Engineering News, Vol. 113, Sept. 1934.
46. m "STRUCTURAL PROGRESS" by H. V. Spurr. Illustr. Arch. Forum, Vol. 60, June 1934.
47. m "TERMITES AND BUILDINGS" by J. M. Hamilton. Diags. Architecture, Vol. 68, Dec. 1933, Jan. 1934.
48. m "BIBLIOGRAPHY ON BUILDING, HOUSING AND CONSTRUCTION." 18 pp. Chamber of Commerce of the U. S. A., Washington, D. C.
49. m "HEAVY CONSTRUCTION REQUIRED FOR BREWERY STOCKHOUSE" by H. M. Matthews. Illustr. Engineering News, Vol. 113, Oct. 1934. See also—ARCHITECTURAL RECORD, Vol. 76, July 1934.
50. m "PURLINS AND GIRTS IN MILL BUILDINGS CONSIDERED AS CATENARIES" by R. Flemming. Engineering News-Record, New York City, Apr. 1, 1937.

5c. COSTS

(Of Construction)

1. m "CONSTRUCTION COST STATISTICS" by J. S. Taylor. Journal of the American Statistical Assoc., Vol. 29, March 1934.
2. CONSTRUCTION COSTS—1910-1935. By Engineering News-Record, 330 W. 42 St. New York City. \$2.
3. DEPRECIATION. By Roy B. Kester. The Ronald Press Co., New York City, 1924, 105 pp. Diags. Forms.
4. m "TO BUILD OR NOT TO BUILD" by H. K. Ferguson. Factory Management, Apr. 1937.
5. m "GET THE MOST OUT OF YOUR BUILDING DOLLAR." Illustr. Factory Management, Vol. 95, Apr. 1937.
6. m "CONSTRUCTION COSTS." 9th ed. 1936. 128 pp. \$2. McGraw-Hill Co., New York City.
7. m "ELEMENTS OF BUILDING COSTS." Tabulation. Engineering News, Vol. 118, May 1937.
8. m "COST TECHNIQUES." Evaluation of construction cost data, methods of estimating. Arch. Forum, Vol. 65, Aug. 1936.
9. m "SOLID BRICK WALLS COST LESS THAN VENEER." Illustr. Brick and Clay Record, Vol. 89, July 1936.
10. m "CHART FOR DETERMINING INVESTMENT RETURN ON AIR CONDITIONING." Power, Vol. 79, Nov. 1935.

6. SERVICES

(Internal)

1. m "INDUSTRIAL LIGHTING PROBLEM." Electrical Engineering, May 1937. Also includes a bibliography on the subject.
2. MECHANICAL EQUIPMENT OF BUILDINGS. By Harding and Willard. John Wiley & Sons, New York City, Vol. I. Heating and Ventilation. Vol. II. Power Plants and Refrigeration. A reference book.
3. NATIONAL ELECTRIC CODE HANDBOOK. By A. L. Abbott. McGraw-Hill Book Co., Inc., New York City. 547 pp. Illustr. \$3. Interprets nat'l. code requirements. Practical reference book.
4. INDUSTRIAL ELECTRICITY AND WIRING. By J. A. Moyer and J. F. Wostrel. Division of University Extension, Mass. Dept. of Education, 2d ed. Describes standard electric practice.
5. WIRING FOR LIGHT AND POWER. By Terrel Croft. McGraw-Hill, New York City. 562 pp., 400 illustrations, \$3. Shows plainly how to meet the requirements of the industrial code.
6. ELECTRICAL EQUIPMENT. By H. W. Brown. McGraw-Hill, New York City. 586 pp., 331 illustrations, 1931, \$5. Principles and practice, costs. Problems.
7. m "WATCH THAT POWER FACTOR" by H. Brooks. Factory Management, Dec. 1936.
8. m "REVIEW OF RECENT ELECTRICAL DEVELOPMENTS" by G. A. Van Brunt. Factory Management, Jan. 1937. Illustr.
9. m "PROCESS APPLICATIONS OF THE POWER SERVICES; BASIC PROCESS EQUIPMENT." Power, Dec. 1936, Vol. 80, pp. 657-63.
10. m "CIRCULATING UNIT HEATERS REDUCE PRODUCTION COSTS IN METAL PLANTS" by F. Merish. Steel, Feb. 8, 1936.
11. m "EXAMPLE OF SIMPLIFIED FACTORY HEATING." Newark Wire Cloth Co. Plans. Sheet Metal Worker, Jan. 1937.
12. m "EFFICIENT LIGHTING PLUS ECONOMIES IS RESULT OF IN-

- GENIOUS LIGHT SYSTEM.** Steel, Dec. 21, 1936.
13. m "60 FOOT-CANDLES MEAN REAL SEEING." Overall plant. By J. F. Andrews. *Factory Management*, March 1937.
14. m "ELECTRICAL FACTORS CAN EFFECT SAVING IN CHANGES OR ADDITIONS TO PLANTS." Steel, March 22, 1937.
15. m "REPORT ON LIGHTING IN THE SHOE MANUFACTURING INDUSTRY." Illustr. *Illuminating Eng. Soc. Transactions*, Vol. 32, pp. 289-312. March 1937.
16. m "WHEN WIRING YOUR PLANT" by F. L. Aime. Illustr. *Factory Management*, May 1937.
17. m "OVERHEAD DISTRIBUTION." Substation on roof. *Electrical Record* (London), Vol. 118, May 8, 1936.
18. m "LIGHTING IN CLOTHING FACTORIES." C. Manning and H. A. Byrne. U. S. Women's Bureau Bulletin, Vol. 109, 1935. See also—*Monthly Labor Record* (Conn.), Oct. 1935.
19. m "HIGH INTENSITY MERCURY LAMPS FINDING INCREASING USE IN AUTOMOTIVE PLANTS." Illustr. *Automotive Industries*, Vol. 73, July 27, 1935.
20. m "LIGHTING DOES A PRODUCTION JOB." American Hard Rubber Co., Butler, N. J. By B. Shereff. Illustr. *Factory Management*, Vol. 93, Oct. 1935.
21. m "INSTALLATIONS IN FACTORIES." Safety points to be noted. By F. Cooper. *Electrician*, Vol. III, Nov. 17, 1933.
22. m "TWENTY WAYS TO CUT FACTORY POWER COSTS." Illustr. *Power*, Vol. 77, Dec. 1933.
23. m "HIGH SEE LEVEL." Illumination at new De Soto plant. By E. L. Bailey. Illustr. *Factory Management*, Vol. 95, May 1937.
24. m "REPORT ON LIGHTING IN THE TEXTILE INDUSTRY." Illustr. *Transactions of the Society of Illuminating Engineers*, Vol. 32, March 1937.
25. m "PIPE WORK FOR MODERN CHEMICAL WORKS." Diags. *Chemical Age*, London, Vol. 34, Feb. 1936.
26. PRACTICAL HEATING SYSTEMS—TROUBLES AND REMEDIES. By E. W. Riesbeck. F. J. Drake & Co., Chicago, Ill. 1927. 277 pp.
- J. M. Demarest. Illustr. *Heating and Ventilating*, Vol. 32, June 1935.
7. CONTROLLED HUMIDITY IN INDUSTRY. By M. C. Marsh. 123 pp. C. Griffin & Co., London, 1935. A bibliography on the subject is included.
8. m "DIRECTORY OF HEATING, PIPING AND AIR CONDITIONING EQUIPMENT FOR INDUSTRY AND LARGE BUILDINGS." Classified by products, trade names, and manufacturers' addresses. *Heating, Piping*, Vol. 9, Jan. 1937.
9. m "ABNORMAL AIR CONDITIONS IN INDUSTRY." Their effect on workers and methods of control. By C. P. Yaglov. *Journal of Industrial Hygiene*, Vol. 19, Jan. 1937. Bibliography included.
10. AIR CONDITIONING AND ENGINEERING. By the engineering staff of American Blower Corp., Div. of American Radiator Co., New York City. 1935. \$5.
11. THE AMERICAN SOCIETY OF HEATING AND VENTILATING ENGINEERS GUIDE. Vol. 15. Published by the Society, 51 Madison Ave., New York City. \$5.
12. m "AIR CONDITIONING IN INDUSTRY." Handling of foods. By M. O. Soroka. Illustr. *Heating and Ventilating*, Vol. 33, Nov. 1936. (See also Vol. 34, March 1937.)
13. m "AIR CONDITIONING IN TEXTILE PLANTS" by C. H. S. Topholme. Illustr. *Rayon*, Vol. 17, Aug. 1936.
14. m "AIR CONDITIONING OF PAPER AND PRINTING PLANTS" by W. G. Schlichting. *Paper Trade Journal*, Vol. 103. July 1936.
15. m "AIR CONDITIONING ENABLES ESSENTIAL OILS CONCERN TO CONCENTRATE BUSINESS ON UPPER FLOOR OF LOFT BUILDING" by F. H. Leonhardt. *Food Industries*. Vol. 8, June 1936.
16. m "SOLVING THE FOUR TYPES OF PROCESS AIR CONDITIONING PROBLEMS" by W. Goodman. *Charts. Heating, Piping, and Air Conditioning*, Vol. 8, June-July 1936.
17. m "HOW TO AVOID TROUBLE FROM NOISE IN AIR CONDITIONING INSTALLATIONS" by P. H. Geiger. *Heating, Piping, and Air Conditioning*, Vol. 8, Nov. 1936. See also—Vol. 8, Sept. 1936.
18. m "AIR CONDITIONING IN THE SOUTH." *Manufacturer's Record*, Vol. 104, Apr. 1935.
19. m "CHOOSING THE RIGHT AIR CONDITIONING SYSTEM" by A. W. Canney. Illustr. *Heating, Piping, and Air Conditioning*, Vol. 6 and Vol. 7, Nov., Dec. 1934. Feb., Apr., June, Aug., Oct., and Dec. 1935.
20. m "FORD PLANT ADOPTS AIR CONDITIONING." *Heating and Ventilation*, Vol. 32, Nov. 1935.
21. m "EXAMINING THE STRUCTURAL DETAILS OF A BUILDING PREPARATORY TO ESTIMATING AIR CONDITIONING" by A. J. Mellish. Illustr. *Sheet Metal Worker*, Vol. 26, Oct. 1935.
22. m "WHY AIR CONDITIONING BIDS VARY" by L. A. Hardigg. *Diags. Heating, Piping, and Air Conditioning*, Vol. 7, July 1935.
23. m "AIR CONDITIONING IN CIGAR FACTORIES." *Electrical World*, Vol. 105, March 1935.
24. m "AIR CONDITIONING A CHOCOLATE PLANT" by W. F. Schaphorst. Illustr. *Power Plant Engineering*, Vol. 39, May 1935.
25. m "SELECTION AND MAINTENANCE OF INDUSTRIAL AIR CONDITIONING SYSTEMS" by W. A. Hanley. *Heating, Piping and Air Conditioning*, Vol. 7, Jan. 1935.
26. m "HOW MUCH NOISE IS PERMISSIBLE?" by P. H. Geiger. *Heating, Piping, and Air Conditioning*, Vol. 8, Dec. 1936.
27. m "PREHEATING APPLIED TO AIR CONDITIONING" by A. Merle. *Diags. Power*, Vol. 78, May 1934.
28. m "ESTIMATING AIR CONDITIONING, FITTINGS AND DUCT WORK." *Sheet Metal Worker*, Vol. 24, Jan. 1933.
29. m "AIR CONDITIONING IN THE DRUG-MANUFACTURING INDUSTRY" by W. A. Hanley. Illustr. *Industrial and Engineering Chemistry*, Vol. 25, Jan. 1933.
30. m "AIR CONDITIONING IN THE FUR INDUSTRY" by C. B. Harris. *Diags. Heating and Ventilating*, Vol. 30, Oct. 1933.
31. m "AIR CONDITIONING IN THE MODERN BREWERY" by L. L. Simmons. Illustr. *Heating, Piping, and Air Conditioning*, Vol. 5, May 1933.
32. m "AIR CONDITIONING TROUBLE INSPECTION REPORT" by O. W. Thomas. *Diags. Domestic Engineering*, Vol. 141, Jan. 1933.
33. m "AIR DISTRIBUTED THROUGH PERFORATED CEILING." Illustr. *Sheet Metal Worker*, March 1937.
34. m "A REFERENCE LIST OF IMPORTANT PUBLICATIONS DEALING WITH HEATING AND AIR CONDITIONING." Compiled by the editorial staff of *Heating and Ventilating*. Issue of Feb. 1937, pp. 42-44.
35. HEATING, VENTILATION, AND AIR CONDITIONING. By Harding and Willard. John Wiley & Sons, Inc., New York City, 1932, 963 pp. Illustr. \$10. A reference book.
36. ELEMENTS OF HEAT-POWER ENGINEERING. By Barnard, Ellenwood, and Hirschfeld. John Wiley & Sons, Inc., New York City. 3 vols. Vol. 3 on air conditioning.
37. PRINCIPLES OF HEATING, VENTILATING, AND AIR CONDITIONING. By A. M. Greene, Jr. John Wiley & Sons, Inc., New York City, 1936, 446 pp. Illustr.
38. THE PRINCIPLES OF HEATING AND VENTILATION. By H. M. Vernon. E. Arnold & Co., London, 1934, 232 pp. Illustr. Includes bibliography on the subject.
39. m "AIR CONDITIONING IN ALL-GLASS WINDOWLESS BUILDING." Owens-Illinois Glass Co. *Power*, Vol. 80, March 1936.
40. m "STATE LAWS ON AIR CONDITIONING FOR INDUSTRIAL BUILDINGS, AND REFERENCE DATA." *Heating and Ventilating*, Vol. 32, Oct. 1935.
41. m "VENTILATING A WAREHOUSE." *Plan. Sheet Metal Worker*, Vol. 24, Dec. 1933.

7. AIR CONDITIONING

- THE FOLLOWING COMPANIES PUBLISH UP-TO-DATE ENGINEERING DATA PORTFOLIOS:
 - Carbondale Mach. Corp., Harrison, N. J.
 - Carrier Corporation, Newark, N. J.
 - Chrysler Corp., New York City.
 - Delco-Frigidaire, G. M. Corp., Dayton, Ohio.
 - Frick Corp., Waynesboro, Pa.
 - General Elec. Co., Air Cond. Dept., 570 Lexington Ave., New York City.
 - Westinghouse Elec. & Mfg. Co., Mansfield, Ohio.
- HEATING AND AIR CONDITIONING. By Allen and Walker. McGraw-Hill Book Co., Inc., New York City, 1935, \$4. Illustr. Chap. 20 deals with "industrial air conditioning." A handbook.
- m "HEAT AND VENTILATION" by M. Freund. *Factory Management*, Apr. 1937.
- m "AIR CONDITIONING IN INDUSTRY" by M. O. Soroka. *Heating and Ventilating*, May 1937.
- m BIBLIOGRAPHY OF INFORMATION ON AIR CONDITIONING. U. S. Bureau of Foreign and Domestic Commerce, Washington, D. C. 1934.
- m "INDUSTRIAL AIR CONDITIONING FOR COMFORT." International Business Machines Corporation Plant. By

8. WELFARE

- SEE PP. 18-22 OF I-1 for a general discussion of welfare requirements and British standards relating to same. This includes: Welfare and Welfare Supervision, Ventilation, Cloakrooms, Washing Facilities, Drinking Water, Sanitary Accommodations, Dust, Light, Fatigue (Flow of Work), Noise, Medical Attention, Fire Protection.
- INDUSTRIAL AMERICA, ITS WAY OF WORK AND THOUGHT. By Arthur Pound. Little, Brown, & Co., Boston, Mass., 234 pp. Illustrated. \$2.50.
- m "PRACTICAL PLANNING OF THE FACTORY CAFETERIA." "Layout of Medical Depts. of an Industrial Plant." *Architectural Forum*, Sept. 1929, Part II.
- DIE WELT DER MODERNEN FABRIK. By Christian Schmitz, Jena; K. Zwing. 1929. 202 pp. Illustr.

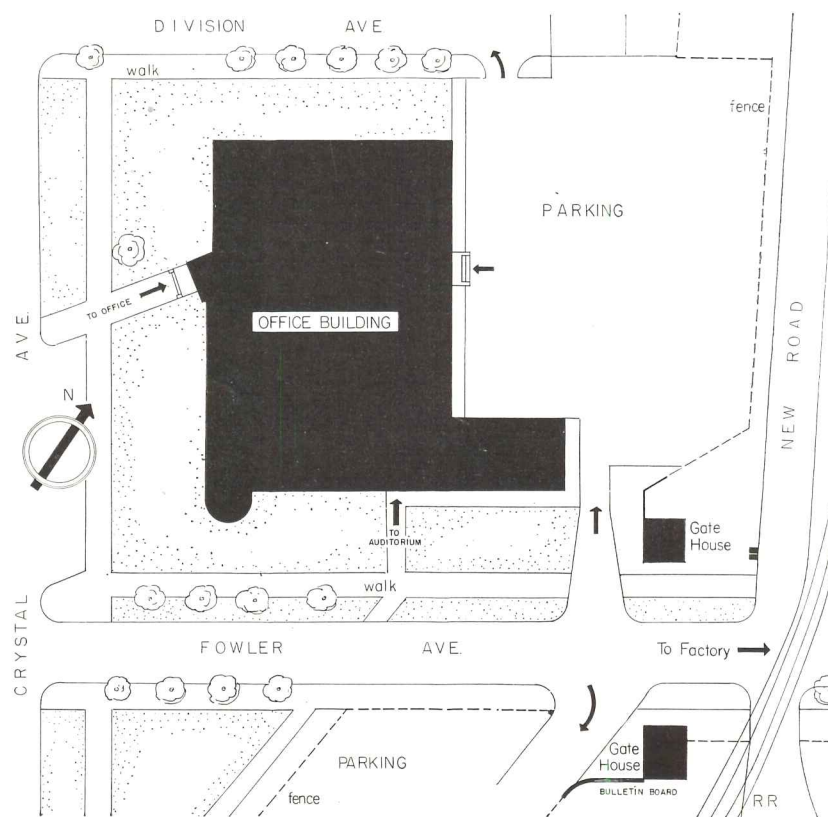
(Continued on page 140)

1 FACTORY ADMINISTRATION



KIMBLE GLASS CO., VINELAND, N. J.

WILLIAM LESCAZE, ARCHITECT



PLOT PLAN

MAIN entrance for customers and visitors is on Crystal Avenue. Employees, most of whom come in cars, use entrance off parking area.

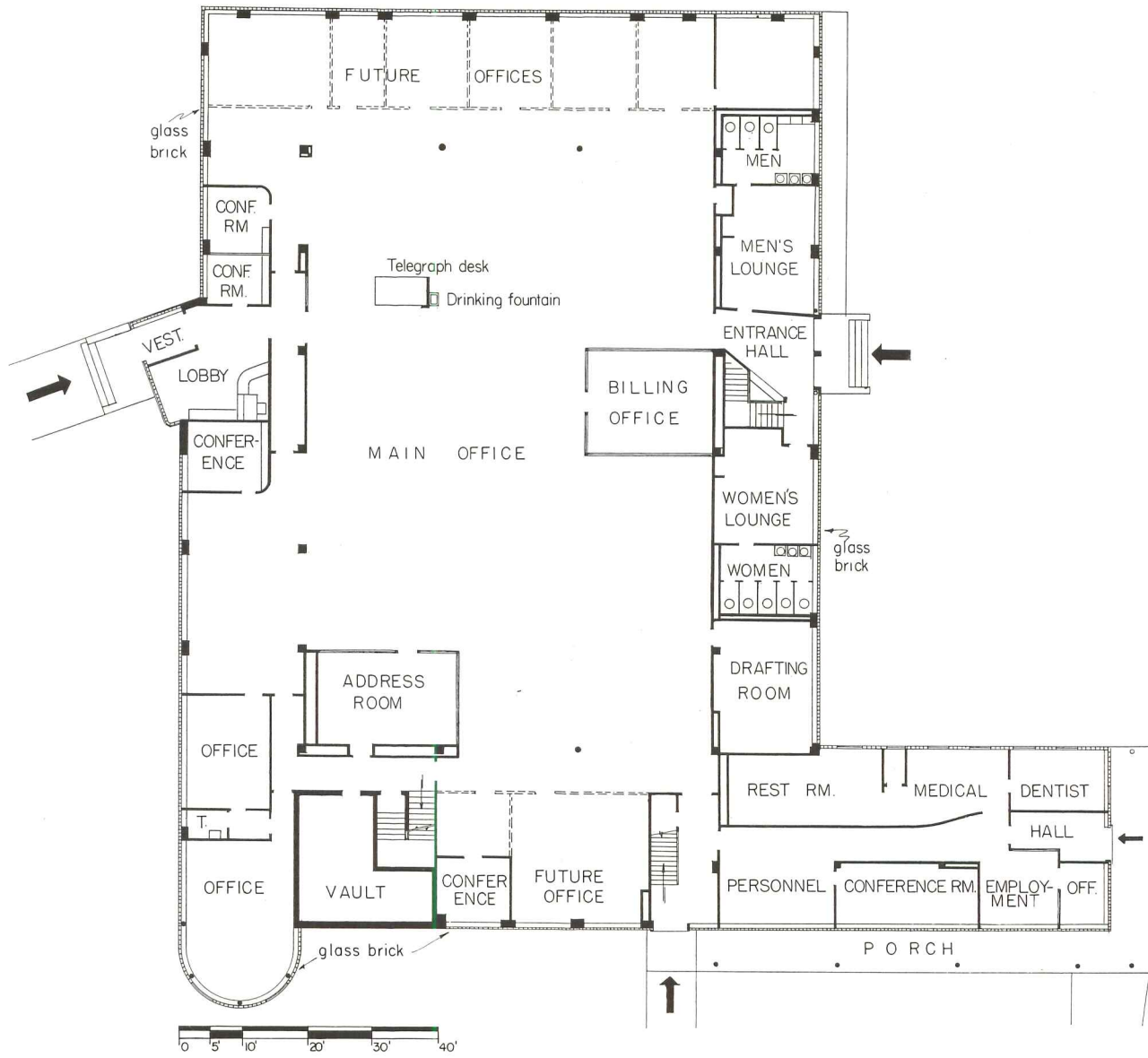
The main office as well as the address and billing offices extend through two floors. Employee recreational and educational facilities, on the second floor, include a lecture room (60 ft. by 32 ft.). Sliding doors permit this area to be converted into three conference rooms. Also provided is an employee lounge with a kitchen adjoining. An inverted truss forms the main office ceiling, resulting in the maximum reflection of light to the office area.

SCHEDULE OF MATERIALS AND EQUIPMENT

FOUNDATIONS	Reinforced concrete
FRAME	Structural steel and reinforced concrete
EXTERIOR	
Walls	Face brick—glass brick (Owens-Illinois) Limestone
Sash	Steel casement (Hope's Windows)
Roof	Built-up asphaltic, slag surface Built-up asphaltic, quarry tile surface
SCREENS	Bronze (Hope's)

(Continued opposite)

AND CONTROL BUILDING 1



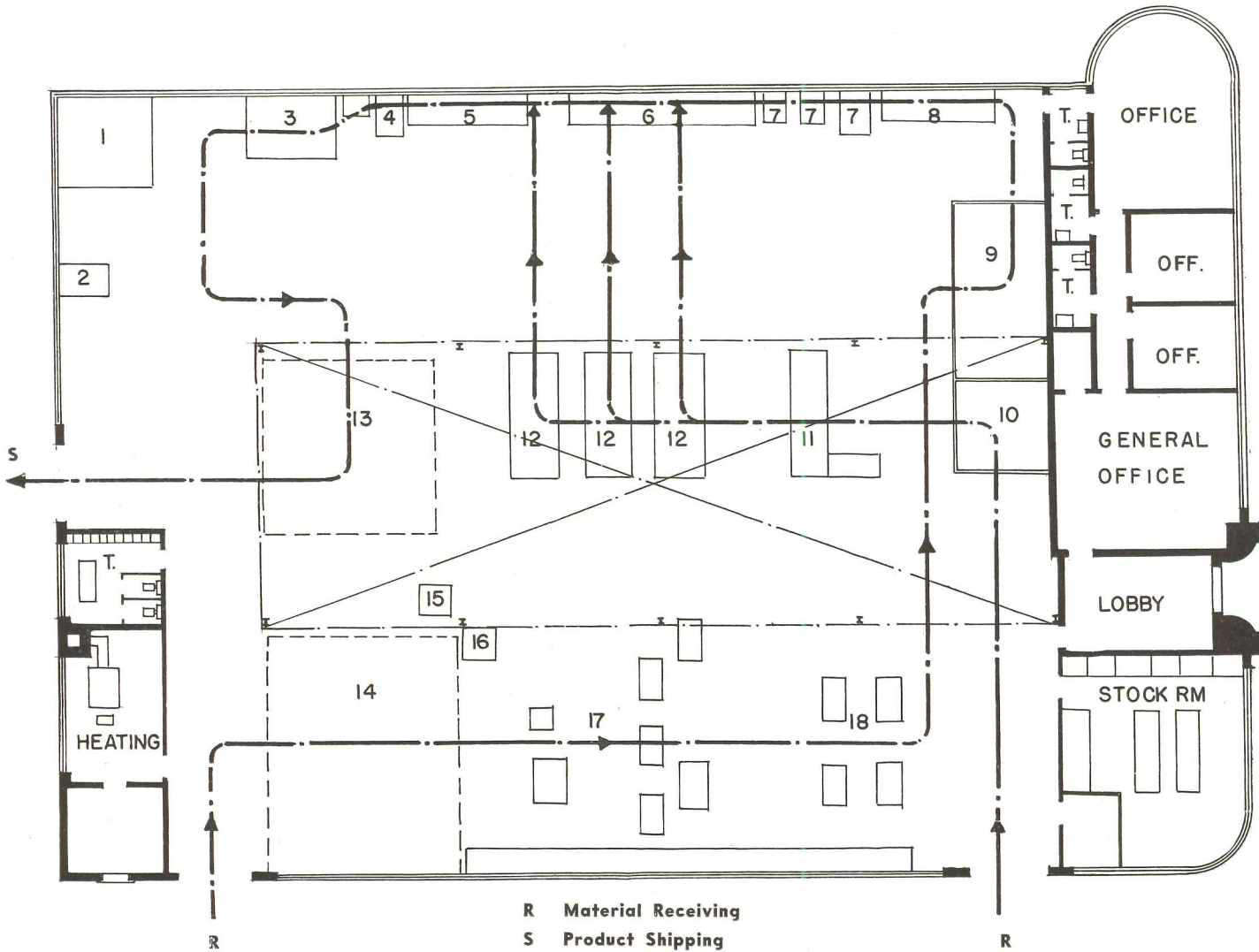
FIRST FLOOR PLAN

- WATERPROOFING** Integral waterproofing below grade
Exterior walls waterproof paint
- INSULATION** Spun glass (U. S. Gypsum Co.)
- GLAZING** Standard double thick glass (Pittsburgh Plate Glass Co.)
- PLUMBING**
- FIXTURES** White china (Crane Co.)
- HARDWARE** Chromium finish (Schlage Lock Co.)
- INTERIOR**
- Partitions** 3" T.C.
- Finish**
- Floor** Masonite (12" x 12" squares), except:
Ceramic tile: toilets and kitchen
Rubber tile: entrance hall, corridors, conference room
Cement: basement lobby and mechanical equipment rooms
Carpet: main offices
Glazed tile, except:
Rubber tile: entrance hall corridors
Cement: basement lobby
Ceramic tile: toilets and kitchen
Aluminum: entrance vestibule and lobby
- Base**

- Wainscot** Ceramic tile: toilets
Perforated Masonite: address room and billing room
- Walls** White plaster, except:
Smooth T.C.: mechanical equipment rooms
Keene's cement: toilets
Acoustical plaster: billing room and address room
Glazed T.C.: time office
- Ceiling** Hard white acoustone plaster, except in basement and stairs
- Stairs** Steel and concrete
- Treads** Alundum or Masonite
- AIR CONDITIONING** Complete with cooling throughout—using well water
- Control** Electric (Minneapolis Honeywell)
- LIGHTING**
- Indirect Lighting** Holophane fixtures recessed in ceilings
- PAINTING** Frazer Paint Co.

THE ALLEN CORPORATION DETROIT, MICHIGAN

DESIGNED AND BUILT BY THE AUSTIN CO.



PLAN SHOWING PRODUCTION LINE

Purpose:

To house the administrative and production elements of a metal ventilator factory.

MECHANICAL LAYOUT

- | | | |
|-------------------------------|--|---------------------------------|
| 1 Shipping supplies | 7 Spot welding machine | 13 Completed ventilator storage |
| 2 Saw (for crate manufacture) | 8 Rotor blade forming machine | 14 Heavy material storage |
| 3 Paint spray booth | 9 Finished sheet metal storage | 15 Power punch shear |
| 4 Assembly fixtures | 10 Sheet metal storage | 16 Metal band saw |
| 5 Final assembly bench | 11 Power shear | 17 Metal forming department |
| 6 Rotor balancing | 12 Sheet metal forming table
(cones - bars - bands) | 18 Machine department |

A METALWORKING PLANT 2

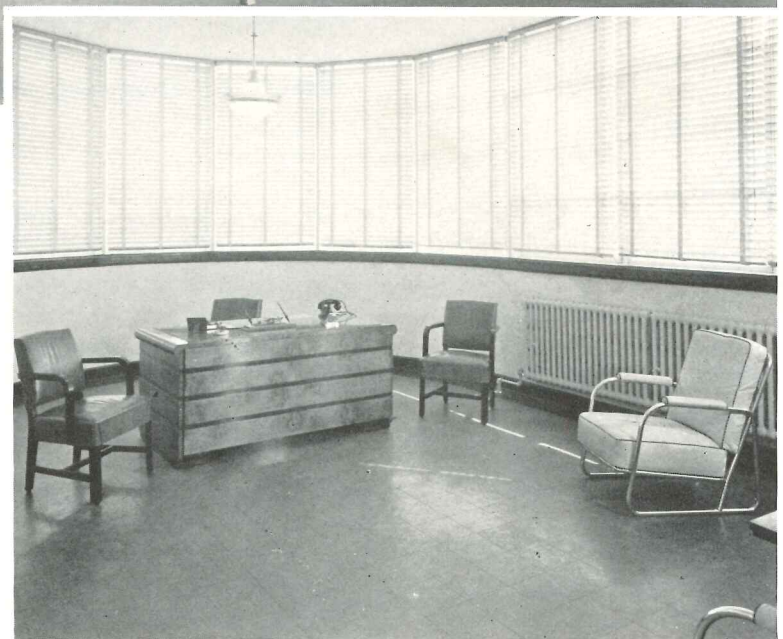
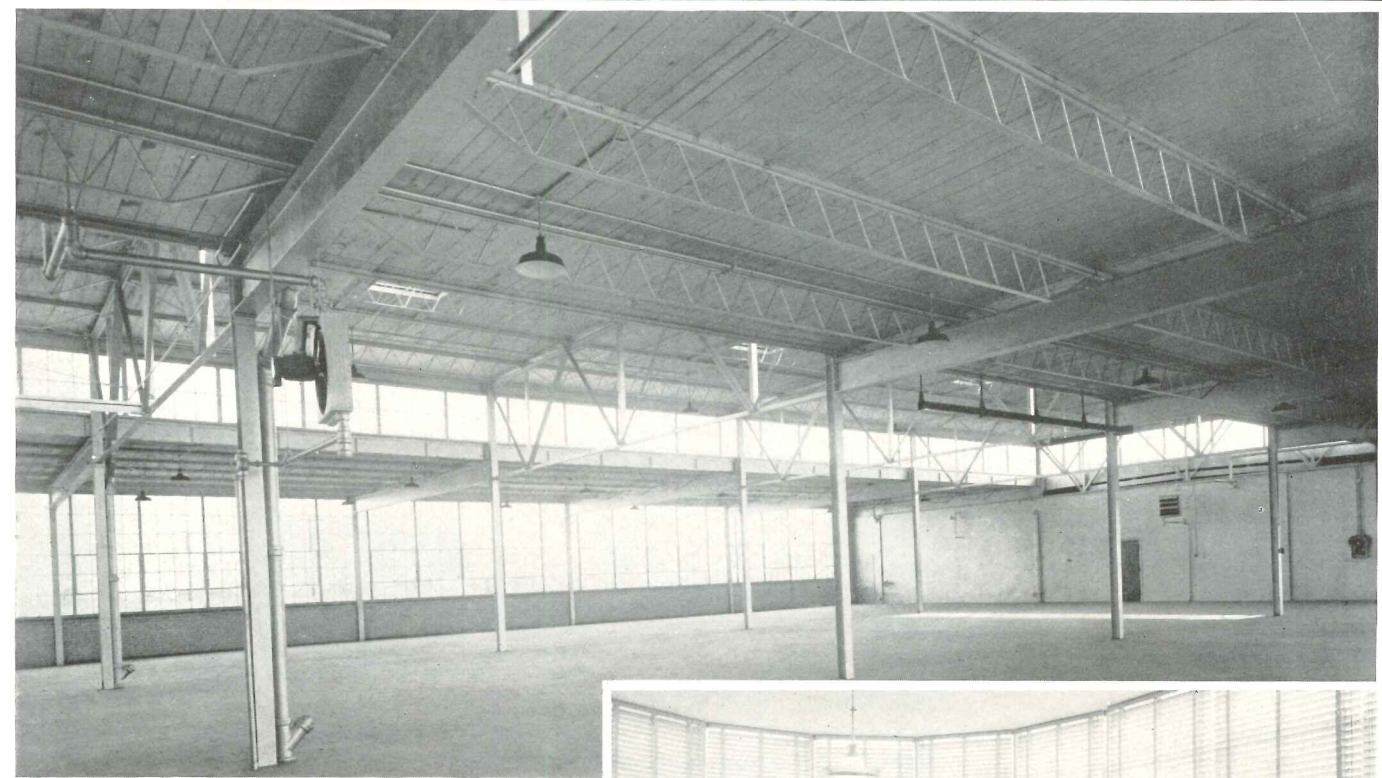
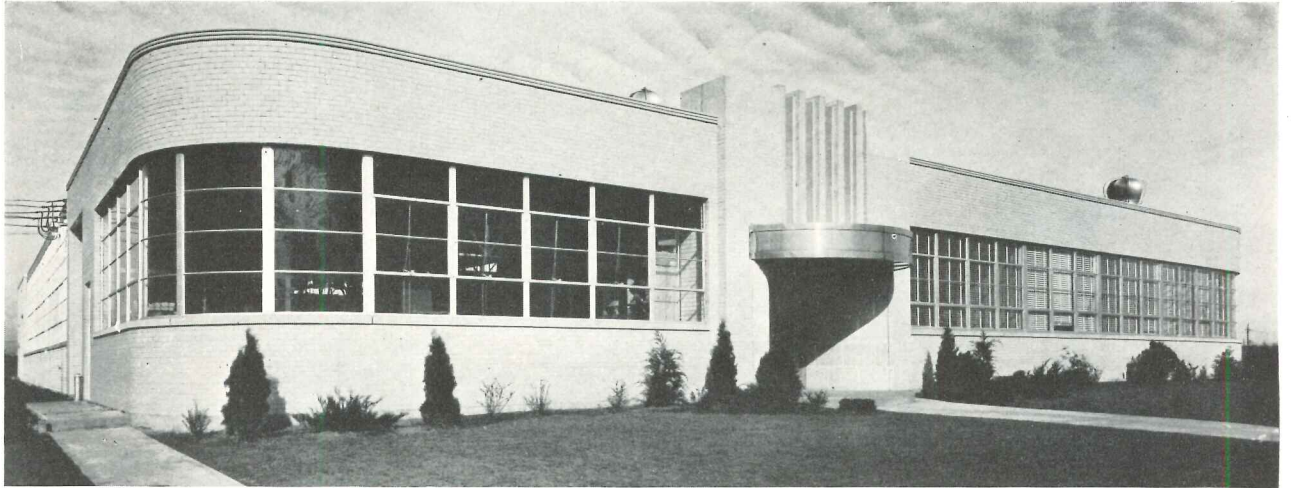
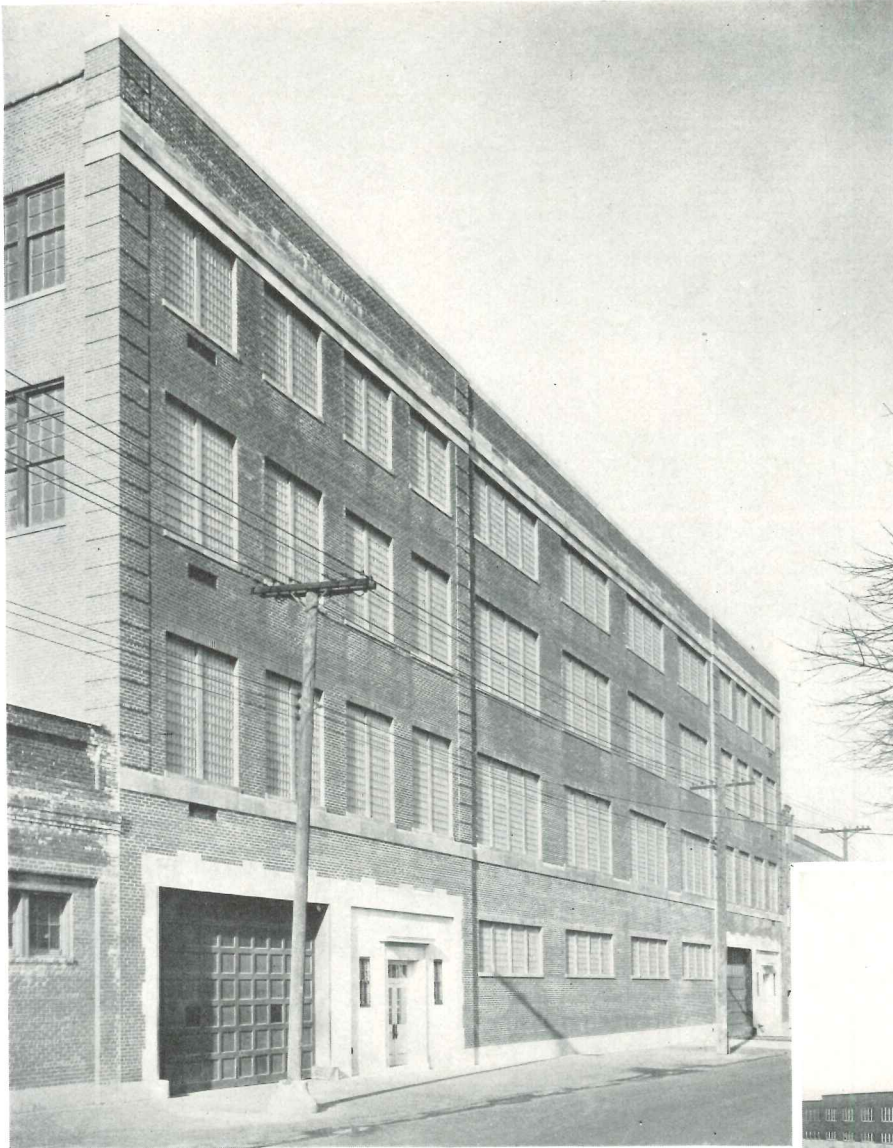


Photo by The Heiser Co.

Top—FRONT ELEVATION

Center—SHOP INTERIOR

Right—OFFICE OF THE PRESIDENT



Photos by Eric J. Baker

SHEFFIELD FARMS CO., Inc.
JAMAICA, LONG ISLAND

WILLIAM C. STOHLREIR,
ROBERT G. ZETSCHKE,
ARCHITECTS

**ELEVATIONS showing railroad siding
(material receiving) and truck en-
trance (product shipping)**



SCHEDULE OF EQUIPMENT AND MATERIALS

FOUNDATIONS	Reinforced concrete—steel pipe piles	Walls and Columns	Salt glazed tile in plant area (Hanley Co.)
FRAME	Structural steel (Bethlehem Steel Co.)	Stairs	Steel, Alundum treads
EXTERIOR		HEATING System	2-pipe vacuum steam supplied from central plant
Walls	Red face brick (Hanley Co.) Glass brick (Owens-Illinois)	AIR CONDITIONING	(except cooling) in manufacturing areas (Clarage Fan Co.) Air turbine ventilators (Allen Co.) Ducts: 16-oz. copper
Trim	Indiana limestone	PLUMBING Fixtures	All copper pipe throughout (Standard Plumbing Co.)
Roof	Built-up-pitch-slag surface (Philip Carey Co.) Copper and glass over R.R. loading platform	REFRIGERATION	Brine system from central power-house Refrigerators — 4" cork insulation (United Cork Co.)
Sash	Kalamein	ELECTRICAL	Lighting: 110-v. direct lighting Fixtures: industrial type (Benjamin)
Doors	Truck entrance: automatic (Overhead Door Co.) Others, Kalamein	ELEVATOR	20,000-lb. capacity—gearless traction (Houghton Elev. Co.)
WATERPROOFING	4-ply membrane waterproofing on all floors (Philip Carey Co.) Integral (Stearate) waterproofing all concrete 1" "Insulite" under roofing	DOORS	Manual type (Peele Co.)
INSULATION		HARDWARE	Bronze (Corbin)
INTERIOR			
Floors	Reinforced concrete slab		
Finish	Packing House tile in working areas Cement finish in trucking areas Red quarry tile in corridors, toilets, stair halls		

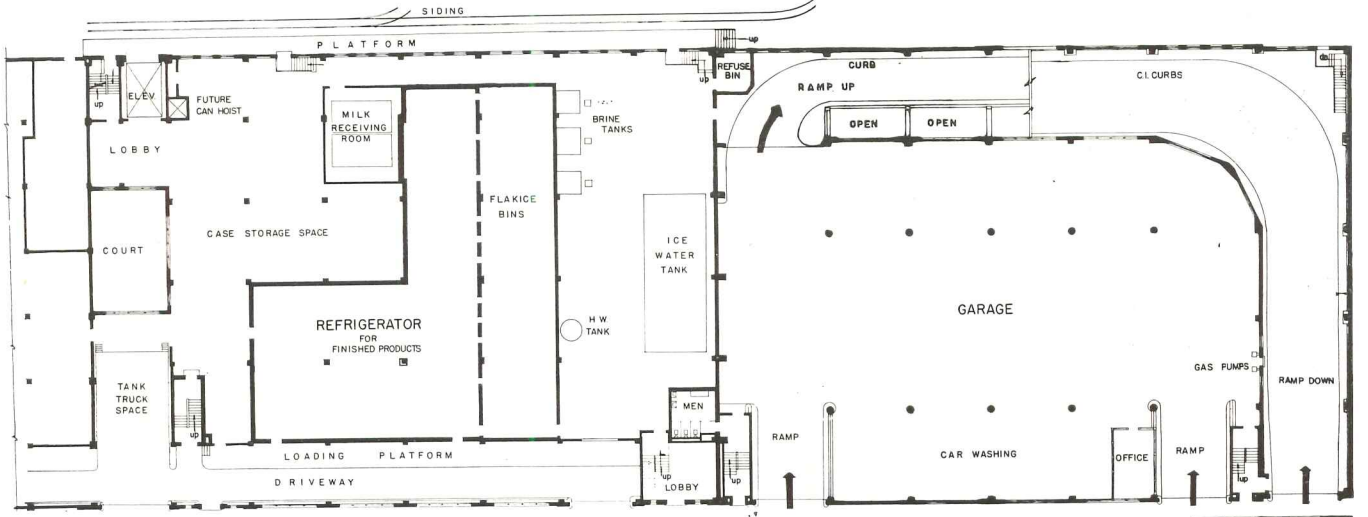
D I S T R I B U T I N G P L A N T 3



BASEMENT FLOOR PLAN

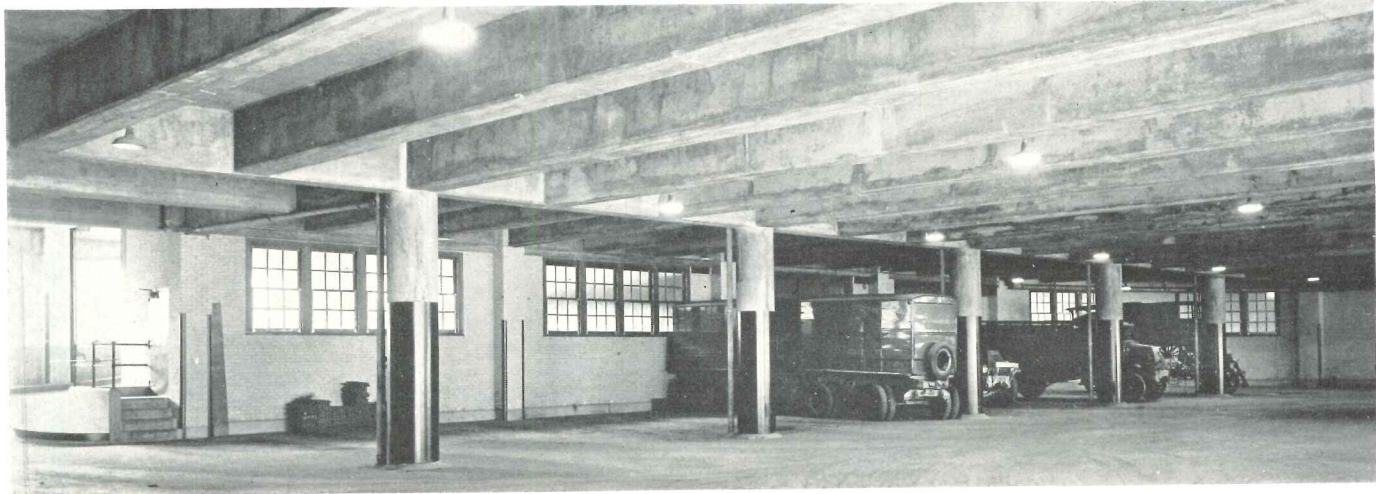
TRAILERS and trucks serving distributing branches are loaded on the basement floor. Route vehicles are serviced from the enclosed driveway on the first floor. The basement loading platform permits the loading of nine trailers at one time, after which operation they are

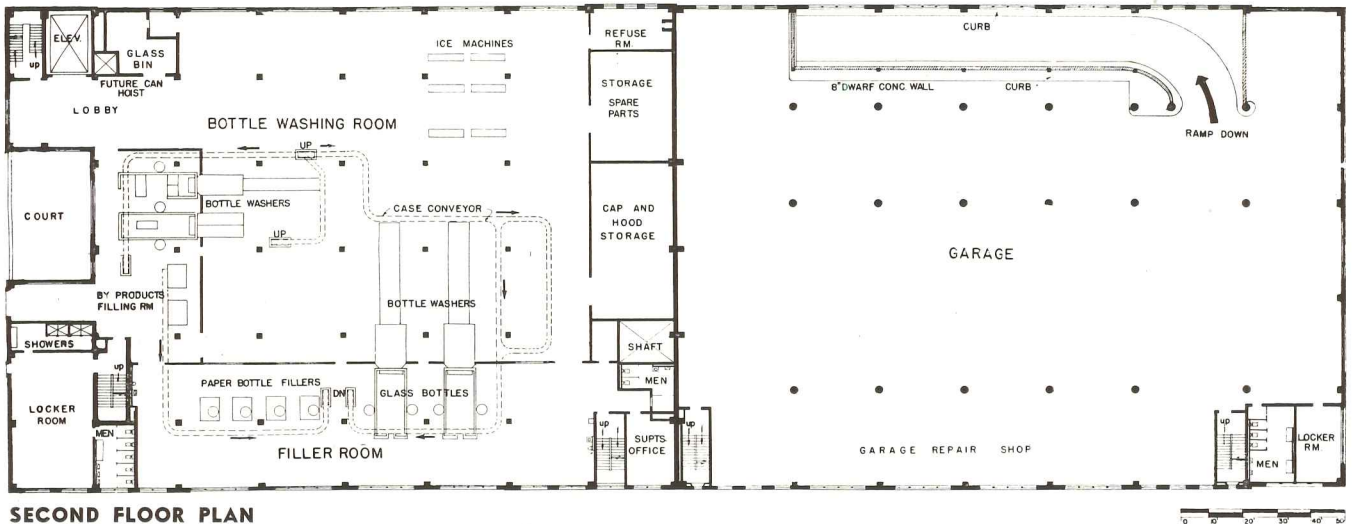
top-iced through hatches, by "Flakeice," delivered from the bins on the first floor. This basement loading area will accommodate the storage of 59 trailers and the ramp connecting to the street level allows the passage of two trailers abreast.



FIRST FLOOR PLAN

VIEW OF GARAGE FLOOR





SECOND FLOOR PLAN

THIS PLANT receives milk in bulk from the glass-lined tank cars brought to the siding and loading platform. It is then pasteurized, bottled and delivered, by truck, to nearby distribution stations. In addition to the treatment and delivery of milk, the plant also provides for the manufacture of milk byproducts—among these are: chocolate drink, buttermilk, butter, and cottage cheese.

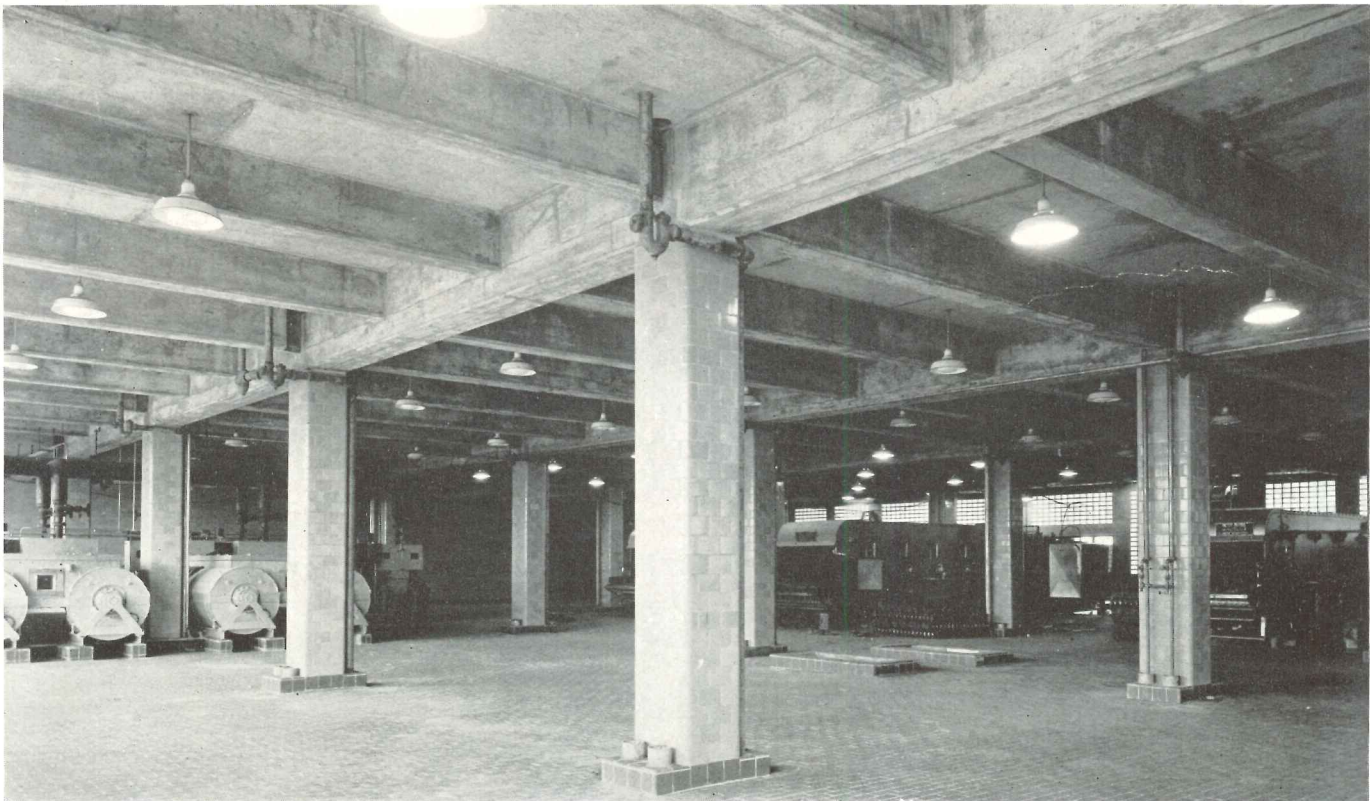
The maintenance problem was given special consideration in every department. Materials were selected that would stand up under the conditions which prevail in a milk plant. All construction is of the heavy duty type,

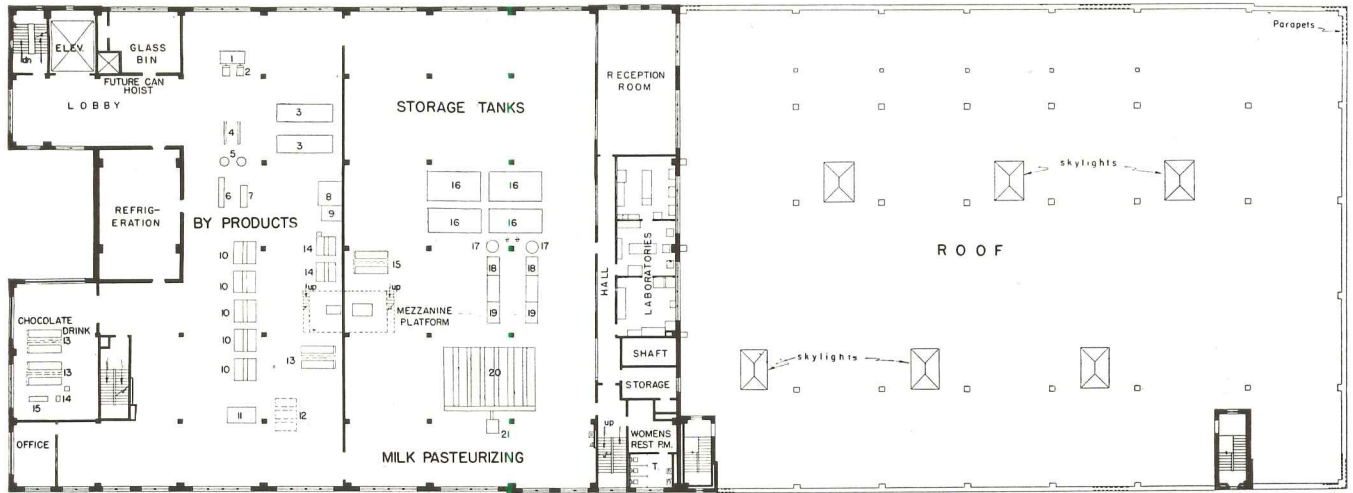
the floor slabs being designed for a maximum load of 400 lbs. per sq. ft. The floor fill, as well as the slab, is reinforced with steel and all curbs in the trucking area are protected by a cast iron armor. No materials subject to deterioration in the constant presence of steam or moisture have been used. Partitions were eliminated wherever possible to allow for future expansion and changes in methods or equipment.

Glass brick, not included in the original design, was used to minimize possible neighborhood complaints of noise emanating from the plant.

BOTTLE WASHING ROOM

Photo by Eric J. Baker





THIRD FLOOR PLAN

BYPRODUCT AND MILK PASTEURIZING ROOM LAYOUTS

- | | | |
|---------------------------|--|---|
| 1. W.T. supply tank | 8. Churn | 15. 30-Can sweet cream spray vats |
| 2. Sump pumps | 9. Motor | 16. Milk storage tanks, 4400 gals. each |
| 3. 100-Can cheese vats | 10. 105-Can buttermilk tanks | 17. Clarifier |
| 4. Box-tube heaters | 11. 50-Can chocolate tank | 18. Heater |
| 5. Separators | 12. Portable cream dump tank positions | 19. Cooler |
| 6. Separated cream cooler | 13. 30-Can butter cream spray vats | 20. Pasteurizers, 500 gals. each |
| 7. Plate heater-cooler | 14. 65-Can cream ripeners | 21. Circulating pump |

FILLER ROOM

Photo by Wurts Bros.



4 A P R I N T I N G P L A N T

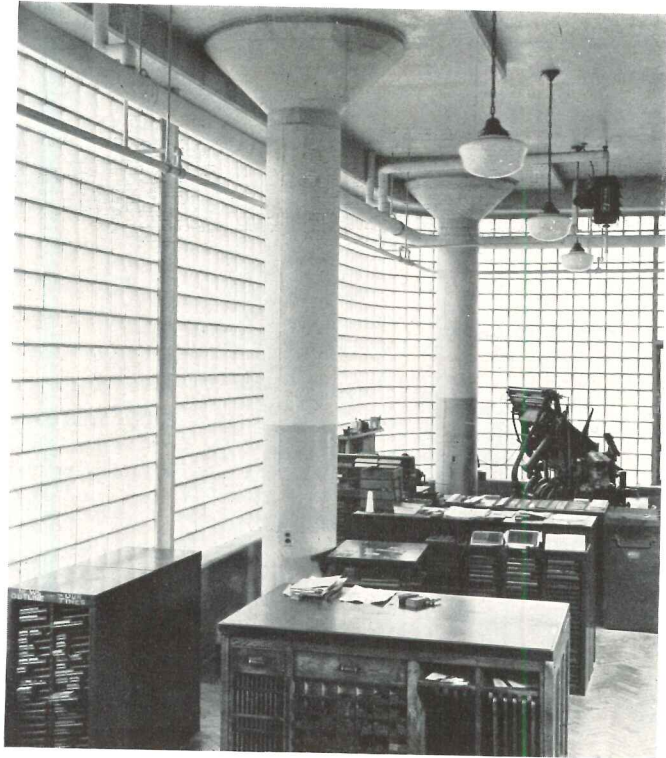


THE AMERICAN
EDUCATION PRESS, Inc.
COLUMBUS, OHIO

RICHARDS, McCARTY
AND BULFORD,
ARCHITECTS



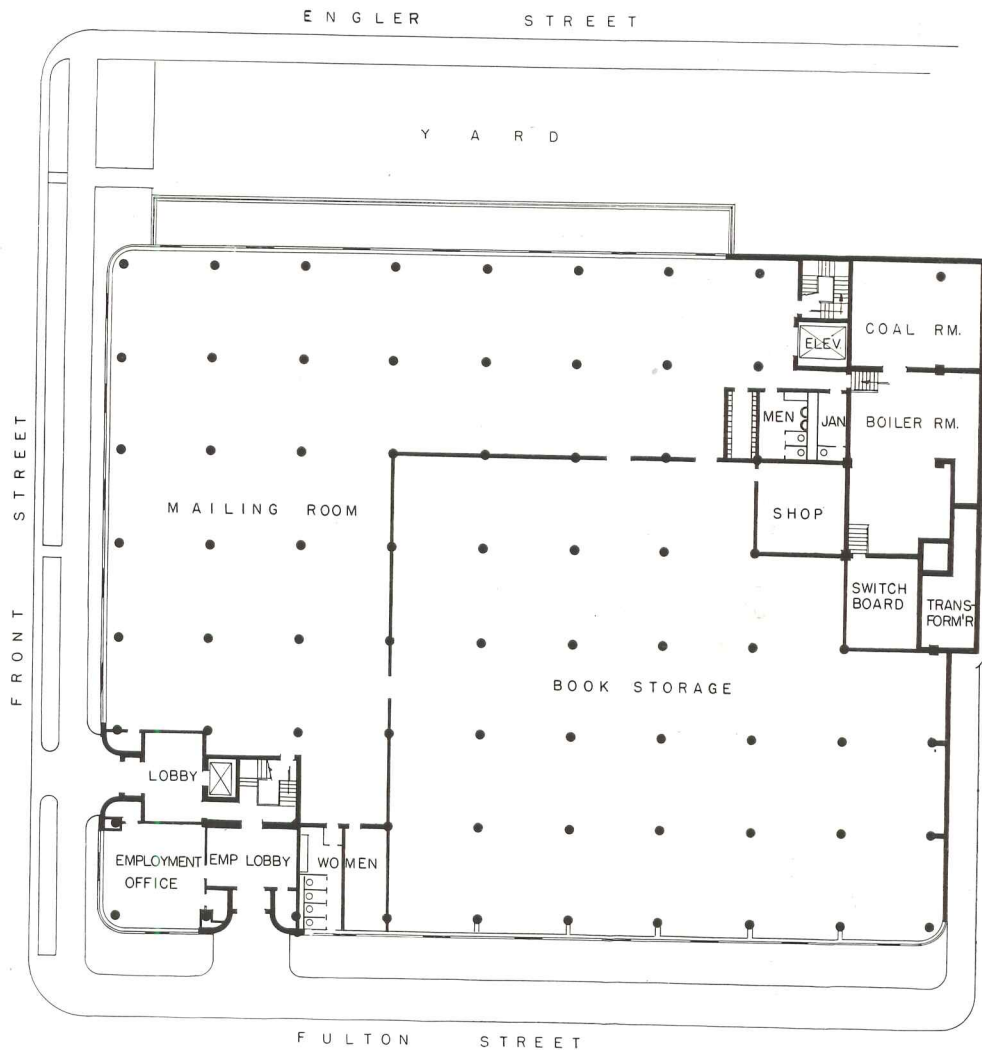
A P R I N T I N G P L A N T 4



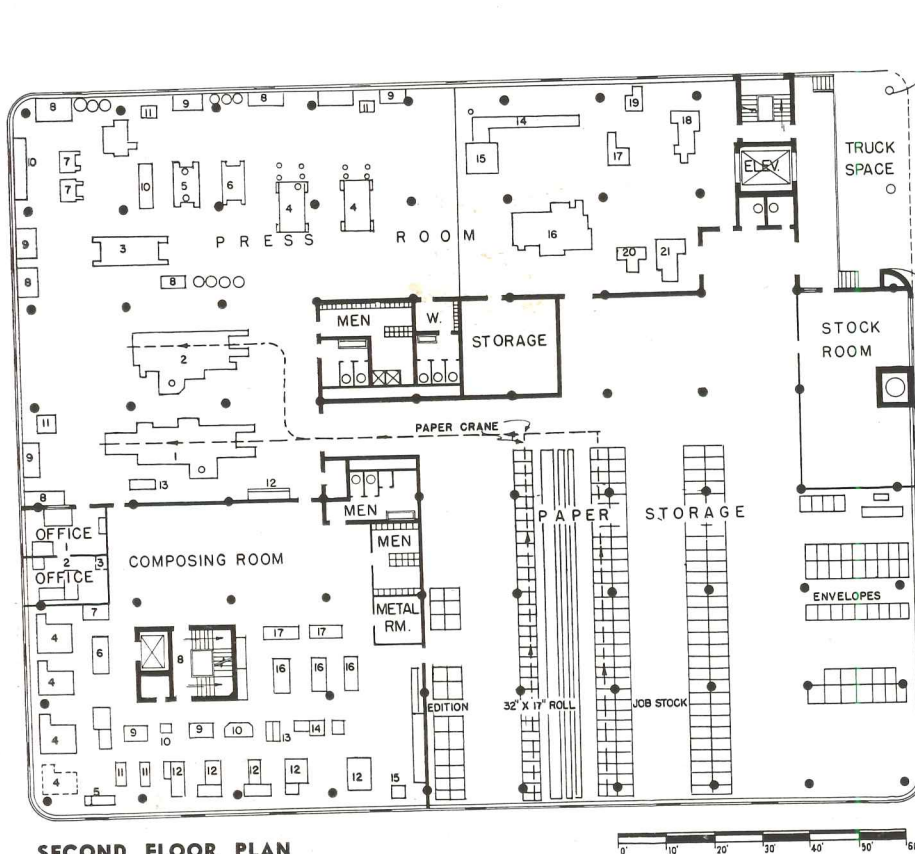
Purpose

To house the equipment, operations, and 200 employees engaged in the creation and production of weekly periodicals of varying contents and format which are printed, bound, and mailed to schools throughout the United States.

Glass brick was chosen for the window area because it was believed that its appearance and light-diffusing quality would result in a structure both comfortable and attractive to its occupants—and that it should also prove an economy in maintenance.



FIRST FLOOR PLAN



ON THE third floor are located the private offices of the executives and editors, the library, cut-file room, art department, and circulation department. The private offices are arranged along the exterior walls of Fulton and Front Streets—the other departments are lighted by large sawtooth skylights as well as by the glass brick wall exposures.

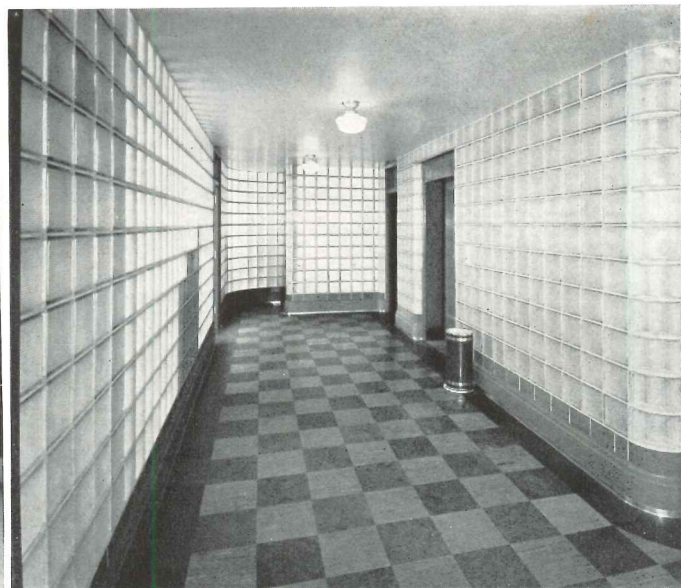
The roof construction is reinforced concrete in the exterior bay around the entire building. Inside this area, where the skylights occur, the roof is poured gypsum slab supported by steel framing. This construction will permit the addition of future story. Provision has also been made for the future air conditioning of the third floor area.

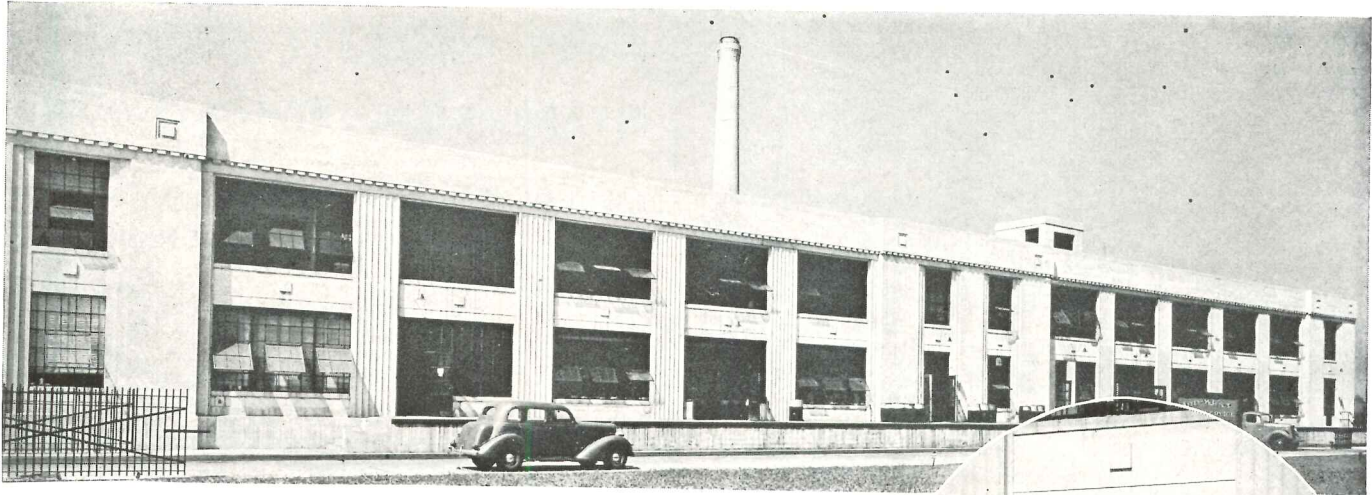
MECHANICAL LAYOUT OF PRESSROOM

- 1 Hoe 48-page rotary magazine press
- 2 Hoe 24-page rotary magazine press
- 3 Miehle No. 0 two-color press
- 4 Miehle No. 41 units (2)
- 5 Miehle horizontal
- 6 Miller simplex
- 7 Miehle vertical (2)
- 8 Paper crates
- 9 Inspection tables
- 10 Shelving
- 11 Light boxes
- 12 Ink storage
- 13 Cutler-Hammer conveyor to mailing department below
- 14 Christensen 6-station gathering and stitching machine
- 15 Seybold three-way trimmer
- 16 Dexter folder
- 17 Model W Cleveland folder
- 18 Model O Cleveland folder
- 19 Wright drill punch
- 20 Seybold 55-in. cutter
- 21 Seybold 44-in. cutter

MECHANICAL LAYOUT OF COMPOSING ROOM

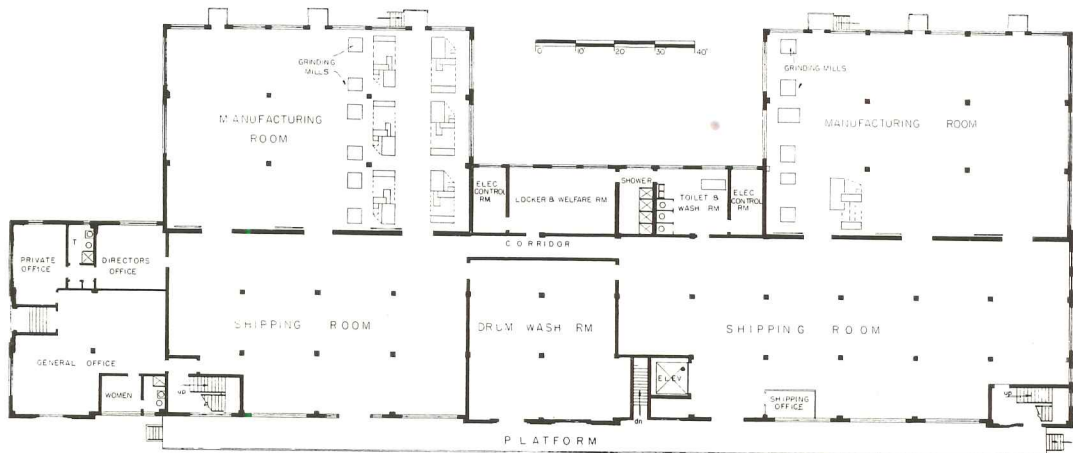
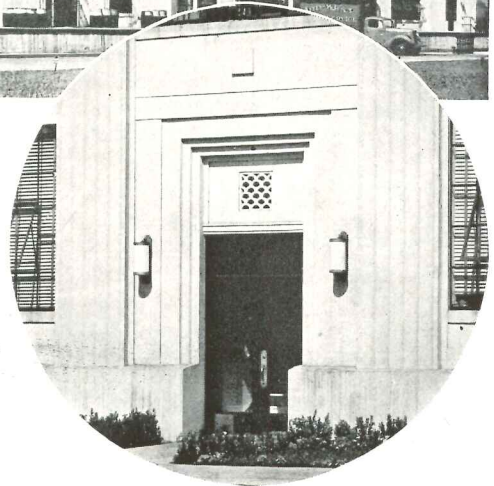
- 1 Mechanical superintendent's office
- 2 Composing room superintendent's office
- 3 Conveyor to proofroom above
- 4 Linotype machines
- 5 Machinist's bench
- 6 Elrod casting machine
- 7 Layout table
- 8 Elevator shaft and stairway
- 9 Proof press
- 10 Saw-trimmers
- 11 Dumps
- 12 Stone and galley storage
- 13 Galley storage
- 14 Trays, type, and furniture storage
- 15 Turtle
- 16 Type cabinets
- 17 Cut storage cabinets





IN - TAG COMPANY
CHICAGO, ILLINOIS

THIS steel and reinforced concrete structure is devoted to the manufacture of various printing inks. Solvents are delivered to underground tanks from tank car siding—pumped to automatic weigh hoppers on the second floor. The flow is then to the mills located on the first floor, pigments, lacquers, and other ingredients being added from the second floor hatches. An experimental laboratory, an essential department of such a plant, is located on the second floor.



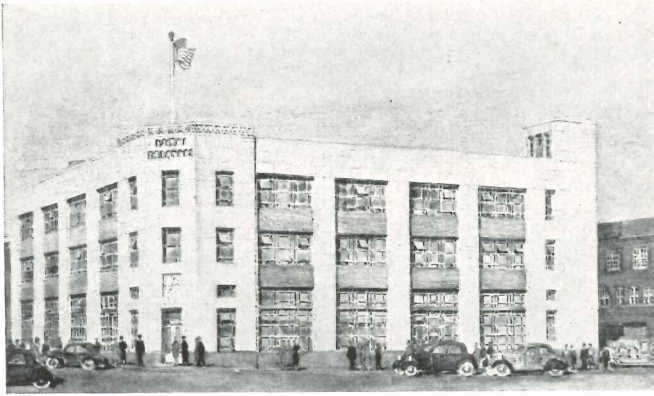
FIRST FLOOR PLAN

LABORATORY LAYOUT

- 1 Fadeometer
- 2 Desk
- 3 Files
- 4 Pull Table
- 5 Laboratory Table
- 6 Shelving
- 7 Autoclave
- 8 Erosion Tester
- 9 Centrifuge
- 10 Sink
- 11 Cabinet
- 12 Roller Mill



SECOND FLOOR PLAN



POST GAZETTE BUILDING PITTSBURGH, PENNSYLVANIA

WILLIAM GINSBERG,
ARCHITECT-ENGINEER

THIS completely fireproof building for the Pittsburgh Post Gazette is of two-way flat slab-type reinforced concrete construction. It is three stories high with full basement for paper storage. The entire exterior is veneered with granite, limestone and face brick. Windows on the street fronts are double-hung steel and those of the rear elevation are projected-type steel sash.

In general the concrete surfaces on the interior are not plastered but made smooth by means of plywood in the forms.

The office section of the building has soundproof ceilings and the partitions between the factory portion of the building and the office section are so constructed as to eliminate noise and vibration of the factory areas from the offices. The office floors are covered with terrazzo, linoleum, asphalt tile and other finishes suitable for the various spaces.

The factory portion of the building interior is exposed concrete. Where brickwork and partition work is installed, however, the surfaces are plastered. The floors in the factory portion of the building are of the industrial type suitable for the work in the various departments. The composing room floor has block type of flooring and in the laboratories an acidproof type was installed. Where heavy loads are applied and where floors will be subject to rough usage, they are covered

with steel plate properly anchored to the concrete slabs. Due to the atmospheric conditions in Pittsburgh, the paper storage spaces and the pressroom will be humidified and air conditioned in order to maintain constant atmosphere to prevent brittling of paper. Constant humidity will also prevent static electricity from developing where the paper revolves in the presses at high speed.

The entire building is built on concrete piles encased in steel shells and these foundations were built to receive additional floors should expansion be necessary in the future. Splitting the building into two parts so that a vertical section through the building will keep the factory on one side and the office section on the other has been found expedient in keeping vibration and noise of machinery away from those parts of the building where it is necessary to have quiet.

All foundations for machinery are isolated from the building to prevent this vibration and noise from entering the office section. Thus, floors of the pressroom are completely separate from the floors of the building proper. Separate piles, which are entirely independent of the main structure, were driven to carry the presses. The presses were designed to be carried on the piles by means of a beam and girder construction capping these piles. This beam and girder unit is isolated from the column footings of the building and separated by a sand

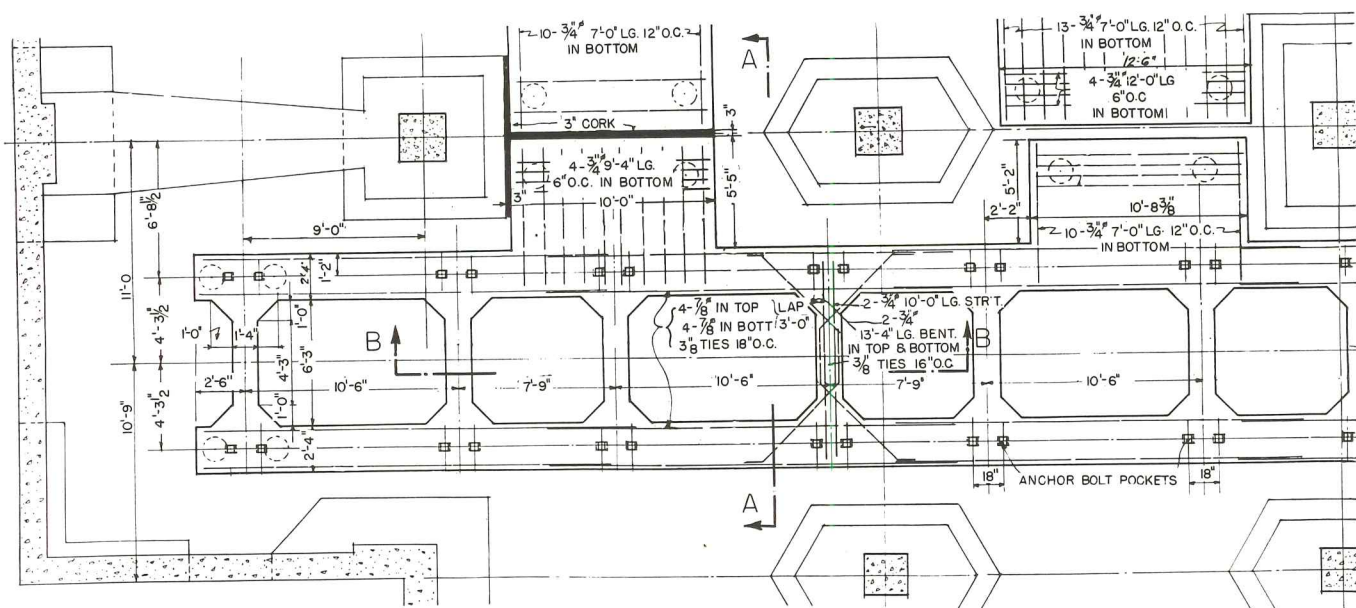


FIGURE 1 Plan of Press Foundation

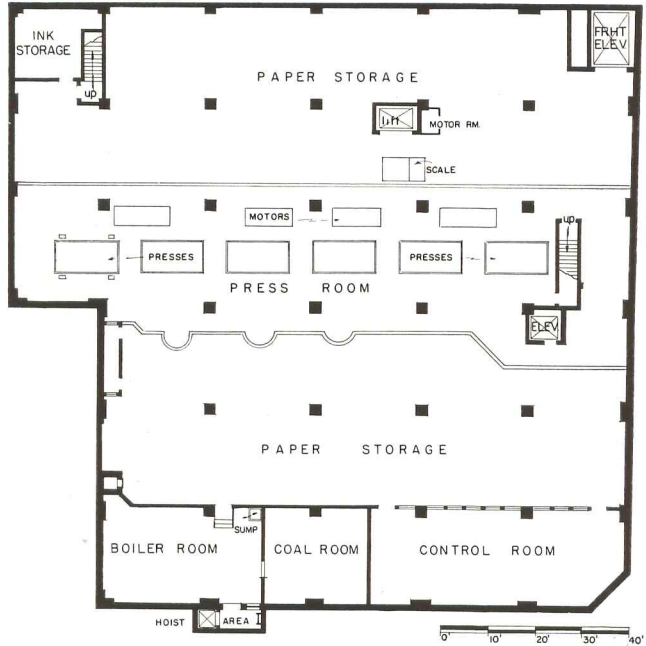
cushion in order to insure proper absorption of vibration by the soil. This construction has proven very effective in several other plants, in taking the load as well as the vibration, and has been found to be a valuable substitute for the old type of mat which has been generally accepted as a standard press foundation. (Figs. 1, 2, 3.)

Operation—Needs and Form

In laying out the plant, particular care was taken in arranging the mechanical and factory portions of the building so that they would operate in correct sequence. The considerations were:

1. Receiving, handling and storing of raw materials.
2. Locating the various mechanical departments so that the steps in manufacture will permit the finished product to reach a point of distribution near the street.
3. The handling and distributing of the finished product.
4. Locating the administrative and office departments so that they will have easy access to the factory sections of the building in which each office department is particularly interested.

The building is located on three streets and the delivery of raw materials takes place on the rear street where newsprint paper, stock, lead and other materials are delivered at one end. The various types of stock can be handled by means of the freight elevator to the end of the building where the freight elevator is located. Each



BASEMENT FLOOR PLAN

floor has assigned to it, on the same side of the building, the factory section; while the opposite section is assigned to offices and editorial departments.

The newsprint paper is handled by means of an automatic paper drop located on a loading platform on the first floor. Trucks backing up with paper automatically unload and discharge the paper to the basement reel room where the paper is stored and installed in the presses. The handling of the paper is facilitated by means of a system of track and turntables making it possible not only to distribute the paper throughout the basement and storage space but also to feed the presses.

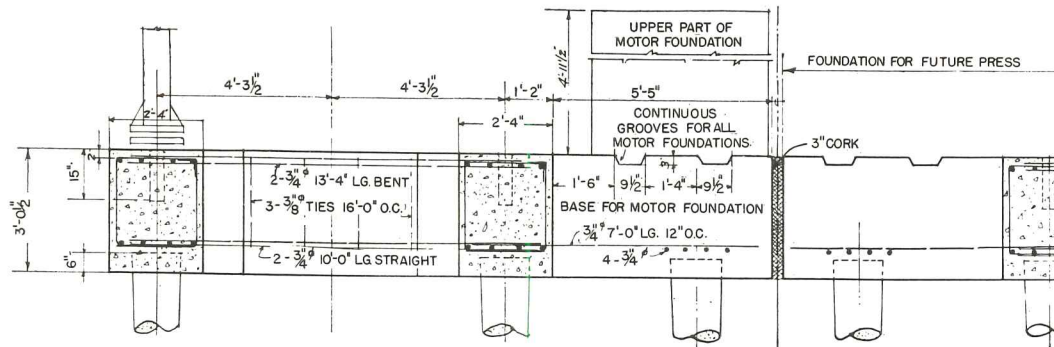


FIGURE 2
Section A-A

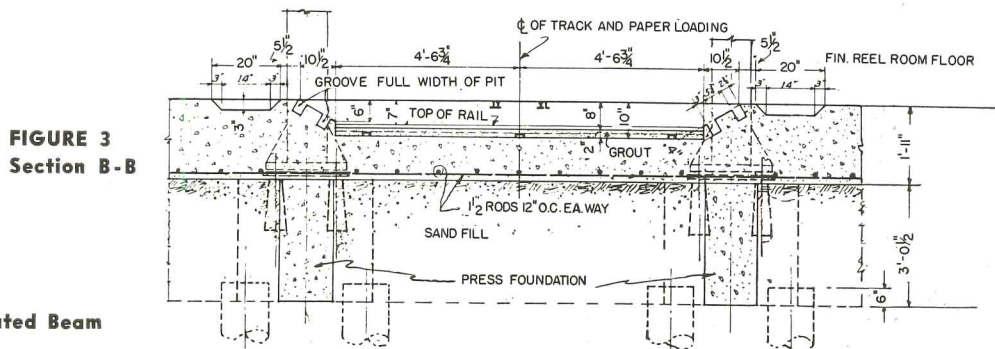
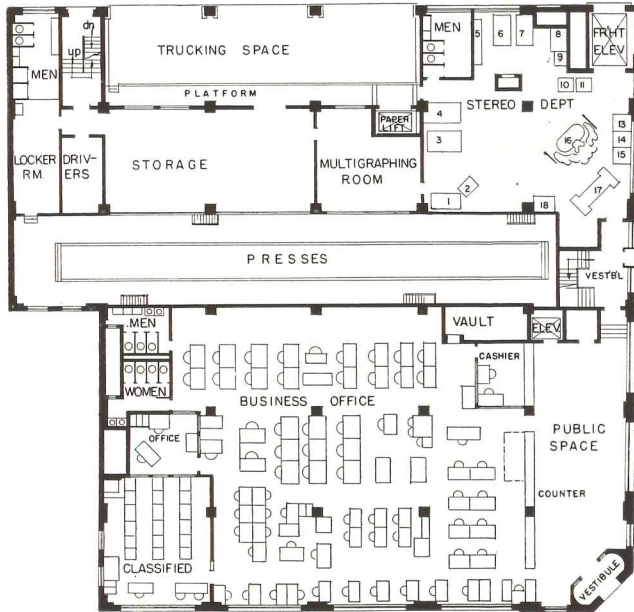


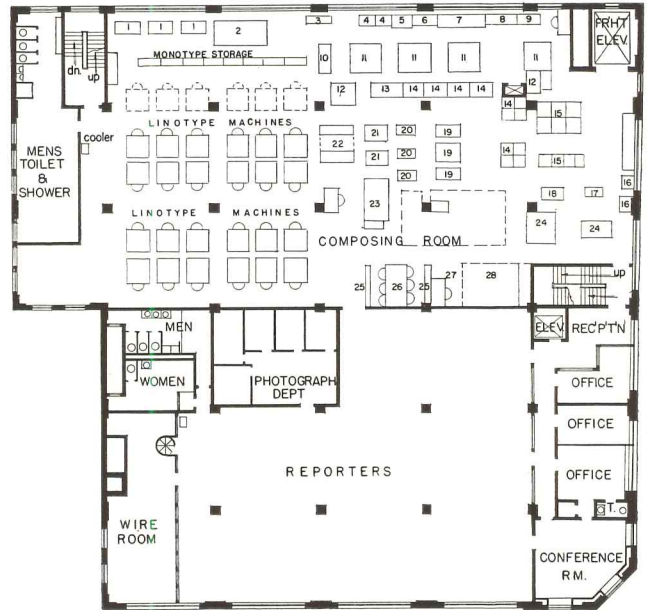
FIGURE 3
Section B-B

Details of newly developed Isolated Beam and Girder Press Foundation.

6 A NEWSPAPER PLANT



FIRST FLOOR PLAN



SECOND FLOOR PLAN



STEREOTYPE DEPARTMENT LAYOUT

1. Job Pot
2. Flat Cast
3. Saw
4. Shaver
5. Work Table
6. Saw
7. Shaver
8. Band Saw
9. Jig
10. Sta
11. Hi
12. Roaster
13. Packer
14. Cutter (metal mat chute above)

15. Pot
16. Shaver
17. Router

COMPOSING ROOM LAYOUT

1. Monotype Machine
2. Linotype Remelt
3. Pick Up
4. Wood
5. Ad
6. Quad Rack
7. Slug Rack
- 8, 9. Storage Racks
10. Ad Case
11. Ad Type

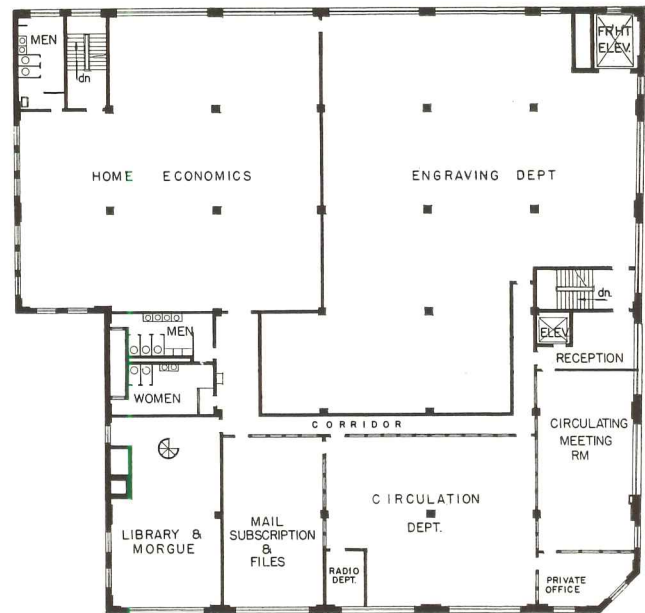
12. Miller Saw
13. Make-Up Table
14. Make-Up Cabinet
15. Type Cases and Galley Rack
16. Humidor
17. Wringer
18. Cutter
19. Proof Press
20. Type Case
21. Ludlow
22. Head Alley and Type
23. Ad Bank
24. Moulder
25. Correction Bank
26. Proof Table
27. Foreman
28. Make-Up Space

The stereotype department which makes the plates for printing purposes is located in the space adjacent to the press and these plates are automatically conveyed to the presses by means of a plate conveyor, making the handling of the plates as well as the paper efficient and automatic.

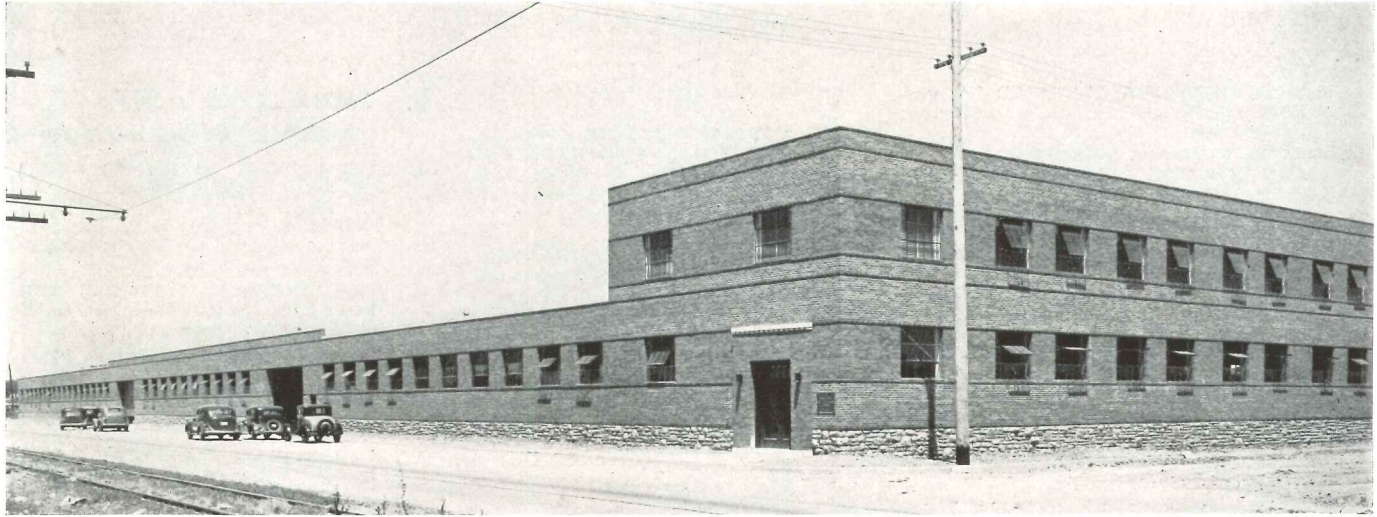
The first floor provides also, on the office side of the building, for the business, classified and advertising departments which are available to the public by means of a separate entrance in the main corner.

The second floor contains the composing room, which is immediately over the presses and the stereotype department. The finished product from the composing room is sent down by gravity to the stereotype department. Adjacent to the composing room is located the editorial department, the photographic department and the library, giving the editor and his associates easy access to the composing room where the copy may be examined and checked after the type is arranged.

The third floor contains the photoengraving department, the circulation department and other miscellaneous sections of the newspaper plant which may be located remote from the mechanical departments.



THIRD FLOOR PLAN

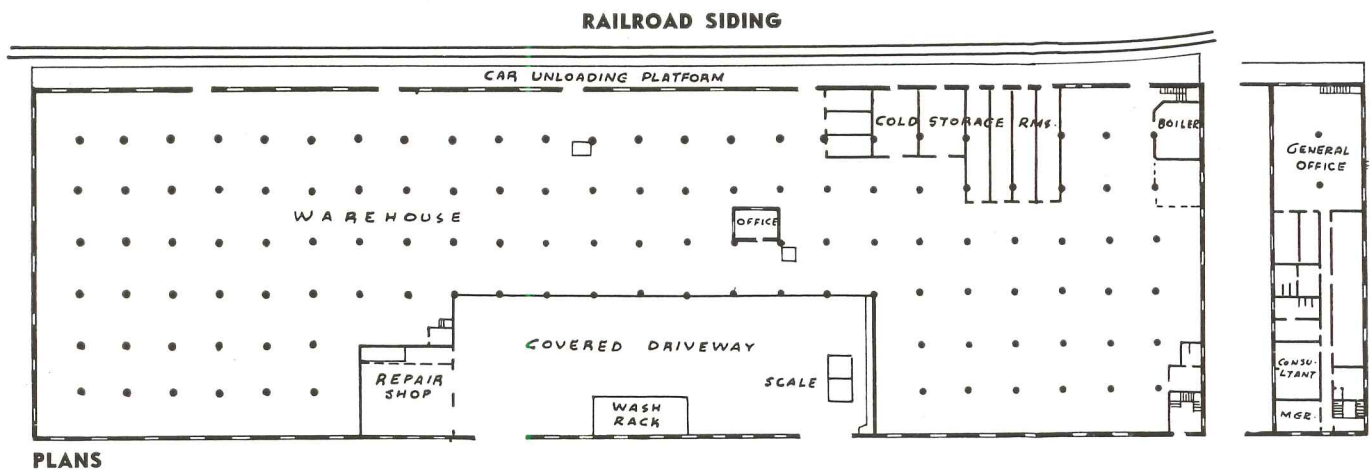


Ortho Photo Co.

KROGER GROCERY AND BAKING CO.

NORTH KANSAS CITY, MISSOURI

KEENE AND SIMPSON, A.I.A., ARCHITECTS



PLANS

Purpose

Groceries are delivered to the building from railroad siding—distributed to a wide area by truck.

Capacity

The building (500' x 152') provides approximately 60,000 sq. ft. of storage area. Offices occupy an area of approximately 6,000 sq. ft. on the second floor.

Cost

Approximately \$2 a sq. ft.

Details

Construction of reinforced concrete and structural steel, solid masonry walls. Built-up asphaltic roof, slag surface.

The offices are completely air conditioned, an independent refrigerating plant being used for the large refrigerator rooms which serve the storage of meats, vegetables, and bananas. These various compartments are kept at varying temperatures and degrees of humidity as contents require.

Bibliography . . . Factory Design and Construction

(Continued from page 123)

8.

5. m "HOUSEKEEPING IS EASIER IN A BRIGHT PLANT" by C. F. Scheer. National Safety News, Jan. 1937.
6. "INDUSTRIAL ENVIRONMENT AND HEALTH." World Peace Foundation, 1936.
7. m "FACTORY SANITATION—WASH-ROOM FACILITIES." Illustr. National Safety News, March 1937.
8. m. "INDUSTRIAL VENTILATION AND SILICOSIS PREVENTION." Illustr. Heating and Ventilating, Vol. 33, June 1936.
9. m "SHOWER AND WASHROOMS. PREVENTION AGAINST SPREAD OF RINGWORM INFECTIONS." National Safety News, Jan. 1936.
10. m "INDUSTRIAL HYGIENE AND SANITATION SURVEYS IN CHEMICAL ESTABLISHMENTS" by Sayers, Dalla Valle, and Yant. Illustr. Industrial and Engineering Chemistry News, Vol. 26, Dec. 1934.
11. m "KEEPING WORKERS HEALTHY" by A. C. Carruthers. Illustr. Safety Engineer, Vol. 69, Apr. 1935.
12. m "AUTOMOTIVE PLANT'S SAFETY PROGRESS" by G. Applegren. Automotive Industries, Vol. 75, Sept. 1936.
13. m "INDUSTRIAL HYGIENE." Journal of Industrial Hygiene, Vol. 19, Jan. 1937.

9. INDUSTRIAL ARTS (And Related Bibliographies)


1. INDUSTRIAL CHEMISTRY AND CHEMICAL ENGINEERING. By John H. Perry, Ed. in Chief. McGraw-Hill, New York City, 2609 pp. Illustr. \$9. A reference work that covers the chemical engineering and related fields.
2. ELEMENTS OF CHEMICAL ENGINEERING. By Badge and McCabe. McGraw-Hill, New York City, \$5. Classifies the various types of equipment used in the chemical industries.
3. FACTORY ORGANIZATION AND ADMINISTRATION. By Hugo Diemer. McGraw-Hill, New York City, 1935, \$4.
4. INDUSTRIAL MANAGEMENT. By Robbins and Folts. McGraw-Hill, New York City, \$5.
5. PRACTICAL FACTORY ADMINISTRATION. By M. Porosky. McGraw-Hill, New York City, \$2.50. Industrial organization. Building and equipment.
6. FACTORY STOREKEEPING, THE CONTROL AND STORAGE OF MATERIALS. By H. H. Farquhar. McGraw-Hill, New York City, 1922. Illustr.
7. ENGINEERING FACTORY SUPPLIES. By W. J. Hiscox. Sir I. Pitman & Sons, London, 1926. The purchase, storage, and distribution of factory materials.
8. PLANT ENGINEER'S MANUAL. By L. C. Morrow. Industrial Engineer, Chicago, Ill., 1929. Illustr.
9. m "WASTE ELIMINATION." By F. J. Poppelen. Soc. for Advancement of Management, March 1937.
10. FACTORY SANITATION. HANDBOOK ON OFFENSIVE TRADES. By D. Ronald, W. Hodge & Cox, London, 1935. 204 pp., 15 shillings.
11. m "ROTATING STEEL BINS FOR FACTORY USE." Illustr. Iron Age, Sept. 24, 1936.
12. m "SIXTEEN BASIC MAINTENANCE PRINCIPLES" by C. J. Stuart. Factory Management, Vol. 92, Sept. 1934.
13. m "ERECTION AND EQUIPMENT OF A NEW CHEMICAL PLANT" by J. H. West. Chemical Industries, Vol. 39, Dec. 1936.
14. m "MINIATURE MODEL OF A MODERN DISTILLERY." Illustr. Chemical and Metallurgical Engineer, Vol. 43, Dec. 1936.
15. m "DIESEL POWERED COMMUNITY." Freeport, New York. With cost data. By J. W. Anderson. Illustr. Power, Vol. 81, Jan. 1937.
16. m "GERMAN FOUNDRY EXHIBITION." Illustr. Engineer, Vol. 162, Nov. 6, 1936. Also—Engineering, Vol. 142, Dec. 11, 1936.
17. m "FIRE PREVENTION IN PAINT AND VARNISH PLANTS" by D. R. Loney. Canadian Chemistry and Metallurgy, Vol. 20, Dec. 1936.
18. THE DESIGN OF STEEL MILL BUILDINGS AND THE CALCULATION OF STRESSES IN FRAMED STRUCTURES. By Milo S. Ketchum. McGraw-Hill Book Co., New York City, 1932.
19. m "CEMENTS AND SEA WATER" by A. J. Blank. Including bibliography Rock Products, Vol. 40, Apr. 1937.
20. m "CHEMICAL ENGINEERING IN THE PULP AND PAPER INDUSTRY" by T. L. Crossley. Illustr. Canadian Chemistry and Metallurgy, Vol. 21, March and April 1937.
21. m "SURVEY OF LITERATURE ON THE MANUFACTURE AND PROPERTIES OF IRON AND STEEL."

\$1407⁰⁰—SAVED

with

DETROIT Lo Stoker

READ THIS LETTER



O'SULLIVAN'S RUBBER HEELS AND SOLES

WINCHESTER, VA.

March 26, 1937

Detroit Stoker Company
General Motors Building
Detroit, Michigan

Gentlemen:

It took us about eight months to decide what stoker to install under our 150 HP H.R.T. Boiler in our Winchester, Virginia, Plant, but only one month's use to prove that we had made a wise decision by installing a Detroit Stoker and that our savings in coal were far beyond what we had expected.

In addition to the savings in coal and labor, we at all times have a constant steam pressure which is extremely important in a manufacturing process such as ours.

The coal records submitted to you will speak for themselves and may be used as you see fit in your endeavor to save manufacturers money by installing Detroit Stokers.

Very truly yours,
THE O'SULLIVAN RUBBER CO., INC.
R. L. Hunter
R. L. Hunter, Plant Manager

rlh:k

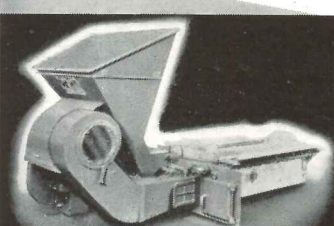
Write for Bulletin 364

DETROIT STOKER COMPANY

Fifth Floor, General Motors Building • Detroit, Michigan

Works at Monroe, Michigan . . . District Offices in Principal Cities

Built in Canada at London, Ontario



Iron and Steel Institute Journal, Vol. 134, No. 2, 1936.

22. m "ENAMEL MANUFACTURE." Illustr. Electrician, Vol. 117, July 1936.

23. THE ADVANCED TECHNIQUE OF PORCELAIN ENAMELING. By J. E. Hansen. Published for the Ferro Enamel Corp. by the Enamelist Publishing Co., Cleveland, Ohio, 1932. A complete analysis of modern enameling plants.

24. THE PRINCIPLES OF LEATHER MANUFACTURE. By Procter, Spon & Chamberlain, 120 Liberty St., New York City. Illustr. 673 pp.

25. INDUSTRIAL FURNACES. By W. Trinks. 2 vols. John Wiley & Sons, New York City.

26. m "BREWERY INDUSTRY" by G. L. White. Illustr. Canadian Chemistry and Metallurgy, Vol. 20, Jan. 1936.

27. CONCRETE CONSTRUCTION. (Vocational Ser. No. 5.) 88 pp. Including a bibliography on the subject. U. S. Office of Education, Washington, D. C. \$10. Supt. of Documents, 1935.

28. "COAL AND COAL PRODUCTS." Bibliography on this subject. 65 pp. By F. R. Wadleigh, 800 Prince St., Alexandria, Va.

29. m "PLACE OF THE PILOT PLANT IN PROCESS DEVELOPMENT" by F. C. Uilbrandt. Including a bibliography on the subject. Transactions of the American Institute of Chemical Engineers, Vol. 31, 1934, 1935.

30. m BIBLIOGRAPHY OF PULP AND PAPER MAKING. 1928-1935. By C. J. West. 803 pp. \$8. Lockwood Trade Journal Co., New York City, 1936.

31. m FLOUR MILL PROCESSES. By J. H. Scott. 416 pp. \$7.50. Van Nostrand, New York City, 1936.

32. THE BOOT AND SHOE INDUSTRY. By J. S. Harding. Pitman and Sons, New York City, 1931.

33. STEAM POWER PLANT ENGINEERING. By L. A. Harding. 777 pp. Illustr. \$10. 1932. John Wiley & Sons, Inc., New York City.

34. m "EUROPEAN FOUNDRY PRACTICE." Bibliography on the subject. Foundry, Vol. 63. Dec. 1935. Also—Apr., June, Sept., Oct., Dec. 1936.

35. FLOUR MILLING PROCESSES. By J. H. Scott. 416 pp. \$7.50. Van Nostrand, New York City.

36. m "SURVEY OF LITERATURE ON THE MANUFACTURE AND PROPERTIES OF IRON AND STEEL." Journal of Iron and Steel Institute, Vol. 135, No. 1, 1936.

37. m "ELECTRIFIED LAUNDRIES." Data sheet. Electrical World, Vol. 106, March, May, June, 1936.

38. DIESEL ELECTRIC PLANTS. By E. J. Kates. 181 pp. \$2. American Technical Society, Chicago, Ill., 1936.

39. m "ALUMINUM AND RUBBER MANUFACTURE" by R. T. Griebing. Illustr. Rubber Age, Vol. 39, Aug. 1936.

40. m "PRESENT DAY PROBLEMS OF THE ROLLING-MILL INDUSTRY" by A. Nöll. Illustr. Engineering, Vol. 142, Dec. 1936.

41. m "SOAP INDUSTRY." Illustr. Fortune, Vol. 13, Apr. 1936.

42. m "DEVELOPMENTS IN STEEL WIRE MANUFACTURE" by K. B. Lewis. Blast Furnace and Steel Plant, Vol. 24, Jan. 1936.

43. m "BIBLIOGRAPHY ON INDUSTRIAL ENGINEERING." Journal of the Institute of Electrical Engineers, Vol. 77, Oct. 1935.

44. m "CHEMICAL ENGINEERING AS A BASIC FACTOR IN MODERN INDUSTRY" by W. E. Gibbs. Engineering, Vol. 136, July 1933.

45. m "TREATMENT OF BEER SLOP AND SIMILAR WASTES" by A. M. Buswell. Illustr. Water Works and Sewerage, Vol. 82, April 1935.

46. m "BREWING PROCESSES" by R. Schwarz. Illustr. With flow-sheets. Industrial and Engineering Chemistry, Vol. 27, Sept. 1935.

47. m "BIBLIOGRAPHY ON THE COOLER STORAGE OF BEEF" by A. W. Ewell. Refrigerating Engineering, Vol. 29, Jan. 1935.

48. m "SCOTTISH SHALE OIL INDUSTRY." The technique of its operations. Illustr. Chemical Age (London), Vol. 33, July 1935.

49. CIGAR MANUFACTURING INDUSTRY (Including a bibliography). 140 pp. \$2.50. Univ. of Penn. Press, Phila., Pa., 1933.

50. m "HANDLING AND STORING OF GRAIN WITH SPECIAL REFERENCE TO CANADIAN METHODS" by H. H. Broughton. Illustr. Proceedings of the Institute of Mechanical Engi-

neers, Vol. 124, 1933. Includes a bibliography.

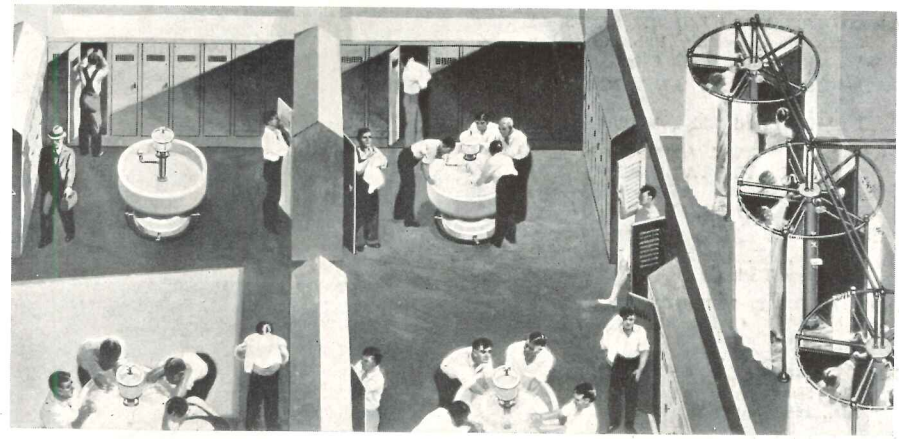
51. ART AND THE MACHINE. By Sheldon and Martha Cheney. McGraw-Hill Book Co., New York City, 1936.

52. THE METALLOGRAPHY OF IRON AND STEEL. By C. Hubert Plant. London, 1933. Pitman & Sons. Illustr. Includes a bibliography.

53. THE MANUFACTURE OF SUGAR FROM THE CANE AND BEET. By T. H. P. Heriot. Illustrated, 436 pp. \$9.50. Longmans, Green, & Co., 114 5th Ave., New York City.

54. SWEET'S CATALOG FILE. Published annually in sets. F. W. Dodge Corp., 115-119 W. 40 St., New York City. A very practical reference file of manufacturers and their building products or equipment.

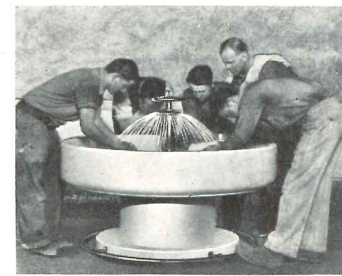
(Continued on page 142)



Improve Your Washing Facilities Save Money, Time and Space

Group washing facilities, Bradley Washfountains and Bradley Multi-Stall Showers, are saving money, time and space in industry's workshops in every part of the country.

The Washfountains accommodate 10 persons at one time, use but little more water for the 10 than for one at an ordinary wash basin. Each person gets his own clean running water—and this grouping into one fixture saves floor space, piping and maintenance expense.



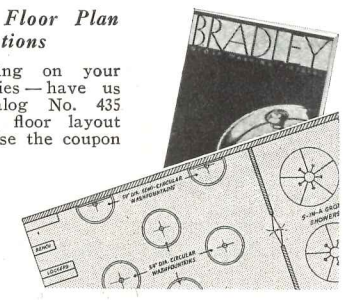
Above: Portion of typical wash-room—Bradley Washfountains with Bradley Group Showers at right.

At Left: Close-up of Washfountain illustrating convenience.

The Multi-Stall Showers—three or five showers in one unit—make installation easier—save space—save maintenance. The latest in economical shower facilities and already widely used in factories, institutions, clubs, airports, etc. BRADLEY WASHFOUNTAIN CO., 2227 W. Michigan St., Milwaukee, Wis.

Catalog has Floor Plan Suggestions

Before deciding on your washing facilities—have us mail our catalog No. 435 which includes floor layout suggestions. Use the coupon reminder.



BRADLEY WASHFOUNTAINS and GROUP SHOWERS

BRADLEY WASHFOUNTAIN CO.
2227 W. Michigan St., Milwaukee, Wis.
Please mail copy of Catalog No. 435.

Name

Address

City..... State.....

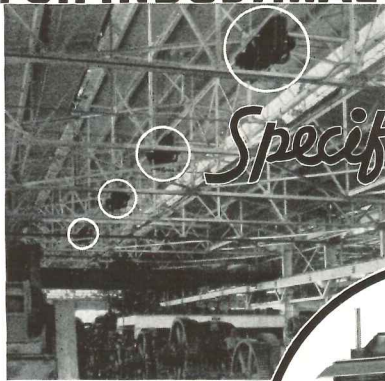
Bibliography . . . Factory Design and Construction

(Continued from page 141)

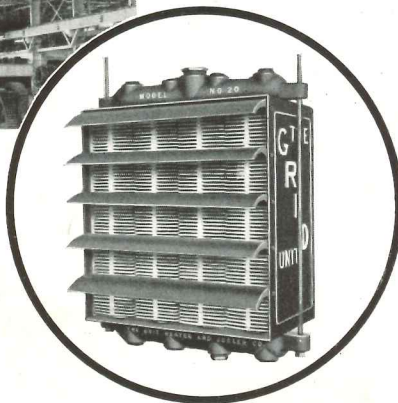
LIST OF PERIODICAL REFERENCES

- AMERICAN ARCHITECT AND ARCHITECTURE.** No. 3. Single copy \$1. Hearst Mags. Inc., 572 Madison Ave., New York City.
- JOURNAL OF THE AMERICAN CHEMICAL SOCIETY.** \$8.50. Mills Bldg., 1709 G. St. N. W., Washington, D. C.
- AMERICAN GAS JOURNAL.** \$2. Single copy \$.25. American Gas Journal, Inc., Dodge Bldg., 53 Park Pl., New York City.
- TRANSACTIONS OF THE AMERICAN INSTITUTE OF CHEMICAL ENGINEERS.** \$10. Single copy \$3. Bellevue Court Bldg., Phila., Pa.
- AMERICAN MACHINIST.** \$3. Single copy \$.35. McGraw-Hill Pub. Co., Inc., 330 W. 42 St., New York City.
- JOURNAL OF THE AMERICAN STATISTICAL ASSOC.** \$6. Single copy \$1.50. 722 Woodward Bldg., Washington, D. C.
- ANNALS OF THE AMERICAN SOCIETY OF POLITICAL AND SOCIAL SCIENCE.** \$5. Single copy \$2. 3457 Walnut St., Phila., Pa.
- ARCHITECTURAL RECORD.** \$3. Single copy \$1. F. W. Dodge Corp., 119 W. 40 St., New York City.
- AUTOMOTIVE INDUSTRIES.** \$1. Single copy \$.25. Chilton Co., Chestnut and 56 St., Phila., Pa.
- BLAST FURNACE AND STEEL PLANT.** \$2. Single copy \$.25. Steel Publications, Inc., 108 Smithfield St., Pittsburgh, Pa.
- BRICK AND CLAY RECORD.** \$5. Single copy \$.50. Industrial Publications Inc., 59 E. Van Buren St., Chicago, Ill.
- CANADIAN CHEMISTRY AND METALLURGY.** \$4. Single copy \$.40. U. S. Agents: Macintyre and Simpson, 75 E. Wacker Drive, Chicago, Ill.
- THE CANADIAN ENGINEER.** \$4. Single copy \$.15 (in U. S.). 341 Church St., Toronto, Ont.
- CHEMICAL AND METALLURGICAL ENGINEERING.** \$3. Single copy \$.35. McGraw-Hill Pub. Co., New York City.
- CHEMICAL INDUSTRIES.** \$3. Single copy \$.25. 149 Temple St., New Haven, Conn.
- CIVIL ENGINEERING.** \$5. Single copy \$.50. 33 W. 39 St., New York City.
- EDISON ELECTRIC BULLETIN.** \$2. Single copy \$.25. 420 Lexington Ave., New York City.
- ELECTRICAL WORLD.** \$4. Single copy \$.25. McGraw-Hill Pub. Co., New York City.
- ENGINEER.** Published Essex St., Strand, London, W.C.
- ENGINEERING.** Published Bedford St., Strand, London, W.C.
- ENGINEERING NEWS-RECORD.** \$5. Single copy \$.25. McGraw-Hill Pub. Co., New York City.
- FACTORY MANAGEMENT AND MAINTENANCE.** \$3. Single copy \$.35. McGraw-Hill Pub. Co., New York City.
- FOOD INDUSTRIES.** \$3. Single copy \$.35. McGraw-Hill Pub. Co., New York City.
- FOUNDRY.** \$2. Single copy \$.25. Penton Bldg., Cleveland, Ohio.
- HEATING AND VENTILATING.** \$2. Single copy \$.30. Industrial Press, 148 Lafayette St., New York City.
- HEATING, PIPING AND AIR CONDITIONING.** \$2. Single copy \$.25. Keeney Pub. Co., 6 N. Mich. Ave., Chicago, Ill.
- INDUSTRIAL STANDARDIZATION & COMMERCIAL STANDARDS.** \$4. Single copy \$.35. American Standards Assoc., 29 W. 39 St., New York City.
- IRON AGE.** \$6. Single copy \$.25. Chestnut and 56 Sts., Phila., Pa.
- MACHINERY.** \$3. Single copy \$.35. Industrial Press, 148 Lafayette St., New York City.
- MANUFACTURERS RECORD.** \$2. Single copy \$.25. Commerce and Water St., Baltimore, Md.
- NATIONAL PETROLEUM NEWS.** \$2. Single copy \$.10. 1213 W. 3 St., Cleveland, Ohio.
- PETROLEUM AGE.** \$1. Single copy \$.25. 500 N. Dearborn St., Chicago, Ill.
- POWER.** \$3. Single copy \$.35. McGraw-Hill Pub. Co., New York City.
- POWER PLANT ENGINEERING.** \$2. Single copy \$.25. 53 W. Jackson Blvd., Chicago, Ill.
- ROCK PRODUCTS.** \$2. Single copy \$.25. 205 W. Wacker Drive, Chicago, Ill.
- RUBBER AGE.** \$2. Single copy \$.25. 250 W. 57 St., New York City.
- SHEET METAL WORKER.** \$2. Single copy \$.25. 45 W. 45 St., New York City.
- STEEL.** \$4. Single copy \$.25. Penton Pub. Co., Penton Bldg., Cleveland, Ohio.
- TEXTILE WORLD.** \$3. Single copy \$.35. McGraw-Hill Pub. Co., New York City.

FOR INDUSTRIAL BUILDINGS



Specify the **GRID**
UNIT HEATER



No other unit heater like it. The heating sections are all-cast aluminum bonded to cast high-test iron steam chambers . . . no soldered, brazed or expanded joints . . . no pressed or rolled joints . . . no unions, and the fewest connections possible. Cannot be affected by electrolysis. Lint, dust, or fumes will not plug it up. And, a sturdy construction that can neither be bent out of shape nor broken. The Grid Unit Heater is permanent equipment that requires no maintenance expense—and will last indefinitely. Write for complete engineering data.

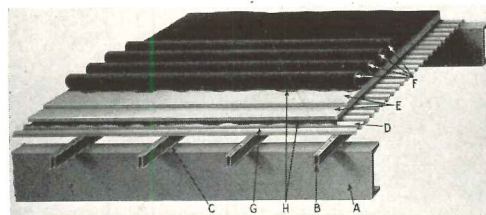
THE UNIT HEATER & COOLER CO.
WAUSAU, WISCONSIN
Offices in all principal cities

GRID UNIT HEATER

UNIVERSAL INSULATED STEEL ROOF DECK

A New, Simple Principle of Long-lived Construction

Extremely rigid, low in cost and light in weight, also flexible in application. The answer to many roof problems. Adaptable to every normal load and roof condition. The Aluminized Finish resists corrosion. Approved by Engineers and Architects.



- A. Purlins
- B. Universal Metal Sections
- C. Weld
- D. Special Corrugated Top Sheet
- E. Insulating Material mopped down with hot Asphalt —(H)
- F. Waterproofing
- G. Nails — Helyx or Similar

The Universal Sections are welded to the purlins, and the top sheet is fastened to the Sections with special Helyx Drive Screws. This sheet is then covered with pressure board type insulating material, mopped down with hot asphalt, and the whole is covered with built-up waterproofing, shingles or other roof coverings. On steep pitches, a clip or dart is provided to attach the insulation to the steel deck.

Universal Decks have been erected on factories, gymnasiums, schools, hospitals, garages, theatres, warehouses and municipal buildings, and they are recommended wherever an inexpensive, light, fire-safe insulated roof is required.

Write Today for Catalog and Engineering Data

**THE UNIVERSAL METAL
SECTIONS COMPANY**

1740 E. 12th Street, Cleveland, Ohio

