

# BUILDING NEWS

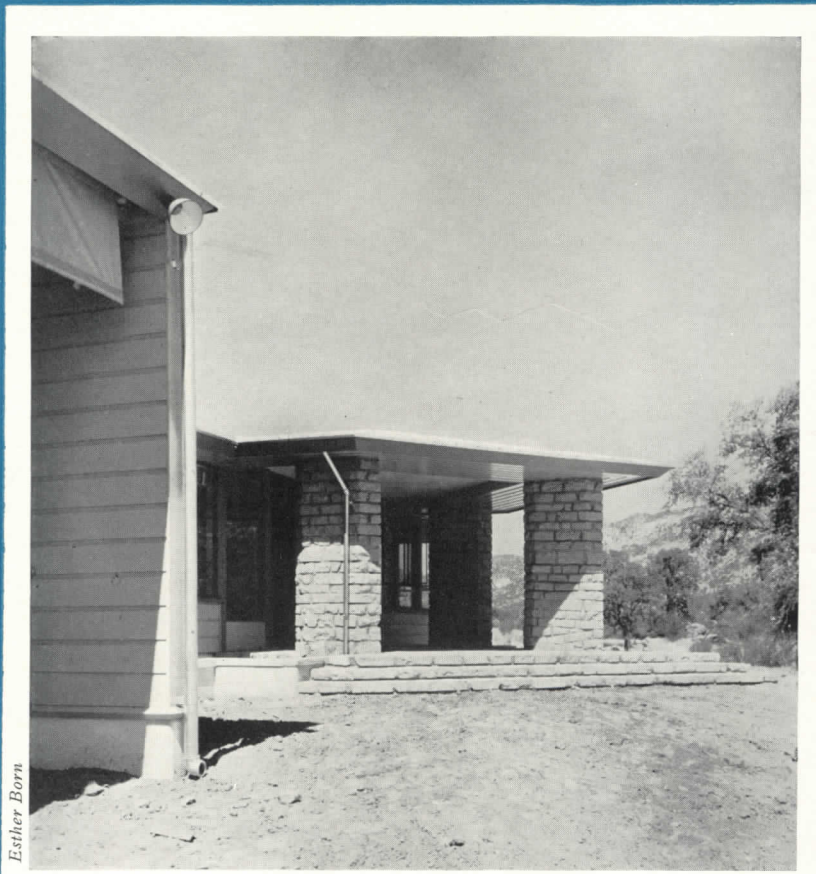

*Estler Born*

**High School in California . . . See pp. 40-42**

ARCHITECTURAL  
RECORD



# NEW, REMODELED, AND FUTURE STORE BUILDINGS IN UNIFIED DESIGN

E. L. ROBERTSON, AIA, and JOHN R. WEBER, Architects

ELEANOR LEMAIRE, Designer of Interior Fixtures

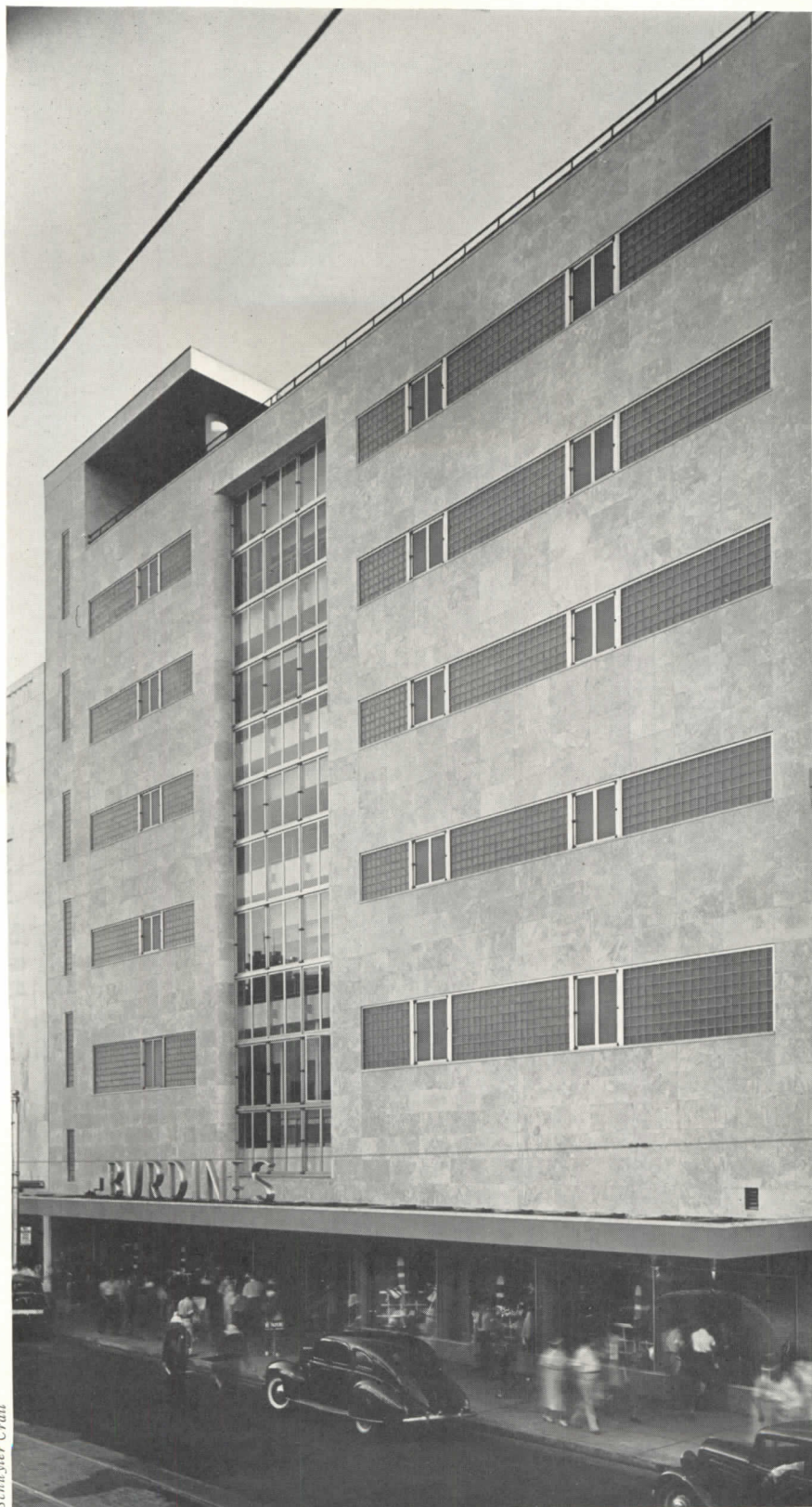

Schuyler Crail

Exterior view of addition to Burdine's Department Store, Miami. This new building is joined to a remodeled structure behind it. Out of the picture to right is a corner building which will be replaced by another addition.

IMPROVEMENTS TO Burdine's Department Store in Miami, Florida, include a new building seven stories high, and the remodeling of an existing six-story structure which faces another street and is separated from the new building by a corner plot. At the expiration of a lease which has about four years more to run, the new building will be extended to include the corner. The problem to be solved, then, was one of coordinating old, new, and future structures into a relatively unified design.

There are wider spans and fewer columns in the new structure than in the old. Nevertheless, columns are aligned, with alternate rows eliminated. Ceilings and floors, their position established by the older structure, are kept flush. Ceilings are relatively low with little space between them and the floors above; this has precluded the installation of air-conditioning ducts above ceiling height. The ducts were, however, installed inside partitions wherever possible.

The new building has a structural-steel frame and Robertson metal floors. The street front is of cantilever construction; columns are set back 6 ft. from the building line, so that there are no obstructing columns in the show windows. The street-front exterior is faced with a local stone obtained on the "Keys" south of Miami. This material is of coral formation and porous. It is cut the required size, filled with white cement, colored to desired shade, and then polished.

Interior lighting fixtures are of the flush type; these are supplemented by trough neon tubing. The street front is illuminated by floodlights concealed on top of the marquise. Escalators are installed from first to fourth floors, with framing provided for a possible future extension of the system to the sixth floor.

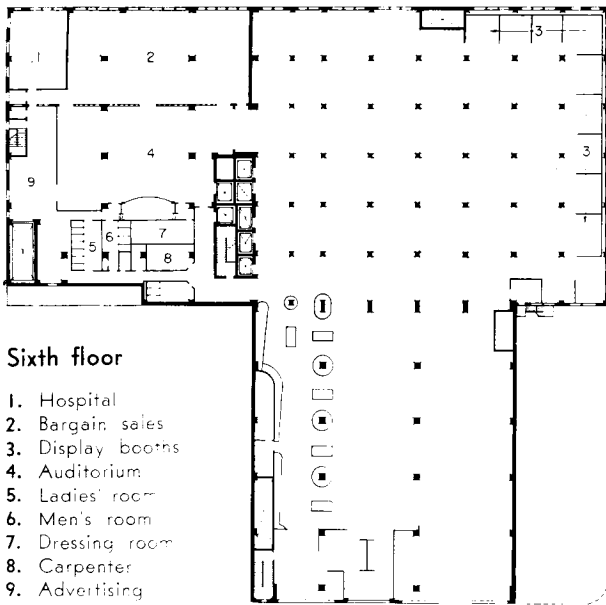

**Sixth floor**

- 1. Hospital
- 2. Bargain sales
- 3. Display booths
- 4. Auditorium
- 5. Ladies' room
- 6. Men's room
- 7. Dressing room
- 8. Carpenter
- 9. Advertising

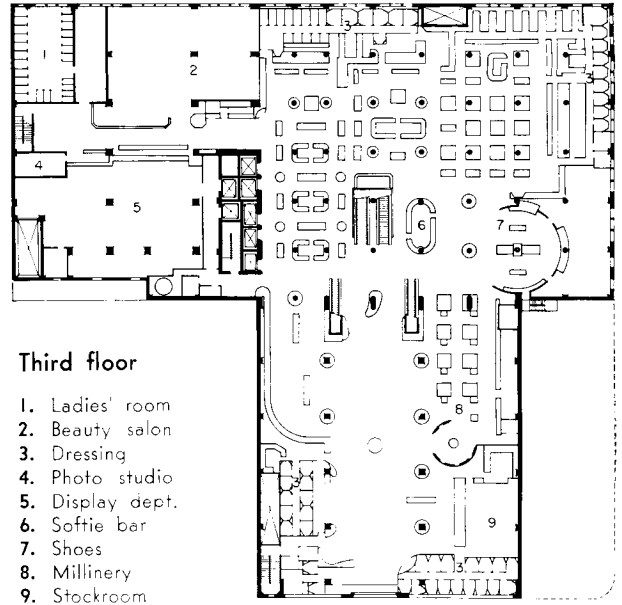

**Third floor**

- 1. Ladies' room
- 2. Beauty salon
- 3. Dressing
- 4. Photo studio
- 5. Display dept.
- 6. Softie bar
- 7. Shoes
- 8. Millinery
- 9. Stockroom

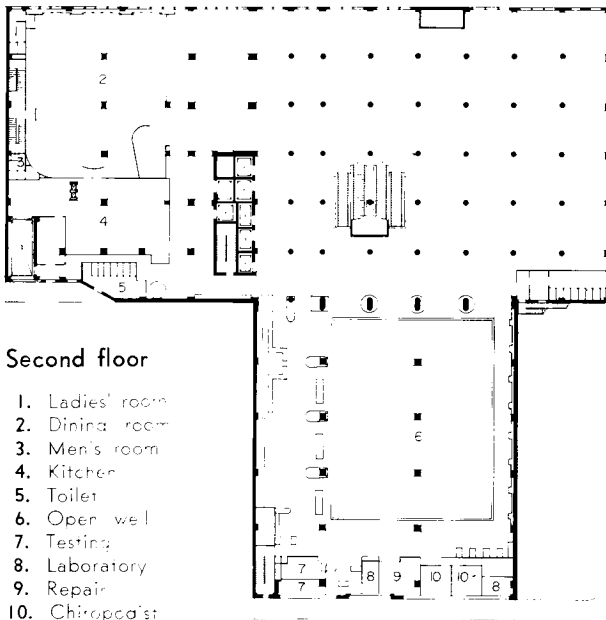

**Second floor**

- 1. Ladies' room
- 2. Dining room
- 3. Men's room
- 4. Kitchen
- 5. Toilet
- 6. Open well
- 7. Testing
- 8. Laboratory
- 9. Repair
- 10. Chiropract

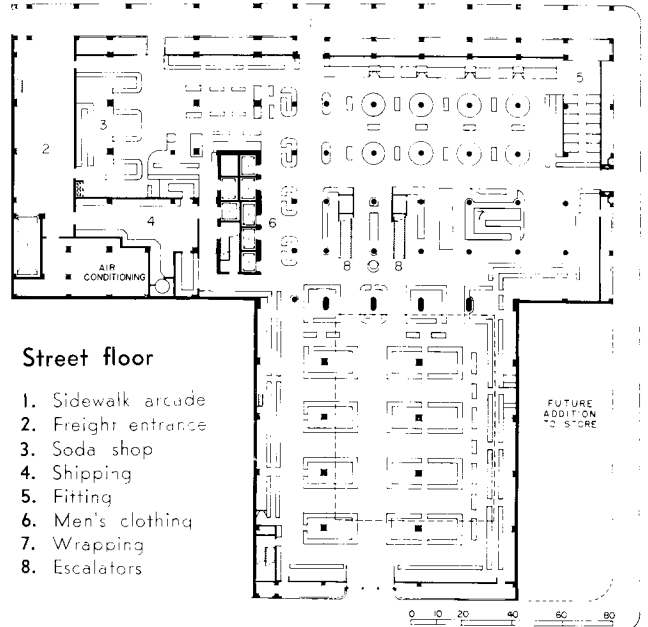

**Street floor**

- 1. Sidewalk arcade
- 2. Freight entrance
- 3. Soda shop
- 4. Shipping
- 5. Fitting
- 6. Men's clothing
- 7. Wrapping
- 8. Escalators

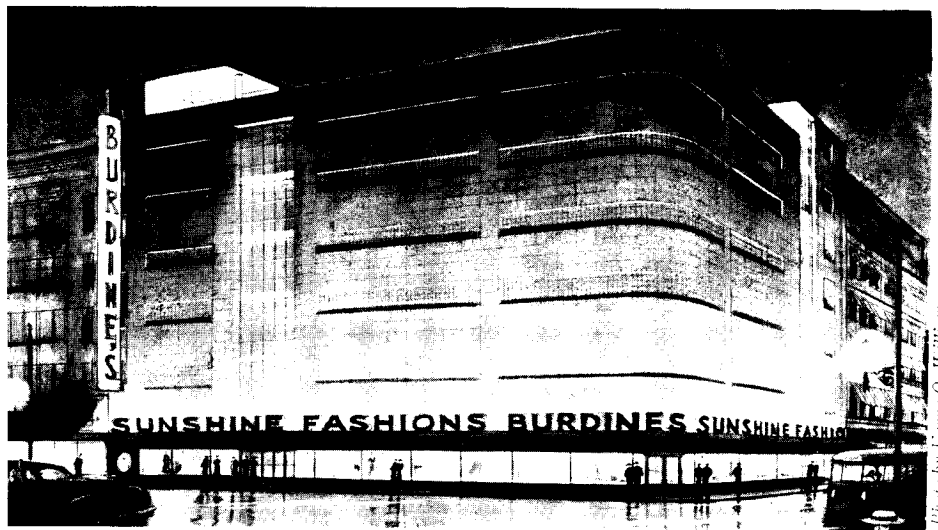

Burdine's Department Store as it will look when another addition has been built in the corner plot.

Photo by Frank O. Williams



Main floor, new building. Column rows are aligned; but in the new structure every other row has been eliminated.



Women's show department, third floor. Various departments of the store are designed as separate specialized shops.



Women's dress department, third floor. Flush-type lighting fixtures are supplemented by indirect trough neon illumination.

Photos by Fernie O. Williams



## STORE IN MIAMI

1. Air-conditioning machinery room
2. Light trough
3. Escalator
4. Floodlights
5. Transformer vault
6. Basement: machinery only

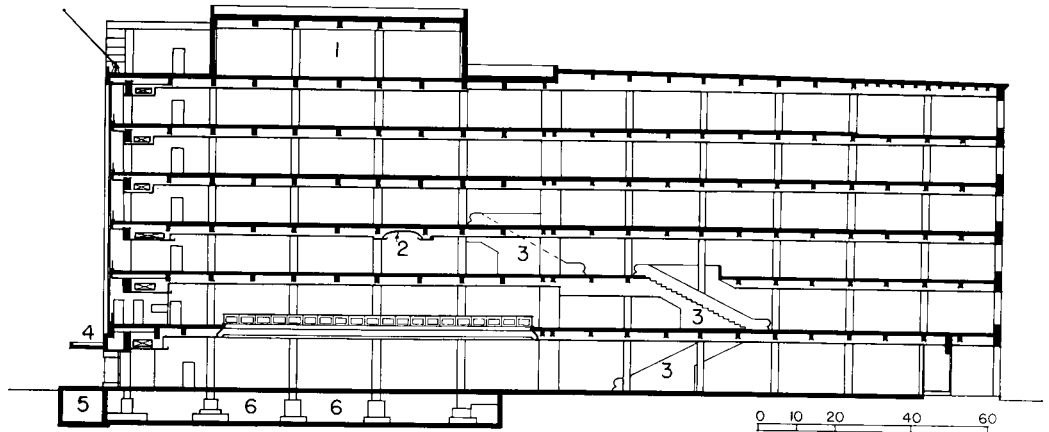

The old building is six stories high. The new building has an additional story for the air-conditioning machinery. The system is divided into seven zones, each with its own atmospheric requirements.

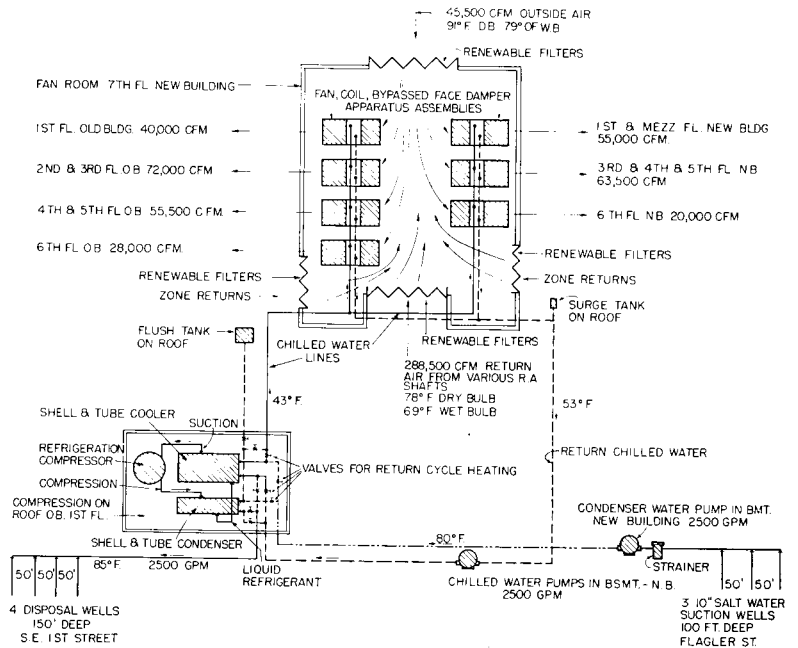

THE DESIGN of the air-conditioning system was determined by three factors: 1, available condensing water; 2, available space in the building for ducts, equipment, etc.; 3, available funds.

Because of the high wet-bulb temperature, the usual cooling tower on an installation of this size was not economically feasible, as the temperature of condenser water available from such a tower would increase the power required for the compressors by 15 to 20%. Since fresh well water is not available in downtown Miami, salt well water at 80°, was decided on; this water, because of its corrosive properties, required special handling. Three wells of a total capacity of 2,500 gal./min. were drilled on the north side of the building. The water, drawn from these wells by condensing water pumps aided by a vacuum primer, was delivered to the condensing surface of the refrigeration apparatus; from here it flows to four discharge wells on the south side of the building, approximately 300 ft. from the intake wells.

The compressor, condenser, and water coolers, were placed on foundations on solid rock and set level with the street floor, precluding the possibility of damage from flood conditions. The system was designed for a capacity

of 960 tons and has room for future expansion.

The air is discharged from a seven-zoned apparatus. The requirements of each zone vary according to exposure to sun, prevailing winds, number of customers, entrances, uses, etc. The quantity of fresh air delivered in each zone is in keeping with good ventilation practice—10 c.f.m., as calculated for peak conditions.

The control system is so arranged that, under favorable outside conditions, up to 60% of the total air handled will be from the outside. This arrangement materially reduces the total load on the system during those winter days when the temperature of the outside air is lower than inside maintained temperature.

Air is returned to the system at a level of 7 to 8 ft. above the floor; since winter heating is an easy problem in Miami, it was not necessary to use low returns. To distribute and return air from the old building to the roof of the new building, large hurricane-proof ducts were constructed across the roof of the old building.

The system was designed to supply heating, if that should be necessary, by the use of the reverse-cycle principle. The mechanical and air-conditioning systems were designed by Maurice Connell.

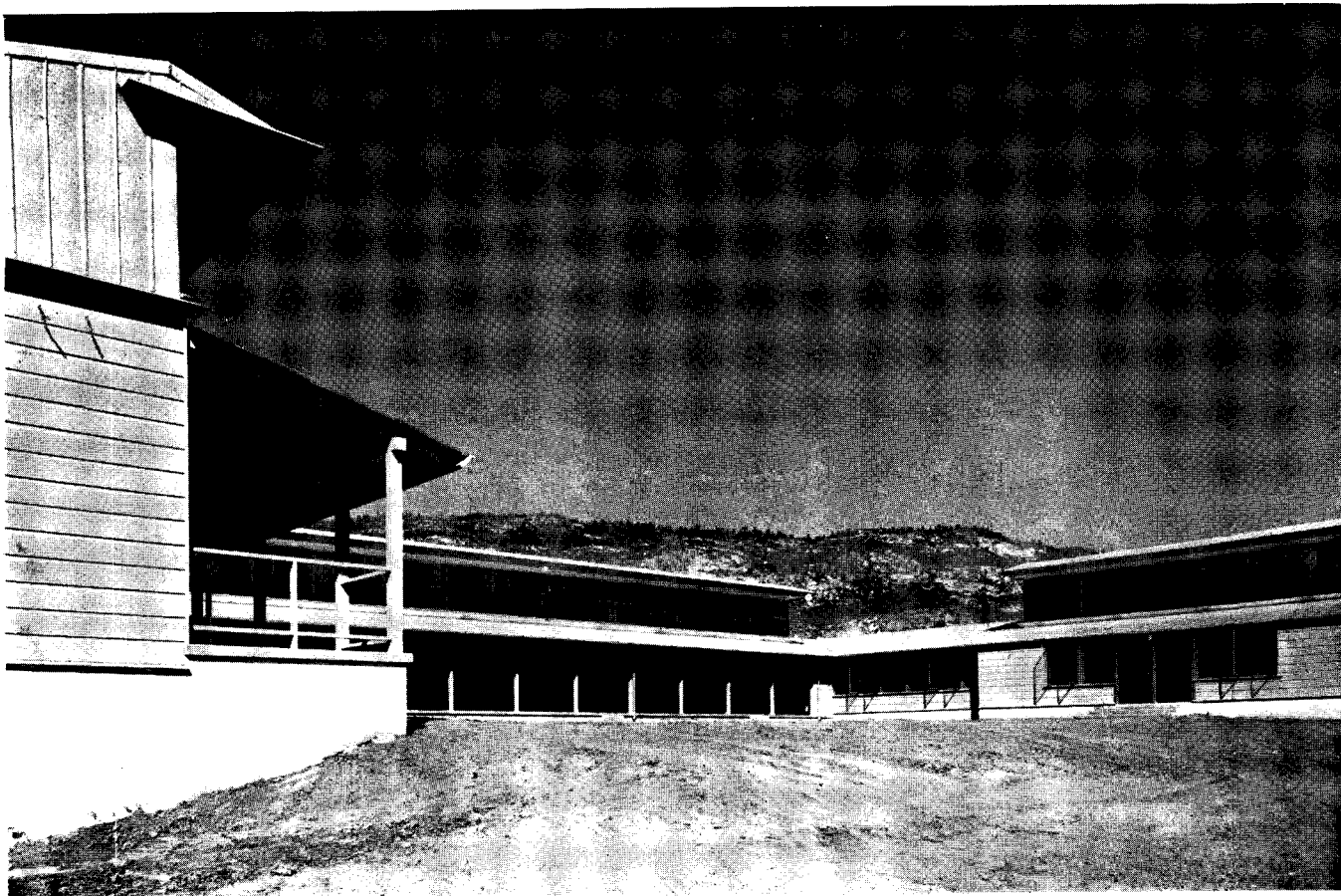

Continuous upper banks of windows are protected by canopy; these windows are used only for lighting, not for ventilation.

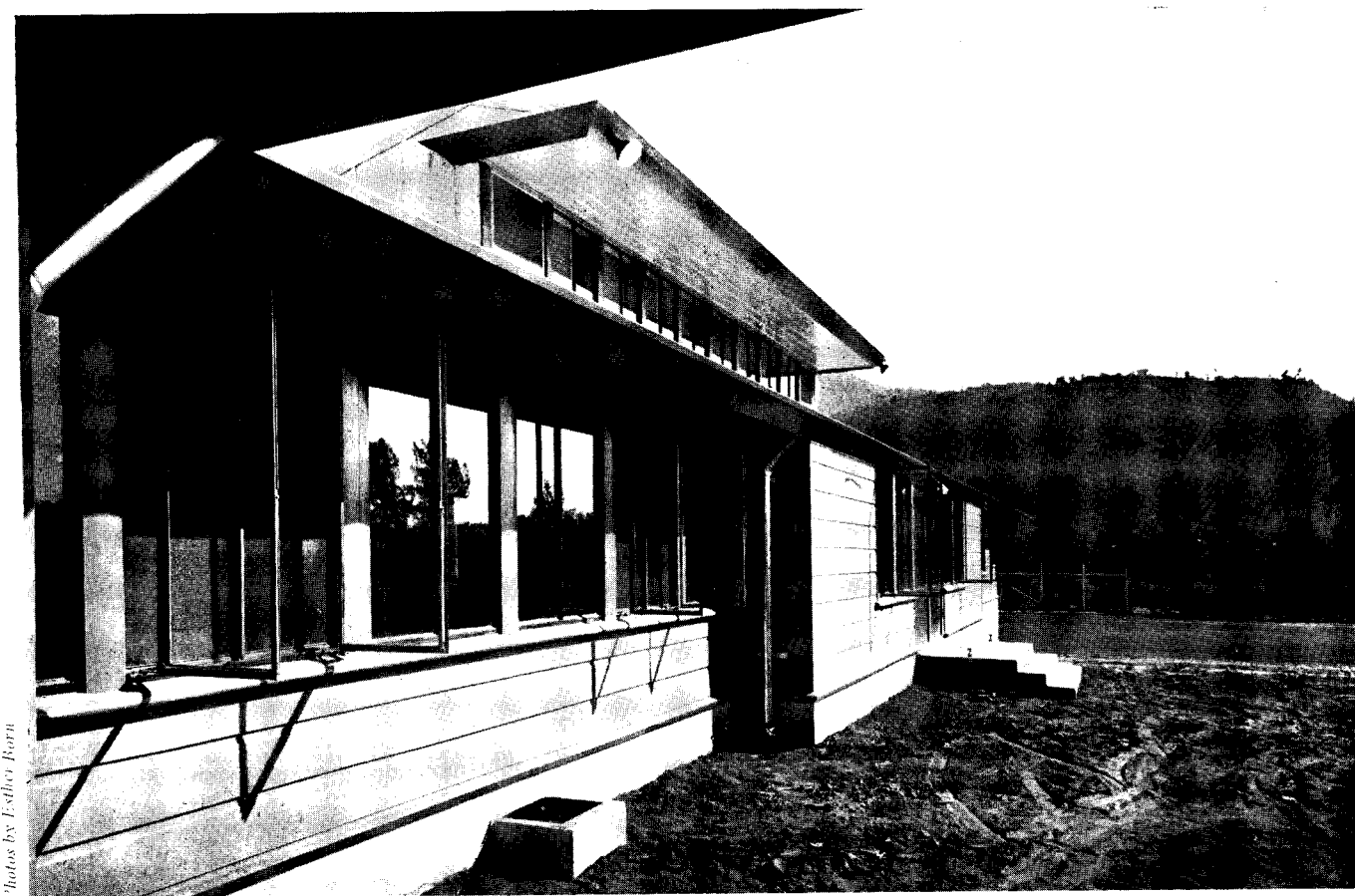

Photos by Estley Born

Post-and-joist system, based on a 4-ft. module, permits placing of windows or doors at any 4-ft. interval in exterior walls.



# DESIGN FOR SUN CONTROL, STRUCTURAL FLEXIBILITY, INTEGRATION

FRANKLIN and KUMP, Architects

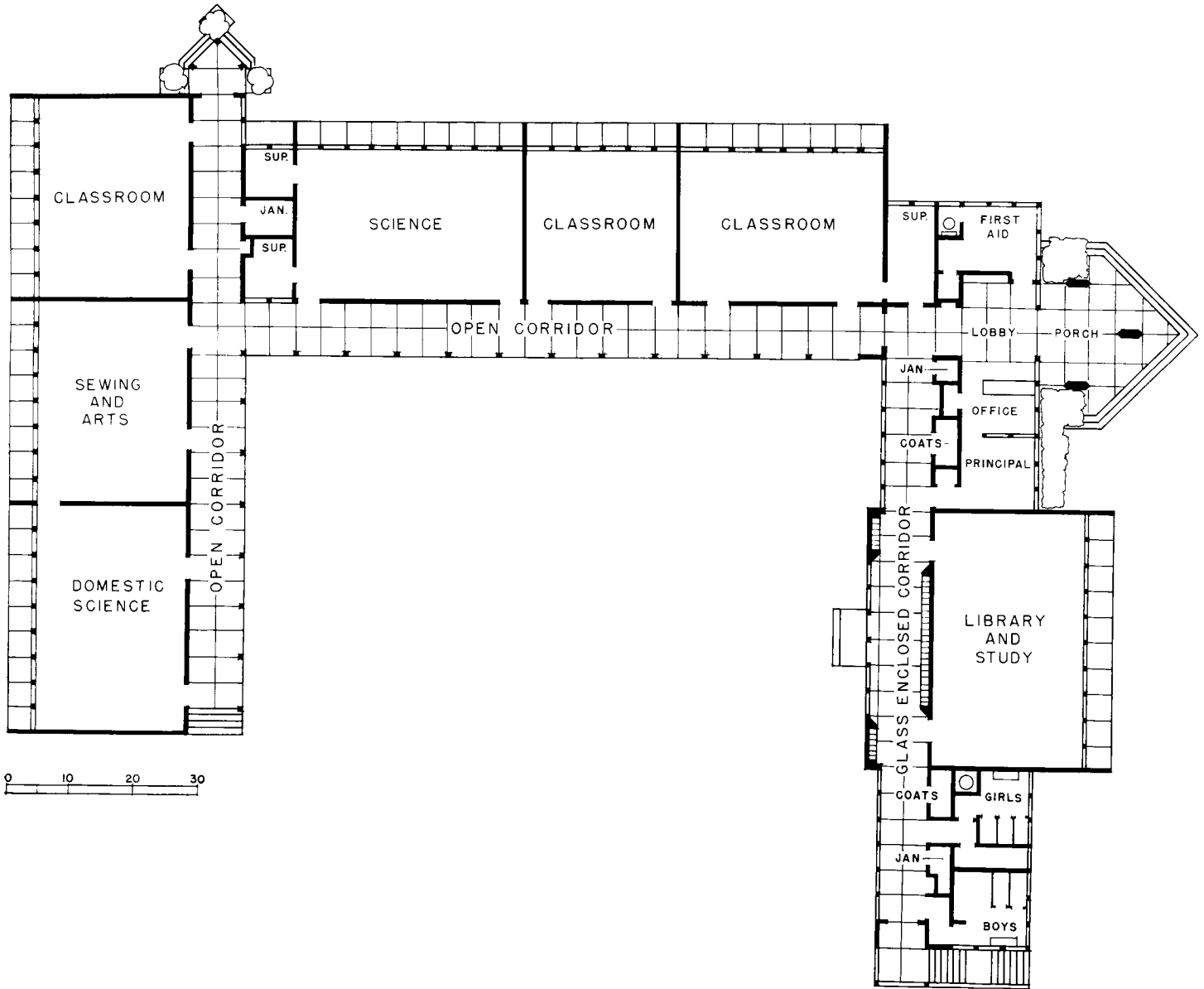

THE DESIGN of the Sierra Union High School was determined by these requirements: first, control of the glare and heat of the California sun; second, a structural system sufficiently flexible to resist seismic disturbances; third, integration of outdoor and indoor spaces for maximum use.

To satisfy the first of these requirements, a system of natural bilateral lighting was adopted. On the large-window side of classrooms, a cantilever canopy with wing walls has been provided. For sun control, this canopy accommodates a drop shade, aluminum in color on the outside and Nile-green on the inside; this control can be adjusted vertically to any height to keep the direct rays of the sun off the glass at any time during the year; the view is unobstructed at all times. The wing walls prevent diagonal light rays from entering classrooms. The opposite side of the room is lighted by a continuous upper bank of windows protected on the exterior by a 2-ft. canopy; these windows are used only for lighting; the use of them for ventilation would upset the light balance. Over the sash on the interior are aluminum-slat shades. The

slats are secured in position to reflect direct light to the ceiling, giving indirect light to the room; these shades may be raised on sunless days. Cross ventilation is provided by adjustable, lightproof wall ventilators at either end of each room.

The second requirement is a quake-resistant structure. The structural system chosen is a post-and-joist construction based on a 4-ft. module. The roof is framed with joists 2 ft. on centers. The acoustic-plaster ceiling is applied to stripping and diagonal sheathing underneath; the spaces between joists are filled with mineral-wool insulation. Joists are sloped to drain, giving a slight slope to the classroom ceilings; attic spaces are eliminated. Resistance to seismic forces is increased; the building, a diagonally sheathed box, transfers all forces directly to the ground.

This structural system permits placing a window or door at any 4-ft. interval in the exterior walls. It also makes possible the moving of cross partitions at any 4-ft. interval, without the necessity of structural change.

## SCHOOL IN CALIFORNIA

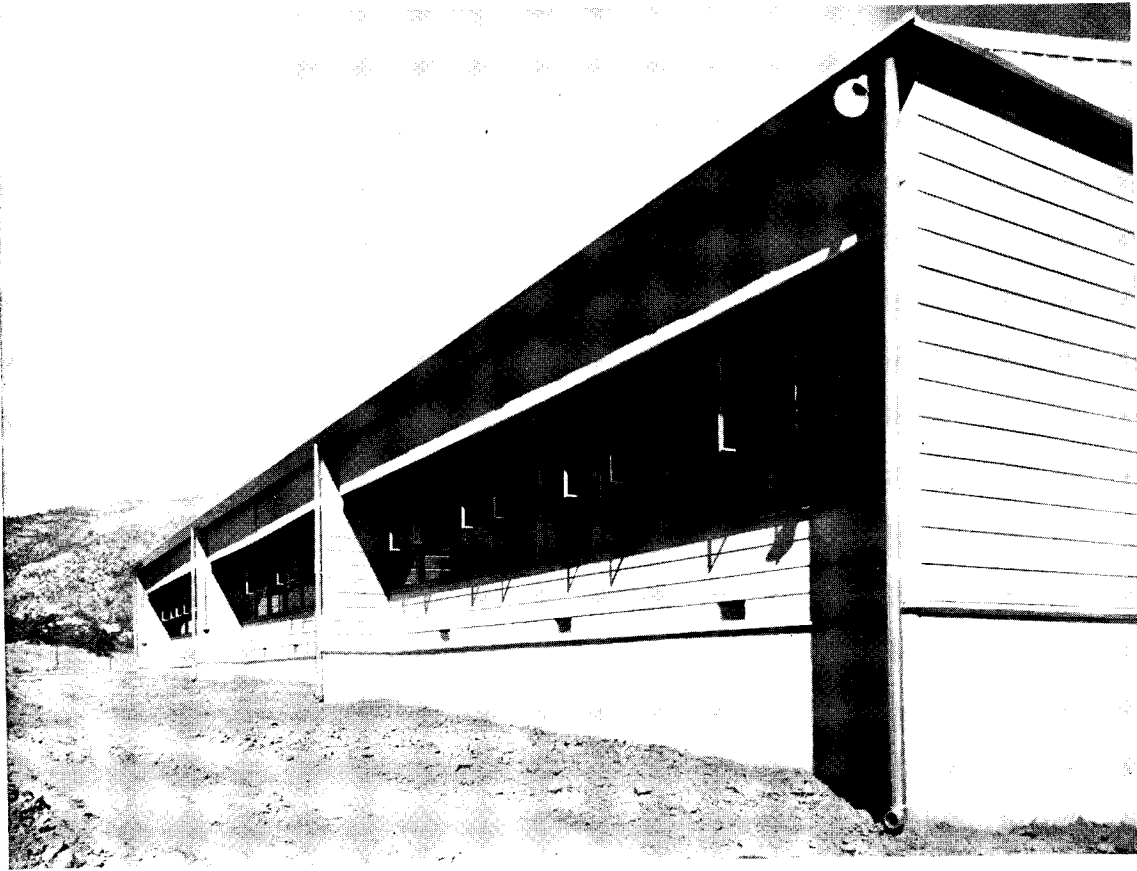

Wing walls exclude diagonal light rays. Aluminum-slat shades inside reflect direct light to ceilings.

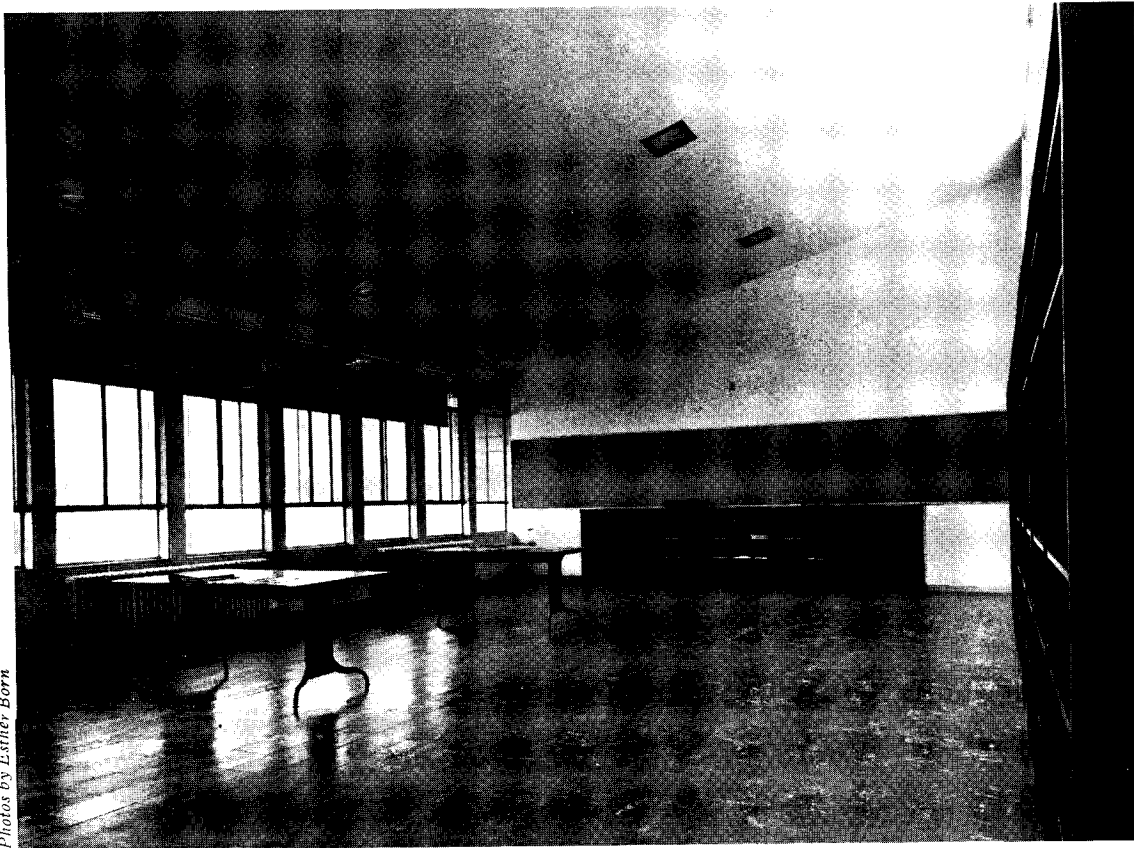

Photos by Estler, Born

Joists are sloped to drain; attic spaces are eliminated. This construction increases quake resistance.



# BAND SHELL DESIGNED FOR VISIBILITY AS WELL AS ACOUSTICS

WILLIAM A. GANSTER, Architect

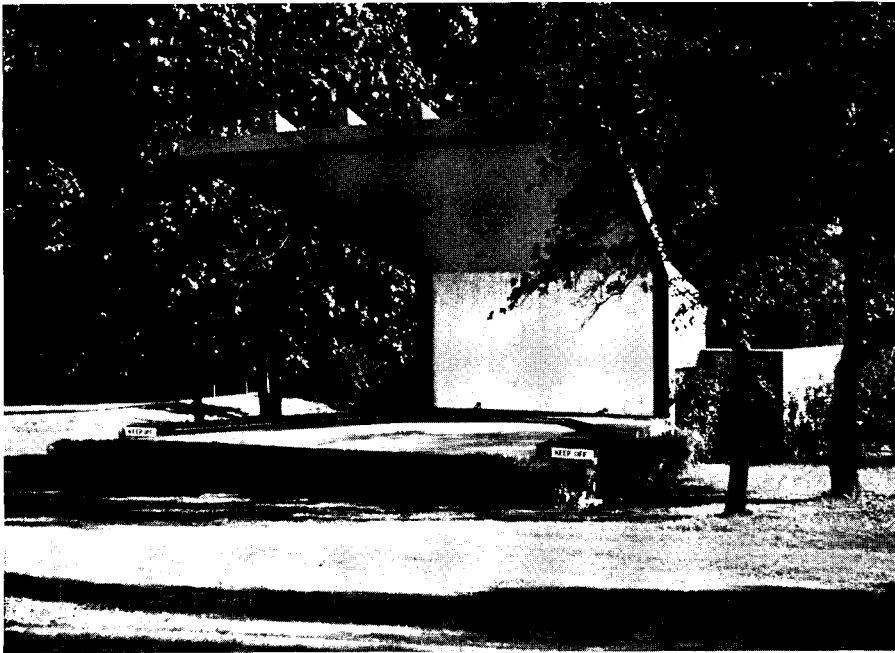

The sounding board is vertical with a pitched reflecting surface for ceiling.



A tool shed and toilets for men and women are part of the design problem.

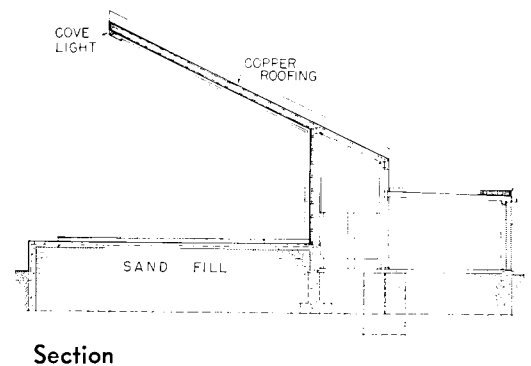
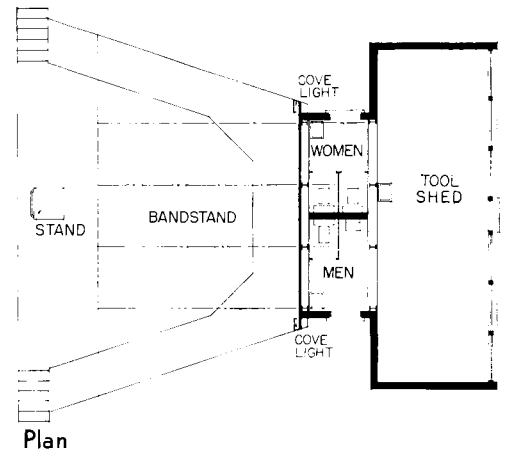

THIS BANDSTAND in Waukegan, Ill., is located in a natural amphitheater, the audience sitting on a slope facing the shell.

The shape of the shell was determined with the assistance of Professor Watson of the Department of Physics, University of Illinois. It was estimated that a vertical sounding board with a pitched reflecting surface for ceiling would produce less concentration of sound foci in the audience than any other shape. The shell has been designed without sides for

greater visibility; it is estimated that sides would increase the acoustical efficiency of the shell only about 15%. The sounding board is of white pine.

The platform will accommodate an orchestra of about 100 pieces. The shell is wired for an amplifying system, which will consist of two twin lattice-steel towers with three speakers on top of each. There are six microphone outlets in the ceiling and four plug-ins on the floor.

# CIRCULAR AUDITORIUM TO BE A UNIT OF PROPOSED CIVIC CENTER

W. F. RUCK, Architect, and ZARA WITKIN, Civil Engineer

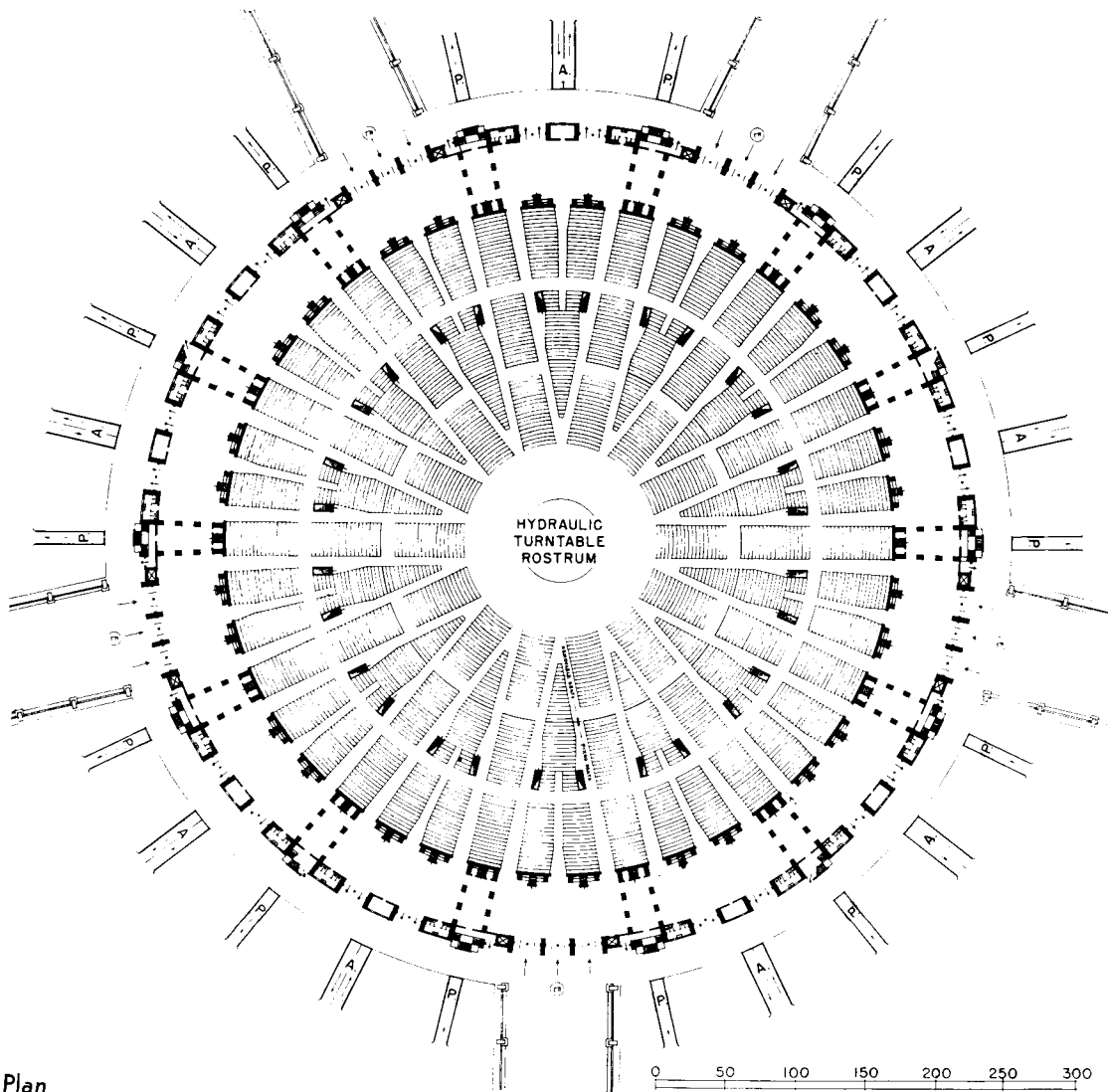
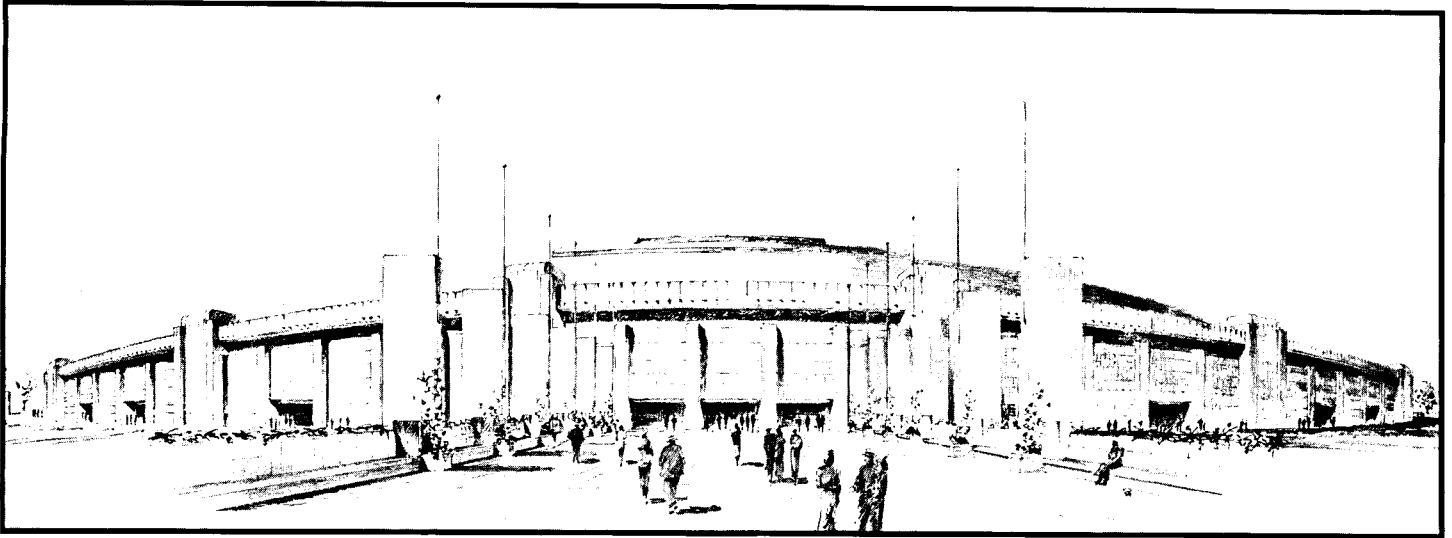

Plan



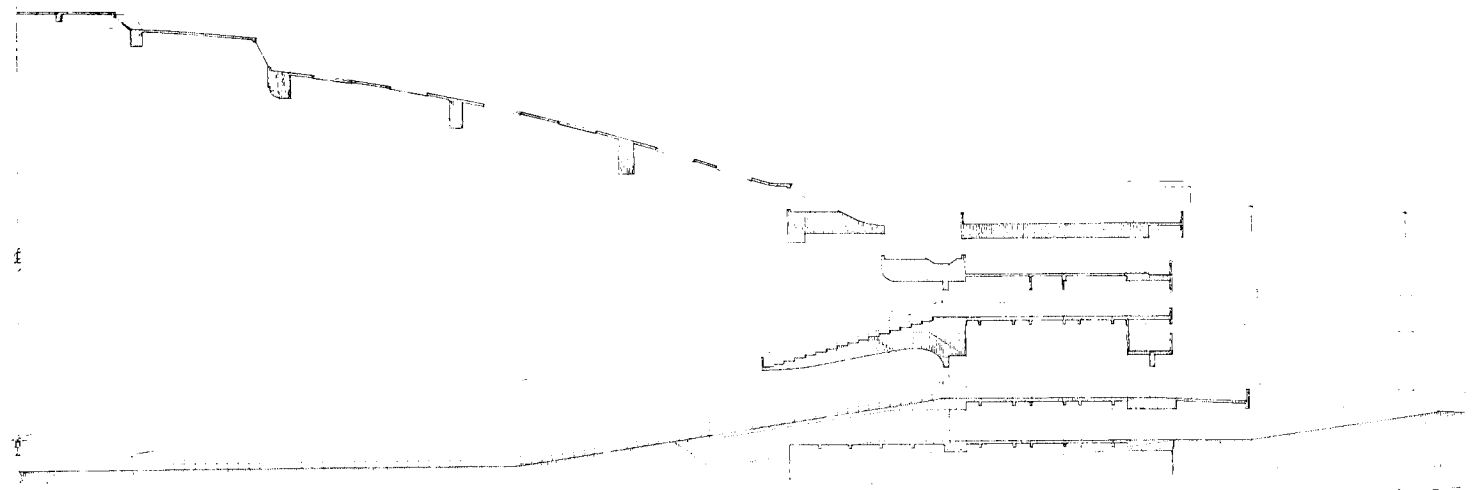

Half section

IN THE PAST 20 years, Los Angeles has experienced a more rapid increase in population than any other great city in the United States.\* Because of the speed and relative planlessness of its growth, the city is scattered and uncoordinated. Attempts are now being made to redesign the city into a coherent and efficient whole, partly by the creation of a community center to serve as a nucleus for the city's cultural life.

An important unit of the proposed center is a municipal auditorium. This structure is to be readily accessible to all elements of the population and their separate residential areas. The city's transit system is relatively inferior and its population centers scattered; one consequence of this is an unusually high auto-population ratio (see AR, 11/38, p. 43). Provision had therefore to be made for unusual parking facilities, accessible from all directions, both within the structure and around it. This, in turn, made necessary auto and pedestrian adits on all sides. The solution here proposed is a circular auditorium with platform in the center.

Other factors, too, suggested this design: a circular floor plan simplifies accessibility to toilets, elevators, etc.; it eliminates dead ends and encourages uniform density of traffic in circumferential corridors; it eliminates traffic congestion at strategic points, an important factor in the event of panic; it reduces by about two-thirds the average distance of the audience from the platform, with consequent visual and auditory benefits.

The auditorium, designed to seat 30,000 people, has an arena diameter of 575 ft. The most feasible type of roof for so great a span is a dome.

In the proposed structure, the dome is extended clear to the foundations instead of bearing upon vertical walls. This form has many advantages: it is highly quake-resistant,

because stresses are distributed through the whole structure; the shell yields to stresses from any direction, and returns undamaged to its original contour; all material is in compression, always an advantage in concrete construction; vision-obstructing columns are eliminated. The load-bearing shell of the dome is reinforced by concentric rings, which are stiffened, in turn, by radial arches. These arches anchor to a reinforcing ring near the cap. A shallow cupola bears on this ring, topping the structure. To reduce deadload, it is planned to use a special concrete aggregate, with high compressive strength in relation to its weight; a shell, varying in thickness from 3 to 4 in. at the base to 1½ to 2 in. at the cap, will be sufficient.

It is planned to use a 60-ft. turntable platform, accommodating 300 seats, with heights adjustable by hydraulic lift. Built into the center of the platform will be a speaker's podium, which may be raised or lowered with the turntable. The turntable may consist of a series of concentric rings, to be elevated independently, so that platforms of varying diameters and heights will be available. The whole platform will revolve slowly so that the speaker at some time faces every part of his audience.

In a circular auditorium, sound waves emanating from the center travel unobstructedly to the extremes of the envelope, and any reflections of sound from vertical wall surfaces are uniform throughout. There is no distortion because each differential part of the wave reaches the barrier of the envelope at the same instant. The sound travels radially from the source and any reflection or echo also travels along this radius, so that there is no crossing of sound waves from different angles. Actually, in this project, there would be practically no reflection of sound, because the rising tiers of people on all sides act as an absorptive medium.

\* 1920 . . . . . 576,673 (U. S. Bureau of Census)  
1938 . . . . . 1,540,000 (estimate of California Taxpayers' Association)

# NEW YORK: NEW TRAFFIC REGULATIONS BRING ROOF-DECK PARKING

THOMAS W. LAMB, Architect, and FRANK S. PARKER, Engineer

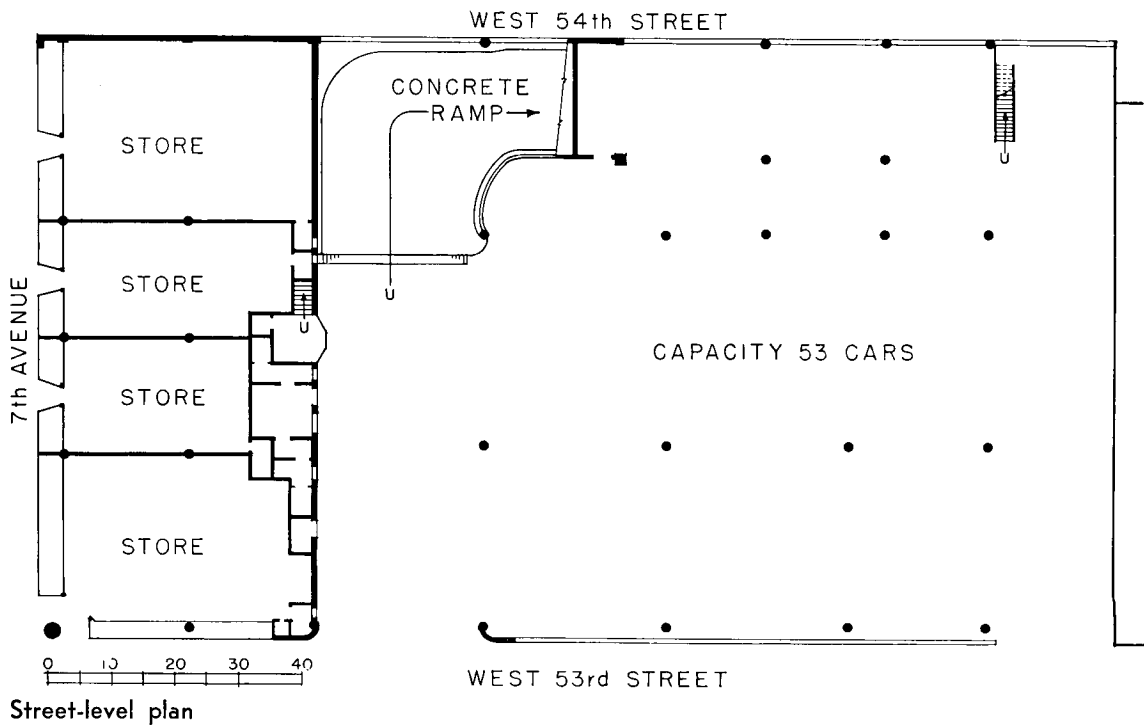

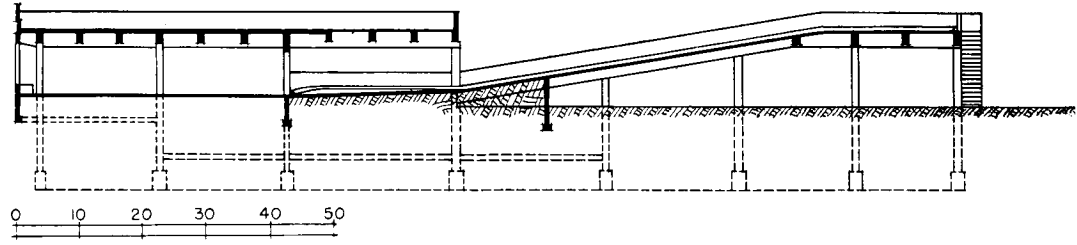

Section through ramp

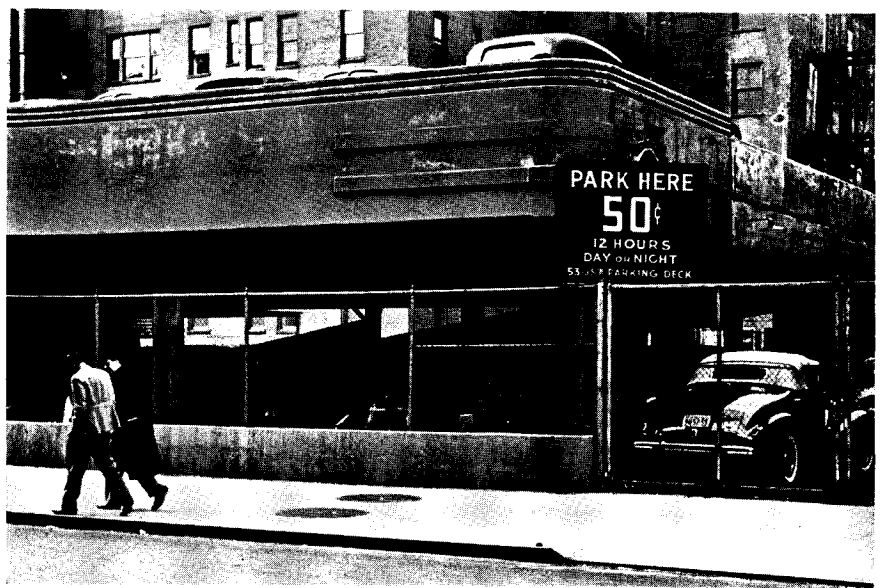

Parking capacity of lower level is 53 cars. Gates at right lead to stairway.

SINCE THE beginning of 1938, parking has been severely restricted on most cross-town streets in mid-Manhattan, New York City. One result of this policy has been an increased need for parking space on private properties within the area affected.

Real-estate values in this district make the usual parking lot unprofitable or expensive. In the solution shown here, a roof parking deck over a row of rented stores has been provided. About 123 cars can be accommodated, 53 of them on the ground level, 70 on the roof deck. There are two stairways to the upper deck: one in the southwest corner of the building, another near the center, rising from beside the entrance driveway. The floor of the ground level is of packed cinders. The structure is of reinforced concrete.

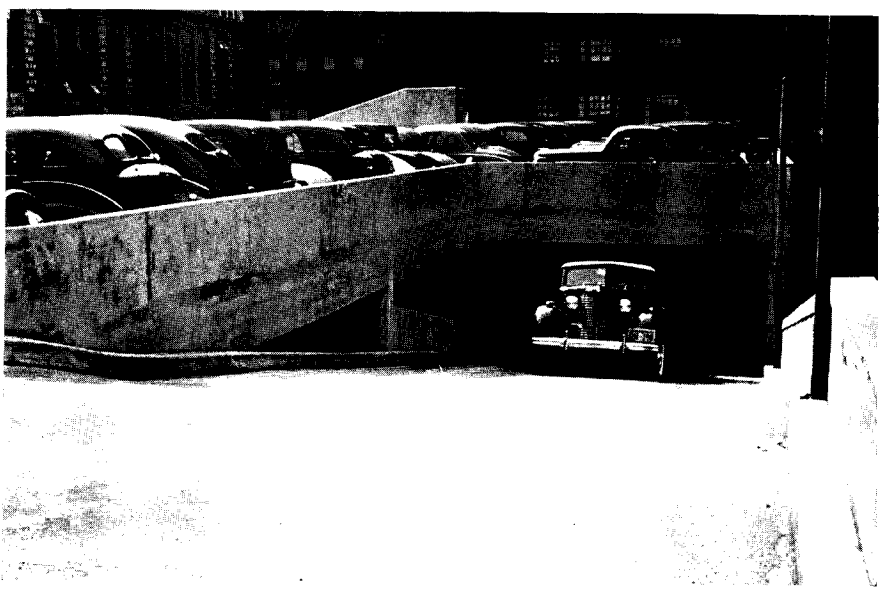

Automobile ramp to roof deck seen from the top of the corner stairway.

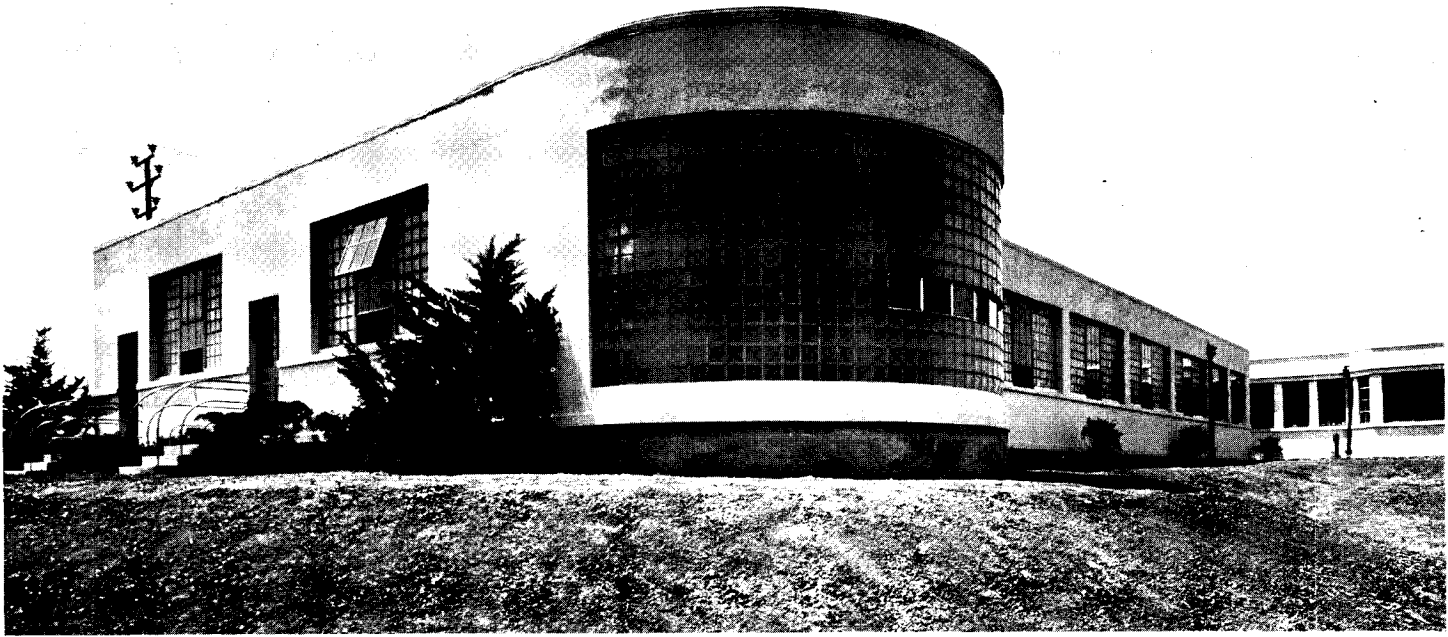

Dining-room wing of the building. In the background at right can be seen one of the other buildings of the Monsanto Chemical Company; the laboratory was designed as a one-story independent structure to minimize possible damage from explosions.

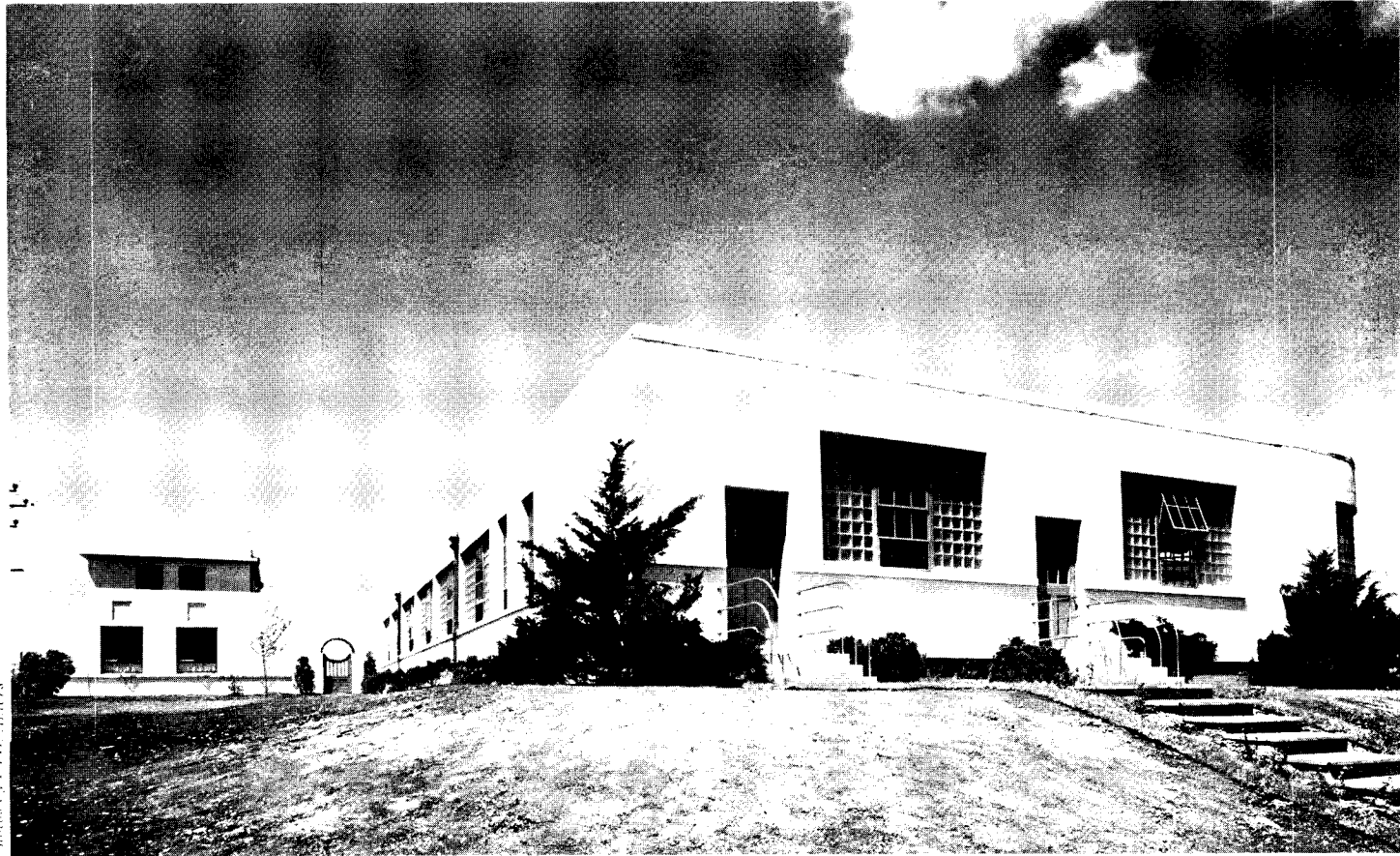

Photos by P. E. Hifers

Door at left leads to kitchen, door at right to corridor and dining room. Gate in rear leads to an open court between buildings.



# GLASS BLOCK AND SASH COMBINED IN EXTERIOR WALLS OF BUILDING

J. DOUGLAS LORENZ, AIA,  
Architect

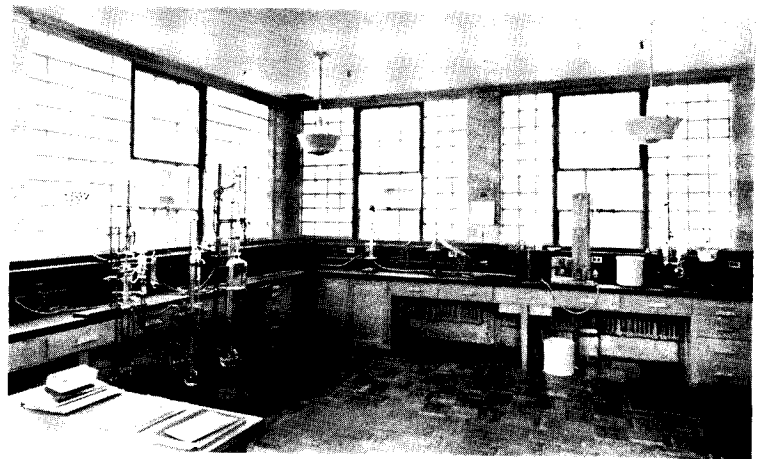
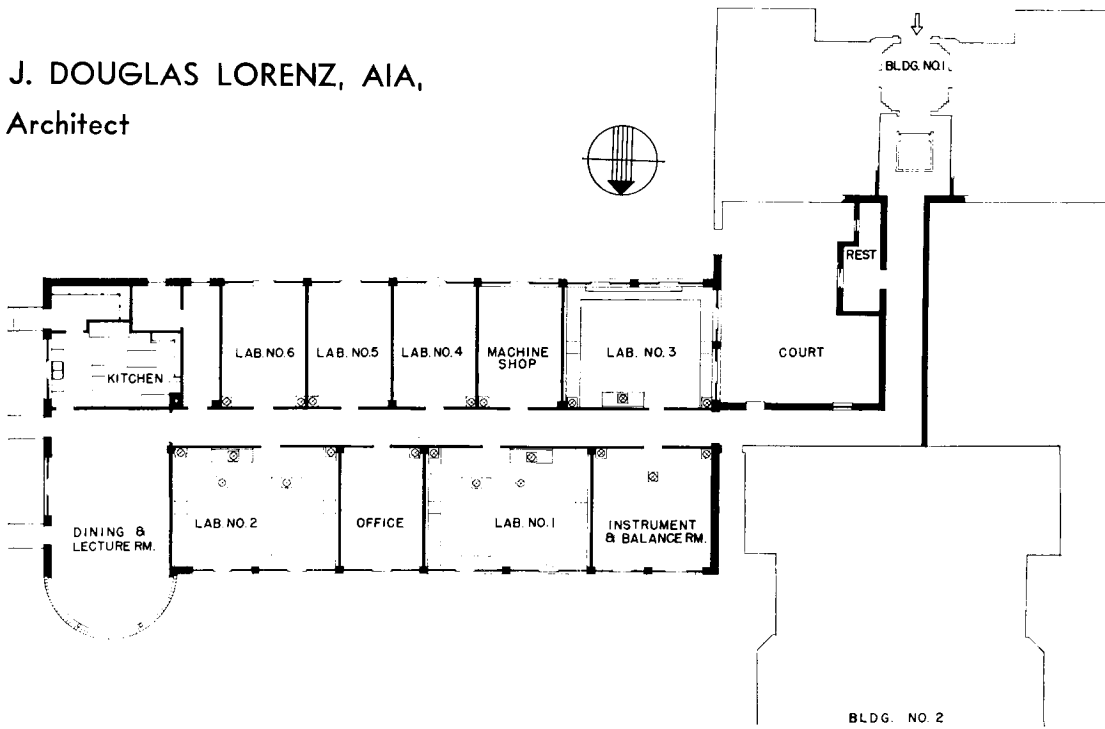

The combination of glass block and sash affords maximum light with insulating value plus access to outside air.

THE EXTERIOR walls of this laboratory building of the Monsanto Chemical Company in Dayton, Ohio, contain large panels of glass block and metal sash: each panel is about 80% glass block and 20% operable metal sash—the first for maximum light with insulating value, the second for vision and access to outside air. All interiors are faced with glazed tile and all flooring is wood block. The dining room has a solid glass-block bay and is air-conditioned. The rest of the building is steam-heated. To reduce damage from possible explosions, the building was limited to a single story. Its total cost was \$41,450.



Dining room may be quickly converted into lecture hall.

# FILM LABORATORY DESIGNED FOR PRECISE ATMOSPHERIC CONTROL

BERTRAM TEITELBAUM, Architect

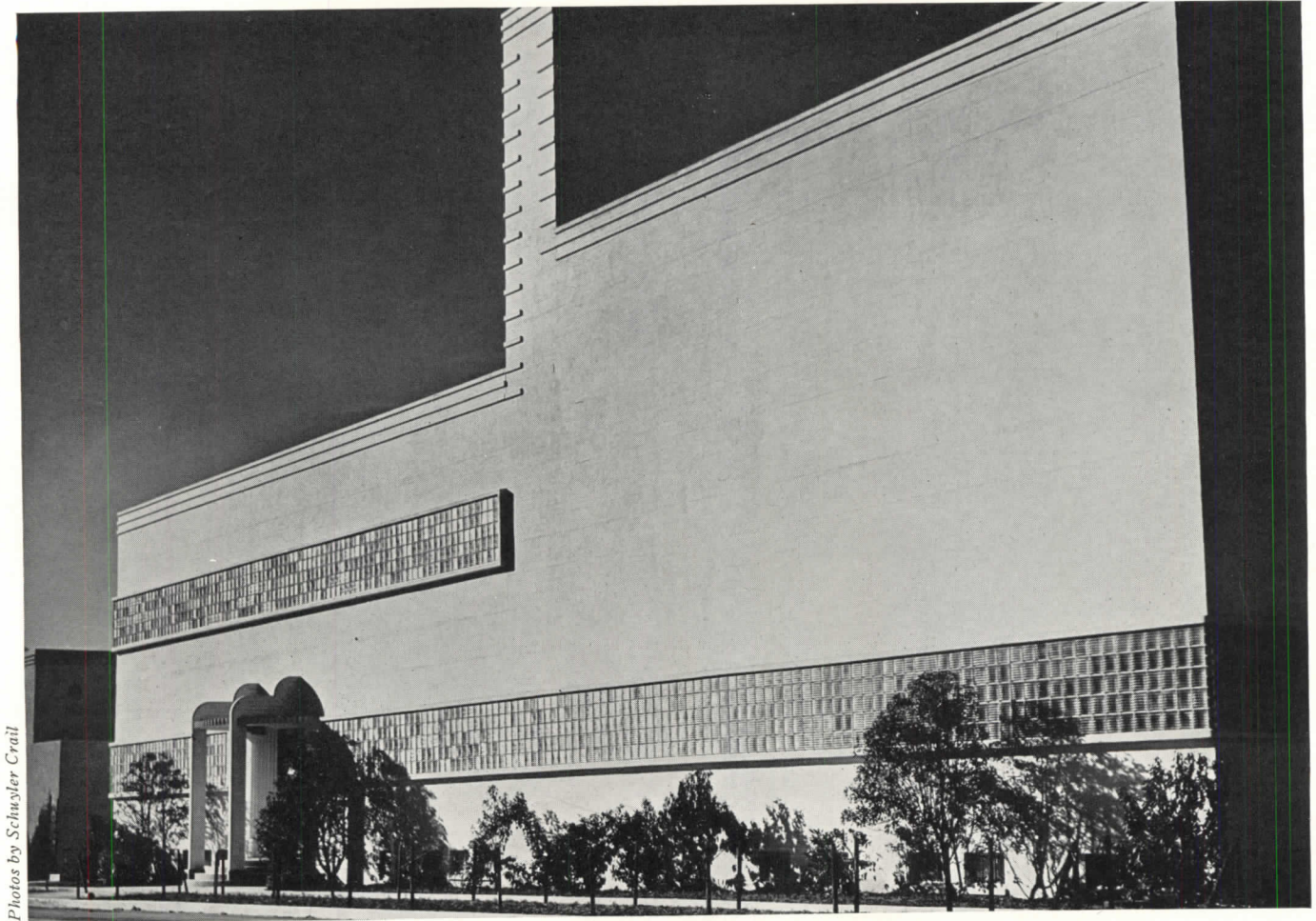

Photos by Schuyler Crail

1. Negative cutting
- 2, 3. Offices
4. Chemical fades
5. Women's toilet
6. Printing
7. Sound breakdown
8. Negative breakdown
9. Light trap
10. Duplicate room
11. Vault
12. Pos. and neg. timing
13. Developing room
14. Instruments
16. Maintenance
17. Shipping room
18. Sound-track assembly
19. Negative assembly
20. Polishing and waxing
21. Positive assembly
22. Washing and drying

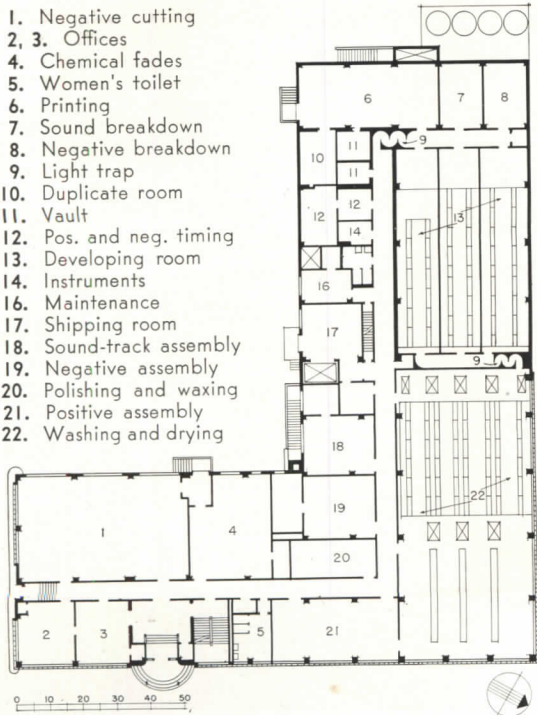

First floor

1. Unassigned
2. Office
3. Rest room
4. Locker room
5. Women's toilet
6. Shower
7. Duct space
8. Janitor
9. Men's toilet
10. Ventilating penthouse
11. Review room
12. Projection booth
13. Store room
14. Corridor
15. Chemical storage and laboratory
16. Drying room
17. Key room

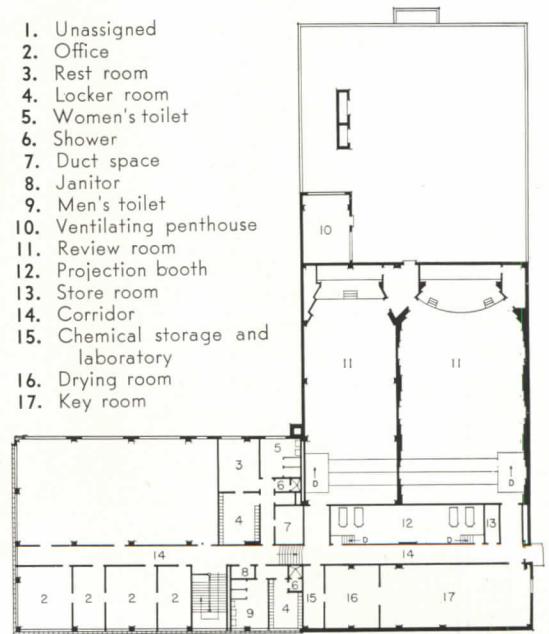

Second floor

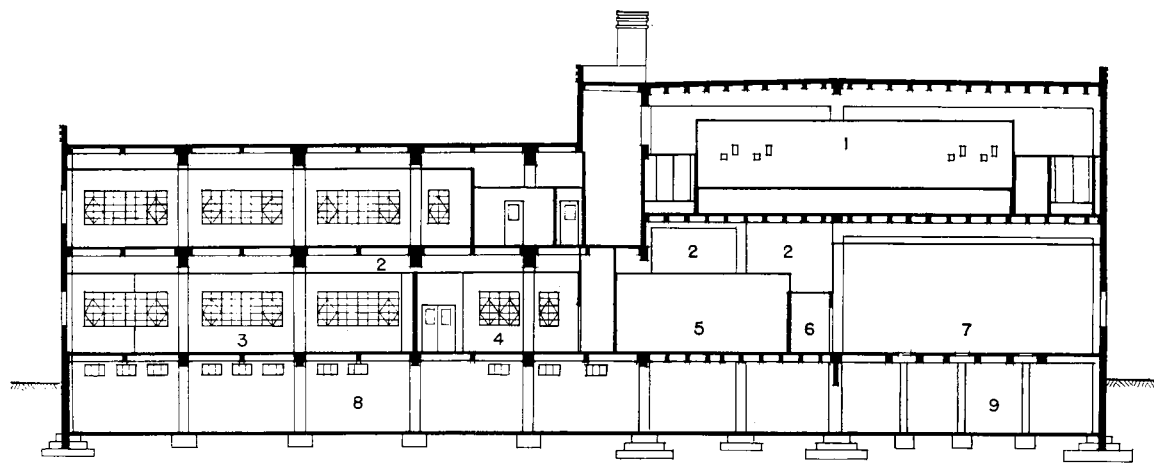

1. Projection booth
2. Plenum chamber
3. Negative-cutting room
4. Chemical fades
5. Polishing and waxing room
6. Corridor
7. Washing and drying room
8. Basement
9. Lower part of washing and drying room

Section

To INSURE consistent results in developing and printing motion-picture film, precise atmospheric control within the film laboratory is essential. To this end the structure is built as a sealed envelope: daylight is admitted through glass brick; there are few exterior doors, and these are kept closed and locked except when in actual use. A permanent record is made of atmospheric conditions in various parts of the structure, so that check can be made at any time regarding the conditions under which any film was processed.

The exhaust plenum chamber is located between first and second floors and extends the full width and length of the building. Clearance within the plenum chamber varies, with an approximate minimum clearance of 4 ft. The air is passed through a self-cleaning oil filter, then sucked through felt or paper filters. Suction is preferred to pressure, as it creates an even atmosphere differential over the whole area of the filter, increasing its efficiency. To facilitate cleaning operations, the ducts, which are large enough to accommodate workmen, are equipped with 84 man-hole openings at convenient points.

To permit repairs without disturbing the operation of the system, four compressor units are used; probably no more than three of these will ever be needed, a situation which provides a comfortable margin of safety. About 65% of the exhaust air is washed, filtered, heated or cooled, and recirculated.

Because of the possibility of future expansion or changes arising from improvements in laboratory technics, structural flexibility is an important consideration; the building is therefore designed as a reinforced-concrete shell with load-bearing columns within but no load-bearing partitions. All partitions are of steel-post and metal-lath construction, plastered; they can be torn down and relocated in approximately three days. For fire safety, no room is accessible directly from another room, only from the hall.

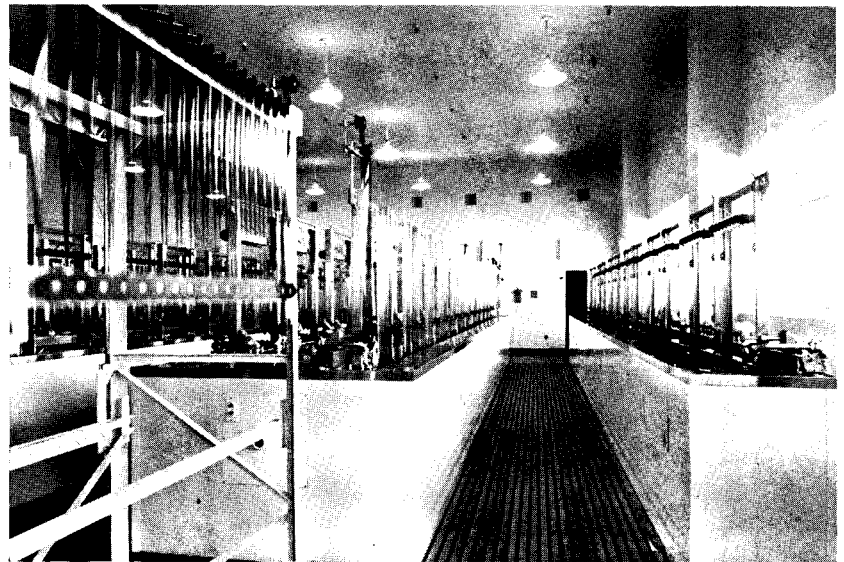

Film-processing equipment. Note removable floor for access to pipes, etc.

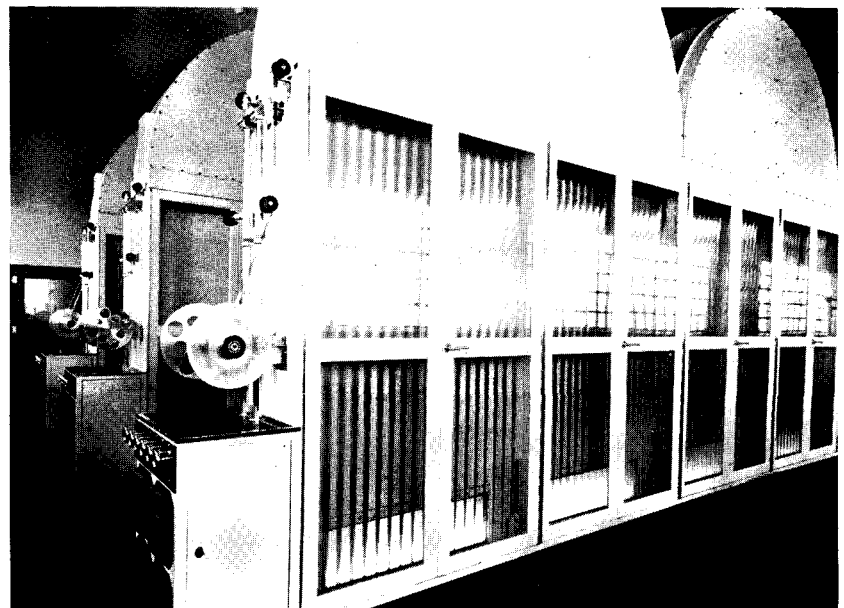

Drying chambers. Units at left control atmospheric conditions in chambers.



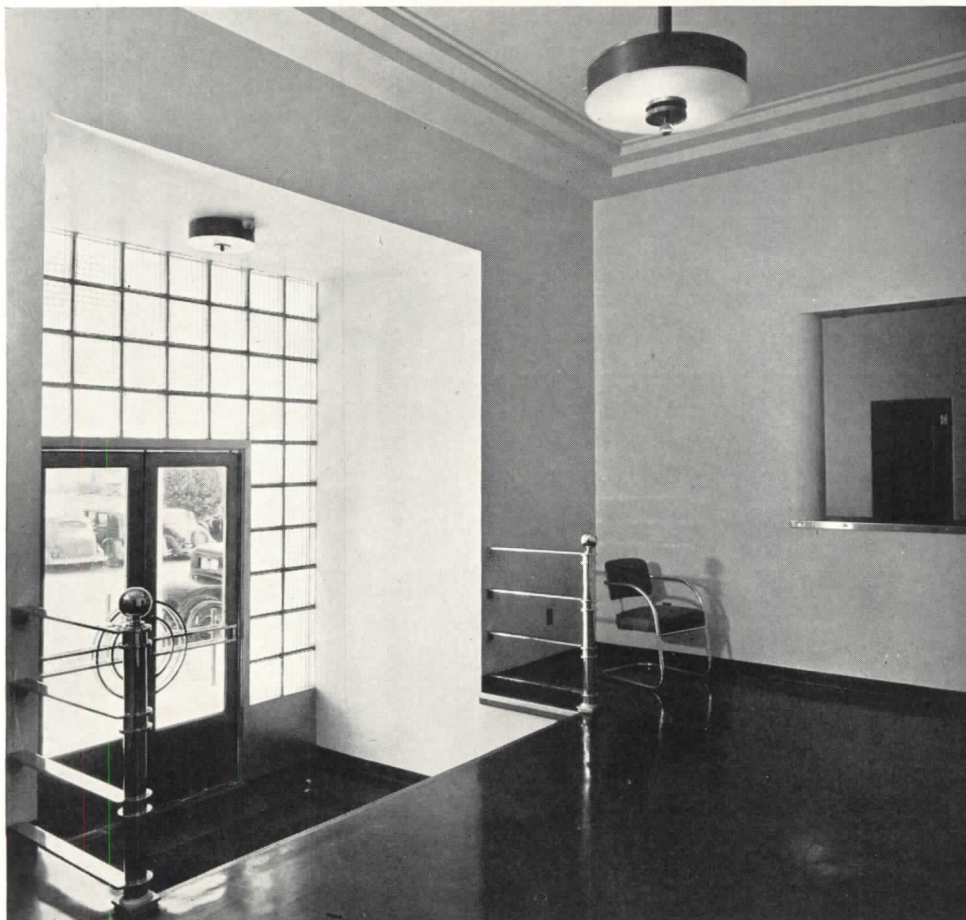

Photos by Schuyler Crail

Top: Main entrance and lobby; except when in actual use, doors are kept locked to help maintain uniform atmospheric conditions inside. Bottom: All furnishings are metal (usually stainless steel) to reduce fire hazard and help maintain a dust-free atmosphere.



# WINNERS OF PRODUCTIVE HOME COMPETITION ARE ANNOUNCED

THE WINNERS of the Productive Home Architectural Competition have been announced. This competition was sponsored by organizations interested in decentralization, domestic production, land conservation, and related objectives.

Winners of the five \$1,000 prizes were: for the Northeast, Alexis Dukelski, New York City; for the South, Rudolph A. Matern, Woodhaven, New York; for the Middle West, Harry Weese, Bloomfield Hills, Michigan; for the Southwest, Lois W. Worley and William W. Caudill, Cambridge, Massachusetts; for the Northwest, J. R. Sproule, Seattle, Washington. These five were chosen from among the 55 winners of the first stage of the competition, whose names were announced last month (See AR, 4/39, p. 10).

The report of the jury follows in part:

"There were five major elements that decided the choice of the winning designs: 1) adaptability to productive activities in the home; 2) layout of land and outbuildings; 3) economy in planning, construction, and materials; 4) suitability to the various regions of materials, design, climate, etc.; 5) ability of the competitor (as indicated by his entry) to prepare proper working drawings and specifications. The Jury considers that the winners have in the great part fulfilled these five requirements.

"The one requirement most generally neglected was that of economy; but since the Program indicated that the occupant of the house might participate in its finishing, as well as in the construction of outbuildings, none of the five winning plans was thought beyond a reasonable economic range.

"The Jury does not wish to present the idea that any of the winning designs will be an ideal Productive Home, and only hopes that they might serve as a springboard for the ultimate ideal. The Jury was gratified by the spirit shown in the designs submitted, and by the general character of the architecture presented for a productive semirural life."

Except for two cases, the Jury was unanimous in its decisions. The jurors' personal opinions of the designs submitted follows:

MISS ELOISE DAVISON: "There is a noticeable lack, evidently, among the contestants, of a proper conception of storage space requirements. Not enough attention was given to protecting the homemaker from noise, confusion, and dust, in the rooms where she spends her working hours. An additional washroom should be given serious consideration in simplifying homemaking routine; and storage of dirty clothes outside, to avoid bringing dirt into the house. . . . It is a striking example of backward kitchen planning, to leave no space for storage units convenient to working areas."

DR. BAKER BROWNELL: "The house that won in the Northeast section is probably the smartest and handsomest home of any entered, but it is too costly for the family in our problem. If the decorative features were eliminated, there would be only a mediocre square house with a cupola, without much other external value. . . ."

MONSIGNOR LUIGI LICUTTI: "The possibilities for the future development of the house were not so well emphasized as they might have been. The cost of most of the homes was too high for the income of the family who would build them. Not many of the contestants thought out the plot arrangement for a complete family-food subsistence production for a whole year. Storage of the various types of food needed, to be produced on the plot and used throughout the year, was not

given much consideration in many cases. Further, little attention was paid to a place for preparing food, such as butchering, or smoking meats. It is questionable . . . whether there is room for a cow on such a small plot of ground. Pigs would be good economy, for they require little space. . . . None of the designs selected have any sort of basement. There is no essential objection to a basement. As to heating, the availability of cheap fuel requires careful consideration."

MR. FREDERICK L. ACKERMAN: "The plans should have been made more simple for flexibility of use, combined use of the units, and for the family's participation in construction and finishing. Regional values were lacking in general, not enough consideration being given to local materials, climatic conditions, etc."

MR. RICHARD J. NEUTRA: "Subsistence homesteading, a transplantation of white-collar and industrial workers, of part-time employed, into a semi-agricultural situation offers a psychological adjustment problem for the entire family group. Active life in overalls must at least occasionally be interrupted by clean rest periods and the refreshment of a bit of social life. The plan of a productive home, of a *home and production plant* under *one* roof must nevertheless be articulated sufficiently, so that areas for relaxation and friendly social life at some evening and holiday hours are detached. Such a living area in and outdoors must be easily accessible from the entrance, and protected against the dirt and disorder which naturally accumulate from work traffic, from muddy shoes, or soles of outdoor-playing children. The bathroom and toilet must be easily accessible from outdoor work and play areas without floors and stairs of the inner dwelling proper being soiled. A disregard of this rule will exasperatingly increase the toil of house cleaning for housewife and mother, who is called upon for many more duties in a productive home than in a city dwelling. The woman must be guarded against an overload of work and granted the satisfaction of seeing a certain part of the dwelling area defended by the very layout itself against a perpetual reverting to an unclean, messy condition. . . ."

MR. ANTONIN RAYMOND: "It is my belief that one of the shortcuts to attaining consciousness of other than material things in our life is contact with Nature. That is an explanation of the trek to the country from the city which is going on. To attain again a real simplicity of life through contact with Nature and working the fields would have a profound effect on our being, and would give every man what he is entitled to: sun, fresh air, and appreciation of Nature's own beauty. . . . The house for such living would be, therefore, of utmost simplicity, and of natural materials, letting Nature come into the home. . . . Simplicity is the principal thing, and that was unfortunately missed."

MR. BURNHAM HOYT: "Of the designs selected, none were stereotyped buildings, all were fitted to productive living. They were perhaps too large and would cost more than the man with an income of \$2,500 a year could afford. However, given the premise that some of the work of building could be done by the man himself, all the winning designs were considered possible. There was, as in the first stage, a general disregard for the use of the cheapest possible fuel. In almost all cases, however, it would be possible to arrange for the use of coal or wood in the localities where it would be more reasonable."

**WINNER FOR NORTHEAST: ALEXIS DUKELSKI**

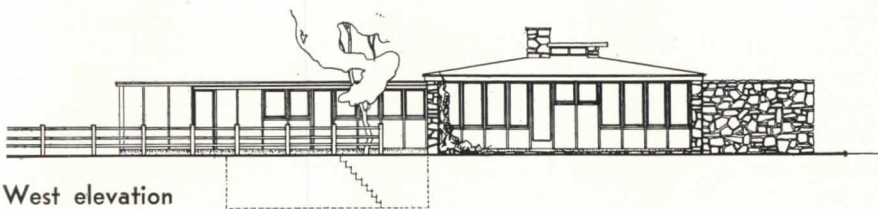
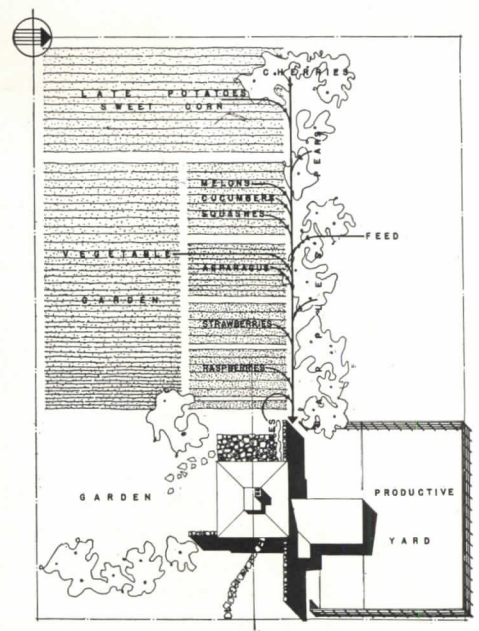
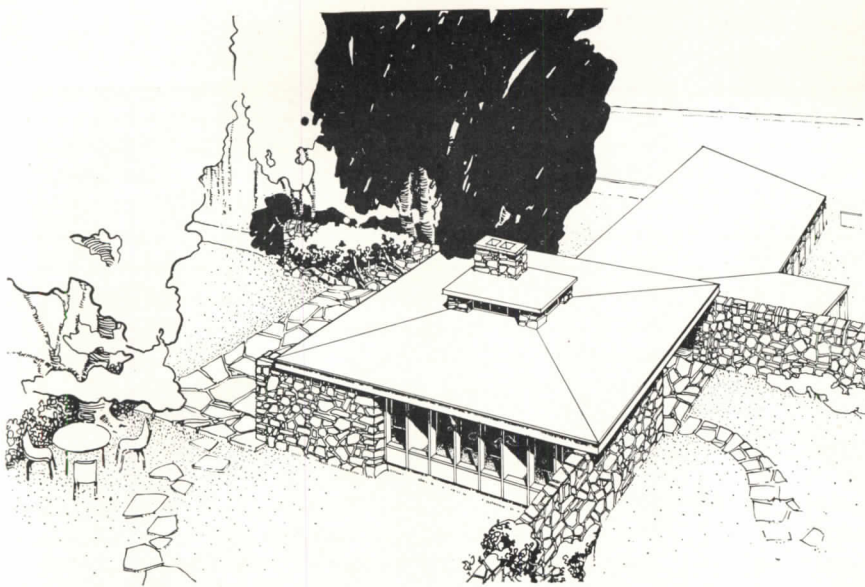

West elevation

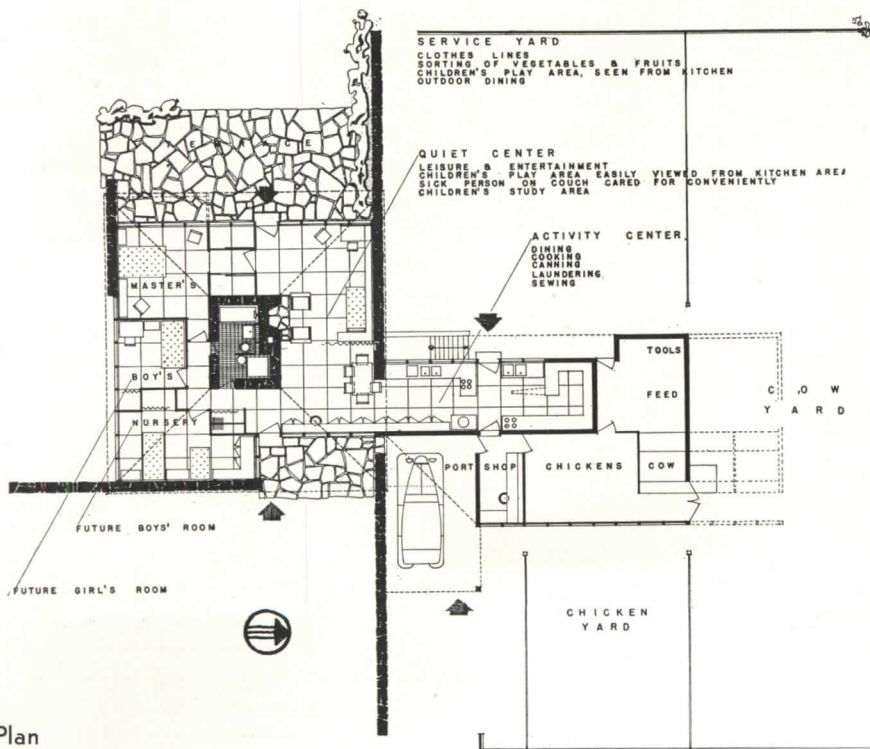

Plan

The design of this house is based on a 3-ft. module. Walls and ceiling are plywood box-beam panels filled with mineral wool; each panel is 3 ft. wide. There is no basement; a flat slab is poured directly on grade. Fieldstone walls at north and east sides protect the house from prevailing northeasterly winds and also separate the productive wing from the house proper; it is assumed this fieldstone is found on the site. Plumbing and heating equipment is concentrated in the center of the house. An oil burner is specified, with a refill tank outside. No interior trim or painting (except wax) has been used. Most doors have been eliminated. Since poultry and cow require close attention, they are located nearest the kitchen.

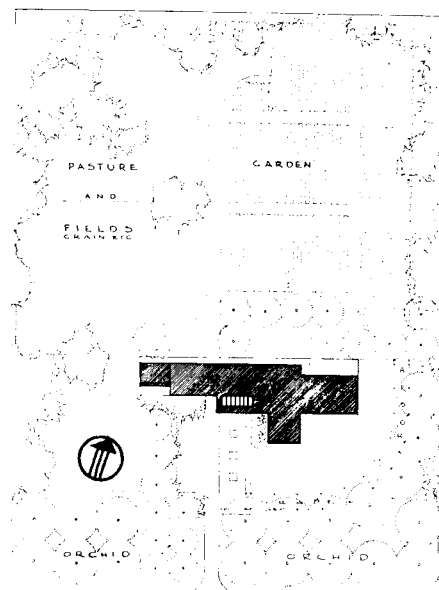
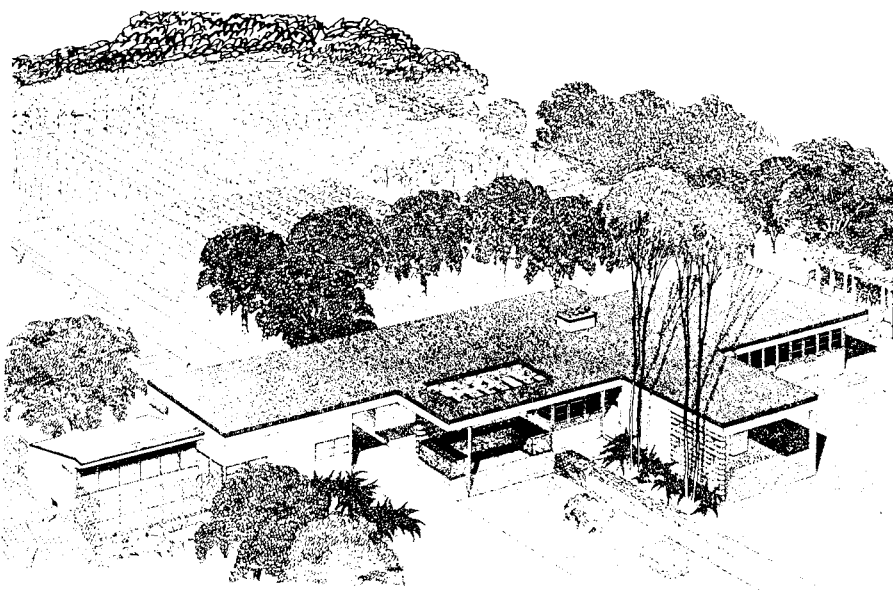

North elevation

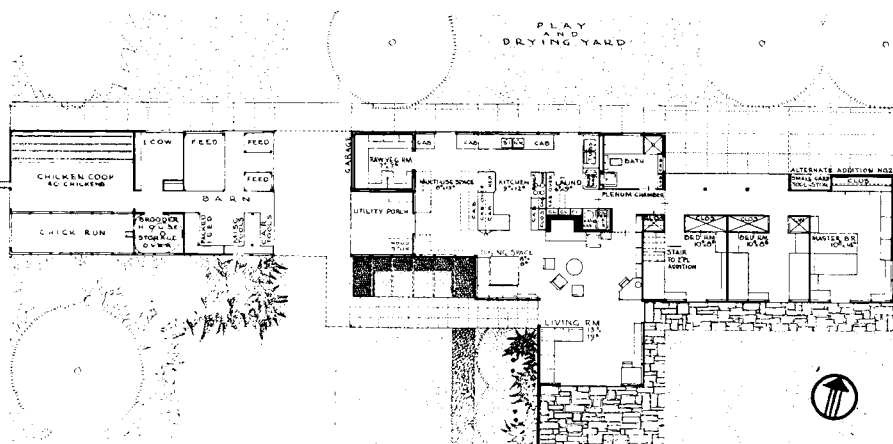

Plan

This house is of modular design to be constructed of plywood. The designer has offered several alternate combinations of work spaces for different uses and avocations. The cubage of the living area is 13,384.5 cu. ft. The cubage of the garage, barn, and chicken coop is 5,312 cu. ft.

**ALTERNATE USES AND COMBINATIONS OF WORK AREA AND INDIVIDUAL OWNER'S AVOCATION FOR FLEXIBILITY**

BASIC PLAN & EQUIPT.      KITCHEN-UTILITY COMB.      HANDICRAFT-DINING COMB.      SHOP & KITCHEN-DINING COMB.

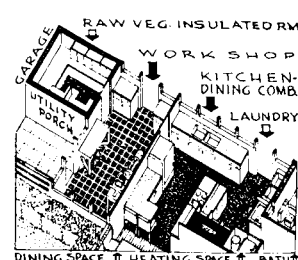
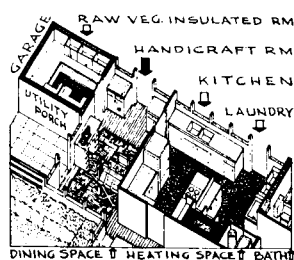
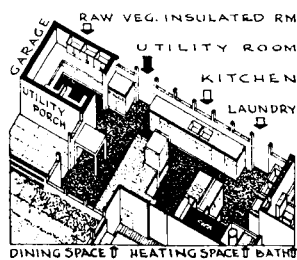
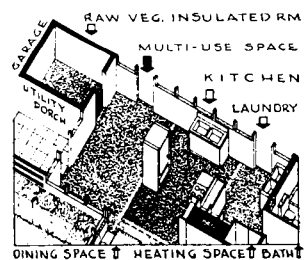



# WINNER FOR MIDDLE WEST: HARRY WEESE

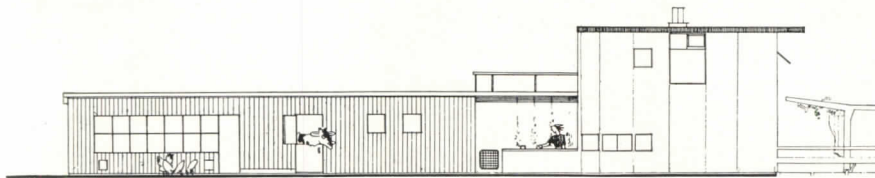
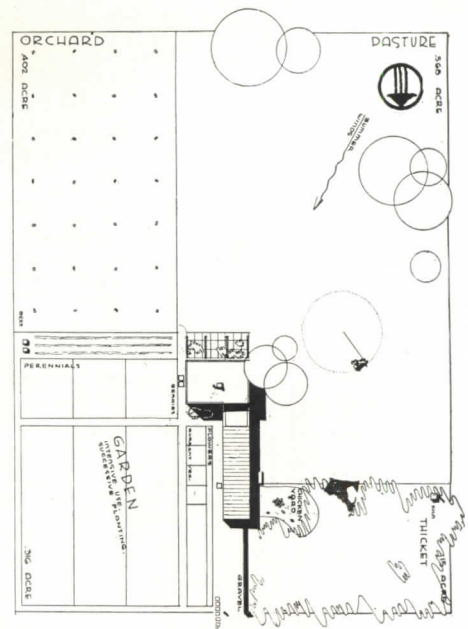
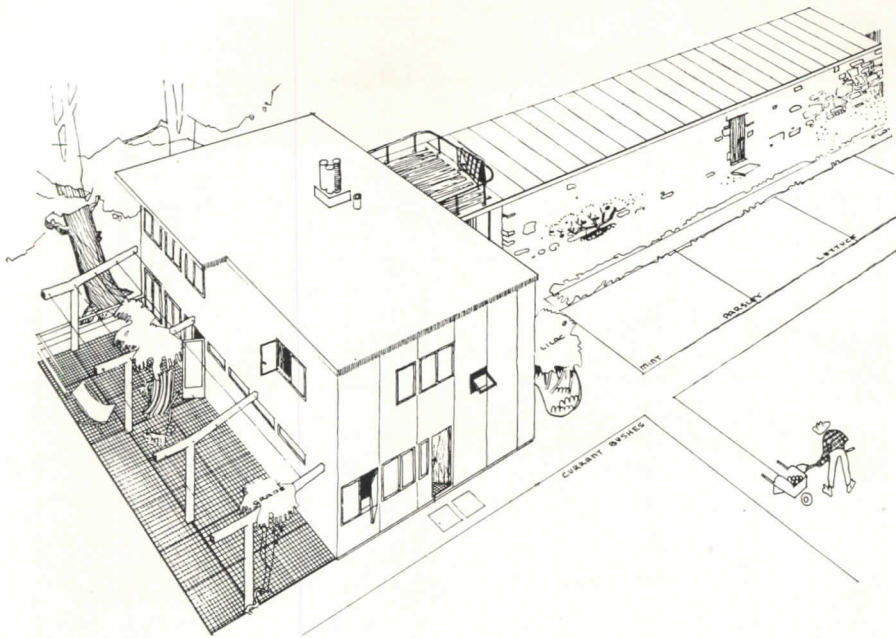

West elevation

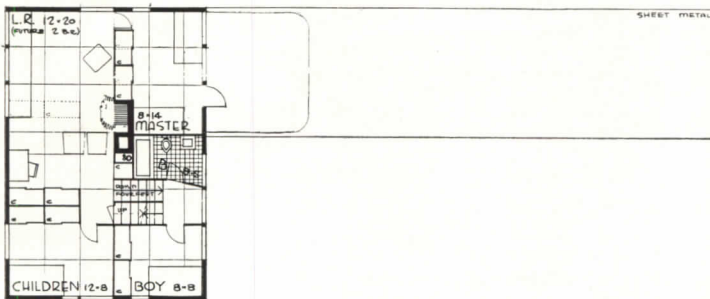

Leisure floor

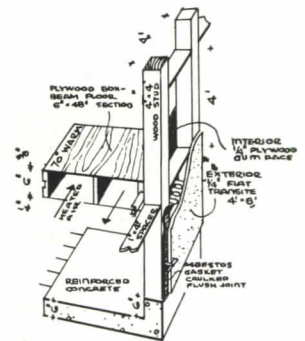

Construction detail

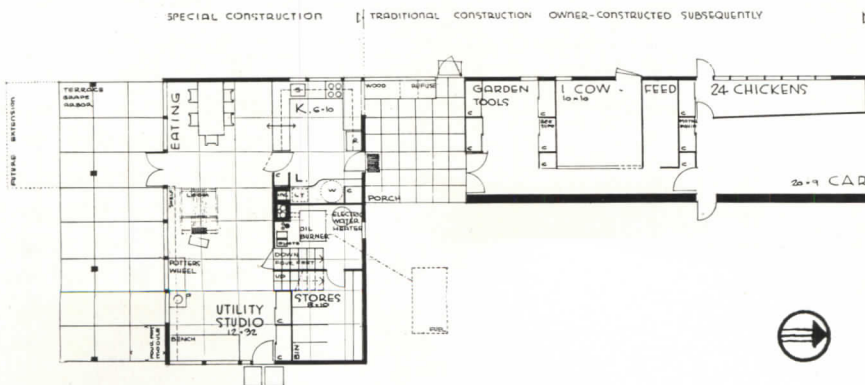

Production floor

The design of this house is based on a modular, plywood-panel construction, which eliminates cutting and fitting. Panels satisfy structural, insulation, and surface requirements; no additional finishes are needed. The panels also make possible the use of radiant heating. Mechanical services have been centralized, and a special plumbing stack is used. Bath and phone are located conveniently at the half story. There is cross ventilation in every room. Cubage of house is 14,003 cu. ft.; cubage of shed is 5,544 cu. ft. Cost of the house is estimated at 27¢ per cu. ft.—a total of \$3,781. Estimated cost of the shed is 16¢ per cu. ft.—a total of \$887.



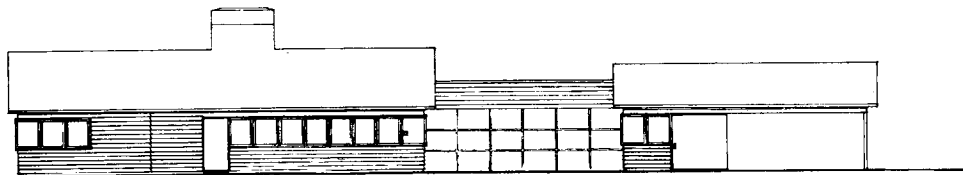
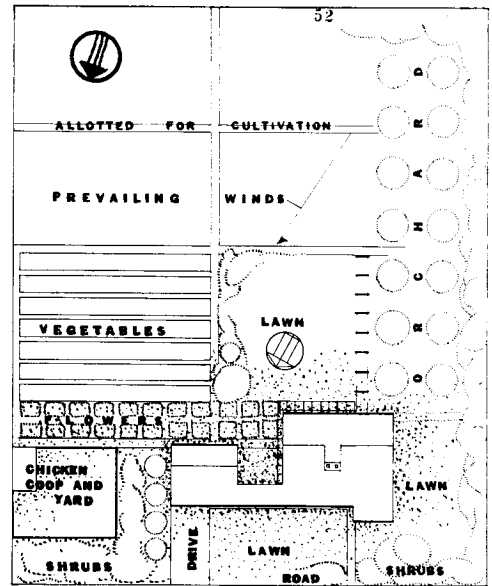
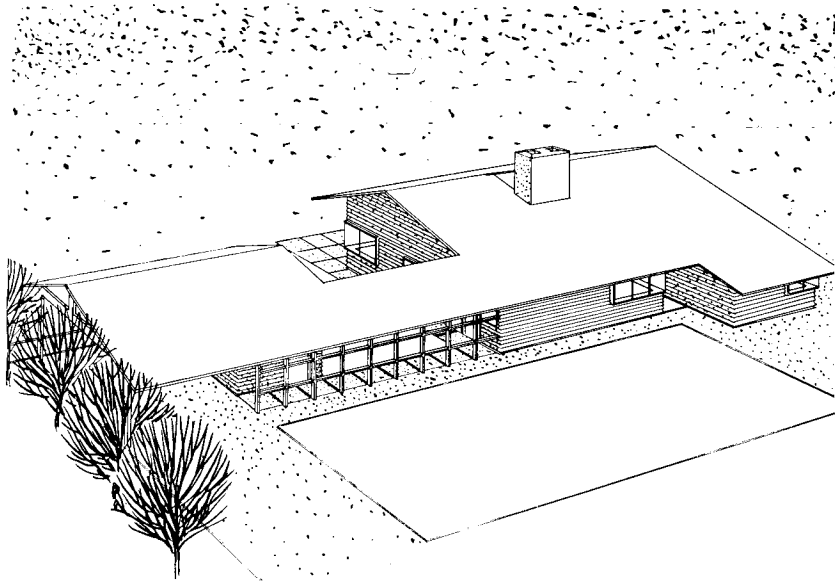

South elevation

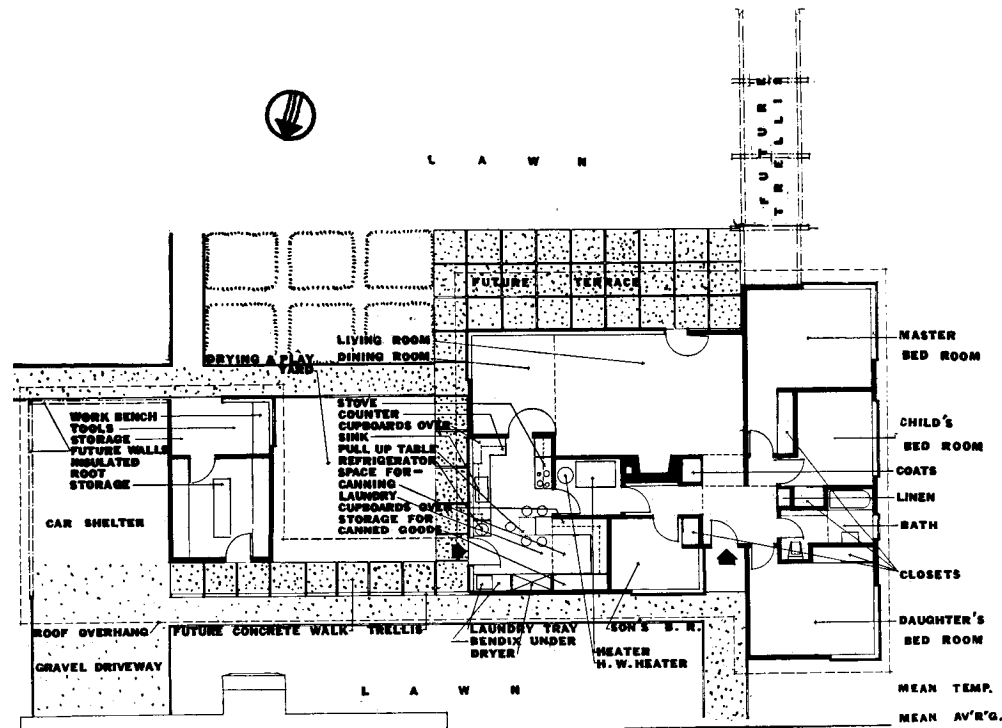

Plan

A post-and-joist construction is employed, with finish siding of beveled cedar. Interior plaster is to be unpainted. Floors are to be built on a waterproofed 3-in. concrete slab set on gravel fill. Roof is 4-ply built-up asbestos, with top sheet white for lower fire insurance rates. Fuel for hot-air heating is oil; a hot-water heater is also to be installed.

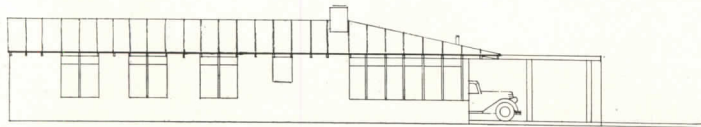
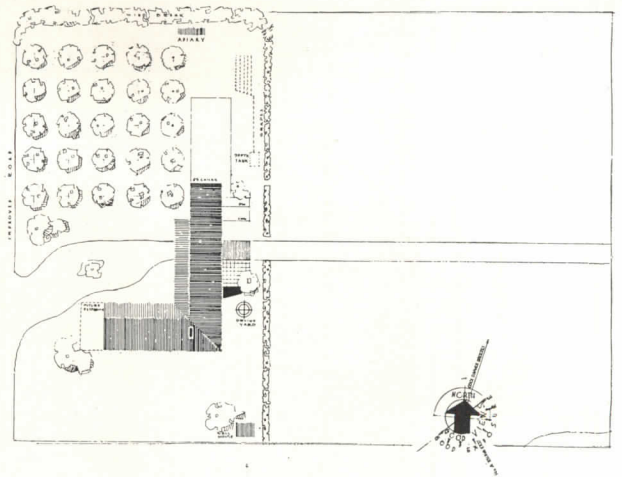
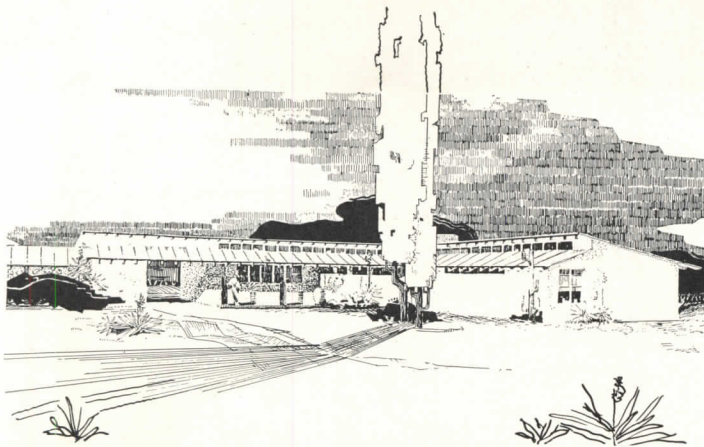

South elevation

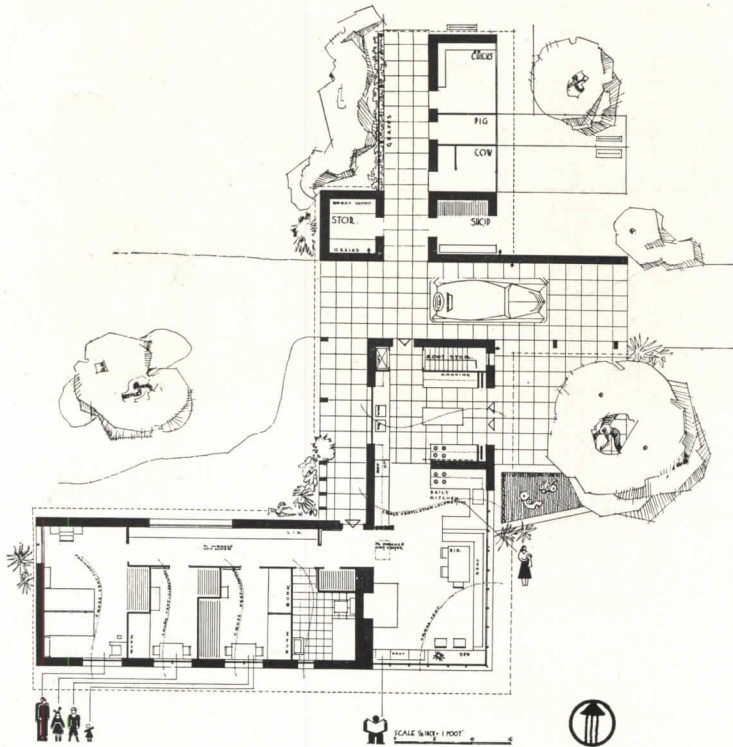

Plan

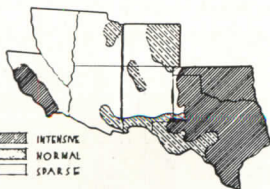

Gas-line distribution

RATES UNDER		HOME POWER RECOMMENDED	
7.50	●●●●● SANTA FE	7.50	COMMERCIAL LOADS RECOMMENDED
7.00	●●●●● SALT LAKE & DENVER	6.00	
6.50	●●●●● EL PASO & FORT WORTH	5.50	
5.50	●●●●● AMARILLO	5.00	
4.50	●●●●● TULSA	4.50	
3.25	●●●●● SAN DIEGO	4.25	
		4.00	
		3.10	

Calculated over-all power consumption of 128 k.w.h. monthly



In shaded areas, earth has been used in building

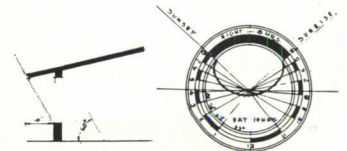

Summer solstice (about June 21); lat. 35°, long. 106°, at Santa Fe

**FUEL:** Natural gas is the preferred fuel; it is especially plentiful and cheap in this region.

**POWER:** Total power consumption of this productive home from both domestic and industrial sources is estimated at 128 k.w.h. per month. Research indicates all cities have reasonable domestic rates for such a project, with the exception of Santa Fe; home generators are recommended for that locality. In Oklahoma and Texas, gas rather than electricity for refrigeration is recommended.

**MATERIALS:** Exterior walls of house are of tamped-earth construction; grey earths, common in the Southwest, are suitable. This construction, it is claimed, provides excellent insulation and requires no interior or exterior finishes. It costs 25% less than similar wall of brick, 50% less than concrete, 25% to 30% less than good frame construction.

**SUNLIGHT:** Angle of sun with horizontal at 10 a.m. and 2 p.m. is approximately 60°. To exclude sunlight from the building during these hours of summer months, provision has been made for 4-ft. projecting eaves, which permit entrance of sunlight during the other seasons when it is most needed. They also project enough to allow open windows in the rainy season.

**COSTS:** Cost of house is estimated at \$4,200 to \$5,200. The design permits construction in successive stages and the financial set-up may be grounded on a pay-as-you-build basis.



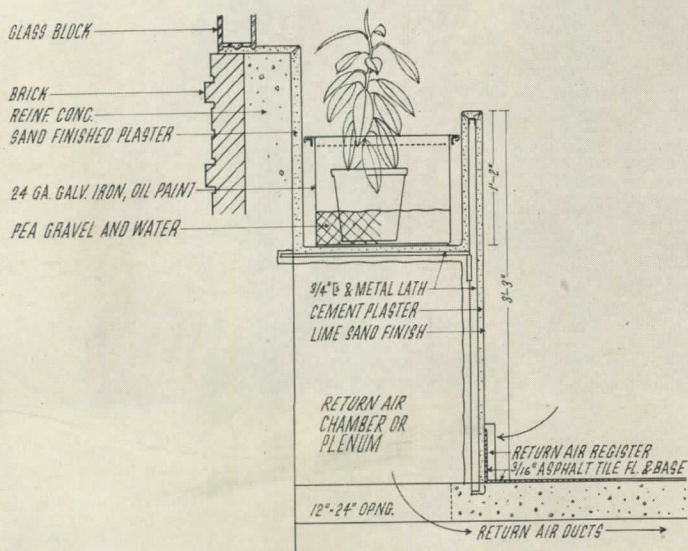

## 1. EDOUARD MUTRUX Architect

FOR INDOOR plant growing, built-in units are increasingly popular, and have particular value as a means of decoration. The unit here pictured is integral with the structure of the building: the bench, on which is placed the zinc tank for plants, is actually the top of the plenum chamber. The building is completely air conditioned, and the glass-block rounded bay admits sufficient light for the types of plant grown here. Plants absorb moisture through their porous clay pots from the 4-in. layer of pea gravel saturated with water.

### Materials and equipment

Glass block: Pittsburgh Corning Corp. Floor: asphalt tile, Johns Manville. Walls: plaster, U. S. Gypsum over rock lath.

Drawings in this section by Torben Müller; photo by Piaget

# NEW DWELLING UNITS: FLORICULTURAL



# NEW DWELLING UNITS: FLORICULTURAL

Courtesy Lord & Burnham Company



## 2. EDWIN B. GOODELL

Architect

CONSERVATORY and lounging area are here combined in a structure of which the roof and two sides are clear glass. A third wall is surfaced with a copper-backed mirror to increase the apparent size of the room. The conservatory opens off the living area of the residence. Ample sunlight is available through the glass walls and roof for plant growing; slat shades on the roof exterior can be adjusted to admit the desired amount of sunlight, and to regulate the temperature in summer. Hand-operated panel vents in the wall and a motor-driven ventilator on the roof, which operates by push-button control, provide proper conditions of humidity. A patented drip-proof glazing method (see detail) prevents moisture from falling in the room. The sill is of 10-in. cast iron. Plant benches are faced with reddish-purple Italian marble. The floor is purple slate.

### Materials and equipment

Glass: Roland Glass Co. Floor: Vermont purple slate, Glassi Co. Slat shades and greenhouse construction: Lord & Burnham Co.

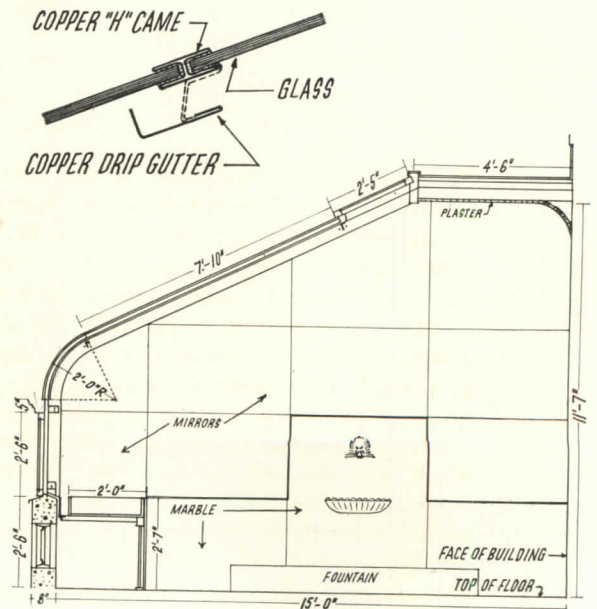





Photos by Paul Korzantiski

### 3. O. BAUER

Architect

THE CLEAR-GLASS stair tower of this villa at Garches, France, commands a superb view of the surrounding countryside and of the Eiffel Tower and the Sacré Coeur in Paris. The tower is on the south side of the house so that ample sunlight is provided for plant growing. Along the upper run of the stairs, at a height convenient for maintenance, are arranged pots of geraniums, begonias, ferns, and ivy. These stand on perforated iron trays which are attached to the metal muntins. Since the porous clay pots stand inside ornamental vari-colored ceramic pots, the plants can be watered without dripping, and can also absorb moisture by standing in water.





# NEW DWELLING UNITS: FLORICULTURAL



Ernest Ludtich

## 4. J. R. DAVIDSON

Architect

THAT FLORICULTURE is not confined to any particular part of a dwelling is evidenced by this stairway unit. Boxes lined with 16-gauge copper are placed at the window and at second-floor newel. The tanks have a layer of gravel in which porous pots can be placed; in some of the tanks, plants are grown in soil laid directly over the gravel. The bottom layer of gravel permits sufficient moisture, but prevents the soil from getting sour. The plate-glass window on the stairwell admits a good amount of daylight which is supple-

mented by light from another window, of equal width, across the landing. For night lighting, an indirect-light trough, lined with Alzac aluminum reflecting surface, is provided in a plaster cove. In the newel there is a built-in X-Ray reflector with flush opal-glass cover which is directed upward.

### Materials and equipment

Window: steel sash, Druwhit Metal Products Co.; plate glass, Pittsburgh Plate Glass Co. Lighting: X-Ray reflector, Curtis Lighting, Inc.; indirect, Lumiline, Westinghouse Electric and Manufacturing Co.

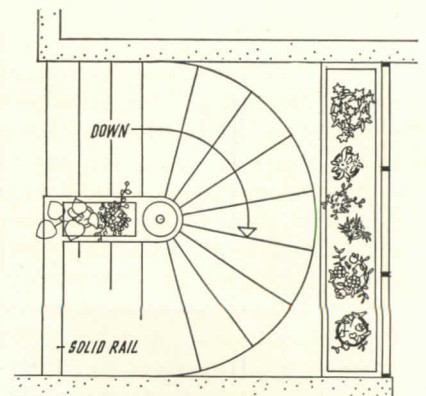
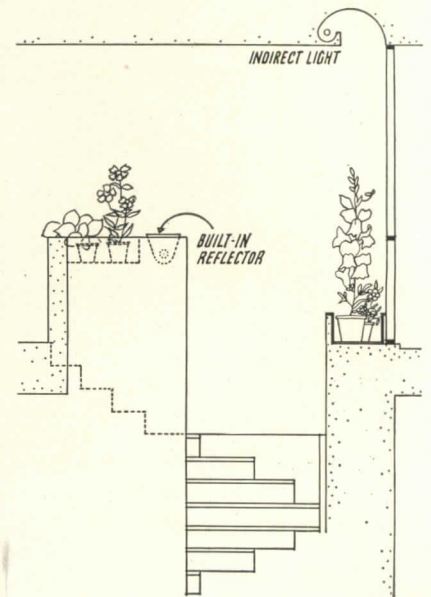

0 1 2 3 4 5 feet





## 5. HANS SCHAROUN

Architect

AN INTEGRAL PART of the living room, this all-glass conservatory is suitably located on the sunny side of the house. The splay on one side of the plant room gives more floor area than would ordinarily have been possible and actually admits more light than a vertical partition. By means of adjustable metal louvers on the exterior of the house, the amount of sunlight can be controlled. Entrance to the conservatory is through a door opening off the living room. Condensation and heat loss in this floricultural unit can be considerably reduced, since, although heated, its temperature need not be the same as that of the living room.

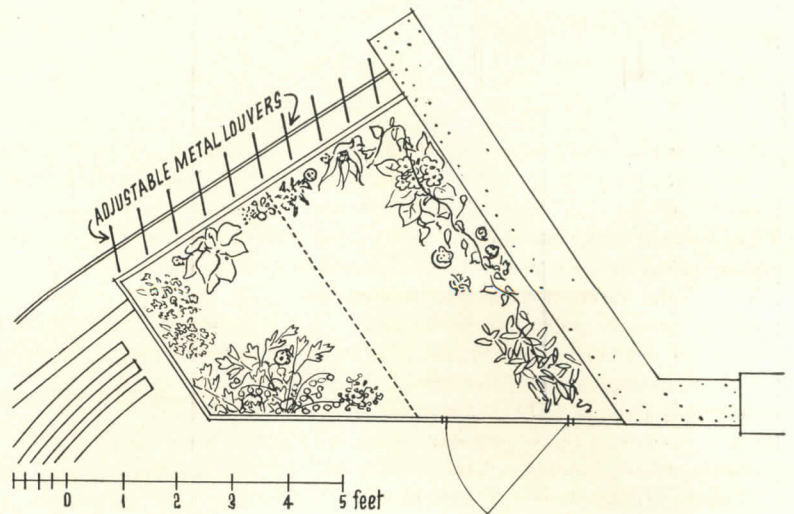



## NEW DWELLING UNITS: FLORICULTURAL



### 6. ERNST LICHTBLAU

Architect

THIS GLASS-ENCLOSED floricultural unit provides space for potted plants of varying sizes. The floor-length window admits light direct to the plants, and the glass partitions serve a two-fold purpose: transmission of borrowed light from other windows in the room, and provision of necessary *temperature and moisture control*. The ceiling is equipped with small electric-light bulbs which can be used both to induce growth of the plants and to illuminate the enclosure. A small, manually controlled radiator is located at one end of the floricultural unit. The floor, raised several inches above the level of the rest of the house, is of marble.





7. SAMUEL GLASER  
Architect



Rollin W. Bailey

THE INTEGRAL construction of this plant box and its location under a window provide a suitable medium for plant growing. Of particular interest is the provision for draining, which consists of an open shaft, running the depth of the box, immediately over the drain. This latter connects with an outside dry well or sewer. Plants are grown directly in the loam, laid over open-joint planks supported by wooden horses. Broken-stone fill in the bottom of the unit facilitates drainage and prevents the soil from becoming sour. At one end of the box is a faucet to which can be attached a small hose spray for watering plants.

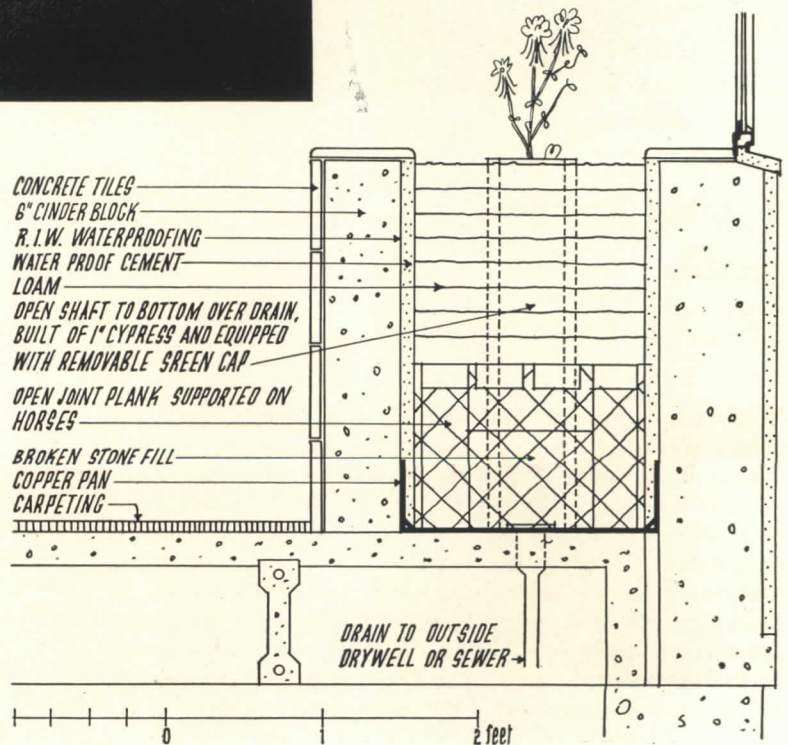



# NEW DWELLING UNITS: FLORICULTURAL

## 8. WAHL SNYDER

Architect



Ernest Graham

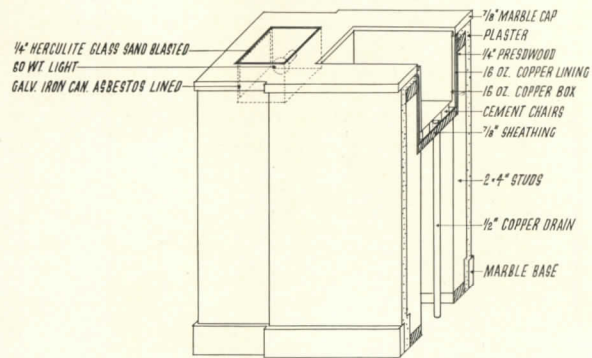

LESS OFTEN used is the type of built-in plant box shown here, where it serves as demarcation between living room and sunroom. The plant unit itself is flanked at either end by light boxes of asbestos-lined galvanized iron in which bulbs are placed under panels of frosted glass for indirect upward lighting. Plant boxes, of 16-oz. copper, are removable. Cap and base of the unit are of white Alabama marble; sides are of smooth plaster.

### Materials and equipment

Plaster: U. S. Gypsum. Plant boxes: made to order, G. & L. Roofing Co. Light box: made to order, Beach Lighting Co. Glass panels: Herculite, Pittsburgh Plate Glass Co.

## 9. HERBERT SPIGEL

Architect



Ben Schnall

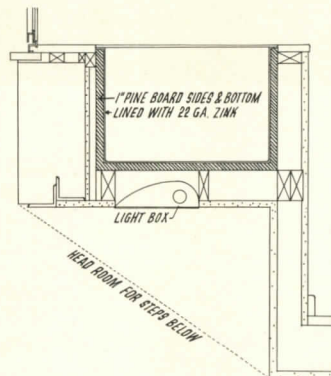

THIS PLANT BOX ingeniously makes use of an otherwise awkward corner necessary to obtain ceiling height for the stairs beneath. The box itself is of 1-in. pine boards lined with zinc; a 3-in. furred area separates the box from the interior finish of the room. Over crushed charcoal in the bottom of the zinc pan is a layer of peat moss, upon which stand porous pots of plants. Since the moss also surrounds the pots, a moist atmosphere is maintained, and the necessity of a drain is eliminated. Sheet moss covers the pots and simulates loam.

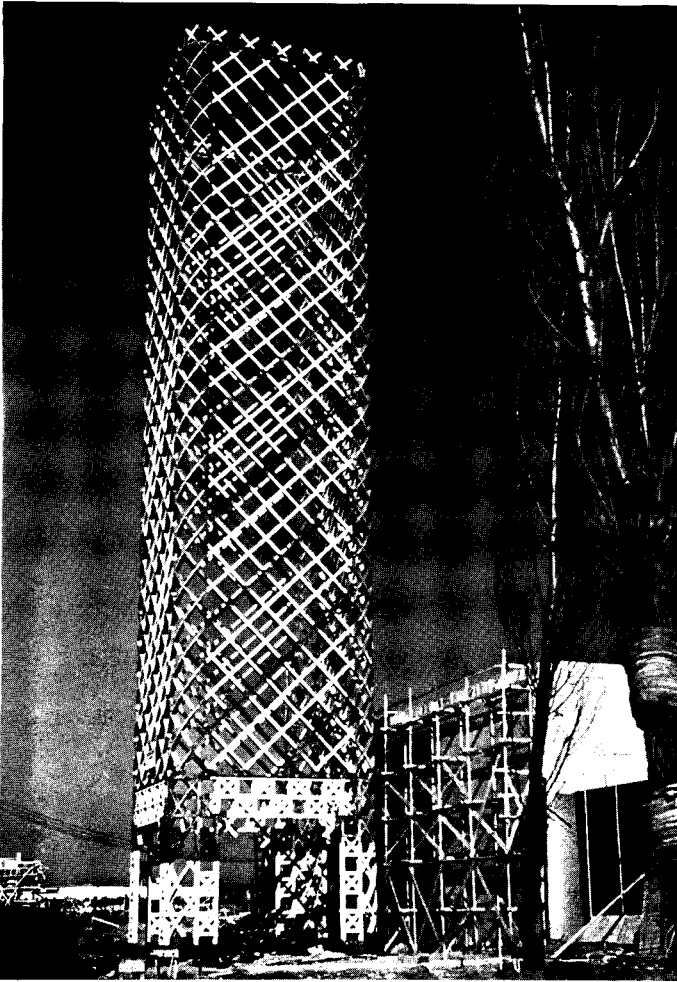

St. Thomas

### Welded rigid frame designed to meet unusual architectural requirements

THE ARCHITECTS of the Republic of Poland's building at the New York World's Fair conceived an entrance tower which was to be open at the top, to be free of all internal structural members or bracing, to have curved corners and wall perforations in a diagonal pattern. The required shell construction was made possible by ingenious engineering design, using welded joints throughout. Designed by A. D. Stark, Associated Consulting Engineer in the office of William Wilson, 101 Park Avenue, New York, the rigid frame, partially shop- and partially field-welded, met all the conditions imposed by the architects.

The lattice-framed superstructure, above the portal, is about 119 feet in height and, except for corner framing, is composed entirely of 8-in. rolled I-beams. These weigh, for the topmost 60%, 17 lbs. per ft.; for the next 20%, 19 lbs. per ft.; for the remaining portion, 21 lbs. per ft. Because of the impracticality of using rolled shapes for the curved framing at the corners, these members were made up of flat plates corresponding in thickness to the rolled sections used at the same level. Because of the relatively severe compressive stress occurring at the inner knuckle of a rigid frame, it was necessary to strengthen these corner members by doubling the thickness of the inner flange. In addition to gravity loads, the framing is designed to resist a wind force of 20 lbs. per sq. ft. on the full area of the tower. An additional allowance of 6000 lbs. per sq. in. was made for local internal stresses due to temperature changes.

Every third diagonal (dark members on the photograph) indicates a field splice. Other joints, except at corners, were shop-welded.

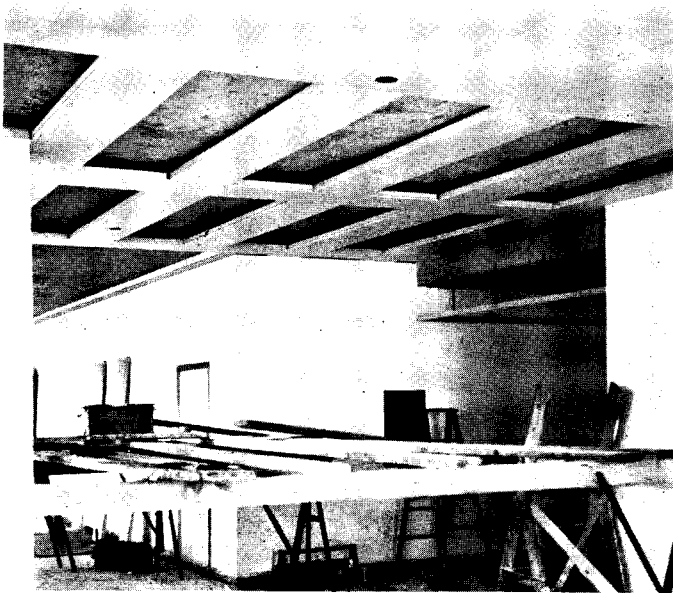

"Panasteel" ceiling installation, indicating how main members are supported from rough ceiling. Acoustical units may be inserted in intermediate areas for variety of effects.

### Prefabricated suspended ceiling permits flexibility in use of acoustical units

"PANASTEEL" ceilings, fabricated by W. J. Lucius of Mount Vernon, N. Y., introduce basic improvements in design and construction of suspended ceilings. These prefabricated metal panels, which may be adapted to any ceiling condition, provide a flexible system in which the acoustical area may be readily increased or decreased after erection. The main panels are securely suspended from the unfinished structure above, thus forming the interlocking supports for the balance of the ceiling. The intermediate areas may then be filled with absorptive and/or reflective units in any proportion and in a variety of patterns.

Flush lighting fixtures or ventilating grilles can be worked into the general pattern of the ceiling. The panels themselves may be perforated for uniform air distribution from the plenum or ducts above. Universal interchangeability facilitates replacement and also makes possible easy access to all present and future service pipes and ducts.

Drop-borders, beams, coffering, scoring, fluting, or other effects can be attained, and simple adaptations have been perfected for combining various acoustical materials with the steel panels. Veneers, fabrics, or textures may be applied either in the factory or after installation.



## NEW EQUIPMENTS



Recent installation of Thompson Hanger in this Cleveland conservatory (left) solved a problem in maintenance which otherwise would have required elaborate scaffolding. The Hanger (right) showing lamp lowered for cleaning, circuit broken.

DESIGNED TO increase efficiency and reduce maintenance costs of industrial lighting, a new series of lamp-lowering hangers has recently been introduced by the Thompson Electric Co. of Cleveland, O. The Thompson Hanger is essentially an auxiliary overhead switch, supporting the lamp in its operating position, with "remote control" by means of a pulley system. This enables high lamps to be easily disconnected and lowered away from the electric circuit, so that cleaning can take place safely and as frequently as desired. When the hanger is returned, it automatically locks back into the electric circuit. Coming in a variety of sizes, the hanger may be used with all standard lighting equipment; a wide range of accessories (including shock absorbers for lamps affected by vibration) make installation possible anywhere. A model, with the entire hanger recessed, will shortly be in production.

## NEW MATERIALS

### Mass production adapted to manufacture of concrete products

IN RESPONSE to the need for nationwide standardization of prefabricated concrete building units, the recently formed Cemenstone Corporation announces starting of production by its first licensee, the D. J. Kennedy Company of Pittsburgh. The standard units are said to meet all construction requirements for which many different shapes are now used. They simplify design problems by providing finished units for sills, jambs, lintels, etc. Wall units include various sizes of panel-faced veneer and full-sized concrete block and also blocks inset with glass.

The three main features of the Cemenstone system of manufacture are: use of vibration while molding to produce a finer texture and stronger product; use of heat to hasten the chemical reaction and to control volume; and use of mass-production methods which permit rapid cycles of manufacture and the making of several shapes at one operation.

Production equipment consists of a rigid steel frame over a curing chamber which produces a temperature of 160 degrees, Fahrenheit. A hopper, which fills the molds with concrete, mixed to a plastic state, rides on the top

of the frame, together with vibrators which agitate the mix. Steam from the curing trough keeps the molds constantly hot. After the concrete has hardened sufficiently, the products are lifted out in large groups and unloaded for aging under cover and in a constant temperature, to prevent unfavorable weather conditions from arresting the proper chemical reaction within the concrete.

Equipment and methods are adaptable to production of blocks for wall construction and channel-shaped short-span slabs for floors and roofs, as well as long-span slabs, concrete planks, joists, brick, insulating tile and veneering, curbs, sidewalks, and fence posts.

### Twisted steel provides improved reinforcing bars

UNDER PATENTS of the American Isteg Steel Corporation, an improved reinforcing bar used for the past eight years in Europe, is now produced by the Wickwire Spencer Steel Company of New York. Isteg reinforcing consists of two plain round bars twisted together cold to form a double helix. Dur-

ing the twisting operation the ends of the bar are restrained against shortening, thereby stretching the bars. The physical properties and shape resulting from this cold working in tension and torsion produces a high yield-point bar of uniform structure and strength, free of mill scale. The process of manufacture is a severe test on the homogeneity of the steel and reveals hidden flaws which result in failure of the bar during the twisting process. By this method of manufacture, the yield point of the steel is raised 50% so that a bar, having normally a yield point of 40,000 lbs. per sq. in., when used in this manner has a yield point of 60,000 lbs. per sq. in., thus permitting a reduction of one-third in the amount of steel required. In addition, the greater surface area, the elimination of mill scale, and the deformation of the twisted bar results in a superior bond.

Tests made at Columbia University indicate that Isteg bars are safer at a design stress of 27,000 lbs. per sq. in. than ordinary steel bars at a stress of 18,000 lbs. Use of Isteg reinforcing is permitted by the New York City Building Code and has been specified by the Procurement Division of the U. S. Treasury Department.

# DESIGN TRENDS

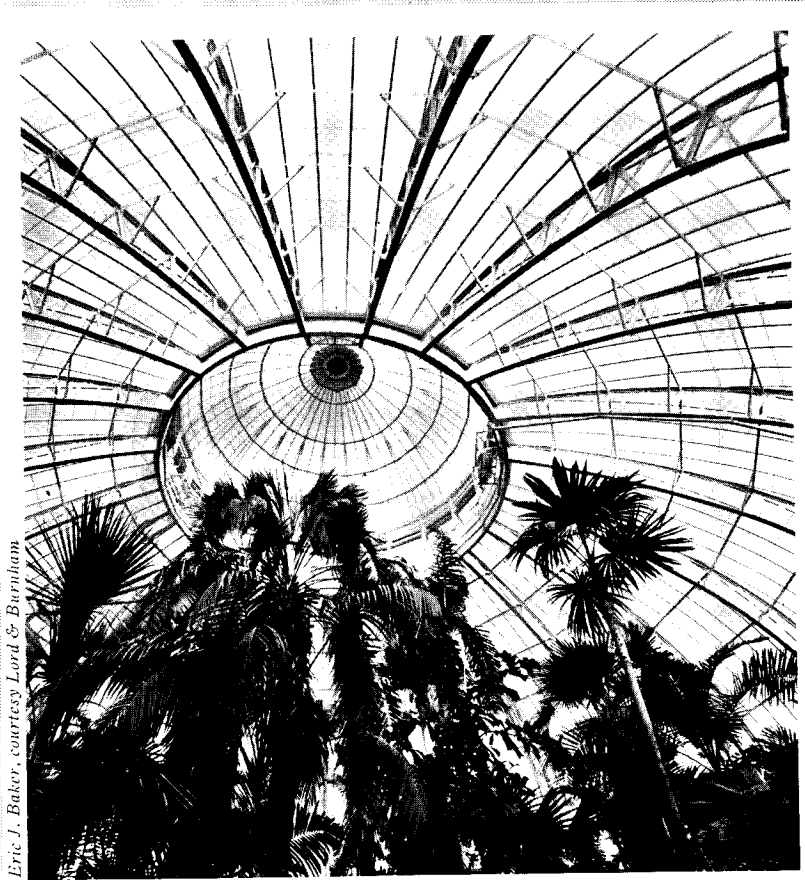

*Eric J. Baker, courtesy Lord & Burnham*

**In the city, Nature itself takes on new meaning . . .**

ARCHITECTURAL  
RECORD



# LANDSCAPE DESIGN

by GARRET ECKBO  
DANIEL U. KILEY  
JAMES C. ROSE



ALL ORGANISMS SEEK the natural environment most favorable to the complete development of their species, and where nature fails to meet the biologic necessities, adaptation of either environment or organism must occur for life to continue. Each species produces its own forms which provide for its specific requirements in the struggle for existence. In lower organisms, the process of adaptation is so intimately related to the life cycle that it is hardly distinguishable; in vigorously motile and highly socialized organisms, the central forms are no longer individual, but are produced by the community to provide a wider adaptation to satisfy specific needs. The honeycomb of the bees and the beavers' dam are very advanced examples of such forms. Unlike the insects, however, the environmental adaptation of man is infinitely complicated by his own half-social, half-individual makeup, his uneven evolutionary development, and his distribution over every variety of geographic, topographic, and climatic conditions.

Generally speaking, man's central effort—the exploitation of all mineral, plant, animal, and insect forms for his own social welfare—has taken two forms, industrial and agricultural production. Where one of these production forms predominated, a characteristic type of environment resulted—*urban* for industry, *rural* for agriculture, *primeval* for those areas either untouched or only superficially exploited (trapping, lumbering, etc.). Although none of these environments were as socially desirable, efficient, or expressive as they might have been, they served one purpose admirably: they enormously increased man's productivity and laid the material basis for still higher forms of environment.

But as productivity rose, necessary labor time decreased: time for play as well as work became a reality for the average man. This, in turn, posed a new problem: the *absolute necessity* for and the *real possibility* of man's controlling his environment for his pleasure as well as his labor, for recreation as well as production.

**WITH INCREASING SHARPNESS, MODERN LIFE POSES** the questions: How can man most constructively use his free time? What physical accommodations are essential to his recreation? Who will design them? . . . Since nature—plant life, landscape, open air—are of at least as much importance in this phase of environmental control as architecture, ARCHITECTURAL RECORD has asked Messrs. Eckbo, Kiley, and Rose to explore the subject from the standpoint of landscape design. This study covers recreation in the urban environment; subsequent installments will analyze the rural and primeval.



# THE URBAN ENVIRONMENT

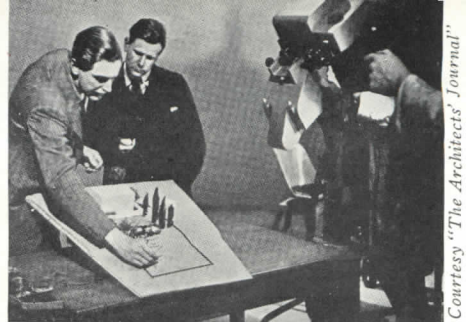

Courtesy "The Architects' Journal"

England: televising a landscape lecture

This wide and expanding need of society for planned recreational environments offers tremendous new opportunities to landscape designer and building designer alike. These needs are so newly discovered, the means of meeting them so varied, and the design standards so nebulous, that it is perhaps wise to discuss the recreational needs of each type of environment relative to its dominant production forms, i.e., urban, rural, primeval.

Before beginning any discussion of the part of landscape design in creating such environments, a few facts about the origin of this specialized field might be worthwhile. The farmer was the first landscape designer. However remote from reality they may have since become, the great schools of landscape design sprang from the agricultures of the period. Most advances—new plant forms, new fertilizers, new construction equipments and methods—were developed to increase agricultural production, not to make possible a Tuileries or a Kensington Garden.

The farmer has no preconceived ideas of form; he uses all available knowledge and technics to meet a given need; he plants and cultivates without abstract theories of design or beauty. He is interested in the maximum production for the minimum expenditure of time and effort. His forms are not static, but change constantly with the seasons, with advances in farming methods and plant materials. The resulting landscapes, at their best, assume a biologic, plastic quality which express man's achievements and aspirations in dramatic terms. The rice terraces of China and Japan, the wheat fields of North Dakota, the vineyards along the Rhine, are not only socially productive, they are designs which easily rival the gardens of Villa D'Este or the Alhambra.

This is not to discount for a moment the great schools of design of the past, as the English landscapist, Christopher Tunnard, has been quick to point out "If, then, a new garden technique is to be evolved, it need not necessarily reject the traditional elements of the garden plan. Rather, its aim must be

to infuse them with new life. . . . Just as the design of the locomotive, the aeroplane, and, for that matter, the modern house, is being changed by scientific invention, in a similar way science will transform the garden of the future. The latter must necessarily be influenced by new materials and their methods of application, for example, by plant importation and hybridization, and the amelioration of soil and weather conditions." This is more than ever true when the landscape designer turns from the design of the individual garden\* to the great recreational environments of tomorrow.

### Cities redesigned for living . . .

"The remodeling of the earth and its cities," Lewis Mumford has said, "is still only at a germinal stage: only in isolated works of technics, like a power dam or great highway, does one begin to feel the thrust and sweep of the new creative imagination: but plainly, the day of passive acquiescence to the given environment, the day of sleepy oblivion to this source of life and culture, is drawing to an end. Here lies a new field. . . ."

Certain it is that the city today stands between man and the source of recreation, consuming his free time in traveling to and from those areas which provide a means of restoring vitality dissipated in work.

The sharp division of working and recreative worlds in today's urban areas has produced a fallacious weighting of their relative values. Work has become the dominant fact of human life—leisure and recreation a more or less luxurious afterthought which is fitted in around it. The dreary preponderance of building, the almost total absence of gardening, in our metropoli, is a direct reflection of this. Yet leisure and recreation, in their broadest sense, are fundamentally necessary factors of human life, especially in an industrial age. Recreation, work, and home life are fundamentally closely interdependent units, rather than entities to be segregated by wastefully attenuated transportation facilities, as they are today.

Since most production in the city takes place under roof, indoors, it is obvious that urban recreation must emphasize the out of doors, plant life, air, and light. In our poorly mechanized, over-centralized, and congested cities the crying need is for organized space: flexible, adaptable outdoor space in which to stretch, breath, expand, and grow.

### Trend towards recreational systems

The urban dweller requires a complete, evenly distributed, and flexible system providing all types of recreation for persons of every age, interest, and sex. The skeletal outlines of such systems are emerging in many American cities—New York, Cleveland, Washington, New Orleans, Chicago—although usually in a fragmentary and uncoordinated form. Of these, the combined park systems of New York City, Westchester County and Long Island (see p. 77) undoubtedly constitute the most advanced examples.

But, aside from their sheer inadequacy—no American city boasts even minimum standards of one-acre open space to each 100 population—these systems have many qualitative shortcomings. Public park systems are usually quite isolated: on the one hand, from the privately owned amusement and entertainment centers—theaters, dance halls, stadia, and arenas; and, on the other, from the school, library, and museum systems. This naturally makes a one-sided recreational environment. Even the largest elements—Lincoln Park in Chicago, Central Park in New York—are too remote from the densest population areas to service them adequately. And nearly all of these systems, or parts of systems, still labor under antiquated concepts of design, seldom coming up to the contemporary plane of formal expression. Nevertheless, the trend is more and more toward considering a well-balanced system essential, such a system including the following types:

\*For detailed discussion of the potentialities of the modern garden, see recent series of studies by Messrs. Eckbo and Rose in *Pencil Points* magazine.



1.



4.



2.



3.



5.

**NATURE**, by its very scarcity, achieves a great cultural significance in the city. Thus, instead of vacant lots (1), the urbanite's environments should provide for such things as demonstrations of scientific advances in plant growing (2), botanical gardens for exotic or out of season flora (3), opportunities to grow plants (4), reproductions of botanically interesting plant "communities" (5). Emphasis should be on scientific approach, encouraging active group participation in experiment wherever possible.

1. *Play lot*—a small area within each block or group of dwellings for pre-school children. One unit for every 30 to 60 families; 1,500 to 2,500 sq. ft. minimum. A few pieces of simple, safe but attractive apparatus—chair swings, low regular swings, low slide, sand box, simple play materials, jungle gym, playhouse. Open space for running. Enclosure by low fence or hedge, some shade. Pergola, benches for mothers, parking for baby carriages.

2. *Children's playground*—for children 6 to 15 years. At or near center of neighborhood, with safe and easy access. 1-acre playground for each 1,000 total population; 3 to 5 acres minimum area in one playground. Chief features: apparatus area; open space for informal play; fields and courts for games of older boys and girls; area for quiet games, crafts, dramatics, storytelling; wading pool.

3. *District playfield*—for young people and adults. 1/2- to 1-mile radius; 10 acres minimum size, 20 desirable. One playfield for every 20,000 population, one acre for each 800 people.

4. *Urban park*—large area which may include any or all of above activities plus "beauty of landscape." Organized for intensive use by crowds—zoos, museums, amusement, and entertainment zones.

5. *Country park and green belts*—for "a day in the country"—larger area, less intensive use, merely nature trimmed up a bit. Foot and bridle paths, drives, picnic grills, comfort stations.

6. *Special areas*—golf course, bathing beach, municipal camp, swimming pool, athletic field, stadium.

7. *Parkways and freeways*—increasingly used (1) to connect the units listed above into an integrated system and (2) to provide quick, easy, and pleasant access to rural and primeval areas.

**But quantity is not enough . . .**

But the types listed above constitute only the barest outlines of a recreational system; provision of all of them does not in any way guarantee a *successful recreational environment*. In other words, the problem is qualitative as well as quantitative—not only *how much* recreational facilities, but *what kind*. Here the element of design is vital, and success is dependent upon accurate analyses of the needs of the people to be environed. These needs are both individual and collective.



Every individual has a certain optimum space relation—that is, he requires a certain volume of space around him for the greatest contentment and development of body and soul. This space has to be organized three-dimensionally to become comprehensible and important to man. This need falls into the intangible group of invisible elements in human life which have been largely disregarded in the past. Privacy out-of-doors means relaxation, emotional release from contact, reunion with nature and the soil.

Collectively, urban populations show marked characteristics. Not only do their recreational needs vary widely with age, sex, and previous habits and customs (national groups are still an important item in planning); but they are also constantly shifting—influenced by immigration, work, and living conditions. Recent studies by Professor Frederick J. Adams of M.I.T. indicate constantly changing types of activity within definite age groups, and a gradual broadening of the ages during which persons participate most actively in sports. Organized recreation is spreading steadily downward (to include the very young in kindergarten and nursery) and upwards (to provide the elderly with passive recreation and quiet sports).

In addition, the urban population uses a constantly increasing variety of recreation forms—active and passive sports, amusements, games, and hobbies. Old forms are being revived (folk dancing, marionettes); new forms are being introduced (radio, television, motoring, etc.); foreign forms imported (skiing, fencing, archery).

Consideration of the above factors imply certain design qualities for the recreational environment which are generally absent from all but the very best of current work. Design in the recreational environment of tomorrow must (1) integrate landscape and building, (2) be flexible, (3) be multi-utile, (4) exploit mechanization, (5) be social, not individual, in its approach.

1. *Integration.* The most urgent need is for the establishment of a *biologic* relationship between outdoor and indoor volumes which will automatically control density. This implies the integration of indoors and outdoors, of living space, working space, play space, of whole social units whose size is determined by the accessibility of its parts. Thus landscape cannot exist as an isolated phenomenon, but must become an

Provisions for: games and running; play-house, play materials, and toys; slides, swings, sandpiles; rest and story-telling.



**PLAYLOTS** are the base of the recreational pyramid. They should provide as a minimum a quiet, protected space for pre-school children in each block, (1) and (2); parking for baby carriages; benches for mothers. In some of the USHA projects, playlots are now combined with nurseries.

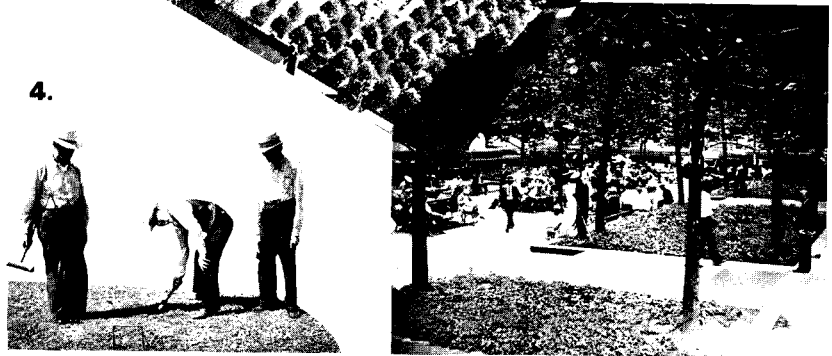
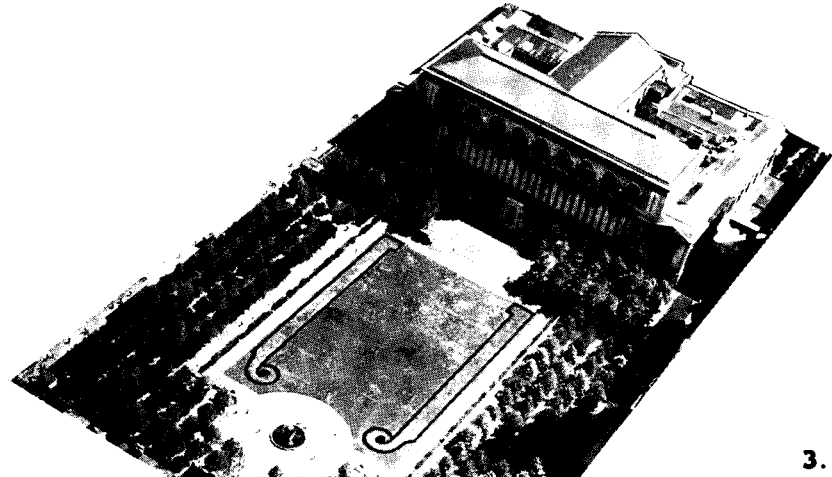

**NEIGHBORHOOD PARKS**, although common to most cities, are usually more decorative (3) than useful (4). Elderly persons increasingly need space for games—croquet, horseshoes, shuffleboard, checkers—as well as the more usual reading, knitting, gossiping, beer-drinking, etc.

Photos courtesy National Recreation Association, N. Y. Dept. of Parks, Works Progress Administration; sketch courtesy "Journal of the Royal Institute of Architects"

Provisions for: apparatus, informal play, wading pool, various field and court games for older children, quiet games, dramatics, etc.



1.



2.



3.

4.



**PLAYGROUNDS** for the most active of all age groups—6 to 15 years—are a generally recognized necessity. Yet the majority of urban children are still forced to use the street (1). Equipped, but crowded and exposed is (2), while good planning, plant life, and privacy add measurably to (3) and (4). Two-thirds of the children attending playgrounds live within 3 blocks, 75% within 4; thus, intimate relation between dwelling and playground—uninterrupted by streets and highways—is essential.

integral part of a complex environmental control. It is quite possible, with contemporary knowledge and technics, to produce environments of sufficient plasticity as to make them constantly renewable, reflecting the organic social development. It is possible to integrate landscape again with building—*on a newer and higher plane*—and thus achieve that sense of being environed in great and pleasantly organized space which characterized the great landscapes of the past.

2. *Multiple-use.* Most types of recreation are seasonal and, within the season, can be participated in only during certain hours of the day or evening. In addition, different age and occupational groups have free time at different hours, and a great variety of recreational interests exists within the same groups. The trend toward multiple-use planning reflects needs which permeate all forms of contemporary design: decreased maintenance, increased utility, and saving of time in unnecessary travel.

3. *Greater flexibility* in building design—to provide for wider varieties of use and greater adaptability to changing conditions—can be extended into the landscape. The construction creates a skeleton of volumes which are perforated enough to permit air and sunlight for plant growth. Plants now replace the interior partitions, and divide space for outdoor use. When building and landscape achieve this flexibility, we discover that the only difference between indoor and outdoor design is in the materials and the technical problems involved. Indoors and outdoors become one—interchangeable and indistinguishable except in the degree of protection from the elements.

Flexibility in design expresses in a graphic way the internal growth and development of society. For this reason, the great tree-lined avenues and memorial parks terminating the axes are not satisfactory, though they may have twice the open area per person above that which might be called an optimum. Once such a scheme is built, it is a dead weight on the community because it is static and inflexible. It is neither biologic nor organic, and neither serves nor expresses the lives of the people in its environs.

4. If scientific and technical advance has created the urban environment of today, it—and it alone—has also made possible the urban environment of tomorrow. This implies a frank recogni-



tion, on the part of landscape designers particularly, of the decisive importance of "the machine"; it must be met and mastered, not fled from. Indeed, the only way in which landscape design can be made flexible, multi-utile, and integral with building is by the widest use of modern materials, equipments, and methods.

As a matter of fact, this is already pretty generally recognized, though, again, in a fragmentary fashion. The great parkway systems of America are the best example of new landscape forms evolved to meet a purely contemporary demand. The sheer pressure of a mobile population forced their creation; and archaic design standards fell by the wayside almost unnoticed. The landscapings of the New York and San Francisco fairs are other examples, though perhaps more advanced in the construction methods employed than in the finished form. The use of modern lighting and sound systems, mobile theatrical units (WPA caravan theaters, Randall Island rubber-tired stages, St. Louis outdoor opera theater) is already widespread. Throughout America, advances in agriculture, silviculture, horticulture, and engineering are constantly being employed by the landscape designer.

But there are, as yet, few examples which exploit the full potentialities or achieve the finished form which truly expresses them. Nor does the use of the fluorescent light, microphone, or automobile alone guarantee a successful design. The real issue will be the use to which such developments are put. The parkway, for example, can either serve as a means of integrating living, working, and recreation into an organic whole; or it can be used in an effort to sustain their continued segregation. The theoretical 150-mile radius at the disposal of all urban dwellers for recreation is a dream of the drafting board, which, for the majority of people, is blocked at every turn by the inconvenience and cost of transportation. Only if the parkway reduces the time, money, and effort involved in getting from home to work to play, will it justify its original outlay.

In building the recreational environment of tomorrow even our most advanced forms must be extended and perfected. Man reorganizes materials consciously; their form effect is produced consciously; any effort to avoid the problem of form will produce an

Provisions for: playground; major sports—football, baseball, field hockey, soccer, etc.; swimming; tennis, bowling, archery, shuffleboard; theater, bandshell; recreation building.

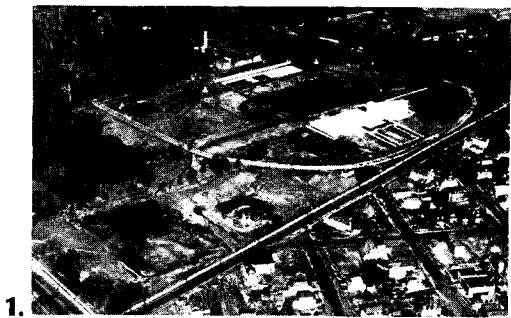

1.



2.

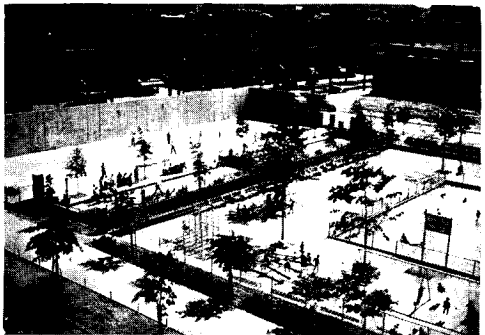

3.



4.

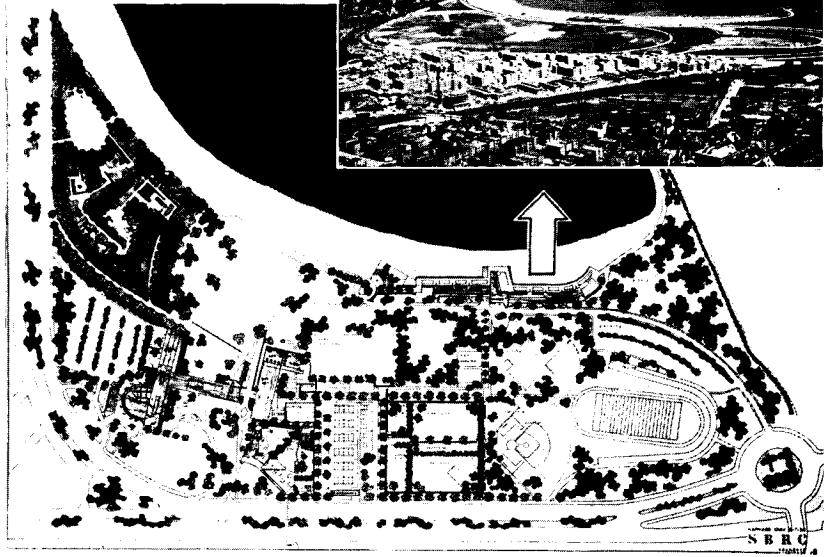

**PLAYFIELDS**, for young people and adults, are often combined with high schools—though this is not essential or necessarily desirable. Space (1), equipment (2), and plant life (3) are all essential to the success of the playfield; but design—such as indicated in the student project for the new USHA development in Boston (4)—is decisive. Four Harvard students here analyzed the recreational needs of an actual population: freedom of choice, flexibility, and segregation of functions are achieved.

Photos courtesy U. S. Housing Authority, N. Y. Dept. of Parks, National Recreation Association



1.

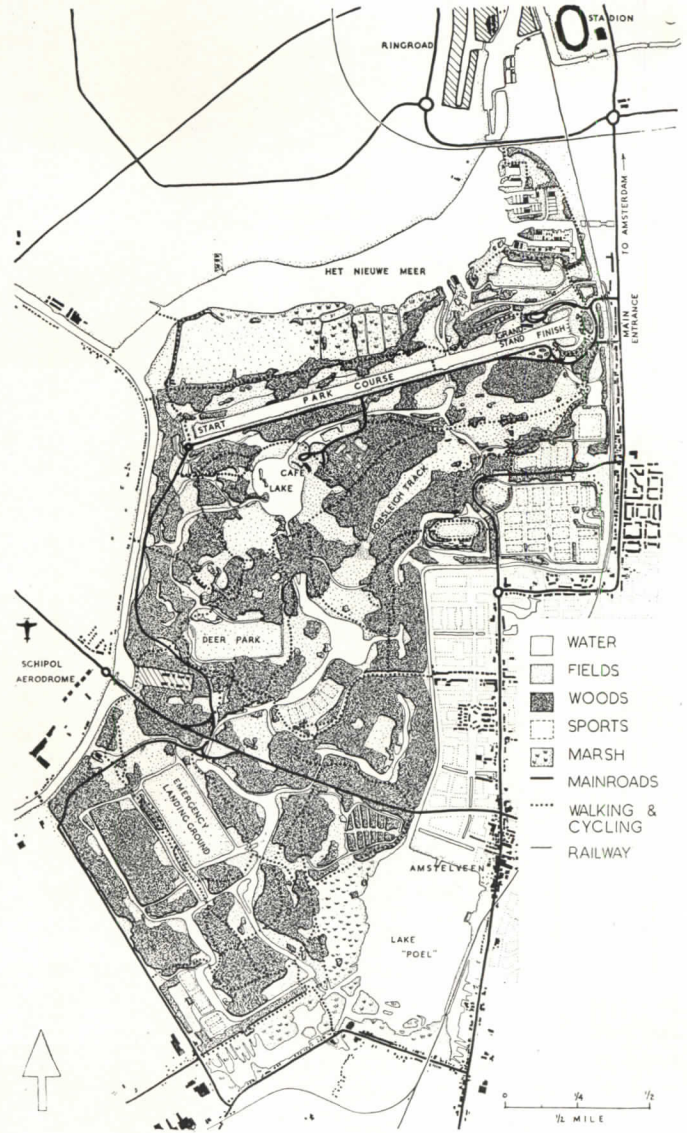

2.



3.

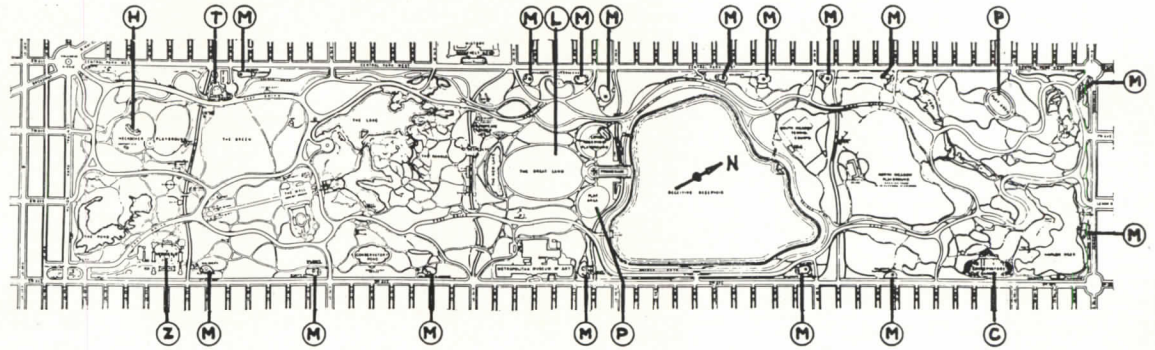

Key to plan: C. Playfield. H. Special playground. L. Play lawn. M. Playlots. P. Playgrounds. T. Restaurant. Z. Zoo.

**PARKS**—Since intown parks are the earliest of all recreational types, most urban recreational systems already include them. However, they are often too few and too small, too remote from the dwelling centers, and not up to contemporary levels of design. Most famous in this country is New York's Central Park (3), which has been greatly improved in recent years by addi-

tion of many specialized recreational facilities. Chicago's "lake-shore" parks (1) represent progressive design, although located at the edge of the city. Probably the most advanced intown-park design is that for Amsterdam's new Boschplan (2); located in the fastest-growing portion of the city, and connected to the rest by good transportation, it provides a wide variety of facilities.



equally consciously developed form. Nothing in the world "just happens". A natural scene is the result of a very complicated and delicately balanced reaction of very numerous natural ecological forces. Man, himself a natural force, has power to control these environmental factors to a degree, and his reorganizations of them are directed by a conscious purpose toward a conscious objective. To endeavor to make the result of such a process "unconscious" or "natural" is to deny man's natural place in the biological scheme.

5. While the individual garden remains the ancestor of most landscape design, and while it will continue to be an important source of individual recreation, the fact remains that most urbanites do not nor cannot have access to one. And even when (or if) each dwelling unit has its private garden, the most important aspects of an urban recreational environment will lie outside its boundaries. The recreation of the city, like its work and its life, remains essentially a social problem.

**Landscape—like building—moves forward**

Landscape design is going through the same reconstruction in ideology and method that has changed every other form of planning since the industrial revolution. The grand manner of axes, vistas, and facades has been found out for what it is—a decorative covering for, but no solution to, the real problem. Contemporary landscape design is finding its standards in relation to the new needs of urban society. The approach has shifted, as in building, from the grand manner of axes and facades to specific needs and specific forms to express those needs.

Plants have inherent quality, as do brick, wood, concrete, and other building materials, but their quality is infinitely more complex. To use plants intelligently, one must know, for every plant, its form, height at maturity, rate of growth, hardiness, soil requirements, deciduousness, color texture, and time of bloom. To express this complex of inherent quality, it is necessary to separate the individual from the mass, and arrange different types in organic relation to use, circulation, topography, and existing elements in the landscape. The technics are more complicated than in the Beaux Arts patterns, but we thereby achieve volumes of organized space in which people live and play, rather than stand and look.

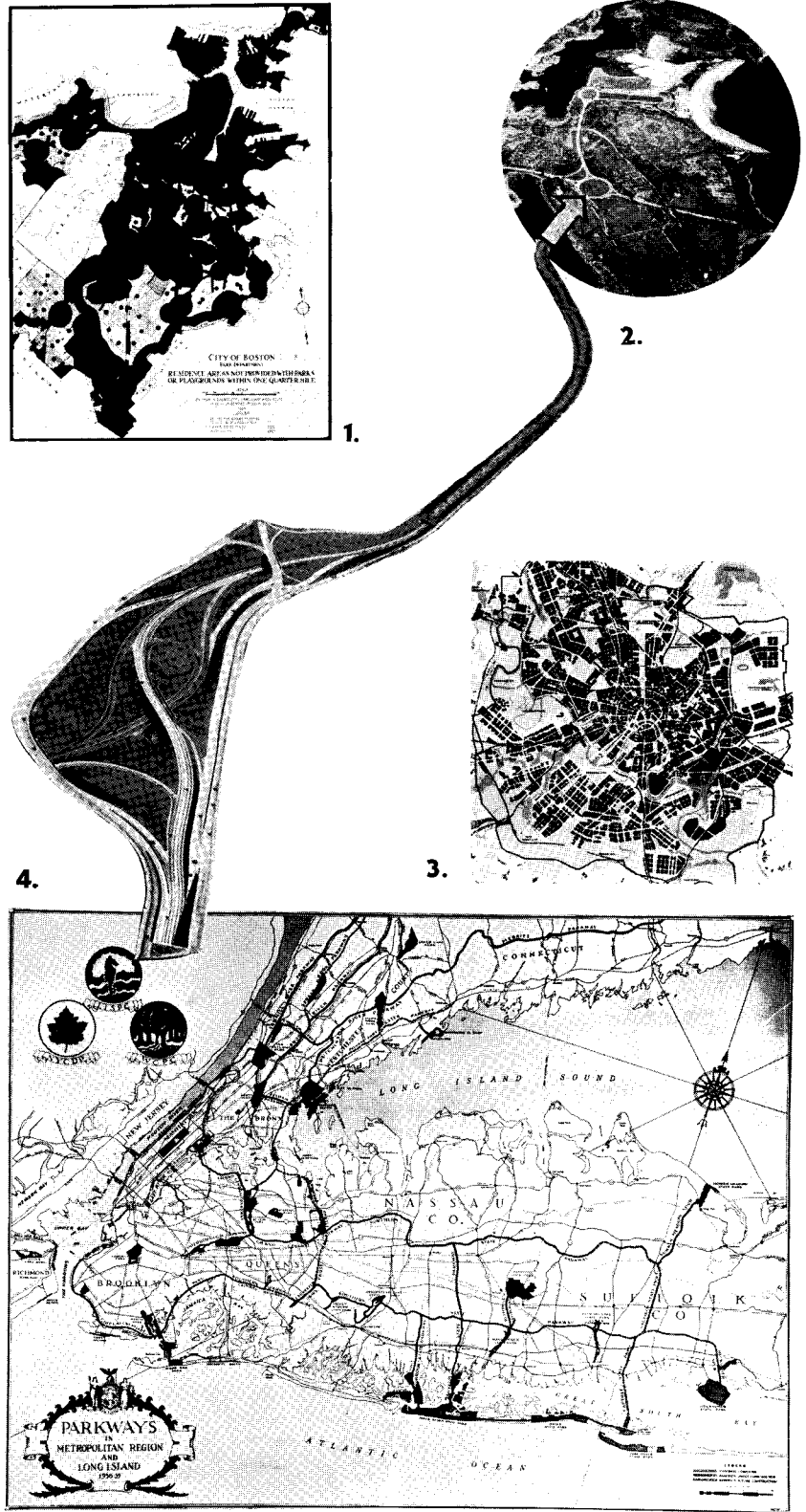

**PARK SYSTEMS.** The recreational environment of tomorrow is at least indicated by the park systems of today; but the variation is extremely wide. A map of Boston (1), plotting areas not within 1/4 mile of playgrounds, shows more than half the city without facilities. Moscow (2), on the other hand, has a park system which penetrates and connects the entire city. In New York (4) the parkways have been extended to make special areas (2) available to the population, thus forming the skeleton of a recreational system; but other elements are still too few.

Photos courtesy N. Y. Dept. of Parks

Akron Studios, courtesy Bakelite Corporation

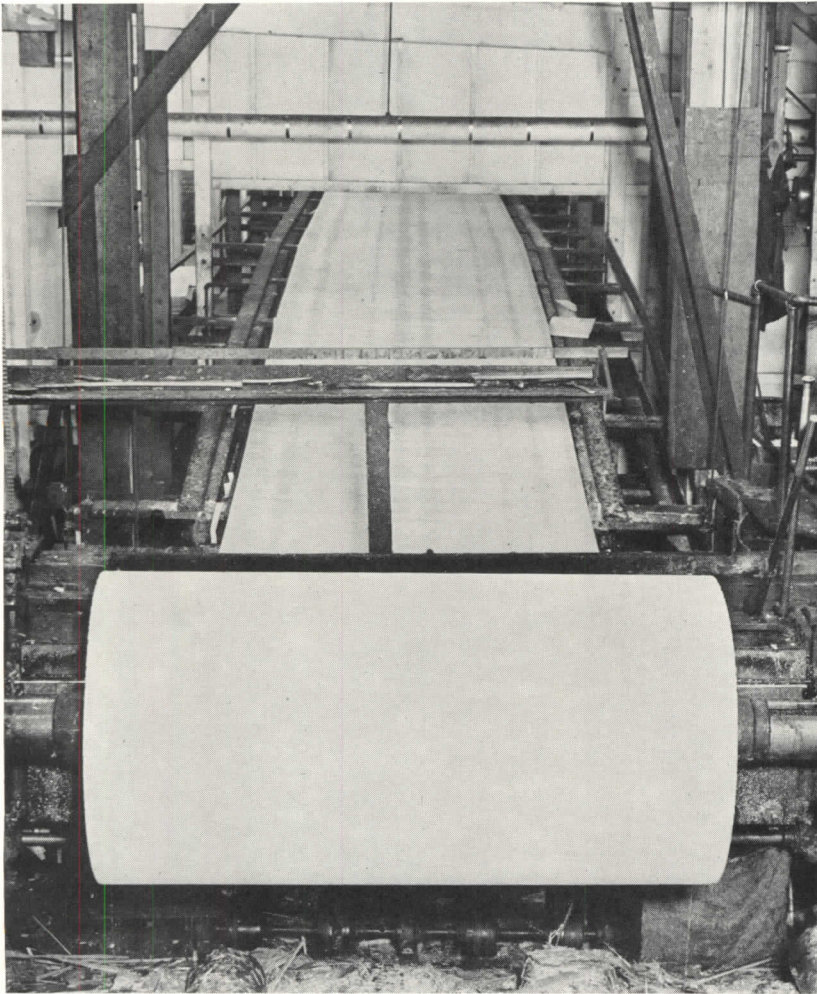
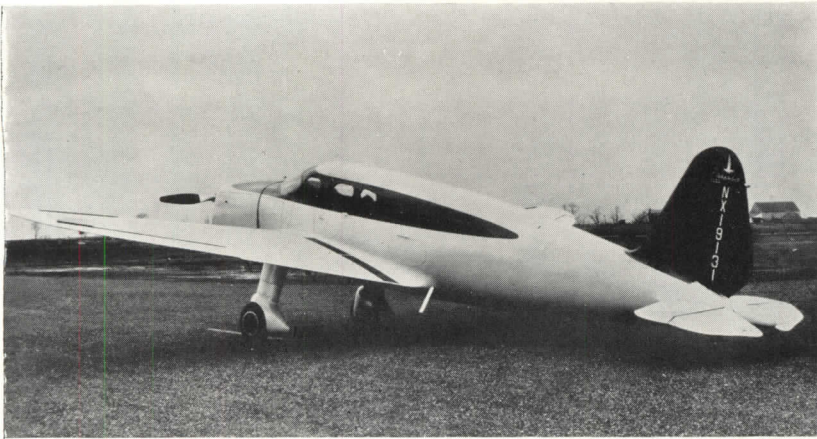

Charles Kamarlan, Inc.

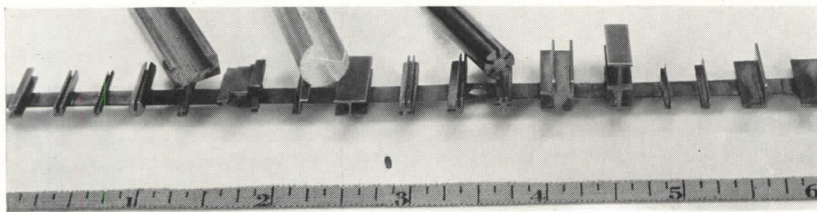

Increased industrialization in the fabrication of materials brings new potentialities in construction. Top: experimental plane whose fuselage is molded in two sections out of sheets of resin-bonded hardwood veneer; in future whole wing sections may be so molded. Center: a lathe that shaves an unbroken sheet of wood in thicknesses of 1/16 to 5/16 in. from a revolving bolt. Bottom: The increased precision characteristic of such developments is exemplified by plastic shapes made to a tolerance of .002 in.

TECHNICAL PROGRESS in construction, as in other industries, is related to market factors. These factors are here discussed under: 1, sources of materials; 2, extent of need; 3, resistance to change. *Sources of materials:* The most important single factor in this connection is the activity of research technicians in analyzing performance standards, in remaking old materials, and in developing new ones. Today, methods for improving our forest crop, for making use of wood scrap and other "wastes", and for creating new materials from agricultural products and non-metal minerals, are resulting in cheaper and more efficient structural, insulating, and surfacing materials. Reduced costs made possible by improvements in the fabrication of materials, in distribution and construction methods, result in keener competition among materials and make available a wider range of them.

*Control of market:* Expanding markets or more centralized sources of purchasing power are incentives to the further development of building materials and methods. A large stabilized market in the building industry could make possible the increased use of industrially produced units; this would require more centralized control over design and greater efficiency of materials.

*Resistance to change:* Obstacles to the further improvement of materials of construction are similar to those affecting innovations in other industries; inhibiting factors are intensified by the relative backwardness of the building industry, organizationally and technically. Although competition among material manufacturers tends to stimulate development of new products, shortsightedness on the part of various established interests has been a retarding influence. Obsolete building codes are



# THE DEVELOPMENT OF BUILDING MATERIALS

**This study is concerned with developments in building materials. The forms in which materials are fabricated are constantly changing. In varying degrees, "materials of construction" become units of assembly. This trend has an important bearing on the status of the designer and his relation to building operations; he is placed increasingly in a position where he must specify performance of materials and equipment not fabricated under his supervision. This study was prepared by Mr. Milton Lowenthal.**

often the means by which the dominance of relatively costly and inefficient materials is maintained. Efforts to maintain economic advantage over competitors; costs of introducing new materials; resulting losses in capital investment; hesitancy to disturb a market which already yields profits through production of older materials; the difficulties encountered by small-scale enterprises entering the field;—all these are economic factors in the path of technological advance. Further resistance to the introduction of some of the new materials and methods comes from craft labor unions, which see in them a threat to handicraft skills, increased unemployment, and (or) reduced wages. Building designers, too, are often reluctant to experiment with untried materials. Recent trends, however, resulting partly from industrially produced materials, indicate a break with traditional forms that is even affecting house design.

Because of the various restricting factors described, the use of new materials in building is still comparatively limited. Nevertheless, their greater use in big engineering projects (bridges, dams, tunnels, highways), as well as in the more advanced industries (transportation, chemical, oil, power), foreshadow their larger use in building, too.

## **Trends in materials**

The limitations and characteristics of fabrication, distribution, and construction methods determine the properties of building materials. These properties are controlled with ever greater precision to satisfy increasingly exacting requirements; they are here discussed in terms of (1) increased workability and (2) increased control over specific properties.

*Increased workability:* Today mate-

rials are produced more and more by precision-controlled equipment with close commercial tolerances, using testing and inspecting instruments far more accurate than the human eye. With such tools it becomes possible to attain greater homogeneity of products, so that they may be more easily machined, molded, cast, welded, extruded, or rolled. This increased homogeneity is apparent in the processed older materials (controlled concrete, wood impregnated with plastics, stainless steel) as well as in the newer "synthetic" materials (plastics, insulating materials, wood-fiber panels).

A material may be the "product" of an industrialized plant and still be only a "raw material" in relation to the building operation. Therefore, "workability" also applies to the adaptability of materials to the hand methods now usually employed at the building site, and also, in some instances, adaptability to mechanized methods in shop-production of wall or floor systems. The trend toward dry construction, and the development of larger units that are nevertheless easily handled by one or two men, are examples of increased workability at the site.

The limitations of our transportation systems have an effect on the size and type of products handled and determine the organization of fabrication shops. Shipping costs are based on bulk as well as weight; this is an important factor in location of fabrication and assembly plants. Because of the limitations on bulk that may be handled on the railroad and highway, the major building types will probably not be completely shop-assembled, until, and unless, more integrated production systems are developed. The design of minor building types (diners, small farm structures), which are complete-

ly shop-assembled today, is strongly affected by the physical limitations of existing transportation facilities.

*Increased control over specific properties:* More precise functional analyses result in materials designed to meet specified requirements for specified periods of time. These new materials are characterized by increased resistance to deterioration or destruction by external forces, and by more favorable strength-weight ratios. More satisfactory surfacings are being developed to meet requirements for cleanability, color, texture, sound and light absorption, reflection, etc.

The development of corrosion- and rust-resisting metals; acid-resisting plastics; resin-impregnated woods, resistant to water, fire, and termites; improvements in insulating materials—in connection with which experiments are being made with practically every known substance—are excellent illustrations of the activity of our research laboratories. The most advanced methods of scientific analysis (radiography, spectrography, photoelastic analysis) are used to study the structure of materials.

Greater strength results in lighter construction, with reduced dead loads. Research in the composition of cements, greater control of proportioning of aggregates, and highly developed curing methods have resulted, in the past 25 years, in an increase of about 50% in the compressive strength of concrete. The ultimate strength of the steel wire used in the cables of the great bridges is today four times that of the wrought-iron wire once used. The new low-alloy steels, e.g., chrome-copper and nickel-copper, are characterized by a high ratio of yield point to ultimate strength; they permit lighter construction, thus competing with the more costly stainless steels and aluminum alloys.

Photos courtesy General Motors Corp.



New methods of fabricating old materials are constantly being developed. One of these is the powder-metallurgy technic for metals of high melting point. This process of molding finely powdered metals without casting or machining is said to give greater precision of structure and composition than the more usual melting and casting technic. Above: Progressive diffusion of copper and tin particles by the powder-metallurgy method; note homogeneity of the resulting alloy.

Photo by Haas-Schreiner, courtesy Columbia Steel Co.

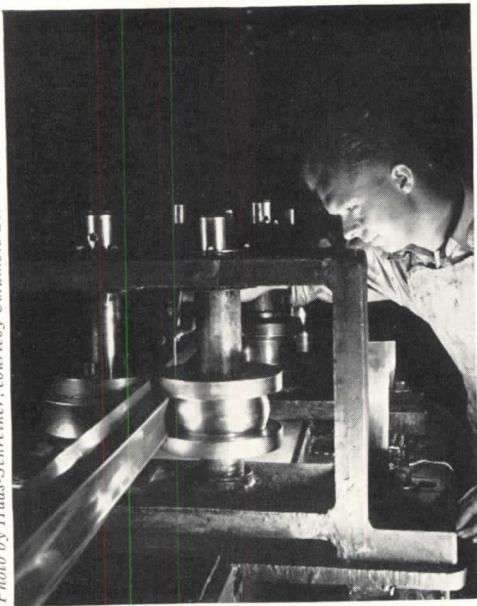

Steel used in Budd trains is cold-rolled for greater elasticity. Above: Coils of strip steel fed through drawbenches to be formed into structural shapes.



Because of their comparative homogeneity, alloy steels are readily welded. The time, current, and pressure necessary for each shotweld are carefully controlled.

Courtesy Roberts and Schaefer Co.



Precision control in fabricating materials implies precision testing of finished structures. Above: An engineer checks for deflection in a static-load test.

Photos courtesy Budd Mfg. Co.



Increased tensile strength of steel wire: 335,000 lbs. per sq. in.



Increased strength of concrete: Z-D test dome; shell thickness is 9/16 in.



Increased strength of plate glass specially processed by heat and chilling.

Courtesy Pittsburgh Plate Glass Co.



## Structural materials

THE TREND in materials is apparently toward an integration—toward combining the structural, insulating, and surfacing requirements in a single system. But materials must still be developed to meet the requirements of traditional construction, and it will facilitate presentation to discuss them under the separate headings.

Structural materials may be classified in the following groups: wood and fibrous materials, concrete and clay products, and metals.

1. *Wood and fibrous materials*: This group includes, in addition to wood, pressed materials such as fiberboards, plywoods, and all fibrous materials that can be formed mechanically into boards.

Wood is relatively cheap and easily worked. Its great weakness is expansion and contraction resulting from moisture absorption.\* Today, improved silvicultural, nursery, planting, and harvesting methods, and better selection and breeding of tree species are resulting in an improved raw material. Careful grading has resulted in the formulation of standard working stresses for structural timber. Laminated construction and more efficient connectors have made possible the fabrication of large wooden members from small-dimensioned stock and the use of wood for wider spans. Chemicals are being used more widely to preserve wood and make it fire-resistant.

In being "remade", the natural material has been given new form and new properties. Developments along these lines are the laminating of wood layers and the compressing of wood fibers, both resulting in large, thin, lightweight panels. The increasing use of structural plywood, especially since it has been made waterproof with the use of phenolic-resin glues, indicates the possibilities of large, easily handled construction units. Finished metal surfaces are now laminated to plywood, and plastics are being laminated to and impregnated in plywood panels.

Wood fibers and shavings, cane fibers, and other organic materials, some non-metal minerals like asbestos and mineral wool—all these are being used and further developed for structural as well as insulating purposes. Some of these

materials are produced by plants similar to paper mills, the complete operation from raw material to finished board being accomplished by automatically operated equipment.

Another development is the impregnation of wood with metals and with plastics. Impregnation with metals (see AR, 7/37, p. 38) creates a material that resists fire, climatic changes, and chemicals, and does not split, blister, or splinter easily. Similar properties are attained by impregnation with resin, which enters the finer structure of the wood and is fixed through polymerization under temperature.

2. *Concrete and clay products*: This group includes structural materials developed from non-metal minerals.

Major progress in the fabrication and use of concrete is recorded in the larger engineering projects and in shop fabrication, where it has been possible to exercise better control over proportioning of aggregates, mixing and vibrating processes, and curing. In the field, greater control of the water-cement ratio, and more precise methods of proportioning are in use, and the distribution of particle sizes of aggregates is determined by rigid specification. One result is the development of different types of Portland cement to satisfy specific requirements.

Magnesium oxychloride cements, first developed in 1876, have great strength, high resilience, bind well with many materials, and are quick-setting. More recently, by the addition of finely divided copper powder, these cements have been further improved in strength, in resistance to abrasion and damage by water, in elimination of harmful expansion, in reducing efflorescence, and also in making possible permanent bonds with Portland cements.

Vibration technics to develop greater flexural strength and resistance to shear are used increasingly both in field and shop production. Compressed-air and electrically operated devices are used effectively in the field. Vibration, applying the principle of "limited amplitude" to control segregation, results in concrete having greater strength, low absorption, and density, without a trace of separation of the coarse aggregate from the fine particles. It is even claimed that control of the rhythm of vibration has a definite effect on the density and strength of the finished slab, in some cases having resulted in roof slabs so dense as to be waterproof.

Proper curing aids in volume control

and is essential to the production of high-quality concrete.

When high early-strength cements are used, the high-pressure steam and electric-curing methods permit the shipment of finished products on the day of manufacture.

The introduction of automatic machinery for production of concrete blocks has also resulted in greater strength, uniformity of texture, and sharp, straight edges. Experiments with dry-masonry construction are still going forward and systems have been devised using various types of precast slabs (White system). Other products that are being used increasingly are lightweight reinforced concrete and gypsum planks (Cantilite, Pyrobar), both of which are readily cut and will take nails.

Other improvements in this group of structural materials include developments in brick construction. Revised ASTM specifications call for descriptions of conditions to which brick is to be exposed and for specific properties to meet specific conditions. Brick construction is being designed with reinforcing for greater strength.

3. *Metals*: Although research has brought developments which are affecting experimental work, the new metals are still little used in building. In auto-truck, airplane, and railroad-car construction, where efficiency of materials is often a matter of life and death, and where large savings in operation result from reductions in weight, high-strength metals and new construction technics are being used. The stressed-skin system of construction, where the surfacing material acts as a structural member, had been used in airplane construction for some time. Research in its use for railroad coaches resulted in a car in which roof, walls, and floor act as a tubular beam. (See AR, 9/38, p. 60).

Experimental work for the Budd streamlined trains resulted in a new electric-welding process in which the time, current, and pressure necessary for each weld are carefully controlled. The surface structure of the metal is not damaged in this "shot weld" process and therefore the metal cannot corrode at the weld; mechanical inspection assures uniformity.

In its application to building, welding has resulted in lighter structures by permitting the use of lighter members, and by making possible shapes that lead to a better distribution of stresses in service.

\*"A thoroughgoing analysis has been made of the influence of moisture on mechanical properties of wood and an exponential formula developed for moisture-strength adjustment of the data previously published. The work applies specifically to cases where moisture is uniformly distributed throughout the cross section." "Wood—Construction Material of Present and Future," J. A. Newlin and L. J. Markwardt, *Journal of Forestry*, Sept., 1938, p. 870.

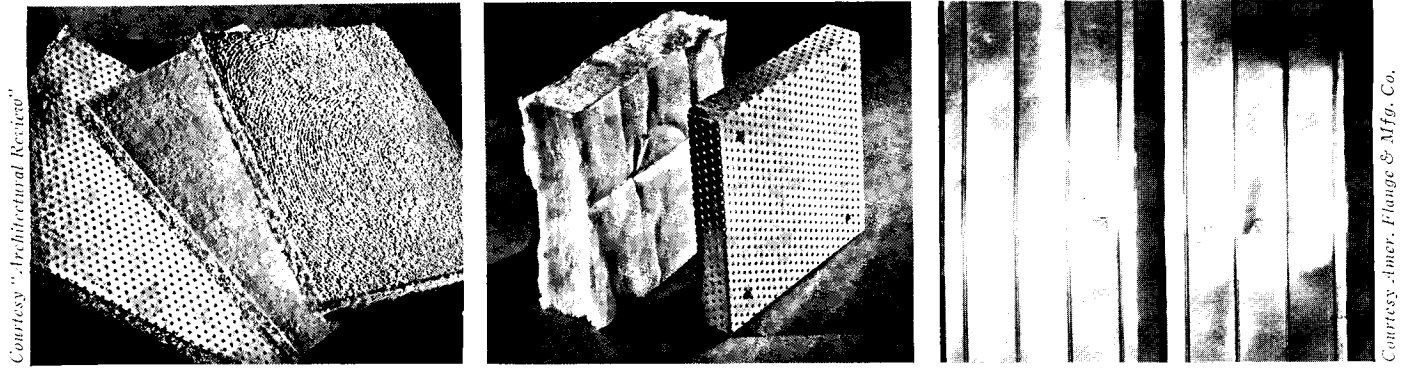

Courtesy "Architectural Record"

Courtesy Amer. Flange & Mfg. Co.

The effectiveness of most sound or thermal insulation is, in general, dependent on internal air spaces which resist the passage of heat or sound (above, left, and center). For thermal insulation, materials more recently developed depend for their effectiveness on heat reflection rather than absorption; the critical factor is surface, not mass. Ferro-Therm, for example (right), steel sheets, which reflect 95% of all radiated heat, are only 0.006 in. in thickness.

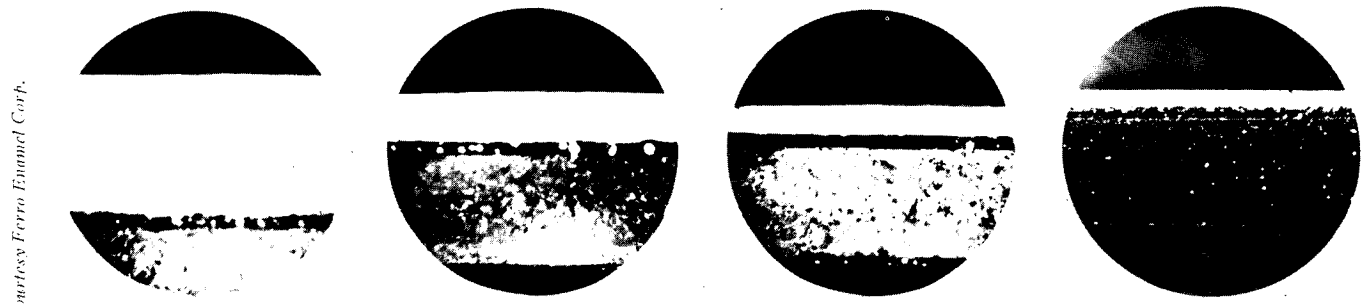

Courtesy Ferro Enamel Corp.

1929

1933

1938

1939

Characteristic of the trend in surface materials is an increase in covering power and strength. Photomicrographs show the development of porcelain-enamel finishes since 1929; the light band in each photo represents the surface; in 1929 246 grams of enamel per square foot of surface were needed to give an opacity now obtained with only 32 grams.

Courtesy Insulation Mfg. Co.

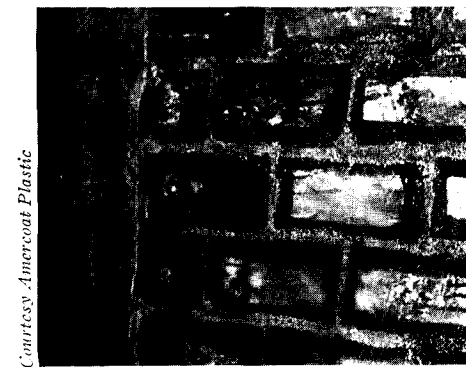

Courtesy Amercoat Plastic

Plastic surfaces for corrosion-proofing: acid-proof brick, with Amercoat plastic for bonding, is partly covered with plastic mixed with aggregate.

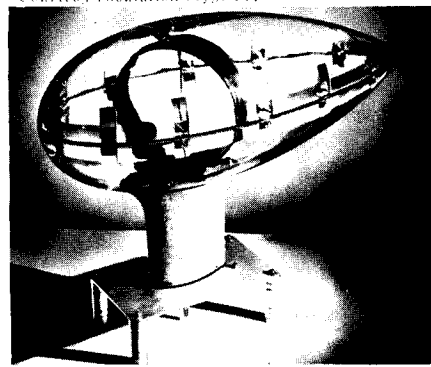

Plastic surfaces are integral with structure or insulator: a Synthane housing for wireless loop combines machinability, strength, and stability.

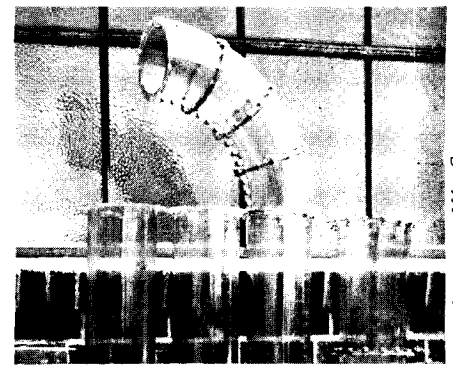

Courtesy Ingmerson Mfg. Co.

Transparency of plastics makes them valuable for experimental models: Pyralin pipes used by Government engineers for water-flow experiments.

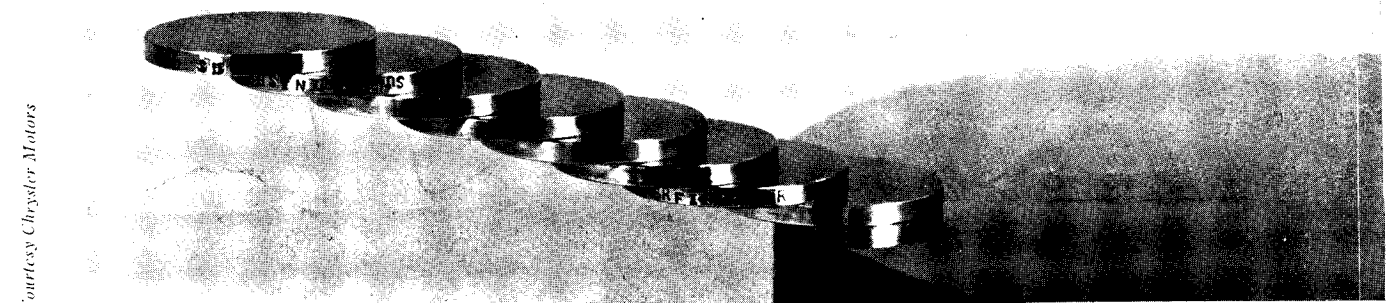

Courtesy Chrysler Motors

The potential precision with which materials can be fabricated is exemplified in a new superfinishing process perfected by Chrysler research engineers. By this method average roughness can be brought down to 2 micro-inches (0.000002 in.); above, surface of metal discs is so smooth that atmospheric pressure holds each firmly against its neighbor.



## Insulating materials

IT HAS BEEN SAID that we have adequate insulating materials but that "our principal difficulty is in the design of buildings for efficient and economical installation of the insulation." (L. H. Whittemore, Bureau of Standards). Research, however, is resulting in a better understanding of condensation and the relation of the vapor barrier to the insulating material. This is important, as condensation may render insulating materials useless. (AR, 3/38, p. 109).

Heat-insulating materials, at present, fall into two main groups: the blanket, fill, and rigid-board types; and the aluminum-foil reflective type. Insulating materials of the first group are effective in proportion to their density, and those of the second, in proportion to the width of the air spaces faced with reflective metals.

In developing materials with innumerable small dead-air spaces, use has been made of virtually all known substances: wood shavings, wood fiber, cane fiber, cellulose, mineral wool, asbestos, gypsum, pumice, glass wool and foam, and many "synthetic" products. These insulating materials have been developed mainly for use in conjunction with other structural or surfacing materials. The trend, however, is toward structural materials which themselves have the desired insulating properties. New developments, for example, in light plaster (Microporite), rubber (Rubatex), and certain non-metal minerals (mineral wool and diatomaceous earth), may result in panels sufficiently rigid and having the strength, durability, and surface characteristics necessary for a satisfactory wall.

Effective vapor barriers have been made of: asphalt-impregnated, surface-coated, and glazed building paper; asphalt-laminated kraft paper; double-faced reflective aluminum foil; two coats of aluminum paint applied to an interior plaster surface.

Insulating materials now on the market (Celotex, Masonite, etc.) have thermal conductivity factors ranging from 0.27 to 0.48, as compared to 1. for wood and 12. for masonry construction; i.e.,  $\frac{1}{2}$  in. of such materials is more effective as insulation than 1 in. of wood or 12 in. of masonry.

In glass, developments of block and plate glass, glass wool and foam for insulating purposes, and glass for ceramic uses, are indicative of the highly developed research involved in its improvement.

Efforts to control heat transmission and to eliminate glare have resulted in tougher, highly tempered plate glass which, it is claimed, transmits less than half the solar heat. Some glasses do not transmit the infrared rays which are harmful to certain dyes and other products, while others are designed to permit passage of ultraviolet rays which are desirable health aids (Actinic, Solex). A double glass which was on the market, advertised as effecting 40% savings in heat costs, has been withdrawn because of difficulties with condensation.

## Surfacing materials

There is a trend toward the development of materials that meet both structural and surfacing requirements. However, because surfacing problems in buildings of traditional construction have still to be met, and because new surfacing problems arise more rapidly than it is possible to adapt structural systems to them, highly specialized surfacing materials and techniques are resulting. There is a pronounced trend toward mechanization of field applications (use of spray equipment) and toward shop fabrication of finished surfaces (wood, plastic, metal, and porcelain panels).

Industrial utilization of farm products is becoming a more important factor in connection with the wider use of lacquers, improvements in paints and varnishes (use of tung and soy-bean oil) and in plastics.

While most plastic surfacing panels consist of a layer laminated to plywood or metal (Lamicoid, Micarta), there have been developments in which the plastic encases insulating material, forming a two-surfaced door or wall panel (Vinylite), and others in which plastic and wood fibers form an integral panel (Benaloid). Progress in the development of plastic laminated panels for construction has been greatly accelerated by the use of waterproof phenol-resins as bonding adhesives.

Improvements in porcelain enameling, resulting in greatly increased opacity and a 40% reduction in thickness of coating compared with that used a year ago, have just been announced. The new method, it is claimed, greatly increases resistance to shock and scratching and practically eliminates chipping.

Surfacing materials serve three main purposes: (1) preservation of structural materials, (2) protection of person, and (3) "psychological effect." A

few examples may be cited:

1. To increase resistance of structural materials to deterioration, more durable paints, wood preservatives, fireproofing liquids and paints, waterproofing and water-repellent solutions have been developed. Waterproofing compounds for concrete, corrosion-resisting paints for metals, and casein paints that are more opaque and more easily spread are in use.

2. There is on the market a material (Belmont tile) which, it is claimed, destroys the organism causing "athlete's foot" and other growths such as bacteria fungus and moss.

3. The use of color to create atmospheres conducive to relaxation or stimulation (nurseries, recreation areas) is resulting in a greater demand for those materials (plastics, lacquers) that provide more vivid colors in a wider range. Some manufacturers report increased production resulting from brightly painted factory interiors. Integral-colored metals are being developed.

## Integration of materials

Reference has been made to integrated construction systems as examples of the application of industrial methods in building. An important illustration of a relatively high integration of materials is the stressed plywood-panel construction, developed by the U. S. Forest Products Laboratory. This prefabricated wall panel is three inches in overall thickness, and is constructed with  $\frac{1}{4}$ - and  $\frac{3}{8}$ -inch resin-bonded plywood for the inner and outer faces respectively. The  $2\frac{3}{8}$ -in. wall space is filled with mineral-wool insulation. Floor panels are constructed in a similar manner using quilt insulation. With the addition of an asphalt-impregnated and coated paper as a moisture barrier, the vapor transference is reduced from 0.019 gram to 0.0047 gram per square foot per hour, for a temperature differential of 70° F. and for a relative humidity on the warm side of 40%; that is, the moisture movement is reduced three-fourths by the moisture barrier. Expansion changes caused by moisture are negligible in this type of wood construction, as plywood absorption is approximately one-tenth that for solid wood. The glued joints are at least as strong as the wood itself.

The development of such structural systems requires the use of materials whose properties have been determined by precise control in fabrication.



THE *Symbol* OF MODERN  
AIR CONDITIONING

*The Control Standard  
for Comfort Cooling*

## BECAUSE OF ITS PRECISION

MODERN air conditioning installations demand that all factors involved be properly balanced by the control system. Often the difference between a satisfactory or an unsatisfactory job hinges upon the control system itself. Its importance cannot be too strongly emphasized.

The M-H Modutrol System provides compensated control which is a precise means of balance between outside weather and inside comfort. The Modutrol System also provides an automatic means for switch-over from the cooling to the heating cycle. This change is necessary during many days in late spring and early fall.

The M-H Modutrol System has proved its dependability and accuracy in control installations for Summer, Winter and Year-round Air Conditioning. Think first of Minneapolis-Honeywell, a name which stands for economy and precision in the control of all six factors that make True Air Conditioning. Don't risk your client's dissatisfaction with an air conditioning installation because of inadequate or improper control system.

Minneapolis-Honeywell Regulator Company, 2804 Fourth Avenue South, Minneapolis, Minnesota. Branch and distributing offices in all principal cities.

# MINNEAPOLIS-HONEYWELL

*Modutrol System*  
... OF ELECTRIC CONTROL

ARCHITECTURAL RECORD



# BUILDING TYPES



*Van Anda*

**Planning Units for House Design**

**FORTHCOMING ISSUES:** 1939—June, Factories; July, Houses; August, High Schools; September, Apartment Houses; October, Theaters; November, Houses. **PRECEDING ISSUES:** 1939-1938—April, Retail Stores; March, Housing Developments; February, Elementary Schools; January, Restaurants; December, Office Buildings; November, Houses (\$25,000 and Up)

ARCHITECTURAL  
RECORD



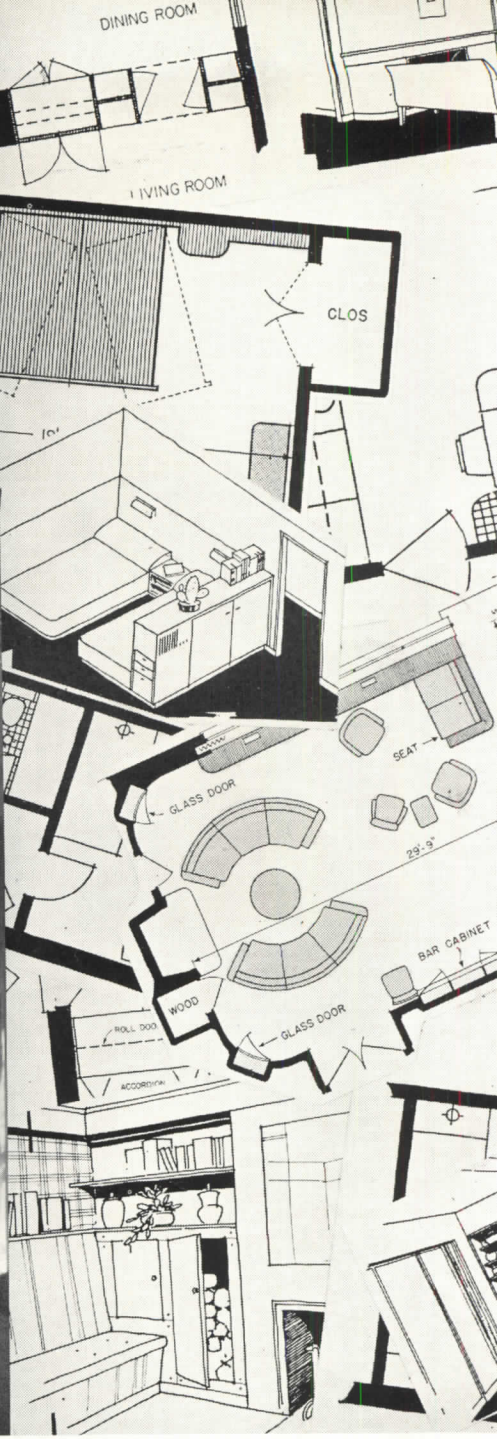

THIS REFERENCE STUDY—the first of three on Houses to appear in Building Types during 1939—deals, primarily, with planning units as a basis for house design. It has a twofold purpose: first, to survey current trends of house design in terms of the new techniques that are developing from the growing trend toward increasing industrialization of building processes; and, second, to report in graphic usable form, provisions for a number of major activities which, through years of custom, have become standard requirements of upper middle-class American families.

<b>New Developments in Design Technique . . . . .</b>	<b>87-91</b>
<b>Furniture-Group Units as a Basis for Design . . . . .</b>	<b>92-106</b>
Living Rooms—Time-Saver Standards . . . . .	93-100
Dining Rooms—Time-Saver Standards . . . . .	101-102
Bedrooms—Time-Saver Standards . . . . .	103-105
Service Areas—Time-Saver Standards . . . . .	106
<b>Eight Representative Small Houses . . . . .</b>	<b>107-112</b>
Southern House for Informal Living . . . . .	108
Flexibly Planned New England House . . . . .	109
West Coast House with Efficient Circulation . . . . .	110
Midwest House for Family of Three . . . . .	110
Window-walled House in Southwest . . . . .	111
Three-bedroom House in Pacific Northwest . . . . .	111
Three-bedroom House in Eastern Development . . . . .	112
House Built Into Hillside on West Coast . . . . .	112



# PLANNING UNITS for HOUSE DESIGN

## NEW DEVELOPMENTS in DESIGN TECHNIQUE

AMONG THE most significant developments in the technical field of building is the growing trend toward utilization of structural and equipment "systems," characterized by the integration of numerous materials and products formerly installed as separate items. Development of such systems has resulted from attempts to industrialize the processes of building, in order to reduce costs, improve quality. As applied to the construction of residences, the term "industrialization" broadly describes efforts now being made to utilize factory methods of manufacture, distribution, and assembly in place of time-worn, handicraft methods of house building.

Industrialization is rapidly expanding. It is a force that every building designer must reckon with. But its progress cannot be charted along a straight line.

The experimental nature of many attempts to industrialize building practice tends to obscure the objective which is common to all. This, briefly, is to produce better houses for less—less money, less labor, less time, and, consequently, less over-all confusion. Likewise, the significance of industrialization as a method of reaching this objective has, possibly, been clouded by the very diversity of experimental activities. To many, the results have seemed to be inconsistent with stated objectives in view of current limitations imposed by production and distribution costs, controversial labor situations, and habit-worn construction practices.

But activity along the industrialization-trend line cannot be denied as a fact. New systems of construction and equipment are constantly being perfected; new production methods are being explored; new schemes for simplifying field assemblies are being tested. And along a parallel line, new systems of design are being scrutinized

by those designers who recognize industrialization as a controlling element in the production of more economical and more generally efficient houses. Most of these involve use of some form of module.

Various types of modules have been used, probably, as long as architectural design has existed. Witness the modularization of the classic orders and the modular rationalization of the city plan of ancient Rome. But in these and other similar instances, use of a module was largely an exercise in esthetics—primarily a means of standardizing proportion and effect, and only secondarily a means of integrating elements of design to simplify the various processes of building.

Current practice has reversed this emphasis on modular application. Modular design is, today, being explored as a means of utilizing, to the greatest possible degree, existing standards of fabrication that have developed through custom in the building field, or have been more or less arbitrarily established by manufacturers of building materials and equipment. Because so many different fabricating standards exist, it has been—still is—virtually impossible to find a module greater than  $\frac{1}{4}$  in. which is common to all currently manufactured building products. This is, obviously, too small for practical use as a module. Therefore, any sort of module becomes an arbitrary standard. In certain applications, moreover, it becomes only nominal as a governing dimension; and actual sizes of various products must be adjusted to meet established tolerances of the modular system.

In practice, modular design is not as complicated as a casual explanation makes it appear to be. And those who use it have discovered that it can produce a number of economies in building without limiting the scope of a de-

signer's creative ability to any appreciable degree.

Proponents of modular designing claim that economies would be vastly increased were a module to become a measurement standard, commonly accepted as a fabricating basis by all manufacturers of building products. A project to research the possibilities of dimensional coordination upon some basis of this kind has been recently authorized by the American Standards Association, sponsored jointly by the American Institute of Architects and the Producers' Council, Inc. According to an ASA announcement, "This project seeks, first, a basis for dimensional coordination and, finally, standard sizes and dimensions that are coordinated."

Another organization, the Modular Service Association, was incorporated in the fall of 1938 to further the modular method of design developed by Bemis Industries, Inc., under direction of the late Albert Farwell Bemis. This method employs a "cubical module" of 4 in.—a dimension that research has shown is applicable, in even multiples, to current stock sizes of building products more generally than any other small, even-inch dimension as 3, 6, or 8 in. Likewise it bears a *nominal* relation to thickness dimensions of commonly used methods of construction.

This dimension is regarded by the Modular Service Association as "a size increment on which the sizes of building material and equipment, in the form of parts to be assembled, are standardized." Therefore, it offers a basis for standardizing dimensions of building construction which permits extremely accurate fabrication, characterized by a maximum of pre-cutting and factory pre-assembly with a minimum of field fabrication. This implies reduction of construction elements to standardized parts suited to mass production and economical assembly.

Furthermore, it imposes no undue restriction on flexibility of design ac-



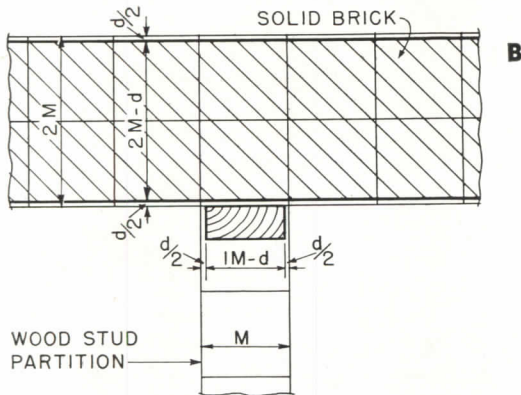
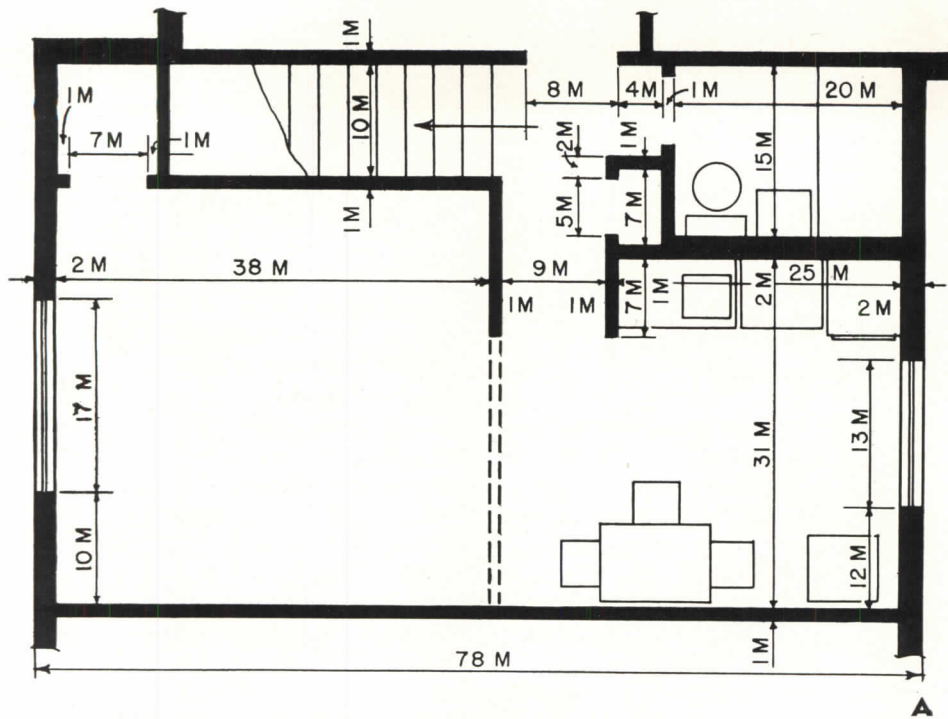

### BEMIS CUBICAL MODULE

A module—as 4"—is a uniform size increment applying to all three dimensions of a structure. Thus any *nominal* dimension can be expressed as  $kM$  where  $k$  is any positive number and  $M$  is the size of the module in inches. Any *actual* dimensions can be expressed as  $kM \pm d$ , when  $d$  is numerically less than the module. Modular dimensions in the plan above indicate *nominal* dimensions only, and can be quickly laid out on scaled cross-section paper. Differences between modular sizes and actual sizes are indicated as  $d$  and  $d/2$  in details B, C, and D. These sketches illustrate one simple method of relating standard construction details to modular locations by spacing structural parts on the module centerline. In C the nominal opening of a window or door is adjusted to the actual window or door dimension by jamb studding, sills, and headers located with reference to the finished frame.

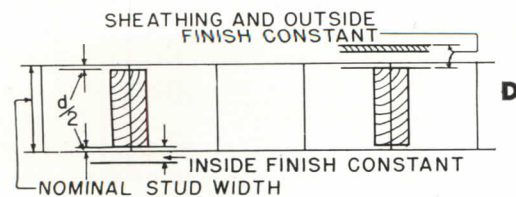
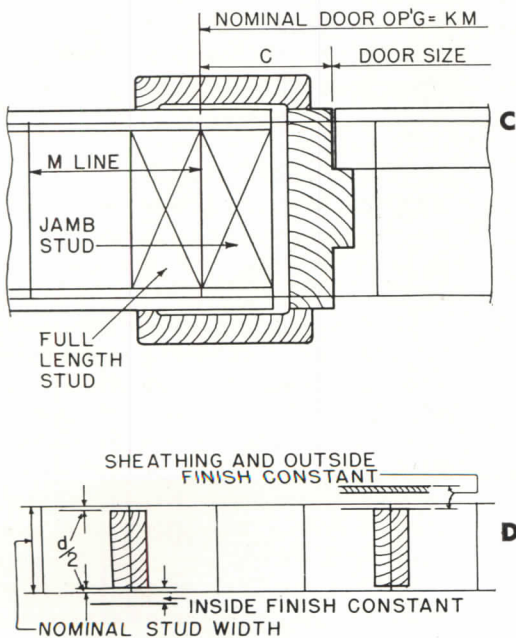

According to architects who have employed the 4-in. module system. Since nominal measurements under this system are necessarily made in multiples of 4 in., slight adjustments in layout may often be required, as, for example, a correction to 16 ft. by 12 ft. 4 in. as the nominal size of a room which might have been first designed with unrelated dimensions of 16 ft. 1 in. by 12 ft. 3 in.

Application of this system of modular design to frame construction has been tested over a number of years by the Homasote Company of Trenton, N. J. Since the first announcement of the "Precision-built" system (see AR, 7/37, pp. 34 and 35, 86 and 87), details have been perfected for all types and conditions of "dry" construction involving use of the Bemis module.

The activities of the Homasote Company, the Modular Service Association, and the research project of the American Standards Association, are wide in scope and are primarily attempts to achieve varying degrees of dimensional coordination within a wide category of building products that necessarily become related in house construction. But they do not represent the entire field of possibility inherent in the modular method of design. One of the earliest advocates of this method, Ernest Flagg, has used a dimension of 3 ft. 9 in. as a module for the economical employment of stock-size framing lumber. The late Harrie T. Lindeberg employed a 2-ft. module in designing houses for construction with steel panels (see AR, 9/33).

Other designers seeking a close and economical correlation between design and fabrication are using modules of 8 in., 16 in., 2 ft., and 4 ft. in a variety of combinations to permit planning flexibility without sacrificing the advantages of pre-cutting, factory subassembly, and simplicity of field erection. For example, one such modular system employs a basic panel 4 by 8 ft., constructed of plywood on the stressed-skin principle perfected by the Forest Products Laboratory a few years ago. Panels are constructed with internal framing members on an 8-in. spacing, making possible a modular design with any unit in multiples of 8 in. up to 4 ft. Nominal dimensions are run to inside faces; and corner connections are made with an arrangement of posts and bolts.

An even further extension of the



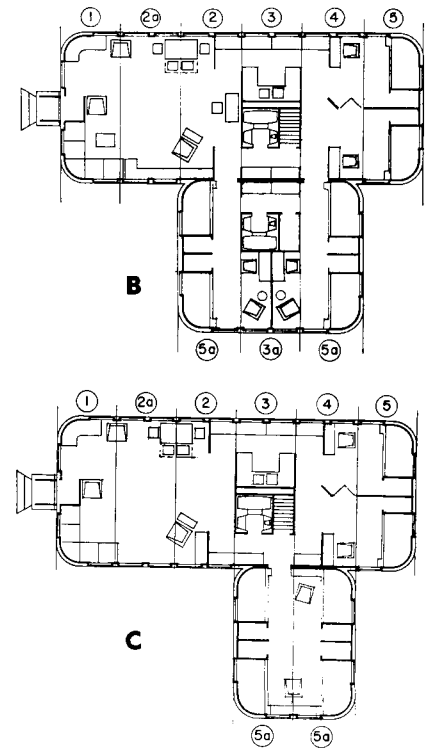
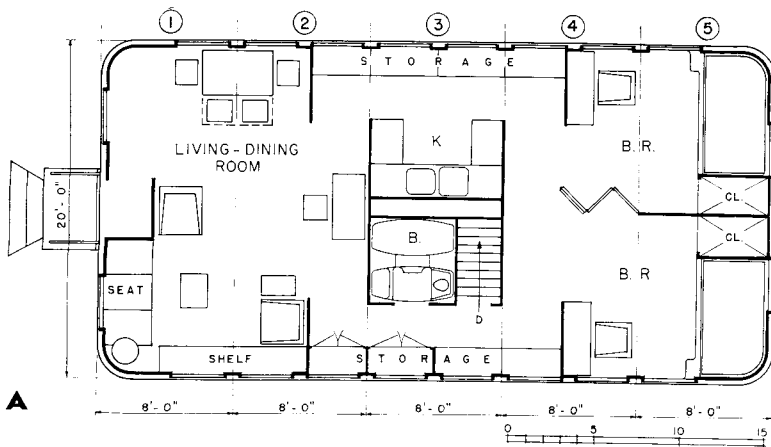
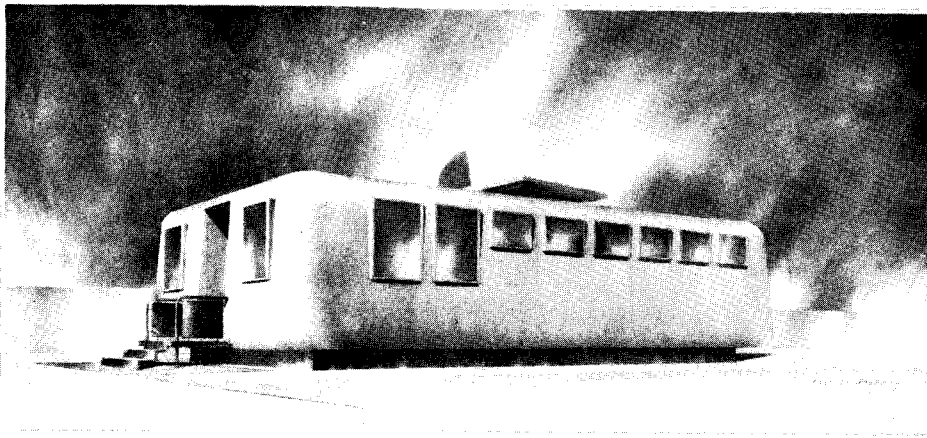

**SECTIONAL-UNIT MODULE**

devised by Pierre Blouke, Architect,  
and C. M. Goodman.

A design for an integrated, industrially produced dwelling composed of standardized sections. Each section measures 8x8x20' and is designed to include floors, walls, windows, doors, roof, and interior equipment.

This sectional-unit system involves a standardized, minimum layout "A", assembled with five basic sections. Each is reversible. In addition each is subject to variation as concerns interior arrangement and equipment. Units 2a and 5a, for example, are the same as Units 2 and 5 respectively, except for the omission of partitions. Similarly, Unit 3 may be rearranged internally to produce Unit 3a without change in the basic form or structure of the section.

Especially noteworthy is the fact that all utilities are centered in Unit 3 as a "core," containing heating plant, etc., in a small basement, pre-assembled kitchen, and the Fuller integrated bathroom.

Plans "B" and "C" suggest possibilities of combining a number of such standard unit sections to provide housing facilities beyond the minimum of Plan "A".

The perspective indicates a design for fabrication in either stamped metal or formed, weather-proofed plywood. It is evident that the conception of unit sections completely shop-fabricated as subassemblies is susceptible to development within a wide range of design possibilities.

modular conception takes the form of space-and-construction units in which areas for various specified uses are standardized in terms of structural units. This system of designing may produce—under well-controlled conditions of industrial fabrication—a large-scale sectional module, as in the design of Pierre Blouke above. Another may produce a series of standard room units for combination in a number of ways to meet a variety of requirements, as in the system of B. J. McGarry on the following page.

Ultimately projected, the modular

concept of design produces a completely integrated unit—a house which, manufactured upon an industrial basis, involves little or no necessity for dimensional coordination with building products as currently manufactured. There are few houses of this type now being produced.

It is evident that as the size of a design module increases, flexibility of design decreases. Likewise, as units of construction become larger, the necessity for standardization becomes more forceful. Industrialization, as a method of producing goods economically in

large quantities, has been based upon the principle of standardization. Evidence points to the fact that standardization is also a principle that is conditioning experiments in the field of house design. On the one hand, dimensional standardization of parts is proposed as a basis for the widest possible latitude in design. And on the other hand, a limited standardization of design is being advocated to produce the greatest possible degree of integration of building products upon the basis of complete industrialization, from design through fabrication and distribution to erection at the site.

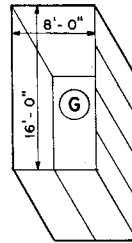
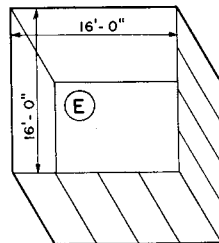
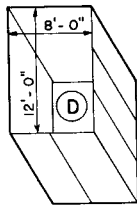
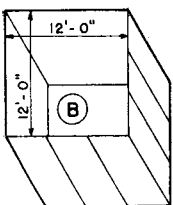
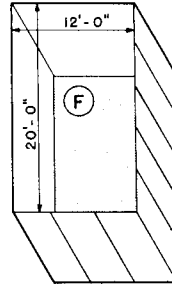
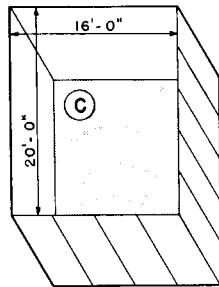
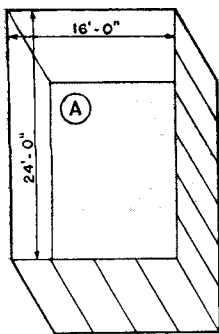
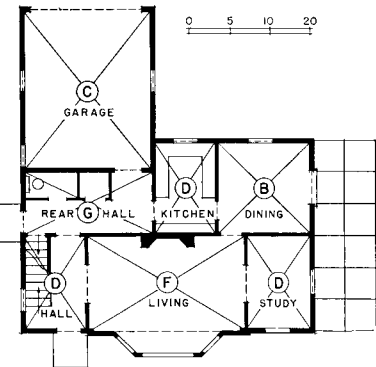
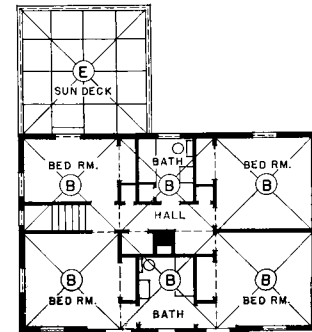
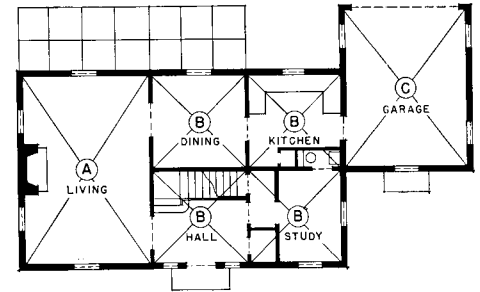
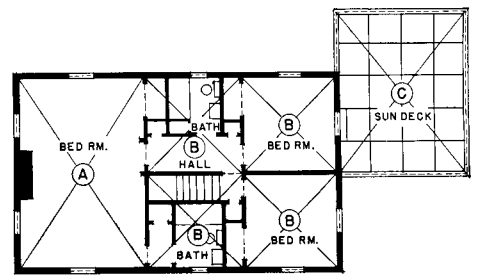
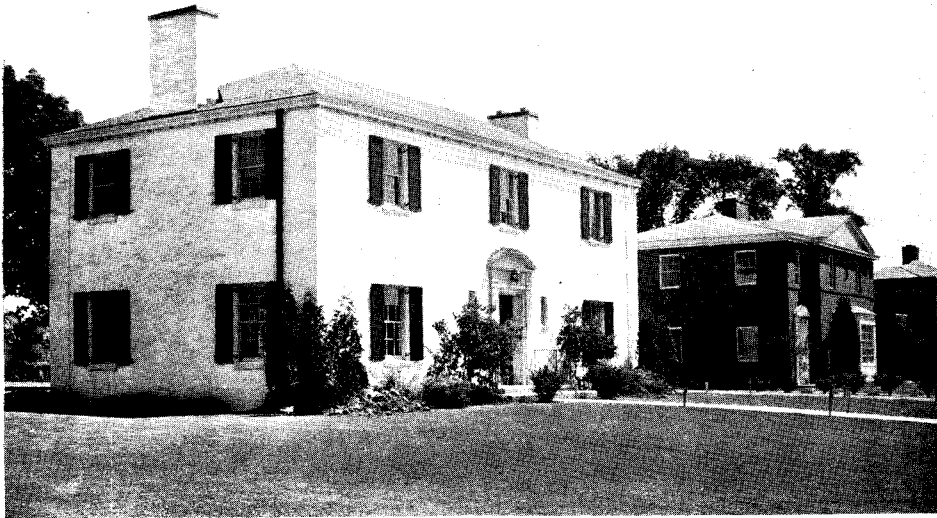

**SPACE-and-STRUCTURE UNITS**  
devised by B. J. McGarry, of Contemporary Homes, New York.

IN THESE UNITS an attempt has been made to coordinate space requirements with fabricating standards toward the end of increasing production efficiency and reducing costs. The units are essentially structural blocks composed of 4 by 8 ft. panels for the walls, and floor and ceiling panels 4 ft. wide and from 8 to 16 ft. long according to the smallest wall-to-wall span. Panels are susceptible to factory production as standardized units, some of which contain windows and interior and exterior doors as in-

tegral parts of construction.

Dimensions of various units are governed by space requirements. Within units, non-bearing partitions can be arranged as desired and equipment laid out to conform to dimensional and fabrication standards of various manufacturers. On such a basis, it would be possible to develop a series of completely standardized space-unit layouts that would make adequate provision for all commonly encountered living requirements. Within limits set by the

structural and dimensional characteristics of panels, planning flexibility is not sacrificed. Unit blocks can be assembled into many combinations. Plans above suggest the diversity of arrangements possible with comparatively few units.

According to the inventor, "This method of planning allows factory methods of production, new building materials, and new means of construction to be used. The system can produce any type of house in any style of architecture without change in production."



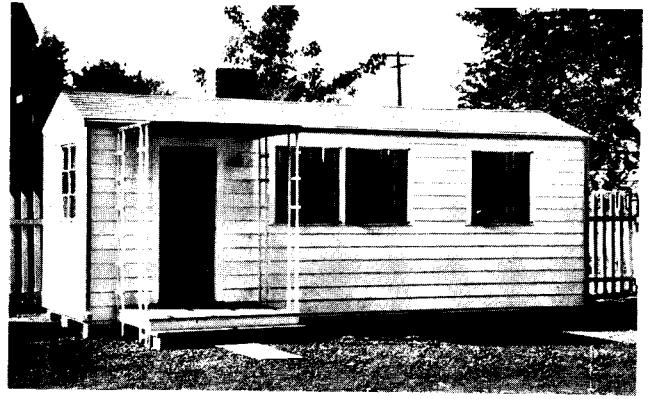

A factory-made, trailer-type week-end house designed to sell for \$1,200.

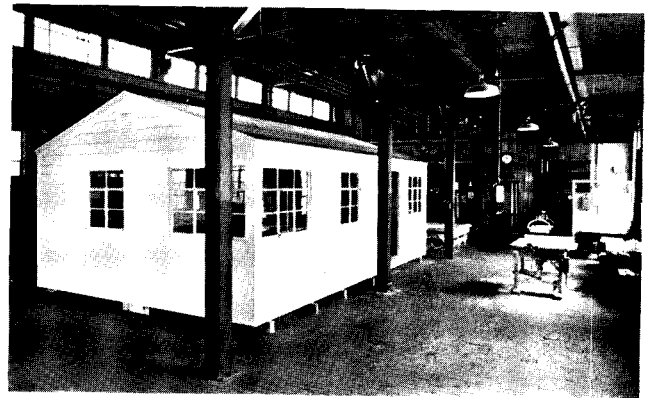

"Minimum house" designed to sell for \$1,600 on a factory-production basis of ten per day.

**FACTORY-BUILT DWELLING UNITS**

produced by Carpenter Pre-Bilt Homes, Elkhart, Ind.

THESE HOUSES are designed as completely integrated standard units and are manufactured on a moving production line with the aid of high-speed milling machinery, assembly jigs, conveyer cranes, and other time- and labor-saving industrial devices. Their designer, M. H. Carpenter, was formerly an automobile manufacturer, and to the greatest practical degree he has adopted in his factory the principles of standardization and mass fabrication which characterize automobile production. Houses, how-

ever, are not essentially different from other so-called "prefabricated" designs. High-grade material—plywood sheathing cemented to wood studding—is used to obtain accuracy and speed in parts fabrication and assembly. Mechanical units, including cabinets and kitchen and bathroom fixtures, are developed from commercially available products.

Units are completely equipped and finished before leaving the factory, and are shipped for installation on permanent foundations by trailer-truck within

a radius of 100 miles. Shipment is in sections 8 ft. wide and up to 30 long—the legal limit for highway transportation. On the site, sections are drawn together with a patented system of dowels and bolts.

The minimum house measures 16 by 28 ft. and contains a combination living-dining-room-and-kitchen containing 160 sq. ft., a bathroom, and two bedrooms, one containing 110 sq. ft., the other 80 sq. ft. Installation of this house requires about four hours' time for two men.

# FURNITURE-GROUP UNITS as a BASIS for PLANNING

Mary Davis Gillies, Home-planning Editor of *McCall's* magazine, has first-hand knowledge of how American families live, and what they need and use in their homes. On this page she discusses their needs as reported in a number of wide-spread surveys made by *McCall's*. Information from these surveys also forms the basis for diagrams which appear on the following pages, which were developed jointly by Mary Davis Gillies and William I. Hamby, Architectural Consultant for *McCall's* magazine.

RESIDENTIAL SPACES, ordinarily called "major rooms," or "owners' quarters," are as much subject to the requirements of utility as kitchens or bathrooms. Activities which take place in living areas may be less definitely routinized than those found in service areas; but the furniture with which living activities are associated has to be so accommodated that normal activities result naturally and easily from its use.

Knowledge of activities in which American families engage is essential. Surveys and competitions conducted by *McCall's* magazine, whose circulation is large enough to insure accumulation of data which truly reflects existing conditions, reveal that, in a sense, living activities are standardized. This country may still be a democracy, we may be an independent breed, we may have climates varying from north temperate to tropical—but there exist typical American living habits, tastes, and activities.

Due to newspapers, magazines, radios, automobiles, and telephones, news and ideas travel rapidly. As a result, from Atlantic to Pacific, we all think in the same manner at the same time; we all do similar things. It is therefore logical to suspect the existence of an additional fact: that the same basic furniture is used throughout the country. Surveys made by *McCall's* and others indicate that this is true. Furniture is supplied from only a half-dozen centers and has similar styles and proportions. Stores in Boston sell exactly the same pieces that are sold in Los Angeles.

To the staff of *McCall's* also come thousands of complaints which indicate that few designers in the country take into account the living requirements of the families for whom they plan houses. The complaints concern both new and old residences.

Unusable rooms, perhaps with no place for a sofa, with entrances which are too wide, or with impossibly placed doors and windows, justifiably distress families which try to maintain max-

imum comfort levels in their homes. Moreover, resale values are directly affected. At present, mortgage values seem to take this planning factor into little account.

**Typical furniture-group units:** Due to the reported similarity of tastes and activities of families throughout the country, and because standard types of furniture are universally available, it is possible to report typical furniture arrangements. While the schemes presented in the following pages by no means cover the entire range of possibilities, they do cover the fundamental uses to which living, dining, and sleeping spaces are put. From the suggested schemes furniture arrangements can be developed to suit any particular problem or set of problems with which a designer may be confronted.

Furniture sizes may vary fractionally; those indicated are the averages commonly met with in upper middle-class homes, and are not affected by changes in style or similar matters of individual preference. Few diagrams are concerned with built-in furniture, for two reasons: the use of built-in units is by no means as universal as the use of typical portable furniture; and the design of most built-in furniture is a matter for individual study as each planning problem develops. However, dimensions of furniture and group-unit space requirements may be readily adapted for designing built-in groups.

Special attention is directed to establishing basic furniture arrangements for houses costing from \$5,000 to \$20,000. These, together with the maintenance of certain normal tolerances between furniture pieces, and between group units, determine the design of rooms. Increased cubage in larger homes ordinarily has the effect of increasing the number of furniture-group units included, or of increasing the tolerances between units, or both. By allocating spaces for certain furniture pieces, or

group units, activities are provided for. After the necessary groups are determined, confines or walls of the room can be located, and doors and windows placed. Formal placing, i.e., symmetry, is by far the most universally desired type of arrangement. This applies also to the location of openings. Similarly, if windows in a room are all of one size, or of similar shapes, and if window and door heads are aligned, window curtaining is simplified.

**Specific space allowances:** In studying furniture groupings, it becomes obvious that certain clearances are required. Spaces, lanes, avenues, or paths of different types develop naturally between furniture-group units. Minimum distances for comfort have been established by numerous planners. These, and in some cases, maximum distances based upon requirements for human intercourse, have been incorporated in the diagrams. A listing of those generally applicable to all rooms follows:

1. *Single passage* (not a traffic lane) between low objects, such as a sofa and coffee table: 12 in. is the minimum.

2. *For single passage* (not a traffic lane) between tall objects, hip height or over: 2 ft. to 2 ft. 6 in. is desirable.

3. *Practical minimum, general traffic lane* (for small rooms): 3 ft. 4 in. is required. As rooms increase in size, this minimum increases, in order to preserve the space-scale of the room. The traffic lane between an entrance door and a major group unit is preferably generous in width. It is desirable to place doors so that the central portions of rooms do not become major traffic ways between different parts of the house.

4. *Seating area, confined* (for instance, between a desk and a wall): 3 ft. is a minimum tolerance, which permits one person to pass back of an occupied chair, as would be the case when a maid is serving. This minimum does not constitute a major traffic lane.





TYPICAL FURNITURE GROUPS in the living room are as follows:

1. **Primary conversation group** . . . Chairs and sofa normally grouped around the fireplace.
2. **Secondary conversation group** . . . Chairs and love seat at end of room or in corner.
3. **Reading group or groups** . . . Chair, ottoman, lamp, table.
4. **Writing or study group** . . . Desk, lamp, one or two chairs, bookcases.
5. **Music group** . . . Piano, bench, storage space.
6. **Game group** . . . Game table and four chairs.

According to the price of a house and the cubage allotted to the living room, two or three or all of the furniture-group units may be included. The fireplace is so closely associated with the furniture that it has been found neces-

sary to include fireplace location in all schemes.

From surveys and competitions conducted by McCall's and on the basis of a consumer investigation made by the National Piano Manufacturers' Association in 1938, it is evident that definite preferences exist for certain types of living-room furniture. From 90 to 95% of the women in the country wish to have fireplaces around which to group their primary conversational furniture. Preferences, expressed in percentages of the totals interviewed, for articles of furniture are approximately as follows:

Sofas	89.2
Studio couches	6.1
Love seats	50.7
Pianos	68.6
Of which 35% prefer grands and 33.6% console, or miniature, uprights.	
A flat top desk	47.0
Breakfront bookcases	34.1
Secretary	28.1
Built-in bookcases	23.5
Game and bridge group	12.8

**Clearances:** Traffic tolerances in living rooms are important as numbers of

people use the room, and narrow lanes between furniture-group units are uncomfortable. An adequate traffic lane between the main entrance and major seating group is 3 ft. 4 in. wide; 4 ft. 6 in. preferred. The minimum clearance between facing pieces of furniture in a fireplace group is 4 ft. 8 in. for a fireplace 3 ft. wide. 1 in. is added to this space for every inch added to the size of the fireplace.

If a wide sofa is placed directly opposite the fireplace, this group is often spread. A 6-ft. tolerance is usually considered the maximum because conversation is difficult to carry on over a greater distance.

A considerable flexibility in location of doors and windows is possible and all wall pieces can be shifted. Doors flanking a fireplace are to be avoided in order that the furniture group may be concentrated around the fireplace opening. If the plan requires doors, at least 2 ft., or room for a console, on each side of the fireplace, is desirable.

FURNITURE-  
GROUP UNITS **LIVING ROOMS** (continued)

SOFAS

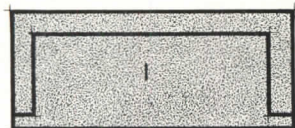

"SHERATON" TYPE  
LENGTH 6'-0"  
DEPTH 2'-6"  
HEIGHT 3'-0"

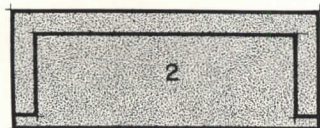

"CHIPPENDALE" TYPE  
L. 6'-6"  
D. 2'-6"  
H. 3'-0"

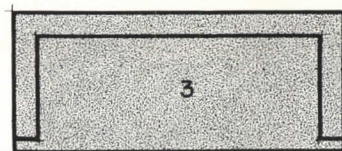

PLAIN UPHOLSTERED  
L 7'-0"  
D 3'-0"  
H 3'-0"

LOVE SEATS

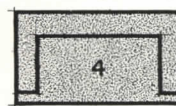

SMALL  
L 3'-6"  
D 2'-0"  
H 2'-3"



LARGE  
L 4'-6"  
D 2'-6"  
H 3'-0"

CHAIRS

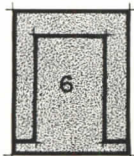

CLUB  
LENGTH 2'-6"  
DEPTH 3'-0"  
HEIGHT 3'-0"

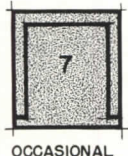

OCCASIONAL  
L 2'-3"  
D 2'-6"  
H 3'-0"

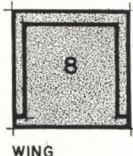

WING  
L 2'-6"  
D 2'-6"  
H 3'-0"



SIDE OR  
DESK  
L 1'-6"  
D 1'-6"  
H 2'-6"

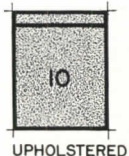

UPHOLSTERED  
ARMLESS  
L 2'-0"  
D 2'-6"  
H 2'-6"

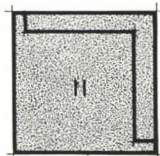

UPHOLSTERED  
CORNER CHAIR  
L 3'-0"  
D 3'-0"

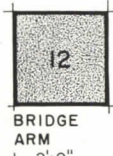

BRIDGE  
ARM  
L 2'-0"  
D 2'-0"  
H 2'-6"



BRIDGE  
ARMLESS  
L 1'-6"  
D 1'-6"  
H 2'-6"

DESKS



FLAT TOP... SMALL  
LENGTH 4'-0"  
DEPTH 2'-0"  
HEIGHT 2'-6"



FLAT TOP... LARGE  
L 5'-0"  
D 2'-6"  
H 2'-6"

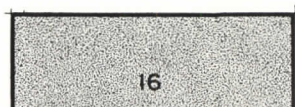

FLAT TOP... VERY LARGE  
L 6'-0"  
D 3'-0"  
H 2'-6"



GOVERNOR  
WINTHROP  
L 3'-0"  
D 2'-0"  
H 3'-6"



SECRETARY  
L 3'-0"  
D 2'-0"  
H 7'-0"

BREAKFRONT BOOK CASES



SMALL  
LENGTH 4'-0"  
DEPTH 1'-6"  
HEIGHT 6'-6"



LARGE  
L 5'-0"  
D 1'-6"  
H 7'-0"

TABLES

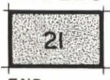

END  
L 2'-0"  
D 1'-3"  
H 2'-0"



END  
L 1'-8"  
D 1'-8"  
H 2'-0"



COFFEE  
L 3'-0"  
D 2'-0"  
H 1'-6"



BRIDGE  
L 3'-0"  
D 3'-0"  
H 2'-6"



CONSOLE  
L 3'-0"  
D 1'-6"  
H 2'-6"

LOWBOYS



AVERAGE  
LENGTH 2'-6"  
DEPTH 1'-6"  
HEIGHT 2'-6"



LARGE  
L 2'-8"  
D 1'-8"  
H 3'-2"

HIGHBOYS



SWAN TOP  
L 3'-0"  
D 1'-6"  
H 7'-0"



FLAT TOP  
L 3'-0"  
D 1'-6"  
H 5'-0"

PIANOS

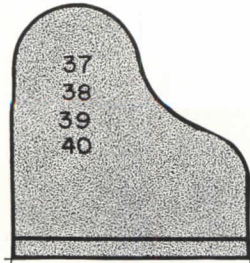

37...CONCERT GRAND  
L. 9'-0"  
D 5'-0"  
H 3'-4"

38. MUSIC ROOM GRAND  
L 7'-0"  
D 5'-0"  
H 3'-4"

39. PARLOR GRAND  
L 6'-0"  
D 5'-0"  
H 3'-4"

40. BABY GRAND  
L 5'-6"  
D 5'-0"  
H 3'-4"

41. CONSOLE  
L 5'-0"  
D 2'-0"  
H 4'-3"

42. MINATURE  
L 4'-8"  
D 1'-7"  
H 3'-0"

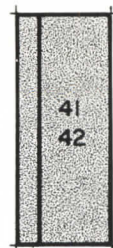

CIRCULAR PIECES



LOW COFFEE TABLE  
DIAM. 3'-0"  
HEIGHT 1'-6"



DRUM TABLE  
DIAM. 3'-0"  
H 2'-6"



PIECRUST TABLE  
DIAM. 3'-0"  
H 2'-6"



DUMBWAITER  
LARGEST DIAM. 2'-0"  
H. 2'-6"



STAND  
DIAM. 1'-0"  
H 2'-6"



LAMP TABLE  
DIAM. 2'-0"  
H. 2'-6"



ROUNABOUT SEAT  
DEPTH OF SEAT 1'-6"  
DIAM. 4'-0"

All drawings at scale: 1/4" = 1'-0"



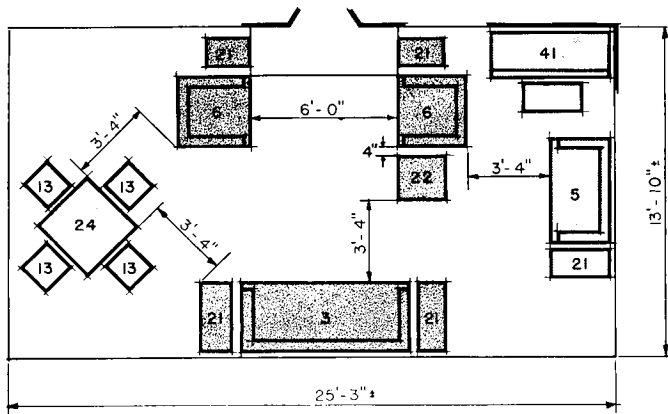

1. In all living rooms shown, main conversation group centered about fireplace is dark gray. Bay or picture windows may be used as focal points, instead of fireplaces.

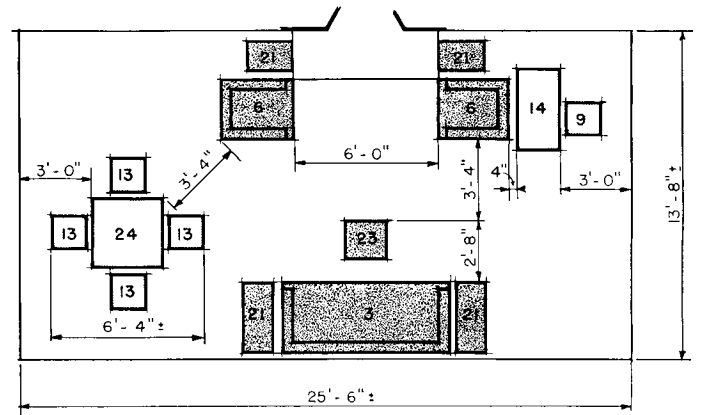

2. Clearance between low coffee table (23) and easy chairs (6) ought to be maintained at 3'-4" even though table is low, because the aisle here constitutes a major traffic way.

All drawings at scale:  $\frac{1}{8}'' = 1'-0''$

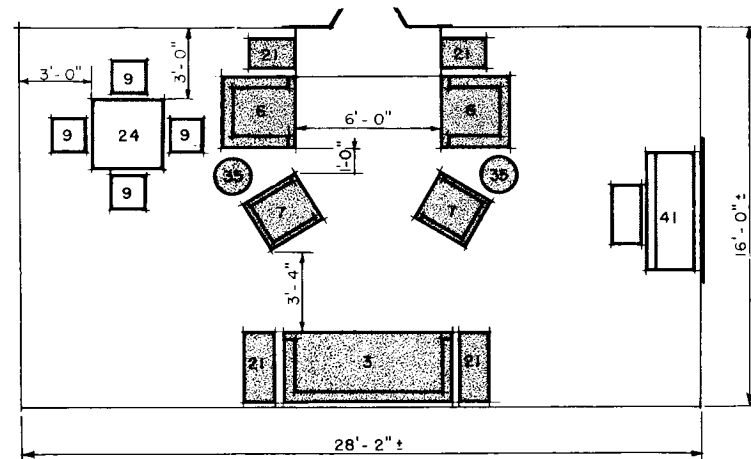

3. For larger families, or for those who entertain often, seating for 7 to 8 persons in the primary group is a reasonable design limitation. Off-center location of game group provides for a corner entrance door.

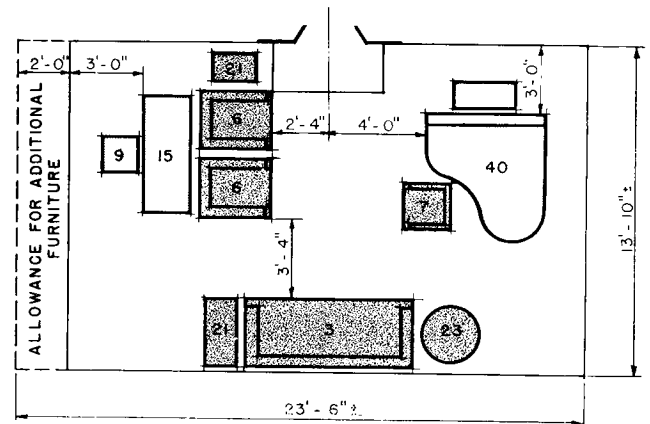

4. Minimum length for a room which must contain a baby grand piano is approximately 20'. If minimum clearances of 1' between piano and wall, and 3' between desk (15) and wall, are to be maintained, room length must be increased.

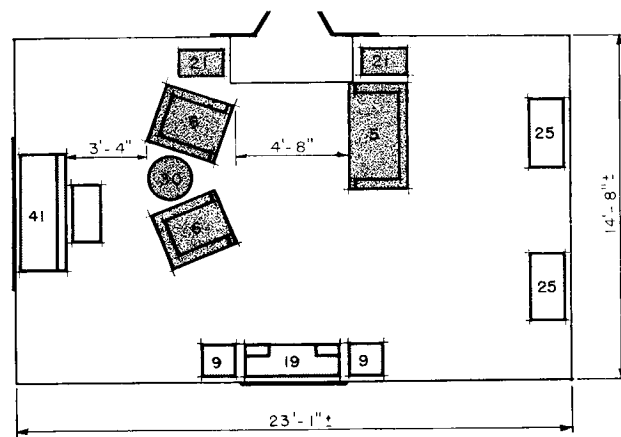

5. If sofa opposite fireplace is omitted, primary group can be brought closer together. In schemes 1 to 4, note that wide groups permit conversation without twisting to see speakers seated on sofa; here this restriction is removed.

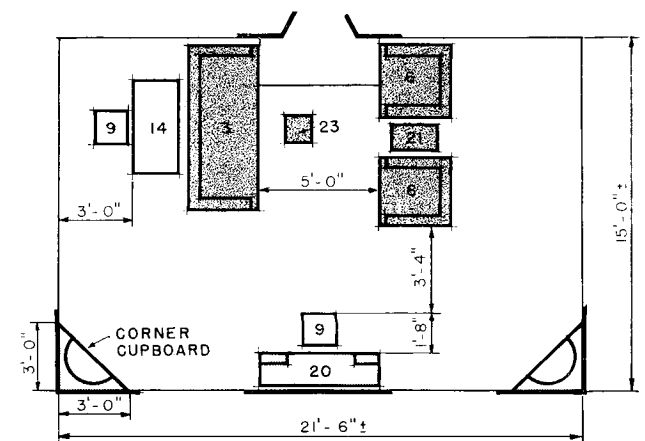

6. Here, presumably, doors at ends of room indicate use of one side of room as a traffic route. Primary furniture is grouped closely about fireplace; wall pieces are all that can be used on opposite side.

FURNITURE-  
GROUP UNITS **LIVING ROOMS** (continued)

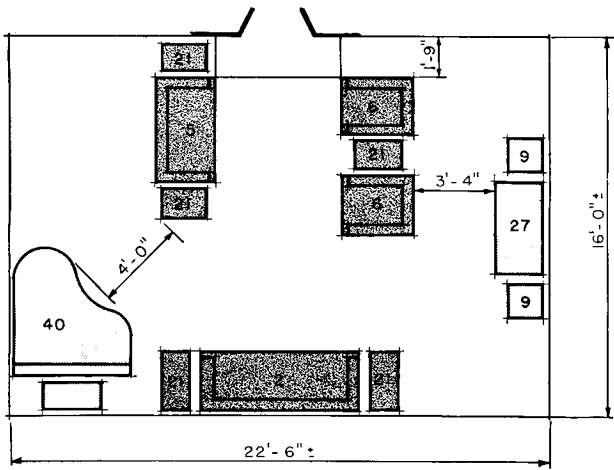

7. Grouping for door locations at both ends of room; ideally, 1-ft. clearance is desirable between piano and wall. Chairs (6) are smaller than those previously listed, 2'-6" x 3'-0".

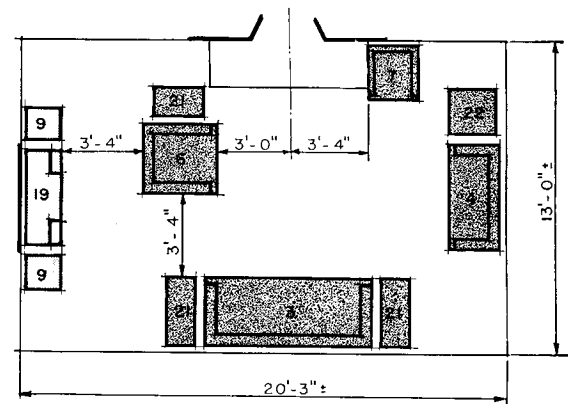

8. If living room has a "dead end" (no doors), primary unit may be spread to include entire end of room. Inclusion of music or game group would demand more area.

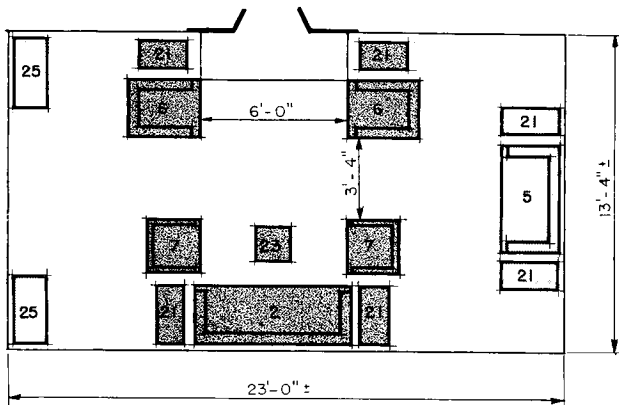

9. Primary group shown is one of most popular arrangements. Unit placing suggests entrance at left end. Secondary conversation unit often becomes music or game group.

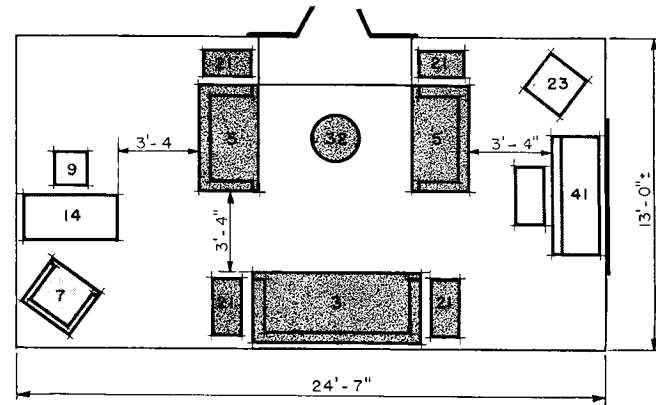

10. Writing or study group at left, music or game group at right, and center primary group, need minimum passages only when room is narrow.

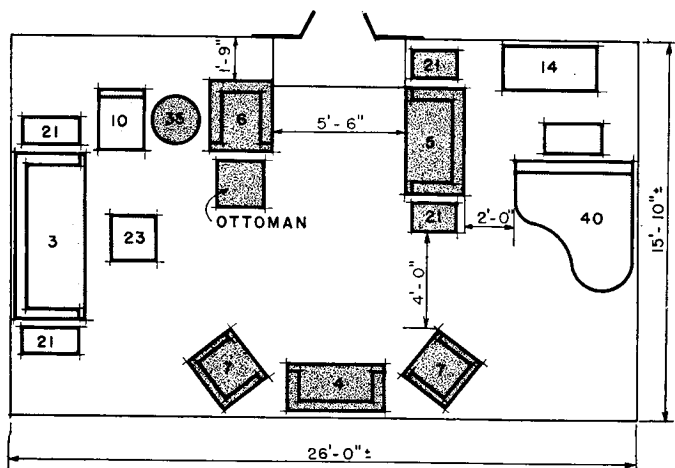

11. Ten persons can be comfortably seated in this type of arrangement, in which primary and secondary conversation groupings almost merge into one.

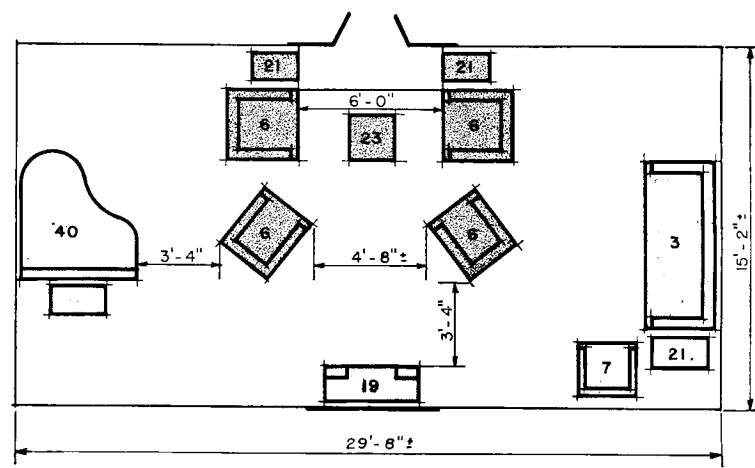

12. Arrangement designed to permit door locations on side walls rather than ends. Angled chairs (6) are small size, noted in Fig. 7, and often used in other arrangements.

All drawings at scale: 1/8" = 1'-0"



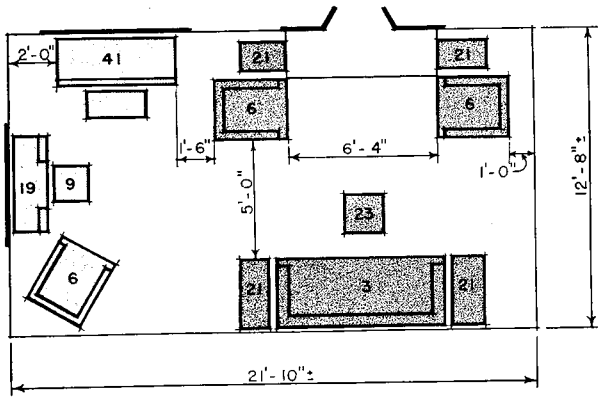

13. Previous diagrams have shown schemes arranged symmetrically about centered fireplaces; here and on page 98 are schemes for cases when foci cannot be centered.

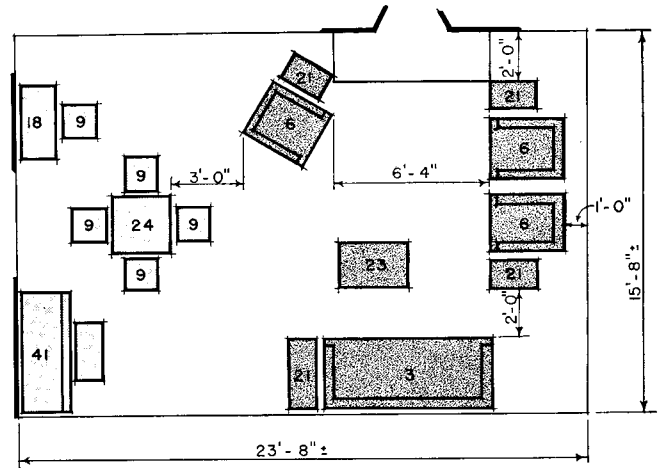

14. Off-center rooms often divide naturally into two parts: primary group, and other groups combined. Clearance no greater than 2' will not accommodate a major traffic lane.

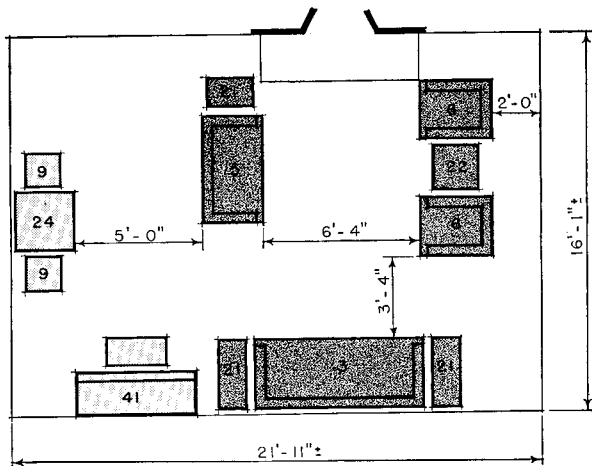

15. If primary, music, and game groups are all to be contained in a small area, one must be curtailed. Here game group consists of table and only two chairs.

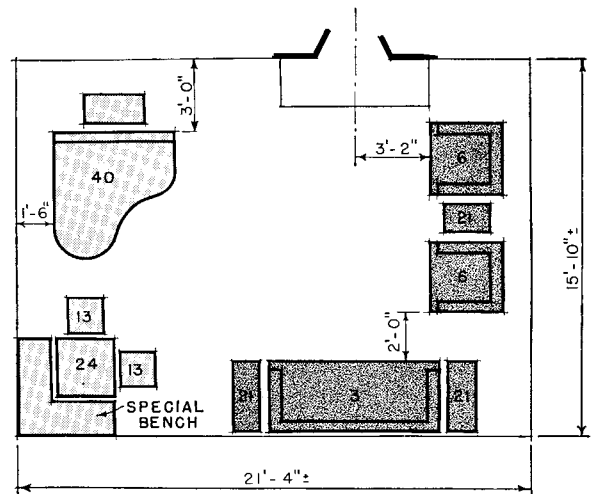

16. In this case the primary conversation group is curtailed to permit inclusion of a grand piano; use of corner bench for game group may result in some loss of comfort.

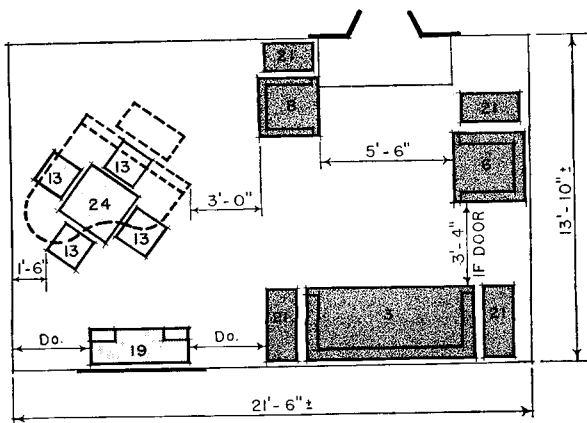

17. Two smaller upholstered chairs (6), each 2'-6" x 3'-0", might be accommodated at the right of the fireplace in this room with only a slight increase in room width.

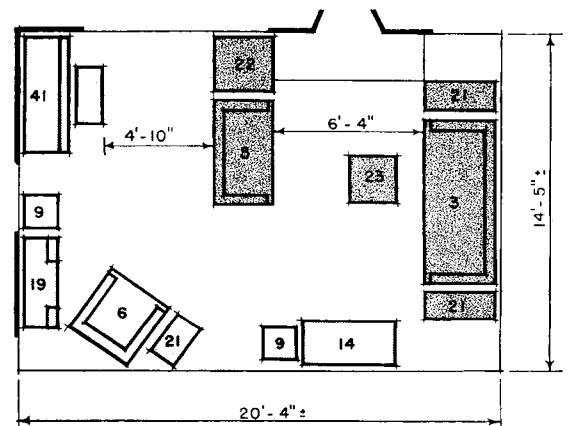

18. In a room with only one door the minimum traffic lane of 3'-4" needs to be increased to at least 4'-10", which will accommodate two persons side by side, without crowding.

All drawings at scale: 1/8" = 1'-0"

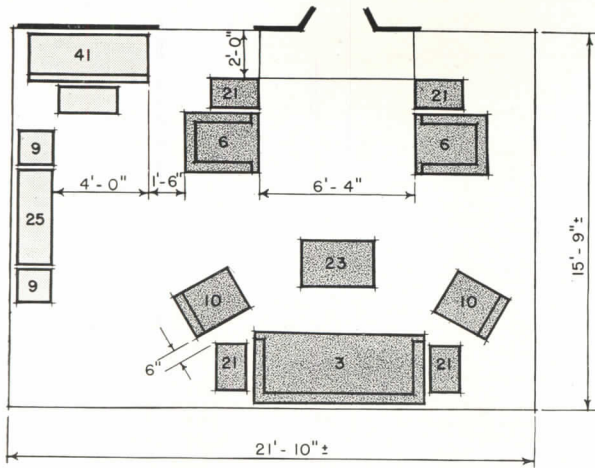

19. Another example of wide entrance lanes. Placement of doors so that at least 10" is allowed between room corners and door trim will permit installation of "built-in" bookcases.

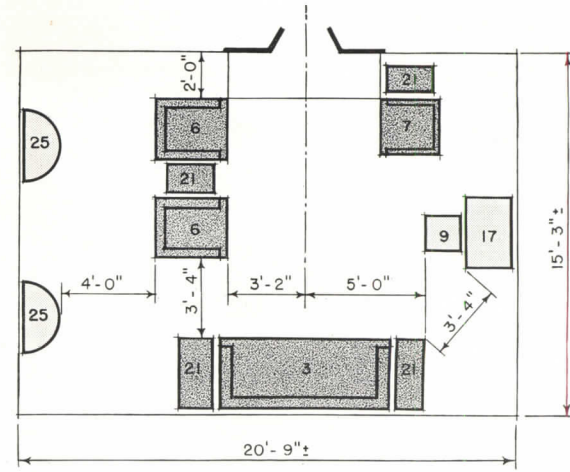

20. Several doors may be accommodated with this type of furniture-group unit arrangement. A traffic lane is assumed to exist at the left end of the room.

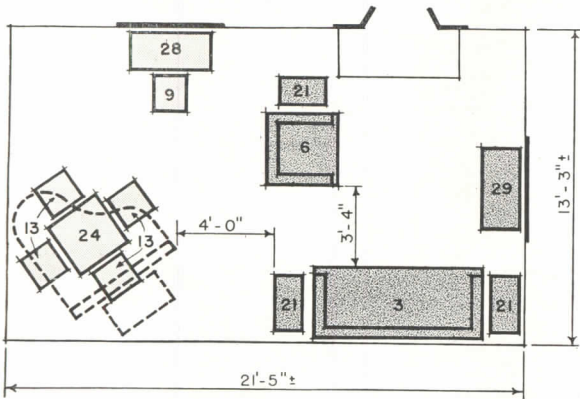

21. Notice that a game-table group occupies almost the same floor area as a baby grand piano. Placement at an angle is intended for informal rooms.

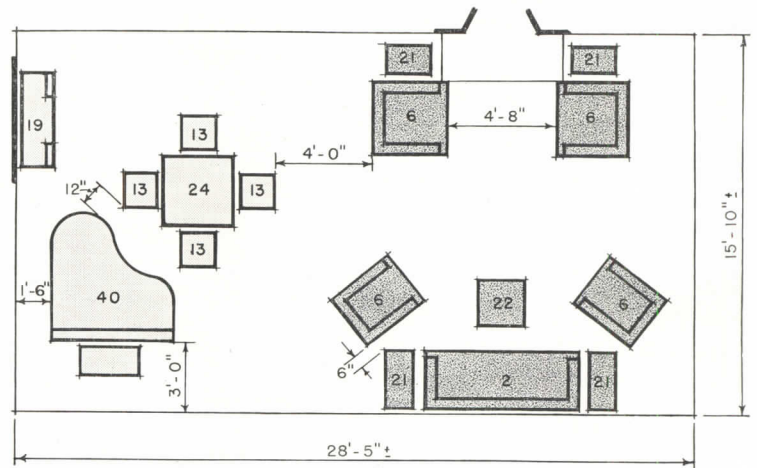

22. Larger rooms may contain four or more furniture-group units; it may be desirable to increase clearances. Use of chairs set at angles requires increased areas.

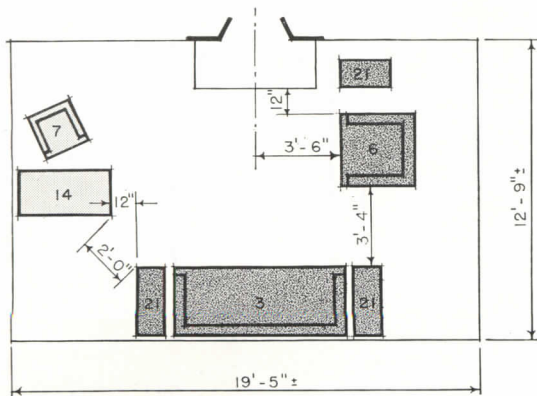

23. Fireplace chairs set 3'-6" back from center line of fireplace permit occupants to gaze at the fire comfortably. General traffic cannot be accommodated in a 2-ft. lane.

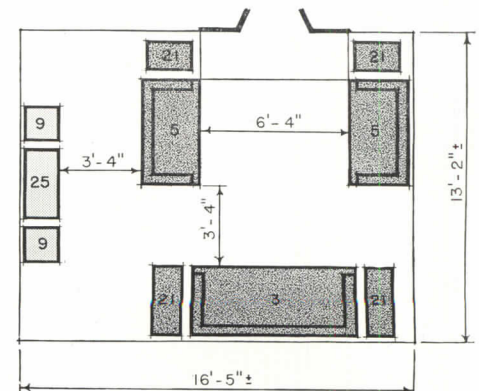

24. By using love seats instead of pairs of chairs at sides of fireplace, considerable space can be saved even though seats are not placed the minimum distance apart.

All drawings at scale:  $\frac{1}{8}'' = 1'-0''$



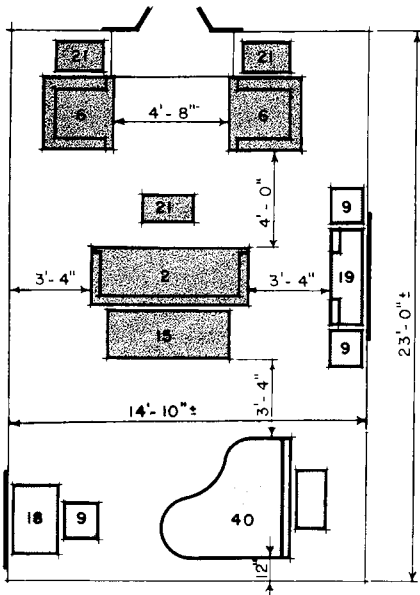

25. In rooms with fireplaces in end walls, as in the schemes immediately preceding, furniture arrangements often fall naturally into two distinct groups.

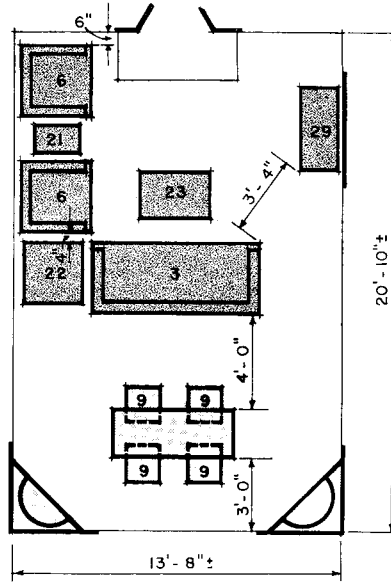

26. One of the two groups may be adapted for dining, eliminating need for a separate dining room. Minimum clearance around dining table should be 3'-0" (see page 101).

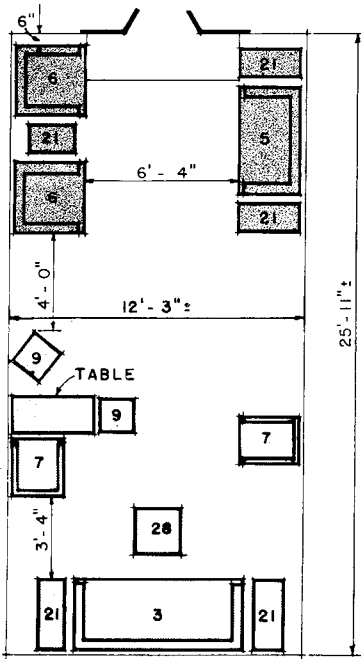

27. In this scheme, by placing the sofa on the long axis opposite the fireplace, furniture is held together as a single unit. There are two obvious positions for an entrance door. It is possible to back the sofa against a group of windows.

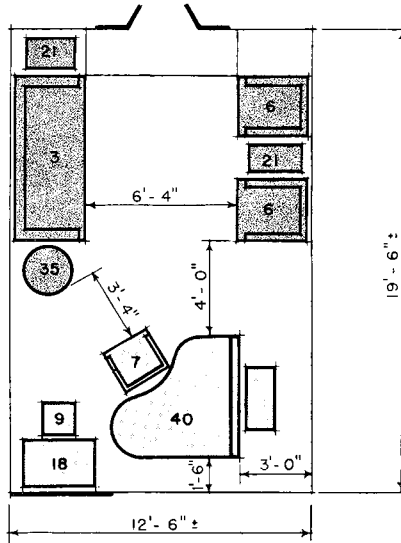

All drawings at scale:  
1/8" = 1'-0"

28. Backing the primary-group furniture against walls eliminates passage behind them and reduces room width to a minimum.

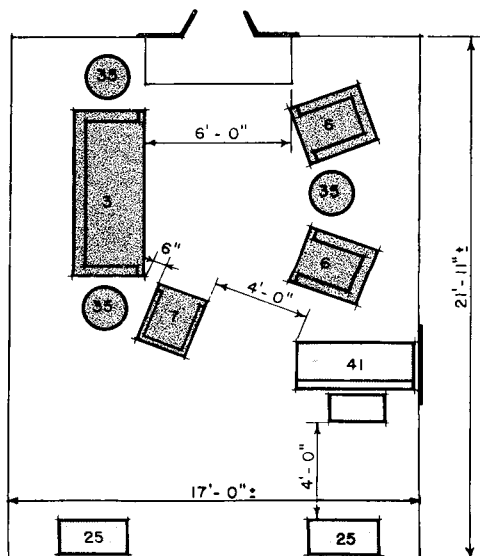

29. Here the left side and end opposite the fireplace are available for doors. Piano should, if possible, be placed against an inside wall.

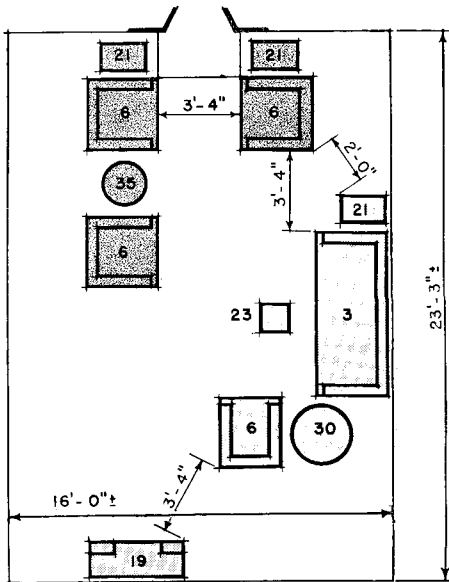

30. Placing the sofa against one side of the room tends to open up the primary group—in effect, to merge with it the secondary conversation-group furniture.

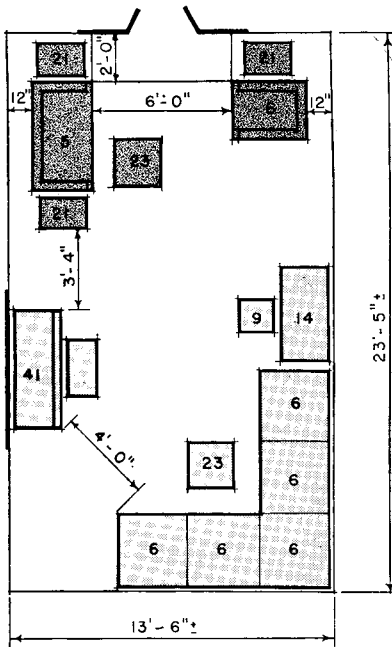

31. The entire area may be treated as a single unit, all furniture being brought into the principal group.

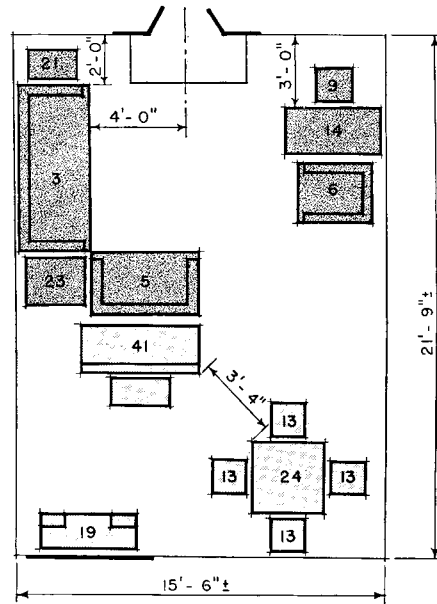

32. Here the placing of the desk group (14) allies it closely with the fireplace unit. Four units are included.

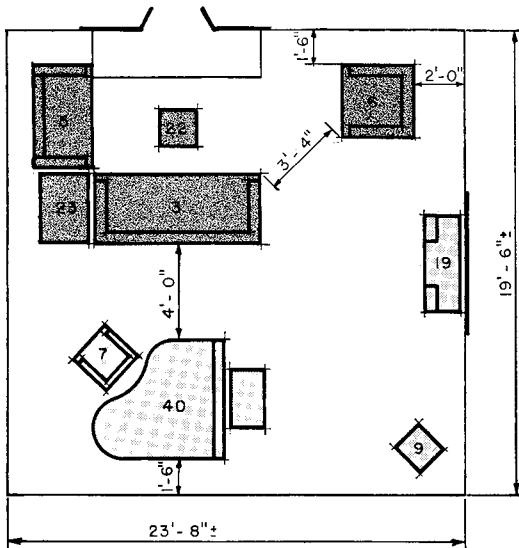

33. By interchanging the positions of the fireplace furniture in Fig. 32, a grand piano can be accommodated.

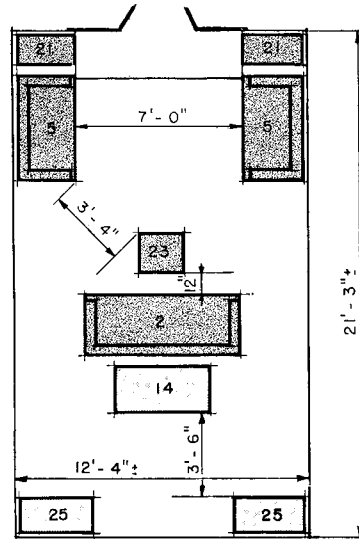

All drawings at scale:  
1/8" = 1'-0"

34. Completely symmetrical arrangement in comparatively small space; music group might replace items 14 and 25.

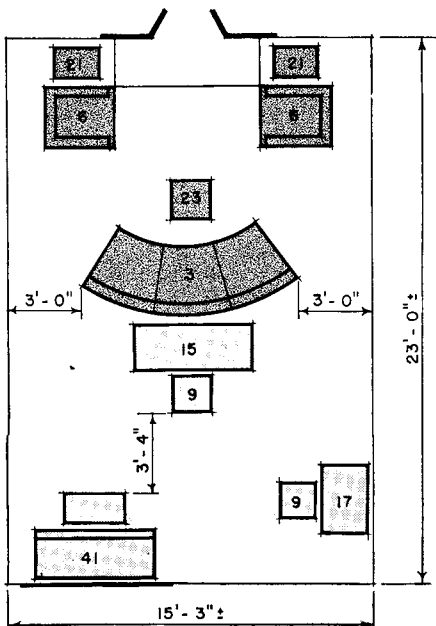

35. Type of sofa shown is becoming increasingly popular. Chairs (6) may be units which can be added to sofa, if desired.

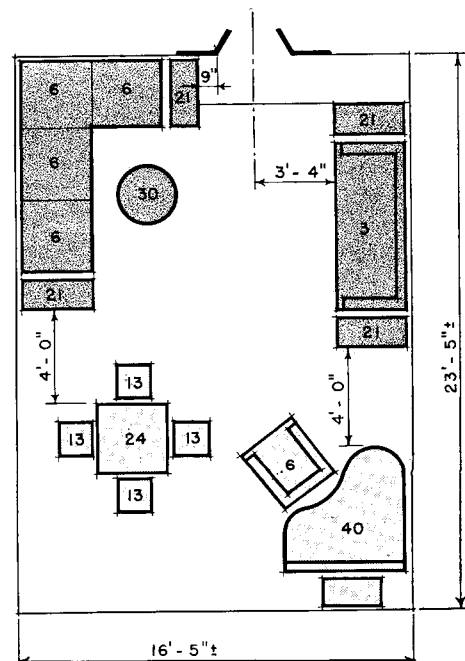

36. "Unit" types of sofas are particularly suited to corner groupings. Scheme shown contains three group units.





Ernest Graham

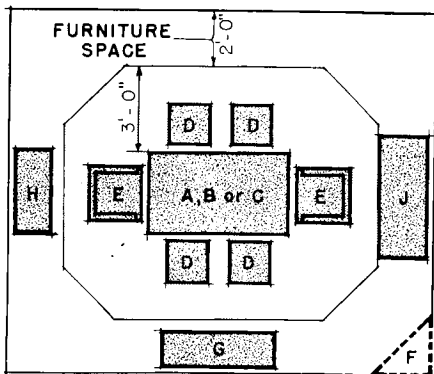

**Dining Furniture Dimensions**

- TABLES:** A—Rectangular . . . 3'-0" x 5'-0"  
 B—Refectory . . . 2'-6" x 5'-6"  
 C—Round . . . . . 4'-6" diam.
- CHAIRS:** D—Side . . . . . 1'-6" x 1'-6"  
 E—Arm . . . . . 2'-0" x 2'-0"
- CUPBOARDS:** F—Corner . . . . . 1'-6" x 3'-0"  
 G—China cab. . . . . 1'-6" x 4'-0"
- SERVERS:** H—Serv. table . . . 1'-6" x 3'-0"  
 J—Sideboard . . . . 2'-0" x 4'-6"

DINING ROOM SURVEYS show two apparently divergent results. First, dining rooms, rather than alcoves or spaces within other rooms, are still preferred, particularly outside areas of urban influence and in western states.

Secondly, many dining rooms are reserved for use on special occasions only. Following are results of a survey conducted to determine use of dining rooms:

Routine daily meals served in dining rm.	%	Used on special occasions only	%
All meals	20.0	Sundays and holiday meals only	13.3
Breakfast and dinner only	2.9	Guest meals only	39.0
Dinner and lunch (or supper) only	8.8		
Dinner only	23.3		
	55.0		52.3

Surveys also reveal that approximately 85% of American dining rooms are furnished with dining suites. According to the Retail Furniture Association

the usual suite, in the West, consists of a table, six chairs, and buffet. In the East, suites more often contain a table, six chairs, buffet, china cupboard, and serving table. Other occasional pieces or special-purpose furniture sometimes used include: chest of drawers, hanging shelves, bench, tea wagon, portable or built-in corner cupboards, love seat, desk or console piano.

Since many dining rooms have to accommodate three wall pieces, it is advisable to preserve large wall masses. Archways may be reduced in width and doors kept off centers of wall spaces. However, buffets, etc., are often placed against window groups.

The one important space tolerance is the unobstructed 3-ft. surround for the table. This permits one person to pass behind occupied chairs.

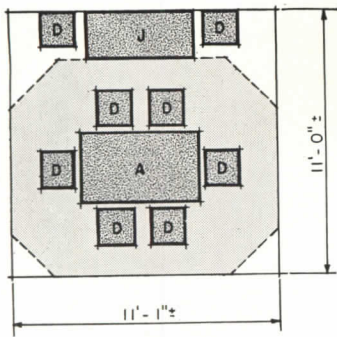

1. Minimum requires 2-ft. buffet space on one side only; 3' more length is needed for extension table.

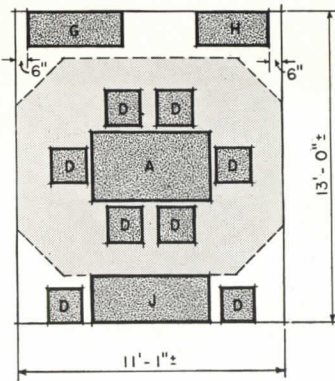

2. Typical dining-room suite, as used in East and on West Coast, requires furniture space on two sides of room.

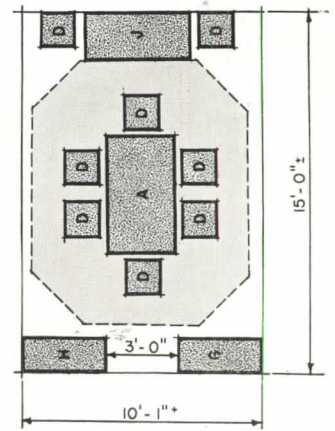

3. Long narrow area with some waste space results when wall pieces are at ends, and end entrance is needed.

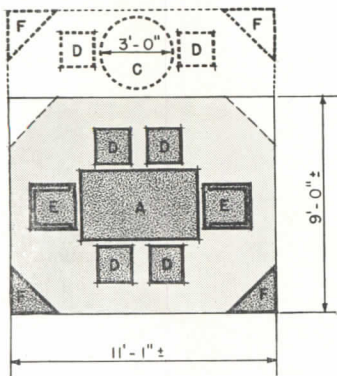

4. Solid lines indicate minimum room with corner cupboards, no wall furniture. Dotted lines indicate added space for 3' breakfast table.

All drawings at scale:  
 $\frac{1}{8}'' = 1'-0''$

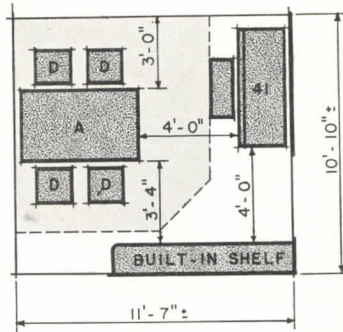

5. Table-and-passage unit in one corner permits use of minimum space for multiple activities; piano may be replaced by desk, love seat, etc.

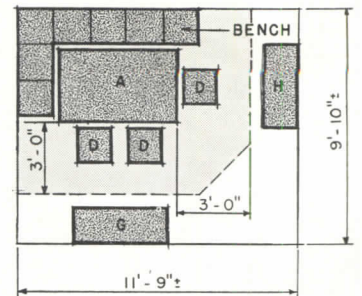

6. Spaces smaller than the usual minimum can be utilized if built-in seats are included; seating and table-service comfort are sacrificed.

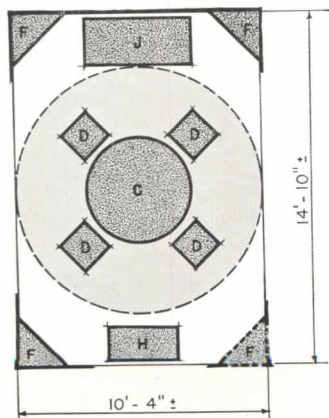

7. The same set of clearances applies to the seldom used round table as to the more popular oblong table.

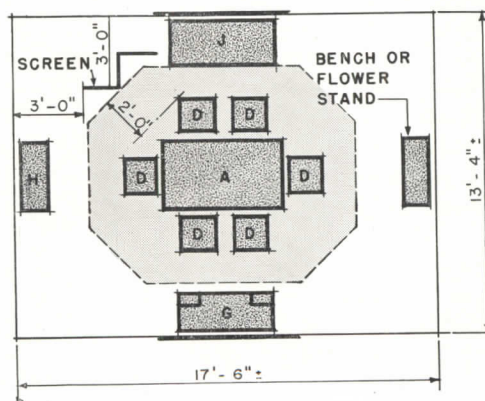

8. Arrangement of typical suite in larger-than-minimum space, when a screen is used at serving door.

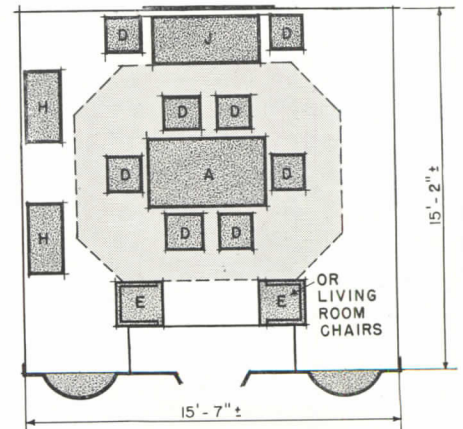

9. Dining rooms with fireplaces have to be larger than minimum for the comfort of those seated at table.





A WIDE RANGE of types of bedrooms is included in these diagrams—from the minimum to a reasonable maximum, beyond which the scope of this study does not carry. There is only one furniture-group unit, consisting of a bed and night tables. The additional pieces of furniture are usually single items which must be related to the largest object in the room, the bed.

**Types of furniture:** According to manufacturers, sales of twin beds have rapidly increased since 1930. These require larger over-all areas than are needed for a double bed, if passage and traffic tolerances are preserved.

In the Far West, according to the National Retail Furniture Association, the most popular bedroom suite consists of three pieces: table, bed, or two single beds, a dresser, and chest. Next in order of popularity come a boudoir chair, a side chair, bedside table, and then a dressing table or a desk.

On the eastern seaboard, seven-piece suites are favored, and include a bed, or beds, dresser, chest, side chair, night stand, and vanity and bench. In larger rooms, the following occasional pieces, not listed as to size, may be added to the standard suites: chaise longue, desk, breakfast table and pair of chairs, day bed, love seat, bench at foot of bed.

**Clearances:** It is desirable to place the bed in a free-standing position with passage on two sides, so that it is not necessary to pull the bed out in order to make it up. Such a plan requires a large room. A clear passage of 2 ft. 6 in. is required on at least one side of the bed and a 3-in. clearance at one end in order to be able to pull the bed out. Dead-end passages between low objects require only 1 ft. to 1 ft. 6 in. of clearance; 3 ft. is the widest traffic lane usually required. As rooms increase in size, traffic lanes may be increased in proportion. Use of large occasional pieces, particularly chaises longues, also ordinarily requires wider passages.

**BEDS**

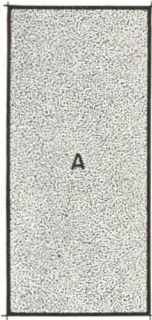

**SINGLE**  
6'-6" x 3'-0"

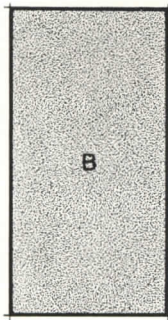

**TWIN**  
6'-6" x 3'-3"

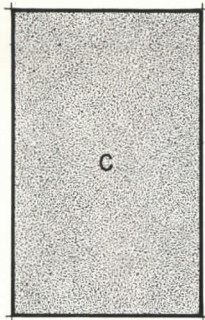

**THREE QUARTER**  
6'-6" x 4'-6"

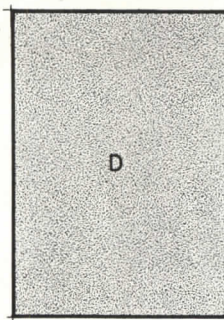

**DOUBLE**  
6'-6" x 4'-6"

**CHESTS**

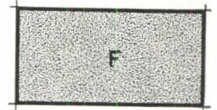

**CHEST**  
4'-0" x 2'-0"

**TABLES**



**KIDNEY**  
3'-0" x 1'-6"

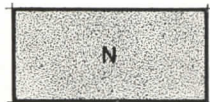

**LARGE DRESSING**  
4'-0" x 2'-0"

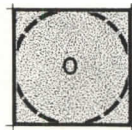

**SMALL OCCASIONAL**  
2'-6" x 2'-6"



**SMALL NIGHT**  
1'-2" x 1'-6"



**MEDIUM NIGHT**  
1'-6" x 1'-6"



**SMALL CHEST**  
3'-0" x 1'-6"

**CHAIRS**

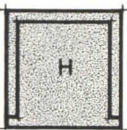

**BOUDOIR**  
2'-6" x 2'-6"

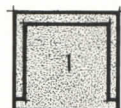

**SMALL BOUDOIR**  
2'-2" x 2'-2"



**SIDE**  
1'-6" x 1'-6"

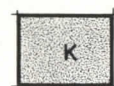

**BENCH**  
2'-0" x 1'-6"



**DRESS'G TABLE**  
1'-6" x 1'-6"



**DRESSER**  
4'-0" x 2'-0"

**TYPICAL AVERAGE FURNITURE SIZES**

Scale 1/4" = 1'-0"

**TYPICAL UNIT ARRANGEMENTS**

Scale 1/8" = 1'-0"

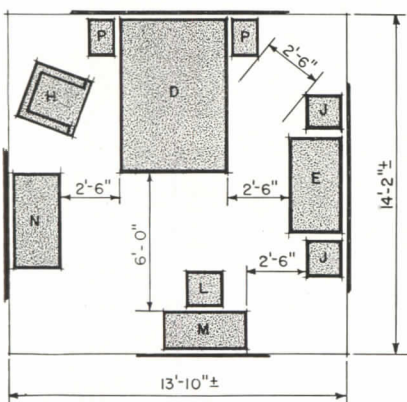

1. For comfort, 2 night tables are desirable with a double bed. A minimum double-bed unit arrangement may be achieved by omitting arm chair and one side chair, and reducing to 3'-6" the traffic lane at foot of bed.

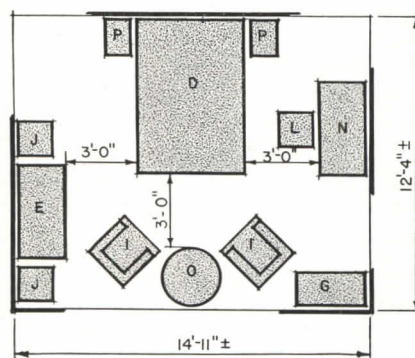

2. Use of small chairs and chest makes possible the addition of conversation or lounging furniture (2 chairs and table) to a typical suite, without increasing square footage. Use of 3-ft. passages eliminates crowding.

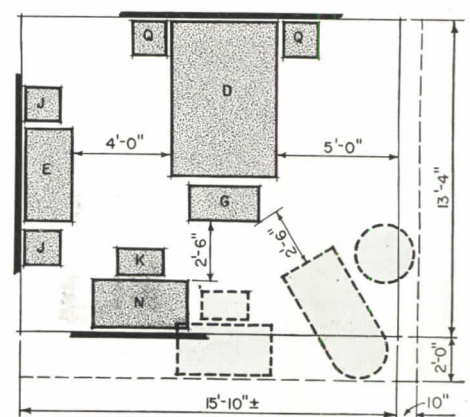

3. Other types of arrangements beyond the minimum include addition of a chaise longue (shown dotted above), which is usually placed at an angle to walls, requires a table, and necessitates ample passages.



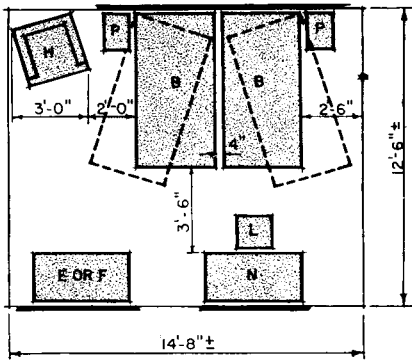

4. Minimum twin-bed group (2 night tables) needs 9'-6" wall.

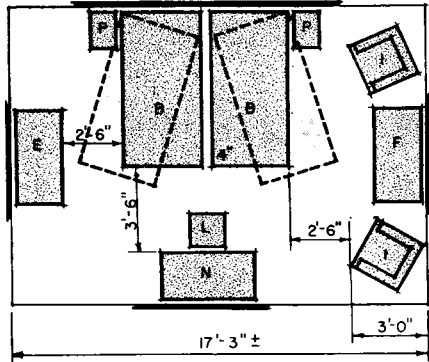

5. Increased requirements for addition of dressing table and boudoir chair.

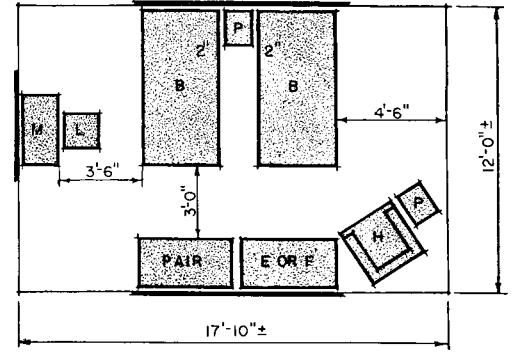

6. Twin beds with single night table require 8' of wall space.

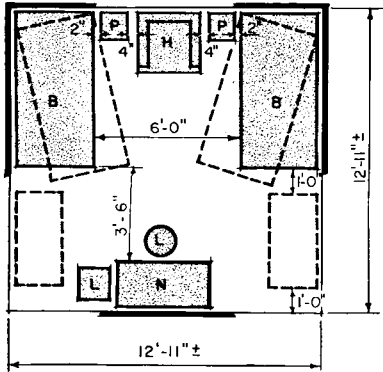

7. Variations on this plan may be developed by replacing the chair between the beds with a dressing table which serves also as a night table. This would free other walls for twin chests, shown dotted.

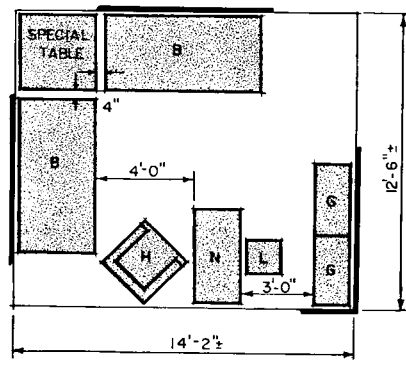

8. Twin beds heading toward a common corner may require less space than is indicated if dressing table and boudoir chair are omitted.

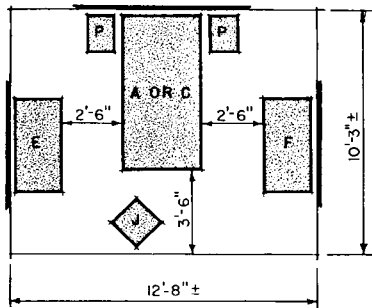

9. Single-bed unit with two night tables requires 6'-6" wall.

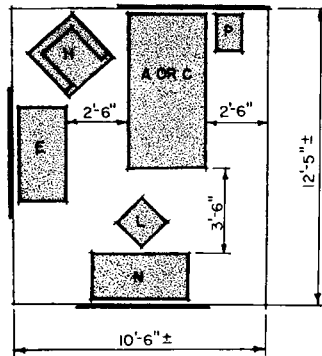

10. Minimum dimensions for passage both sides of bed.

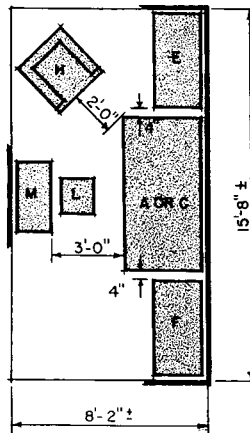

11. Unusual but satisfactory arrangement or long, narrow space; if units E and F are reduced 2'-0" in length, room length may be decreased 2'-0".

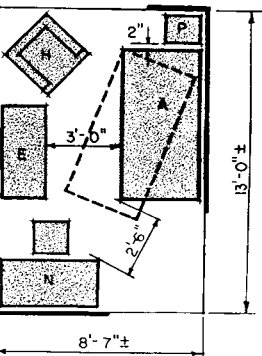

12. Minimum for couch or single bed placed sideways to wall.

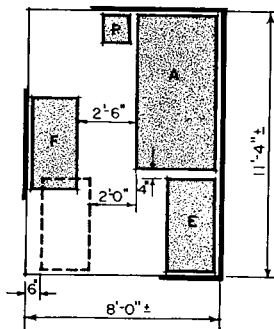

13. If position of chest is changed room width may be reduced 6".

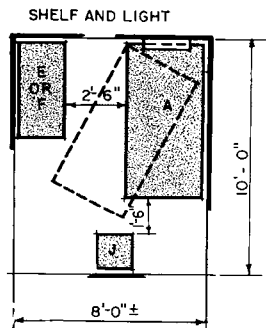

14. Door-swings may require increased clearance at foot of bed.

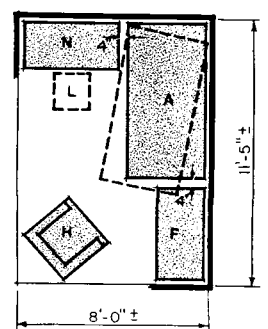

15. Slightly more comfortable than Fig. 14, but bed making is difficult.



Van Anda

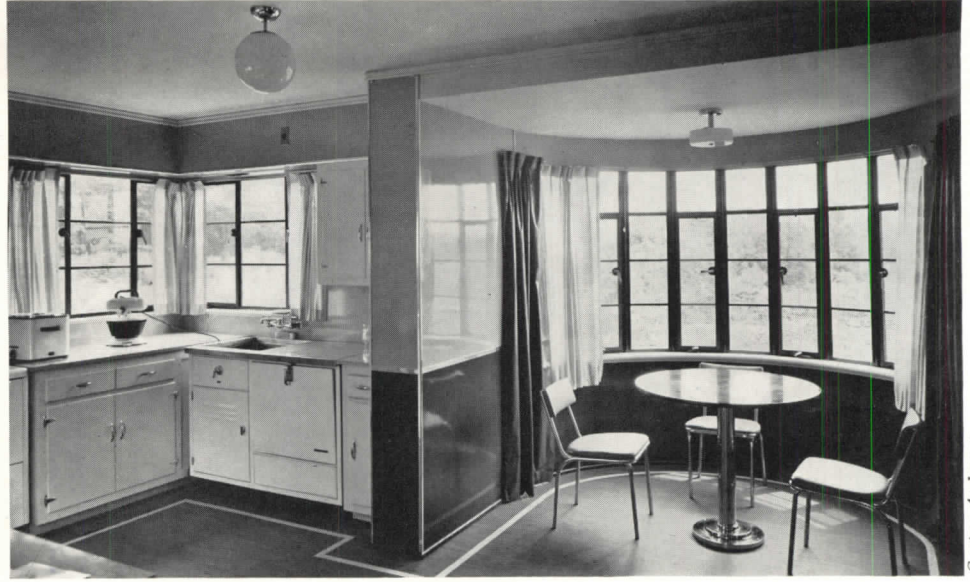

Gustaf Anderson

Kitchens, bathrooms, stairhalls, etc. . . .

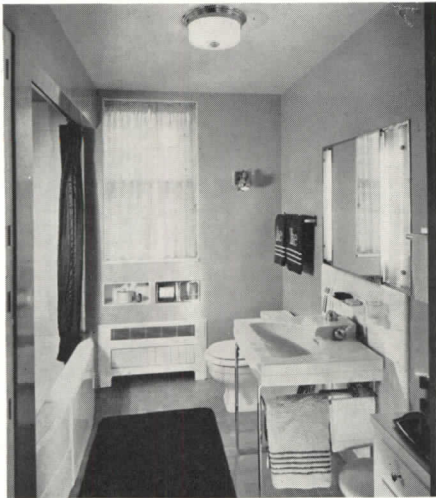

Hedrich-Blessing



SERVICE UNITS of a house have become well standardized as to function, sizes, forms, and types of equipment. Manufacturers of building products are more and more employing their capacity for industrial research, engineering, and design toward production of units adequate to meet such residential living requirements as food preparation, storage, toileting, laundering, circulation—and even hobbing (photography, wood-working etc.).

Today a series of equipment combinations in a variety of stock sizes and standard arrangements is available for solve virtually all problems of servicing that the residential designer is likely to encounter. Engineering staffs of manufacturers which produce these are more and more undertaking the double duty of design coordination and product improvement.

This trend of industrial activity may ultimately relieve the building designer of the necessity for detailed layout and involved specification of servicing facilities. He need then only provide in his design adequate space for a required unit and the necessary elements of construction or equipment, and need merely specify the degree of *performance* considered essential to the integrated development of his design problem. On this basis engineering service staffs of some manufacturers will today produce a detailed layout, specification, and installation program.

In addition, many manufacturers pro-

vide engineering consultation on technical matters involving performance standards of service units. Their research staffs are a source of information which relates not only to improving the efficiency and reducing costs of specific service units, but also to more economical and generally satisfactory methods of integrating them with other basic elements of residential design.

*Kitchens:* Minimum average floor areas range from 36 sq. ft. (L-shaped, 6 by 6 ft.) to 80 sq. ft. (2-wall, 10 by 8 ft.) for a unit normally suitable for a six- or seven-room house. *Pantries* for three- to five-bedroom houses require from 25 to 64 sq. ft. of floor area. *Dining space*, as part of the kitchen-pantry unit, averages about 64 sq. ft.

*Bathrooms:* For usual 3-fixture unit, minimum floor area, including required clearances, is 32½ sq. ft.; with stall shower and corner lavatory, 25 sq. ft. *Lavatories*, with two fixtures and minimum clearances, occupy from 14 to 18 sq. ft. depending on fixture type. (See Amer. Archt., May, 1937).

*Stairhalls:* Minimum stair width for single-file use is 2 ft.; 3 ft. is normal standard. Pitch (tread-riser ratio) approved by Workmen's Compensation Service Bureau ranges from 30° 35' to 35° 16', allowing a range of riser height from 6½ in. to 7½ in. and a tread width from 11¾ in. to 10¼ in. On this basis either 15 or 16 risers are satisfactory for a 9-ft. floor-to-floor height. (See Amer. Archt., Feb., 1937).





Ernest Graham

## EIGHT REPRESENTATIVE SMALL HOUSES

HOUSES ILLUSTRATED on the following pages suggest the wide range of type, size, and location within which the preceding data is applicable. A study of the plans reveals that, though arrangements differ, sizes of rooms for comparable uses are nearly the same; and that, furthermore, floor areas are roughly equal to averages developed in the furniture-group unit diagrams.

Other general similarities exist: the size of the houses, for example, relative to provisions for varying family size, and the comparative standardization of service facilities. Points of difference obviously are many, for such matters as cost, orientation, site, climate, personal tastes, etc., were controlling factors not

of equal weight in the solution of each design problem. But generally the houses bear out the contention of Mary Davis Gillies (page 92) that "there exist typical American living habits, tastes, and activities." The statement suggests that provisions for the major activities of American families may be subject to a much greater degree of standardization — even within a limited range of size, type, and cost—than is generally realized.

With the possible exception of the Florida house for Mr. and Mrs. Reinhold—the living room patio of which is shown above—each of the houses might have been developed, with equal success, almost anywhere in the country.

## Southern House for Informal Living and Entertaining

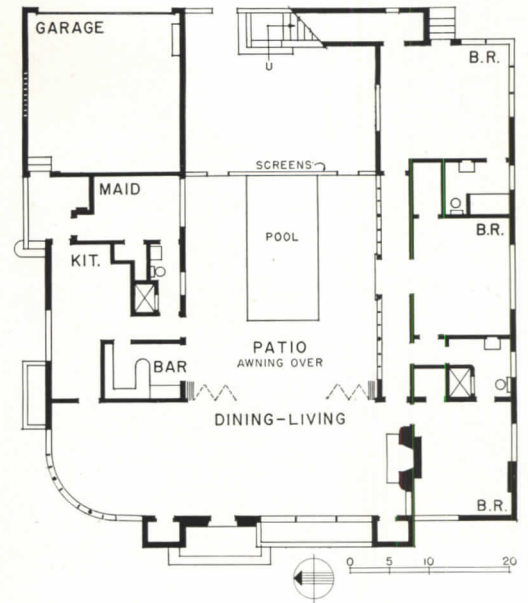

Photos by Ernest Graham

THE OWNERS of this Florida house entertain, informally, large numbers of people, and occupy the house during the entire year. These factors, and climatic conditions, made it desirable to provide folding living-room doors which open a full 24 feet to bring the canvas-roofed, monel-screened pool into the usable living area. The generally open plan permits a maximum utilization of natural ventilation; broad eaves shelter open windows from rain and sun: both are requirements for all-year occupancy.

In chilly weather, heat is furnished by the living-room fireplace, from which ducts run to bedrooms. Construction is reinforced concrete and concrete block. Roof is white-clay tile; sash are steel; flashing is copper.

The house, in Coral Gables, was designed by T. Trip Russell and Igor B. Plevitzky, architects, for Mr. and Mrs. Ernest Reinhold.

A view of the patio and pool may be seen on page 107.



## Flexibly Planned New England House

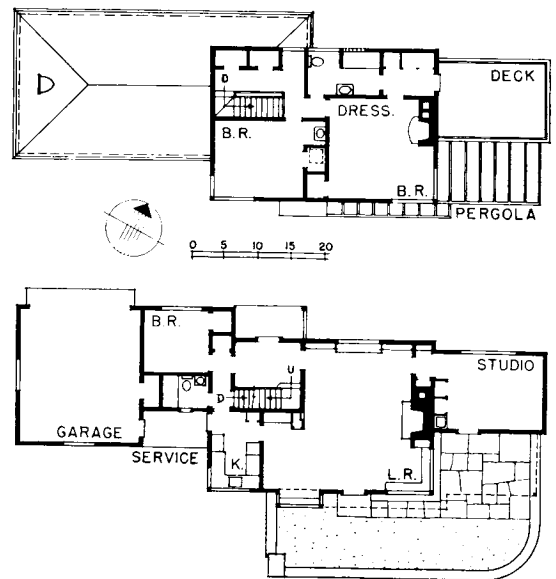

THE OWNER had three main requirements in planning this house: A certain flexibility of room arrangement so that the first-floor bedroom and bath could be used for either servant or guest; preservation of a southerly and southeasterly view; and freedom of treatment and fenestration without loss of harmony between the house and the natural background.

The first-floor bedroom and bath, adjacent to the kitchen but accessible from the hall, serve double function, making the plan suitable for either week-end or all-year use.

Except for the studio, which serves as a workshop and has north light, all the principal rooms and the terrace overlook the view.

Bleached redwood, and plywood painted a warm gray, were combined with a stained shingle roof to achieve harmony with the terrain.

The house, in Warren, Conn., was designed by Willis N. Mills, architect, and Allan McDowell, associate, for Anthony Kimbel.



Photos by Ian Andra

## West Coast House with Efficient Circulation and Services

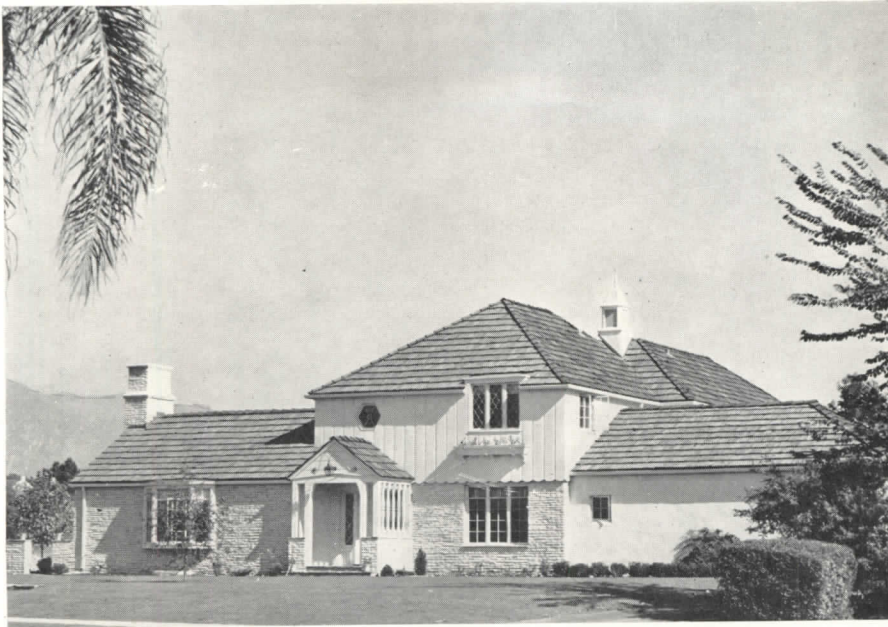

GARAGE AND FRONT DOOR are easily reached without traversing major rooms. Grouping of first-floor service areas, with second-floor baths centered above, segregates work from living quarters and assures efficient plumbing layouts. First story is veneered in precast cement block, painted. Robert H. Ainsworth, architect, designed the house in San Marino, Calif., for Dr. L. W. Ellis.

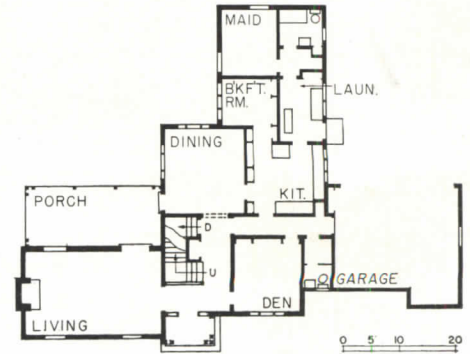
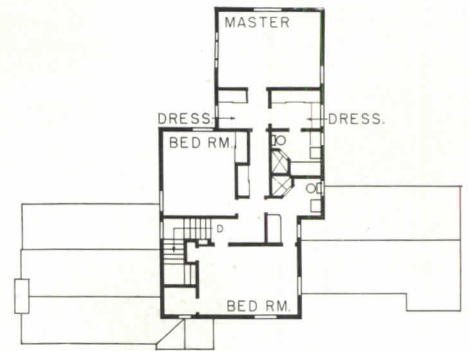

## Midwest House for Family of Three



THIS HOUSE PROVIDES for a family consisting of husband, wife, and one child; and for a guest room and servant's quarters. Site was undeveloped, with a northwest exposure overlooking a golf course. The wood-frame structure is completely insulated and has year-round air conditioning. Roof is black slate; exterior is faced partly with Philadelphia stone, partly with siding. Louis André Lamoreux, architect, designed the house, in Ashland, Ohio, for Curtiss Ginn, Jr.

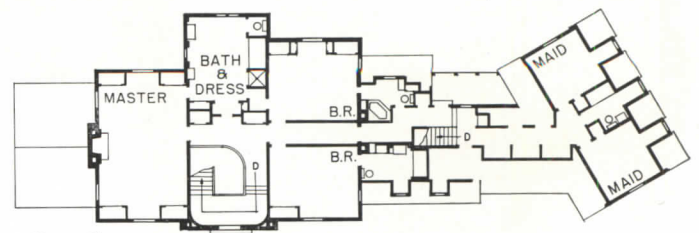
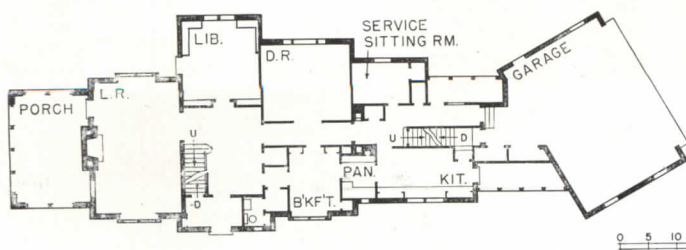

0 5 10 20 30 40



## Open-planned, Window-walled House in Southwest

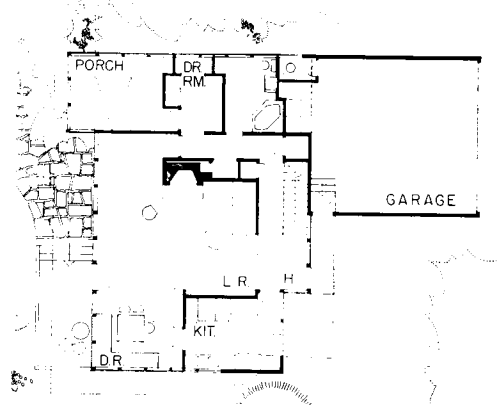
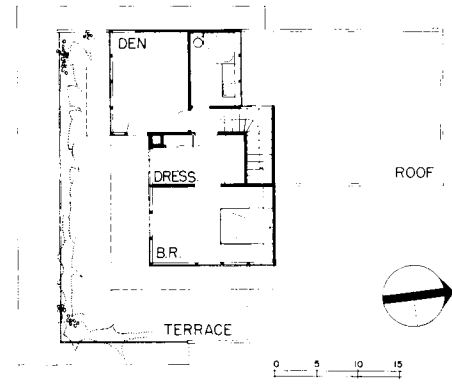
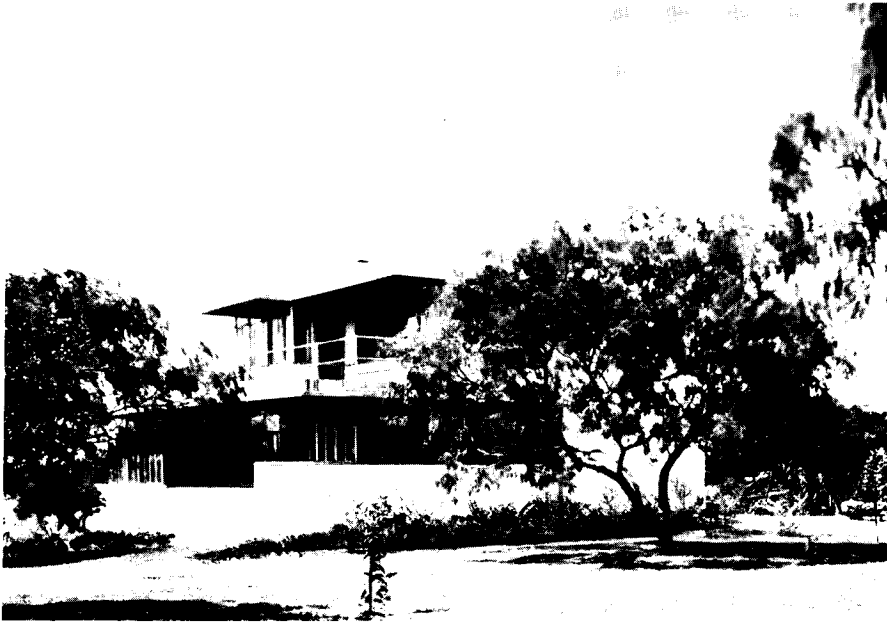

THE PROBLEM HERE was to design a well-ventilated house for a hot climate, for a bachelor and male servant. Exterior is faced with cement plaster and sheet steel over steel and wood framing on a raised concrete platform. Richard J. Neutra, architect, designed the residence, in Brownsville, Texas, for George Kraigher.

## Three-bedroom House in Pacific Northwest



THREE STANDARD-SIZED bedrooms, each with two exposures, and two bathrooms, are so compactly planned that only 9½ ft. of second-floor hall is needed. Living, dining, and breakfast rooms are at the rear overlooking a ravine; service areas occupy the street front. George Wellington Stoddard, architect, designed the house, in Seattle, Wash., for Walter H. Tuesley.

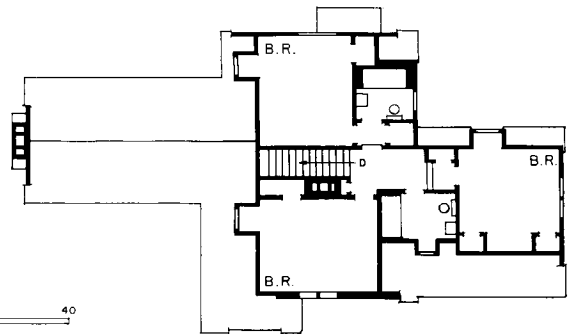
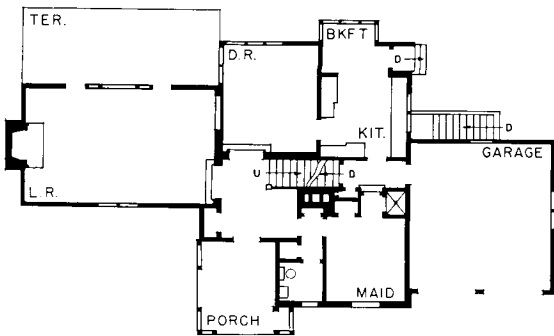

## Three-bedroom House in Eastern Development



Gustav Anderson

A SQUARED PLAN with a central chimney which permits efficient layout of the heating system, also reduces excavation and foundation costs. Walter Spelman, architect, designed the house for erection in Rockville Center, New York. A view of the kitchen and breakfast alcove may be seen on page 106.

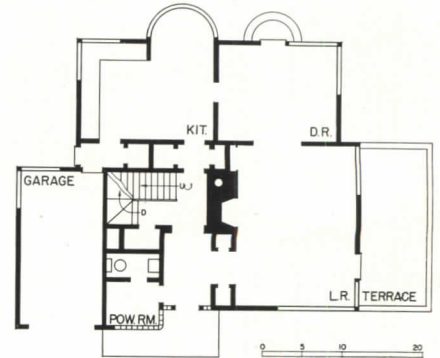
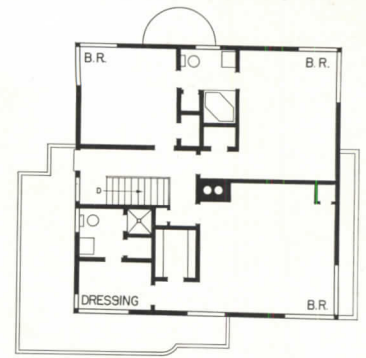

## House Built into Hillside on West Coast



Stuart Grant

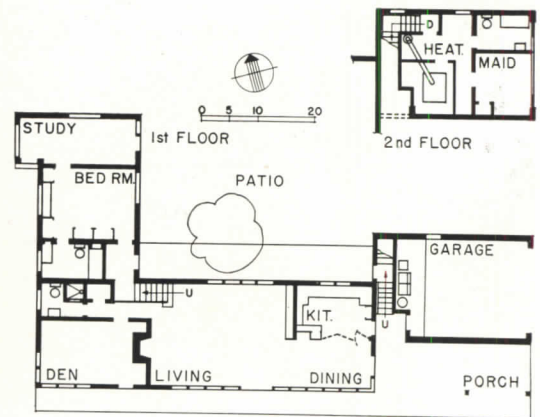

LOW PROPORTIONS were made possible and a high outlook avoided by terracing this house into the hillside. Excessive excavating was obviated by using an oil-fired forced warm-air heater which was located in the small second-floor extension. Cement-block construction was selected as being suitable for building against earth. There is no hall in the usual sense; bedrooms may be reached from porches. William Wilson Wurster, architect, designed the house, in Happy Valley, Calif., for Dr. Olin H. Garrison.