

BUILDING NEWS



Newsreel Theater in Boston . . . see pp. 38-41

ARCHITECTURAL
RECORD



Haskell

View of theater entrance. Each plane has been accentuated to enlarge apparent space; doors are dark blue; wall is yellow.

THEATER BUILT IN SEVEN BAYS OF EXISTING OFFICE STRUCTURE

MARC PETER, JR., and HUGH STUBBINS, Architects



Haskell

THE PROBLEM involved here was the design of a newsreel theater on the street floor of a large office building in Boston. Provision was to be made in an unobstructed space, 20 by 119 ft., for 250 seats, foyer, manager's office, projection booth and rewind room, toilets, necessary storage, and sale booths. The space available included seven 17-ft. bays; ceiling height is 15 ft. In the foyer and entrance each plane has been accentuated in an effort to enlarge the apparent volume. The yellow wall brightens the foyer and permits cutting down the amount of electric light, softening the contrast between auditorium and foyer. The posters and other advertising material used for the opening were designed by the architects.

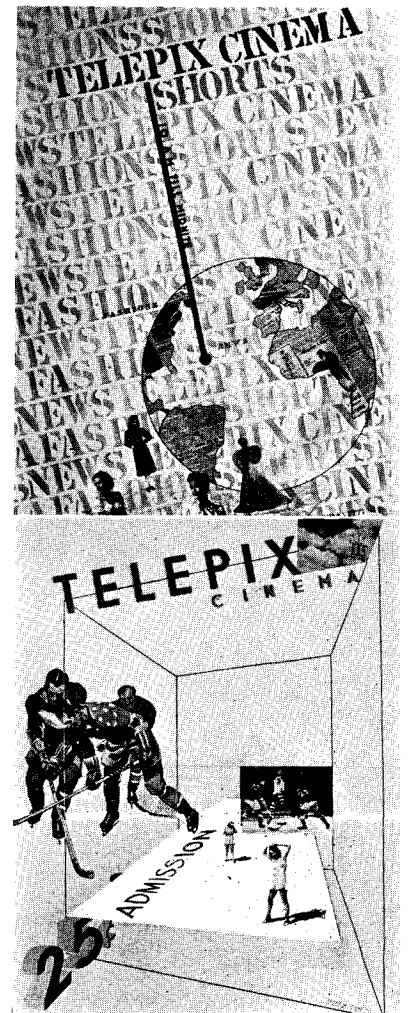

Posters designed by the architects and used at opening of theater.

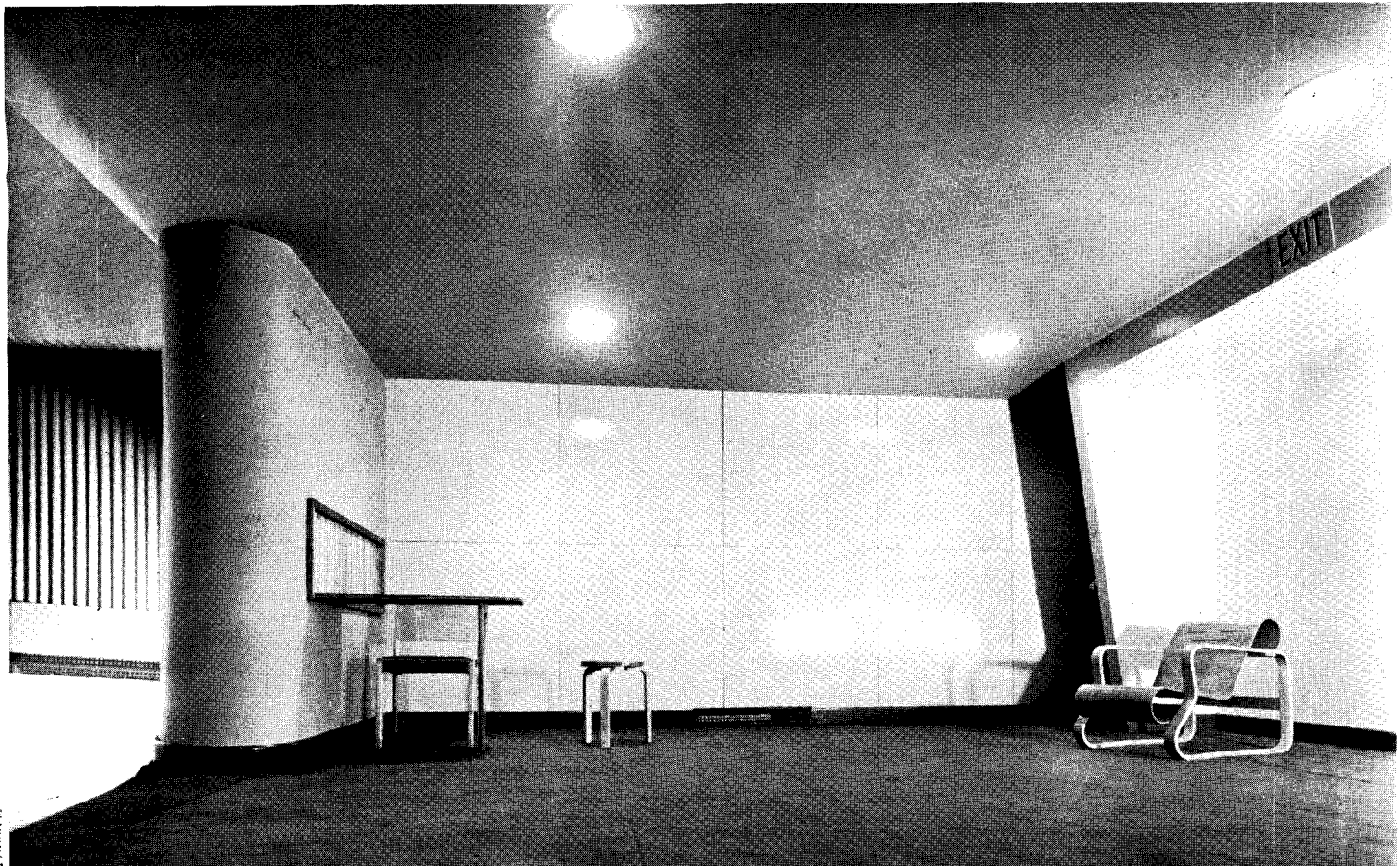

Hashell

View of foyer, showing director's desk and stairway to public toilets and projection and rewind rooms; exit doors at right.

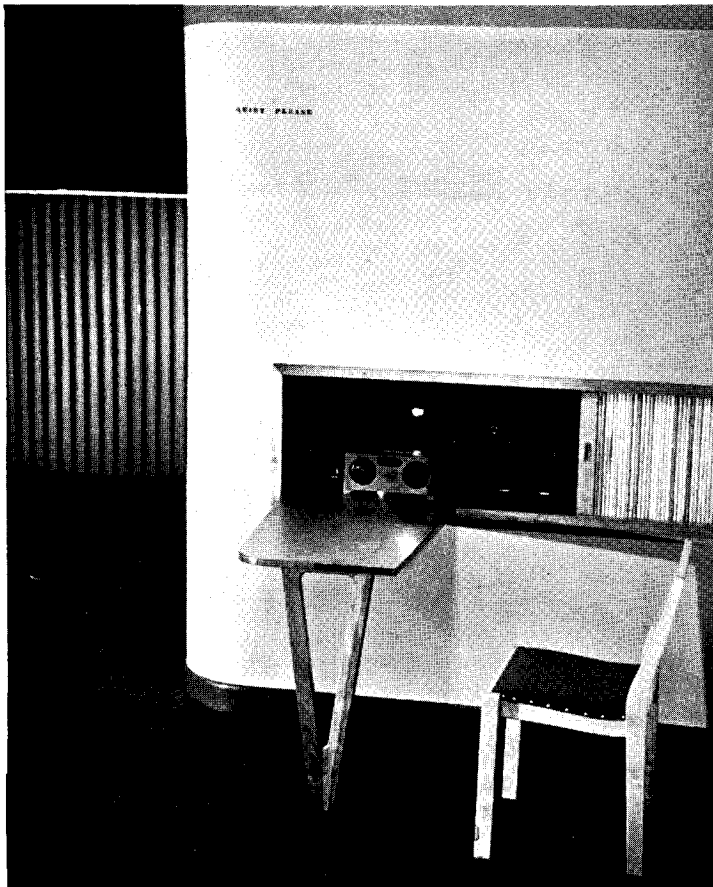

Air conditioning and light converters are controlled from here.



Corner of foyer with entrance at left, exit doors at center.

THEATER IN BOSTON

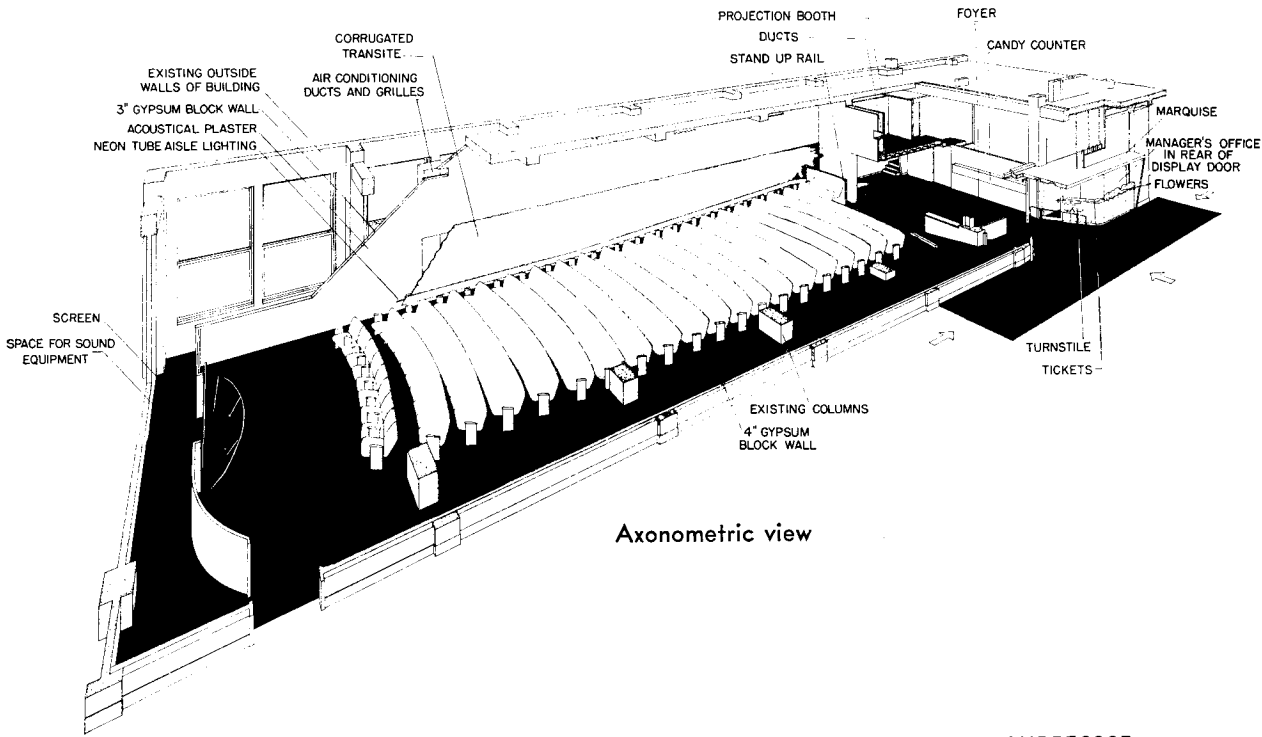

Axonometric view

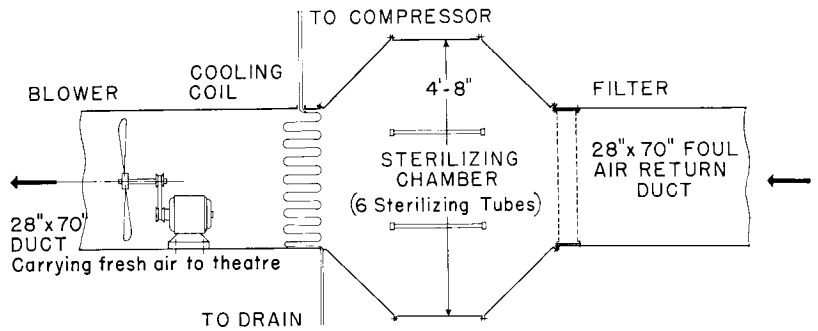

Sterilizing chamber in air duct

To COUNTERACT the "tunneling" effect of the long and narrow shape of the auditorium, acoustical plaster has been applied to the side and back walls; this reduces the reverberation time to .89 as against an optimum of 1.20; the dado of corrugated asbestos cement, on the other hand, acts as a drum, thus preventing muffling, and raising the sound to the desired quality and sharpness. Interior columns are painted the same color as the ceiling to minimize their volume.

The air-conditioning system is equipped with sterilizing lights placed behind the filters; it is claimed that the sterilizing rays kill 90% of air-borne bacteria within a radius of 24 in. These generators are strong in the bactericidal range, but do not produce the very short ultraviolet rays in the ozone range. The eyes have to be shielded from these lights. Telepix Corporation has applied for a patent on the installation method.

Neon-tube strip lighting is used for aisle illumination. Special seats have been installed; on flat springs, they give a "rocking-chair" effect.

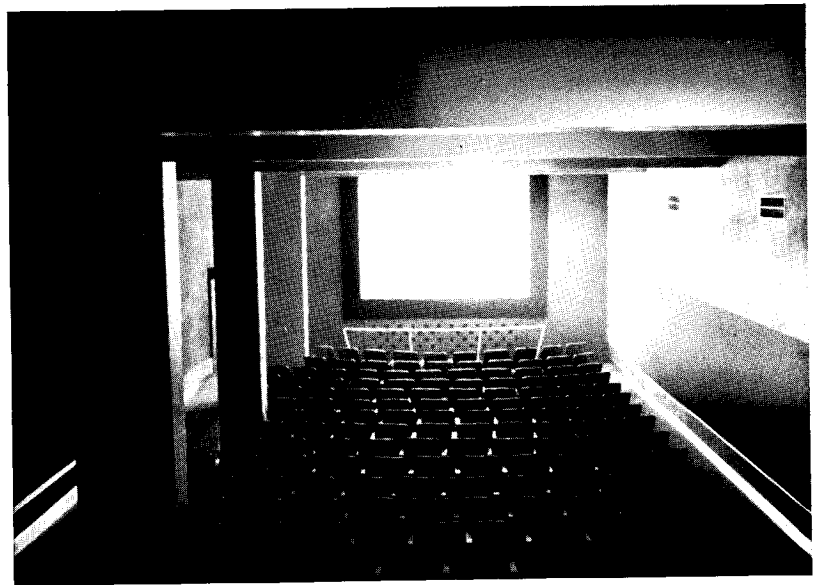

Walls at left and front are painted dark brown; the dado at right is dark pink, as are the columns and ceiling; wall above the dado is white.

AUSTIN, TEXAS: MUNICIPAL BUILDING ENLARGED AND REMODELED

PAGE & SOUTHERLAND, Architects

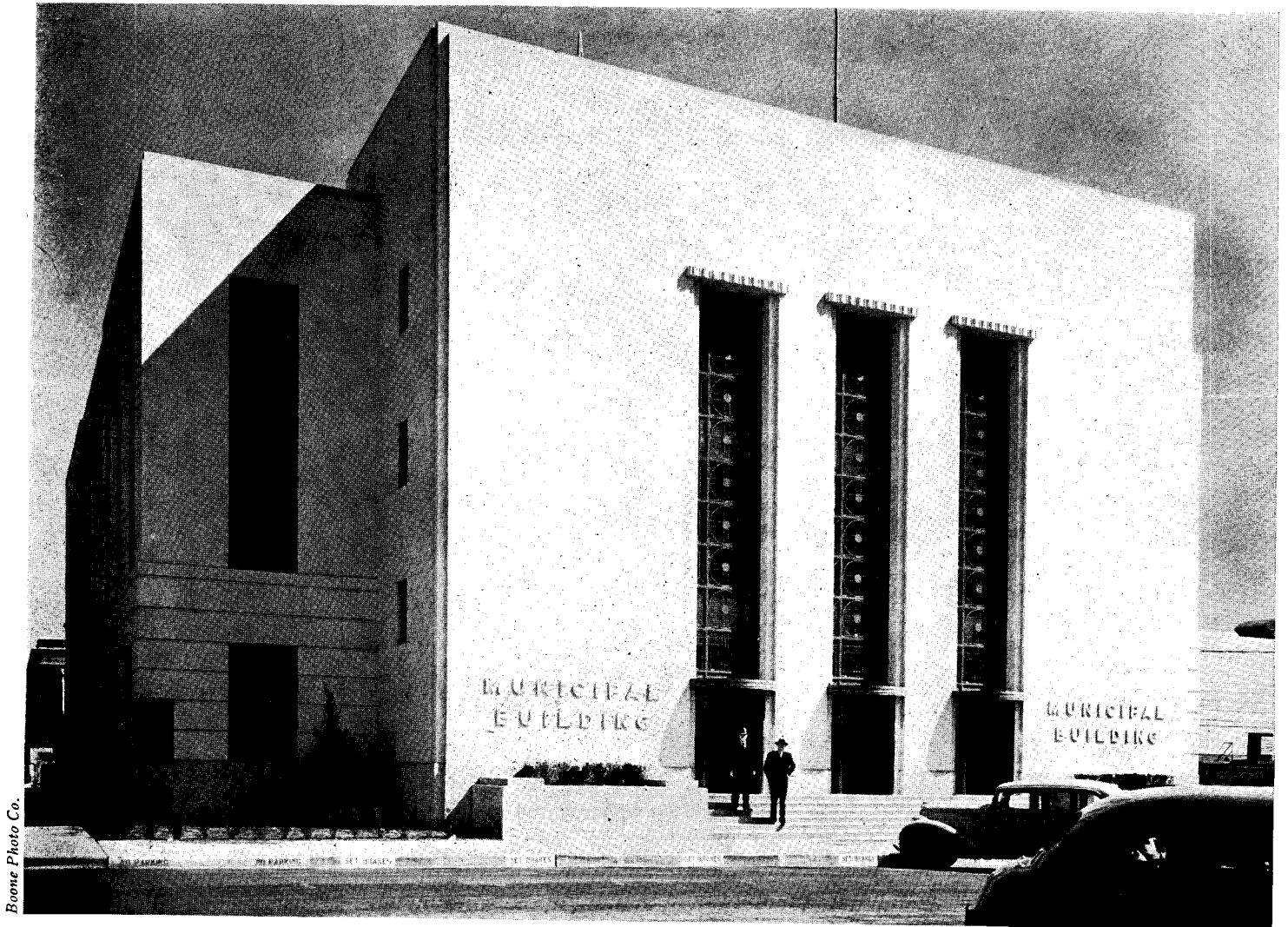

IT WAS DECIDED to remodel the Municipal Building of Austin, Tex., instead of building a new one, partly because the old structure contained some relatively modern equipment in excellent condition. The size of the building was more than doubled, but the frame of the old structure has been utilized. Some foundations were strengthened by underpinning; wood floors were replaced by concrete slabs on high-ribbed lath over bar joists; and the old wood roof framing was replaced by a slab. The walls retained from the old building are solid masonry. Walls of additions are brick and tile. The building is veneered with 4 in. of limestone.

The first floor provides space for those offices with which the public is in constant contact, such as the water, light, tax, and accounting departments. Permanent files of these departments are readily accessible by stairway to the base-

ment. The second floor is occupied by engineering departments, the purchasing agent, and the legal department.

The third floor houses the police department. The main problem involved in the planning of this floor was the location of offices according to their function and the type of persons who normally have business with them. The police chief, traffic division, and judge of the corporation court were therefore placed near the front elevator and lobbies, and the detective division, the jail, and that part of the organization dealing with criminals were located in the rear. Thus persons charged with traffic and similar violations are less likely to be thrown in contact with the more sordid phases of police activity. Adequate space and equipment have been provided for a uniform crime-reporting system, identification bureau, and photography and records rooms.

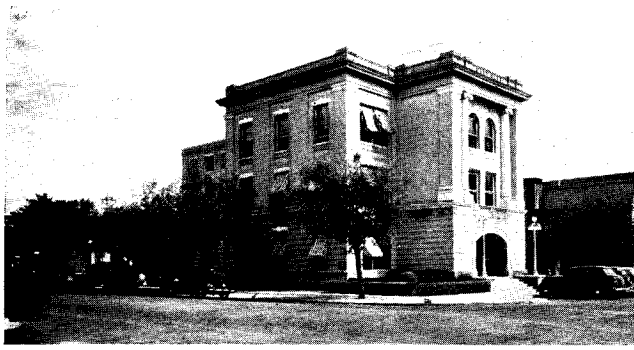

View of Municipal Building before remodeling began.

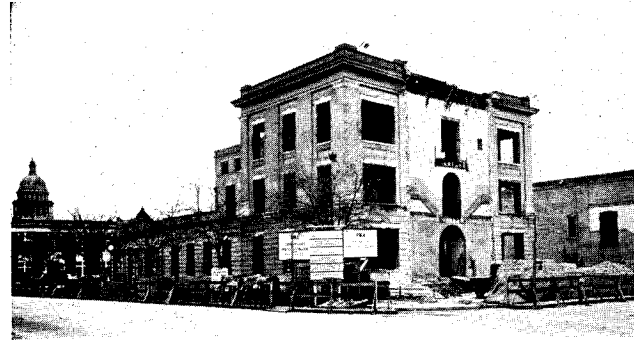

In remodeling, most of the old structure was utilized.

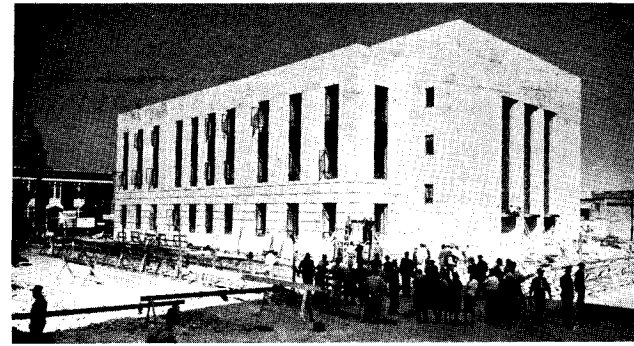

Enlarged and remodeled building nearing completion.

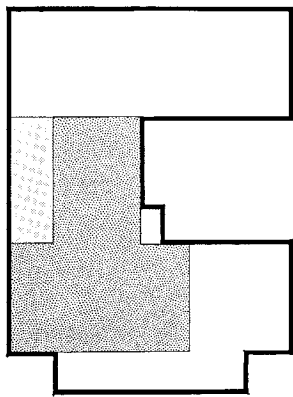

Old 3-story structure

Old 1-story structure

Diagrammatic plan of building. Shaded areas indicate where old structure has been reused.

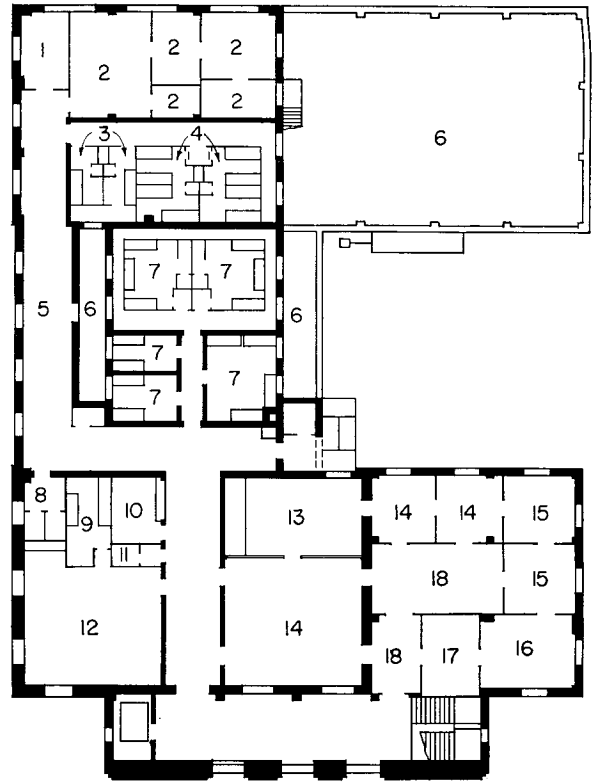

Third-floor plan: 1. Uniform Crime Records. 2. Detective Division. 3. Jail for Juveniles. 4. Jail for Women. 5. Corridor. 6. Roof. 7. Jail for Men. 8. Men. 9. Dark Room (Identification Bureau). 10. Police Desk and Broadcasting Station. 11. Women. 12. Identification Bureau. 13. Jury. 14. Corporation Court and Chambers. 15. Traffic Division. 16. Chief of Police. 17. Clerical and Records. 18. Reception.

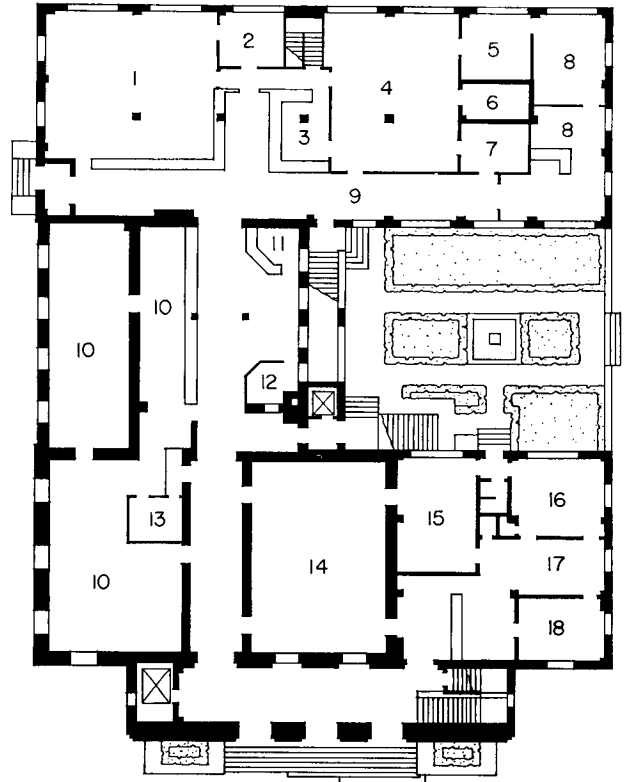

First-floor plan: 1. Tax Dept. 2. Board of Equalization. 3. Cashier. 4. Accounting Div. 5. Director of Recreation. 6. Vault. 7. City Clerk. 8. Recreation Dept. 9. Corridor. 10. Water and Light. 11. Switchboard. 12. Concession. 13. Complaints. 14. City Council. 15. Mayor and Council. 16. City Mgr. 17. Stenographic. 18. Executive Assistant.



Main building: Load-bearing partitions facilitate use of continuous fenestration. Exterior walls are covered with colored stucco.

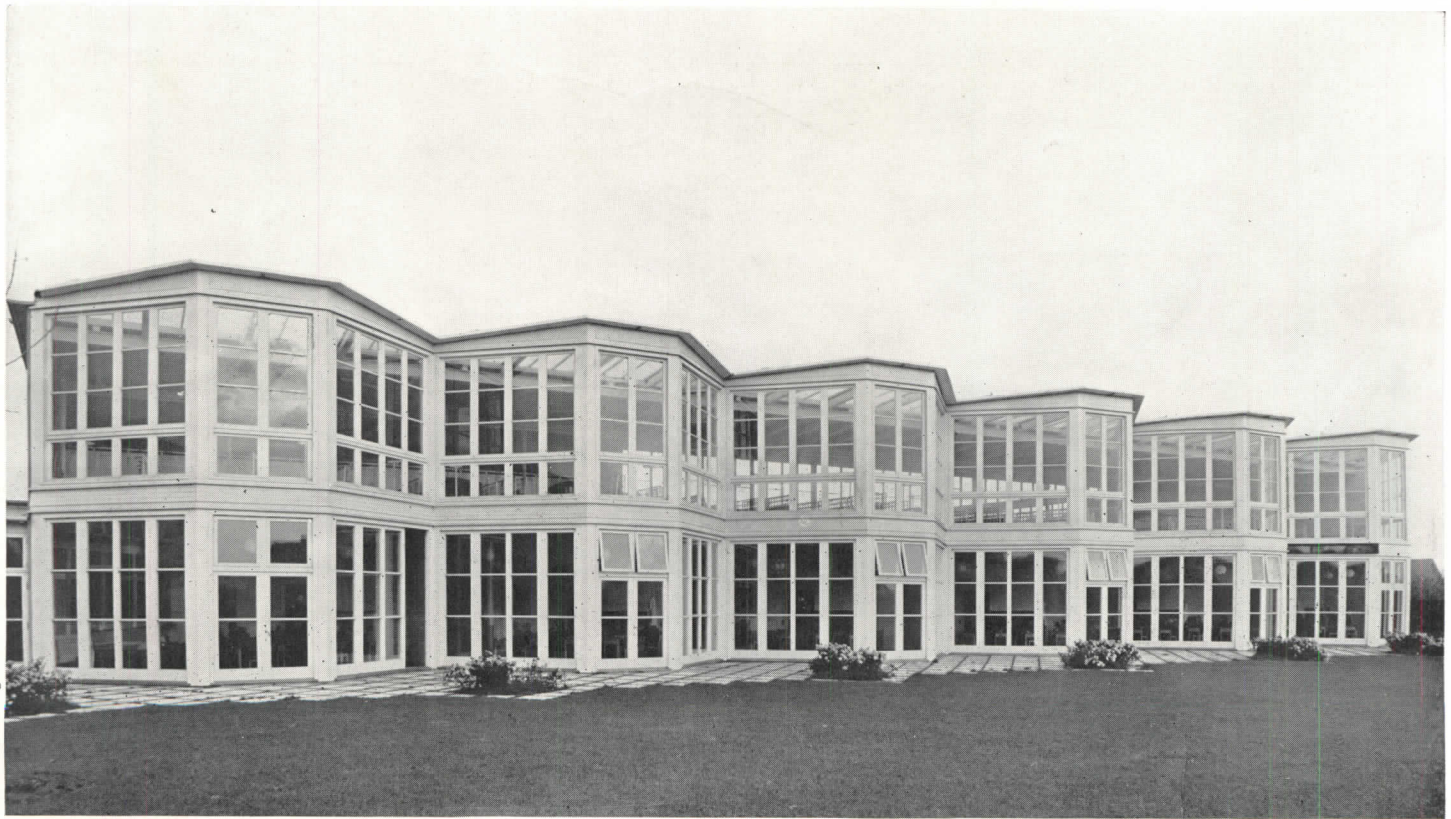

Photos by Radina

Open-air school: There are six classrooms on the lower floor. On floor above are cots used in rest periods.

DENMARK: EDUCATIONAL GROUP INCLUDES "OPEN-AIR" SCHOOL

K. GOTTLOB, Architect

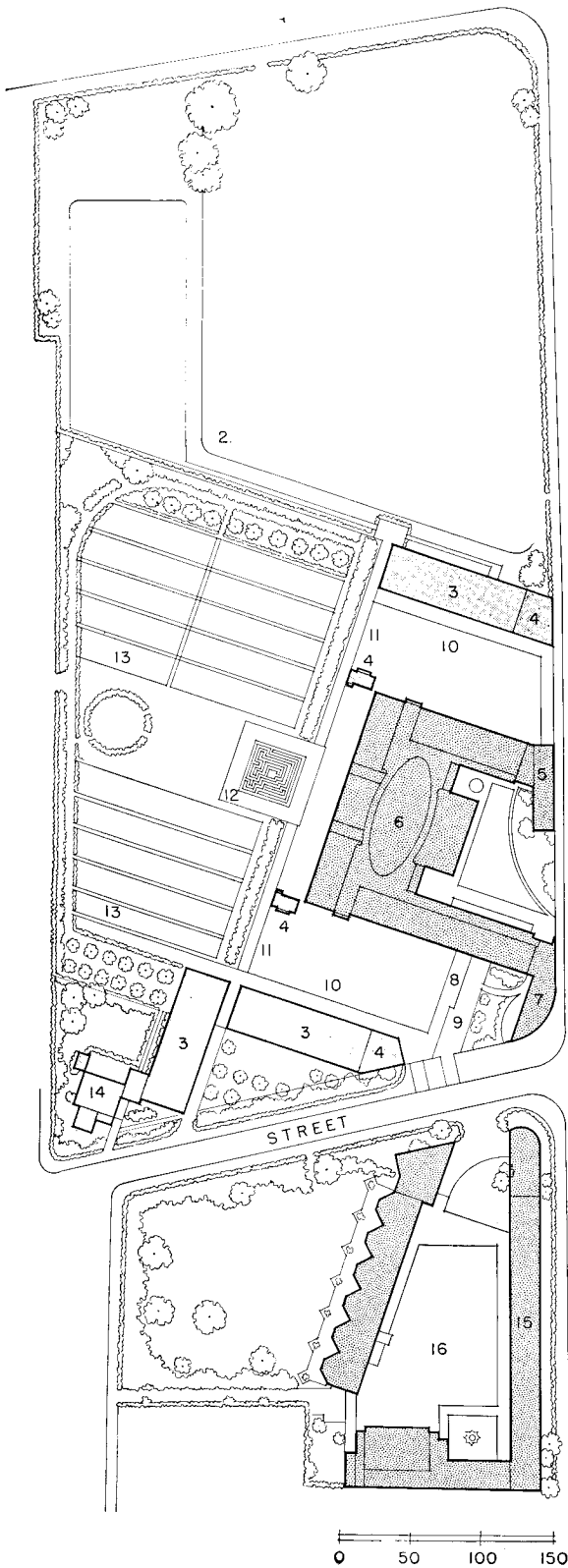

Plot plan: 1. Playground. 2. Sports. 3. Gymnasium. 4. Lavatory. 5. Nurse. 6. Central hall. 7. Janitor. 8. Bicycle ramp. 9. Yard. 10. Playground for boys. 11. Pergola. 12. Shelter. 13. School gardens. 14. Principal's residence. 15. Open-air school. 16. Courtyard.

THIS GROUP in Sundby, Denmark, includes two schools, three gymnasiums, workshops, a clinic, houses for the principal and janitor, sports fields, and school gardens.

One school is of a type which has become fairly common in Denmark within recent years: it has three floors about a central elliptical hall which runs up the three levels. The second school is an "open-air" type, the first of its kind in Denmark; here children of delicate health receive special care and nursing, at the same time being taught the regular curriculum.

The buildings have been so placed that they shelter the playgrounds from the wind and permit the school gardens on the south to get plenty of sunlight. The main building has been set along the east line of the site, close to the open-air school. The principal, part of the faculty, and the janitor are the same for both schools, and the houses of the school principal and of the janitor have both been placed conveniently close to both.

The main building is of reinforced concrete. Radiant heating has been used: the heating system consists largely of parallel pipes in the ceiling, spaced closer together along the windows; for this reason, the roof, too, is reinforced concrete instead of wood, which would have been less expensive. All windows in this building are double-glazed. Exterior walls are covered with colored stucco.

The open-air school, designed in collaboration with the chief health official in the educational system, has three classrooms, each for 24 children. All classrooms are faced diagonally south, so that there are glass walls on two sides; these walls can be slid open.

The pupils spend more time inside this building than do children of normal health: they have rest periods inside the school; their meals are prepared in the school kitchen; they are given needed medical attention during school hours. Above the classrooms is a space for cots, which are used during rest periods. This rest room, too, has mobile glass walls, and part of the roof can also be opened. There are exits to the garden from all classrooms.

To the north of the open-air school is a one-story building with kitchens and dining rooms, laundry, toilets, and a clinic. Along the east side is a gym with dressing room and shower bath. And on the west side is a faculty room and a residence for the person in charge of food preparation. The classroom structure is reinforced concrete, the roof wood. The other buildings are of brick and wood. Classrooms have radiant heating; all other rooms have radiators. Doors and windows have double glazing. The exterior walls are covered with colored stucco.



Photos by Rading

The elliptical central hall is lighted from a clerestory. This 3-story hall is used during recess and assembly periods.

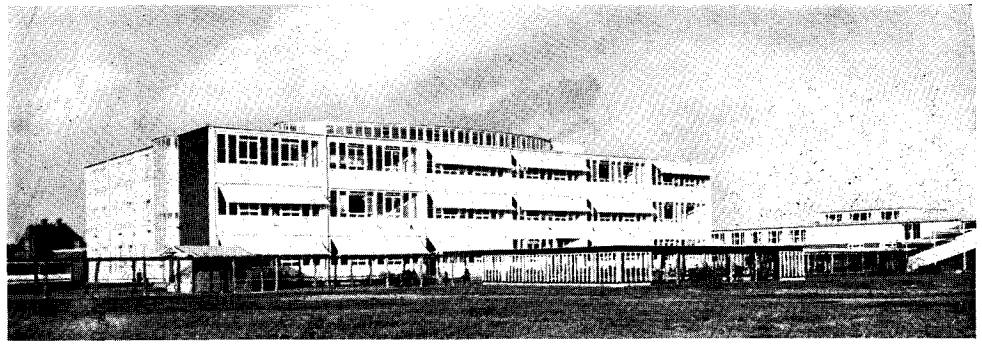

Second floor

- 1. Kitchen
- 2. Washroom
- 3. Woman teacher
- 4. Pantry
- 5. Preparatory kitchen
- 6. Classroom
- 7. Flower unit
- 8. Wardrobe
- 9. Drafting
- 10. Central hall
- 11. Storeroom

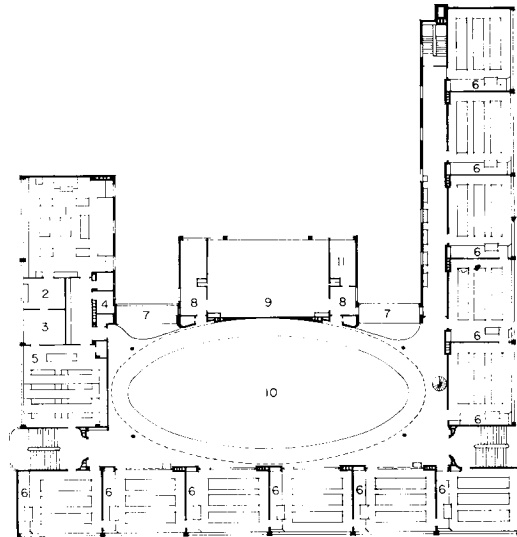

First floor

- 1. First aid
- 2. Nurse
- 3. Doctor's office
- 4. Housekeeper
- 5. Storeroom
- 6. Waiting room
- 7. Kitchen
- 8. Dining room
- 9. Reading room
- 10. Classroom
- 11. Foyer
- 12. Principal
- 13. Filing room
- 14. Porch
- 15. Telephones
- 16. Foyer
- 17. Wardrobe
- 18. Teachers' room
- 19. Kitchen
- 20. Showers
- 21. Washroom
- 22. Dining room
- 23. Living room
- 24. Bedroom
- 25. Master bedroom

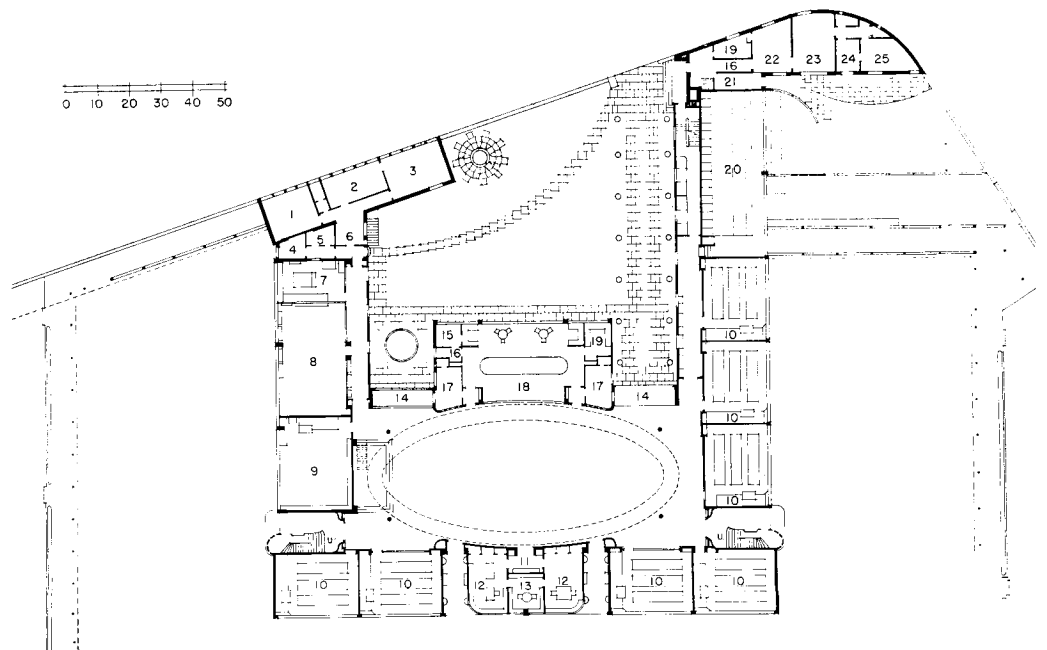

THE MAIN BUILDING has 29 classrooms. The part of the building in which the general classrooms are located faces south. Most of the specialized classrooms face east and west. Facing north are the faculty room, sewing room, and

drafting room. All the classrooms facing the center hall have wide windows over the door for air and light.

Partitions are loadbearing; walls and floors are well insulated. Construction facilitates use of continuous windows.

DENMARK: OPEN-AIR SCHOOL

Reading

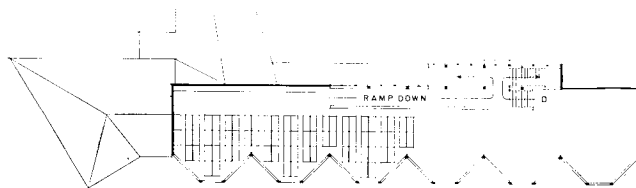
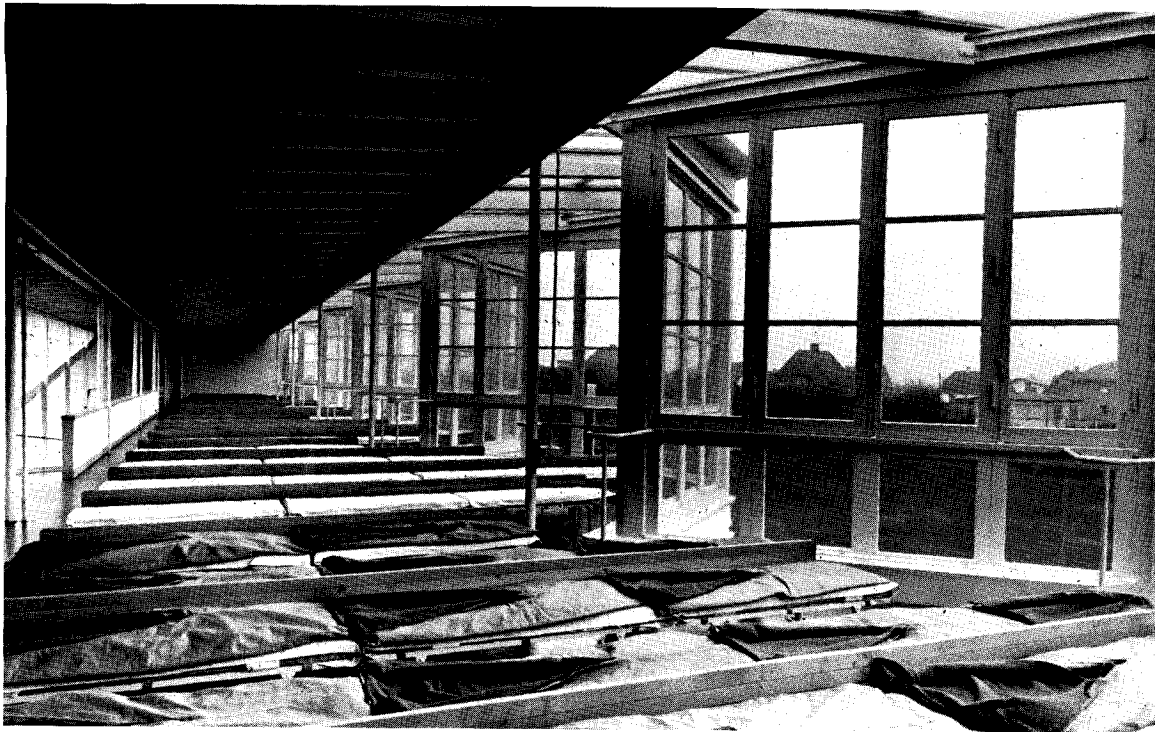

Second floor

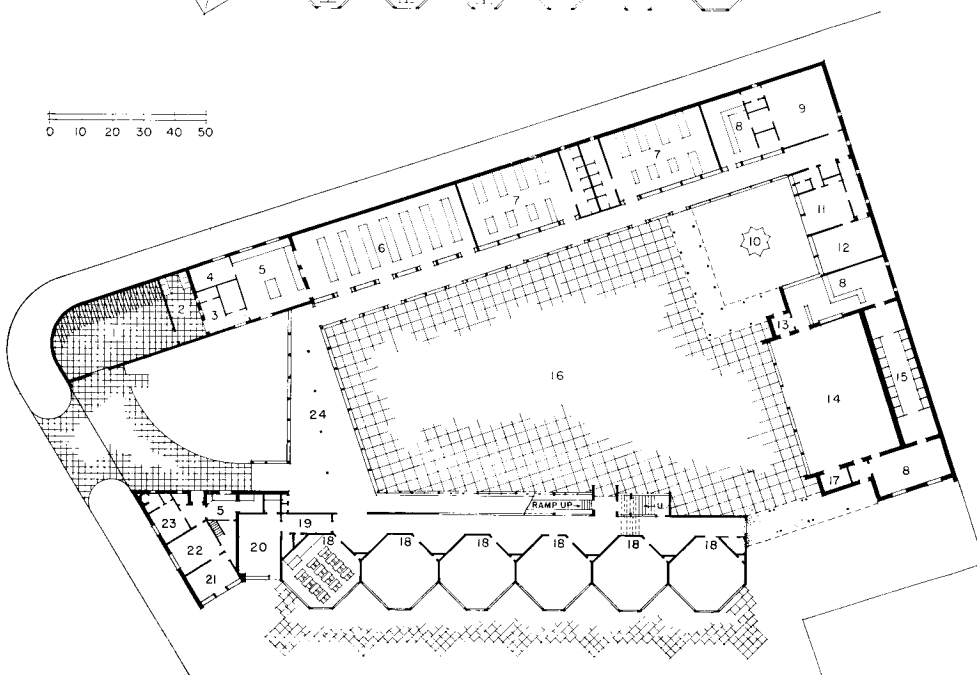
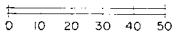

First floor

1. Bicycle
2. Kitchen yard
3. Wardrobe
4. Storage
5. Kitchen
6. Dining room
7. Lavatory
8. Dressing room
9. Light therapy
10. Fountain
11. Nurse
12. Doctor's office
13. Foyer
14. Gymnasium
15. Lavatory
16. Courtyard
17. Equipment
18. Classroom
19. Wardrobe
20. Teachers' room
21. Dining room
22. Living room
23. Master bedroom
24. Pergola

THIS OPEN-AIR school is designed to accommodate 144 children. All of them can eat together in the dining room. The lavatory adjoining the gymnasium is so placed that it can be used

alternately by boys and girls. The dressing-room roof is clear glass for maximum sunlight. The gymnasium is relatively small, but one wall is all glass with door to the playground.



Johnson and Son

RADIANT HEATING COMBINED WITH REVERSE-CYCLE GENERATION

C. E. BOGGS, Designer

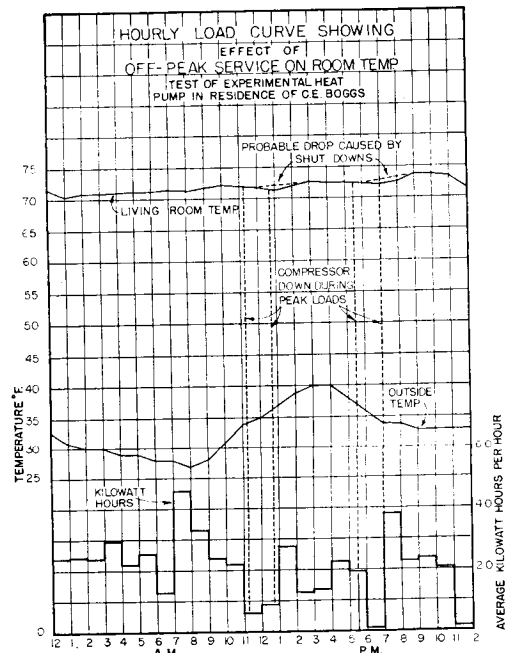

Record of average current expenditures and temperatures during week of Dec. 18 to 24.

IN THIS house in Boise, Idaho, reverse-cycle heat generation has been combined with radiant "panel" heat distribution, probably for the first time outside a laboratory. The house was especially designed to test the system.

The results are said to indicate that the installation cost of an electric heat pump need not exceed the combined cost of heating by fuel-burning equipment and cooling by mechanical refrigeration, under most climatic conditions, and that the operating cost of the heat pump at a rate of one cent per kilowatt hour is approximately competitive with fuel oil at eight cents per gallon.

An unexpected development was the "storage" of heat in the heated walls, by means of which a comfortable temperature was maintained during extended periods of no heat input; a time switch was installed which kept the plant off the line during the power company's peak loads at noon and at night.

It is planned to continue this plant in operation next year, but with an air-circulating fan and condenser coil added, so that a combination of panel and warm-air heating can be sampled. The same plant, with compressor connections reversed, is to be used for cooling the house in summer.

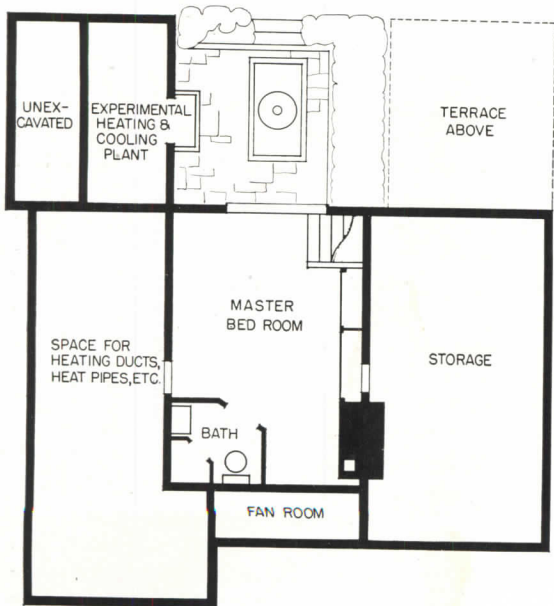

Basement

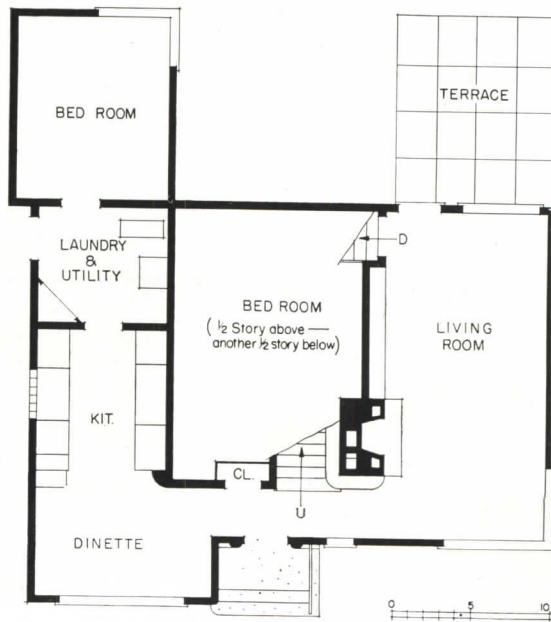

First floor

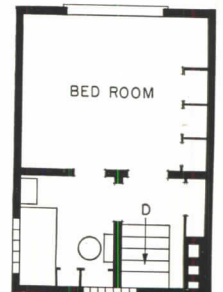

Second floor

HOUSE IN BOISE, IDAHO

A MOTOR-DRIVEN refrigeration compressor is so operated that the cold side extracts heat from 60° water pumped from a well, and the hot side gives up this heat into a network of small copper tubing embedded in the plastered walls of the heated spaces. No fuels are burned; the source of heat is well water. The plant has been in successful use for several months; there have been no operating troubles of any kind, and the effect of the warm walls on the feeling of comfort is said to be marked.

Three types of insulation are used. In walls and ceilings heated by the experimental plant, 3 in. of loose-fill mineral wool were installed, with one ply of aluminum-foil paper facing the interior. The ceiling of the mezzanine floor is insulated with six-ply "Airmet" accordion insulation. All other exterior walls and ceilings are insulated with 4-in. mineral-wool batts. Exterior walls are designed for a heat transmission factor of one-tenth Btu per hour per degree Fahrenheit as against the usual factor of three-tenths.

Electrical, mechanical, and sanitary equipments are conceived to be an integral part of the house design, and not a collection of gadgets independent of the structure and of each other.

Exhaust fans and dishwashers keep the air of the kitchen as clean as that of any other room: therefore no walls between kitchen and dining space, nor between these and living space. A Bendix machine washes clothes daily at the snap of a switch: therefore no big laundry room separated from the rest of the house by basement stairs; the laundry space adjoins the kitchen.

Practically all the plumbing is in one wall. There are nine fixtures, seven of which are served by hot water; no fixture is farther than 12 ft. from the hot-water tank. Water heating is by electricity; hot-water pipe-runs to fixtures are short and all of them are well insulated.

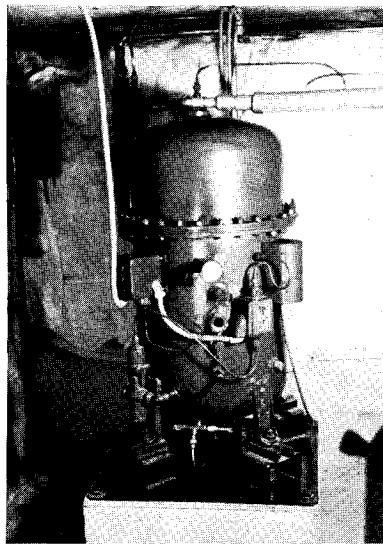

Compressor unit in concrete cell; regular service supplies motor.

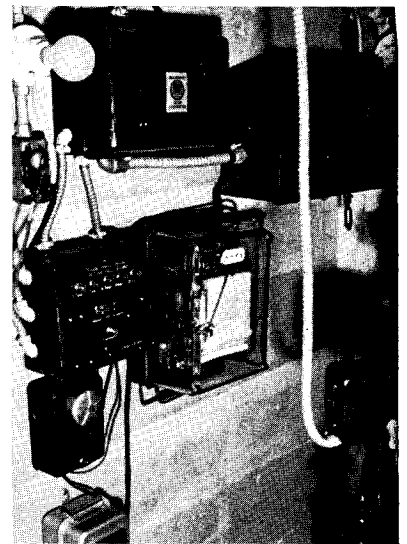

Control and recording test equipment adjacent to compressor unit.

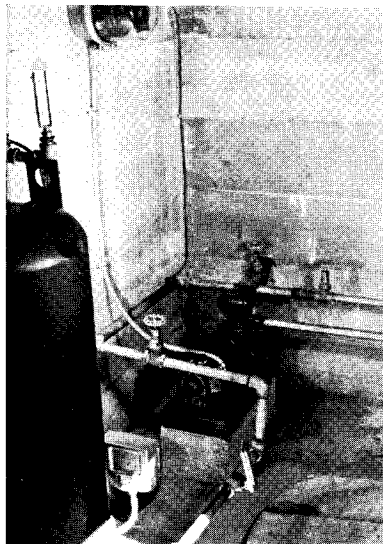

One-third hp. pump which supplies well water to the heat pump.



Panel-heating installation; copper tubing mounted on face of laths.

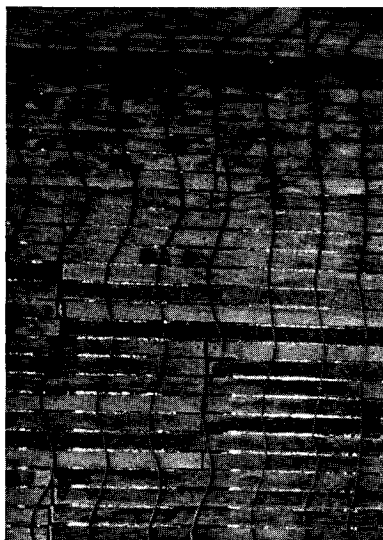

Behind laths, aluminum-foil paper on rock wool reflects heat inward.

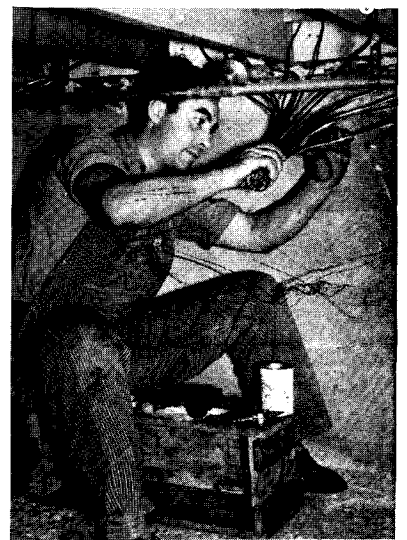

Tubes in clusters are sweated into return headers in basement.

HOUSE IN BOISE, IDAHO

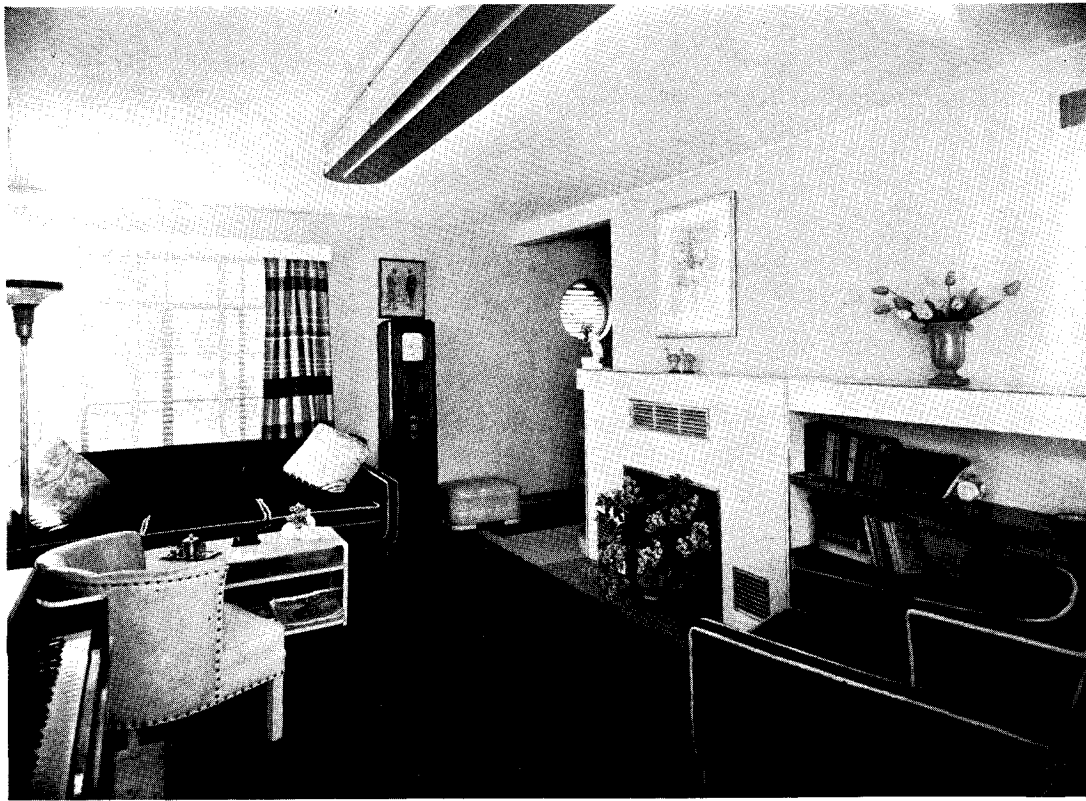

The living room is served by a totally indirect louver type of fixture. In anticipation that the experimental plant might not serve permanently, an air-duct system has been provided, too.



Photos by Johnson and Son

The kitchen is served by enclosed direct light and is equipped with electric range, refrigerator, water heater, combination sink and dishwasher, exhaust fan, food mixer, coffee makers, toaster, etc.

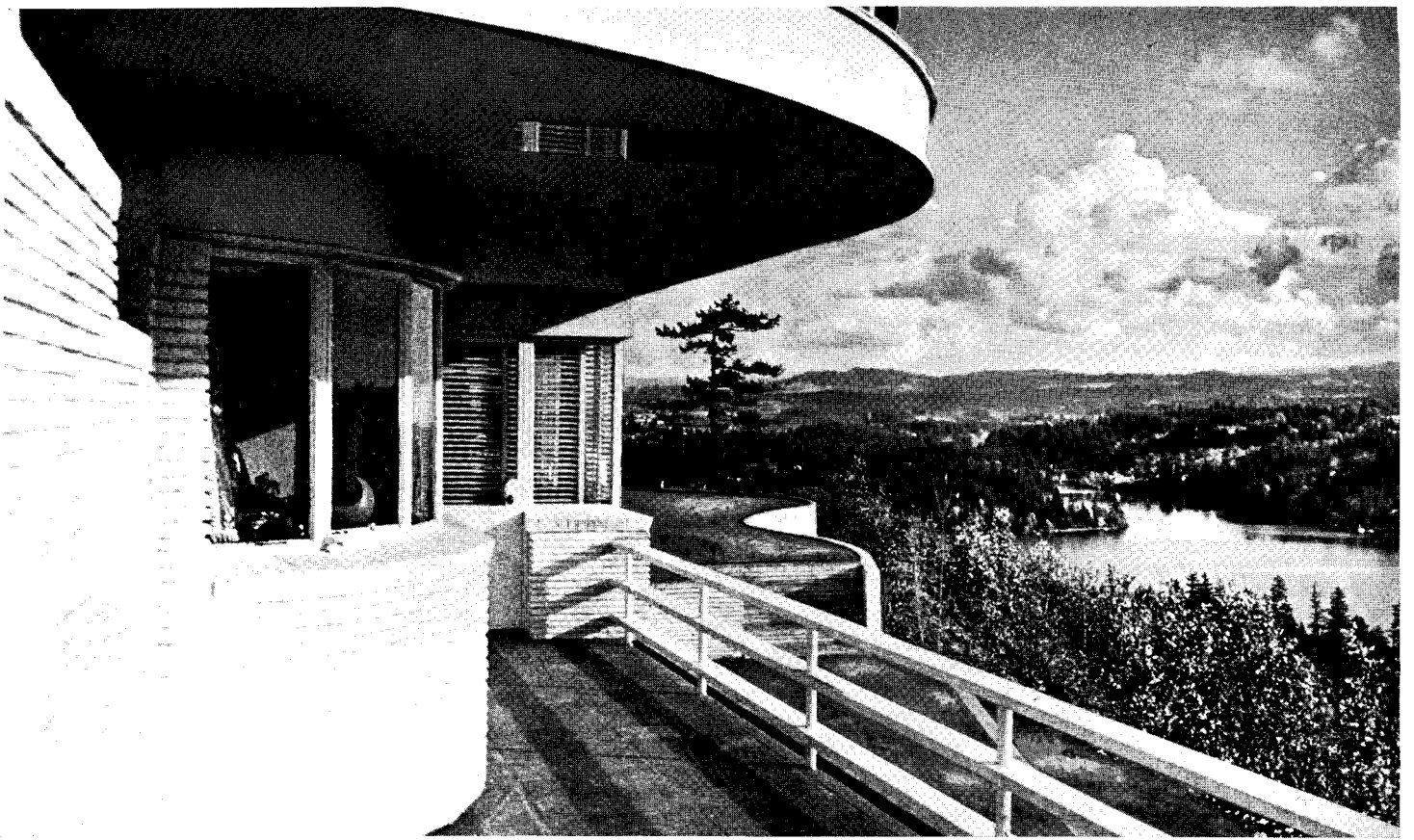

PORTLAND, OREGON: SPLIT-LEVEL HOUSE HAS VIEW FROM EVERY ROOM

VAN EVERA BAILEY

Architect

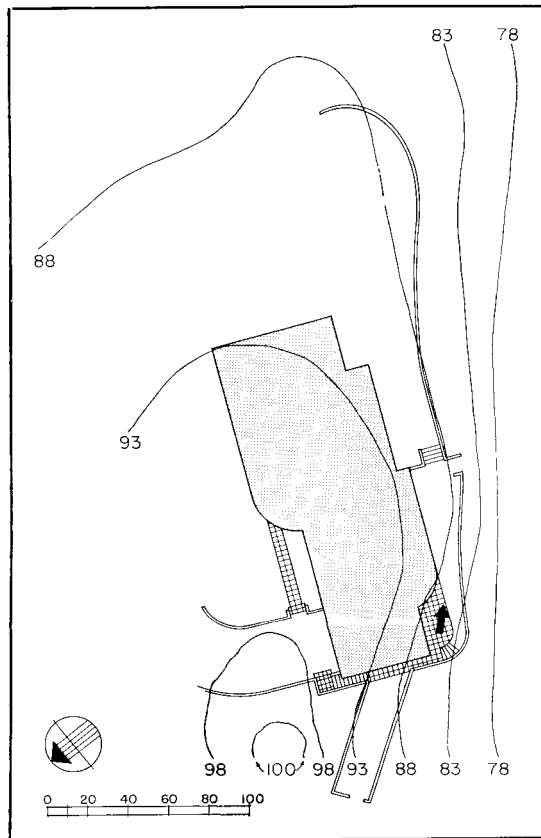

Plot plan (arrow indicates view from deck)

ON A HILL OVERLOOKING Lake Oswego, near Portland, Ore., the residence of Mr. and Mrs. Thaddeus B. Bruno was planned to take full advantage of a magnificent view toward the snow-capped Cascade range of mountains. The house was placed as far back (i.e., toward the lake) on the plot as possible, primarily in order to develop a level front yard; in so doing, the effectiveness of the house as a viewing unit was greatly increased. The main rooms of the house are all situated on the lake side; because the house was designed to fit the contours of the site, each room has access to a deck or terrace. The exterior walls of the house are brick veneer and cedar siding with a matched dividing member, on a wood frame. All sash are steel; windows are casements with bronze screens, except in the living room where plate glass is used. Doors likewise have a steel sash, but are not screened. The cost of the house was \$16,100; the retaining wall cost \$500 additional.

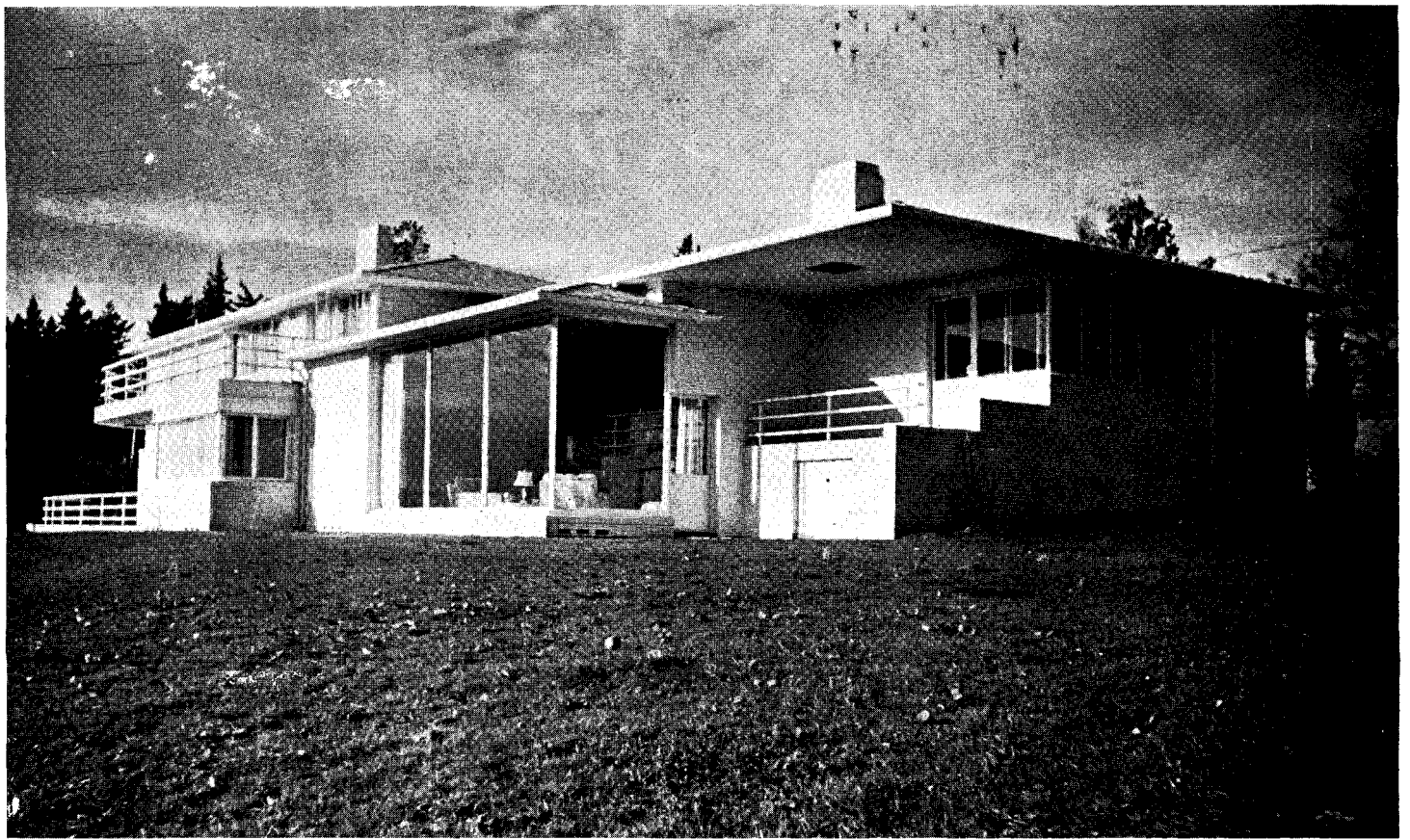

The rear or living-room side of the house provides decks, terrace, and large window areas for full exploitation of the view.

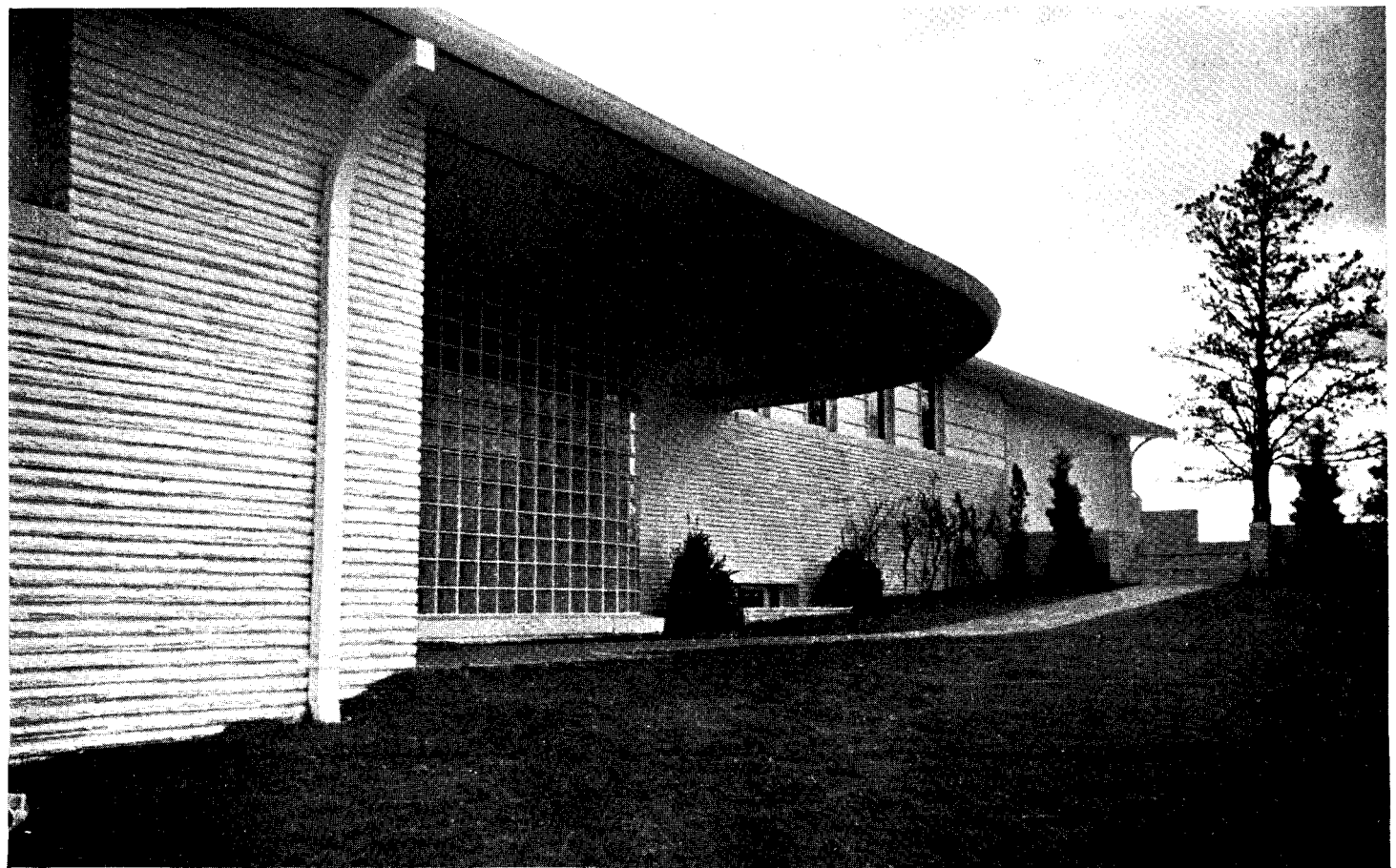

Steps lead from the road at second-floor level to a brick path which slopes gently down, along a natural grade, to the front door.

OREGON HOUSE

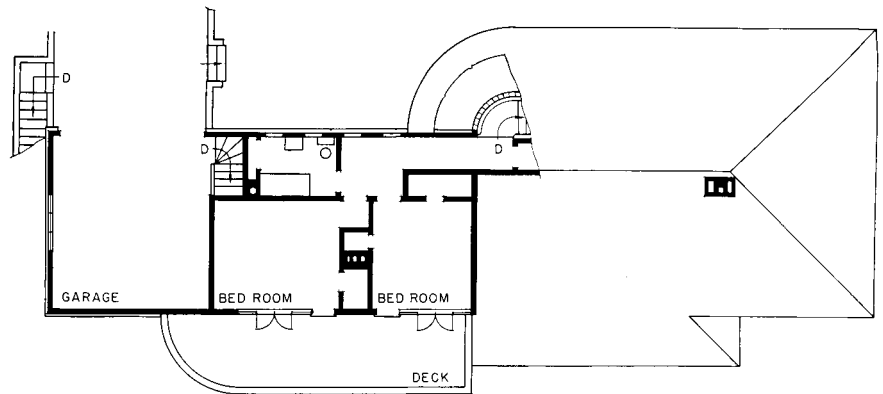

Second-floor plan

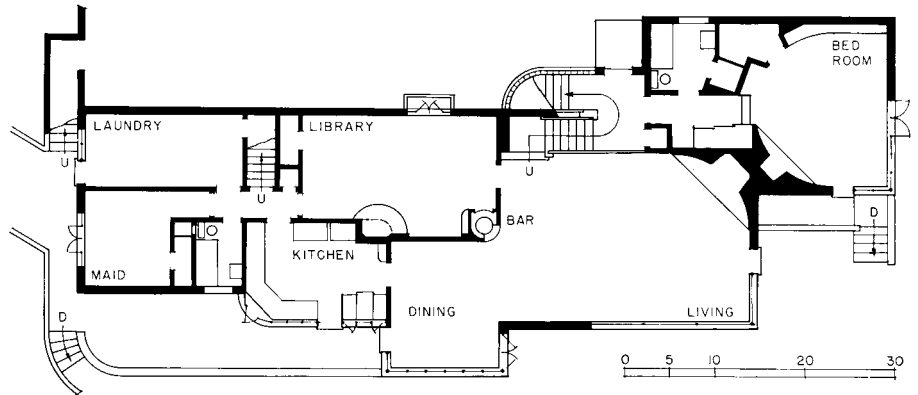

First-floor plan

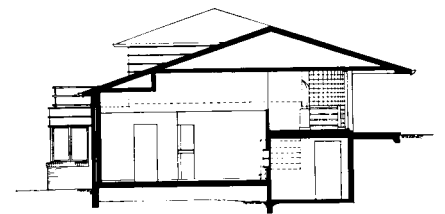

Transverse section

A DIFFERENCE of 9 ft. in grade between the front and rear makes possible this split-level plan. The entrance hall, on the side away from the lake, is on the same level as the master bedroom, but is eight risers above the living-room floor. From the entrance hall, the stairs lead up to the second floor. On this same floor is the garage, which, because of the grade variations, is also level with the road. This particular location for the garage was selected because it was the only point from which there was no panoramic view. Inside steps from the garage lead to the lower floor and connect with the service end of the house. The kitchen and dining room open onto the same balcony; outdoor dining is easily serviced since the kitchen door is a direct means of communication with the balcony. The interior walls of the house are all painted plaster except in the library where horizontal cedar boards, detailed with a tongue-and-groove dividing piece, are used. Windows have plaster jambs with wood stools. Floors are of fir, carpeted; kitchen and bath have linoleum floors with coved bases.

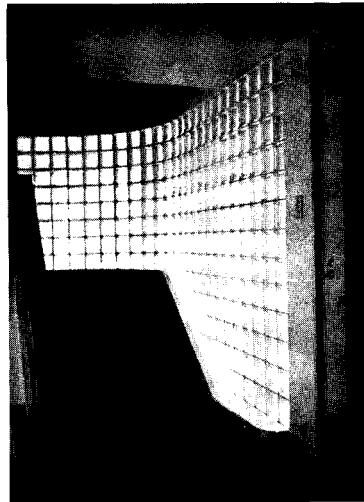
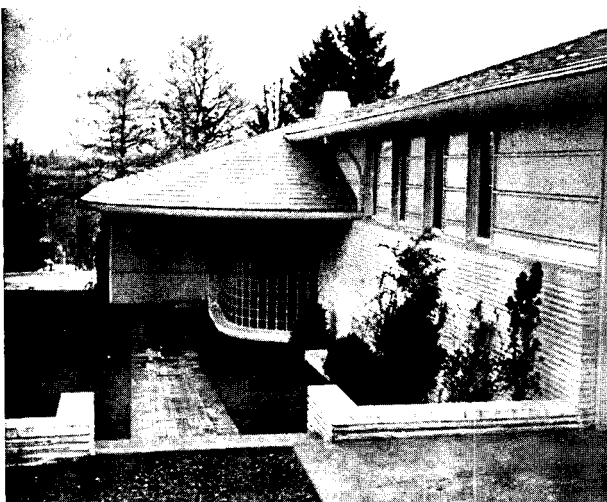

Above, left: view toward entrance; center: entrance and stairway; right: entrance hall showing relation to living room.

OREGON HOUSE



Large plate-glass windows permit a dramatic view, seen here from the entrance hall.

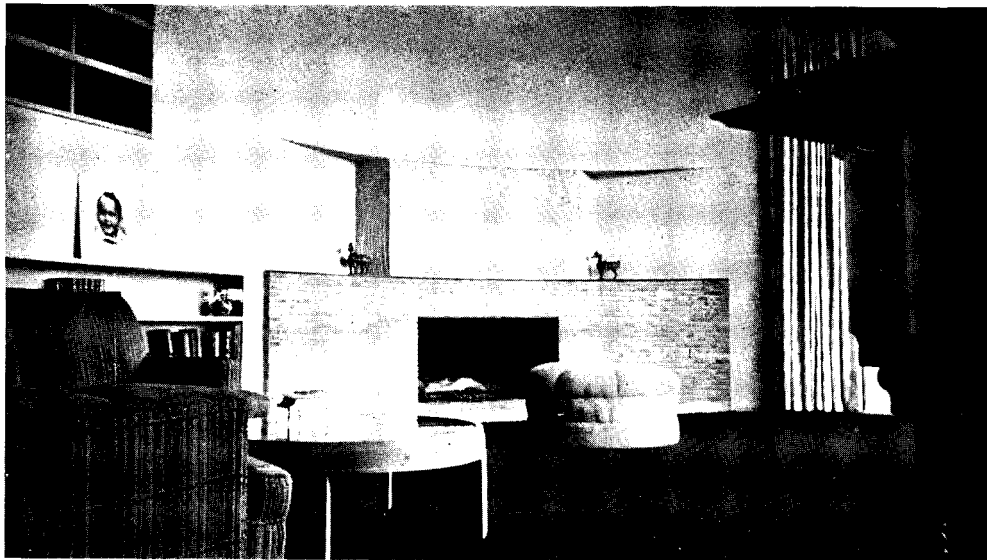

The living room, on a lower level than the entrance hall, is two stories in height.

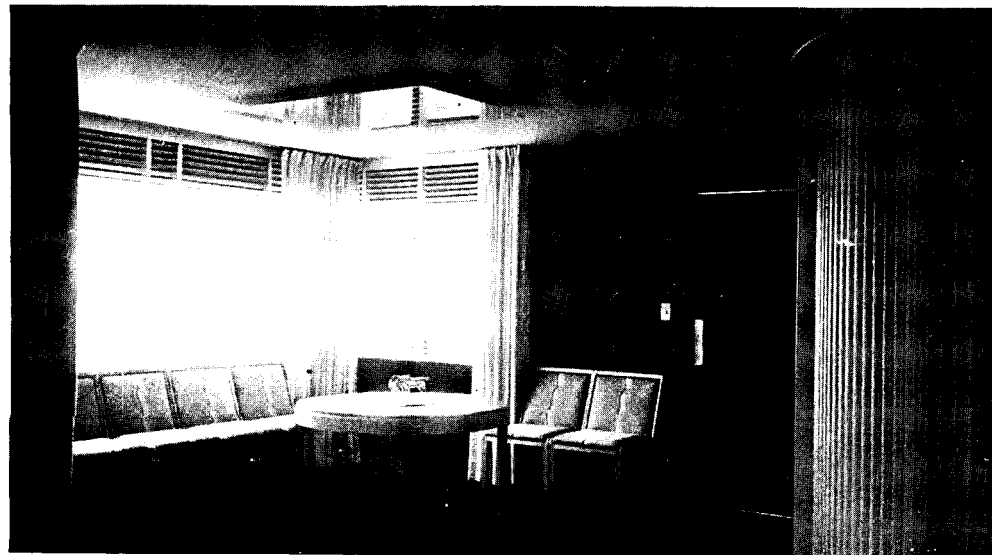

The dining room also takes advantage of the view; at the right is a semi-circular bar.



GRADE VARIATION PERMITS THREE LEVELS IN TWO-STORY HOUSE

WILLIAM J. BAIN
Architect

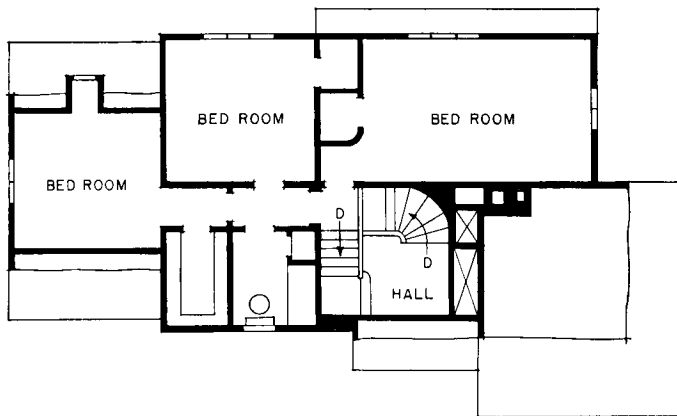

Second floor

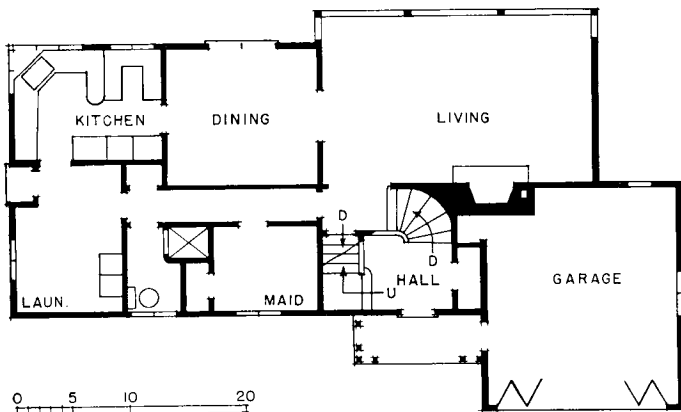

First floor

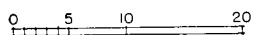

FULL ADVANTAGE of a sloping lot was taken in planning this house at Sherican Beach, Seattle, Wash. Entrance to the house is from street level, but because of the variation in grade, the entrance hall is actually a mezzanine floor. The stair leads down to the living area, and up to sleeping area. Adjacent to, and on the same level with the entrance, is a garage. The main rooms of the house all face the lake. One wall of the living room is entirely given over to windows which open onto a terrace. The exterior is wood framed, with 25-in. hand-split shakes, and 12-in. clear cedar siding, laid 10 in. to weather. Interior walls and ceilings are plaster; floors are oak, except in the kitchen, where they are of linoleum.

Photos by W. F. Roberts



WASHINGTON, D. C.: NOVEL DUPLEX ON TRIANGULAR LOT

H. CUNIN, Designer



BUILT ON A narrow triangular plot (25½ ft. by 115 ft.) in Washington, D. C., this two-family dwelling takes maximum advantage of allowable projections. Because of the proximity of the building line to one of the streets which surround the dwelling, and to obtain the greatest possible amount of sunlight, most of the fenestration is on the Longfellow Street side. The building contains a basement and two independent dwellings. Inclusion of the basement not only gives privacy from passersby for the first-floor dwelling, but provides maid's room, club room, laundry, and boiler room, and, because the lot slopes toward Shepherd Road, a garage at street level. The exterior has a light-red range-brick facing, except around the entrance, where thin slabs of rough rubble stone and glass brick are used. Sound insulation is installed between first and second floors; 4-in. mineral-wool batts are used over second floor for heat insulation.

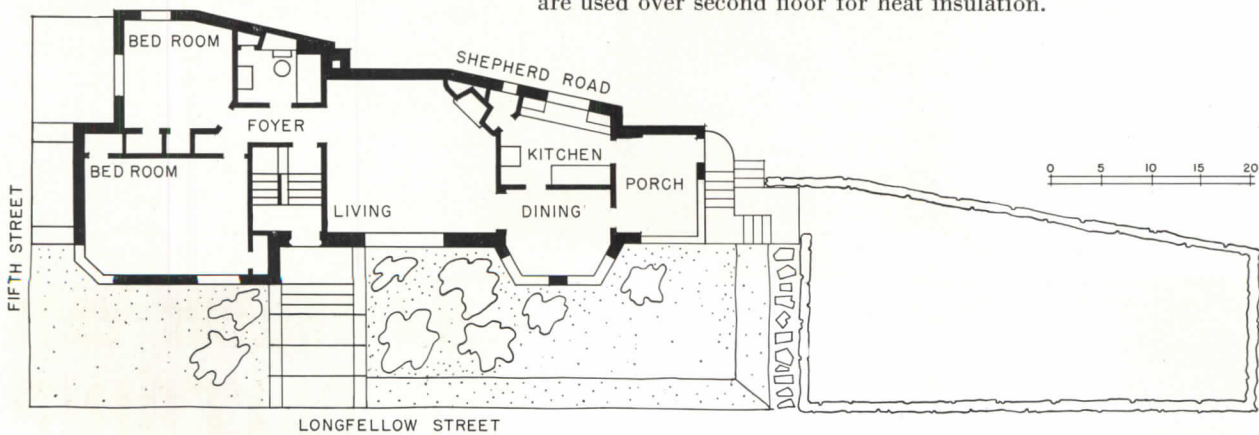

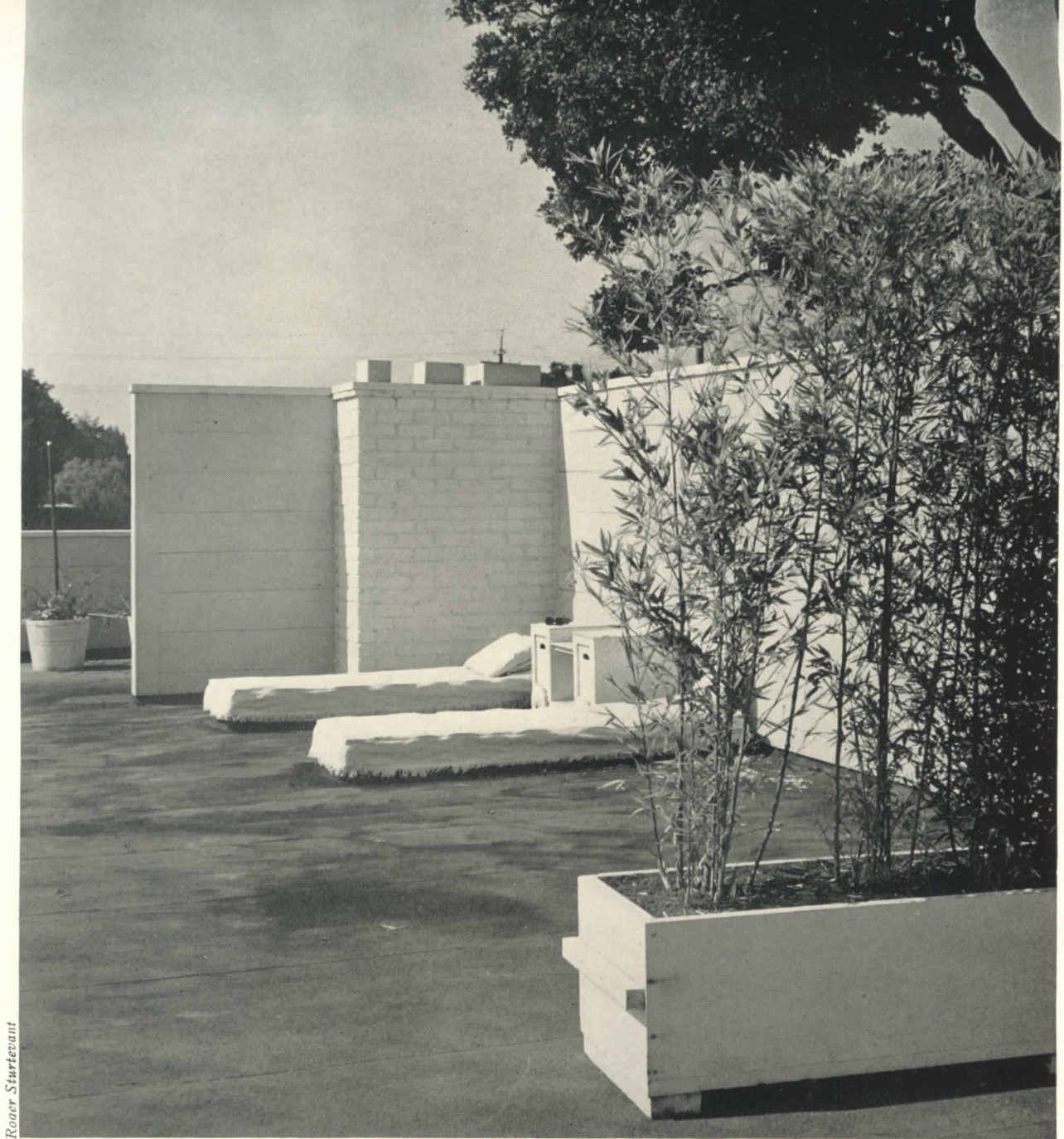

Roger Sturtevant

1. WILLIAM WILSON WURSTER, Architect

ALTHOUGH THE USE of a roof deck is generally limited to sunbathing, its availability as an outdoor sleeping unit is by no means precluded in regions where the climate permits. The deck of this California residence has been equipped with only the essentials: two low beds, with canvas-covered mattresses, and a dresser cabinet. The deck is covered with slate-colored, mineral-surfaced roofing. The redwood wall is warm gray.

NEW DWELLING UNITS SLEEPING

Drawings by Torben Muller

NEW DWELLING UNITS: SLEEPING

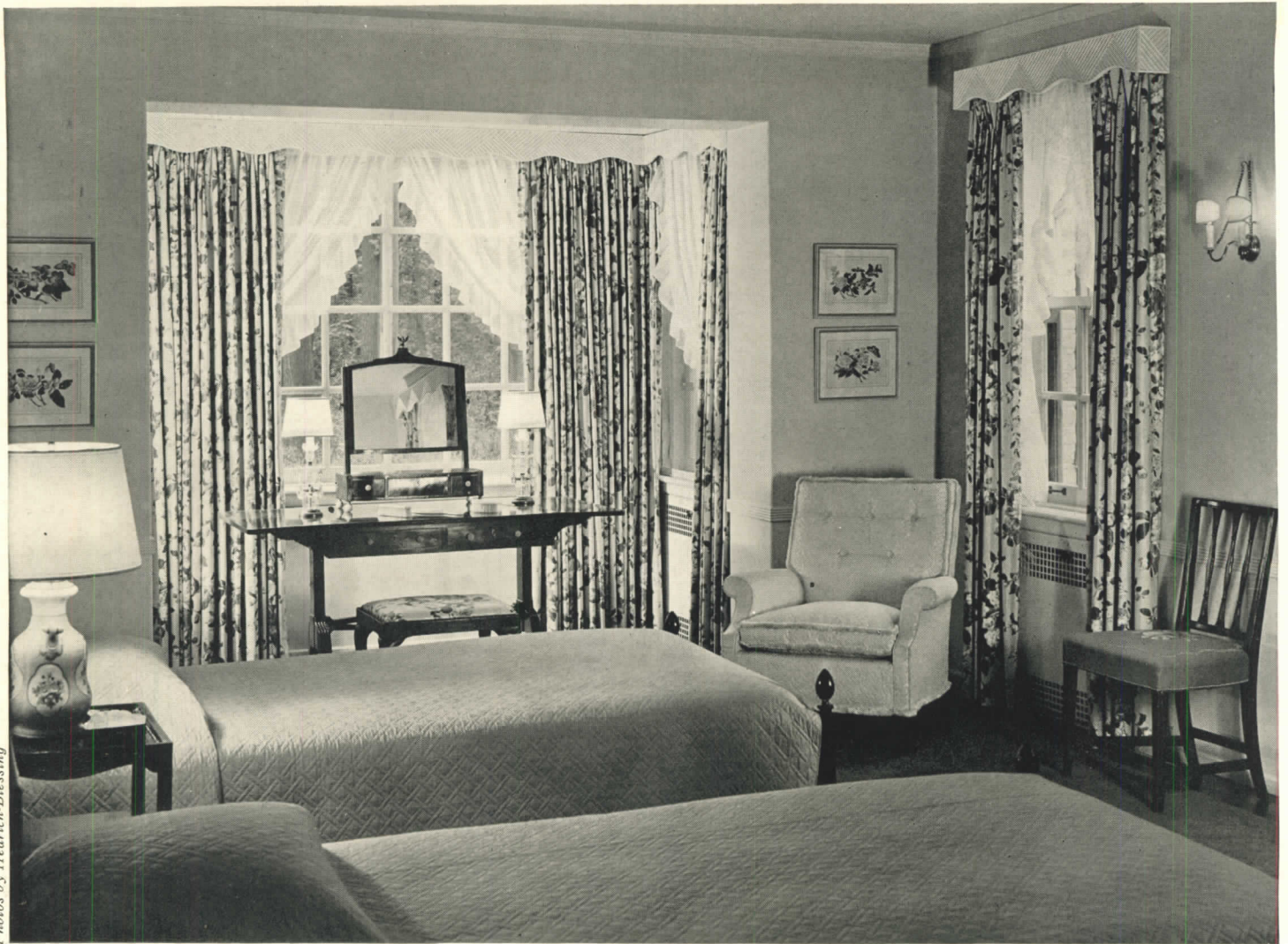

Photos by Hedrich-Blessing



2. ALFRED SHAW, Architect

H. R. WALSH, Marshall Field & Co., Decorator

IN THESE TWO traditionally styled bedrooms the color scheme is built around the colors in the English chintz and linen draperies. The dominant colors in the room shown above are dusty pink, white, and dull green. Walls and bedspread are dusty pink; the carpet is dull green; and the woodwork, including the wood valance, is white. The side chair, dressing table, and bench are Sheraton. At left is another bedroom in the same house; the color scheme here is turquoise and brown. Walls, ceiling, and tufted rug are beige; all woodwork is off-white; bedspreads are turquoise. The chaise longue is covered with the same material used for draperies. The mahogany beds are reproductions of Chippendale ladder-back beds; the chest is a Sheraton reproduction.

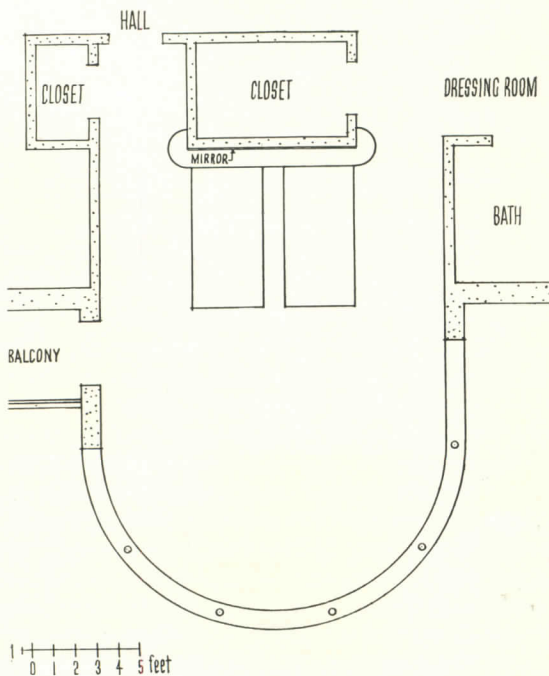

3. ROBERT LAW WEED, Architect

IN THIS BEDROOM emphasis has been placed on the planning: the sleeping unit is centrally located with respect to storage, bathing, and dressing units. With these necessary facilities provided for outside the bedroom proper, this last becomes a clear and uncluttered space. Hence, only a modicum of wall space is required, and one end of the room is given over to a rounded bay window. The reflection of this bay shows in the large copper-backed mirror over the bed. The color scheme is cool, with off-white predominant. Plaster walls and wood trim are off-white; so are the enameled headboard of the bed and most of the furniture. Upholstery on the chairs is coral-colored rough cotton. Venetian blinds are white with green tapes. The linoleum floor is jade green and off-white.

Materials and equipment

Windows: intermediate-weight bronze casements, Campbell Metal Window Corp. Mirror: copper-backed, Libbey-Owens-Ford. Doors: Rezo, cell type, birch, Paine Lumber Co., Ltd. Floor: linoleum, Congoleum-Nairn Co. Headboard of bed: Wirt Fixture Co. Furniture: Modernage. Lighting: lamps, Pitt Petri. Venetian blinds: Sistrunk Venetian Blind Co.

NEW DWELLING UNITS: SLEEPING



Hedrick-Blessing

4. BURNHAM HOYT Architect

THE EXTREME SIMPLICITY of this bedroom is relieved by a strong contrasting color scheme. Focal point of the room is the bed with its dark-blue wooden frame and a head board finished in quilted white-glazed chintz. Walls of the room are plaster, painted dark blue; the ceiling is also plaster, painted a lighter shade of blue. The floor is dark-blue linoleum. Lighting is by indirect fixtures at the windows and by bed lamps.

Materials and equipment

Floor: linoleum, Nairn Sealex, Congoleum-Nairn Co. Venetian blinds: Pella, Rolscreen Co.

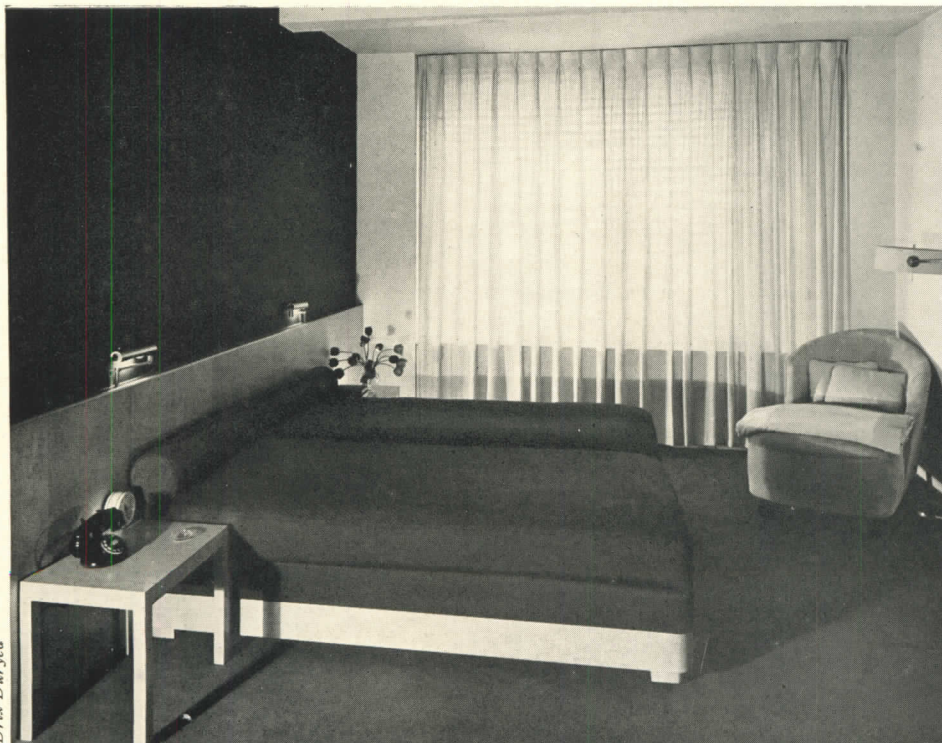

Dirix Durycya

5. JOSEPH ARONSON Designer

THE SAME COLOR scheme was used in this bedroom as in the one shown above, but here the application is reversed. The bed frame, head panel, and bedside tables are natural polished birch. The bedspreads are dark-blue chevron mohair. Ceiling, woodwork, and curtains are off-white; walls are also off-white except above the bed panel where dark blue is used. The carpet is fawn-color. The chaise longue is covered in off-white ribbed linen velvet. Lighting is by specially designed bed lights of brushed chrome and a chrome floor lamp.

Materials and equipment

Curtains: textured silk, Cheney Bros. Bedspreads and box-spring upholstery: F. Schumacher & Co. Chaise-longue upholstery: J. H. Thorp & Co. Carpet: Gotham Carpet Co. Lighting: bed lamps, designed by Joseph Aronson; floor lamp, Nessen Studio.

6. CHARLES HINMAN, Architect
ROBERT BOONE, Decorator

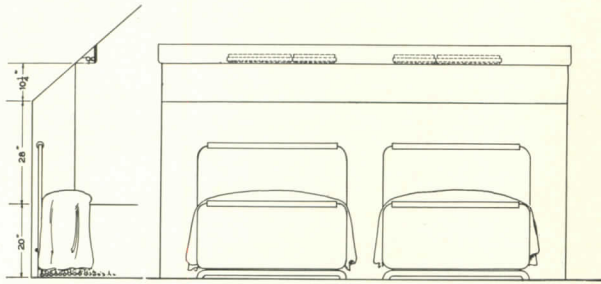

OF PRIME INTEREST in this room is the lighting. Concealed behind the wooden valance over the beds are four lumiline lights, each with its own metal reflector. Silent switches within easy reach of the beds control these units. Walls are papered in plain peach; the ceiling is in the same color. The carpet is in three shades of fawn with a self-figure. Beds are of bleached maple with stencilled decoration.

Materials and equipment

Lighting: designed by General Electric Co.; plug-in strips, National Electric Products Corp.; central fixture, Lightolier Co.; floor lamp, Excelsior Art Studios. Furniture: bed and table, W. & J. Sloane Co. Carpet: Bigelow-Sanford.



Photo and drawing courtesy General Electric Co.

7. J. R. DAVIDSON
Designer

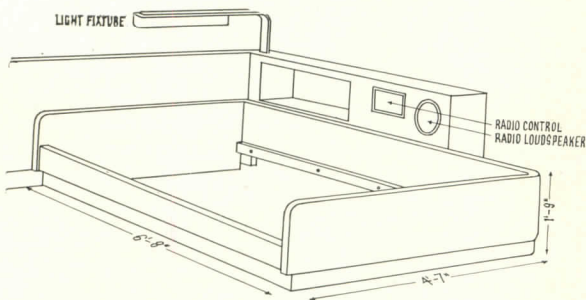

THIS BUILT-IN sleeping unit is in bleached birch and consists of bed frame, book shelf, and radio. The specially designed lamp is satin-finish chrome with a translucent white plastic shade. Walls are covered with painted canvas. The table has a natural duralumin frame and transparent plastic top.

Materials and equipment

Bed: made to specification by Soule Manufacturing Co. Carpet: "Pebbleweave," Chas. P. Cochran Co. Walls: canvas, with three coats of paint, Oakley Paint Co. Lamp: frame, Hollywood Lighting Fixture Co.; Formica shade, Formica Insulation Co. Table: frame, Hollywood Lighting Fixture Co.; top, Lucite, E. I. DuPont de Nemours and Co.

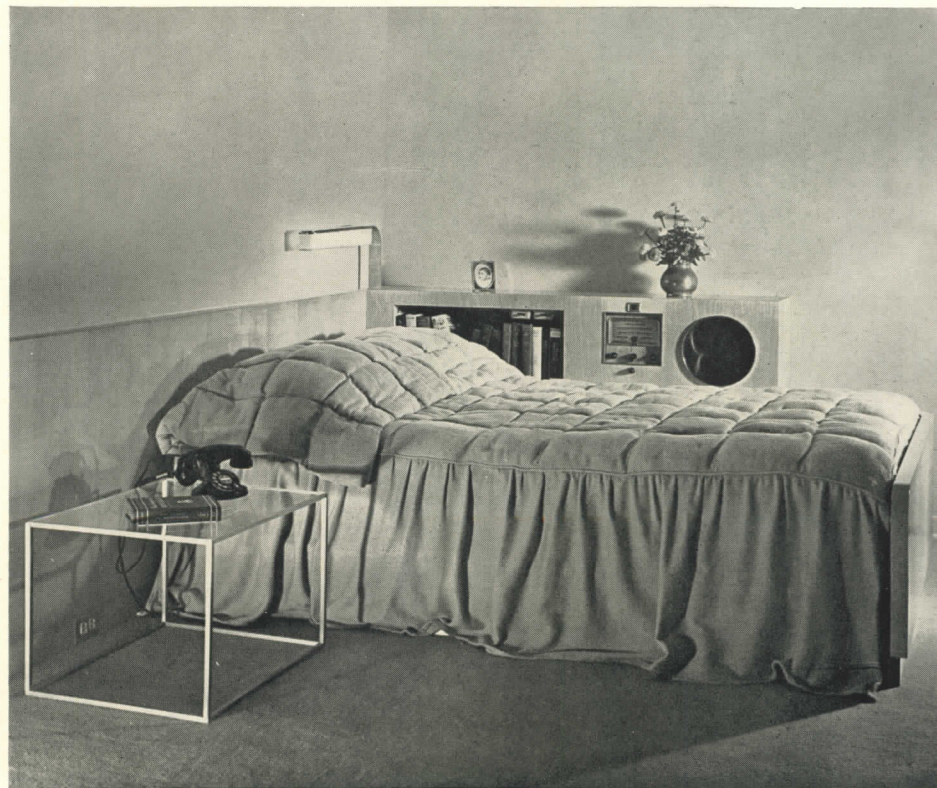

Ernest Ludewick

NEW DWELLING UNITS: SLEEPING

Robert M. Damora

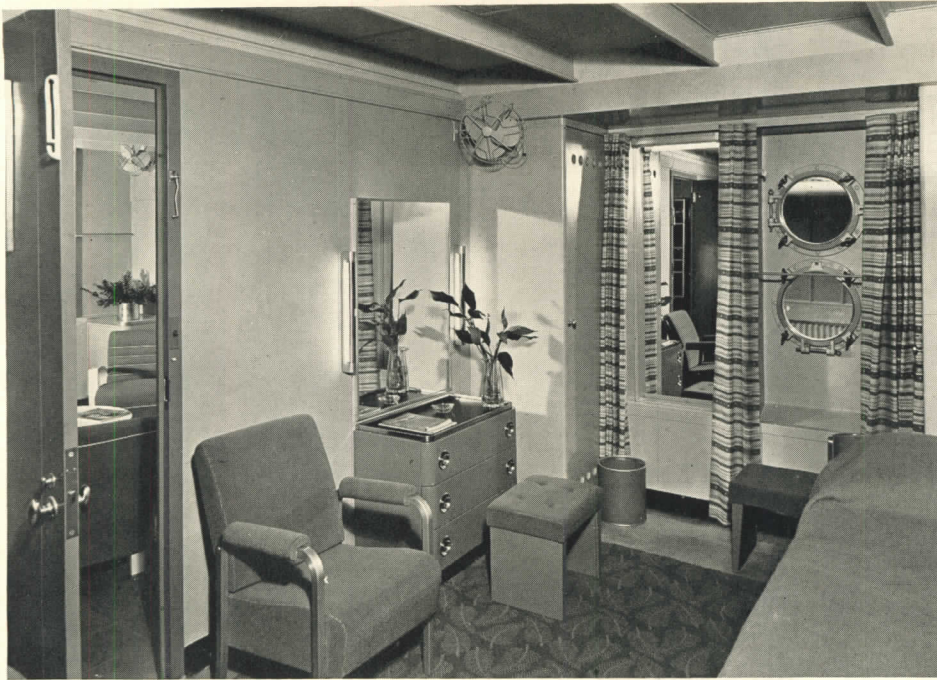

8. RAYMOND LOEWY Designer

THIS STATEROOM on the recently completed S. S. "Panama" makes maximum use of minimum space. Since the ship is in tropical service, the color scheme is cool: walls are light blue; ceiling is pale yellow; carpet is a neutral color. The furniture is metal, enameled in blue gray, with stainless steel trim. The combination vanity and dresser is built-in; its top is of black plastic.

Materials and equipment

Furniture: made to specification by General Fireproofing Co. Lighting: tubular, wall lights and special lamp over bed, The Dayton Manufacturing Co. Mirror: Pittsburgh Plate Glass Co. Dresser top: Formica Insulation Co. Carpet: Karagheusian Co.

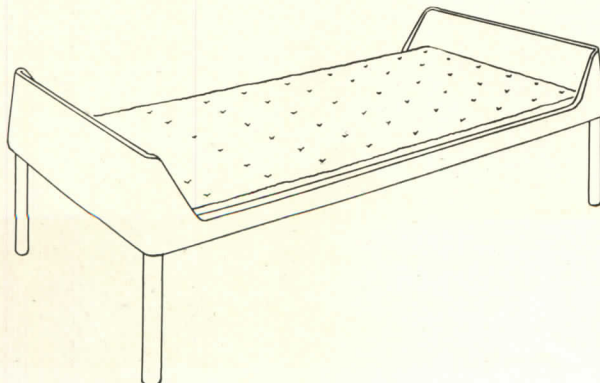
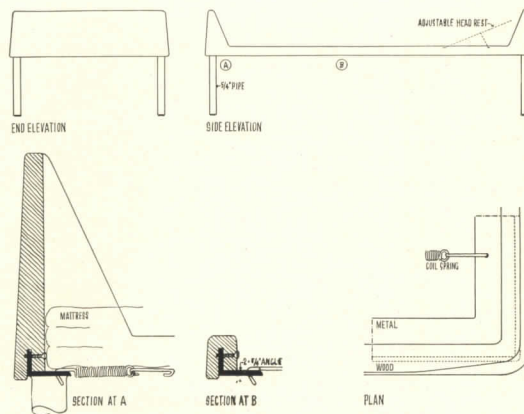
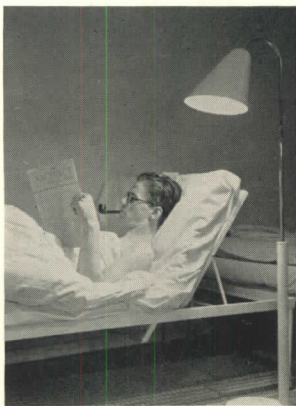

9. TORBEN MULLER Architect

IN DESIGNING this bed, the materials selected were used according to function: where strength was needed, iron was used; where comfort was the consideration, wood—a material which is neither hard nor cold to touch—was used. The frame is consequently a combination of 1 1/4-in. welded-pipe legs, 2 by 1 1/4-in. angles, and wood side, head and, foot boards. One end of the bed is adjustable so that pillows are unnecessary.

10. RITS VAN WITSEN
Architect

THE UNUSUAL grain of the wood veneer in this room centers interest on the sleeping unit itself. The head and foot boards are veneered with sapoli mahogany, the grain of which is rich brown and gold in color. The frame of the bed and trim of the built-in night table at right are black cuba mahogany. Set flush in the top of the headboard are two light bulbs whose frosted-glass covers give diffused illumination. Walls of the room are papered in light blue. The floor is covered with natural-color twisted matting; one of the two handwoven rugs is white with a yellow pattern; the other is blue with red.



11. EUGENE AND LEE SCHOEN
Designers

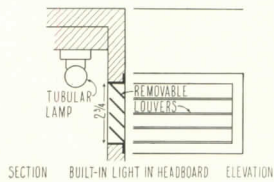

THE PARTICULAR feature of this bedroom is the integration of electrical services in the common headboard of these twin beds. The louvered panel over each bed contains a lumiline light (see detail); the louvers direct the light so that only one bed is illuminated. The central tambour panel contains the dials for both long- and short-wave radio; the loud speaker is at one side of the bed. Telephones are in the cabinets at the side of each bed.

Materials and equipment

Carpet: chenille, champagne-colored, Mohawk Carpet Co. Furniture: white enameled wood made to specification by Schmiegl and Kotzian. Fabrics: Stroheim and Romann. Upholstery and drapery: Lancaster Furniture and Drapery Shop.



NEW DWELLING UNITS: SLEEPING

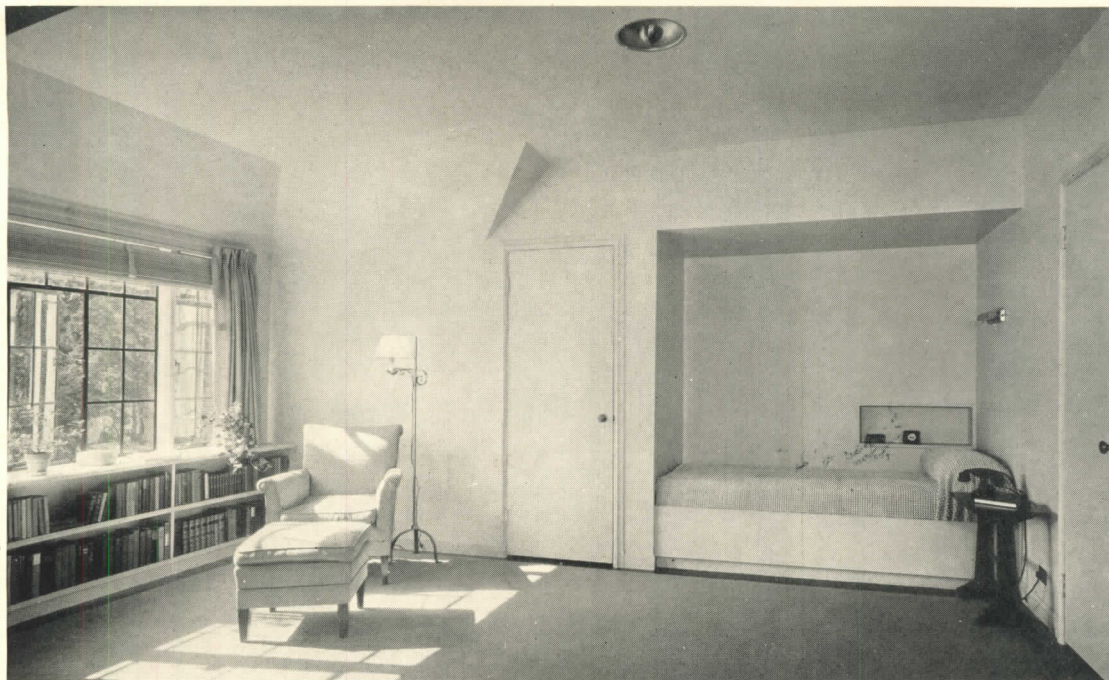

Rollin W. Bailey

12. SAMUEL GLASER, Architect

ALTHOUGH AN INTEGRAL part of the room, this sleeping unit, by reason of its location in a recess, is actually quite isolated. The bed has a built-in wood frame which is painted light orchid. Plaster walls and woodwork are also light orchid. Draperies are orchid and blue

taffeta; chairs are upholstered in blue. The carpet is light gray.

Materials and equipment

Windows: steel casement, Detroit Steel Products Co.; glass, Libbey-Owens-Ford. Lighting: recessed ceiling fixture, Kurt Versen.



Hedrich-Blessing

13. HOLABIRD & ROOT Architects

THIS SLEEPING UNIT has a double function as it is designed to be a davenport during the day. Fastened to the wall along the back and head of the davenport are leather-covered bolsters built up of pillow springs and hair padding. The footboard is of solid walnut and is the same height as the bolster. The seat is a comfortable depth for lounging. When used as a bed, box spring and mattress pull away from the wall by means of a patented device so that the bed is entirely free of the bolsters. A two-sectional panel provides an individual headboard: the lower section is fastened to the box-spring frame, and the upper section is hinged to the lower panel. Sliding metal bars secure the board.

Materials and equipment

Furniture: made to specification, Garland Furniture Co. Carpet: Bigelow-Sanford.

DESIGN TRENDS



Acme

Air Conditioning Mt. Palomar observatory. Between inner and outer aluminum-plate walls is a 4-ft. plenum chamber.

ARCHITECTURAL
RECORD



Photo by Joseph Molitor, courtesy Anemostat Corp. of America

Office of American Airlines. Harrison & Fouilhoux, Architects. Anemostat is combined with trough lighting.

AIR CONDITIONING AND BUILDING DESIGN

AIR CONDITIONING begins with building structure: for it is useless to produce a given set of atmospheric conditions if the building will not hold them. Moreover, for increased uniformity of atmosphere in a given space, the design of rooms, their size and shape, may be influenced by air-conditioning requirements. The performance of other operational systems within buildings affects and is affected by the air conditioning: the heat generated by lighting fixtures, the use of water and sewer facilities by the air-conditioning plant, the sound vibrations generated by it—these are problems of integration for the building designer.

Changes or improvements in one system imply compensating changes in other systems: for example, improvements in thermal insulation and the increased use of equipment which raises normal humidity have exaggerated the problem of condensation within walls; similarly, the recirculation of cool air through a building may increase the bacteria concentration and so emphasize the necessity of controlling air-borne bacteria.

The ducts of air-conditioning systems often require more space than is readily available. Partly for this reason, the use, in central-station systems, of large refrigerating machines to supply a cooling medium to several air-handling units, remotely located, is increasing; by using a number of small units instead of one large unit, zone control of conditions is simplified, large main ducts are avoided, and return-duct systems are reduced. These advantages are also obtained by the use of portable, self-contained units. On the other hand, integration with structure—the use, for example, of perforated ceilings for the induction of air—is increasing too.

Atmospheric control for “industrial conditioning” as well as for “comfort conditioning” becomes increasingly important. Precision in production implies precision control of the atmospheric conditions in which manufacturing operations are carried on. For example, the 8-ton gears to be used for training the giant eye of the 200-in. Palomar telescope are ground under temperature conditions which do not vary more than $\frac{1}{2}^{\circ}$ in 24 hours; if this were not done the very precise spacing of gear teeth which is required would not be obtainable; teeth gashed in a colder part of the metal, for instance, would be too wide after subsequent normal heat expansion.

In agriculture, climate is obviously a prime factor. The use of air conditioning in growing mushrooms, in curing hay, etc., may suggest the possibilities in this direction.

Air conditioning has recently been used—reportedly with success—in the treatment of arthritis and rheumatic fever, asthma, sinus and middle-ear infections, pneumonia, high blood pressure, kidney and heart diseases. As a result of this apparently successful use of air-conditioning therapy, Dr. Albert G. Young of the Corey Hill Hospital in Brookline, Mass., has proposed a new building type—air-conditioned schools for children suffering from such diseases as rheumatic fever, asthma, and hay fever.

The study on the following pages deals with the control of air distribution, temperature, and humidity, and the relation of such control to building design. A report on air purity, in next month's RECORD, will complete this study of air conditioning.

Acknowledgment is made to the following sources: A. L. Greenlaw, Tuttle & Bailey; Lee P. Hynes, Engineer; Professor C.-E. A. Winslow, Yale University; Margaret Ingels, Carrier Corporation; Charles S. Leopold, Engineer; Peter Cable, General Motors; R. B. Derr, Aluminum Co. of America. But specific statements are not to be attributed to any one person unless it so noted.

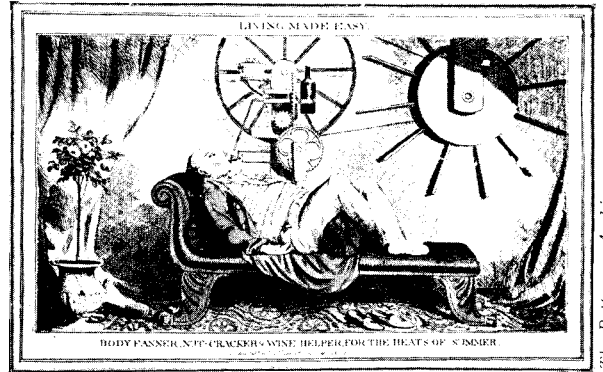

The Bettmann Archives

Air conditioning with improvements: a satirical forecast of "comfort conditioning," made about 1830.

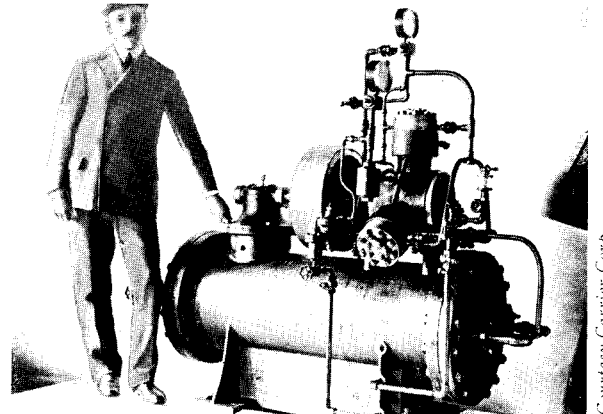

Courtesy Carrier Corp.

A 3-ton compressor unit of 1901; today's compressors occupy about 1/6 the space of this machine.

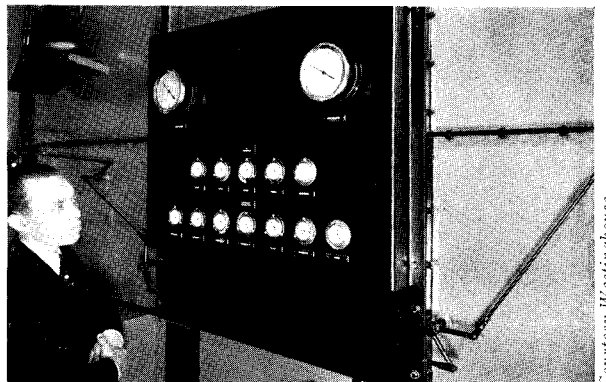

Courtesy Westinghouse

Today's systems may be precision-controlled: above, a gauge panel of a "refrigerated-heat" unit.



California Citricograph

Atmospheric control in the out-of-doors: above, heating an orchard to avert damage by frost.

Control of Air Temperature and Humidity*

IN MOST occupied buildings, the control of heat loss from the human body is the major objective of heating and ventilation.

The first basic fact is that the body, under given circumstances, produces a definite amount of heat and that the environment must be so adjusted as to carry off this heat fast enough but not too fast, so that the human machine can maintain normal body temperature.

However, the environmental comfort zone is by no means a fixed and definite one. The desirable environment, from the standpoint of heat loss, depends directly on the heat produced in the body and this heat may be five times as great when a man is exercising violently as when he is reclining and at rest. Furthermore, the weight of clothing worn is a vital factor. Thus, with moderate relative humidity and minimum air movement, an air temperature of 80° F. has been found ideal for the lightly clothed subject at rest in a reclining position. In factories where light work is performed in summer time, the ideal has been found to be about 76°. For children (who have a high metabolism) at school, in winter clothing, 70° has been considered correct; while in a gymnasium, 55° is desirable.

For simplicity, we have been speaking of air temperature alone. It is, however, of the first importance to remember that this is only one of the four distinct factors which govern heat loss from the body. These four factors are the temperature, the movement, and the relative humidity of the air, and the mean radiant temperature of surrounding surfaces. So long as the air temperature is below that of the skin, air movement will increase heat loss by convection; and even when the air is warmer than the skin, air movement will still increase heat loss by evaporation. The effects of radiation are less generally recognized; but it is a fact that—irrespective of any atmospheric influence whatever—the body is constantly losing heat by direct radiation to surfaces cooler than itself. In experiments at the Pierce Laboratory, it was found that reclining subjects were well adjusted and comfortable in air at 50° F. if radiant heat equivalent to 110° was reflected toward them from surrounding copper walls. In a room

with cold walls and window area, air temperature may be a wholly fallacious measure of comfort.

From the standpoint of winter heating, air temperatures and wall temperatures are the two problems that must be solved. The maintenance of comfortable conditions in the dwelling in winter obviously depends on two factors—heat production within the building and heat losses from the building. The latter factor has, in the past, received far less attention than it deserves.

The building designer must be specifically mentioned because consideration of this problem begins with structure. A primary factor which materially affects heating is the orientation and fenestration of the building with respect to the absorption of radiant heat from the sun. Henry Niccols Wright recently changed the orientation of the same one-story house (in a laboratory model) from a position in which these rooms (with rearranged and slightly increased fenestration) faced west of south. This change decreased average summer-sun heat to one-ninth and increased average winter-sun heat to four times its value with the original orientation.

Furthermore, it is of fundamental importance that initial consideration should be given to the problem of heat insulation. Recent studies have shown that good insulation in walls and roof may cut down heat losses by one-half. Next, of course, comes the choice of a heating system adequate to maintain air temperature at 70° at knee height under all but the most extreme winter conditions. Here we have today the choice between various forms of convection heating, the use of free-standing radiators, and radiant heating by low-temperature surfaces in wall, ceiling, and floor. An important, but generally neglected, consideration is the degree with which a given heating system maintains uniform vertical temperatures throughout a room. In many crude installations there is a 30° differential between floor and ceiling, while with proper insulation and a high proportion of radiant heating, this differential may be cut down to less than 5°. Such a low differential is not only conducive to health but is of great importance in reducing heat loss from the upper parts of the room, thus effecting fuel economy. From this standpoint, the aim should be to provide heat at a low temperature from the largest possible surface.

In the ordinary dwelling these are the only considerations of importance with

regard to the thermal control of the indoor environment. In schoolrooms and commercial and industrial establishments where a large number of persons are present, the heat produced by the human body comes into the picture, and to remove this heat we must rely upon air change. In very large offices, workrooms, and auditoriums, the only recourse is the use of plenum fans (perhaps supplemented by fan exhaust) to furnish an adequate supply of tempered air to carry off the heat produced by human bodies without objectionable draft.

Our other problem is that of keeping air-occupied spaces cool in summer. The physiological responses of the body under conditions warmer than the optimum are quite different from those which are manifest in the cold zone. Here, the major defense of the body is evaporation, and the secretion of sweat is delicately adjusted to maintain thermal equilibrium over a considerable range of environmental conditions. This type of adaptation—while thermally effective—is accompanied by a marked sense of discomfort; and it has a rather sharp upper limit beyond which the sweat runs off without evaporating and exerting its cooling effects upon the body surfaces. For the lightly clothed body, at rest in a semi-reclining position, this limit is reached at 127° in perfectly dry air and at 88° F. with air completely saturated with moisture.

In this zone the relative humidity of the atmosphere is of prime importance, along with air temperature, air movement, and wall temperature. There is no very practical method of cooling walls, but summer comfort can be promoted by modifying either one of the other three factors involved. Orientation and insulation are as important in the exclusion of summer heat as in safeguarding us against winter cold.

Where a complete plenum system is installed, dehumidification of the air supply will go far to provide a comfortable atmosphere, or, finally, the temperature of the air may be reduced to any desired degree. In connection with the latter procedure, one should note the danger of overcooling. Real injury to health must have resulted from the very sharp contrast between air-conditioned trains and the outside atmosphere in the early days of this practice. The ASHVE Guide suggests that with an outdoor temperature of 95°, indoor temperatures should not fall below 80°; at 90° outdoors, the differential should be only 12°; at 80° outside, only 5°.

*C.-E. A. Winslow, Professor of Public Health, Yale University.

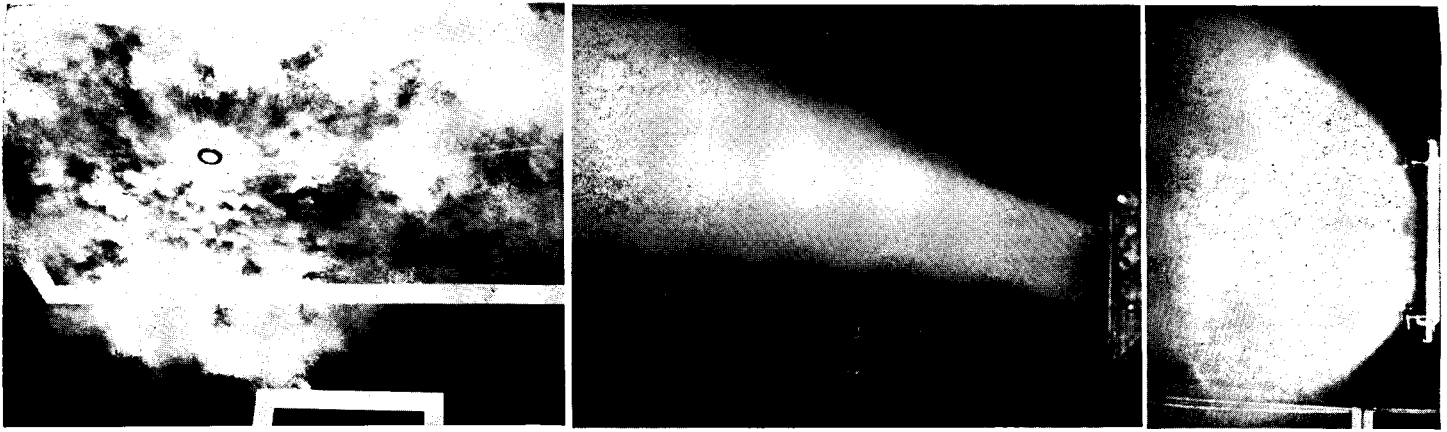

Smoke test shows path from ceiling outlet. . . . from straight-flow grille; air is deflected upward . . . from fan-type grille.

Control of Air Distribution*

THE FINAL objective in any air-conditioning problem is maintenance of a predetermined atmospheric condition within an enclosed area. This may involve the control of temperature, humidity, air motion, or any of the other factors affecting the physical or chemical properties of the air. There may be many theoretical methods of arriving at any final room conditions, but at present it is the general practice to treat a predetermined quantity of outside, or recirculated air, or a mixture of the two, and then blow it into the room; after it has mixed with the air already there, the desired results will be produced.

It can be seen, therefore, that the manner in which this treated air is supplied to the room plays a vital role in bringing about the desired conditions. It must be supplied so that it will mix properly with the room air to produce uniform conditions, and at the same time its energy must be dissipated so that there will not be excessive air motion in the inhabited areas.

The problem of maintaining a uniform humidity throughout a conditioned area is relatively simple from a distribution standpoint. The humidity or water vapor in the air is really a gas under partial pressure; and since from Dalton's law, gases under partial pressure act as though no other gases were present, the partial pressure of the water vapor in the room air will quickly equalize. In other words, the water vapor in the supply air will not have to be actually distributed throughout the enclosure. Upon leaving the duct it will expand and thus compress the vapor already present in the room, until the

vapor pressure reaches a state of equilibrium. With humidity, then, there is not a problem of distribution but merely one of supplying or removing enough moisture to keep the partial pressure at the desired level.

Getting a uniform temperature and the proper air motion within a room is, however, considerably more of a problem than just supplying the proper amount of air at the proper temperature differential. The supply and room air must be actually mixed. Temperature is really the measure of the activity or the energy in the molecules; the more active the molecules, the higher the temperature. To cool a room, then, cold or less active molecules must be brought in by the supply air and actually mixed with those already present so that the average energy in the mixture will be decreased and, consequently, the temperature lowered.

There may be several other factors—such as cleaning the air and removing smoke or odors—which must be considered in conditioning the supply air. But from a distribution standpoint, all of them can be reduced to either a problem of mixing the supply air or of supplying the proper amount. Therefore, when the problem of getting a uniform temperature and proper air motion is solved all the other conditions will be automatically met.

The supply and return are the only external sources of energy for agitating the room air, and of these, the supply seems to be the only one that has any appreciable effect. The return apparently acts merely as a pressure relief, and there is no noticeable room-air motion set up by it. Temperature studies

made in heating tests indicated that the return could be placed in any part of the room, or in any one of several interconnecting rooms, with the same results. Practically every conceivable location was tried, and the temperature conditions did not vary more than one-half a degree with any of them. That is, if the difference between the ceiling and floor temperature were 5° with one location, it might be $5\frac{1}{2}^{\circ}$ with another. A velocity study made in front of a return handling 1,000 cfm. at a velocity of 2,500 ft. per minute indicated that a foot away the velocity was only 100 ft. per minute and at two feet, it was below 50 ft. per minute. It can be seen then that the air motion set up by the return is extremely localized and even then is very slight. Smoke tests are sometimes misleading in showing the apparent effect of returns. When smoke is blown into a room it often indicates that there is a definite air motion toward the return. It is immediately concluded that the return is pulling the air, when as a matter of fact the air currents would take that same path if the return were not there. It would, of course, be absurd to place a return where it would short-circuit the supply air or would tend to hinder air motion in a desired direction, but it is just as absurd to expect any radical improvements when one location is used in place of another. In general, with forced-air circulation, the return may be placed wherever most convenient.

The supply, unlike the return, has a very decided effect on the room-air motion, and the location, type, and number used must always be given careful consideration.

*Alfred L. Greenlaw, Engineer, Tuttle and Bailey, Inc.

Barber-Colman Co.

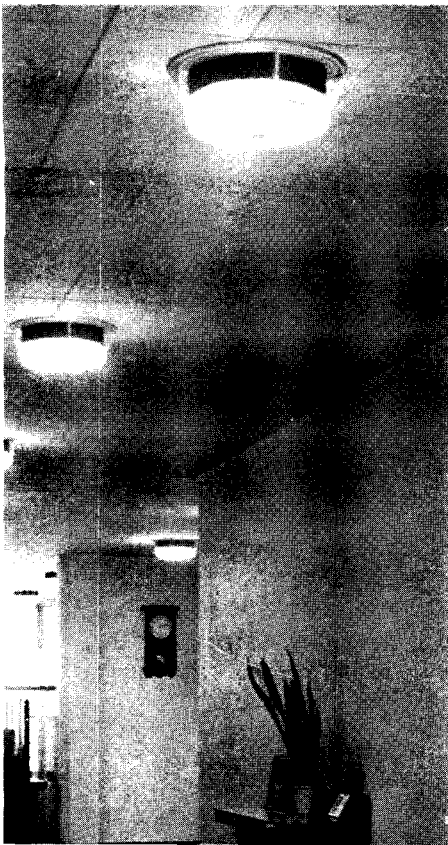

1. A combination of direct lighting with outlet for supply duct; heat generated by lighting is modified at the source.

Ezra Stoller



2. Grilles of supply ducts were designed for minimum obstruction to air flow and maximum directional control.

Stuart O'Brien

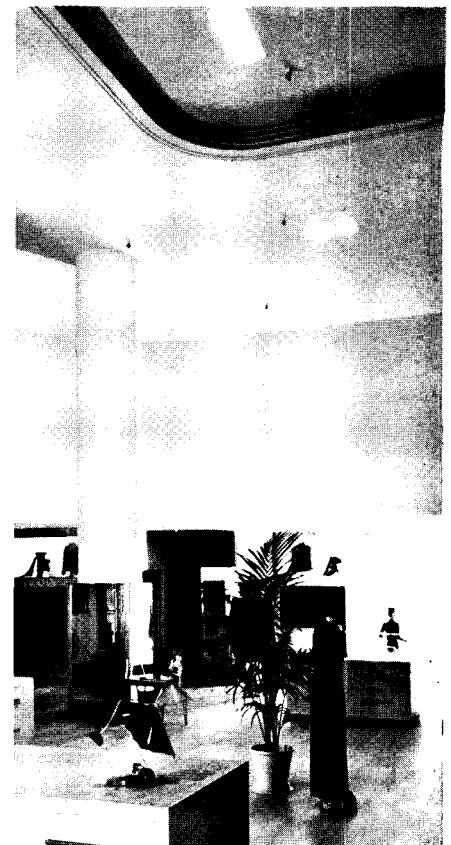

3. Space between ceilings and floors above is a plenum chamber; most of the lamp heat is carried off in air outflow.

Courtesy Carrier

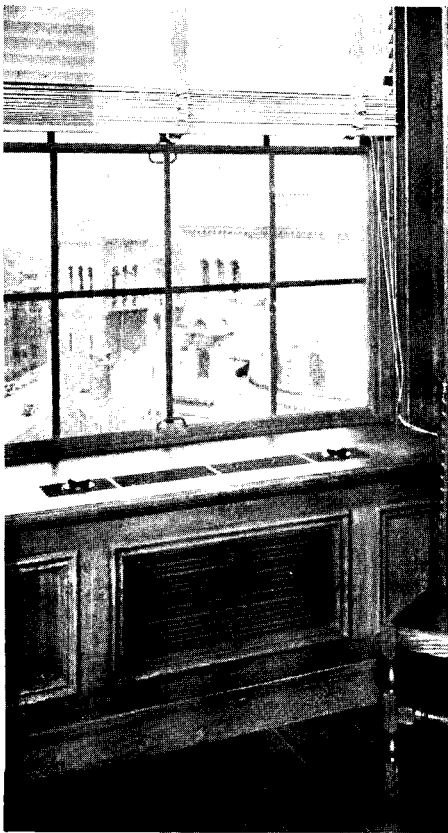

4. A built-in air-handling unit; primary air from a central plant induces a secondary flow of air into the room.

Courtesy Carrier



5. Floor outlets near an exposed wall counteract the cold air which sweeps down the outer wall and across the floor.

Joseph Muller, Courtesy Aucostat Corp.

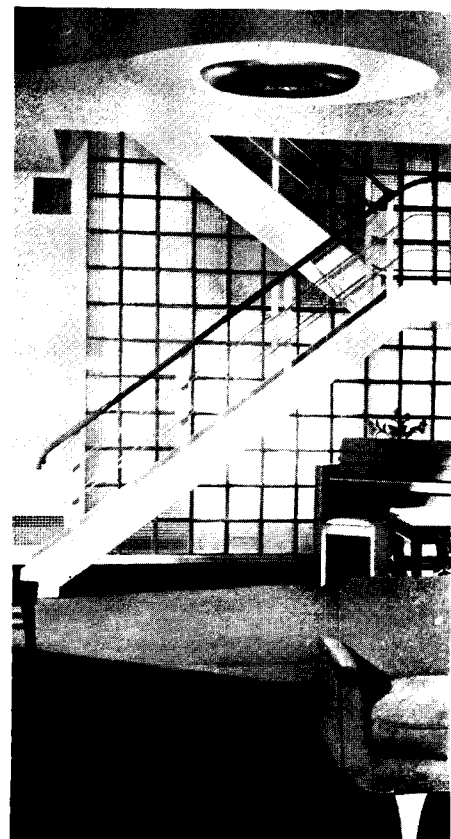

6. Outlet combined with indirect lighting; a vacuum effect between jets tends to pull the air around parallel to ceiling.

Location and types of outlets

IN HEATING, the floor should be kept warm without raising temperature at the ceiling. The degree of stratification which takes place with any given type of heating supply will therefore be a measure of its efficiency. Temperature studies were made in a room 23 by 20 by 8 ft., using various types and locations of heating supplies, with the idea of comparing the different outlets from the point of view of temperature variation. From these it was found that the best results could be obtained when the supply was placed in the baseboard and the air blown out parallel with the floor or slightly downward. It did not seem to make any difference whether the supply was placed in the exposed wall, the inside wall, or in such a way that the air swept along the exposed wall. The main objection to this location is that there is a stream of warm air going across the floor. This objection can be almost eliminated by using a fan-type grille or one that spreads the air over a wide angle. With this type of grille the air stream was hardly noticeable at a distance of three feet in front of the outlet. It was important that the air be directed either parallel with the floor or slightly down; otherwise the air went up to the ceiling and heated the upper part of the room, leaving the floor cold.

When the supply was placed high on the inside wall, and the air was blown across the top of the room, the stratification was almost twice as much as with the low supply. The room conditions were still satisfactory, however. This location, of course, has the decided advantage of keeping the air stream up out of the way. It relies on the aspiration effect of the supply air for stirring up the cold strata near the floor.

Another location for the outlet that appears to have theoretical advantages is in the floor near the exposed wall, or in a window sill, the air blowing up the cold wall, thus counteracting the tendency for the cold air to sweep down the outside wall and across the floor. This location gave about the same room conditions as were obtained with the high sidewall location. A fan-type grille was used in this case to create as much aspiration along the wall as possible.

A floor outlet has recently been developed which delivers the air parallel with the floor and spreads it out over an arc of 180°. The air is supplied through a series of semicircular jets, which start the air at an angle of about 45° from the vertical; the air is then

pulled around by a vacuum effect created between the jets so that it is actually delivered parallel with the floor. This outlet has the advantage of the baseboard supply in that the air is supplied at the floor and parallel with it, and it has a very short blow because of the 180° spread.

In cooling, the conditioned air should be supplied at the top of the room, with the problem of having to deliver the air directly into the occupied zone eliminated. However, since the supply air is colder than the room air, there is always a tendency for it to drop into the occupied area before its velocity is dissipated. The primary distribution problems in cooling are to keep the supply air up above the occupied area and have it lose its velocity before it hits any walls or obstructions which might deflect it downward.

It is sometimes thought that, in cooling, an outlet should be used which will blanket the whole top of the room. Therefore, a series of temperature studies were made in a room 25 by 20 by 12 ft. to determine whether the type of outlet used made any difference in the temperature conditions throughout the room. The conditioned air was supplied first from a straight-flow wall outlet, then from a fan-type wall outlet, and finally from a ceiling plaque. Electric heaters were used to create the heat load. It was found that very uniform conditions were maintained with all the outlets as long as the blow was such that the primary air did not enter the occupied area. The heaters were moved to various parts of the room and the heat load was either distributed evenly over the room or concentrated in one spot. The general results seemed to be the same in all tests. The aspiration effect of the primary stream was apparently enough in all cases to keep the room air and primary air well mixed. There is also a gravity recirculation effect which tends to eliminate temperature variation on the same horizontal plane. That is, if there is one spot where the temperature tends to rise above the surrounding temperature, warm air will rise from this point, and cooler air will come in to take its place.

It can be seen, then, that the main problem in distribution is to supply the conditioned air so that it will neither drop into the occupied zone, nor hit any obstruction before its velocity has been practically all dissipated from stirring up room air.

There are at present three distinct

methods of supplying the conditioned air for cooling—the wall grille, the ceiling outlet, and the perforated ceiling. The perforated ceiling is probably the least familiar of the three, possibly because of the expense involved. When this method of distribution is used, a blanket of cold air will be formed at the top of the room and will settle slowly to the lower areas. There will be very little room-air motion set up by this type of distribution because of the very low supply velocity; and if the supply velocity is very low the energy available for creating room-air circulation is very low. This may or may not be an advantage and only practice can tell.

The wall supply is probably the most common type of outlet. It is the cheapest and generally the easiest to install, and properly used it gives very good results. Various ways have been tried to increase the rate of mixing from this type of outlet, but the only method that seems to have any real effect is to spread or fan the air out. This shortens the blow from a given outlet considerably.

It should not be concluded that when the air starts out at an angle of 50° from the center line of the outlet that it will keep this direction and hit the side walls. As can be seen in the photograph on p. 71, the air pulls around and tends to go almost straight a short distance from the outlet.

The amount that a stream of cold air will drop varies almost directly with the temperature differential and inversely with the supply velocity. Consequently, the higher the velocity used, the less the air will drop. However, with too high a velocity, the blow will be too long and too much energy will be available for stirring up room air. There will also be danger of too much noise.

Today the ceiling outlet is becoming almost as popular as the wall outlet. This consists primarily of some sort of device which will turn the air from the vertically downward path it has on coming through the ceiling to one parallel with the ceiling; the air is pulled around by a vacuum effect created between circular jets so that the final path of the air is parallel with the ceiling.

The ceiling outlet has a much shorter blow than the wall outlet and there seems to be a tendency for the air delivered from it to hug the ceiling. This type of outlet is well suited for conditions where a large quantity of air must be supplied to a small space, where the ceiling is low, or where a high temperature differential is desirable.

Equipment

AIR-CONDITIONING equipment becomes increasingly lighter: weight and space per ton of refrigeration are today only one-sixth what they were thirty years ago.

There are three general types of air-distribution systems. One type utilizes local self-contained units with built-in supply and return openings. Another type has a central fan with ducts for the air distribution. There is also a system combining these two methods.

Since a duct system will not deliver air to each outlet in exactly the proper volume, it is necessary to provide means for balancing the system. This is accomplished in several ways, chiefly by means of dampers in the ducts or by reducing the effective area at outlets. The principal control is usually accomplished by dampers in the supply or return ducts, or both, with a further local control at the outlets. Where the same duct system is used for both heating and cooling, it may be necessary to increase the volume of air being handled when heating is taking place. This may be accomplished by changes in damper setting or in fan speed, or both.

Local self-contained units for heating and for cooling do not seriously affect building design. There is, however, another type of installation which combines the use of local units and air ducts. Outdoor air is brought into the building at a central point, filtered, humidified in winter, and dehumidified in summer. It is then distributed in small ducts at comparatively high pressure and velocity to local room units. Each local unit contains heating and cooling surface usually served by pipes from central systems. This plan reduces the difficulty of adaptation to the design of the building.

The increasing number of air-conditioning installations and their demand on water-supply lines and disposal systems have, in the past, caused some concern. Evaporative condensers have been designed to reduce water demands of the refrigerating equipment. The use of absorbents (e.g., activated alumina, silica gel) by which independent control of temperature and humidity is obtainable may further decrease water demands. Such materials have the property of absorbing water vapor from the air and can be reactivated by boiling off the accumulated water. However, in most air-conditioning systems, cooling and dehumidifying are accomplished simultaneously.

Pictures, Inc.

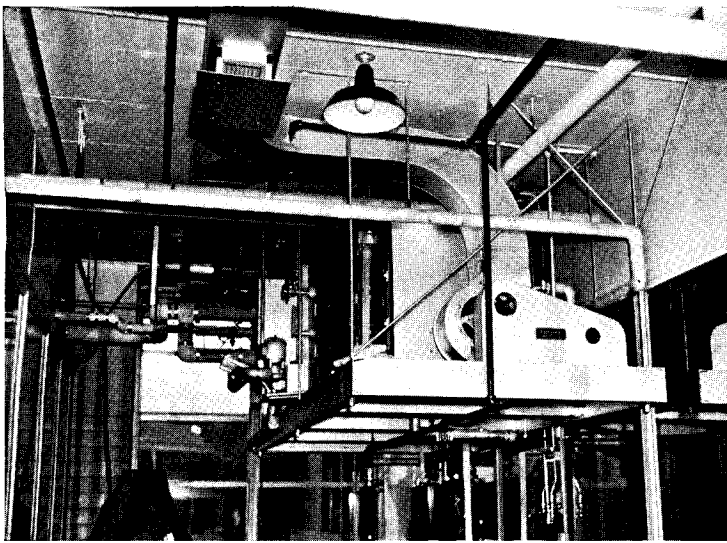

Air-conditioning unit which is one of several receiving chilled water from a centrally located refrigerating machine.

Courtesy Carrier

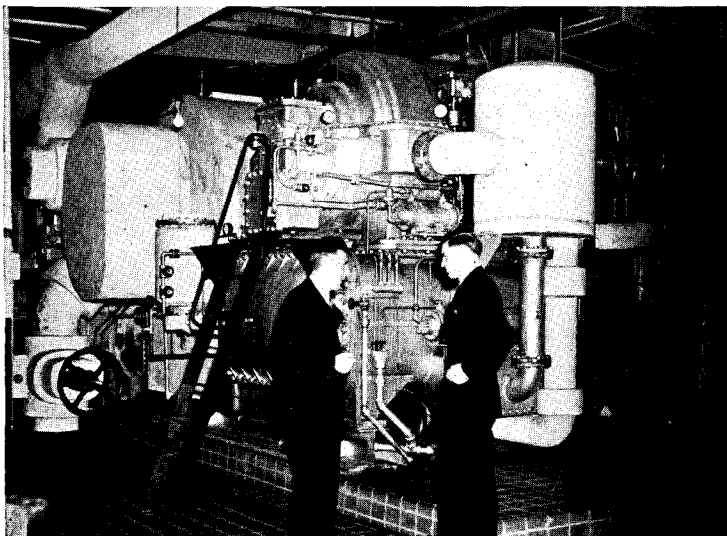

Centrifugal refrigeration equipment which supplies chilled water to several air-conditioning units remotely located.

Courtesy Carrier

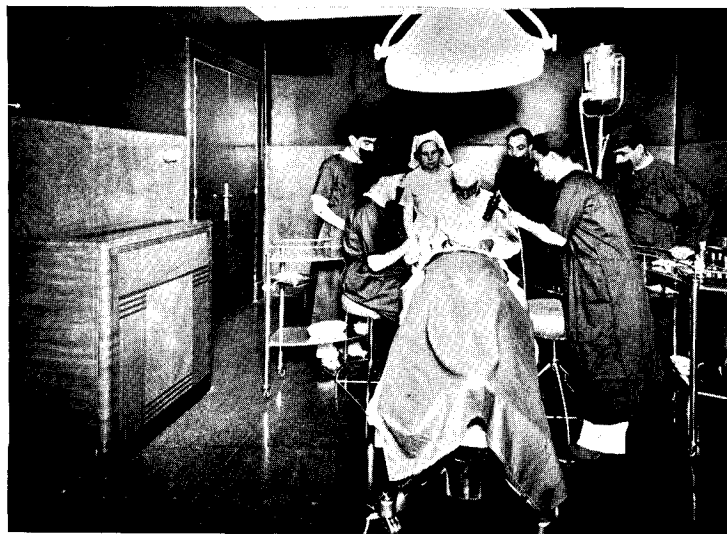

A self-contained air-conditioning unit in ophthalmological clinic in Cairo, Egypt. Such units do not require the use of ducts.

FIGURE 1: "Court of Lovers," Louis P. Hart, Architect.

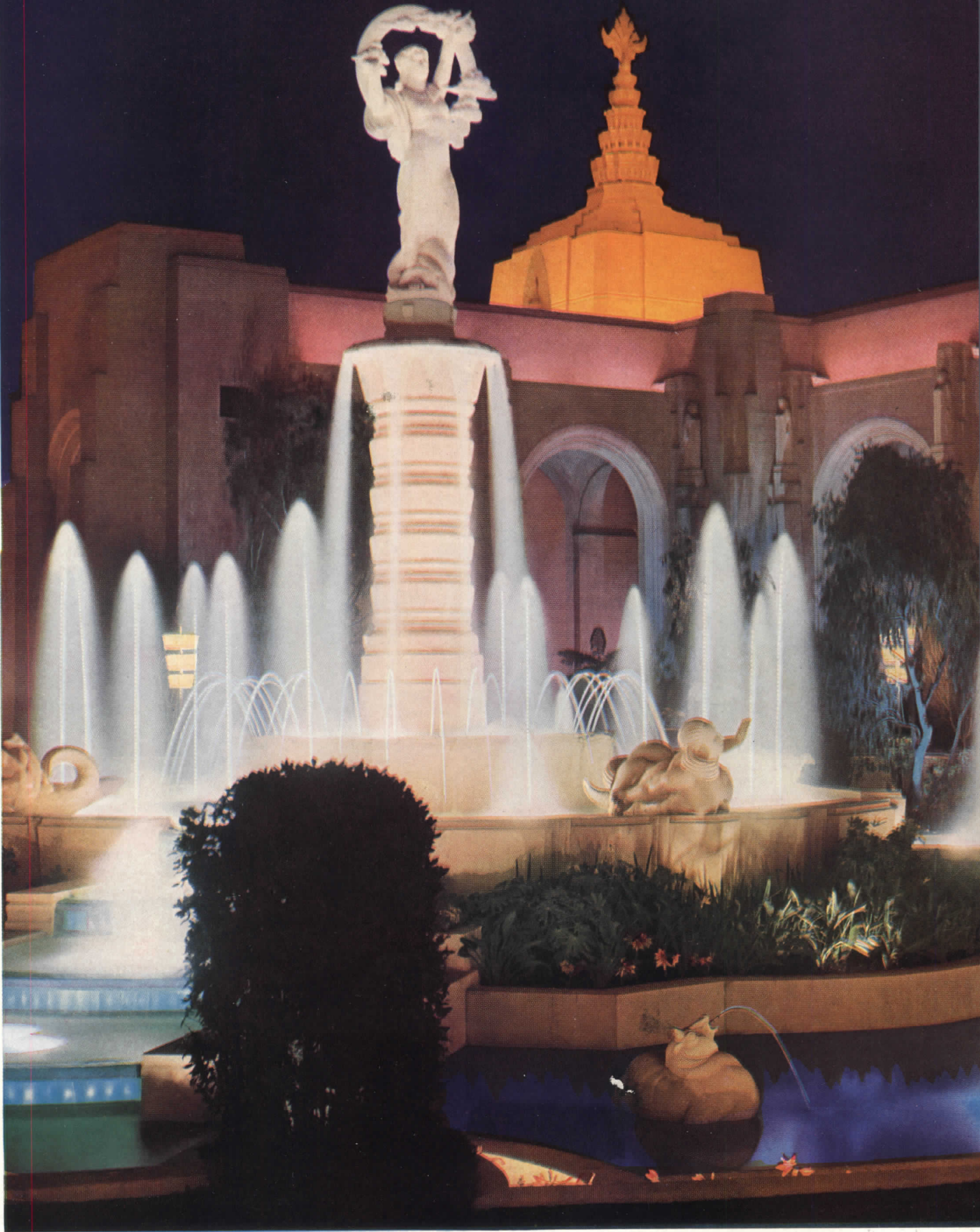

COLOR: NEW SYNTHESIS IN THE WEST

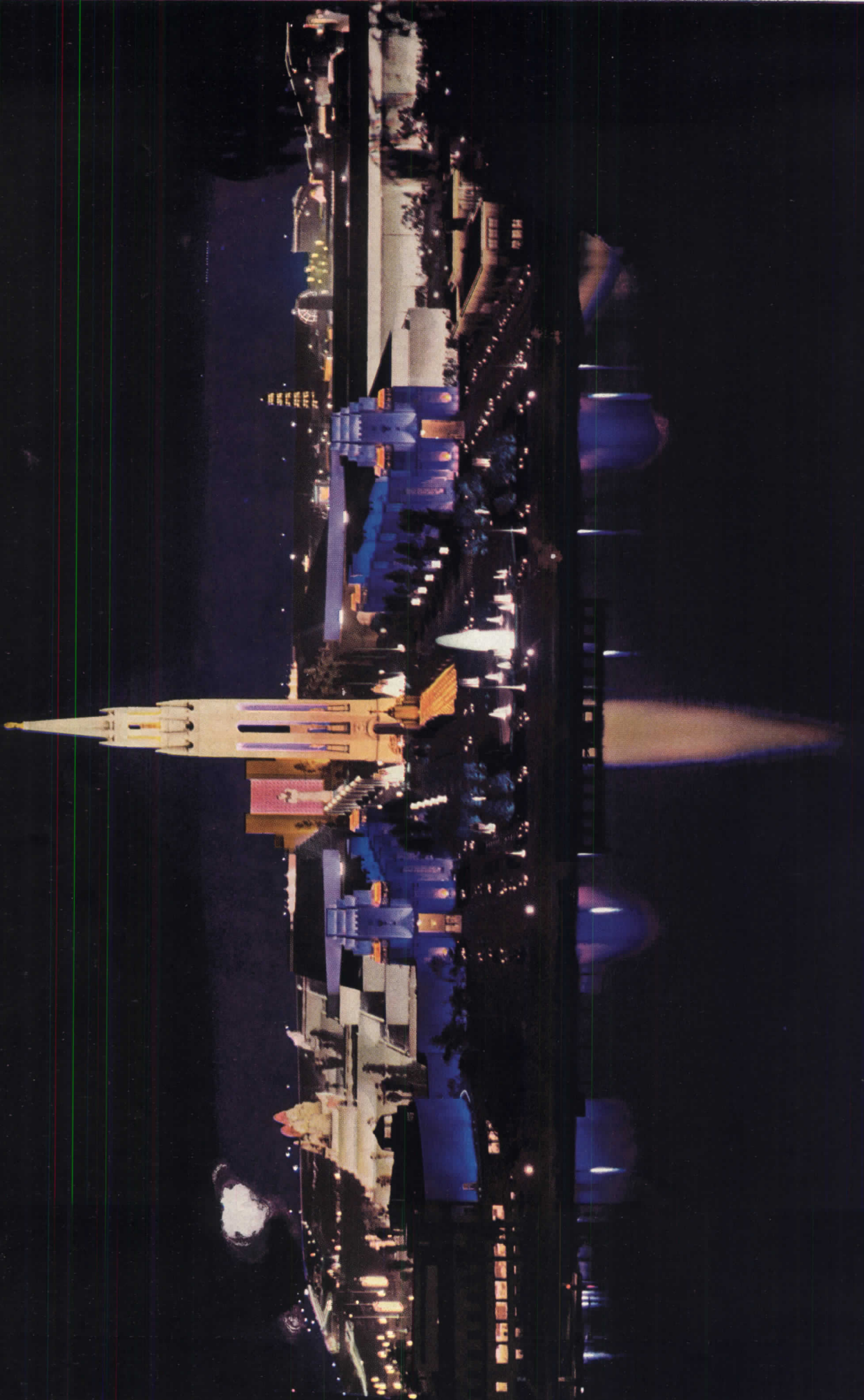

PLATE 2. One of the most dramatic aspects of the Golden Gate International Exposition (seen here from Yerba Buena Island) is the clear integration of the exterior illumination system with the architectural design. Note the careful organization of both colors and intensities, the visual sequences achieved thereby, the subdued and largely decorative role of street lighting.

COLOR, LIGHT AND STRUCTURE: NEW SYNTHESIS IN THE WEST

by **A. F. DICKERSON,**
*Director of Illumination**

EACH OF THE great American expositions has marked progressive advances in the field of artificial illumination. Chicago's Columbian Exposition of 1893 startled the world with its wide use of the then-novel incandescent lamp. In 1915 the Panama-Pacific Exposition in San Francisco reached new levels in the use of exterior floodlighting. Chicago's Century of Progress showed further advances, particularly in the field of color. But it is safe to say that the current expositions employ a wider variety of new illuminants, equipments, and installations than all their predecessors combined. The Golden Gate International Exposition furnishes dramatic proof of such advances; and because the problems involved are applicable to all building design, description of its principal features seems worthwhile.

Daylight color: A standard palette of 19 colors and gold was adopted—with ivory, brown, gold and blues predominate. Seven colors are body or foundation colors; eight are used for embellishment of minor architectural features, four and gold for trim. Tints and shades, rather than pure colors, are employed throughout. All body colors are warm, with light intensities—yellow, ivory, fawn, ecru, taupe, brown, and blue; the secondary colors include yellow, jade (light and dark), emerald, four additional blues, red, mauve, and apricot.

In the majority of cases, this color was applied in pigment form in the plastered surfaces, in paint form on trim and detail. The plaster itself has an unusual luminosity, an effect achieved by pressing a mica product into plastered surfaces. The mica had first been heated to a high degree so that it became flaky and the laminations tended to separate. The result is a breaking up of the wall surfaces into innumerable small holes with a high reflective factor.

Night color: The artificial illumination must be understood as being superimposed on a base of the colors and surfaces described above. But the night color *does not seek to reproduce that of natural daylight.* On the contrary, many of the most successful effects are achieved solely with colored illumination on near-white surfaces. Compare, for

example, the daylight and night colors of the Court of Pacifica (Pl. 3 and 4). Nor do the various intensities, shadows, and silhouettes seek to duplicate those of natural daylight. In fact, the illumination may be said to yield an additional—and entirely new—design over and above that of daylight.

The basic consideration in designing the illumination of the Exposition was to make it a truly integral part of the building design. Such integration of light and structure implied much more than mere concealment of the light sources, or avoidance of glare and shadows. That it has been achieved—and with spectacular success in installations such as that of the Court of the Moon (Pl. 9) and the Elephant Towers (Pl. 5)—is apparent. Here color achieves a luminosity which appears as coming from *within* the building rather than of being applied from *without*.

Once inside the bright exterior walls, the visitor moves through a series of color effects in a succession of walled courts—each lighted differently, with a harmony which makes the transition from one to another easy, yet distinct. In these courts, lighting has been used to fit the visitor psychologically to enjoy the setting. Emotions are excited toward gaiety by shades of red, rose, orange, and yellow—while greens, blue greens, and blues are used as tranquilizers. Colors are always in harmony and restricted in number from any viewpoint. Highlights, shadows, and silhouettes break up the monotony of the usual flatness of floodlighted surfaces. Advantage has been taken of every flag, niche, or unusual architectural element, to introduce a change of color or a highlight in order to increase the liveliness of the night scenes. Fountains throughout the grounds are illuminated, usually in static colors excepting in the Court of Pacifica (Pl. 3) where a shifting color cycle is controlled by thyatronns. In many places trees have been lighted by concealed mercury floodlights; but in general they count as dark masses against light.

Installations and fixtures: While the effect of the Exposition's illumination system may often appear extravagant, construction and operation were in fact relatively

simple and inexpensive. All equipment is commercially available, including a weather-proof low-cost searchlight and a low-cost fluorescent floodlight, both of which were especially developed by General Electric for the Exposition. The various installations are in common use in ordinary commercial buildings: *floodlighting*—in trenches, set-backs, soffits, etc.; *spotlighting* of architectural features—towers, sculpture, niches, etc.; *groundlighting* by means of light standards and recessed fixtures; *water lighting* by underwater floodlights, lip lighting, etc. The chief interest here lies largely in demonstrating the extraordinary versatility possible with careful study at a sufficiently early stage.

But each of these installation types represents a high degree of specialization so that, when properly integrated, there is little need for supplementary lighting. This explains the relative unimportance of street-lighting units in the illumination design. In the major courts, these units serve more as architectural features than as sources of illumination. Outside the courts, street-lighting units of a more utilitarian character are used.

Illuminants: The range of lighting media includes all commercially available sources—incandescent, lumiline, arc, mercury- and sodium-vapor, neon, fluorescent, and ultra violet "black light" for use with luminescent paints. These media were used singly and in combinations, depending upon the colors, changes, and intensities desired. Quantitatively the most important were incandescent and fluorescent lamps—the specially developed fluorescent floodlights being widely used.

All illumination designs shown are by General Electric's Illuminating Laboratory.

*The overall design of day-and-night color is the end product of close cooperation between the following Exposition officials: W. P. Day, Director of Works; Jesse E. Stanton, Director of Color; Edward L. Frik, Chief of Division of Architecture; William R. Van Bokkelen, Chief of the Electrical Division; George E. Garthorne, Assistant Chief and in charge of Exterior Illuminations; the entire Architectural Commission under the chairmanship of Arthur Brown, Jr.; and Mr. Dickerson, Director of Illumination. No novice in the field, Mr. Dickerson played an important part in the illumination of the Panama-Pacific Exposition of 1915, the Brazilian Centennial in 1922, A Century of Progress in 1933, and in floodlighting of Niagara Falls. Since 1932, he has been head, Illuminating Laboratory and Lighting Sales of the General Electric Company at Schenectady, N. Y.

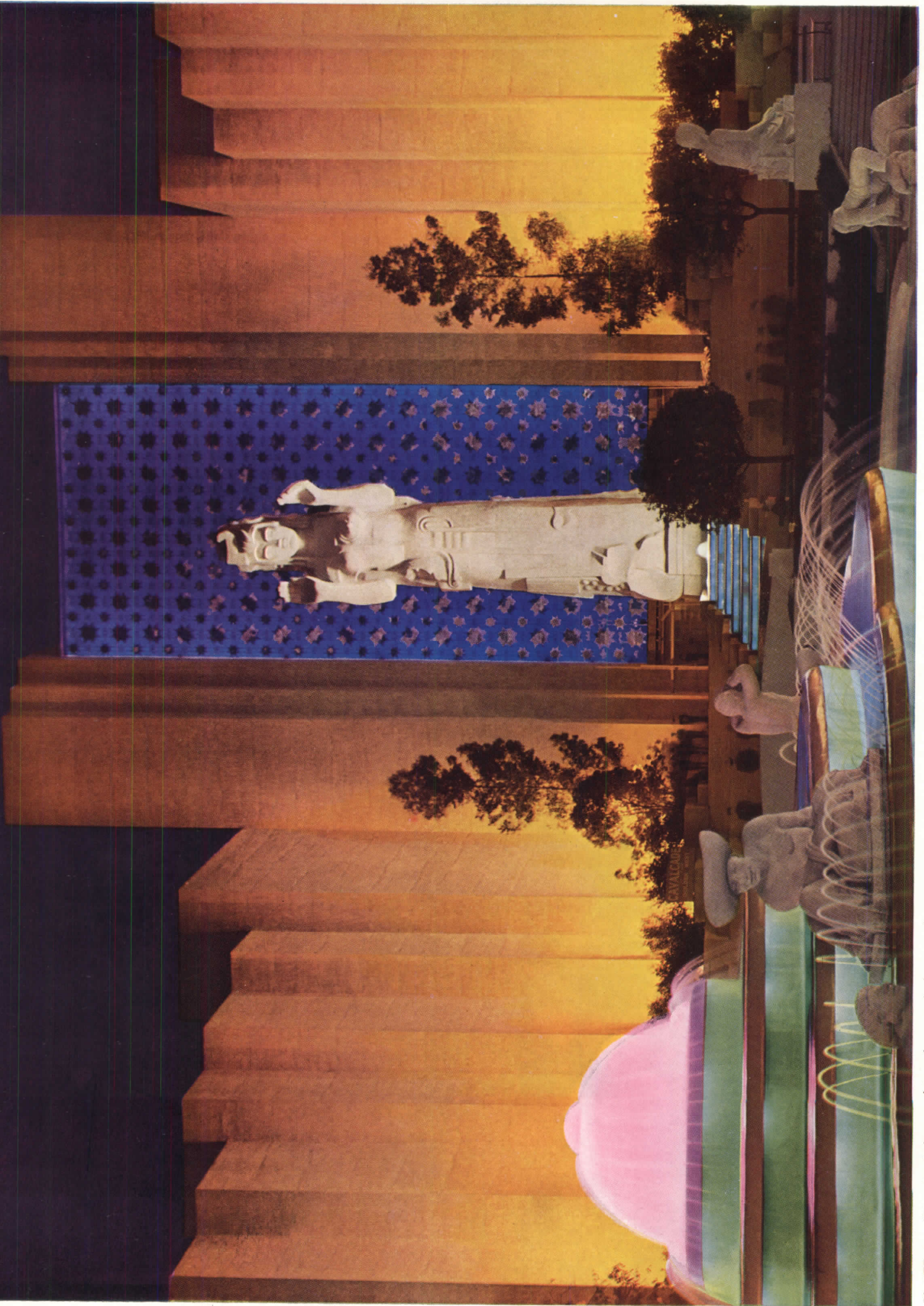

PLATE 3. Vivacity is here achieved not only by a wide variation of color and intensity of light but also by its movement. Synchronized thyatron controls give smoothly changing yet steady emphasis to the two most important architectural features—the statue and the fountain. Backgrounds have even values and harmonized colors which silhouette the planting.

THE COURT OF PACIFICA

TIMOTHY L. PFLUEGER, Architect

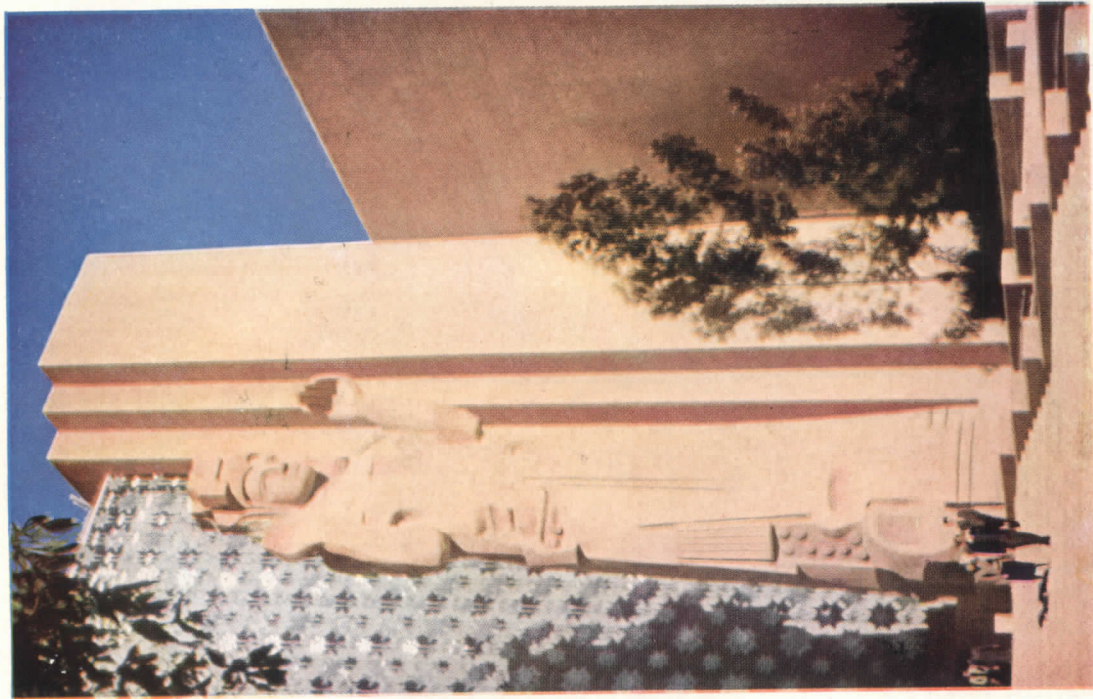

PLATE 4. This daylight view serves as a point of reference as regards the daylight-color base on which illumination is superimposed. All structures illustrated have similar colors and values.



FIGURE 1

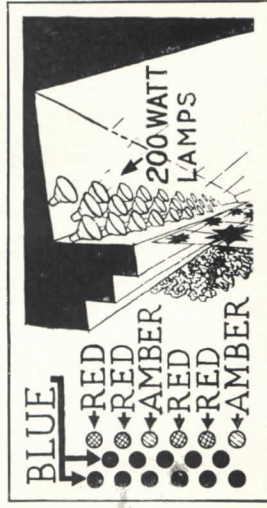

FIGURE 2

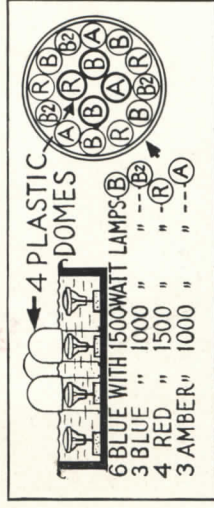

FIGURE 3

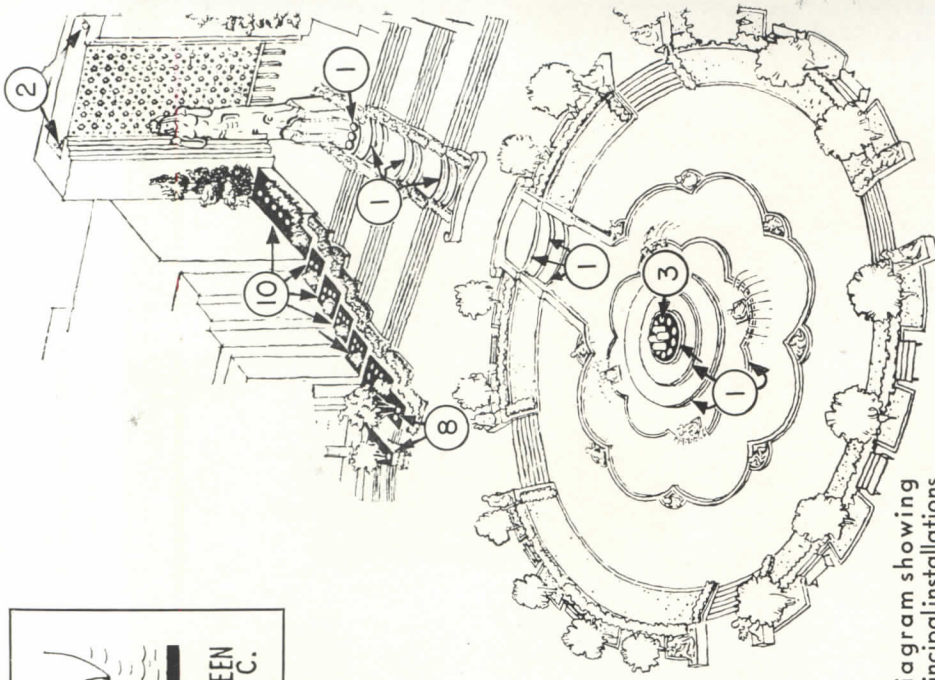

Diagram showing principal installations

THE DESIGN of this court, as well as its location adjacent to the most popular entrance to the Exposition, called for a lighting treatment tending toward the spectacular. The chief installations of the illuminating system are:

The Great Window with its stainless-steel screen and plaster backdrop lit by 75 amber, 150 red, and 300 blue 200-w. floods controlled by thyristors. (Fig. 2); Robert Stackpole's 85-ft. statue, "Miss Pacifica," lighted by two 1500-w. underwater floods (Fig. 1);

The cascades and central fountain, with lip lighting of green and changing colors from underwater floods where there are jets. (Figs. 1 and 3);

The 80-ft. walls flanking the Grand Stairs and also

the walls of the East Entrance are flooded in a golden amber (similar to Fig. 10);

Sixteen 86-ft. cylindrical lanterns (not shown) of Glyptal-treated fabric shed a warm glow that completely envelopes the Court. Each lantern has three hundred 60-w. lamps, or a total of 288 kws. is used for the 16 standards (design similar to Figs. 6 and 7);

All of the main trees are lighted with 250-w. mercury floods concealed in ground cylinders (Fig. 8); The East Entrance and the Gateway Plaza are lighted by decorative units with tiers of amber-orange lamps and banners. This exposed lighting furnishes a transition to the Amusement Section. Approximately 550 kws. of lighting are used in this Court.



PLATE 5. Highest intensities and lightest colors have been widely used on those elements primarily designed to be seen from afar. Thus the brilliantly lit West Facade, with its monumental entrances, actually serves as a huge sign which dominates the city's eastern horizon and intersects its traffic lanes to the mainland. Colors are concentrated at the entrances.

THE ELEPHANT TOWERS AND WEST FACADE

ERNEST E. WEIHE, Architect

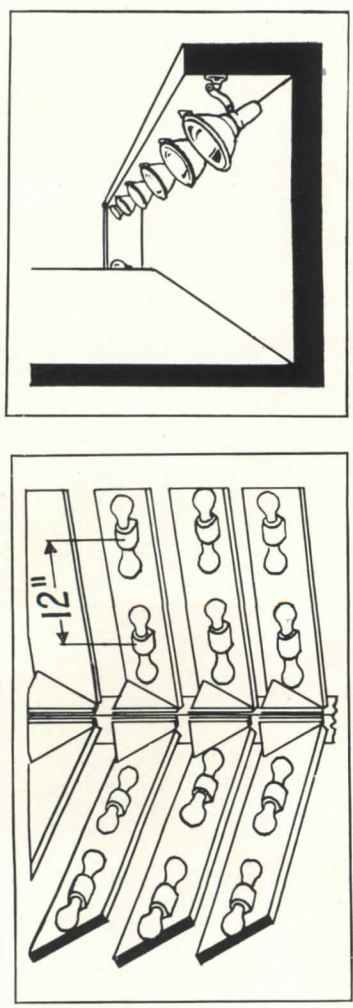

FIGURE 4

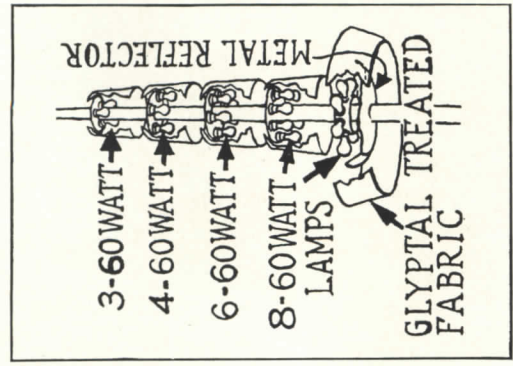

FIGURE 5

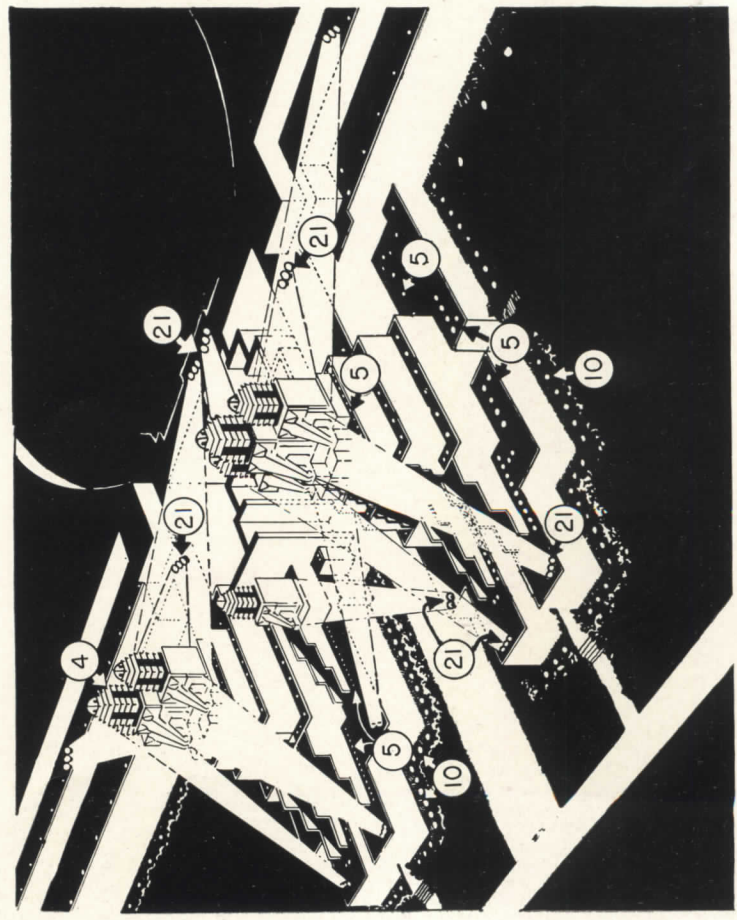

Diagram showing search- and floodlight locations for Towers and West Facade

THE WEST FACADE, for its entire distance of 3600 ft. from the Administration Building north, is floodlighted in white with color reliefs at the South Tower, main Elephant Tower entrance, ferry entrance, and in the seven large green circles above the entrances. Thirty cylindrical lanterns, 50 ft. in height with 4920-w., and 102 similar small lanterns, 18-ft. high with 1620-w., add a festive note to this area. These lanterns are all steel framework on steel poles with decorated Glyphical-treated fabric as the transparency (Figs. 6 and 7).

The main wall is lighted by Novalux L-49 floods with polished Alzak-processed reflectors, asymmetric lenses and 500-w. I. F. MAZDA lamps. These are spaced on 10-ft. centers, 15 ft. from the base of the wall, in a specially provided trench that is completely concealed by trees and shrubbery. (Similar trenches of various widths are used for all floodlighting throughout the Exposition. See Fig. 10.) In general, illumination values increase with height (Pl. 5): on the first set-back 200-w. floods with etched reflectors and clear lenses are used on 8-ft. centers; 300-w. floods on 10-ft. centers light the second set-back (Fig. 5). The elephants themselves are picked up with 18-in. incandescent searchlights equipped with 1500-w. floodlighting lamps (Fig. 21). The lowered "howdahs" are in red, with 60-w. natural ruby incandescent lamps 12-in. o.c. (Fig. 4).

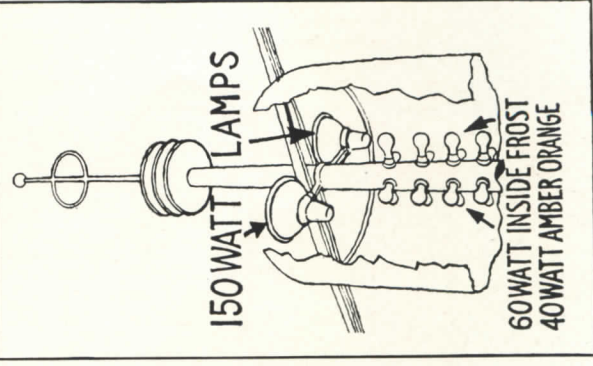

FIGURE 7



White light on the cream plaster yields surfaces whose values are approximately equal to those of daylight



PLATE 6. The richly textured golds of Lulu Braghetta's and Jaques Schnier's bas-reliefs are carried in pink, the towers in golden amber, while the set-backs are carried in lavender. Here, again, a brilliant lighting effect is adequately framed by quiet, unlighted water. Thus the scale and balance of daytime are maintained at night while new colors are introduced.

THE CAMBODIAN TOWERS AND EAST FACADE

WILLIAM G. MERCHANT, Architect

THE ENTIRE East Facade (to the right but not shown) is lighted in uncolored light in much the same manner as the West Facade. Trenches of 6-ft. width, completely concealed by shrubs and trees, house 500-w. asymmetric floods on 8-ft. centers for lighting walls (Fig. 10); the illumination of the set-back is provided by 200-w. floods. This lighting is broken by large standards at the building entrances and the East Towers and murals (Pl. 6) which form the East entrance to the walled city.

The Towers, rising from tiers of steps, are heavily ornamented in gold leaf and carried in golden light at night. The huge bas-relief gold-leafed murals are lighted by pink fluorescent floods concealed at their bases (Fig. 12), and similar installations light the set-backs in lavender. The terraces and stairs are lighted by Siamese umbrella-type units built of fabric. Trees in the center are floodlighted by 250-w. mercury-vapor lamps (Fig. 8). The lighting of flags and flag masts uses the same installation employed elsewhere (Fig. 9).

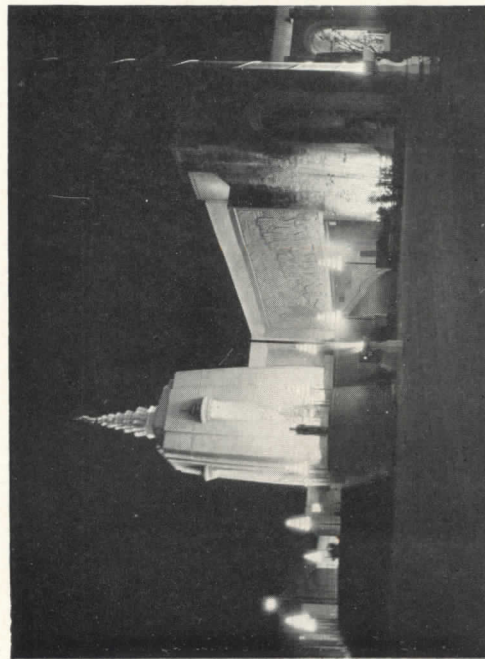

FIGURE 8

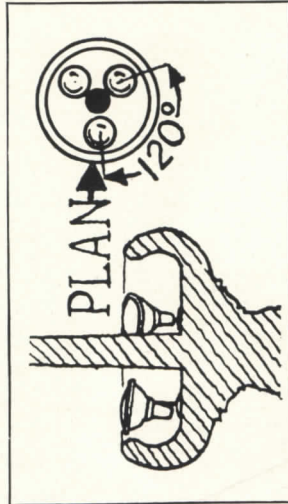

FIGURE 9

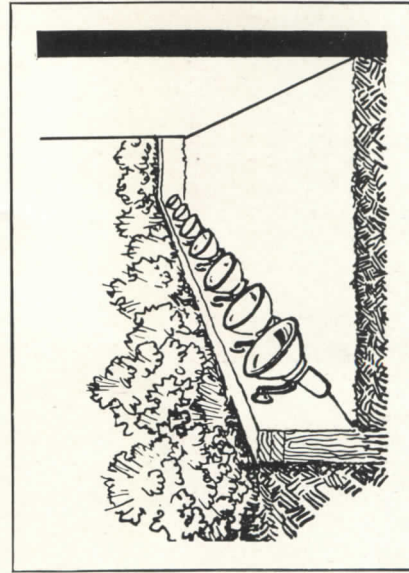

FIGURE 10

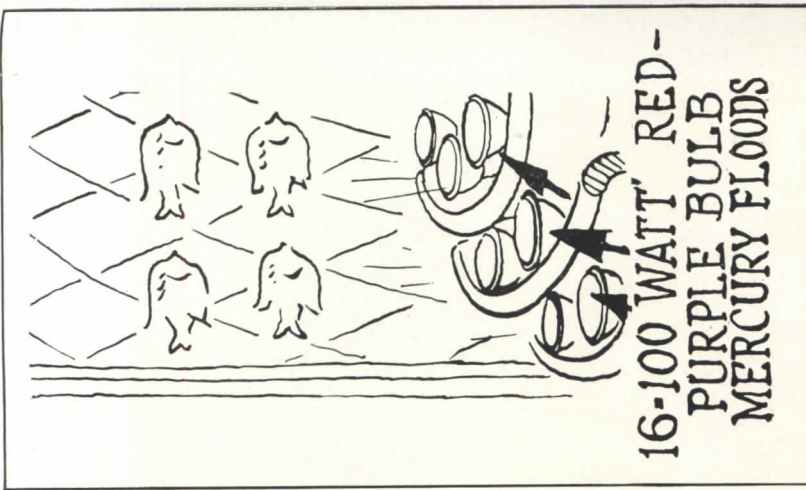

FIGURE 11. Luminescent murals used in the Court of the Seven Seas.

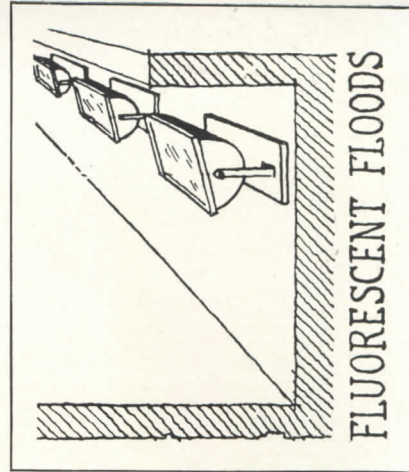
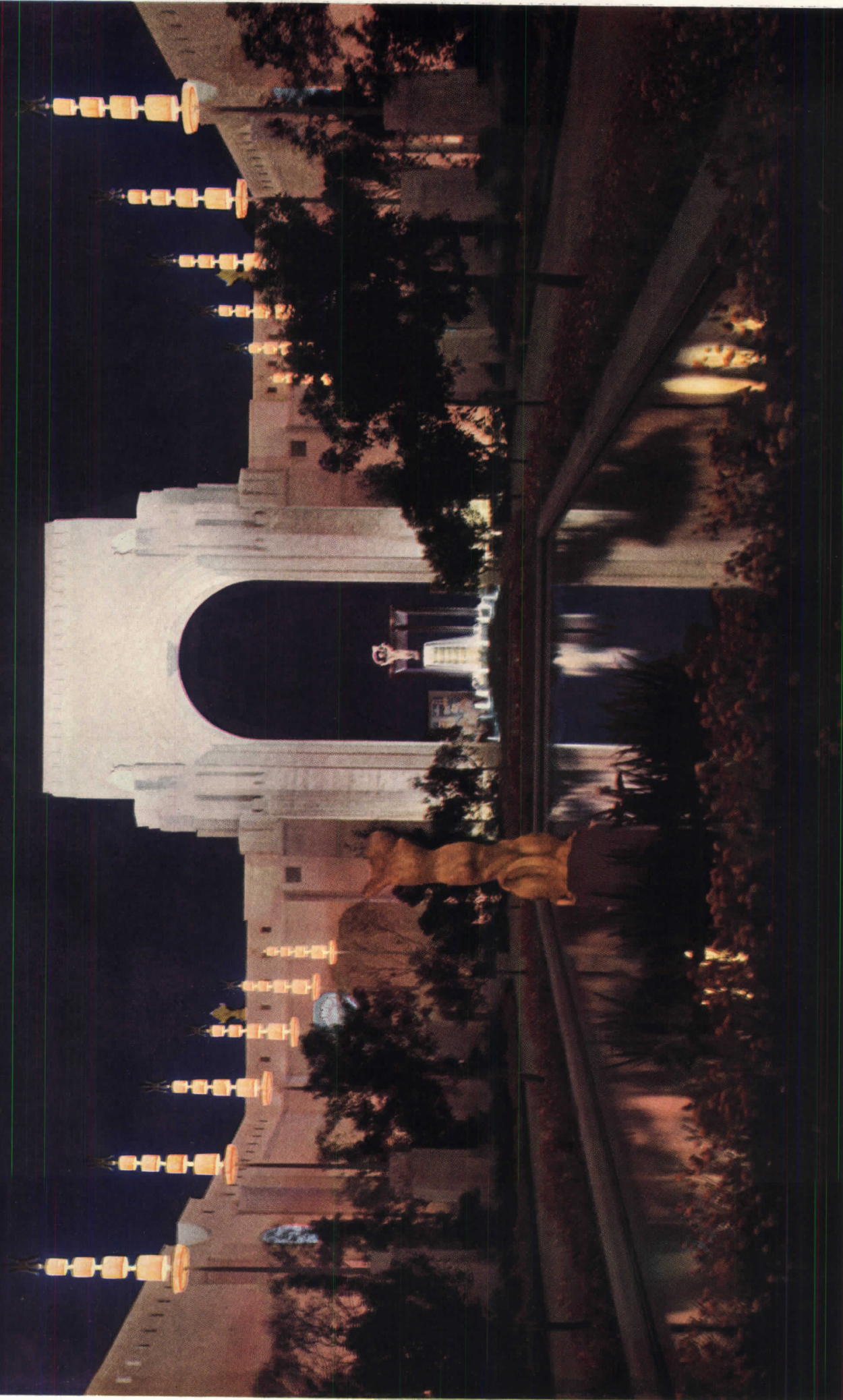

FIGURE 12



THE COURT OF REFLECTIONS

LOUIS P. HOBART, Architect

PLATE 7. Connecting the brilliant East Entrance (Pl. 6) and the Tower of the Sun (Pl. 11), the color and lighting levels of this court are adroitly handled. Walls and set-backs are lighted with pink fluorescent floods (Fig. 12), niches with blue fluorescent tubes (Fig. 22). The Arch is flooded from base and adjacent roofs with white 18-in. incandescent searchlights (Fig. 21).

PLATE 8. Looking west in the Court of Reflections towards the Tower of the Sun. As the name implies, water is here used as a reflecting medium to pick up and repeat the brilliantly lit Tower of the Sun. Elsewhere (Pls. 1, 10, and 11) water becomes part of the illumination system itself, adding not only color and movement but a considerable amount of light.



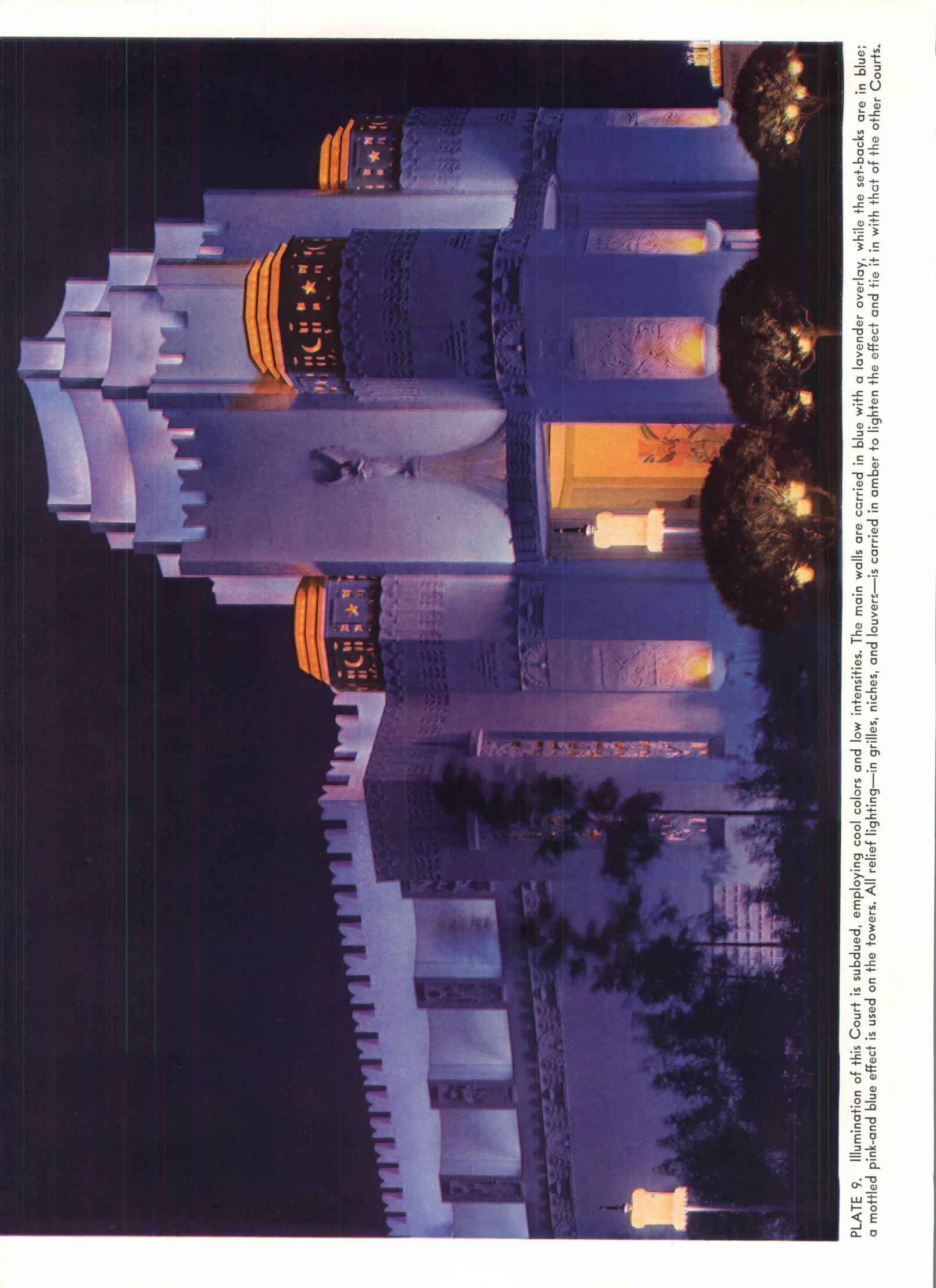

PLATE 9. Illumination of this Court is subdued, employing cool colors and low intensities. The main walls are carried in blue with a lavender overlay, while the set-backs are in blue; a mottled pink-and blue effect is used on the towers. All relief lighting—in grilles, niches, and louvers—is carried in amber to lighten the effect and tie it in with that of the other Courts.

THE COURT OF THE MOON

GEORGE W. KELHAM, Architect

HERE, AGAIN, illumination cannily implements both architecture and circulation: although physically one of the four major axes which radiate from the Tower of the Sun, this court is unimportant circulation-wise. The illumination is thus subdued, designed for relaxation, not for pulling heavy traffic. For the walls, 500-w. blue floods are used on 30-in. centers; in the same trench, pink fluorescent floods on 60-in. centers tint the blue to an orchid shade (Fig. 16). The crenelated set-backs are lighted with three 15-w. blue fluorescent floods (Fig. 15). Both blue and pink fluorescent floods are used on the tops of the towers for producing the striking mottled effect (Fig. 14).

Ground lighting is by downlights in ten units concealed in decorative elements of iron and Celoglas (Fig. 17). The other lighting features are: the 24 arches of water, lighted by seventy-two 250-w. amber underwater floods; the north fountain with its falling jets and cascades in amber (Fig. 13); mercury lighted trees; spotlighted statuary; grilles and turrets in amber relief lighting.

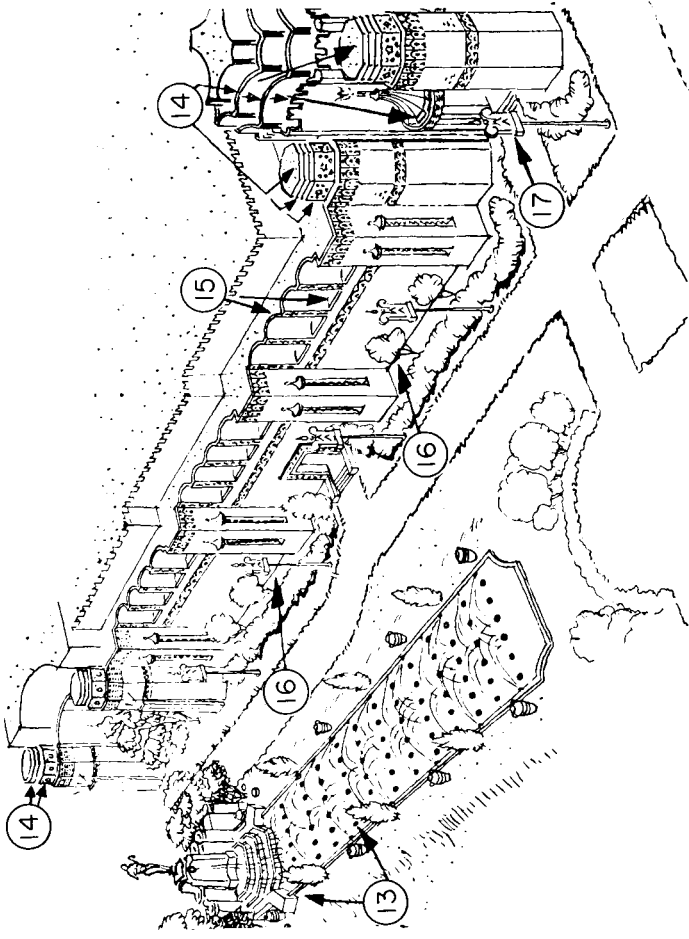

Diagram showing relationship of major installations in Court of the Moon

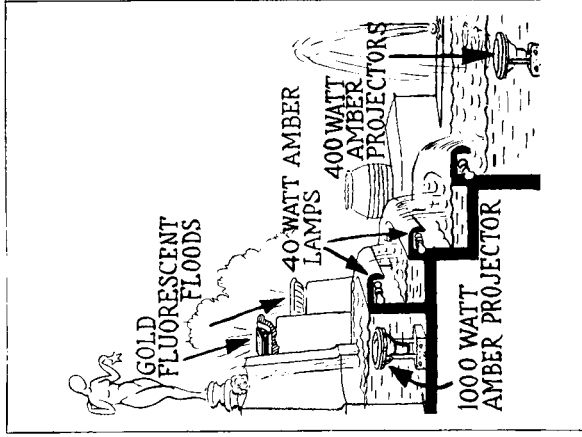

FIGURE 13

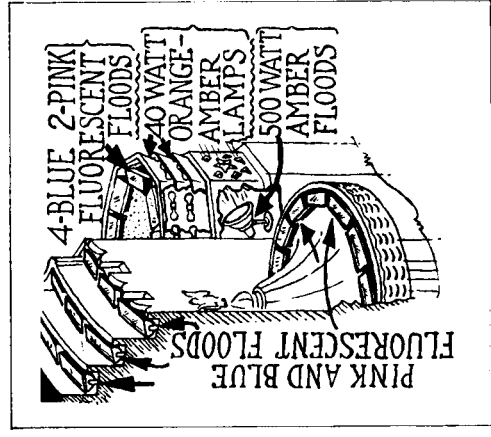

FIGURE 14

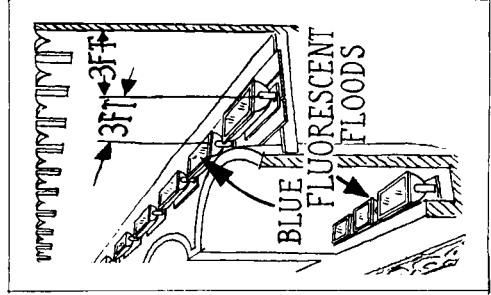

FIGURE 15

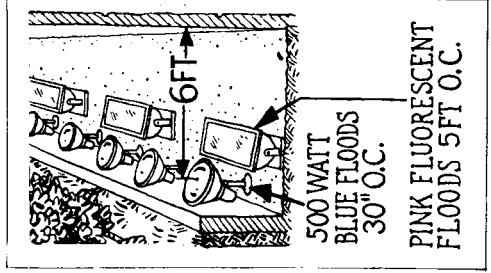

FIGURE 16

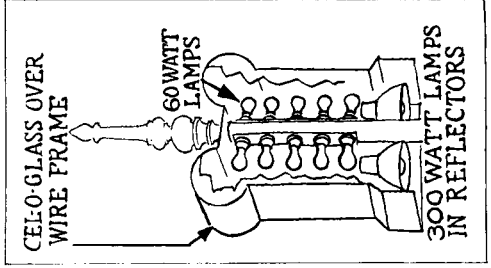
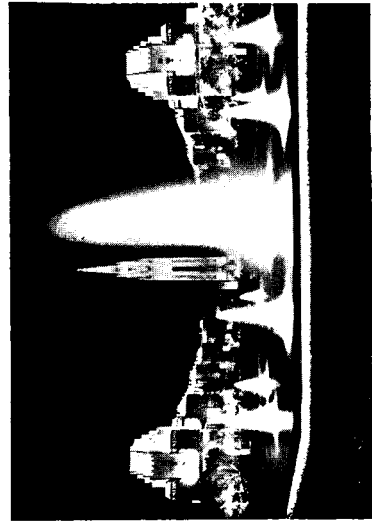

FIGURE 17



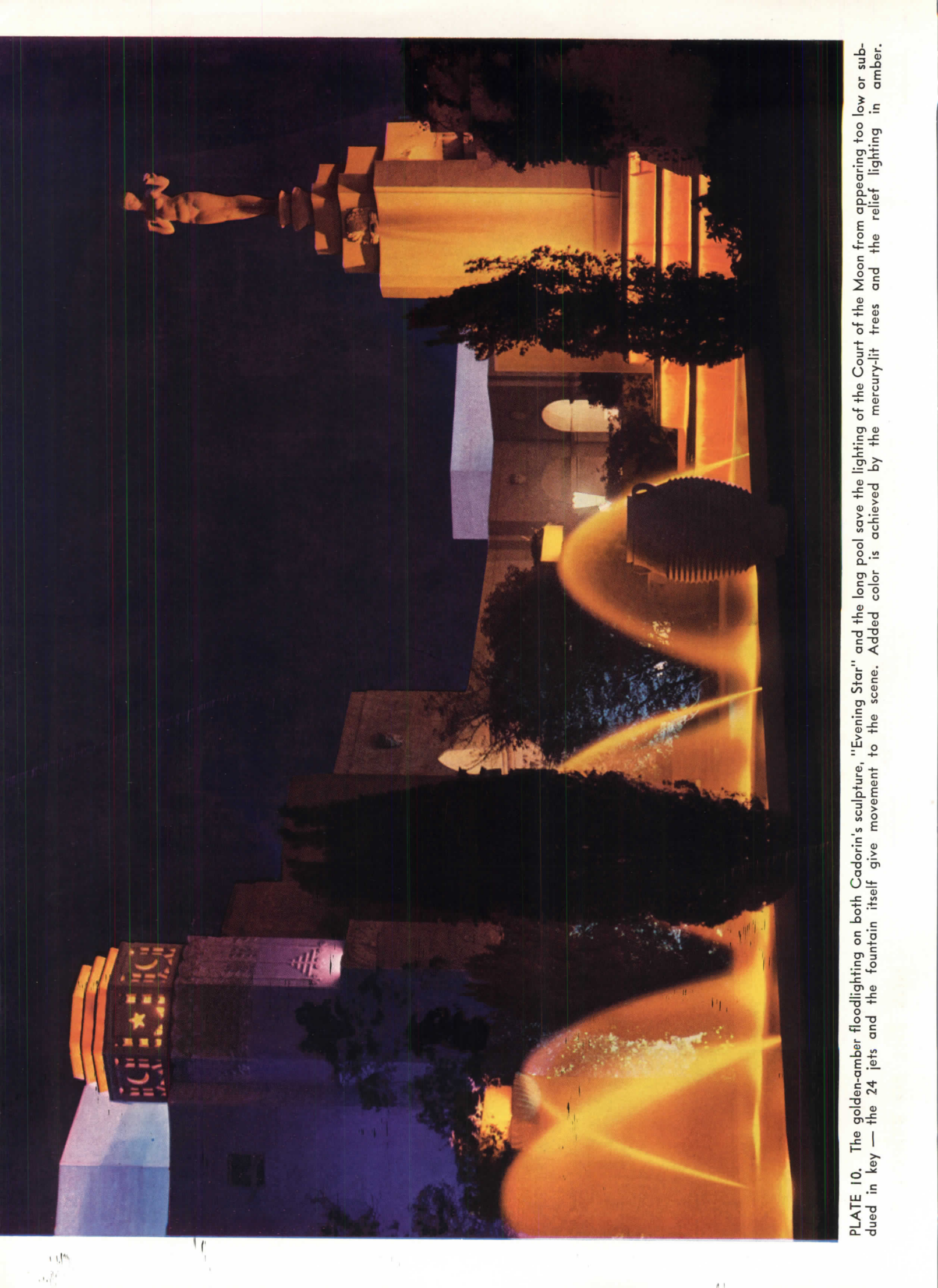

PLATE 10. The golden-amber floodlighting on both Cadorn's sculpture, "Evening Star" and the long pool save the lighting of the Court of the Moon from appearing too low or subdued in key — the 24 jets and the fountain itself give movement to the scene. Added color is achieved by the mercury-lit trees and the relief lighting in amber.

THE TOWER OF THE SUN

ARTHUR BROWN, JR., Architect

SINCE THE Tower of the Sun is the "thematic center" of the Exposition, and since the Court of Honor in which it stands is consequently the most important traffic intersection within the Exposition gates, it was important that the night effect be at least as dramatic as that of daytime. This has been accomplished (Pl. 11) by concentrating light at high intensities on the Tower, which in turn lights the Court by reflection. The shaft proper is lighted by 56 white 1500 w. searchlights (Fig. 21), 24 amber and 24 white 1000 w. floodlights, and 60 amber 1000 w. floodlights (Fig. 20). A ring of twenty-four 500 w. concealed street-lighting units (Fig. 23) supplements the court lighting. Other features are: the four illuminated fountains (Fig. 1), the eight flags (Fig. 9), the four belvederes and the lighted trees (Fig. 8).

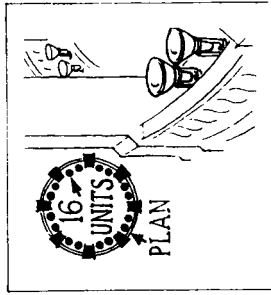
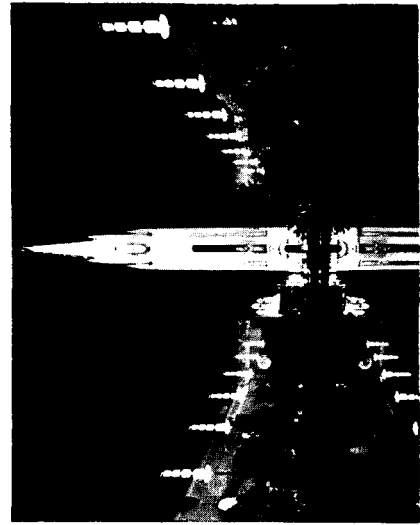

FIGURE 18

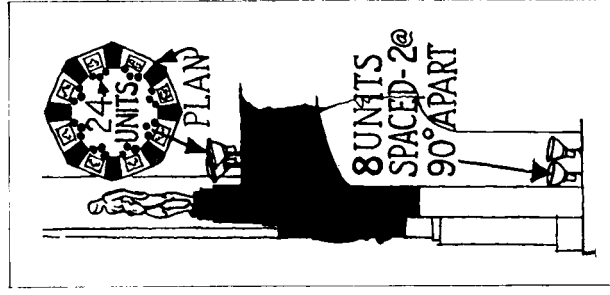

FIGURE 19

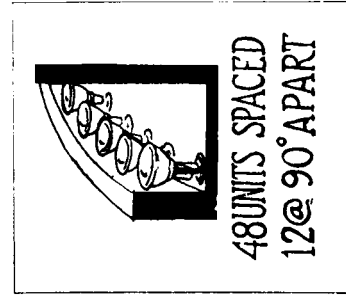

FIGURE 20

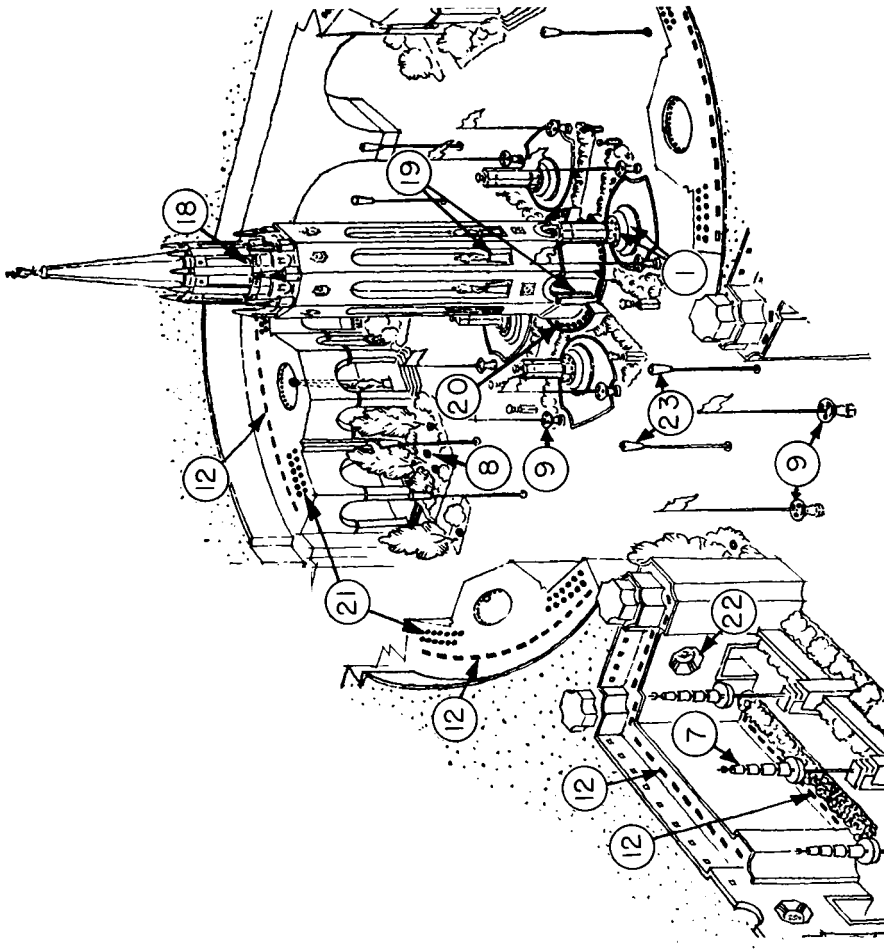

Diagram of all installations in Court of Honor and Tower of the Sun

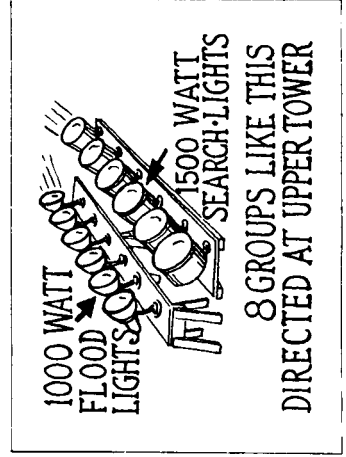

FIGURE 21

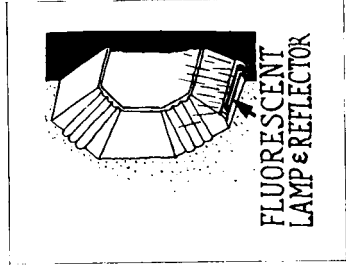

FIGURE 22

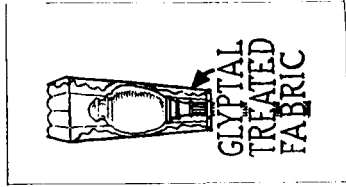

FIGURE 23



PLATE 11. Beginning with a warm amber at the base, the Tower of the Sun changes gradually to a white of increasing intensity at the top. Relief lighting is blue at the base, straw yellow at the belfry, amber at the pinnacle (Figs. 18, 19 and 20). The surrounding Court of Honor is mainly illuminated by this reflected light, although 24 decorative street lighting units supplement the design.

Current Trends of Building Costs

Compiled by Clyde Shute, Manager, Statistical and Research Division, F. W. Dodge Corporation, from data collected by E. H. Boeckh & Associates, Inc.

CURVES INDICATE trend of the combined material and labor costs in the field of residential frame construction. The base line, 100, represents the U. S. average for 1926-1929 for residential frame construction.

Tabular information gives cost index numbers for the nine common classes of construction. The base, 100, in each of the nine classes represents the U. S. average for 1926-1929 for each particular group. The tables show the index numbers for the month for

both this year and last.

Cost comparisons, as percentage differences for any particular class of construction, are possible between localities or periods within the same city by a simple process of dividing the difference between the two index numbers by one of them. For example: if index for city A is 110 and index for city B is 95 (both indexes for A and B must be for the same class of construction), then costs in A are approximately 16% higher than in

$B \left(\frac{110-95}{95} = 0.158. \right)$ Conversely it may be said that costs in B are approximately 14% lower than in

$A \left(\frac{110-95}{110} = 0.136. \right)$

Similar cost comparisons, however, cannot be made between different classes of construction since the index numbers for each class of construction relate to a different U. S. average for 1926-1929.

CONSTRUCTION COST INDEX U. S. average, including materials and labor, for 1926 - 1929 equals 100.

ATLANTA

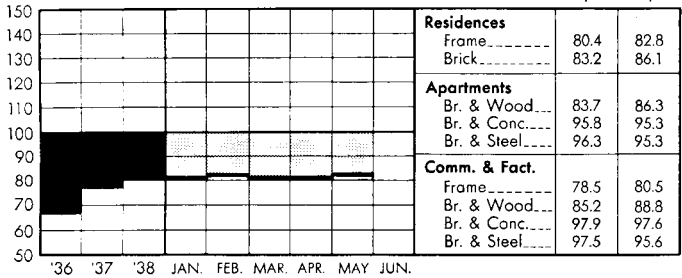

CHICAGO

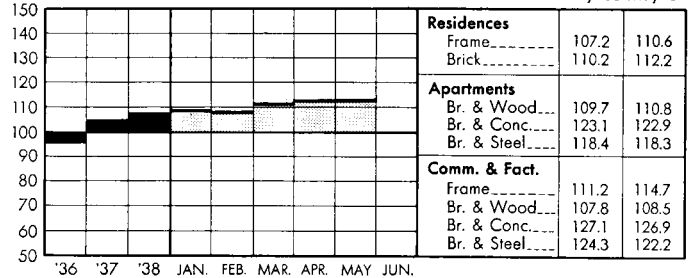

BALTIMORE

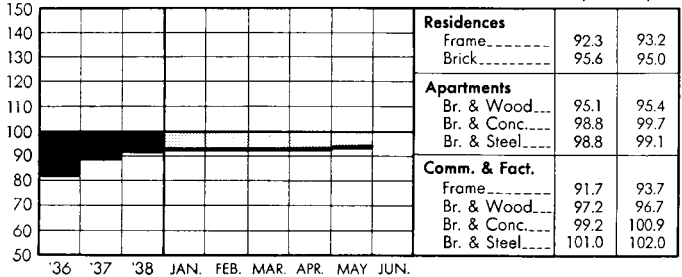

CINCINNATI

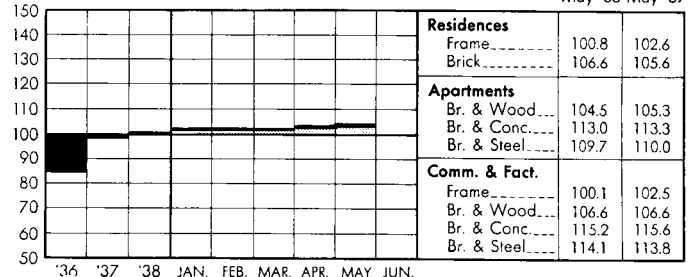

BIRMINGHAM

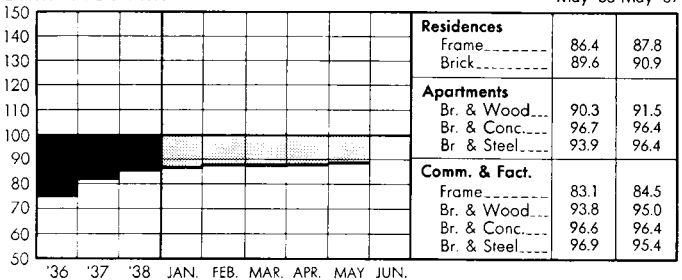

CLEVELAND

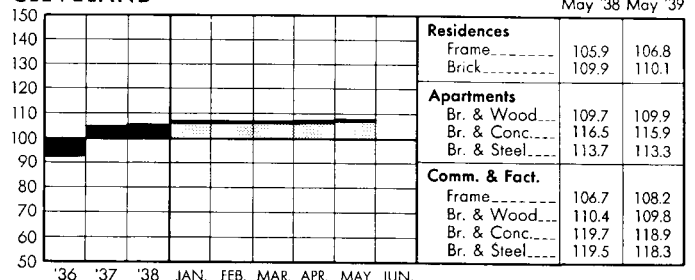

BOSTON

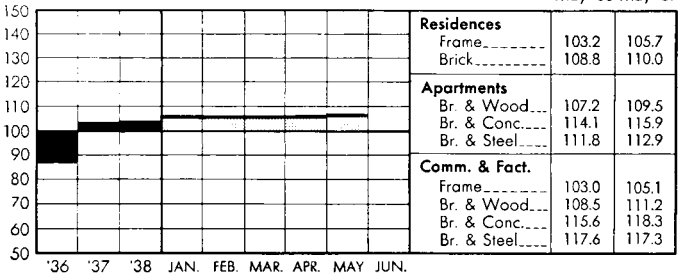

DALLAS

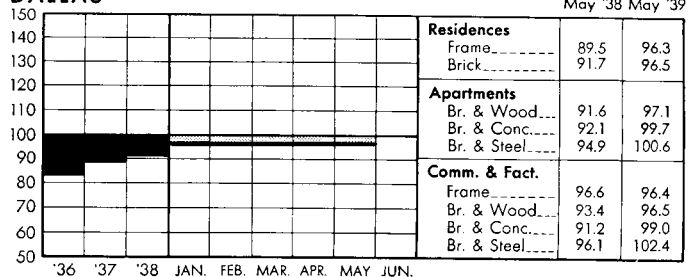

DENVER

May '38 May '39

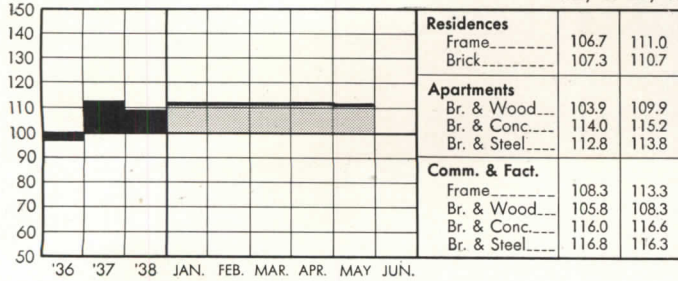

NEW YORK

May '38 May '39

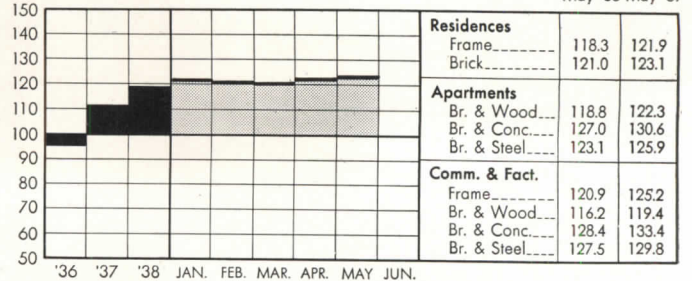

DETROIT

May '38 May '39

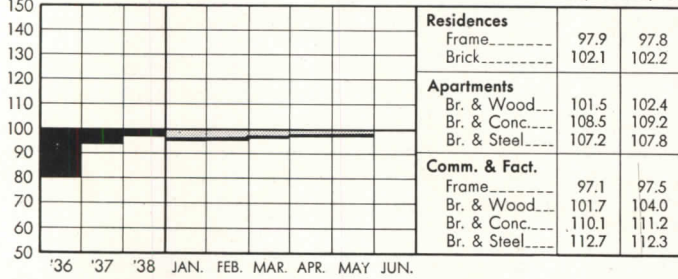

PHILADELPHIA

May '38 May '39

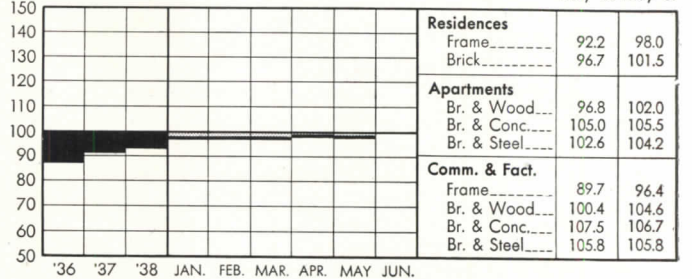

KANSAS CITY

May '38 May '39

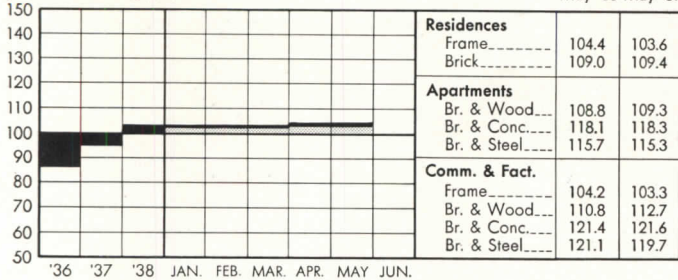

PITTSBURGH

May '38 May '39

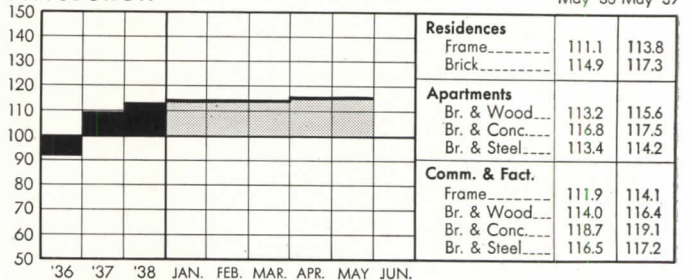

LOS ANGELES

May '38 May '39

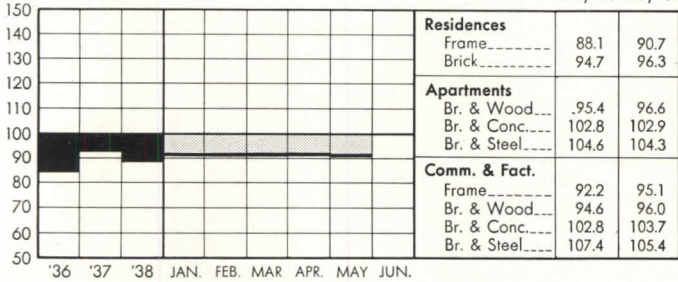

ST. LOUIS

May '38 May '39

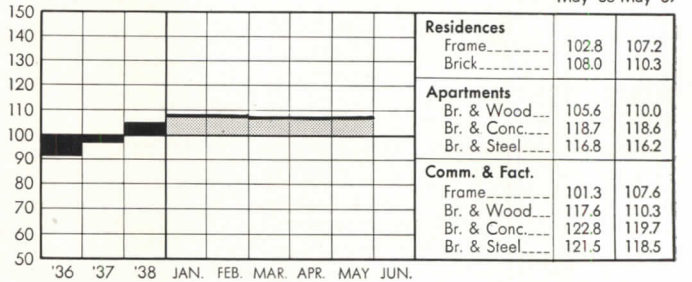

MINNEAPOLIS

May '38 May '39

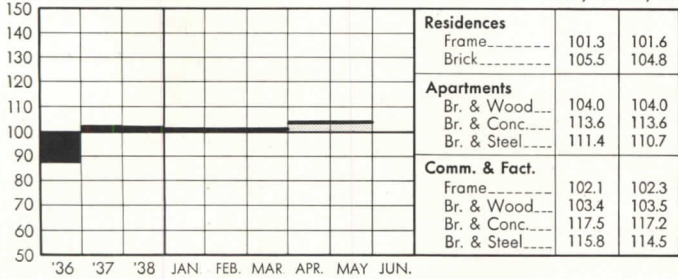

SAN FRANCISCO

May '38 May '39

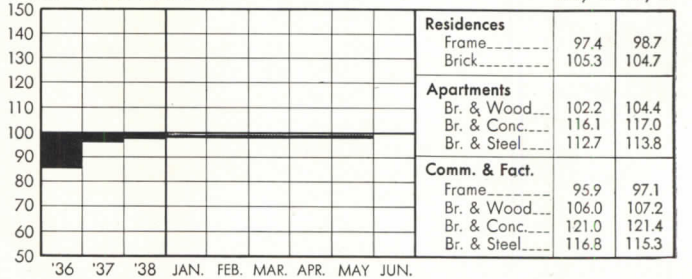

NEW ORLEANS

May '38 May '39

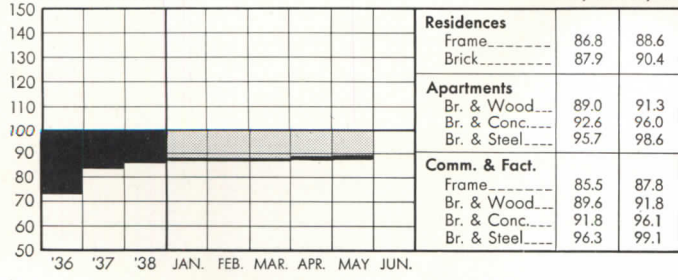

SEATTLE

May '38 May '39

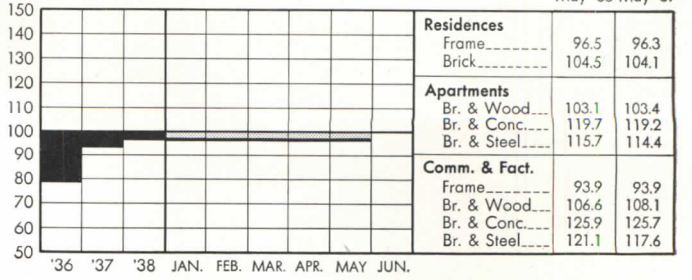

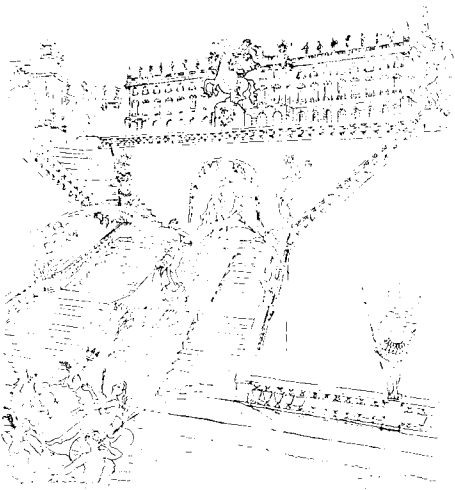

Baroque: from "Pillar to Post, or English Architecture Without Tears."

PILLAR TO POST, OR ENGLISH ARCHITECTURE WITHOUT TEARS. By Osbert Lancaster. With illustrations by the author. Published by Charles Scribner's Sons, New York. 84 pp. 6 1/2 by 9 1/2 in. \$1.75.

AT THE OUTSET of this work, the author declares: "This is not a textbook . . . whether the ogival vault first appeared at Durham or at Morienvall will remain unanswered. . . the precise difference between Baroque and Rococo will be left undetermined." The purely avid-for-facts reader is advised to turn rather to "some of those innumerable stout volumes" which this present author declares he has long intended to read. However, the reader discovers that Osbert Lancaster's own presentation, with drawings and wittily incised facing-page critiques, of styles and influences discernible in English architecture, from early Egyptian to Twentieth-century Functional, serves to induce "an attitude less reverent and of greater awareness." Facts are given, very assimilable when leavened with salt, which should cause even the most technically harried reader to become conscious of the many blatant absurdities in his architectural environment.

CHANGING NEW YORK, A BOOK OF PHOTOGRAPHS, by Berenice Abbott. Text by Elizabeth McCausland. A publication of the Federal Art Project of the Works Progress Administration in the City of New York, under the sponsorship of the Guild's Committee for Federal Writers' Publications, Inc. E. P. Dutton and Co., Inc., New York. 208 pp. 9 by 11 1/2 in. \$3.00.

IN THIS collection of photographs, the author has selected views exemplifying the curious juxtapositions to be ob-

Notes on New Books

served in New York City—old tenements and elevated structures in counterpoint to shining skyscrapers and affluent apartment dwellings. Together with textual commentaries by Elizabeth McCausland, she presents the curiosa of metropolitan life—pushcarts and barber shops, bridges and remote byways of Greenwich Village; ornate buildings, palaces, and theaters of a by-gone architecture.

OUTLINES OF THE HISTORY OF ARCHITECTURE, Part IV: Modern Architecture with Particular Reference to the United States. By Rexford Newcomb, M.A., M.Arch., A.I.A. Published by John Wiley and Sons, Inc., New York. 318 pp. 8 1/4 by 10 1/2 in. \$4.00.

THIS FOURTH part in the series of outlines, prepared primarily for lecture-room use by the Dean of the College of Fine and Applied Arts, University of Illinois, covers the periods of colonial and national architecture in the United States, as well as modern trends and types in various countries of Europe. To the end of each section is appended a comprehensive bibliography of books and periodicals relative to the particular subject matter contained therein.

RICHARD UPJOHN, ARCHITECT AND CHURCHMAN. By Everard M. Upjohn. Published by Columbia University Press, New York. 243 pp. 6 by 9 1/2 in. \$4.00.

THIS BIOGRAPHY by the great grandson of Richard Upjohn, designer of New York City's Trinity Church and moving spirit behind the foundation of the American Institute of Architects, traces the development of the architect's style from early castellated, through the for-generations-there-after-dominant Gothic for ecclesiastical structures and renaissance for civic, to that of his villa-house designs, which constitute an early

episode in the emergence of functional expression. The author has included in the appendix a catalog of the Richard Upjohn architectural commissions.

FUNDAMENTALS OF HOUSING STUDY: A Determination of Factors Basic to an Understanding of American Housing Problems. By Joseph Earl Davies, Ph.D. Published by Bureau of Publications, Teacher's College, Columbia University, New York City. 356 pp. 6 1/4 by 8 7/8 in. \$2.85.

BASING HIS analysis on recent housing literature, the author answers in this book such questions as: "What kinds of shelter are now available and occupied in the United States? What are the shortages which affect production, distribution, and use of housing? What patterns of housing reform are advocated by housing authorities?" In addition he presents a bibliography and a summary and analysis of source material on the subject.

AIR CONDITIONING. By James A. Moyer, S.B., A.M., and Raymond U. Fittz, S.B. Second Edition. Published by McGraw-Hill Book Co., Inc., New York and London. 455 pp. 5 3/4 by 9 1/4 in. \$4.00.

IN THIS new second edition, the authors have entirely rewritten their first chapter, on the principles of air conditioning, in the light of recent practices and trends since 1933, the date of the first publishing. The chapter on automatic control apparatus has been similarly revised, a set of practical air-conditioning problems and a table of saturated-steam properties appended, and a new chapter added giving data "on sun effect, heat transmission through building materials, and methods of calculating and selecting the proper size of unit air conditioners of various types."

(Continued on page 130)

A new breadth of Service in **PNEUMATIC CONTROL**



THE Minneapolis-Honeywell Gradutrol System of Pneumatic Control insures positive positioning of valves and dampers in infinite numbers from closed to open position.

Backed by a national service organization, with more than half a century of field and laboratory experience the Gradutrol System will produce any temperature control sequence or result that you require.

If you are not already familiar with Gradutrol advantages, call in the M-H control consultant. His counsel is avail-

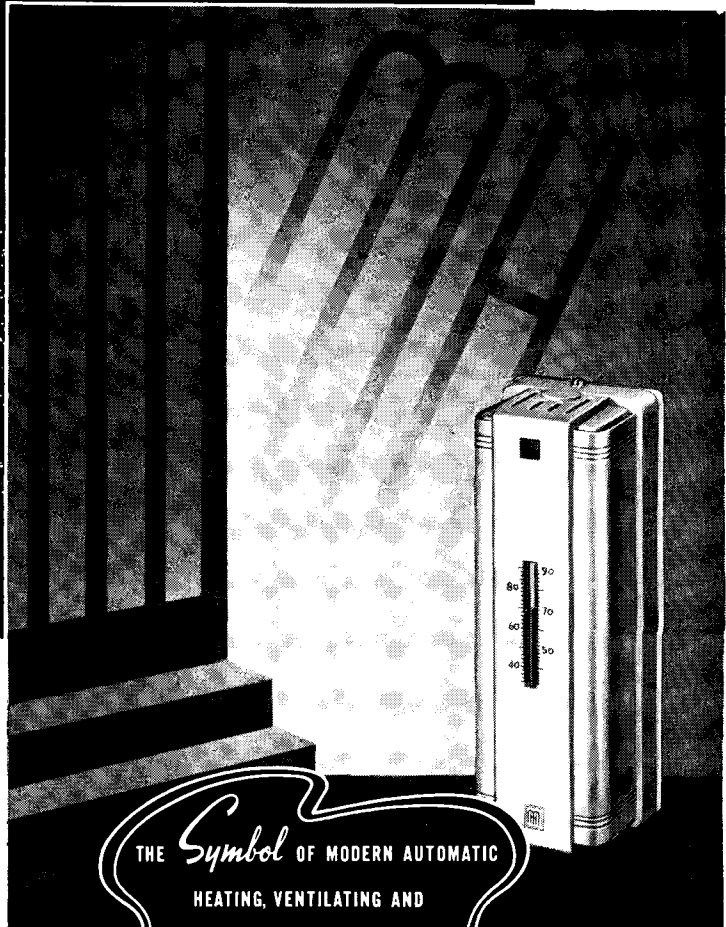

THE *Symbol* OF MODERN AUTOMATIC
HEATING, VENTILATING AND
AIR CONDITIONING

able to building owners, operators, school officials, architects or engineers, without cost or obligation.

Minneapolis-Honeywell Regulator Company, 2804 Fourth Avenue South, Minneapolis, Minn. Branch and distributing offices in all principal cities.

MINNEAPOLIS - HONEYWELL

Gradutrol System
... OF PNEUMATIC CONTROL

ARCHITECTURAL RECORD

BUILDING TYPES

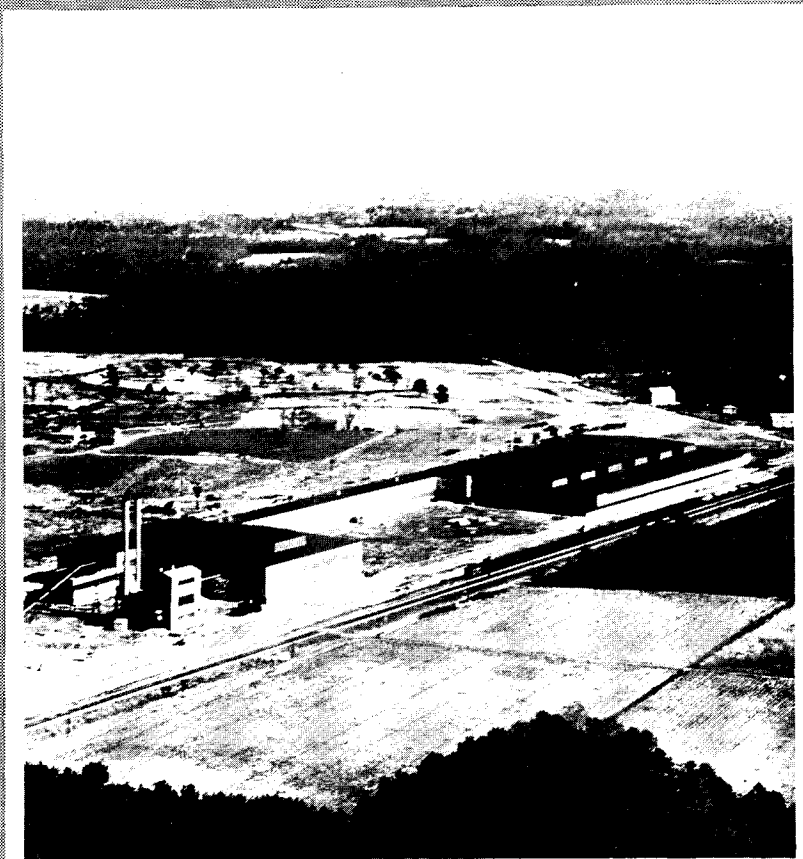

F A C T O R I E S

FORTHCOMING STUDIES: 1939—July, Houses; August, High Schools; September, Apartment Houses; October, Theatres; November, Houses; December, Hospitals. **PRECEDING STUDIES:**

1939—May, Houses; April, Retail Stores; March, Housing Developments; February, Elementary Schools; January, Restaurants.

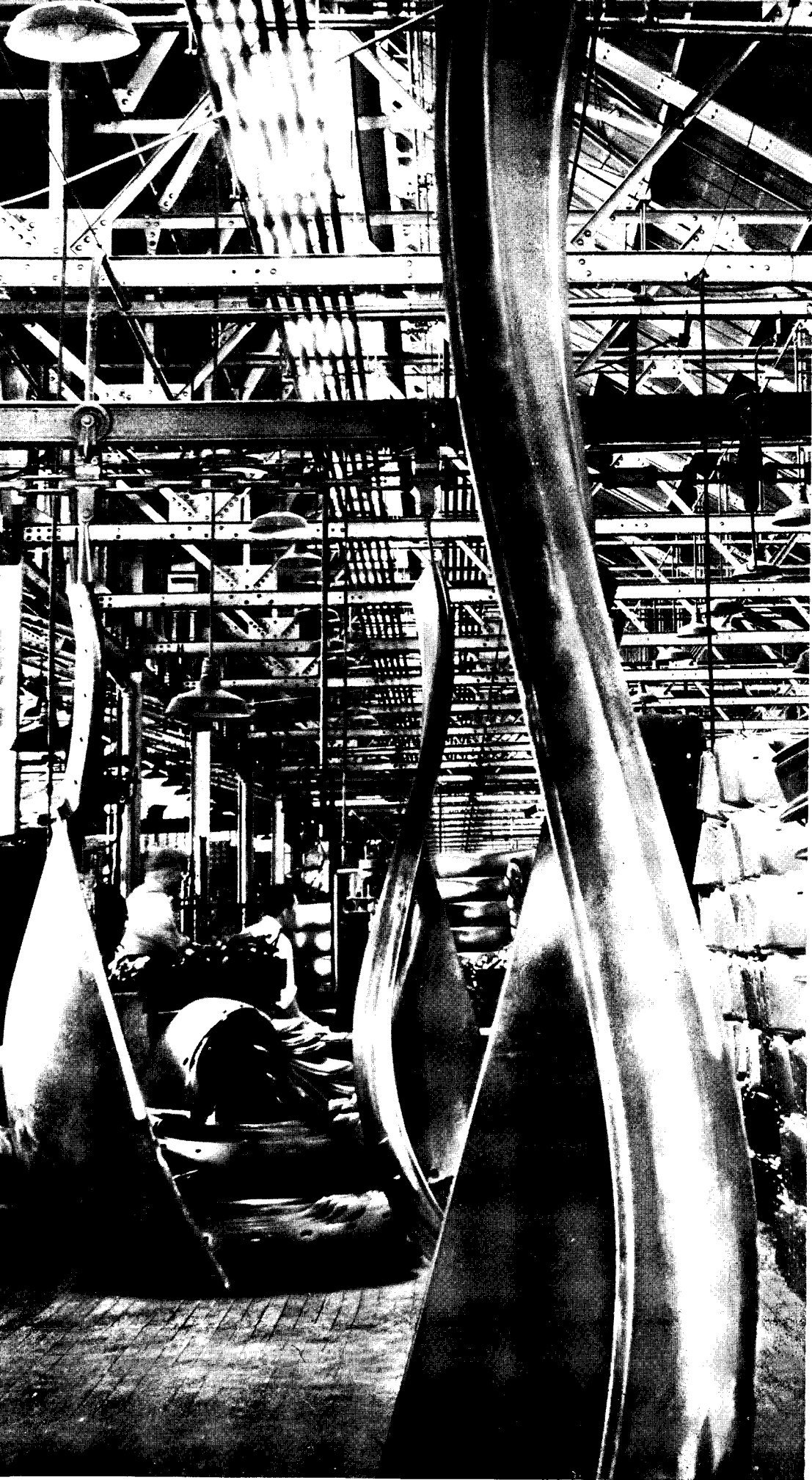

Margaret Bourke-White from Pictures, Inc.

INDEX

Performance Standards and Trends of Design.....	97-99
Current Practice in Construction	99-100
How Production Mobility Affects Design	101-102
Case Studies	103-122
Simonds Saw & Steel Company	103-109
Dodge Half-ton Truck Plant.....	110-115
Mutual Sunset Lamp Corporation	116-118
Johns-Manville Products Company	119-122

FACTORY BUILDINGS

A survey of trends in layout and construction with illustrated case studies of four recently completed factory buildings . . . For data upon which the accompanying text is based, particular acknowledgment is given to H. K. Ferguson, President, The H. K. Ferguson Co., Incorporated, Engineers and Builders; Dexter Purinton of the Mahony-Troast Co., Engineers and Builders; Walter H. Weiskopf, of Weiskopf and Pickworth; and Matthew Hiller, Jr., both Consulting Engineers.

Performance Standards and Trends of Design

FROM THE industrial point of view a modern factory is just as truly a means of production as a press, lathe, drill, or any other manufacturing device. Its purpose is simply to provide working conditions under a control sufficient for the economical and efficient organization of men, materials, and machines, in terms of a specific manufacturing program or production process.

Thus, the success or failure of any factory design can be measured not by its adherence to, or departure from, any esthetic standard, but by the extent of its contribution to the orderly and profitable operation of a manufacturing enterprise.

Because industrial activities vary so widely in size, character, and technical requirements, it is virtually impossible to set forth rules for factory design that will hold true in the majority of cases. It is true that "standard factories" exist; and these could be easily cataloged in terms of standardized dimensions, construction details, equipment units. But they fit the needs of a relatively small part of industry and do so only because their designers have compromised desirability to expediency in terms of averages and rigid economy. They are produced primarily for small enterprises as light machine-shops, repair shops, small shaping mills, etc.

At the other end of the design scale are those plants for industries so highly specialized in technical requirements that they necessarily adhere to no standards of design. Such are found

largely in the process industries—chemical plants, oil refineries, rough-forming mills, ore-reduction plants—and in heavy manufacturing activities that require ponderous reducing, forming, and handling equipment.

Between these two extremes lie industrial requirements that control the design of most factory buildings with which an architect is concerned. But here again the category is too broad to permit anything but generalization, except in terms of the standards of performance, which reflect characteristics commonly desirable in factories for all types of manufacturing.

These might all be summed up, or at least suggested, by the phrase "Build the plant around the process" which is a brief method of stating the desirable objective of a factory design. It is too brief, however, for it hides a number of important criteria which form the basis for plant layout, construction, and equipment.

1. OPERATING EFFICIENCY

As a means for production a factory must permit an arrangement of manufacturing equipment that will conserve area, save time during each manufacturing operation, and promote the smooth flow of production from raw materials to finished product.

This implies the necessity for carefully prepared flow diagrams based upon both a production process and manufacturing program and geared to physical limitations of site characteris-

tics (as topography, transportation means and locations, orientation for daylighting). Such a flow diagram will largely determine the plant layout relative to receiving, storage and shipping areas, working spaces, service areas, and offices. It will determine column spacing, truss spans, clear heights, number of floors, required loadings, extent of interior conditioning required (as heating, air conditioning, sound isolation, lighting) and will serve as a preliminary basis for development of both structural and mechanical systems.

There appears to be no "best practice" in setting up standards of these technical requirements. Those standards are best for any given manufacturing organization which establish a means of facilitating the most economical and efficient production.

Trends are toward mobility of continuous process; stability of labor; constant improvement in products that tend to simplify manufacturing processes and alter production flow; a horizontal flow (one story) rather than a gravity flow (multi-story); labor specialization and departmental organization.

2. FLEXIBILITY

A cardinal principle of modern factory design is susceptibility to easy alteration, enlargement, or demolition. Obsolescence is an important factor of most manufacturing enterprises. Improvements in methods or machines



Wide column spacing—40 by 60 ft.—leaves floor space unobstructed and promotes flexibility in plant operation. By designing roof beams as cantilevers over supporting columns the weight of structural steel per sq. ft. is no more than would be required if column spacing were 40 by 30 ft. Picture shows part of the interior of the Dodge Truck factory in Detroit for which Albert Kahn, Inc., was architect and engineer.

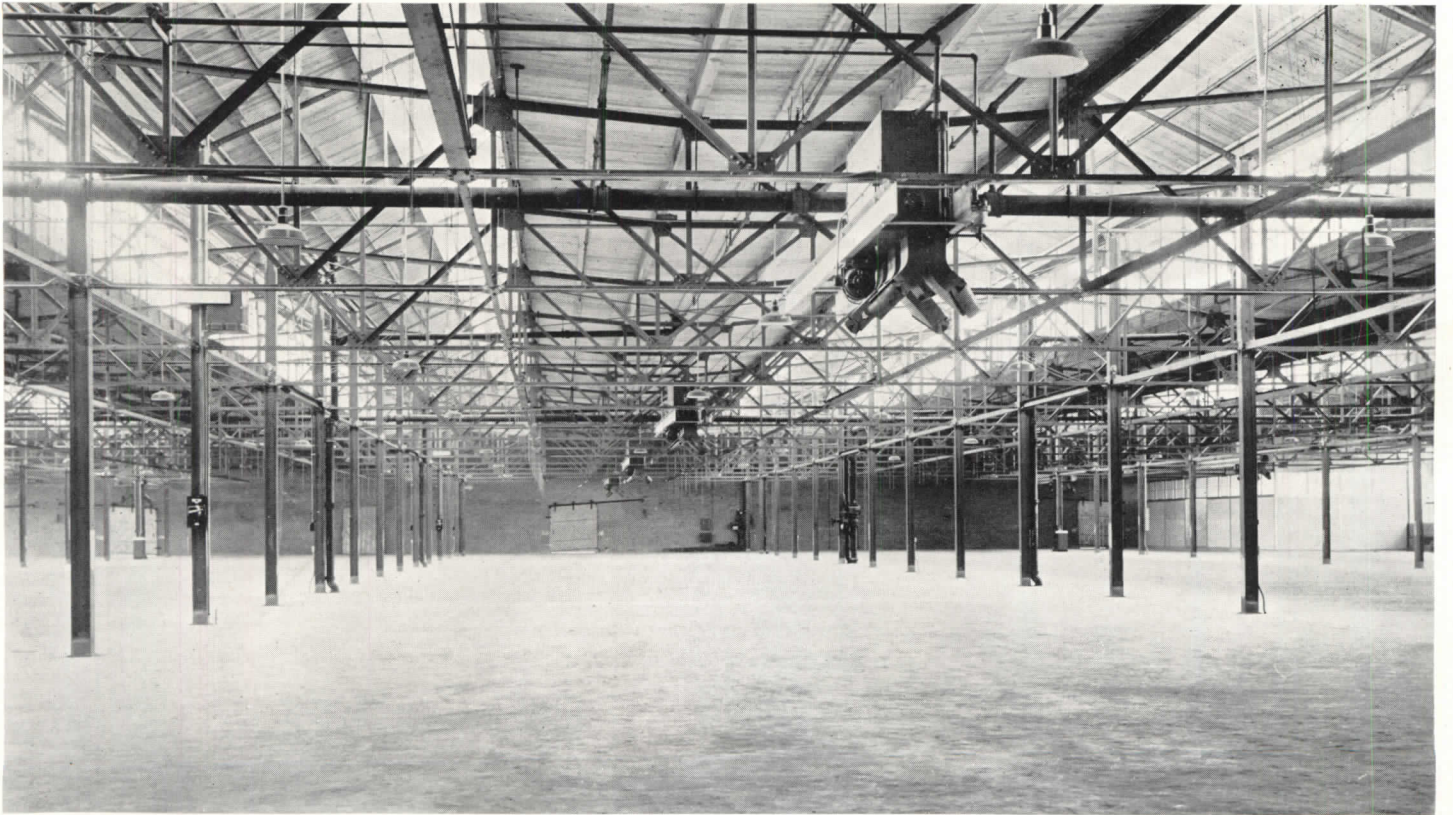

A wide one-way span employing a more conventional type of structural framing. Even distribution of daylight from monitor sash results when the monitor is 2.4 times the width of the valley bay measured at the top of the monitor. The interior of the Star Box and Printing Company plant at Chattanooga, Tenn. The H. K. Ferguson Company, engineers and builders.

tend to eliminate or combine operations. The result may be a radical change in the process of production which may even render the factory building itself obsolete as an economical and efficient plant.

Conversely, physical growth must be coordinated with existing facilities. Beyond the point where an acceleration in production flow can be absorbed by mechanical improvements or the re-routing of operations, plant expansion is necessary. The design must permit additions to care for such expansion without interruption of any currently essential operation.

Trends relative to layout are toward long spans, a succession of large uniform bays, segregation of administrative areas along a permanent wall to permit expansion on three sides, central locations for toilet and equipment-control rooms, the least possible obstruction of floor areas for manufacturing, uniform lighting (natural or artificial) in all parts.

Relative to construction, trend is toward uniformity of members (columns, trusses, sash, etc.) and simplicity of assembly to facilitate economical and speedy erection and demolition, prefabrication of large subassemblies by welding, use of cantilevers to increase bay dimensions, suspended construction for toilet and equipment

rooms, movable partitions for interior subdivisions.

3. WORKING CONDITIONS

However highly mechanized a manufacturing process may be, labor is still regarded as a highly important part of that process. Experience has indicated that maintenance of comfort conditions involving heating and cooling, air purification, ventilation, lighting, sound control, fire protection, and other safety measures contributes in large degree to labor's efficiency. Consequently, these are factors of factory building design which may aid economical and efficient production.

To what degree it is feasible to provide *ideal* comfort conditions remains a question which can be answered only in reference to a specific manufacturing problem. Theoretically ideal standards for all these factors have been established and widely published. But, so far as is known, no inclusive research has been completed to ascertain how these can—or should—be adjusted to increase individual efficiencies in view of workers' tolerances to occupational conditions (noise in a stamping mill, for example, or high temperatures in a heat-treating plant). One of the few new plants in which complete conditioning has been attempted has not been operating long enough to make data available on the basis of practical experi-

ence. (See Simonds Saw plant, page 103).

Provisions for employee recreation as rest rooms, game rooms, auditoriums, playfields, lunch rooms—and for personnel training and maintenance as class, demonstration, and training rooms, locker rooms, clinics, first-aid stations, stores, and the like—are subject to decisions based on a number of variables. Again, theoretically, an enlightened labor-relations policy might include them all. Practically, however, size of plant, type of product manufactured, plant location, character of personnel, and rates of payment all are factors to be considered.

Trends, relative to conditioning systems, are toward more adequate control of air temperature and humidity, dust control, and ventilation, which implies increasing use of air-purification methods. In lighting, the trend is toward relatively high level of general illumination (15 to 30 foot-candles) by daylight from sawtooth, inclined, and vertical monitors, and from side walls combined with artificial lighting from suspended fixtures. Sound control is increasing as a design factor of importance, and the trend toward provision of completely adequate safety systems (fire protection, non-slip surfacing, local spot lighting, machine guards, color identification) is marked.

Current Practices in Construction

INNOVATION in the technique of factory construction—structural design, and methods of fabrication and field assembly—have resulted from intensive efforts to reduce costs and at the same time improve plant efficiency. The following paragraphs note construction practices that have proved their worth as means of reaching these objectives. They deal with: 1, Framing; 2, Roofs; 3, Walls; and 4, Floors.

1. Framing: Uniform bays are economical and provide a desirable flexibility in plant operation. They permit shop fabrication of typical subassemblies (in steel) on a mass-production basis; field erection becomes a repetitive routine. Time and labor are both saved, and expansion involves merely addition of standard framing units.

Welding—and flame-cutting—facili-

tate fabrication, simplify design, develop advantageous new designs ("tree form" rigid framing, drop-frame, monitor truss, "portal truss," "column-beam") characterized by simplicity of connection, weight reduction, ease of maintenance.

For over-all economy, typical bays are best designed with reference to space and loads of both plant and process equipment, as well as for structural adequacy. Thus, columns and trusses must often bear added weight of crane booms, conveyor-equipment supports, pipe runs, heating elements, and may be employed, also, as rigging holds for machinery installations. Trusses should be designed for a 4,000-lb. concentrated load at any panel point to accommodate conveyor loads, transient hoists. Economical spacing of sprinklers, light and power outlets, present and future

pipe sleeves is a factor of design.

Vibration may become important structurally, particularly in long-span construction. To avoid serious deflection due to harmonic vibration, structural unit weights can be varied—as a 30-lb. I in one bay, a 40-lb. I in an adjoining one, etc. In addition bracing—especially in long rows of straight wall—and use of knee angles and X-tie rods may be necessary.

In large factories expansion joints must be provided. Tendency is to set roof steel on steel columns instead of masonry to permit expansion-slip-joint and to speed erection and demolition.

2. Roofs: For light loads—up to 120 lbs.—typical roof panels range from 25 to 30 ft. square and for heavier loads—up to 250 lbs.—from 20 to 24 ft. square. This implies one or two in-



Under-floor installation of utility ducts and pipes allows greater flexibility in the economical layout of machinery and material-handling equipment.

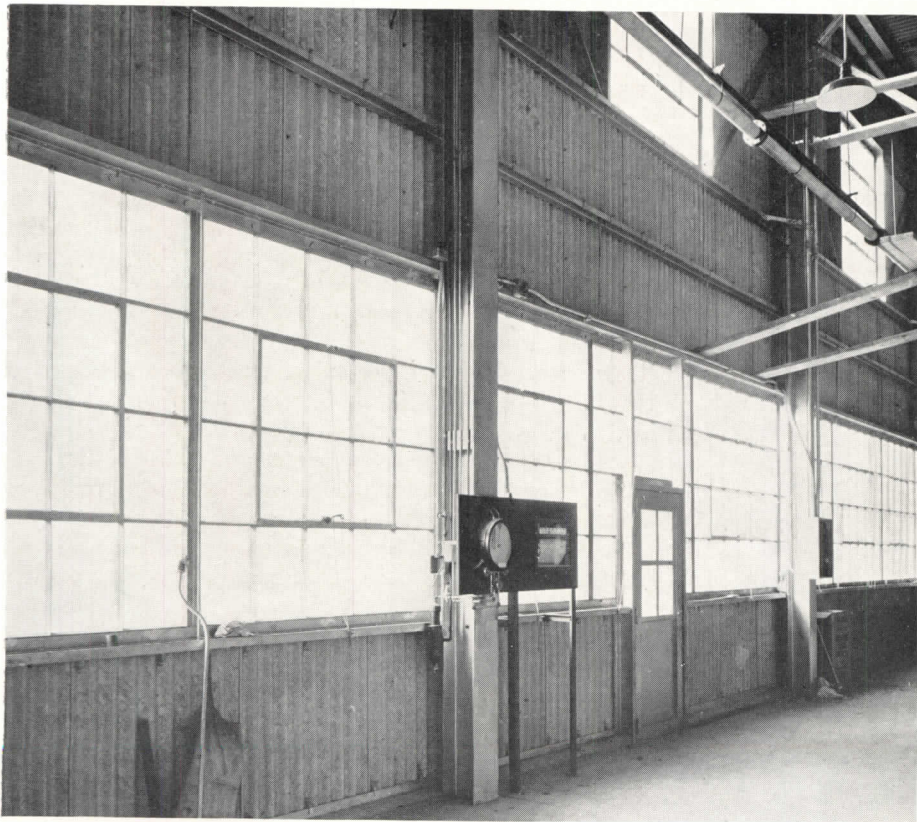

Curtain wall of corrugated asbestos attached to a light steel skeleton frame—a type of low-cost construction satisfactory for buildings in which thermal insulation is not essential.

intermediate roof trusses and purlins for a column spacing of 60 ft.

Roof framing is chiefly steel—invariably so in the case of large floor areas that require monitors. For coverings, wood plank is widely used because of low cost, but use of precast gypsum and light weight, precast concrete units is increasing since resistance to fire and low maintenance costs are inherent qualities of these materials.

Corrugated asbestos, steel sheets, and preformed steel panels are widely used for low-cost buildings. The last two must be heavily insulated to prevent condensation and require periodic painting to prevent corrosion. Most factory roofs are being insulated today as a matter of course, mostly with sheets of rigid fibreboard or cork from ½ in. to 2 in. thick depending upon prevailing local plant and weather conditions.

Smooth finished roofs—without slag or gravel—are becoming less common than formerly; and use of white limestone chips as a finish to reduce effect of solar heat is increasing, also the use of mastic for flashing. So is acoustic treatment of ceilings; and although not yet common practice, ceiling surfacing of porous refractory material is being used to absorb noise in special cases. White is the most commonly satisfactory color for ceilings for it has a reflection value of 85 to 90 per cent.

3. Walls: Foundations are normally of poured concrete, frost cut-off walls being 3 to 4 ft. deep, and 8 to 10 in. thick with pointed ends. For heavy loads, 2- or 2½-ft. steel caissons have been used. They are driven to rock by an oil-well drilling technique and a socket drilled into the rock. Caissons are then filled with concrete, using a steel-column section as a core resting in the socket. Such construction can support 750 tons on a single caisson.

Walls are commonly of curtain construction to speed erection and permit economical alteration or demolition. Wall base—often to window sills of first floor—is frequently of concrete above grade or of masonry units glazed on the inside to reduce cost of maintenance. In some instances exterior columns are covered with glazed brick or clay tile to the window head. For low-cost buildings or those subject to continual alteration, lightweight sheet cov-

crings such as corrugated asbestos are satisfactory.

Use of steel sash with pivoted or projected ventilators is current practice for factories that are not air-conditioned. In areas housing paint shops, inflammable stores, or special processes, explosion sash should be installed.

Choice of glass depends upon interior conditions, type of process, orientation. Ribbed factory and wire glass is employed in side walls, skylights, and monitors because of low-cost and as a means of reducing fire hazards. However, use of glass blocks and non-glare glass of special composition to reduce transmission of solar heat is increasing.

Partitions are increasingly of the movable type except enclosures for dirty, noisy, or dangerous operations. They are seldom as high as the factory ceiling, do not usually exceed 8 ft. in height and are joined with a separate ceiling when complete enclosure is required. Borrowed light is common practice, as is use of obscure glass to facilitate cleaning and assure privacy.

Interior plastering is being supplanted by use of pre-finished wall and ceiling units in office areas and by ma-

sonry, painted or pre-finished (as glazed brick or tile) in such areas as toilet and equipment rooms.

4. Floors: Concrete is generally accepted for factory floors because of relative economy. But increasing attention is being given to reinforcement, metallic hardeners, liquid sealers, and special treatments of finished surface according to the character of its use under plant-operating conditions. For heavy trucking, concrete must either be hardened, or laid with armored-gird reinforcement. And no concrete should be used at all if floors are exposed to chemical action—particularly acid action. Expansion joints—of great importance—should be from 50 to 60 ft. on centers and should have metal edges to prevent spalling.

Hardwood strips, edge-grain wood blocks, linoleum, coatings of mastic and magnesite compositions are increasingly employed because they are resilient compared to concrete. They are applicable to a wide range of factory installations where movable traffic is relatively light. Wood blocks, however, have proved satisfactory under heavy-

duty conditions. Maintenance is a factor of selection for all types of floor materials; and choice ought to be governed also by the type of manufacturing activity involved.

Construction of floors for single-story factories tends to become increasingly simplified. Floor fill is being eliminated or kept to absolute minimum in many cases. This holds particularly for factories that are subject to constant alteration of process and where pipes, wiring, etc., must be exposed to facilitate required modification.

For light floor loads—up to 120 lbs.—use of precast slabs of gypsum or concrete is increasing. Such construction can be finished with linoleum, cement, or hardwood strips. In multi-story buildings an economical and generally satisfactory floor consists of 2-, 3-, or 4-in. planking—depending on load requirements—laid over beams spaced 5 to 8 ft. apart. Finish is normally hardwood strips, but can be linoleum. Wood strips are preferably laid along the direction of travel.

When metal is to be used for platforms, sills, stair treads, etc., a non-slip characteristic is essential.

How Production Mobility Affects Design

BECAUSE THE principle of "mobility of process, stability of labor" is such an important factor of modern industrial production, means for promoting such mobility exercise a certain degree of control in the design of a factory to house a specific process. These means, in general, refer to the layout of manufacturing tools relative to a production process and available space. More specifically, they concern devices for handling raw materials, parts, and finished products in orderly sequence; and to the extent that use of such devices contribute to production efficiency the factory designer must make provision for their installation.

This implies the desirability of technical collaboration of building designer, plant engineer, and handling-equipment specialist, notably at the early stages of the entire design procedure. Industrial experience has shown that solution of the materials-handling problem has a direct bearing upon process organization, which in turn may importantly

affect the layout, construction, and equipment of the factory itself.

A mobility system must necessarily be developed relative to specific conditions. For example, one type of production might flow from top to bottom of a plant; another might flow in the opposite direction; in a third a combination of up-and-down flow might prove most efficient. Again, a horizontal flow might prove best in a circular arrangement or in a straight-line progression. The production system may require trucks, cars, chain, belt, slat or roller conveyors, chutes, tubes, boosters, elevators, travelling hoists, or other handling devices. Thus, design criteria can be stated only in general terms.

Trucks: Whether manually operated or power-driven, trucks require wide, relatively straight traffic lanes and turning areas, both well lighted and located in relation to receiving, shipping, or storage areas and to manufacturing areas

to permit shortest-possible travel distances and to prevent interference with production lines. Floor surfaces must be smooth and rugged (steel, hardened or armored concrete, wood block) without inclines greater than 15 per cent.

Overhead conveyors: Floor space may be required when conveyors are fitted with various types of carrier trays or are used for moving large parts—as automobile fenders—in a factory with low ceilings. Installations can be suspended from beams or truss members, or can be supported from floor standards and wall brackets. Load factors are not important except in rare cases; but locations relative to operations to be served, presence of building equipment elements (heating units, air ducts, water and sewer pipe power conduits, etc.) and structural characteristics are all factors of production-flow design.

Floor or table conveyors: These require floor area, but often can be so effi-

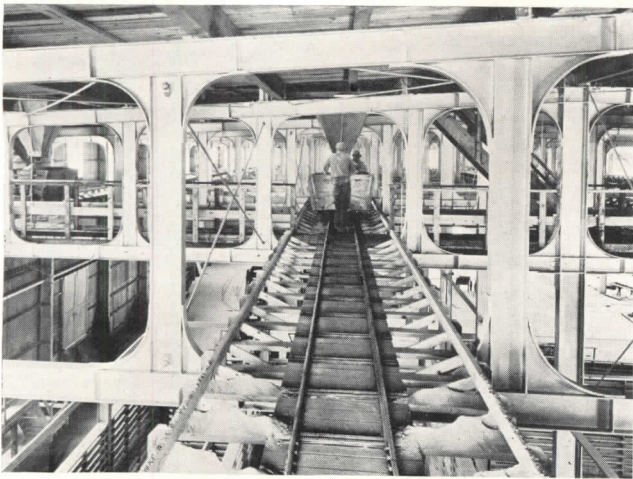

Courtesy, Austin Co.

Cars travel through openings of an all-welded, rigid-frame "portal truss" to distribute raw materials in a fertilizer plant.

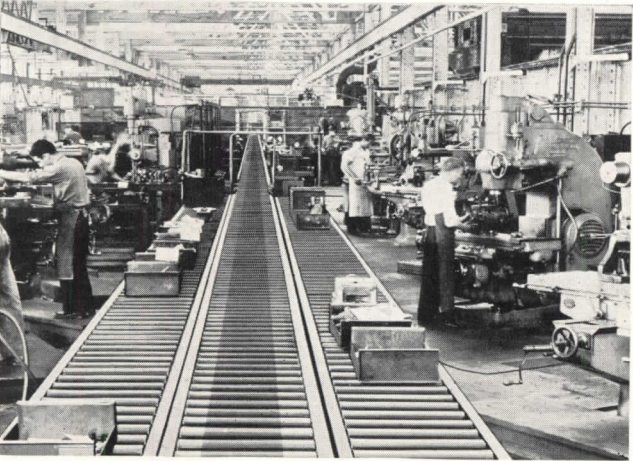

Courtesy, The Lamson Co., Inc.

A live-roller conveyor in the center carries parts of electric motors between distant machine operations of a large plant. Flanking conveyors simplify straight-line handling of parts requiring a succession of related operations.

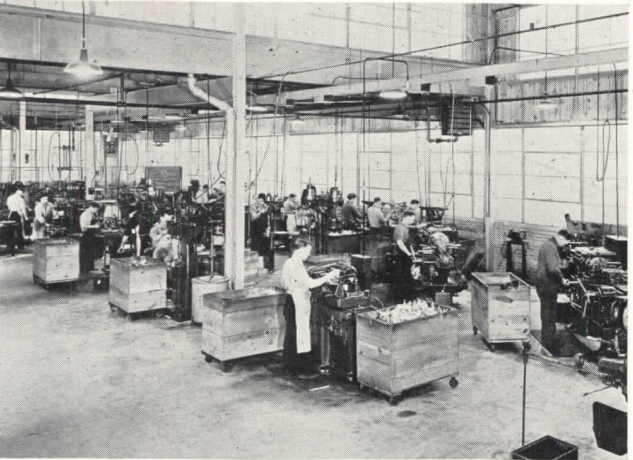

Courtesy, Austin Co.

In a small plant parts can often be trucked to and from machines without loss in operating efficiency, as in this factory for the manufacture of portable power tools.



Courtesy, The H. K. Ferguson Co.

In this assembly plant the product—a calculating machine—is itself movable. Small parts are trucked to operators in boxes. The product is easily moved by hand through a series of assembly operations.

ciently related to operations—as material receiving, machinery of various sorts, assembly, storage, and shipping—that a net saving of floor space may result.

Conveyors are an extremely flexible method of moving materials or products. They can be linked with vertical boosters to serve an up-flow system or installed at an incline to coordinate multi-floor manufacturing operations which involve both an up and down production flow.

Chutes: Limited to a gravity flow, both floor area and special construction may be required for an efficient installation. Technical experience is also necessary to conserve space and control speed of flow relative to the type of product manufactured and the production problems involved. Spiral chutes have been installed to a height of 12 stories. Multiple chutes within the same enclosure save space and permit links with separate conveyors. In addition such spiral chutes have value as a storage area in some plants. In a Buffalo, N. Y., biscuit plant, for example, a day's run of one machine can be stored on one line of a 7-line spiral be stored on one line of a seven-line spiral chute.

Tubes: Application of tubes for material handling is largely confined to plants using loose, bulk materials such as food- or beverage-processing and cosmetic plants, and in instances where gravity flow is practical. Installation involves careful collaboration of designer and engineers to provide satisfactory slopes, lengths of runs, adequately large curves where necessary, and proper locations relative to materials and process involved.

Combination of one or more devices is usually necessary to develop the high degree of production mobility required in most modern factories. Selection must be governed entirely by specific requirements and by the general rule that simplicity of operation and design tends to produce an increase in overall plant efficiency. The remarkable organization of space and equipment; the split-second coordination of materials and manufacturing devices; and the speed by which complex products are made generally available through mass production are the results of planning. Adequate provision for time- and labor-saving handling devices, skillfully engineered in terms of a specific manufacturing problem, constitutes an important phase of such planning.

EFFICIENT MEANS FOR MASS PRODUCTION

Case studies of four recently completed factories



Rollin W. Badley

CONTROLLED ENVIRONMENT IN WINDOWLESS PLANT FOR SIMONDS SAW & STEEL CO.

Fitchburg, Mass.

The Austin Company, Designers

THE SCIENTIFIC superiority of artificially controlled environment furnished the basis for designing this completely windowless plant. Air, light, heat, humidity, and sound are all regulated to provide the best attainable working conditions for employees, and a maximum of efficiency in manufacturing processes.

Although begun in 1931, the Simonds plant has just been completed, due to business depression. The factory is laid out for straight line production with the greatest possible number of

operating hours. From one to four productive shifts may be used; with normal requirements, two 8-hour shifts are planned, from 7 A.M. to 11 P.M.

Several advantages result from having machinery idle only 8 hours (as against the usual 14 to 16 hours) per day. Plant and equipment investment is lowered. Machines, being fully utilized, can be depreciated on a "wearing-out" basis, rather than a costly "obsolescence" basis. Coupled with effects of controlled environmental con-

ditions upon labor, this nearly continuous operation increases production both per man-hour and in total.

Eight major, straight production lines extend the length of the plant, for the manufacture of many types of saws, points and shanks, machine knives, files, hack-saw blades, and the like. Careful attention to space conservation has resulted in the consolidation of three old plants, covering a total of 17½ acres, in the new 5-acre plant, with almost an acre to spare.



Rollin W. Bailey

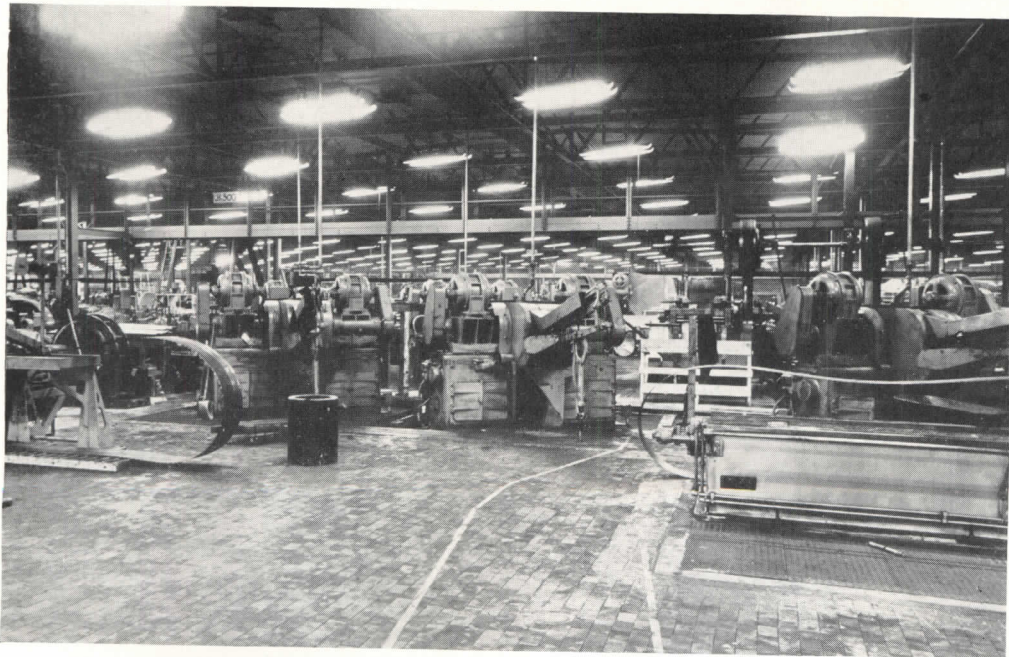

Above, one of the production aisles: Raw materials enter at the far end, are processed in the middle distance, packaged in the foreground. Production is supervised from suspended walkway at upper right of picture. Left, view across several production lines. Flooring materials vary according to the needs of the process.

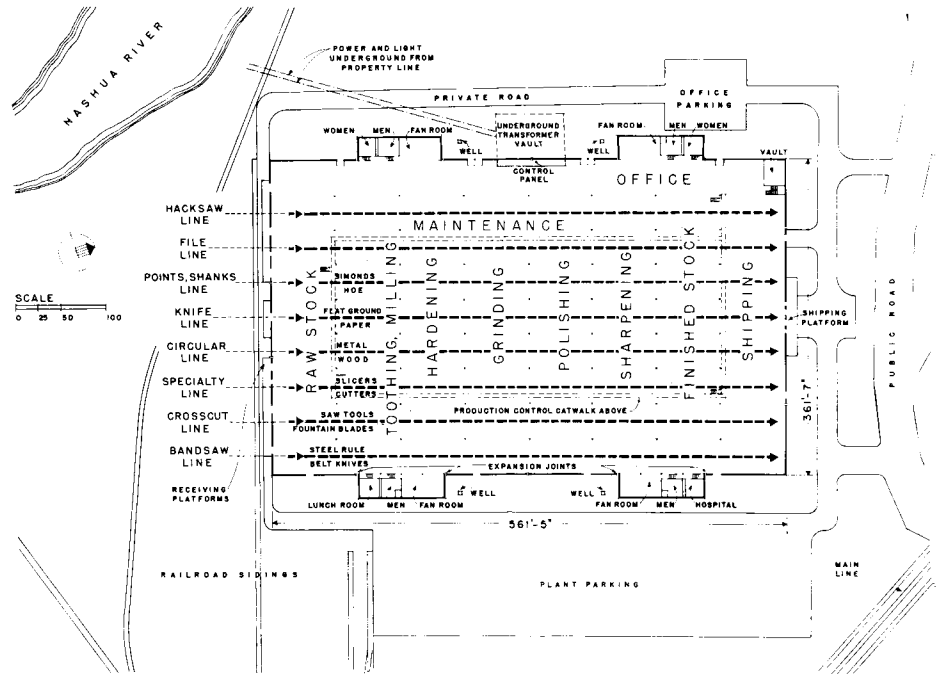

PRODUCTION-LINE LAYOUT was the principal factor which governed structural-system layout. Every operation was analyzed; functions of every employee and piece of equipment was studied. The management estimated that each unnecessary interior column wastes approximately 42 sq. ft. of machine space; hence, interior columns number only 56, as contrasted with approximately 1000 required in some comparable factory structures.

The 70- by 40-ft. column bays thus obtained provide aisles 70 ft. wide for the eight parallel production lines, each furnished with water, gas, steam, power, light, air, and oil carried directly to more than 1000 machine and furnace locations. Production has been so coordinated and services so simplified that only 3 or 4 telephones will be used in the entire plant; no public address system is contemplated; and the use of conveyors is minimized.

Right: The catwalk from which production is supervised is suspended 11 ft. above floor, is 4 ft. wide and 1/4 mile long. Note that overhead lines are limited to those which could not be placed elsewhere: sprinkler and water supply piping, roof-drainage line, electrical conduit. Curved duct at left is pneumatic tube from office space to order-filling area.

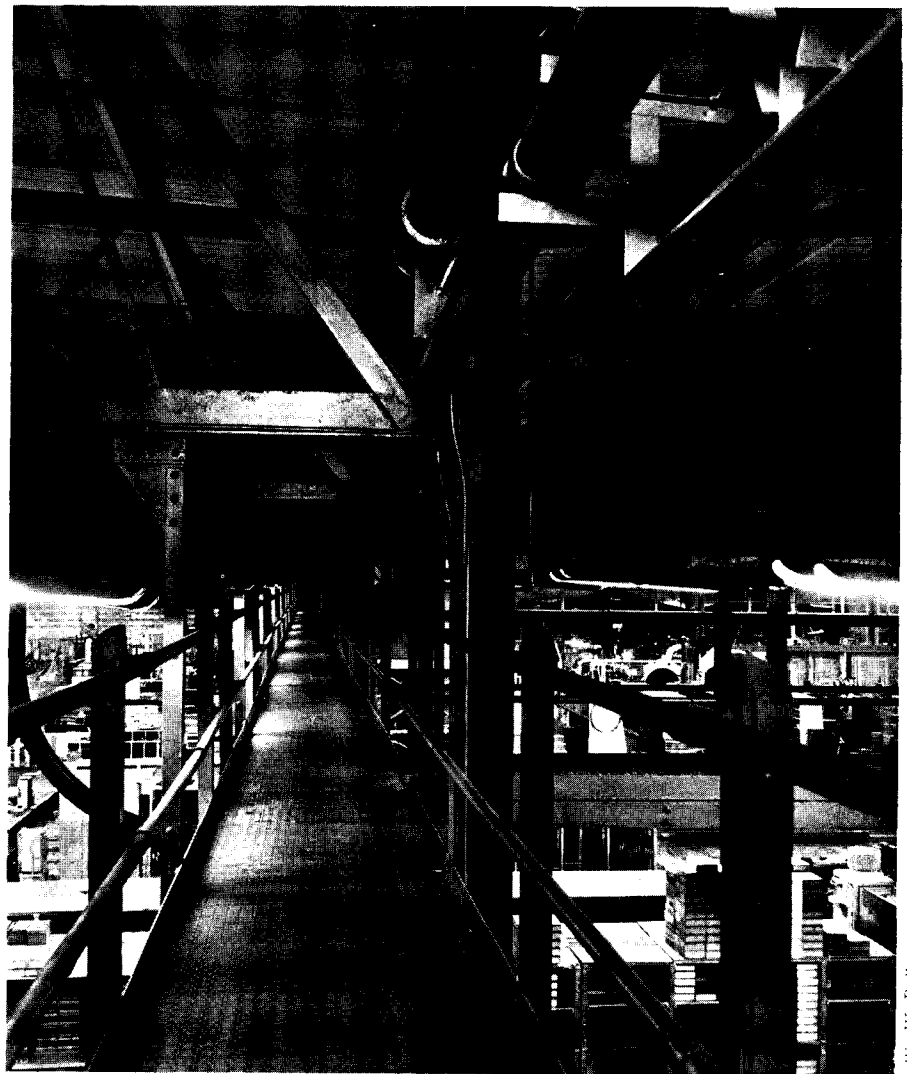

Rollin W. Bailey

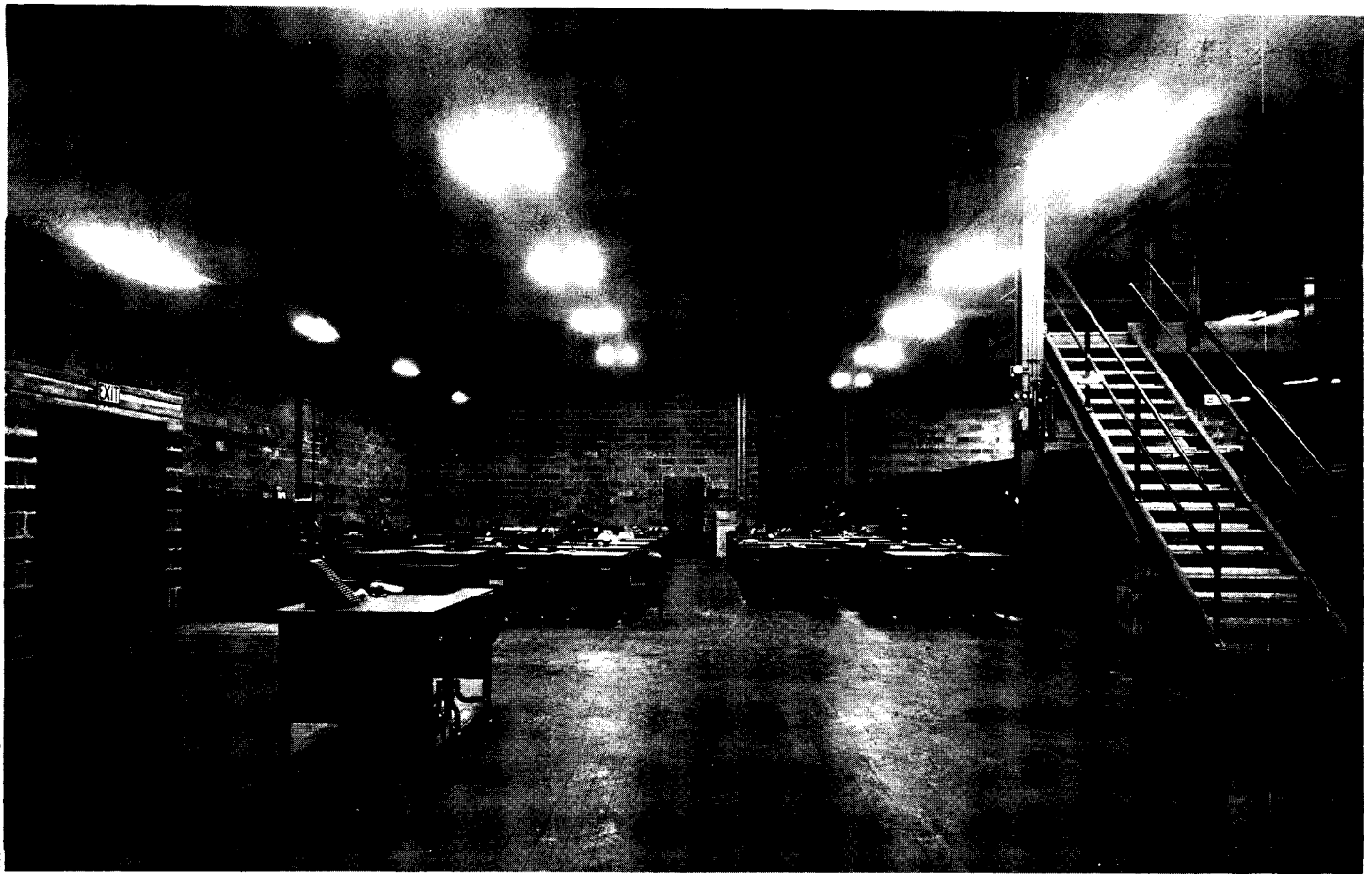

Kedlin W. Bailey

TYPICAL UNDERFLOOR FLUES

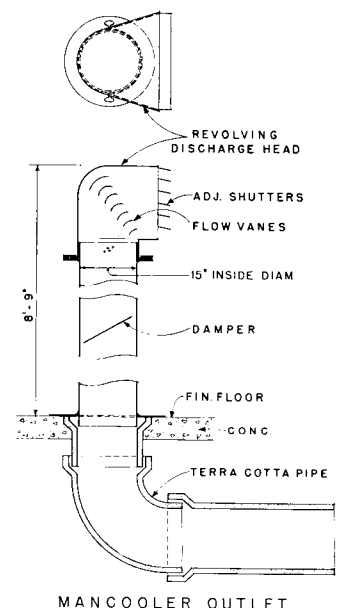
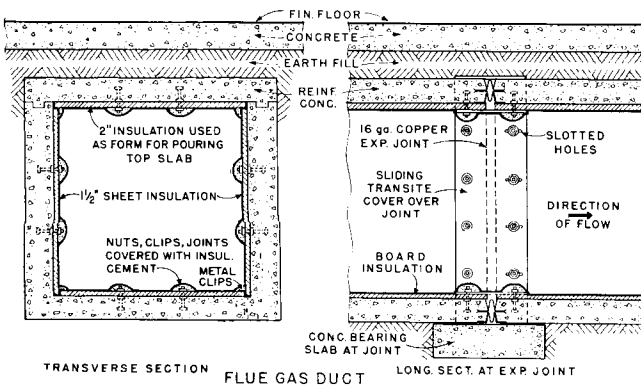
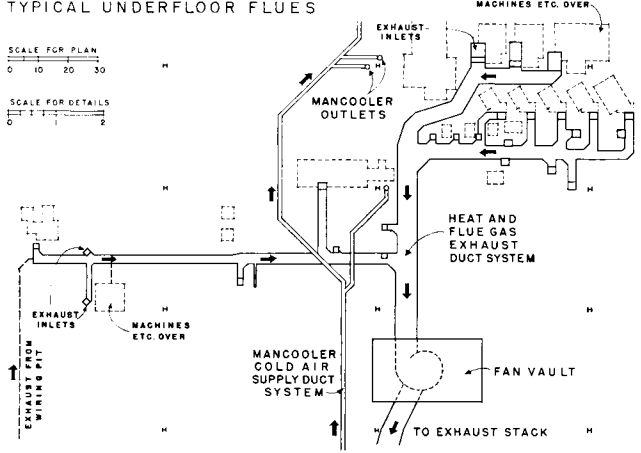

Above, offices; the Simonds plant is said to be the first in which furnaces, ovens, and other processes are operated under the same roof as offices without any separating partitions. At left, plan of a portion of flue-gas removal and mancooler systems, and details.

ATMOSPHERIC CONTROL was complicated by the presence of many heat- and dust-producing units. Systems devised are of four types: *Air Conditioning*, involving the usual factors of air motion, tempering, humidifying, and cleaning; *Flue-gas Removal*, which takes care of heat and gases generated by heat-treating furnaces, annealing ovens, tempering tanks, etc.; *Mancooling*, which supplies blasts of cool air to furnace operators; and *Dust Removal*, which catches dust from grinding and sharpening machines at the point of origin.

The air-conditioning system is of the evaporative condenser type with a capacity of approximately 400,000 cu. ft. per minute. Four fan rooms are located in the wings, adjacent to each of which is an artesian well which supplies cooling water. About 3,000 linear feet of overhead ducts are required. Toilet rooms located in the same wings are conditioned by air drawn from the plant and exhausted outdoors.

The flue-gas system, detailed on the opposite page, consists of hoods which trap heat at the source, and insulated concrete ducts under the floor which convey heat, fumes, and smoke to exhaust stacks located in three of the four wings. In addition, some batteries of machines have over them metal canopies, extending from the ceiling down to bottom chords of trusses. These are exhausted directly through the roof.

The mancooler system, also detailed on page 106, consists of terra-cotta tile laid beneath the floor, which deliver cold air to points from which heat cannot be removed quickly enough to maintain comfortable local working conditions. Outlets are sheet metal, above head height, and are adjustable both as to amount and direction.

The dust-collecting system is more or less typical of similar installations in other plants, except that it is also exhausted through ducts located beneath the floor. These ducts are of galvanized sheet iron inclosed in tile. Dimensions of the pits and length of the sections of galvanized duct have been coordinated to permit easy replacement.

Photos: top, light-colored pyramidal hood at left, and circular stacks at right, serve the flue-gas system. Lower portion of a typical canopy is visible across top of picture. Center: typical fan room and overhead air-conditioning duct. Bottom: typical dust-removal inlet.

Rollin W. Bailey

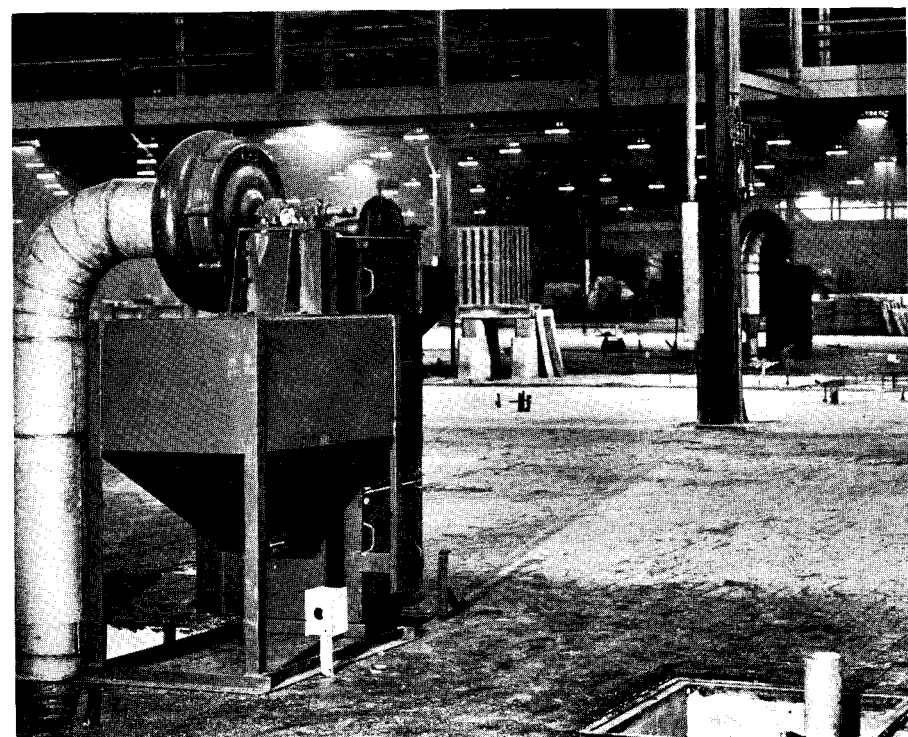
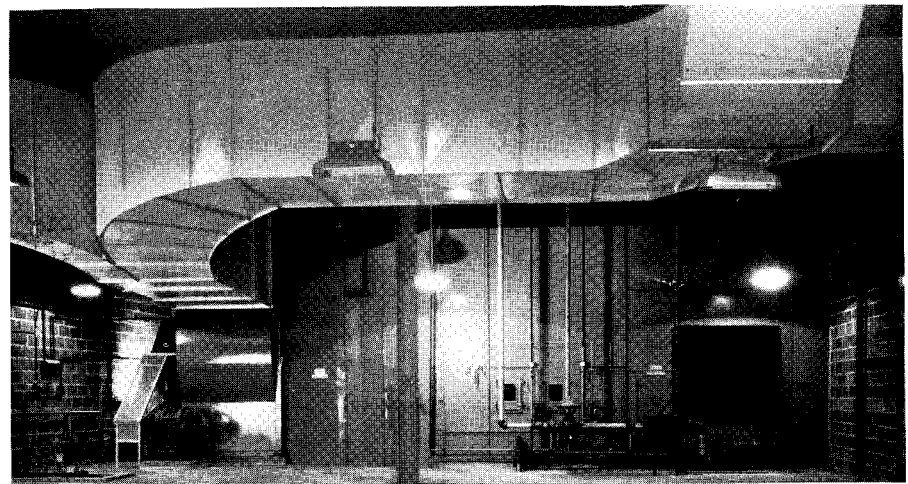



Above, 100-w. Cooper-Hewitt fluorescent lamps installed in pairs. Below, underfloor power duct; all risers run up columns. System provides maximum flexibility and frees overhead space of wires, etc.

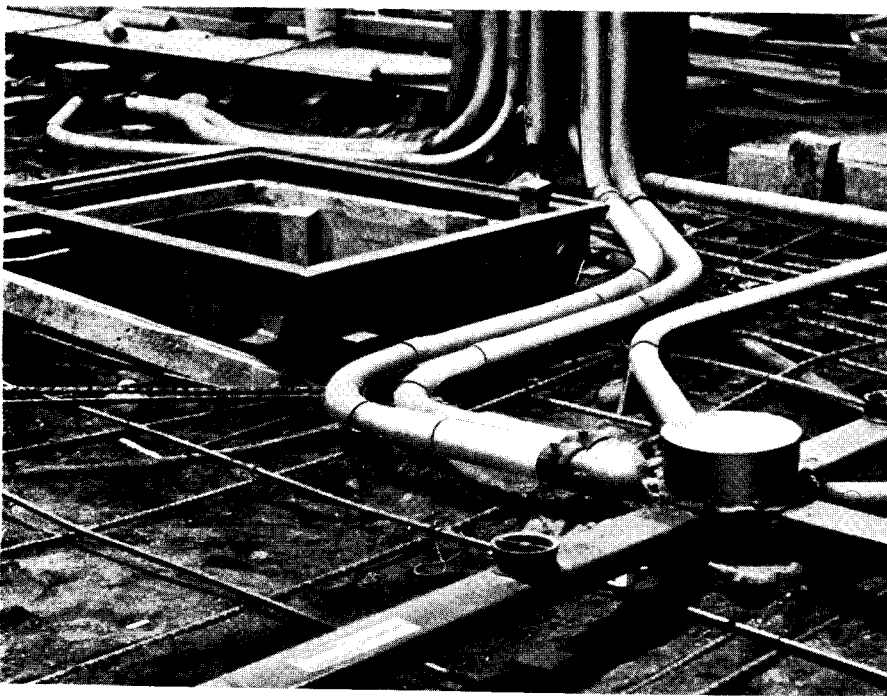

SINCE DAYLIGHT is excluded, lighting was carefully studied. As first planned, 650-w. industrial units were used; before completion, 100-w. Cooper-Hewitt fluorescents replaced previous fixtures. These are mounted on 14- by 20-ft. centers, 16 ft. high, and provide 20 footcandles.

Underfloor power ducts are on 10-ft. centers. Outlets equipped with magnetic finders are at 2½-ft. spacings.

Plant's connected load of 6,000 H.P. is controlled through a 66-ft. main switchboard; outside is a transformer vault, to which lines run underground. Power is supplied at 13,500 volts, 3-phase, by the local utility company. An independent Diesel plant in the Simonds File Co. across the Nashua River supplies 2,300-v. 3-ph. auxiliary current which can operate lighting and air conditioning units; 48-hr. emergency lighting is provided by an automatic storage-battery system.

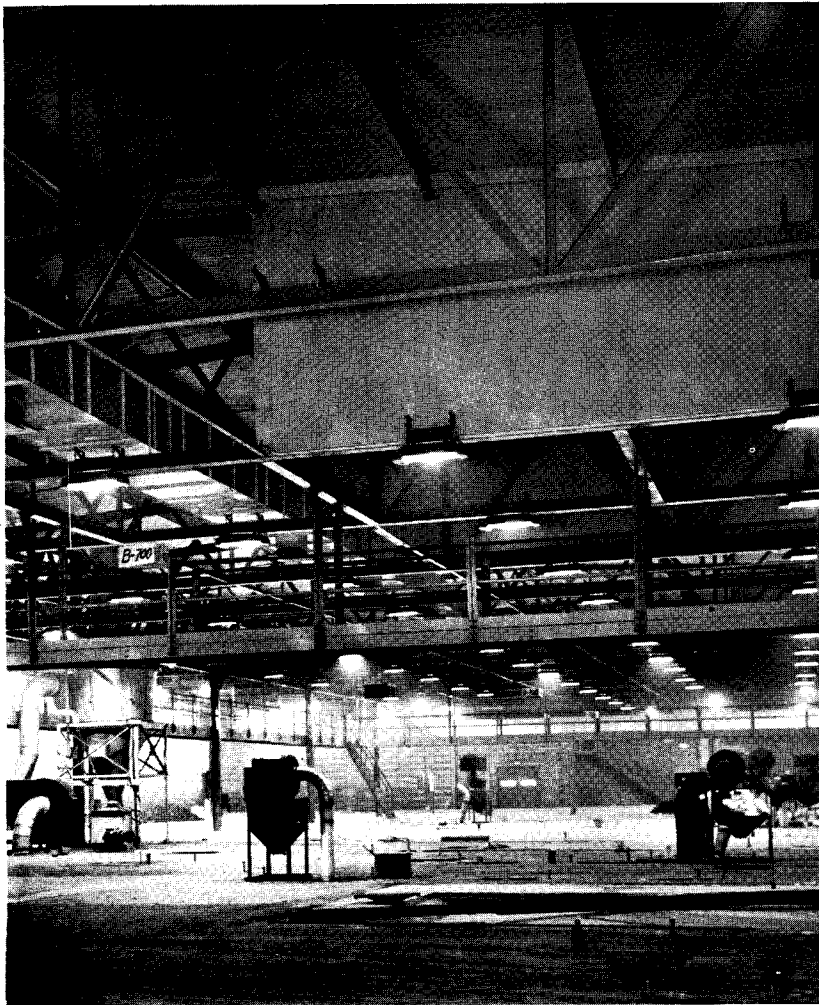

Interior, before machines or new fluorescent lighting were installed.

Framing is steel, entirely welded, with 70- by 40-ft. column bays. Size of structure necessitated use of many expansion joints. Floors are creosoted wood block in some areas, hardened cement in others, depending on proposed usage. Construction provides for absorbing about 60% of sounds generated. Walls have cinder-block backing, roof is acoustic type (see detail), and machines are cushion-mounted to absorb vibration and noises. Estimated labor-efficiency increase due to these precautions is 35%.

Safety provisions include push-button operation of all equipment, elimination of as much overhead wiring and ductwork as possible, and use of aluminum and yellow paint on machines to increase visibility. Methods of construction and of supplying services reduce fire hazards to a minimum. Sprinklers are needed in only one small area, including offices and packing department.

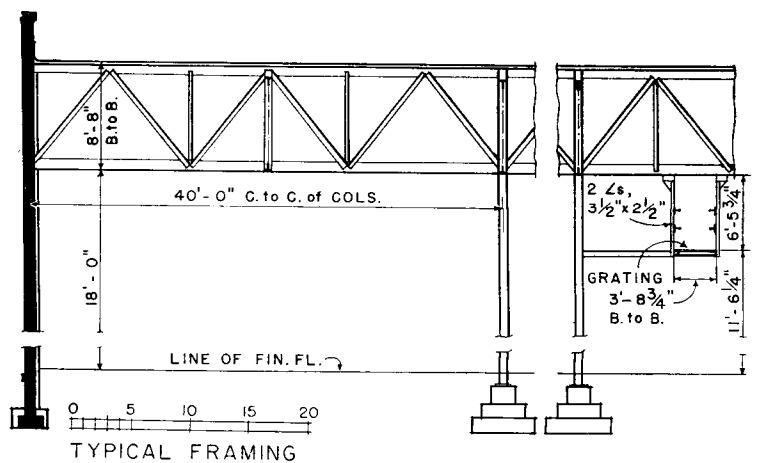
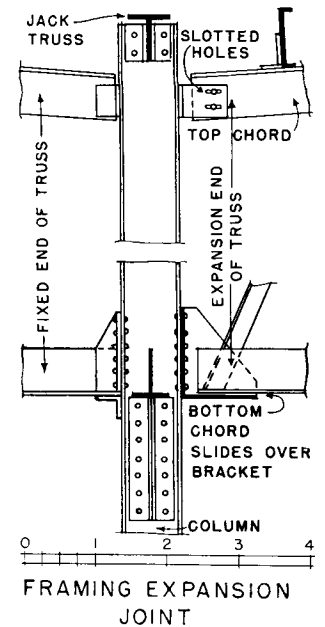
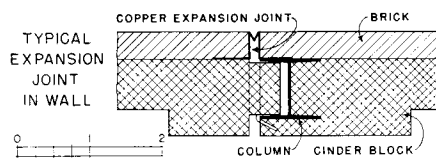
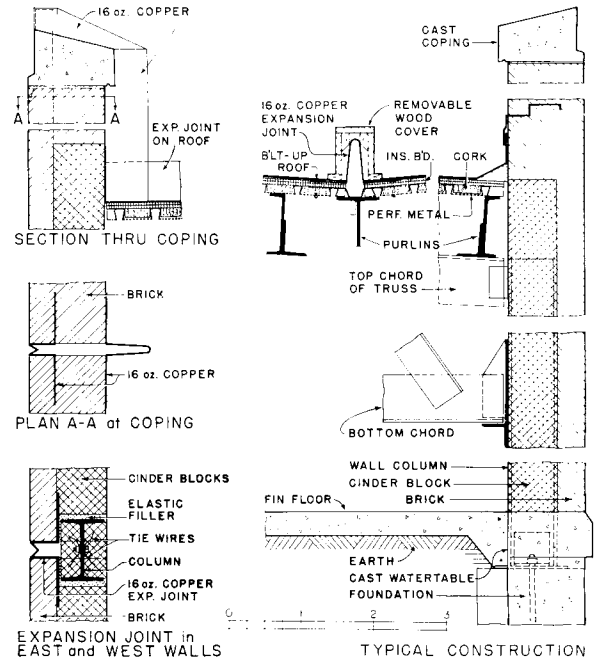

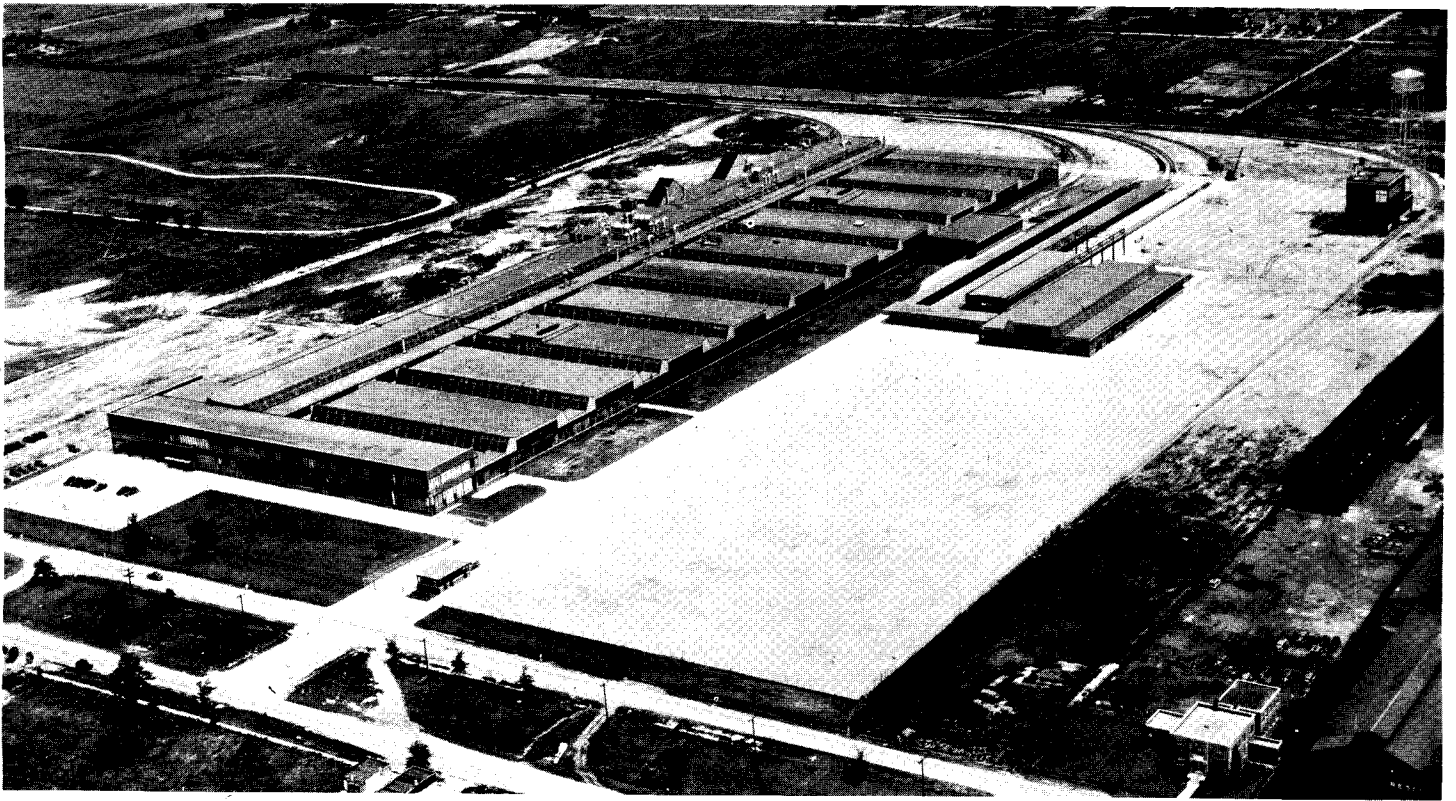

QUARTER-MILE-LONG ASSEMBLY and EXPORT PLANT for DODGE HALF-TON TRUCKS

Chrysler Corporation, Detroit

Albert Kahn, Inc., and Chrysler Corp. engineers, Architects and Engineers

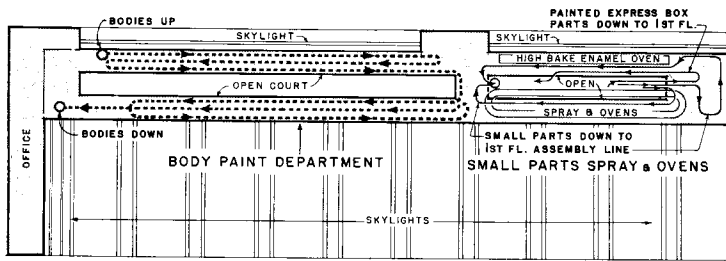

SECOND FLOOR

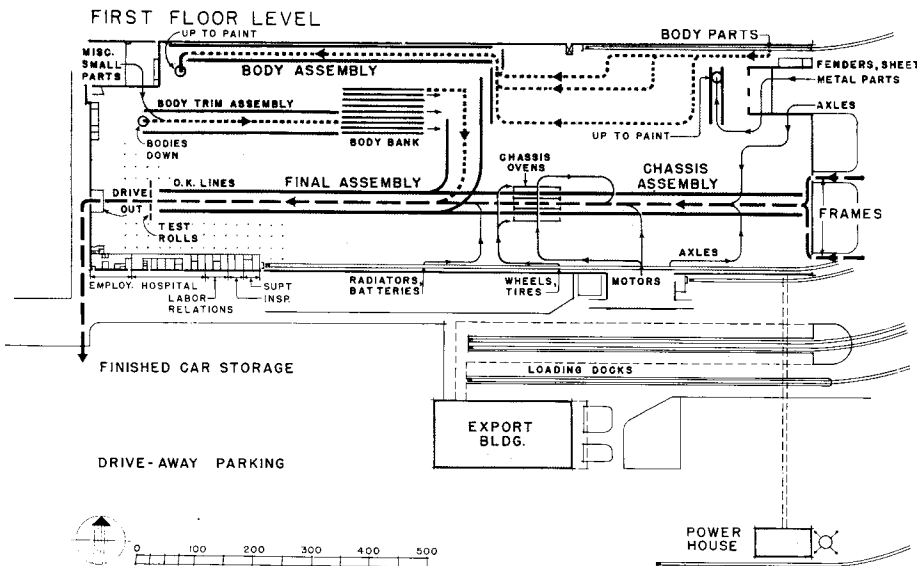

FIRST FLOOR LEVEL

Assembly Building is 1261 ft. 9 in. long by 401 ft. 8 in. wide. Railway sidings run into and alongside Assembly Building; Export Building's loading docks are partly roofed, partly open to permit crane to load freight cars. Main assembly line is shown by long dashes; dotted line indicates body assembly; fine lines show sub-assembly lines.

THE NEW DODGE TRUCK PLANT is situated on a tract of 136.5 acres, of which buildings and storage space together occupy approximately 49 acres. The main assembly building occupies 11.5 acres of this area, and contains 693,163 sq. ft. of floor space on two levels. A branch railroad line serves the rear of the property.

Buildings comprise Main Assembly Building; Export Building, where trucks are taken down and crated for shipment abroad; and Power House and water tank. Large paved space is for temporary storage of new trucks as well as for future expansion.

Important factors in the plant's design were: provision for future expansion, straight-line production, use of facilities and equipment to assure continuing improvements in production methods and quality, and provision of best possible working conditions for employees.

Construction is steel frame, part welded, part riveted, with enclosing walls of glass and other salvageable or inexpensive materials. Power house is so located that erection of additional buildings will not necessitate changing its position.

Normal capacity is 700 trucks per day. Production flow is continuous throughout, with various materials being added through subassembly lines to the main assembly line as the manufacturing process advances. Materials and parts are delivered both by rail and by truck to receiving ports as close as possible to their points of use in assembly lines.

Chassis frames enter at one corner and travel straight through to test rolls and drive-away exit. Bodies enter at another corner, are assembled, raised to second floor, painted, lowered to first floor, where trim and hardware are added and the completed bodies travel to the chassis assembly line. Axles, motors, etc., are added to the main assemblies at appropriate points.

Photos: top, west front of Main Assembly Building. In lower story, at left, is miscellaneous small-parts entrance; center, employees' entrance; right, drive-away exit. Second floor houses paint shop and offices. Center and lower photos, Export Building, showing shipping docks and canopies.

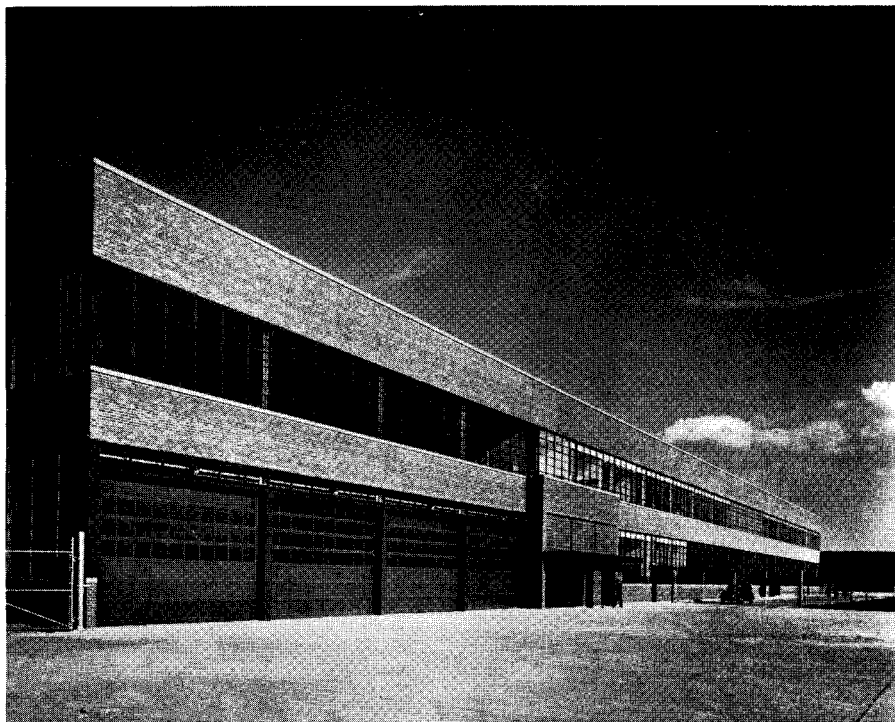

Photos by Hebrich-Blessing

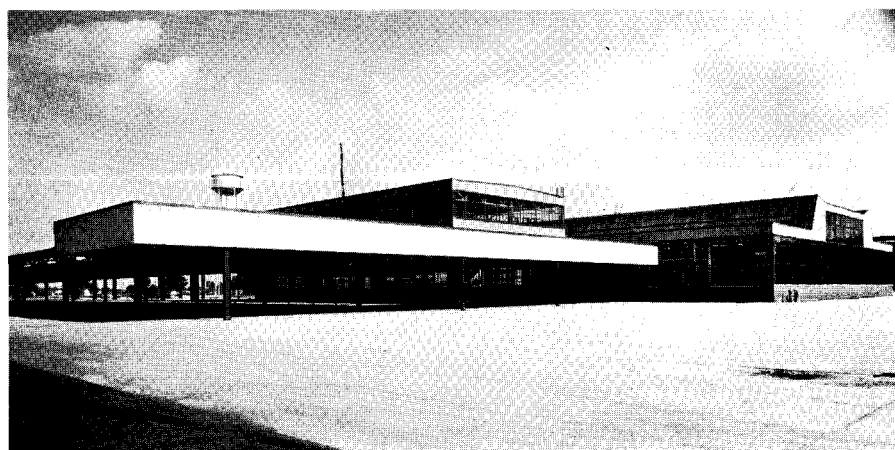
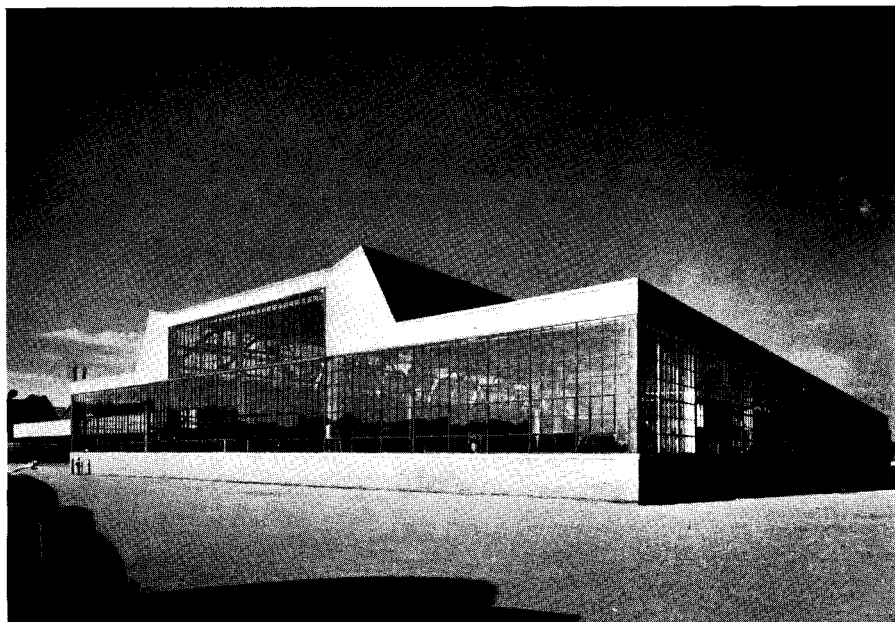

DODGE TRUCK PLANT



THE PLANT'S fifty conveyor systems extend a total distance of nearly seven miles, carrying parts and materials not only horizontally but also vertically to second-floor paint shops and back. It is claimed that the most modern painting equipment in the industry has been installed. All booths are of a hydro-filter type which provides an abundance of fresh air for workers.

As the completed trucks roll off the double assembly lines under their own power, they are stopped with their rear wheels resting on pairs of testing rollers. During the time trucks are being subjected to rigid inspections, exhaust fumes are drawn off through pits and underfloor ducts, and exhausted through the roof. At this location in the plant, combination incandescent and mercury lighting is used to facilitate inspection.

Special precautions are taken to prevent heat loss at material entrances and exits. At trucking platforms, hot-blast heaters are mounted overhead and warm the entering cold air. At the drive-away port, trucks pass through a vestibule whose inner doors close automatically before outer doors open.

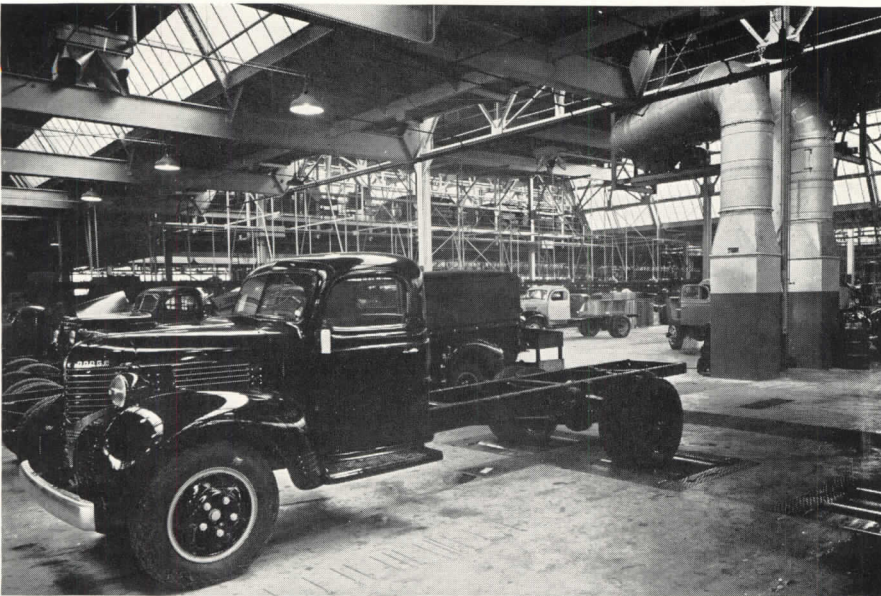

Photos: top, overhead conveyors carry parts from paint shops to assembly lines. Center, testing rolls; motor fumes are exhausted under floor to stacks shown in rear. Lower, drive-away exit vestibule.

To avoid the necessity for intermediate columns which might otherwise have obstructed first-floor manufacturing space, as much as possible of the second floor, or mezzanine, is hung from roof girders. Four toilet rooms and the two power sub-stations necessary to the distribution system are completely suspended. Access to them, from the second floor, is by means of catwalks; from first floor, by stairs.

The large open office area on the second floor is heated by recirculated, filtered warm air. Enclosed offices are heated by automatic, cabinet-type hot-water radiators, whose water is heated through an exchanger operated by steam from the plant's power house. The main plant heating system consists of approximately 130 ceiling-mounted unit heaters with directional control, ranging in rating from 50,000 to 500,000 Btu per hr., controlled by local thermostats.

Good natural light is provided for all operations. Approximately five acres of glass are used in wall and monitor construction. Monitors contain 1 sq. ft. of glass per 4 sq. ft. of total floor space, exclusive of glass side walls.

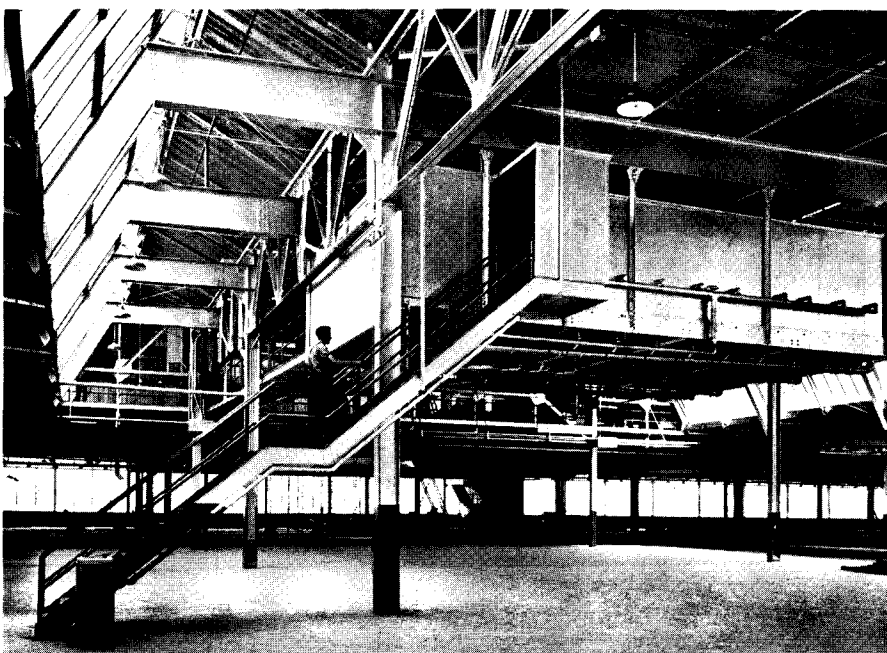

Hedrich-Blessing



Photos: top, suspended toilet and wash-room. Center, washroom interior. Lower, second-floor offices; 18 footcandles of light are here supplied by 500-w. indirect fixtures 11 ft. high, on 14-ft. centers.

Photo by Hendrich-Blessing



Bent-beam trusses carry the roof, monitors, and suspended second-floor areas. Construction is partly shop-welded and partly field-riveted, depending on which was more economical or feasible in the particular location in question. Monitors are rough wire glass.

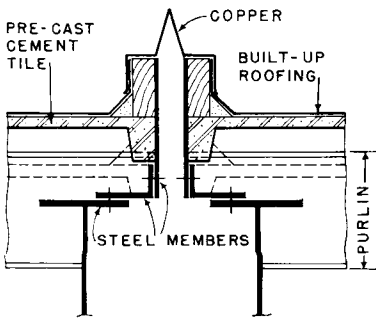

ROOF

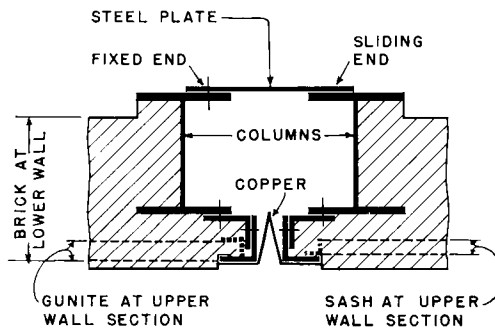

EXTERIOR WALLS

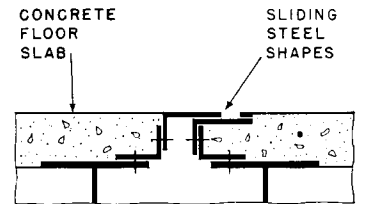

SECOND FLOOR

TYPICAL EXPANSION JOINTS

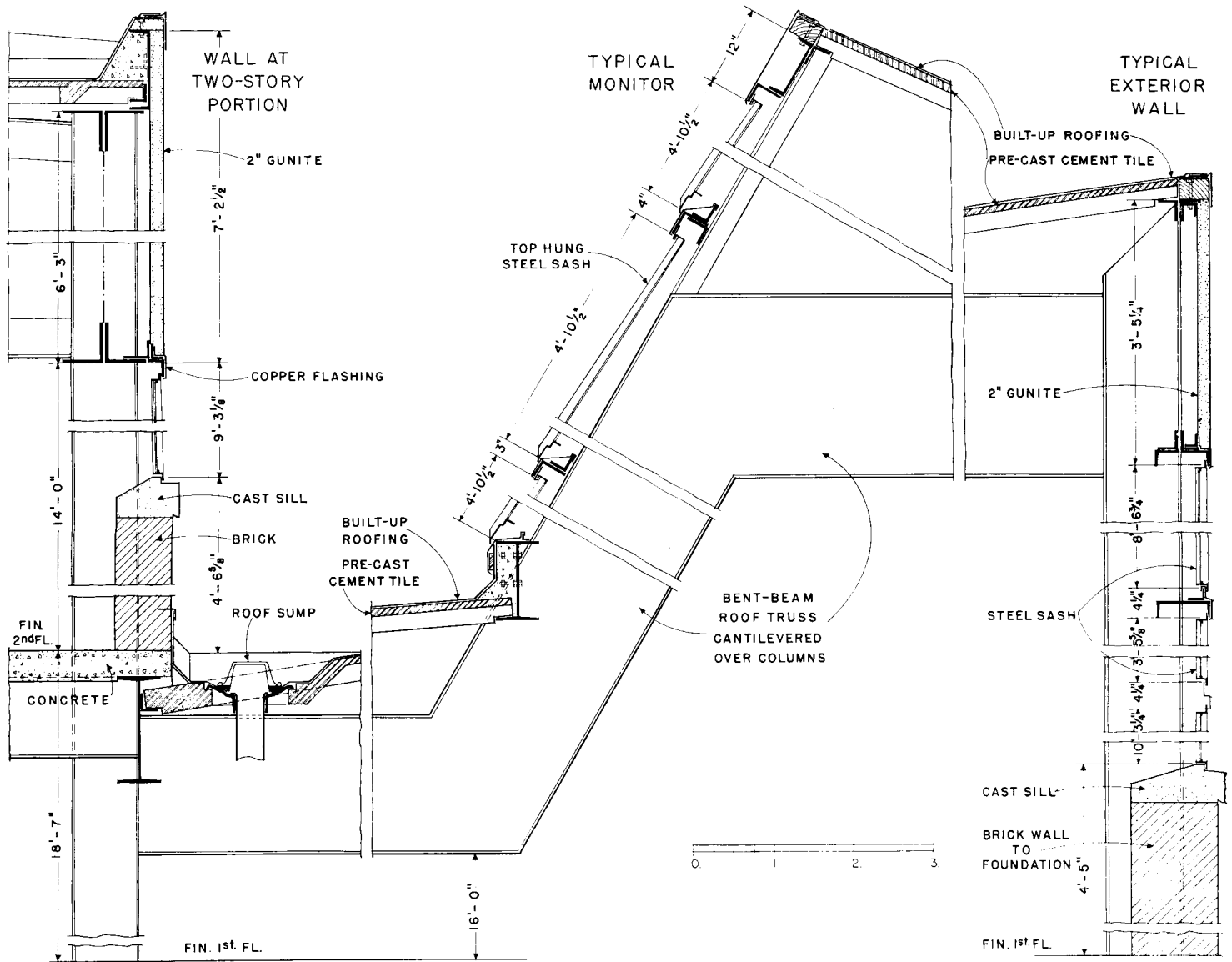

ENCLOSING walls of brick, Gunite, and steel sash cover the welded and riveted steel framing. Roofs are lightweight cement channel-tile covered with built-up roofing. Over offices, 1 in. of mica-pellet insulation is used.

Column bays are 60 by 40 ft. to permit maximum convenience in placing equipment and material. Intermediate bent-beam trusses are carried on girders.

Floors are generally of cement, surface-hardened in aisles. Offices and First-aid Room have asphalt tile and linoleum-finish floors.

Doors are of many types: elevator doors are counter-balanced; railroad doors are four-fold; and overhead, hinged, or horizontal sliding doors are employed according to location and use. Office partitions are metal sash, and toilet partitions, metal.



Main assembly line, showing some of the fifteen hundred 450-w. mercury lamps.

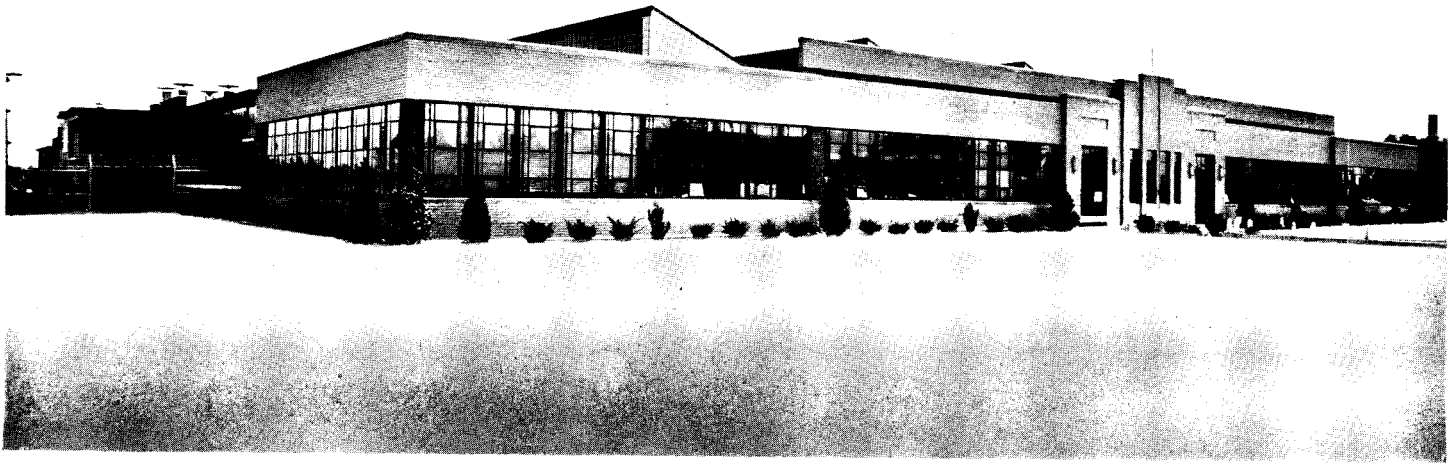

PLANT FOR MANUFACTURE AND ASSEMBLY OF PORTABLE LAMPS AND LAMPSHADES

Mutual-Sunset Lamp Manufacturing Co.

New Brunswick, N. J.

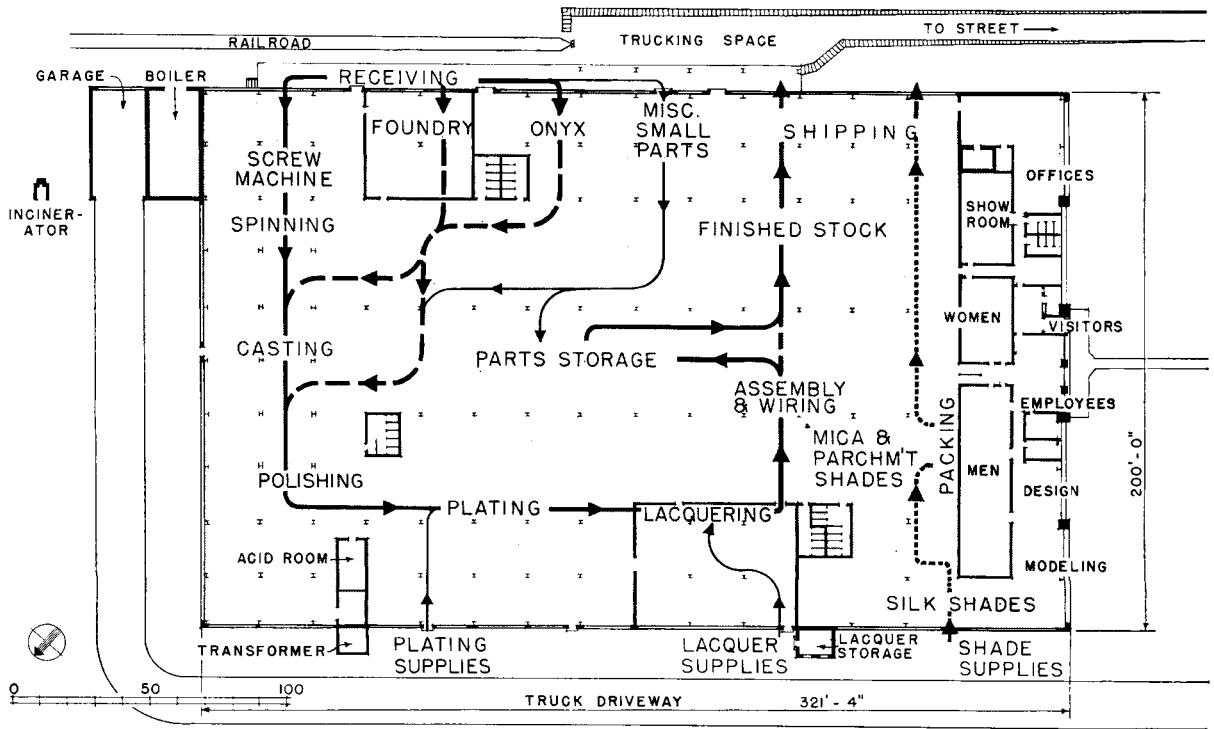



Plating Department: Acid-bath fumes caused wood roof deck to be used; on steel framing only is periodic painting needed.

THE DESIGN OF THIS PLANT was developed by company engineers in collaboration with independent consultants. Floor and table lamps of all types are here manufactured from various metals, onyx, and marble; as well as silk, mica, and parchment shades. Lamps and shades each require separate production lines.

Although the size of the factory requires employment of only a small receiving force, it was decided that efficient production could best be attained by having the receiving clerk travel from entry to entry rather than by having all materials enter at one point. Heavy materials—brass and foundry stock, onyx, and marble—are received at the start of the line, partially

processed and reduced in bulk and weight, and added to the line where needed. A complicated material-distribution system was thus avoided.

Approximately ten times more products can be stored as “parts” than as “finished” stock. Consequently not all goods manufactured are immediately completely assembled. Only orders whose quantity is sufficient to make complete processing economical are routed directly from “assembly” to “finished-stock” areas.

The shade-production line involves a great proportion of hand work and is as straight as possible. Design and modeling departments, locker rooms, offices, and showroom are concentrated along the entrance front.

Structural system is of conventional saw-tooth steel-frame type. Column bays are 20 by 40 ft. and 20 by 20 ft.; larger spans were not considered economical for the particular problems involved.

Several unusual details were required by the manufacturing process. Fumes from acids used are corrosive to unprotected metal; for this reason, and for low initial cost, the roof deck is of light mill construction. Storage of explosive lacquer required the building of an outside vault equipped with explosion-type vents. An incinerator is located some distance from the main building, for disposing of combustible cloths used in lacquering, and for other plant debris.

MUTUAL-SUNSET PLANT

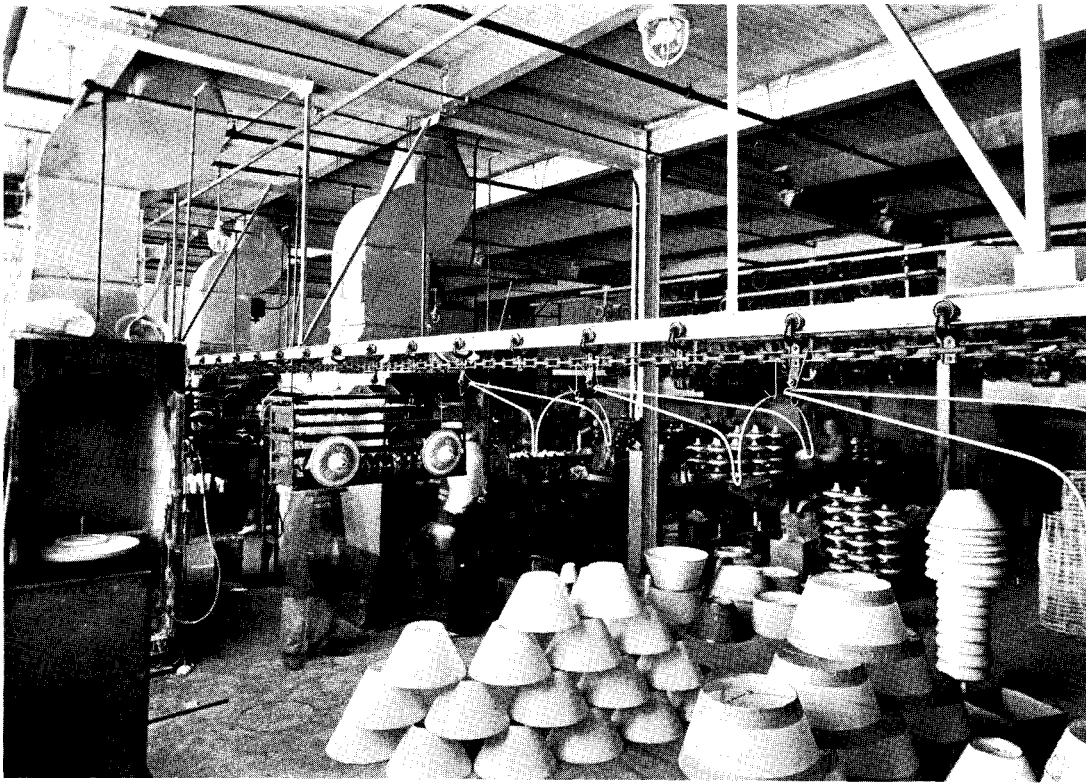

Lacquering Department: Conveyors here carry some coated parts through baking ovens. Only a few conveyors have as yet been installed; others may be added as needs become apparent. Note explosion-proof lighting fixtures.



Interior, looking toward Assembly and Wiring Department. In left foreground is portable rack for conveying parts from one operation to another. Unit heaters are suspended. Lighting fixtures are direct type with prismatic reflectors.

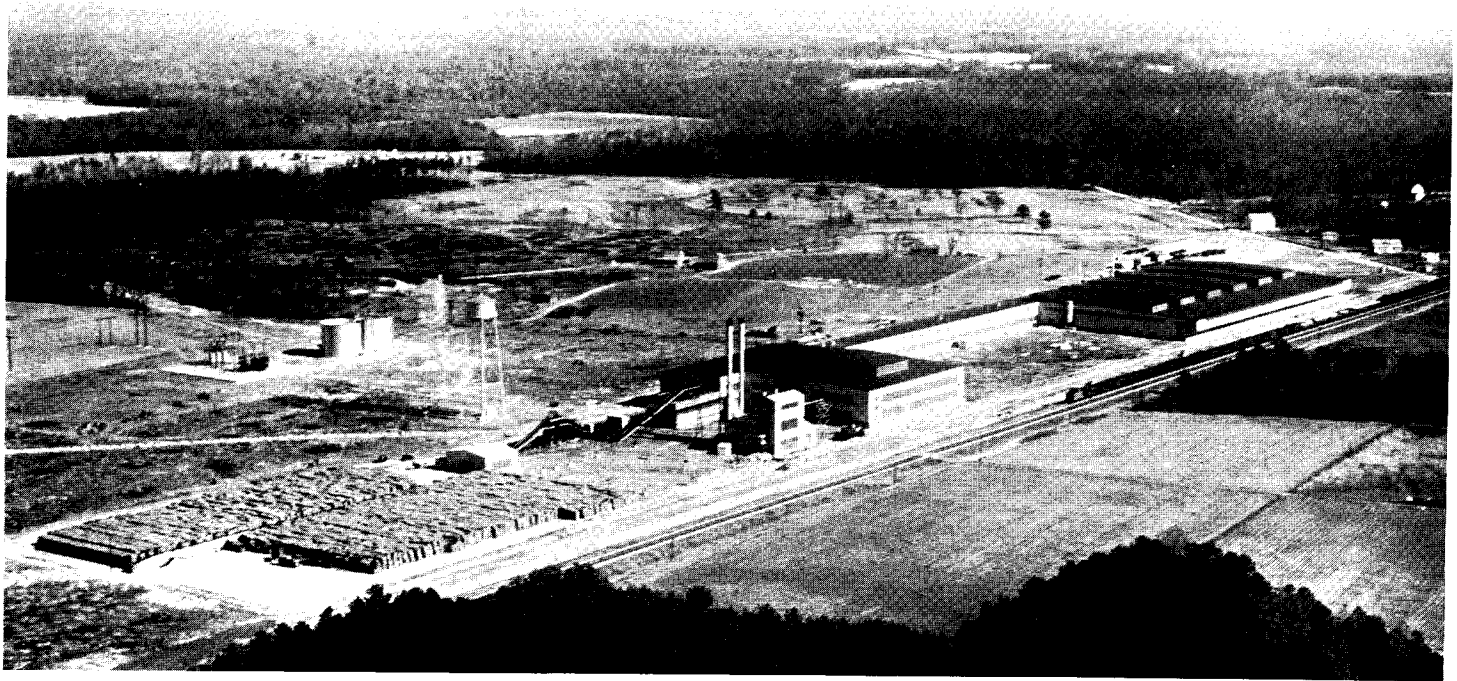

FIBERBOARD MATERIALS PLANT FOR JOHNS-MANVILLE PRODUCTS CORP.

Jarratt, Virginia

Stone and Webster Engineering Corp., Engineers

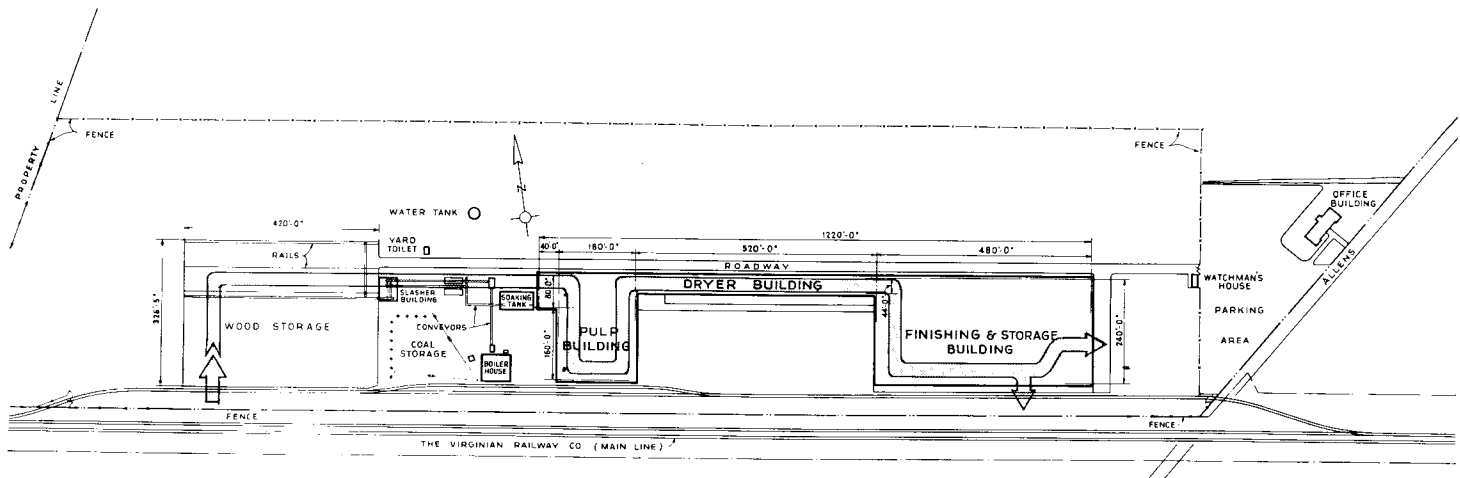

EXPERIMENTS WITH PULP WOODS developed a fiberboard, made from southern pine, which is superior to the present product. The new Johns-Manville fiberboard plant is close to extensive stands of pine, on a main line railway, with adequate local labor, ample room for expansion, and with the Nottoway River, 2½ miles distant, available for process-water.

Pulp logs are at present trucked into the Storage Yard. Railway delivery may also be utilized in future, as is indicated by the gray line shown on the plan above. Logs are mechanically conveyed to Slasher Building, thence to a barking drum. Sawdust and bark are used for fuel. Logs are then reduced to pulp, processed in the Pulp Building, and emerge from a continuous forming machine at the end of which is a wet saw.

Cut sheets are automatically transferred to an 8-deck con-

tinuous dryer running the full length of the 520 ft. Dryer Building. Upon entering the Finishing and Storage Building, sheets are formed into various products, packaged, and either stored, or shipped by truck or rail.

The plant is laid out primarily to house equipment. Its U-shape results naturally from the equipment layout. It was considered advisable to make the Dryer Building of sufficient width to take one dryer only, both as a matter of economy and in that the dimensions for a possible future dryer could not be determined at the time the plant was designed. However, the roof trusses are so designed that they may be readily spliced and transformed into typical 80-ft. spans similar to those in the finishing and storage section. Area south of the Dryer Building is reserved for expansion, in case additional dryers are installed.

JOHNS-MANVILLE FIBERBOARD PLANT

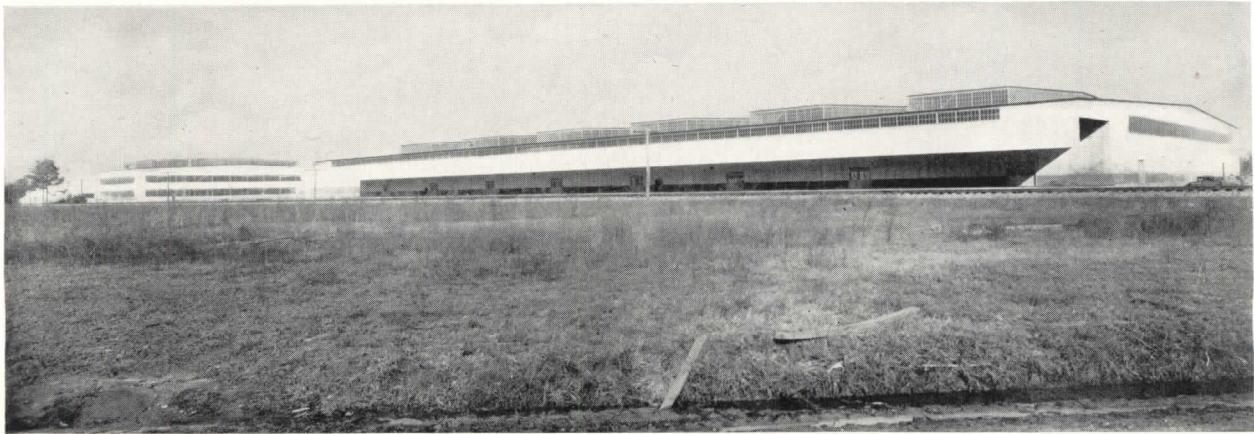
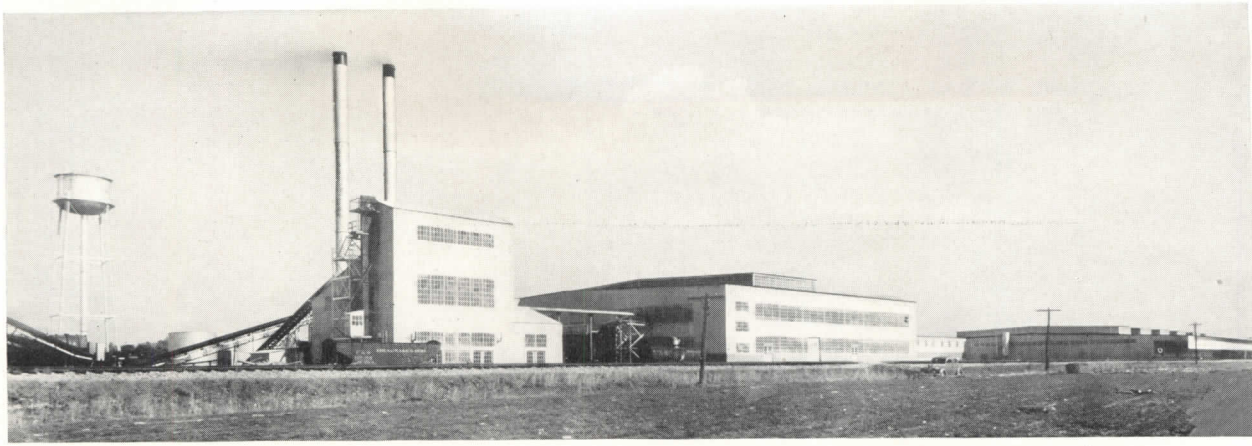

Top, view from southwest, and lower, from southeast. Cantilever-roofed shipping platform extends full length, 480 ft., of Storage and Shipping Building.



Shipping-platform width permits carload lots to be assembled without obstructing passage of trucks or human beings.



Position of suspended apron provides weather protection for men and materials. Note cantilever trusses.

Charles Phelps Cushing

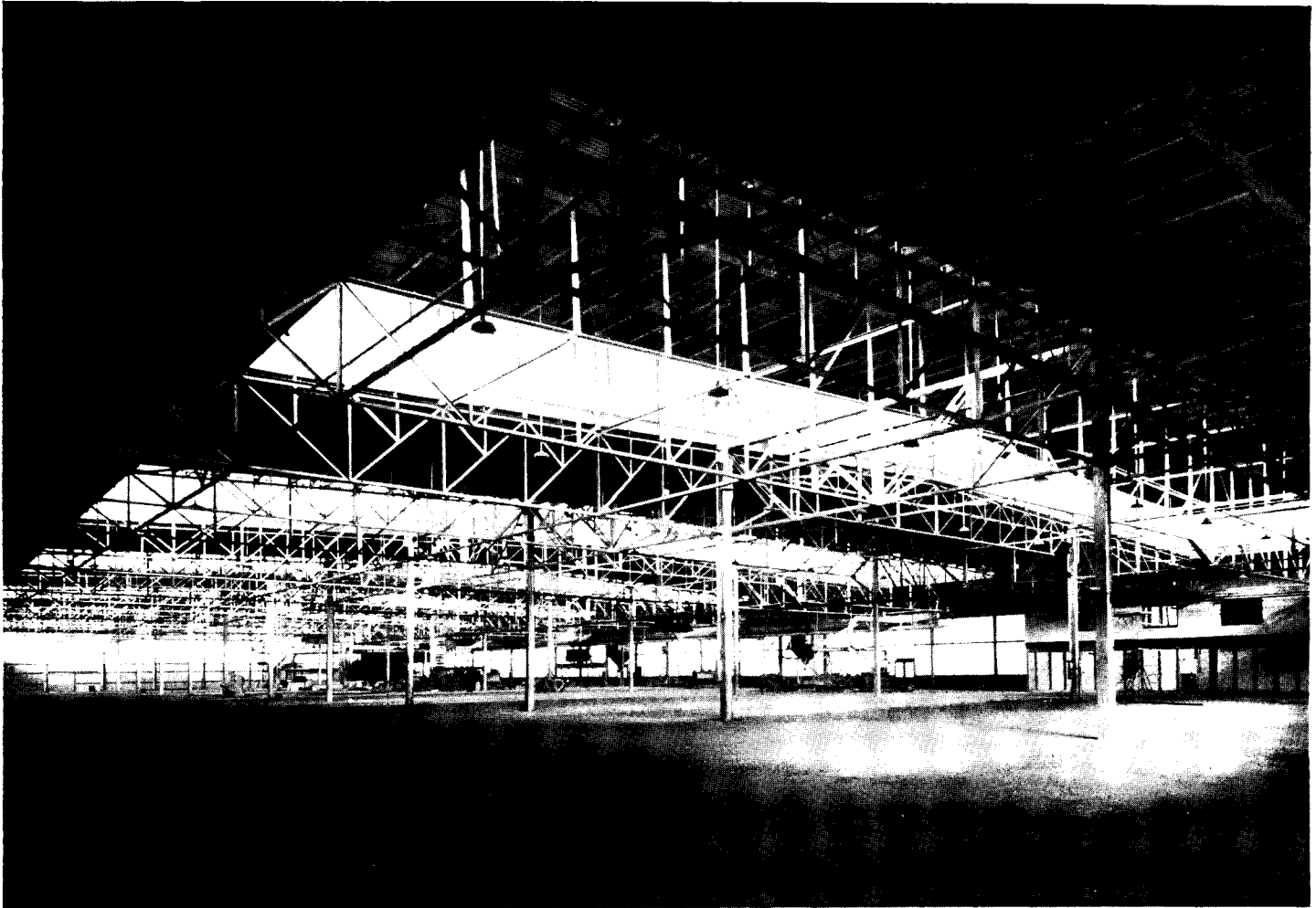

Above, Finishing and Storage Building: In all buildings, trusses were shop-welded, saving 70 tons, or 5%, of steel.

THE FINISHING AND STORAGE Building is one-story steel frame, 20 ft. high in the clear, with 40- by 80-ft. column bays. In all buildings, footings are concrete on compact sand and clay. Walls are concrete to floor, brick to sill, corrugated Transite and steel sash above. Floors are concrete on fill, at freight-car height. Roofs are insulated Transite, designed for minimum dead weight, with sufficient insulation to prevent condensation from moisture developed during manufacturing processes.

In the Finishing and Storage Building, an 80-ft. span truss was found economical for the light roof loads involved. The 40-ft. rather than 20-ft. longitudinal span allows latitude in locating finishing equipment without interference with building columns, and provides freedom in trucking and handling the finished product. A uniform load per square foot on trusses was assumed for suspended conveyors, dust collecting system, piping, and similar equipment.

Much of the conveyor system is floor-mounted. Sash in this building are so distributed that manufacturing areas receive ample natural light, storage areas somewhat less.

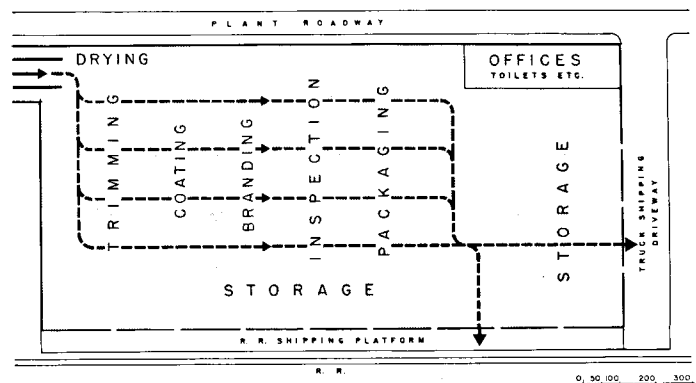

Flow of material, Finishing and Storage Building: Products are decorative-coated insulating board, asphalted "Weathertite Sheathing," insulating lath, and rigid "Roofinsul."

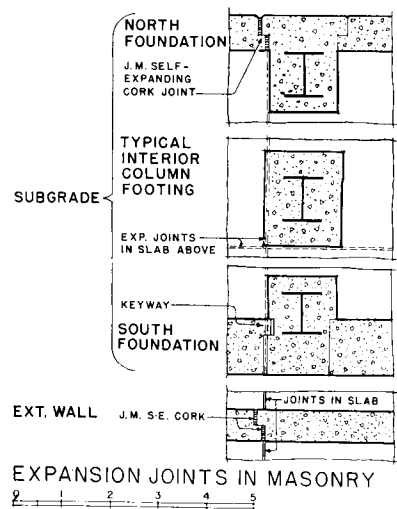
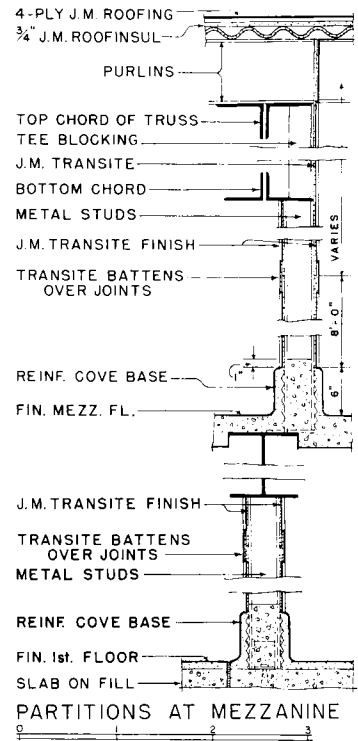
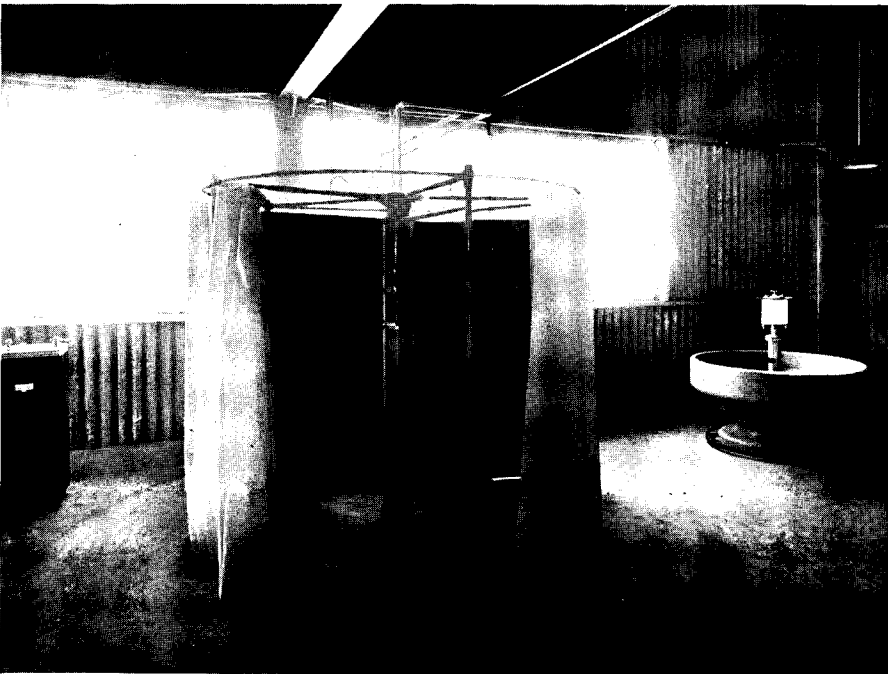
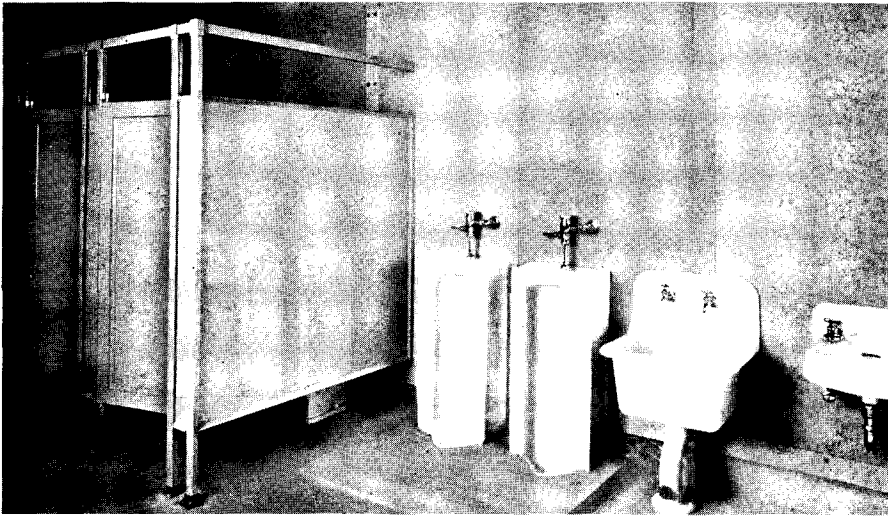
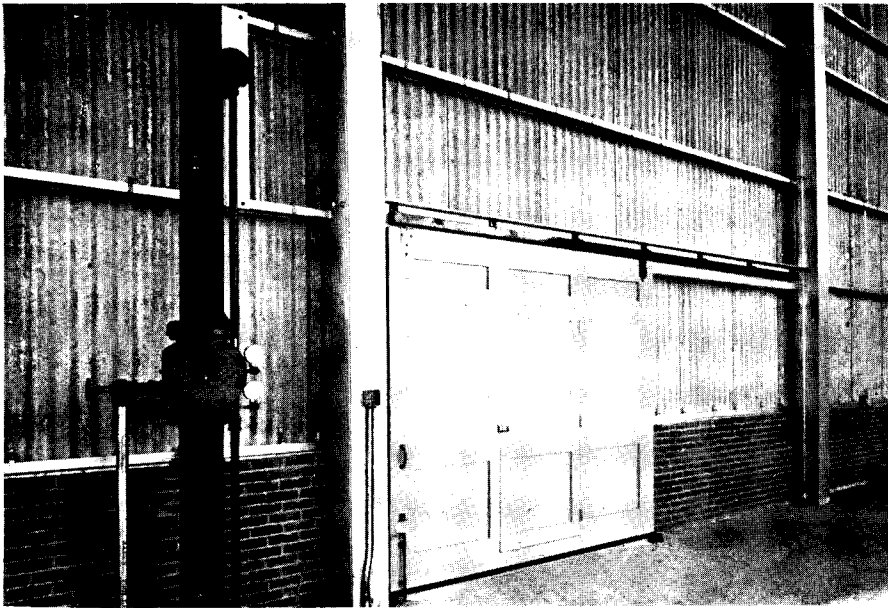

Details of construction: Due to buildings' length, expansion joints were needed approximately every 250 ft. In the superstructure, these consist of overlapping, spring-acting stainless plates. Self-expanding cork joints in masonry walls and footings expand by absorbing atmospheric moisture. Cork is compressible without apparent bulging.

Photos: top, typical exterior wall construction; center, toilet rooms walled with Transite; lower, five-compartment shower, drinking fountain, and wash fountain.

ARCHITECTURAL RECORD

PUBLISHED BY F. W. DODGE CORPORATION, 115-119 WEST 40TH STREET, NEW YORK. COPYRIGHT 1939. ALL RIGHTS RESERVED.

INDEX TO VOLUME 85 JAN.—JUNE 1939

BT—BUILDING TYPES SECTION
TSS—TIME-SAVER STANDARDS

Air conditioning, Robert H., arch. Ellis house—May, p. 110
AIR CONDITIONING AND BUILDING DESIGN—June, pp. 68-74
AIR RAID PRECAUTIONS. "What does Military Design Offer the Architecture of Peace?"—Jan., pp. 49-56; Mar., pp. 66-75
Albertson, A. H., Wilson & Richardson, arch. St. Joseph's Church—Apr., p. 77
Alley Dwelling Authority, Washington, D. C.—Jan., pp. 28-31
American National Theatre & Academy. Competition winners announced. Prize-winning designs—Apr., pp. 61-64
ARCHITECTURAL OPPORTUNITIES IN PUBLIC HOUSING, by Catharine Bauer—Jan., pp. 65-68
Aruson, Joseph, designer. Bedroom—June, p. 62; Dining Alcove—Apr., pp. 68-69
Auditorium, Municipal (Proposed), Los Angeles, Calif.—May, pp. 44-45
Austin Co., designers. Simonds factory—June, pp. 103-109

Bailey, Van Evera, arch. Bruno House—June, pp. 53-56
Bain, William J., arch. House, Seattle, Wash.—June, p. 57
Ballard, Wm. F. R., assoc. arch. Queensbridge Houses—Mar., pp. 117-120
Bandstand, Waukegan, Ill.—May, p. 43
Bank, Modernized. Los Angeles, Calif.—Mar., pp. 41-43
Bard & Vanderbilt, arch. St. Austin's Church—Apr., p. 78
Bars, Food and Liquor. TSS—Jan., pp. 79-80; illus.—Jan., pp. 84-85
Bauer, Catharine. "Architectural Opportunities in Public Housing"—Jan., pp. 65-68
Bauer, O., arch. Villa, Garches, France—May, p. 61
Bedrooms. Furniture-Group Units (TSS)—May, pp. 103-109
Bedrooms. See Sleeping Units
Belluschio house, Portland, Ore.—Feb., pp. 56-58
Berkshire Symphonic Festival, Proposed theatre for—Jan., pp. 44-45
Besse, Georges, and C. Meyer-Levy, arch. French pavilion, Golden Gate Exposition—Apr., p. 48
Bloch & Hesse, arch. Schrafft's restaurant—Jan., pp. 91-93
Blouke, Pierre, & C. M. Goodman, designers. Design for integrated, industrially produced dwelling—May, p. 89
Boggs, C. E., designer. House, Boise, Idaho—June, pp. 49-52
Bookshops. See Shops, Book
Booths, Restaurant. TSS—Jan., p. 74; illus.—Jan., p. 86
Brook & Co. Store, Los Angeles, Calif.—Apr., p. 118
Brooks' Store, Utica, N. Y.—Apr., p. 98
Brown, Arthur, Jr., arch. Tower of the Sun, Golden Gate Exposition—June, pp. 89-90
Brown, Louis A., Jr., arch. Flanders Restaurant—Jan., p. 104
Bruno house, Lake Oswego, Ore.—June, pp. 53-56
BUILDING MATERIALS. TRENDS IN THE DEVELOPMENT OF, by Milton Lowenthal—May, pp. 78-83
Buard, John E., and David Mayer. "A Survey: Progress in Systems of Construction."—Apr., pp. 84-88
Burdine's Dept. Store, Miami, Fla.—May, pp. 36-39

Cammeyer Shoe Store—Apr., p. 99
Carpenter Pre-Built Homes, Elkart, Ind. Factory-built dwelling units—May, p. 90
Catholic Church Design. See Church Design, Catholic
Caudill, Wm. W., & Lois W. Worley. Prize-winning design for Southwest, Productive Home Competition—May, p. 58
Channel Bookshop, New York City.—Apr., pp. 100, 115
Chateau Restaurant, St. Louis County, Mo.—Jan., pp. 100-101
Christ the King, Chapel of, Evergreen, Colo.—Apr., p. 82
Chrysler Corp., Detroit. Dodge Truck Plant—June, pp. 100-101
CHURCH DESIGN, CATHOLIC. "Recent Trends in Catholic Church Design," by Maurice Lavanoux—Apr., pp. 76-83
Churchill, Henry S., assoc. arch. Queensbridge Houses—Mar., pp. 117-120
Clare Anne Dress Shop, Chicago, Ill.—Apr., p. 92
Clements, Stiles, O., arch. Modernized bank—Mar., pp. 41-43
"Climatorium" (Proposed)—Jan., pp. 46-47
Co-Cathedral of Christ the King, Atlanta, Ga.—Apr., p. 78
"Color, Light, and Structure: New Synthesis in the West." Article by A. F. Dickerson—June, pp. 75-90
Conservatories. See Floricultural Dwelling Units
CONSTRUCTION, PROGRESS IN SYSTEM OF, by J. E. Burchard & David Mayer—Apr., pp. 84-88
Cooking Units, New. Portfolio—Mar., pp. 57-64
Cotton Shop, The. Check & card-writing desk—Apr., p. 104; ground floor and Oval Shop—Apr., p. 109
Courts, Four-Wall. Proposed design—Mar., p. 49
"Crossroads of Sport, The" Shop, New York City—Apr., p. 116
Cunin, H., designer. Two-family dwelling. June, p. 58
"Current Trends of Educational Programs." Article by N. L. Engelhardt, Jr.—Feb., pp. 87-88

Dagit, Henry D. & Sons, arch. Co-Cathedral of Christ the King—Apr., p. 78
Dailey, Gardner, arch. Brazilian Pavilion, Golden Gate Exposition—Apr., p. 45

d'Ans, Armando, arch. Argentinian Pavilion, Golden Gate Exposition—Apr., pp. 46-47
Daniels, Albert J. See Pittsburgh Glass Institute Competition
Daniels, Mark, arch. Hall of Floriculture, Golden Gate Exposition—Apr., pp. 58-59
Davidson, J. R., designer. Built-in sleeping unit—June, p. 63. Stairway with built-in plant space—May, p. 62. See also Pittsburgh Glass Institute Competition
Dawson & Oliver, arch. Channel Bookshop—Apr., pp. 100, 115; Doubleday-Doran Bookshop—Apr., p. 99; Penn Station Arcade Bookshop—Apr., p. 114; Rand-McNally Map Shop—Apr., p. 115
Department Store, Burdine's, Miami, Fla.—May, pp. 36-39
Devine, Harry, arch. St. Joseph's Church—Apr., p. 80
Dickerson, A. F. "Color, Light & Structure: New Synthesis in the West"—June, pp. 75-90
Diehl house, Midland, Mich.—Mar., pp. 54-56
Dining Rooms. Furniture Group Units (TSS)—May, pp. 101-102
Dining Units—Apr., pp. 65-72
Displays, Interior. Small Retail Shops (TSS)—Apr., pp. 100-101
Dodge Truck Plant, Chrysler Corp., Detroit, Mich.—June, pp. 100-101
Doubleday-Doran Bookshops, Fifth Ave.—Apr., p. 99; Penn Station Arcade—Apr., p. 114
Dow, Aiden B., arch. Diehl house—Mar., pp. 54-56; Kitchen for family of two—Mar., p. 62
Doyle, A. E. & Assoc., arch. Belluschio house—Feb., pp. 56-58
Dubin & Dubin, arch. Dining unit—Apr., p. 72
Dukelski, Alexis, Winner for Northeast, Productive Home Competition—May, p. 54
Dwelling dwells, Washington, D. C.—June, p. 58
Dwelling types and unit sizes, low rent housing developments. TSS—Mar., pp. 97-103

Eames & Walsh, arch. St. Mary's Church—Apr., p. 82
Eckbo, Garret, D. U. Kiley & J. C. Rose. "Landscape Design in the Urban Environment"—May, pp. 70-77
"Educational Programs, Current Trends of" by N. L. Engelhardt, Jr.—Feb., pp. 87-88
ELEMENTARY SCHOOL BUILDINGS. BT section—Feb., pp. 85-122
Ellis house, San Marino, Calif.—May, p. 110
Engelhardt, N. L., Jr. "Current Trends of Educational Programs"—Feb., pp. 87-88
Entrances, Restaurant—Jan., p. 83

Factories. BT section—June, pp. 95-122
Farm buildings, Prefabricated. See Prefabricated farm buildings
Fashion Shop, Lawrence, Mass.—Apr., p. 110
Federal Housing Administration, designers. Plywood Panel houses, Fort Wayne, Ind.—Mar., pp. 38-40
F. A. E. C. T.—Fourth National Convention—Jan., p. 48
Film-processing laboratory—May, pp. 50-52
Flanders restaurant, Philadelphia, Pa.—Jan., p. 104
Fleischer studios, Miami, Fla.—Jan., pp. 33-37
Floricultural Dwelling Units. Portfolio—May, pp. 59-66
Florist Shops. See Shops, Florist
"Forest Life." Sculptured mural by Carl Milles—Jan., p. 10
Fort Wayne Housing Project, Fort Wayne, Ind.—Mar., pp. 38-40
Fowler Elementary School, Fowler, Calif.—Feb., pp. 120-122
Franklin & Kump, arch. Fowler Elementary School—Feb., pp. 120-122. Sierra Union High School—May, pp. 40-42
Friedman, Wm., and Hilda Reiss, designers. Dining room—Apr., p. 66; House, Pleasantville, N. Y.—Mar., pp. 44-48; kitchen unit for family of 3—Mar., p. 60
Frost, Frederick G., assoc. arch. Queensbridge Houses—Mar., pp. 117-120
"Furniture-Group Units as a Basis for Planning," by Mary Davis Gillies—May, pp. 92-93

Ganster, William A., arch. Bandstand—May, p. 43
Garrison residence, Happy Valley, Calif.—May, p. 112
Gas station. Pacific Steel Building Co., designers—Jan., p. 32
Giesecke & Harris, arch. Mexican Housing Project—Mar., p. 116
Gift shops. See Shops, Gift
Gillies, Mary Davis. "Furniture-Group Units as a Basis for Planning"—May, pp. 92-93
Ginn residence, Ashland, Ohio—May, p. 110
Gier, Samuel, arch. Bedroom—June, p. 66; window box—May, p. 65
Glass. Examples of entries in Pittsburgh Glass Institute Competition. Portfolio—Jan., pp. 57-64
GLASS—STRUCTURAL MATERIAL OF TOMORROW. by Dr. Jaroslav Polivka—Feb., pp. 66-72

Glass block and sash combined in exterior walls of building. Monsanto Chemical Co. Laboratory—May, pp. 48-49
Golden Gate International Exposition. Brazilian, Argentinian, French Pavilions, Pacific House, U. S. Govt. Building, California Group, Hall of Floriculture, Hall of Fine & Decorative Arts—Apr., pp. 45-60; color photos of Illumination and article by A. F. Dickerson—June, pp. 75-90
Golmerstein, Dr. I., and Prof. K. Stuediek, designers. Proposed "Climatorium"—Jan., pp. 46-47
Goodell, Edwin B., arch. Conservatory and lounging area—May, p. 60
Goodman, C. M. See Blouke, Pierre, & C. M. Goodman
Goodman, Michael, arch. Dining space—Apr., p. 70; kitchen for family of 3—Mar., p. 61
Goodwin, Philip L., and Edward D. Stone. 2nd and 3rd prize-winning designs, National Theatre Competition—Apr., pp. 63-64
Gottlob, K., arch. School group, Sundby, Den.—June, pp. 44-48
Graf, Hugo K., arch. Le Chateau Restaurant—Jan., pp. 100-101
Greenhouses. See Floricultural Dwelling Units

Hadden, Gavin, engineer. Design for 4-wall courts—Mar., p. 49
Hannon, George C., mech. eng., Schrafft's restaurant—Jan., pp. 91-93
Harris, Harwell H., designer. Dining room & terrace—Apr., p. 67
Harris H. H., and Carl Anderson. See Pittsburgh Glass Institute Competition
Haskell, Douglas. "What Does Military Design Offer the Architecture of Peace?"—Jan., pp. 49-56; Mar., pp. 66-75
Hattson, John M., arch. Peck & Peck Shop—Apr., pp. 94, 108; Stetson Shoe Shop—Apr., p. 104
Hedges Shop—Apr., p. 110
Hentz, Adler & Shutze, arch.—Dining room—Apr., p. 71
High School, Sierra Union—May, pp. 40-42
Highlands Grade School, White Plains, N. Y.—Feb., p. 116
Hinman, Charles, arch. Bedroom—June, p. 63
Hobart, Louis P., arch. Court of Reflections, Golden Gate Exposition—June, pp. 84-85
Holabird & Root, arch. Built-in sleeping unit—June, p. 66
Holiday Home for Children, Victoria, Australia—Feb., p. 98
Homsey, Victorine & Samuel, arch. Kitchen for large-scale entertaining—Mar., p. 64. See also Pittsburgh Glass Institute Competition
Hopkins Place, Washington, D. C.—Jan., p. 30
Hospital, London Fever—Jan., pp. 40-41
HOUSE DESIGN, PLANNING UNITS FOR. BT section—May, pp. 85-112
HOUSING DEVELOPMENTS, LOW-RENT. BT section—Mar., pp. 83-120
HOUSING, PUBLIC. ARCHITECTURAL OPPORTUNITIES IN. by Catharine Bauer—Jan., pp. 65-68
Howe, George. See Pittsburgh Glass Institute Competition
Hoyt, Burnham, arch. Bedroom—June, p. 62
Hubbard School, Fort Worth, Texas—Feb., p. 117
Hubert, Cyril P., engineer. M.G.M. sound stages—Feb., pp. 40-43
Hunter, Harbin F., arch. Rothchild's Men's Store—Apr., pp. 112-113. See also Pittsburgh Glass Institute Competition

Ilder, John, Exec. Officer. Alley Dwelling Authority—Jan., pp. 28-31
Isolation Block, London Fever Hospital—Jan., pp. 40-41

James, Frederick. See Saarinen, Eero, Ralph Rapson & F. James
Jewelry Shops. See Shops, Jewelry
Johns-Manville Fiberboard Materials Plant—June, pp. 119-122
Jourdain, F. P. See Nelson, Paul, Nitzschké, F. P. Jourdain

Kahn, Albert, Inc., arch. Dodge Truck Plant—June, pp. 110-115
Kahn, Ely Jacques, arch. Longchamps restaurant—Jan., pp. 94-97
Kasten residence, Detroit, Mich.—Feb., pp. 59-61
Kastner, Alfred. See Pittsburgh Glass Institute Competition
Kelham, George W., arch. Court of the Moon, Golden Gate Exposition—June, pp. 86-87
Kiley, Daniel U. See Eckbo, Garret, D. U. Kiley & J. C. Rose

Kimbel house, Warren, Conn.—May, p. 109
Kindergarten-Primary schools. TSS—Feb., pp. 101-110
Kitchens. See Cooking units.
Koch, Carl & Edward D. Stone. Grand Prize winners, Pittsburgh Glass Institute Competition—Jan., pp. 57-59
Kraigher house, Brownsville, Texas—May, p. 111
Kuehne, H. F., supervising arch. See Mexican Housing Project

laboratory building, Monsanto Chemical Co.—May, pp. 48-49
Laboratory, Film-processing—May, pp. 50-52
Laloux, M. V., arch. Orleans station, Paris—Feb., p. 66
Lamb, Thomas W., arch. Roof deck parking space—May, pp. 46-47
Lamoureux, Louis Andre, arch. Ginn residence—May, p. 110
LANDSCAPE DESIGN IN THE URBAN ENVIRONMENT. By Garret Eckbo, D. U. Kiley, J. C. Rose—May, pp. 70-77
Lapidus, Morris, arch. Stetson shoe shop—Apr., p. 100
Lavanoux, Maurice. "Recent Trends in Catholic Church Design in America"—Apr., pp. 76-83
Le Marec, G., engineer. Reservoir, Nantes, France—Jan., pp. 42-43
Lemaire, Eleanore. Interior designer. Int. fixtures, Burdine's Dept. Store—May, pp. 36-39
Levy, Jacques Fernand. "Bauhaus—1919-1939"—Jan., pp. 71, 118
Lichtblau, Ernst, arch. Conservatory—May, p. 64
Liebes, Mrs. Dorothy & Shepard Vogelgesong, directors. Fine & Decorative Arts Exhibit. Golden Gate Exposition—Apr., p. 60
Lighting. Golden Gate Exposition—June, pp. 75-90
Little residence, Auburn, Ala.—Mar., pp. 52-53
Living rooms. Furniture-Group Units. TSS—May, pp. 93-100
Loebli & Schlossman, arch. O'Connell's restaurant—Jan., pp. 102-103
Loewy, Raymond, designer. Stateroom on SS Panama—June, p. 64
Longchamps restaurant, New York City—Jan., pp. 94-97
London Fever Hospital, Isolation block—Jan., pp. 40-41
Lorenz, J. Douglas, arch. Monsanto Chemical Co. laboratory—May, pp. 48-49
Los Angeles Civic Center (Proposed). Municipal auditorium—May, pp. 44-45
LOW RENT HOUSING, SITE PLANNING FOR. BT section—Mar., pp. 83-120
Lowenthal, Milton. "Trends in the Development of Building Materials."—May, pp. 78-83
Lyll, John M., assoc. arch. Fleischer Studios—Jan., pp. 33-37
Lyndon & Smith, arch. Kasten residence—Feb., pp. 59-61

McDowell, Allan, assoc. arch. Kimbel house—May, p. 109
McGarry, B. J., designer. Space & structure units—May, p. 90
Maillard, Robert, engineer. Hall, Zurich—Mar., p. 80
Marcus & Co. Jewelry shop. Show window & interiors—Apr., pp. 102, 104, 119
Martin, Marcus W., arch. Holiday home for children—Feb., pp. 98-99
Martinez, Alfredo. Fresco for Church of Mary Star of the Sea—Apr., pp. 76, 80
Mary Star of the Sea, Church of, La Jolla, Calif.—Apr., pp. 76, 80
Matcham, Charles O., arch. Dining unit—Apr., p. 72
Matern, Rudolph A., arch. Prize-winning design for South, Productive Home Competition—May, p. 55
Mayer, David. See Burchard, John E. and David Mayer Men's Wear shops. See Shops, Men's Wear
Merchant, William G., arch. Cambodian Towers and East Facade, Golden Gate Exposition—June, pp. 82-83; Pacific House—Apr., pp. 49-50
Metro-Goldwyn-Mayer sound stages, Culver City, Calif.—Feb., pp. 40-43
Mexican Housing Project, Austin, Texas—Mar., p. 116
Meyer-Levy, Claude. See Besse, Georges & Claude Meyer-Levy
Meyers, Harry, Inc., Florist Shop, New York—Apr., p. 120
Miles, Carl, sculptor. "Forest Life"—Jan., p. 10
Mills, Willis N., arch. Kimbel house—May, p. 109
Modernized bank, Los Angeles, Calif.—Mar., pp. 41-43
Monroe, John K., arch. Chapel of Christ the King—Apr., p. 82
Monsanto Chemical Co., Laboratory Building—May, pp. 48-49
Montgomery, Newcomb T., designer. Molded glass radio cabinet—Jan., p. 57
Mopin, Eugene, engineer. "Mopin system."—Feb., pp. 44-46
Morris, Sidney, arch. Rosenberg Shop—Apr., p. 100
Movie sound stages. M-G-M studios, Culver City, Cal.—Feb., pp. 40-43
Muller, Torben, designer. Bed—June, p. 64
Municipal Building, Enlarged and remodeled. Austin, Texas—June, pp. 42-43
Murchison, Kenneth. Obituary—Jan., p. 10
Museum of Science (Proposed)—Feb., pp. 48-51
Muxux, Edouard, arch. Built-in plant-growing unit—May, p. 59
Mutual-Sunset Lamp Mfg. Co. Plant, New Brunswick, N. J.—June, pp. 116-118

Neely, Richard, assoc. arch. Our Lady of Loreto—Apr., p. 82
Nelson, Paul. Nitzschké, F. P. Jourdain, arch. Proposed Museum of Science—Feb., pp. 48-51
Neutra, Richard J., arch. Kraigher house—May, p. 111
Newsreel theatre. See Theatre, Newsreel
Nimmmons, Carr & Wright. See Pittsburgh Glass Institute Competition
Nitzschké, F. P. See Nelson, Paul, Nitzschké, F. P. Jourdain
Norma Restaurant, Stockholm, Sweden—Jan., p. 74, 90
Nursery Schools. TSS—Feb., pp. 89-100

O'Connell's Restaurant, Chicago, Ill.—Jan., pp. 102-103
O'Farrell & Villegas, arch. Two-family house—Feb., pp. 52-55
Open-Air School, Sundry, Denmark—June, pp. 44-48
Our Lady of Loreto Church, Philadelphia, Pa.—Apr., p. 82

Pacific House, Golden Gate Exposition—Apr., pp. 49-50
Pacific Steel Building Co., designers. Gas station—Jan., p. 32
Page & Southerland, arch. Remodeled & enlarged municipal building—June, pp. 42-43
Parker, Elizabeth, designer. "Crossroads of Sport" Shop—Apr., p. 116
Parker, Frank S., engineer. Roof deck parking space—May, pp. 46-47
Parking space. Roof deck, New York City—May, pp. 46-47
"Parklawn," Milwaukee, Wis.—Jan., p. 66
PARKS. See "Landscape Design in the Urban Environment"
Pavilion for summer symphonic festivals (Proposed), Tanglewood, Mass.—Jan., pp. 44-45
Peck & Peck Shop, New York City—Apr., pp. 94, 108
Pete, Marc, Jr., & Hugh Stubbins, arch. Telepix Cinema—June, pp. 38-41
Petrillo, Frank L., arch. Our Lady of Loreto—Apr., p. 82; May, p. 7
Pfleuger, Timothy L., arch. Court of Pacifica, Golden Gate Exposition—June, pp. 78-79; U. S. Government Building—Apr., pp. 51-53; California Group—Apr., pp. 54-57
Pittsburgh Glass Institute Competition. Examples from entries. Portfolio—Jan., pp. 57-64
Playgrounds. TSS. Nursery schools—Feb., pp. 96-97; Kindergarten-Primary—Feb., pp. 108-109
PLAYGROUNDS. See "Landscape Design in the Urban Environment"
Playrooms. Nursery schools. TSS—Feb., pp. 94-95
Pomeroy, James C., architect. Kindergarten-Primary schools. TSS—Feb., pp. 106-107
Plexiglas, Competition for sculpture in. Announcement—Jan., p. 48
Polivka, Dr. Jaroslav. "Glass—Structural Material of Tomorrow"—Feb., pp. 66-72
Polevitzky, Igor B. See Russell, T. Trip, & Igor Polevitzky
PRECISION CONTROL IN BUILDING PRODUCTION. By Ralph E. Winslow—Mar., pp. 76-80
Prefabricated Dwelling Units—May, pp. 87-91
Prefabricated Farm Buildings—Jan., pp. 38-39
Productive Home Architectural Competition. Announcement—Jan., pp. 17, 48; Winning designs—May, pp. 53-58
Public Works Administration. "Westfield Acres," "Parklawn," "Mirapalmeras"—Jan., p. 66

Queensbridge Houses, New York City—Mar., pp. 117-120

Radio cabinet, Molded glass—Jan., p. 57
Raney, Vincent G., arch. Restaurant overlooking the Golden Gate—Jan., pp. 98-99
Rapson, Ralph. See Saarinen, Eero, Ralph Rapson, Frederic James
Recreational facilities. Low-rent housing developments. TSS—Mar., pp. 104-107
Reinhard & Hoffmeister. See Pittsburgh Glass Institute Competition
Reinhold house, Coral Gables, Fla.—May, pp. 107-108
Reiss, Hilda. See Friedman, William and Hilda Reiss
Reiss, Winold, & A. C. Schweizer, designers. The Cotton Repp, Apr., pp. 104, 109; Longchamps restaurant, Jan., pp. 94-97
Reservoir, Nantes, France—Jan., pp. 42-43
RESTAURANTS. BT section—Jan., pp. 73-104
Retail Shops. See Shops, Retail
Robertson, E. L., & J. R. Weber, arch. Burdine's Dept. Store—May, pp. 36-39
Rose, James C. See Eckbo, Garret, D. U. Kiley & James C. Rose
Rosenberg Shop, Evanston, Ill.—Apr., p. 100
Rosenthal, Rena, Inc. Shop—Apr., p. 117
Rothchild's Men's Store, Beverly Hills, Calif.—Apr., pp. 112-113
Roux-Spitz, arch. Library at Versailles, Cafe in Paris—Feb., p. 49
Ruck, W. F., arch. Auditorium for proposed civic center, Los Angeles, Calif.—May, pp. 44-45
Russell, T. Trip, & Igor B. Polevitzky, arch. Reinhold house—May, pp. 107-108

Saarinen, Eero, Ralph Rapson & Frederic James. 1st prize-winning design, National Theatre Competition—Apr., pp. 61-62
Saarinen, Elio, arch. Proposed pavilion for Berkshire Symphony Festival—Jan., pp. 44-45
St. Ann's Church, Hamilton, Ohio—Apr., p. 78
St. Austin's Church, Minneapolis, Minn.—Apr., p. 78
St. Charles Borromeo Church, Newark, N. J.—Apr., p. 80
St. Joseph's Church, Sacramento, Calif.—Apr., p. 80
St. Joseph's Church, Seattle, Wash.—Apr., p. 77
St. Mary's Church, Helena, Ark.—Apr., p. 82
St. Mary's Court, Washington, D. C.—Jan., p. 31
Saldana Hotel, Brighton, Eng.—Feb., p. 47
San Francisco World's Fair. See Golden Gate International Exposition
Sanger, George W., arch. Swope's store—Apr., p. 106
Scharoun, Hans, arch. Conservatory—May, p. 63
Schoen, Eugene & Lee, designers. Built-in sleeping unit—June, p. 65
SCHOOLS. ELEMENTARY. BT section—Feb., pp. 85-122
Schraft's Restaurant, New York City—Jan., pp. 91-93
Schulte, Edward J., arch. St. Ann's Church—Apr., p. 78
Schwartzman, Daniel, designer. Small house—Feb., pp. 62-64
Schweizer, Albert Charles. See Reiss, Winold and A. C. Schweizer
Science museum. See Museum of Science
Service units. Restaurant. TSS—Jan., p. 81
Serving units. Restaurant. TSS—Jan., p. 81
Shanley, Joseph S., arch. Church of St. Charles Borromeo—Apr., p. 80
Shaw, Alfred, arch. Two bedrooms—June, p. 60
Shops, Book. TSS—Apr., pp. 114-115
Shops, Florist. TSS—Apr., p. 120
Shops, Gift. TSS—Apr., pp. 116-117
Shops, Jewelry. TSS—Apr., pp. 118-119
Shops, Men's Wear. TSS—Apr., pp. 110-113
SHOPS, RETAIL. BT section—Apr., pp. 93-120
Shops, Women's Wear. TSS—Apr., pp. 106-109
Show windows and entrances, small retail shops. TSS—Apr., pp. 102-103
Sierra Union High School, California—May, pp. 40-42
Simonds, George Patton, arch. Kitchen for family of 4—Mar., p. 63
Simonds Saw & Steel Co. factory, Fitchburg, Mass.—June, pp. 103-109
Site organization of housing developments. TSS—Mar., pp. 88-96

SITE PLANNING FOR LOW RENT HOUSING. BT section—Mar., pp. 83-120
Sleeping units. Portfolio—June, pp. 59-66
Smith, Homer J., arch. Alley Dwelling Authority—Jan., pp. 28-31
Snyder, Wahl, arch. Built-in plant box—May, p. 66
Sound-recording building, Fleischer Studios—Jan., pp. 36-37
Sound stages, M-G-M studios—Feb., pp. 40-43
Spelman, Walter, arch. House, Rockville Center, N. Y.—May, p. 112
Spencer, Eldridge, assoc. arch. French Pavilion, Golden Gate Exposition—Apr., p. 48
Spigel, Herbert, arch. Built-in plant box—May, p. 66
Sproule, J. R., arch. Prize-winning design for Northwest, Productive Home Architectural Competition—May, p. 57
Stairways. Portfolio—Feb., pp. 73-80
Stark, A. D., designer. Welded steel frame for Polish building, N. Y. World's Fair—May, p. 67
Steel-Panel Prefabricated Farm Buildings—Jan., pp. 38-39
Stetson Shoe Shop—Apr., pp. 100, 104
Stoddard, G. W., arch. Tuesley house—May, p. 111
Stoediek, Prof. K. See Goldmerstein, Dr. I. and Prof. K. Stoediek
Stone, Edward D. & Carl Koch. Grand prize winners, Pittsburgh Glass Institute Competition—Jan., p. 57, 59
Stone, Edward D. & Philip L. Goodwin. 2nd and 3rd prize-winning designs, National Theatre Competition—Apr., pp. 63-64
Stone & Webster Engineering Co., engineers. Johns-Manville Fiberboard Plant—June, pp. 119-122
Store, Department. Burdine's—May, pp. 36-39
Stubbins, Hugh & Marc Peter, Jr., arch. Telepix Cinema—June, pp. 38-41
Swope's Store, St. Louis, Mo. Shoe department—Apr., p. 106

Table clearances (for restaurants). TSS—Jan., pp. 75-77
Taylor, Jonathan, assoc. arch. Kasten residence—Feb., pp. 59-61
Teitlebaum, Bertram, arch. Film-processing laboratory—May, pp. 50-52
Teichin & Gina, arch. Brooks Store—Apr., p. 98; Cammeyer Shoe Shop—Apr., p. 99; Men's Wear Shops—Apr., p. 110
Telepix Cinema, Boston, Mass.—June, pp. 38-41
Tennessee Coal, Iron & Railroad Co. Steel-panel prefabricated farm buildings—Jan., pp. 38-39
Theatre, Festival, & Fine Arts Bldg. Prize-winning designs in National Theatre Competition—Apr., pp. 61-64
Theatre, Newsreel. Telepix Cinema—June, pp. 38-41
Ticket Office, Union Pacific. See Union Pacific Ticket Office
Tooker & Marsh, arch. Highlands Grade School—Feb., p. 116
Trailer chapel. St. Lucy's of Tenn.—Apr., p. 76
TRENDS IN THE DEVELOPMENT OF BUILDING MATERIALS, by Milton Lowenthal—May, pp. 78-83
Tucker, C. Sheldon, arch. Fleischer Studios—Jan., pp. 33-37
Tuesley House, Seattle, Wash.—May, p. 111
Turner, Burnet C., assoc. arch. Queensbridge Houses—Mar., pp. 117-120
Two-family house, Buenos Aires, Argentina—Feb., pp. 52-55
Two-family house. See Duplex dwelling

Union Pacific ticket office, Chicago, Ill.—Mar., pp. 50-51
URBAN LANDSCAPE DESIGN. See "Landscape Design in the Urban Environment"

Van Witsen, Rits, arch. Built-in sleeping unit—June, p. 65
Vogelgesong, Shepard. See Liebes, Mrs. Dorothy & S. Vogelgesong

Waldron, Gordon, Shop of, New York City—Apr., p. 117
Walker & Gillette. See Pittsburgh Glass Institute Competition
Walsh, H. R., decorator. 2 bedrooms—June, p. 60
Watching United Men's Shop. Shelves—Apr., p. 110
Weber, Maurice E., arch. Isolation block, London Fever Hospital—Jan., pp. 40-41
Weber, John R. See Robertson, E. L., and John R. Weber
Weed, Robert Law, arch. Bedroom—June, p. 61
Weese, Harry, arch. Prize-winning design for Middle West, Productive Home Competition—May, p. 56
Weibe, Ernest E., arch. Elephant Towers and West Facade, Golden Gate Exposition—June, pp. 80-81
Wellman, W. T., arch. Union Pacific ticket office—Mar., pp. 50-51
"Westfield Acres," Camden, N. J.—Jan., p. 66
Westin, Kjell, arch. Norma Restaurant—Jan., pp. 74, 90
WHAT DOES MILITARY DESIGN OFFER THE ARCHITECTURE OF PEACE? by Douglas Haskell—Jan., pp. 49-55; Mar., pp. 68-75
White & Weber, arch. Kitchen for family of 5—Mar., pp. 58-59
William & Mary College. National Theatre Competition for fine arts building and festival theatre. Prize-winning designs—Apr., pp. 61-64
Williams, H. C., designer. Union Pacific ticket office—Mar., pp. 50-51
Windowless factory. Simonds plant—June, pp. 103-109
Winslow, Carleton M., arch. Church of Mary Star of the Sea—Apr., p. 80
Winslow, Ralph E. "Precision Control in Building Production"—Mar., pp. 76-80
Withers Architectural Co., Inc., arch. Hubbard School—Jan., p. 117
Witkin, Zeev. Civil Engineer. Auditorium for proposed municipal center, Los Angeles—May, pp. 44-45
Women's Wear Shops. See Shops, Women's Wear
Worley, Lois W. See Caudill, Wm. W., and Lois W. Worley
Wurster, Wm. Wilson, arch. Dining room—Apr., p. 71; Garrison residence—May, p. 112; sleeping unit—June, p. 59

Youtz, Phillip N., consultant. Pacific House, Golden Gate Exposition—Apr., pp. 49-50