

BUILDING NEWS



Courtesy California Toll Bridge Authority

Public garage in railway terminal . . . see pp. 30-32

ARCHITECTURAL
RECORD

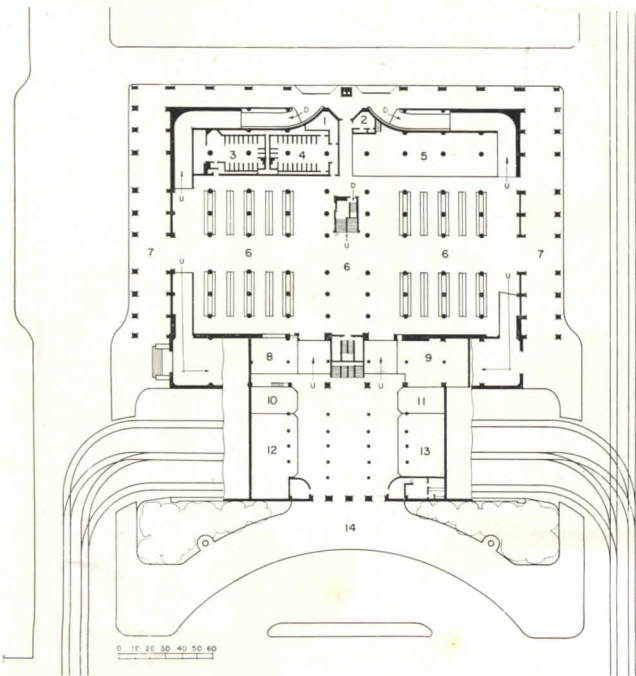

Ground floor: 1. Women's rest room. 2. First aid. 3. Men. 4. Women. 5. Restaurant, etc. 6. Waiting room. 7. Arcade. 8. Bakery. 9. Lunchroom. 10. Fruits. 11. Flowers. 12. Stand. 13. Stand.

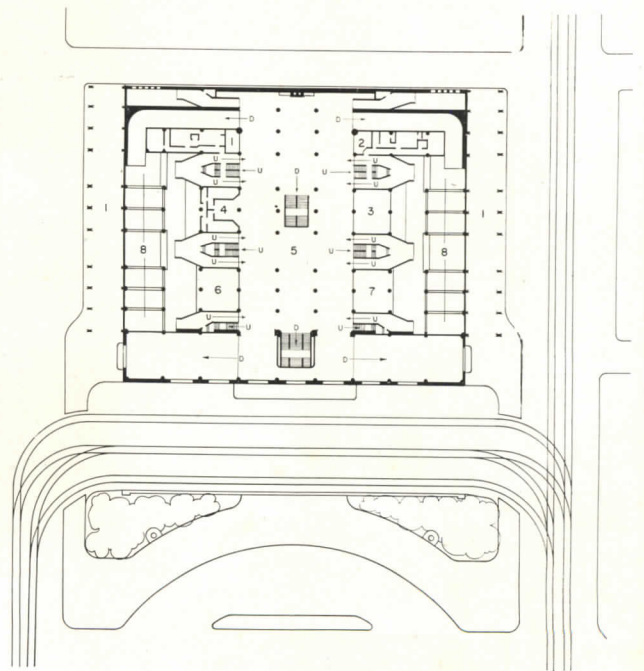

Mezzanine floor: 1. Travel agency and (or) ticket office. 2. Telegraph office. 3. Soda fountain and lunch counter. 4. Ticket office. 5. Concourse. 6. Drugstore. 7. Newsstand, candy. 8. Furred space.

RAILWAY TERMINAL DESIGNED TO SPEED COMMUTER TRAFFIC

TIMOTHY L. PFLUEGER, ARTHUR BROWN, JR., and JOHN J. DONOVAN

Consulting Architects

THIS NEW terminal accommodates passengers of the first direct railway between the City of San Francisco and the east shore of the five-mile-wide San Francisco Bay. Probably the most heavily concentrated commuter traffic of any city in the country occurs here during the peak hour: ninety-five trains, carrying approximately 14,000 passengers, leave the terminal in an hour's time. In a 20-minute period between 5:00 p.m. and 5:20 p.m., about 7,300 commuters are transported from San Francisco to their East Bay homes. Annual commuter traffic between the two points is approximately 35,000,000.

Speed in loading and unloading passengers was the driving consideration. To this end the structure has been designed as a system of ramps and stairways arranged to minimize walking and to facilitate passenger distribution. There are seven ramps or stairs serving each train. Ramps

have a maximum grade of 10% and are surfaced with an abrasive, non-slip material. Seventeen entrances and exits at the street level make it possible for passengers to reach any street bounding the terminal, thus avoiding congestion at any single point. No doors, except those which lead from the streets to the waiting room, obstruct travel paths to the train level. Further to reduce walking distances for passengers, heights between floors are only 10 ft.: the total vertical distance from tracks to street level is 20 ft.

Space for 600 cars is available in the basement, street, and mezzanine floors of the west unit and in the basement of the center unit; this makes it the largest public garage in San Francisco. Space for concessions has been placed in the principal paths of travel.

Total cost of the structure was \$2,300,000.

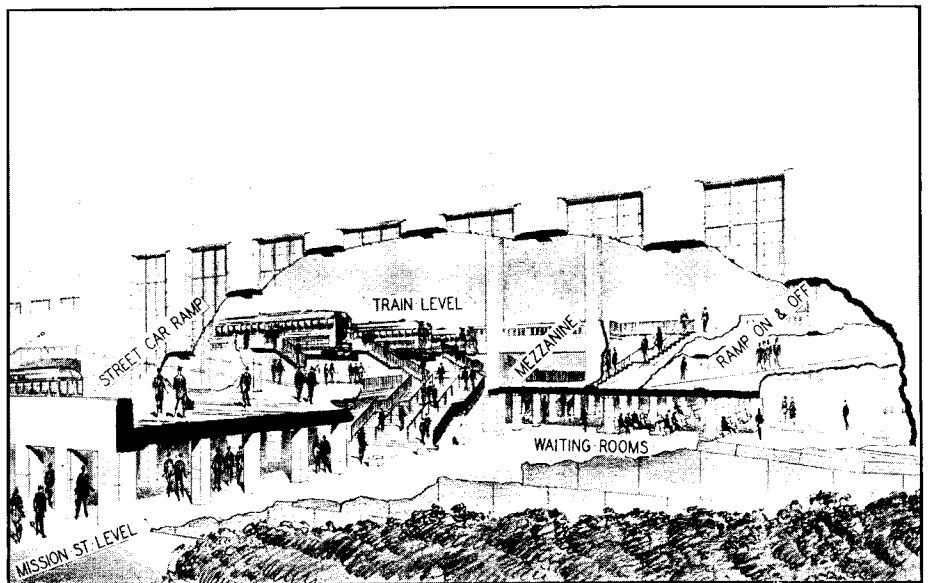

Electric trains come in on the upper level over six tracks entirely enclosed. Streetcars loop over a viaduct at mezzanine level.

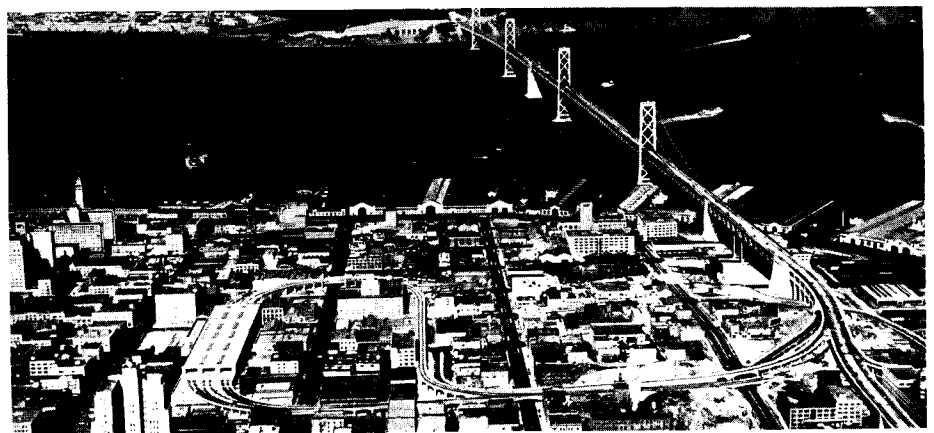

The bridge enters the city at an approximate elevation of 175 ft.

SAN FRANCISCO TERMINAL



The mezzanine floor is a concourse with directional signs. The track level is above.



Waiting room on street floor. Average waiting period per passenger: about 10 minutes.

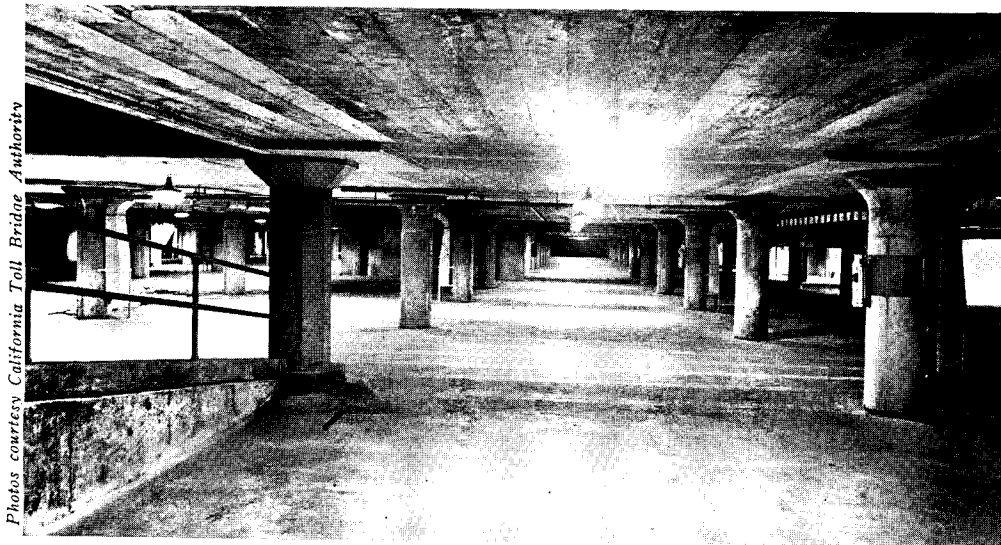

Photos courtesy California Toll Bridge Authority

View shows public parking space in the basement of the west unit of the building.

NEW YORK WORLD'S FAIR: FARM USES OF ELECTRICITY DEMONSTRATED

HARRISON & FOUILHOX, Architects

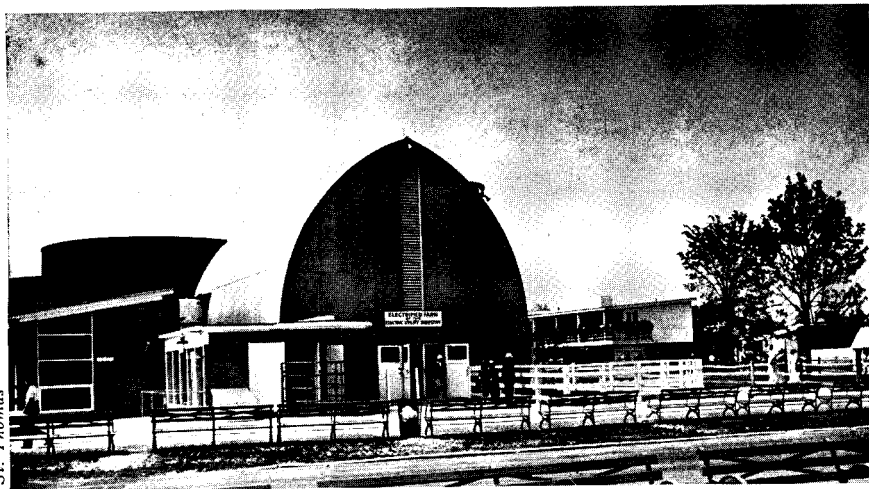

St. Thomas

View of barn from southeast



View from southwest

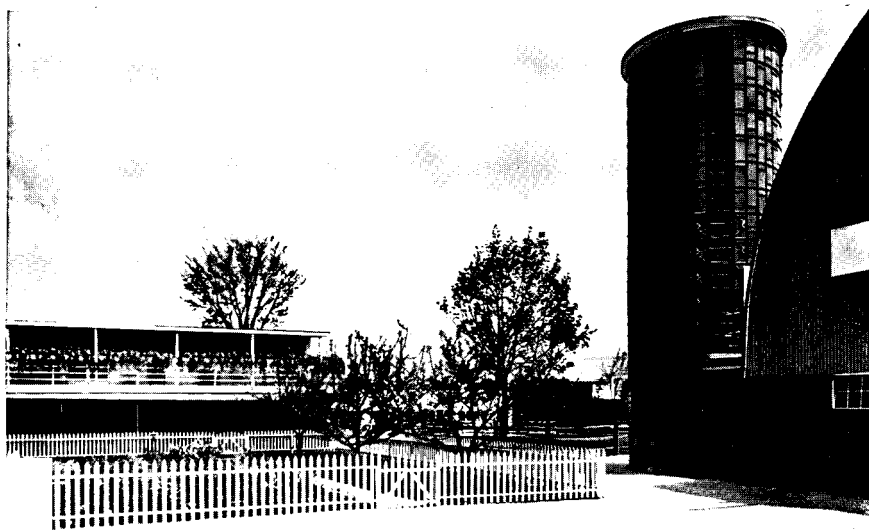

View from east

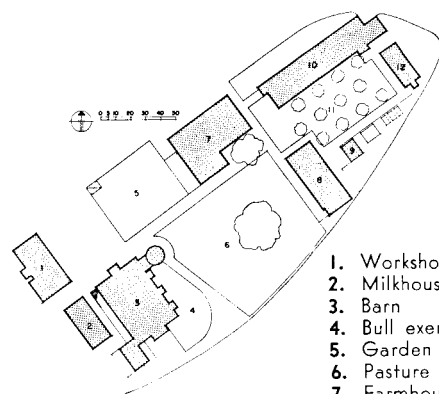

Plot plan

1. Workshop
2. Milkhouse
3. Barn
4. Bull exerciser
5. Garden
6. Pasture
7. Farmhouse
8. Poultry house
9. Brooder
10. Cooperative
11. Apple orchard
12. Greenhouse

THERE ARE almost 1,500,000 farms in the United States which receive electric service, and more than 200 types of farm work are performed by electrically powered equipment. Over 100 of these uses of electricity are installed at the Electrified Farm, sponsored by the Electric Utilities Exhibit Corporation, at the New York World's Fair. The design of the farm group involved cooperative research by architects, technicians from the utilities industry, and specialists from various universities. The completed project, within the limitations of the site and the purposes of the exhibition, is a working farm.

In orienting the farmhouse, the designers have faced the living rooms to the south, overlooking the garden and fruit trees; the south side is mostly glass, with slightly projecting porch roofs; and the east, west, and north sides have few windows. For centuries, farmers have partially recognized the advantage of such orientation and have turned the almost windowless backs of their houses to the cold north winter winds. The designers of the farmhouse at the Fair have gone farther: by putting large windows in the south wall and few in the east and west, the heat of the low winter sun from the south is gained; in the summer, an insulated roof and east and west wall keep the house cooler, and the high summer sun is excluded by the eaves over the south windows.

Other farm buildings include a barn, "milking parlor," dairy, workshop, poultry house, packing house, and greenhouse.

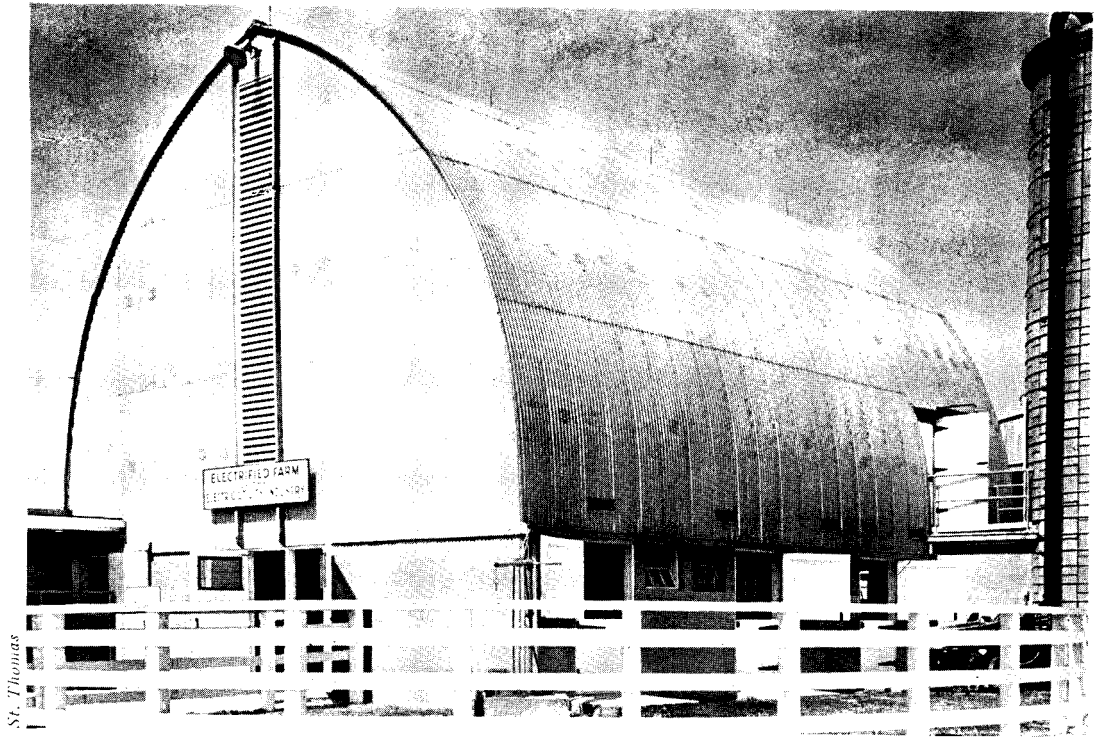

View of barn from the south

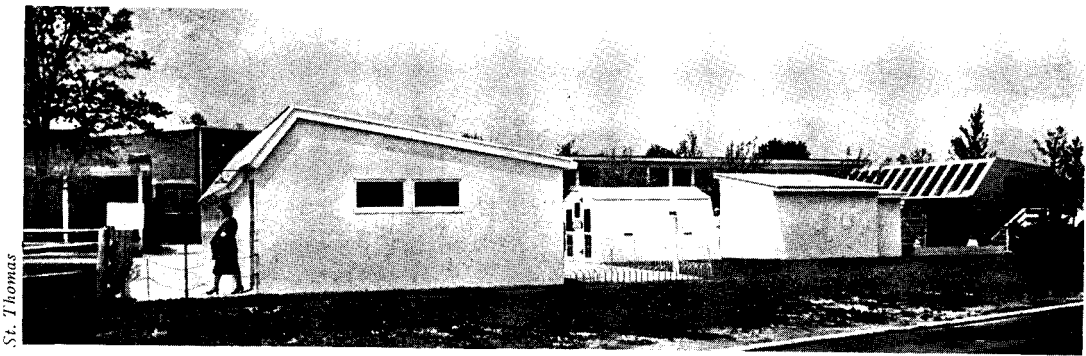

Farm buildings from the south

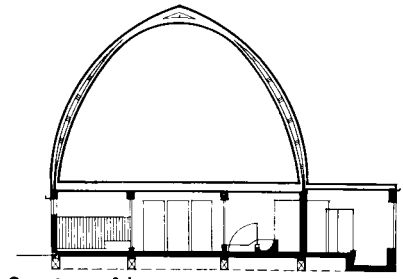

Section of barn

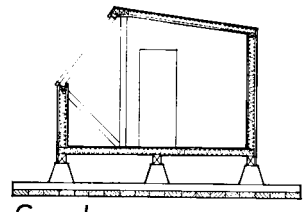

Greenhouse

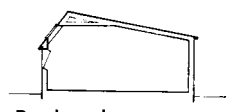

Poultry house

The design of the farm buildings was determined largely by considerations of economy in roof construction—single slope with slight pitch—and by a concentration of windows where they are most needed. The south side in the greenhouse, poultry house, milk parlor, dairy, and farmhouse. The design of the

barn roof is an adaptation of the Lowden roof arch, which gives maximum hay storage in a given space. The roofing material of the barn, as well as of all other buildings, is fire-resisting zinc-coated corrugated iron sheets: this to help prevent the spread of possible fires from building to building.

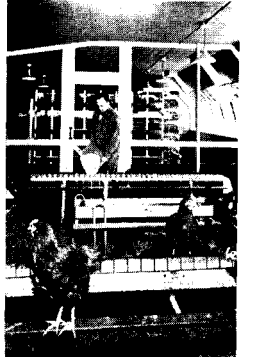
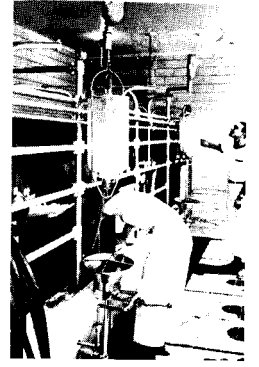
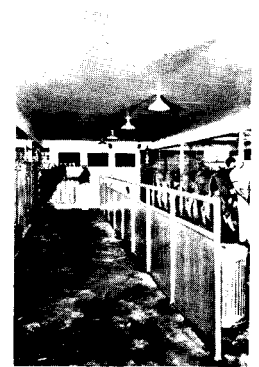

LECTURE ROOM IS PART OF PERMANENT EXPOSITION

JADWIGA and JAN OSTROWSKY, ZYGMUNT STEPINSKI, Architects

Photos by *Czesław Olaszowski*



View of seating

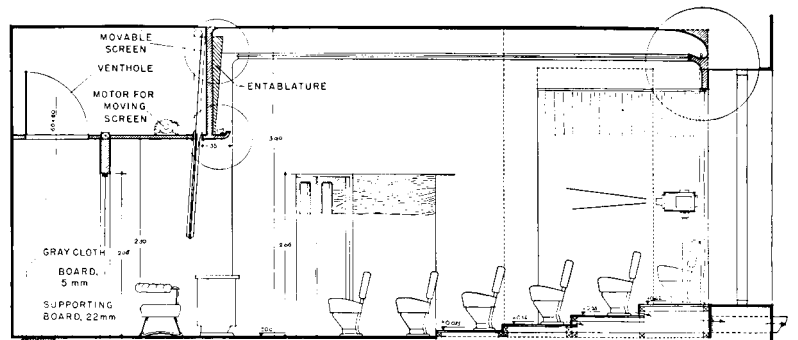

Section

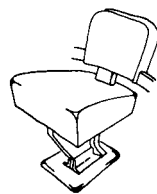

Perspective

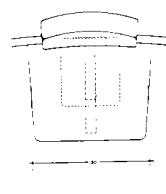

Plan

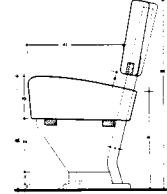

Side

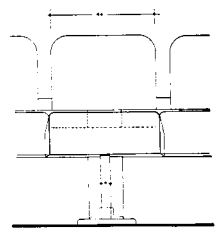

Front

THIS LECTURE ROOM is part of a permanent "demonstration salon" in Warsaw, Poland, whose purpose it is to educate prospective users to the advantages of electrical equipment in the home. The room seats about

60 persons. The chairs permit revolving and backward movement. They are of wood, covered with navy blue chamois leather. A concealed motion-picture screen above the lecturer's desk can be lowered mechanically.

SHELL DEMONSTRATES NEW POSSIBILITIES OF CONCRETE

ROBERT MAILLART, Engineer

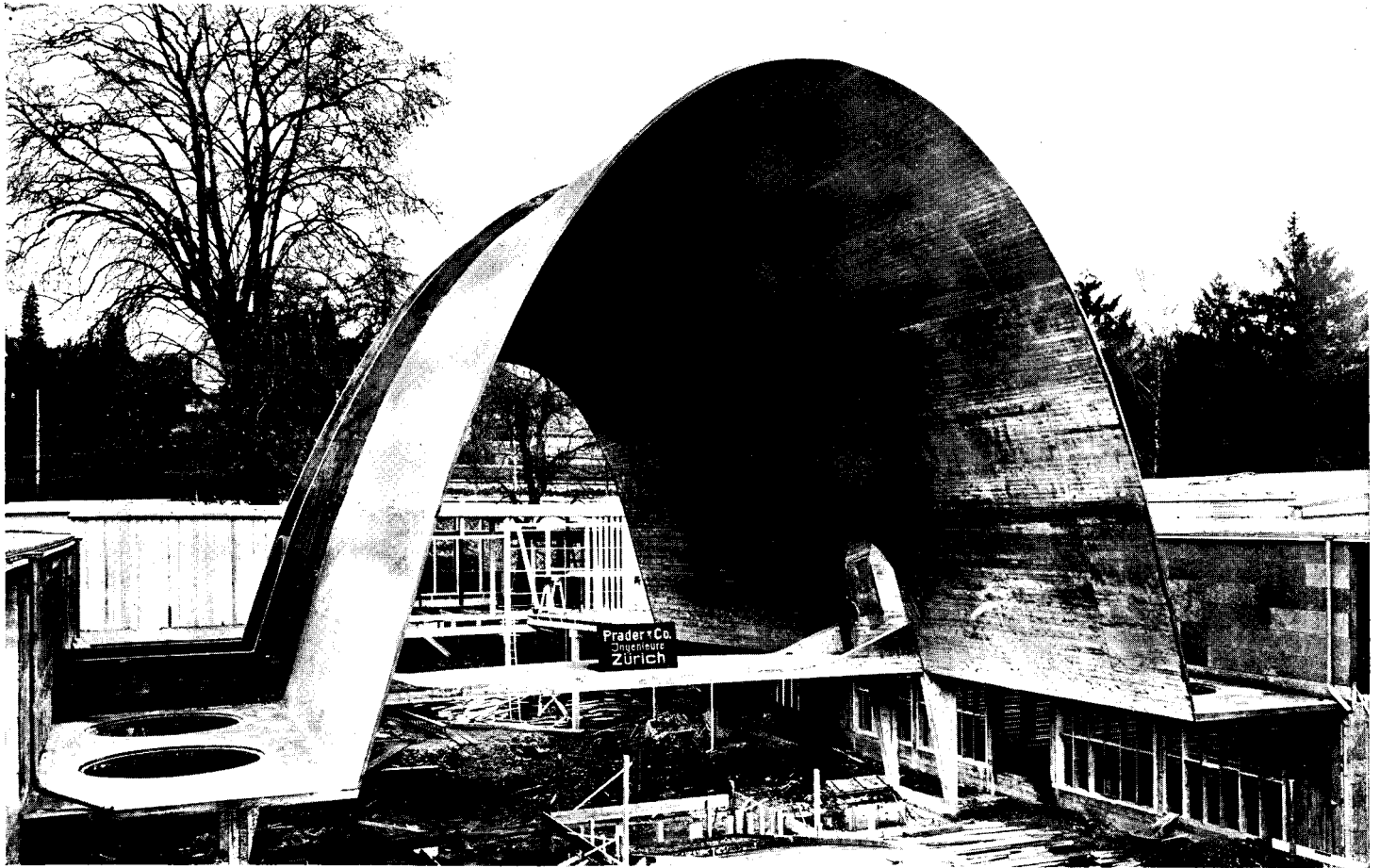

Photos by H. Wolf—Bender's Erlieu

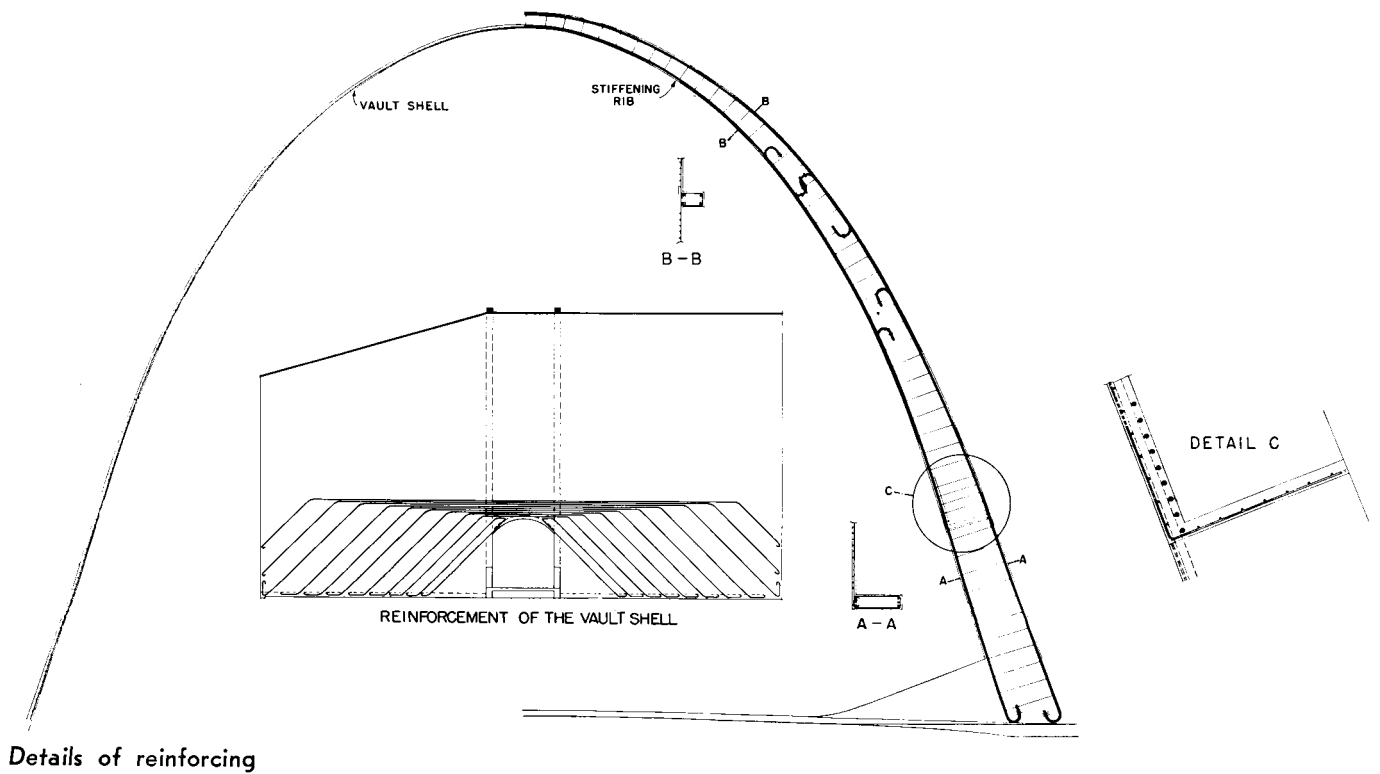

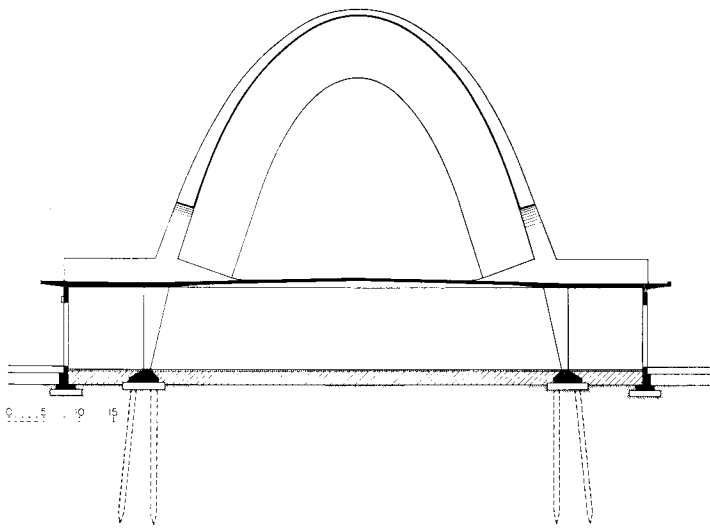

Section

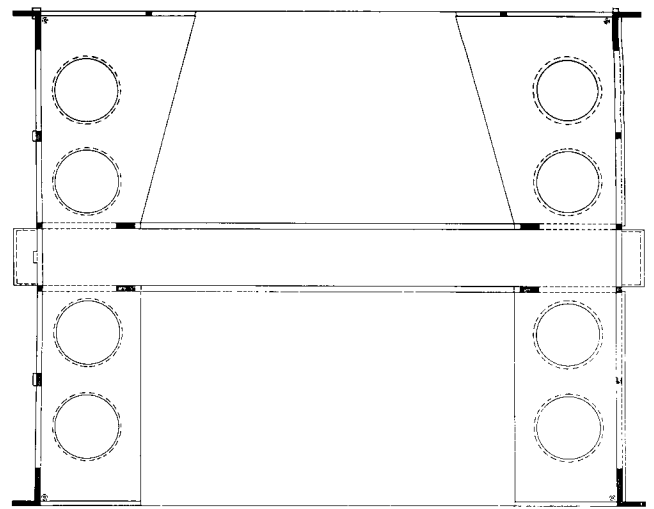

Plan

THIS STILL UNFINISHED building at the 1939 Swiss National Exposition is a demonstration of the new structural possibilities of reinforced concrete. The structure is a concrete shell, only 6 centimeters thick (2.36 in.), flanked by low flat-roofed areas on either side. The lower part of the shell, bearing the load of the vault from above and of the hole-pierced side roofs from below, is provided with heavier reinforcing; the better to resist tension, the lower shell is not bent either.

There were to be as few interior supports as possible; only four pillars, directly under the center bridge, are needed. Despite the short distance between the supports, 2.74 meters (9 ft.), the shell, 21.4 meters (70 ft. 2½ in.) in its longitudinal direction, is stable even in a strong wind. For stiffening, particularly against wind stresses, two ribs, extending up from the supports, are used to reinforce the shell.

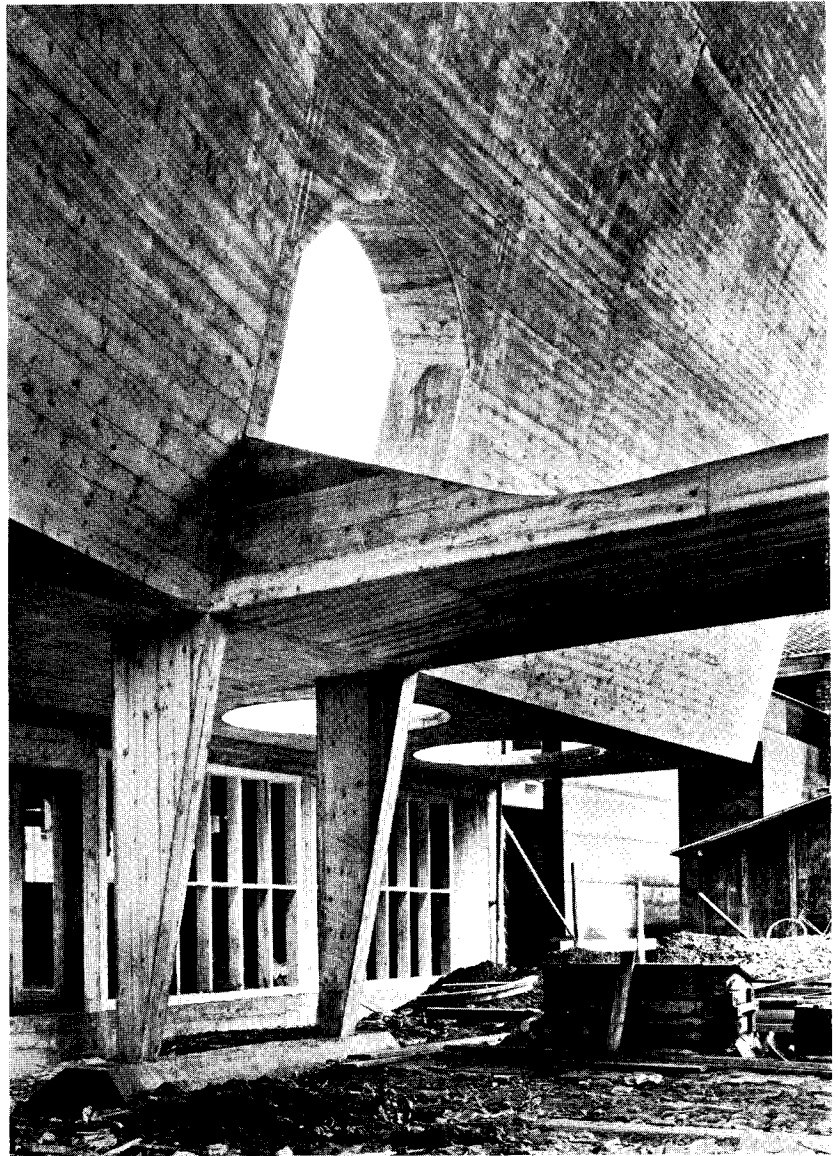

Four pillars, two on each side of the vault, are the only interior supports.

DESIGNERS OF SHOWROOM AND DISPLAYS STUDY SALES METHODS

RUSSEL WRIGHT and ASSOCIATES, Designers

Photos by John Hans, Inc.

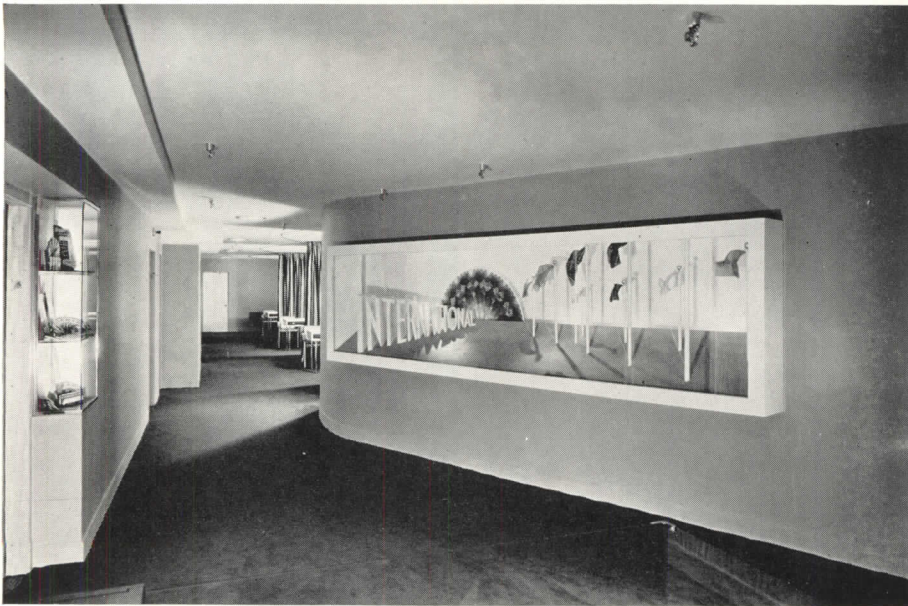

Handkerchiefs, the product to be sold, are prominently displayed at the entrance.



Private showrooms are formed by sliding curtain partitions along the south wall.

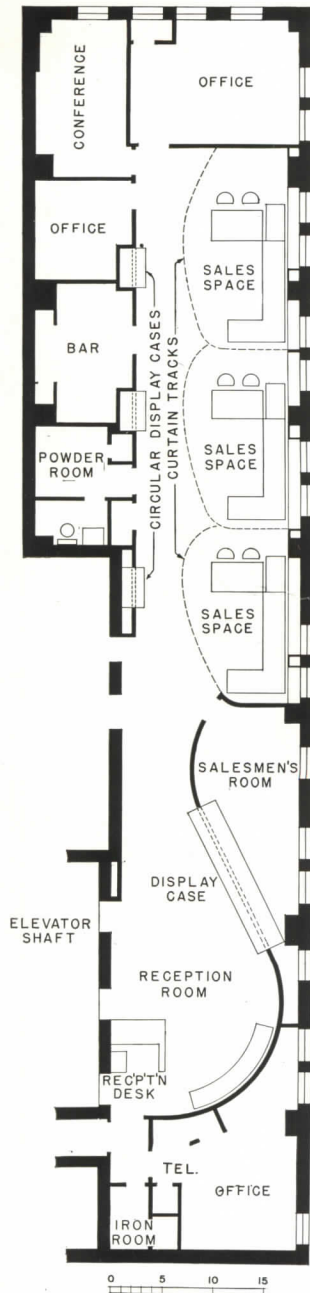

Plan

THE DESIGN of a showroom and displays for the International Handkerchief Company involved a study of the merchandising methods employed by the company's salesmen. Each study moved from the handling of merchandise in selling, through its display in showrooms, the entertainment of buyers, finally to the display of merchandise in customers' shops.

The design adopted provides:

1. Privacy: draperies on curved tracks shut off each customer and salesman from the general view.
2. For the display of handkerchiefs: cards were de-

vised to be placed in books. The colors of materials chosen for the background of these cards are complementary to the merchandise displayed: blond wood veneer, black felt, red felt, polished chromium, and pigskin. The books containing these cards are housed in specially built cabinets.

3. For the entertainment of buyers: there is a bar in the rear. A powder room is provided for women buyers.

The new showrooms are said to have resulted in increased orders for handkerchiefs.

OPEN PLAN OF NEW BANK BUILDING PERMITS EASY VISIBILITY

V. C. BUTLER, Architect

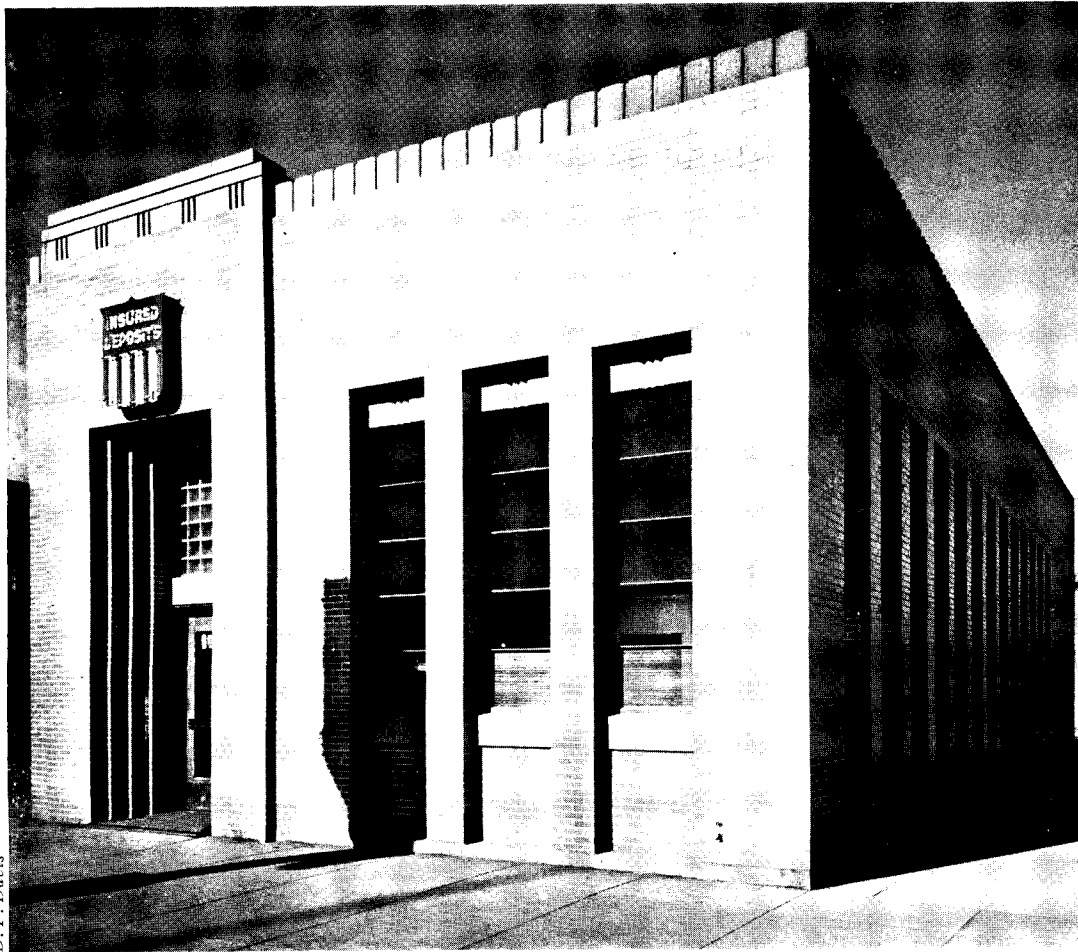

D. F. Davis

IN THIS new building for the Commercial Bank, in Spanish Fork, Utah, the feeling of security usual with bank structures has been combined with a sense of freedom and light. Vertical windows along front and one side admit ample light; since the lower panes are shielded by fine-mesh bronze screens which permit vision only toward the light, no privacy is sacrificed. The second row of panes is of clear glass, and the upper three rows are of opaque glass to recall the texture of the glass block over the entrance. The exterior of the building is of grey salt-glazed brick with a precast stone trim of imitation granite. The plan is such that all departments are visible from all points. Walls and ceiling are treated with acoustic plaster so that the noise from the bookkeeping department at the rear is no real source of disturbance. The interior color scheme is light in tone. A waist-high partition of rosetta marble separates lobby and office space; a dado of the same material repeats the line along the opposite wall; other partitions are of quarter-sawn white oak. Walls and ceiling are of light-cream plaster. The lobby floor is blue-grey rubber with black strips along the edge; the president's and cashier's offices have rust carpet, and the remainder of the floors are covered with rust-colored jaspé linoleum. The steel sash are painted light green; the red upholstery of the lobby chairs is the only strong color accent. The building has year-round air conditioning, equipment for which is in attic space in the rear portion of the building; air is delivered through ceiling plaques and taken out at the floor line. All windows, except small ones in rear, are stationary and sealed against infiltration of dust.

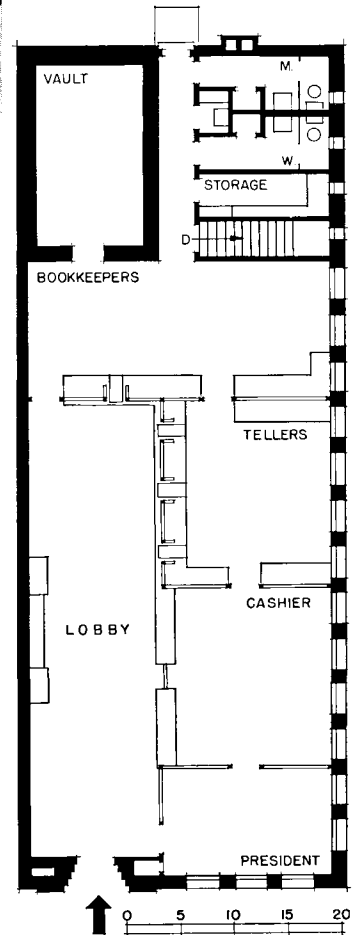



by D. F. Davis

Above: view from entrance, looking toward bookkeeping department and rear of bank. Below: bookkeeping department, showing glass screen for reduction of noise transmission without affecting view of front offices.

ST. LOUIS, MO.: OFFICE AND RESIDENCE INTEGRATED IN ONE STRUCTURE

EDOUARD MUTRUX, Architect

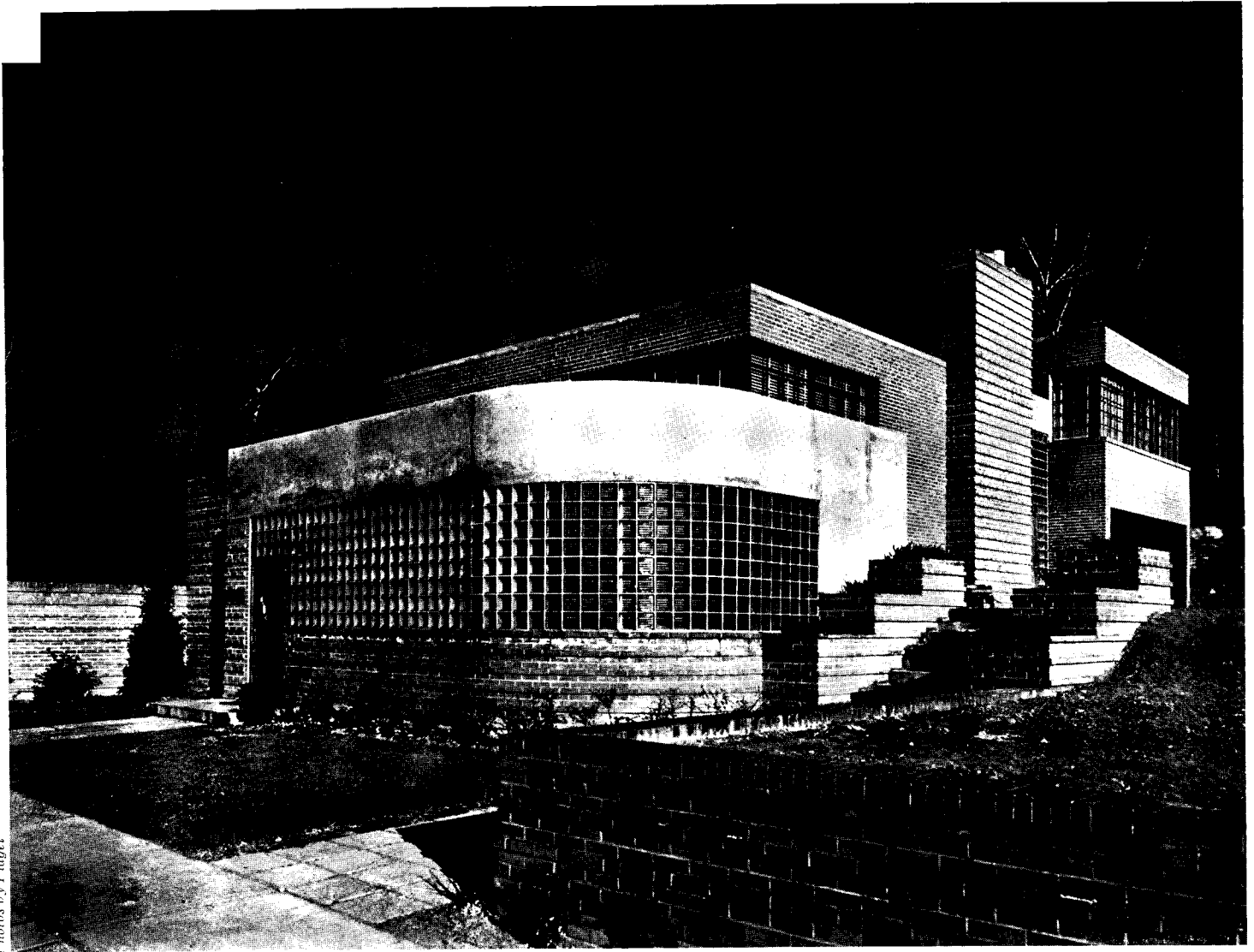

Photos by Piaget

THE COMBINED OFFICE and residence for Dr. Sam Bassett is of particular interest in that both functions of the building are well integrated but independent of each other. The main problem was to provide easy access to the office without excessive excavating and without the use of stairways. Consequently, the ground floor is devoted entirely to the doctor's offices and equipment rooms with the entrance at the front of the building near the street. The residence, however, has a longer approach and is entered from the side of the building. The slope of the lot makes it possible to enter at a level halfway between the ground floor and the upper floors on which is located the residence. Thus each entrance is simple and clearly defined. The building rests on a 13-in. reinforced-concrete foundation; exterior walls are of brick and hollow tile. Glass block plays an important part in the office portion of the building, which is entirely air-conditioned.

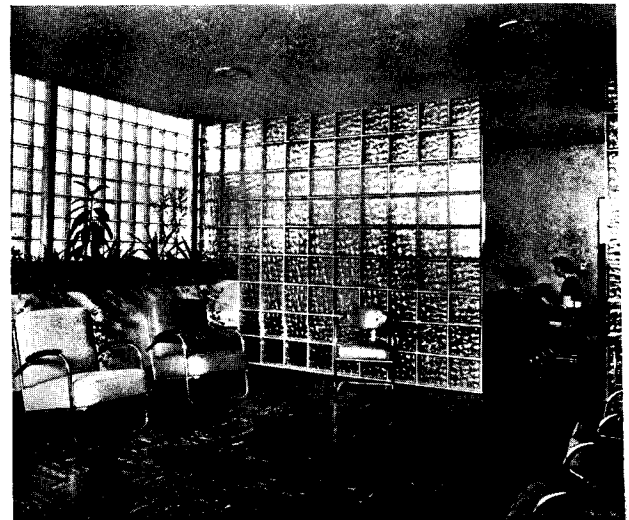

View of the waiting room looking toward entrance hall

DOCTOR'S OFFICE AND RESIDENCE

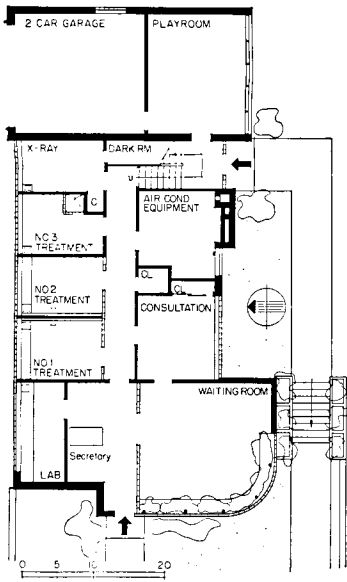

The ground-floor plan is organized along "flow" lines for convenience of both patients and doctor. A glass-block partition separates entrance hall and waiting room. At the rear is the entrance to the residence; on the same level with this hall is a playroom which connects with the garage.

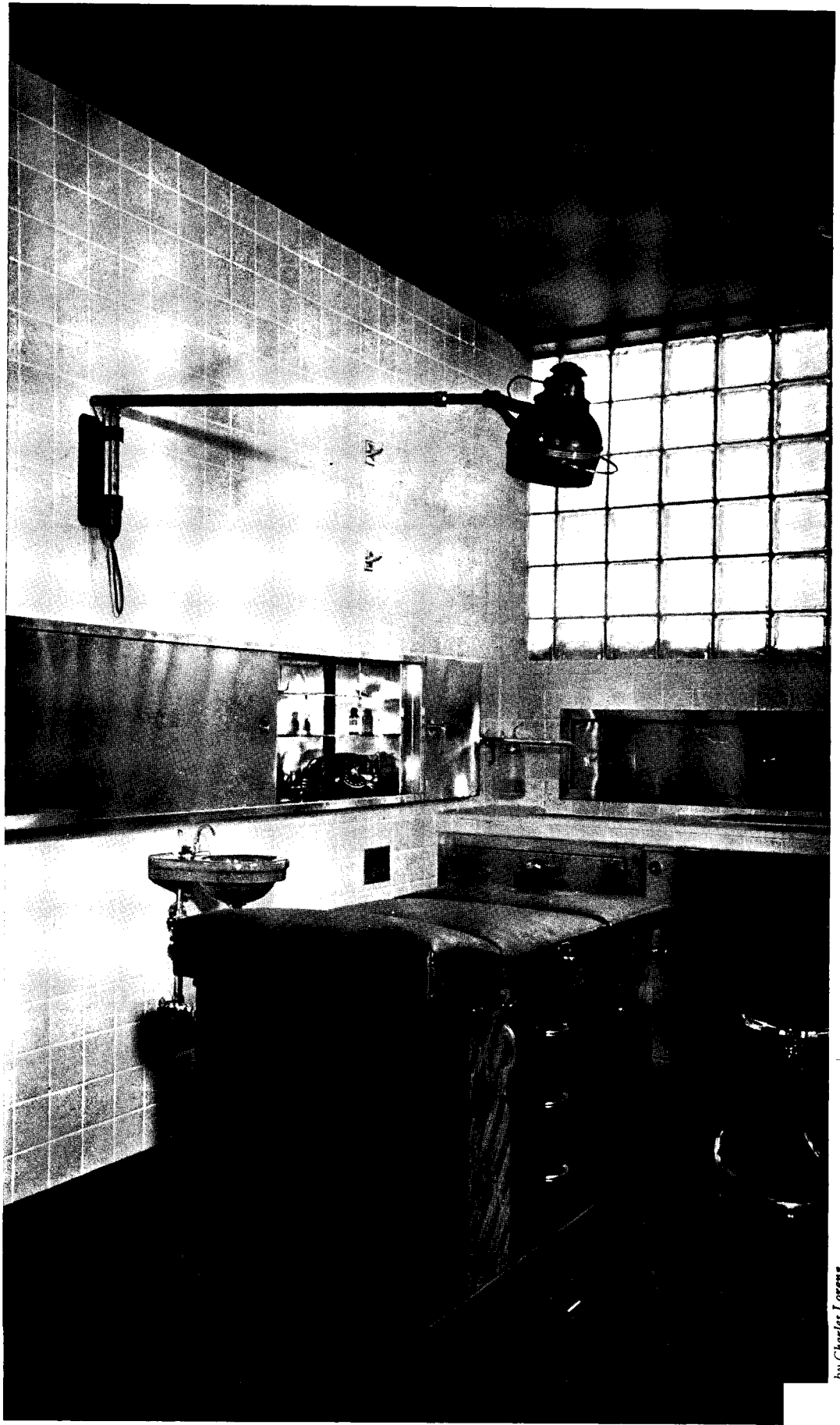

View of treatment room No. 2 showing equipment, stainless-steel wall, and base cabinets



View of stainless-steel cabinet seen from treatment room No. 1, looking past the illuminated shelves into treatment room No. 2

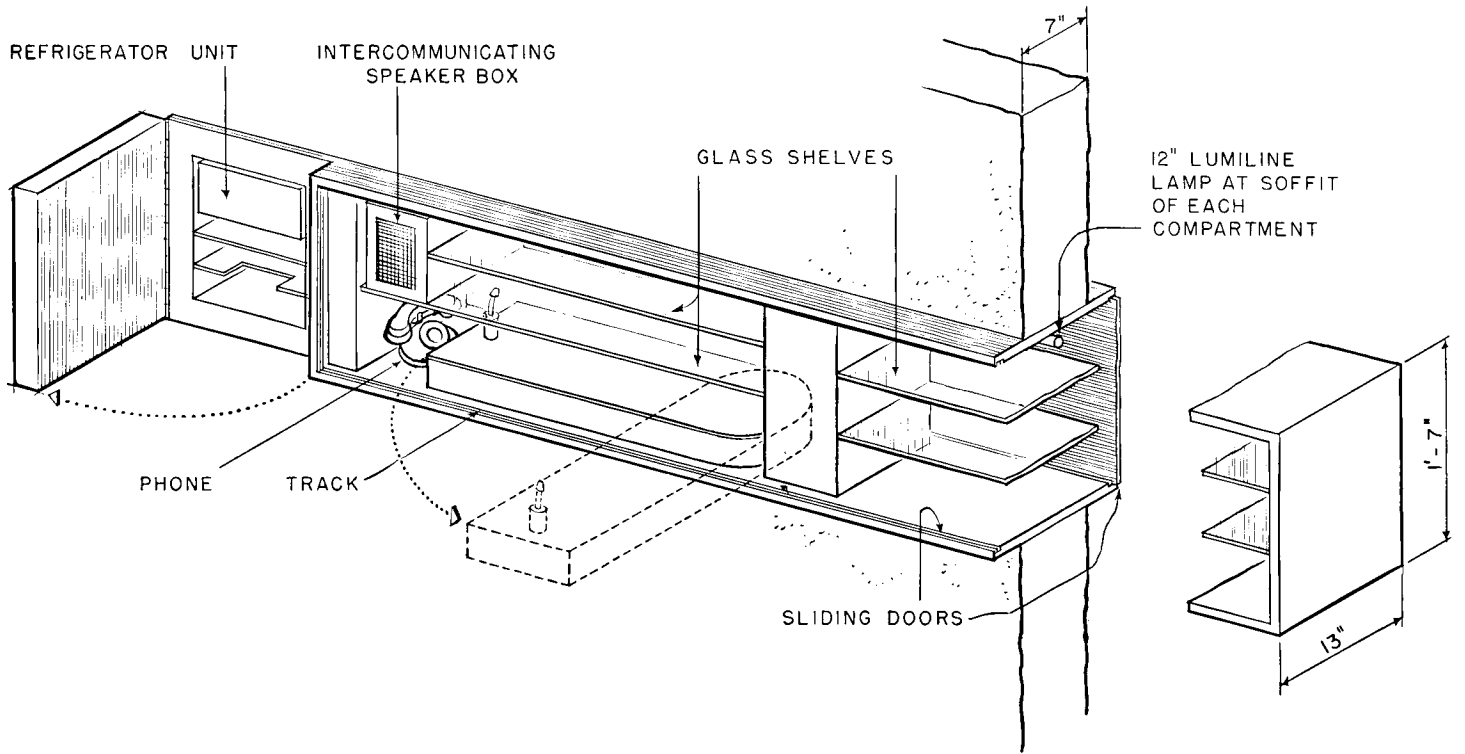

CABINETS IN treatment room No. 1 are ranged along the wall adjacent to treatment room No. 2, so that they are mutually accessible by means of sliding doors on each side. These cabinets are encased in stainless steel. At the far end is a refrigerator unit for storage of serums, etc., which also has doors on either side. Instruments for minor surgical operations are readily distinguishable on the glass shelves in the central compartment; each compartment is illuminated by a centrally located lumiline lamp. Shown in the isometric but not visible in the above photograph is a tray so mounted that it swings into either room.

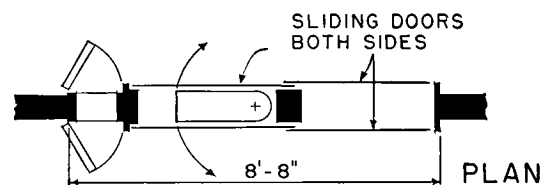

DOCTOR'S OFFICE AND RESIDENCE

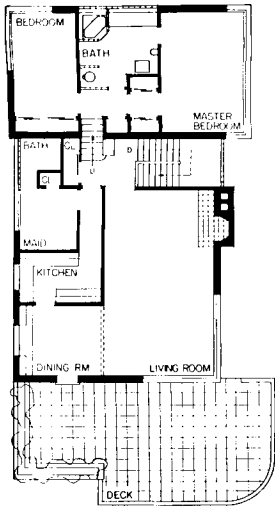

The residence takes advantage of the difference in grade by using a split-level plan. The living area is a full story above the office portion of the building, while sleeping quarters are a half floor above the living area, but a whole floor above the entrance and play-room level. Dining room and living room both open on the paved sun deck.



Lorenz

The dining alcove opens off the west end of the living room. Built-in cabinets and open shelves frame the north window. Floor and coved base are of dark linoleum.



Picquet

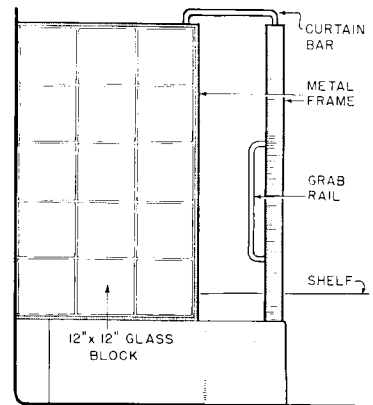
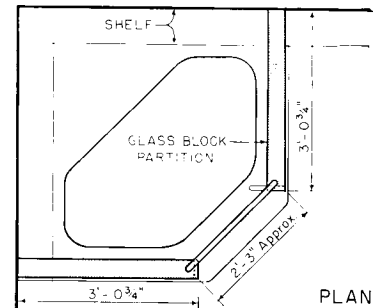

Glass-block partitions are used in the bathroom. Above is the corner tub, with side walls of glass block set in a metal frame, and a curtain bar provided over the opening.

MT. VERNON, N. Y.: SPLIT-LEVEL ELIMINATES WASTE SPACE

CHARLES N. & SELIG WHINSTON, Architects



Living room looking toward stairs and dining room.

THE APPLICATION of the split-level plan to this residence in Mt. Vernon, N. Y., reduces the number of steps necessary between living and sleeping quarters. The living room is two steps lower than the entrance hall, dining room, and service end of the house. Four steps up from the entrance hall is the bedroom level. Above this is the second floor, with study, maid's room, and play room. Ingenious use of the difference in ceiling heights makes possible a stage in the play-room. The exterior of the house is red-brick veneer, with flush and beveled white siding on frame walls. Both rockwool and metallic insulation were used to effect economy in heating. The residence cost \$10,500.

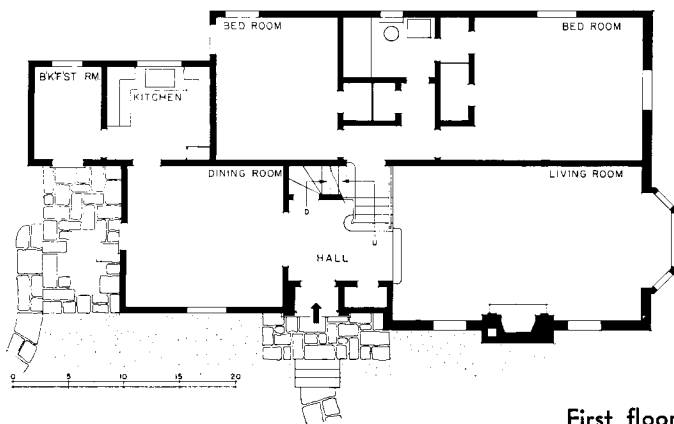

First floor

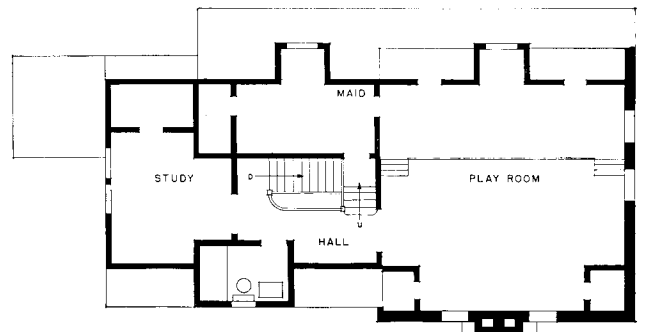

Second floor

CALIFORNIA RESIDENCE HAS ENTRANCE MIDWAY BETWEEN FLOORS

WILLIAM WILSON WURSTER, Architect

Photos by Roney Sarricant

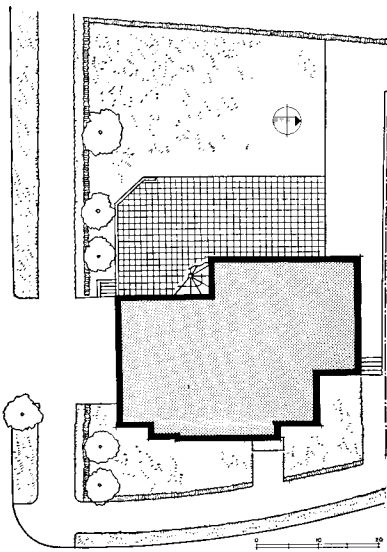
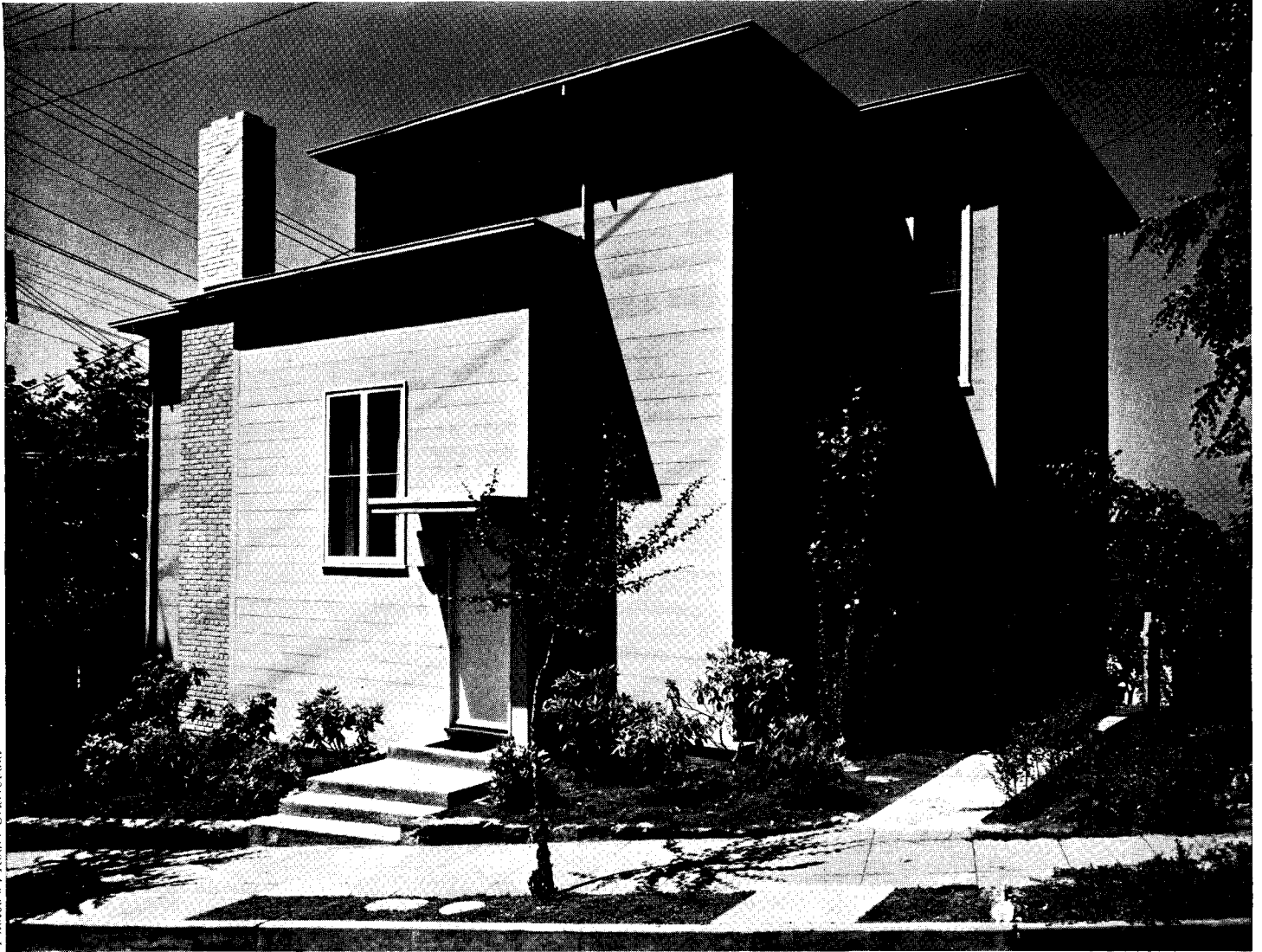

SITUATED ON A SMALL, steep lot in Berkeley, Cal., this residence for Mr. and Mrs. Leslie M. Van Deusen has its entrance at a level midway between the first and second floors. Because of the slope of the lot, this was dictated by convenience. The house was placed near the street in order to provide for a terrace and garden at the rear. From the entrance hall stairs lead down to the dining room and the service area (first floor), and up to the living and sleeping area (second floor). The separation of these two operational units of the dwelling (dining and its attendant functions; living and sleeping) on different floors is here particularly apt, and solves the problem posed by need for a vertical rather than a horizontal plan. On the third floor, reached by another stair, are two bedrooms and a deck. These two upper floors command an excellent view of San Francisco Bay. The exterior is finished in resawed redwood boards painted warm stone grey; the trim is redwood painted white. Chimney and underside of roof are also white.

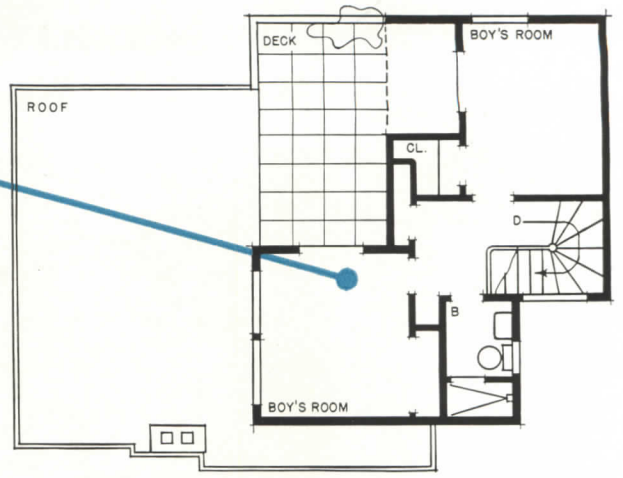

Third floor

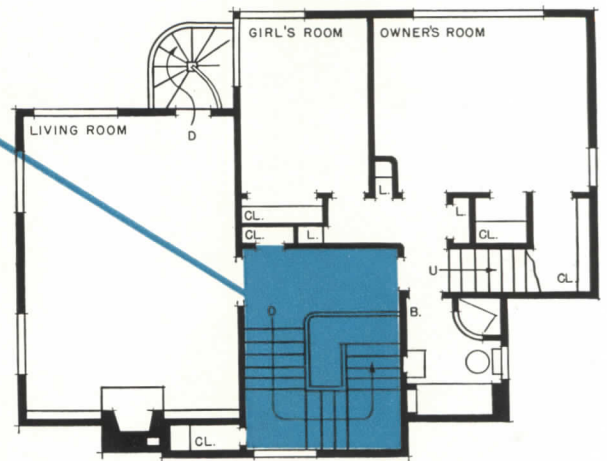

Second floor

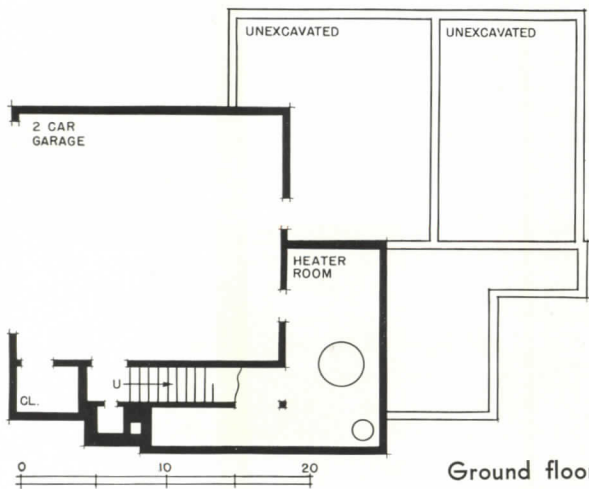

Ground floor

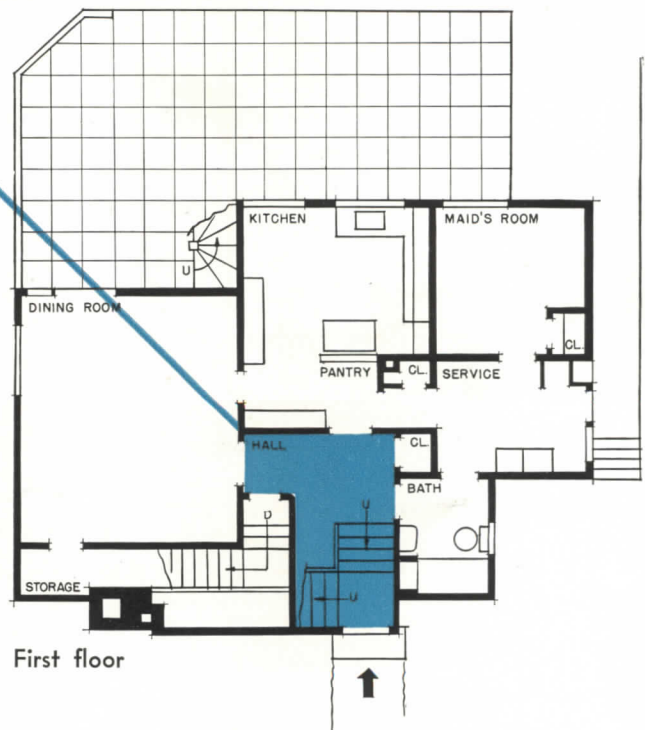

First floor

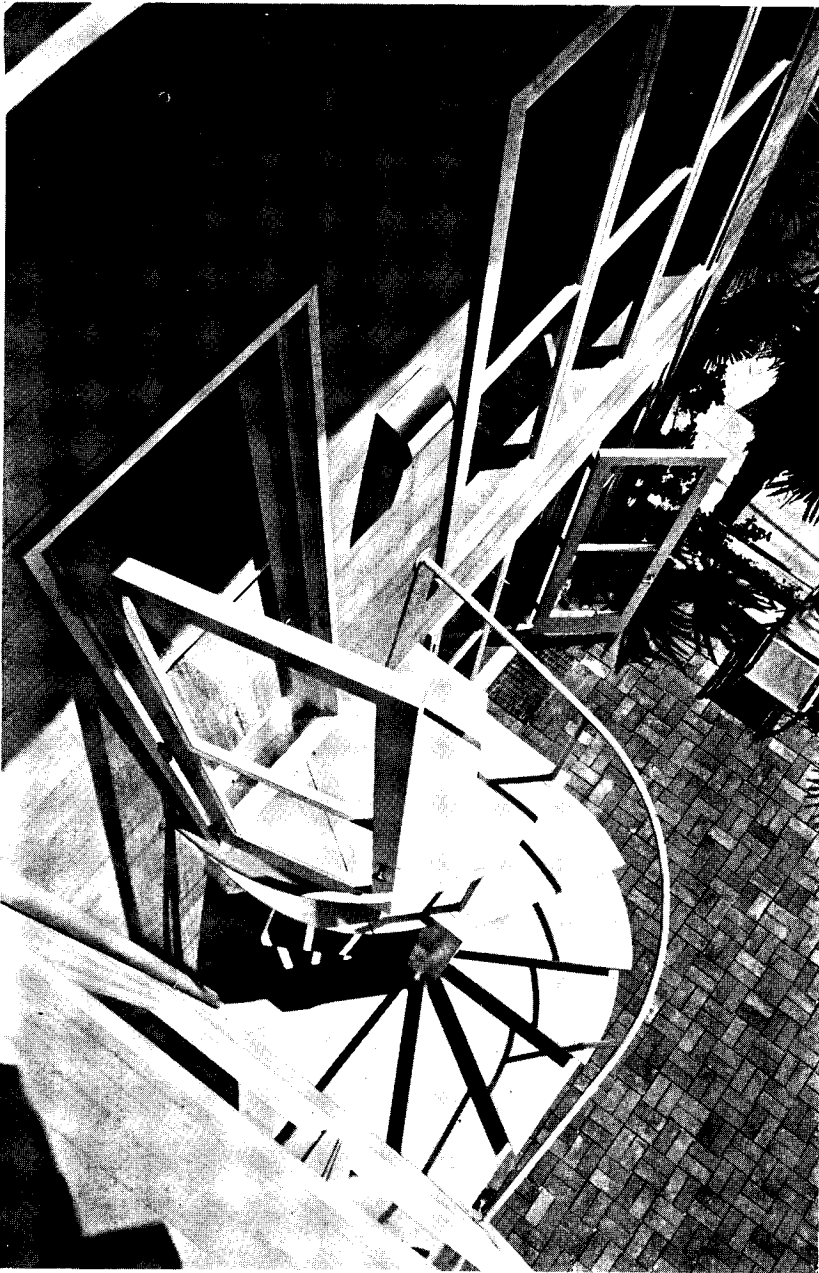

Photos by Roter Sturtevant

ONE OF THE REQUIREMENTS for this residence was that it should have a garden; furthermore, the garden was to be accessible from the living room via the terrace. But the steep lot made it necessary to place the living room on the second floor. The solution to this problem was an outside spiral staircase (above). The interior of the house is simple, and the color scheme is light. The walls are fine sand-finish plaster, painted the color of natural suede leather, but with a slight olive cast. The floors are oak.



Living room, looking toward the Bay.



Dining room, looking toward terrace.

FLORIDA HOUSE PLANNED TO SUIT CLIMATE AND LOCATION

IGOR B. POLEVITZKY, T. TRIP RUSSELL, Architects

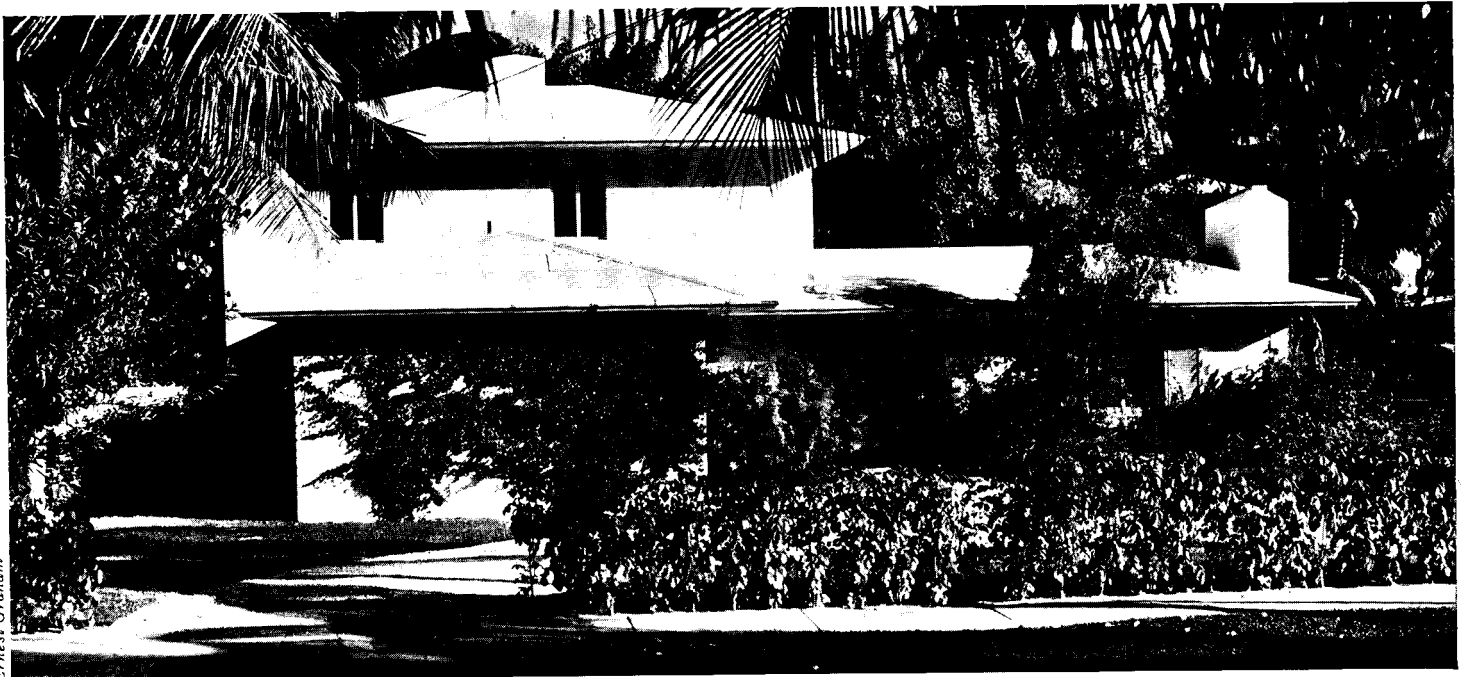

Ernest Graham

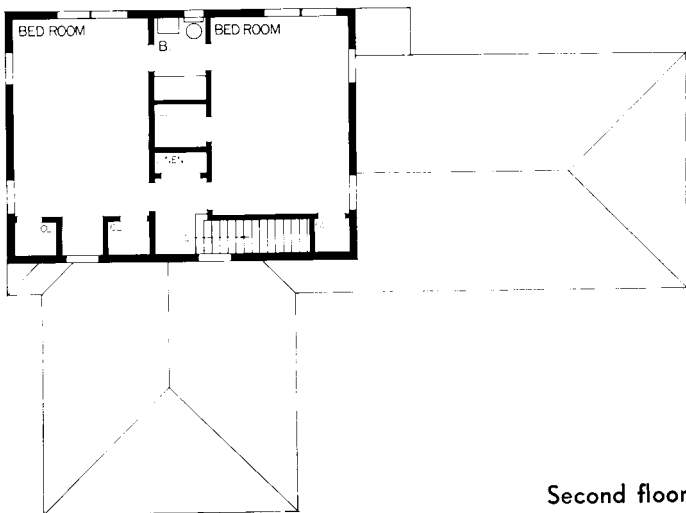

Second floor

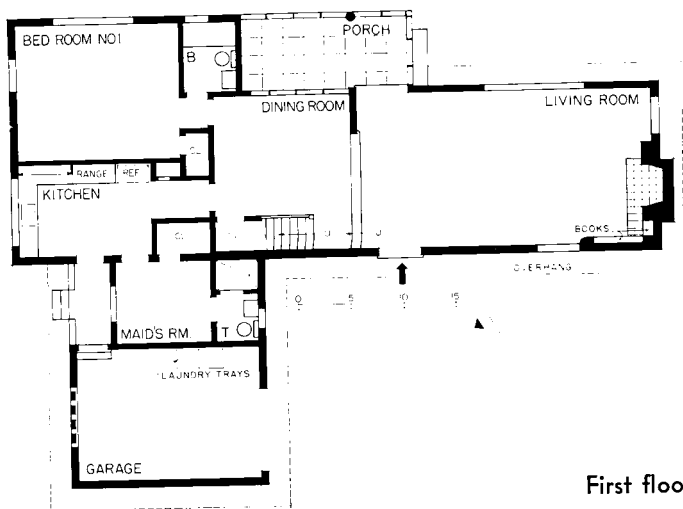

First floor

THE LONG, LOW LINES of this residence in Miami Beach, Fla., resulted from the owners' desire for a house that would not be truly traditional, but would be in keeping with the geographical location and the informality of surrounding residences and landscape. Hence, neither exterior nor interior partake of any particular style. Although the house was designed for two unrelated young women, its plan could easily be adapted to a family group. Since the climate is mild, the plan is open but, withal, compact and efficient; service wing, living area, and sleeping quarters are well related. Ample closet space has been provided for storage of personal belongings and household equipment. The interior is protected from direct sunlight by wide overhanging eaves. Exterior walls are of 4-in. precast concrete block covered with stucco, except around the living room where the concrete is plain. Windows have steel-casement sash, with copper screens in tubular steel frames. The house contains 31,400 cu. ft., and cost \$12,000.

FLORIDA RESIDENCE

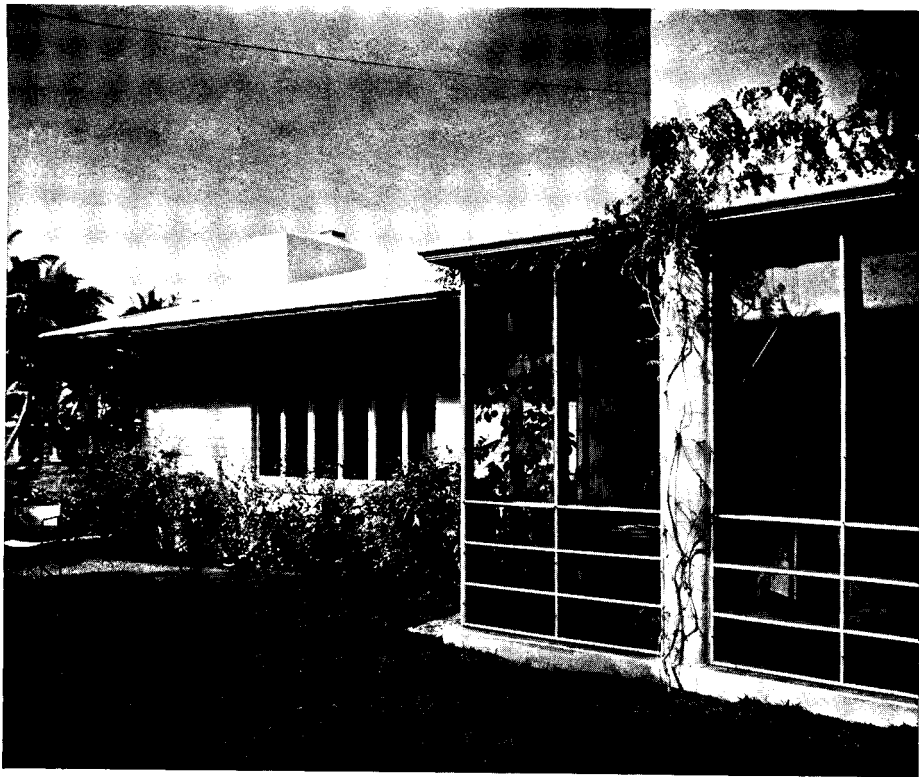

Screened porch and grass terrace give ample opportunity for living out-of-doors.



Typical of the interior is this view of the living room with its simple fireplace.

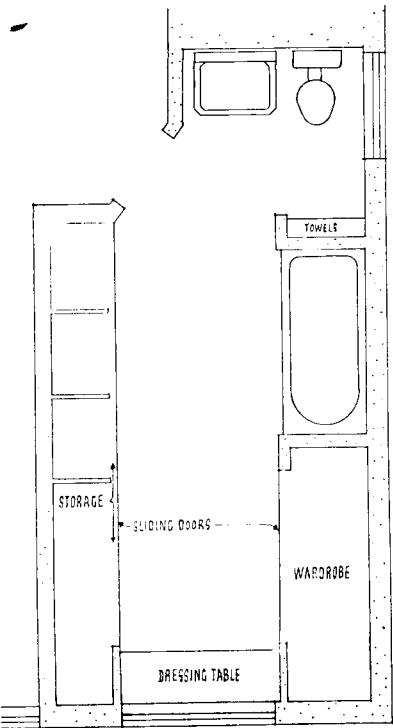

1. BURNHAM HOYT Architect

IN THIS ROOM the bathing unit, taking advantage of an elongated plan, is segregated from other equipment and forms part of a dressing room. Walls, floor, and ceiling of dark blue make a contrasting background for the fixtures, all of which are white with chrome fittings.

Materials and equipment

Walls and floors: Sealex linoleum, Congoleum-Nairn Co. Ceiling: plaster. Trim: metal, Knapp Bros. Mfg. Co. Doors: Rezo, Paine Lumber Co. Plumbing fixtures: Crane Co. Mirror: rectangular plate, Crane Co. Venetian blinds: Pella, Rolscreen Co.

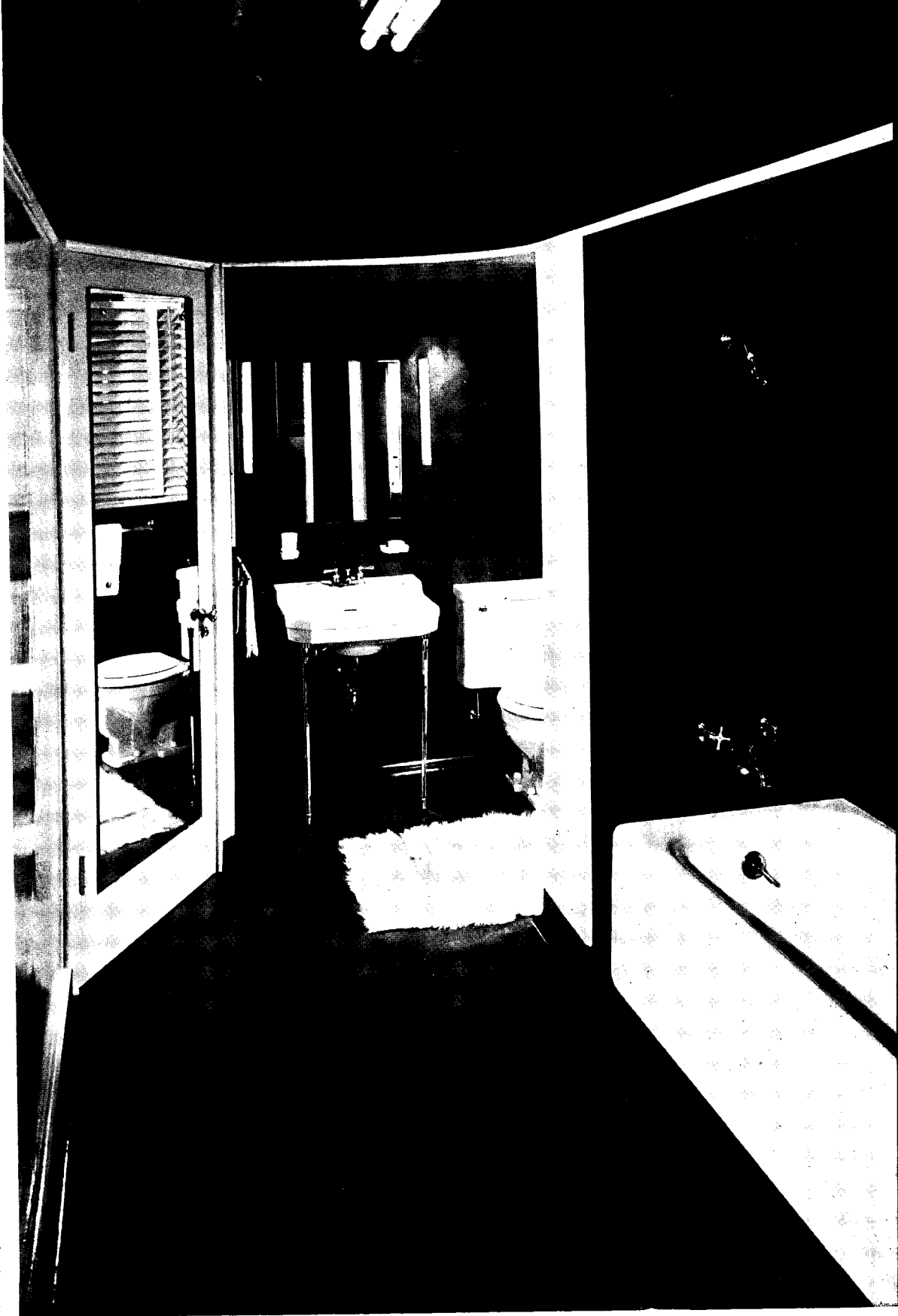

NEW DWELLING UNITS

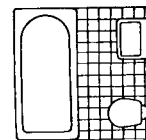

BATHING

Drawings in this section by Torben Muller

NEW DWELLING UNITS: BATHING

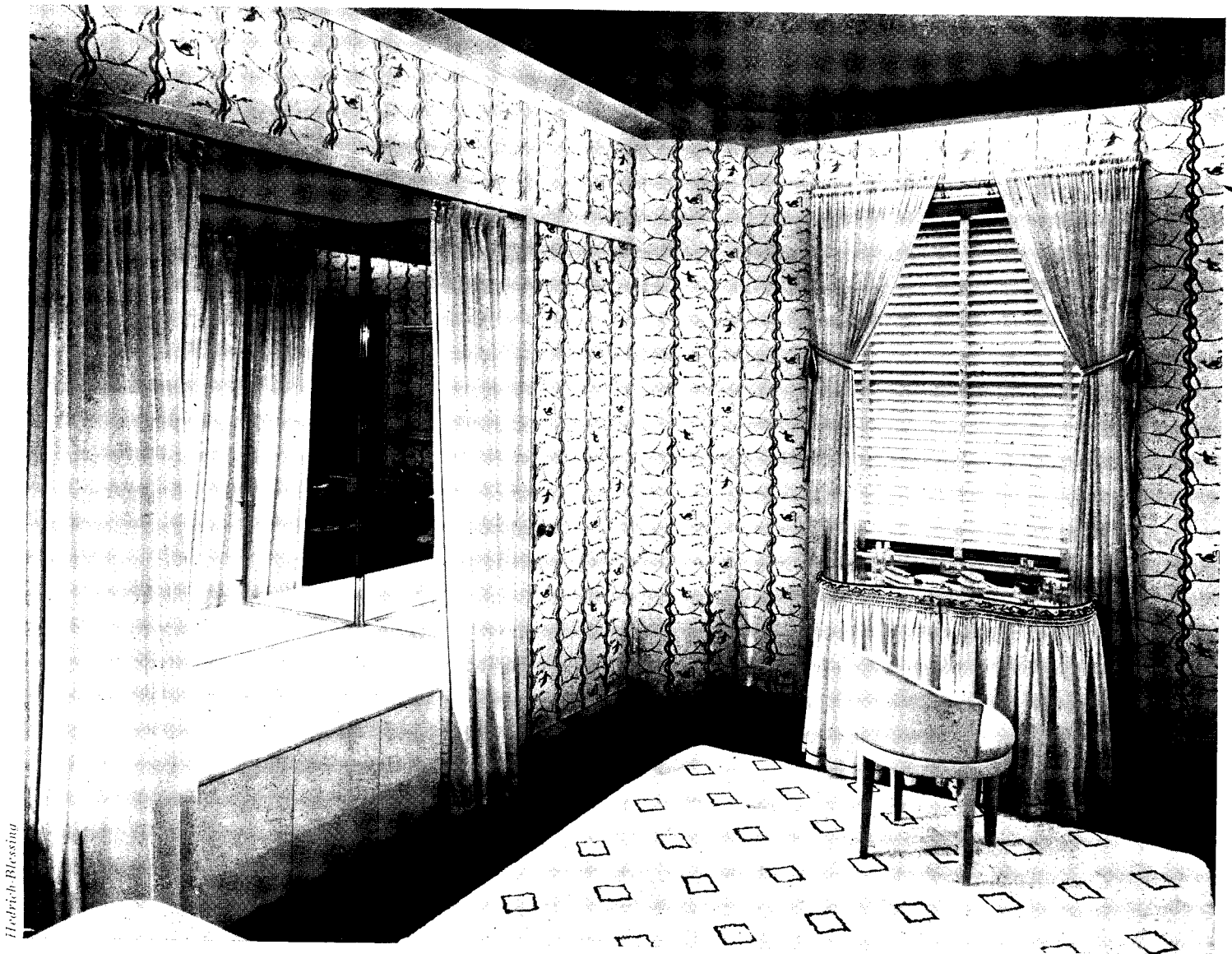

Hedrich-Blessing

2. ALFRED SHAW

Architect

A MIRRORED RECESS forms the bathing unit of this combination bath and dressing room. Flanking the tub and placed along the opposite wall are closets for clothes storage. Separated from the main room is the toilet; the fixture itself is concealed by a wall, but for convenience and ventilation there is no door. In the same alcove is a linen closet. The color scheme is light in tone, with a predominance of white. Walls are of plaster papered in a conventionalized design. The floor is terrazzo with white metal inserts. A simple white rug covers the central portion of the room. Cove lighting on two sides provides illumination and adds to the effectiveness of the light color scheme.

Materials and equipment

Walls: plaster. Floors: terrazzo. Trim: stainless steel. Closet doors: sliding, stainless steel, mirrored; also, papered to match wall on either side of tub. Mirrors: Pittsburgh Plate Glass Co. Plumbing fixtures: Crane Co.

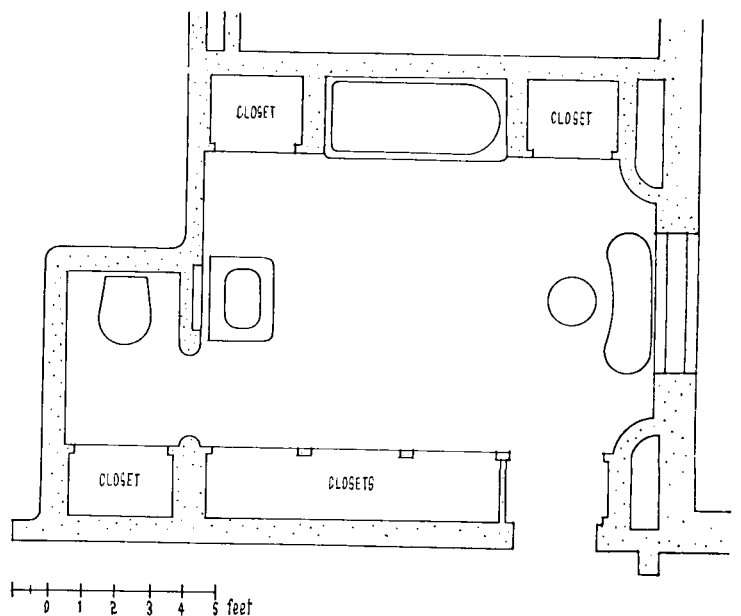

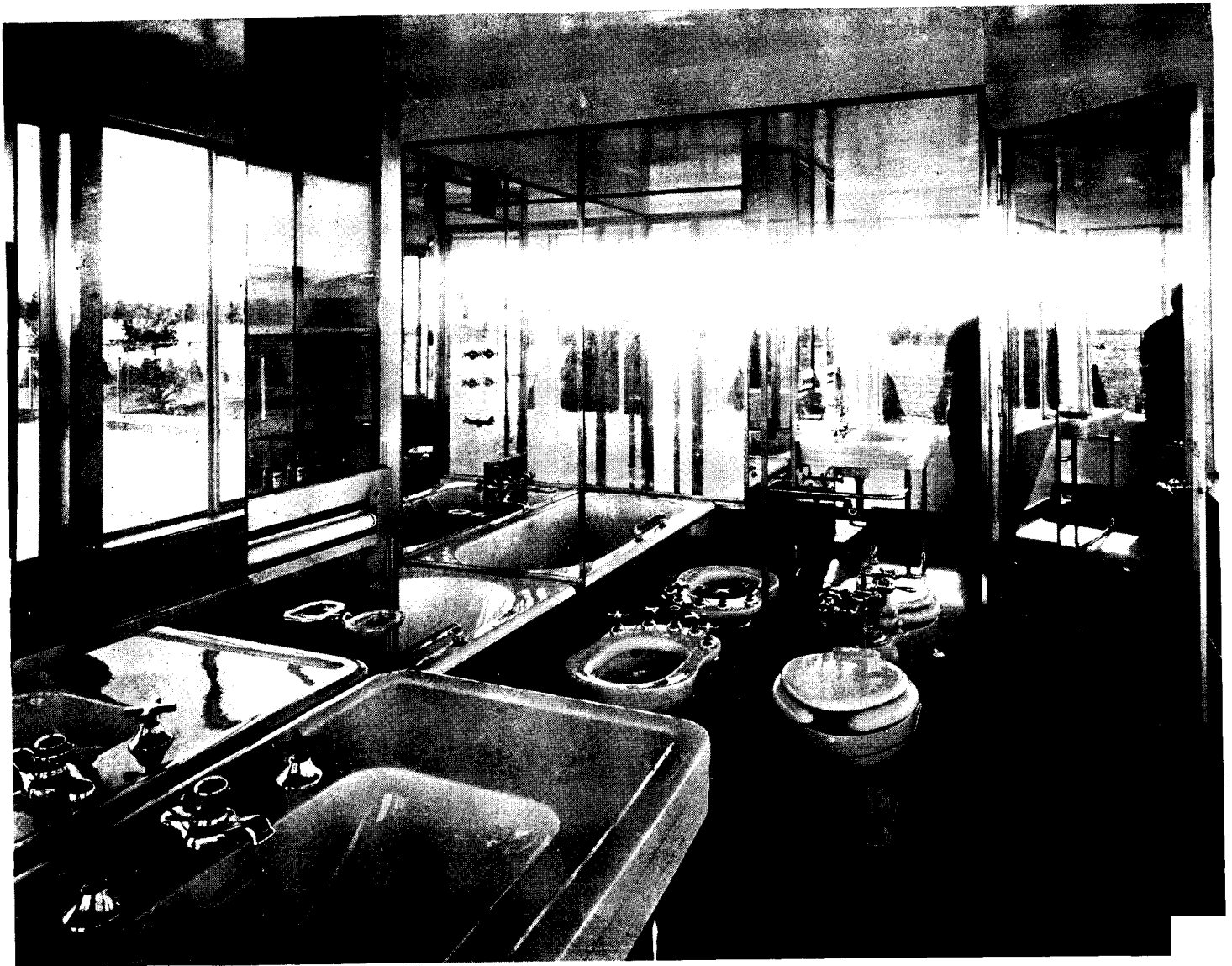

3. RICHARD NEUTRA Architect

MIRRORS AND PLATE GLASS form the wall surfaces of this bathroom. Two of the four walls are given over to windows from which the surrounding countryside is visible. The bathing unit proper consists of a tub in a mirrored recess, and a shower with plate-glass door. Since the house itself is remote from other buildings, the openness of the room is no detraction to privacy. Above the lavatory is a mirrored panel, on each side of which is a cabinet, with plate-glass sliding doors, for storage of toilet articles. Beneath these cabinets are lumiline lights. The floor and tile facing of the tub are black; ceiling and fixtures are white; all trim is metal. Included in the equipment is a bidet, more commonly used in Europe than in this country.

Materials and equipment

Walls and door: copper-backed mirror, Libby-Owens-Ford. Extruded sections and moulds: Marvel Alumaloy, Aluminum Company of America. Floor: black battleship linoleum, Armstrong Cork Products Co. Plumbing fixtures: white, Crane Co.

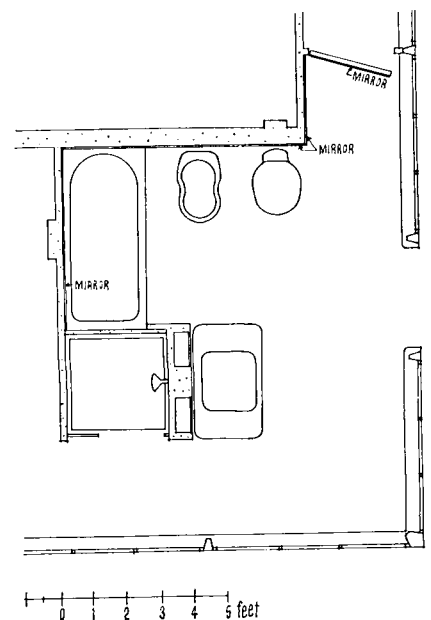

NEW DWELLING UNITS: BATHING

Julius Shulman



4. GREGORY AIN

Designer

CLIMATE USUALLY affects the bathing unit less than any other portion of the dwelling; in this unit, however, full advantage of a mild climate has been taken. Adjoining the shower, and accessible by means of a full-length sliding steel-framed door, is a water-proofed balcony planted with grass and surrounded with flower boxes. When indoor bathing palls, the shower head can be turned out for use on the balcony, which also invites sunbathing. A bank of near-by eucalyptus trees provides privacy. The shower stall has a 16-in. curb, and while only 3 ft. square in size, can be used as a tub. *Since the space occupied by this unit is small, compact planning was dictated; hence the linen closet opens on the hall instead of the bathroom.*

Materials and equipment

Walls: grey enameled, Sherwin-Williams Co. Floor: grey linoleum, Armstrong Cork Products Co. Sash: special, Druwhit Co. Tile: blue, Gladding, McBean & Co. Plumbing fixtures: Kohler Co. Accessories: Hall-Mack.

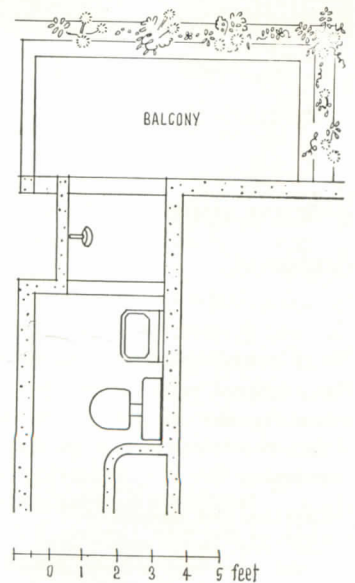

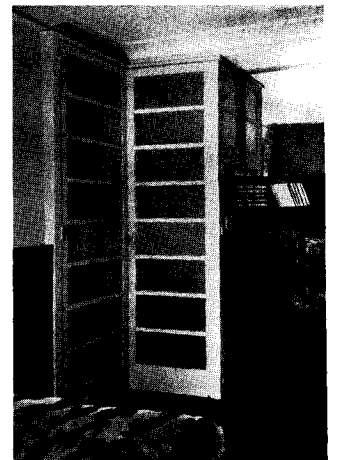
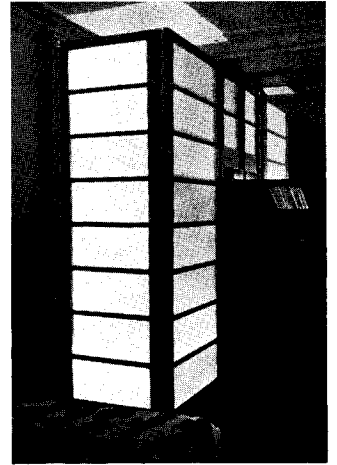
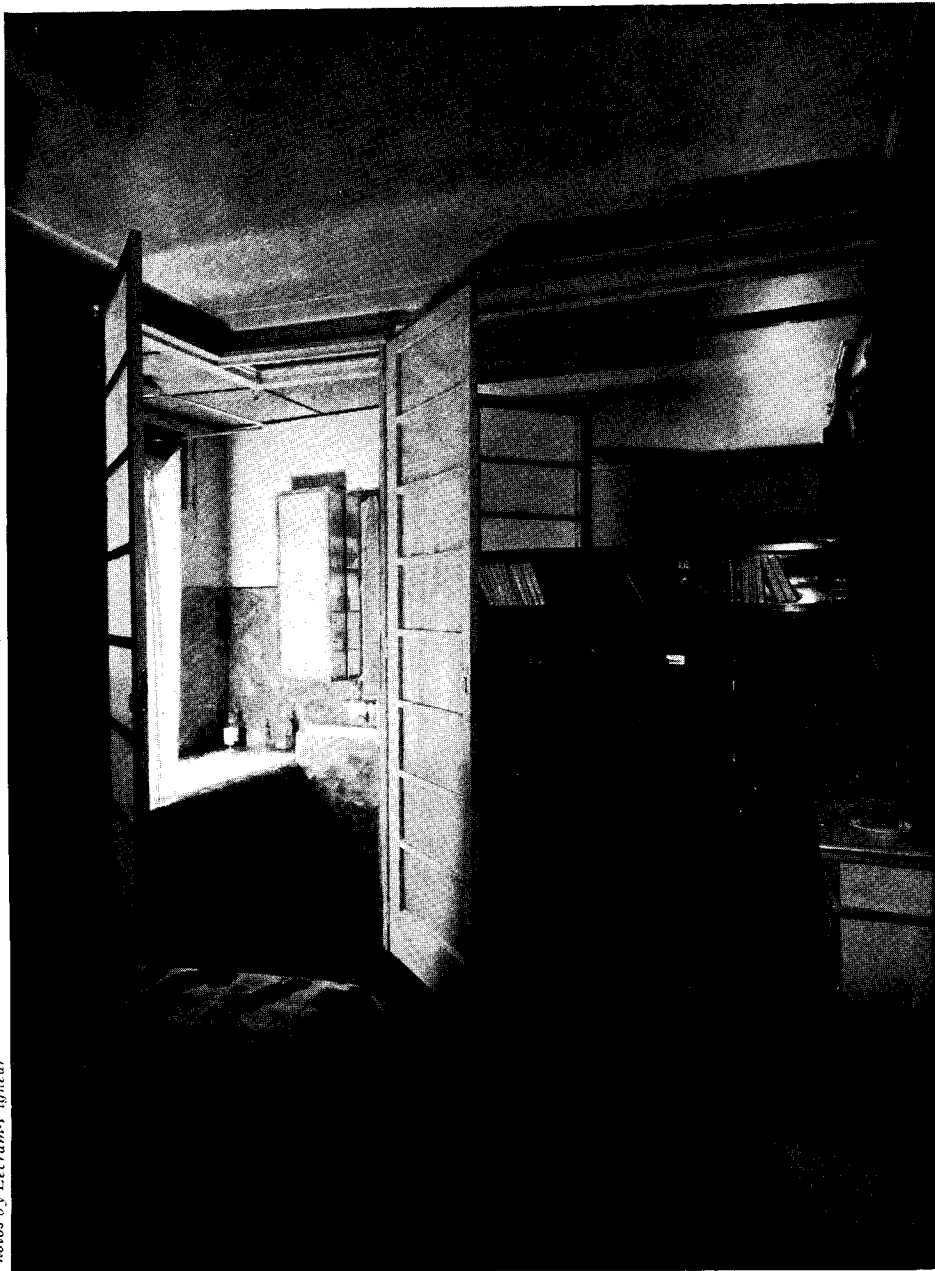

5. O. BAUER
Architect

THAT A BATHING UNIT can be accommodated in very little space is evidenced by this compact plan. Folding doors, so hung that they swing in an arc of 180°, allow the size of both bathroom and bedroom to be adjusted to suit the need. When the bathroom is in use, these doors form a right angle in the bedroom, decreasing its size somewhat and increasing the size of the bathing unit (top, right). When the bathing unit is not in use, the doors may be left open, giving a view of the unit (above, left), or closed (bottom, right), forming a right angle in the bathroom. Doors are of frosted glass, wood-framed. The tub and built-in lavatory are faced with marble. Walls and ceiling are plaster.

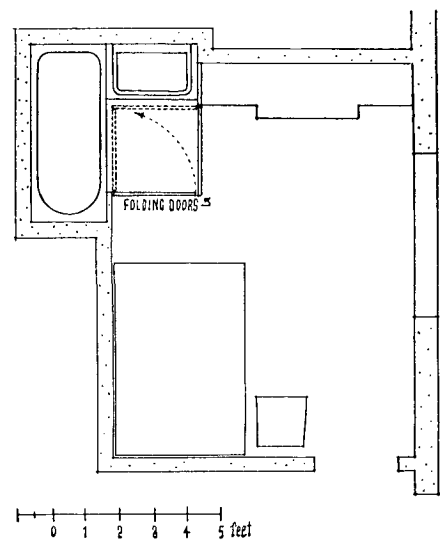

NEW DWELLING UNITS: BATHING

F. S. Lincoln



6. A. KIMBEL & SON, INC.

Decorators

OF PARTICULAR INTEREST is the color scheme in this bathroom. The vitrolite walls have a dado and trim of black; above the dado are alternate courses of pearl grey and Chinese red. The ceiling is dead white. The floor is of 4-in. squares of black faience tile laid with a grey joint. The tub has black sides and top, thus extending the line of the dado. The shower curtain is of metallic silver cloth as a recall of the pearl grey in the wall. Fittings are satin chrome with transparent red catalin handles. Lighting is from a central fixture, the opal glass panel of which conceals not only the bulbs but a ventilator.

Materials and equipment

Walls: vitrolite, Libbey-Owens-Ford. Plumbing fixtures: Crane Co.

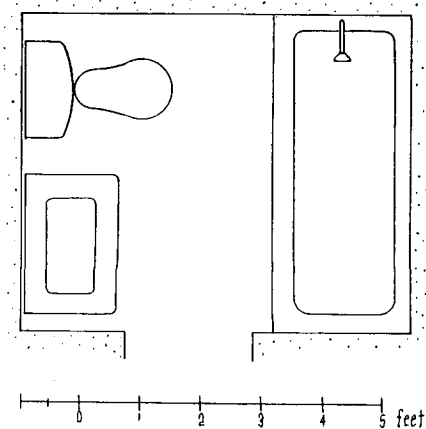

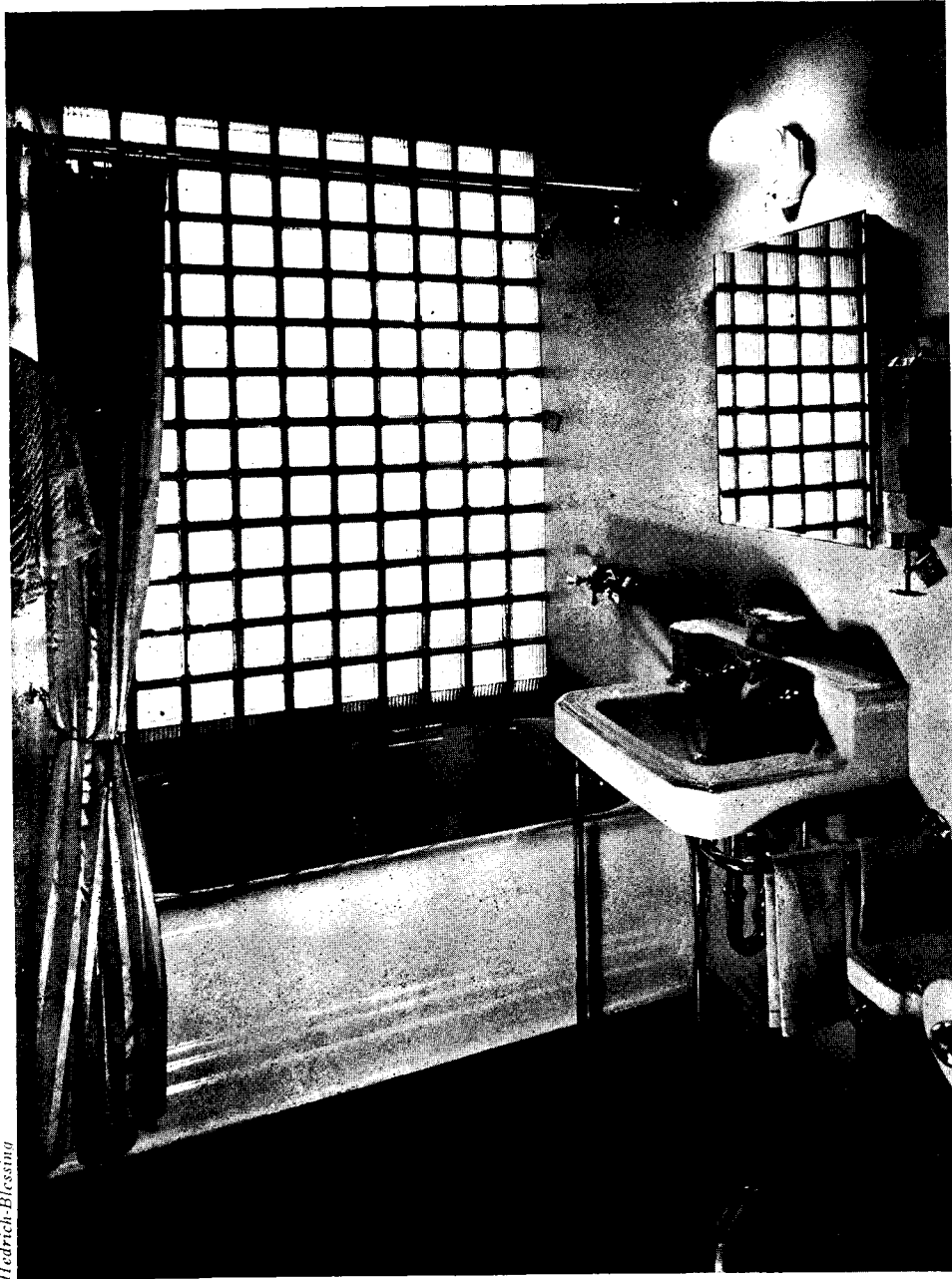

Hedrich-Blessing

7. ANDREW REBORI

Architect

THE MAIN FEATURE of this bathing unit is the wall of glass block over the tub, insuring privacy and providing ample natural illumination. Although the over-all dimensions of this room are small (5 ft. by 7 ft.), the arrangement of fixtures allows a 3-ft. clearance between wall and lavatory. Since all fixtures are ranged along one wall there is a resulting economy in piping which is not to be overlooked. Walls are plaster, painted; ceiling is likewise plaster with a painted canvas surface. The floor is asphalt tile over concrete.

Materials and equipment

Plumbing fixtures: Standard Sanitary Corp. Medicine cabinet: Hess Warming & Ventilating Co. Glass block: Owens-Illinois Glass Co.

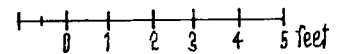
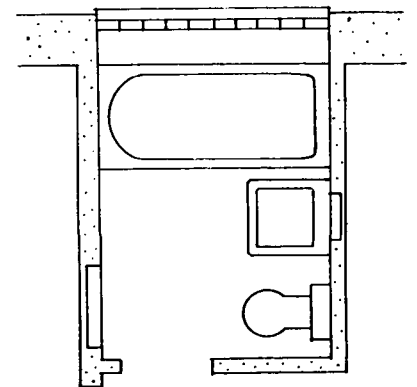

NEW DWELLING UNITS: BATHING

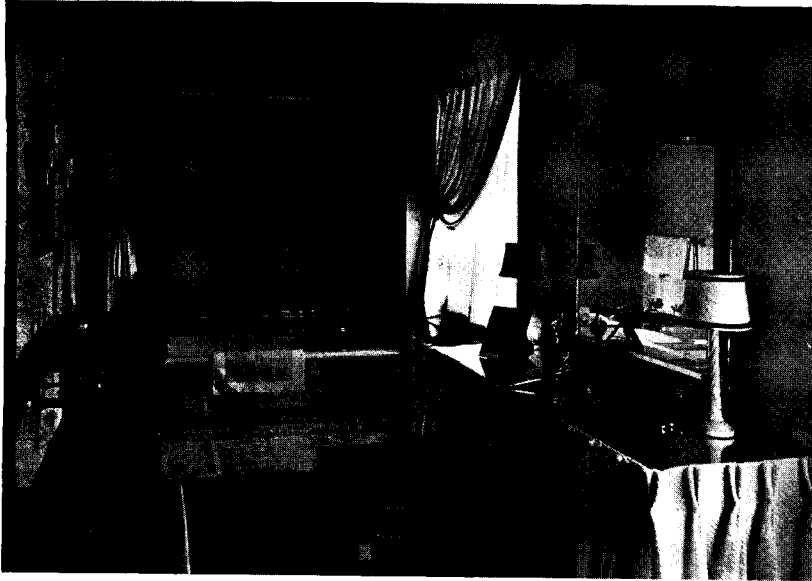

Gottscho

8. FRANK MILES, Architect

DESIGNED FOR USE by two adults, this bathing unit has, in addition to separate shower and tub, two lavatories. The tub is at one end, in a peach-colored recess with a turquoise trim. Walls are plaster, painted off-white, except for the wood base which is turquoise. The floor is aqua-blue with a white

border. The ceiling is also aqua-blue.

Materials and equipment

Mirrors: over vanity and facing of tub, Pittsburgh Plate Glass Co. Floor: Wingfoot rubber sheeting, Goodyear Tire & Rubber Co., Inc. Tile in shower: Franklin Tile Co. Plumbing fixtures: Standard Sanitary Corp. Accessories: Hall-Mack.

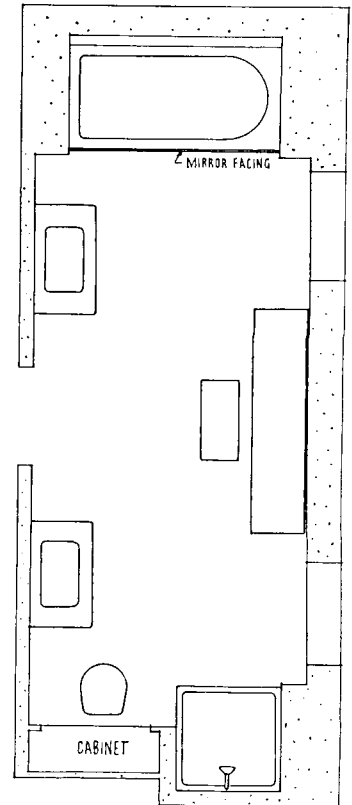

0 1 2 3 4 5 feet

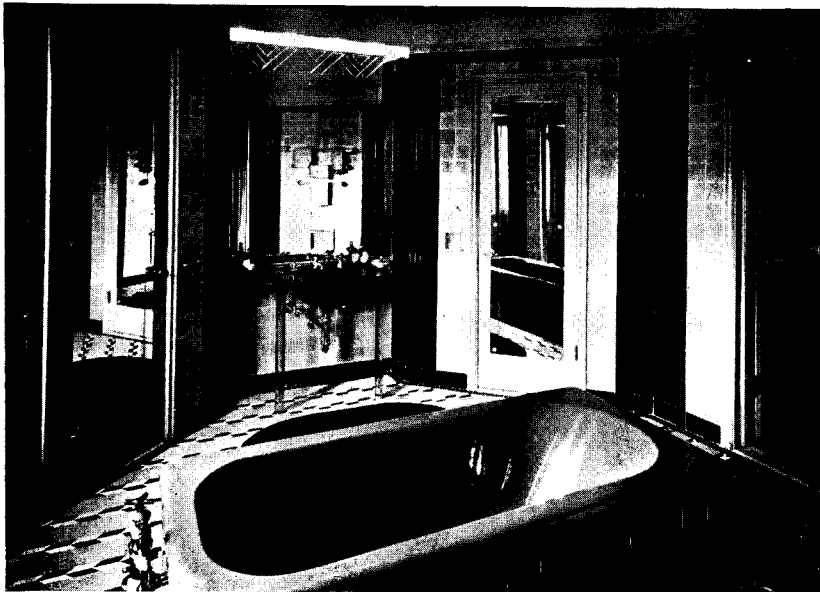

Holdt

9. HENRY D. DAGIT & SON, Architects

IN THIS OCTAGONAL room, the tub is red with a tile facing; walls are peach tile with black pilasters. Floor is peach, white, and black tile. The lavatory has a black and

gold marble slab, and glass legs.

Materials and equipment

Walls, pilasters, and floors: tile, Robertson Art Tile Co. Mirrors: Pittsburgh Plate Glass Co. Plumbing fixtures: Standard Sanitary Corp.

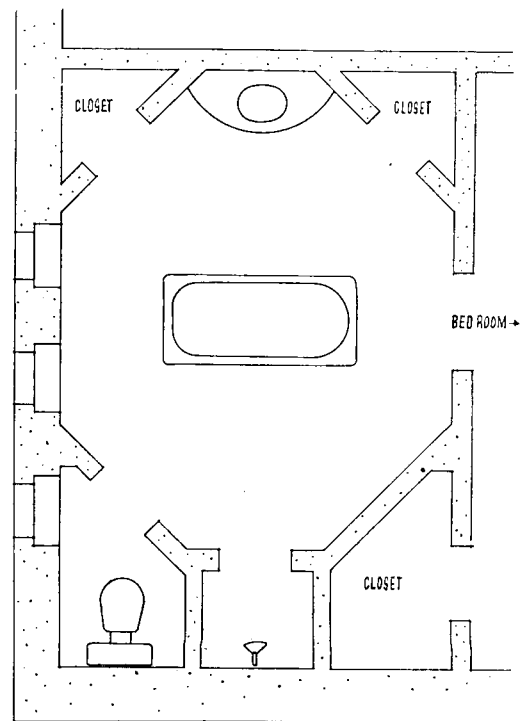

0 1 2 3 4 5 feet

DESIGN TRENDS

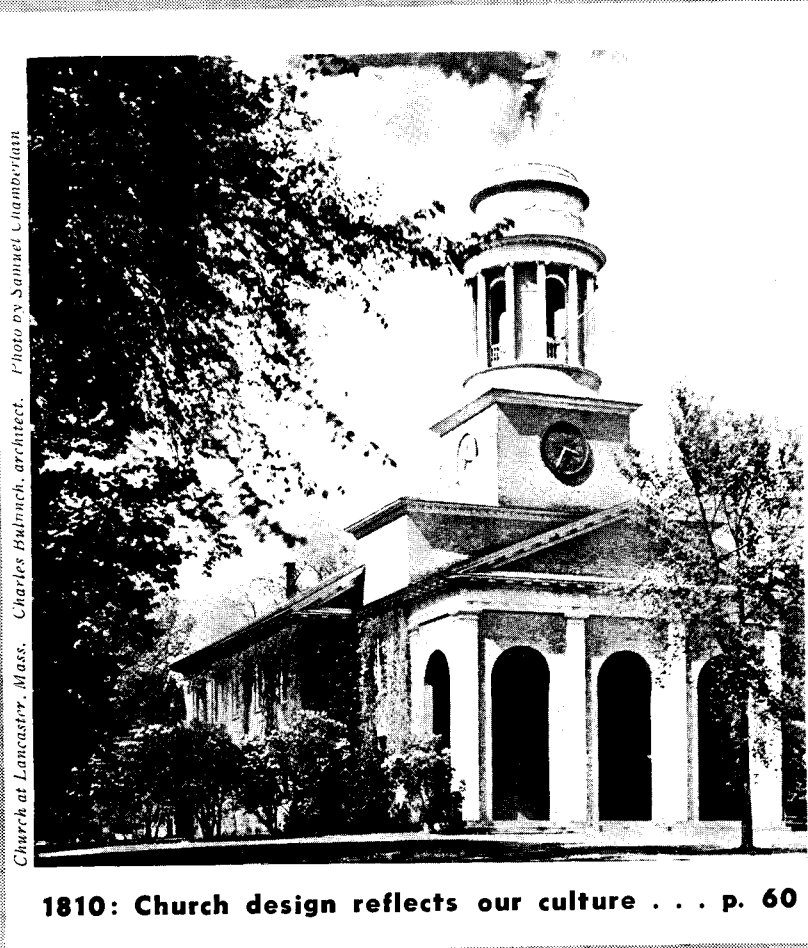

Church at Lancaster, Mass. Charles Bulfinch, architect. Photo by Samuel Chamberlain

1810: Church design reflects our culture . . . p. 60

ARCHITECTURAL
RECORD



Samuel Chamberlain

A SURVEY:

tion by the use of partitions and may be shut off from the auditorium or rotunda by sliding partitions, for the work of teaching and opened again into the gen-

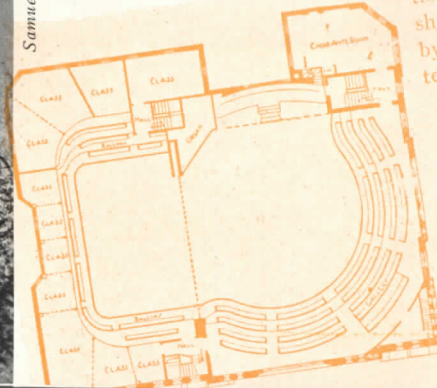

Arthur Hassell

PARK CONGREGATIONAL CHURCH.
Kramer & Hamilton, Architects.

From the earliest beginnings . . .



Through the Gothic Revival . . .

From the first days of architectural expression in America until about 1830, church design was almost completely indigenous, a spontaneous and true reflection of our life and culture. But early in the 19th century, there began a succession of so-called "revivals," evidence of a cultural servitude to Europe. Now with new needs to be filled, ecclesiastical architecture has at its disposal new means to express its basic principles in new forms, which will more truly reflect today's life and culture. Top, left, is the early New England church at Buxford, Mass., a religious expression of contemporary society; top, right, the Park Congregational Church, Brooklyn, N. Y., by Kramer and Hamilton, an attempt at the end of the century to reconcile specific needs with an academically imported, misunderstood mode; center, Cram and Ferguson's East Liberty Presbyterian Church, Pittsburgh, built in 1935, a last flowering of the Gothic revival; bottom, Antonin Raymond's Chapel at Tokyo, Japan, an American Protestant mission field project which points toward a new day in church design.

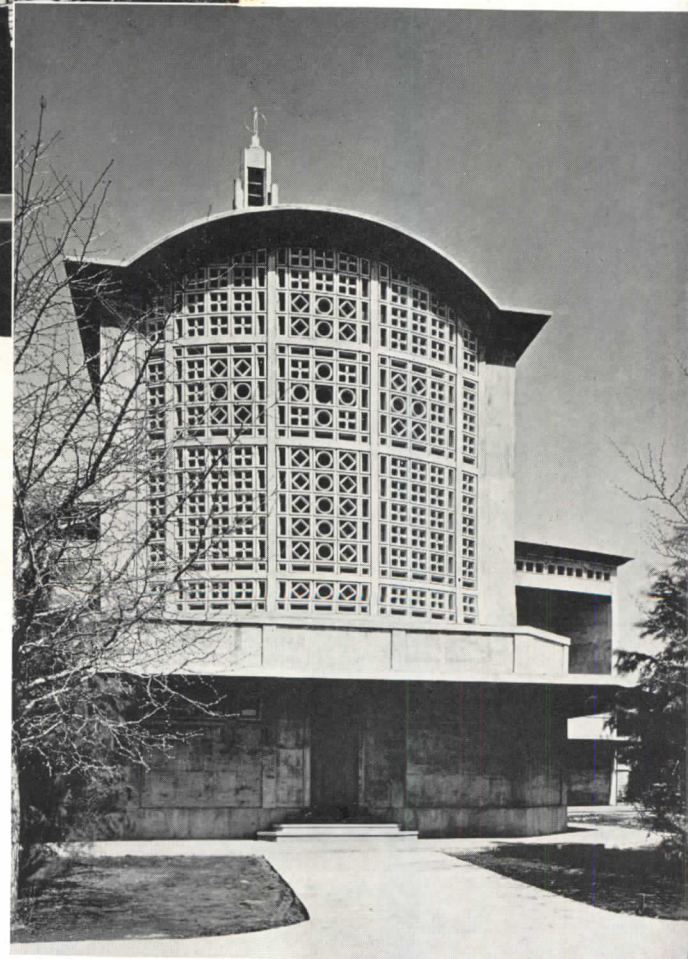

To new structural techniques and new forms

PROTESTANT CHURCH DESIGN IN AMERICA

by **WALTER A. TAYLOR, A.I.A.***

Such developments as the recent consolidation of the three Methodist churches into one nationwide organization serve to focus the attention of the building designer on the Protestant churches. What are the needs of these expanding organizations? What technical means are at hand to meet them? What forms are desirable? For this analysis—second of a series of three—**ARCHITECTURAL RECORD** has asked Mr. Taylor to survey the field. The final study—Jewish synagogue design—will appear in a forthcoming issue.

OF ALL the building types which are normally designed by architects, the church is a fairly frequent type. The average town will have ten churches to one library, one court house, one post office, and three or four schools. Yet it is the general experience of church agencies concerned with guiding and aiding church building projects, that many architects who are generally competent in other types of buildings, do not produce good church buildings, apparently because they are not sufficiently interested to bring themselves up-to-date. The major reason for this lies in an apparent indifference to church work on the part of the practicing architect and a lack of accurate knowledge of the needs of the Protestant churches.

Contemporary requirements of Protestant churches generally are most conveniently stated in terms of the "Threefold Program"—worship, religious education, and social-recreational activities. These general requirements are fairly uniform across denominational lines, and will vary more according to local situations than denominations. The "Threefold Program" implies a great change from that of the one-room church of fifty years ago. Judged relative to it, an estimated 90% of Protestant church buildings are inadequate or out-moded for some part or all of the normal program of today. All parts of this program have important interrelations which definitely affect the plan, requiring careful analysis and creative design. In most cases there must also be overlapping of facilities for reasons of cost. Many existing church structures which were built in three or four units over a period of from 50 to 100 years, illustrate perfectly the development of the typical Protestant program, with an "accumulative" plan which is unavoidably less satisfactory than a whole layout planned for today's program. Yet in some entirely new buildings with complete facilities, architects of wide experience have repeated the "accumulative" plan—using, by force of habit and through lack of analysis, a bottleneck 3-ft. 8-in. door adjoining the chancel as the only connection between the nave and the remaining two-thirds of the church building.

Worship becomes more formal

The most pronounced trend is in the matter of worship (liturgy). The former emphasis on the sermon, manifested by the high rostrum and central pulpit in a lecture-hall type of auditorium, is now giving way to a more diversified and formalized service of worship, invoking the more significant use of architecture and the arts. Nave and chancel become more formal, most frequently with the pulpit on one side balanced by a reading desk. There is usually no sanctuary in the traditional sense—it has been telescoped with the choir—but the term "sanctuary" is now applied to the whole nave and chancel. It is a very real problem to arrange the Protestant

* As consultant architect to the Interdenominational Bureau of Architecture, Mr. Taylor has had a varied experience in the field of which he writes. He is an associate of the office of Hobart Upjohn, and was formerly associate architect in the Baptist Department of Architecture, and lecturer in History of Architecture at Columbia University, New York City.



1812

Monumental Church, Richmond, Va., Robert Mills, architect. Greek Revival runs afoul of the Renaissance dome tradition, with serious compromises in both the plan and the fenestration.

Bagby



1851

First Presbyterian Church, Nashville, Tenn., William Strickland, architect. American Eclecticism combines Egyptian columns with a tower tradition derived from the Alexandria lighthouse, by way of North Africa, Italy, France, and England.

Ed Clark, Nashville, Tennessee



1852

St. Paul's, Brookline, Mass., Richard Upjohn, architect. Typical of beginning of Gothic Revival: restrained English Gothic by a migrated Englishman.

Photos by W. P. Woodcock

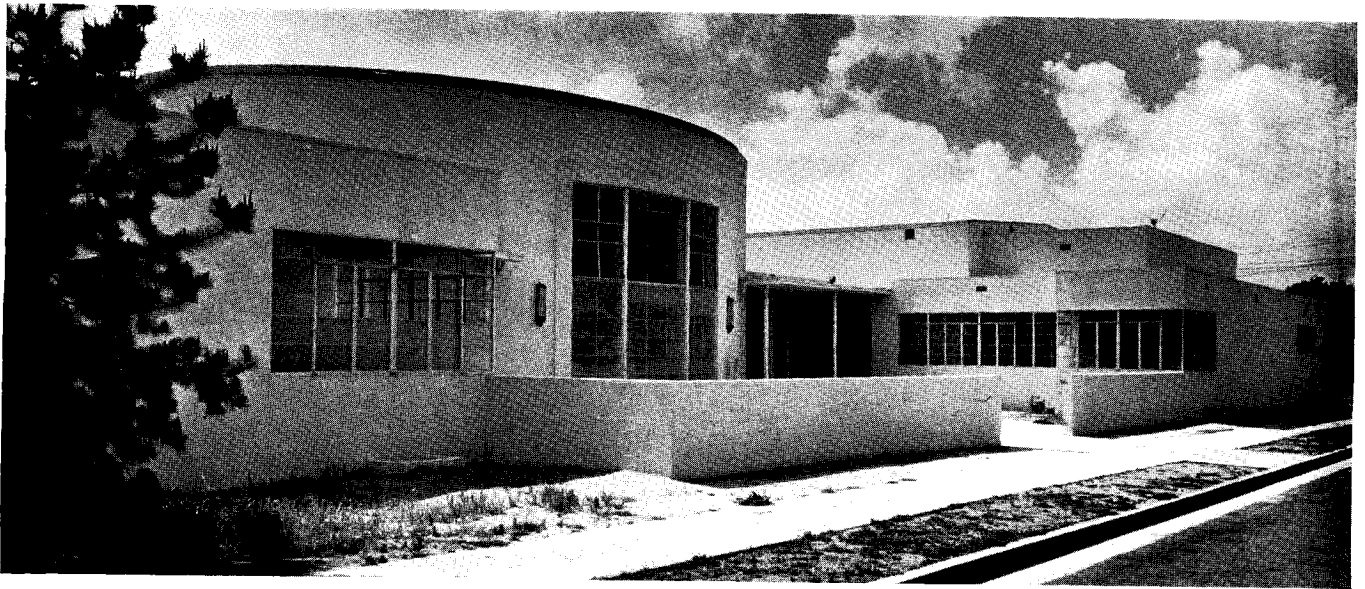

The chapel dominates the group by its central location and its distinctive oval shape; large glass areas give ample light.

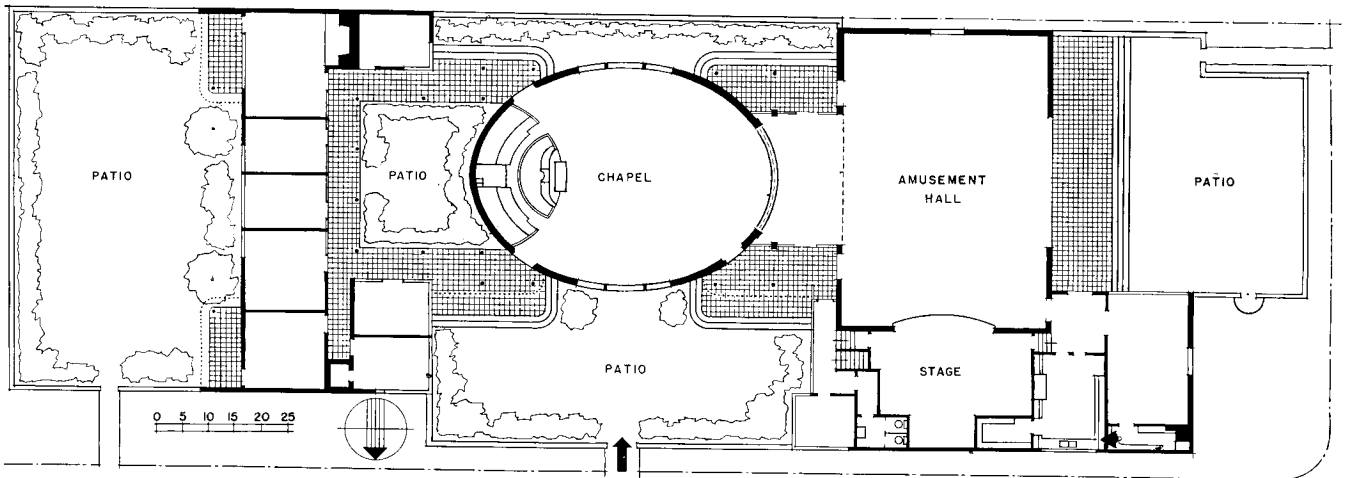

Plot and floor plan.

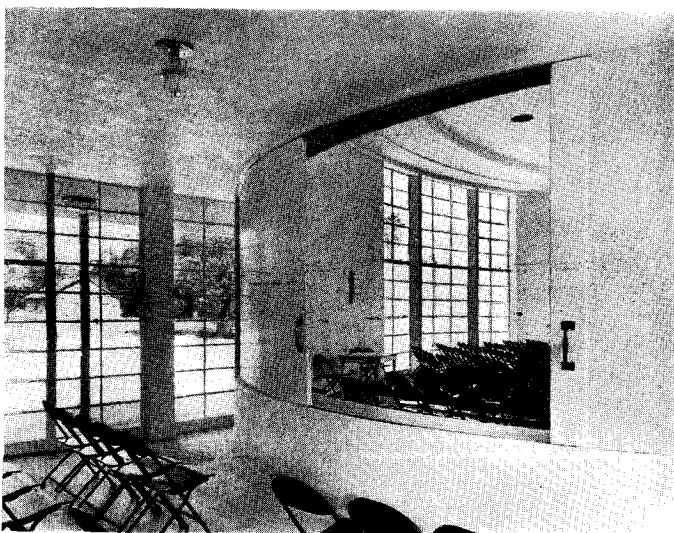

Rolling doors between chapel and lounge give added seats.

LATTER-DAY SAINTS' CHURCH GLENDALE, CALIFORNIA

GEORGIUS Y. CANNON, Architect

THE OPEN plan of this ecclesiastical group makes ample provision for the three-fold program, and recognizes the need for a flexible use of the various elements. A large portion of the wall space is given over to fenestration. Although the mild climate warranted and economy demanded the use of semi-enclosed walks between chapel and classroom wings, these are perhaps not adequate enough for easy circulation. The relation between the religious education wing at left and the patio provides for the requirements of the progressive program. For overflow seating the amusement hall and connecting lobby are used. The photograph at left shows temporary seating, used in the lounge, and in the chapel before pews were installed.

chancel in a workable plan and to make of it an effective focal composition, at the same time providing facilities and furniture for five or six major and several minor services.

Churches which have in the past been called free or non-liturgical—Congregational, Baptist, Presbyterian—although they have had fairly uniform orders of service, are now studying and experimenting with the psychological and aesthetic aspects of worship. Many churches are being altered for the sole purpose of providing a chancel or some type of architectural setting for a more formal kind of worship. Along with this interest in ritual and liturgy there is a very marked revival of choirs, including junior choirs of boys, girls, and young people. Neither the seating arrangement nor the music are of the concert hall or jazz-hymn type of twenty years ago; the music has a full range and includes processions, recessions, *a capella*, and antiphonal singing.

In all of these matters, there is manifested the same danger of borrowing the form of the older liturgical churches, with an imperfect understanding of its symbolic content. For instance a middle-western Baptist church asks for a sanctuary lamp in the new chancel, although the congregation would be horrified at the suggestion of practising the Reserved Sacrament which it symbolizes. However, where the liturgy and architecture have been creatively designed, the erstwhile non-liturgical churches are discovering for themselves that there is no basic antipathy between a rich and generous use of all of the arts and vigorous evangelistic preaching.

The present trend toward combining church and Sunday school services so as to include all ages from juniors through adults, tends to eliminate or reduce the number of Sunday school assembly rooms, and has a radical effect on the general plan in that there must be a direct and convenient access, preferably from rear of the nave, to the Sunday school classrooms and the robing room of the junior choirs. There is increasing demand for a separate chapel used by seniors and young people for Sunday school assembly; less frequently asked for is the juvenile chapel definitely scaled to primary and kindergarten children.

Provision should be made for an almost universal 100% increase in attendance on Easter and Christmas over the average for all other Sundays. Folding doors between the auditorium and a room at the side are unsatisfactory in every way. The additional seating should be in transepts, galleries, narthex, or the parlor opposite the narthex, used normally for other purposes.

Religious education demands flexibility

Religious education has become a highly specialized field, and the facilities required represent a great departure from those of former days. In general, religious education has followed the lead of secular education, with necessary adaptations and a lag of a decade or two. The transition, as in secular education, from teacher-textbook technique, to the "learning-by-doing" method—library research, art and handicraft, workshop, discussion group, and dramatic presentation—relates religious education closely to social-recreation in method as well as in use of space and facilities.

Present trends are toward (1) larger individual classes, (2) longer periods of instruction, (3) more space per pupil, (4) assembly of departments in chapel for worship, or worship centers in assembly rooms, (5) weekday religious instruction in conjunction with public school, (6) daily vacation Bible school, (7) motion pictures in department assembly rooms.

Two general principles seem to be firmly established: one is departmental grading, and the other is the use of the separate sound-proof classrooms with single hinged doors. Attempts to compromise with these standards are unsatisfactory and do not result in economy of gross floor area. Rolling, folding, and sliding partitions are not worth their cost except for a few major divisions.

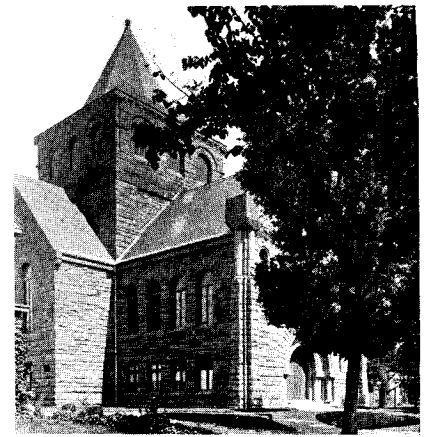

1886

Baptist Church, Newtown, Mass., H. H. Richardson, architect. An example of conscientious effort to adapt a European style to American requirements.

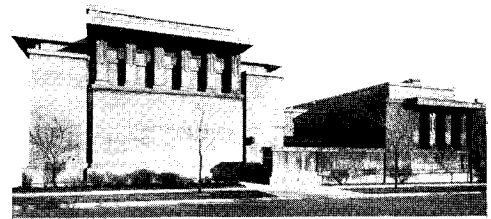

1908

Unity Temple, Oak Park, Ill., Frank Lloyd Wright, architect. Space and proportions, as determined by plan and structural system, control exterior design.



1914

Methodist Church, Grand Rapids, Iowa, by Louis Sullivan. Characteristically direct is this solution recognizing the functional "Akron Plan".



1928

Presbyterian Church, Greensboro, N. C., Hobart Upjohn, architect; Harry Barton, associate. An example of the free use of an early medieval style.

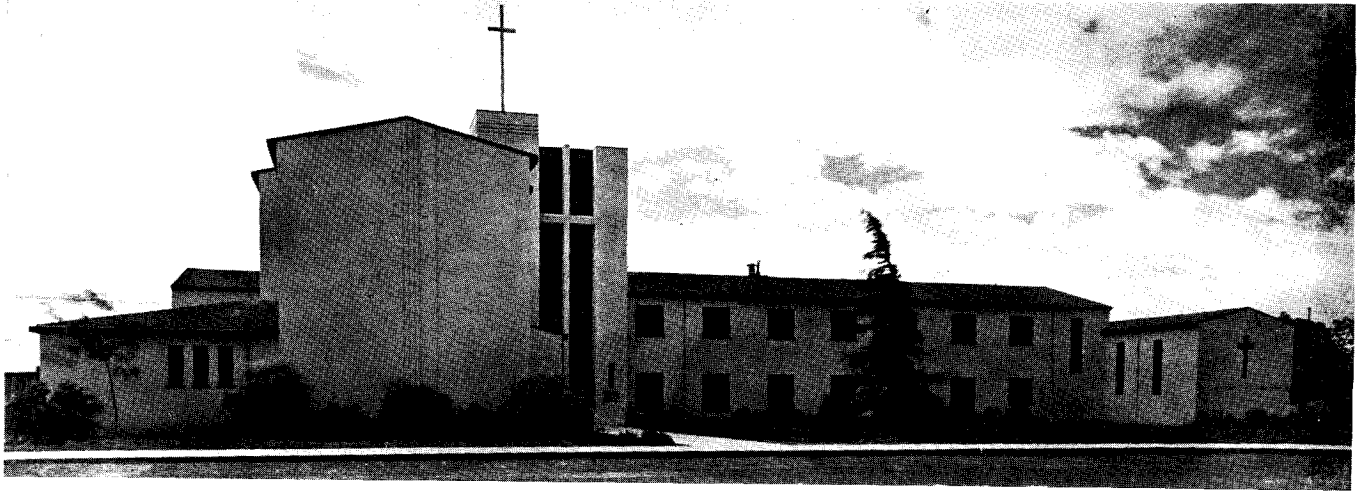

FEDERATED CHURCH, ORLAND, CALIFORNIA

GEORGE PATTON SIMONDS, Architect

AN EXAMPLE of the use of concrete as a plastic material, this church achieves character without the aid of traditional style, and with considerable economy. The church dominates the group of buildings which includes also a parish hall and chapel. Each has an adequate public entrance. Noteworthy in the plan is the provision for overflow seating in the parish hall, and the location of the kitchen for three-way serving. The main feature of the interior is the system of three-hinged timber arches, with split-ring connectors which determined the splay form. Except for the Cross at the focal point of the sanctuary, the interior is without decoration; directional lights instead of fixtures hang from the ceiling.

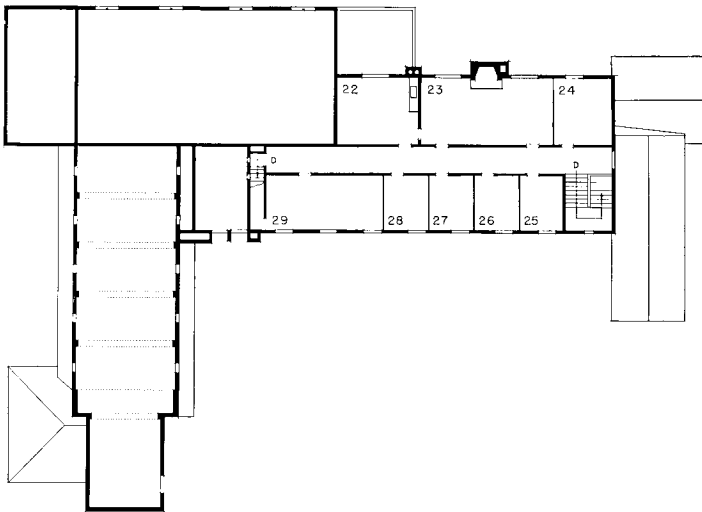

Second floor: 22. Classroom. 23. High-school group. 24-29. Classrooms.

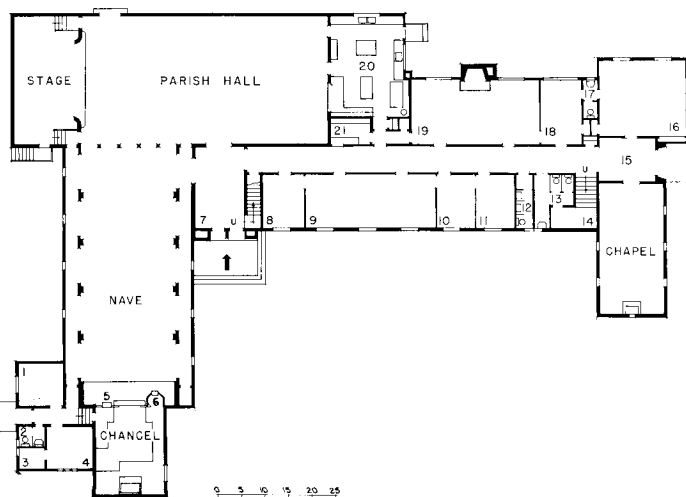

First floor: 1. Study. 2. Toilet. 3. Robe room. 4. Chair room. 5. Lectern. 6. Pulpit. 7. Northex. 8, 10, 11. Classrooms. 9. Primary Room. 12. Wash room. 13. Toilet. 14. Stairs. 15. Lobby. 16. Beginners' Room. 17. Toilet. 18. Nursery. 19. Ladies' Parlor. 20. Kitchen. 21. Pantry.



Structural form is the dominant motif of the interior.

Though the above trends are by now well defined, allowance must be made for further advances in both theory and practice in the future. There is always the danger that the best building may be somewhat outmoded a few years after completion. Thus, while meeting these requirements, the architect must devise a *plan* which provides flexibility for several uses during the week, as well as changes in assignment or in schedule from year to year; and a *type of construction* which permits inexpensive alteration, to anticipate changes in general program.

Social recreation requirements are complex

The social recreation program of the modern seven-days-a-week church is a vital and integral part of the whole life of the congregation and community. This program is not in competition with public or commercial activities and is not necessarily an extension of evangelistic technique. Although outwardly similar and requiring similar equipment, the content and purpose are quite different. The emphasis varies greatly in different communities and the needs must be carefully analyzed. This program centers largely in the general purpose social hall, including complete stage and adequate kitchen. This social hall is used for eight or ten distinct types of activities during the course of a week and is therefore one of the most difficult parts of the building to design and specify. Its use for public or semi-public functions may require that it have independent direct access from the street and at the same time be properly related internally to the remainder of the church buildings.

The most pronounced trend is seen in the greatly increased interest in dramatics which require, in some cases, almost professional types of stage and equipment, together with property rooms and workshop. In this way the social-recreation program relates itself to worship, for, with increasing frequency, religious dramas are presented in the sanctuary. The trend is away from complete gymnasiums and swimming pools which in many instances have proved to be white elephants.

New techniques free the church form

Although new materials and methods of construction have been widely used where they could either be concealed or adapted to traditional styles, there has been a pronounced reluctance, even a resistance, to a thorough-going utilization of contemporary techniques. The very interesting west-coast churches of reinforced concrete are too often confined to styles based on small units of stone or brick. Only infrequent attempts have been made to design Protestant churches in terms of the plastic quality and structural possibilities of reinforced concrete (see p. 68). Likewise, structural steel is widely used, but only for economy, for compliance with building codes, or to accomplish an otherwise impossible stylistic effort. Actually, steel has so far practically never been allowed to influence in any real way the architectural design of a Protestant church.

There is still a great deal of unnecessary mystery and misunderstanding about the subject of acoustics. Today there is no excuse for faulty acoustics in any building. Because some of the best ecclesiastical architects have disdained to utilize the science of acoustics, many laymen are still convinced that arcades and open trusses contribute to faulty acoustics, whereas the reverse is often true. There is, however, a general use of acoustical-corrective materials, but these are still applied to imitate other materials.

Some factors that control form

Many architects fail to regard the complete church building as a public building in which adequate and obvious circulation is vital. Owners are often reluctant to allow sufficient area for vestibules, stairs, and corridors, whereas many architects who do not fully understand the relationship of the various spaces will produce a plan which has unnecessary lengths of unpleasant corridors. Owners

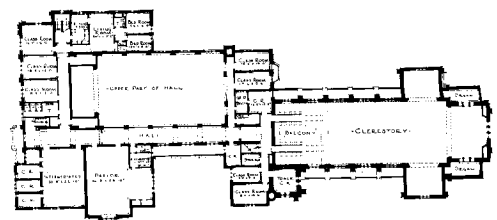

Second floor

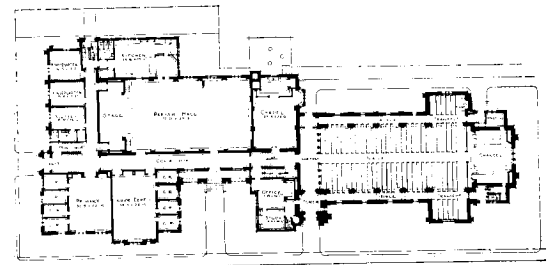

First floor

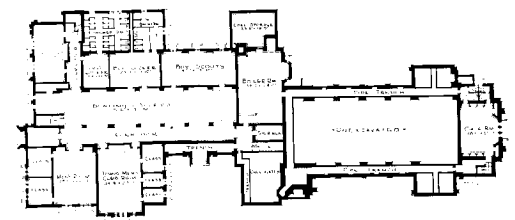

Basement

1928

Methodist Episcopal Church, Muskegon, Mich., Wenner and Fink, architects; A. F. Jansen, associate; Walter H. Thomas, consultant. A complete and well studied plan for the threefold program. Sanctuary is oriented in relation to remainder of building but keeps its independent entrance. Chapel and social hall are both well located for public as well as Sunday school use. A reasonable amount of basement is put to proper use. In many cases it would be preferable to interchange the locations of parlor and junior departments.

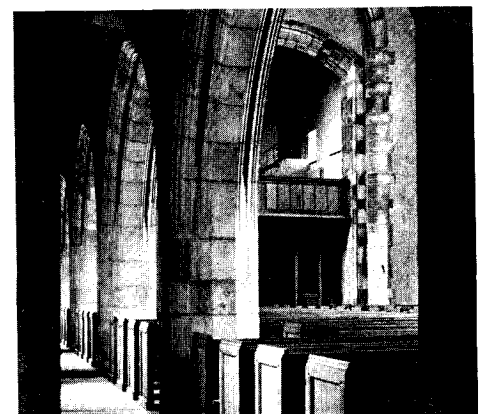

1929

Methodist Church, Knoxville, Tenn., office of John Russell Pope, architects; Barber and McMurry, associated architects. Simplified Gothic retains scale and proportions. A helpful carry-over of essential values of medieval ecclesiastical architecture.

**ST. MARK'S EPISCOPAL CHURCH
ST. LOUIS, MISSOURI**

NAGEL & DUNN, Architects

THAT PROVISION for further expansion of this church was almost as important a consideration as meeting present needs is evident from the plot and floor plans, which have been arranged for successive construction of units. The present plan provides an altar at the east end of the single center aisle; in the event of an addition, this altar will stand free of the wall, with the celebrant facing the congregation. While there is hardly more than a trace of traditional ecclesiastical detail in this building, it is unmistakably a church. The exterior has copings, door architrave, and window lintels of stone on a wall surface of white brick. The interior walls are of the same brick, painted in a light color; such features as choir screen, entrance doors, altar rail, and pulpit are of polychromed and gilded wood. The heroic figure of St. Mark on the exterior and the altar crucifix are by Sheila Burlingame.



Photos by George Harris

The simple brick exterior has only a suggestion of traditionalism.

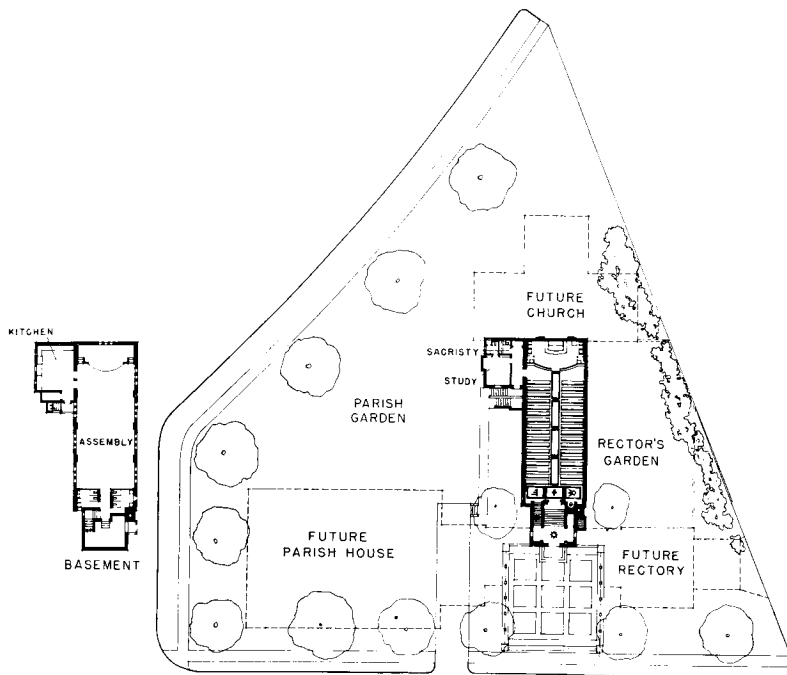

Plot and floor plans.

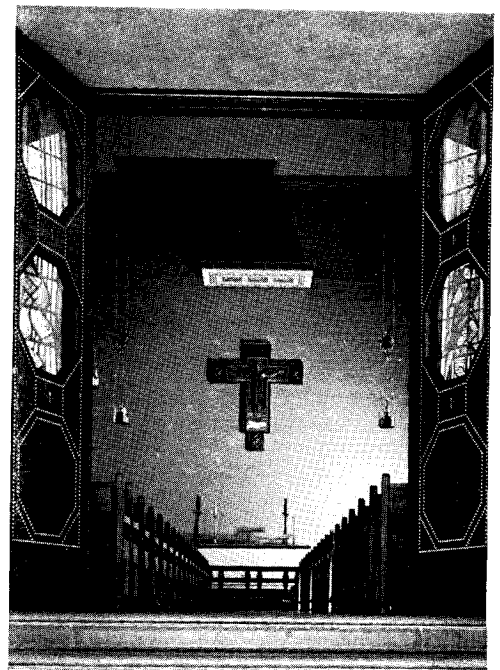

View of interior, looking toward the altar.

will also often insist upon an excessive amount of basement space supposedly for reasons of economy, when there is no real economy in well-constructed and well-ventilated basement space below the frost line. Such basement space should not be used for any purpose for which it would not be permitted in a public school building.

The erroneous idea persists that the square, octagonal, or circular auditorium is mandatory for a Protestant church. Actually, for a place of worship and preaching, the rectangular auditorium with a longitudinal axis is better for the following very practical reasons: 1. Such a form is less likely to require acoustical correction, since the principal wall areas reinforce, but do not create echoes or late reflections. 2. For satisfactory proportion in section, height should be related to the minimum span; this gives less volume for the same area, and makes for advantageous acoustical and heating conditions. 3. The minimum roof span is less for the same area. 4. Most of the congregation (90% as against 30%) are directly in front of the preacher and have a direct view of chancel. 5. Rectangular blocks of straight pews seat 10 to 15% more persons than curved pews and radiating aisles. 6. The rectangular auditorium lends itself more readily to temporary or future expansion, at the ends or by addition of transepts. 7. It has a natural focal point whereas the focus of a circle or polygon is in the center (witness unsuitability of Renaissance centralized domed churches).

In the matter of style, the trend is still definitely conservative and will probably continue to be so for another decade. This pronounced preference for traditional architecture may be due to the following factors:

1. Forty years ago the plan of the typical Protestant church was very functional in terms of what were then considered the ideal "auditorium" and Sunday school, i.e., the corner pulpit, bowled floor, curved pews, with overflow seating area in the adjoining "Akron plan" galleried Sunday school. Marvelous ingenuity was displayed in squeezing this plan into a cruciform Romanesque exterior. Now we are called upon to remodel these buildings, by further exercises of ingenuity, into a sanctuary which looks like a church, and to provide space for graded religious education which is not limited to one hour's use per week. It is not surprising, therefore, that church leaders are cautious about innovations of plan or style in new buildings.

2. The strong liturgical movement carries with it the idea that the traditional architecture of the more liturgical churches is somehow necessary for the desired effect.

3. The congregational form of government which exists in many Protestant church requires official action by committees. Most laymen who serve in this capacity are unfamiliar with architecture, and are unwilling to authorize any departure from the security of respectability.

4. The average layman and church official reacts very unfavorably to the extremely crude and hard character of many of the contemporary churches in Europe, which are practically all that can be shown as examples of contemporary style.

5. Many clients as well as architects believe that working in a contemporary style will result in the loss of distinctive character.

6. The architectural profession has sold the idea of style so completely that most Americans still require that a building of any type whatsoever have a style label. However, the traditional styles can be used with the greatest of freedom, with a semblance of tradition sufficient to justify a label. (See pp. 62 and 64 of this issue.)

Suggestions on how to proceed

The architect who has a church project on his hands will serve his own interest and those of the church, by refusing from the beginning to indulge in informal competition of free sketches.*

* Church leaders are advocating selection of an architect as in any other professional service and payment of proper fees from the start.



1930

Swedish Baptist Church, New York, Martin Hedmark, architect. Fresh and vigorous detail, recognizing steel and terra cotta as design elements.



1932

Community Church, Millburn, N. J., Hobart Upjohn, architect. Typical of liturgical trend. Colonial details freely used in 3-aisled plan with shallow chancel.

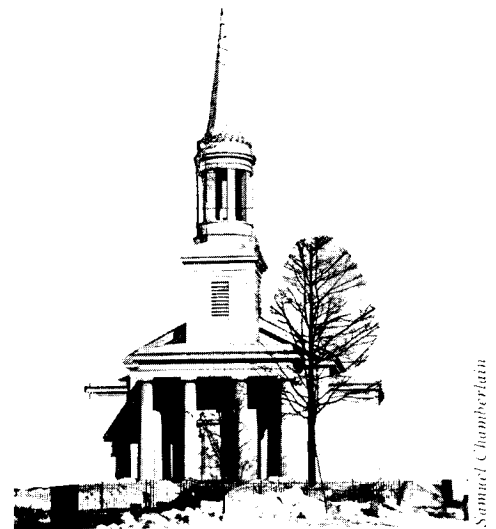

1933

First Church, Waltham, Mass., Allen, Collens, and Willis, architects. Greek archeology and Georgian combined to express tradition of earlier church.



1933

Plymouth Congregational Church, Lincoln, Neb., H. V. Magonigle, architect; R. W. McLaughlin, associate. Notable in its free use of traditional material.

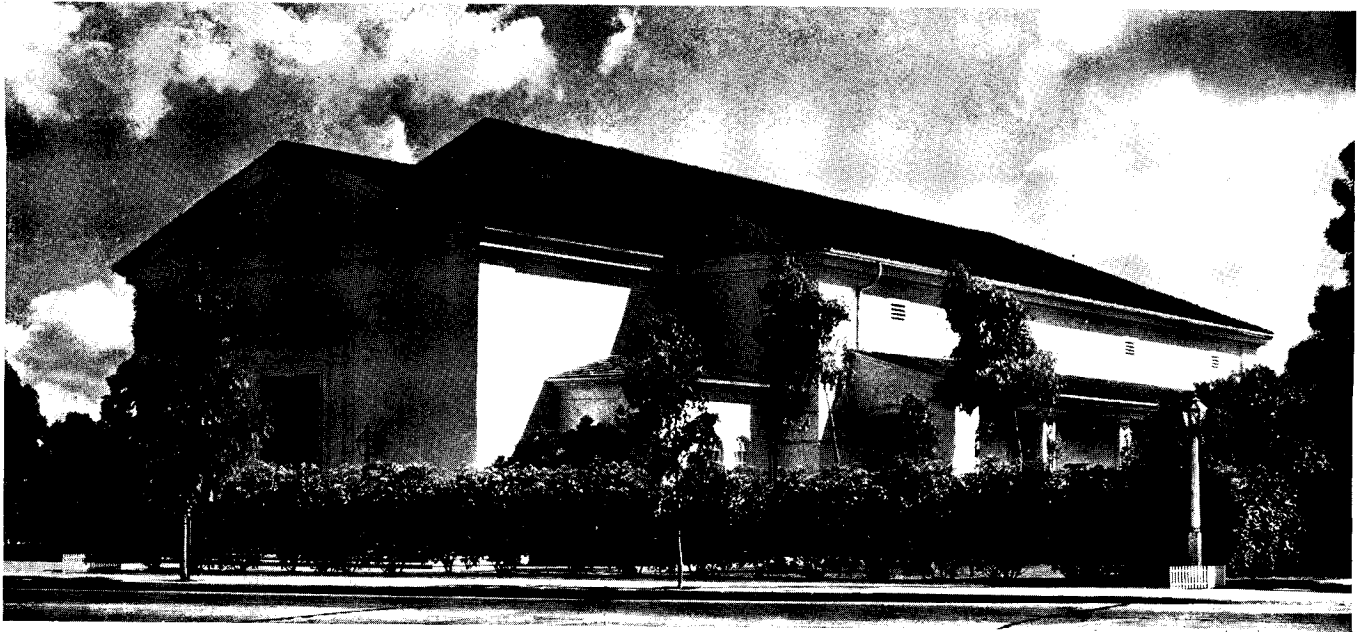

TWENTY-FIFTH CHURCH OF CHRIST SCIENTIST, LOS ANGELES, CALIFORNIA

H. ROY KELLEY, Architect

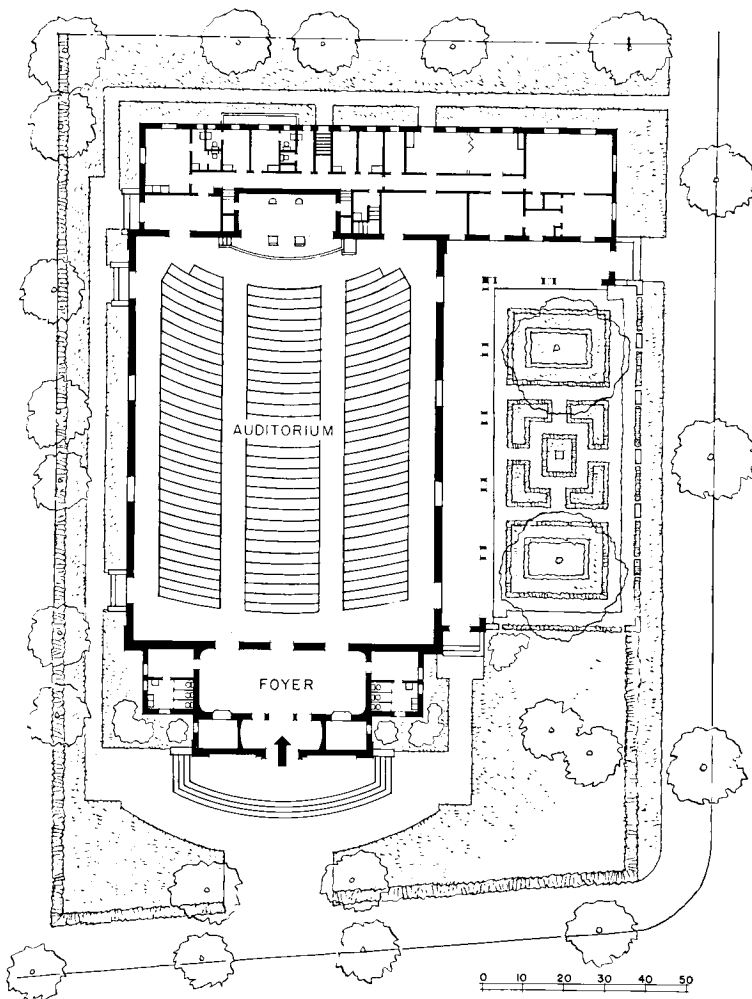

IN CHARACTER and plan, this church is a local adaptation of the New England meeting house. The simple auditorium, with its panelled ceiling finished in acoustical plaster, seats 1100 persons; further program requirements were simple and are provided for at the rear of the building. Opening off the auditorium is a wide portico which leads to an enclosed garden. This open portico serves as a secondary means of circulation, made possible by the mild climate of the region. The exterior plaster surface is buff colored, with white trim; the interior walls are light ivory with the ceiling painted in a deeper and warmer tone of the same color.

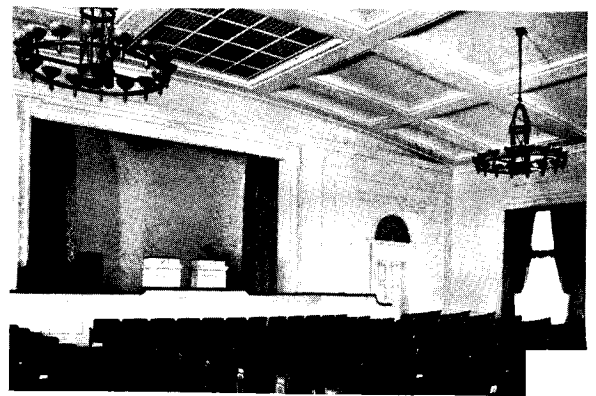

The auditorium has a flat segment shaped ceiling.

Before making any false starts, the architect should insist upon a complete and definite program. He should encourage his clients to retain expert advice in formulating this program. Before laying down a building program the church committee, aided by its city, state, or national denominational officers, should analyze carefully its present and future relationship to the community. Population increase, racial and religious population trends, real estate values, zoning, social needs and existing provisions for them—all these factors should be analyzed. After determining the location and broad policies, the building needs must then be carefully analyzed, preferably with the aid of a consulting architect or an accredited church consultant. (Avoid the consultant who may be a specialist in or an enthusiast for one type of activity—e.g., religious education.)

The consulting architect can expedite the progress of the project in several ways: he can insist upon and assist in compiling and crystallizing the program of building requirements; help the committee to make decisions in the inevitable compromises between budget and program and between competing departmental interests; reduce areas or multiple uses of space, etc

The consultant can support the architect in setting the right *parti*, and overruling antiquated ideas or over-advertised building materials or the technical-minded member of the congregation, automatically on the committee, who knows more than everyone else. The association of the consulting architect with the project often aids the financing of the project—in the set-up of the financial campaign; in public presentation of the approved plans; and, in some instances, may encourage favorable consideration of the church's application for loan or grant from the denominational financing bureau.

The architect should in any case demand, and in his own schedule allow, ample time for preliminary studies. In democratic Protestant polity, everybody's ideas, good or bad, must at least be given a hearing. The architect will in the long run save drafting time by arranging a series of conferences with successive small-scale preliminary schemes. Display drawings and models should not be made until the committee has approved a general design for presentation to the congregation.

In the writer's experience with several hundred church projects, there have been no duplicates. This fact seems to indicate that stock plans are of no value, except as a means of suggesting to clients some of the facilities they may wish to include. Although the general principles and trends here outlined are very widely accepted, their local application is always conditioned by a hundred variables—statistics, finance, prevailing architectural mode, materials, site, orientation, codes, etc. The best possible solution requires both the familiar knowledge of the local minister and architect and the generalized experience of religious and architectural consultants.

Will religious architecture again assume a dominant position?

Religious architecture has been dominant and pioneering in similar creative periods of the past. In the ecclesiastical field are to be found the most challenging occasions for creative design; to this field must inevitably come the contemporary mode now best exemplified in our commercial and public work. The possibilities of great achievement could be realized if architects of demonstrated ability in traditional ecclesiastical design could discard academic inhibitions and archeological habits, and could bring to contemporary design the really basic values of the best religious architecture—frank and logical expression of structure, height, vista, rhythm, focal climax, harmony of form and color—in terms of today's materials and techniques. Otherwise we face the possibility of enduring decades of trial and error by structural and industrial engineers as in the Romanesque period, before we can arrive at a really great period analogous to the Gothic.

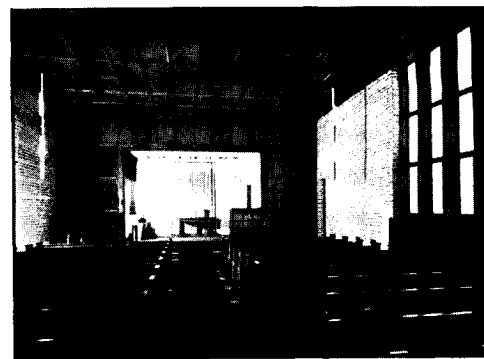

Hedrich-Blessing

1936

Unitarian Church, Oak Park, Ill., Paul Schweikher, architect. An unostentatious interior where effectiveness depends upon careful use of a few simple materials, with a minimum of ecclesiastical influence.



1936

Presbyterian Church, Pottstown, Pa., Harold E. Wagoner, architect (for De Long and De Long). A remodeling job brings order out of chaos: two views from almost the same point. Main lines of seating harmonize with lines of building; arrangement of lighting fixtures emphasizes focal point.

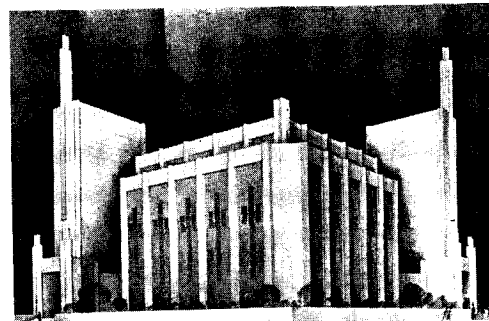

1939

Congregational Church (proposed), Chicago, Ill., Barry Byrne, architect. An effective answer to the problem of the downtown church which must compete with adjoining tall buildings. Composition calculated to individualize special purpose of structure.

EFFECT OF



Direct ultraviolet irradiation in the operating room of a hospital in Boston protects the surgical incision against infection by air-borne bacteria.

THE AVERAGE person breathes about 25 lbs. of air daily compared with an average consumption of food and water weighing approximately $5\frac{1}{2}$ lbs. As much as 85% of the deaths from infections and parasitic diseases are reported to be caused by microorganisms whose normal entry to the body is through the upper respiratory tract.

The theory that infections can be transmitted by air-borne microorganisms has received considerable experimental corroboration in recent years; although the issue is still in controversy, available evidence appears increasingly to support the theory. There is reason to suppose that, within our enclosed rooms, we may be exchanging respiratory flora, with consequences analogous to those of the exchange of our intestinal flora through the medium of food or of water. Bacteria-laden dust and droplets, smoke, pollen, odorous gases, etc., are transported by air currents inside buildings as well as out of doors. The problem thus posed has been magnified by the increased use of conditioned air, 50 to 90% of which is usually recirculated. In some instances this consideration has even prevented installation of air-conditioning equipment.

Air purification is usually accomplished by filtration, by precipitation, or by ultraviolet radiation. Filtration and precipitation are more effective against dust, pollen, and other particles, but remove a large percentage of bacteria too. Mechanical filters remove the larger particles—in general, those over two and one-half thousandths of an inch in size. But much of the smoke and dust in the air of great cities is considerably finer. For example, the average particle in cigarette smoke is approximately four-millionths of an inch in diameter; billions of such particles are emitted in every puff. To remove these particles, several types of electrical precipitators have been developed.

Ultraviolet lights may be used to kill air-borne bacteria. Various methods of combining filters or electrical precipitators with ultraviolet-light generators are being perfected.

At the Laboratories for the Study of

AIR SANITATION ON BUILDING DESIGN

Air-borne Infection, University of Pennsylvania, William Firth Wells (in collaboration with Mildred Weeks Wells) has worked out a method for measuring the rate at which microorganisms are vented or removed from the air: ventilation by replacement of air from the outside or from another part of the building can be described in terms equivalent to those used in describing the killing of bacteria in the air—that is, in number of air changes per hour. Wells has found, by a large number of determinations, that during the winter months, when the spread of respiratory infections is widest, when people tend to congregate in buildings with closed windows and no other provision for ventilation than seepage around doors and windows, air turnovers are fewer than ten per hour.* In mild weather, in houses with open windows, air turnovers may reach 100 per hour. The number of air changes hourly in a room varies between these limits; ordinarily it is much nearer the lower limit. By comparison with these figures, the introduction of ultraviolet radiation for eliminating air-borne bacteria has made possible the purification of air at a rate equivalent to more than 100 and even more than 500 turnovers hourly. Recirculation of irradiated air raises these figures further.

The relative efficiency of methods of air purification is now being determined in a new building erected for the Cradle Society of Evanston, Ill. Over a period of 12 years the Cradle had perfected a technic for the prevention of contact infection which has been widely adopted by other hospitals. Nevertheless, respiratory and certain other infections continued to be transmitted from baby to baby. To discover how this cross infection takes place, the Cradle Society has undertaken an experiment.

Its new building** is divided into

*Advances in thermal insulation and "window conditioning" may even reduce this.

**The building was designed by Schmidt, Garden, and Erikson, architects. Standards for the unit depending on solid barriers and rapid replacement of air to prevent air-borne infection were set up by J. A. Reyniers of Notre Dame University. Mr. Erikson, W. F. Wells of the Laboratories for the Study of Air-borne Infection, Curtis Lighting, Inc., and the General Electric Company collaborated in the design of the ultraviolet installation.

three units. In one of these, an attempt is made to eliminate microorganisms in the air by solid barriers and rapid air change. In another unit, barriers of ultraviolet light have been installed between the babies. For control purposes, a third unit is of the usual cubicle type. Careful records of the results of this experiment are being kept.

Typical design problems are involved in such installations. For instance, the ultraviolet sources must be so installed that eyes of room occupants are shielded; too long exposure of eyes may result in conjunctivitis. The use of indirect lighting involves a choice of most efficient reflecting surfaces. Problems of air-tightness of material and construction may also be involved. Similarity of fluorescent and ultraviolet light sources suggests the possibility of an integration of lighting and air sanitation. The use of ultraviolet generators in the supply ducts of air-conditioning systems is also being studied.

Measures for air purification have been most frequent, perhaps, in places of public assembly. In addition to filters or precipitators, for example, ultraviolet sources have been installed in theaters and railway cars. In industry, precision in production requires increasingly that composition of the atmosphere within the production plant be controlled. Measures for air sanitation in beverage, dairy, and food plants have been especially frequent.

References:

1. Wells, W. F., and Wells, M. W. Air-borne Infection. Journal of American Association, 107:1698 and 1805, 1936.
2. Wells, W. F., and Wells, M. W. Measurement of Sanitary Ventilation. American Journal of Public Health, 28:3, March, 1938.
3. Chope, H. D., and Smillie, W. G. Air-borne Infection. Journal of Industrial Hygiene. 18: 780-92 (bibliography), December, 1936.
4. Pincus, Sol, and Stern, A. C. A Study of Air Pollution in New York City, American Journal of Public Health, 27: 321-333, April, 1937.

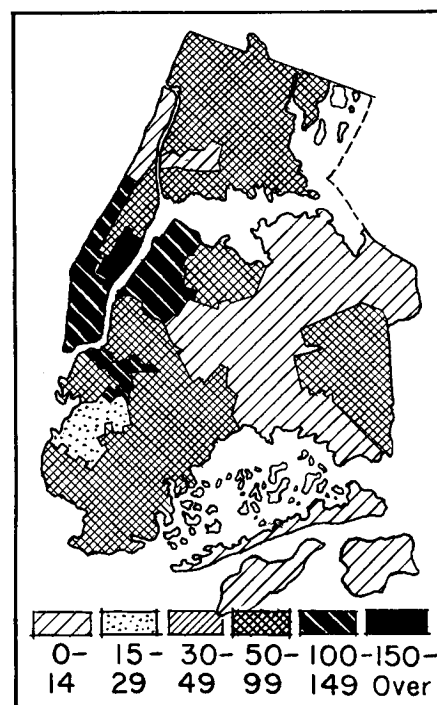

TONS OF SOOT PER SQ. MI. PER MO., N. Y. C.

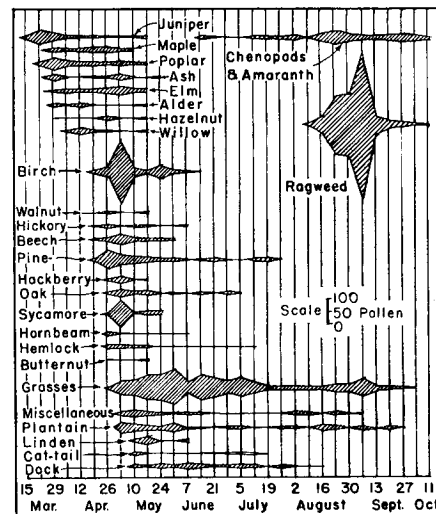

POLLEN COUNT, CENTRAL PARK, NEW YORK CITY, 1936
BACTERIA PER CU. FT. OF AIR IN N. Y. C. INCUBATED 18 HOURS AT 98.6° F.

Type of Location	SHEEP'S BLOOD BEEF INFUSION AGAR		BEEF INFUSION AGAR	
	No. of Samples	Bacteria Per Cu. Ft. of Air	No. of Samples	Bacteria Per Cu. Ft. of Air
Schools	707	29.6	678	21.1
Subway	290	19.2	294	12.4
Theaters— non-ventilated (auditorium)	104	13.2	110	8.4
Theaters— ventilated (ducts)	149	3.1	114	1.4
Streets	143	11.2	134	8.5
Park	13	3.0	18	1.8

Courtesy "Modern Hospital"



A barrier of ultraviolet light across the corridor of the isolation unit of the Children's Hospital in Boston, Massachusetts. Tests have shown that such screens can be made practically impervious to air-borne bacteria.

Courtesy Vestinghouse

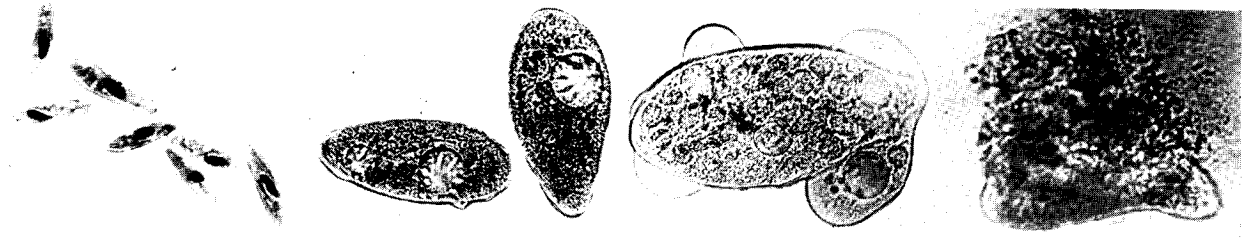

Microphotographs show the effect of ultraviolet radiation on unicellular organisms: the animals blister, swell, and explode. The time needed to kill varies with the type of organism and distance from the light source.

Control of air-borne bacteria*

THERE ARE TWO general conditions under which a designer might install equipment for the control of air-borne microorganisms (bacteria, molds, and yeasts) in a room or a building: first, where it is desired to prevent any possibility of disease-producing organisms being transmitted by air from one building occupant to another; and second, where it is desired to prevent contamination of a manufactured product by air-borne microorganisms.

The control of air-borne microorganisms is effected either by removing the microorganisms by filtering or washing the air, or else killing the organisms while they are still suspended in the air. The most common means for killing bacteria in air is irradiation with ultraviolet light. Once killed, the organisms merely add to the dust in the air.

Prevention of the transmission by air of bacteria from the exhalation, sneezing, coughing, or expectoration of one building occupant to the nose and throat of another individual obviously is most important in hospitals, next in importance in schools, auditoriums, and other places of public assembly.

The extent to which diseases, particularly those of a respiratory character, can be transmitted by air is controversial. Many doctors adhere to the hitherto almost universally accepted concept that such transmission is possible only by direct contact with liquid droplets of saliva or mucous propelled into the air by the act of sneezing, coughing, or expectorating. Recent experimental evidence, however, has been interpreted by a constantly growing group to indicate that transmission of disease by air-borne bacteria can occur hours after the organisms were first introduced into the air and long after the original liquid droplets have evaporated and disappeared. We have ample evidence that air contains many living bacteria and that the number of such organisms per cubic foot of air increases in proportion to the human population per unit volume of any room or building. We also know that some of these organisms are similar to those of the nose and throat, and that this latter group contains some characteristics of diseases of the nose and throat. Despite this evidence, the final link in the chain is still missing, that the presence of these organisms in the air we breathe will give us disease and that their absence prevents us from

contracting these same diseases.

In operating rooms, however, open wounds or incisions are subject to infection from organisms falling into them from the air. In such cases, the infecting organisms are not necessarily of nasopharyngeal origin and their portal of entry into the subject is not through the nose or throat. Under these conditions, diminishing the number of live bacteria in the air has been shown to cause more rapid and more successful recovery from operations, and it can be definitely stated that such control is effective.

And despite the fact that we cannot at present predict from experimental or clinical data that freedom from colds, coughs, and other respiratory ailments will follow as an immediate consequence of the installation in a room or building of equipment to control air-borne bacteria, it is logical to infer that such a result would take place. Therefore, it is not unreasonable, even with our present lack of certainty, to include bacterial control in the design of new hospitals and schools today.

Control of air-borne microorganisms in industry is mainly a problem of the food industry, where the organisms causing putrefaction, food poisoning, and decay are invariably unwelcome, and those causing fermentation are either wanted or unwanted according to the particular process involved. In some processes such as brewing and baking, a particular strain of yeast may be desired and be introduced by the brewmaster or baker. It is important thereafter that contamination by air-borne wild yeasts and other microbiological fermentative agents be avoided. In making sour cream, a strain of bacteria is added. In cheese-making, both bacteria and molds are active agents. Cheeses that could once be made only in specific isolated caves and caverns in Europe can now be made in an air-conditioned factory, provided the factory atmosphere be so controlled that none but microorganisms typical of the original caves be introduced to the milk and cheese from the air. Other fields in which bacterial control of air is undergoing intensive commercial exploitation are butchers' refrigerators and bakers' proofrooms.

The actual technic of control by mechanical removal of microorganisms from the incoming air is identical with that of dust removal. In general, a filter with high dust-removal efficiency

will also have a high bacteria-removal efficiency, but reliance must always be placed on actual test data. The same holds true of removal by electrical precipitation.

Bacteria removal by washing incoming air in conventional air washers is effective if the washer is close to 100% efficient in removing dust and if the wash-water itself is free of bacteria. If the water has an appreciable bacterial content, the act of spraying it into the air and the evaporation of some of the spray droplets will release bacteria from the water and add them to the air. This has been known to result in the effluent air from an air washer having a higher bacteria content than the influent air. However, the addition of a liquid germicide to the wash-water so as to render it almost sterile will overcome this trouble. The liquid germicide must be odorless and non-toxic on inhalation. This greatly limits the choice. However, there are several which have been successfully used.

Just as the bacteria may be mechanically removed from incoming air to a room or building by filtration or washing, they may also be killed by an ultraviolet lamp bank in the inlet duct; in commercial ultraviolet lamps, energy at and near the 2537 Angstrom unit line of mercury vapor is generally employed. The principal advantage of ultraviolet for bacterial control is that it does not necessarily have to be applied to incoming air as must filtration or washing, but can be used to (a) irradiate the room itself, (b) irradiate any specified portion of the room, or (c) provide, within a room or hall, a light barrier of sterilizing rays through which air must pass. By installing lamps in a room rather than in the duct leading to a room, a longer period of exposure of air-borne bacteria to the bactericidal radiation is possible, requiring fewer lamps. The sanitary effect of the lamps is allowed to control the bacteria thrown into the air by the inhabitants of the room, as well as the bacteria in the incoming air from the duct. The "artificial sunlight" of several years ago combined both visible and ultraviolet illumination in the same lighting fixture. However, the ultraviolet wavelengths employed were those producing sunburn, but not those most effective bactericidally. The room illumination of the future may well combine visible light with sources of bactericidal (but non-suntanning) rays.

* Arthur Cecil Stern, Consulting Engineer

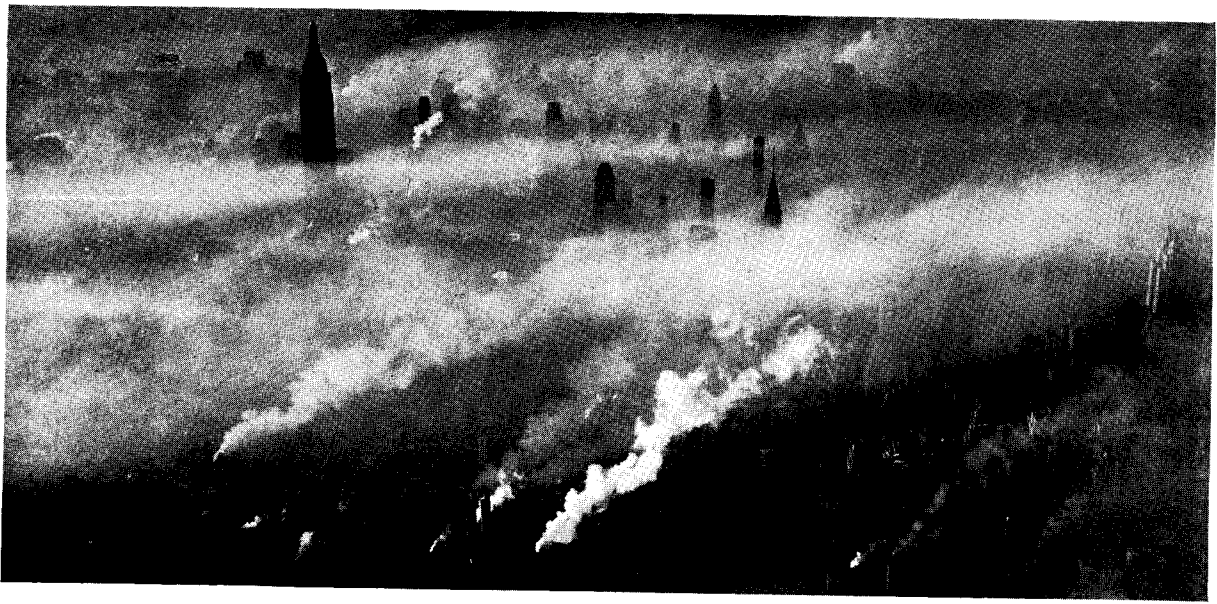

Atmosphere of lower Manhattan. Over 150 tons of soot per square mile per month fall over this area.

Aerial photos by Fairchild Aerial Survey



Dust storm in the Texas Panhandle. Eroded top soil may be carried in the atmosphere for thousands of miles.

Science Service



Flowering oak and tall ragweed releasing pollen to which some hay-fever patients are sensitive.

Control of air-borne dust and smoke*

ONE OF THE outstanding recent developments in air-cleaning equipment is in the higher efficiencies secured in the removal of smoke, fumes, and microscopic dust particles.

Many of the air cleaners now in general use are highly efficient in the removal of dust particles of the order of 1 micron (.00004 in.) and over. However, smoke, fumes, and ultra-microscopic particles (about .01 to 1 micron) pass through such filters in the form of a gas and sometimes condense or agglomerate into larger particles on the clean air side; this is due possibly to condensation on cooler surfaces, the development of electrostatic charges in passing through the filter, or some other increase in molecular activity which causes the particles to coalesce or agglomerate. This phenomenon will help explain the following:

Investigations have shown that air which is relatively free from air-borne solids directly in back of an air filter will sometimes show an increased dust count after passing through a heat exchanger, a fan, or even moderate lengths of straight duct work. Secondary filters at the outlet openings have sometimes been found advantageous, but it has frequently been impossible to eliminate entirely the discoloration of outlet grilles and the contamination of materials in process by the use of air filters or air washers.

Recent developments in the field of electrical precipitation have now made available, at relatively low cost, devices which will eliminate from an air stream a large percentage of all solids including smokes, fumes, and microscopic dust particles. While the principle of electrical precipitation as applied to industrial ducts has been understood for many years, its application to air-conditioning and general ventilation problems has been hampered by the high cost of such equipment and by the high voltage required, as well as by the fact that considerable volumes of ozone and nitrous oxide were sometimes liberated into the air stream. The efficiency of electrical air cleaners is relatively high against smoke and sub-microscopic particles.

It has long been recognized that forest air is purer than city air; the foliage of the trees acts as a viscous impingement filter, removing dust and air-borne organisms from the atmosphere.

All forms of bacteria are measurably less numerous in forests than on the outskirts; in some cases the difference is as much as 25%. In the Middle Ages it was noted that towns entirely surrounded by forests were particularly free from certain forms of epidemic disease.

Investigations in this country and abroad have shown a surprisingly close relationship between excessive pollution of city air and the abnormal prevalence of respiratory infections. Studies conducted in Pittsburgh by the Mellon Institute seem to establish this relationship rather definitely, and many other similar investigations emphasize the relation between air-borne impurities and disease.

Until very recently physicians had accepted the theory forwarded by Flügge that infectious drops and organisms were not carried in the air stream for any considerable time or distance. However, in 1934 W. F. Wells, then of the Harvard School of Public Health, rather definitely demonstrated the fallacy of this conclusion. He reported in the November 1935 issue of the *Journal of Industrial Hygiene* that droplets expelled into the air from the nose and throat in sneezing, coughing, etc., may drift for long times and considerable distance with the slightest air current. He demonstrated that microorganisms in these droplets frequently remain alive for periods long enough to be transmitted to other persons in the same rooms or buildings, and he recovered some of the organisms in a still chamber 48 hours after their artificial dissemination into the air.

Mr. Wells also reports that dust particles provide the principal source of air bacteria in cotton mills, while bacteria in nuclear residues of humidifying water, predominate in weaving rooms. He further demonstrated that a one-room air conditioner in the basement of the Harvard School of Public Health distributed these organisms throughout the entire three-story building. Numbers of these test organisms were recovered from the ends of every corridor up to the top floor in concentrations of approximately 1% of that in the air-conditioned room.

Recent bacteriological studies in England show conclusively that millions of streptococci may settle on the floor of a scarlet-fever ward in 24 hours. This may explain the spread of types of organisms found in the

throats of many patients, even though all who show the presence of such organisms do not show clinical signs of the disease. This means that in the light of our present knowledge it is probable that practically all persons become infected before they are adults with the common so-called contagious diseases, whether they come down with a frank case of the disease or not.

The tests reported by T. S. Carswell and Associates corroborate Mr. Wells' findings and check very closely with the investigations made by G. L. Larson of the University of Wisconsin in 1916.

The studies made by the WPA Air Pollution Survey (*American Journal of Public Health*, April 1937) in 1937 indicated that in 678 samples of air taken from city schools, the average bacteria count was 21.1; in 110 samples of air from theaters without ventilating systems the average number of bacteria per cubic foot was 8.4. In theaters equipped with ventilating systems and air filters, the average of 114 tests showed a bacteria count of 1.4 bacteria per cubic foot. This compares with 1.8 bacteria per cubic foot in 18 air samples taken in public parks.

The Bacteriological Survey conducted by Dr. C. B. Coulter and Associates of the College of Physicians and Surgeons, Columbia University, extended over a period of 18 months and covered 246 telephone booths. It was found that telephone booths equipped with air filters in some cases reduced the number of germs materially. In 7 telephone booths at Radio City the average was found to be 32 bacteria, while in the Long Island Railroad Station the figures for 5 instruments had an average of 500 organisms.

Although it is very difficult to say definitely that the excessive pollution of air-borne organisms is necessarily a menace to health, we know that in industrial process work the degree of bacterial contamination is almost a direct factor of the number of such organisms in the air. In the brewing industry, in the production of gelatin, dry milk, surgical sutures, and pharmaceutical products, we have learned to insist upon maximum freedom from air-borne organisms.

The efficiency of an air filter in removing bacteria very closely parallels its efficiency in removing dust particles. An efficient dust filter may remove as high as 99% of many pathogenic organisms.

* H. C. Murphy, Vice President, American Air Filter Company, Inc.

Control of odors*

REMOVING ODORS from the air is an ever-present but frequently neglected problem in air conditioning. It is customary to displace the commoner odors by supplying additional ventilation: 30 cu. ft. of air per minute are sufficient to reduce their concentration to the "threshold point," that is, to the concentration at which odors are barely detectable by trained observers entering an enclosure from clean outdoor air. This rate has proved sufficient against body odor from average types of persons, together with such other odors as those from light perfumes and light smoking; it is subject to modifications in special situations and it is increased generally when other odors such as those from the handling, cooking, and serving of foods, from alcoholic

* F. H. Munkelt, Vice President, W. B. Connor Engineering Corporation.

Ionization and air conditioning*

WE ARE ALL aware that air inside a poorly ventilated building containing people lacks the freshness and invigorating power of outdoor air. This fact has led to an inquiry into the cause for the air's apparent staleness. The staleness has been attributed to various causes, one of the most recent being a deficiency in ionization. When this was first suggested as the cause for the staleness of air, it was not known whether or not the ionization of air inside a poorly ventilated room diminished when the room was occupied. It was soon discovered, however, from investigations at Harvard, that the number of molecular ions undergoes a diminution when a closed room is occupied by people. This discovery strengthened the belief held by many, that a connection exists between the freshness of air and its ionization. Molecular ions are produced in the air of a room principally through the radiations given off by solid radioactive material in the walls, floors, ceilings, etc., of the building and by radioactive gases and solids that have escaped into the air.

The destruction of molecular ions, or more properly speaking, the destruction of the electric charges, occurs when two ions of opposite polarity meet and neutralize each other's charge. Another destruction process is continually at work through the action of the larger ions in the atmosphere. These larger

* G. R. Wait, Physicist, Department of Terrestrial Magnetism, Carnegie Institution of Washington.

beverages, or from heavy smoking are present. But when the odors are concentrated or unusually pungent or objectionable, displacement by using large quantities of air becomes quite expensive. There are cases, too, where odors cannot be exhausted to the outside atmosphere because they create a nuisance in the neighborhood.

Of the various methods proposed for the control of odors, the method of removal by solid adsorbent is one which actually removes the odor. Such a material adsorbs condensable vapors and gases which come in contact with its surface, and holds them firmly in a condensed condition until forced by special means to release them. Coconut-shell activated carbon, for example, is very active in adsorption of hydrocarbons and organic gases. Smoke consists of solids in very fine particles

ions absorb the molecular ions through cohesion with them. In most industrialized communities, processes are at work creating great quantities of large ions. They are produced through most combustion processes, such as the burning of solid materials or of gases. The large ions from these combustion processes accumulate over such localities and tend to prevent the molecular ions in the air from becoming very numerous.

Large ions also tend to accumulate in the air of a closed building where people congregate, and thus tend to prevent the molecular ions in the building from becoming very numerous. The accumulation of large ions in the air of such a building is due to the fact that they are produced in large quantities under such circumstances. Each person in the building is a source of the large ions. People everywhere produce continuously large quantities of large ions and send them forth into the surrounding atmosphere. Little is actually known regarding the character of these particles which make up the large ions. The particles are very large compared with the size of an air molecule, having a diameter perhaps several thousand times larger. It is not yet known whether these particles are of gaseous or solid composition, nor what is their precise origin. The great majority of the particles come with the breath from the human system. The greater part of the particles emerge with an electric charge. About as many

as well as gaseous odors. The smoke solids carry with them certain of the odorous, combustion-produced gases in one or both of these ways: by adsorbing the odors lightly, holding them, and slowly releasing them; by volatilizing the odors from their own mass. For satisfactory abatement of smoke, therefore, efficient filtering as well as odor adsorption must be provided.

Air-conditioning installations in which measures for odor control have been taken include department stores, offices, manufacturing spaces, restaurants, fur-storage vaults, physical-therapy and massage rooms in which excessive body odors are present, animal laboratories of pharmaceutical firms, etc. The importance of the control of odors is that it permits a higher recirculation of air, thus affecting the initial and operating costs of air-conditioning systems.

of them are charged positively as negatively. A few of the particles appear to be without an electric charge. Much remains to be learned concerning the particles from the human system, and it is a question whether breathing them into the lungs has any noticeable physiological effects. They no doubt tend to be associated with small organisms thrown off from the human system. These particles, taken into the air passages of another, may be a potential source of danger to the individual.

The accumulation of particles from the human system in the air of an occupied room not only alters our views on the ion content of such air, but constitutes an important problem in air conditioning. Whether, or to what extent, the presence of such particles may be seriously objectionable from the point of view of health and comfort remains yet to be determined.

Besides the air molecules there are different-sized particles in the atmosphere, a certain fixed percentage of which tend to become electrically charged. About one-third of the largest particles will tend to be without charge, one-third to be positively and one-third negatively charged. About 70% of the relatively small particles are uncharged, and only 15% are charged positively and 15% negatively. The ionizer attached to the precipitators now in use does not necessarily insure that the particles become charged, but hastens the attainment of equilibrium conditions between charged and uncharged particles. Large particles thus tend to have two-thirds of their number electrically charged in the ionizer and removed in passing through the precipitator. Only about 30% of the smaller particles will be removed.

[H. C. Murphy of the American Air Filter Company declares that "from the experience of our own research workers we know definitely that approximately 85% of all particles of commercially significant size (those capable, for instance, of producing discoloration by the U. S. Bureau of Standards Test Procedure) can be electrically precipitated from an air stream which has been subjected to the influence of ionizing apparatus."—Ed. Note.]

Types of air cleaners*

BASICALLY, air cleaning is concerned with the removal of two types of dusts: namely, outdoor or nuisance dusts and industrial dusts, continued exposure to which may lead to certain forms of physical disability. Nuisance dusts are present in the air of all large cities. They are characterized by a relatively high percentage of carbon (approximately 65%), and are usually considered to have a limited effect on health. Their widespread occurrence causes extensive damage to materials with which they come in contact, and contributes a certain measure of discomfort. The concentration of outdoor dust varies in different localities according to the degree of industrialization and geographical location. However, concentrations rarely exceed 500,000 particles per cu. ft., and in most instances average from 50,000 to 100,000 particles per cu. ft. In addition to dust are bacteria and pollens, not always identifiable, but which sometimes result in ill health.

The need for cleaning outdoor air prior to distributing it through ventilating systems is at present based almost entirely on economic considerations. Experience has shown that the discoloration of interior walls by settled dust leads to large expenses in repainting and refinishing. Similarly, clean air in department stores has made it possible for merchandise to be stored for longer periods of time without deterioration. The cost of maintaining delicate equipment such as is found in telephone exchanges and laboratories is much reduced if clean air is provided. Again air cleaning aids in the preservation of valuable books, papers, and manuscripts in our libraries and archives.

Industrial dusts are associated with the cause of certain lung diseases called the pneumoconioses, of which silicosis

is one. These dusts, unless controlled, may often reach concentrations exceeding 1,000 million particles per cu. ft. Continued exposure over long periods of time to concentrations as low as 5 million particles per cubic foot may result in lung impairments.

Air cleaning has required constant research for the development of equipment possessing four essential characteristics: namely, high efficiency, low resistance to flow, long life, and low cost of maintenance and repair. Air-cleaning devices may be classified briefly as follows; air washers (sprays), oil filters, solid filters and precipitators for nuisance dusts, and solid filters for industrial dusts.

Though spray-type air washers are valuable as humidifiers they appear to have a decreasing application to air-cleaning problems. Chief among the criticisms leveled against these devices are their relatively low efficiency and the need for recirculating the water used. In addition, this constant recirculation may lead to the growth of algae and other water forms, thus giving rise to odors and other inconveniences. Spray-type washers are rarely used with industrial dusts.

Oil filters of the manual and self-cleaning types have low resistances and find extensive use for the removal of nuisance dusts from air. Many of the early objections to oil odors, bacterial growth, and potential fire hazards have been removed by the development of suitable viscous fluids. Another attribute of these devices is their long life and their need of only occasional attention. Since air cleaning often produces little tangible evidence of savings, but rather adds to the expense of upkeep, oil filters are favored by building designers. But the efficiency of these filters is relatively low for small particles.

Solid filters, represented by loose

packings of steel wool, glass wool, or other similar material, and cloth and paper of various kinds are widely used. The air-cleaning industry has developed cheap replaceable packings, usually oil-covered, with low resistance to flow and satisfactory efficiencies. Such replaceable filters are popular because of the ease with which they may be replaced when infrequent need demands.

More efficient than the cleaners so far mentioned are cloth and paper filters. These involve higher initial costs and resistances to air flow than most other types. However, they find increasing use, because of their efficiency to capture both large and small dust particles and, to a certain extent, bacteria and pollens. In industry, wherever dust-laden air is cleaned prior to recirculation, cloth filters are used almost exclusively.

The most recent development in stationary air cleaners is the electrostatic precipitator. It has a negligible resistance to flow and is effective in the removal of suspended dust and smoke.

Several types of electrical precipitators which give satisfactory service have now been developed.† These usually consist of an ionizing device arranged to produce ions without the generation of ozone. In passing through the ionizer, the air impurities are bombarded by ions and receive an electric charge. The air then passes through a collection chamber consisting of parallel charged plates to attract and collect the charged particles from the air stream. The voltages used are small; the device interposes a very low constant resistance to air flow; and the efficiencies obtained are of a very high order. The price of this equipment is approximately two to three times the cost of automatic viscous air cleaners.

† Description of electrical precipitators is by H. C. Murphy.

* Dr. R. R. Sayers, Senior Surgeon; Chief, Division of Industrial Hygiene, National Institute of Health, U. S. Public Health Service.

Courtesy "Philadelphia Record"

Westinghouse

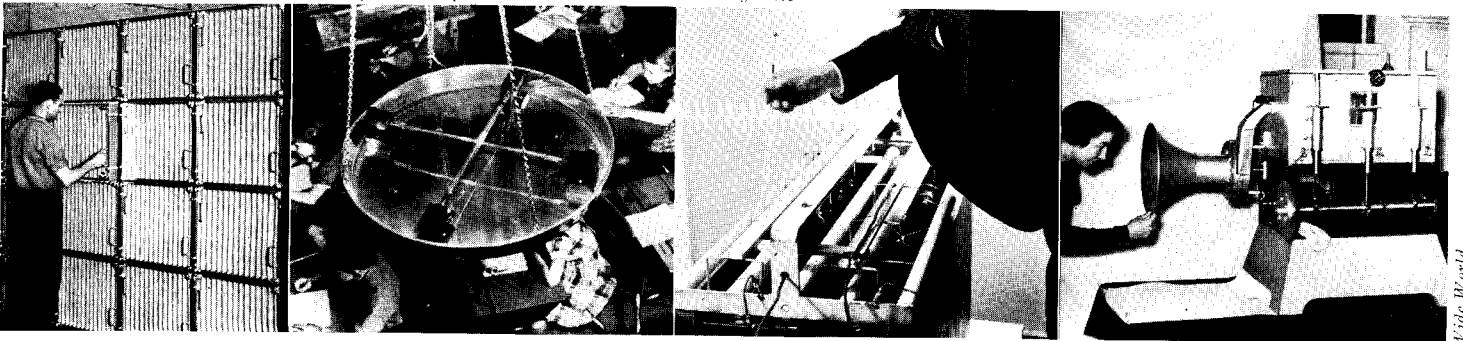

Dry electrostatic filter

Ultraviolet light and reflector

Ultraviolet in precipitator

London: purifier against gas bombs

PROMISES FULFILLED

IN 1937 Minneapolis-Honeywell Regulator Company acquired the National Regulator Company and entered the field of pneumatic control. . . . At that time we stated our objective was to build a line of controls with basic improvements over existing pneumatic units. Our engineering program included: Precision manufacture of all units; Standardized units for tailor-made application; Lifetime accuracy in operation; Infinite positive positioning of valves and dampers; Greater economy in installation and elimination of service.

These promises have been fulfilled. All devices in the old National line have been redesigned, with forty-two distinct improvements. The Gradutrol System, the most significant contribution to the field of pneumatic temperature control in the past two decades, has proved its real superiority in the field. Progress has not stopped. Shortly will be announced another real contribution to the science of pneumatic control.

We express our appreciation to the architectural, engineering and contracting fraternity, who have shown their confidence and faith in Minneapolis-Honeywell products and service, by placing with us during the past year, in spite of declining business conditions, the largest volume of pneumatic control business ever enjoyed by this company or its predecessor company. Minneapolis-Honeywell Regulator Company, Minneapolis, Minnesota.

**A Statement Regarding
the Entrance of
Minneapolis-Honeywell
into the Field of
Pneumatic Control**

MINNEAPOLIS-HONEYWELL

Gradutrol System
... OF PNEUMATIC CONTROL

ARCHITECTURAL RECORD

BUILDING TYPES



Courtesy Oregon-Washington Plywood Co.

HOUSE CONSTRUCTION

FORTHCOMING ISSUES: 1939 — August, High Schools; September, Apartment Houses; October, Theaters; November, Houses; December, Hospitals. PRECEDING ISSUES: 1939 — June, Factories; May, Houses; April, Retail Stores; March, Housing Developments; February, Elementary Schools; January, Restaurants.



Wood structure system devised by Antonin Raymond, architect: essentially post-and-lintel construction with curtain walls.

THIS IS THE SECOND of three Building Types studies on houses to appear in 1939. The first (May) dealt with planning units for house design; the last will be concerned with house equipment. . . . This study reports progress in residential construction techniques, most of which tend toward elimination of waste by reducing amounts of materials and decreasing production time. There are three parts: first, a survey of improved performance standards necessitated by the demand for structural simplicity and economy; second, reports of effects of these standards on structural elements of houses; third, data on various complete structural systems which use modern materials and methods—all means of producing "more house for less money." . . . Information was compiled by William H. Hayes, Assistant Professor of Architecture, Columbia University, from data supplied by a large number of individuals and organizations who, though too numerous to list individually, merit the thanks not only of RECORD editors but also of every designer who benefits by their experience.

INDEX

Structural Requirements for Houses. . .	81-87
Durability	81
Fire Protection	82
Increased Strength Plus Reduced Weight	83
Minimum Volume Change.	84
Insulation—Thermal and Acoustical	85-86
Fabricating Economy	87
Structural Elements of Houses.	88-92
Foundations	88
Floors	89
Walls and Partitions.	90-91
Roofs	92
Modern Structural Systems.	93-106
Wood	94-97
Masonry	98-99
Concrete	100-102
Steel	103-105
Combined Materials	106

STRUCTURAL REQUIREMENTS FOR HOUSES

1. DURABILITY

THE QUALITY OF DURABILITY as applied to residential structures may be defined as their ability to resist change. It is particularly important in its effects upon maintenance. Durability is also a measure of resistance to damage by weather, fire, insects, and the results of shrinkage due to evaporation of natural moisture content.

There are current some technical and financial opinions which indicate that it may be desirable to limit the degree of durability to that necessary for a reasonable span of useful life. Economically useful life of a dwelling depends upon the type of neighborhood in which it is erected; changes in occupancy to be expected; changes in living habits which are in turn due to introduction of new types of equipment such as heating, plumbing, cooking units, and are also due to increases in leisure time which change recreational habits. At the present time there exist no evaluations of a dwelling's economically useful life which are satisfactory to all parties involved.

Durability of structures depends both on materials and on methods of assembly. Physical and chemical properties of materials may be used to advantage to resist attacks by weather, fire, and various forms of decay. An assembly's durability depends upon: 1. adequacy of materials; 2. methods of assembly; 3. workmanship.

Wood: Resistance to damage by fire may be increased by application of, or impregnation with, chemicals, with no loss of other properties except that certain treatments make "natural" finishes more difficult to apply.

Weather attacks wood by moisture and temperature changes, and is resisted by means of proper seasoning and preservatives which reduce decay, minimize volume changes, and in many

cases successfully resist insect attacks.

Preservatives are of two types: coatings and impregnations. Coatings are: 1. those containing metal leaf or powder; 2. oil paints and varnishes; 3. asphaltic, bituminous, and similar paints; 4. primers and fillers; 5. rubber cement and latex coatings; 6. waxes and glues. As an example of their effectiveness, aluminum primer on wood increases durability of succeeding coats of white lead and zinc paints from 42 to 49 months.* In tests, the increase was found to be greatest on those woods which usually hold paints least satisfactorily. Impregnations consist of chemicals such as coal tar, creosote, zinc-chloride, and mercury salts.

Masonry: Resistance to fire-damage of properly constructed brickwork is well-established. Weather resistance—permeability of brick masonry—is the subject of much research. A digest of a recent report follows.**

Workmanship affects the permeability of walls more often than any other factor. Leaks are most often through open cracks, not through mortar or brick itself. Walls with tooled joints are less permeable than similar walls with cut joints; but quality of workmanship inside walls has a greater influence than surface finish of joints.

Walls built with high-cement, low-lime mortars are slightly less permeable. Also, the use of a lime of low plasticity may produce a mortar which tends to develop increased permeability. Pargeting and brush coating with cement paint were found to reduce permeability.

Tests on walls of brick face and tile

*"The Effects of Aluminum Priming Paint on the Durability of House Paints on Wood," by Dr. F. L. Brown, Forest Products Laboratory.

**Report BMS7, U. S. Dept. Commerce; "Water Permeability of Masonry Walls," by C. C. Fishburn, D. Watstein, and D. E. Parsons.

backing showed slightly less permeability than solid brick walls. "Cavity" brick walls showed little or no leakage completely through the wall, though face and backing sections are permeable (see pages 90 and 98).

The critical consideration remains workmanship; next in order are accessories and the general assembly.

The American Society for Testing Materials is now revising its specifications for brickwork. A major factor in new specifications is to be "durability," rather than strength.

Concrete: Resistance to fire-damage of properly proportioned, reinforced, and cured concrete is high. Cinder concrete provides a high degree of heat insulation because of entrapped air cells. Weather resistance has been improved by design of mixes, vibration, and the vacuum process. Stone concrete has been found less generally permeable than cinder, both in solid walls and hollow units. Tests showed that cinder concrete required 50% more waterproofing (cement paint, etc.) because of its high porosity. New processed-slag aggregates are reported to reduce this difficulty. The vacuum process (see page 102) enables a finish coat to be made virtually monolithic with structural wall, therefore promotes greater impermeability.

Steel: Resistance to fire-damage of present types of steel is low unless it is protected. However, heat resisting steels are being developed; the possibility of these being produced economically may change building technique greatly and extend use of the material.

Corrosion of steel due to weathering is great. When protected, however, it becomes nearly permanent. Protective coatings of metal (aluminum, chromium) are now technically possible but are costly.



Courtesy H. H. Robertson Co.

Pouring cement grout fill on cellular steel floor framing, providing incombustible floor structure.

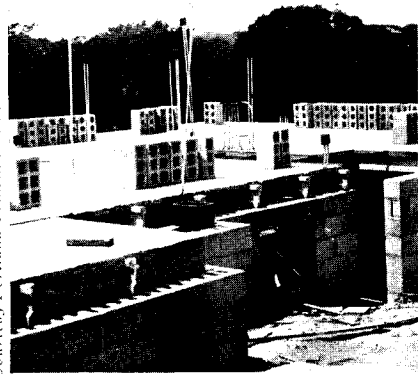

Courtesy Portland Cement Ass'n.

Concrete basement and first-floor construction provides a means of confining fires to the most common point of origin.



Courtesy Brick Mfrs. Ass'n., N. Y.

Reinforced brick floor panels between steel joists are a comparatively new development.

OF THE 10,000 deaths in this country from fire per year, two-thirds occur in private homes.* Most casualties occur before fire departments arrive; few fatalities result from burns; gases of combustion plus intense heat constitute the deadly agents.

Most fires start in basements. Usual house plans aggravate the situation, as heat and gases are baffled at the middle of the ceiling and spread laterally, increasing in pressure. Escape therefore becomes hazardous. The degree of fire resistance offered by different methods of construction varies greatly. Expense is often a major factor and the optimum of fire resistance suffers as a consequence.

Current practice indicates that certain parts of every house may profitably be made more or less invulnerable. This has resulted in establishing desirable minimum performance standards. Various constructions are evaluated by means of fairly universal standardized tests which are incorporated in most building codes. Requirements of codes are based on proper construction, and on such major factors as: hazard of occupancy, height, area; and hazard of exposure (even though 90% of fires originate within the building involved.) Although codes vary, the general overall minimum requirement for one- and two-family dwellings is that the type of construction employed be such as to withstand a one-hour fire test, except that frame construction (which may be built so as to resist one-hour tests) is entirely prohibited within the fire limits of some cities.** Fire-stops are considered of supreme importance, in preventing spread of fire through air spaces in walls, partitions, and floors.

At present, the more important and recognized minimum standards of fire resistance are reflected in the following general requirements:

1. First-floor supports are required to be of incombustible material.**
2. Basement ceilings are required to be fire-retarded, at least over and ad-

jacent to heating plants, with an assembly having a one-hour fire rating.***

3. All bearing partitions and furred spaces require fire stops, preferably of incombustible material.

4. Frame construction is generally limited in height and area, as well as location on the lot, to reduce "exposure hazard."****

5. For frame walls, exterior and interior, fire-stops are required at junction of each tier of horizontal framing. This construction serves also as a rodent barrier.

6. Header and trimmer members are located 4 in. away from chimneys and fireplaces, and the space is filled with incombustible material.*****

7. Wood structural members, supported on masonry, require "fire-cuts," and at least 4 in. of masonry between members.

8. Attached garages are considered best with no communication to living quarters. If an opening is necessary, then a self-closing metal-clad door and frame is required. Interiors of garages finished with fire-resistant materials are required by most codes.

9. Roofs are considered vulnerable elements insofar as "exposure hazard" is concerned. Such hazards are increased by congestion, therefore highly resistive roofings are preferred in many communities.

10. Opportunity is presented for new materials and assemblies to qualify as fire-resistive materials and assemblies through standard time-temperature tests. It is significant that, in general, the newer materials and assemblies which have been most widely accepted are the more fire-resistant.

*"The Deadly Guest." Technology Review. Massachusetts Institute of Technology, June, 1939.

**New York City Building Code.

***"Recommended Minimum Requirements for Small Dwelling Construction," U. S. Dept. Comm., Building and Housing Publication No. 18.

"Uniform Building Code," Pacific Coast Building Officials Conference, Los Angeles, California.

"Building Code," National Board of Fire Underwriters, New York City.

****New York City Code, National Board of Fire Underwriters.

3. INCREASED STRENGTH PLUS REDUCED WEIGHT

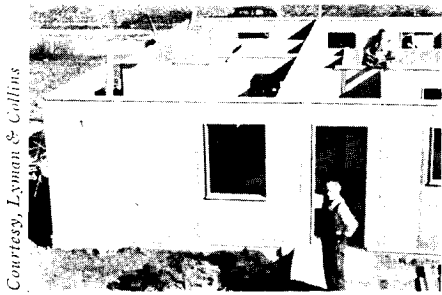

Courtesy, Lyman & Collins

Use of plywood in frame construction has led to design of extremely light structural members, particularly when panel systems are employed.

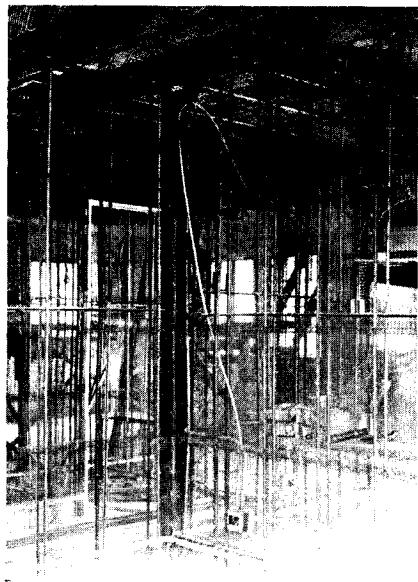

Courtesy, Metal Lath Mfrs. Assn.

Use of metal lath systems and stucco or plaster permits decrease in wall or partition thickness.

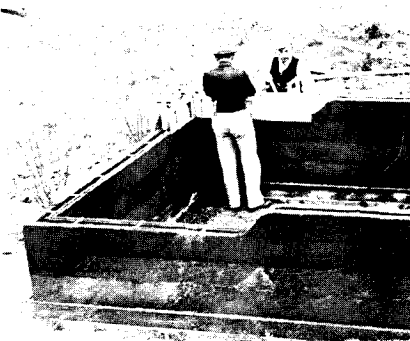

Courtesy, Hellige Conc. Wall Mold Co.

Two 4-in. membranes, of concrete or masonry, with a 2-in. air-space between, form walls adequate for strength, reduced in weight, and less permeable to moisture.

LOADS DEVELOPED in residential construction are normally so small that if structures are designed for strength alone they may lack resistance to collapse. This is highly important because at present it is possible to use less material in a structure without impairing its strength, a condition which may introduce difficulty in securing adequate insulation, thermal and acoustical.

Standardization. Tests: General acceptance of standard tests* for strength, stability, etc., tends to expedite acceptance of tested materials and assemblies.

Lumber:** American Lumber Standards** recognize certain nomenclatures, basic grades, seasoning standards, sizes, grade markings, and inspections; and have resulted in economical use of material through: increased allowable working stresses***; uniformity of specific sizes; exact grading of structural material; and availability of standard material. Rapid development of glues and gluing techniques may greatly extend use of wood, and may alter building techniques. Further development of metal framing connectors may also affect framing methods.

Mortars**:** Improvements in manufacture and in knowledge of how to combine materials has permitted use of increased working stresses.

Concrete: Increased knowledge of its characteristics has made the use of concrete more satisfactory than was formerly true. Finer and more uniform cement, general use of low water-cement ratios, physical treatment through vibrating and vacuum processing, and better curing methods, all tend to improve its desirable properties. Conse-

quently some building laws assign increased allowable stresses to "controlled" concrete.***** "Lightweight" concretes are also available*****.

Masonry: Recent tests on masonry materials, made by the U. S. Bureau of Standards, show that its properties may be greatly influenced by changes in masonry units, or mortar; and demonstrate that inferior workmanship may reduce compressive strength as much as 40%; also that structural clay tile laid with webs vertically, and with good workmanship, develops compressive strength approximately 45% greater than when webs are laid horizontally. Tests have likewise shown that 8-in. stone-concrete hollow blocks, laid in lime-cement mortar with good workmanship, may develop an ultimate compressive strength of nearly 40,000 lb. per sq. ft.

Steel: Besides increased allowable working stresses, welding techniques permit additional economies, as gross sectional area of members (rather than a net area) is available to resist stresses. American Iron and Steel Institute, realizing possibilities for steel residential construction, is conducting research looking toward extending use of steel.

* "Lumber," Simplified Practice Recommendation 16-29, U. S. Dept. Comm.

** "Wood Handbook," prepared by Forest Products Laboratories, U. S. Dept. Agriculture.

*** "Wood Structural Design Data," National Lumber Manufacturers' Association, Washington, D. C.

**** National Lime Association; Report BMS7, U. S. Dept. Commerce; and National Clay Products.

***** American Concrete Institute Code Uniform Code

New York City Code
"Ordinary concrete" = 1 part cement plus 7 parts (fine and coarse) aggregate and at most 8½ gal. water, which should develop 2000 psi as an ultimate, but this concrete is assigned an allowable working stress of only 400 psi. "Controlled" concrete is assigned an allowable working stress of .40 fc (i.e., 40% of ultimate developed in test).

***** Haydite, Porete, Pottisco aggregate, etc.

ROOF LOADS

	Rise less than 4"/ft.	Rise 4-12"/ft.	Rise more than 12"/ft. (wind normal)
U. S.*	30 #/sq. ft. (horiz. proj.)	20 #/sq. ft. (horiz. proj.)	20 #/sq. ft.
Underwriters**	30 " " " "	20 " " " "	20 " " "
Uniform***	20 " " (plus snow)	20 " " " "	15 " " "
N. Y. C.****	40 " " (3" max. rise)	30 " " (3-12" rise)	20 " " "

All codes require 40 #/sq. ft. L.L. for roofs used as floors.

WIND LOADS (Pressure normal to surface)

U. S.*	No specific recommendations; proper framing, bracing, and tying emphasized.		
Underwriters**	15 #/sq. ft. (walls under 40 ft. high)	30 #/sq. ft. (walls over 40 ft. high)	
Uniform***	15 " " " "	20 " " " "	60 " " " "
N. Y. C.****	Neglected for walls under 100 ft. high		

All codes permit increase in allowable working stresses of 33⅓% for combined live, dead, and wind loads.

* "Recommended Minimum Requirements for Small Dwelling Construction," U. S. Dept. Comm.

** "Building Code," National Board Fire Underwriters.

*** "Uniform Building Code," Pacific Coast Building Officials' Conference, Los Angeles.

**** New York City.

4. MINIMUM VOLUME CHANGE



Courtesy Oregon-Washington Plywood Co.

Installing plywood so as to minimize shrinkage effects. (See pages 90 and 96)



Courtesy Portland Cement Association

Weakened plane joints accommodate concrete shrinkage.

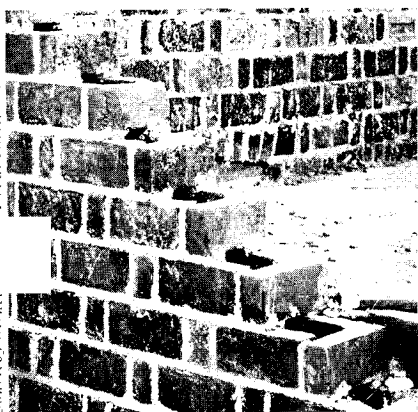

Courtesy Shred Prod. Inst., Inc.

Formulation and workmanship affect mortar shrinkage.

ALL MATERIALS of construction undergo some volume changes. These may be due to one or both of two principal causes: variations in temperature, and variations in moisture content. Effects of volume change are of major importance when various materials are combined into an assembly since different materials react differently.

Minimizing moisture changes: The British Building Research Station* has made a general classification of materials relative to changes in volume. Their findings, coupled with those of various American organizations** may be summarized as follows:

1. Materials which must be wet before use undergo greatest volume change during initial drying stages. Subsequent changes are estimated to attain only 50% (average) of the initial change. It follows that such materials as concrete and plaster should preferably be cured slowly or under carefully controlled conditions, to permit materials to shrink uniformly, without setting up severe internal strains. Reinforcement adequate to resist such strains is important.

2. Porosity of material used in exposed places is important, because alternate wetting and freezing will cause expansion and contraction.

3. Ventilation increases evaporation of moisture, particularly in "unexcavated spaces," regardless of type of construction. F.H.A. recommends 2 sq. ft. of ventilating area for each 25 lineal feet of wall.

U. S. Forest Products Laboratory is investigating the practicability of impregnating wood with phenolic preparations in attempts to reduce moisture changes. The National Bureau of Standards, U. S. Dept. of Commerce,*** has issued reports on accelerated aging tests of various fiberboards to determine whether their initially satisfactory prop-

erties (strength, rigidity, insulation, density, permeability to water and air, and nailholding ability) are retained in use. Performance of proprietary fiberboards was found to vary. Water resistance was found to be the most changeable property, and finished or surfaced boards were found to have lower rates of expansion due to moisture penetration.

Shrinking of mortars in masonry has been investigated, but satisfactory conclusions have not yet been reached by all participants. A ratio of cement to lime of 1:1 is recommended for general use by the Brick Manufacturers' Association of New York (see page 98).

Concrete shrinkage is susceptible to a degree of control by reducing water content of the mix to the minimum necessary for hydrating the cement, as in vibration and vacuum processes.

Construction methods designed to accommodate moisture changes: Techniques for conventional wood framing have been developed by many agencies and are too generally available to need review here. Proper seasoning of framing timber, in accordance with Lumber Standards referred to on page 83, is of prime importance.

Concrete may be treated, in addition to proper reinforcement and curing previously noted, by providing "weakened plane joints," horizontal or vertical, at which points shrinkage cracks are designed to occur.****

Thermal changes can be accommodated by selecting (for combination) materials having similar coefficients of expansion; and by designing structures to expand and contract automatically without danger. Findings* may be summarized as follows: 1. Temperature changes may be slow, seasonal (summer to winter); or rapid fluctuations which take effect in a few hours. Slow changes have the greater range, but to these buildings seem to be able to accommodate themselves by "creep," or gradual redistribution of mass. Rapid changes may cause damage.

2. Damage occurs when movement is restrained, especially when parts of a structure are heated unequally.

3. Greatest exterior thermal expansion occurs when material is normal to sun's rays.

*"Principles of Modern Buildings," by R. Fitzmaurice, Bldg. Research Station, Dept. Scientific & Ind. Research, London, England.

**"Volume Changes in Brick Masonry Materials," U. S. Dept. Comm. Research, Paper No. 321.

"Minimizing Wood Shrinkage & Swelling," by Alfred J. Stamm, Sr. Chemist; "Chemical Seasoning of Douglas Fir," by W. Karl Loughborough, Sr. Engineer; "Minimizing Wood Shrinkage & Swelling," by Alfred Stamm & L. A. Hanson, U. S. Dept. Agr. Forest Products Laboratories, Madison, Wis.

"Moisture Content of Wood in Dwellings," by Ed. C. Peck, U. S. Dept. Agriculture, Circular No. 239.

***Reports BMS 3, 4, and 13, Bureau of Standards, U. S. Dept. Comm.

****"Weakened Plane Joints," Architectural Concrete, Vol. 5, No. 1, Portland Cement Association. "Experience with Weakened Plane Joints," by T. C. Kistner, "Architectural Concrete," Vol. 5, No. 2, Portland Cement Association.

5. INSULATION—Thermal and acoustical



Complete stoppage of air infiltration is necessary; it may be achieved, as here, by using plywood sheathing plus attention to detail at openings.

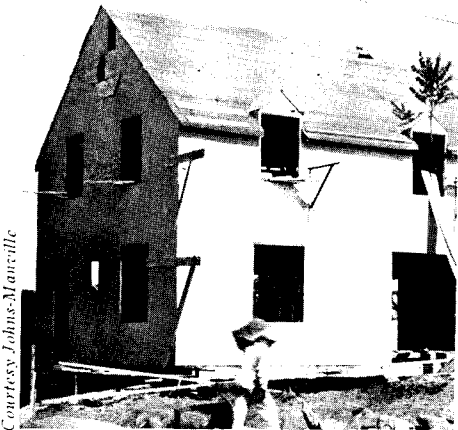

Fiberboard sheathing may be used to obtain insulation and also stoppage of air infiltration.



Tacking-flanges on wool-batt and reflective-metal types of insulation simplify installation.

THERMAL

DETERMINING the economic value of insulation is largely a matter of balancing heating fuel savings against insulation costs.* Savings on fuel have been variously estimated at from 15 to 60%. Other factors include the possibility of installing smaller heating units; possible increases in summer and winter comfort; and the necessity of insulation for satisfactory performance of air conditioning.

A great proportion of winter heat losses are due to air leakage resulting from loose construction, and from cracks at openings and joints. Hence tight cornices, firestops, pointing and caulking, weatherstripping, careful jointing, lapping building papers, and tight construction around openings are all important. Plaster and heavy building papers form good wind insulation; paper should be lapped 3 in. but not necessarily sealed at joints.**

Heat losses through glass (for a typical exposed wall, 1 5 glass) may average 20 to 35% of total heat loss. Large glass areas render wall insulation useless**. For example, glass constituting over 1 3 of the area of a wall makes wall insulation unjustified economically for brick walls 8 in. thick. Storm windows, and double and triple glazing, are found to cut winter heat loss through glass almost in half. However, such precautions do not eliminate summer insolation; for this purpose, heat resisting glass is available.

The remainder of heat losses are transmitted by conduction and convection through materials of assembly, amounts depending on coefficients of conduction of materials and assemblies. A dead-air space is one of the most efficient insulators against conducted heat. Dryness is a factor since thermal values are reduced when insulations are wet. "In general, the lighter the material per unit of total volume, the better its insulating value per inch of thickness."* Ventilation of attic space is important; 12½ sq. in. of free opening (cross-ventilation) per 100 sq. ft. of ceiling area is found satisfactory for summer insulation and removal of condensation in winter. Insulation and vapor barriers placed in attic floors are considered most efficient. Insulating materials show increased efficiencies up to 33⅓% when used in center of an air space. In selecting insulating material, utility,

durability, insulating efficiency, ease of application, thickness, weight, fire-resistance, resistance to moisture, and economy are factors for consideration.***

Condensation **** (accumulation of moisture or ice on interior wall surface in winter, occurring in walls, roofs, and exposed floors) is most severe in regions where temperature changes are greatest, and is most often noticed on roofs and attic floors in leaks or stains. Presence of condensed water vapor in a structure is a result of differences of relative humidities caused by the extreme temperature variations between inside and outside air, and may be caused by improper installation of insulation. Modern structures have high interior humidities in winter, and in general resist free passage of water vapor, which condenses on the colder outside wall surfaces. In many assemblies these offer great resistance to vapor.

Vapor Barrier: Movement of water vapor is independent of air movement; vapor flows from high to low vapor pressure areas, or from hot to cold. Vapor pressure will pass through materials which are dense, highly wind-resistant, and moisture-resistant. Condensation cannot occur within walls or roofs unless vapor pressure can penetrate from the warm side to the region, within the construction, where the dew-point temperature of the air within the wall exists. A vapor barrier on the warm side of the wall or roof is therefore the best solution.

The fault of many types of construction has been that vapor resistance of outside sections of walls has been greater than that of inside sections; to correct this, efficiency of the cold-side barrier may be reduced and vapor resistance on the warm side increased.

Materials for vapor barriers, for placement at inside face of studs:

1. Asphalt-impregnated, surface-coated, glazed building paper, lapped (3-in.) but unsealed joints;
2. Asphalt-laminated sheathing paper;
3. Double-faced reflective insulation;
4. Aluminum paint in two coats (on inside surface of plaster);
5. Oil paints (less efficient than above);
6. Reflective metal barriers .0005 in. thick when used inside a second insulation;
7. Heavy continuous layer of asphalt;
8. Vapor-sealed insulation materials;
9. Phenolic resin glues (as in plywoods).

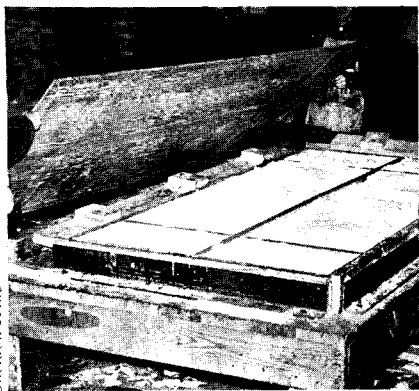

Sheldon Hine

Prefabricated panels packed with loose mineral-wool insulation.

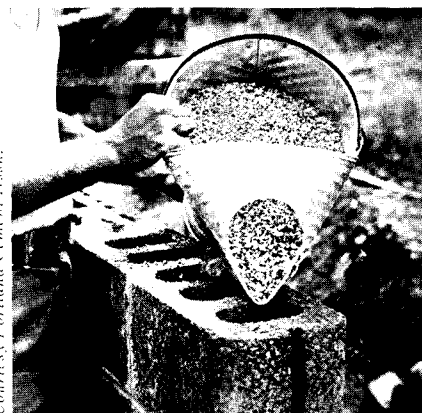

Courtesy Portland Cement Assn.

Pouring mineral-pellet insulation in hollow-block walls.

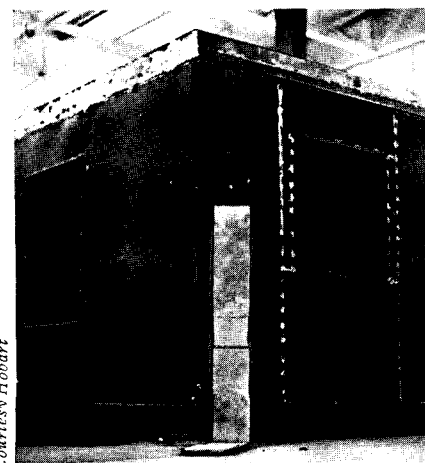

Courtesy Hobart

Prefabricated, welded-steel house insulated both thermally and acoustically at the factory.

Non-vapor-sealed rigid insulation used as outside sheathing is so permeable to water vapor that its use reduces condensation. The air space in such walls, convection currents, and slight venting through joints will tend to relieve dampness which might occur temporarily under adverse conditions. Rigid board used as a plaster base may have a vapor barrier incorporated in it, but under average conditions its high permeability permits it to act alone, *providing* the structure of the wall beyond is equally permeable.

Building paper on outside of exterior sheathing used in combination with vapor barrier is preferably not a vapor barrier itself. Sheathing paper may be omitted where a vapor barrier is used provided adequate wind resistance is provided by the remainder of the structure.

ACOUSTICAL

This subject**** is increasing in importance because: 1. More mechanical equipment, with its accompanying noises, is installed in the average house; 2. The actual weight of the structure is being reduced. Location of the house, whether suburban or urban, determines noise levels which may be comfortably tolerated, which in turn dictate the degree of insulation desirable or required. Street noises are often predominating factors.

Object of sound control, generally speaking, is to reduce amount of sound reflected and to eliminate transmission; these facts often result in two different and, at times, separate problems: 1. *Exclusion* of exterior sounds; and 2. *Absorption* of interior sounds.

The problem is made complex by reason of the fact that sound may be reflected, absorbed, and transmitted. Acoustical agents are designed to:

1. Reduce amount of reflected sound to such an extent that the time of reverberation is acceptable. The efficiency of such an agent depends, to a great extent, upon its texture (smooth or rough) and density (hard or soft).
2. Absorb reasonable amounts of sound so that the amount of reverberation is

reduced to a comfortable level. Complete absorption would produce a "dead room" which is undesirable in some cases as "some reflection is necessary to reinforce properly the sound source." (Example, in a kitchen, bedroom, etc., it is desirable to have maximum absorption, while in living room, etc., it is desirable to have less efficient absorption of sound). The efficiency of such an agent depends on its density and thickness.

3. Eliminate transmission of sound to a practicable degree. Sound energy which is not reflected or absorbed will be transmitted; therefore, transmission will be small if reflection or absorption is great. The efficiency of such an agent depends upon its density and elasticity.

From the above facts it may be concluded that:

1. Walls and floors approximately homogeneous may need to be excessively heavy to be good insulators, as definite relationship has been established between the weight of homogeneous walls and their "sound-reduction factors." This relationship is "that the reduction factor increases roughly in direct proportion to the logarithm of the weight (per unit area) of the wall."
2. When walls and floors are built in layers loosely connected, sound-isolation properties are greatly improved. Elimination of direct contact, to the greatest possible degree, of various parts of the assembly (staggered studs and joists) is one means.
3. Small openings may completely destroy the insulating value of an assembly. Therefore, methods of construction are more important, in some cases, than the nature of materials used.

*Bulletin No. 376—U. S. Bureau of Standards.
 **"Air Infiltration Through Various Types of Wood Frame Construction," Larson, Nelson, and Braatz. ASHVE Journal, June, 1930.
 ***"House Insulation"—Report of National Committee on Wood Utilization, No. 19.
 ****"Preventing Condensation . . . etc.," Rogers, AR 3/38.
 "Condensation . . . etc.," Teesdale, Forest Products Lab., 1937.
 "Condensation . . . etc.," Rowley, Algren, and Lund, ASHVE, 1/38.
 *****"Building Materials and Structures," Report BMS17, U. S. Dept. Comm., by V. L. Chrisler.
 "Theory and Use of Architectural Acoustical Materials," by the Acoustical Materials Association.
 "Acoustics of Buildings," Prof. F. R. Watson, University of Illinois.
 "Principles of Modern Building," Building Research Station, His Majesty's Stationery Office—London, England.

6. ECONOMY OF CONSTRUCTION

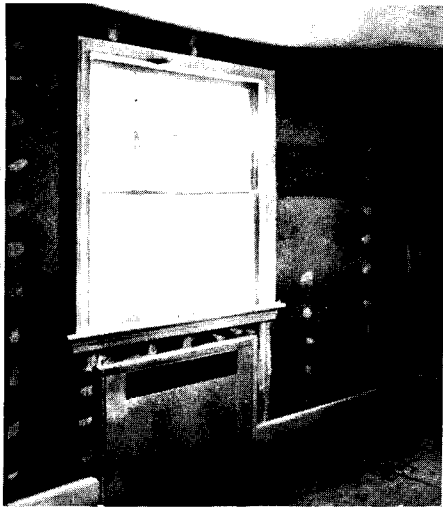

Dagton Snyder, courtesy Oregon-Washington Plywood Co.

Use of standard sizes and large-unit materials permits mass-production economies with conventional systems.

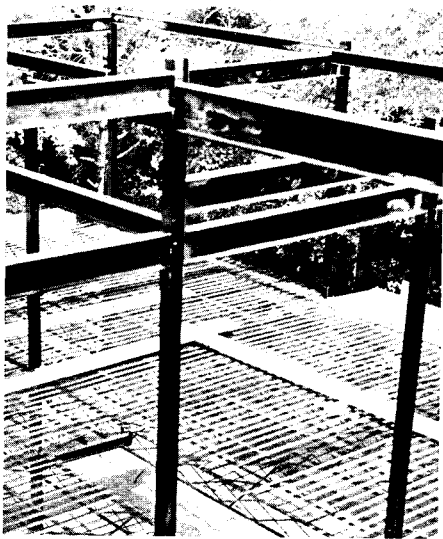

Courtesy Metal Lath Mfgs. Assn.

Many proprietary systems consist of curtain walls and isolated supports.

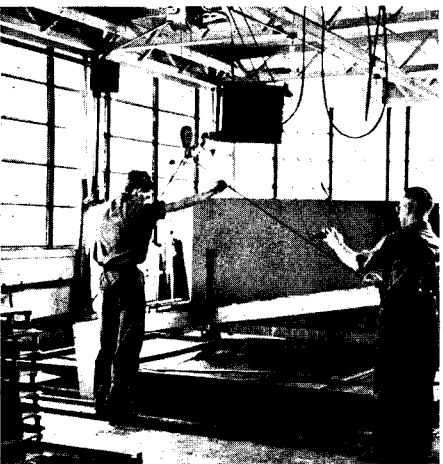

Courtesy Hubart

Complete prefabrication may achieve maximum savings.

STRUCTURAL ECONOMIES may be achieved by reducing quantities of materials required, by eliminating waste of material, and by reducing construction time. The first factor is discussed on pages 81 and 83. Elimination of wasted time and material remain as the factors probably most susceptible to improvement. Three trends in construction techniques are particularly noteworthy.

Dry construction involves elimination of building materials which require wetting before use, and may result in valuable time-savings. The U. S. Forest Products Laboratory* estimates that, in the average six-room house, 1000 gals. of water are used in plastering, and must be evaporated before the house is ready for interior finish. Saving of this and other obvious time-losses, such as those incurred when freezing weather causes suspension of "wet" building operations, are recognized as desirable. There remain many situations in which dry construction is unsuitable. For instance, few cases exist when masonry or concrete foundations can be eliminated, although at least one steel structural system uses driven steel columns (page 105).

Usual construction types called "dry" consist of sheet surfacing materials applied in large units to supporting members, and replacing both sheathing and interior wall and ceiling finish; often replacing subfloors. Materials used include plywoods, plasterboards, fiber (or "insulating") boards, and steel. Special techniques of joining the sheets are necessary to prevent cracking interior surface finishes; or joints may be recognized and incorporated in design of surface treatment. Further extensions of dry construction principles make possible exterior wall and roof surfacing in large units, as of plywood.

The need of accommodating initial shrinkage of wet materials (page 84) presents an argument in favor of the use of precast unit materials, such as precast concrete slabs and joists, which eliminates handling of most wet mate-

rials on the job. Vibrated concrete, which permits use of dry mixes, and the vacuum concrete system**, which removes water from mixes so rapidly that drying-time loss is minimized, are other developments in the direction of dry construction.

Standardization of parts*** for residential construction has been to some extent achieved, and is increasingly apparent. It results not only in reduction of time and material waste, but in many cases improves quality. Use of materials pre-cut to size may eliminate waste almost entirely, simply and expedite construction. Use of shop-assembled units permits more exact fitting (as with windows and doors), thus making possible greater accuracy and quality of workmanship than if work is performed at the site, often under adverse conditions. Most of the structural systems noted on pages 93 to 106 make use of some degree of standardization.

Modularity, or the principle of designing in relatively large, repeated, similar units, has been discussed at some length in the previous 1939 Building Types residential study (May). Use of construction modules may be applied to house structural systems as a result of the use of standardized parts or units. Use of large sheet units, as in dry construction methods, introduces, if maximum economies are to be obtained, a degree of modularity. Construction modules in actual use at present range from standard brick sizes, stud spacings, etc., to sizes of large sheet surfacing materials, preassembled window and door units, and in some cases entire construction systems.**** Modularity thus is seen to be a means of realizing the economies inherent in both dry construction methods and use of standardized parts.

*"Wood Handbook," U. S. Forest Products Laboratory, and various industry publications.

**Portland Cement Ass'n; Vacuum Concrete Corp., N. Y. C.

***See also FHA Technical Bulletin No. 1, on fabricated materials and units, and factory production methods applied to house construction.

****As for instance, structural "engineering" of houses as accomplished by "Precision-built" homes (The Homasote Co.).

STRUCTURAL ELEMENTS OF HOUSES

Ways in which the advances previously noted affect
foundations, floors, walls, partitions, roofs

FOUNDATIONS



Courtesy Portland Cement Ass'n.

WHILE FOR THE average house some excavated basement space may be necessary, in many cases excavations may be reduced to a minimum, or (as in recent "low-cost" experiments) entirely omitted. However, the house structure requires protection from dampness, frost action, and insect attacks.

Protection from dampness: Exact methods depend on local conditions, and are too well known to need repeating. Wood floor structures require ventilating space beneath them; F.H.A. recommendations are noted on page 84.

Frost-action has been studied by Prof. Baumeister of Columbia University (and others), with a view to eliminating the need for trench walls under floor slabs laid directly on earth. Methods of control evolved include: 1, provision of adequate slab reinforcing, which may be uneconomical, and which may transmit damage to the superstructure; 2, use of footings extending down to frost line (present general practice); and 3, provision of a trench filled with porous material (such as coarse gravel)

around the slab perimeter. The latter method has not been extensively applied; its object is to provide a place in which moisture can collect and freeze without causing damage.

Decay and insect or rodent attacks may be forestalled by using metal termite shields between foundations and wood sills, by using chemically treated or naturally resistant lumber (cedar, redwood) in exposed positions, and by impregnating soil around foundations with chemicals, such as sodium fluoride, which form heavy repellent or destructive gases upon contact with soil-moisture. Various authorities recommend use of from 2 to 6 in. of cinder concrete over partially excavated areas under floors.

Floor treatments to increase comfort are discussed on page 89. *Soil capacities* have no great effect upon the average house structure designed and built in accordance with current standards of good practice. However, reinforcing may be used in footings where unequal bearing strengths are suspected.

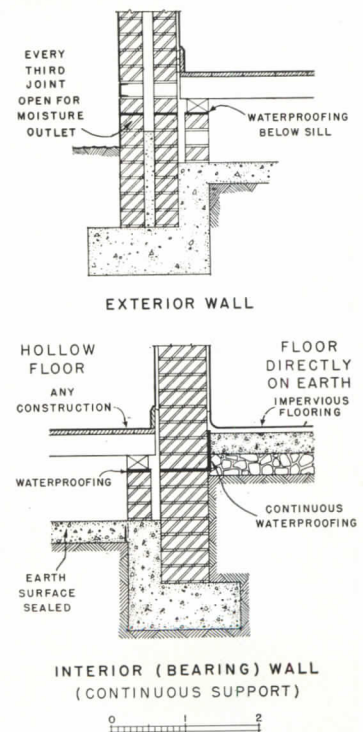

Adapted from "Principles of Modern Building"

Methods of eliminating the penetration of dampness from footings.

FLOORS PLACED directly on or close to earth require resilient flooring, such as wood finish on sleepers, if maximum comfort is to be maintained; effects of moisture penetration may cause structure damage. For this reason, water-resistant finishes such as asphalt tile are more common. Coldness complained of in such cases may be offset by incorporating panel floor heating, or uncovered heating mains, in the construction; by venting partial excavations to warm basement spaces; or by insulating the construction.

Wood: Two newly evolved methods of wood floor construction are claimed to offer substantial economies and adequate strength and rigidity. First developed by the Forest Products Laboratory, and since adopted by others, is the "box-girder" type, consisting of comparatively shallow, widely spaced framing members (2 by 6 in.) faced top and bottom

with plywood "stressed skins". The entire construction acts as a unit, confining deflections to safe limits. The "Palisade" type of floor illustrated below has also been developed for wall construction (see also page 94).

Masonry: Use of reinforced brickwork for panels between steel or concrete joists has been confined to relatively few applications.

Concrete: Use of precast concrete joists is illustrated below. Precast slabs are not in common use and apparently offer few economies; but use of vacuum concrete principles (p. 102) offers substantial time and material savings.

Steel: Various patented floor assemblies, such as "Robertson" floors, have been available for some time. Steel joists, particularly if protected by masonry above and plaster below, offer obvious fire-safety.



Olsen, courtesy Metal Lath Mfrs. Assn.

Type of floor construction used in the Lurie (metal-lath) construction system, essentially a concrete floor on steel joists; but use of expanded metal lath spread across joists eliminates need for forms. Concrete used is moderately dry; droppings are said to be negligible.

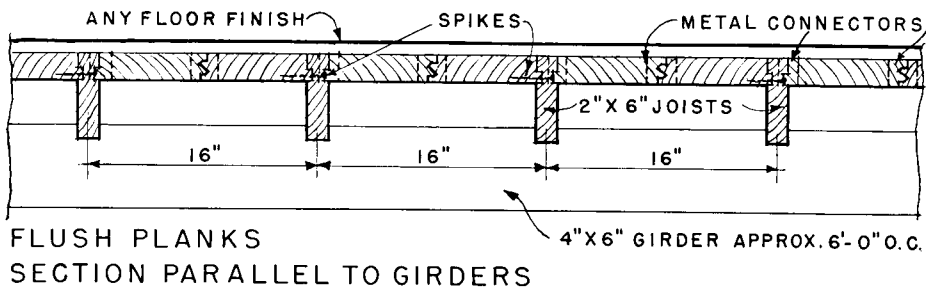

FLUSH PLANKS
SECTION PARALLEL TO GIRDERS

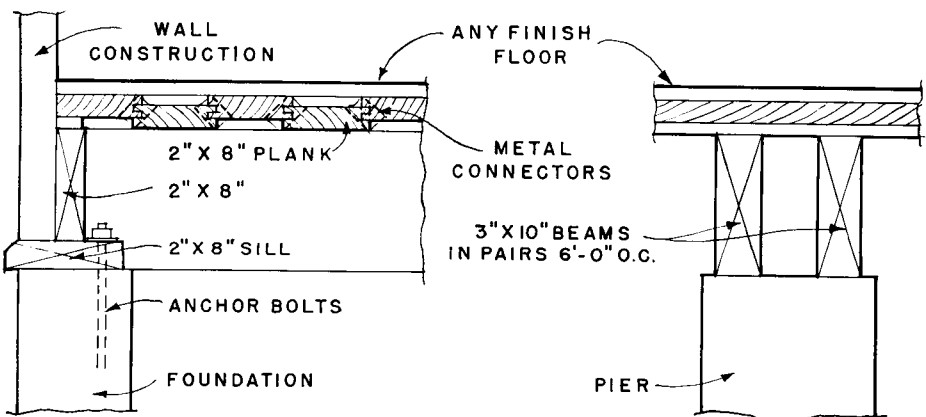

STAGGERED PLANKS
SECTION PARALLEL TO GIRDER

SECTION
ACROSS GIRDER



Courtesy Portland Cement Assn.

Precast concrete beams and field-cast floor slab

Details at left show principles of "Palisade" plank floor construction now being tested, with satisfactory results forecast. F. H. Alcott, consulting engineer in New York, controls patents.



Exterior walls consisting of sliding screens, interior walls consisting of sliding and folding sections, permit a maximum of flexibility and are supported by post-and-lintel construction. Wood columns are built up of small pieces (Antonin Raymond, architect).

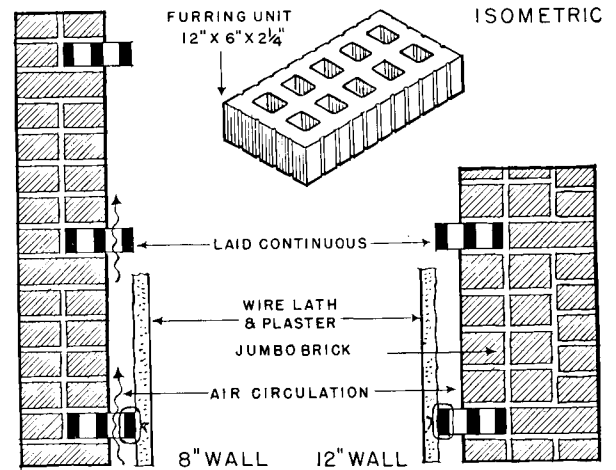
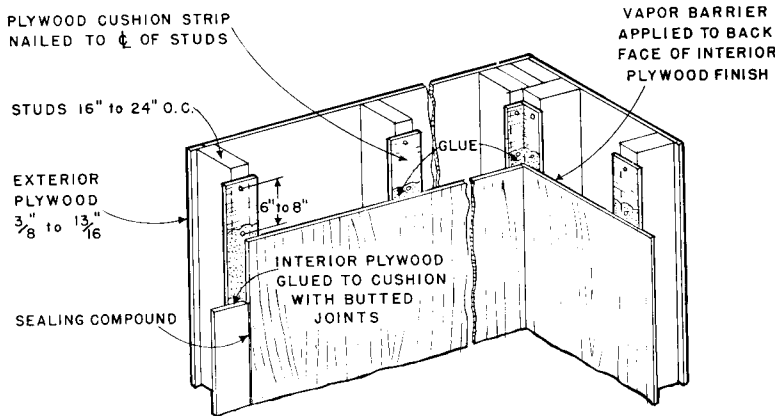

Plywood wall construction as recommended by U. S. Plywood Corp.: Interior plywood is glued to cushion strips, whose face grain runs at 90° to face grain of finish plywood. Cushion strips are wire-nailed to center lines of studs; effect of expansion and contraction of framing is thus said to be minimized. Interior plywood is shoved into place. Joint-sealing compound is similar to painters' "Spahkle"; vapor barrier may be asphaltum. Walls may be painted, or papered over felt-paper base. Edges of exterior resin-bonded plywood sheets are resin-primed; joints may be $\frac{3}{8}$ in. open and sealed with mastic. Houses erected a year ago with similar interior finish show remarkably few cracks visible through interior paint (A.R., May, 1938, pp. 93-95).

Furring for interior or exterior finish on solid masonry walls is necessary but time-consuming. Illustrated is one of several self-furring units for building-in, to which lath may be directly attached without need for furring strips.

Wood: Various types of dry construction, such as "Dri-bilt", "Uniwall", etc., have been developed. Use of plywood is the principal, and limiting, characteristic. It is claimed that, since plywood used as sheathing increases strength of conventional wood-stud wall assemblies, stud spacings may be increased beyond the normal 16 in.* Newest development in this field is a means of securing non-cracking interior joints, illustrated on page 90. Important are design of framing to minimize cross-grain shrinkage, and use of lumber whose moisture-content approximates average natural air moisture-content of the locality where the house is built.

Masonry: Emphasis on cavity brick walls is perhaps the newest development. Methods of waterproofing are shown below; discussion of brick systems is contained on pages 98 and 99. In use of terra-cotta back-up tile, increased strength (for bearing walls) of tile laid

*U. S. Bureau of Standards tests found 9 by 14-ft. stud panels with glued-on 3/8-in plywood 1/2 again more rigid than diagonal-sheathed, lathed-and-plastered panels, and 1/3 stronger in compression.

with webs vertical should be borne in mind. However, the problem of workmanship remains; joints ought to be filled with mortar having a minimum of shrinkage and maximum of impermeability. Waterproofing treatment may be required on the wall's inside face. There are available types of grooved or keyed blocks, which are claimed to reduce water penetration substantially.

Concrete: Most significant advance is development of vacuum treatment, which has been noted previously and is described on page 102.

Steel: Use of widely spaced steel supports and curtain walls of Gunitite or plaster on metal lath (Lurie system, page 106) is claimed to offer substantial savings. Panel and sheet-metal methods have been used for some years; some types of sheet finishes show characteristic "waves"; others are molded crimped, or corrugated to minimize this difficulty.**

**As in the Le Tourneau "floating" houses, Tennessee Coal and Iron Company's houses for Farm Resettlement Administration, etc.

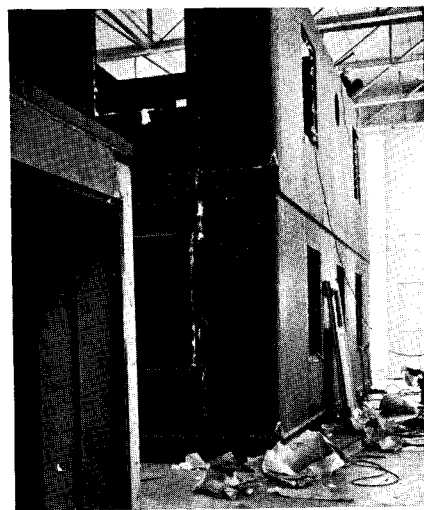

Courtesy Hobart

Walls of sheet steel are used in some prefabricated systems, as in these Hobart all-welded houses.

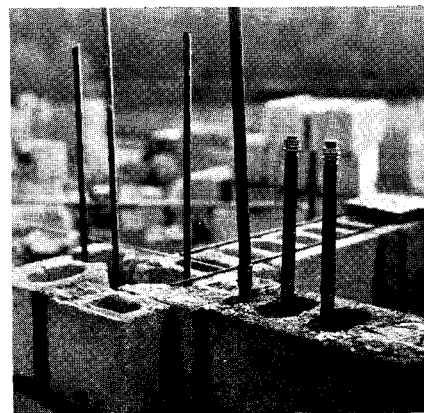

Courtesy Portland Cement Assn.

Making use of interstices in hollow block as pipe and conduit chases.

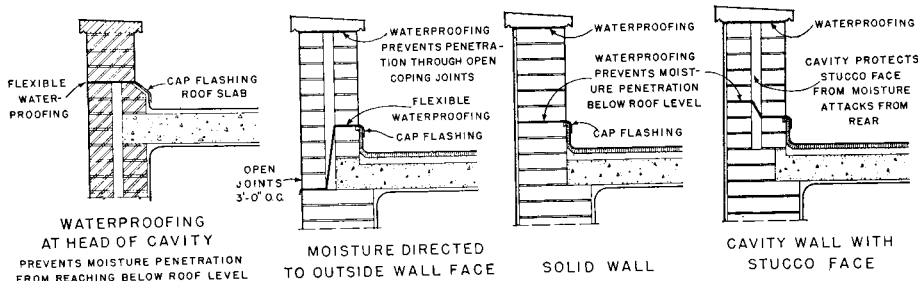

PARAPET CONSTRUCTION

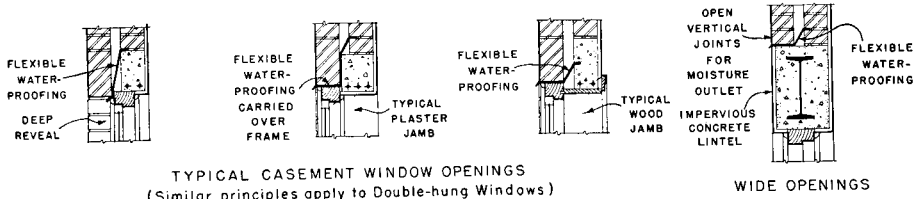

HEADS OF OPENINGS

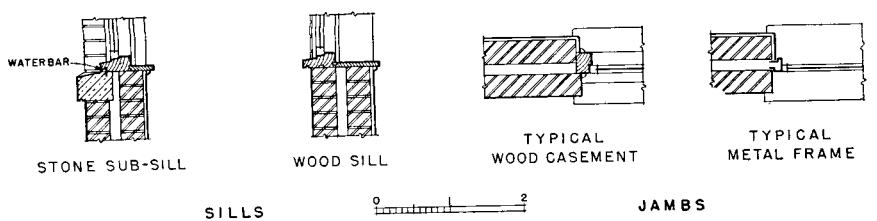

Methods of dampproofing brick walls, as approved by the British Building Research Station, Department of Scientific and Industrial Research, London.

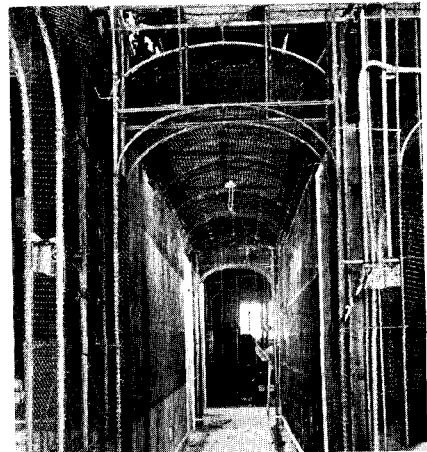

Photo by Olsen, courtesy Met. Lath Mfrs. Assn.

Metal lath and lath channels used in thin single or double partitions decrease both weight and space necessary.

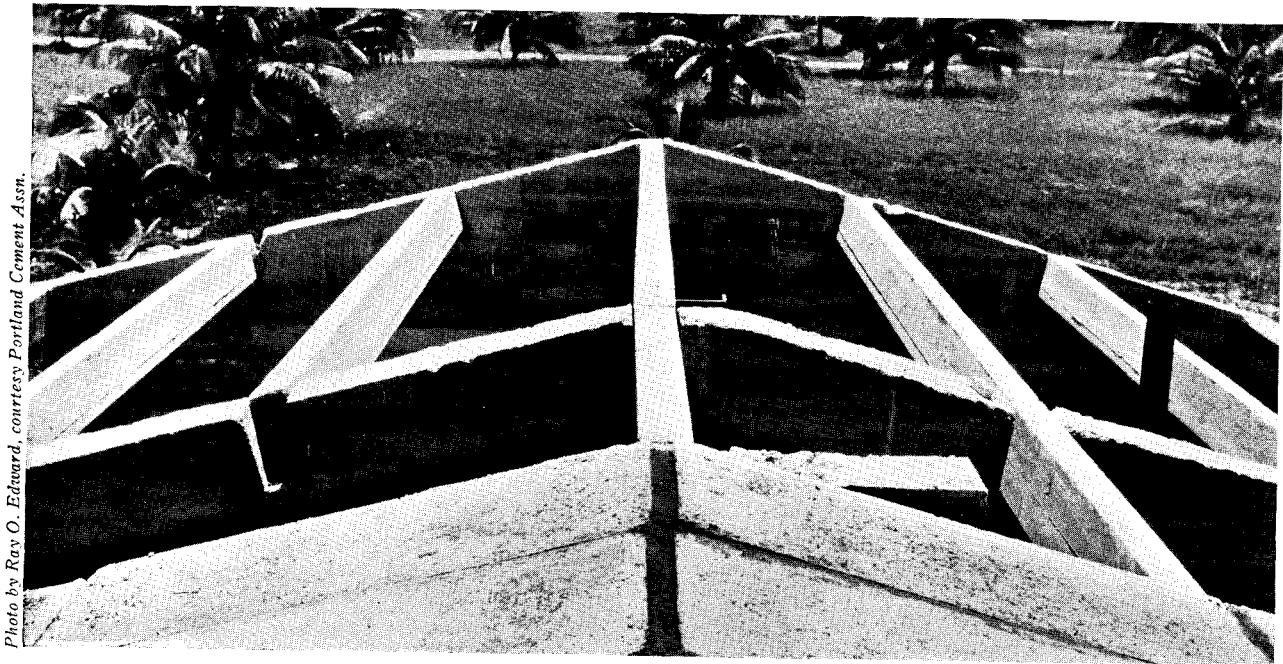
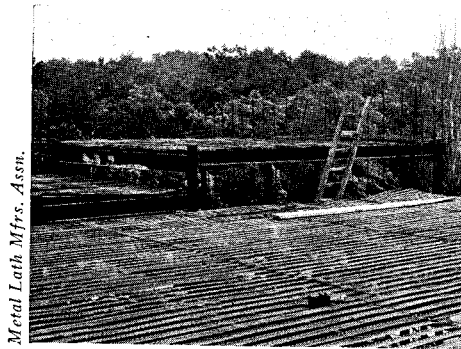

Photo by Ray O. Edward, courtesy Portland Cement Assn.

Precast concrete joists and slabs used for roofing: The Portland Cement Association recommends a more positive method of joining slabs to joists than the mortar joints here shown. Unless slabs are vibrated sufficiently to achieve maximum density and waterproofness, additional covering may be needed.



Metal Lath Mfrs. Assn.

Metal lath (Lurie system) used as forms and reinforcing for flat concrete roof: process is substantially similar to floor construction illustrated on page 89.

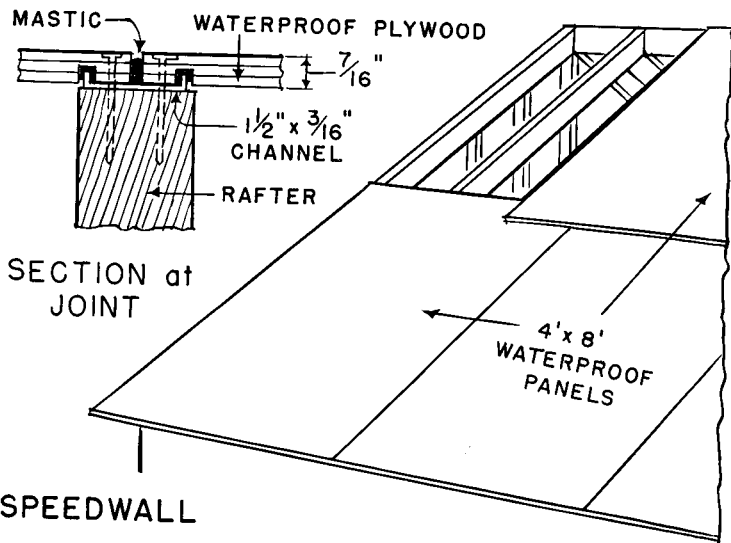

Method of using plywood for finished roofs, developed by originators of "Speedwall" dry-construction system.

PROTECTION from fire, moisture, and summer heat (or loss of winter heat) are important functions of a roof. Fire-resistant surfacing materials have been developed; wood-shingle manufacturers claim that straight-grained red-cedar shingles properly laid are rot-resistant and resistant to curling, hence are more fire-safe in that flying embers find no chance to lodge and start fires. Moisture-resistance depends

upon proper laying and flashing of roofing materials. Since roof loadings are comparatively light, structure necessary is commonly quite thin; this makes for a need of insulation. It is significant that even in houses where designers considered side-wall insulation to be uneconomical, roof insulation was installed (see particularly the plywood house on pages 96 and 97, and the vacuum-concrete house on page 102).

MODERN STRUCTURAL SYSTEMS

TIME-SAVER DATA on recent developments in systems of residential construction which make possible more economical, and at the same time more durable, structures



Robert W. Tebbes



Samuel Gottsche

1 and 2



3

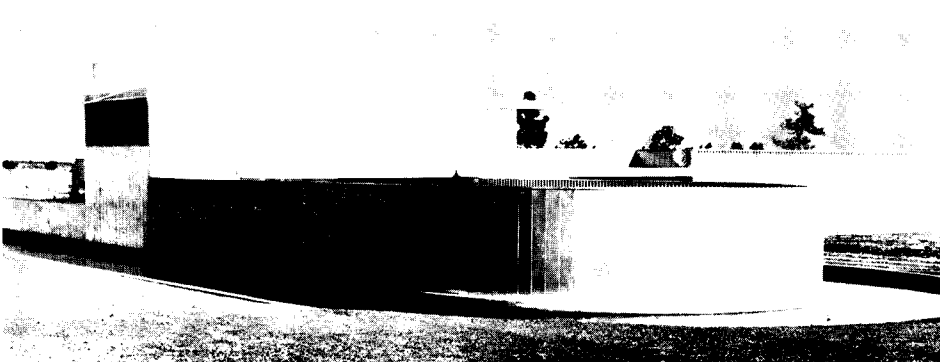

4

Courtesy H. H. Robertson Co.

Photographs: 1, typical wood-frame house in Westfield, N. J., Raymond O. Peck, architect. 2, brick house in Riverdale, N. Y., development, Dwight James Baum, architect. 3, monolithic concrete house for J. L. Shakely, Tulsa, Okla., F. H. Mattern, designer. 4, all-steel house for Joseph Von Sternberg, Chatsworth, California, Richard J. Neutra, architect. 5, combination of reinforced concrete and steel frame, pre-cast block exterior walls, and stud partitions, Wellington W. Cummer, architect, Jacksonville, Fla.



5

Buckingham Studio

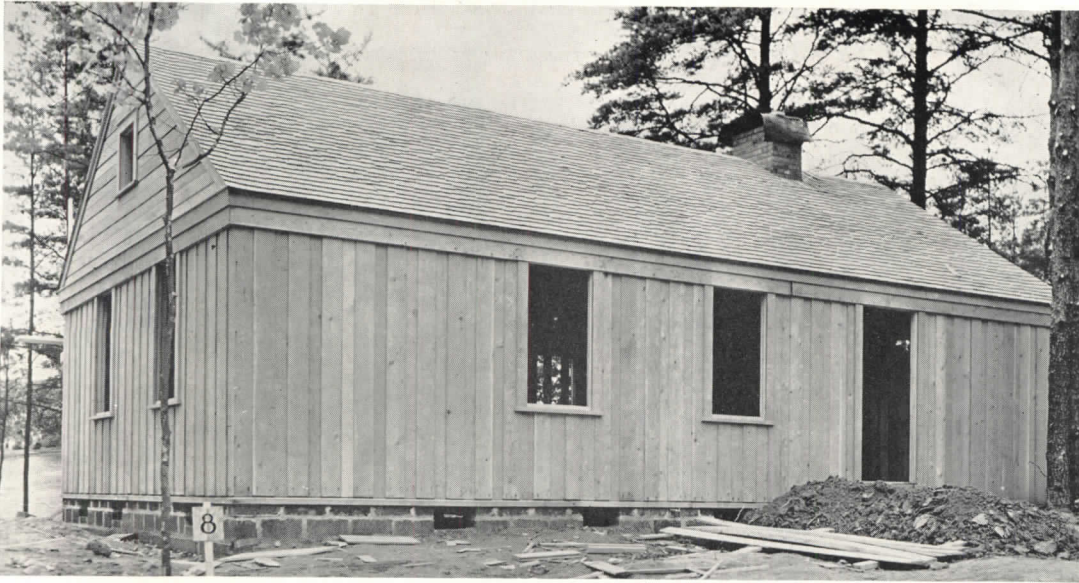

House built according to the Palisade system, which uses nominal 2-in. planking to form walls and subfloors. Planks in typical wall and in one type of floor are tongued-and-grooved, and staggered; double-faced plywood partitions approximately 2 in. thick have also been developed. Additional information is given on page 89.

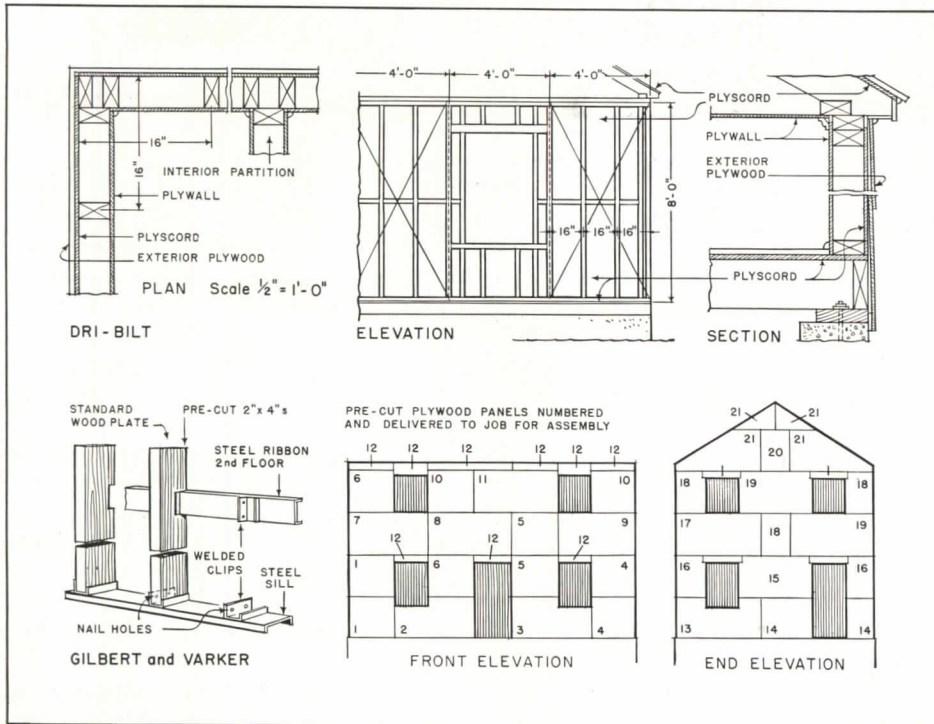

Dri-bilt system shown at top of sketch is sponsored by plywood manufacturers, and is essentially typical frame construction in which sheathing, subflooring, interior and exterior finish may all be of plywood. Methods developed by Gilbert and Varker (lower sketch) make

maximum use of savings possible with a more-or-less standard system. All materials are delivered to the job pre-cut to size; as many units as possible (windows, doors, stairs) are preassembled; use of steel sills and ribbons with stud-spacing clips preplaced reduces labor.

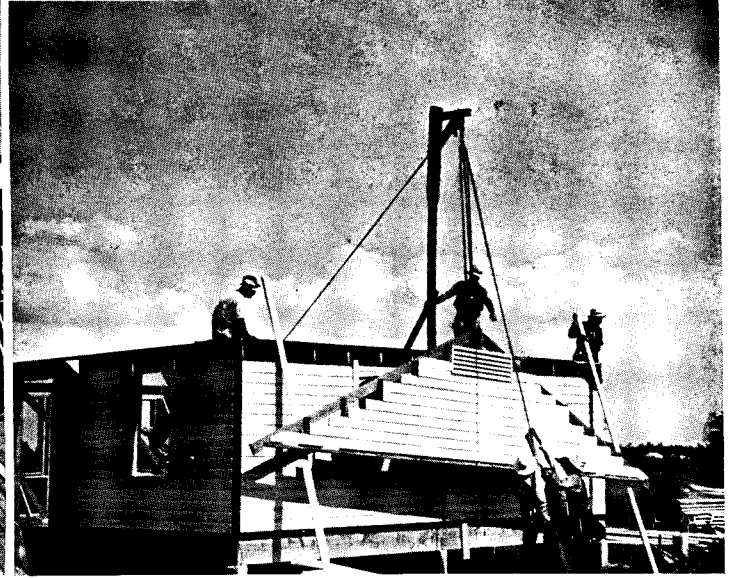
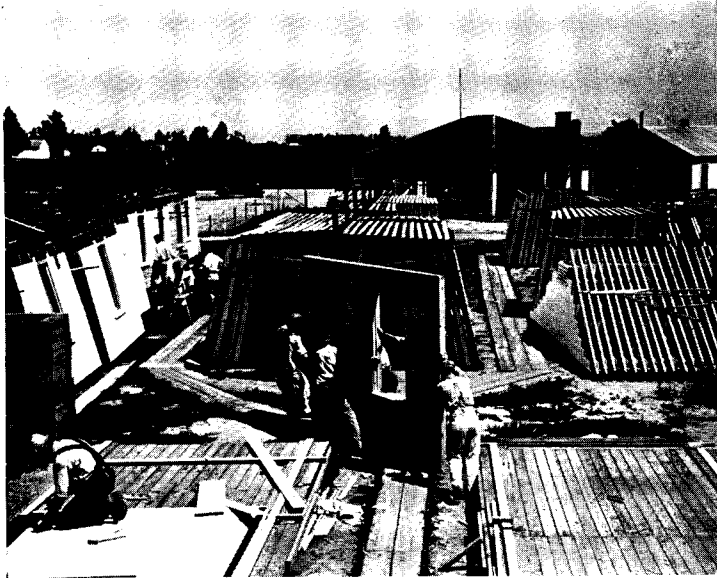

"Southeast Missouri Homes", constructed by the Farm Security Administration, were prefabricated in sections. Methods acceptable locally were used: panels have studs 2 ft. on centers; sheathing is omitted; floor framing is set

on precast concrete posts. Left, above, yard used for fabricating and storing wall and gable panels, roof trusses, etc.; right, hoisting complete gable-end. Panel sizes were limited to those which four men could handle (8 by 12 ft. typical).

PRE-CUT FRAMING offers a means of effecting savings without substantially altering conventional wood techniques. Facilities for accomplishing this end are at present available to the fullest degree only in certain localities; but from recent experience, methods seem susceptible to adoption anywhere in the country.

In the Los Angeles area, a plan sponsored by local organizations offers to selected builders, who "have ready three or more simultaneous wood frame buildings whose total lumber list is 30,000 to 40,000 board feet", all wall and partition framing except plates pre-cut to "exact lengths, marked and bundled, ready for immediate erection". After trial, construction costs were estimated to have been reduced by approximately \$10 per 1,000 board feet of such framing, with no added mill costs.

The Gilbert & Varker system used in Clairton, Pa., employs pre-cut wood framing which is attached to templated steel sills and ribbon pieces as indicated in the drawing on the opposite page. Because the development totals 300 houses, and partly due to coopera-

tion with the Carnegie-Illinois Steel Corporation, preassembled steel sash (specially designed for economy of installation), steel stairs, prefabricated closets, etc., were delivered in carload lots, as was framing. Deliveries were geared to production needs. Manufacturers were supplied with keyed plot plans and time schedules for deliveries. As each house became ready, all hardware arrived on the job in a single package, all plumbing in another lot, etc.

To a lesser degree, such facilities are universally available, in that some material manufacturers are prepared to supply packaged framing cut to fit average standard opening dimensions (doors, windows); or preassembled window units; pre-fitted doors, etc.

Dry construction methods are easily applied to wood frame construction. Both the Gilbert & Varker technique described above, and the Dribilt system, which has been widely publicized (see also opposite page), make use of plywood interior finish and exterior sheathing. In the Gilbert & Varker system,

even the plywood sheathing was delivered to the job pre-cut to shape. Both methods apply the "dry" principle only above first-floor level, and employ standard stud spacings.

The Palisade system illustrated opposite and on page 89 employs as framing 2-in. wood planking, placed vertically in walls, horizontally in floors. Typical construction employs the staggered technique diagramed on page 89; the special type of tongue-and-groove joint used increases the area of wood faces in contact. Metal connectors may be of the common, corrugated drive-type; or may be of types especially developed for the purpose. Wall finish may be diagonally furred, lathed, and plastered; or plywood may be used. Strength tests now being conducted are reported to show ample strength in both compression and flexure. Volume change due to moisture has not been reported. A similar construction for floors has been developed by the National Lumber Manufacturers' Association.

Another dry technique employs logs specially formed and placed, and is adaptable to special-purpose houses.

Photos by Dayton Snyder, courtesy Oregon-Washington Plywood Co.



Photographs on these two pages record construction of a typical small house built in Stamford, Conn., for R. B. Edward. Richard Everett was the architect. Important is the fact that, built by a typical residential contractor, the conventional finished product contains plywood subflooring, sheathing, and interior finish.



Shingling the Edward house. Use of plywood and prevention of wind-leakage at openings reduced air-infiltration so greatly that use of wall insulation was considered uneconomical. However, roof insulation was included. Specifications were prepared in cooperation with the Oregon-Washington Plywood Co., using the "Uniwall" system.

MANUFACTURERS commonly label plywood as to its suitability for exterior or interior use. While plywood may not be, in itself, less costly than other forms of wood, savings in labor-time, due to its use, have been reported as high as 50%. Thicknesses recommended by manufacturers range from 3/8 to 13/16 in. for sheathing (dependent on stud spacing) and 1/4 in. for interior finish.

Plywoods are also made fire-resistant to satisfy building codes, either by impregnation of core or by facing with asbestos or metal veneers.

While use of plywood reduces contraction and expansion, volume change is not eliminated and must be taken into consideration in larger installations. Laying face veneer grain horizontally will eliminate some expansion and contraction; the rest must be accounted for at joints. Interior joints may be butted, V-jointed, or battened. Butted joints require glue sealing against moisture at ends of panels. For exterior joints at least a 3/8-in. spacing between sheets has been recommended, and may be filled with mastic, possibly covered with battens. Interior plywood may be nailed or glued to studs; for glue process see page 90. Exterior plywood re-

quires a resin seal at edges of panel; and particularly if of soft wood, benefits from the use of resin primers. This minimizes entrance of water from sides and checking of the wood surface.

A vapor barrier of asphalt, metal foil, resin, or lead-and-oil paint may be applied to the concealed face of the interior finish (see also page 85).

Prefabrication: Many types of panel or modular systems have been developed besides those diagramed on the opposite page, ranging from unit systems to complete houses, such as those produced by the Gunnison system. "Mobile" houses have been built in Seattle. All take advantage to varying degrees of dry-construction economies. Structural economies resulting from use of "stressed-skin" construction are evident. Those selected show wide variation in methods of joining panels (which constitutes the greatest difficulty and the greatest difference between systems), and in methods and materials used for exterior finishes.

Forest Products Laboratories reports: "Serviceability of Glue Joints", April, 1938; "Controlled Exposure Tests on Birch Plywood", November, 1938; "Artificial Resin Glues for Plywood", September, 1937; "Minimizing Shrinking and Swelling", November, 1937.



R. B. Edward house: laying subflooring of five-ply, 4 by 8 ft., 5/8 in. thick, unsanded "Plyscord."



Applying "Furstix" (sanded 1/4-in. plywood cushion strips) to studs, to receive interior plywood.



Applying interior plywood: in "Uniwall" system used, 1/4-in. plywood is both glued on and nailed with finishing nails.

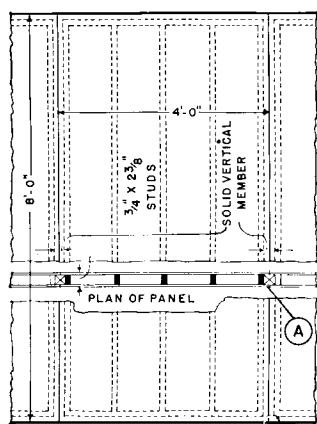

PANEL ELEVATION

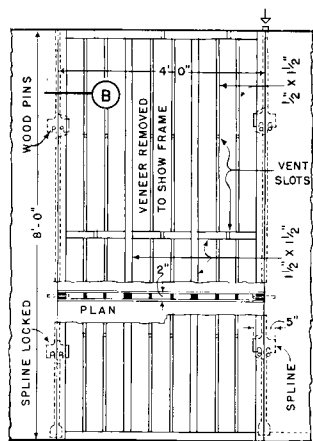

PANEL ELEVATION

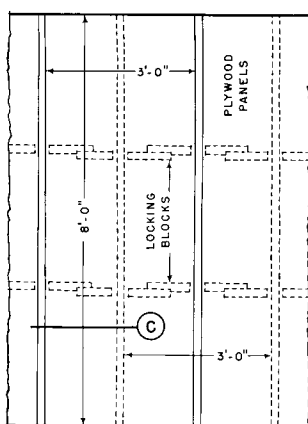

PANEL ELEVATION

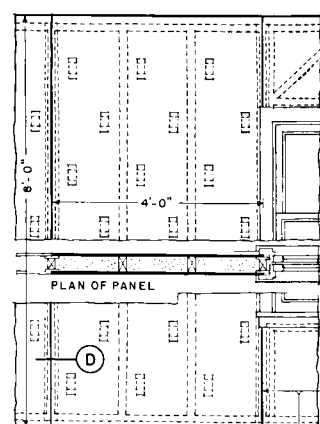

PANEL ELEVATION WINDOW UNIT

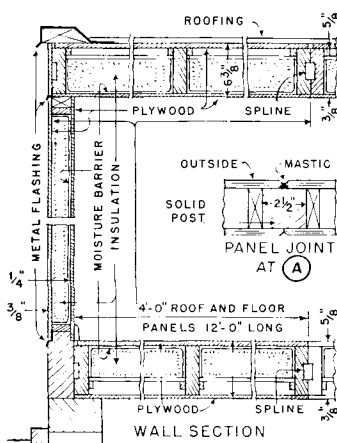

FOREST PRODUCTS

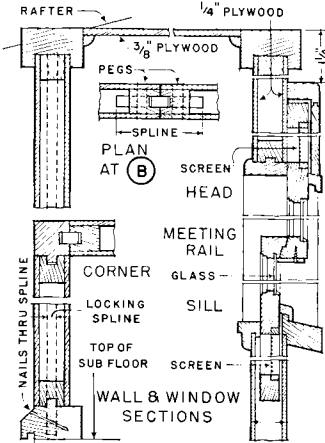

LYCO SYSTEM

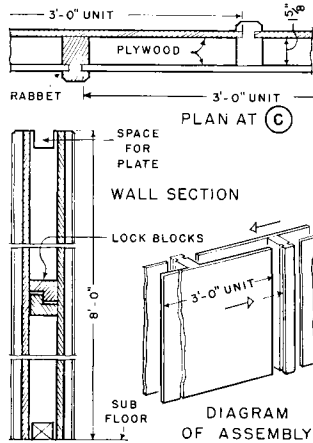

SPEEDWALL

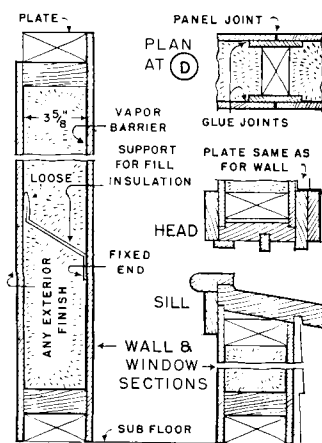

SEVERSON SCHLINTZ

Prefabricated plywood panel systems: joints are significant. System at right makes use of any desired exterior finish.

Courtesy Structural Clay Products Inst., Inc.

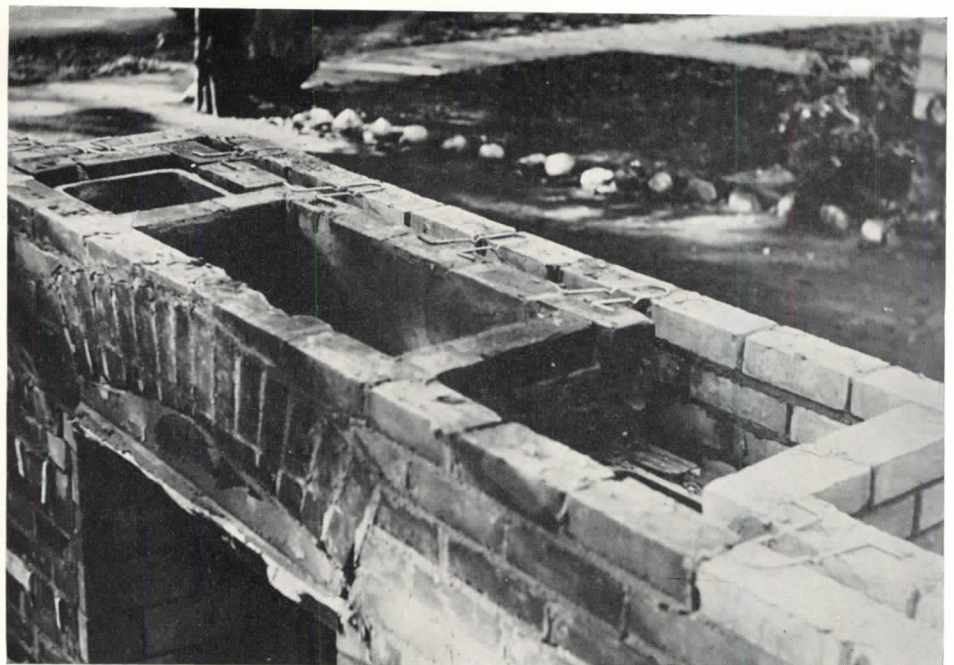
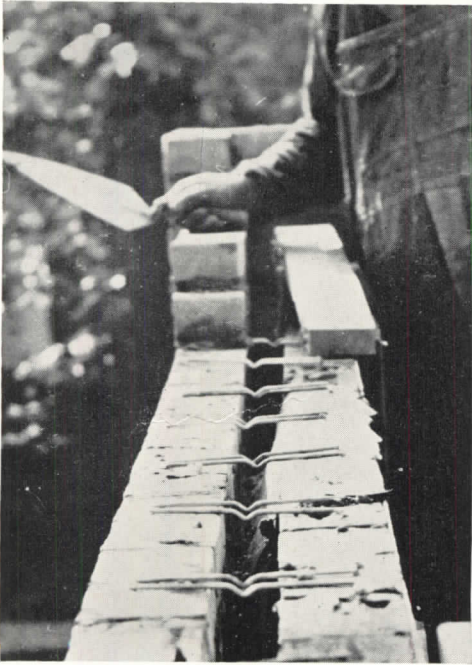

Method of laying cavity, or "barrier", brick walls: at left are shown metal wall ties crimped in the center to provide a drip for moisture; at right, chimney built according to "cavity" principle.

FEW ADVANCES, in terms of changes in systems, have been recorded in masonry construction; effort has been concentrated on improvements on existing techniques, and on popularizing in this country systems popular abroad.

Strength, permeability, and other properties of masonry construction are dependent both on the units employed and on the mortar which bonds them; consequently, quality of workmanship employed in combining the two materials might be considered of utmost importance. This contention is borne out by results of tests conducted by the Bureau of Standards.

Tests were conducted principally on brickwork, and showed that walls constructed according to high standards developed less permeability and strengths up to 70% greater than walls laid in violation of standard techniques evolved. Two essentials were stated to be use of flat bed joints and complete filling of vertical joints. No perceptible increases in mason's time were required to obtain satisfactory construction.

The uneven bedding provided by the commonly used "furrowed" mortar bed produces bending stress in the brick, causes local concentration of loads, and may facilitate entrance and retention of moisture.

Vertical joints are required to be filled solid, at least on exposed withes.

Methods include *shoving*, and *grouting*. When brick are shoved downward and endwise into place, vertical joints have to be completely filled. Grouted joints are made by filling vertical joints with a mixture of bed mortar, water, and cement. Brick may have outside edges buttered to prevent loss of grout.

Joint thickness affects strength of walls to some degree, although no definite relationship has been proven. Thin joints tend to increase strength. Tooling joint faces produces a more dense mortar surface, but is considered less important than workmanship within the wall.

Brick specification has in the past depended principally upon strength. However, the Brick Manufacturers' Association of New York states that even the weaker brick now manufactured have ample strength for residential loads; and that strength of a completed wall is dependent to a great extent upon strength and bonding power of the mortar employed. Relatively "strong" brick plus "weak" mortar may result in comparatively weak masonry; relatively "weak" brick plus "strong" mortar may produce strong walls. The American Society for Testing Materials is now revising its specifications for brick to include durability rather than strength.

Mortar specifications have been subject

to much discussion. The National Lime Association advocates a large percentage of lime in mortar; others recommend extremely small quantities. The Brick Manufacturers' Association of New York* points out that some lime is needed to impart plasticity to mortar; that too much decreases mortar strength unduly; and that proprietary brands of lime vary widely in their qualities. In tests, much greater proportions of some brands of lime were needed than of others to achieve the same plasticity. A.S.T.M. is working on specifications intended to resolve these difficulties.

Cavity (or "barrier") wall construction (see also page 90) depends upon a 2-in. internal air space to collect all moisture which may penetrate the outside withes of brick. It is necessary to eliminate all obstructions, such as mortar droppings, which may block the cavity and convey moisture (by capillarity, or across horizontal surfaces) to the inner withes. Damp-proofing, usually flexible, is required to conduct to outer faces moisture which may collect over heads of openings or at foot of walls. Weep holes or open joints, or both, serve as drains at such points. Metal ties used in this country are most often bent 1/4-in. or 3/16-in. rods, crimped in the middle to afford a drip for moisture.

* This association recommends a cement-lime ratio of 1:1/4 for high strength; 1:1 for common use.

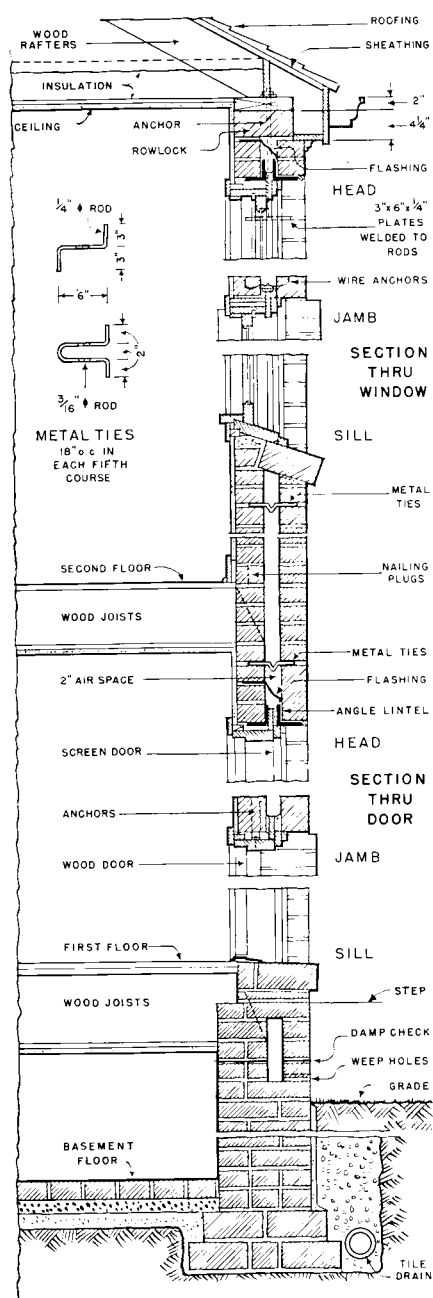

BARRIER WALLS

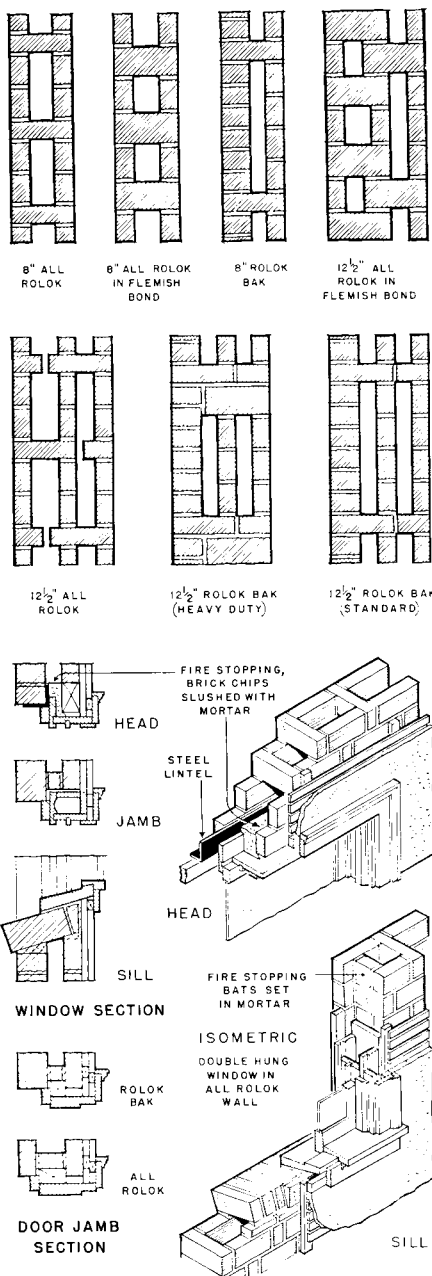

ROLOK WALLS

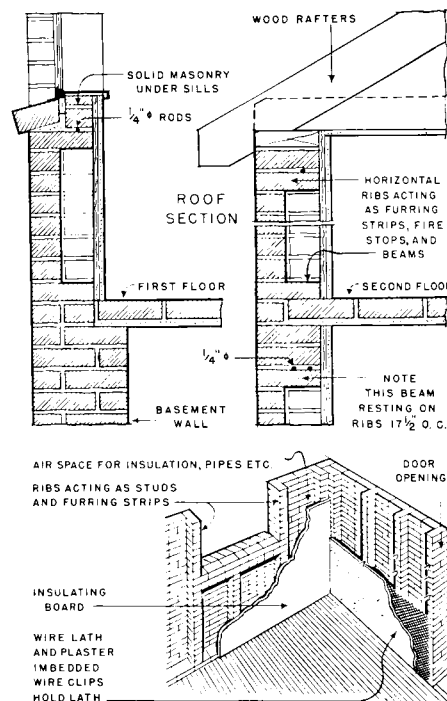

ECONOMY RIBBED WALLS

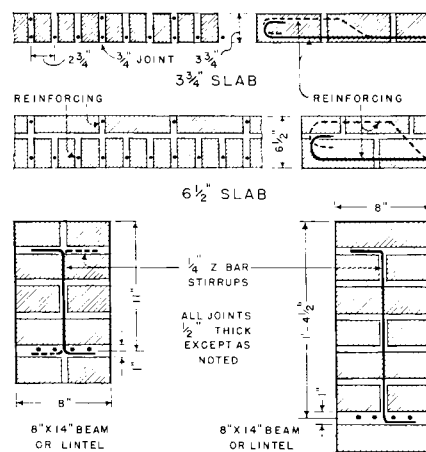

REINFORCED BRICK MASONRY

Various proprietary types are available abroad. Corrosion of ties has not been found a serious problem in English experience, with satisfactorily galvanized or rust-inhibited iron; for permanence, the British Building Research Station recommends bronze and similar metals.

Thermal insulating values of cavity walls are stated to be slightly greater than for solid masonry of equal thickness; however, the air-space in properly vented cavity construction is not "dead." Strength of cavity walls, according to test results not yet released for publication, are more than ample for residen-

tial purposes, whether loads are concentrated upon inner wythes or spread over entire wall thickness.

Other hollow-wall types include "Rolok" walls, which permit use of minimum quantities of brick. Problems of moisture penetration remain to be combated, except in the 12 1/2-in. type shown above, in which bonding brick are not connected through the wall's entire thickness. "Economy," or ribbed, walls have similar characteristics.

Reinforced brickwork, particularly floor slabs and beams, has been available for

some time. Design data has been previously published.** Simple reinforced lintels may be formed in cavity walls by placing rods in bottoms of cavities over openings and filling to the desired depth with concrete grout. This method has been used over openings up to 11 ft. wide.*** Grout-locked brickwork, developed subsequent to California earthquakes, consists of reinforcing rods dropped in internal vertical joints which are then grouted full.

** American Architect and Architecture, October, 1937.

*** Brick Manufacturers Association of New York

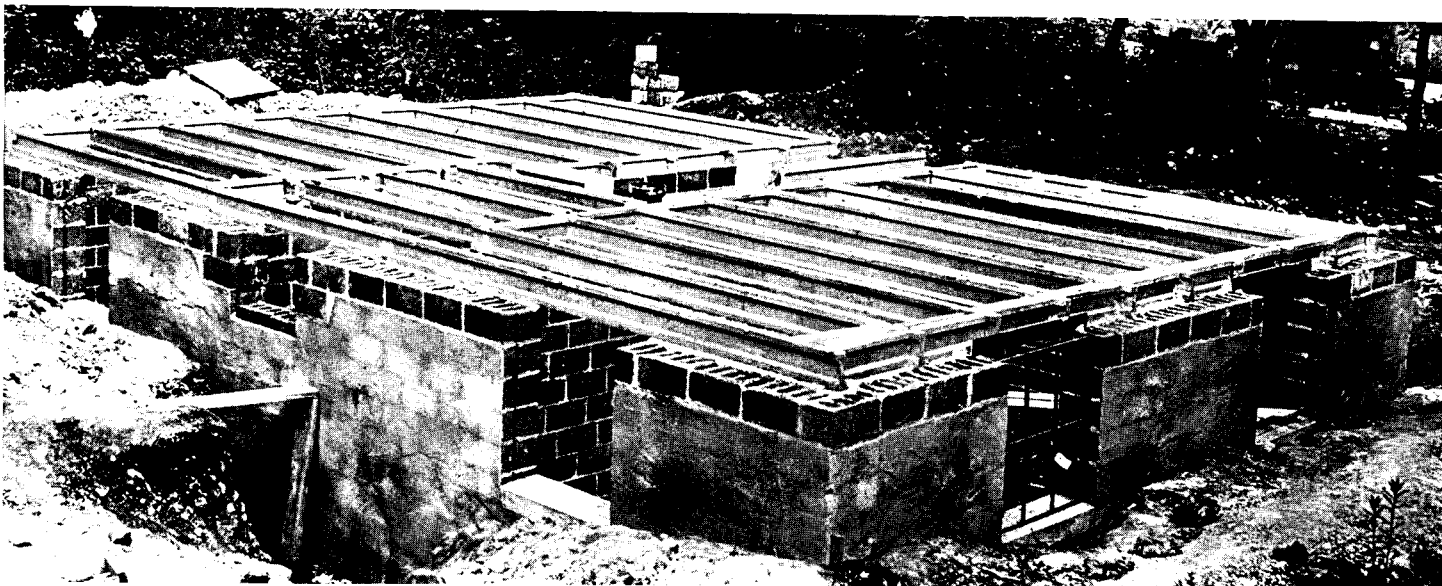

Photos courtesy, Portland Cement Assoc.

Typical concrete construction: block foundations with parge-coat waterproofing, precast joist floor ready for pouring the slab.

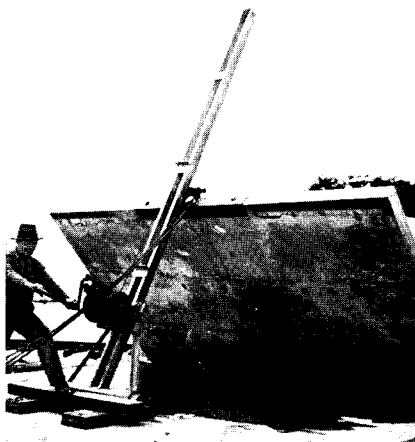

"Tilt-up" construction; entire walls are cast as units on poured first-floor platform, raised, and joined by poured corner-posts.

ADVANCES in masonry-unit construction include standardization of formulae, sizes, and curing methods; and use of materials claimed to have acoustical or thermal insulating properties. Among the latter are blocks in which are incorporated layers of cork. In addition to standard 8 by 12-in. face sizes, blocks are manufactured in ranges of sizes for random masonry effects, so that jointing may be incorporated in design. Construction methods are similar to those for other types of masonry.

Field-poured concrete costs depend to some degree on amount of form-work involved, also on mass of material placed. Forms which may be used repeatedly, and various types of hollow or ribbed walls, have been devised to reduce costs. Both sheet metal and plywood may be used for economical form-work. Effects of initial shrinkage and of thermal expansion may be counteracted by use of "temperature" reinforcing, or by use of designedly weak plane joints at locations where cracking is anticipated.

Prefabricated systems in concrete have in the past met with little success except locally, according to the Portland Cement Association; perhaps because mass-production principles have been imperfectly applied. Two recent types

deserve mention. The Twachtman system provides factory-produced hollow-wall panels, of ceiling height and up to approximately 16 ft. in length. Sash and doorframes are cast in slabs; building design may be of widely differing types. System is available at present only in the vicinity of the sponsor's one factory.

The Tilt-up system is illustrated at the left. Forms for openings, chases, etc., are incorporated. Paper is spread over the platform before casting; lumber constitutes the edge-forms; walls are tilted up into position by means of special winches and booms. Reinforcing is required to resist erection strains.

Vibration principle, when applied to field-poured concrete, requires that forms be sufficiently strong to resist action of vibrating hammers, etc. Use of vibration permits use of relatively dry concrete, which in turn permits use of low water-cement ratio; this may result in strength increases up to 30% in flexure, 33% in compression. Bonding of successive pours and of reinforcing is also strengthened. Principles are applicable to prefabricated concrete units, including blocks and other masonry units, slabs, and joists. Other methods of physical treatment, such as steam-curing, are also applicable.

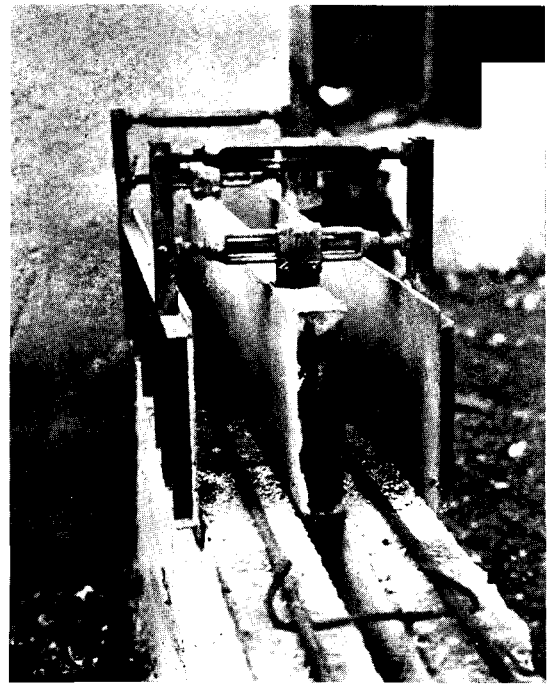

House in Troy, Wisc., built with patented molds distributed by Hollow Concrete Wall Mold Co.; at right, construction method. Mix is relatively dry, well tamped; top of each pour is left rough for bonding. Forms may be

re-used quickly; successive layers are rapidly poured. Time and form costs are thus minimized. Forms come in sets, one unit for corners, one for straight walls, etc., and are supported by wall ties.

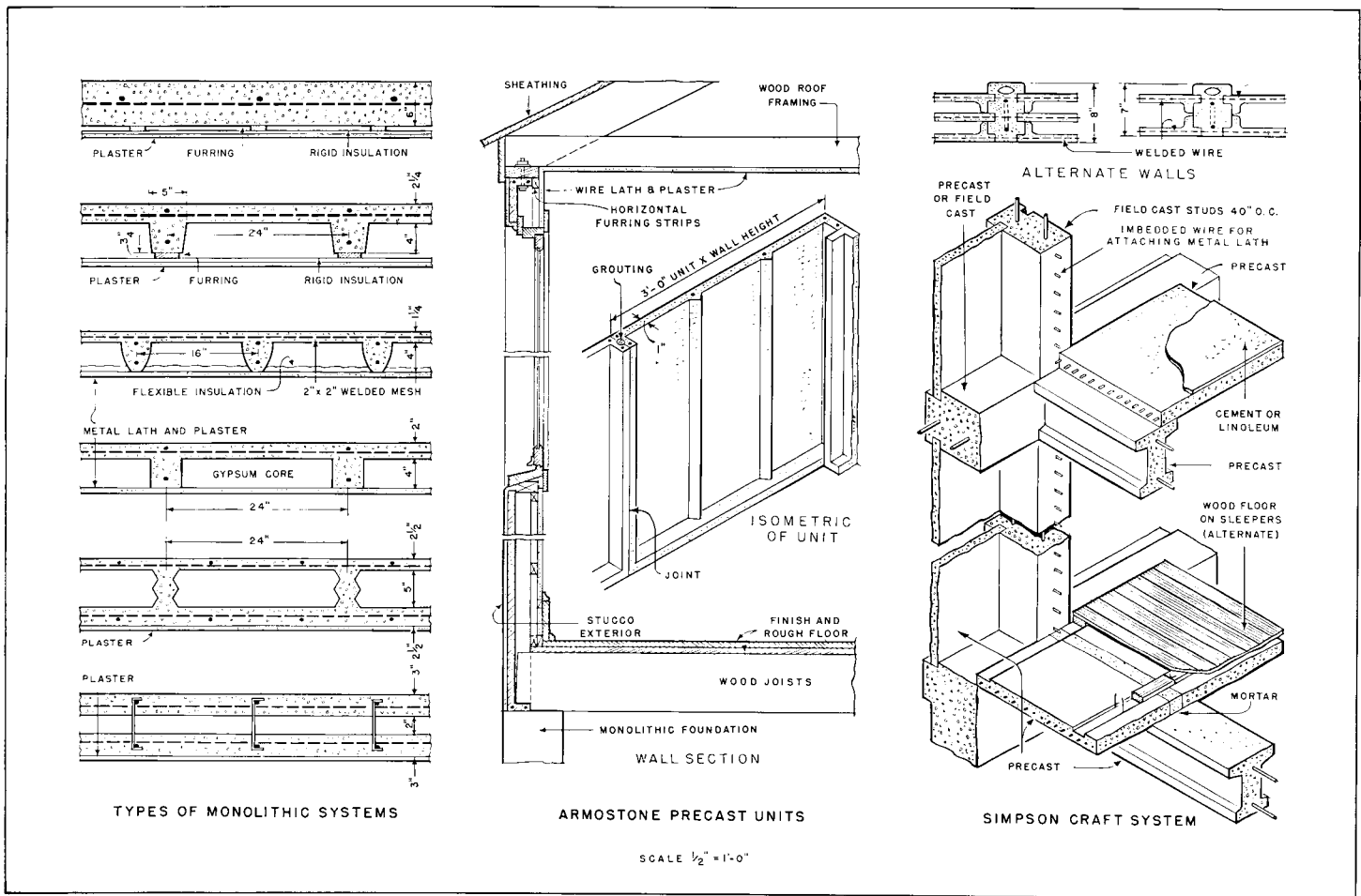

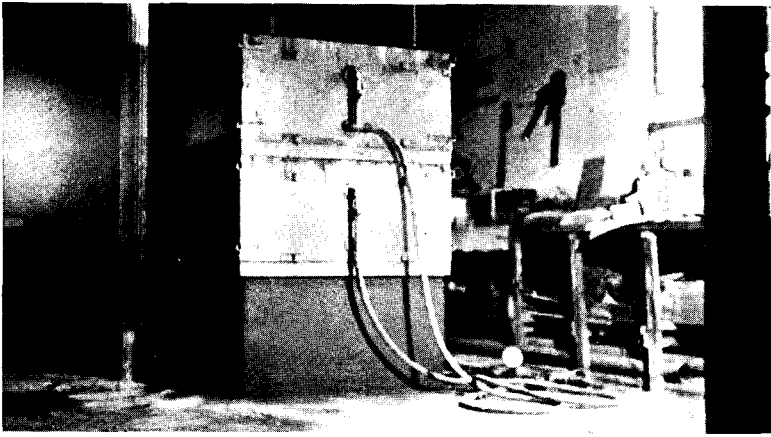

1

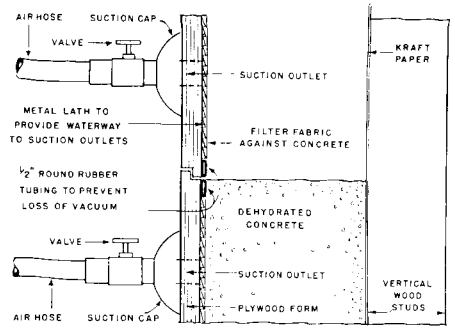

Form-work required for vacuum concrete: frame for paper backing is only form-support needed.

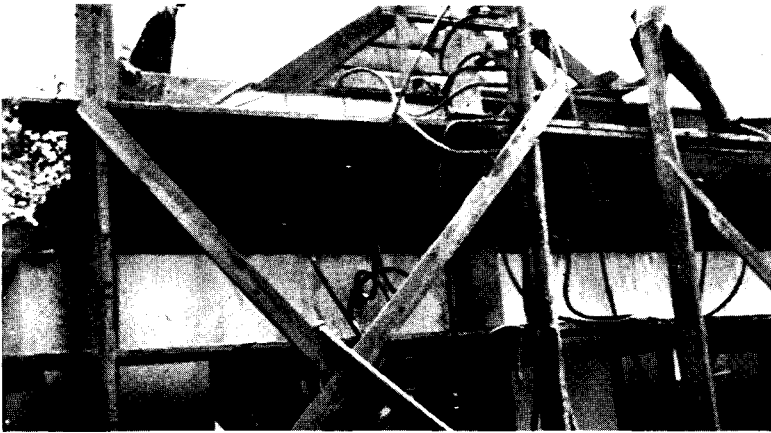

2



3



4

"Sky-hook" vacuum-concrete forms: 1, laboratory demonstration showing, at bottom, pour from which form has just been removed; above that, form held in place by atmospheric pressure; top, form supported on second-course form. 2, gable-end of a house in Westchester County, N. Y. 3, roof of same house. 4, scaffolding supported on unset, dehydrated concrete

Vacuum concrete, developed by The Vacuum Concrete Corporation: Principle consists of applying a vacuum to concrete poured in place, thereby extracting any desired amount of water up to the minimum required for hydration of cement. Filter membrane illustrated reduces cement-loss to a negligible amount. For residences, two 3 in. thick walls plus 6-in. air space, have been used. Reinforced roof slabs 2 in. thick are possible.

Procedure: Backing forms and first vacuum face-form are placed. Concrete with a slump of approximately 7 in. may be poured in lifts as high as 3 ft.; flattened rubber hose around edges of form seals the pour against air. Vacuum is applied; second form is set atop the first and is poured and vacuumed. Second-lift forms are automatically held in place by atmospheric pressure; first form is then removed and placed on top of second form. Procedure is repeated to top of wall, eliminating bracing, ties, spreaders, etc. Successive lifts may be poured at 15- to 20-minute intervals, depending on height of lift and vacuum.

Vacuum causes concrete to become hard, but does not hasten final set. Freshly-stripped concrete has supported workmen. In building roof shown at left, temporary forms were erected and lined with insulating board containing anchors which secured it to the finished 2-in. slab when bracing was removed.

Finish (brushed, floated, stuccoed, colored) becomes integral with the wall. For hand finishes, low vacuums are used. Because finished product is dense and finish integral, vacuum concrete is practically impervious to water.

Photos courtesy Vacuum Concrete Corp.

STEEL

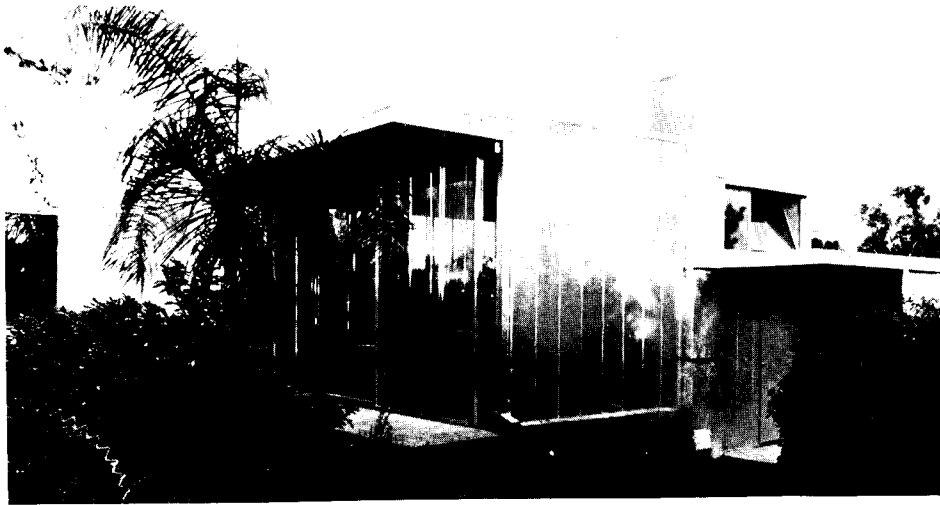

Interior and exterior of house in California designed by Richard J. Neutra, architect, who used Robertson system for walls, floors, and roofs. Note particularly the exposed cellular units on underside of porch roof.

STEEL STRUCTURAL systems have developed in the direction of prefabrication of units, assemblies, and complete houses, perhaps due to experience with steel in other building types, and to difficulties of job-fabricating the material. All forms of steel, from isolated members used in combination with other materials, to complete systems, are available in standard forms and sizes, whose structural properties have been investigated and compiled for easy reference.

The Robertson system, which has been widely publicized, was first used for floor and roof construction. Structural members consist of sheets formed into deeply corrugated "keystone" shapes. Adjacent members may be crimped together with special tools; and, while furnished in standard lengths, are easily cut to provide stairwells, duct openings, etc. Any type of floor finish

may be applied over the lightweight concrete used to fill the corrugations. Ceilings may be exposed, in which case a ribbed, or beamed, appearance results; or a type of member fitted with flush steel ceiling sheets, suitable for painting, etc., may be used. Partition framing, strap-anchors for ducts, piping, etc., may be attached with self-tapping sheet-metal screws. Openings in cells may be utilized for pipe or conduit space. Partition construction may be of stamped steel studs supporting metal lath. For exterior walls, any usual type of construction, or Robertson panels, stood on end and secured to channel sills, may be used.

Of the systems which in form are comparable to wood framing, Stran-Steel, also widely publicized, is perhaps representative. Steel is here used for framing only. Studs, plates, sills,

etc., are used. Studs contain a corrugated groove into which nails may be driven for holding conventional sheathing and finishing materials.

Steel joists are manufactured in several types, all of whose properties are available in handbooks. Included are rolled, stamped, and built-up sections. The latter may consist of a lattice formed of a continuous steel bar, welded to angle flanges. Open-web types offer little hindrance when piping or wiring is incorporated in the structure.

Accurate figures on material savings, resulting when framing members are field-welded together, are not available. Since residential loads are light, savings in members themselves may not be substantial; savings in such items as shelf-angles, brackets, etc., and in erection time, may be more recognizable. Prefabricated units may offer savings.

Photos courtesy of Hobart Bros. Co.



Hobart all-welded steel houses are completely shop-fabricated, trucked to the site, placed on the foundation, and hooked up to utilities. Walls and floors are thin, double-faced, reinforced steel, welded together and packed with insulation. Center, below, forming a door panel; and, bottom, houses on the production line.

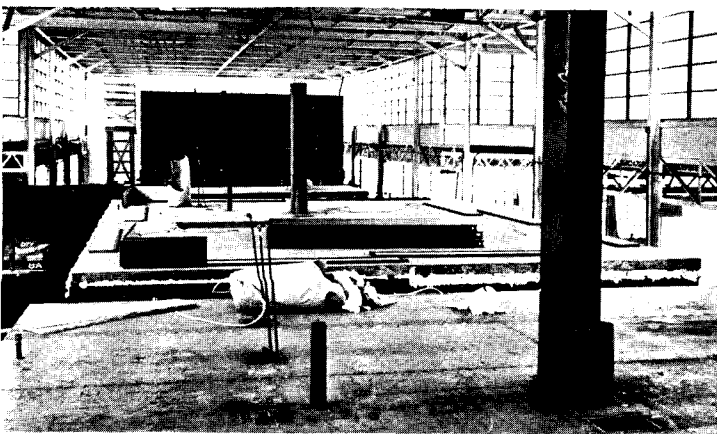
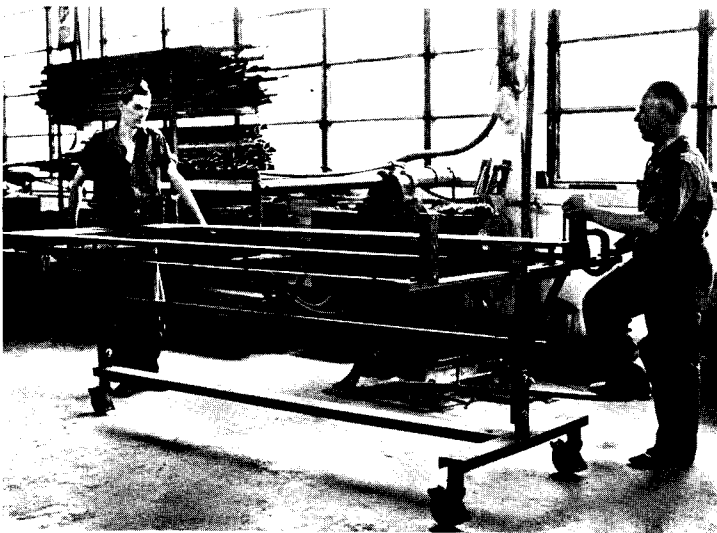

STEEL SYSTEMS shown on these pages illustrate a trend toward prefabrication. Many require use of a module for economical utilization of the system.

Soulé system employs prefabricated structural members with interior and exterior finish of conventional materials, and is similar to wood framing.

Steelox system is an example of formed sheet steel. Sheet edges are interlocked. Exterior finish is steel; but interior finish, and floor construction and finish, may be of any type.

U. S. Steel's Panel-bilt system, used by Tennessee Coal, Iron & Railroad Co. in constructing homes for the Farm Resettlement Administration, employs steel for everything except interior finish. Since most homes have been erected for "low-cost" housing in the South, foundations consisting of driven steel members have proved acceptable. Wall and roof construction using box-rib corrugated siding permits circulation of air within the construction.

Arcy system makes use of the structural properties imparted to sheet metal by forming. Wall and floor panels may be described as, in essence, "accordion-pleated" sheets, formed in multiples of 18 in. Surplus metal is stamped out; "pleats" are reinforced with angles or integral crimping; finish, both interior and exterior, may be any material.

Ferrocon system consists of crimped metal shapes (acting as studs or joists) with metal lath on floor, ceiling, and both wall faces. Subfloors are concrete; interior finish is plaster; finish floors may be any material; exterior finish is stucco or other materials.

Robertson system is described on page 103.

Mobile housing: Hobart houses are illustrated in photographs at left. Small dwellings are moved as units; larger houses may be moved in sections, with "invisible" slip-joints concealing the junctures of two or more units upon completion. Plumbing, heating, electrical systems, insulation, etc., are pre-installed; provision of a foundation and connection to utilities are all that are required at the site.

Somewhat similar is the Buell Prefabricated House (not illustrated), which has not been put into active production.

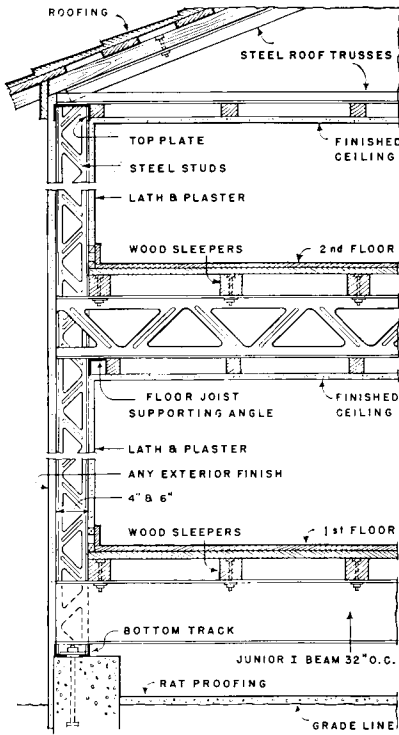

SOULE

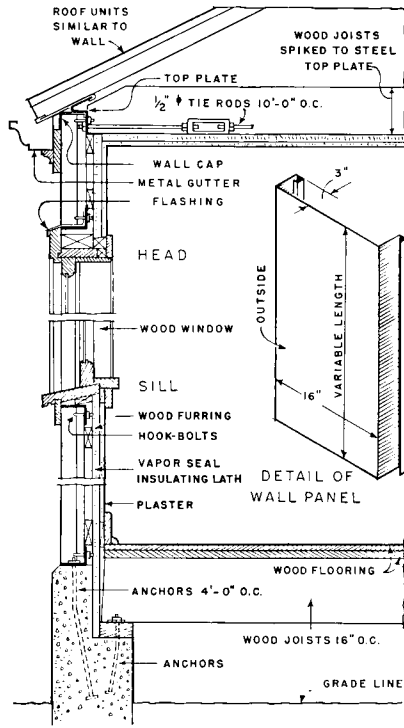

STEELOX

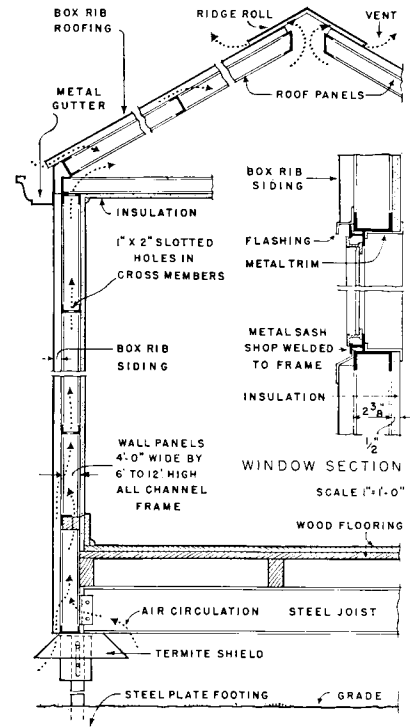

PANEL BILT

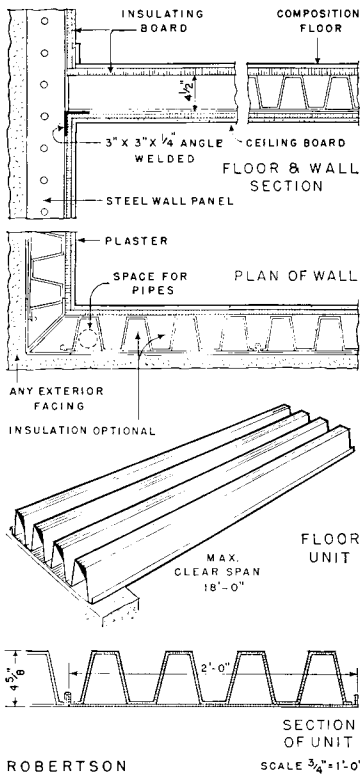

ROBERTSON

SCALE 3/4"=1'-0"

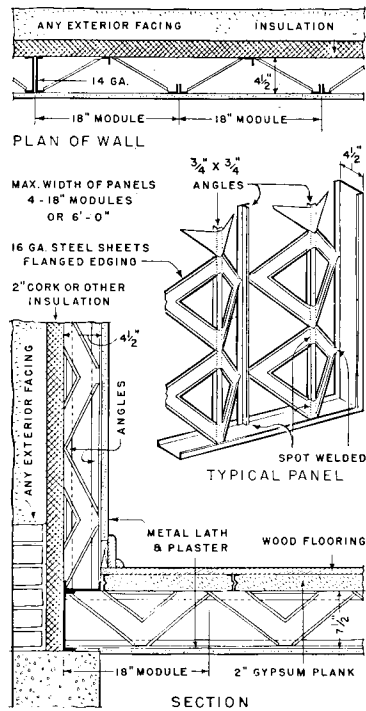

ARCY

SCALE 1/2"=1'-0" UNLESS OTHERWISE NOTED

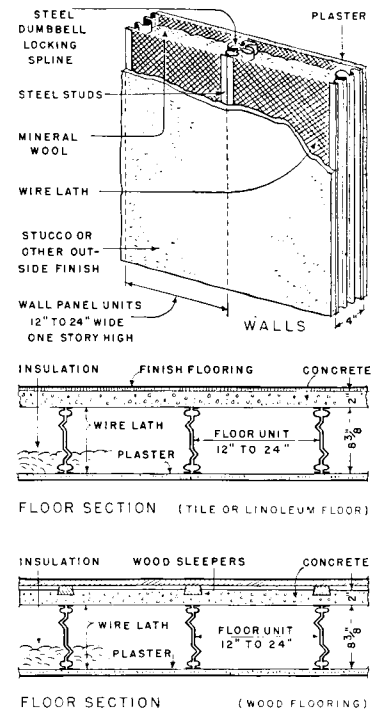

FERROCON

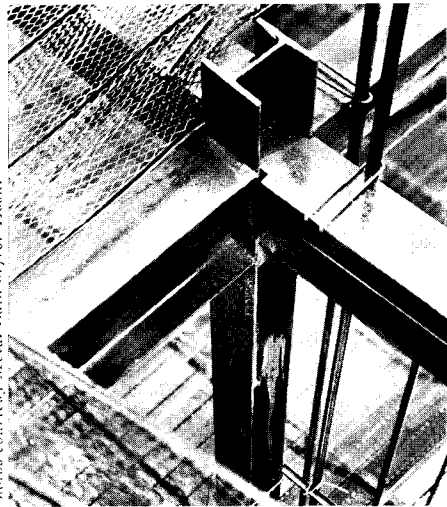
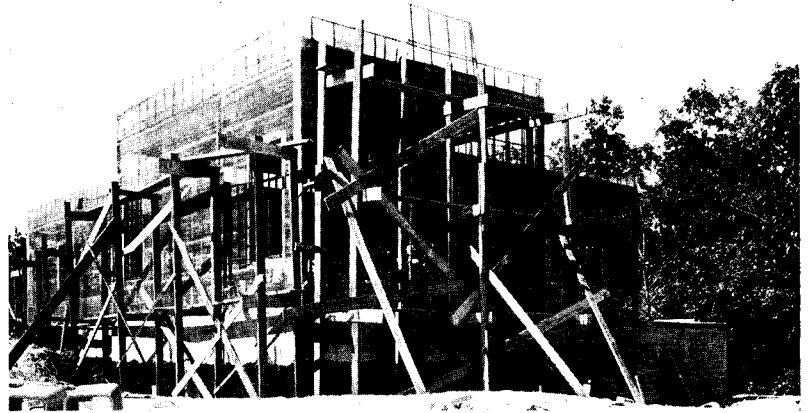
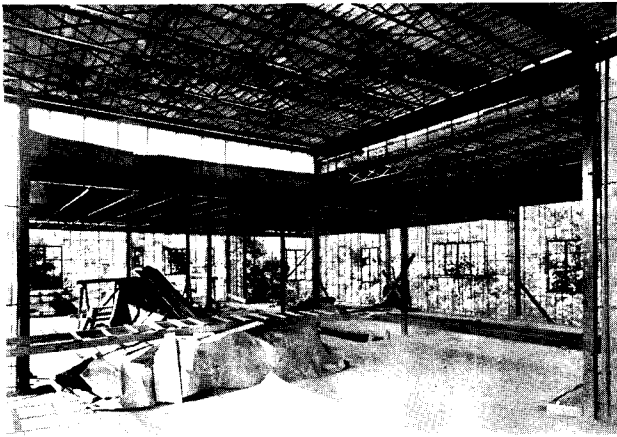

Photos courtesy Metal Lath Mfrs. Assn.

In Lurie system, channels are wired together and secured to beam flanges with hooked clips. Framing is welded. Sash are wired to lath channels.

Lurie system (Metal Lath Mfrs.' Assn.) uses widely spaced steel frame, and metal lath supported on $\frac{3}{4}$ -in. channels. Exterior walls consist of 2 in. of Gunite, an air space, an inside skin of plaster on metal lath. For floors and roofs see pages 89, 92.

MANY SYSTEMS use combinations of materials for framing. Among prefabricated composite systems may be listed that developed by General Housing Corporation in Seattle, in which conventional framing is aligned against light structural steel shapes. Houses are constructed in halves, trucked to the site, and turnbuckled together. Entire fabrication is on production-line basis. Foundations and utility connections are only items supplied by the purchaser.

The Harnischfeger system, of steel-framed panels and wood nailers, with large-unit sheathing, comes prepared for application of any type of interior or exterior finish desired. Walls, floors,

and roofs are included. Conventional finishes (clapboards, shingles, brick veneer) have been found most saleable.

The Crowe system, of steel-framed panels combined with cellular concrete sheathing-slabs, is designed for production in local yards. Joints are poured on the job. Panels are in essence double, with waterproofing membrane between. Cellular concrete specified is stated to have an insulating coefficient (k) of approximately 0.85.

The Rockwood system, on the market for some years, consisting of combinations of special gypsum tile and job-poured concrete, is now being adapted to the low-cost house market.

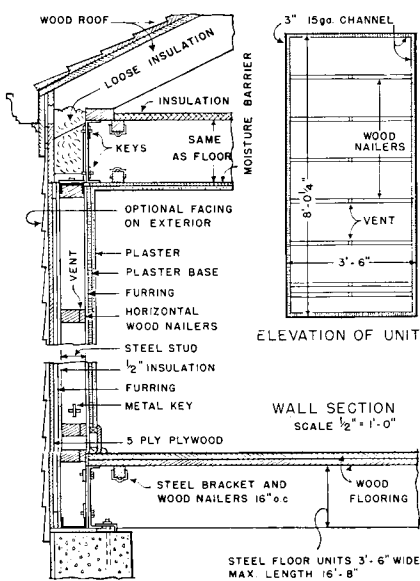

HARNISCHFEGER

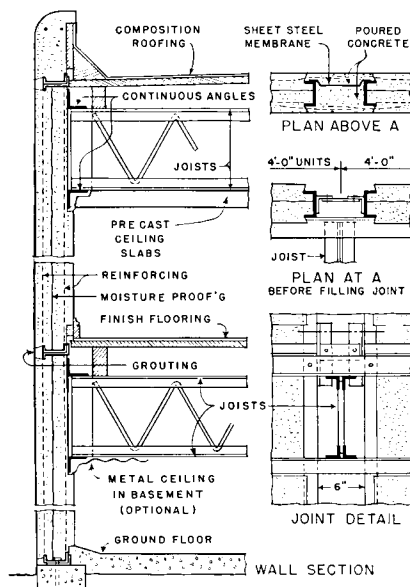

CROWE

SCALE $\frac{1}{2}$ " = 1'-0"

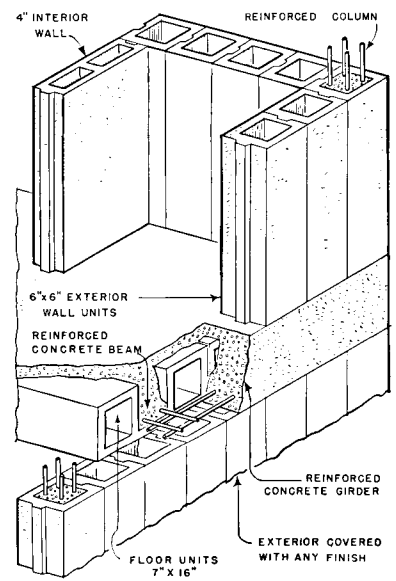

ROCKWOOD (GYPSUM)