

ARCHITECTURAL RECORD

COMBINED WITH AMERICAN ARCHITECT AND ARCHITECTURE

VOLUME 87

APRIL 1940

NUMBER 4

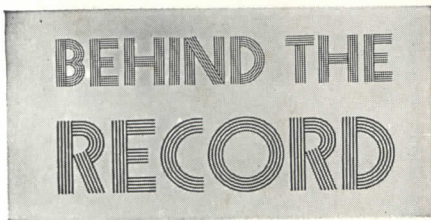

WOULDN'T it be helpful if every time you started on a new project you could go to a shelf and select an up-to-the-minute reference study on the very type of building you are confronted with? That, precisely, is what you can do if you have a file of RECORDS on hand. The Building Types section provides studies on from 9 to 11 different types of buildings each year. One month the subject is houses; the next, schools; the next, hospitals; and so on. Our objective is to save you hours and maybe days of research by providing information that, in fairness to yourself and to your client, you would somehow, someway, have to dig out for yourself.

This month, for instance, we offer an authoritative work on *Vocational Schools*. In it you will find first a discussion by Dr. Arthur B. Moehlman, editor of "The Nation's Schools," of present-day requirements affecting the design of this increasingly important type. This is followed by time-saving data on planning and equipment, and by informative illustrated case studies from various sections of the country. Comments awaited!

Other types of buildings are reported each month, of course, and the selection this issue is not without vari-

(Continued on page 7)

BUILDING NEWS

39

NEW BUILDINGS*

39-55

Architectural School and Art Gallery for the University of Southern California	40-43
Multi-use Fire Station, Miami Beach	44-48
Music, Camera, and Sports-Equipment Store, New York City	49-52
Seattle Catholic Diocese Headquarters	53-55

NEW SYSTEMS, MATERIALS, EQUIPMENT

56

NEW HOUSES* with three bedrooms in:

57-66

New Jersey	58, 59
Southern California	60, 61
Wisconsin	62, 63
Oregon	64, 65
Massachusetts	66

NEW HOUSE UNITS* (lounging)

67-72

DESIGN TRENDS

73

STEEL: A Study of Trends in its Structural Application	73-80
ARCHITECTURE ON PARADE	81-83
WHERE ARE ARCHITECTURAL PASTURES GREENEST?	84
TRENDS IN BUILDING COSTS	85, 86

BUILDING TYPES

87

VOCATIONAL SCHOOLS

87-114

Modern Educational Standards Require New Facilities for Industrial Arts Training	88-90
Planning for Threefold Educational Program Plan Types	91 92-95

TIME-SAVER STANDARDS

96-100

Planning and Construction	96, 97
Provisions for Equipment	98, 99
Vocational Shop Requirements	100

CASE STUDIES*

101-114

(Index to Advertisements . . . Page 158)

*Material and equipment schedules sent on request.

Copyright, 1940, by F. W. Dodge Corp. All rights reserved.

Editorial Director: Thomas S. Holden. *Editors:* Orville C. Anderson (*Managing*), James M. Fitch, Jr., Roger Wade Sherman. *Associate Editors:* Elisabeth Kendall, Irvin Kuper, Frank G. Lopez, Jr., George A. Sanderson. *Art Director:* Gene Hawley. *Desk Editor:* John W. Ragsdale.

Editorial Consultant: Michael A. Mikkelsen.

Architectural RECORD (combined with *American Architect and Architecture*) is published monthly by F. W. DODGE CORPORATION, 115-119 West 40th Street, New York. Truman S. Morgan, Pres.; Howard J. Barringer, Vice Pres. and Treas.; Irving W. Hadsell, Vice Pres.; Thomas S. Holden, Vice Pres.; Michael A. Mikkelsen, Vice Pres.; H. Judd Payne, Vice Pres.; Chauncey L. Williams, Vice Pres.; John M. Williams, Vice Pres.; Sanford D. Stockton, Jr., Secy.; Walter F. DeSaix, Asst. Treas.; Edwin H. Freed, Asst. Treas. Member Audit Bureau of Circulations and Associated Business Papers, Inc. Architectural RECORD is indexed in Readers' Guide, Art Index, and Industrial Arts Index.

Subscription Rates: United States and Possessions, Canada, Cuba, and Mexico, \$3 the year, \$5 for two years, \$6 for three years; Elsewhere, \$5 the year; Single copy, \$1. *Circulation Manager:* Robert C. MacDougall.

Manuscripts, photographs, and drawings which conform to RECORD'S editorial aims are welcomed. Every effort will be made to return material (if accompanied by stamped, addressed envelopes); but the editors will not be responsible for losses.

Other Dodge Services: REAL ESTATE RECORD, SWEET'S CATALOG FILES, HOME OWNERS' CATALOGS, DODGE REPORTS, and DODGE STATISTICAL RESEARCH SERVICE

SAVED...

25 DAYS AND \$300

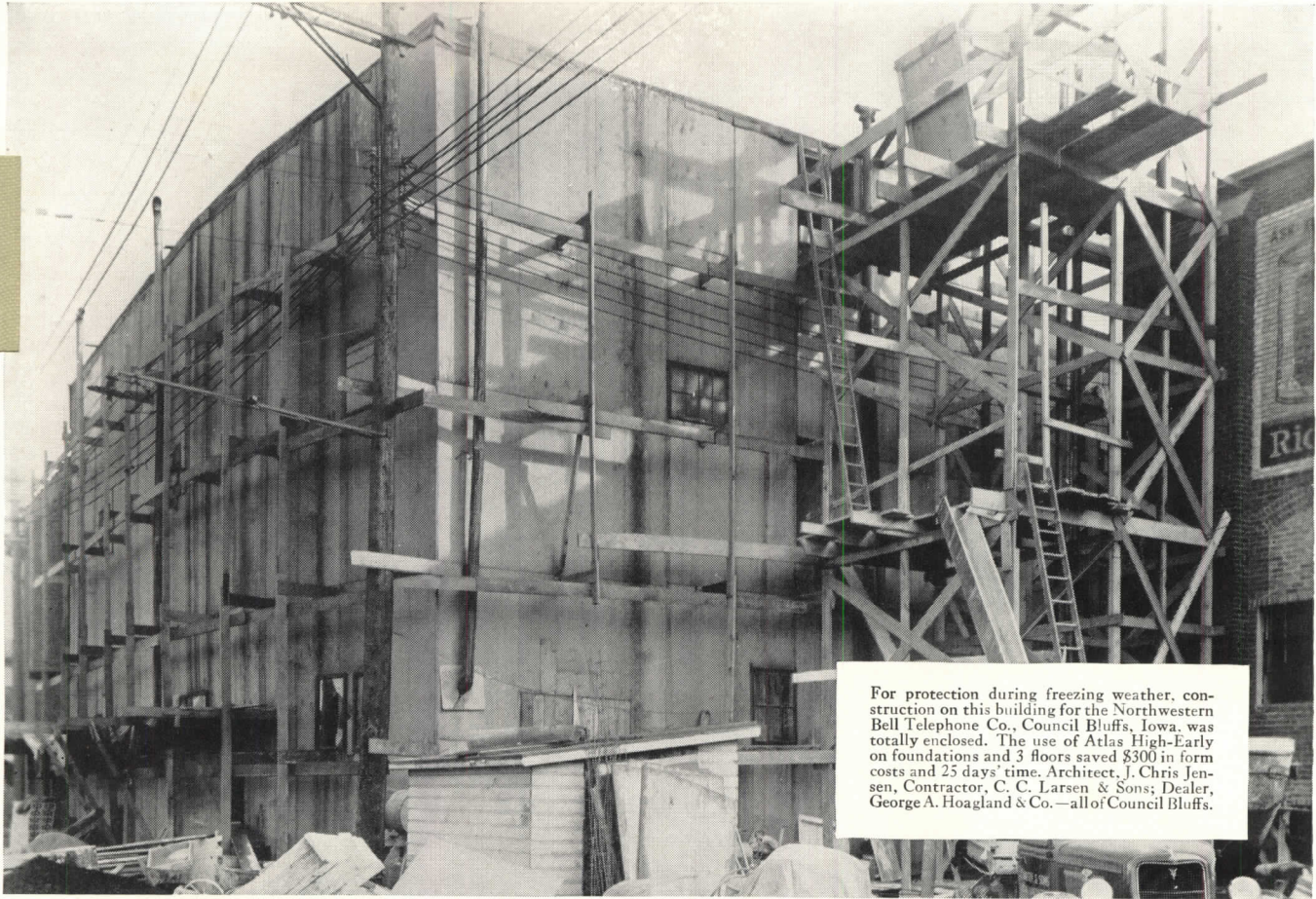

For protection during freezing weather, construction on this building for the Northwestern Bell Telephone Co., Council Bluffs, Iowa, was totally enclosed. The use of Atlas High-Early on foundations and 3 floors saved \$300 in form costs and 25 days' time. Architect, J. Chris Jensen, Contractor, C. C. Larsen & Sons; Dealer, George A. Hoagland & Co.—all of Council Bluffs.

Northwestern Bell Telephone Company Building, Council Bluffs, Iowa, ready for occupancy nearly a month sooner, thanks to Atlas High-Early cement!

CONCRETING of this building could not wait for spring. Work had to be rushed during some of the coldest weather you'll find anywhere. The superstructure was actually concreted in temperatures which were as low as 18° below zero, and never above freezing.

So, the time needed for protection and curing promised to be long and therefore costly. However, the archi-

tect found a way to speed construction and keep costs down. He specified Atlas High-Early cement—the cement that gains strength several times faster than normal portland cement. Here's the result:

Concreting of the substructure was started on January 1. The superstructure was completed on March 5. The architect and contractor estimate that the use of Atlas High-Early con-

crete enabled them to save 25 days' time and, consequently, greatly reduced protection and curing costs. Also, forms were stripped in 36 hours, thus saving one set of forms . . . or \$300.

Aside from speeding up rush construction, Atlas High-Early cement often pays back its slightly higher cost over and over again by saving days and even weeks of costly building time. Give Atlas High-Early a trial on your next job! Universal Atlas Cement Co. (United States Steel Corporation Subsidiary), Chrysler Building, N. Y. C.

AR-H-12

ATLAS HIGH-EARLY CEMENT

A UNIVERSAL ATLAS PRODUCT



BEHIND THE RECORD (continued)

ety. There's that striking multi-use *Fire Station* in Miami you've heard so much about . . . an interesting *Retail Shop* in New York, where each succeeding retail project these days seems to set a new standard . . . the *Church Offices* of the Catholic Diocese of Seattle . . . and a whole portfolio on *New Houses and New House Units*. The latter is worth special attention on at least two counts. First, the house presentation is concerned with three-bedroom projects—a classification in line with our determination to make information more useful. Second, the units (*lounging*) include larger and more comprehensive detail drawings than heretofore. If you ask us, this new house department is finding its stride.

Rounding out the April menu, providing the vitamins and calories essential to well being, are a major study on *Steel* and footnotes on *Architectural Exhibitions* (East and West), *Concentration of Architects* in various states; Pratt Institute's *Architectural Clinic*, etc. Because of steel's import, because its potentialities in building have been only partially developed, and because the architect is one of three factors responsible for its future role in building, we rest our case on the April issue by declaring, unequivocally, that *Steel* is *required* reading.

Public relations and you

It is increasingly apparent that architects believe the public should be made better acquainted with the advantages of architectural services, and that to expedite this some sort of co-operative action should be undertaken. Various organizations throughout the country are holding exhibitions of one kind or another (see pp. 81-83), and in almost every mail we get comments that are far more than straws in the wind.

Though this corner will have to yield to other RECORD departments for an adequate discussion of the whole broad subject of public relations, there is one relevant offer we want to put on paper before we forget it.

If you employ in your work some unusual method of getting on the good side of Mr. or Mrs. General Public, and want to pass it on to fellow practitioners, why not tell us about it? We're making a collection of such notes and thinking up ways and means to broadcast them. For example, one



Decorated with drawings by Schell Lewis of historic colonial buildings, including Independence Hall, Mt. Vernon, Monticello, and many others, the tea set illustrated above is being sold on its own merits by the Architects' Emergency Committee, 115 East 40 St., New York, N. Y., as a means of raising money for unemployed architects. The set is copyrighted and limited in number.

reader recently told us about a film of his own making that he uses to show prospective clients. If we can get our hands on that number, we'll have an illustrated item on it next month in *With Record Readers*. What have you to offer for a succeeding month?

Public relations (distaff side)

IN OUR efforts to get to the bottom of things, we're forever asking various architects with work on the boards the following question: "Aside from your own reputation, what factor would you

say was responsible for your getting this commission?" Sometimes we get a reply that tells us to mind our own business, and sometimes we get one that leaves us flat-footed and open-mouthed. Such a one came our way last month when we queried George Nemeny of New York concerning a recent assignment in Denver. He looked us straight in the eye and said: "Certainly! My *mother-in-law* recommended me highly and the principals were so nonplussed that they took her at her word!"

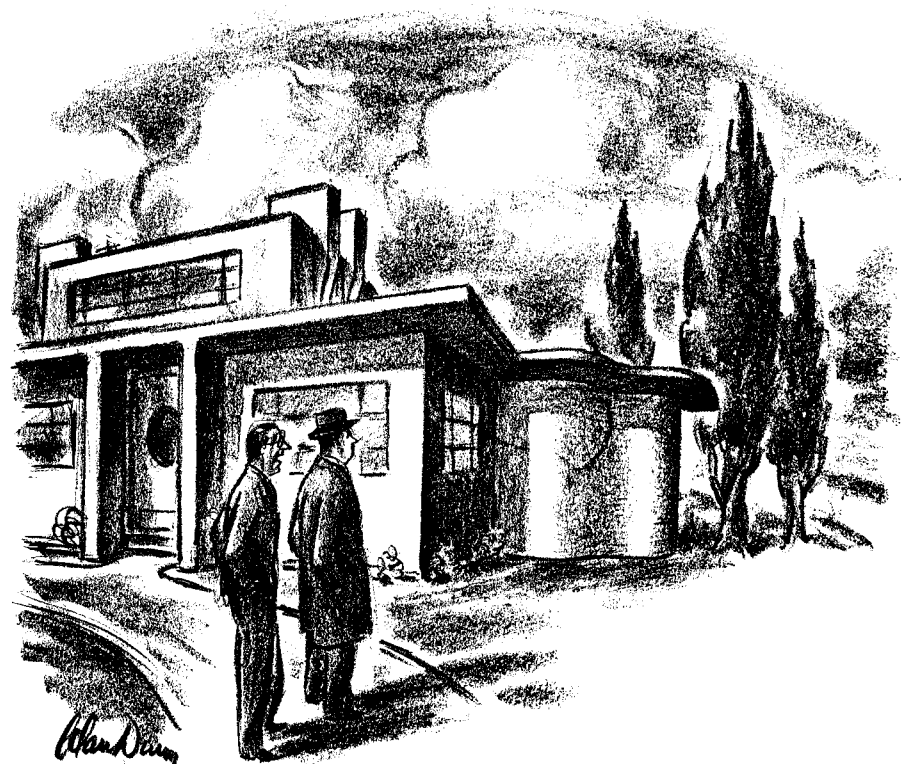

"I designed it from the inside out—the grand piano was quite a problem!"

—Drawn for the RECORD by Alan Dunn

WITH RECORD READERS



"Intern" Rauni Lampe gathers the case history of a client's building problem.



In the field, F. Treffeisen and J. Olson plan the procedure of a remodeling job.

Pratt Architectural Clinic Gives Experience to Students, Business to Architects

As a means of gaining the practical experience required in advance of State registration exams, the Pratt Institute Clinic not only benefits architectural students, but discovers and directs projects to architects already established in practice.

IN THE RECORD's survey of the status of recent architectural graduates (AR 3/40, pp. 81-87), 460 replies to the questions concerning registration, from graduates during the past four years, indicated that only 42, or 9%, of the respondents had passed their State examinations. Comments from the group not only emphasized the difficulty of obtaining the one to three years' of

practical experience required beforehand, but went on to describe the experience, once achieved, as not sufficiently comprehensive or stimulating, in many cases, to be of much value later on in private practice.

To bridge the gap between school and practice, the Department of Architecture (Cecil C. Briggs, Supervisor) of the Pratt Institute, Brooklyn, N. Y.,

has undertaken to provide and supervise such advance experience as a part of what it believes will be a more adequate educational policy.

Judging by the number of inquiries directed to magazines, certain information bureaus, etc., the school authorities recognized that the public has a great many problems which it feels are too small to bring to a practicing architect or which architects find they cannot profitably handle. These problems the Clinic undertakes to solve, with a number of advanced architectural students serving in a capacity similar to that of internes in the medical profession. A general information service is maintained in regard to materials, specifications, contractors' qualifications, and professional advice. Rough estimates are calculated. Questions asked in person or by mail, relating to the entire field of building, are answered without charge. For a registration fee of \$1, any particular building problem will be analyzed and a program of action laid out. If a project requires the services of an architect, on a profitable part or full-time basis, the client is so advised. Other jobs are carried through by the Clinic itself, on a non-profit basis, the client paying only the actual cost of the work done. Typical jobs include remodeling and repair work, minor commercial and residential structures.

It is hoped that through the performance of the Clinic, the public will be led to a sharper recognition of the architects' indispensability in building planning, and, further, to a fuller utilization of the profession's services. The "internes" themselves will profit not only in the direct application of their training to a broad variety of projects, but also in the opportunities for actual professional contact with clients, contractors, etc. They will learn to meet problems which other forms of "practical experience" might never raise for them.

Amplification of the program is planned, beginning next September, to include recent graduates from the Institute in the Clinic's operations. Four fellowships will be provided to cover the minimum expenses of selected holders of Bachelor of Architecture degrees, who will remain as "clinical internes." To be appointed by an Advisory Board of Architects and the

(Continued on page 10)

MAKE THIS TEST -
Prove **BRIXMENT** *is* **BEST!**



1

Slap a small amount of Brixment mortar, and an equal amount of mortar made with lime and cement, on a brick. Wait a minute, then feel each mortar.

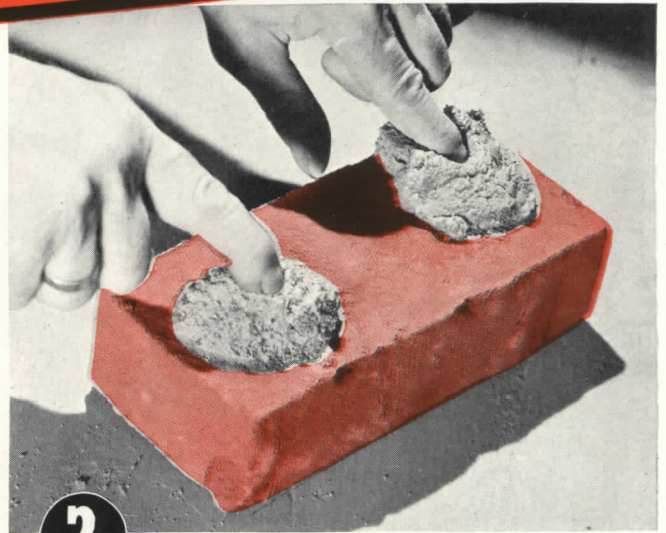

2

Test each mortar. You will find that the Brixment mortar stays plastic *far longer* than the other mortar. This proves *greater water-retaining capacity*.

BRIXMENT has Far Greater **Water-Retaining Capacity!**

WATER-RETAINING CAPACITY is the ability of a mortar to retain its moisture, and hence its plasticity, when spread out on porous brick. High water-retaining capacity is of *extreme importance* in mortar. If the mortar does not have high water-retaining capacity, it is too quickly sucked dry by the brick; the mortar stiffens too soon, the brick cannot be properly bedded, and a good bond cannot be obtained.

Brixment mortar has extremely high water-retaining capacity. It strongly resists the sucking action of the brick. Brixment mortar therefore stays smooth and plastic when spread out on the wall.

This permits a more thorough bedding of the brick, and a more complete contact between the brick and the mortar. The result is a better bond, and hence a stronger and more water-tight wall.



BRIXMENT

For Mortar and Stucco

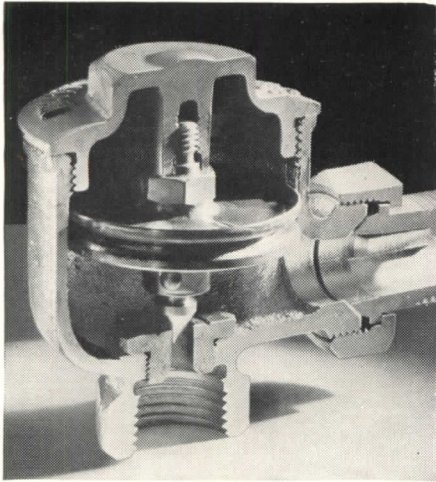

In this Webster Trap, valve piece and renewable seat are stainless steel. 60-degree cone and sharp-edged seat assure dirt-free operation. The rugged operating member is fully compensated for pressure.

It's part of a System

It is more than just a matter of ingenuity in design, generosity in materials, precision in manufacture and severity in tests—much more. The operating record of more than 1,700,000 Webster Thermostatic Radiator Traps is due in equal measure to a business policy of selling Webster Heating Systems—Webster Equipment coordinated for results.

In buildings of every type—department stores, office buildings, industrial plants, schools, hotels, apartment houses—Webster Thermostatic Radiator Traps are coordinated with other Webster Equipment to provide heating economy, comfortable indoor temperatures and minimum repair and maintenance bills.

As combined in Webster Systems of Steam Heating, Webster Thermostatic Traps, Radiator Supply Valves, Orifices, concealed Webster System Radiation and Webster Moderator and Hylo central heating controls are products of one manufacturer under undivided responsibility. Webster Service is available through Representatives in 65 principal cities. Consult your local telephone directory.

GET THIS BOOK . . .

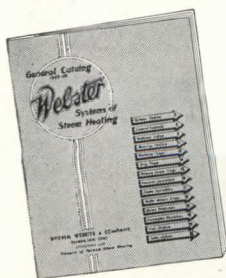

It gives ratings and dimensions of all types and sizes of Webster Thermostatic Traps. Illustrates and describes the various items of Webster Equipment used in Webster Systems of Steam Heating. Ask for the "General Catalog."

WARREN WEBSTER & CO., Camden, N.J.
Pioneers of the Vacuum System of Steam Heating
Representatives in 65 principal U. S. Cities :: Est. 1888

WITH RECORD READERS (Continued from page 8)

faculty of the Department of Architecture, these internes will not only gain the practical experience afforded by the Clinic but will be assigned to architects' offices and be given review courses before the State examinations. All work will be done under super-

vision of the Advisory Board and faculty members who are licensed architects. The Board will also decide whether any particular problem should be turned over to private architects. In no way will the supervisors allow competition with the profession.

Michigan Society of Architects Holds Twenty-Sixth Annual Convention



Left: B. V. Gamber, new president, Michigan Society of Architects. Center: K. C. Black, retiring president. Right: T. C. Hughes, reelected executive secretary

ARCHITECTS of Grand Rapids, Mich., were hosts on Friday and Saturday, March 15 and 16, to the Twenty-Sixth Annual Convention of the Michigan Society of Architects, pronounced one of the most successful and constructive in the Society's history. Seventy-one architects registered at the convention, and 81 producers or their representatives attended.

Following business sessions and committee reports on Friday, the following elections were held: *Branson V. Gamber*, president; *C. William Palmer*, first vice-president; *Emil Lorch*, second vice-president; *Roger Allen*, third vice-president; *Cornelius L. T. Gabler*, secretary; *John C. Thornton*, treasurer; and *Talmage C. Hughes*, executive secretary (Mr. Hughes is editor of the Society's Weekly Bulletin, now in its fourteenth year of publication—690 issues).

Clair W. Ditchy, *Alvin E. Harley*, and *Alden B. Dow* were elected directors at large. Other directors elected for the various divisions of the State Society were: *Branson V. Gamber*, Detroit; *Harry L. Mead*, Grand Rapids; *Edward X. Tuttle*, Battle Creek; *Adrian N. Langius*, Lansing; *James A. Spence*, Saginaw; *David E. Anderson*, Marquette; and *William D.*

Cuthbert, Ann Arbor. It is expected that since Mr. Gamber was elected president of the Society, a successor will be named to fill his term of office as director from the Detroit Division.

Friday activities were climaxed in the evening by a smoker. "The entertainment," say reports, "was outstanding." President-elect Gamber performed in his first ex-officio capacity by leading the singing.

Saturday, the new board of directors met and President Gamber outlined before them a work program for the coming year. At the Saturday business session, *Clair W. Ditchy*, Regional Director of the American Institute of Architects, outlined the Institute's proposed program for unification (see article following).

At the banquet Saturday evening, concluding event of the convention, Mr. Gamber took over the gavel from retiring president *Kenneth C. Black*, who in his valedictory expressed appreciation and gratitude to the retiring directors and other officers of the Society, commented on the AIA's unification program, and proposed the launching of a "planned program of public education." Mr. Black urged the incoming board of directors to ap-

(Continued on page 12)

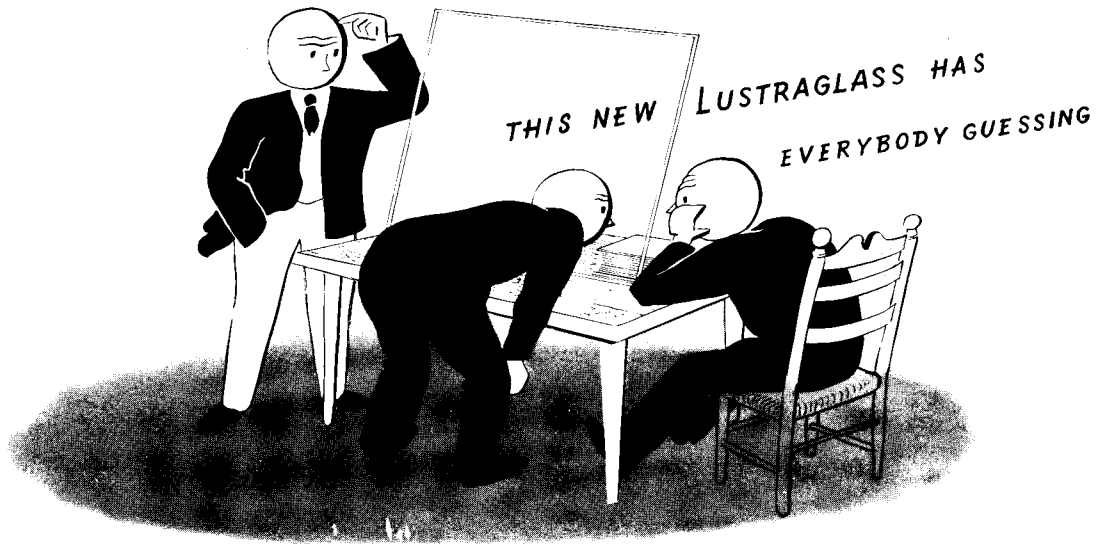

what would you call it ?

you can't call it window glass

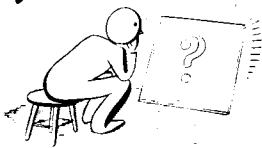

... because it is practically free of that waviness and consequent distortion which distinguish window glass from plate.

and you can't call it plate glass

... because it is not made by the plate glass process and, although it looks like plate, it sells at window glass prices.

Experts who have seen this new Lustraglass agree that it represents the greatest forward step in the history of sheet glass making . . . Years of intensive research created it. It cost thousands of dollars to perfect it . . . Its jewel-like luster, ultra-violet ray transmission and "whiteness of metal" alone place it above competition. And now add to these its plate-like appearance, freedom from distortion and low price, and you have a sheet glass that demands the immediate attention of every architect and builder.

AMERICAN WINDOW GLASS CO., PITTSBURGH, PA.

Manufacturers of Plexite, the safer safety glass; Lustrablur and Lustragold for ornamental uses; Crystal Sheet, Chipped and Special Glass for industrial purposes.

THE SHADOWGRAPH TELLS THE STORY

by amplifying distortion and defects 20 times



(1) This is high quality cylinder drawn window glass. The bent and twisted lines shown by the shadowgraph testing device indicate the presence of considerable distortion. This glass became obsolete in 1928.



(2) Here is what most manufacturers offer today as top quality window glass . . . Made by the sheet drawn process, it shows a characteristic distortion in the waviness of the black lines.

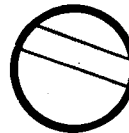

(3) Now look at this "shadowgraphed" sample of the new Lustraglass. Obviously an important improvement. The lines are straight, showing relatively perfect vision—freedom from distortion.

Write for the new Windowgraph Slide Rule Chart and a sample of the new Lustraglass. Examine both—then tell us what you think.

THIS NEW TYPE OF
LUSTRAGLASS
 The Ultra-Violet Ray Window Glass

LOOKS LIKE PLATE GLASS—SELLS AT WINDOW GLASS PRICES

Only SISALKRAFT OFFERS THESE ...MULTIPLE USES ...EXTRA VALUES

- 1 SIDE WALL PROTECTION** Over all sheathing, to provide positive protection against air, moisture and dust infiltration.
- 2 FLASHING** Sisalkraft is pliable, waterproof, tough, effective as a flashing around door and window openings.
- 3 UNDER FLOORS** Laid as a dry sheet under finish flooring, Sisalkraft helps to check buckling, warping and basement air and dust infiltration.
- 4 MOISTURE BARRIER** A vapor seal of Sisalkraft applied behind the plaster base of side walls, is an effective barrier against condensation.
- 5 CONCRETE CURING** Waterproof and air-proof, Sisalkraft applied over fresh concrete, retards rapid evaporation—assures a hard, smooth concrete.
- 6 OVER SUB-FILL** A sheet of Sisalkraft over sub-fill keeps finish floors dry at or below grade.
- 7 PROTECTING FLOORS DURING CONSTRUCTION** Sisalkraft over finish floors, stairs, woodwork, protects against stains and damage.
- 8 PROTECTION OF MATERIALS** A covering of Sisalkraft assures materials being kept in condition for satisfactory performance in the job.

These are but a few of the multitude uses for Sisalkraft—more than a building paper. Write for complete file of information on this unusual material.

The **SISALKRAFT Co.**
205 W. Wacker Drive, Chicago, Ill.
New York • San Francisco



WITH RECORD READERS (Continued from page 10)

point a committee for this purpose: ". . . to prepare copy for speeches, radio interviews, and newspaper releases to be furnished to local groups for their use." He also advocated that: "Architectural exhibits should be arranged and sent throughout the state, and every effort should be made to acquaint the public with the value of an architect's services."

Dean *Walter R. MacCormack* of the Department of Architecture, MIT, and vice-president of the AIA, was guest speaker at the banquet. Among other topics, he emphasized particularly the opportunities, greater than ever before, for American leadership in world architecture.

Unification Program to be Submitted to AIA Convention in May

ANNOUNCEMENT has been made by AIA President *Edwin Bergstrom* of a comprehensive program for the unification of the architectural profession which will be submitted for adoption by the American Institute of Architects at the Institute's seventy-second convention in Louisville, Ky., May 21 to 24.

The program will be submitted in the form of amendments to the Institute by-laws. The formal presentation has been drawn up by a committee of the AIA's Board of Directors, consisting of *Frederic A. Fletcher* of Baltimore, chairman of the committee on state organization; *Clair W. Ditchy* of Detroit, chairman of the committee on unification, and *Charles T. Ingham* of Pittsburgh, secretary of the Institute.

"If the recommended bylaw changes are adopted," says a statement by Mr. Fletcher, "the profession will at last possess the machinery necessary to bring all practicing architects together in one national organization without working injury to the old, well-established, and well-tried organization and procedures of the Institute, and yet preserve the State Association member as an entity within its own particular territory."

The program, it is explained, should encourage a greater number of State Association memberships and the establishment of regional associations, or councils, long advocated by the Institute. It will increase the ultimate representation of the State Association

members in the Institute conventions from a maximum of 100 votes now permitted under the bylaws when there are forty-eight State Association members, to a possible 188 votes.

Also, under the proposed program, the annual dues to be paid by each State Association member of the AIA are \$1 per voting member within the Association, based on the number of the Association's dues-paying members or associates who have paid their dues, in part or in whole, levied for the year immediately prior to the year for which the Institute dues are payable.

Organization of a regional council within each regional district of the Institute is recommended. The Council's membership would consist of the Institute Chapters and the State Association members within the district, each of which would be represented at meetings of the Council by representatives elected by it. The Chapters of the district, in the aggregate, and the State Association members of the district, in the aggregate, would be equally represented on the Council, which would be an unincorporated nonprofit membership association under the direction of the Institute's regional director for the district. Each regional council would hold at least one meeting a year.

The duties of each regional council would be to consider matters relating

(Continued on page 122)

CALENDAR OF EVENTS

- **April 12-13**—First Housing Conference, Department of Architecture, University of Texas, Austin, Tex.
- **May 1-3**—Spring meeting, American Society of Mechanical Engineers, Hotel Bancroft, Worcester, Mass.
- **May 4-12**—Fifth Annual Home Show, National House and Garden Exposition, Coliseum, Chicago, Ill.
- **May 15**—Final date, reception of applications for Kate Neal Finley Memorial Fellowship in Architecture, Art, or Music. Information may be obtained from Dean Rexford Newcomb, College of Fine & Applied Arts, University of Illinois, Urbana, Ill.
- **May 21-24**—Seventy-second convention, American Institute of Architects, Louisville, Ky.
- **June 1**—Final date, reception of applications for Cranbrook Academy of Art Scholarships. For further information address *Richard P. Raseman*, Executive Secretary, Cranbrook Academy of Art, Bloomfield Hills, Mich.
- **June 3-5**—Convention, National Warm Air Heating & Air-Conditioning Association, Palmer House, Chicago, Ill.



How would you write the **IDEAL** heating spec.?

SOMETHING LIKE THIS, WE'LL GAMBLE —

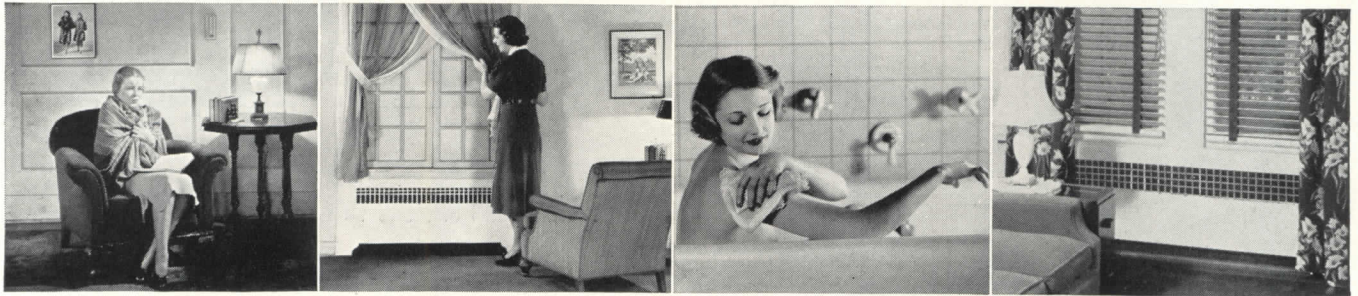

No "Cold 70"—no violent fluctuation of radiator temperature

Radiators must at all times supply **EXACTLY** enough heat to offset heat loss of building

Provision must be made for year 'round domestic hot water at lowest possible cost

Radiators must be small for easy concealment and system must be extremely economical in operation

HOFFMAN

Hot Water

CONTROLLED HEAT

MEETS THESE REQUIREMENTS TO THE LETTER!

Never before have you been able to specify *and get* a heating system which so closely approaches your ideal in heating comfort . . . or at so low an operating cost! Hoffman Hot Water Controlled Heat positively smooths out all the variations in room temperature previously beyond control.

These results are obtained by a dual temperature control of hot water *continuously circulated* through the radiators. The circulating water is accurately and automatically regulated to the degree which *exactly* compensates for the heat loss of the building. Any temperature desired will be maintained to a hair's breadth.

The three basic units of Hoffman Hot Water Controlled Heat are adaptable to any type of automatically-fired hot water boiler. By designing the system for high BTU emissions, radiators can be kept small and easily concealed. Besides, the system is made-to-order for indirect domestic water heating — known for economy in producing an ample supply, summer and winter.

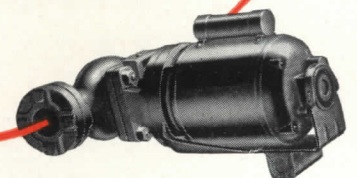
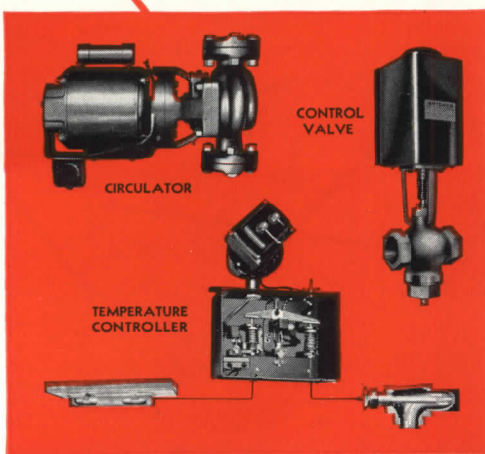

For detailed information, send today for Hoffman literature fully describing this unusual system. Hoffman Specialty Co., Inc., Dept. AR-4 Waterbury, Conn.

Hoffman Hot Water Controls, Valves, Traps and Pumps are sold everywhere by leading wholesalers of Heating and Plumbing Equipment.



Cordell Studio

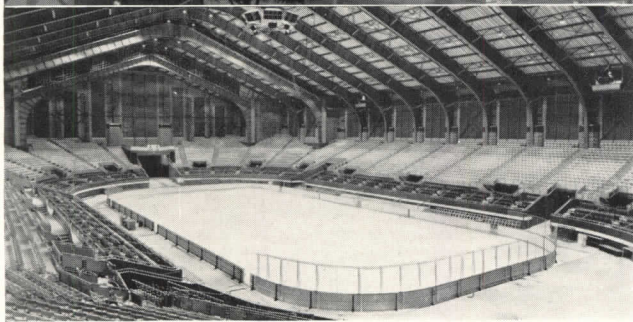

TWELVE VOTES: Indianapolis Coliseum; top, exterior; above, interior. Architects were Russ and Harrison.

Indianapolis Citizens Vote Coliseum Outstanding Building

EFFORTLESSLY magic carpeting two thirds of a nation, the Record poll settles this month over Indianapolis, where the new Coliseum at the State Fair Grounds shows forth with most "lay" citizen votes as the city's outstanding recent building. Since many of the voters called particular attention to the interior, we include an inside shot (left), showing the arch-type, stiff-frame steel roof over the arena, which can be converted almost by sleight-of-hand from an ice rink to a three-ring circus.

All the buildings on this and the overpage are pictured on the basis of votes received from the following "lay" (non-architect) citizens of Indianapolis: *Julian Bamberger*, attorney; *C. A. Berry*, trust officer; *William H. Book*, Chamber of Commerce executive; *James C. Carter*, M. D.; *R. C. Cashon*, engraver; *Lloyd D. Claycombe*, attorney; *D. H. Collins*, advertising executive; *R. L. Dickson*, railroad publicity agent; The Reverend *John B. Ferguson*; *John P. Frenzel, Jr.*, bank executive; *Kenneth P. Fry*, real estate; *W. A. Hanley*, engineer; *W. H. Insley*, manufacturer; *Jacob L. Jones*, head of high school building-crafts dept.; *A. D. Lange*, publisher; *Walter I. Longworth*, manufacturer. Chamber of Commerce president; *E. H. Kemper McComb*, high school principal; *Gordon B. Mess*, President, Indiana Artist Club; *Wilbur D. Peat*, museum director; *Frederick*

(Continued on page 16)

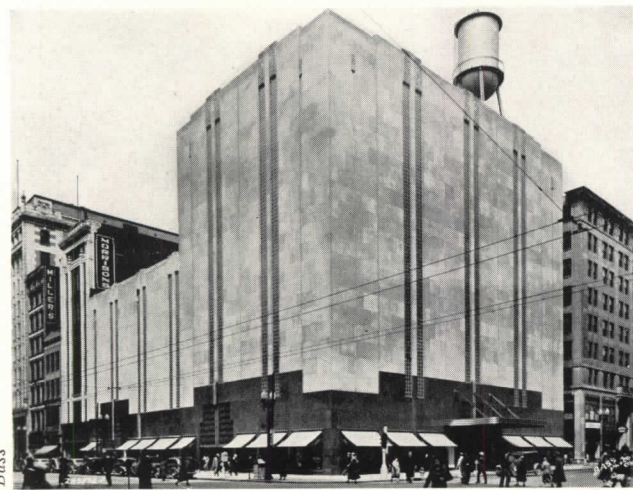

Bass

EIGHT VOTES: the H. P. Wasson and Company Department Store. Rubush and Hunter were the architects.

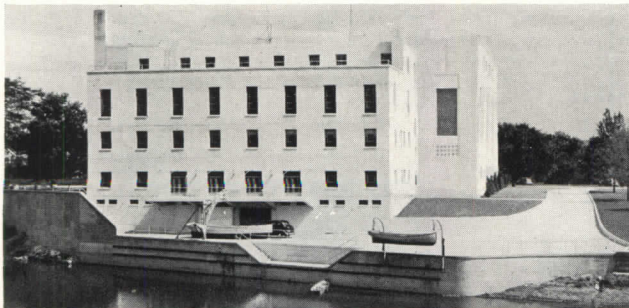

EIGHT VOTES: Naval Armory; B. H. Bacon and John P. Parrish, Architects; constructed as a WPA project

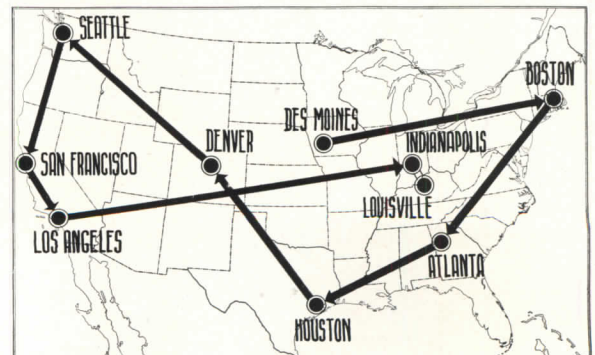

Courtesy American Map Co.

Next hop will be to Louisville, Ky.

"Big business"
ROOF ECONOMY AVAILABLE FOR BUILDINGS OF
any size - any budget

Universal Atlas Cement Co., Leeds, Ala. General Office Building, with roof area of less than 4000 sq. ft., covered with Featherweight Precast Concrete Roof Slabs. Archts., Warren, Knight & Davis; Contrs., Daniel Construction Co., both of Birmingham.

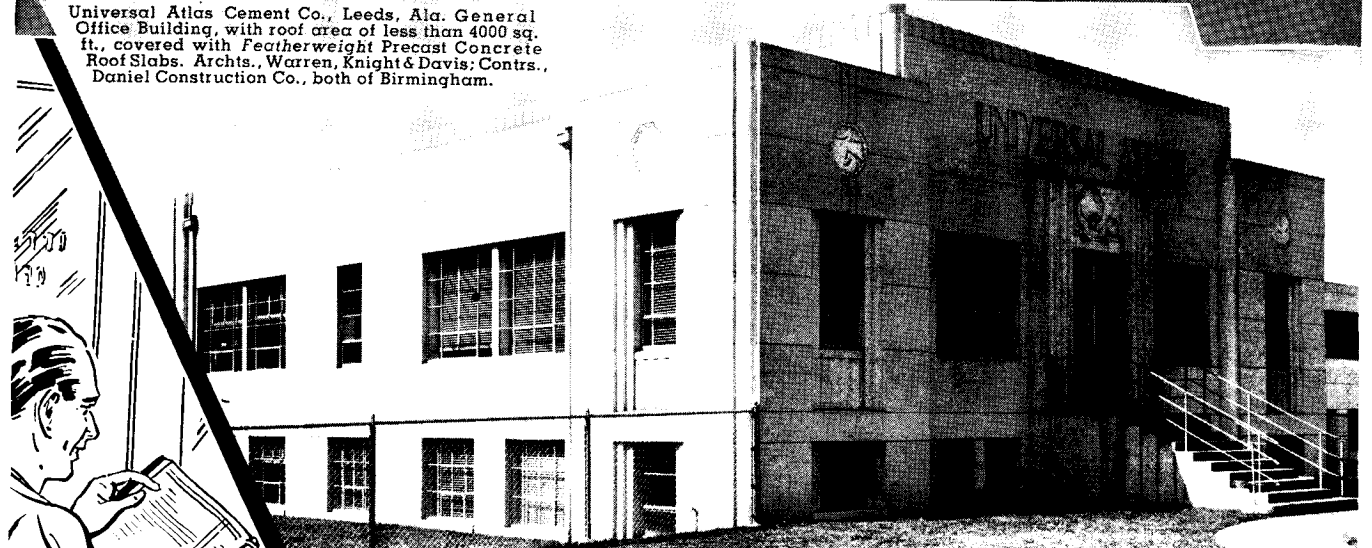

Coca Cola Bottling Co., Milwaukee, roofed with 34,200 sq. ft. of Featherweight Precast Concrete Slabs. Archts., Geo. Schley & Sons, Milwaukee; Contrs., Oliver Wierdsma, Inc., Wauwatosa, Wis.

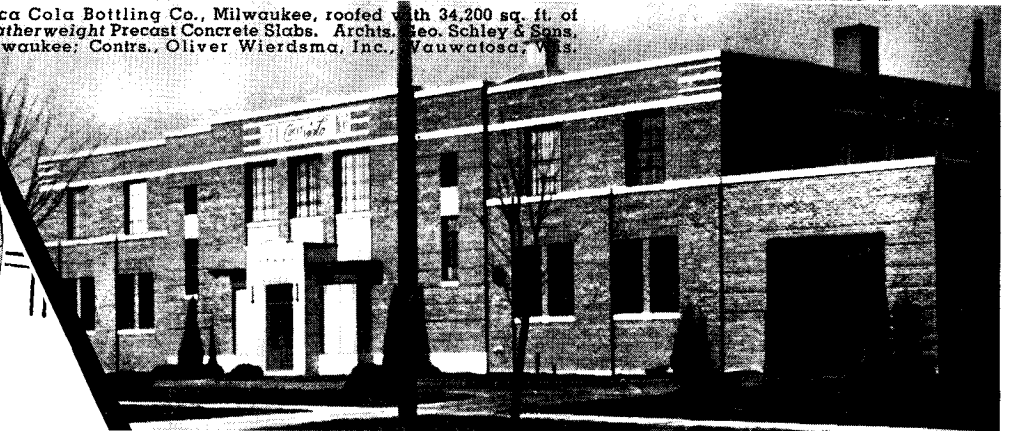

Featherweight **Precast Concrete Roof Slabs**

Although the list of Federal Roof users reads like a Blue Book of industry and includes the largest and most prominent concerns in the country, it also embodies thousands of medium size and smaller companies, who have enjoyed the same high degree of roof economy on smaller buildings.

Size of project or area of roof makes no difference whatever in the results obtained from a Featherweight Precast Concrete Roof. Each job, regardless of size, is individually detailed and fabricated to suit the exact conditions, and the slabs come to the job ready to lay on the roof purlins, without cutting or other field work.

FEDERAL-AMERICAN CEMENT TILE CO.

608 So. Dearborn St. Chicago, Ill.
 Sales Offices in Principal Cities - For Over Thirty Years

They go on the same light steel frame that carries other roofs — are fireproof and last a lifetime without a dollar of expense for painting, repairs, or replacements.

NAILING CONCRETE SLABS available for securely holding an ornamental roof; also **RED INTERLOCKING SLABS**, requiring no composition covering. Catalog and Details on request.

Indianapolis Citizens Choose Outstanding Recent Buildings

(Continued from page 14)

Polley, author-artist; *H. L. Sears*, executive; *Harry G. Templeton*, State Fair manager; The Reverend *F. S. C. Wicks*, D.D.

Honorable-mention group (buildings receiving more than one vote but less than those pictured): Allison Plant Administration Building (Austin Engineering Co., Architects; J. Lloyd Allen, Associate); Electric Steel Castings Co. plant (Foster Engineering Co., Ltd.); Fletcher Avenue Savings & Loan Association Building (D. A. Bohlen & Son); Fourth Church of Christ Scientist (Foster Engineering Co., Ltd.); Fry residence (Maurice E. Thornton); Howe High School (McGuire & Shook); Kesslerwood Homes (Maurice E. Thornton); Moore Peace Chapel (Leslie F. Ayres); Fred Morgan residence (Smith & Hoagland); Post Office Addition (Louis A. Simon, Supervising Architect; Neal A. Mellick, Supervising Engineer; McGuire & Shook, Rankin & Kellogg, Associated Architects); remodeled Woolworth Store (E. H. Anderson, Woolworth Co., Architect; D. A. Bohlen & Son, Associate Architects).

In the May issue, as a sort of curtain raiser to the AIA convention, the Record will publish pictures of a number of historical buildings in the Louisville, Ky., area (the convention's locale), balanced by an equal number of recent architectural examples. A group of architects will choose the former, while, as usual, a panel of "lay" citizens, recommended by architects, will nominate recent buildings which in their opinions are noteworthy.



SIX VOTES: Parkmoor Restaurant; Foster Eng. Co., Archs.



SIX VOTES: Merchants' Bank Br.; D. A. Bohlen & Son, Archs.

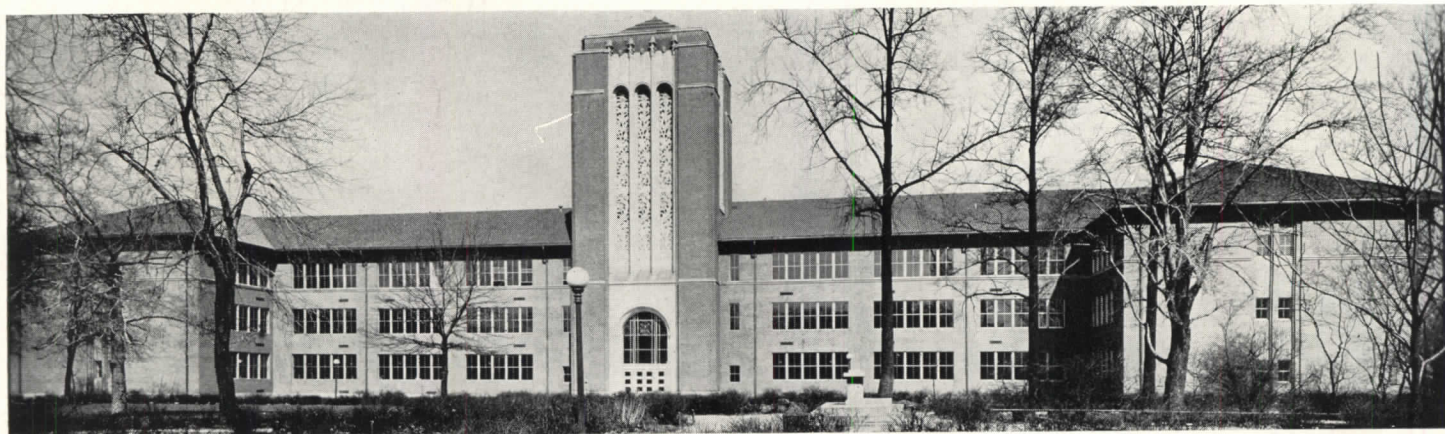

FIVE VOTES: Stuart Building, Arsenal Tech High School; Pierre & Wright, Archs.; D. A. Bohlen & Son, Supervising Archs.



FOUR VOTES and . . .

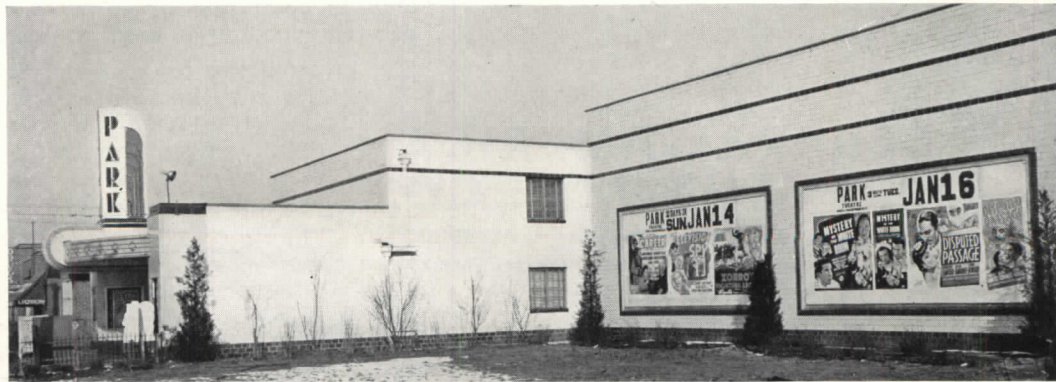

FOUR VOTES: left, Vogue Theater; E. Stenbeck, Arch. Above, Park Theater; M. Thornton, Arch.

NEW COLLEGE OF ARCHITECTURE AND FINE ARTS COMBINED WITH A NEW ART GALLERY IN LOS ANGELES

Many an architect will talk far into the night about what is wrong with architectural schools and their curricula (see AR 3/40 for opinions of recent graduates). Few, though, have the opportunity of designing the physical plant for an architectural school from scratch. In the new building group for the University of Southern California, Los Angeles, Architect RALPH C. FLEWELLING had just that opportunity. More than that: the group consists not only of the new College of Architecture and Fine Arts (May Ormerod Harris Hall, but the new Elizabeth Holmes Fisher Art Gallery as well—two important additions to the University campus, united in a single structure because of the close relation between their functions.

Photos by Fred R. Dapprich



BUILDING NEWS

FINE ARTS BUILDINGS

RALPH C. FLEWELLING, Architect

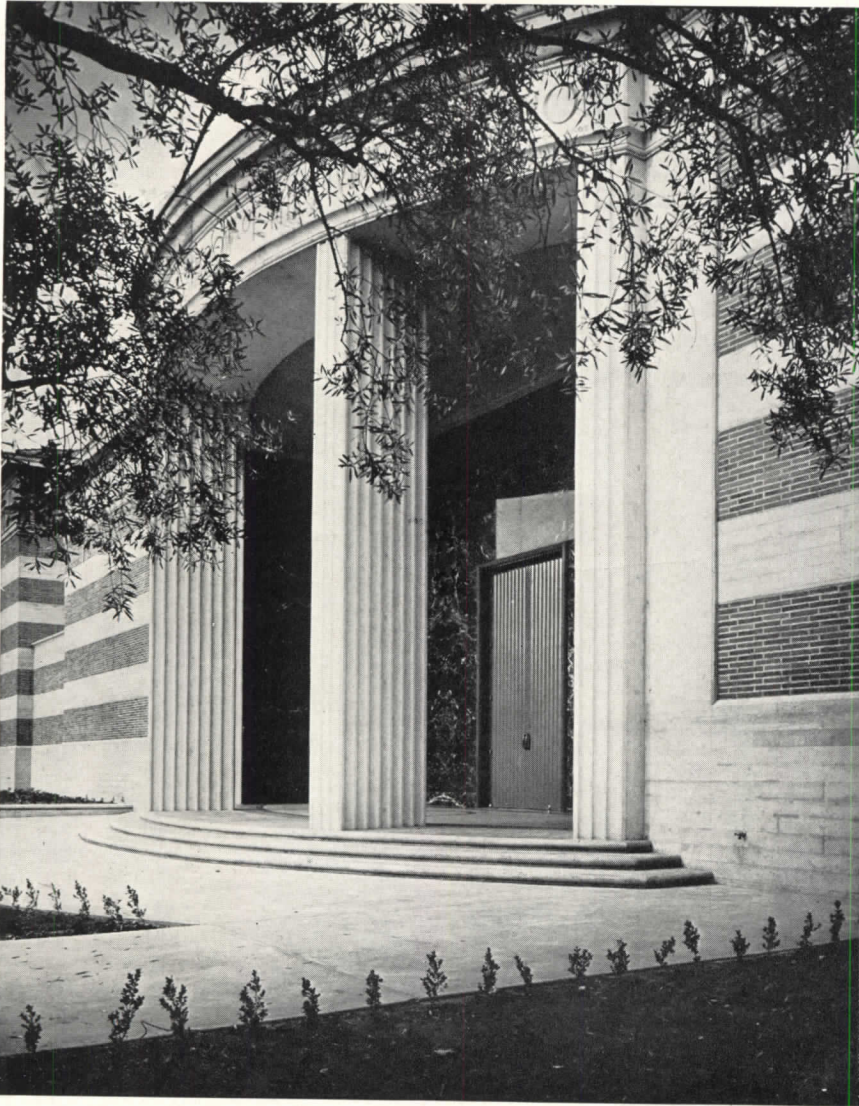

Photos by Fred R. Dapprich

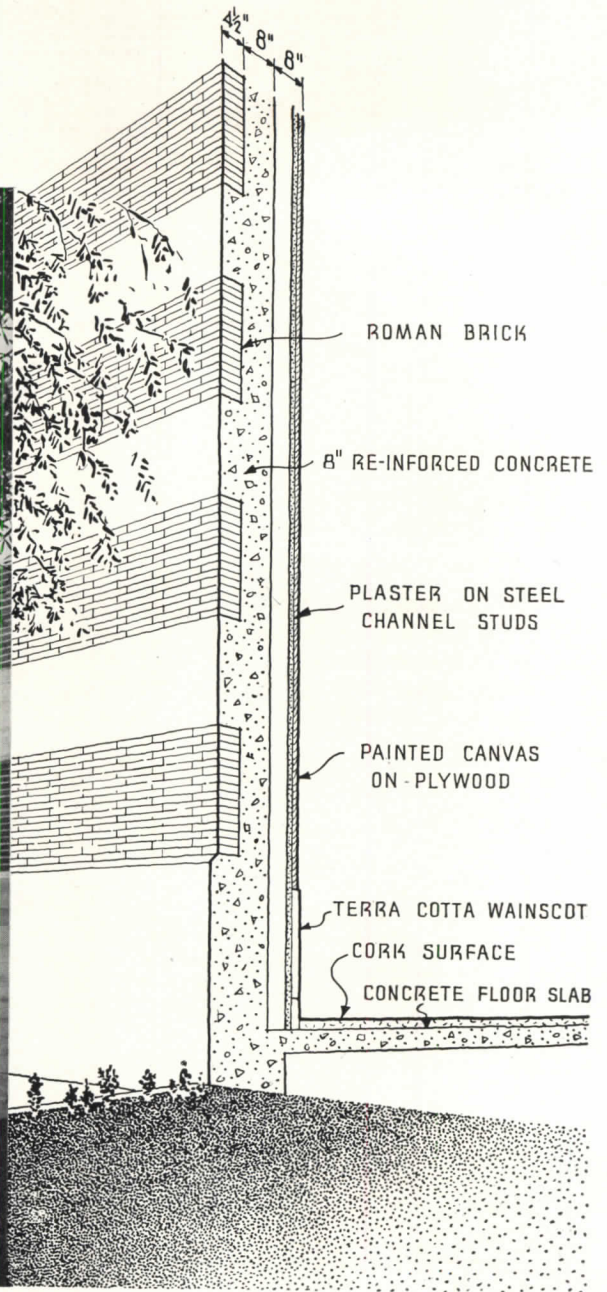

EXTERIOR WALLS of the fine-arts group consist of horizontal bands of red brick relieved by broad bands of unfinished concrete in a warm pink-gray tone. Actually these light bands are projecting ribs integral with the true reinforced-concrete walls of the structure, as shown in the detail of the gallery entrance portico above. In the main courtyard, just below the roof line of the two-story portion of the building, is an incised fresco depicting the history of culture in civilization. The only purely decorative feature of the building, it is the work of Barse Miller.

The plan of the group is roughly that of a chunky letter A. One leg of the A—the one bordering the street—contains the Fisher Gallery, the entrance to the architecture and art school with its attendant offices, two classrooms, and the 225-seat assembly hall. The top of the A consists of general and

industrial design studios and a crafts workshop. The cross bar of the A is the art library. In the other leg of the letter—toward the north—are a large drafting room and a series of sculpture study rooms. These various elements are connected by either courtyard colonnades or short interior corridors. The small court between the dean's office and the gallery is used in connection with social functions.

In the art gallery all light is artificial. The central portion of the ceiling in each of the three rooms is dropped, and the lip so formed conceals the light source. Horizontal metal fins break up the light which is directed solely at the walls. The gallery walls, which are furred out from the masonry, are of plywood, covered with canvas and painted. In gallery rooms, these false walls cut the corners at an angle, forming convenient spaces for vent ducts.

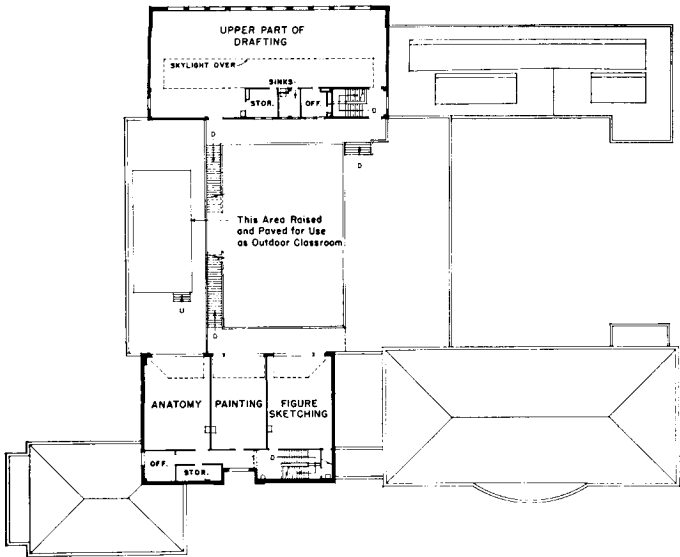

Second floor: in both the upstairs drafting room in the far wing and in the studios in the near wing, the long northern window walls are supplemented by overhead skylights. Between these two second-floor areas, a sizable portion of the roof is finished for use as an out-of-door classroom.

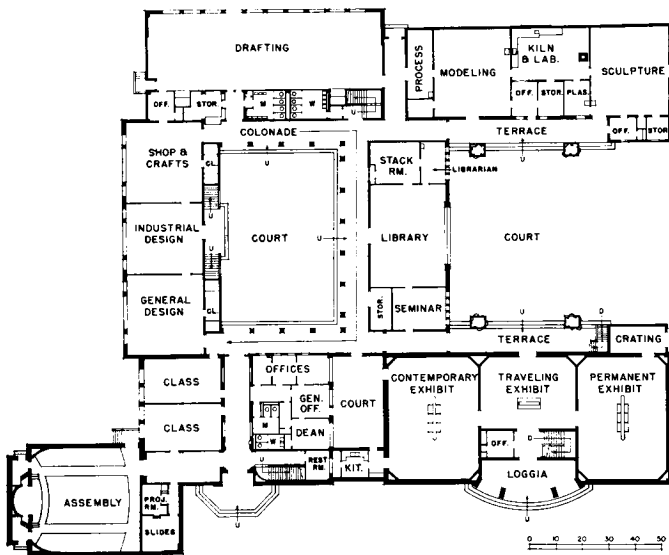

First floor: the entrances to the college (at left) and the art gallery (right) are the only openings in the exterior wall, facing the street. Circulation between the various parts of the school and between school and gallery is by means of courtyard colonnades. Drafting-room windows face north.



At right, above: looking from the art-school court through the portico into the main corridor leading to the entrance to the school. The photo at bottom is just the reverse, showing the modern colonnade that surrounds the court and takes the place of long interior corridors. Note the wall display case, with exhibit of students' current work.

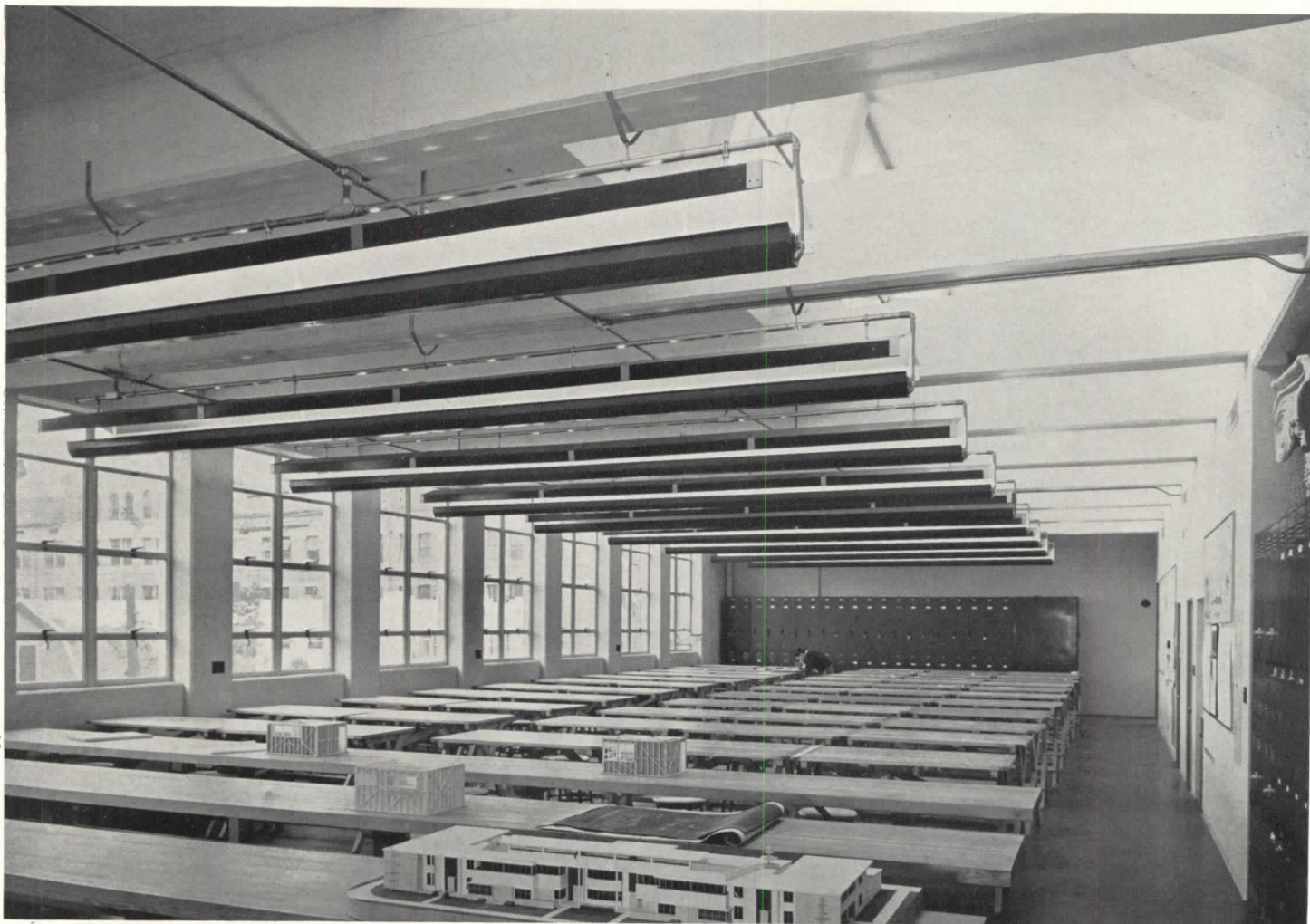

In the second-floor drafting room, both windows and skylights face north. Artificial light is provided by fluorescent tubes.

At right, the library. By using a two-level stack room, this area is segregated in one corner, leaving space for a large window in the east wall, overlooking the courtyard. On the page opposite, at bottom, is shown the lecture-assembly hall. To provide illumination which permits students to take notes while slides are being shown, the screen is recessed so that no direct light falls on it. The hall lighting fixtures provide some indirect illumination, but are also equipped with large ground-glass lenses to throw light directly down onto the seats, which have folding tablet arms. Fluted walls break up echoes, and the ceiling is surfaced with sound-absorbing plaster; the aisles are finished in cork.



Fred R. Dapprich

FINE ARTS BUILDING

RALPH C. FLEWELLING, Architect

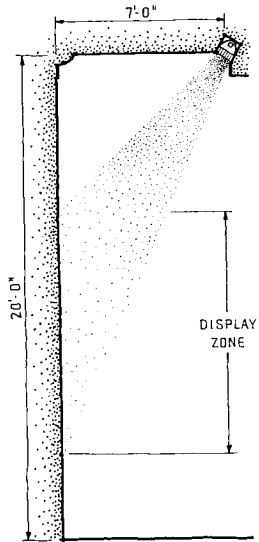

One corner of the art gallery. The detail above shows the directional scheme for focusing light.

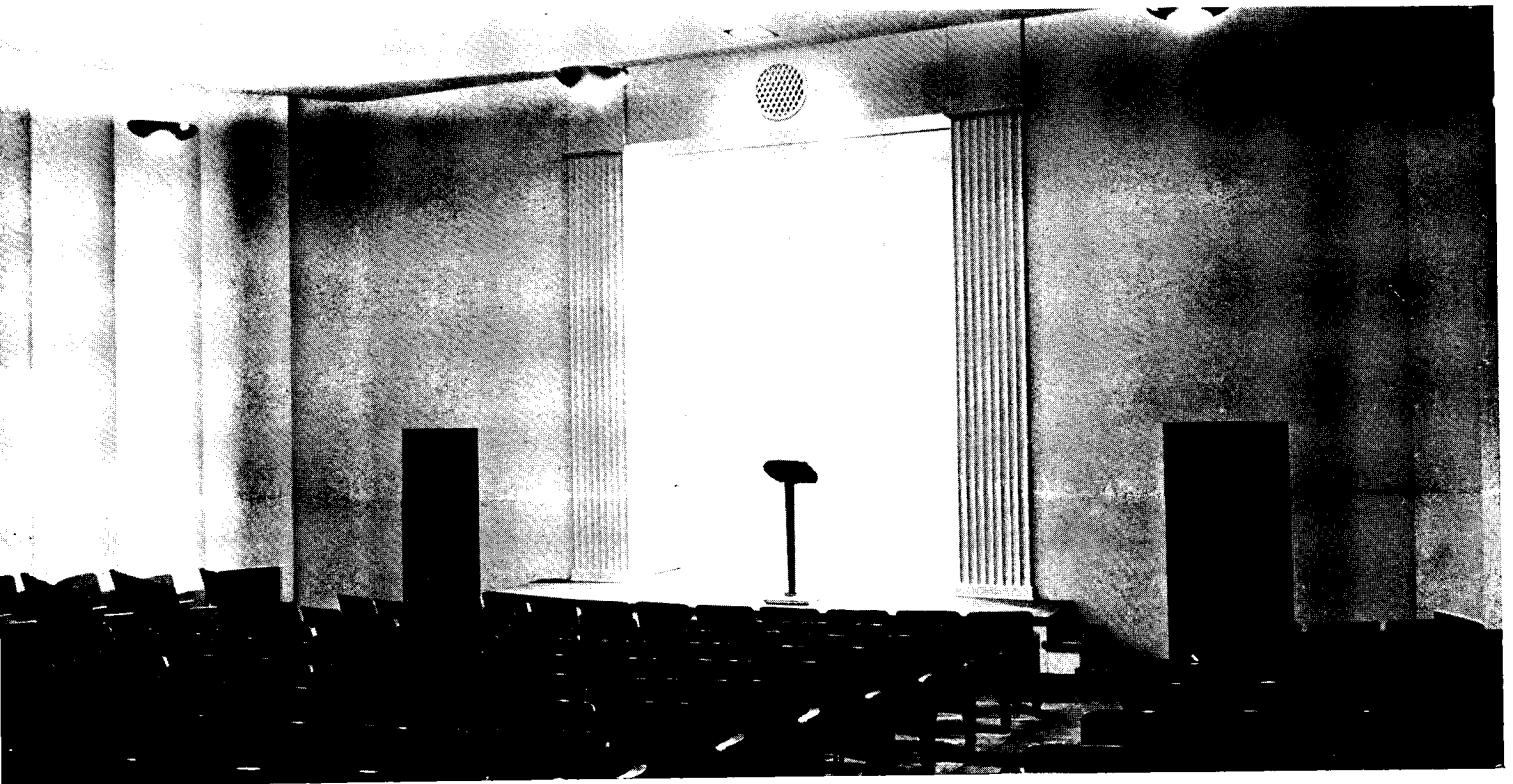



NEW MULTI-USE FIRE STATION AT MIAMI BEACH

In designing the Dade Boulevard Fire Station, Architects ROBERT LAW WEED and EDWIN T. REEDER had to provide for four major services: (1) two fire companies, (2) the city's fire-alarm central, (3) a central training station, (4) a residence for the fire chief. Located at the intersection of two thoroughfares and facing the bridge leading to 23rd Street, the site is strategic for such a combined-use headquarters. Separation of the four services into distinct but integrated buildings, plus the dominating training tower, is a realistic solution to the fourfold nature of the problem. The distinctive design of the tower arises directly out of the specialized needs which it serves, outlined on succeeding pages. The residential character of the group as a whole results from recognition of the restricted residential neighborhood adjoining the station.





Photos by St. Thomas

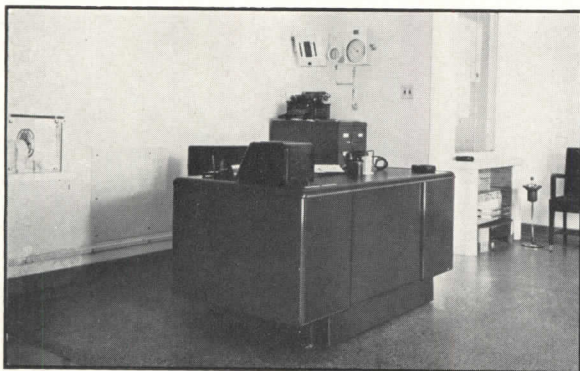

Above: the main control desk from which an officer receives, directs, and relays calls and alarms from all sources. At right, in order: the tile-walled apparatus room, the fully equipped machine and repair shop, and the second-floor dormitory for 14 men



MIAMI BEACH FIRE STATION

ROBERT LAW WEED and EDWIN T. REEDER, Architects

ON THE FIRST floor of the central unit are the control office, apparatus rooms, storage room, and toilets. From the control room, a single officer directs alarms, telephone calls, police radio, etc. On the second floor are the dormitory, captain's quarters, lounge room, lockers, and toilet and bath facilities.

At the rear of this central unit is the six-story drill tower. The two back faces contain pairs of windows at each level which are used for training in the use of hook and ladder and similar equipment. One corner of the tower is open to its entire height. Here, long hoses are suspended for drying. In another corner are fire boxes at each floor and a flue with dampers, for studying the action of drafts and smoke.

The first floor of the left-hand wing of the group is a machine and repair shop. Entrance to this area is from the rear of the building. The city's central alarm system occupies the second floor of this wing and is entirely separate from the rest of the building, with its own entrance door on Dade Boulevard. The right-hand building is a compact residence for the fire-department chief.

The entire group is fireproof, with a concrete frame and walls of brick and hollow tile. Floors throughout the building are reinforced-concrete slabs finished in terrazzo (main building), cement (alarm and service), or cement-tile and wood (residence wing). Walls in the apparatus rooms, storage rooms, and toilets are surfaced with vitreous tile. Incidental heating in the building is provided by gas space heaters.

Deck floor of tower

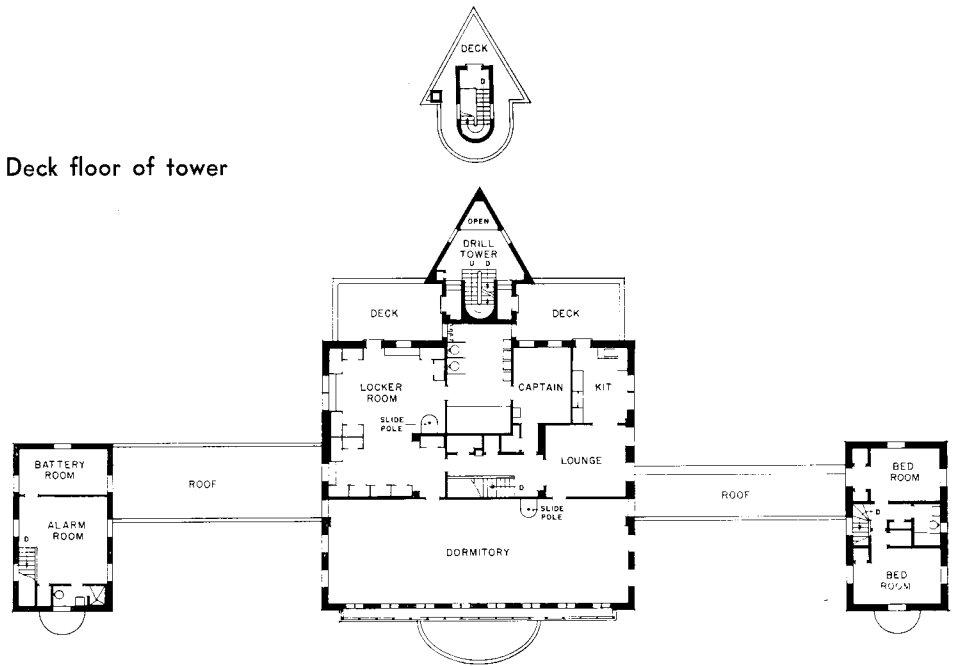

Second floor

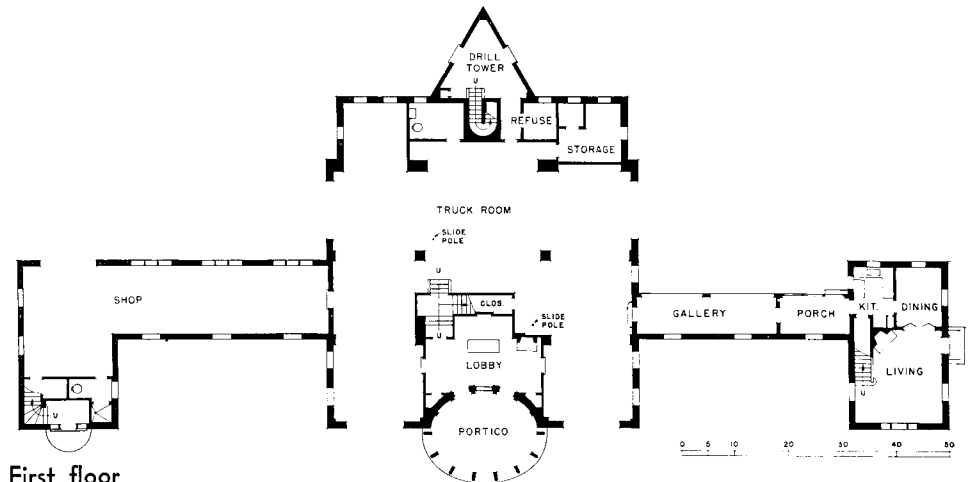

First floor

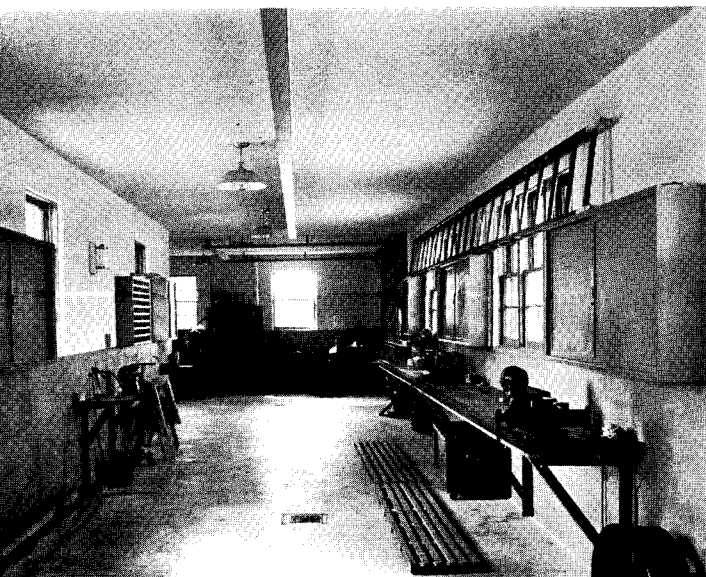

MIAMI BEACH FIRE STATION

ROBERT LAW WEED and EDWIN T. REEDER, Architects

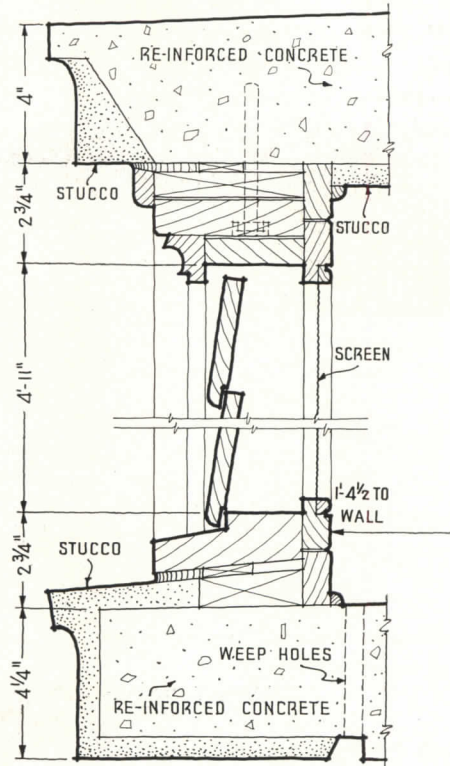

Detail of the adjustable louvered shutters outside the dormitory windows, shown in the photo at left



Photos by St. Thomas

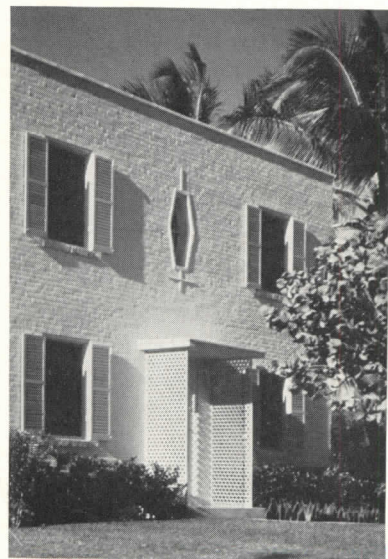

Left and above: the fire chief's residence. Although connecting directly with the rest of the building, by means of an open gallery and porch, the residence is a completely independent unit.

3-IN-1 STORE PLUS SPACE FOR RENT

The problem involved in remodeling two old New York City garages into this modern retail store, according to Architect JOSEPH D. WEISS, was "to design a building to house a music, camera, and sports equipment store with some space on the street level allotted to a separate store for rent".

THE ORIGINAL building on the left was a three-story garage; the one on the right, two stories. In remodeling, Mr. Weiss was able to retain the original floor levels and carrying walls. The first floor of the left-hand structure became the store for rent. All of the rest of the building is occupied by Rabson's various departments.

Plans and photographs on the next two pages show the organization of the display and shopping facilities. In general, the first floor is devoted to photographic equipment; on the second floor are provisions for sale of records, sheet music, luggage, seasonal sporting goods, pianos, radios, victrolas, and electrical appliances. The third floor consists of the service and shipping department, over the left-hand half of the building. The right-hand side at this level is a long open roof deck. This is later to be converted into a ski slide for winter demonstration and a golf-drive practice range for the summer months.

The front walls of the store are Indiana limestone over brick; the roof is smooth-finish built-up asbestos roofing. Store fronts and sash are of stainless steel. On the first floor, the floors are terrazzo with aluminum division strips; elsewhere floors are of maple.



Robert Damora

NEW YORK MUSIC AND CAMERA STORE



Display racks and record booths face . . . the record library and sales section and . . . shelves where albums may be inspected.



Cantilevered stair to the second floor

Camera sales on the first floor

Counter for darkroom equipment

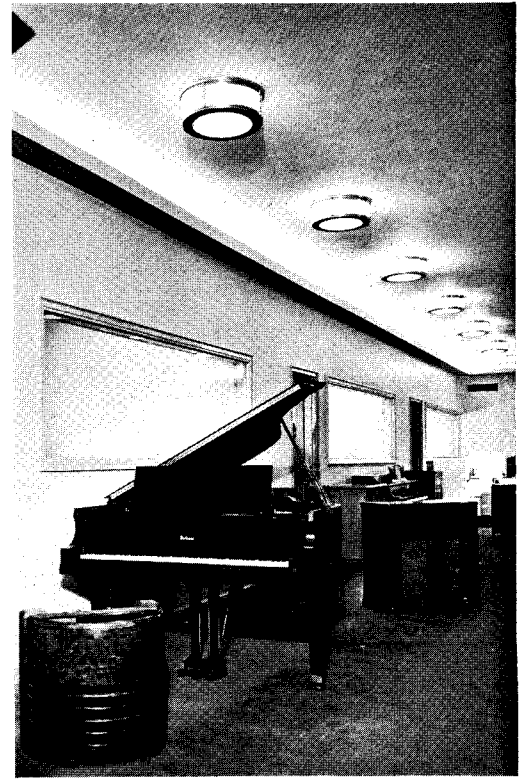

The luggage shop adjoins . . . the sporting-goods section, next to . . . the piano and radio display area.

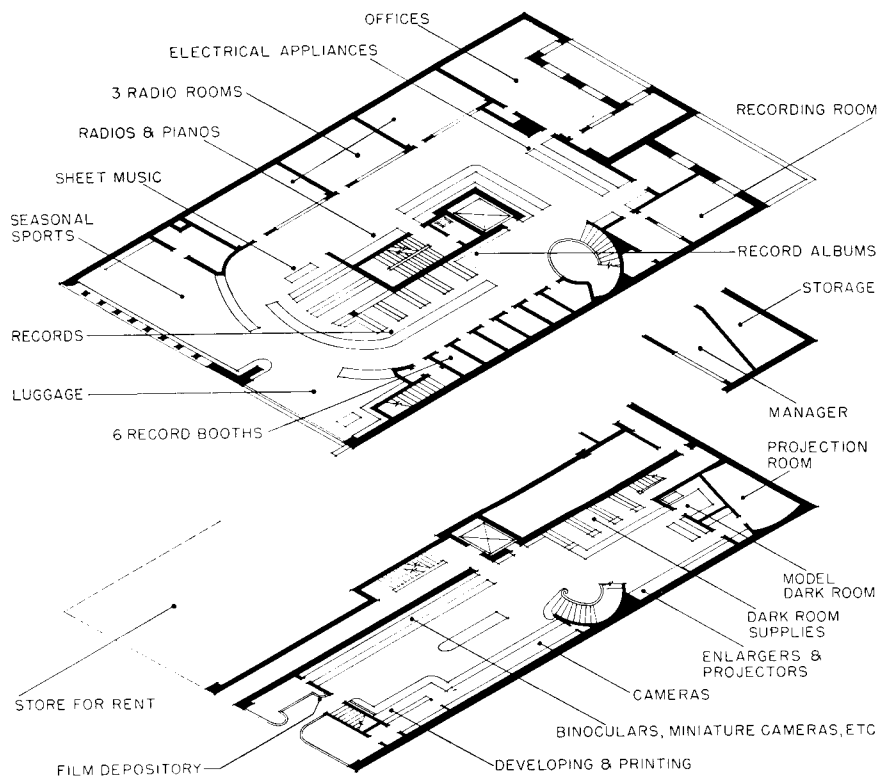

IMMEDIATELY INSIDE the entrance door on the ground floor is the developing and printing department. For use when the store is closed, there is a slot receptacle in which films may be dropped from the outside. Open display cases hold books and periodicals on photography. In back of the darkroom equipment section at the rear is a completely equipped model darkroom. In the other corner, behind the movie section, is a miniature theater for showing either silent or sound films.

Between the first and second floors is a small mezzanine on which the manager's office is located. From the window there is an uninterrupted view of the entire sales area.

By either elevator or stairs, customers arrive on the second floor at the same point. Here is the record sales section, with display or storage space for approximately 70,000 records. For easy accessibility popular records are displayed in open racks. Six sound-proof booths adjoin.

Luggage and seasonal sporting goods occupy the front of this floor. The rest of the area is for piano display and three booths for larger radio and phonograph sets.



Acoustically treated projection room on the first floor where both silent and talking pictures may be shown.

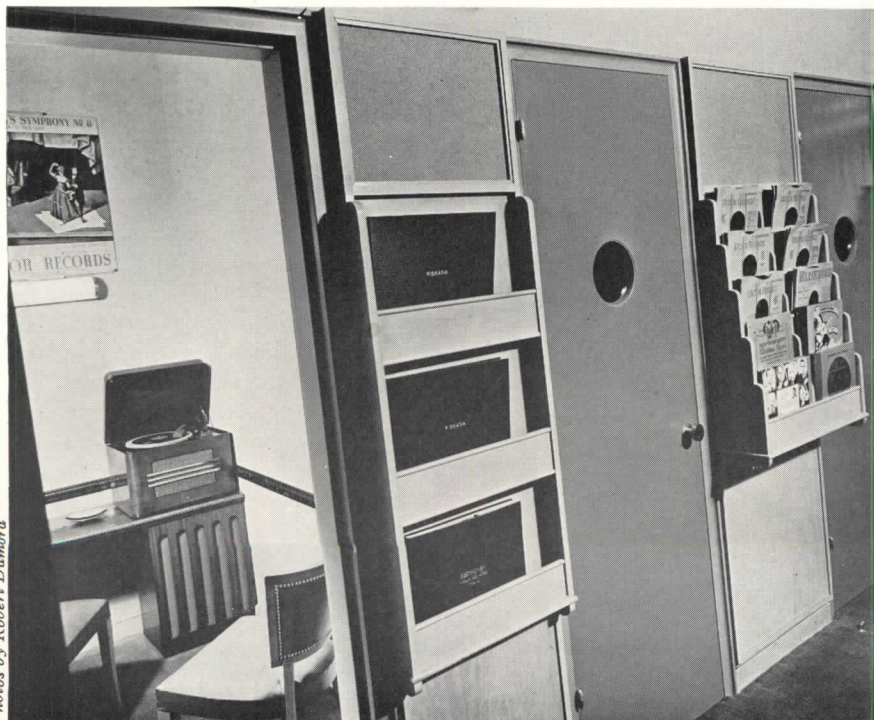

Photos by Robert Damora

Open racks provide immediate accessibility to the most frequently requested albums and recent popular records.



SEATTLE CATHOLIC DIOCESE HEADQUARTERS

Before this dignified structure, designed by Architects PAUL THIRY and ALBAN A. SHAY, was built, the church offices of the Catholic Diocese of Seattle were housed in different office buildings downtown. Now the entire headquarters, from the Bishop's private study to newspaper offices and charity agencies, are united under a single roof. This not only facilitates interrelation between the various units, but effects economies, in that the scattered rents previously paid will in time amortize the entire cost of the new structure.



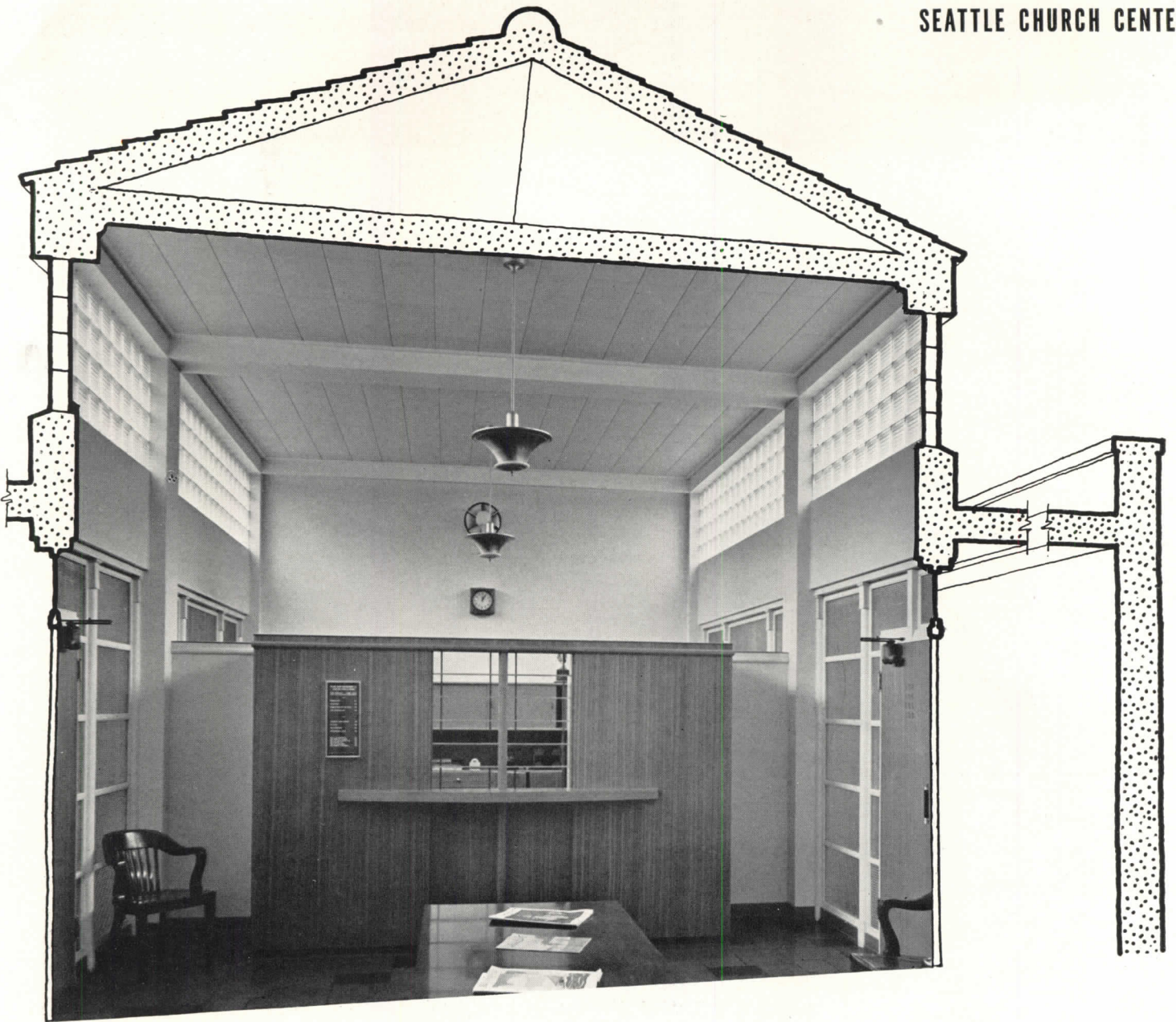

Photos by Roger Sturtevant

THE BASIC T-SHAPE PLAN provides the three desired separate areas, each with its public space, work areas, and subordinate private offices. In anticipation of possible future change, all interior partitions are nonbearing and may be altered at minimum expense.

Construction is of reinforced concrete throughout. Exterior walls are surfaced with a 2-in. veneer of limestone. Interior walls are furred with 2-in. furring tile; permanent interior walls are finished with cement plaster. The flat roof slabs are insulated with 2 in. of cork, topped with 4 in. of cinder concrete, and six-ply, built-up tar-and-gravel roofing. Over the central section, the pitched roof is of Vermont slate.

Interior partitions, in the chancery

are of obscure glass and 3-in. tile-plaster. In the charities and newspaper units, partitions are 2- by 3-in. open studs, filled with 3 in. thick acoustical material and finished with $\frac{3}{8}$ -in. plasterboard.

Slate floors are used in the main entry and chancery public space. In the other two sections and in the basement, the floor surface is asphalt tile; toilet-room floors are of ceramic tile. Slab doors are used throughout. Windows are steel sash.

In the chancery public room and in corridors, ceilings are surfaced with acoustical tile; elsewhere, insulating board tiles 1 ft. square are applied directly to the concrete slab ceiling.

All rooms intercommunicate by both public and private telephone systems.

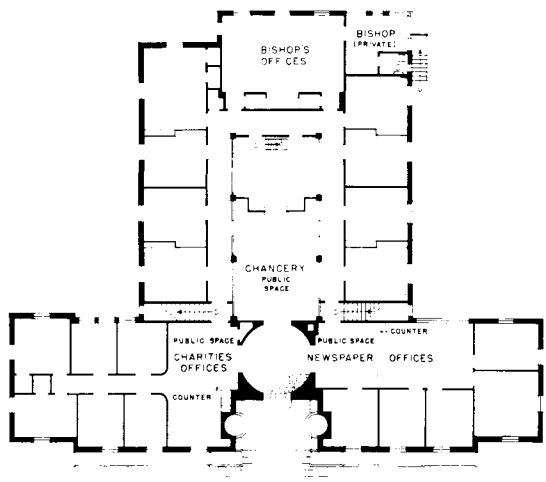

First floor

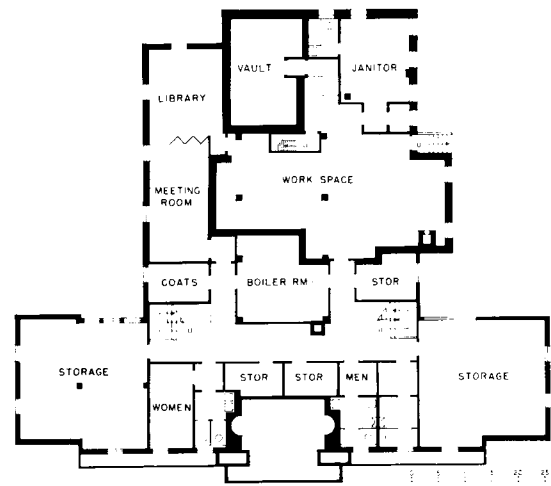

Basement

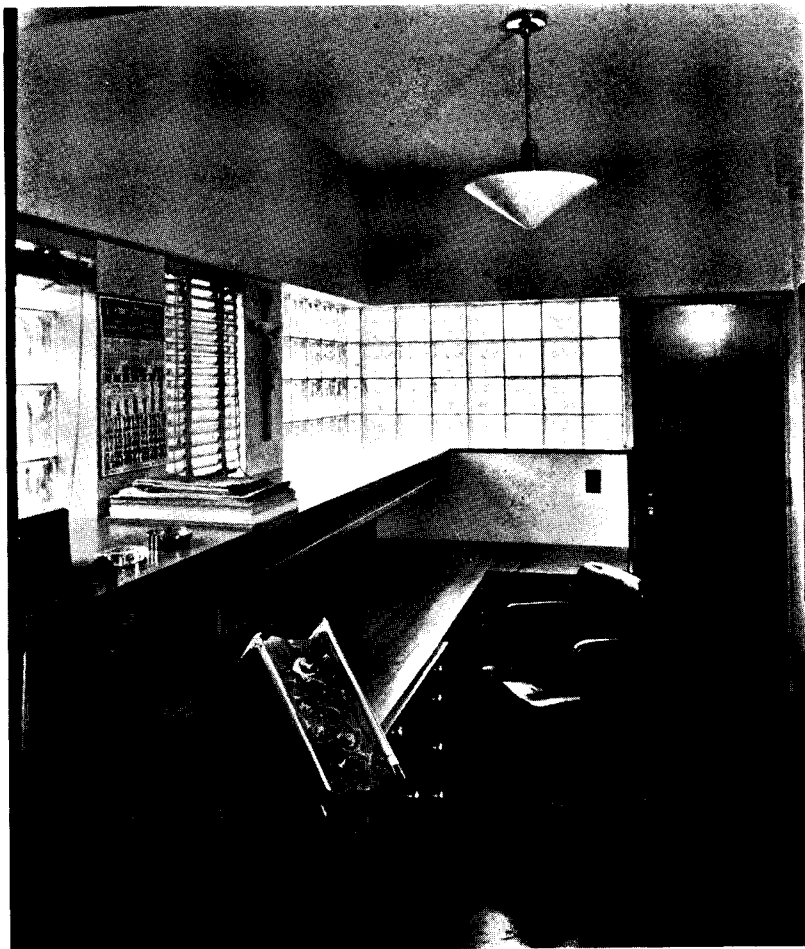

Top: corridor paralleling the chancery, showing light borrowed by the nonbearing partition with panels of diffusing glass. The ceiling is surfaced with acoustical tile. Bottom: the Bishop's private office. The walls are of cork. Woodwork throughout the building is of natural-finished mahogany.

NEW STRUCTURAL SYSTEMS, MATERIALS, AND EQUIPMENT

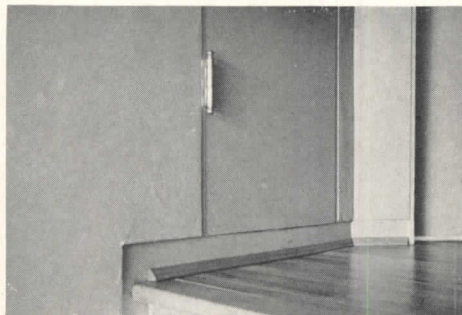
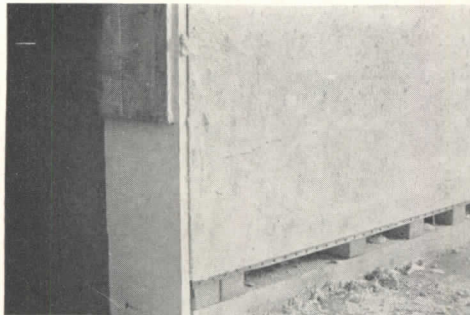
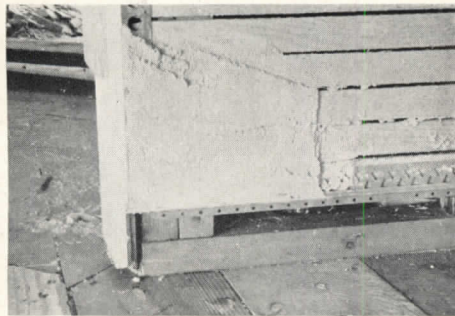
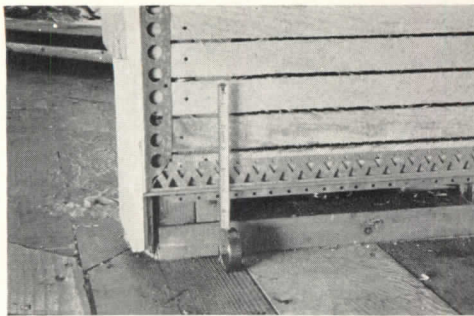

SHOP NOTE: From Architect Van Evera Bailey of Portland, Oreg., comes this suggestion for recessing door jamb and base-board. Savings in cost are less emphasized than the following advantages: (1) the jamb, being protected by metal, can be

set before plastering; (2) the carpenter doesn't have to fit his base trim to plaster irregularities; (3) the painter does a neater job, as his brush cuts the line between metal and wood; (4) the housewife has no tops of baseboards to dust.

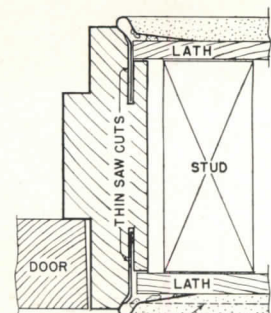

LINE OF RECESSED BASE
PLAN SECTION OF DOOR JAMB

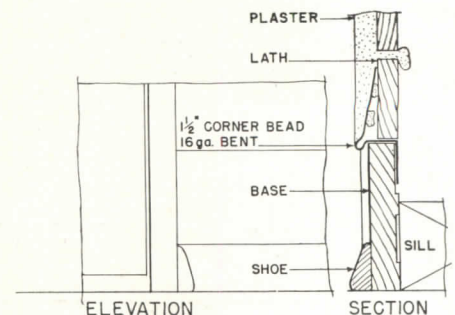

Damp-Proof Linoleum

Nairn Linoleum Tile (damp-proof) is inlaid linoleum of special construction, with a factory-applied adhesive-membrane back. It is said to give satisfactory service when installed directly on damp concrete floors in basements, and may also be applied over wood floors. Nairn Damp-proof Cement is required to activate the water- and alkali-resistant backing. Congoleum-Nairn, Inc., Kearny, N. J.

Resilient Floor Construction

IN A RECENTLY completed gymnasium at 10 Rockefeller Plaza, New York City, Architects Reinhard & Hofmeister used a new type of resilient floor construction. Foundation sleepers were bolted to steel springs, which in turn were set on the base slab in acoustical glue. A subfloor of spruce was laid diagonally on the sleepers, and covered with asbestos paper; over this was placed the finished floor of fireproofed hard maple. Markings for games were then painted on the floor. The final process was to brush the finished floor with Lignophol,

a low-gloss, hard-wearing, non-slip preservative which saturates the wood, and protects the markings on the surface as well as the wood itself.

The resilience of the floor is not immediately apparent, but, after an hour's play, considerably less fatigue has been noticed by players, it is said, than after a similar period of play on a non-resilient floor.

Low-Cost Acoustical Material

A NEW ACOUSTICAL material, called "Fibracoustic", is described as an economical product with good noise-quieting characteristics and attractive texture. The material is a wood-fibre product of low density with a factory-applied paint finish. Tests conducted by the official laboratory of the Acoustical Materials Association show the material to have a noise-reduction coefficient of 75%. Standard colors are white, light buff, medium buff, fawn (dark buff), French gray, and apple green. The material is furnished in a variety of sizes, including square and rectangular units. Johns-Manville, 22 E. 40th St., New York, N. Y.

Fluorescent Theatre Carpet

SPECIALLY DEVELOPED for use in theaters is a new carpet, woven of fluorescent-dyed wools, which glows in a darkened hall when subjected to rays of invisible "black light." The "black light" does not detract from the darkness, since the only visible light comes from the carpet pattern. Four patterns are currently available in this material. Alexander Smith and Sons Carpet Co., 295 Fifth Ave., New York, N. Y.

Pump for 22- to 60-ft. Lifts

FOR USE WHERE the water table lies between the accepted limitation of the plunger-type shallow-well pumps (22 ft.) and lifts of 60 ft. or more, where deep-well pumps are used, a unit has been developed which utilizes the ejector principle. Known as the "Jet" pump, this unit operates by diverting water under pressure down a drive pipe to a jet manifold. The heart of the manifold is a jet made of Tenite, a plastic material. The water emerges from the nozzle at a high velocity and passes upward through a Venturi tube, creat-

(Continued on page 124)

NEW HOUSES AND NEW HOUSE UNITS

Daniel Reynolds Merrill

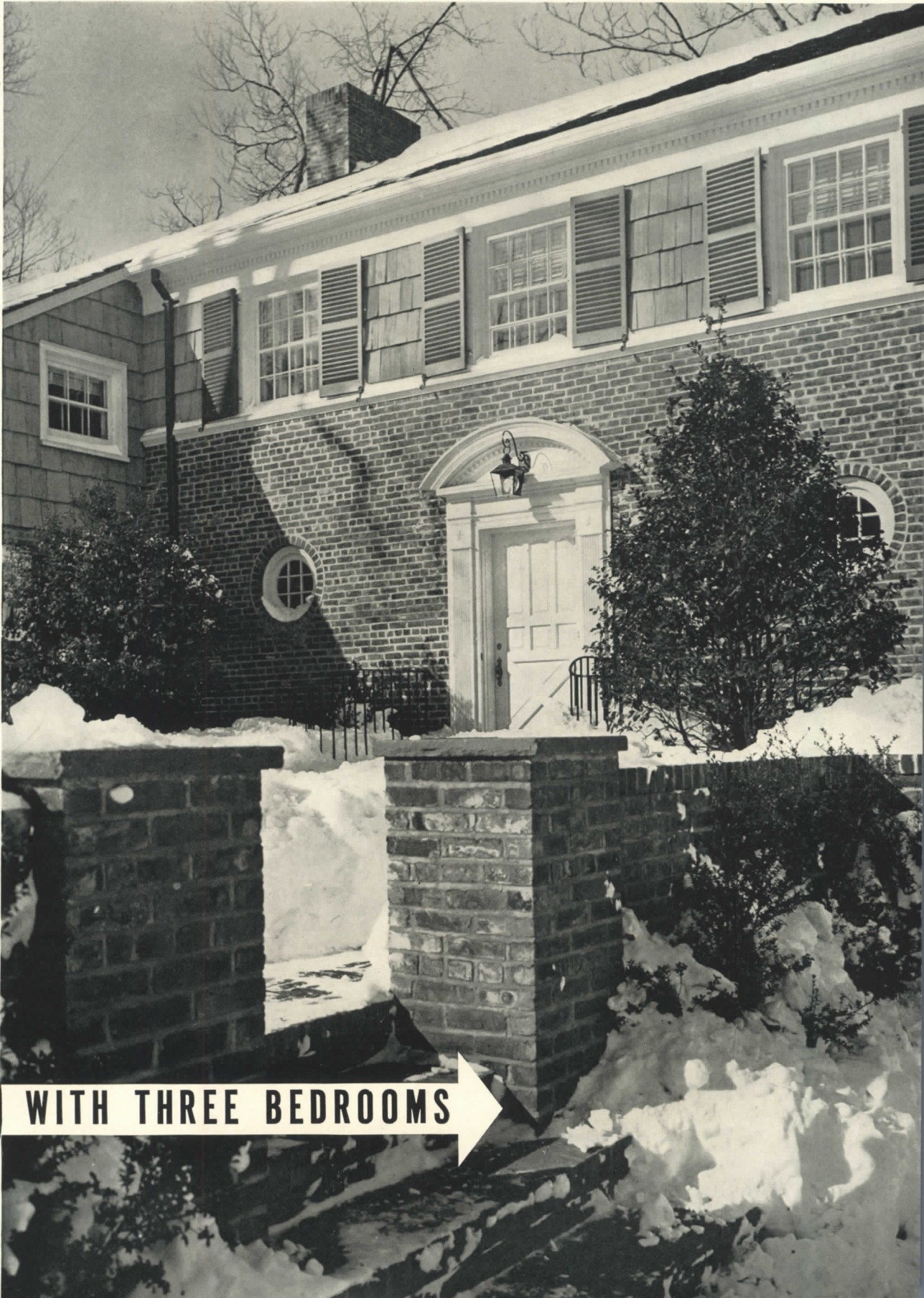

HOUSES WITH THREE BEDROOMS 



ARCHITECT'S HOME IN NEW JERSEY

Located on a sizable wooded site in Verona, N. J., this residence by Architects HOOTEN and TIMPSON was designed for Mr. Hooten and his family. In planning the house a number of requirements were considered: orientation, efficient "closed space", and, in Mr. Hooten's own words, "provision of a house that would lend itself to adaptation for future needs and that would be of such materials and equipment that housekeeping and upkeep would be minimized".

CONVENIENTLY ENOUGH, in orienting the house for the best exposure, it was possible to give all the main rooms a view to the south and west of the surrounding woods and of two streams which converge in a ravine just below the property. The exterior was designed, says Mr. Hooten, with an eye toward providing an exterior "with dignity, important roofs, and general low appearance, but not necessarily symmetrical." Exterior walls of pinkish brick and weathered shakes were chosen because of their minimum upkeep. The plan has an interesting arrangement of rooms and circulation space. By unusual attention to the planning of halls, all main rooms have complete privacy. From the standpoint of closet space, the house is exceptionally equipped; in addition to the usual clothes and coat closets, storage units have been provided for the following: cleaning equipment, card table and chairs, sports equipment, toys, luggage, garden tools, off-season clothes, storm sash and screens. In the event of future expansion, the maid's room can become a family bedroom; the present unfinished attic would then be made into two maids' rooms and bath.

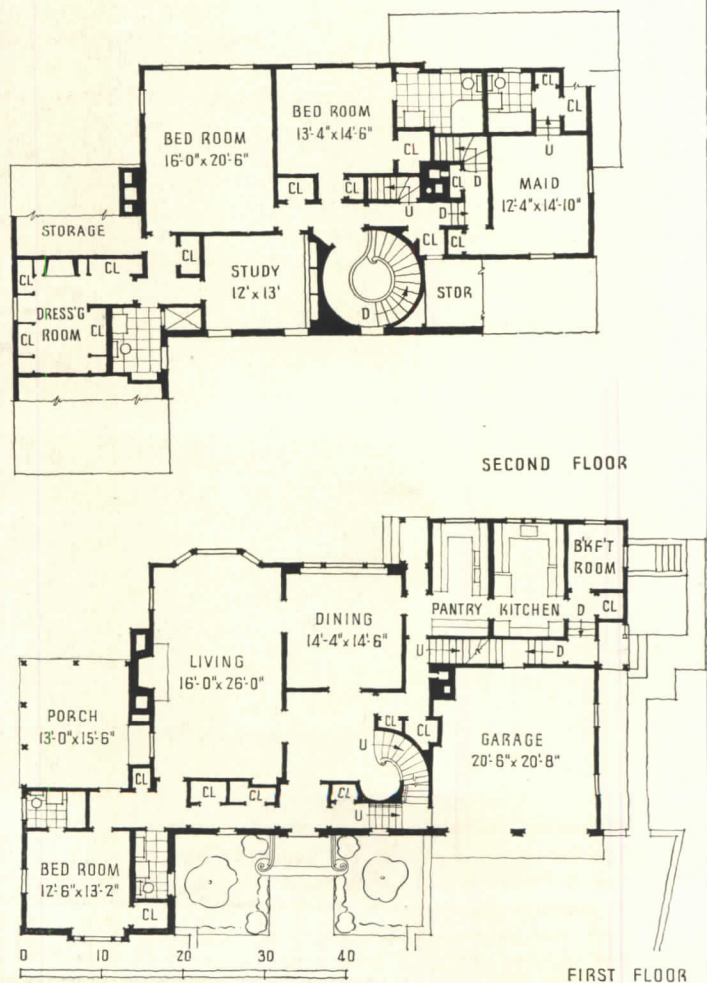



Although colonial in its detail, the interior is as fresh in its handling as the exterior is in its general aspect. A curved stair (above, left) connects first and second floors. Above, right, the living room; below, the dining room which overlooks the woods

Photos by Daniel Reynolds Merrill



HOUSE PLANNED FOR WESTERN CLIMATE

Prime requisite for Designer PAUL LASZLO in planning this house for Mr. and Mrs. Theodore Rosenson at Bel Air, Calif., was that the house should take full advantage of its natural surroundings. An open plan, a terrace, and a half-open play porch that runs the width of the house and connects front and rear gardens, accomplished this aim. Particularly noteworthy are the simplicity of detail and the frankness of structure, as in the posts on the front terrace. In addition to the house, Mr. Laszlo designed the furniture and decorated some of the interiors. "This house is modern in every sense of the word," says Mr. Laszlo, "and proves that not only flat-roofed buildings are modern."

THE HOUSE takes its low lines and spread-out plan from the plot which is long and narrow and covers almost an acre. Its location on a corner in a dead-end street eliminates the traffic problem. The rear of the house is to the north, and faces a hill; consequently rooms on this side are less open than on the south (street side) or on the east, where the ground slopes gently toward the lawn of a golf club. The young couple for whom the house was built like to entertain informally, so the first-floor plan was developed around the large living room.

The dining room opens off one side of the living room; on the other side are the entrance vestibule and the den. A special feature of the den is the two-way bar which can be used from the den or from the play terrace. This porch, or "play terrace," connects the front terrace with the badminton courts at the rear. For protection during winter months the north (rear) wall of the porch has a glass wall and a glass door, so that the view of the back garden is not cut off. All service facilities face north, and all living rooms face south.

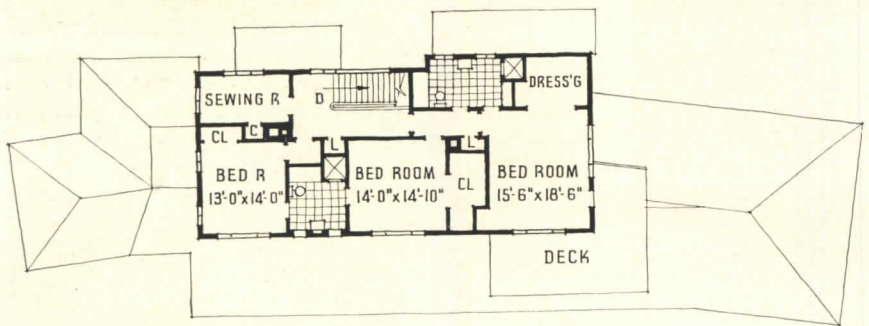

SECOND FLOOR

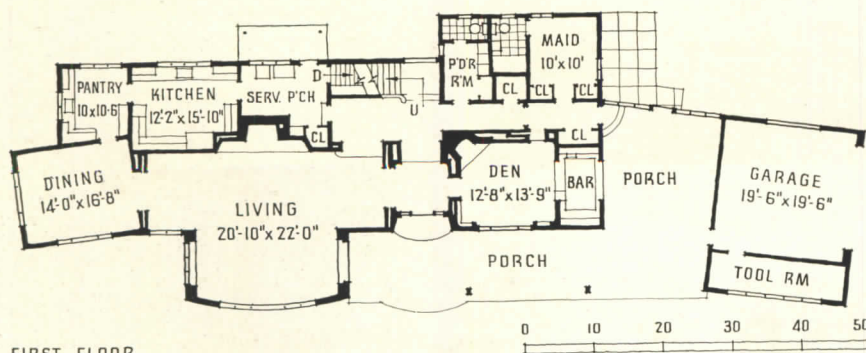

FIRST FLOOR

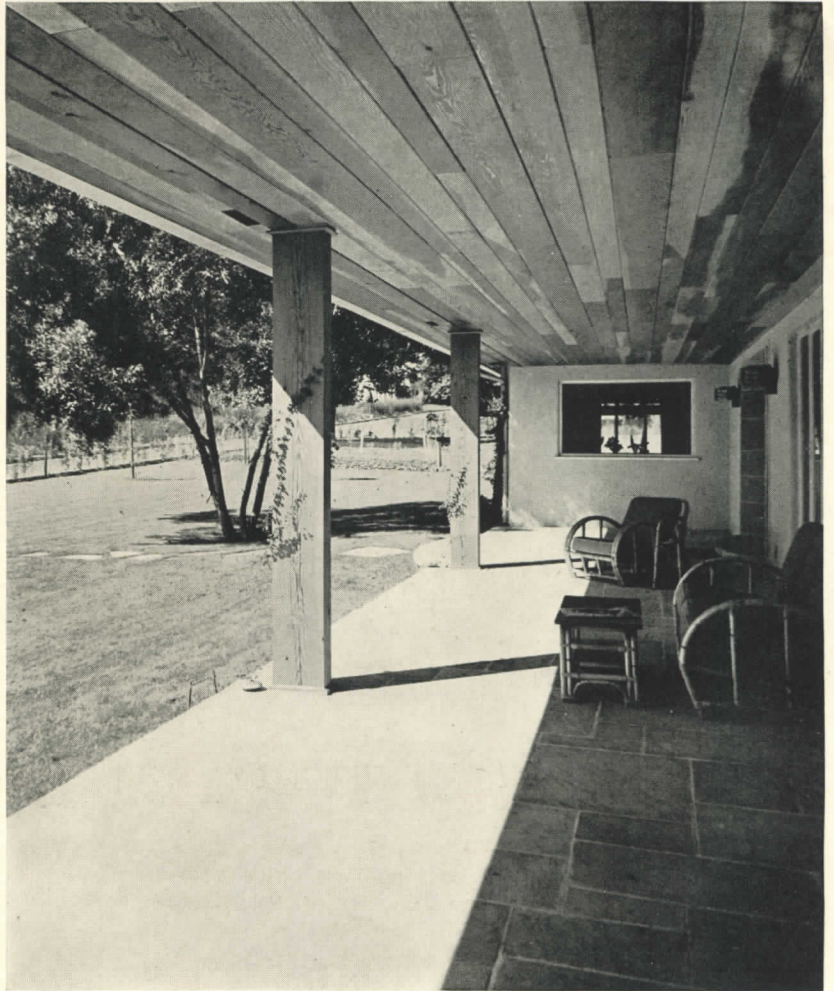
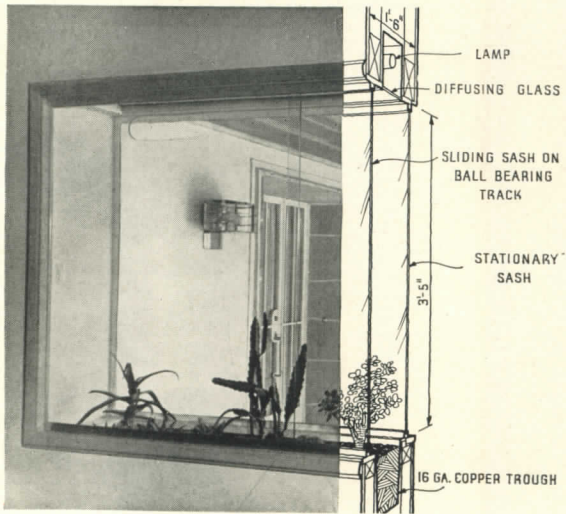

Between living room and porch is a "cactus window" (see detail above and photograph at right) built into the wall. Sliding glass panels make it easy to care for the plants, and to control the moisture content of this indoor garden.

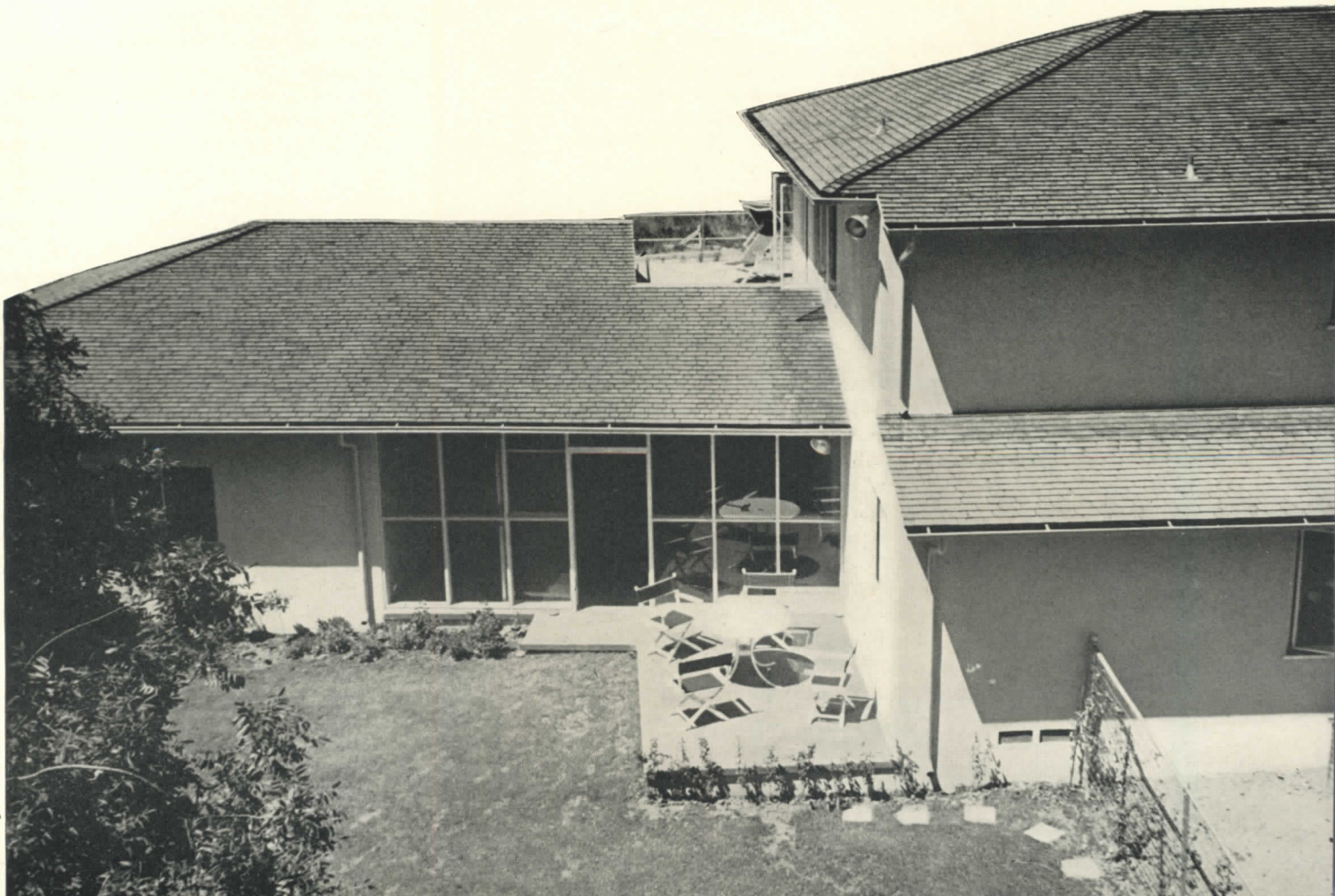



LIVING QUARTERS ON SECOND FLOOR

In this house for Prof. and Mrs. Harry F. Harlow, at Madison, Wis., the architects, BEATTY and STRANG, found themselves up against two highly specialized conditions. One was the site—a sloping hillside plot, which would have had an uninterrupted view toward the lake but for an intervening row of houses. But the owners desired a view, as well as certain specific plan features; the result was this unusual plan.

“THIS HOUSE reflects no architectural precedent,” say the architects; “rather it reflects a whole-hearted respect for the site, the surroundings, and the clients’ living comfort.” The exterior design is a notable example of the transitional style; the pitched roof was decided upon by both architects and owners as the most suitable to the situation of the house. Professor and Mrs. Harlow have no children and they requested an arrangement of living, sleeping, and eating accommodations for themselves that would be quite separate from guest and maid’s rooms and recreation room. To satisfy these requirements the architects evolved a compact second-floor plan which has the additional advantage of making the lake view available to the owner’s quarters. The exterior is of redwood siding with a trim of redwood painted white. For the interior, 4 ft. wide sheets of plywood were chosen—birch in the living-dining room, white pine in other rooms. Total cost was \$9,100.

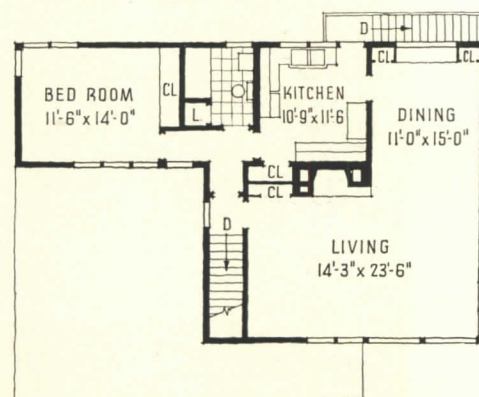

SECOND FLOOR

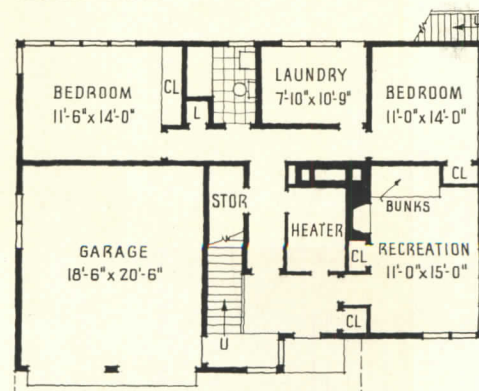

FIRST FLOOR

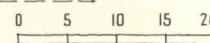



Photos by Charles Bradley

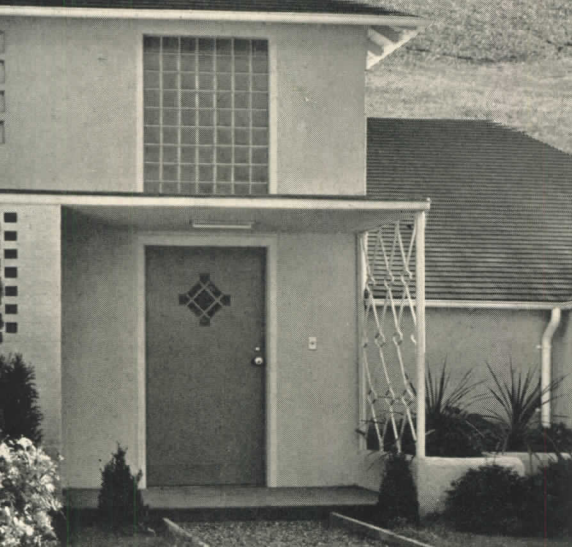
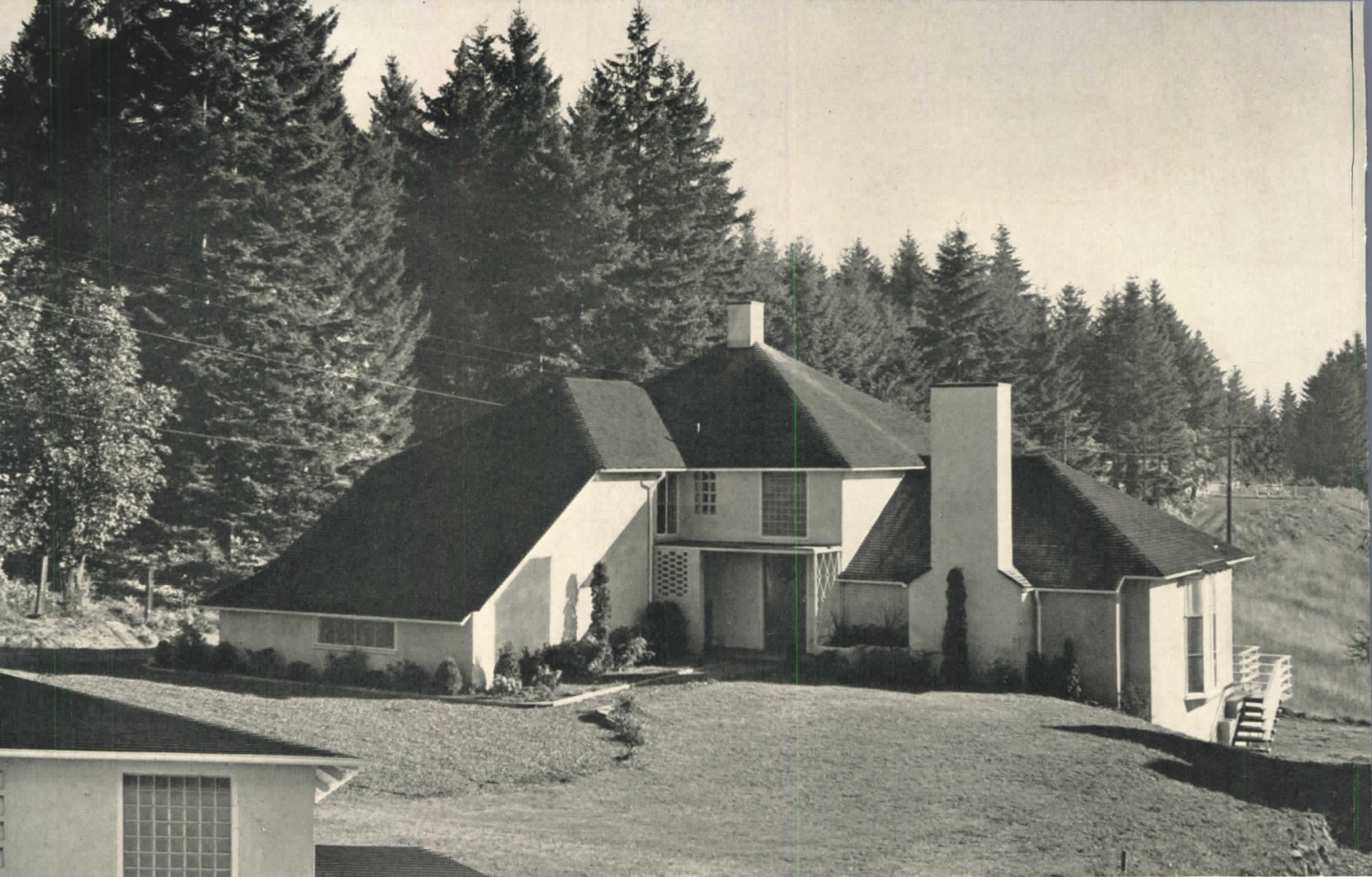

HOUSE WITH SPLIT-LEVEL PLAN

Located on a long narrow plot whose grade slopes 7 ft. in 50, this residence for Mr. and Mrs. V. J. Hamar near Portland, Oreg., designed by Architect HAROLD W. DOTY, takes full advantage of the site by using the split-level entrance device. The long, pitched roofs, reminiscent of traditional forms, have been cleverly adapted to conform with the slope of the site and the contemporary design of the house.

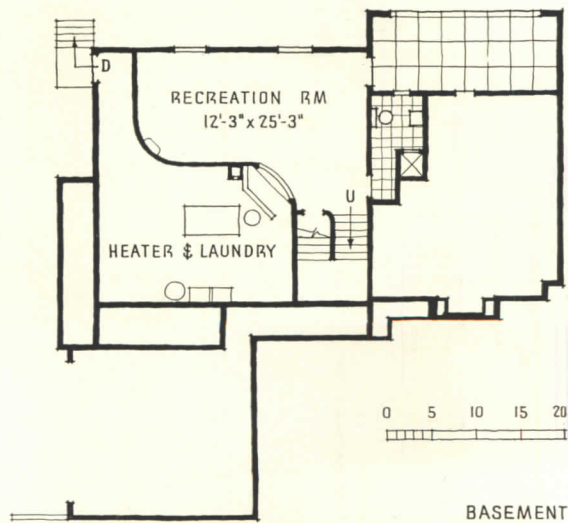

Photos by Roger Sturtevant

ARCHITECTURAL RECORD

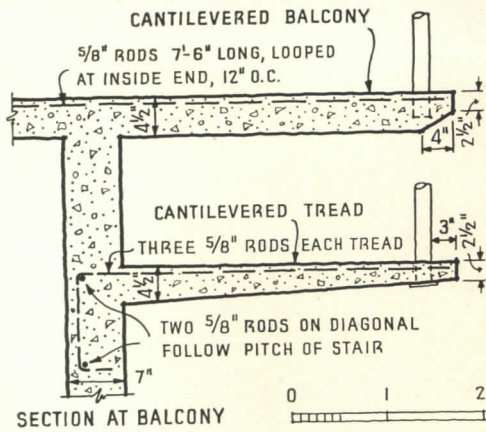

Detail of cantilevered balcony and stair leading from terrace. Uprights of the balustrade are of 1½-in. pipe, which have been drilled to support wood rail dowels.



ALTHOUGH PLANNING is very compact in this house, Mr. Doty has achieved an effect of spaciousness without any waste space. From the vestibule, stairs lead up to bedrooms and down to a short corridor which connects living room and den, and into which kitchen and dining room open. Living room and dining room lead out to a concrete-paved open terrace from which there is a view over rolling hill country. A full-length bay window in the living room supplements the light obtained from the French doors leading to the terrace. On the basement level are the garage (whose entrance faces the access road on the east), and space for heating equipment, laundry, and a recreation room, supplemented by a loggia just under the terrace.

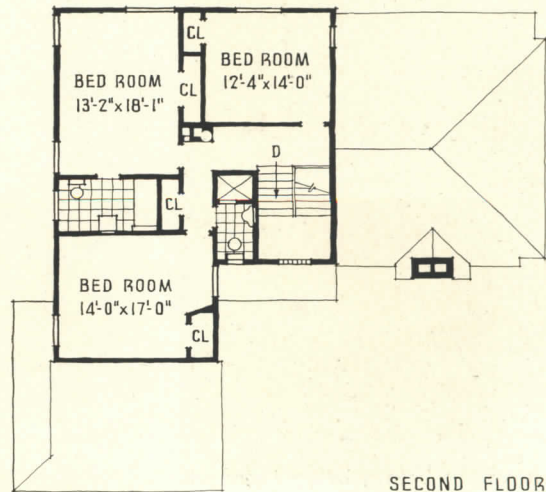
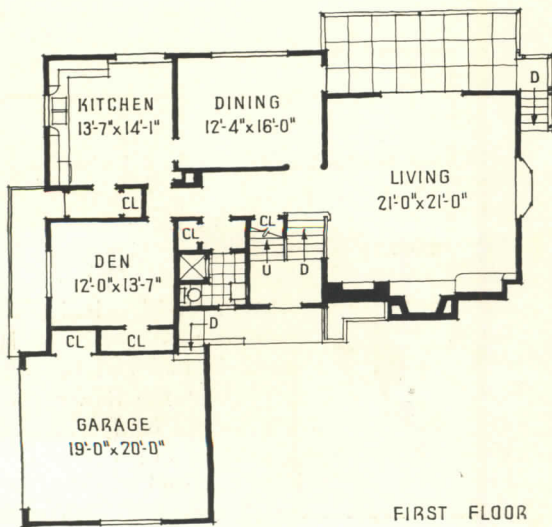

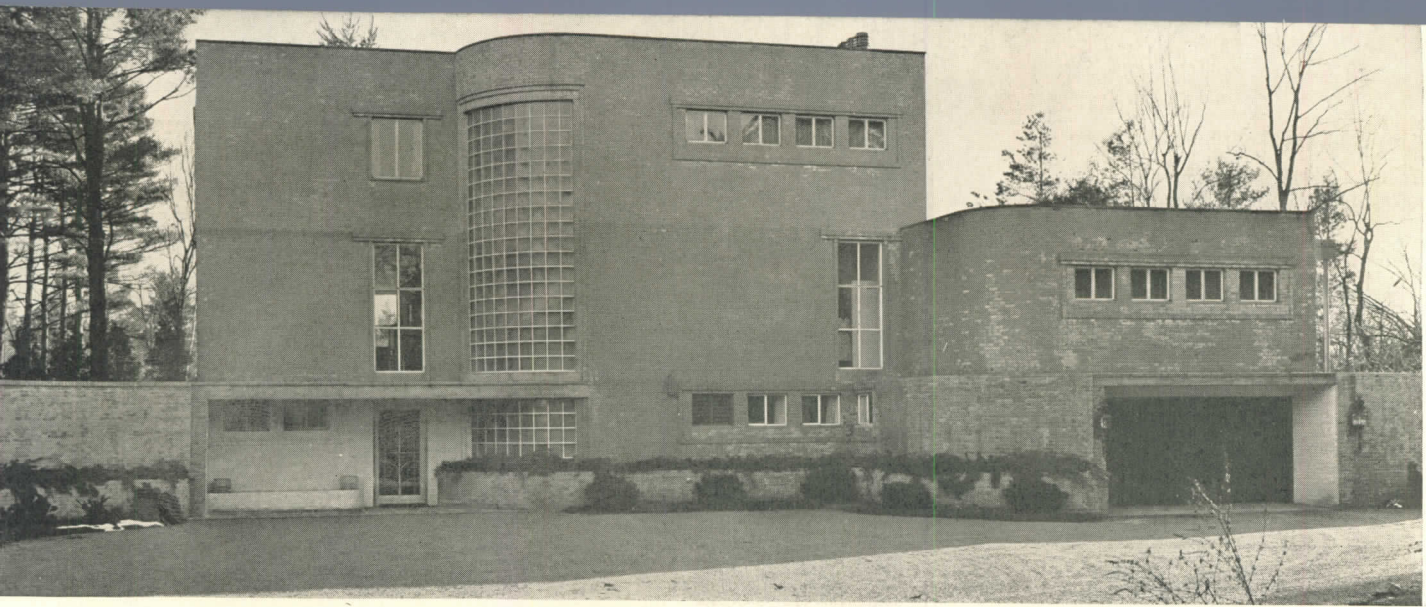

SLOPING SITE SETS DESIGN PROBLEM

Built on a wooded hillside near Medfield, Mass., this residence was designed by Architect NATHANIEL SALTONSTALL (Putnam & Cox & Saltonstall) for himself. The north (front) side of the house faces a main artery, hence the sparing use of windows on this elevation. Because of the angle of the slope, there are three full floors on this side and two on the rear or south elevation; large expanses of glass open the house up toward the south lawn and a view over a pond. The main entrance, on the basement level, leads into a foyer.

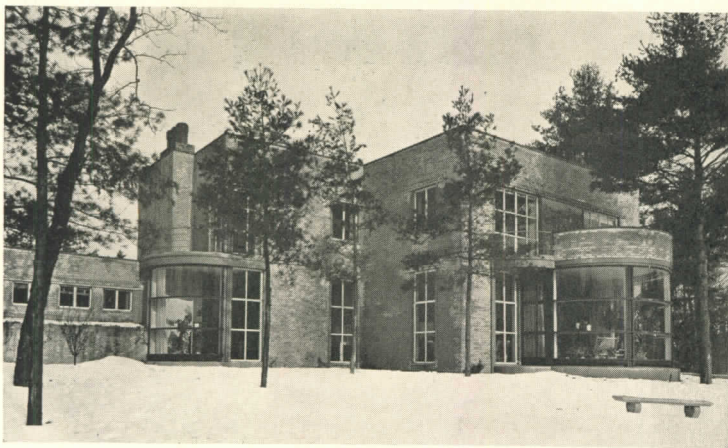

Above, rear elevation; below, living room with walnut shutters.

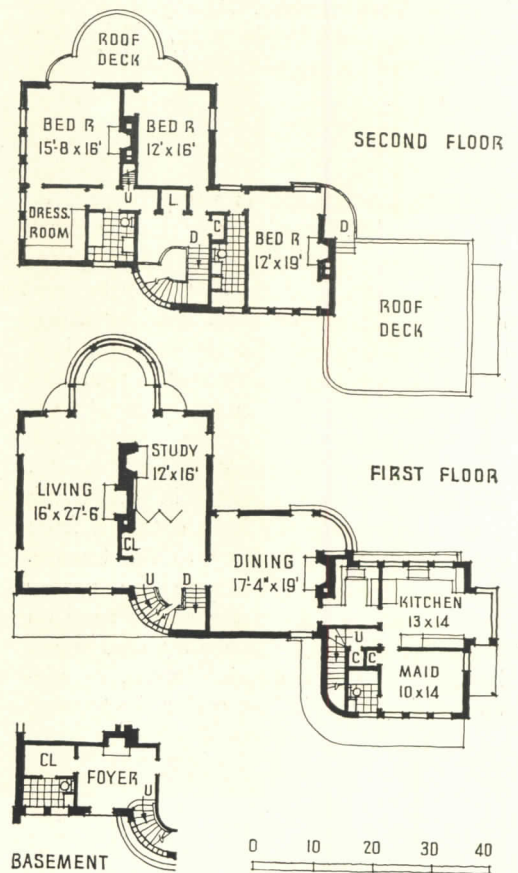

ONE OF THE MAIN considerations in planning this house was to provide easy circulation for a large number of persons, since the owner likes to entertain extensively. Consequently the hall on each floor is large; on the first floor a folding partition divides hall and study. When necessary, this partition is folded back, so that study and hall become one large room, opening at the flower bay into the living room. Bedroom windows are visible from the main artery are 5 ft. above floor level, for privacy as well as for convenience in furniture placement.

UNITS **LOUNGING** 

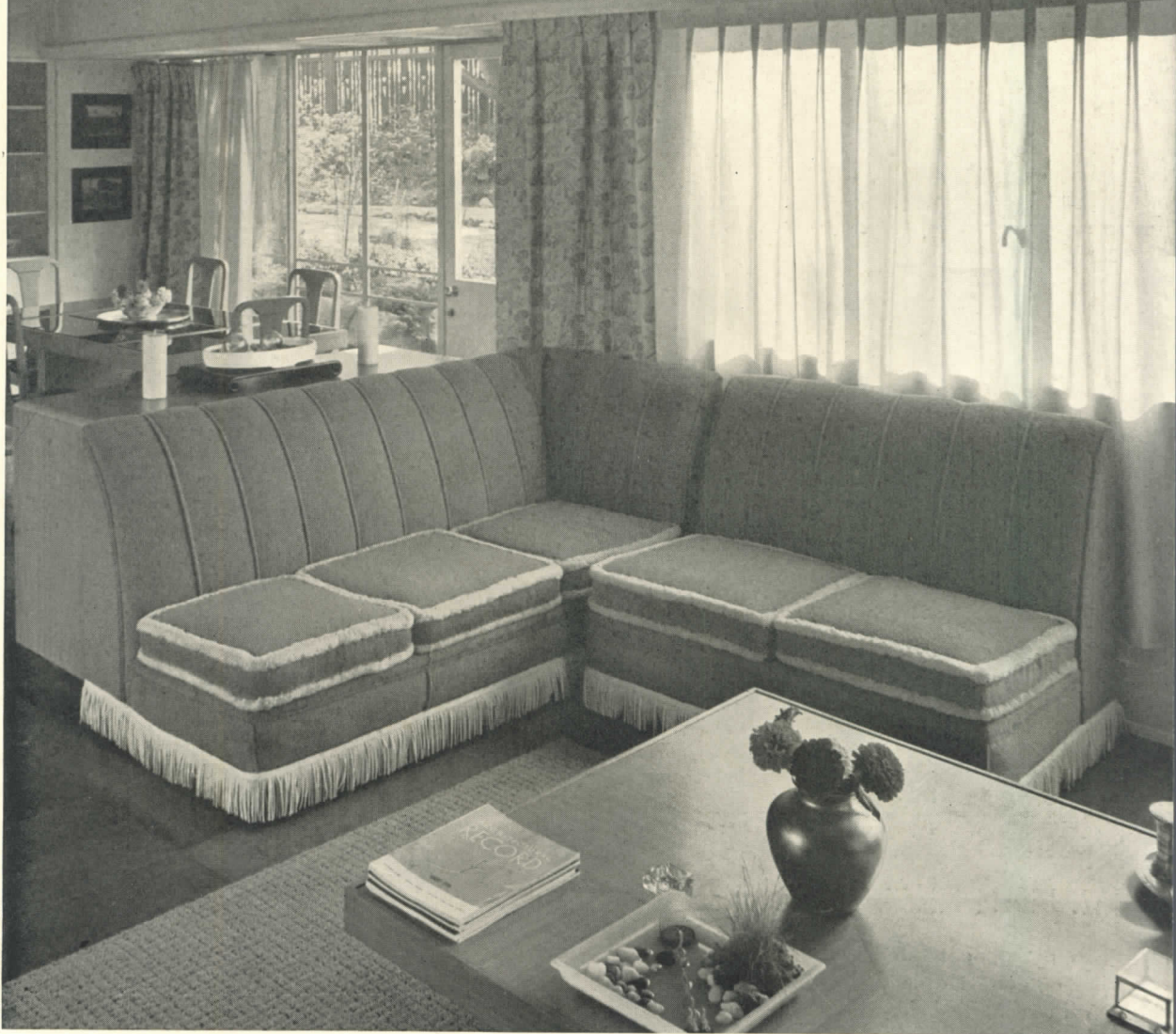

Roger Sturtevant

1. PAUL THIRY, Architect

WITH THE INCREASING use of open planning and its resultant flexibility, the design and arrangement of furniture within the open area becomes an important architectural consideration. Thus, this corner seat (in reality a movable piece of furniture) approximates the function of a partition, differentiating, as it does, the living and dining areas. At the same time that the seat meets this practical requirement, it serves also as a pleasant lounging place. It is upholstered in soft green with cream trim. The wood fibreboard floor is carpeted in pale yellow.

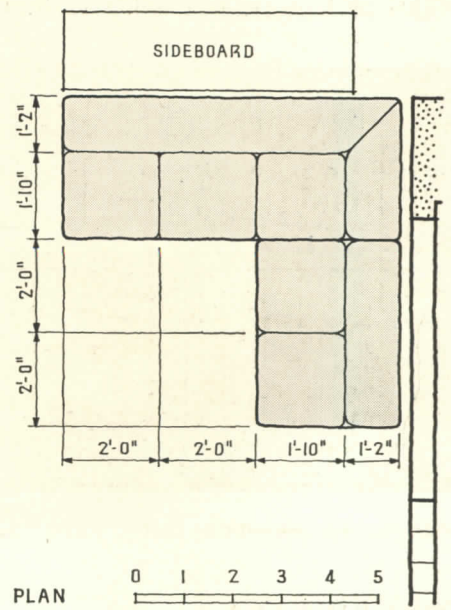

UNITS: LOUNGING



Frank R. Wilson

2. LESLIE CHEEK, JR., Architect

IN LAYING out this room, one of the main requirements was to obtain "a decent place to seat a group for conversation," with a unified but informal grouping of furnishings. The logical center for such a group was the large fireplace; around this are placed two studio couches (each with a detachable back rest), and a big chair. Couches are covered in golden-yellow fabric; the floor is carpeted in deep brown. For contrast there are accents of tomato red and jade green.

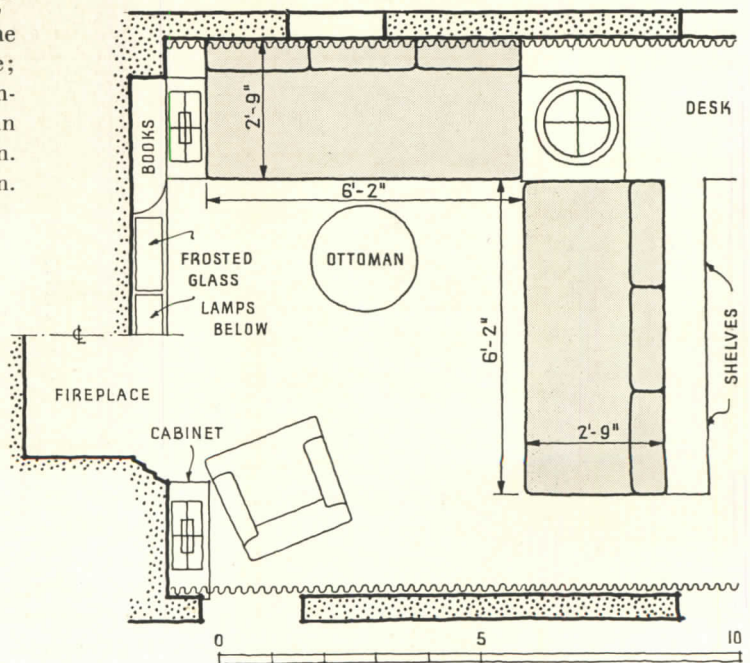
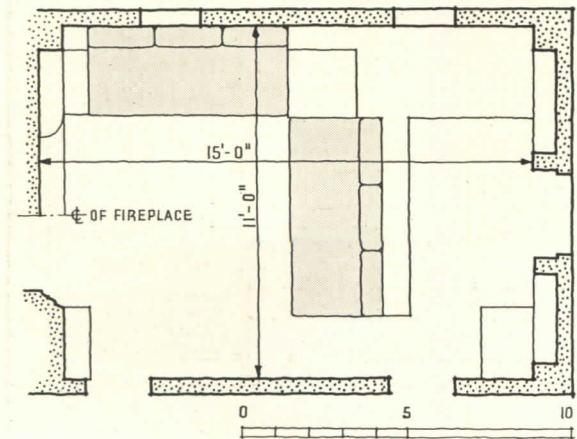

Esra Stoller



3. GEORGE NEMENY, Architect

DESIGNED FOR a formalized room, this lounging unit has a built-in frame (detachable for removal to another dwelling) against which are placed specially designed seats of various widths. These seats can be pulled away from their setting for a less formal furniture arrangement. The couch is upholstered in fabric with gold, light brown, and tan stripes; carpet is brown; the wall above the seat is lemon yellow. All woodwork is of birch.

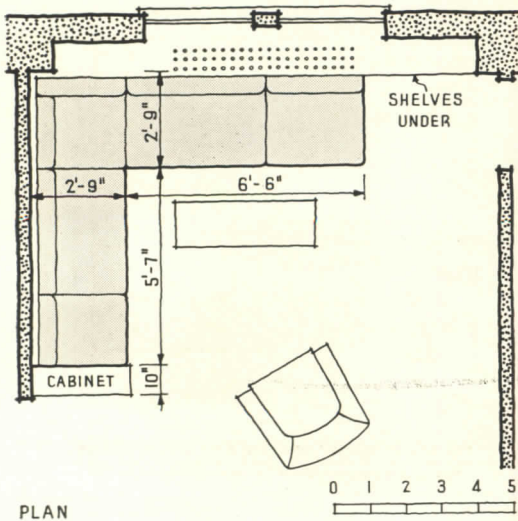

PLAN

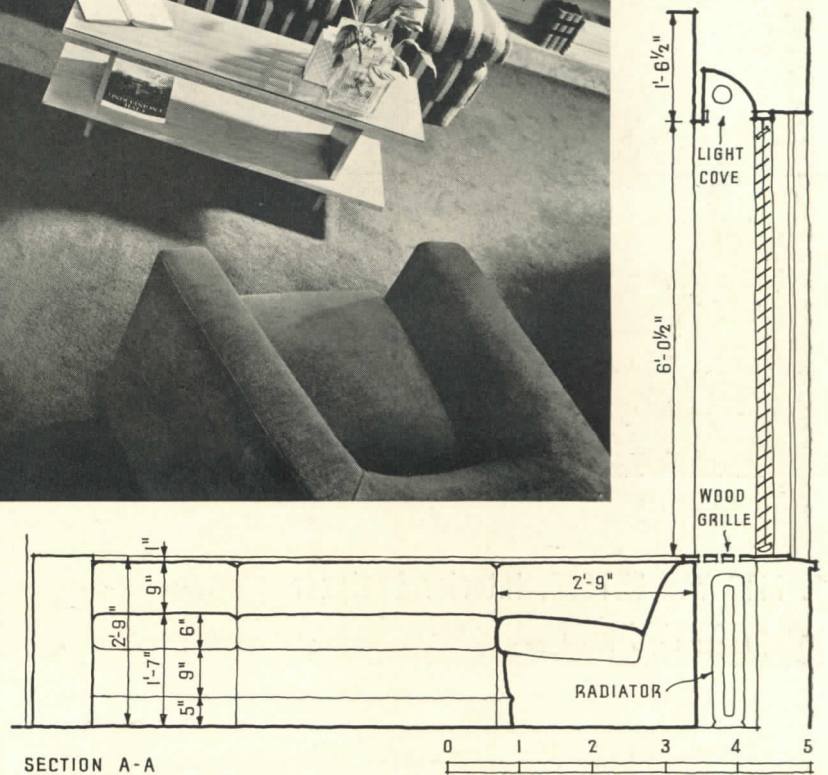

SECTION A-A

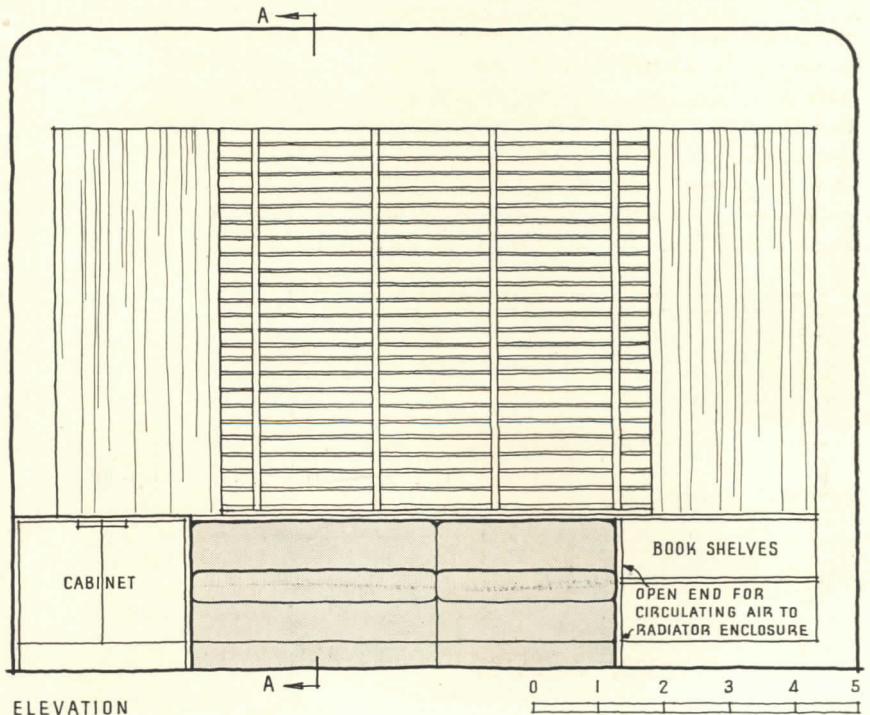

ELEVATION

UNITS: LOUNGING



4. RITS VAN WITSEN, Interior Designer

THIS BUILT-IN, curved seat provides a fixed lounging unit of a rather formal character. The construction of the seat is such that it can be easily demounted and moved to another location. All the woodwork in the room is of white maple; the seat is covered with a wool and cotton fabric in blue. The carpet is taupe; chairs are upholstered in light gray. Walls are plaster, painted in two tones of gray.

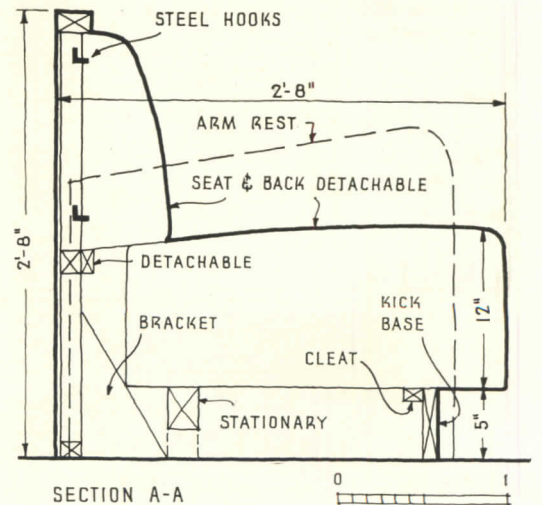
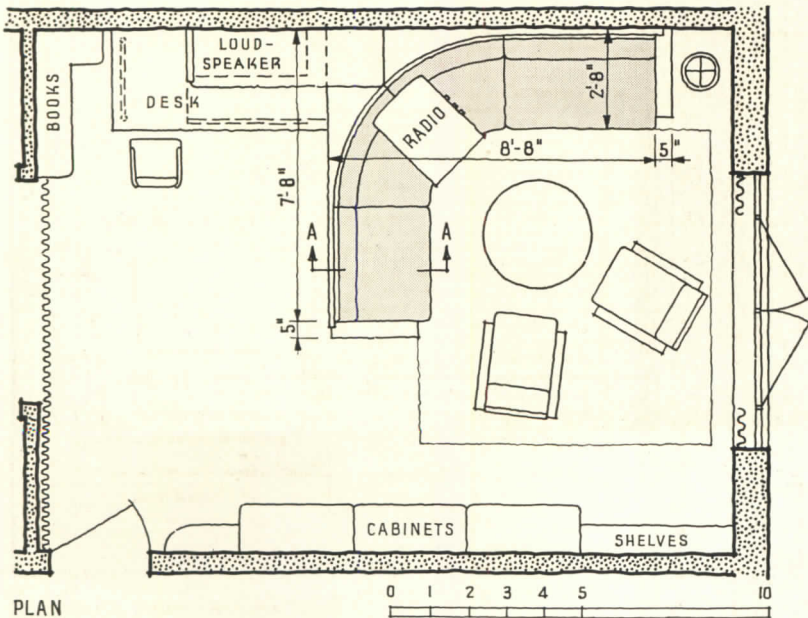
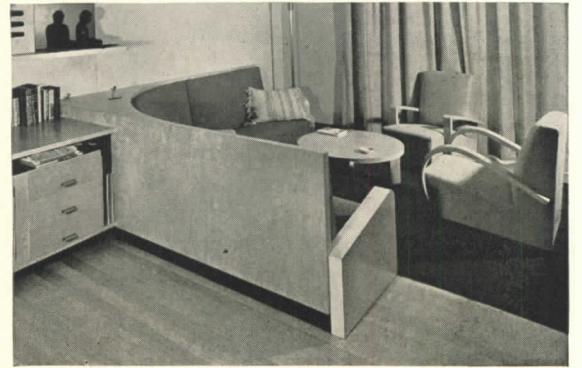

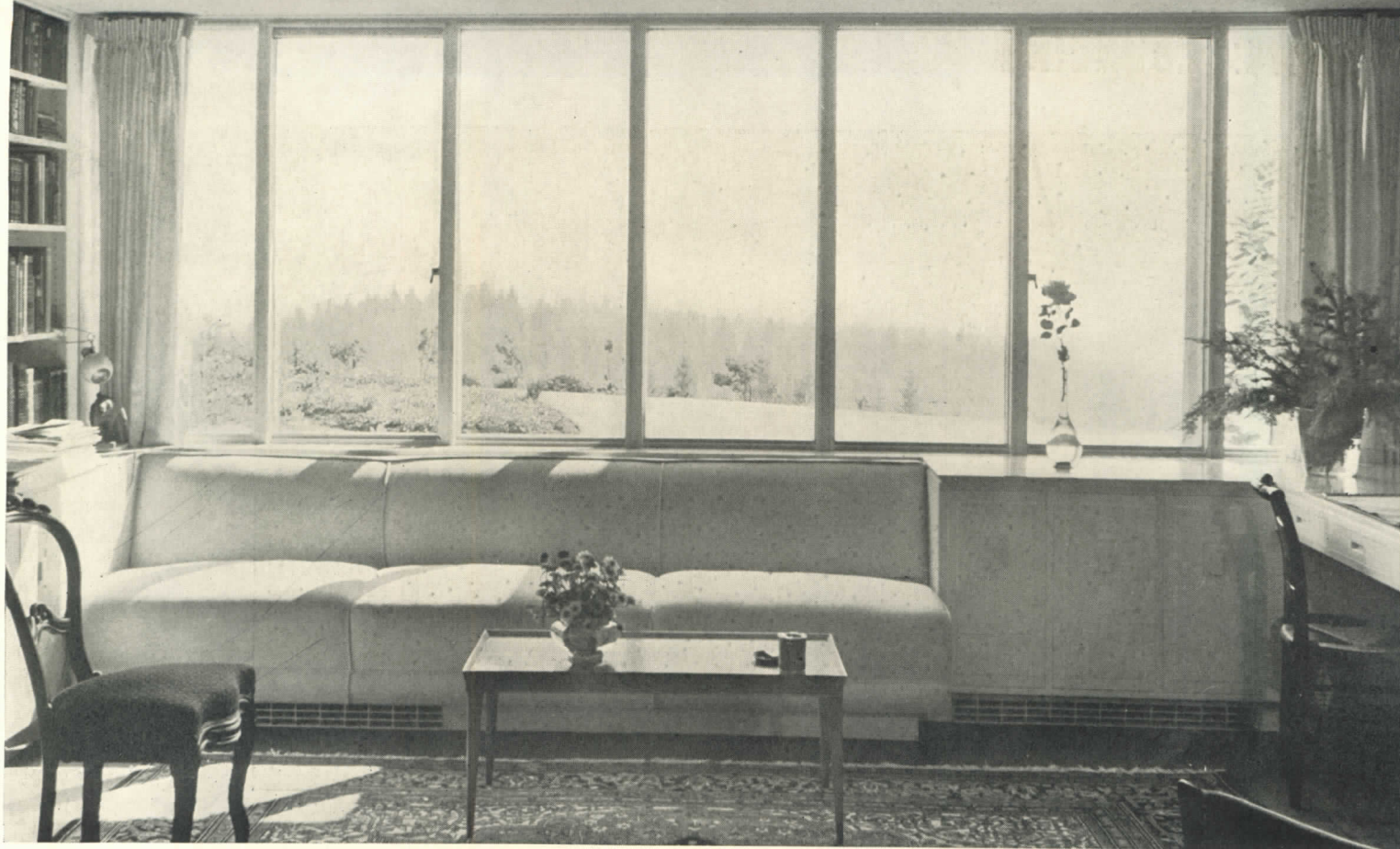

5. A. E. DOYLE & ASSOCIATE, Architects

INTEGRAL WITH the construction of the wall is this built-in lounge. Sofa cushions and back fit into a frame behind which are arranged ducts from heating equipment in the basement. Grilles in the base-board under the seat and in the wide window sill allow for circulation of air through the radiator enclosure. All woodwork is clear pine, bleached; the ceiling is plaster, painted neutral ivory gray.

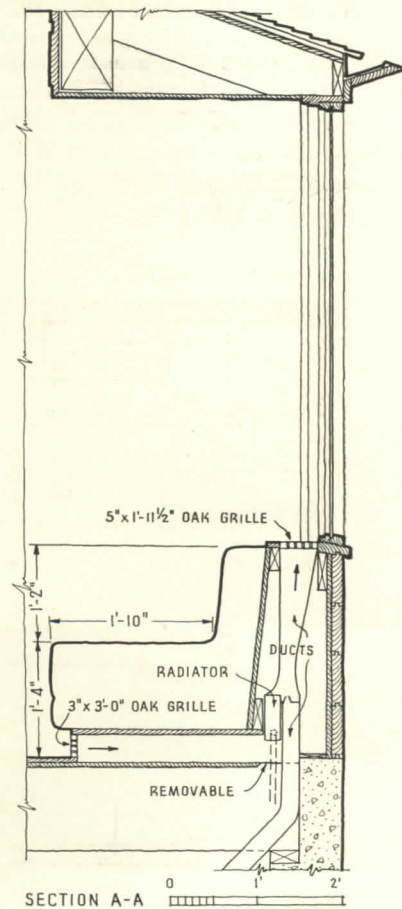
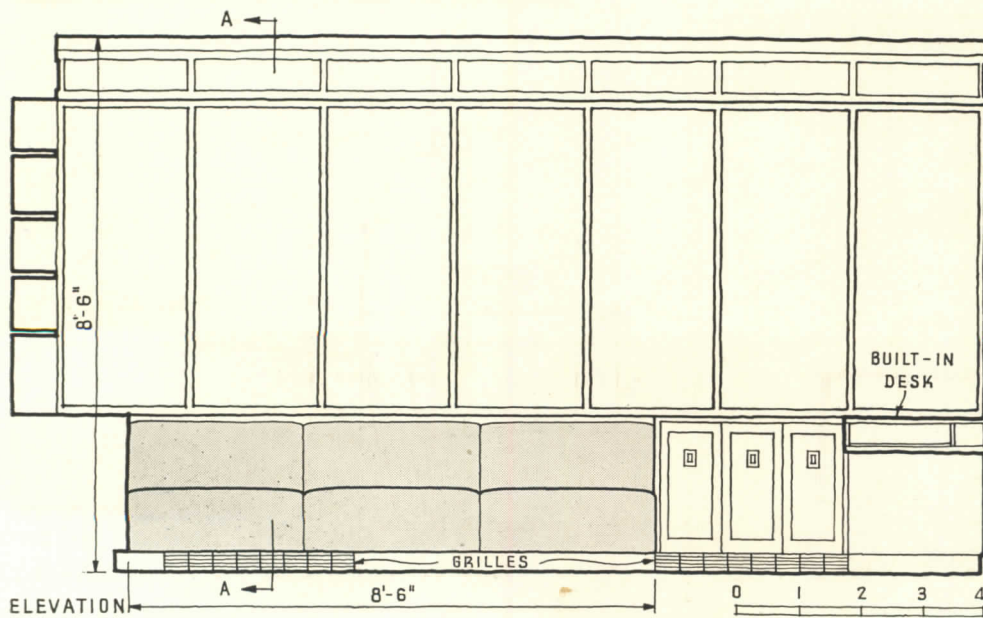

UNITS: LOUNGING



Arthur Haskell

6. JOHN T. JACOBSEN, Architect

A MAXIMUM AMOUNT of seating space is obtained in this lounging unit, using a minimum of floor area. The seat is completely built-in; its frame is part of the wall construction. Cabinets at either end not only provide storage space but act as ends for the seat, and are convenient in height for lamps.

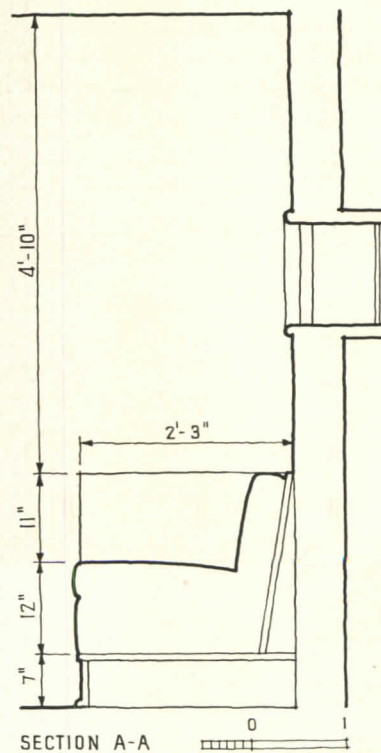
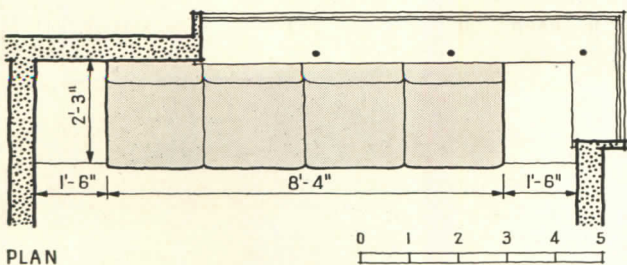
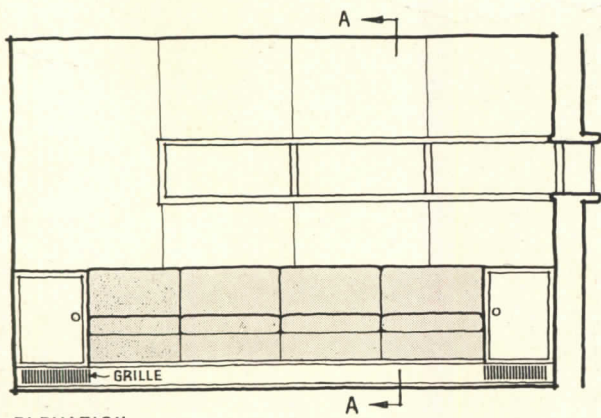

STEEL

Sixth of a series in the RECORD's survey of trends in building materials, this study has been prepared by Dr. Mario Salvadori, of Columbia University's School of Engineering, and Mr. Bruno Funaro.

QUANTITATIVELY, American architects and engineers are the world's largest users of steel as a building material. They use it constantly for myriad purposes in myriad forms—structurally in beams, columns, concrete reinforcing; semistructurally in decking, wall panels, partitions, and lath; nonstructurally in piping, ductwork, furnaces, etc. In each case steel is used because of some special property or group of properties. These properties vary in importance from case to case; but cutting across all of them is the cardinal fact of *steel's great strength*. From this it follows that steel's *main* significance to the building designer lies in its structural application—its use in spanning great areas or in reaching great heights.

By means of steel, American architects have spanned greater spaces (Golden Gate Bridges) and reached greater heights (Empire State Building) than elsewhere in the world. Yet qualitatively the full potentialities of steel in architecture remain only fragmentarily and unevenly exploited. This in the face of the fact that, in other sectors of American industry, steel is being used with a superb and daring confidence based on intimate knowledge of what it can do.

The reasons for this paradox lie in the fact that, at each stage of its progress from mill to finished building, structural steel is progressively under the control of: (1) chemist and metallurgist, (2) stress analyst and test engineer, and finally (3) the architect. Advances in any one of these fields set up repercussions in the other; and it is only by analyzing trends in all three that the architect can ultimately master steel as a structural material.

Particular credit for assistance in preparation of this study is due the American Institute of Steel Construction and the American Iron and Steel Institute, both of New York City.—Ed.

Photos by H. H. Saylor, A.I.S.C., Municipal Art Society of New York, U. S. Steel, St. Thomas

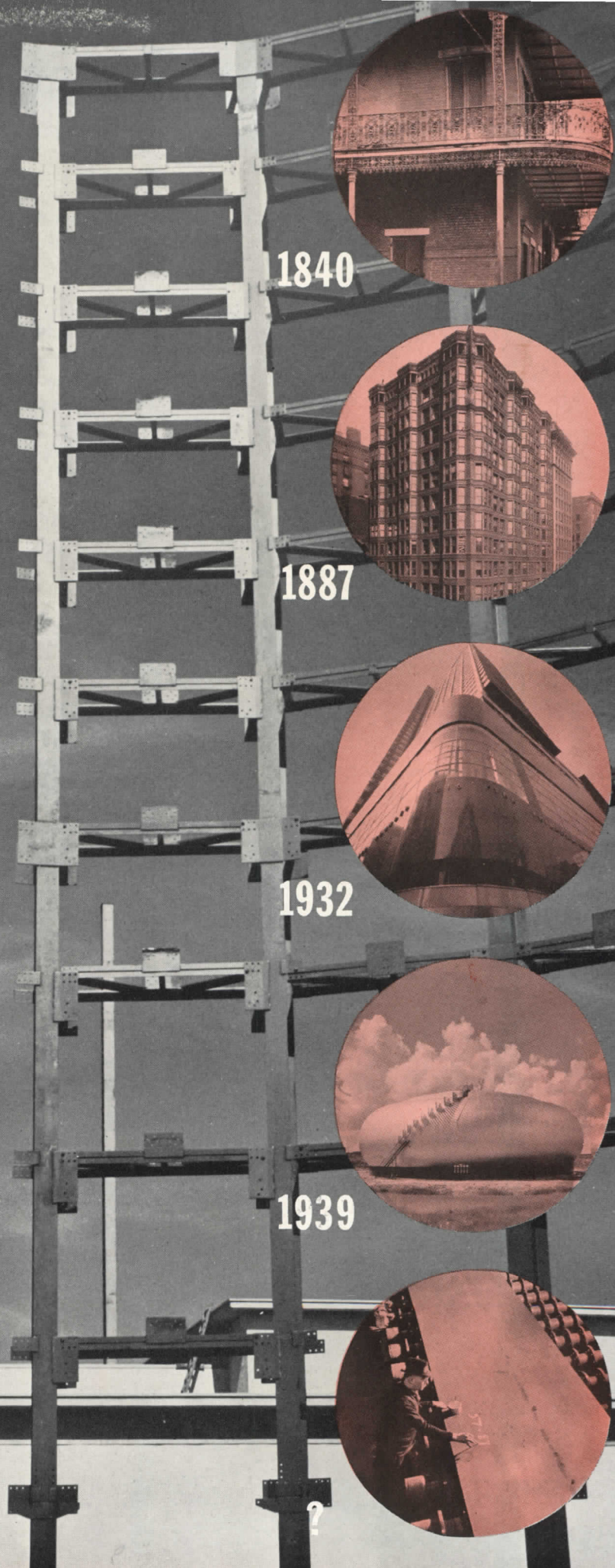

1840



1887



1932

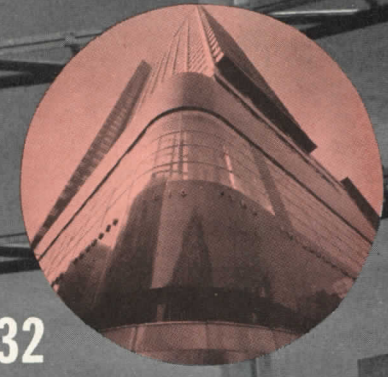

1939

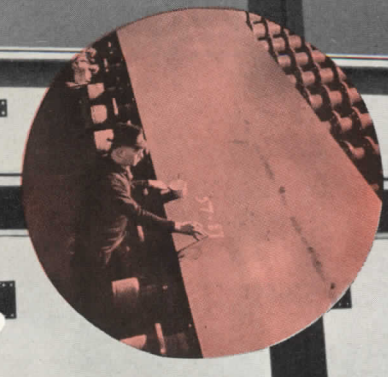
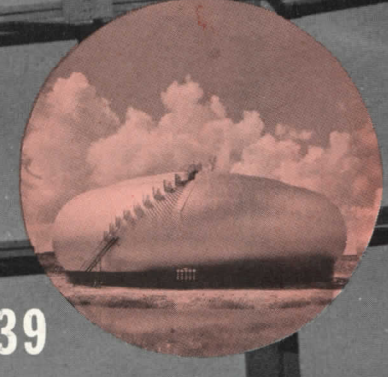

DESIGN TRENDS

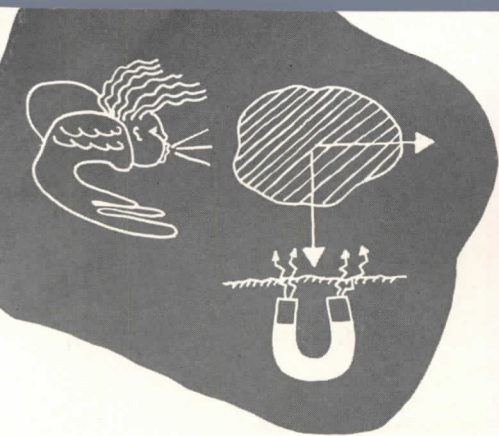

Fig. 1: Two sets of natural forces act upon all building. The structural problem is to resist them with the minimum expenditure of material and energy.

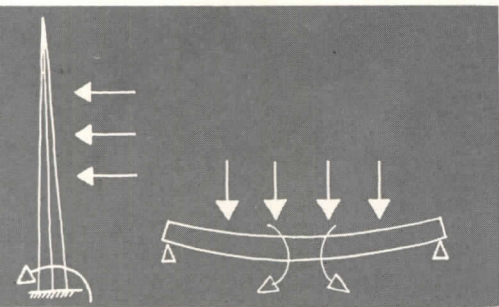
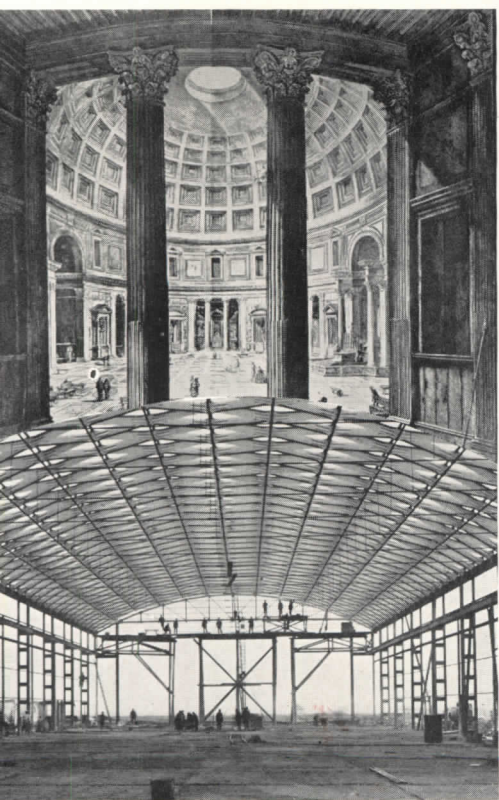

Fig. 2: These forces are usually handled, in their simplest terms, by two structural elements; but modern requirements have forced the development of scores of new structural systems.



M. Strauch, courtesy Lamella

Fig. 3: The material at hand largely determines the specific structural form. Thus, concrete (top) and steel (bottom) were equally adapted to great spans.

STEEL: A versatile material for contemporary structural problems

ALL BUILDINGS are composed of two elements: the *operational*, which directly promotes the activities for which the building has been designed; and the *structural*, necessary but not directly useful, whose purpose it is to enclose, support, and protect the operational. The structural element itself is usually composed of two parts—surfacing and framing—the surface serving to protect the frame itself, as well as the operational parts of the building. Occasionally these two are merged, notably in shell structures—eggs in Nature, spheroid tanks in industry.

All structural systems are subjected, broadly speaking, to two sets of forces:

of the *operational* part
Vertical: the weight

of the *structural* part
Horizontal: wind-pressure and earthquake horizontal forces (Fig. 1).

The structural problem, then, consists in absorbing these two sets of forces and in conveying them to the ground (Fig. 2). In being conveyed to the ground by a structural system, these forces are transformed into characteristic stress patterns—*normal* (compression, tension, and bending) and *tangent* (shear and torsion).

In its simplest terms, this means that materials used for structural purposes must have one or more of these three properties—resistance to pressure, to tension, and to shear. All building materials have one or another of these properties in varying degrees, and, throughout architectural history, their specialized use has recognized this—masonry for load-bearing walls (compression), wood for beams (compression and tension, and therefore bending), hempen rope for cables (tension). Nor did the shortage of one “bending” material (wood) in a given time and place (Roman Empire) prevent the spanning of great areas (Baths of Caracalla). The architects of the time took an abundant material (in this case, concrete), whose major property was its resistance to pressure, and evolved a new design (arch and vault) wherein almost the entire structure was in compression (Fig. 3).

The history of all building materials is but an extension of this sort of experimentation. But it remained for modern industry to increase enormously the range and performance of all building materials. This was all to the good,

but it implied at the same time a wider knowledge than any one man or any one group of men could possibly master. Hence the specialization which characterizes today's building field. Never before have we had so detailed a knowledge of the internal characteristics of materials; and seldom, if ever, has there been so much activity in the field of structural analysis. Much of this activity often seems remote (if not entirely irrelevant) to the individual architect. Yet it is, in the long run, of the most decisive importance to him. Indeed, no modern material—least of all steel—can be used to its best advantage in architecture without a general understanding on the part of the architect of *what* is happening in these two fields and *why*.*

New principles in steel design

For the past three or four decades, the use of steel in American buildings has been largely identified with the skyscraper; and the feeling is still prevalent that with such structures as the Empire State and Rockefeller Center buildings, steel reached the zenith of its contribution to architecture. Such is far from the case. The steel frame represents a structurally satisfactory solution for the multistory building. As long as society requires buildings of this type, the steel frame is likely to remain satisfactory. But in itself it does not necessarily represent the best use of steel.** In fact, theoretically the most efficient use of steel is probably a cable in pure tension; and the great suspension bridges are practical illustrations of this point.

Meanwhile, constant development along many fronts may be summarized in two central facts: (1) increasingly precise knowledge of the characteristics of steel as a material and, based upon this, (2) the design of scores of new or improved structural members and systems. Singly or in combination these offer the architect almost limitless possibilities for the control of architectural space in all types of buildings.

*Interesting in this connection is “Stress, Strain and Structural Damage” by H. F. Moore, Research Professor of Engineering Materials, University of Illinois, University Bulletin, Vol. XXXVII, No. 10, p. 4.

**“The vertical members (in skyscraper framing) are usually columns and the horizontal members are girders or beams, a system fundamentally little different from the post and lintel work of ancient builders. The things that have changed in all this time are the materials; the system of building is essentially the same.” (AR 9/36, p. 237)

STEEL: Chemist and metallurgist make a good material better

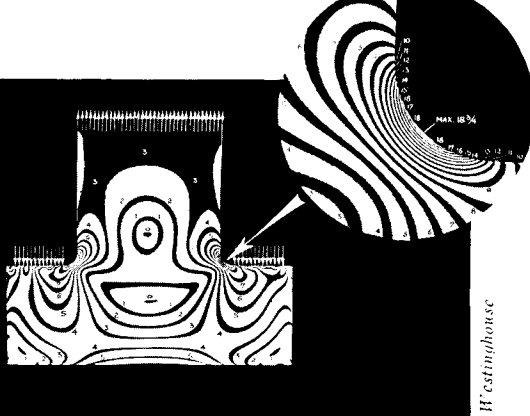

Fig. 4: Of great importance to the building field are current studies in photoelasticity. By means of them, our theories of structure are being checked, refined, and greatly extended.

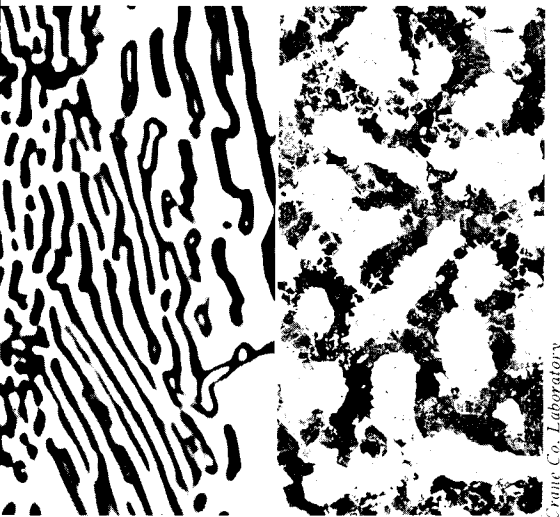

Fig. 5: By means of microphotography steel makers can look inside the material, learning not only why it acts in a given way but how to modify its action in desired directions.

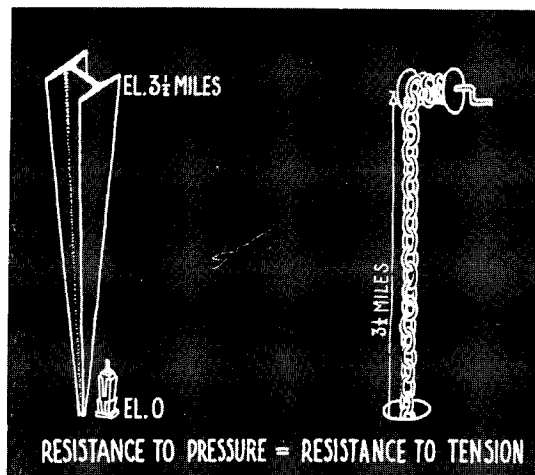

Fig. 6: As a result of advances in chemistry and metallurgy, the properties of steel are being extended and control of them is increasingly precise.

Although all steels are basically compounds of the elements iron (Fe) and carbon (C), two important trends in steel metallurgy are evident: (1) constant improvements in production methods of the ordinary structural steels and (2) introduction of many *new alloy* steels with special properties to meet special service conditions (Figs. 4, 5). In the first case, great advances are being made in the accurate control of the silicon and carbon content and the so-called "impurities" — sulphur and phosphorus. Development of the new alloy steels*, on the other hand, is proving of incalculable importance to industry generally. Although their use in the building field has to date been relatively small (and confined to semistructural or decorative uses), it seems only a matter of time until they assume equal importance here.

Altogether, its mechanical properties make steel the strongest building material known to man. Steel is almost perfectly isotropic—i.e., its mechanical properties are equal in all directions from a given point; and—up to certain limits—it is elastic.** Therefore, it conforms closely to the theoretical laws of applied mechanics.

Resistance to pressure

For a given weight, the area of the column is a function of the resistance to pressure of the material. The potential height of a steel structure is practically unlimited as far as the resistance to pressure of the material is concerned—the tallest structure built is only about $\frac{1}{4}$ of a mile high. Steel, of all commonly used building materials, requires the least column area with consequent space saving and flexibility in floor plan (Fig. 6).

Nature does not allow a complete use of its strength because when the relation between height and area goes over a certain limit, lateral bending becomes the limiting factor, and lateral supports become necessary. In materials other than steel, the architect is seldom conscious of this limitation, because the aforesaid relation cannot reach such high values.

Resistance to tension

In theory, the most efficient structure

*Addition to steel of one or more elements for the purpose of modifying its properties yields what is called an alloy steel.

**Actually, microscopic examination of all structural materials reveals that qualities such as isotropy or homogeneity are only relative, not absolute.

is represented by a cable under pure tension. The tensile strength of steel is extremely high. (Fig. 6). In this country, the tensile properties of steel have been most brilliantly exploited in suspension bridges.

Resistance to bending

Bending is produced by compression and tension stresses within the same element. Bending in horizontal elements is the simplest way to absorb a set of vertical forces, while bending in vertical elements will absorb horizontal forces without the help of tension members. Tensile and compressive strength of steel have the same value. Steel is therefore an ideal bending material.

Plastic stresses

Every architect knows that it is safe to stress the material up to a certain fraction of its elastic limit, but recent studies have indicated that stresses above this limit—the so-called *plastic stresses*—will be absorbed by a steel structure if they are confined to small zones, as there is a natural tendency in the material to redistribute its stresses in order to limit the maximum strain. Along these lines the new theory of plastic stresses is being developed; new and daring structures of steel are promised by further developments of this theory.

Transmission of heat and sound, corrosion

Steel of common structural types possesses three characteristics that frequently require special recognition by the designer who is to make fullest use of this material. Steel is a good conductor of heat and is damaged by prolonged high temperatures; this requires that steel structural systems be fireproofed (where fire hazards exist). It is a good conductor of sound; this requires that (where transmission of sound is undesirable) it be insulated. It is subject to corrosion; this requires that it be protected from the elements.

The new "stainless" steel alloys are almost completely noncorrosive and of very great strength. The chances are that their really wide-spread *structural* use awaits the adoption by architects of the new lightweight structural systems—tension and thin-shell structures. In this field, designers in other fields of industry are setting a pace that the building designer cannot long ignore. (See pp. 79, 80.)

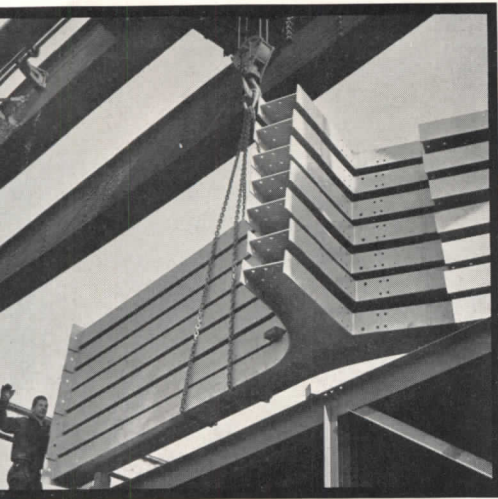

Parade Studio, Courtesy Austin Co.

Fig. 7: Already highly standardized in form, steel has the further advantage that almost any design is "standard" in the sense that it can be shop fabricated with relatively little added cost.

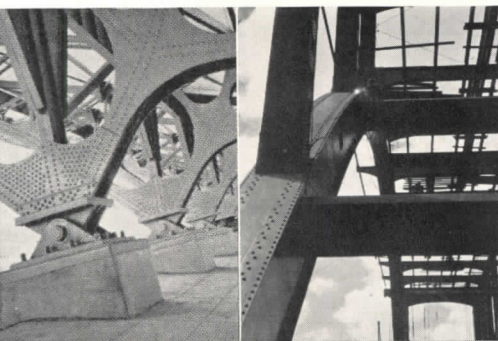

L'Ossature Metallique and Lincoln Electric

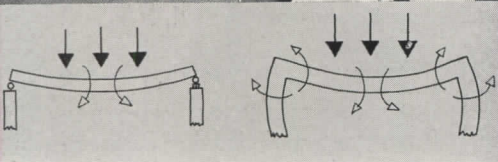
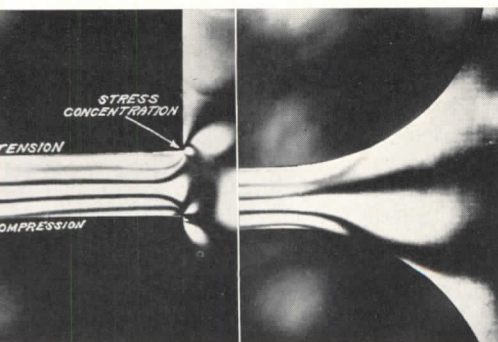

Fig. 8: Whether the connection be hinged (left) or rigid (right), steel as a material is well-adapted to either, with a practical monopoly on the former.



Crane Co. Laboratory

Fig. 9: Photoelasticity studies showing stress concentration at ordinary and at ideal fillets. Such developments as this accelerate the trend towards continuity.

STEEL: Neatly packaged, easily joined, naturally adapted to structural continuity

Generally known, and yet generally underestimated in importance, is the fact that steel, more than any other material, is already produced in standardized forms (or "shapes") which correspond closely to the elementary theoretical shapes required for absorbing all types of load (Fig. 7).

Present forms of steel

A theoretical section needed to absorb tension stresses is the full circle; *steel cables most closely approximate such a section.* To absorb compression stresses, hollow circular or rectangular sections are most efficient; *standard steel pipe and columns and standard structural shapes meet such demands.* Bending stresses require sections with areas widely separated from their center of gravity; *this theoretical requirement is met in the standard steel I-beam.* Combinations of these elementary sections give birth to many structural units of complex character—trusses, hinged arches, rigid frames, etc.; *current steel forms can meet every such requirement.*

When the field of stress is two-dimensional, as in some of the most advanced engineering, flat or curved, smooth or corrugated sheets are used as elementary forms; *steel sheets and plates already are or can be fabricated to meet any such condition.* (The corrugated steel sheet—once regarded as a cheap and temporary *surfacing* material—is rapidly achieving *structural* significance as it appears in an increasing variety of roof- and floor-decks. Actually an exercise in "folding", the trend towards corrugation has become practicable only with the spread of welding and promises almost any desired ratio between light weight and high rigidity.) Where webs are required—as in the reinforcing of other materials—*steel is already available in a wide variety of meshes, laths, webs, and rods.*

"A wall is no better than its joints"

Particular attention in the building field is nowadays centered on the joint; always the weakest point in man's constructions*, it is now being studied more

*" . . . nature builds by cell division with the aim on continuity; man can only build by joining parts together into a unique structure without continuity. Nevertheless, man-made joinings are ultimately controlled not by man but by nature. The process of disruption through natural forces becomes imminent from the very moment of joining parts. Building design must, therefore, aim at the reduction of joints, making for higher resistance, higher rigidity, easier maintenance, lower costs."—"On Correalism and Biotechnique" by Frederick J. Kiesler (AR 9/39, pp. 60-75).

accurately and more closely than ever before. Two main factors are responsible: (1) the fact that the elements always attack the joint first, and (2), even more important, the rapidly developing knowledge of the advantages of *continuity in structural design.* Here steel structures have marked advantages because of the very character of the material.

In nonmasonry construction, there are two ways of joining structural elements: rigid and hinged connections.

Rigid connections transmit both forces and bending moments. This complete transmission of reactions allows a full co-operation between the connected elements. When a beam is rigidly connected to a column, a share of its bending is absorbed by the column.

Hinges are a connection between two elements which permit transmission of forces but not of bending moments. A beam hinged to a column will not transmit its bending to the column, which will therefore be under simple pressure.

Both kinds of connections can be efficiently executed with steel (Fig. 8). Indeed, the rigid junction—up to date the most important in the building field—is characteristic of steel beams and has the great advantage of creating a continuity of elements which reacts favorably to all kinds of external forces.

Welding vs. riveting

The relative merits of riveting vs. welding for rigid connections has been discussed at length during the last 20 years, but the current trend is towards more and more welding (AR 12/38, pp. 61-71). This is partly due to a better knowledge of the theory of continuous structures, partly to both technical and economic improvements in factory and field welding. Although each method has its advantages (and supporters), present technical opinion in the building field has as yet arrived at no generally acceptable basis for comparative rating of the two methods. Thus, the individual architect—faced with the task of designing a steel structure today—can only check both methods for such factors as: rigidity (continuity); structural safety; speed of erection; economy of material; economy of labor; facility of execution; efficient utilization of material; weatherproofness of joints; salvageability.

STEEL: Its versatility keeps it abreast of advance in structural design

More than ever in the past, the trend in architecture is towards *continuity* in structure. This trend is being buttressed by a rapidly increasing knowledge of how individual structural members and entire structural systems behave under all types of load factors. Photoelasticity studies indicate that stress concentrations are higher in the rectilinear connection than in the rounded one. Thus, the larger (or "easier") the radius of the curve, the more efficient the connection appears to be (Fig. 9). What is true of the individual structural member, is true of larger structural units—hence the trend towards "tree form" framing, rigid frames, trussed and hinged arches, etc. (Note photos at left)

Curiously enough, this general "trend towards the curve" in structural design (for reasons of greater mechanical efficiency) is paralleled by a similar trend in plan (for altogether different reasons). Although the great majority of current architecture is still "rectilinear" in plan, growing recognition of the importance of easy circulation and accurate control of light, sound, and atmosphere is having a marked effect on the plan. This is most apparent in nonresidential construction (theaters, stores, factories), where need for a precise control of one or another of these phenomena overrules prejudice in favor of the right angle.

Current practice in the use of steel for structural members closely parallels—if, indeed, it does not actually set the pace for—the trend towards structural continuity.* The characteristics of the material itself (p. 74) make it initially suitable, and the introduction of welding greatly extends the area in which steel can be thus used.

The above, however, is a central, *but not the only*, generalization necessary concerning trends in steel design today. Steel today covers the entire spectrum of the structural problem from (1) concentration of huge loads in a relatively few huge members to (2) dispersion of loads over a wide area in a multiplicity of relatively light members to (3) stressed skin or thin-shell constructions, where surfacing and frame become (to all intents and purposes) a single thin structural element. Except for designs specifically based upon use of a given material—e.g., true arches of masonry, monolithic slabs of reinforced concrete—*there is scarcely a single structural member, element, or system which cannot be efficiently fabricated in steel*; and many of them can be realistically fabricated *with steel alone*. A brief documentation (below) leads to new concepts of steel's extraordinary versatility.

*Many recent developments in the field of timber construction, for example, owe their origin to steel construction. See "Revival of Wood as a Building Material" by Don Taylor, AR 12/39, pp. 63-72.

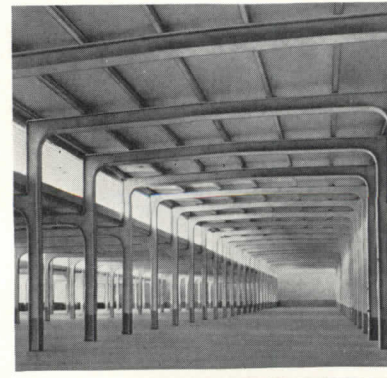
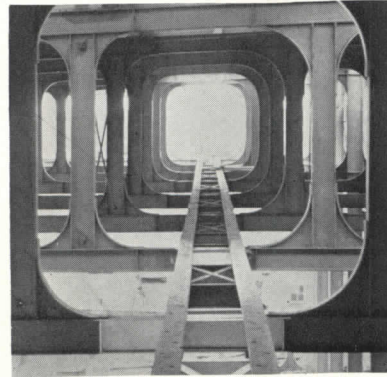
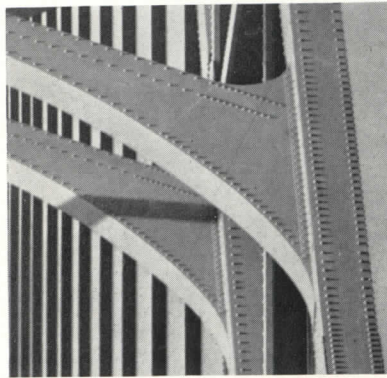
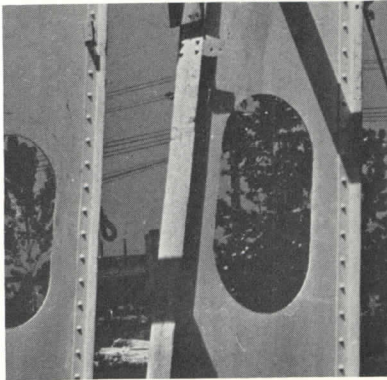
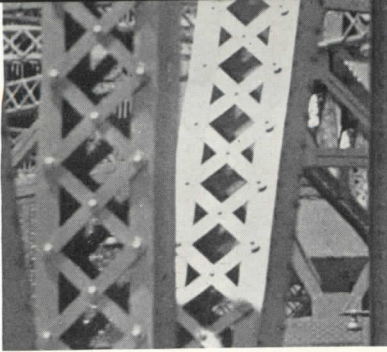

St. Thomas

A.I.S.C.

Austin Co.

Austin Co.

Coleman Wheat

MAJOR STRUCTURAL ELEMENTS ARE EASILY FABRICATED IN STEEL

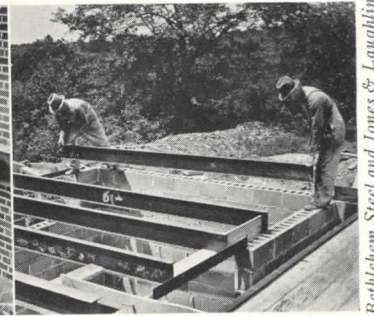
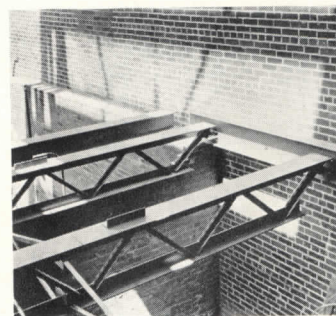
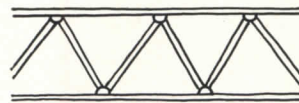

Bethlehem Steel and Jones & Laughlin

1. LIGHT TRUSSES: Steel is today fabricated in a wide variety of shapes, weights, and sizes. Notable are the new lightweight beams, "open web" joists, steel "studs" and

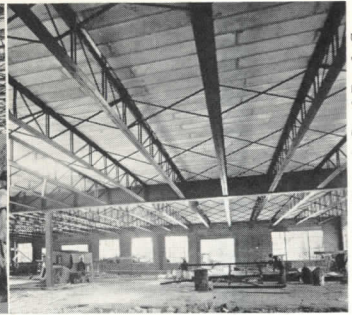
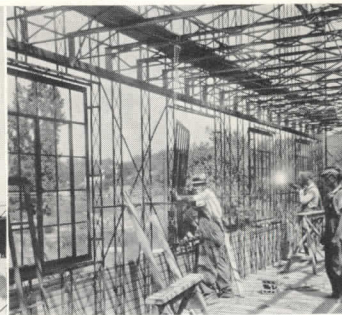
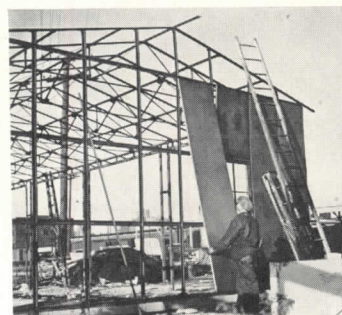

Fensholt Co., Detroit Steel Prod. Co.

"joists", etc., which make it adaptable to almost all types of light construction.

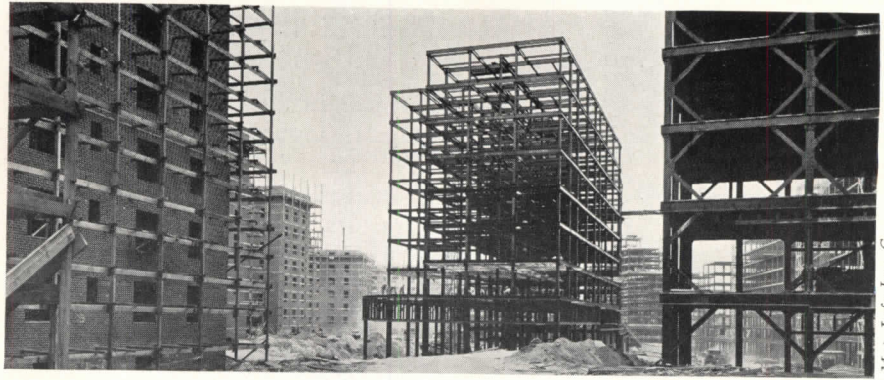
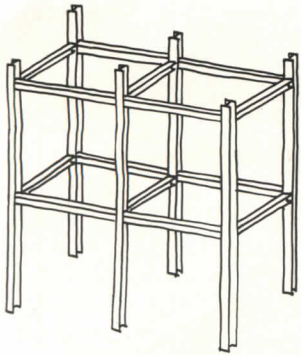

Met. Life Ins. Co.

2. FRAMED STRUCTURES: Largely identified with the skyscraper, where great height was a requirement, steel "structural shapes" are practically standard. Out of experience with such rigid framing were evolved . . .

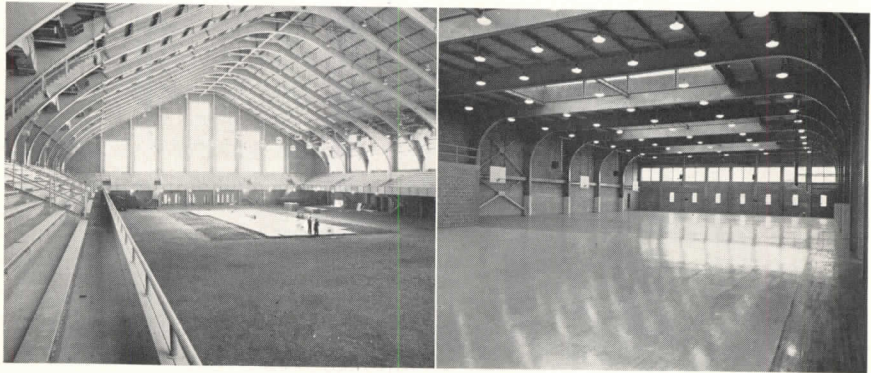
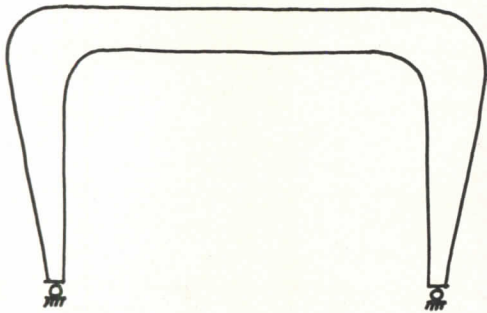

Amer. Bridge Co., and A.I.S.C.

3. RIGID FRAMES: An example of the trend towards continuity in steel. Increasingly popular for long spans, the frames have many varied shapes. Transition from rectangular frames is continuous through polygonal frames to . . .

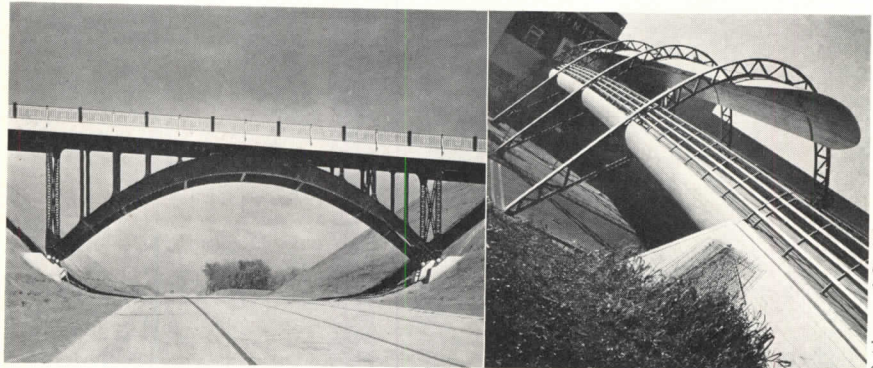
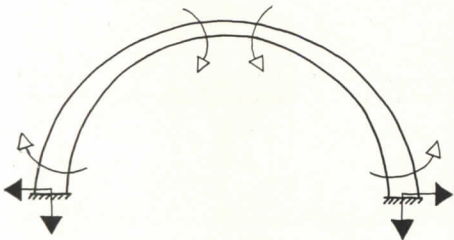

Behler, and St. Thomas

4. ARCHES: Of masonry origin, the arch nevertheless can be efficiently executed in steel with either open web (trussed arch) or solid web.

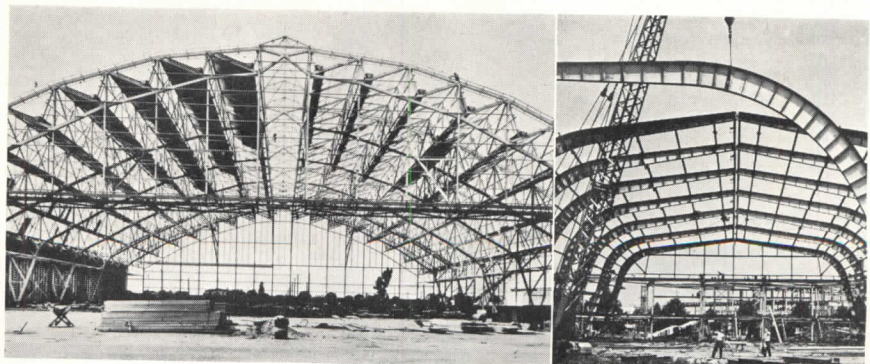
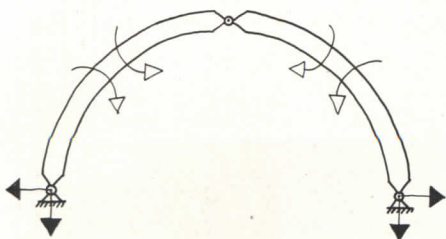

Bethlehem Steel, and St. Thomas

5. HINGED ARCHES: Dangerous stresses, due to temperature and foundation movements, can be overcome by means of the hinged arch.

STEEL

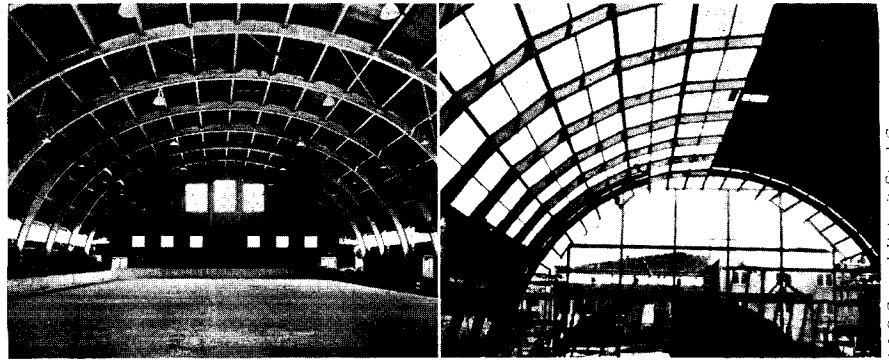
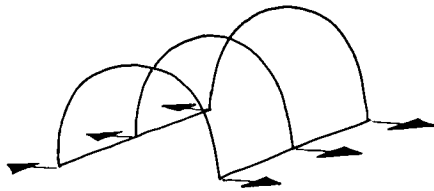

A.L.S.C., and Detroit Steel Co.

6. ARCHED STRUCTURES: Use of a series of relatively light steel arches with intermediate bracing yields what is essentially a new structural type. The trend towards welding steel roof-decking to arches further increases its stability.

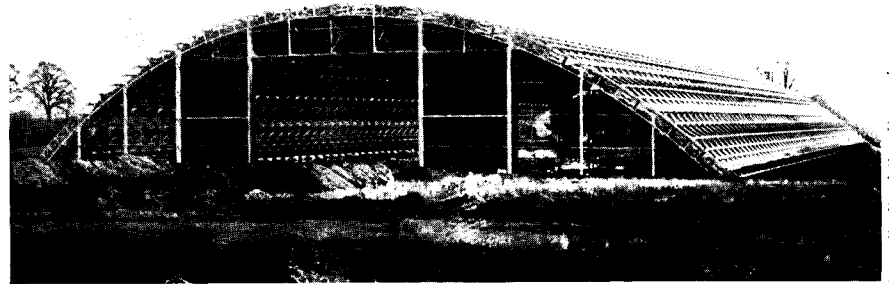
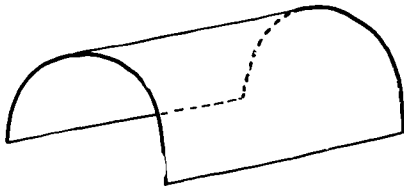

Lamella Roof Syndicate, Inc.

7. VAULTS: In the "vault" the depth of the structural members is reduced by greatly increasing their number, effectively spreading the load. The steel "Lamella" is one of several quite different basic approaches.

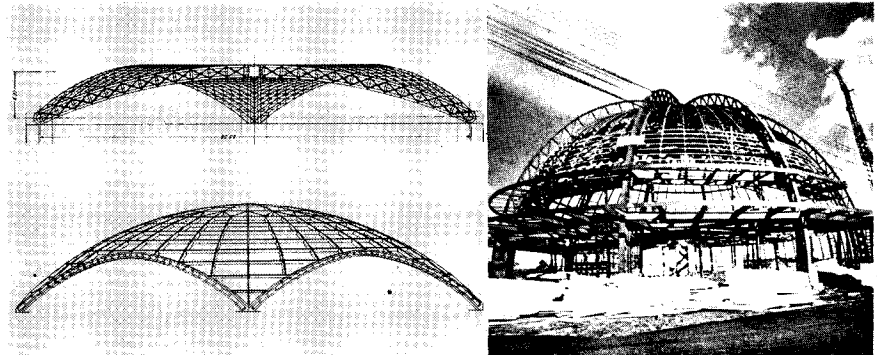
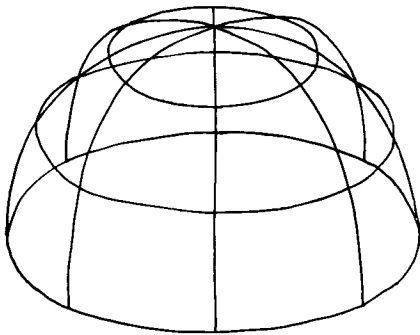

U. S. Steel

8. DOMES: Another form of masonry origin practical in steel, where a combination of arches or polygonal frames in vertical planes are used with curved or polygonal tension members in horizontal planes. Superficially similar are . . .

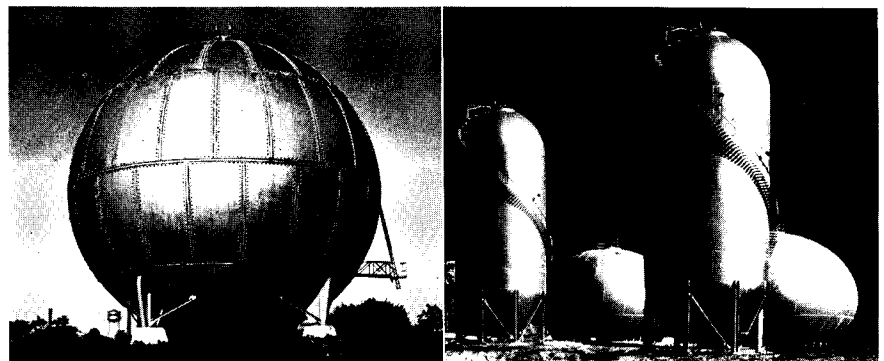
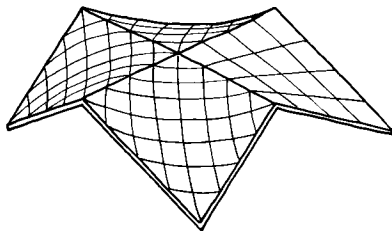

Douglas from Gendreau, and R. Y. Ritchie

9. THIN SHELL STRUCTURES: A sheet of steel has no rigidity and can therefore support no weight; but if given a certain curvature, the sheet acquires a new strength. Here is proof of the effect of shape upon material.

STEEL

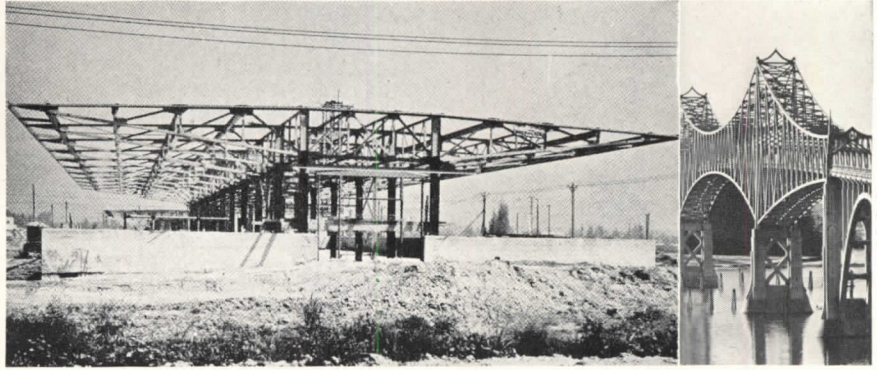
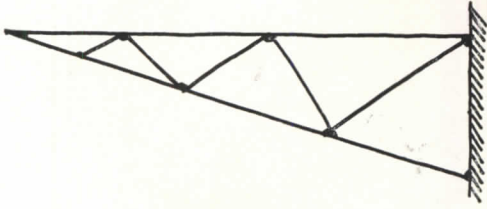

Starret, and A.I.S.C.

10. CANTILEVERS: Although widely used in architecture (as in the California school at left), their potentials are most often indicated in bridge design (right).

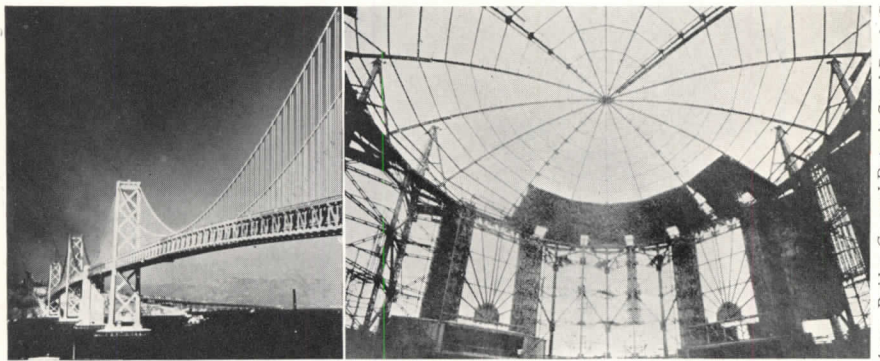

Amer. Bridge Co. and Detroit Steel Prod. Co.

11. SUSPENSION STRUCTURES have been only tentatively suggested in architecture. The Transportation Building (right above) employed steel in tension at Chicago's 1933 Fair. But American architects have been slow to realize . . .

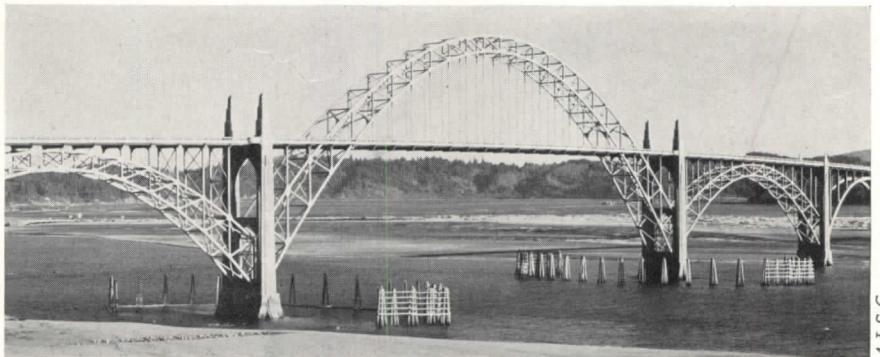
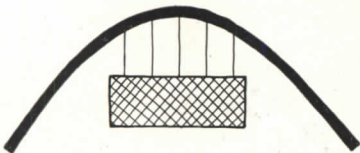

A.I.S.C.

12. The mere existence of such bridges as above establishes the feasibility of entirely new types of steel structures.

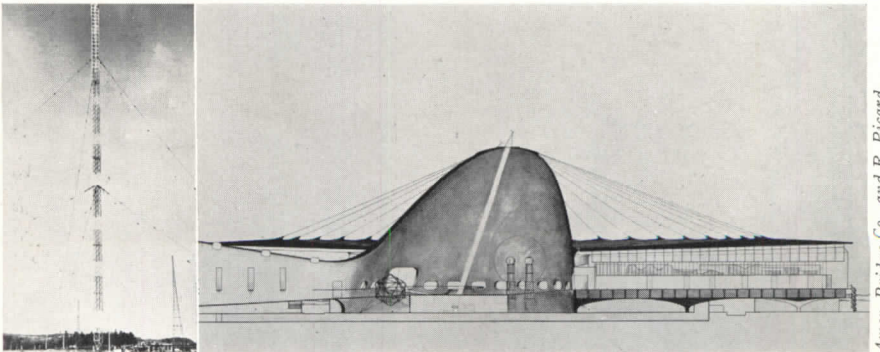
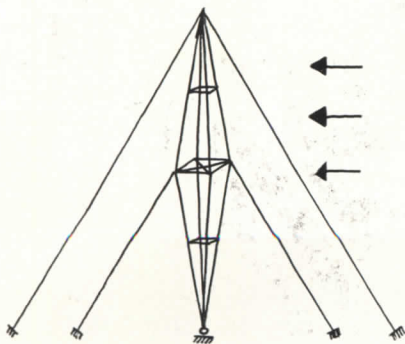

Amer. Bridge Co., and R. Picard

13. The radio towers prove in fact what Nelson's design for the proposed Paris Museum of Discovery can only indicate in principle—that steel adds new dimensions to the field of structural design which architects might well investigate.

ARCHITECTURE ON PARADE

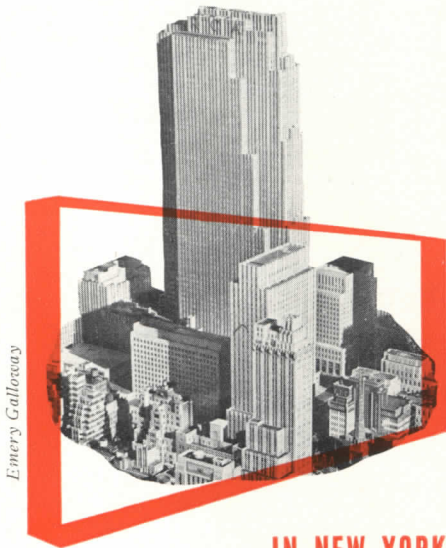

IN NEW YORK

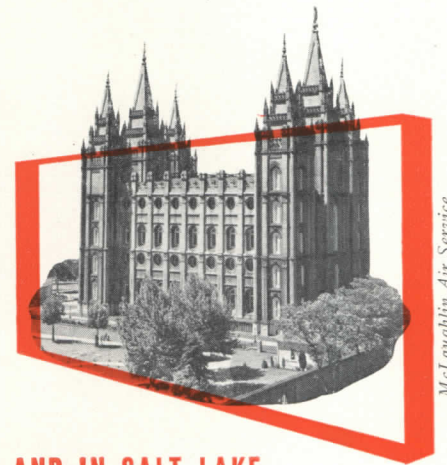

AND IN SALT LAKE



Among ways and means for bettering relations between architects and their public, exhibitions take high-ranking honors for general effectiveness. Backed by local publicity, dramatically presented exhibits of architectural abilities have proved forceful and relatively inexpensive as a method of stimulating interest not only in architectural design but in such related matters as regional planning, civic rehabilitation, slum clearance, and housing. The housing exhibit shown last year in New York's Museum of Modern Art—for which the USHA was co-sponsor—was so well-attended (about 150,000) that it is now making the rounds of some 12 other cities. And delegates to the AIA convention last September recall the success of the Washington Chapter's graphic commentary on city planning needs (see AR 12/39, pp. 56-62). That also is being circulated by the American Federation of Arts.

More recent are two exhibitions, which, though far apart geographically, contain elements in common that are proving effective as points on a trend-line to better public relations. Each was the product of professional initiative; each was staged with a keen sense of showmanship for a lay public critical of display technique through contact with two World's Fairs; each threw the graphic spotlight on "modern"; and each was supported by a well-directed press campaign.

IN NEW YORK CITY on March 5th the Architectural League opened an exhibit, mainly of architectural photographs, with the title of "Versus." Staged by two League committees headed by Hugh Ferriss and presented with the avowed intention of contrasting works of "traditionalists" and "modernists," the show was held on two floors of the League building. Photographs of buildings with a classical character decorously lined the first-floor walls. But above, the League's gallery had been made into an eye-catching labyrinth in which modern materials, signs, models, special lighting arrangements, and strikingly arranged photographs displayed results of the modernists' philosophy.

This show, in contrast to the Utah exhibit, had no particular educational mission to perform, according to its creators. But it was shrewdly geared to stimulate controversy—professional and otherwise. Controversy makes good copy; and the League show has been the subject of many news reports and special articles.

IN SALT LAKE CITY the Utah Chapter, AIA, of which Lloyd McClenahan is president, presented the second of a six-show program at the Utah State Art Center. Planned to emphasize the part that architects play in providing facilities for modern living, the exhibit (constructed by the Art Center staff) stressed the progressive development of "The Modern House" to meet requirements of contemporary family life. During its three weeks' (Jan. 17 to Feb. 7) run, the show was the subject of numerous newspaper features, and three radio programs. Lectures regarding its various aspects were given before local clubs; and it was toured by school and club groups in addition to almost 6,000 interested individuals, ranging from those in the low-income group to successful business men. Results of this program point to a possibility that the exhibit may be shown in other Utah cities; and at least one other direct result was a considerable demand for house plans and more information on building problems from the "lay public" who viewed it.

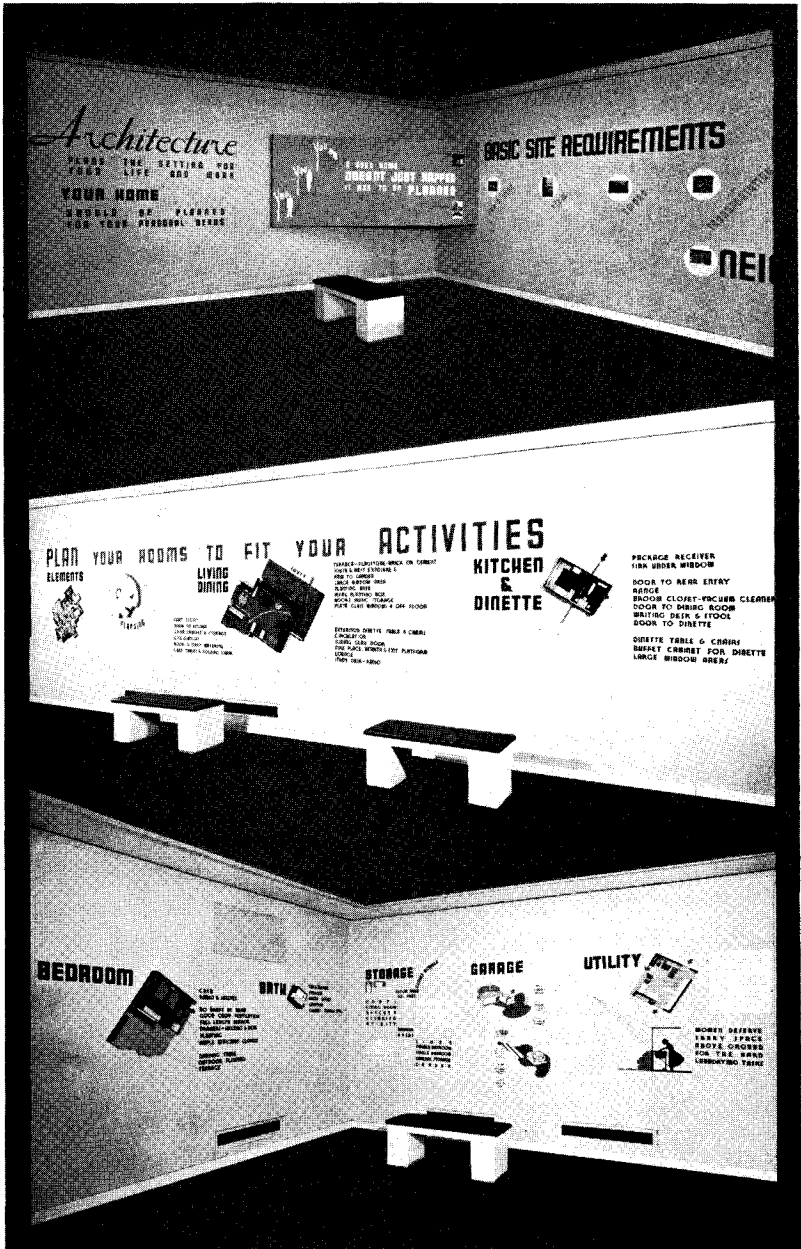
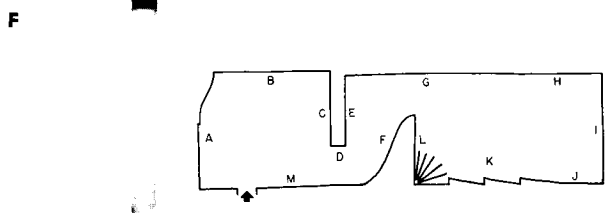
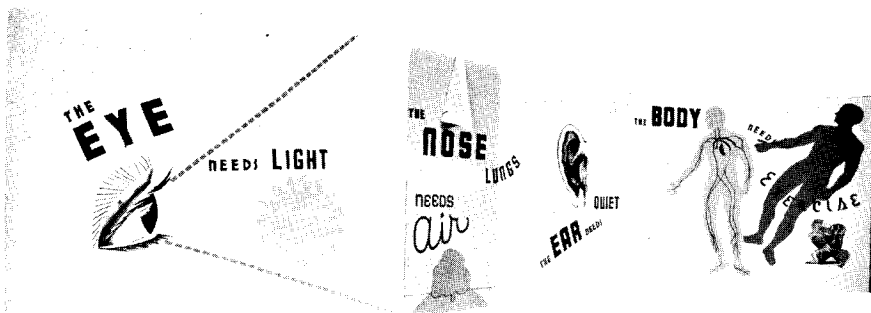

“ARCHITECTURE FOR YOUR LIVING” . . .
 Exhibition of modern planning sponsored by the
 Utah Chapter, AIA

THIS DISPLAY was developed to show that, through intelligent planning, the modern house can most effectively provide for all the various needs that are peculiar to modern family life. In addition, it was part of a campaign to improve business conditions by stressing the value of architectural services in house building activity. . . . The exhibit was arranged in two parts. The first (from A to I in the diagram above) analyzed basic living requirements and by means of plan-models demonstrated how these could be met in a modern house. The second part (J to M) showed, in photographs and plans, the current residential work of Salt Lake City architects. Panels were executed by artists and workmen of the Art Center staff, directed by Donald B. Goodall. Plan models were built by W. H. Shurtliff.



Photographs of executed work—J, K—and a "book" of design sketches and working drawings, L

Photos by D. F. Davis

WHERE ARE ARCHITECTURAL PASTURES GREENEST?

Is the geographical distribution of architects and architects' offices out of balance with prevailing opportunities? Is the grass greener in one state than in another?

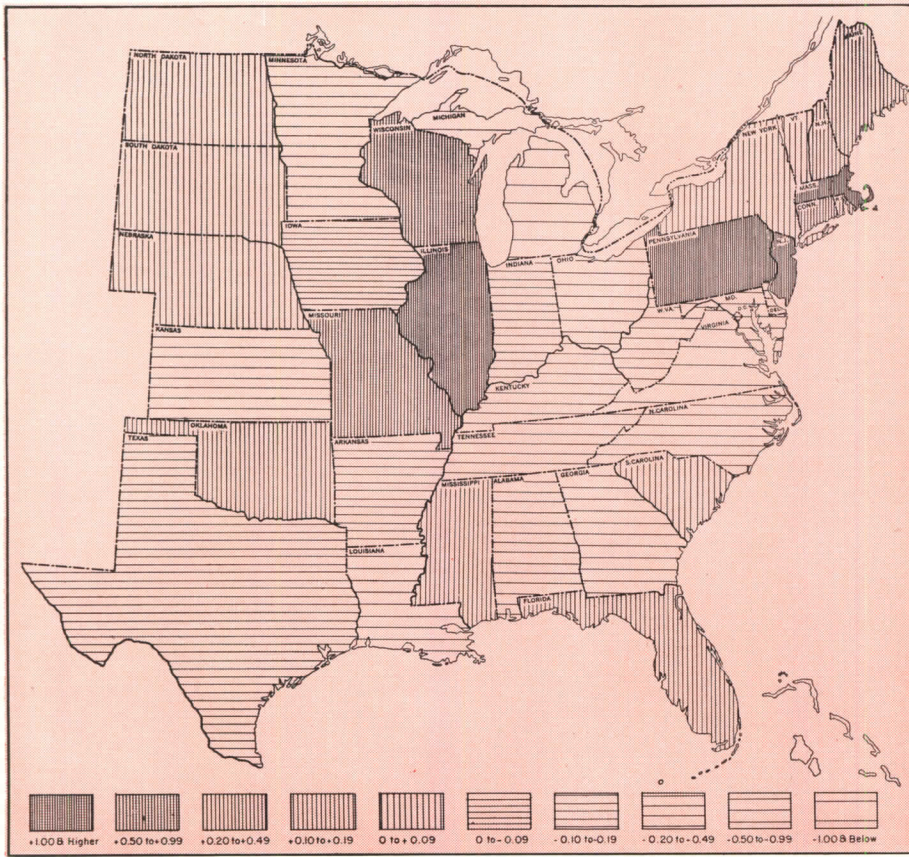

Courtesy American Map Co.

Shown above is the geographical distribution of active architectural offices in relation to 1939 building volume in the 37 eastern states, according to F. W. Dodge Corporation records. Spacing of vertical lines suggests relative surplus, and of horizontal lines relative shortage. Distribution within states not shown.

BEFORE ONE could confidently say that a given state had too many architects or that another had too few, more facts than are currently available would have to be consulted. But registration laws in 31 of the 37 eastern states, and F. W. Dodge Corporation records on active offices and contracts awarded in all 37, provide an interesting approach to the problem.

With these, for example, it is possible to point out that in 1939 the dollar volume of building in Michigan was 5.8% of the total for the 37 eastern states. At the same time, the number of active offices was 4.15% of the total. Massachusetts, on the other hand, accounted for 3.43% of total building, and had 5.22% of the total number of active offices. Thus, based on the relation of active offices to building volume, Michigan is understocked with architects and Massachusetts overstocked.

Active offices alone, however, do not always give a complete summary of conditions. In instances where possible, the number of registered architects should be considered. A case in point is New Jersey. Though its ratio of active offices to building volume was 5.76 to 4.42, its ratio of registered architects to building was 10.7 to 4.42.

The map at the left indicates concentration of active offices in relation to building volume. The table below gives the exact figures, and includes data on registration and residential building.

STATE	% Total Dollar Volume*		% Total Architects		STATE	% Total Dollar Volume*		% Total Architects	
	Residential Building*	All Building*	Registered Architects	Active Offices*		Residential Building*	All Building*	Registered Architects	Active Offices*
Alabama	1.06	1.21	0.72	0.90	North Dakota	0.10	0.15	0.22	0.24
Arkansas	0.43	0.66	.46	0.48	Ohio	7.59	7.05	6.11	6.48
Connecticut	2.22	2.31	2.29	3.04	Oklahoma	1.04	0.97	0.79	1.16
Delaware	0.34	0.47	0.43	0.30	Pennsylvania	7.60	7.16	6.43	8.31
Dist. of Columbia	2.02	2.77	1.21	1.80	South Carolina	0.61	0.81	0.70	0.90
Florida	4.22	3.12	3.44	3.30	South Dakota	0.12	0.17	0.32	0.19
Georgia	2.18	2.13	1.25	1.24	Tennessee	1.64	1.53	0.84	1.23
Illinois	6.00	6.61	7.77	7.81	Texas	5.65	5.65	3.35	5.51
Indiana	2.03	2.33	1.62	2.18	Virginia	2.70	2.70	0.81	1.66
Iowa	0.98	1.28	0.83	1.23	West Virginia	0.95	1.07	0.60	0.74
Kentucky	1.50	1.43	0.86	1.00	Wisconsin	1.91	1.96	2.91	2.65
Louisiana	1.63	1.98	1.11	1.31	Rhode Island	0.59	0.62	0.86	1.02
Maryland	2.90	2.56	1.77	1.95	Kansas	0.83	1.00		0.71
Michigan	7.05	5.80	4.34	4.15	Maine	0.13	0.21		0.48
Minnesota	1.81	2.06	1.99	1.80	Massachusetts	3.44	3.43		5.22
Mississippi	0.40	0.46	0.52	0.57	Missouri	2.79	2.68	10.52†	3.40
Nebraska	0.64	0.74	0.32	0.83	New Hampshire	0.12	0.21		0.45
New Jersey	4.60	4.42	10.70	5.76	Vermont	0.14	0.18		0.23
New York	18.36	18.10	22.94	18.17					
North Carolina	1.68	2.01	0.97	1.60	37 States Total	100.00	100.00	100.00	100.00

*According to 1939 records from F. W. Dodge Corporation reports covering the 37 eastern states.

†Estimated for those states without registration laws.

CURRENT TRENDS OF BUILDING COSTS

Compiled by Clyde Shute, Manager, Statistical and Research Division, F. W. Dodge Corporation, from data collected by E. H. Boeckh & Associates, Inc.

CURVES INDICATE trend of the combined material and labor costs in the field of residential frame construction. The base line, 100, represents the U. S. average for 1926-1929 for residential frame construction.

Tabular information gives cost index numbers for the nine common classes of construction. The base, 100, in each of the nine classes represents the U. S. average for 1926-1929 for each particular group. The tables show the index numbers for the month for

both this year and last.

Cost comparisons, as percentage differences for any particular class of construction, are possible between localities or periods within the same city by a simple process of dividing the difference between the two index numbers by one of them. For example: if index for city A is 110 and index for city B is 95 (both indexes for A and B must be for the same class of construction), then costs in A are approximately 16% higher than in

B $\left(\frac{110-95}{95} = 0.158. \right)$ Conversely it may be said that costs in B are approximately 14% lower than in

A $\left(\frac{100-95}{110} = 0.136. \right)$

Similar cost comparisons, however, cannot be made between different classes of construction since the index numbers for each class of construction relate to a different U. S. average for 1926-1929.

CONSTRUCTION COST INDEX U. S. average, including materials and labor, for 1926-1929 equals 100.

ATLANTA

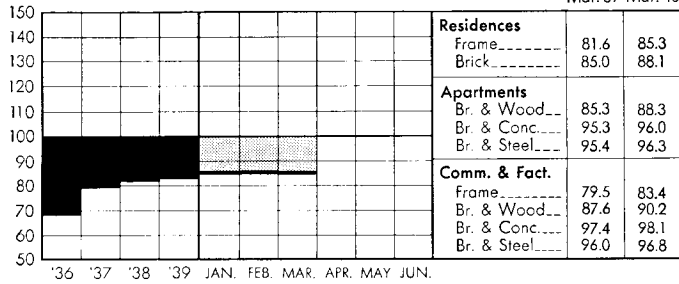

CHICAGO

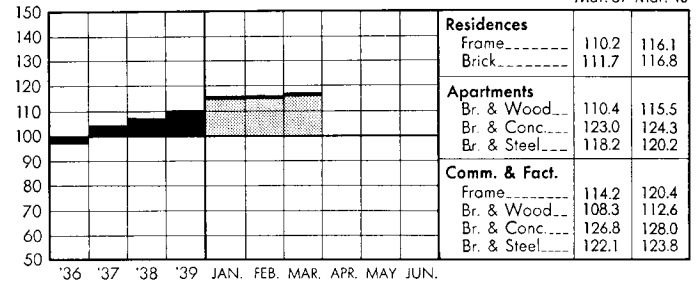

BALTIMORE

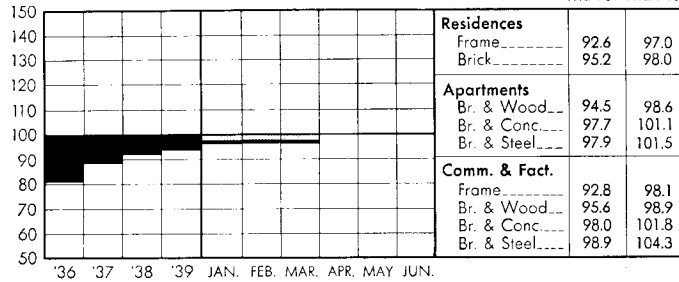

CINCINNATI

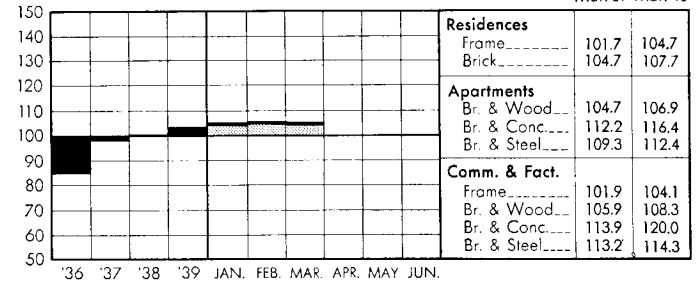

BIRMINGHAM

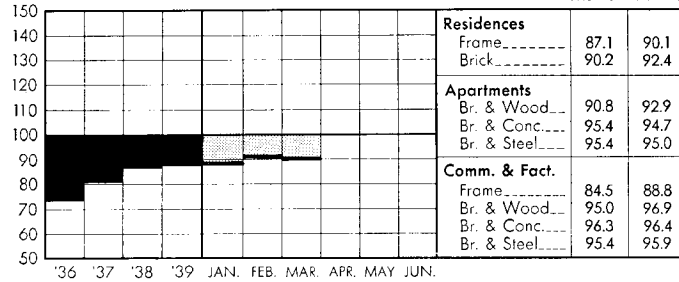

CLEVELAND

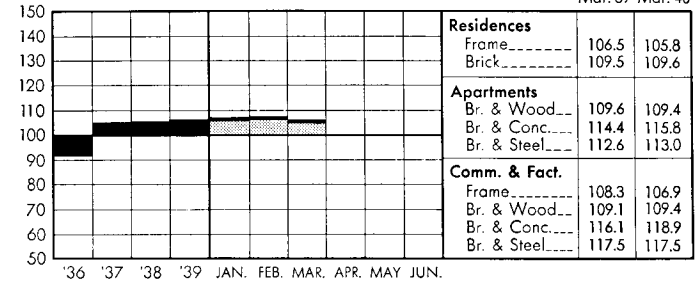

BOSTON

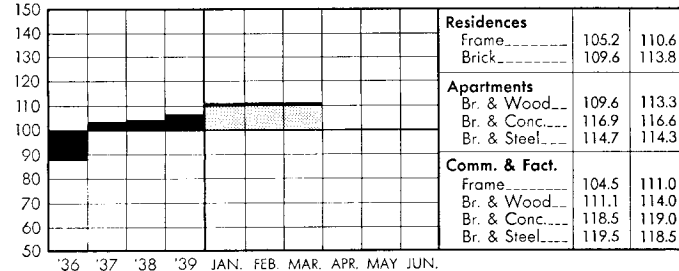

DALLAS

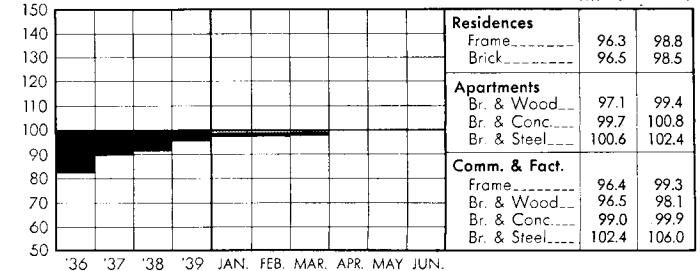

DENVER

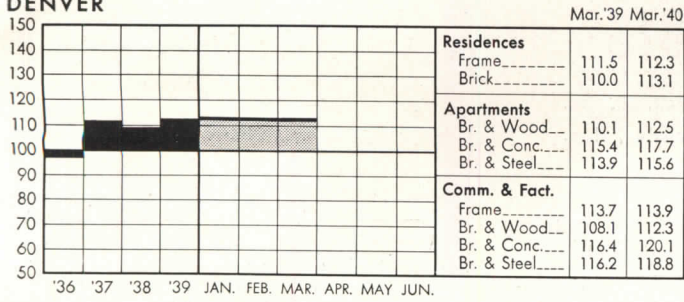

NEW YORK

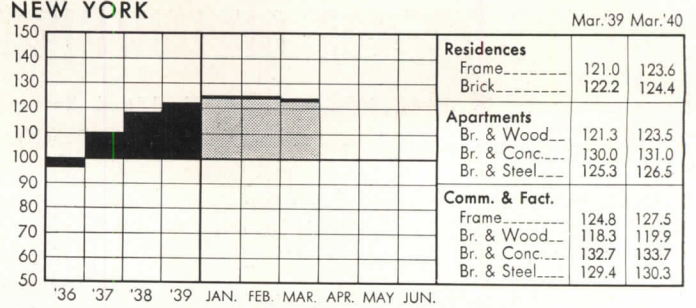

DETROIT

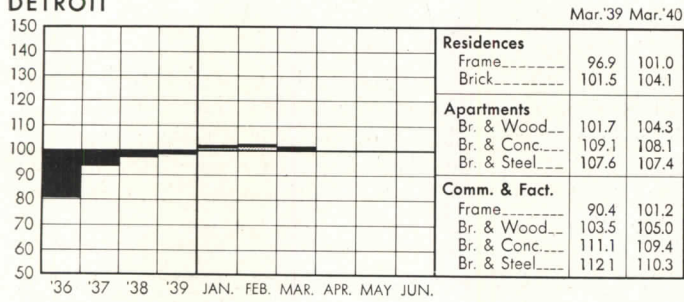

PHILADELPHIA

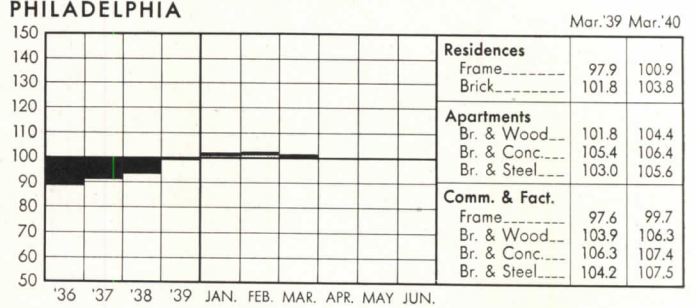

KANSAS CITY

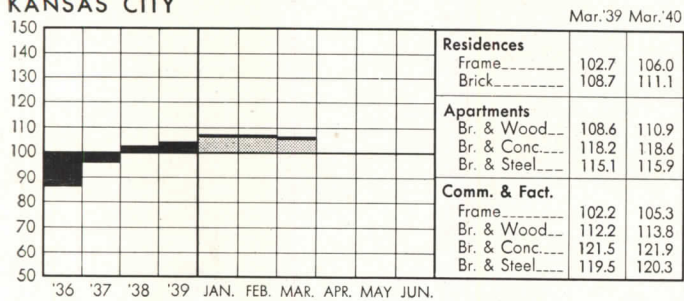

PITTSBURGH

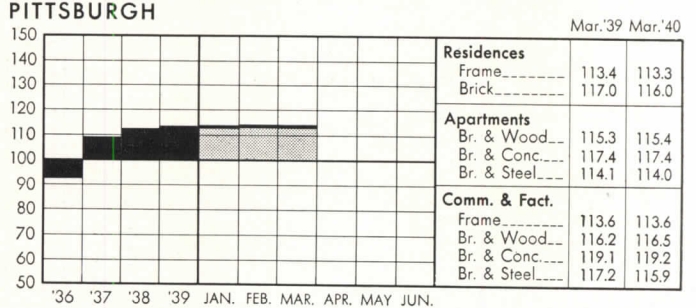

LOS ANGELES

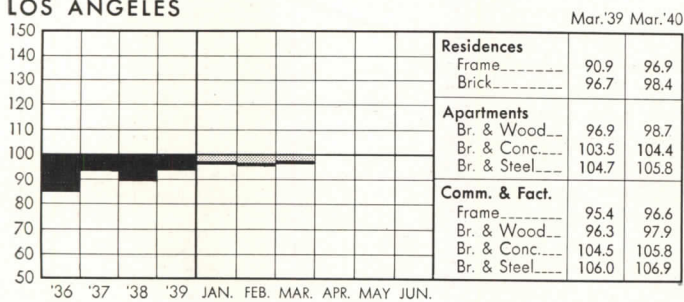

ST. LOUIS

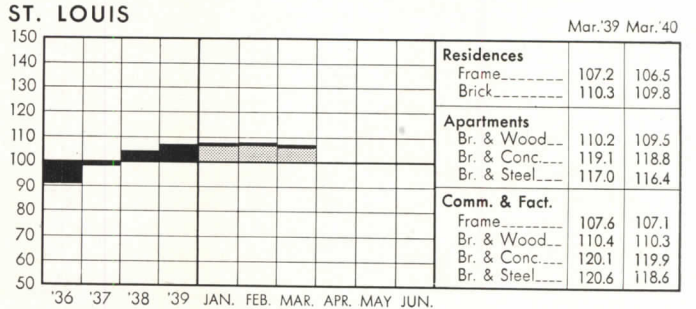

MINNEAPOLIS

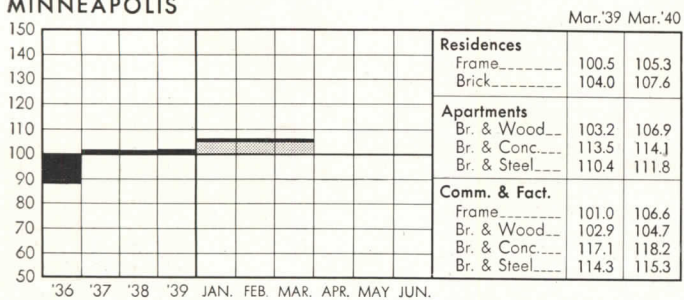

SAN FRANCISCO

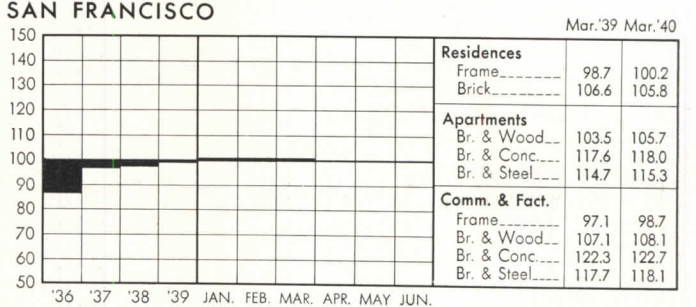

NEW ORLEANS

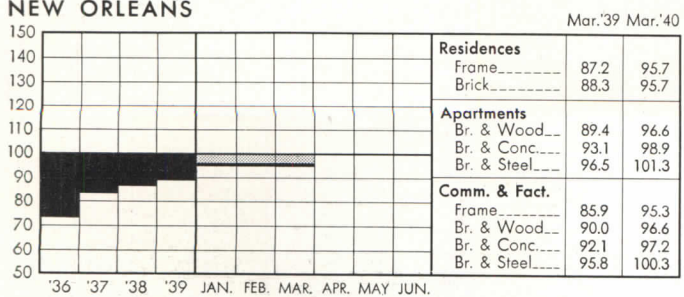

SEATTLE

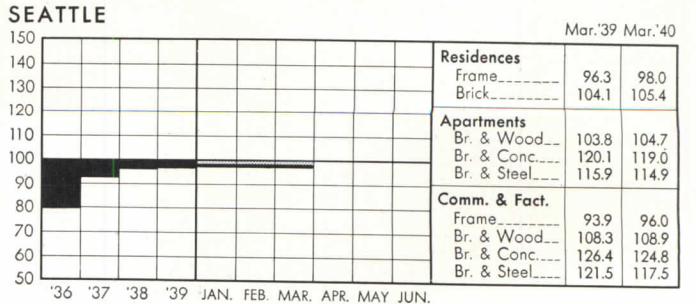

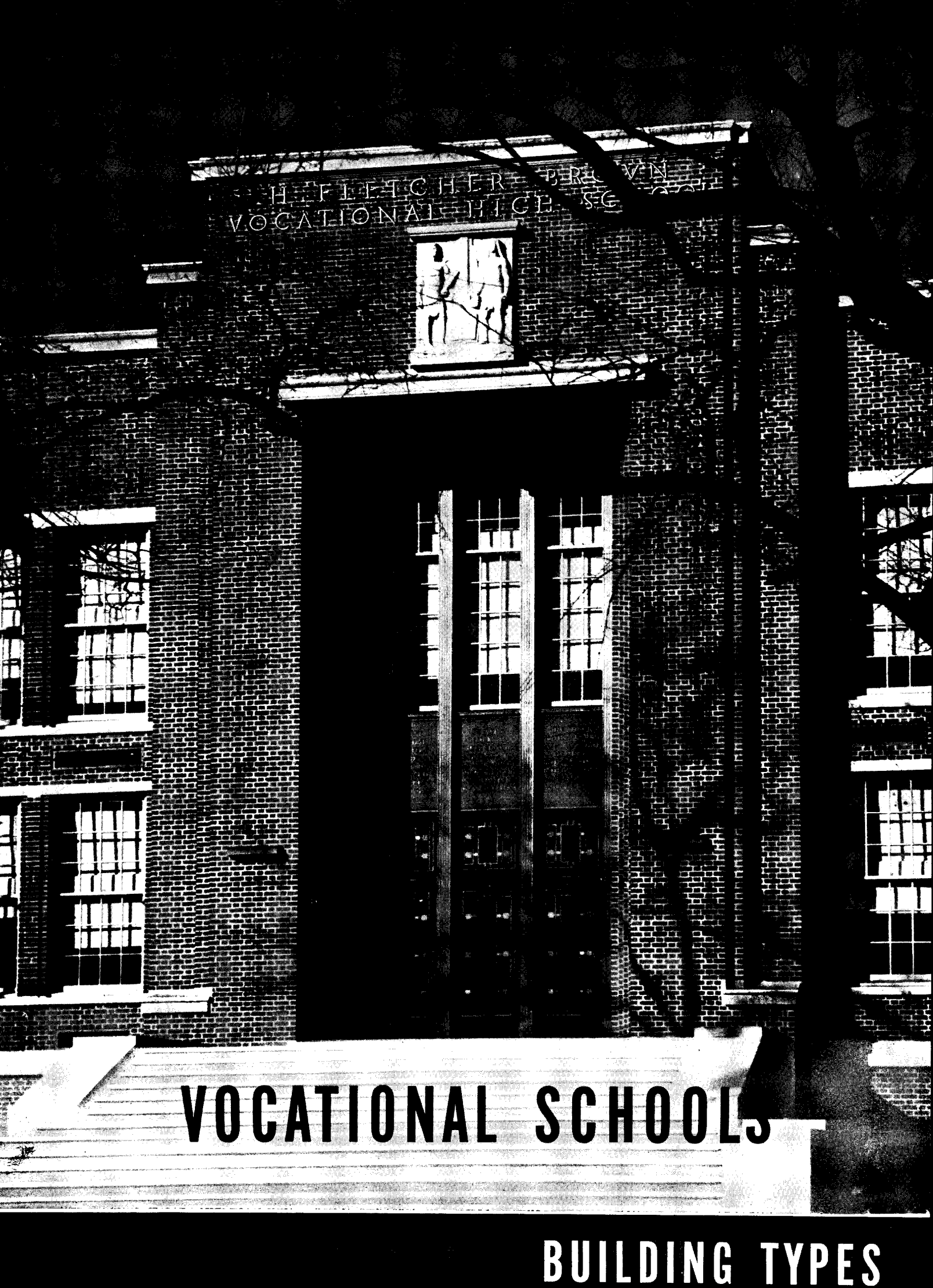

SHEFFLER-BROWN
VOCATIONAL HIGH SCHOOL



VOCATIONAL SCHOOLS

BUILDING TYPES

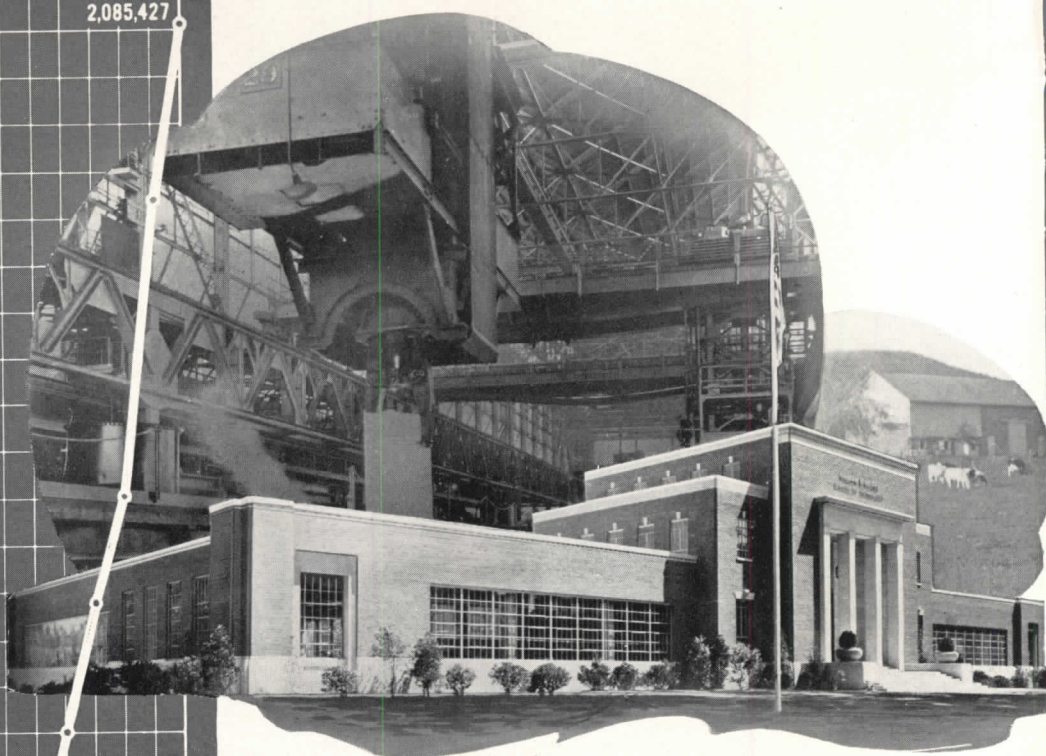
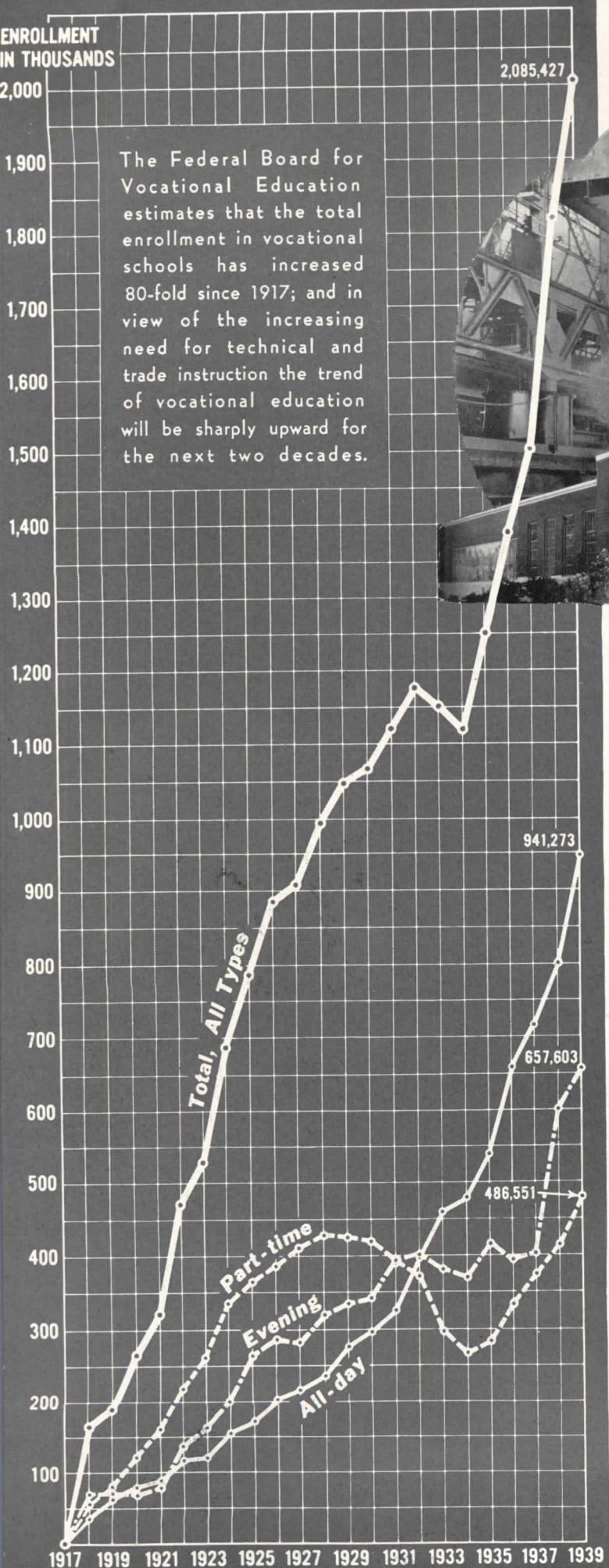

VOCATIONAL EDUCATION is not, as some of the more academically-minded members of the teaching profession believe, a strange and extraneous activity that is gradually infiltrating and diluting the educational process. It has its justification in a fundamental concept of American education. The purpose of education in a democratic social organization is to aid individuals in adapting themselves to harmonious living and to recognize and teach the means for development of the individual. Education must provide for adequate vocational and professional training, and also inculcate in the individual a sense of social and moral responsibility to the group in the use of these skills. Education should serve not only as an agency for cultural reproduction but also as a means for improving the culture through acceptance of leadership for the promulgation of social trends and changes. Vocational and technical education may be considered just as essential and vital on the secondary level as professional training in advanced education.

Development of vocational education in the United States may be divided into three phases. The first period, prior to 1910, represents its orientation wholly within the home, factory, and store. The second phase, extending from 1910 to 1940, is the transition period, marked by a serious consideration of vocational and technical training by the school and including different types of experimental efforts. The third phase, into which the school is now moving, includes the probable development of emerging tendencies that have become more apparent during the past few years.

From colonial times to approximately 1910, vocational education was considered as primarily the responsibility of the craft unions, the home, the factory, and the service outlets. Children who planned to enter the trades, industry, or commerce spent their first six, eight, or ten years in school and then entered commerce or industry as full-time apprentices. In the course of years they became familiar through practice with the demands and required skills and eventually became journeymen or masters in their chosen vocations. The higher craft skills were furnished by large groups of immigrants who brought the very valuable contribution of

Modern educational standards require NEW FACILITIES for INDUSTRIAL ARTS TRAINING

... and those which high-ranking educators deem most important are detailed in this study. To begin it, DR. ARTHUR B. MOEHLMAN, Editor of *The Nation's Schools*, Director of The University High School at Ann Arbor, Mich., and member of President Roosevelt's Advisory Committee on Education, sketches the background and present trend of needs and activities in industrial arts and vocational education that basically affect the design of modern school plants.

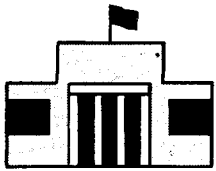

Annual cost of Public Elementary and Secondary Education exclusive of capital outlay (each bag represents 100 million dollars)



(Adapted from the October 1939 School issue of the *Survey Graphic*, which has since been reprinted by Farrar and Rinchart as "Democracy's Challenge to Education")

old-country skills acquired through both apprenticeship and schools in their native lands. Craftsmanship was of significant import; and the combination of large annual importations of industrial and commercial skills plus the simple nineteenth century American economic organization made it unnecessary to look beyond these two sources.

The rapid technological development of American industry that occurred at the beginning of the twentieth century brought with it many new problems. Farsighted industrialists and educators saw that the time was rapidly approaching when reproduction of vocational and technical skills would be delegated at least in part to the schools. Significant changes in domestic and rural economy became apparent in the nineties and had a direct influence. A significant study of these changes was made during the administration of President Theodore Roosevelt. One of the immediate effects of the first world war was to diminish the supply of skilled craftsmen from abroad, and the American industrialists realized for the first time the extent of industrial dependence upon the old country.

The period of experimentation received a definite stimulus in 1917 with the enactment of the Smith-Hughes Act.* Several attitudes toward vocational education developed during this 30-year period. The first tendency, common to most movements, was a swing from the older plan of providing all technical and vocational training on the job to a belief that the school was capable of performing this task by itself and turning out skilled craftsmen and technicians.

More thoughtful educators had come to the conclusion by 1930 that the work of providing vocational education on the secondary school level was co-operative in nature. The school was capable of performing certain tasks; but industry and commerce were needed as supplementary aids in furnishing practical training. This change in attitude was considerably influenced by such examples as Antioch College

*Also called "The National Vocational Education Act." This provides Federal financial aid to States for development of vocational education programs. Amounts vary, of course, with the extent of programs; but in all cases Federal allocations under this act are matched by an equal amount appropriated by a State.

which pioneered in combining a wholesome admixture of theory and practice under life conditions, instead of providing all of the theory first and then allowing the individual to adjust his technical training to practice on the job.

The conception of vocational and technical training as a co-operative venture is gradually permeating the academic mind and may be considered as the significant emerging trend that will be dominant in directing future practice. Summarized briefly, this viewpoint may be conceived as follows: The school must provide in much larger measure than ever before for vocational and technical training. It will be responsible for the inculcation of an understanding and appreciation of the economic organization of American life; for the dissemination of vocational information concerning opportunities and outlook; for the determination of aptitudes and the skillful guidance of individuals into work for which they are best fitted; for the breaking down of absurd attitudes toward the relative merit of "white-collar" and "flannel-shirt" work; and for the development of basic skills and mastery of fundamental mechanical and technical principles. The home, the factory, and the store will co-operate by providing in-service apprentice training, supplementing the school in specialized areas where institutional competence is normally low. As both school and industry appreciate more completely their relative fields, understanding will grow through co-operation.

The future of vocational education is bright. In terms of amount, the secondary school of the future will furnish at least twice as much vocational education as it does at the present time. Studies of President Roosevelt's Advisory Committee on Education indicated that current practices provided for not more than half of the country's need. In terms of extent, vocational education will include much wider provisions for homemaking for girls, including training in mating, the nature and care of the home, the rearing of children, and the transformation of the family from a patriarchal to a modern democratic ideal. In industrial centers vocational training will provide for greater participation



Manipulative operations of this kind are important as training for certain types of trade employment. But they form only one part of a comprehensive "industrial arts education" program that is being increasingly accepted by progressive educators as a means of vitalizing academic public school activities and curricula.



This is not a neighborhood grocery store but a "distributive trades laboratory" in a Philadelphia vocational school. It indicates the extent to which modern scholastic programs are being adapted to meet local vocational needs.

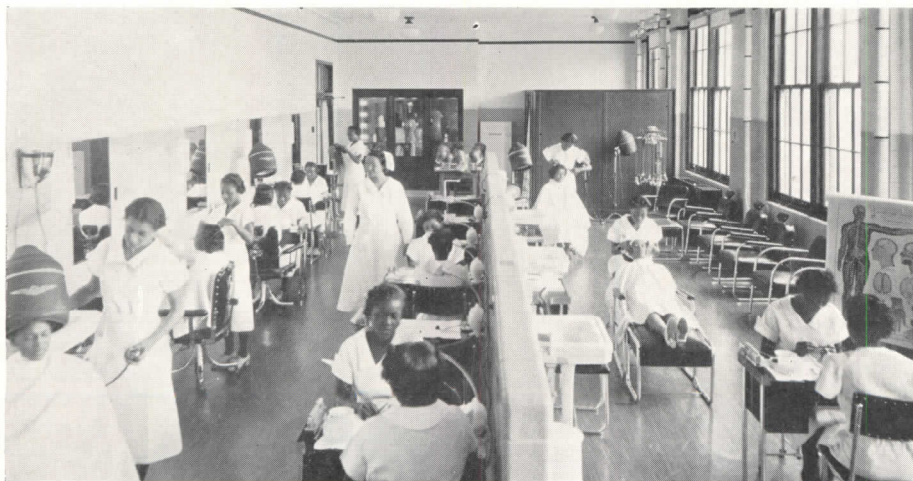

A "service industries laboratory" in a girls' trade school. As one of many such spaces needed for modern vocational education it suggests the complex requirements of space and equipment which architects are being called upon to meet.

through courses in shop and laboratory as well as in the classroom. Trades education will carry youth through the apprentice period in highly organized urban centers and through the journeyman stage in smaller communities. Opportunity will be given to prepare for service and distributive occupations in a manner not dreamed of in the past. In the field of commercial education, greater emphasis will be placed upon the training of competent stenographers, bookkeepers, and commercial machine operators. The excellent work in vocational agriculture in conjunction with the farm as the practical laboratory will continue to expand.

In larger cities the current trend toward the specialized vocational and technical high school may continue. In medium and smaller-sized communities, the organization form will probably be that of a comprehensive high school in which all aspects of essential vocational choice will be possible within the school, so that the essential classlessness of the American school may be retained. Secondary schools can no longer be considered as preparing solely for institutions of advanced learning. They must meet the needs of the 90% of graduates who do not plan to continue their education, as well as continue to provide increasingly good training for the college and university.

These secondary school buildings—from the standpoint of design—will be more extensively equipped with laboratories, shops, and studios. There will tend to be a greater diversification and specialization within the comprehensive school. The educational and architectural problem will be the development of efficient facilities through which the program can be carried out.

Grade placement of vocational courses will also undergo a change. The junior high school will be distinctly limited to general vocational information and elementary "try-out" courses, most of which training can be given in a general shop. The present session of Congress will consider the George-Larrabee Bill amending the Smith-Hughes and George-Deen Acts so that Federal subventions for vocational education will start with the sixteenth instead of the fourteenth year. Results of educational studies and the change in economic conditions, raising the age-level at which jobs are available, all indicate that vocational training will move out of the junior into the senior high school in grades eleven through fourteen.

PLANNING FOR A 3-FOLD EDUCATIONAL PROGRAM

Efficient provision, by architects, of modern facilities for vocational arts training involves basic educational requirements which must be clearly defined. These, though subject to general classification, may vary widely with age groups, the social and economic characteristics of a region, and the type and extent of local educational programs. Following are definitions of three commonly accepted cate-

gories of "vocational education" which can serve as a basis for analysis of specific problems. . . . Material in following pages has been compiled from a number of technical and professional sources too numerous to list completely here. Particular credit, however, should be given to the following: G. A. McGarvey, *Industrial Educ. Service, Office of Education, U. S. Dept. Interior*; Dr. Wm. E.

Warner, *Prof. Educ., Ohio State Univ., and Chairman, Ohio Committee on Industrial Arts Education*; Elroy W. Bollinger, *N. Y. State Education Dept.*; Lane C. Ash, *Adviser, Industrial Education, Dept. of Pub. Ins., Commonwealth of Pennsylvania*; Chas. F. Bauder, *Director of Industrial Arts, Philadelphia, Pa.*; C. M. Miller, *Director, State Board for Vocational Education, Kansas*.

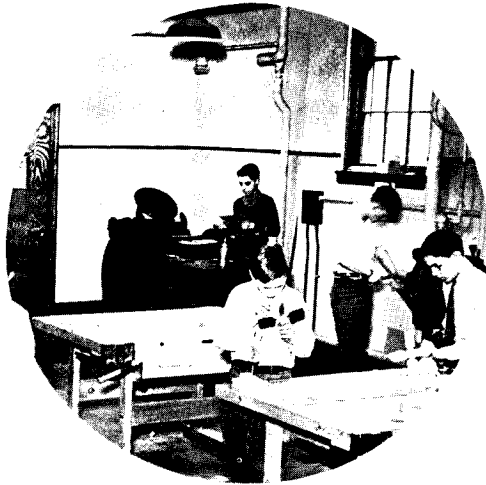

INDUSTRIAL ARTS EDUCATION

GENERAL FAMILIARITY with tools and materials begins at elementary school and is progressively developed to include academic groups in intermediate, or junior high schools (see AR 2/39). From such simple craftwork as wood- and metalworking, courses are advanced to include a wide number of manipulative activities such as cooking, sewing, ceramics, printing, carpentry, and the operation of simple tools. The teaching objectives are to develop manual dexterity of adaptable character; through contact with many subjects, to encourage development of latent skills and interests; and to clarify the interrelationship of various types of operative activities with daily life—*Requirements* of space and equipment vary with age groups and curricula (see AR 8/39). A single space is generally recommended in which equipment can be grouped to form an "industrial arts laboratory." However, in large schools it is often desirable to group equipment of related types in unit shops.



PREVOCATIONAL INSTRUCTION

INSTRUCTION in vocational subjects becomes focused more sharply in upper grades of secondary schools. Here the curriculum is narrowed to specific fields of activity—as, for example, the field of metalworking which includes such trades as tool-making, die-casting, and sheet-metal work. Teaching objectives are to develop fundamental skills in a number of basic processes within one such field; to complement this manipulative practice with instruction in related technical subjects; and thus to provide a general knowledge of a certain field as a basis for the specialized training required for work in a particular trade—*Requirements* involve unit shops, the number, size, character, and equipment of which depend upon activity fields encompassed by curricula. Also necessary in most cases are areas and equipment facilities for technical instruction in such subjects as electronics, industrial chemistry, physics, and drafting. These may include classrooms and laboratories similar to those in academic schools.



VOCATIONAL TRAINING

CURRICULA in vocational schools stress operative routine rather than instruction in theoretical subjects and cover a wide range of specialized activities. The teaching objective is primarily to develop specific skills adequate for employment in certain trades and industries. This involves instruction and practice in a variety of manipulative operations; and the trend is toward maintaining for each trade a teaching environment that reflects as much as possible the actual practices and working conditions that will be encountered—*Requirements* involve a variety of areas for training in the operative, distribution, or service trades. Size, layout, and equipment of such areas may vary widely with trade requirements; thus provision of them should be based upon a survey of industrial, social, and economic needs which are controlling factors peculiar to the locality. Administration and planning laboratories are also of particular importance in schools offering almost any type of vocational training.

PLAN TYPES: 1-INDUSTRIAL ARTS LABORATORIES; 2-PREVOCATIONAL SHOPS; 3-VOCATIONAL SCHOOLS

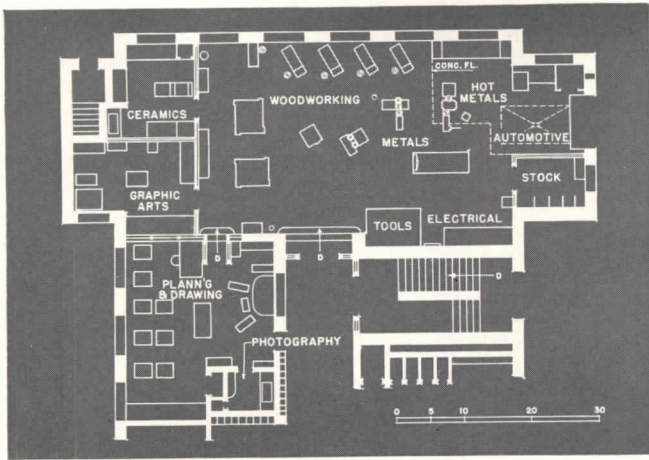

Arts and Industries Laboratory, Central Junior High School, Newark, Ohio

1 INDUSTRIAL ARTS LABORATORIES contain within a single area—or in a closely related series of spaces—subdivisions for teaching many allied subjects. Laboratories are ordinarily similar to the Newark, Ohio, Junior High School plant, but occasionally range as large in size as the Youngstown building, which is part of a high school development. Experience indicates that not more than a two-teacher laboratory (60 pupils max.) is advisable for single laboratory units. Larger classes impose almost unsolvable problems of administrative personnel.

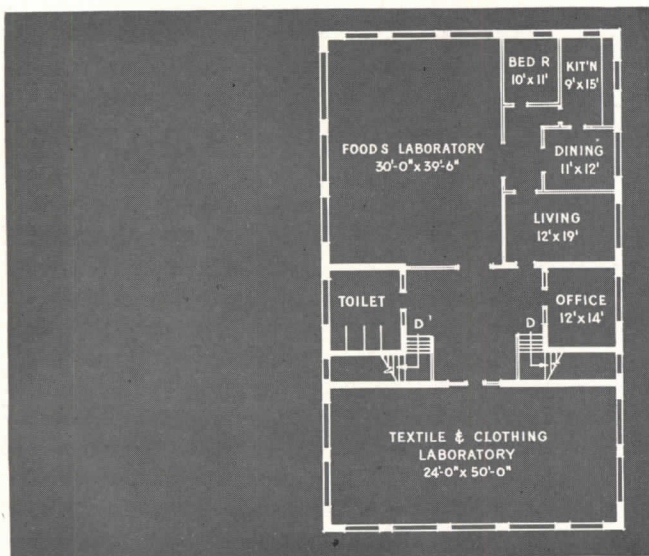

Two-story Arts and Industries Building, High School, Youngstown, Ohio; M. Gilbert Miller, Architect. William E. Warner was consultant in planning this development and the one above.

INDUSTRIAL ARTS programs place emphasis upon the fundamental principles of, and relationships between, all modern arts and industries. Hence, several basic types of areas constitute the laboratory. The *graphic arts center* contains equipment for teaching all methods of graphic reproduction: hand processes (drawing, painting); mechanical processes (printing, blueprinting, etching, photography, mimeographing, etc.). Since project planning is usually graphic, space for this activity, with conference table, library, and visual center, is included in or adjacent to the graphic arts area. *Metals, housing and wood-working, electrical industries, automotives, domestic arts, and applied design* are typical areas, each of which is similarly inclusive. In smaller laboratories, such provisions as a *ceramics* area may serve as a demonstration of the entire larger field of applied design.

Some areas may require segregating behind glass partitions to avoid dust infiltration. To increase headroom, laboratories on ground floors may be dropped two to four steps below level of remainder of floor. Maximum glass area at students' entrance, and corridor display cases with corkboards and rear access, are desirable to increase the laboratory's attractiveness.

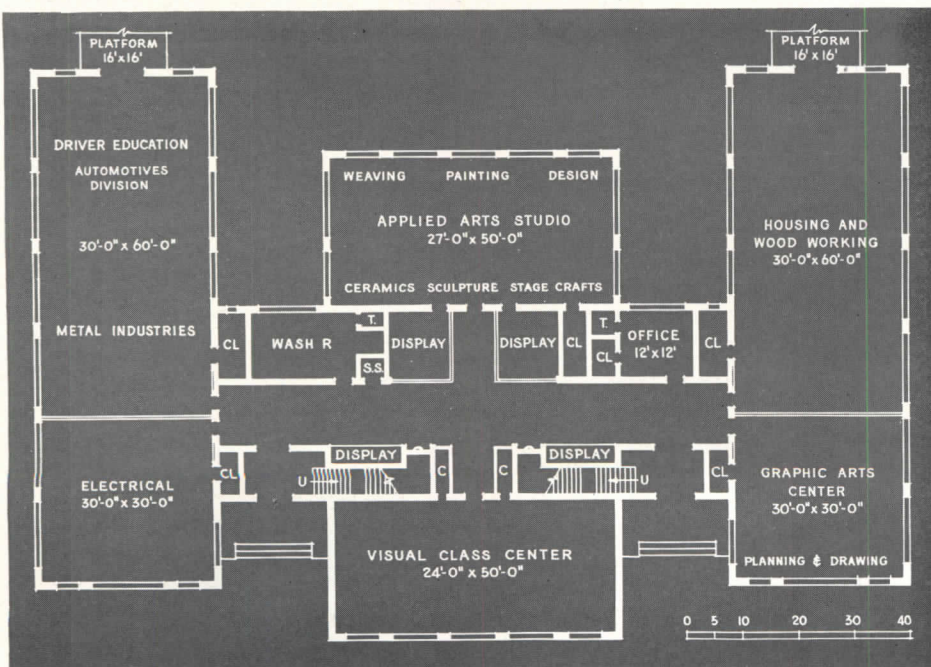

2 PREVOCATIONAL INSTRUCTION

facilities are provided in different ways, according to the school program, space available, and similar local considerations. In the Springfield, Mo., Senior High School, an industrial education building contains shops for general mechanical training, with some provision for specialized vocational study. WILLIAM B. ITTNER, INC., were the architects.

THE FIELD of prevocational instruction is not exactly defined; the term indicates those provisions which span the gap between industrial arts and vocational schools. In some large urban centers, such facilities are included in "general" vocational schools. However, in the usual case, prevocational areas are included along with terminal-course shops in vocational schools. (See tabulation on page 100).

Plan and structural requirements are similar to those for vocational schools (described on the following page). Springfield's Industrial Education Building, shown herewith, is prevocational in the sense that, of approximately 14 courses offered, more than half are general. For instance, both "General Electricity" and "Vocational Electrical Wiring" are offered.

The distinction between "general" and "vocational" provisions in this school is chiefly between the light machines used for prevocational work and industrial types for trade training. Only in one case—woodworking—was it necessary to include a special shop for a general course. Otherwise, the identical shop serves for both types of instruction. The single classroom is used for teaching those subjects most closely related to shop work.

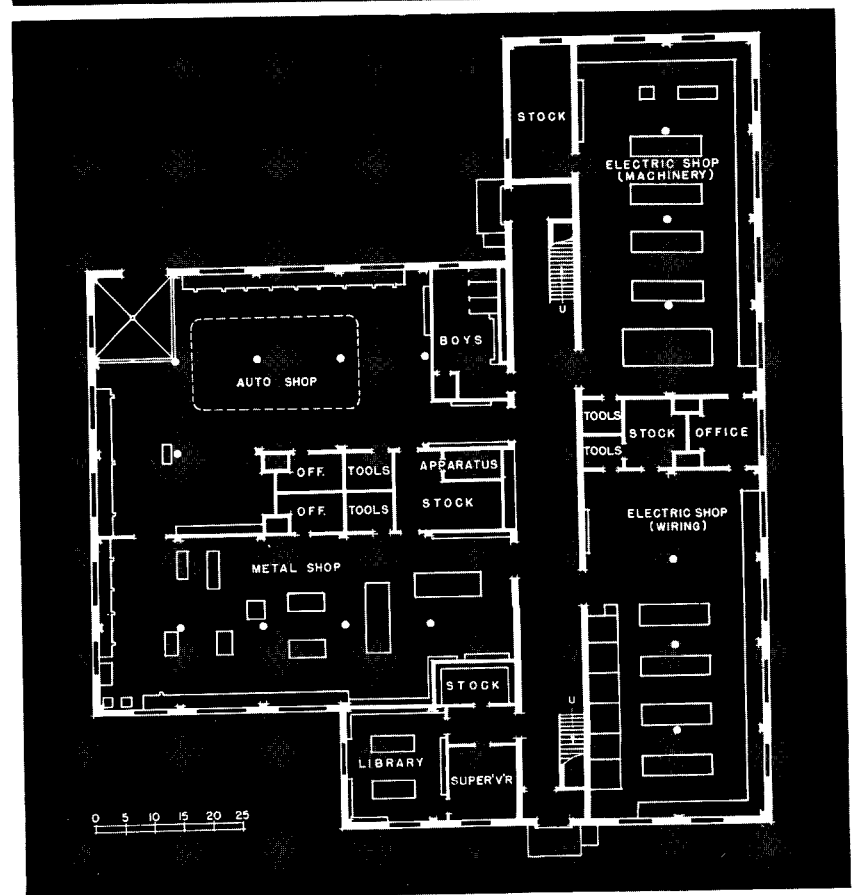
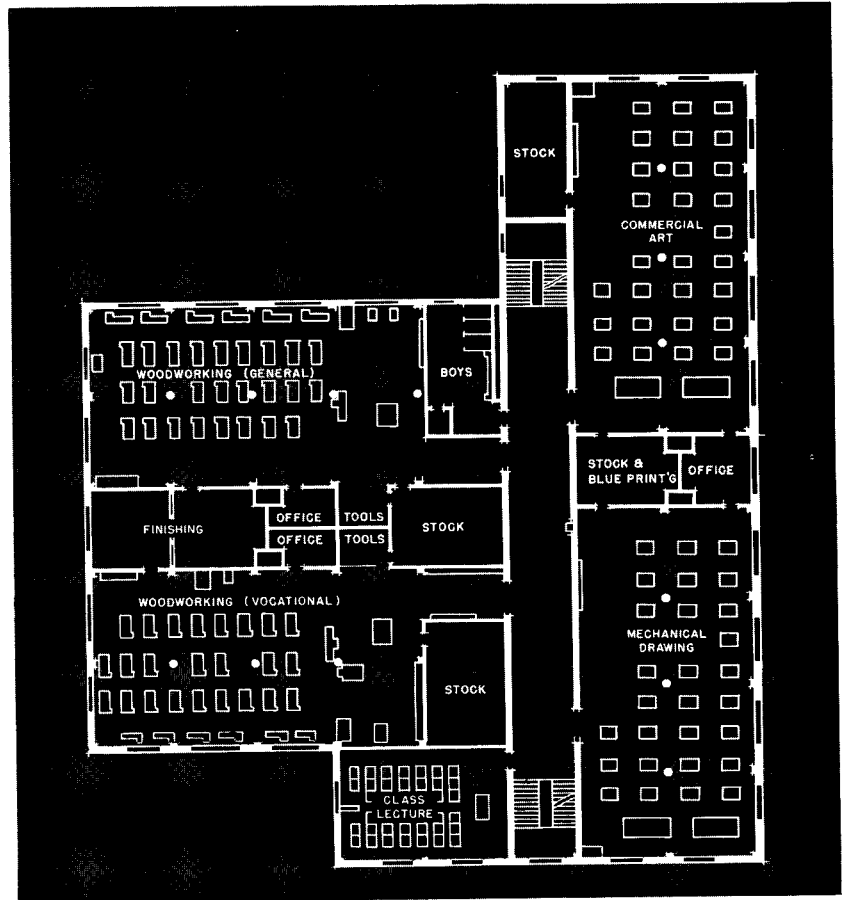

PLAN TYPES

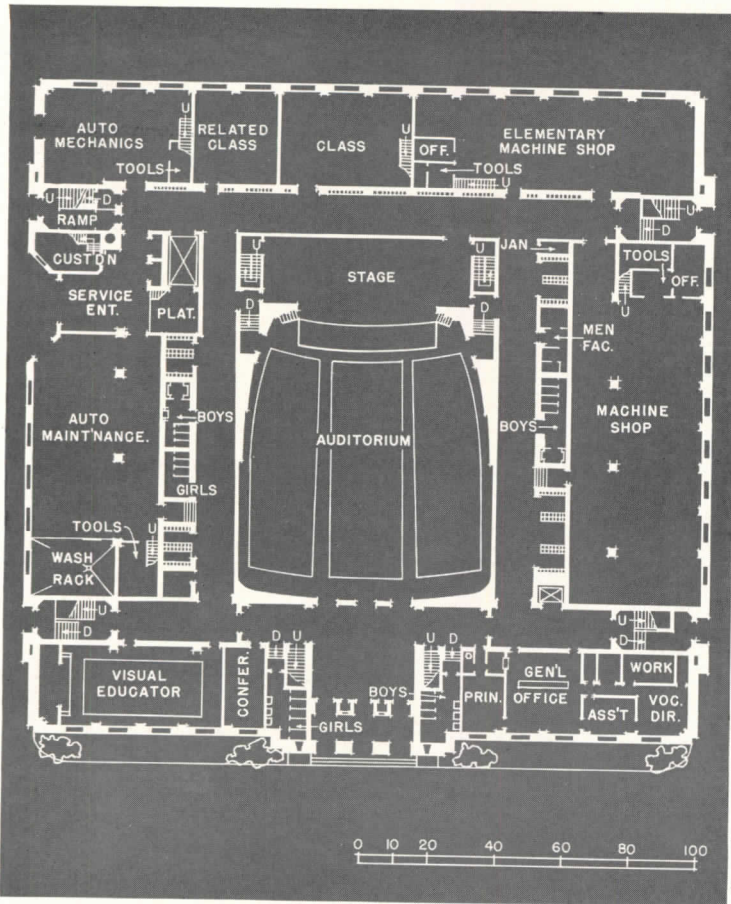

First floor

3 THE VOCATIONAL SCHOOL, with provision for trade training, extension, and apprentice courses, consists principally of a number of unit shops, with classrooms for closely related academic subjects, recreational facilities, and administrative offices. A multistory example is the Timken Vocational School in Canton, Ohio; CHARLES E. FIRESTONE, Architect.

VOCATIONAL PROGRAMS emphasize the importance of duplicating, in the school, industrial practices and operations. The vocational school plant requires a separate shop for each of the subjects taught. Depending upon local policies, the vocational school proper may contain some provisions for elementary, or prevocational trade training. The same shop usually accommodates daytime, nighttime, or extension students, and apprentices.

Types of shops range from auto mechanics to floriculture, from bookkeeping to commercial food trades. Attempts have been made to classify these under several headings, which include: operative trades (machine operation, repetitive operations); skilled operators (machinists, etc.); building trades; service trades (refrigerator servicemen, auto service station attendants, public services); garment trades; food trades; technical (medical attendants, dental assistants, etc.); and others.

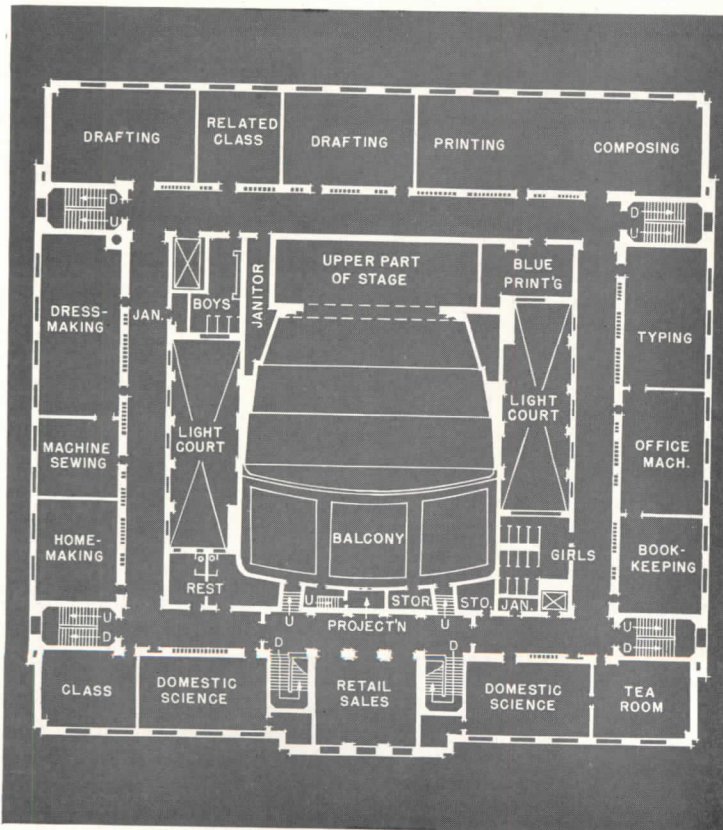

Second floor

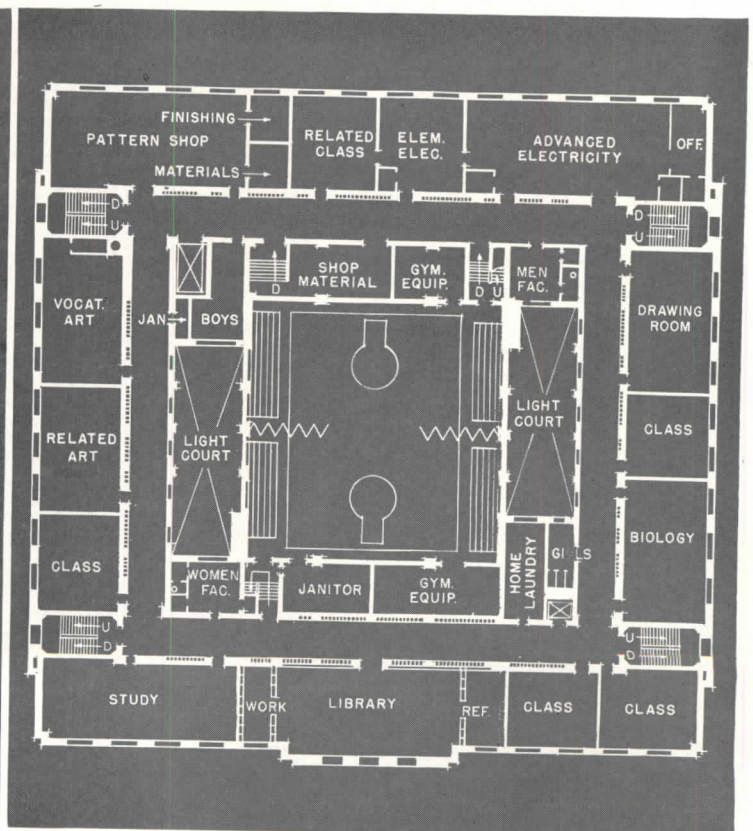

Third floor

Some of these provisions have at times to be included in a general high school, as is often the case with agricultural shops in rural schools.

The vocational school may require several classrooms for related science and similar studies, also display space for projects completed in such shops as commercial art, and sales space for foods and dressmaking shops. Classrooms are preferably close to shops served. Display and sales space has to be planned with consideration for public access. Administrative offices are needed; and the modern trend is to include libraries—even museums—readily accessible from shops, and reasonably complete recreational and eating facilities, such as gymnasias, cafeterias, auditoria, music rooms, etc.

Types of buildings. The single-story building may house all its activities under one roof, or may be developed as a "campus" plan embodying several buildings. Two- or three-story buildings, in which grade-level shops are those which require entrances for large or heavy materials, have been found desirable where land and building costs are moderately high. Multistory buildings (over three floors; for instance, the Timken School illustrated here) may become imperative in highly developed urban areas. Planning problems become more complex in this type of plant. For instance, for vertical distribution of supplies and equipment, location of shops needs study in relation to freight elevators.

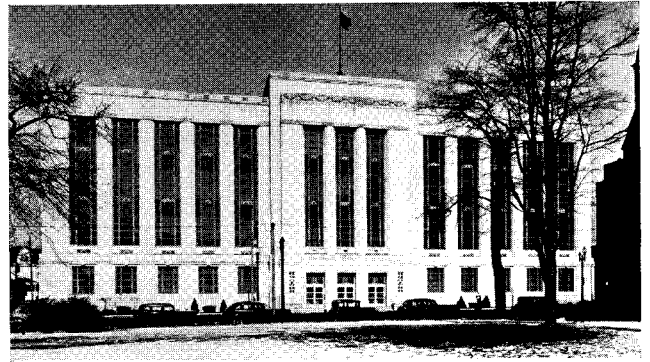

Exterior, Timken Vocational School, Canton Ohio

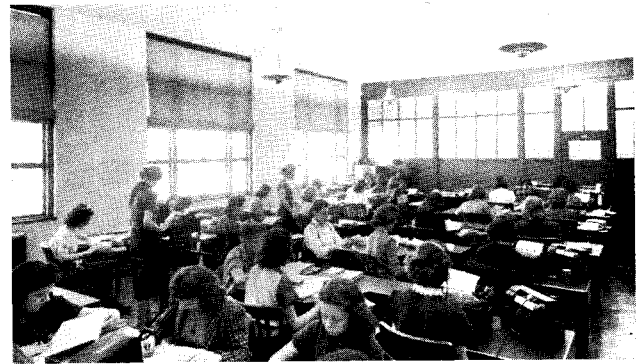

School has both commercial and vocational shops

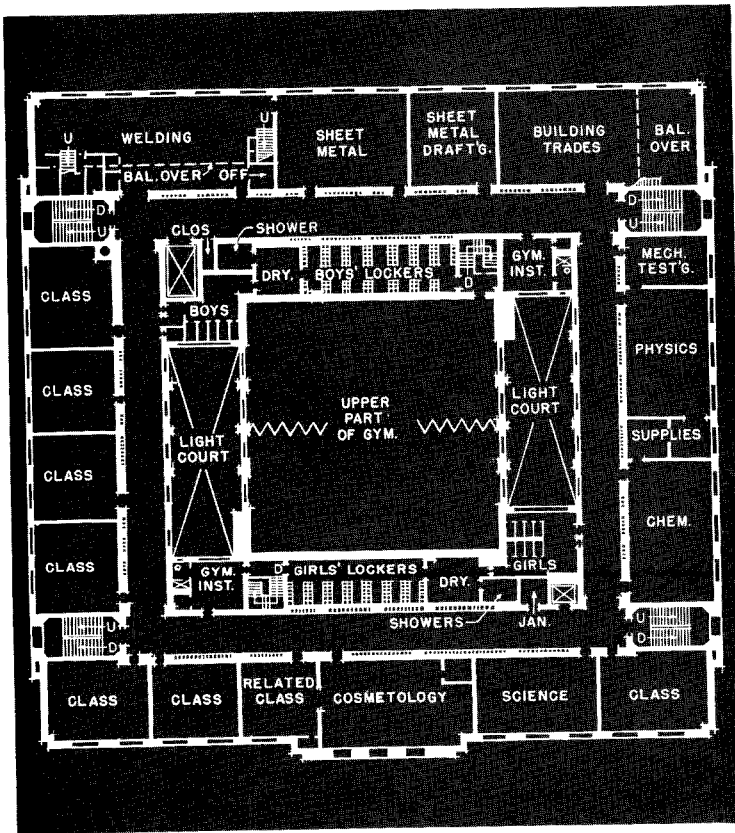

Fourth floor

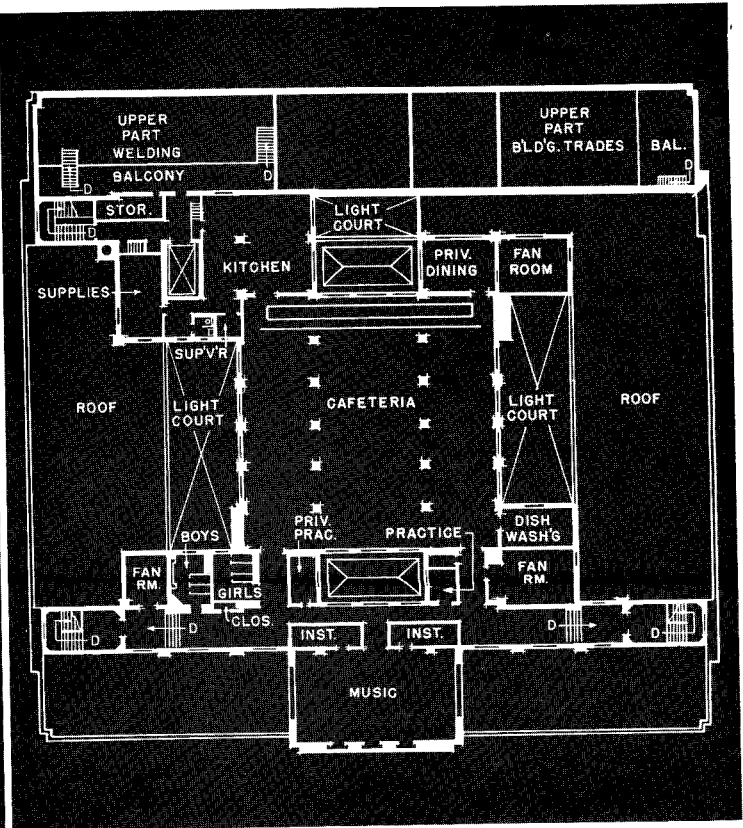

Fifth floor

PLANNING AND CONSTRUCTION

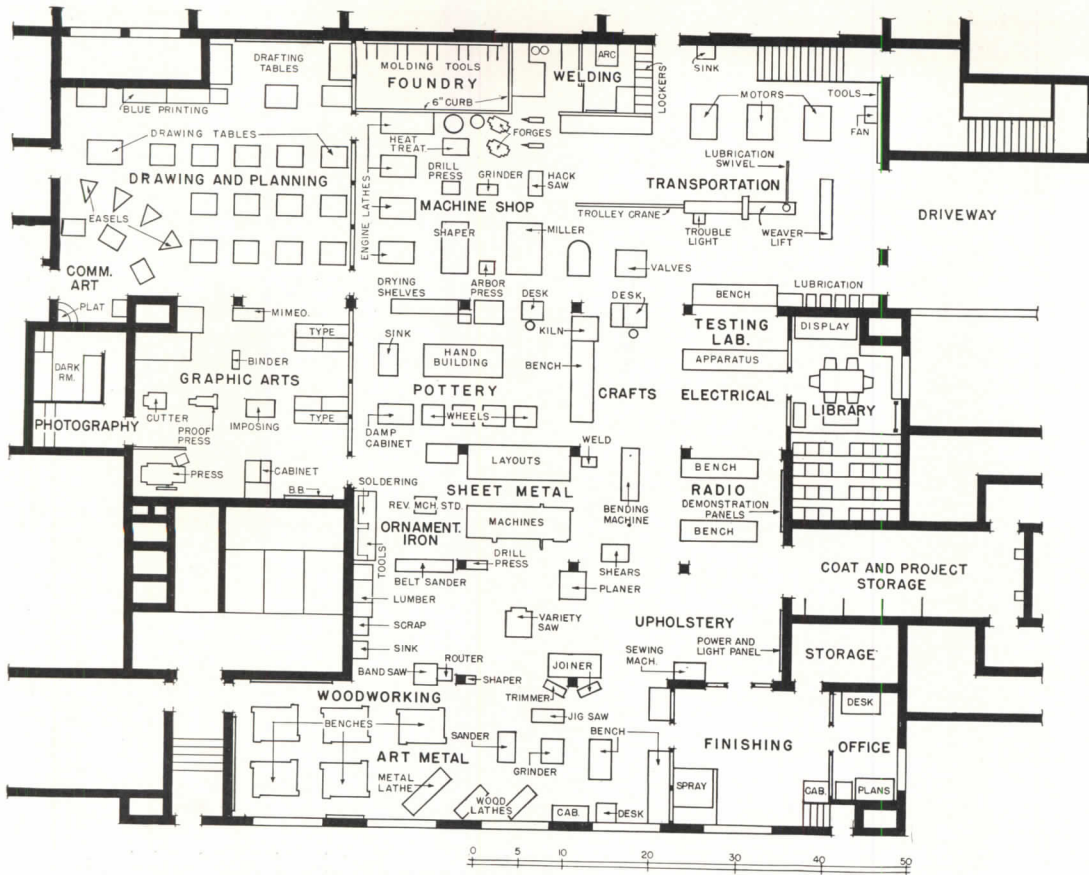

"Arts and Industries" laboratory in Cambridge, Ohio, High School; E. W. Austin, Architect; Wm. E. Warner, Educational Consultant. Note interrelation of such areas as transportation (automotive), machine shop and foundry, metals and woodworking, etc. Dust and noise are eliminated from library, finishing room, graphic arts and drawing rooms by soundproof steel and glass partitions.

MOST OF THE FUNDAMENTAL principles of planning for both industrial arts and technical or vocational programs are in essence similar. Teaching methods, types of machines, and desirability of achieving wholesome working conditions may vary greatly with the type of school program; but the basic design factors depend more on the general type of activity than on specific teaching requirements. Area relationships, safety provisions, building services, and structure may become more complicated as shop programs narrow down to single subjects.

Area Relationships

Circulation of traffic is best reduced to a minimum. Means of accomplishing this include:

1. *Grouping of related shop areas.* For both vocational and industrial arts shops, areas which have similar functions, or whose processes may supplement one another, are preferably grouped: foundry, forge, and welding shops have processes and materials in common; so do machine metal, sheet

metal, and automotive areas; and others.

2. *Distinct demarcation of aisles* in industrial arts laboratories between points of common use, such as storage rooms, tool rooms, and portions of the shop used in common for several purposes. Main aisles have minimum width of 4 ft.; feeder aisles, 2 to 3 ft.

3. *Tools and supplies* are preferably distributed at points of use in industrial arts laboratories; may be in centralized storage areas in vocational shops.

4. *Project storage* lockers are preferably distributed throughout the shop, so that pupils proceed to their stations, find their work close at hand, and start work immediately. This method eliminates disciplinary problems which arise from congestion in isolated project storage rooms. Large projects may, however, require special storage provisions.

Auxiliary Areas

Project planning in most industrial arts shops is carried on in the drafting area. In many vocational schools and some industrial arts laboratories, space is provided in centrally located planning

cubicles, in libraries, or glass-partitioned instructor's office in the shop.

Clothing storage for outer clothing is best separated from industrial arts shops. Some schools have locker rooms; others use corridor lockers. Storage for uniforms may be included in industrial arts laboratories; in vocational schools, separate rooms are often used.

Materials storage rooms should have racks and shelving dimensioned for orderly, safe storage of lumber, sheet metal, steel, paper, hardware, etc. Machines used for trimming stock roughly to size may be located permanently in the store room to eliminate handling hazards in the shop.

Exhibit cases are desirable in shops and in central locations: e.g., main corridors.

Safety Provisions

1. Entire area should be visible from any portion of the shop.
2. Equipment has to be laid out to eliminate hazards.
3. Service facilities ought to be of types and in locations which reduce accident

DESIGN CRITERIA	Industrial Arts Composite Laboratory	Vocational or Trade School Unit Shop	FINISHES AND SERVICES	
Pupils per instructor.....	25 to 30	10 to 30*	Utilities "Foolproof" systems; guard against accidents; underfloor systems recommended in some states; flexibility important; local controls on machines; wall outlets 10 ft. o.c., 3 ft. above floor; flush floor outlets 6 to 8 ft. o.c.; circuit-breaker distribution panels Heating, ventilating Conditioned air preferred; 6 to 7½ changes per hr.; heat sources should not interfere with teaching space (unit heaters, recessed radiators); 65° F., 30 to 60% relative humidity Lighting Natural: window sills above bench height (32 to 40 in.) *Electric: 15 to 20 footcandles at work plane generally; 30 to 50 footcandles for special areas; localized fixtures up to 200 footcandles for presses, saws, lathes, etc.; avoid glare and shadows; maximum diffusion desirable Colors Dull finish to avoid reflected glare; 60 to 85% light reflectivity on walls; 85% on ceilings; possibly warm colors for north exposures, cool colors for south	
Number of instructors.....	1 to 2	Variable		
Square feet per pupil.....	40 to 75	48 to 175*		
Proportions (width to length).....	1:1 to 1:2	1:1 to 1:2		
Minimum ceiling height.....	11 to 13 ft.	12 to 16 ft.		
Other areas, sq. ft. per pupil:				
Heating plant	} See note†	} 4		
Offices				2
Corridors, stairs				20
Lavatories, lockers				10
Miscellaneous			2	
FINISHES AND SERVICES				
Interior finish*				
Floors.....	Hardwood generally, non-slippery*			
Walls.....	5-ft. wainscot, easily cleaned; matt glaze to avoid specular reflection‡			
Acoustic treatment	Walls above wainscot, and ceilings; minimum absorption, 35%; 50-75% preferred; easily maintained materials			
Dust and refuse collection	Underfloor or overhead systems desirable where process demands			

*See accompanying text; also table on p. 100.

†Not included for industrial arts shops unless independent buildings; areas listed are sq. ft. per pupil in total enrollment.

Washing facilities are preferably in or close to the laboratory or shop area; one washing station per 8 to 10 pupils; toilets in same ratio.

‡Tile, terra cotta, glazed brick recommended by many authorities.

hazards and possibility of tampering with fuses, etc. Power panels are preferably in planning centers or offices.

Shop Sizes

There is a pronounced trend toward designing shops (both vocational and industrial arts) independently of arbitrary "classroom" size restrictions. Advanced criteria are based on requirements of the activity housed, and on needs for administration and supervision. Methods of obtaining increased width include: absorbing corridor within the shop; placing shop across end of corridor; placing windows on two sides (preferably adjacent) of shops; placing shop in wing opening to side of corridor, similar to auditorium wings.

Activity requirements. Industrial arts laboratory-shops can accommodate only ½ to ¾ as many students per class as there are pupil stations in the shop because each student may use equipment for several industrial processes during a single class period. "Unit shops," or shops for a single subject, as printing,

welding, mechanical drawing (industrial arts or vocational), can take as many students as there are pupil stations.

Administration. Number of pupils per class is given in the accompanying table. In the case of urban vocational schools, where square footage is expensive, some have top limits of 30 pupils per instructor; others advocate 10 to 24, depending on the subject and the level of instruction (elementary or advanced). Long, narrow rooms, or shops with L- or U-shaped plans, hidden alcoves, etc., increase difficulty of supervision.

Structure

Number of floors in buildings devoted principally to shops varies with total floor area, lot size, and land values. More than three stories are ordinarily undesirable; if factory conditions are to be closely approximated, one floor, possibly two, is better; but urban land values may make multistory structures necessary. Locating first floor at ground level facilitates deliveries, use of automotive shops, etc. Industrial arts shops are preferably on ground floor.

Light. Many state codes call for glass area equal to 16 to 20% of floor area. It is preferable to have windows on at least two sides of shops. These may be supplemented by roof monitors. However, where State regulations permit, reliance is increasingly being placed on artificial sources for the constant high-level light usually required.

Construction methods and materials of many types are used. Prime considerations are fire-safety, flexibility of space enclosed, and, in smaller structures, possibility of future expansion. In one- or two-story trade schools, factory-type construction is often used. Interior partitions are preferably of easily salvageable, sound-resistant materials such as sound-proofed steel partitions. Floors for most shops are hard wood—maple strip flooring, keyed blocks, or paraffined end-grain blocks. Strip flooring is preferable where minute articles are handled, such as slugs of type in print shops. Hot metal processes require earth, sand, or rough concrete floors. Automotive areas usually have surface-treated concrete floors.

TIME-SAVER STANDARDS PROVISIONS FOR EQUIPMENT



Built-in provisions for electrical work in South Vocational High School, Pittsburgh, Pa., include two types of booths, underfloor power service, a partly built house.

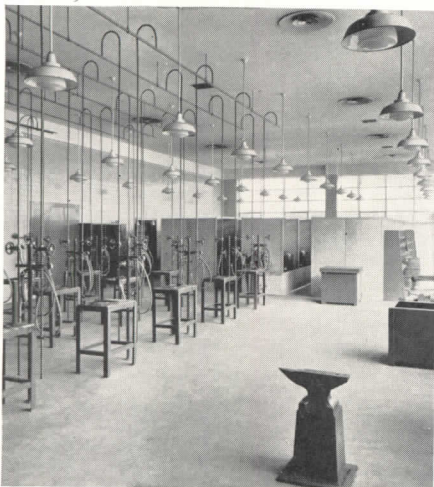

Overhead services, welding shop, South Vocational High School.



Auto shop, High School, Adrian, Mich., Warren S. Holmes Co., Architects.

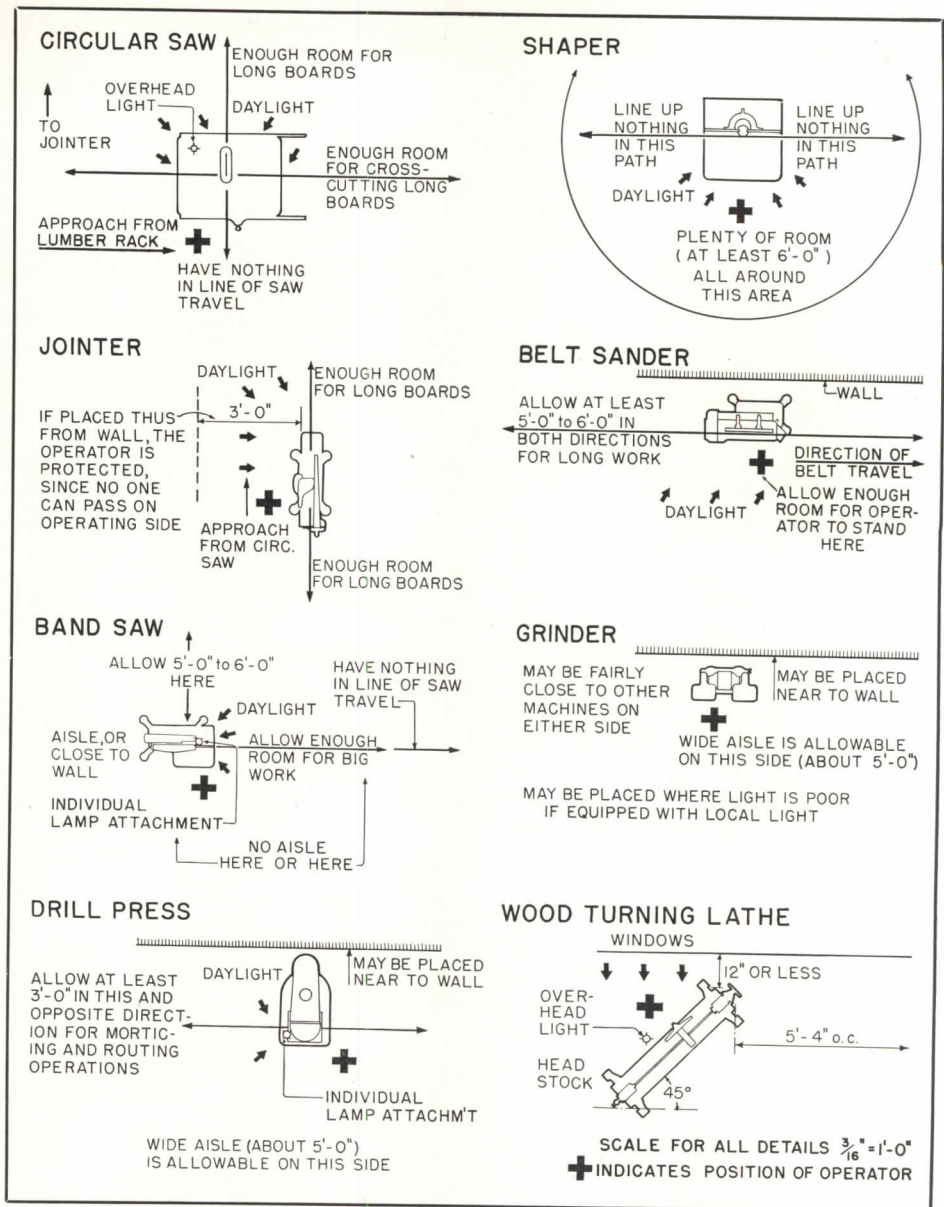

Typical lighting, space, and safety requirements for woodworking machines

Flexibility. As processes and equipment change in industry generally, changes in type and location of shop equipment used for teaching are to be expected. Hence, it follows that individually powered machines are ordinarily preferable to multiple drives. This means to the architect that numerous power outlets of comparatively small capacity are imperative. The same is true of gas, water, and compressed-air outlets. Floors must be designed for uniform loads to permit relocating equipment.

Equipment location is primarily an instructor's or specialist's job; certain factors affect the architect. The most frequently used equipment is best

located near the center of operation, and ample clearances are necessary. Equipment must not interfere with opening of doors. Machines placed on columns or pipes may transmit undesirable noise to other portions of the building. Heavy machine foundations may require sound-isolation. Safety requirements include provision of: first-aid cabinets and fire extinguishers; grounding of power machines; painted safety zones around dangerous machines; collectors or exhaust systems for dust, fumes, gases, etc.

Lighting. Drawings suggest method of locating windows and lighting fixtures with respect to machines. Footcandle requirements are tabulated on page 100.

Typical agricultural shop for 20-25 students, developed by the Engineering Experiment Station, Kansas State College. Farm mechanics shop has to house several types of work, may be separate building or part of a rural school.

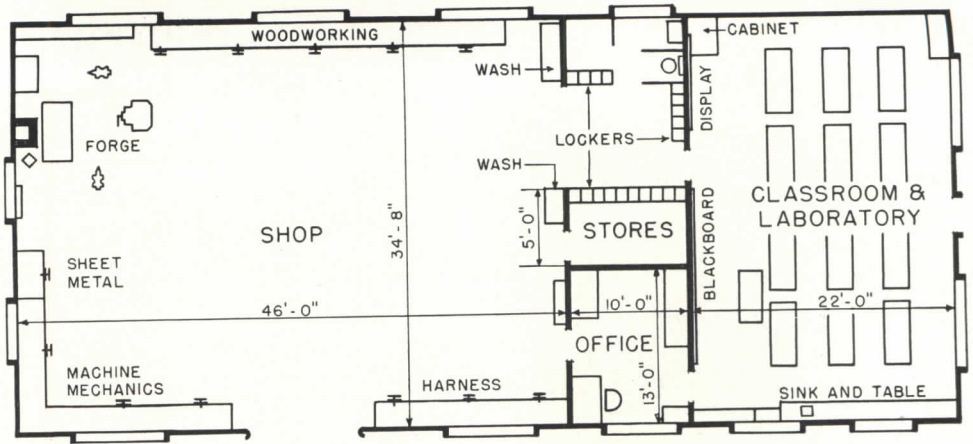

Scale for all drawings: 1/16" = 1'-0"

Elementary (left) and advanced (right) printing shops for 20-23 pupils differ principally in size of equipment. Flow of process and material governs layout.

- 1. Instructor
- 2. Type cabinet
- 3. Proof press
- 4. Galley cab.
- 5. Imposing table
- 6. Binding table
- 7. Press'm cab.
- 8. 12"x18" press
- 9. 8"x12" press
- 10. Paper cutter
- 11. Wash sinks
- 12. Paper storage
- 13. Staple binder
- 14. Blackboard
- 15, 17. File, cork-board
- 16. Bookcase

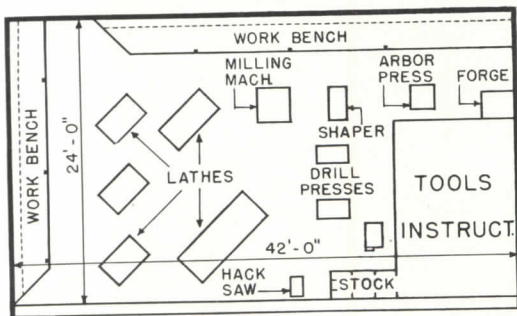
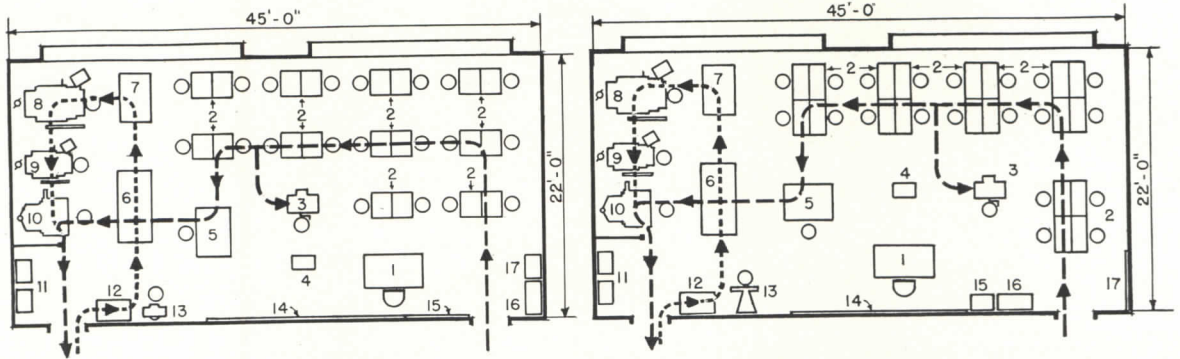

Machine shops for (left) 10-15 students, (right) 15-25 students, indicating relationship of equipment and space allocations for tool room and instructor's office.

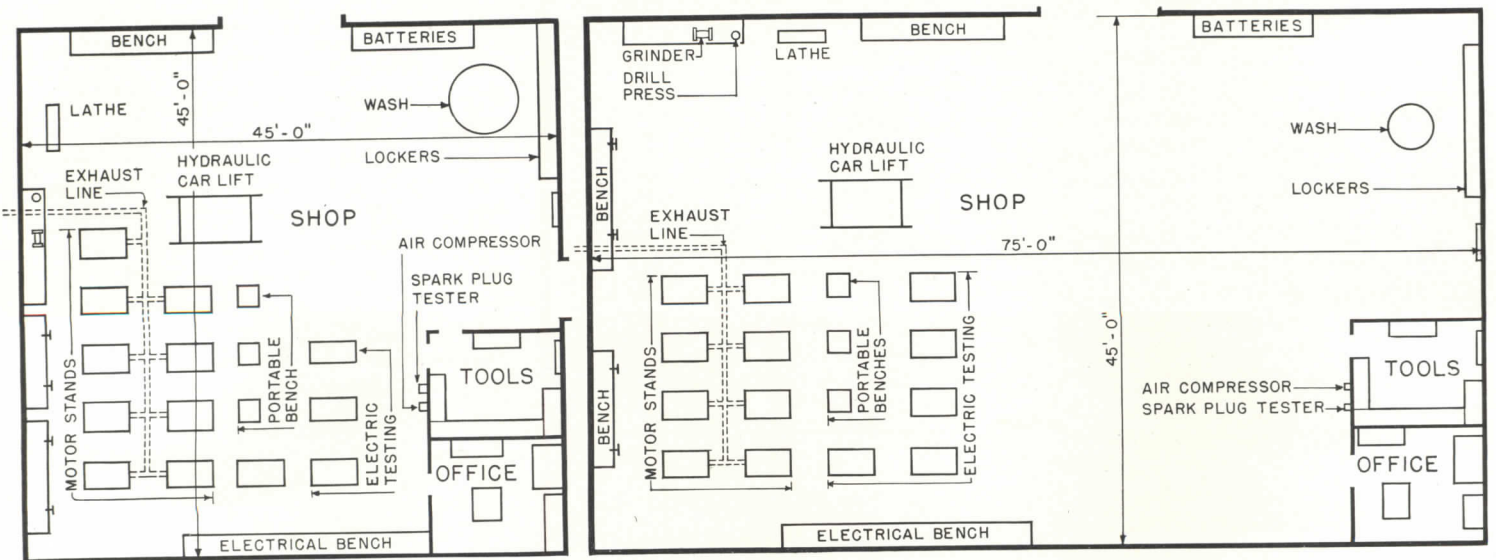
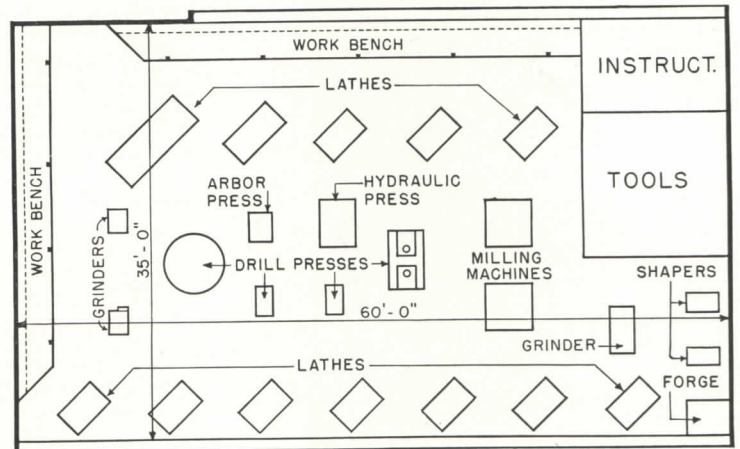

Automotive shops developed by Pennsylvania Dept. Public Instruction have one car work-station, 1,000 sq. ft., per five pupils.

TIME-SAVER STANDARDS VOCATIONAL SHOP REQUIREMENTS



Printing shop, New Britain, Conn., Trade School; Warren S. Holmes Co., Architects.



Linn Camera Shop

Vocational metals shop, Adrian, Mich., High School; also designed by Warren S. Holmes Co.

Vocational shop requirements outlined in the accompanying table are based principally upon research by Elroy W. Bollinger, Supervisor, Vocational Division, New York State Dept. of Education. Additional data have been obtained from various educational authorities. Much of the information is abstracted from the manuscript of a forthcoming book on shop planning, by Mr. Bollinger and Dr. William E. Warner.

It should be remembered, in using the tabulated data, that the figures given are subject to modification depending on local conditions—school program, land costs, appropriation available, etc.

REQUIREMENTS FOR VOCATIONAL SCHOOL SHOPS

Subject	Floor area per student (sq. ft.)	Students per lavatory unit	Type of floor	Illumination level (footcandles)
Agriculture—shop	55-65	4-8	wood, concrete, earth	20
—laboratory	25-32	4	wood	20
Airplane engine mech.	75	6	concrete	20
Airplane mechanics	130	8	wood or concrete	20
Arc welding	60	8	concrete	10
Architectural drawing	35-40	15	wood, linoleum, rubber	30-50
Armature winding	50	8	wood	15
Art metal & jewelry	40	15	wood	30
Auto chassis shop	60	4	concrete	20
Auto electric shop	40	10	wood or concrete	20
Auto engine shop (& Diesel)	50	8	concrete	20
Auto repair shop (live)	130	4	concrete	20
Baking	75	6	wood	20
Barbering	45	..	wood, linoleum, rubber	20
Battery work	40	8	concrete	15
Beauty culture	50	..	wood, linoleum, rubber	20
Blueprinting	11	..	wood	20
Bookbinding	45	16	wood	20
Bricklaying	120	8	concrete	15
Butchering & meat merch.	45	8	wood	15
Cabinetmaking	90	16	wood	20
Carpentry	130	8	wood or concrete	15
Commercial art	35	10	wood, linoleum, rubber	30
Dental mechanics	40	8	wood, linoleum, rubber	30
Dressmaking	35	16	wood, linoleum, rubber	30
Electrical wiring	70	8	wood	15
Electroplating	50	8	concrete	15
Foundry	75	8	earth or concrete	20
Fur operating	55	15	wood, linoleum, rubber	20-30
Garment cutting, patternmaking	60	15	wood, linoleum, rubber	20-30
Garment machine operating	50	15	wood, linoleum, rubber	20-30
Grocery merchandising	40	8	wood, linoleum, rubber	15
Laundry work	60	..	concrete	20
Linotype operating	45	8	wood or concrete	20
Machine shop	70-80	8	wood or concrete	20
Mechanical drawing	35	16	wood, linoleum, concrete	30-50
Millinery	35-40	10-15	wood, linoleum, concrete	30
Moving picture projection	40-60	16	wood, linoleum, concrete	20
Painting and decorating	80	8	wood or concrete	15
Plastering	80	8	concrete	10
Plumbing	60-75	8	concrete	10
Printing, general	60	8	wood, linoleum, rubber	20-30
Printing, composition	40-50	8	wood, linoleum, rubber	30
Printing, presswork	75	8	wood or concrete	20
Printing, stonework	60	8	wood or concrete	30
Printing, design & layout	30	16	wood, linoleum, rubber	30
Radio mechanics	40	16	wood	20
Refrigeration mechanics	50	8	wood	20
Sheetmetal work	60	8	wood or concrete	20
Shoe making and repair	40	12	wood, linoleum, rubber	20
Sign painting	45	8	wood, linoleum, rubber	20
Tailoring	40	16	wood, linoleum, rubber	30
Watch manufacture & repair	35	16	wood, linoleum, rubber	30
Woodworking, general	80	16	wood	20

Values indicate needs for fully equipped shops for comprehensive trade training. Elementary shops require about 4/5 the floor area listed.

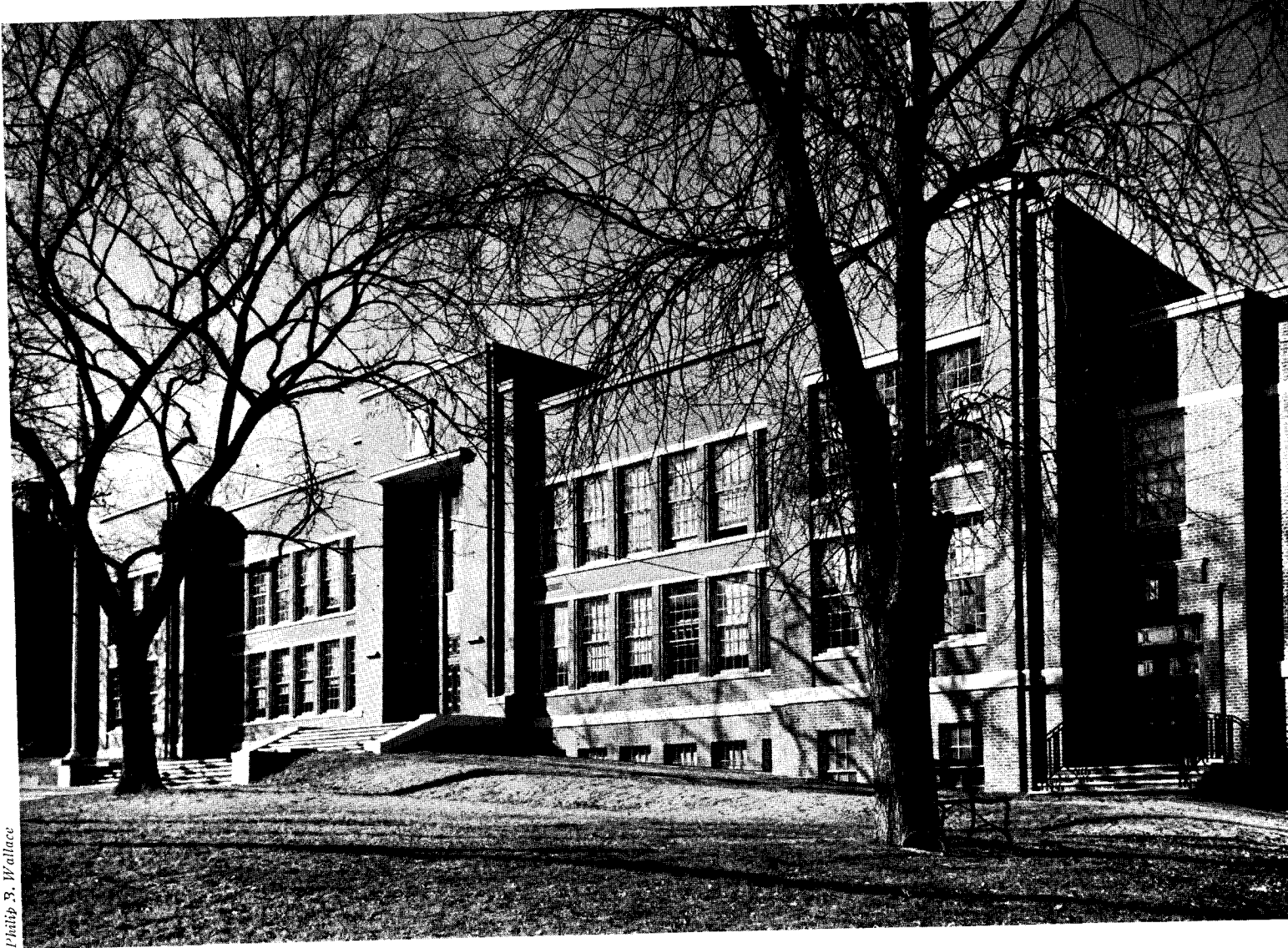

Philip B. Wallace

SCHOOL FOR 800 PUPILS HAS UNUSUAL SITE

The H. Fletcher Brown Vocational High School in Wilmington, Del., was built entirely with private funds and completed in 1938. Architects MARTIN and JEFFERS were confronted with an unusual location and possible changes in the vocational program.

THE SLOPING SITE overlooks the Brandywine River and a city park on one side, and is bounded on the others by semi-business districts. There had to be adequate parking area, grade entrances to several shops, and provision for future extension of both shops and classrooms. Also, the building had to harmonize with its surroundings.

And, since vocational curricula might change radically long before the building could become obsolete, a flexible

plan was requisite. Removable metal partitions divide the various shops. To serve changing processes, sleeves are inserted in the concrete slab floors at 6-ft. intervals to enable new conduit or pipe to be inserted without damage to the floor.

There are twelve shops; nineteen classrooms and laboratories; a gymnasium-assembly unit; library; dining facilities; and guidance, administrative, and service areas.

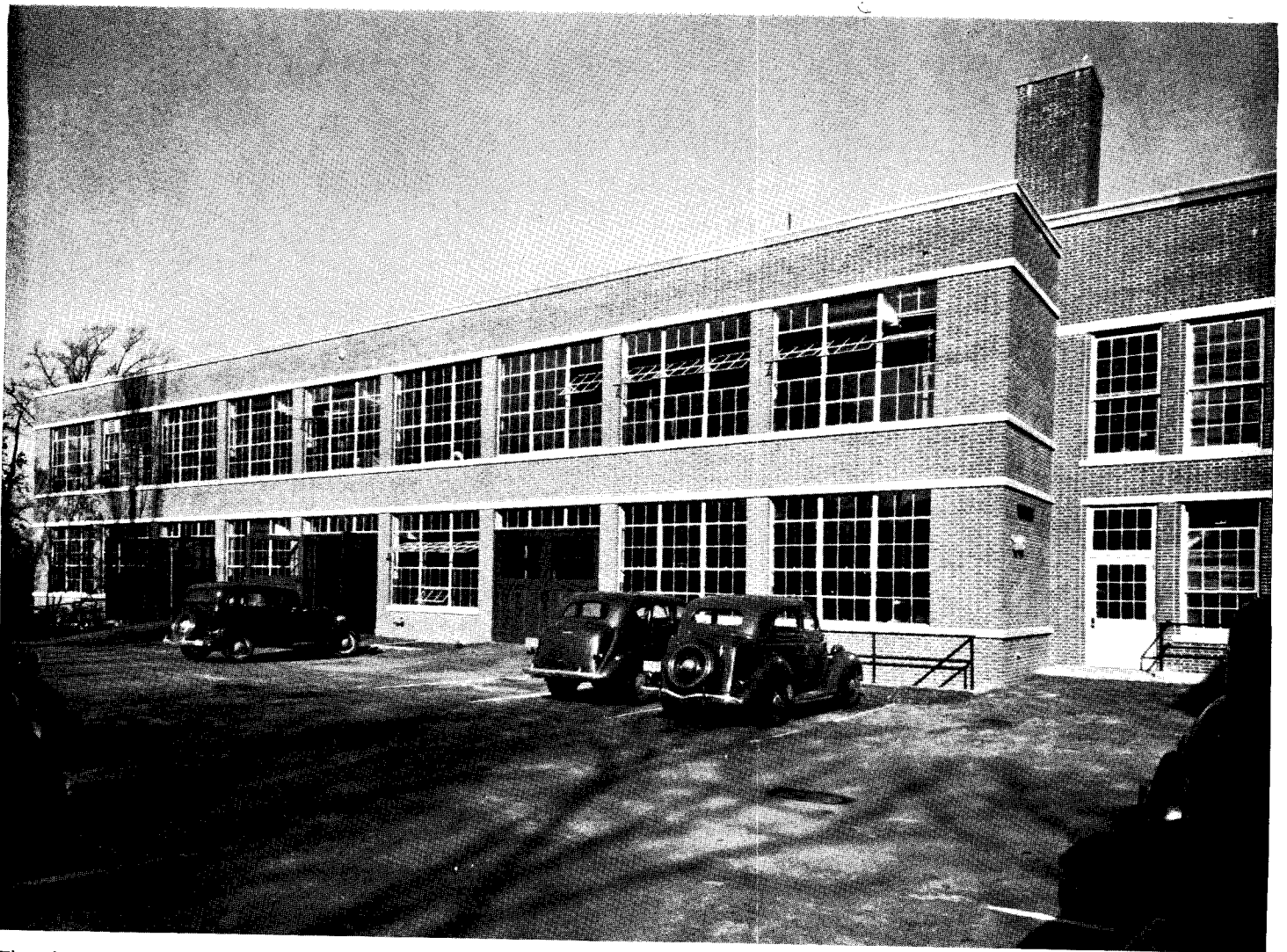

The shop wing extends to the rear. Parking space, which may eventually be partly occupied by extensions of both shop and classroom units, is screened from business buildings on the side street by planting.

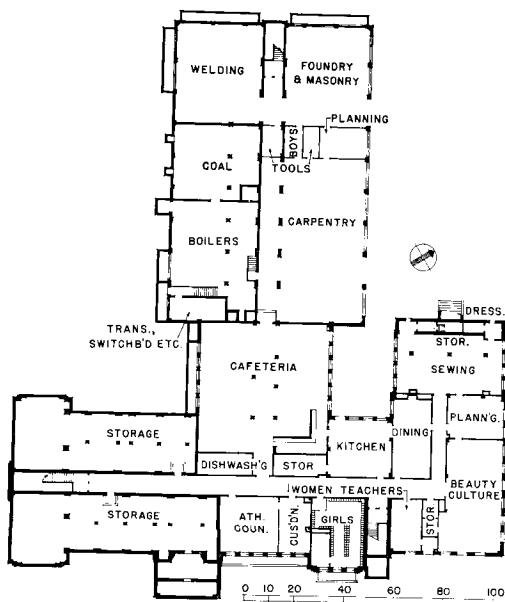

Basement above, first floor at right. Shops are wider than standard classroom width. Site contours permit shop entrances at grade on two floors. Vocational counselor's office (first floor) may become corridor if southwest classroom wing is extended in the future.

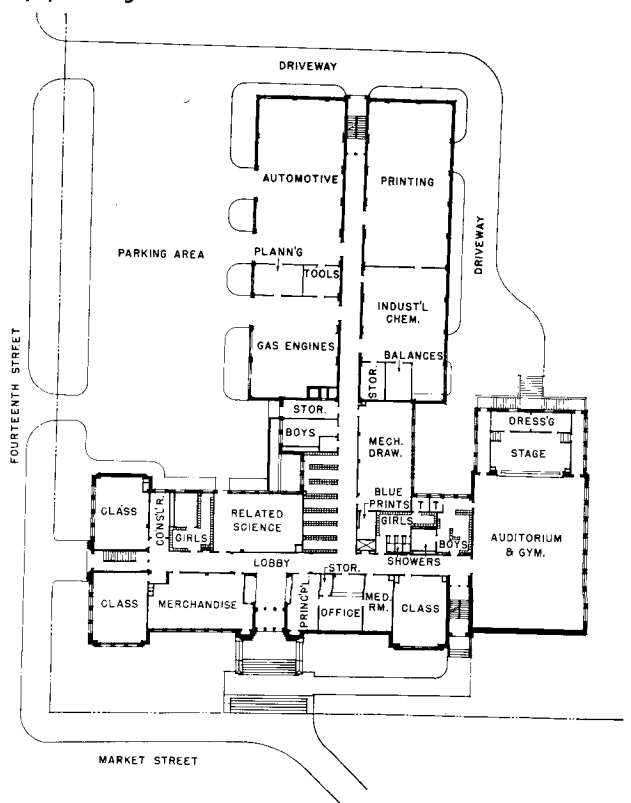

H. F. BROWN VOCATIONAL SCHOOL

MARTIN and JEFFERS, Architects

EACH SHOP has individual project-storage lockers and a tool center, with provision for 30 pupils per class. The plans show a separate entrance for the gymnasium-auditorium block, which may be used when the balance of the school is not open.

Construction is fireproofed steel frame with concrete floor slabs and pre-cast roof. Exterior is red brick with limestone trim. Classrooms have painted plaster walls and maple block floors set in mastic. Classroom sash are wood; ceilings are concrete poured on wood fiberboard and painted. Shops have painted brick walls, painted concrete ceilings, and strip maple floors on wood sleepers; sash are steel. Auditorium-gymnasium has tile wall units, acoustic ceiling, and strip maple floor. Corridors have asphalt tile floors. (Schedule of materials and equipment used in construction may be obtained upon written request to the editors.)

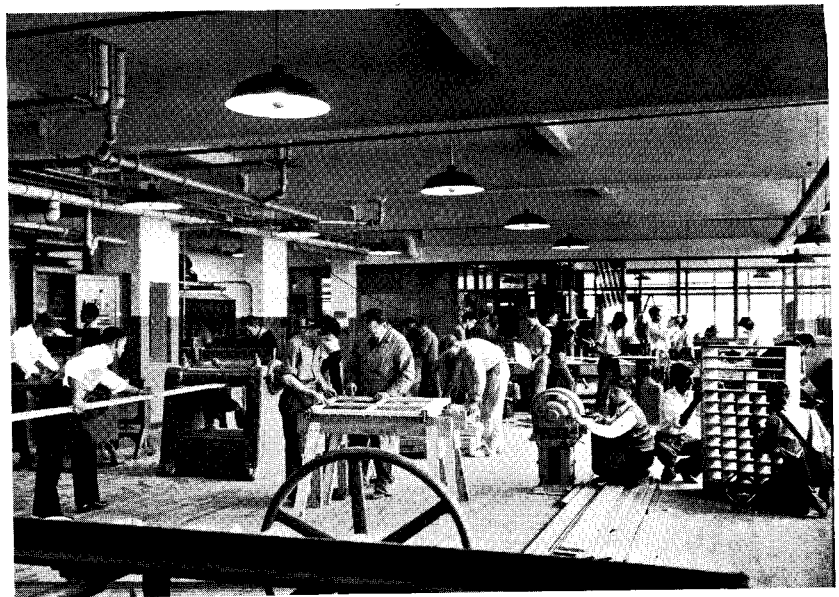

Sanborn Studio



Sanborn Studio

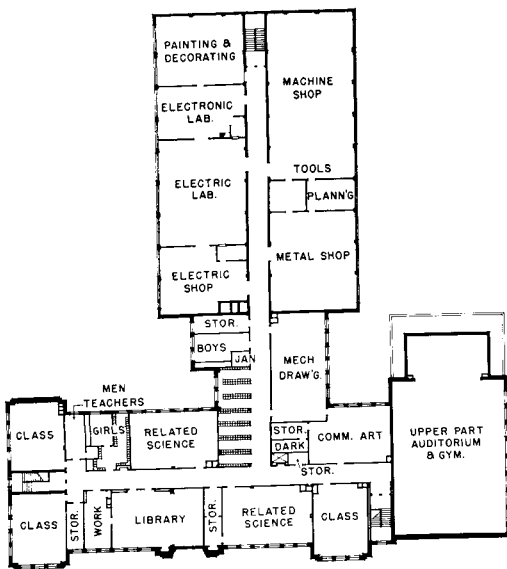

Second floor contains shops for which grade-entrances were not essential. There is a glass-enclosed planning room centrally located in each group of shops.

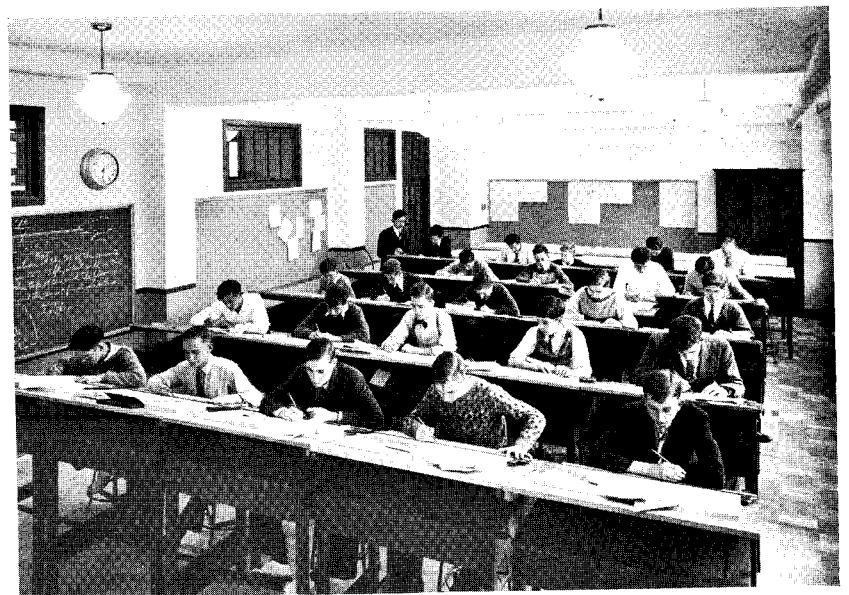

Top, carpentry shop has silvered-bowl direct lighting fixtures; center, sewing shop, with windows on two ends; bottom, mechanical drawing room



HOUSE CONTAINED IN GIRLS' VOCATIONAL SCHOOL

The Middlesex County Girls' Vocational School in Woodbridge, N. J., receives most of its students from industrial workers' homes. ALEXANDER MERCHANT and SON, Architects, used appropriate materials, colors, textures, and ample clearances in designing a building which had to compensate for the students' restricted home life as well as to provide vocational training.



Display case in lobby

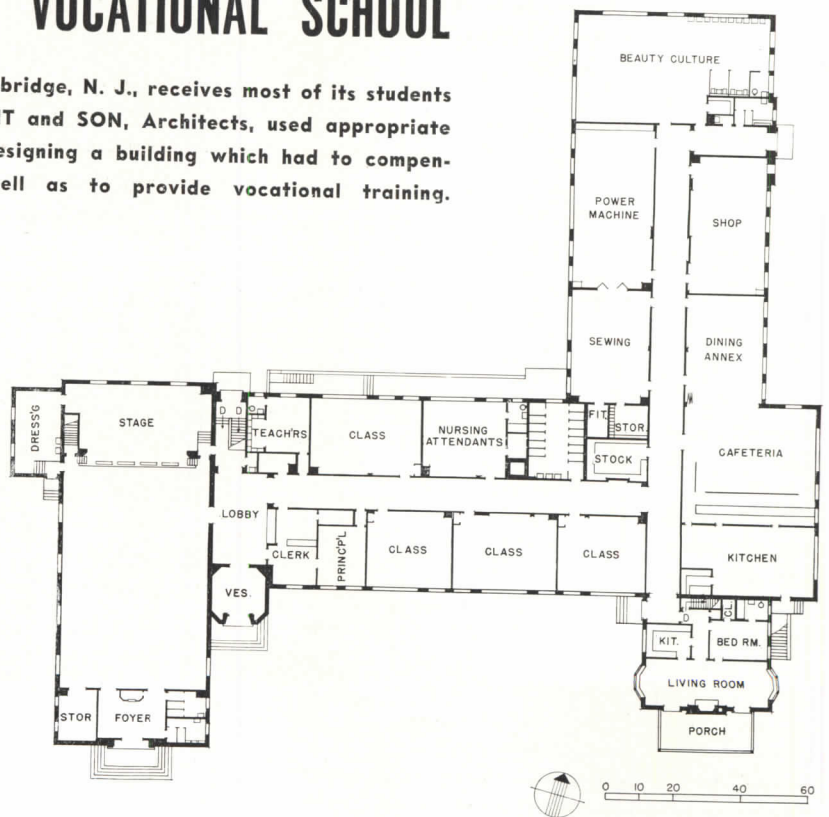

Beneath stage are lockers and showers; house unit at lower right

MIDDLESEX COUNTY Girls' Vocational School prepares girls for trade, industrial, and professional life. Much emphasis is placed on domestic problems and cultural development, since it is felt that in many cases these are feminine responsibilities.

Courses include: power sewing-machine operation; trade dress-making; commercial foods; beauty culture; nursing attendants; and medical secretaries. In related classes students are instructed in working habits; State labor laws; and science, art, and business practice pertinent to trade courses. There are also general courses and recreational facilities. The school is being increasingly used by adults.

Plan has three "zones": recreational, administrative and academic, and vocational. Overhead gates between lobby and corridor may be drawn down to isolate auditorium wing.

Apartment shown at lower right of plan is in effect an independent house, with heating plant and laundry in the basement. Dining annex is used for public lunches and dinners, prepared and served by students.

In addition, by the use of pastel-tinted walls, acoustic treatment in noisy areas, high quality of equipment and furnishings, and ample clearances in corridors, classrooms, and shops, the architects have expressed to the satisfaction of local vocational school authorities the emphasis placed upon cultural, as well as vocational, education.

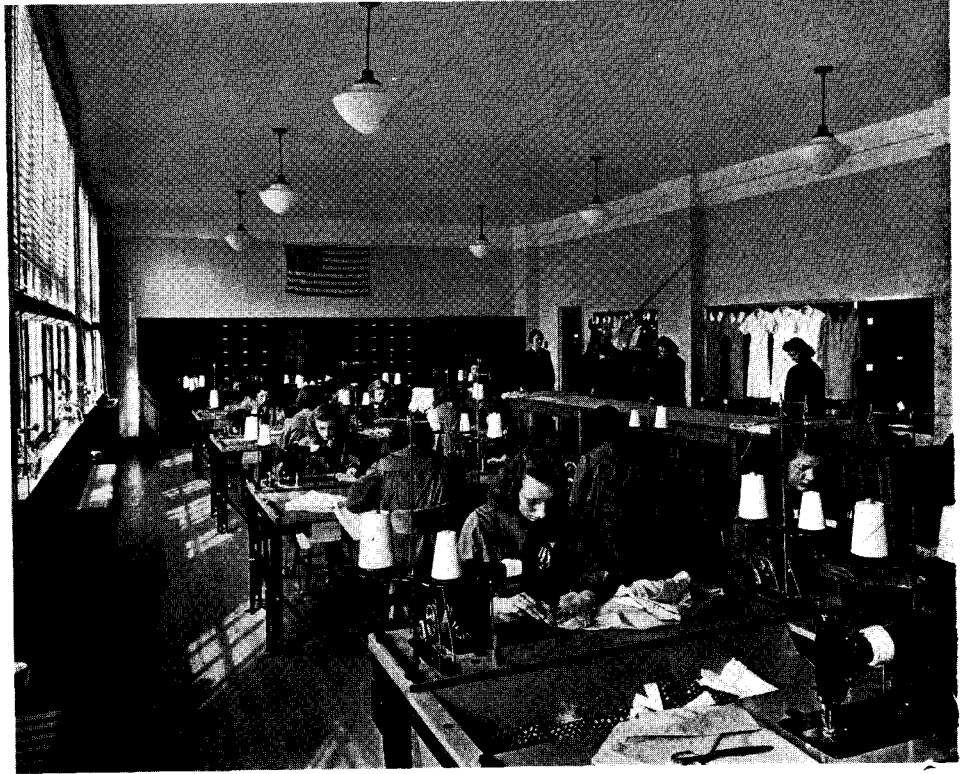

Power machine (industrial sewing) room is said to be one of the finest in the country, and is laid out with ample clearances.



Beauty-culture shop has professional equipment; school certificates are granted only after state license examinations are passed. Note use of Venetian blinds.



An entire wing is laid out as a well-appointed home. Porch (photo below) is used for training in child-care. Wing has its own heating plant and laundry in basement; girls learn the complete business of running a home, as well as how to earn wages.



Photos by Gottscho

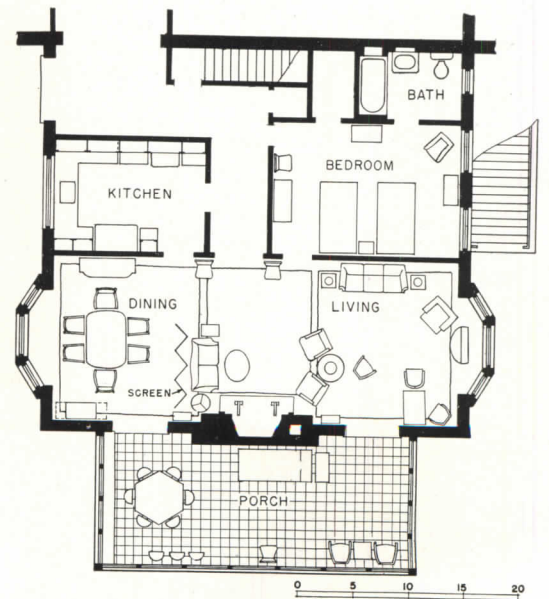

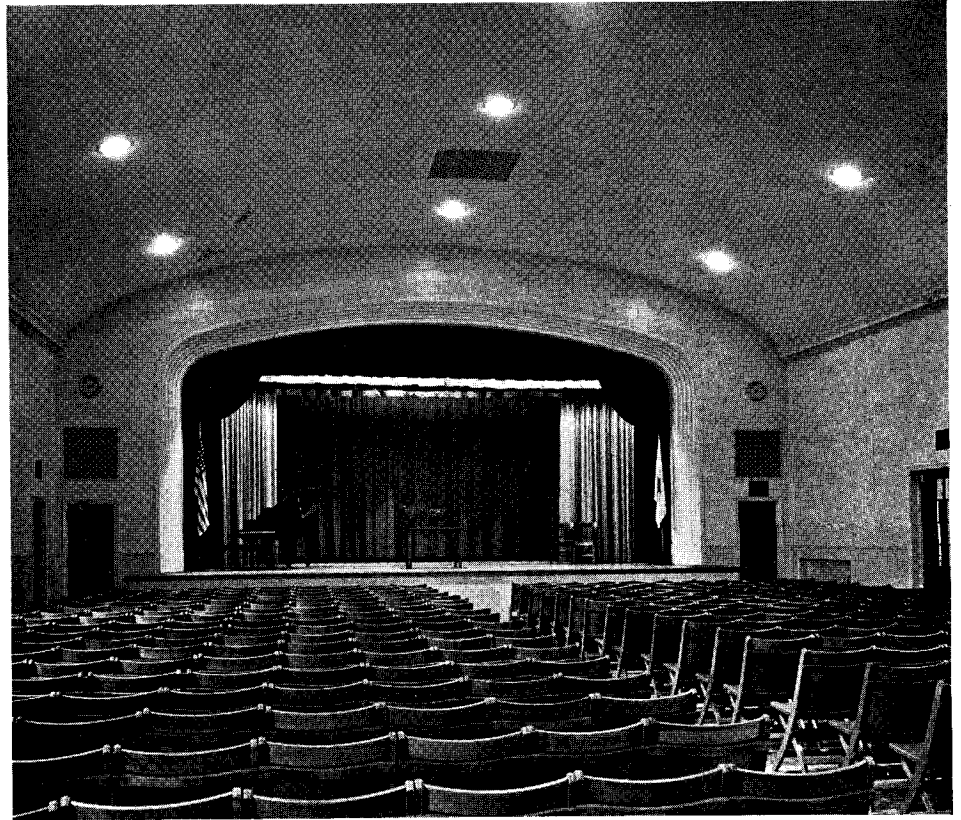

CONSTRUCTION is of masonry with steel roof framing. Basement is mostly unexcavated. Footings are concrete. Exterior walls are red brick with white marble trim. Roof is of precast gypsum carried on steel purlins and surfaced with slate. Metalwork is copper, with copper-lined gutters.

Floors are concrete poured on metal pans, with terrazzo finish in corridors; tile in toilets and showers, cafeteria, and kitchen; linoleum in beauty-culture shop; maple in other shops, classrooms, and auditorium.

Walls have plaster finish generally and are painted in pastel colors, with warm tones for rooms having northern exposures, and cool tones for southern exposures. Corridors have terra-cotta wainscots; showers and toilets have tile wainscots.

Ceilings in auditorium, corridors, kitchen, and cafeteria are acoustic plaster. The remaining ceilings are hard white plaster, painted in colors which have high light-reflecting values.

Heat is supplied by a vacuum steam system equipped with an oil-fired water-tube boiler and cast-iron radiation. Unit ventilators are used. Lighting fixtures are semidirect luminaires, except in auditorium, where flush-mounted ceiling fixtures are used. (Schedule of materials and equipment used in constructing the building is obtainable upon written application to the editors.)

Auditorium has buff terra-cotta tile walls and trim and an acoustical plaster ceiling which is painted light blue.

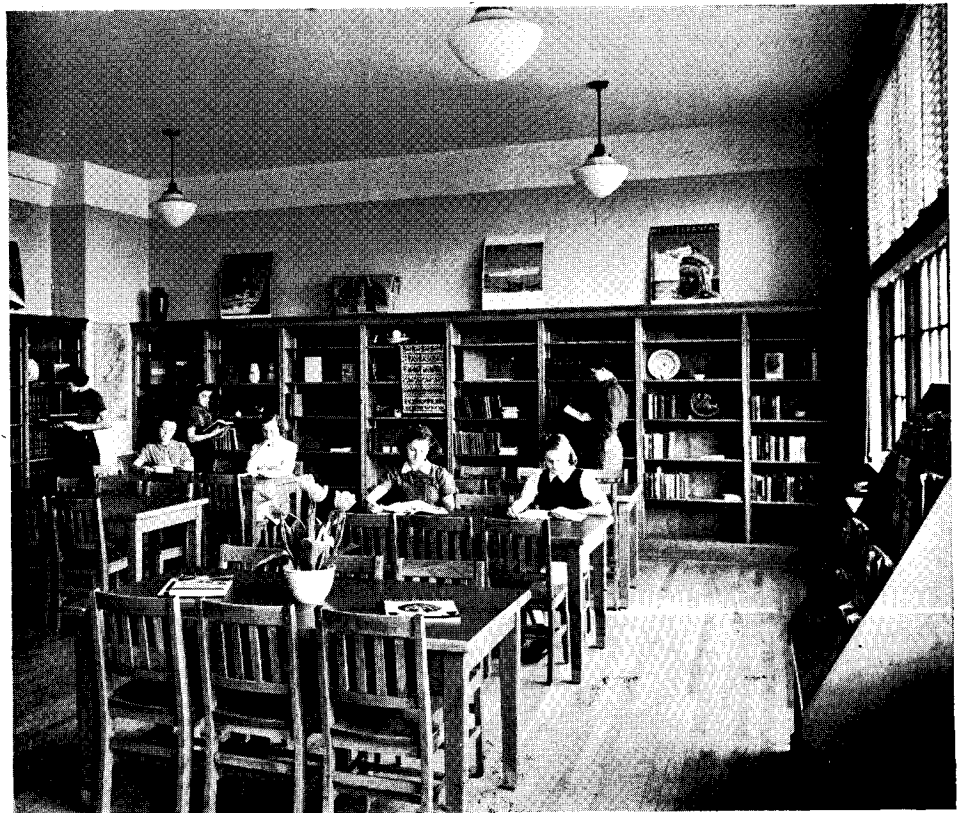

Library-study hall, not yet fully equipped with books, is planned to serve also as a museum, with exhibits demonstrating the growth of American culture.



SCHOOL MIRRORS LOCAL INDUSTRY

Architects FOWLER and LEGEMAN express on the building's exterior the distinction between two types of instruction in the Mechanic Arts School—new boys' vocational school at Evansville, Indiana.

THE SCHOOL at present offers four types of program: (1) six basic trade courses for 300 selected 11th and 12th year high school students; (2) trade extension daytime classes; (3) trade extension night classes; (4) apprentice classes. Girls' courses may be added.

The building is the first on a 22-acre plot upon which Evansville may eventually build either an academic high school which would absorb the present plant, or an enlarged vocational development. Monitor-roofed factory construction is used in the shop, and skeleton steel framing in the non-shop portion. Flexibility to meet local industry's changing demands was considered a most important design factor. Although it was originally planned to partition off shops, better results were obtained by painting lines of demarcation on the floor, and partitions were never installed. The classroom block has floors capable of carrying walls at any point. Steel columns in this portion are on 4-ft. 4-in. centers and act as window mullions. Thus, shop areas may be changed or classroom partitions shifted as more or less area is required for each activity.

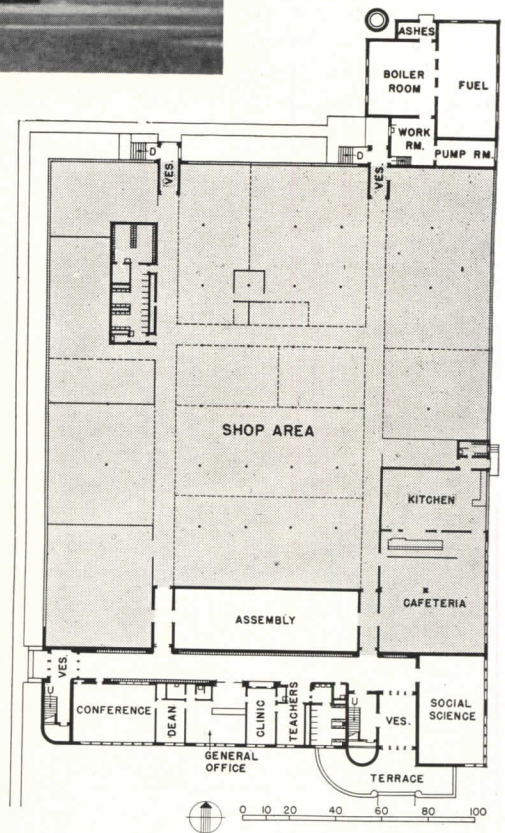

Above, first floor; below, second floor

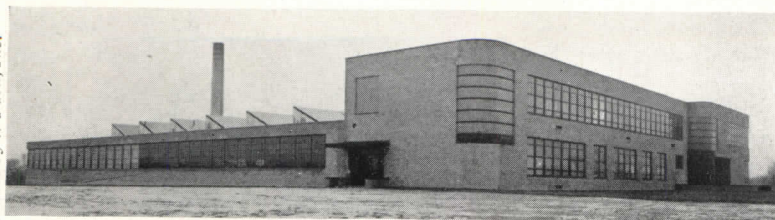
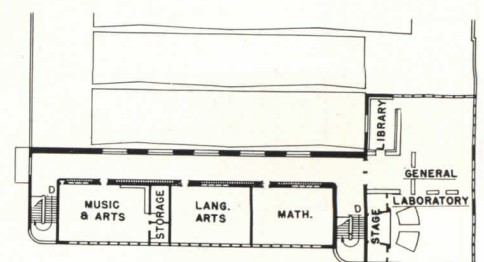

Photos by Walden, Inc.

EXTERIOR of the building is faced with buff brick, with reddish brown terracotta trim. Corridor walls are buff terra cotta. Floors in the academic section are asphalt tile. Floors in the shop area, which is basementless, are of concrete, poured over 3 by 12 by 12-in. hollow clay tile to provide insulation.

Shops have overhead blower-type unit heaters arranged both for recirculating air and for taking fresh air from asbestos ducts which are supplied by intakes on the roof. Special interlocking controls operate the steam valves, fresh-air dampers, and recirculating dampers automatically. Power and other services are carried overhead and dropped to machine locations. (Schedule of materials and equipment used in construction may be obtained on written request to the editors.)

Shop portion, shaded on small-scale plan at left, is reproduced at larger scale at right. Tool cribs and wash fountains are located throughout the various areas as the activities demand. Dotted lines indicate painted markings on the shop floor.

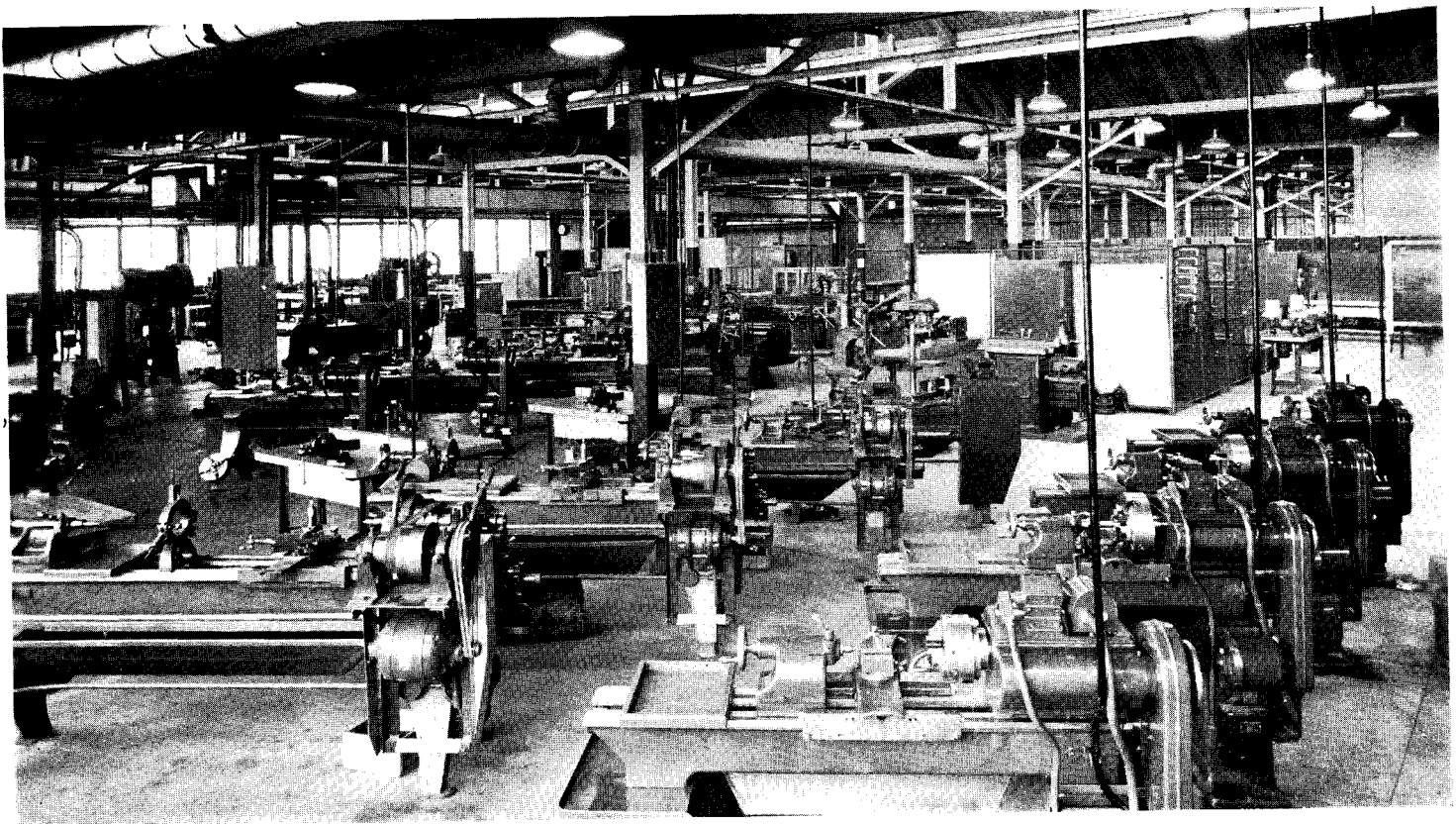
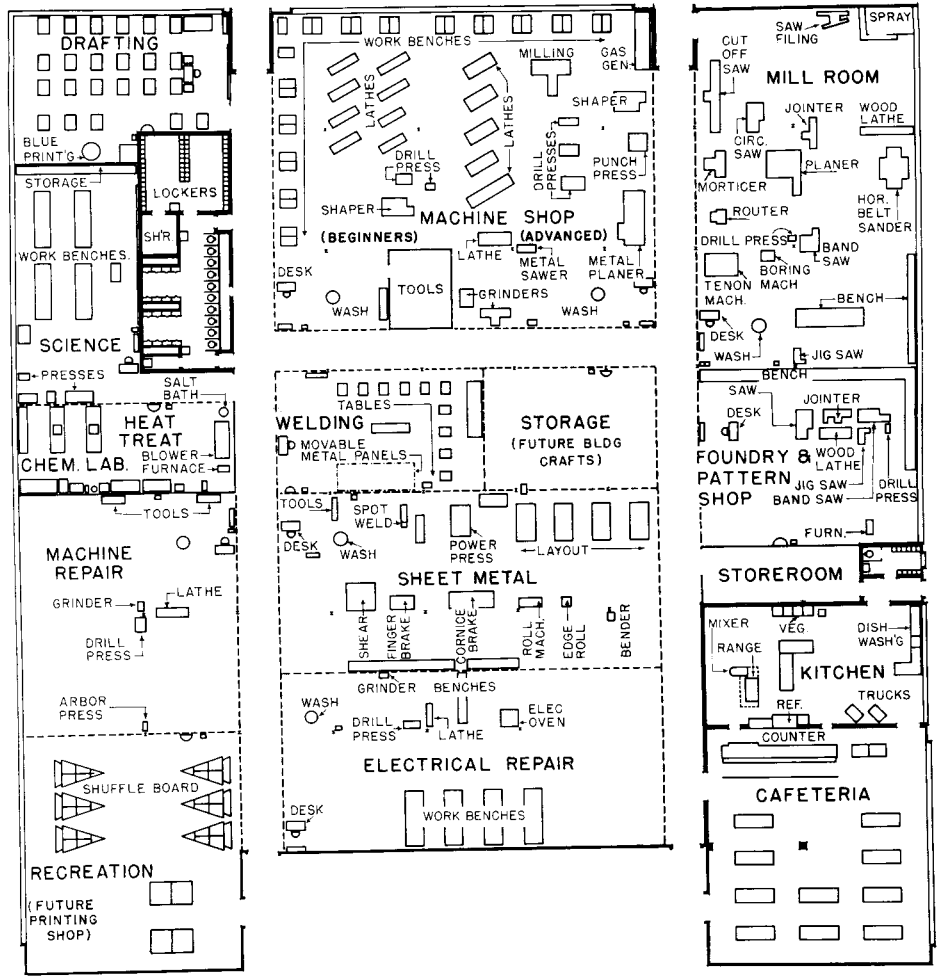



At left, the general education laboratory on the second floor is divided into library, class, and stage areas, and offers the most modern of facilities. The monitor-lighted assembly room, center left, is part of the shop floor. Photo at bottom, left, shows second-floor classroom corridor with recessed lockers, flush ceiling lights, and sloping window sills on which neither dust nor books can accumulate. Lower right, display case in first-floor corridor

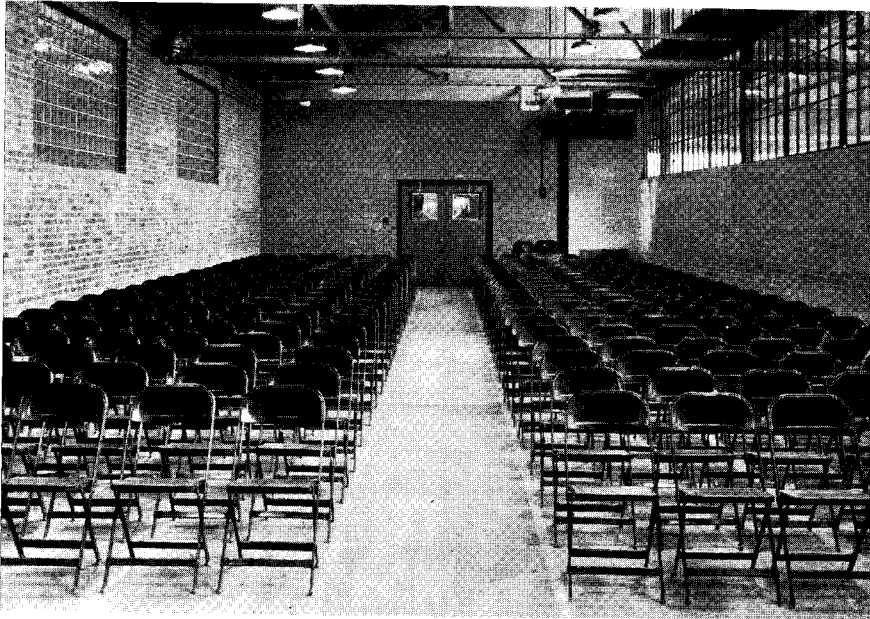

Photos by Walden, Inc.





PRIVATE SCHOOL FOR TRADE TRAINING

The William R. Moore School of Technology in Memphis, Tenn., is not affiliated with any other school, system, or educational program, or any trade organization. WALK C. JONES - WALK C. JONES, JR. were the architects.

ABOUT THIRTY YEARS AGO, Mr. Moore, a merchant of Memphis, left his estate to "found an institution for the education and training of youths in the mechanical arts and sciences." Though insufficient at first, the fund eventually financed a \$250,000 plant and a \$1,000,000 endowment. The school is controlled by a self-perpetuating board of trustees, and operates on a non-profit basis.

The school accommodates about 125 day pupils, and an equal number of employed men at night. Instruction is given in: auto mechanics; electricity; general machine work; sheet metal and ornamental iron work; tool making; die work; welding; rough and finish carpentry; cabinet work; furniture making and upholstering; mechanical and archi-

tectural drawing. Courses include related classwork.

Plant and equipment were designed and selected to duplicate modern industrial working conditions. Teaching projects are practical shop jobs. Each shop has assigned to it a special classroom.

The building is a monolithic concrete structure with rigid reinforced-concrete bents which span the 45 ft. wide shops, eliminating interior columns. The exterior is veneered with face brick and trimmed with cut stone. Shops have continuous-steel factory sash. The roof is 20-year bonded, built-up, applied over 1-in. insulating board. Interior walls are smooth-finished concrete; floors are cement. The lobby has an alberene

stone floor, travertine walls, ornamental plaster cornice, and acoustical ceiling. Alberene stone trim is also used at the main entrance.

Arrangement of shops eliminates the necessity for partitions between them; tool rooms, etc., separate the areas. Toilets are located in mezzanines over the tool rooms, freeing shop floors for teaching purposes.

Approximate costs: Land, \$25,000; building, \$185,000; equipment, \$68,250, of which half was expended in equipping the machine and metals shops. Building was completed in 1939. (Schedule of materials and equipment used in construction may be obtained upon written application to the editors.)



MOORE SCHOOL OF TECHNOLOGY

WALK C. JONES - WALK C. JONES, JR.
Architects

HEATING SYSTEM consists of a low-pressure steam, two-pipe vacuum system, with a steel boiler fired by natural gas.

The central block is heated with cast-iron radiators. Shops and assembly room are heated with thermostatically-controlled unit heaters.

Light and power are distributed from circuit-breaker panels. Shop fixtures are of the diffused-direct type, mounted 16 ft. 4 in. from the floor, and are spaced to provide 18 footcandles at working planes directly under fixtures, 12 to 15 ft. midway between units.

On facing page, interiors of electrical and auto shops illustrate the long-span monolithic concrete construction, ceiling-hung unit heaters, and suspended tracks which make hoists available throughout all shops. Note that services are distributed through floor trenches. Below is shown the penthouse drafting room and, at right, the physics laboratory.

Plans at right show how student circulation between shops and classes is confined to a single corridor and stair. Tool cribs with washrooms above serve to separate shops, eliminating many partitions.

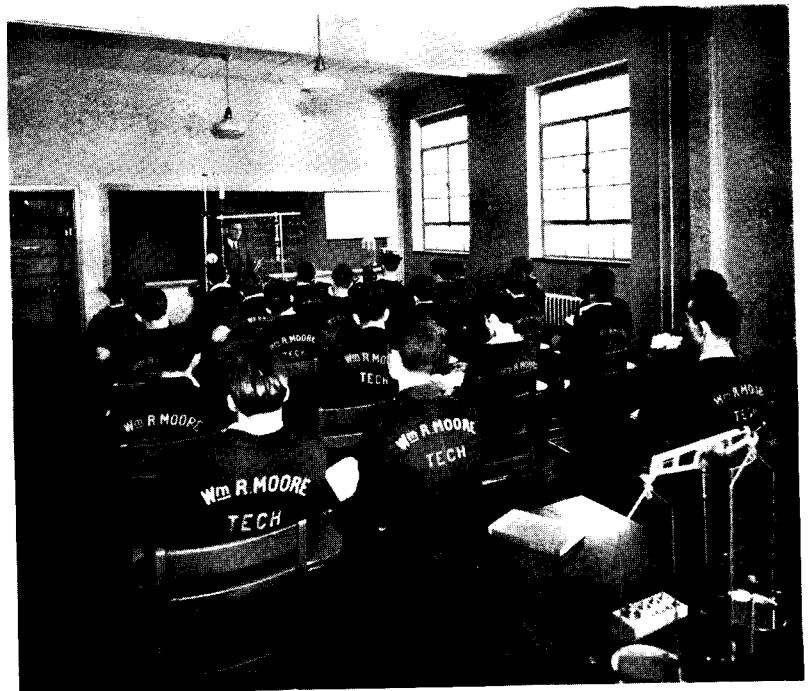
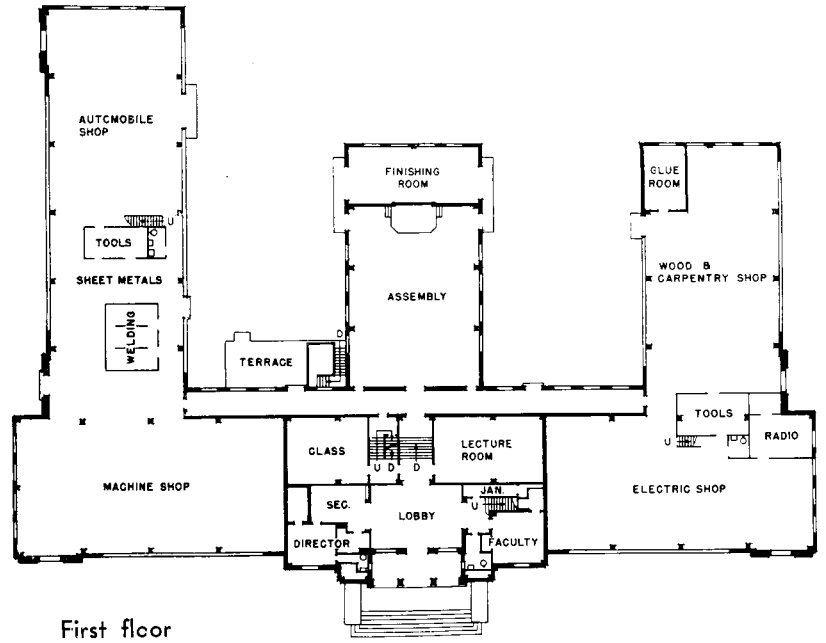
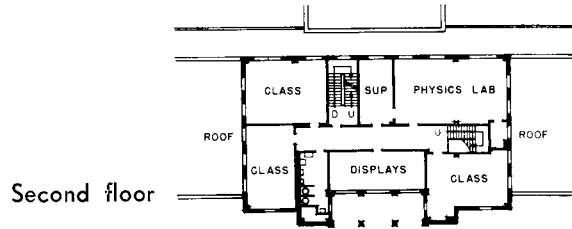
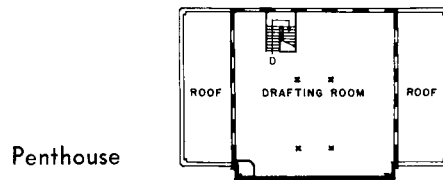

Hitchings

VOCATIONAL SHOPS IN A RURAL HIGH SCHOOL

Architect GILBERT A. JOHNSON designed the Oregon Community High School, in Ogle County, Illinois—a rural community with some industrial and commercial interests.

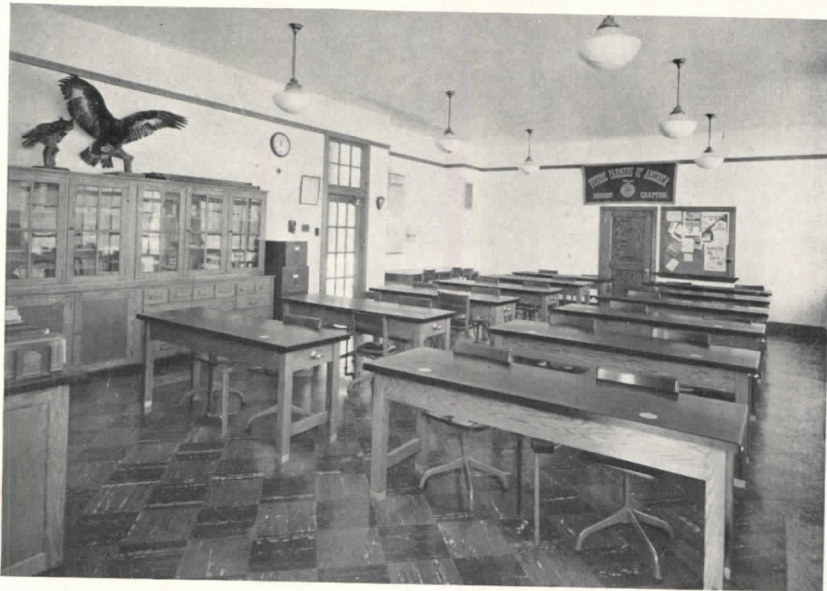
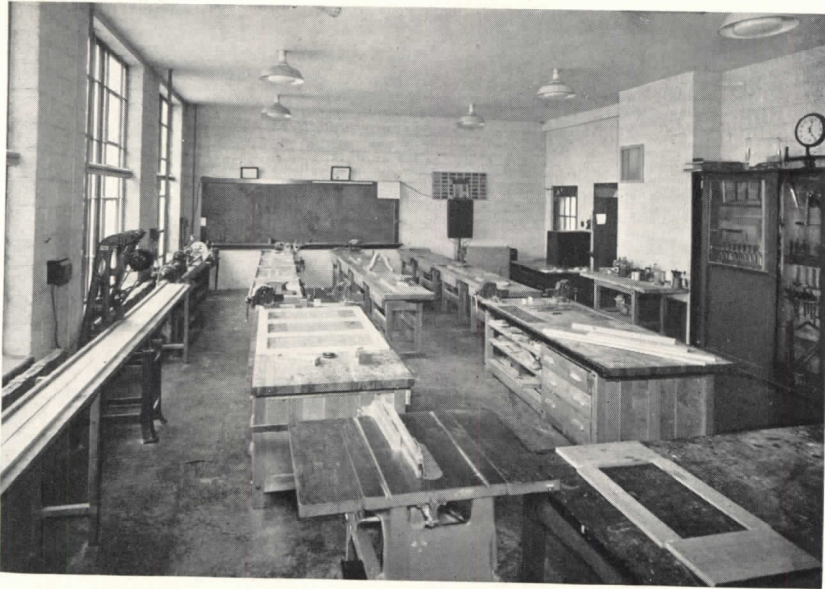

Top, manual arts and farm mechanics shop; below, science and agricultural laboratory

SHOPS AND COMMERCIAL rooms accommodate from 16 to 24 pupils each; classrooms accommodate 30 pupils each. The library-study hall has seats for 96 pupils, plus 4 conference tables which seat 4 each. Adjoining the agriculture laboratory is a greenhouse with seed beds and aquarium.

Construction is of steel frame, with concrete floors poured over steel pans. Exterior is of face brick trimmed with stone. The roof is surfaced with built-up bonded roofing. Interior partitions are hollow gypsum or clay tile, with concrete block used in the manual arts and farm mechanics shop. Ceilings are plastered. Floors are asphalt tile in corridors, commercial and science shops, and classrooms; concrete in toilets, lockers, and manual-farm mechanics shop; maple unit block in gymnasium. Lighting fixtures are semidirect luminaires. (Schedule of materials and equipment may be obtained on written request.)

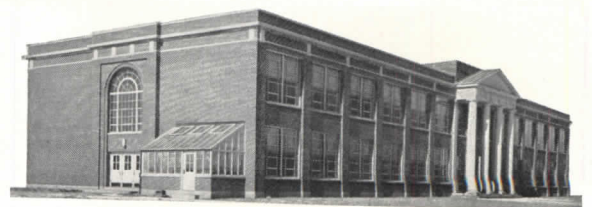
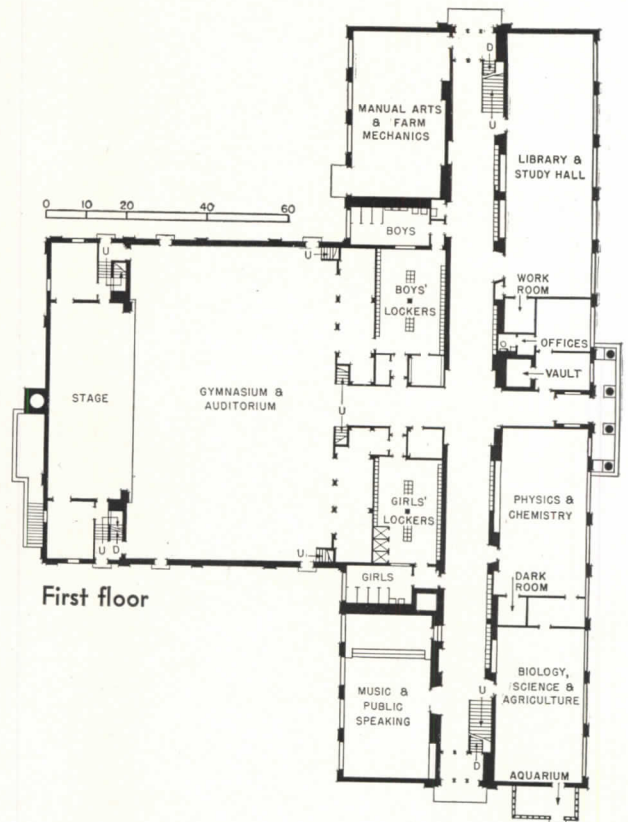
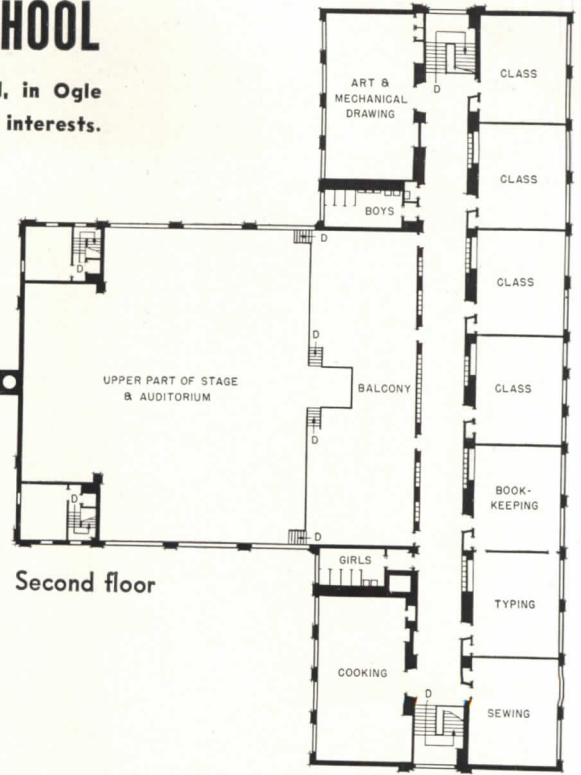

Designed for ARCHITECTURAL CONCRETE

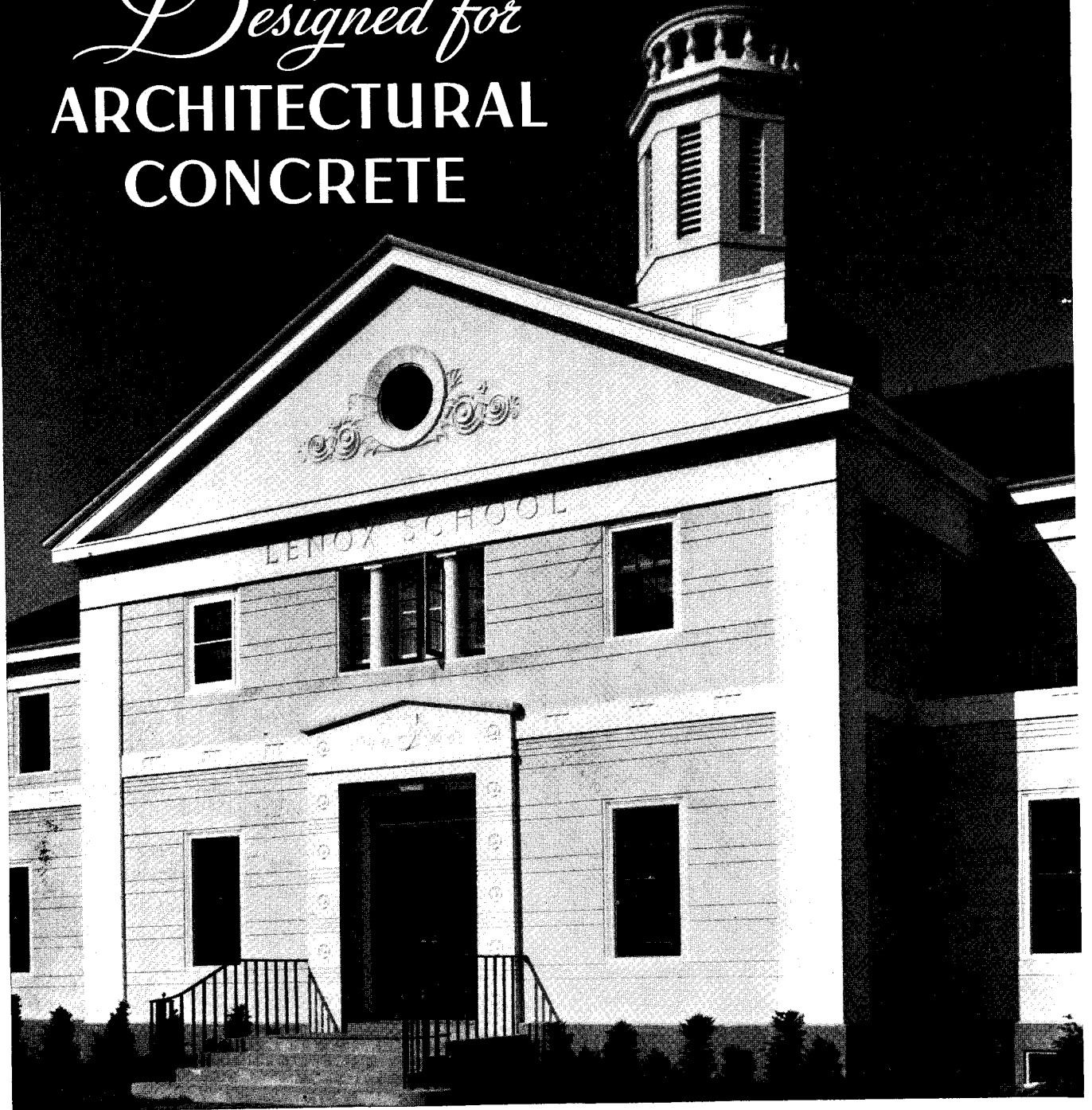

Concrete opens interesting possibilities in the way of surfaces, textures, treatment of detail.

Right there is the tip-off on an advantage unique with concrete—*design flexibility*. In addition, fire-safety, long life and low maintenance are inherent in this enduring material. And concrete effects substantial savings by permitting walls to be cast integrally with frame and floors.

"The NEW Beauty in Walls of Architectural Con-

crete" (free in the U. S. and Canada), illustrates typical concrete surface textures, interesting details and complete buildings. Write for your copy today.

● The Lenox School for Boys at Lenox, Mass., is of reinforced concrete construction throughout. McKim, Mead & White of New York were the architects; Peasley & Wheeler of Hampden, Mass., the contractors.

PORTLAND CEMENT ASSOCIATION

Dept. 4-8, 33 W. Grand Ave., Chicago, Ill.

A national organization to improve and extend the uses of concrete . . . through scientific research and engineering field work.

to the profession within its district, and, particularly, to allocate the work pertaining to the various Chapters and the State Association members within the district.

Under the new plan, regional directors would first be nominated by representatives of Institute Chapters on the regional council. Individual members of the Institute in the district would vote on these nominees by mail ballot, choosing the one to be nomi-

nated for the directorship on the floor of the convention of the Institute by the Secretary of the Institute, for election by the convention.

The State Association members within each regional district would elect a regional coordinator to coordinate and direct the work of the State Association members in the district, to keep records, and to promote the organization of State Association members in every State within the district where

such a membership does not exist.

Annual regional conferences would be held by State Association members in each regional district of the Institute, and an annual national conference of all State Association members would be called immediately prior to and in conjunction with the annual convention of the Institute. The State Association director of the Institute, an office now held by *Leigh Hunt* of Milwaukee, Wis., would be nominated at this national conference and the nomination offered on the floor of the Institute convention by a qualified State delegate, for election by the convention.

Regional coordinators are also to hold a national conference, preceding the meeting of State Association members at the Institute's annual convention. The State Association director of the Institute would preside, and reports of the regional coordinators would be presented.

District conferences of regional coordinators and state delegates are provided for, subsequent to the annual meetings of the State Association members, in the regional district at which they elect their state delegates to the Institute convention, and prior to the national conference. At these district conferences the regional coordinators would read their annual reports before submitting them to the State Association Director of the Institute and the national conference.

Details of the unification plan were worked out by a joint committee composed of Mr. Ditchy, Mr. Ingham, and *Gordon B. Kaufmann* of Los Angeles, representing the Institute's Board of Directors; and Mr. Fletcher, *Thomas Pym Cope* of Philadelphia, and *Matthew W. Del Gaudio* of New York, representing the committee on state organization.

Members of the Institute's committee on state organization in addition to Mr. Fletcher are: Mr. Del Gaudio, vice-chairman; *Kenneth C. Black* of Lansing, Mich.; Mr. Cope; *Sylvanus B. Marston* of Pasadena, Calif.; *Victor A. Matteson* of Chicago; *Floyd A. Naramore* of Seattle, Wash.; *Ivan H. Smith* of Jacksonville, Fla.; *John T. Whitmore* of Boston.

The unification program is the culmination of a three-year study of the relations of the Institute and State Associations of architects.

**GROUP WASH FIXTURES
USED BY OVER 600
SCHOOLS, COLLEGES
and INSTITUTIONS**

**Save Space and Water
— Improve Sanitation and Health**

From Maine to California, Washington to Florida — small schools and large are equipped with Bradley sanitary, modern, group washing fixtures . . . Each circular 54-inch diameter Bradley Washfountain serves 10 students simultaneously, yet requires but three piping connections. Individual wash basins of equal capacity need 30 connections . . . Washfountains save 25% in floor space—70% in water consumption—are convenient, accessible, time-saving. Each user washes in clean, running water,—cleanliness is encouraged, school health improved.

Let us mail you our complete catalog to assist you in modernizing,—or planning washrooms for new schools . . . BRADLEY WASHFOUNTAIN CO., 2227 W. Michigan St., Milwaukee, Wisconsin.

Ask for
Catalog 937

**BRADLEY
WASHFOUNTAINS**

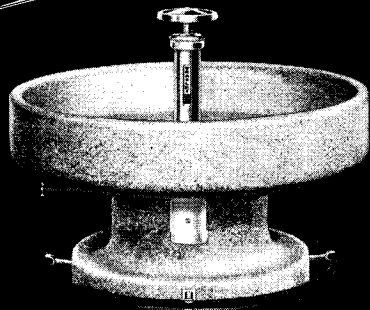

A foot-controlled precast stone Washfountain, 10-person size. Also available in other sizes and materials.

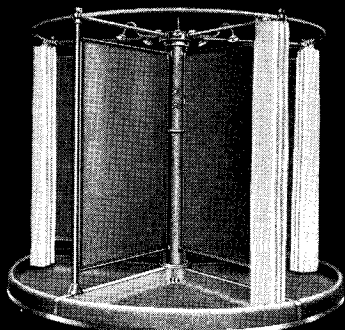

Another Bradley product, the "5-in-a-Group" Shower. Self-contained, sanitary, safe. One set of piping connections serve all 5 stalls.

SPECIFY **QUIET** AT A SAVING with this **NEW J-M MATERIAL**

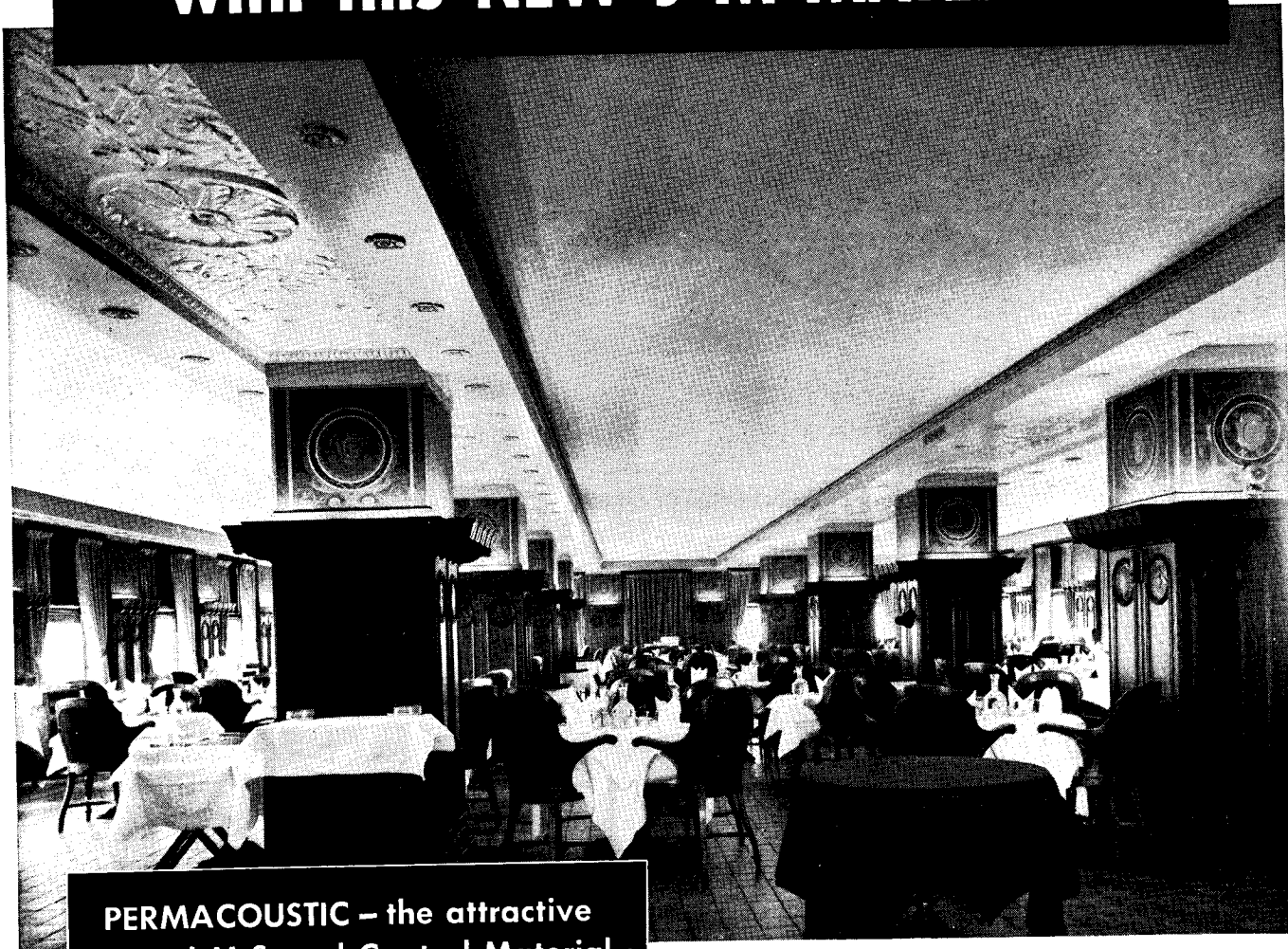

PERMACOUSTIC – the attractive new J-M Sound-Control Material – brings the cost of quiet within the reach of every client

BANKERS CLUB OF AMERICA, New York, N. Y.

Here, Permacoustic with sanded joints was used. When desired, beveled joints may also be specified. Both types provide the same high sound-absorbing efficiency.

NOW you can specify permanent, efficient noise-control treatments with an attractive material that's priced for modest budgets . . . J-M Permacoustic.

Recently developed by the J-M laboratories, Permacoustic's attractive stone-like texture adds beauty and dignity not found in most sound-control materials. Because it is entirely mineral, Permacoustic is fireproof



and rotproof, seldom requires maintenance. Treatments remain an asset to the room as long as the building stands.

You'll find Permacoustic, or one of the many other materials in the complete J-M line, ideal for every client's needs. For details, see Sweet's Catalog or write for brochure AC-26A. Johns-Manville, 22 East 40th Street, New York, N. Y.



JOHNS-MANVILLE

A COMPLETE LINE OF ACOUSTICAL MATERIALS

Permacoustic Sanacoustic Transite Acoustical Units
Spongeacoustic Fibracoustic Airacoustic Sheets

NEW EQUIPMENT

(Continued from page 56)

ing a partial vacuum at this point. The vacuum in turn draws water from the well through the Venturi tube, creating pressure sufficient to force the water up the suction pipe to a point where the centrifugal impeller can pick it up for delivery to the pressure tank. Crane Co., 836 South Michigan Ave., Chicago.

Simplified Winter Air Conditioner

THE NEW LX Coal-Fired Winter Air Conditioner is a manually operated unit

for homes of medium cost. Elimination of automatic firing equipment reduces both original and operating costs. Yet the unit serves the functions of more costly winter conditioners—heating, circulation, humidification, and filtration. It is available in three sizes for small, medium-sized, and large homes and is capable of producing a maximum of 126,000 Btu's per hour at the bonnet. In summer, the blower may be used for air circulation. The unit is assembled in a cabinet with blue Hammerloid steel finish. The blower motor and drive assembly have an adjustable speed pulley

which allows the installing engineer to ventilate the home according to its particular heating requirements. The Round Oak Co., Dowagiac, Mich.

Pitless Oil and Gasoline Separator

THE "SOLUS" OIL and gasoline separator for use in garages, engine rooms, dry-cleaning establishments, etc., can be embedded directly in the earth, thus eliminating construction of a waterproof pit. A further advantage claimed for this separator is that it can be cleaned only from the floor: accumulated oil and gasoline are removed by pail and bucket or by installation of a hand pump. When oil-retaining capacity is reached, discharge is automatically stopped by the lowering of the brass float which acts as a clean-out signal. The inlet pipe is designed to prevent backing up of explosive gases or accumulated oils from the inside of the separator into the incoming drain line. The "Solus" separator is constructed of "one-piece" cast iron. The Central Foundry Co., 386 Fourth Ave., New York, N. Y.



WILL PHOTOS LIKE THESE *be made in your new school?*

How will they clean the floors, the walls, erasers and boiler tubes in your new school? Can you picture any other method as flexible, thorough, easy to use and as low in cost in the long run as the Spencer Vacuum Cleaning illustrated here? The great majority of educators and architects would say, "No—there is no better way."

The Spencer System is used in more than 2500 schools. It is far more powerful than ordinary vacuum cleaners. Special vacuum tools clean all surfaces including cement and linoleum. All dirt and dust goes to containers in the basement.

The Spencer System is dependable and built to last for years.

Ask for the new Spencer Bulletin on Commercial Vacuum Cleaning. Shows how it is used, what it saves. Ask for Bulletin No. 121-R.

SPENCER
Commercial
VACUUM
CLEANING

S-181-A

SPENCER CENTRAL AND PORTABLE
HARTFORD VACUUM CLEANING SYSTEMS

THE SPENCER TURBINE COMPANY, HARTFORD, CONN.

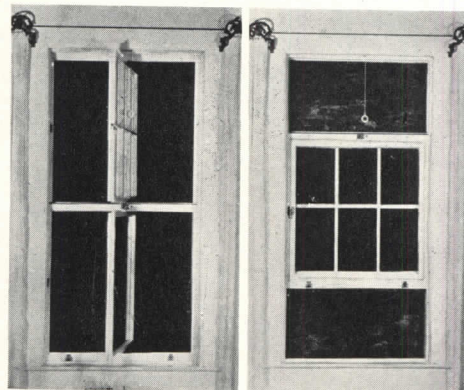

FIG. 1

FIG. 2

Above: Reversible Double-Hung Window

A DOUBLE-HUNG WINDOW with many novel features of flexibility, on which a patent is now pending, was recently announced. Basically the unit looks and performs like a traditional double-hung window. Within the frame of both upper and lower sash, however, the lights are mounted in a separate frame of their own. This inset frame is pivoted at the center, both top and bottom. Joints are so shaped that the interior frame can turn vertically on the central pivot. By turning both upper and lower sash 90°, there is practically 100% ventilation (Fig. 1). The pivoted units may, however, be turned the complete 180°, thus bringing the outside face to the inside, so that both sides of the glass may be

(Continued on page 126)



Meet *Certain-teed* son. He's a horse that all of us ARCHITECTS can ride in the Lucky Forties

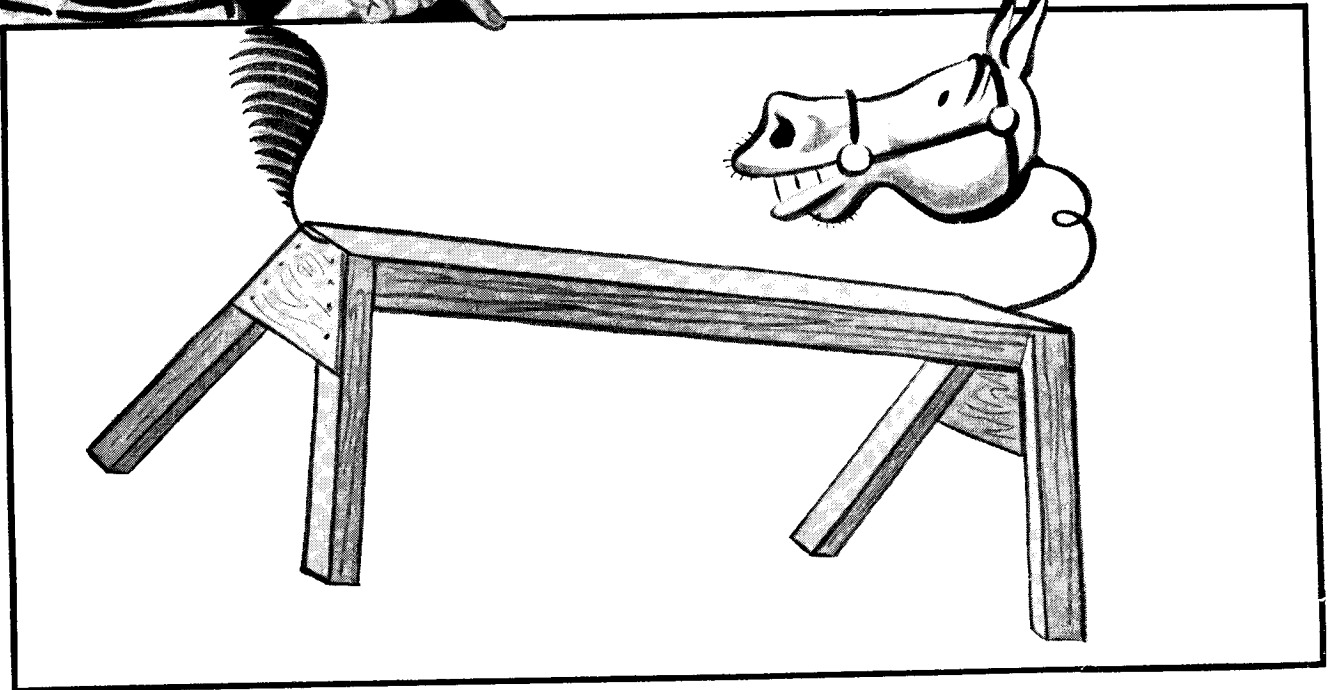

“Why is the horse named Certain-teed, Daddy?”

“He represents one of the biggest and best names in building—the Certain-teed Products Corporation. And he’s certainly one horse the whole building industry can ride with profit.”

“How does Certain-teed profit you, daddy?”

“Well, son, most of my living comes from people who want to live in homes. That goes for the entire industry, too. That’s why we can all ride this horse, Certain-teed. He sells my customers and prospects on the basic idea of building or remodeling.”

“How, daddy?”

“Through Certain-teed national advertising that shows

35,000,000 Americans how much better off they and their country will be when they invest in building. Home owners are the real backbone of America, I think.”

“Don’t all big companies do that, daddy?”

“Not like Certain-teed. There’s one outfit that has the courage and the vision to sell the industry *above* their products—that’s why I’m backing this horse to help me in 1940.”

“Will Certain-teed help you enough to get me a new bicycle, daddy?”

“I’m sure he will, son. I’m betting we’ll climb on Certain-teed’s back and gallop right into the best profit year we’ve ever known.”

Certain-teed’s Basic Policy

Certain-teed believes that only as the Building Industry prospers, so will the nation. Therefore, we consider it our duty to promote the building industry *as a whole*, by stimulating the universal desire to own and live in a good home. For that reason Certain-teed advertising sells your services and your industry *first*; and Certain-teed products *last*. In the interest of the 6,000,000 crafts-

men who depend on the Building Industry for a livelihood Certain-teed pledges to remain faithful to this basic policy.

CERTAIN-TEED PRODUCTS CORPORATION

100 EAST 42ND STREET, NEW YORK

ASPHALT ROOFING SHINGLES AND SIDING • STRUCTURAL INSULATION
WALL BOARDS • GYPSUM BOARD, LATH AND PLASTER PRODUCTS

NEW EQUIPMENT

(Continued from page 124)

washed from the room side.

Concealed behind the trim at both top and bottom are roller screens which are attached (but detachable) to the top rail of the upper sash and the bottom rail of the lower sash. When the sash is either raised or lowered (Fig. 2), the open area is automatically screened.

It is planned to manufacture the reversible double-hung window in materials and sizes for every window need. Special

advantage claimed for the new unit: because the windows can be cleaned from inside the building, this does away with safety belts and hooks and costly risk insurance. The Reversible Double-Hung Window Corp., 103 Park Ave., N. Y. C.

Horizontal-Sliding Windows

A NEW HORIZONTAL-SLIDING wood window is obtainable in units ranging up to 5 ft. 11 in. wide by 5 ft. 6 in. high. Each window consists of a pair of sash which are in the same plane when

closed, and slide past each other on metal tracks to open. The unit is completely weather-stripped and is said to permit almost no air infiltration. Double glazing is optional, and is provided by auxiliary sash which are screwed directly to main sash. Frame and trim are provided as a unit which is installed by nailing through the integral blind stop into studs. The assembly is designed for frame, masonry-veneer, or solid-masonry construction. There are no weights, balances, or weight pockets.

Sash are installed in the frame by pressing them into place on the metal guides. They are easily removable from inside, for cleaning or attaching double-glazing units. Hardware is applied at the factory, and includes a three-way lever-operated lock which causes sash to make positive contact with weather-stripping.

Sash are available glazed similarly to wood casements, or in horizontal panes. Multiple windows require mullions only 2¾ in. wide. Andersen Corporation, Bayport, Minn.

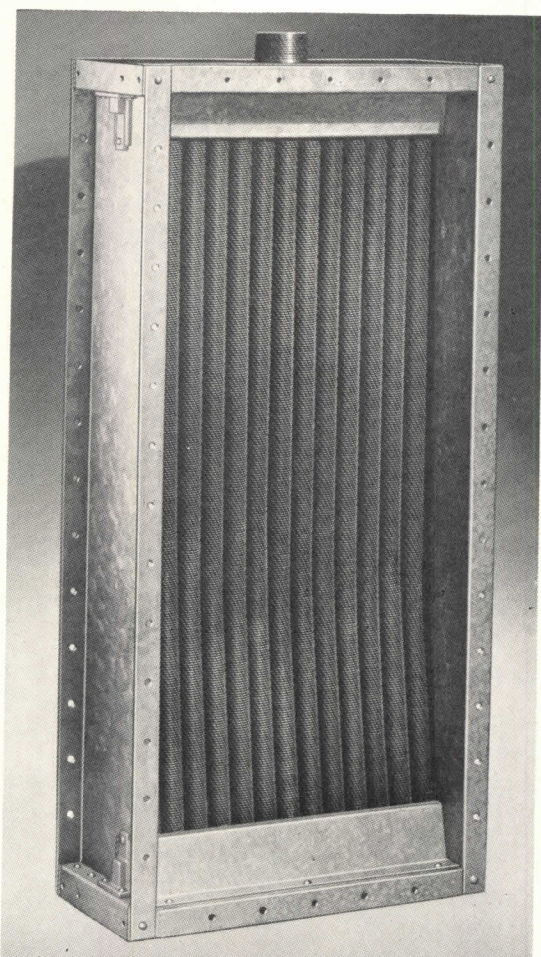

Fedders

new type K

**HEATING
COILS
GIVE
HEATING MEN**

Design

WITH A CAPITAL

"D"

Type K Heating Coil features include patented full-floating relief of over-all expansion stresses, and "knee-action" relief of differential expansion between individual tubes . . . spiral fins are pressure wound and metallurgically bonded on seamless copper tubes . . . entire surface is tinned for protection against corrosion . . . integral orifices and scale breakers . . . generously large cylindrical headers.

Husky, rigid ARMCO ZINCGRIP casings assure adequate protection

against piping stresses and coil distortion. Casings are only 9" deep.

Reserve your personal copy of Catalog H-601 right now.

**FEDDERS
MANUFACTURING CO.**

Air Conditioning Division
47 Tonawanda St. Buffalo, N. Y.

Newly Styled Cold-Storage Doors

JAMISON COLD-STORAGE doors have been restyled by the Paul Cret Organization, Architects and Industrial Designers. Three standard types are available for varying temperature differentials, and numerous doors for special duty. Standard exterior finish is five-panel wood. Special fronts—porcelain enamel, stainless steel, Monel, flush plywood, antique oak—are also procurable. Particular attention has been paid to hardware. The "Model W Wedgetight" fastener has been redesigned to operate at finger-touch, yet is sturdy enough to withstand slamming. New "Adjustoflex" hinges may be set to provide proper seal as the cellular-rubber gaskets require. Rubber sill gaskets are replaceable. The door is furnished complete, ready to install in the rough buck opening. Jamison Cold-Storage Door Co., Hagerstown, Md.

Machine-Vibration Isolator

EASILY INSTALLED is a vibration isolator designed to control, at low cost, horizontal, torsional, and vertical vibration of machines. It is intended for use on bases of motors, generators, pumps, fans, and other equipment where excessive vibration creates noise or damages machine parts, connections, or sup-

(Continued on page 128)

• HEAT TRANSFER SPECIALISTS SINCE 1896 •

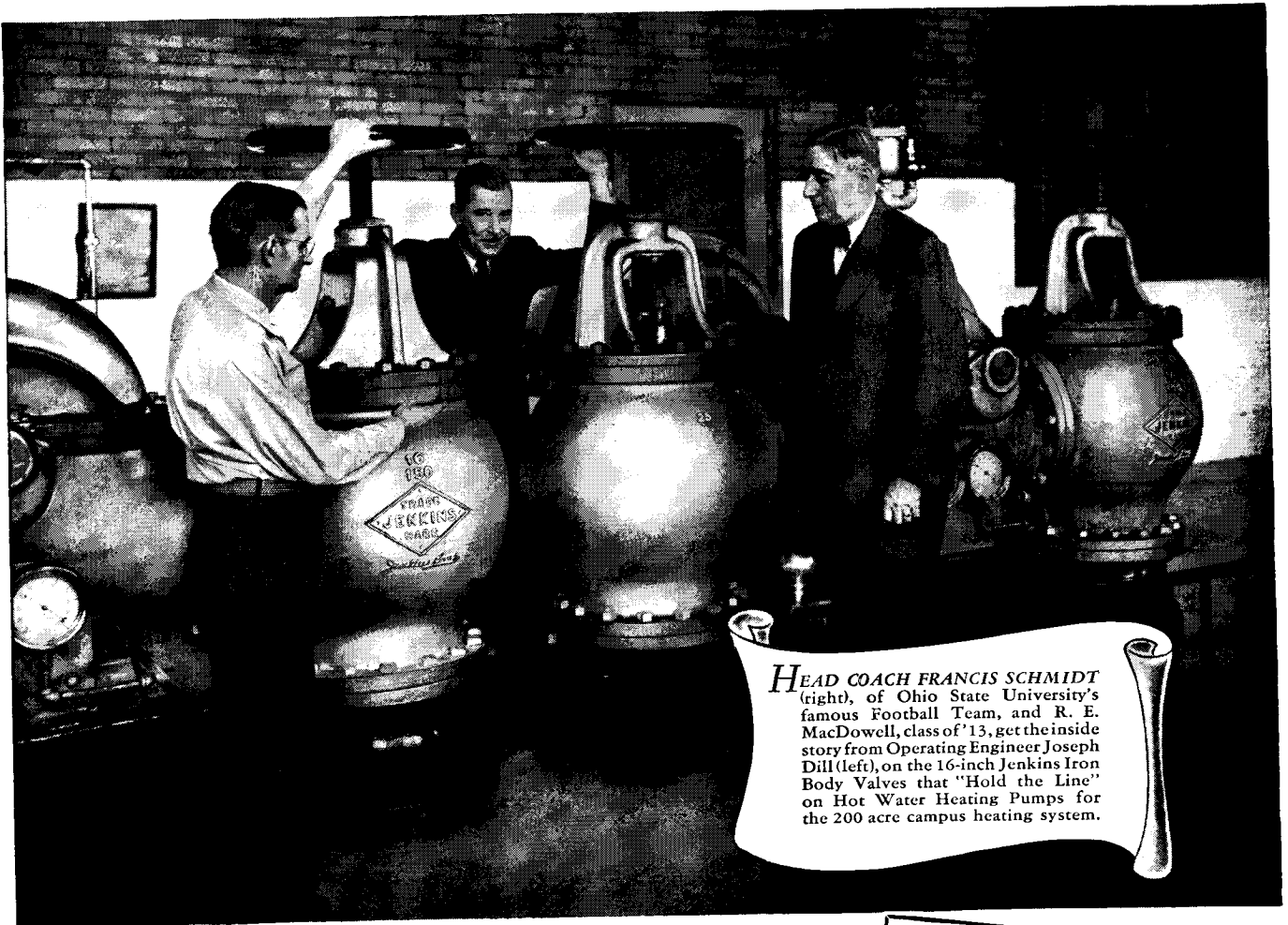

HEAD COACH FRANCIS SCHMIDT (right), of Ohio State University's famous Football Team, and R. E. MacDowell, class of '13, get the inside story from Operating Engineer Joseph Dill (left), on the 16-inch Jenkins Iron Body Valves that "Hold the Line" on Hot Water Heating Pumps for the 200 acre campus heating system.

Hold that line . . . AT OHIO STATE!

Fitting symbol of Ohio's stature and progress is the State University at Columbus, with an enrollment of over 13,000 students. The task of keeping their buildings warm requires the world's largest hot water heating system. And to control the 8 miles of pipe and 600,000 square feet of radiation requires literally thousands of dependable valves.

In talking of this system to our independent investigator, Operating Engineer Dill says — "These Jenkins Valves were installed in 1925. They have served since without maintenance cost — (not even a disc replacement)".

You may consider valve equipment a small part of the total cost of a project such as this. Actually it is a major investment — for in the selection of adequate and proper valves, you write a long-term insurance policy against excessive maintenance and repairs.

JENKINS BROS., 80 White St., New York, N.Y.; Bridgeport, Conn.; Boston; Atlanta, Ga.; Philadelphia, Pa.; Chicago, Ill.; Houston, Texas Montreal, Canada London, England

**TRY THE
COST-PER-YEAR
TEST**

on these Jenkins Iron Valves
(16-inch Fig. 144)

Initial Cost (3 valves) . . .	\$1380.00
+	
Maintenance	0.00
÷	
Years of Service	15
=	
Cost-per-year (per valve) . . .	\$30.67

and they're still going strong!

IN VALVES *Jenkins* GIVES YOU EVERYTHING

NEW EQUIPMENT

(Continued from page 126)

porting construction. Working parts consist of a coil spring, rubber load pad, and adjustable rubber snubber. Johns-Manville, 22 East 40 St., New York, N. Y.

Plate-Glass Blackboard

A NEW CHALK BOARD, called "Nucite," is being manufactured from specially treated, shock-resistant plate glass. It is obtainable in ivory (for use with dark

chalk) and green or black (for light chalk). It was developed to provide a durable material which would lessen eye strain and to give great latitude to designers in providing schoolroom color schemes. Pittsburgh Plate Glass Co., Pittsburgh, Pa.

Bathtub Covering

A COVERING for bathtubs, intended to protect the fixture from installation hazards, has just been introduced. Called "Tubcoat," it consists of a water-

proof membrane shaped to fit standard tub sizes and has adhesive edges which are pressed into place. Tubcoat prevents debris from clogging drains. Protective Covering Co., Bridgeport, Conn.

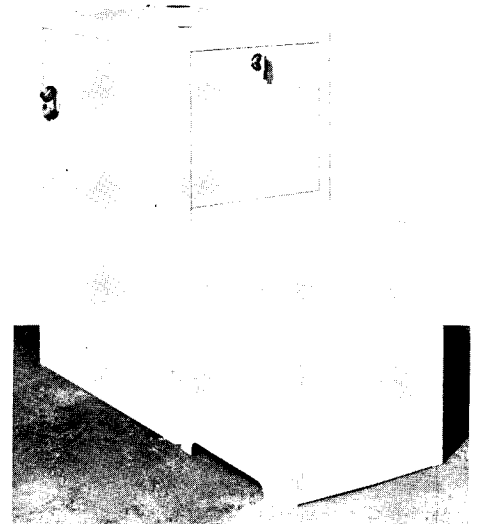

Above: Small Home Water Heater

A NEW AUTOMATIC water-heating unit for small homes, the "Pierce Popular Boiler" is designed exclusively for oil or gas firing. Standing only waist-high, the unit, said to develop sufficient heating capacity for the average six- or seven-room house, can be placed either in the basement or else in the kitchen or other main-floor room, where the boiler can also be used as a radiator. The boiler is of the wet-base type, and the path of burning gases is deflected around numerous fins and passages, making use of practically all of the heat. Heat ratings from 300 to 600 sq. ft. of water radiation. Pierce Butler Radiator Corp., Syracuse, N. Y.

2-in-1 Triangle

RECENTLY ANNOUNCED is a new combination draftsman's triangle which alone provides not only all of the angles of both the customary 30-60 and 45° triangles, but additional angles as well. Made of Pyralin cellulose nitrate plastic, it has deep bevel lifting cuts which facilitate raising from the drafting board. Elmer Coffey, La Grange, Ill.

Drafting-Table Fluorescent Lamp

FOR ATTACHING to the underside of the rear of the board, a fluorescent light fixture with an adjustable arm is now available. The 15-watt daylight fluorescent

(Continued on page 131)

PAGE FENCE

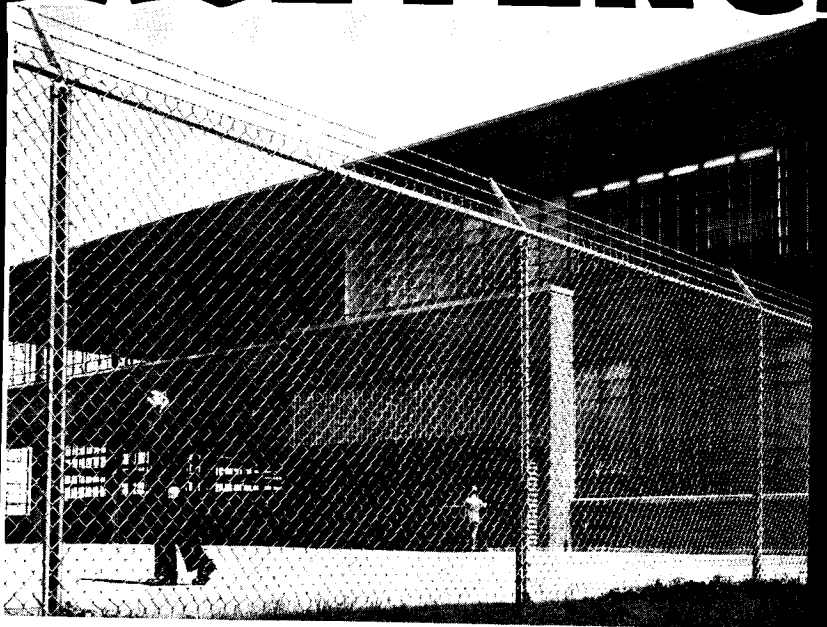

Albert Kahn, Inc., Architects and Engineers

FENCING—INTEGRAL PART OF PLANT!

● More and more, architects are writing Page industrial fence into their plans as an essential part of the plant, not merely optional. As they provide for workers' safety in building design, so do they specify the boundary control and property protection effected by Page Fence.

Page originated woven wire fencing and has pioneered in every major development. It is the only fence available in all of these superior metals: heavily-galvanized copper-bearing steel, Armco ingot iron, Allegheny stainless steel, Alcoa aluminum. Each possesses qualities which make it most suitable under certain climatic and service conditions.

Page developed the "winged channel" line post—only post exclusively for use with chain link fence. And Page created the advisory and erection service which assures expertness and responsibility—an association of 97 factory-trained, local business men, one of whom is near you.

See Sweet's Catalog for detailed information, and write to PAGE FENCE ASSOCIATION, Bridgeport, Conn., Atlanta, Chicago, New York, Pittsburgh or San Francisco for informative books.



A PRODUCT OF PAGE STEEL & WIRE DIVISION—AMERICAN CHAIN & CABLE COMPANY, INC.

America's First Wire Fence—Since 1883