

# ARCHITECTURAL RECORD

COMBINED WITH AMERICAN ARCHITECT AND ARCHITECTURE

VOLUME 87

JUNE 1940

NUMBER 6

## NEWS

47

<b>BANKERS LIFE BUILDING, Des Moines, Iowa</b>	<b>47-68</b>
General	47-51
Planning	52-55
Facilities	56-59
Structure	60-63
Systems	64-68
<b>NEW HOUSES, with four or more bedrooms, near:</b>	<b>69-80</b>
Durham, N. C.	69-72
Portland, Oreg.	73-75
Chicago, Ill.	76, 77
Tulsa, Okla.	78-80
<b>KITCHENS</b>	<b>81-86</b>

## TRENDS

87

<b>INDUSTRIAL DESIGN: A New Horizon for the Architect</b>	<b>87-95</b>
<b>TRENDS IN BUILDING COSTS</b>	<b>96, 97</b>
<b>REVIEWS OF NEW BOOKS</b>	<b>98</b>

## BUILDING TYPES

99

<b>COMMUNITY SHOPPING CENTERS</b>	<b>99-120</b>
<b>Today's Housewife Drives to Her Shopping Center</b>	<b>100-103</b>
Developing the Shopping Center	101
Practice in the Far West	102, 103
<b>14 Ways to Improve Shopping Center Design</b>	<b>104-106</b>
<b>Time-Saver Standards: Stores and Parking Areas</b>	<b>107-110</b>
<b>Case Studies</b>	<b>111-120</b>

<b>Behind the Record</b>	<b>5</b>
<b>With Record Readers</b>	<b>10</b>
<b>AIA Convention</b>	<b>17</b>
<b>Record Poll</b>	<b>20</b>
<b>What's New in Materials and Equipment</b>	<b>124</b>
<b>Index to Advertisements</b>	<b>162</b>

Copyright, 1940, by F. W. Dodge Corp. All rights reserved.

## BEHIND THE RECORD

IN MANY WAYS the materialization of this June issue affects us like the landing of a big, bright-colored game fish, that has somehow managed to grow since we first got him on the line. Over a year ago we hooked into the Bankers Life building, via our Dodge representative in Des Moines, when the project was little more than a gleam in the eyes of its progenitors. Since then we have played it along, reeling in, giving it line, then reeling in some more—our enthusiasm over its development waxing in proportion to our plans for mounting the prize once it was in the bag.

This month, on pages 47-68, we display the splendid creature, depicting in four-color reproductions all its rainbow hues. In addition we examine it for readers, skeletal element by element, and practically scale by scale. Twenty-two pages devoted to a single building, in themselves, ought to make just about the bag limit!

But, packing the creel so you can hear the wicker snap, Building Types winds up this month's catch with 22 pages on *Community Shopping Centers*. Turn to page 100 and see how easily, safely, and efficiently, through the achievements of the architect, "Today's Housewife Drives to Her Neighborhood Shopping Center."

### Next Month

DID YOU KNOW that plastics are being used as plumbing pipes; are the "resin" in resin-bonded plywood; make shatter-

(Continued on page 7)

*Editorial Director:* Thomas S. Holden. *Editorial Consultant:* Michael A. Mikkelsen. *Editors:* Roger Wade Sherman (*Managing*), James M. Fitch, Jr. *Associate Editors:* Elisabeth Kendall, Frank G. Lopez, Jr., George A. Sanderson. *Art Director:* Gene Hawley. *Desk Editor:* John W. Ragsdale.

Architectural RECORD (combined with *American Architect and Architecture*) is published monthly by F. W. DODGE CORPORATION, 115-119 West 40th Street, New York. Truman S. Morgan, Pres.; Howard J. Barringer, Vice Pres. and Treas.; Irving W. Hadsell, Vice Pres.; Thomas S. Holden, Vice Pres.; Michael A. Mikkelsen, Vice Pres.; H. Judd Payne, Vice Pres.; Chauncey L. Williams, Vice Pres.; John M. Williams, Vice Pres.; Sanford D. Stockton, Jr., Secy.; Walter F. De Saix, Asst. Treas.; Edwin H. Freed, Asst. Treas. Member Audit Bureau of Circulations and Associated Business Papers, Inc. Architectural RECORD is indexed in Reader's Guide, Art Index, and Industrial Arts Index.

Subscription Rates: United States and Possessions, Canada, Cuba, Mexico, Central and South America, \$3 the year, \$5 for two years, \$6 for three years; Elsewhere, \$5 the year; Single copy, \$1. *Circulation Manager:* Robert C. MacDougall.

Manuscripts, photographs, and drawings which conform to RECORD'S editorial aims are welcomed. Every effort will be made to return material (if accompanied by stamped, addressed envelopes); but the editors will not be responsible for losses.

Other Dodge Services: REAL ESTATE RECORD, SWEET'S CATALOG FILES, HOME OWNERS' CATALOGS, DODGE REPORTS, and DODGE STATISTICAL RESEARCH SERVICE.

# NEW SPEED, NEW ECONOMY IN CONSTRUCTION

Here's a cement which, on many buildings, provides an answer to a three-cornered question: How to build faster . . . without sacrificing structural strength . . . and at reasonable cost. It's Atlas High-Early, the Triple-Thrift cement with the same uniform quality, dependability, and durability of normal portland cement, but with the added advantage that Atlas High-Early gains strength several times faster. It is thus frequently ready for service loads in much less than the usual time.

*How does Atlas High-Early Cement speed construction?*

1. By reducing the amount of time normally required for protection and curing—as much as 60% to 70%.
2. By permitting earlier stripping of forms.
3. By producing serviceable concrete in less than the usual time, frequently in 1/5 the time.

*How does Atlas High-Early Cement save money? Here's how:*

1. Savings in cost of protection, both winter and summer.
2. Fewer sets of forms may be necessary as forms may be stripped more quickly and reused.
3. The economy of faster construction, which, on a multiple story building, is cumulative. With this saving in time comes a corresponding reduction in general overhead, a saving in labor costs, and earlier occupancy.

*What are the characteristics of Atlas High-Early Cement?*

Atlas High-Early is finer. It provides a plastic, easily placed, easily finished concrete, and remains easily workable long enough for careful placing. It may be used for any type of concreting work, including Architectural Concrete.

*It pays to specify Atlas High-Early . . .*

Scores of architects throughout the country have specified High-Early cement with profitable results. You, too, will find that it is often an outstanding time- and money-saver for your clients. For more complete information, see SWEET'S CATALOG, Section 4, or write us. No obligation, of course. Universal Atlas Cement Co. (United States Steel Corporation Subsidiary), Chrysler Building, New York City.

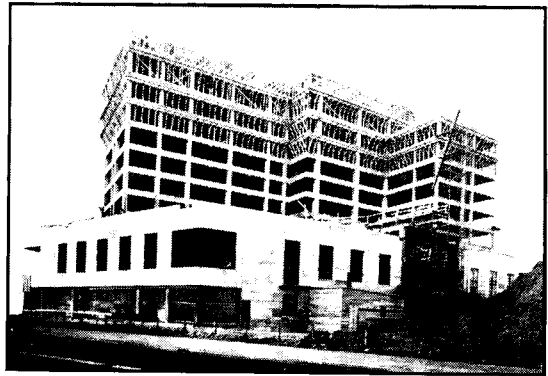

**CONCRETING TIME CUT 29%! Rushing this job through in winter prompted a shift from Universal Atlas portland cement to Atlas High-Early on this 18-story dormitory for Northwestern University, Chicago. Result? Forms stripped in 10 days instead of 14—a saving of 24 days on floors 4 to 9. Concreting time cut 29%. Time and cost of protection and curing greatly reduced. And 2 instead of 3 sets of forms did the job. Architect, J. G. Rogers, New York; General Contractor, R. C. Wieboldt Co., Chicago.**

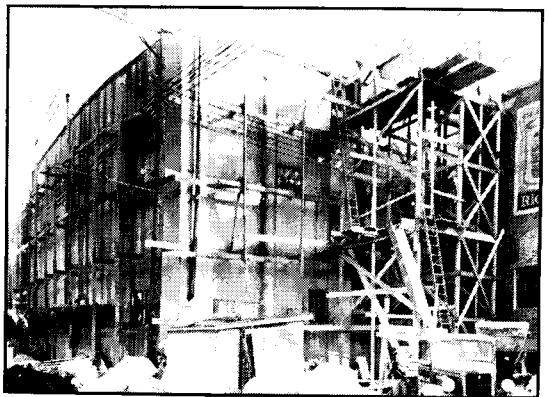

**25 DAYS' TIME AND \$300 SAVED! Concreting of Northwestern Bell Telephone Building in Council Bluffs, Iowa, had to be rushed through in winter, with temperatures as low as 18° below zero. Use of Atlas High-Early cement saved 25 days' time, \$300 on form costs, and cut protection and curing costs. Architect, J. Chris Jensen; Contractor, C. C. Larsen & Sons; both of Council Bluffs.**

AR-H-16

## ATLAS HIGH-EARLY CEMENT

A UNIVERSAL ATLAS PRODUCT



ARCHITECTURAL RECORD



## BEHIND THE RECORD (continued)

proof glass possible; and are being molded as wash basins and coffins? Did you know that these low-cost materials are usually made from waste, surplus, and by-product elements, and have been successfully imitative of ivory, leather, silk, glass, jet, and ceramics—to mention but a few substances?

In a 12-page Trends study for July, Morris Sanders, architect and industrial designer, brings us up to date on this increasingly pertinent topic. The materials themselves will be illustrated in four colors.

The News section will offer its usual complement of *new buildings*, selected and angled every month, as much as they and recent achievements in the field may possibly admit, to give all our readers what they want, when they want it. New houses, in that section, will be of the *three-bedroom* variety; and the "residential details" portfolio will examine new *bedroom* ideas in minutia.

The Building Types study now in preparation for July has been laid down on the broad basis of *Hotels*, with subdivided attention planned for Commercial, Apartment, Resort, and Motor Hotels. Time-Saver Standards data are being developed on the one factor common to all four types, the *hotel room*; and case studies have been chosen for variety of type, geographical location, and, of course, for the light they may shed on the particular problems of RECORD readers.

### A Few Rounds on Us

EVERY NOW AND THEN a *Vox Populi* or "reader reaction" letter comes along with the designed effect on our editorial equipoise of a stiff haymaker brought all the way up from the canvas. Recently we had the following "vox pop" exploded at us:

"The Public Works Administration has saved the bacon of nearly every architect and engineer in the Middle West, and you have been particularly careful to refrain from any mention thereof in your magazine. As the result of your silly practice . . . I have nothing but contempt for your worthless periodical!"

While we talk that one over with the Ref, we submit from a friendly hand in our own corner:

"I note that VOCATIONAL SCHOOLS will be the Building Types feature of your April issue. This is exactly the problem that I have before me now, but my search for information on this subject has produced very little that is helpful. I am sure, however, that your treatment will contain much valuable information.

"Unfortunately I am unable to delay my study of the problem until I receive the April issue in the normal manner, and I am asking if there might be some way in which I could

obtain at least that much of the April number in advance of the regular procedure."

And finally, having clasped our gloves in that direction by rushing him off some page proofs, we turn to meet the measured slants of a recent architectural graduate:

"I believe that a technical magazine should serve as a perpetual text book. Your magazine may or may not be serving this purpose, but the class of work being presented is far out of the scope of duties of a young architect. I can usually evolve an acceptable parti for a problem, but I cannot go to your magazine and expect to find the answer to the construction problems which will present themselves in the execution of the job. In other words, I am searching for the answer to those questions which did not come up in school. As you know, the Beaux-Arts system has never concerned itself with the 'how' and 'why' of construction. Let us see more answers to construction problems and more text devoted to the 'small' job."

All of which strengthens our determination to live right and keep trying to improve our foot work.

### A Little Nonsense Now and Then . . .

DENYING that any element in the foregoing might have inspired our research in Roget's Thesaurus (Thomas Y. Crowell Co. edition, Dr. C. O. S. Mawson, editor), we offer the following extract from that work, listed under the topical heading of *absurdity*:

**Int.** fiddledeedee! pish! pho or phoh! [rare]. pooh! pooh-pooh! bah! stuff and non-

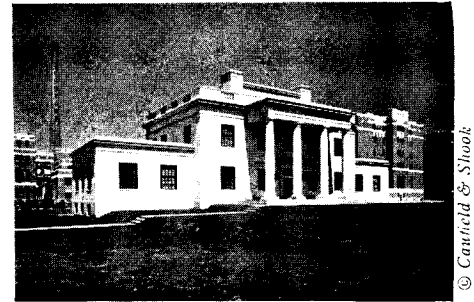

© Canfield & Shook

The Seagram Distillery (above) in Louisville, pictured AR 5/40, p. 20, should have been credited, correctly, to Joseph and Joseph, Architects and Engineers.

sense! fiddle-faddle! bosh! rats! [slang], come off! [slang], "in the name of the Prophet—figs!" [Horace Smith].

To which is added a footnote giving the classical slant:

*Credat Judaeus Apella* [Horace]; tell it to the marines . . . "Say 'boo' to you—'pooh-pooh' to you" [Gilbert].

There's a chance that readers, in moments of professional stress, may find this as pleasantly expressive as we did.

### Correction

Dr. Arthur B. Moehlman was incorrectly titled in our April issue. His titles should properly have read: "Professor of School Administration and Supervision, University of Michigan, and Editor. *The Nation's Schools*."



"The time to tell me you were going to have a baby was before I'd got the cubage all settled."

—Drawn for the RECORD by Alan Dunn



It's the first  
60 seconds  
that count

## Other stores lit candles ... but this chain store had electric light

"A CALL at this chain store was made to inquire how the Exide Emergency Lighting System functioned during an electric current failure ten days ago which put the business district in darkness for over an hour. Other stores used candles. The Exide System in this store operated satisfactorily."—From the report of an Exide Operating Engineer.

This is a typical instance of the way an Exide-equipped building is able to carry on, without loss of business, and without danger of fire or disorder. An Exide System operates *instantaneously* and *automatically* upon any interruption of the normal electric current supply, providing abundant light the instant it is needed most . . . it is the first 60 seconds that count.

Not only stores, but schools, theatres, restaurants, public buildings, and especially hospitals, need this adequate and dependable protection. The utility companies take every precaution, but cannot control the effects of storms, floods, fires, or street accidents.

If you are working on a project that needs this sure safeguard, write or wire the nearest Exide Branch and an experienced Exide Field Engineer will call promptly to help with plans and specifications.

THE ELECTRIC STORAGE BATTERY COMPANY, Philadelphia  
*The World's Largest Manufacturers of Storage Batteries for Every Purpose*  
Exide Batteries of Canada, Limited, Toronto

### EXIDE BRANCH OFFICES

ATLANTA 210 Walker St., S.W.	MINNEAPOLIS 617 Washington Ave., N.
BOSTON 100 Ashford St.	NEW ORLEANS 428 Balter Bldg.
CHICAGO 4613 S. Western Ave. Blvd.	NEW YORK 23-31 W. 43rd St.
CINCINNATI 718-19 Temple Bar Bldg.	PHILADELPHIA Allegheny Ave. and 19th St.
CLEVELAND 6400 Herman Ave., N.W.	PITTSBURGH 1078 Union Trust Bldg.
DALLAS 1118 Jackson St.	ST. LOUIS 1218 Olive St.
DENVER 810-14th St.	SAN FRANCISCO 6150 Third St.
DETROIT 8051 W. Chicago Blvd.	SEATTLE 1919 Smith Tower Bldg.
KANSAS CITY, MO. 129 Belmont Blvd.	WASHINGTON 1819 L Street, N.W.
LOS ANGELES 1043 S. Grand Ave.	

**Exide**  
Keepalite

**EMERGENCY LIGHTING  
UNITS**

ARCHITECTURAL RECORD



# Thermolier "Routed" Heat

*Banishes the Cold Spots!*

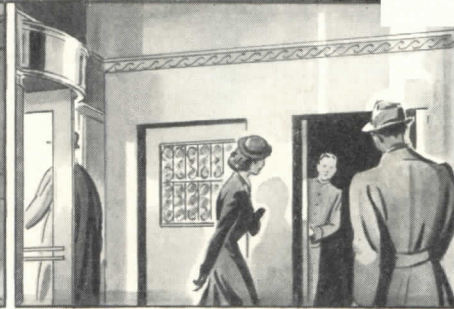

Just as well-planned floor layouts distribute store traffic to prevent congestion, Thermolier unit heaters *route* the heat to eliminate hot and cold zones. Their uniform heat-diffusion insures greater comfort and produces fuel-savings up to 27%!

When you specify Grinnell Thermolier, you get the *only* unit heater that has *proved* its superior design in long service! Engineered as an efficient *heating machine*, it has required no functional improvement since its original development!

No other unit heater has its patented Internal Cooling Leg that insures against flooded tubes, noisy

intermittent draining and impeded circulation. And it was the *first* to employ expansion U-tube construction.

The attractive modern appearance of the Grinnell Deluxe Thermolier . . . with all parts and connections concealed in a satin chrome and neutral grey finished housing . . . offers unusual advantages in decorative planning of interiors.

Before you make your decision, write for the Thermolier Data Book and compare Thermolier's 14 points of superiority! Grinnell Co., Inc., Executive Offices, Providence, R. I. Branch offices in principal cities of the United States and Canada.

*Look for Thermolier in Sweet's Catalog*

### 3 TYPES - 37 SIZES

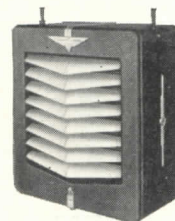

*Deluxe Type* with all pipe connections, fan and motor hidden in smart housing.



*Industrial Type* with polished copper housing, for offices and plants.



*Factory Type* in grey Duco finish, for factories, garages, warehouses.

# GRINNELL THERMOLIER

THE UNIT HEATER WITH 14 POINTS OF SUPERIORITY





Presentation by Julian Clarence Levi of "Great Georgian Homes" to Horacio Acosta y Lara, Mayor of Montevideo, at the Pan American Congress of Architects recently held in that city. Left to right: Ines Floto, Chile; Bartolome Traverso, Uruguay; Moreno de Mesa, Argentina; Carlos E. Becker, Argentina; Alfredo Saenz Garcia, Bolivia; Mr. Levi; George Harwell Bond, U. S. A.; Nestor E. Figueredo, Brazil; Angel Silva, Argentina; Mayor Acosta; and Enrique Gebhard, Chile.

### Pan American Architectural Congress Bestows 70 Awards on U. S. Exhibitors

OUT OF 143 AWARDS conferred on exhibitors during the recent Pan American Congress of Architects at Montevideo, Uruguay, representatives of the United States received nearly half. 386 delegates from 11 countries of the Western Hemisphere were in attendance; *Julian Clarence Levi*, chairman of the foreign-relations committee of the American Institute of Architects, *George Harwell Bond*, architect of Atlanta, Ga., and *Edwin C. Wilson*, U. S. Minister to Uruguay, were accredited delegates of the United States government at the Congress.

Awards were made to participants in the Fifth Pan-American Exhibition of Architecture and Town Planning, a signal feature in the proceedings which drew approximately 4,000 visitors daily. (For brief notes on other important activities and conclusions, abstracted from a report by Mr. Levi, please see paragraphs following the list of winners.) Since the United States exhibit had been made up originally for educational circulation among architectural schools, etc., in this country, no one building nor the work of any architect or firm were shown in sufficient detail to be eligible for the Grand Prize of Honor for the entire exhibition. This award went to

*Mauricio Oravetto*, Architect, of Montevideo.

The U. S. winners, including individuals, architectural firms, and government departments, and the works for which each was cited, follow:

#### PRIZE OF HONOR

*Paul Phillippe Cret* of Philadelphia, recently appointed by President Roosevelt to the National Fine Arts Commission—the Federal Reserve Board Building, Washington, D. C.

*Perry, Shaw, and Hepburn*, Boston—the Williamsburg, Va., Restoration.

*Coolidge, Shepley, Bulfinch, and Abbott*, Boston—New York Hospital, Cornell Medical Center, New York City.

*Reinhard and Hofmeister; Corbett, Harrison, and MacMurray; Hood and Foulhoux*, all of New York—Rockefeller Center, New York City.

#### GOLD MEDAL AND DIPLOMA

*Arthur Loomis Harmon* of New York—Shelton Hotel, New York City.

*Thomas Harlan Ellett* of New York—Cosmopolitan Club, New York City.

*Herbert A. Magoon* of New York—Jones Beach State Park, Wantagh, N. Y.

*Karcher and Smith*, Philadelphia—United States Naval Hospital, Philadelphia.

*Zantlinger and Borie*, Philadelphia—Department of Justice Building, Washington, D. C.

*Shreve, Lamb, and Harmon*, New York—Empire State Building, New York City.

#### SILVER MEDAL AND DIPLOMA

*Ingham and Boyd*, Pittsburgh—Chatham Village, First Unit, Pittsburgh.

*Mellor and Meigs*, Philadelphia—"Laverock," residence of Arthur E. Newbold, Jr., Chestnut Hill, Philadelphia.

*Frank Lloyd Wright* of Spring Green, Wis.—"Fallingwater," residence of Edgar Kaufman, Bear Run, Pa.

*R. C. Reamer* of Seattle, Wash.—Edmond Meany Hotel, Seattle, Wash.

*Ernest A. Grunsfeld, Jr.*, of Chicago—Adler Planetarium, Chicago.

*Lyndon and Smith*, Detroit, Mich.—Beecher High School, Flint, Mich.; Northville Grade School, Northville, Mich.

*Theodate Pope* of Farmington, Conn.—Avon School for Boys, Old Farms, Avon, Conn.

*Janssen and Cocken*, Pittsburgh—"Longue Vue Club," Pittsburgh, Pa.

*Schmidt, Garden, and Erikson*, Chicago—St. Francis Nurses' Home, Pittsburgh, Pa.

*Arthur Brown, Jr.*, of San Francisco—Department of Labor and Interstate Commerce Commission Building, Washington, D. C.

*John Russell Pope* of New York (deceased)—Archives Building, Washington, D. C.

*Jackson, Robertson, and Adams*, Providence, R. I.—Providence County Courthouse, Providence.

*Gordon B. Kaufman* of Los Angeles, Calif.—Boulder Dam and Power House, Colorado River, Colo.

*Holabird and Root*, Chicago—two awards, for Chicago Daily News Building, Chicago.

(Continued on page 12)

### CALENDAR OF EVENTS

• **June 1-July 1**—Exhibition of Van Gogh Paintings, Holland House Galleries, 10 Rockefeller Plaza, New York, N. Y.

• **June 10-August 31** — Summer study sessions for men and women, sponsored by the AIA and the Carnegie Corp., School of Architecture and Applied Art, University of Oregon. Bulletins available from Office of Summer Sessions, 814 Oregon Bldg., Portland.

• **June 17-20** — Semiannual meeting, American Society of Mechanical Engineers, Hotel Pfister, Milwaukee, Wis. . .

• **June 23-August 5**—Visiting Session of Chicago School of Design, Mills College, Oakland, Calif.

• **July 1**—Final date, applications for participation, Summer Program in City and Regional Planning, M.I.T. School of Architecture. Applications should be sent to Professor Frederick J. Adams, M.I.T. School of Architecture, Cambridge, Mass.

• **July 1** — Opening day, Summer Courses in Architecture, Syracuse University, Syracuse, N. Y.

• **July 1-August 10** — Summer School Courses in Architecture, Landscape Architecture, and History of Architecture, Harvard University Graduate School of Design and Smith College Graduate School of Architecture and Landscape Architecture. Harvard University, Cambridge, Mass.

• **July 8**—Registration, Summer Classes, New York School of Fine & Applied Art, 136 E. 57th St., New York City.

• **July 10-13**—Convention, Alpha Alpha Gamma, national fraternity of women architects, Beekman Tower Hotel, New York City.



*Here's where*  
**INSIDE  
 GLAZING  
 is DIFFICULT**

*but*  
**OUTSIDE GLAZING  
 is EASY and  
 INEXPENSIVE**

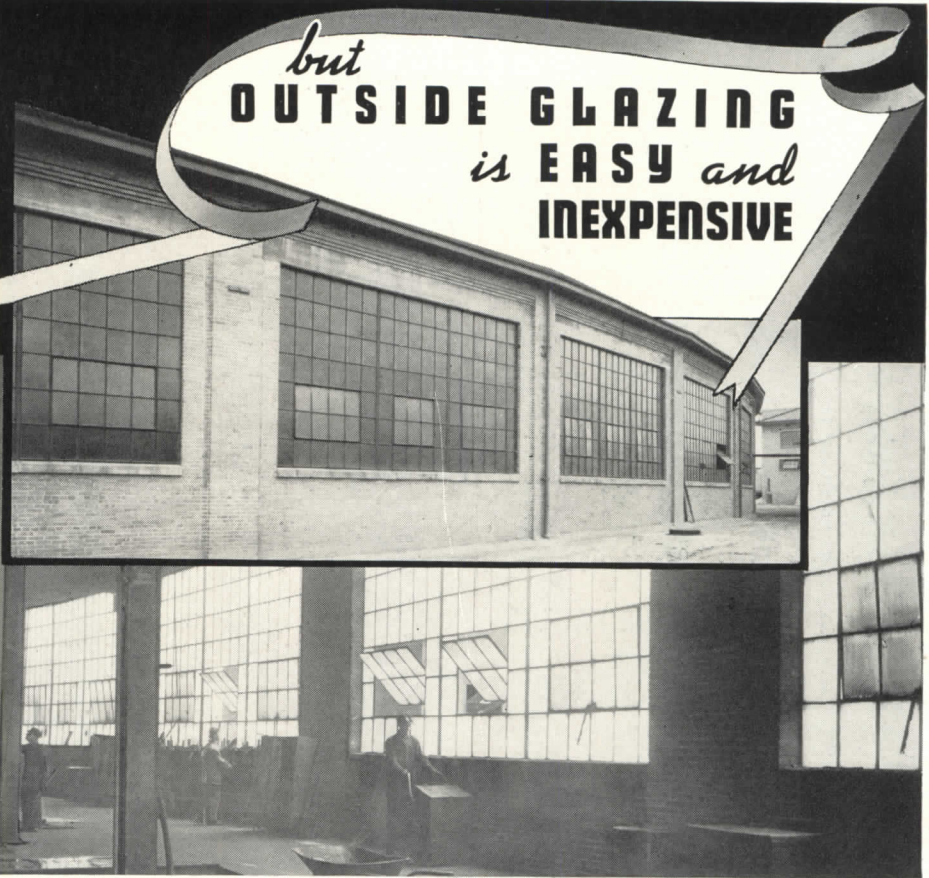
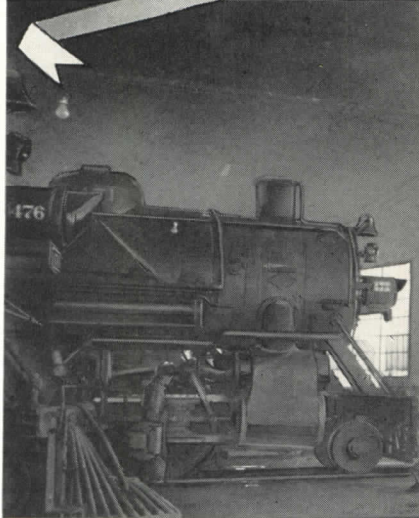

that's why **MESKER** offers you Pivoted Steel Sash  
**"OUTSIDE PUTTY GLAZED"**  
*...for special building conditions*

The big advantages of outside putty glazing are well known to both industrial architects and roundhouse foremen.

Here, where space between the windows and the pits is at a premium and offers the only pathway for workmen, dollies and motor cranes, outside putty glazing completely eliminates the danger and inconvenience of replacing broken lights from the inside.

When designing roundhouses, power plants, assembly plants and other types of industrial buildings where inside working area is necessarily limited, be sure that glazing will be made easy, inexpensive and practical.

Simply add the words "Sash Shall Be Glazed from the Outside" to your specifications wherever your design calls for horizontal pivoted or commercial projected steel windows.

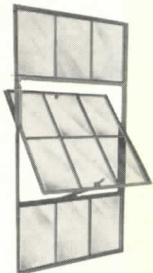

*A typical Mesker horizontal pivoted steel sash, designed especially for outside putty glazing.*

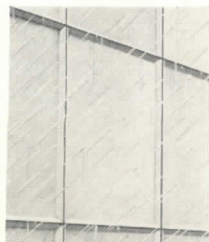

*The illustration shows how putty on the outside covers the metal frame almost completely. It also leaves a sloping putty line that acts as a wash, eliminating all ledges on which rain water can stand, insuring a more water-proof glazing job.*

See the 24 page Mesker catalog in Sweet's 1940 Architectural Files, section 15-15

**M E S K E R   B R O T H E R S**  
 424 SOUTH SEVENTH STREET • SAINT LOUIS, MISSOURI

**CASEMENT  
 WINDOWS  
 MONUMENTAL  
 WINDOWS  
 INDUSTRIAL  
 WINDOWS**

*Mesker*  
 SINCE 1879

**INDUSTRIAL  
 DOORS  
 METAL  
 SCREENS  
 DETENTION  
 WINDOWS**

Manufacturers of Genuine Wrought Iron Windows... Steel Windows with Wrought Iron Sills and All-Steel Windows



# 2 MILWAUKEE STORES GET BETTER HEATING AT REDUCED COST

Webster Moderator System Helps  
Schuster's Mitchell St. Store  
to Save 15% on Coal Costs

ALL SECTIONS HEATED EVENLY

130 New Webster Sylphon Traps  
Installed in Third St. Store  
as Part of Modernization

CORRECT OLD HEATING FAULTS

Milwaukee, Wis.—How department store heating problems can be solved with a Webster Moderator System of Steam Heating has been demonstrated in two Milwaukee stores of Ed. Schuster & Co., Inc.

Formerly hard to heat, Schuster's Mitchell Street Store brought its heating installation up-to-date in 1936 with a Webster Moderator System. There was an immediate improvement in steam distribution, with all sections of the store receiving steam evenly and rapidly.



Mitchell St. Store,  
above

Third Street Store,  
right

Ed. Schuster & Co., Inc., Milwaukee, Wis.

The results were so satisfactory that a second Webster Moderator System, including new Webster Sylphon Traps for 130 radiators, was installed in Schuster's Third Street Store in 1938.

Charles Billenness, Purchasing Agent for Schuster's, says:

"Coal consumption has been reduced 15 per cent in the Mitchell Street Store. Although it is too early to know the exact savings figure in the Third Street Store, we are well satisfied with the improved heating service."

The Mitchell Street Store installation contains 21,972 sq. ft. of installed direct radiation and was made by William F. Noll, Heating Contractor. The installation in the Third Street Store, containing 24,733 sq. ft., was made by Thomas E. Hoyer Heating Co.

These before-and-after facts point the way to maximum comfort and economy in heating new buildings as well as in modernization of existing installations. Consult your architect, engineer or heating contractor. Or address WARREN WEBSTER & CO., Camden, N. J. Pioneers of the Vacuum System of Steam Heating Representatives in 60 principal U. S. Cities—Est 1888

## WITH RECORD READERS (Continued from page 10)

and the U. S. Forest Products Laboratory, Madison, Wis.

*Howe and Lescaze*, Philadelphia—Philadelphia Savings Fund Society Bank and Office Building, Philadelphia.

*Voorhees, Gmelin, and Walker*, New York—Irving Trust Company, New York City.

*Paul Phillipe Cret* of Philadelphia, and *Alexander B. Trowbridge* of Washington, D. C.—The Folger Shakespeare Library, Washington, D. C.

*Bebb and Gould*, Seattle, Wash.—Art Museum, Seattle, Wash.

*John Gaw Meem* of Santa Fe, N. M.—Colorado Springs Fine Arts Center, Colorado Springs, Colo.

*Bertram Grosvenor Goodhue and Carleton Monroe Winslow*, of Los Angeles, Calif.—California State and Fine Arts Building, San Diego, Calif.

*Cram and Ferguson*, New York—Cathedral of St. John The Divine, Nave and West Elevation Baptistry, New York City.

*Hobart Upjohn and Otto F. Langmann*, of New York—All Souls Unitarian Church, New York City.

*United States Housing Authority*, Washington, D. C.—its exhibit as a unit.

*United States War Department*, Washington, D. C.—its exhibit as a unit.

*United States Veterans' Administration*, Washington, D. C.—its exhibit as a unit.

*United States Department of the Interior*, Washington, D. C.—its exhibit as a unit.

*United States Department of Agriculture*, Washington, D. C.—its exhibit as a unit.

*United States Navy Department*, Washington, D. C.—its exhibit as a unit.

### HONORABLE MENTION

*Dwight James Baum* of New York (deceased)—residence of Anthony Campagna, Riverdale-on-Hudson, N. Y.

*Electus D. Litchfield* of New York—Yorkship Village, Camden, N. J.

*Robert Rodes McGowin* of Philadelphia—The French Village, Chestnut Hill, Philadelphia, Pa.

*Clarence S. Stein* of New York—Hillside Homes, Bronx, N. Y.

*Reginald D. Johnson* of Los Angeles, Calif.—Santa Barbara Biltmore Hotel, Santa Barbara, Calif.

*Louis Justement* of Washington, D. C.—Falkland Properties, Silver Spring, Md.

*Harrison and Foulhoux*, New York—Rockefeller Apartments, New York City.

*Wyatt and Nolting*, Baltimore, Md.—Warrington Apartments, Baltimore, Md.

*Coolidge, Shepley, Bulfinch, and Abbott*, Boston—Harvard University Building, Cambridge, Mass.

*Richard J. Neutra* of Los Angeles, Calif.—School Buildings, Los Angeles.

*Lester W. Geisler* of Palm Beach, Fla.—Miami Jockey Club, Miami, Fla.

*Frederick M. Mann* of Heraldsburg, Calif.—University of Minnesota Memorial Stadium, Minneapolis, Minn.

*John Parkinson and Donald B. Parkinson*, Los Angeles, Calif.—Los Angeles Coliseum.

*Schenk and Williams*, Dayton, Ohio—Y.M.C.A., Dayton, Ohio.

*Bennett, Parsons, and Frost*, Chicago—Federal Trade Commission Building, Washington, D. C.

*Paul Phillipe Cret* of Philadelphia—two awards, for the Central Heating Plant, Washington, D. C., and the Calvert Street Bridge, Washington, D. C.

*Delano and Aldrich*, New York—Post Office Department, Washington, D. C.

*Howard L. Cheney* of Chicago—United States Post Office, Miami Beach, Fla.

*Shreve, Lamb, and Harmon*, New York—United States Post Office and Courthouse, Chattanooga, Tenn.

*Aymar Embury, 2d*, of New York—Triborough Bridge and Henry Hudson Bridge, New York City.

*Aymar Embury, 2d*, of New York, and *John L. Hamilton* of Chicago—Winnetka Congregational Church, Winnetka, Ill.

*Joseph Finger, Inc.*, Houston, Tex.—a printing and lithography establishment for Clarke and Courts, Houston, Tex.

*Atlee B. Ayres and Robert M. Ayres*, San Antonio, Tex.—Administration Building at Randolph Field, San Antonio, Tex.

*Milton B. Medary* of Philadelphia Pa.—Bok Singing Tower, Mountain Lake, Fla.

*Davis, Dunlap, and Barney*, Philadelphia—American Bank and Trust Company Building, Philadelphia, Pa.

*Holabird and Root*, Chicago—A. O. Smith Engineering Laboratory, Milwaukee, Wis.

*Morris and O'Connor*, New York—Interior of the Great Hall of the Cunard Building, New York City.

*Edward F. Sibbert* of New York—S. H. Kress and Company, New York City.

*Marston and Maybury*, Pasadena, Calif.—Pasadena Public Library, Hill Avenue Branch, Pasadena, Calif.

*Albertson, Wilson, and Richardson*, Seattle, Wash.—Church of St. Joseph, Seattle, Wash.

Subsequent to the reading of papers and discussion by the Congress, conclusions and resolutions were passed on the following major themes: *Problems of growth of American cities; Middle-class housing; Public competitions; Auxiliary specialists in architectural work; and Complementary studies of specialization in architectural schools.* Unfortunately space does not permit us even to attempt an adequate digest of Mr. Levi's comprehensive report on these particular resolutions.

General conclusions reached were: Participation in the Congress brought the United States closer to the other American countries; recommendations of the Congress can be of real service in reaching solutions for some of our vexing problems; in general it was helpful in showing a similarity of problems in the different countries and in harmonizing national divergences of habit and approach; and, finally, the Department of State, the Pan American Union, and the AIA should jointly study the possibility and means of achieving a larger representation from the United States

(Continued on page 14)



**MAKE THIS TEST -**  
*Prove* **BRIXMENT is BEST!**



**1**

"Cap" one brick with Brixment mortar, and one brick with mortar made with portland cement and lime. After mortars have hardened, place both brick in a pan of shallow water. (Photo 1.) . . .

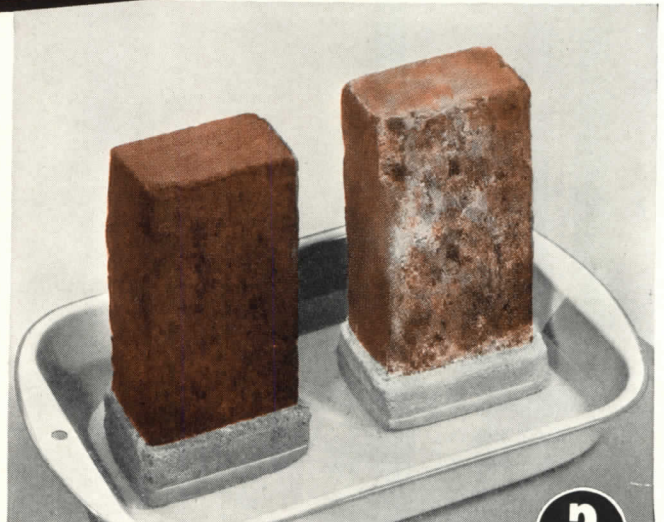

**2**

Keep about an inch of water in the pan. Even if soluble salts are present in the brick or sand, you will soon be convinced that *Brixment mortar helps prevent efflorescence.* (Photo 2.)

**BRIXMENT Mortar Helps Prevent EFFLORESCENCE!**

EFFLORESCENCE is an outcropping of minute white crystals on brickwork. When these crystals occur on colored mortar joints, the condition is sometimes mistaken for *fading*.

Efflorescence is caused by the presence of soluble salts in masonry materials. When reached by water, these salts dissolve and are drawn, by evaporation, to the surface of the wall.

Brixment *never causes efflorescence* because it is practically free from soluble salts. Even when such salts are present in the sand or brick, the waterproofing in Brixment mortar usually *prevents them from coming to the surface.*

Bricklayers who have used Brixment mortar for years say they have *never seen* a case of efflorescence on a Brixment wall. If you have been troubled by efflorescence, we suggest that you *try Brixment.*

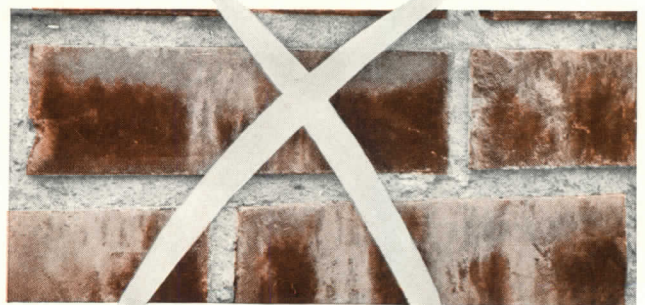

**BRIXMENT**  
*For Mortar and Stucco*

# NATURE ITSELF Specified THIS FAMOUS HEATING PRINCIPLE

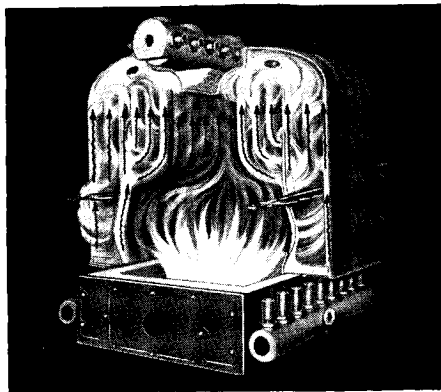

And ARCHITECTS, ENGINEERS and HOME OWNERS . . . FOR GENERATIONS . . . HAVE PROFITED FROM THE SAVINGS INSURED BY GREATER HEATING EFFICIENCY . . .

● Heated water rises most easily thru vertical passageways. Smith engineers have incorporated this primary principle in the design of Mills Boilers whose VERTICAL WATER TUBE CONSTRUCTION affords a rapid circulation of water thru tubes entirely surrounded by hot gases flowing upward.

SMITH MILLS CAST-IRON BOILERS steam faster, achieve higher efficiencies.

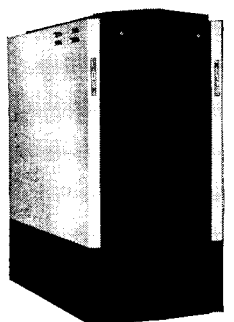

No. 150 MILLS BOILER WITH EXTENDED JACKET, a new oil boiler for small homes

## Now Available

For the first time VERTICAL WATER TUBE CONSTRUCTION in a low-priced small home boiler.

THE NEW MILLS "15" . . . inexpensive to install . . . economical to operate . . . will deliver greater owner satisfaction.

WRITE for DETAILS

The H. B. SMITH CO., Inc.

WESTFIELD • MASSACHUSETTS  
Boston New York Philadelphia

# SMITH

Since 1853

MOST FAMOUS NAME IN HEATING

## WITH RECORD READERS (Continued from page 12)

at future Pan American Architectural Congresses.

### Awards of the Month

JOHN GULIAS, 23, of New York City, is the winner of the 1940 Rome Prize competition in sculpture. This Fellowship, awarded annually by the American Academy in Rome, offers the Fellow two years of study and travel in Italy beginning next October, and is valued at more than \$2,000. If, however, the international situation will not permit Mr. Gulias to carry on his work abroad, he may be given the option of deferring his trip or of fulfilling it in America.

Honorable Mentions went to *H. Richard Duhme, Jr.*, Pennsylvania Academy of Fine Arts; *Abbott L. Pattison*, of Chicago, a graduate of Yale; and *Frederick J. Thalinger* of the St. Louis School of Fine Arts.

There were 15 competitors representing leading art schools of the country. The winner was chosen not for any individual piece of sculpture, but rather on the basis of all work submitted plus any other evidence of qualification.

The jury consisted of *James E. Fraser*, Chairman, *Gaetano Cecere*, *Lee Lawrie*, *Paulanship*, and *Bruce Moore*.

In painting, the Rome Prize award went to *Loren Russell Fisher* of Needham, Ind., a student for the past four years at the John Herron Art School, Indianapolis, where he has held full-time scholarships for three years. He is 27 years of age.

*Sidney Simon* of Pittsburgh, Pa., who studied at Carnegie Institute of Technology and Pennsylvania Academy of Fine Arts, received honorable mention.

Members of the jury of award were *Barry Faulkner*, Chairman, *Gifford Beal*, *John Corbino*, *Dean Cornwell*, and *Allyn Cox*.

\* \* \*

RAY PATTEN, of the General Electric Company; *Henry Dreyfuss*, industrial designer; *Mrs. Altina Sanders*, artist; and *William Joyce, Jr.*, a former bank clerk, were each presented with \$1,000 as winners of the 1939 American Design Awards, sponsored by the New York department store, Lord & Taylor.

The awards were granted to Mr. Patten for the G. E. "Imperial" electric range; to Mr. Dreyfuss for the design of a washing machine for the Apex

Corporation; to Mrs. Sanders for her "Harlequin" spectacle frames; and to Mr. Joyce for leisure-wear zipper shoes.

\* \* \*

DEAN BACON of the School of Architecture at Western Reserve University announces the award of the Charles Frederick Schweinfurth Traveling Scholarship to *Carl H. Droppers*, fourth-year student, and the Fellowship in Building Construction to *G. Robert Phelps*, who will be graduated this June.

The Schweinfurth Scholarship, valued at \$500, which ordinarily sends a student to the Fontainebleau School near Paris, will give the winner a summer of study and travel in Mexico. The Building Construction Fellowship, valued at \$550, will enable its winner to spend eleven weeks observing building trades, materials, and processes.

\* \* \*

DAVID LEAVITT, candidate for the bachelor's degree in architecture at the University of Nebraska this month, has been awarded the Princeton University \$1,000 prize for graduate study at that school.

### Objets d'Architecture

DURING HIS YEARS of developing publication and other enterprises, William Randolph Hearst also managed to build up one of the most extensive and varied art collections of these times. A substantial part of it is now owned and being dispersed by the International Studio Art Corp., 15 E. 57 St., N. Y. C.

Open to inspection by everyone interested are, among seventy-odd complete paneled rooms, a great number of stairways, mantels of wood and stone, decorative carvings, doors and doorways, ornamental ironwork, sconces and chandeliers, hardware, etc. Stored in cases in the warehouse basement are a complete Spanish monastery, two French cloisters, and the facade and principal elements of a 13th-century English manorhouse.

Catalogs are available and inquiries will be answered by the Studio Art Corporation.

\* \* \*

ALONG this same line, it is advised that Nash Bros., 54 Amherst St., South Hadley, Mass., offer to architects and builders a complete line of Dinosaur footprints, from fossil remains of the Connecticut valley, for decorative effects in doorsteps, flagstone work, etc.

# AIA'S 72nd CONVENTION

Round-Table Discussions Review the Past; Explore the Future

In Louisville, Ky., during the week of May 20th, the American Institute of Architects held its 72nd annual convention—which, in form of program, scope of subject, and character of action, was a signal departure from former gatherings. Among delegates and their associates—numbering nearly 500 according to an estimate by Edwin C. Kemper, executive secretary of the AIA—there appeared to prevail a conviction that this year's assemblage reached a new high in professional interest. Both formal and informal meetings were characterized by self-criticism and a realistic consideration of professional and business problems.

Keynoting the convention meetings, President Bergstrom said: "Until we accurately diagnose the case, we will not be sure that some of the remedies we are advocating today will prove to be cures or palliatives. We have been proceeding by trial and error, whereas only a truth-seeking examination and a frank and complete acceptance of the findings and their implications will indicate the sound procedure."



All officers were re-elected: President, Edwin Bergstrom (right); Secretary, Charles T. Ingham (left); Vice-president, Walter R. McCornack; Treasurer, John R. Fugard

ORGANIZATION-WISE, the innovation of round-table discussions proved both successful and popular. In reporting the convention, the RECORD stresses these informal meetings as they focused on problems common to all practitioners, while the formal sessions were largely given over to AIA by-law revisions, reports, and other routine business.

**"The Architect's Equipment for Housing"; Miles Lanier Colean, Chairman**

Three aspects of the housing field were discussed: rural housing, urban housing, and small houses.

**RURAL HOUSING:** *J. Frazer Smith* of Memphis, Tenn., in reporting on his work of surveying rural Mississippi areas, emphasized the importance of research by the architect as the basis for an economic housing plan. Data on social and economic influences, including population statistics, analyses of regional facilities and expenditures, are vital factors affecting housing that must be charted before an intelligent long-range plan can be drawn up.

**URBAN HOUSING:** *A. C. Shire* of USHA cited criticisms of architects in government housing work—failure to study and analyze people for whom the housing is intended; failure to establish a leadership in building which they claim as their due; failure to produce attractive structures—and suggested that unless private architects improve the

quality of service, it may become necessary for local authorities to set up their own architectural staffs.

*Eugene Henry Klaber* of Chicago, Director of Design for the FHA, pointed to the government's cumulative record of housing experience as an invaluable aid to designers of large-scale housing.

*Walter R. McCornack*, dean of MIT's architectural school and chairman of AIA's housing committee, countered with criticism of federal agencies. Stringent design regulations seriously delimit design possibilities; research to lower costs is a job for private industry, not the government; USHA should focus on the lowest income groups instead of verging on the fields for private initiative; standards should be lowered to the level of mere health and safety.

Government urban housing, he maintained, should also fight building rackets, modernize building codes, and look into prefabrication possibilities.

**SMALL HOUSES:** *Kenneth W. Dalzell* of New Jersey summarized AIA chapter reactions to the small-home scheme, sponsored jointly by AIA, the Producers' Council, and the Federal Home Loan Bank Board, as "impracticable and damaging to professional prestige," reducing both quality of architectural services and the architect's income.

Mr. Dalzell proposed that the AIA should officially withdraw from co-operation in the scheme.

However, Mr. Dalzell's suggestion met with opposition: the round table felt that the small-house plan had not either a sufficient trial period for judgment or sufficient co-operation from architects.

**"The Relationship of the Architectural Profession to Society"; Edmund R. Purves, Chairman.**

*Arthur B. Holmes*, former president of the New Jersey Chapter, opened the discussion by pointing out that unless the profession vigorously protects its own interests, it may presently assume "the futile role of spectator."

In analyzing the changing role of the architect from an historic point of view, *Col. William N. Taylor* of Philadelphia said: "Society has at all times, and will at all times, confide the leading role in its building operations to those persons whom it believes will answer most closely their economic and social needs. . . . What are society's requirements and what does society think the architect can contribute? Society thinks of the architect exactly what he thinks of himself."

All too often, according to Colonel Taylor, the architect thinks of himself as being primarily an artist; yet society demands other qualities than beauty in its building. Said Colonel Taylor: "We, the architects, have done a curious thing. We desire to be consulted on every phase of building, yet we have

(Continued on page 18)



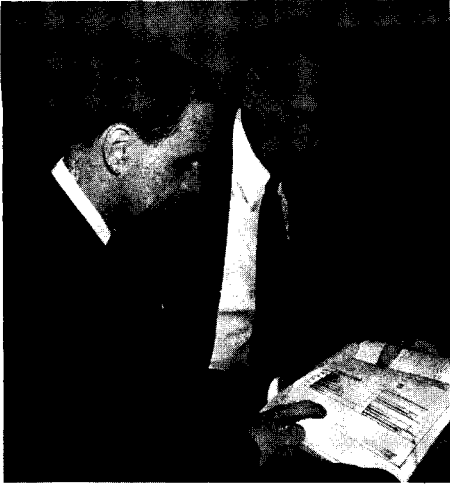

Miles L. Colean, newly elected Fellow and former FHA assistant administrator, talking with Robert L. Davison, housing director of the John B. Pierce Foundation



Albert Harkness and Frederick H. Meyer chatting with Charles D. Maginnis, AIA past president, at the president's formal reception at the Pendennis Club



A pause between sessions: Edmund R. Purves, regional director for the Middle Atlantic District, and Stephen F. Voorhees, past president of the Institute

(Continued from page 17)

insisted on the fine-art element in our protestation of faith; we have openly declared we are not mere builders; we have refused to be engineers; we have declared it unprofessional to take part in contracting or financing buildings to such an extent that society believes us and only calls on us when ostentation is involved."

**"Rural Practice";** *William L. Steele*, Chairman.

Among suggestions for improving rural practice were: need for establishing a registration law in States now without one; need for simplifying registration examinations; need for off-setting work of graduate architects employed by lumber dealers; need for better local publicity; need for better education of students for rural practice.

Suggestions placed before the group: (1) hold annual meetings with other local building interests, and discuss common problems; (2) sponsor group advertising in local papers or on local radio stations; (3) develop evidence to prove to the prospective house client that he saves money by retaining an architect; (4) cultivate outside community interests; (5) become active in rebuilding and modernization projects to lift the face of "Main Street."

**"The Fields of Architectural Practice";** *John R. Fugard*, Chairman; *Arthur B. Holmes*, Vice-chairman.

Discussion at this round table explored present-day trends in the architect's fields of activity.

**FEDERAL:** *Louis A. Simon*, Supervising Architect of Public Buildings Administration, Washington, D. C., spoke on Federal Bureau architecture as represented in projects under the Federal Works Agency, and stated that some means more efficient than either direct selection or competition must be found for selecting qualified architects.

**MUNICIPAL** architecture, said *Paul H. Gerhardt, Jr.*, Chicago City Architect, demands broader training and experience than Federal or State architecture, for it includes the operation and maintenance as well as the design of buildings. Every community, he said, should be served by such an individual.

*Raymond T. Ashton* of Salt Lake City, Utah, approached the same subject from the viewpoint of the private practitioner and noted the greater virility of the architecture when handled by a variety of private architects.

**SCHOOLS:** This field of activity was presented by *William B. Ittner, Jr.*, of St. Louis, and *William Jones Smith*, of Chicago. A recent trend toward bureaucratic design, which makes it increasingly difficult for private architects, should be studied by the Institute, said Mr. Ittner, in stressing the specialized nature of school work and the fallacy of attempting it without proper training.

William Jones Smith noted that both private architects and school-planning builders were essential to good school architecture and suggested that bureaus handle school work that is less desirable to the individual, retaining private architects for the major buildings.

**LOCAL HOUSING AUTHORITIES:** This

subject was jointly discussed by *Howard Dwight Smith* of Ohio State University and *Walter R. McCornack* of Massachusetts Institute of Technology. Mr. Smith emphasized the opportunity offered by housing bureaus for architectural "career" men. Authorities, he said, can operate in conjunction with private architects or, as an alternative, provide full architectural services as well as operation, maintenance, etc. Successful operation of this service compared with efficient private service offers the main basis for weighing the justification of bureaus in public service.

Mr. McCornack expressed his opposition to the type of bureaus which encroach on private practice. Bureaus for program development are valid and have his approval.

**REAL ESTATE FIELD:** Opportunities for the architect in this sphere were presented by *Edward D. Pierre*, of Indianapolis, speaking on home development; by *Eugene Fuhrer*, of Chicago, on appraisal work; and by *Stephen F. Voorhees*, of New York, on property management.

Mr. Pierre noted the challenge to the profession in the design of small, low-cost houses, and emphasized the need for a policy that would include all branches of the building industry.

Mr. Fuhrer defined the fields of appraisal of real estate for general and for tax purposes, and recognized the demand for such service—a service that may take the form of a report, drawings, or oral service, and which, if properly delivered, returns good fees.

(Continued on page 130)

FLOORS WITH A "FLAIR"

FOR MEETING THE ARCHITECT'S REQUIREMENTS

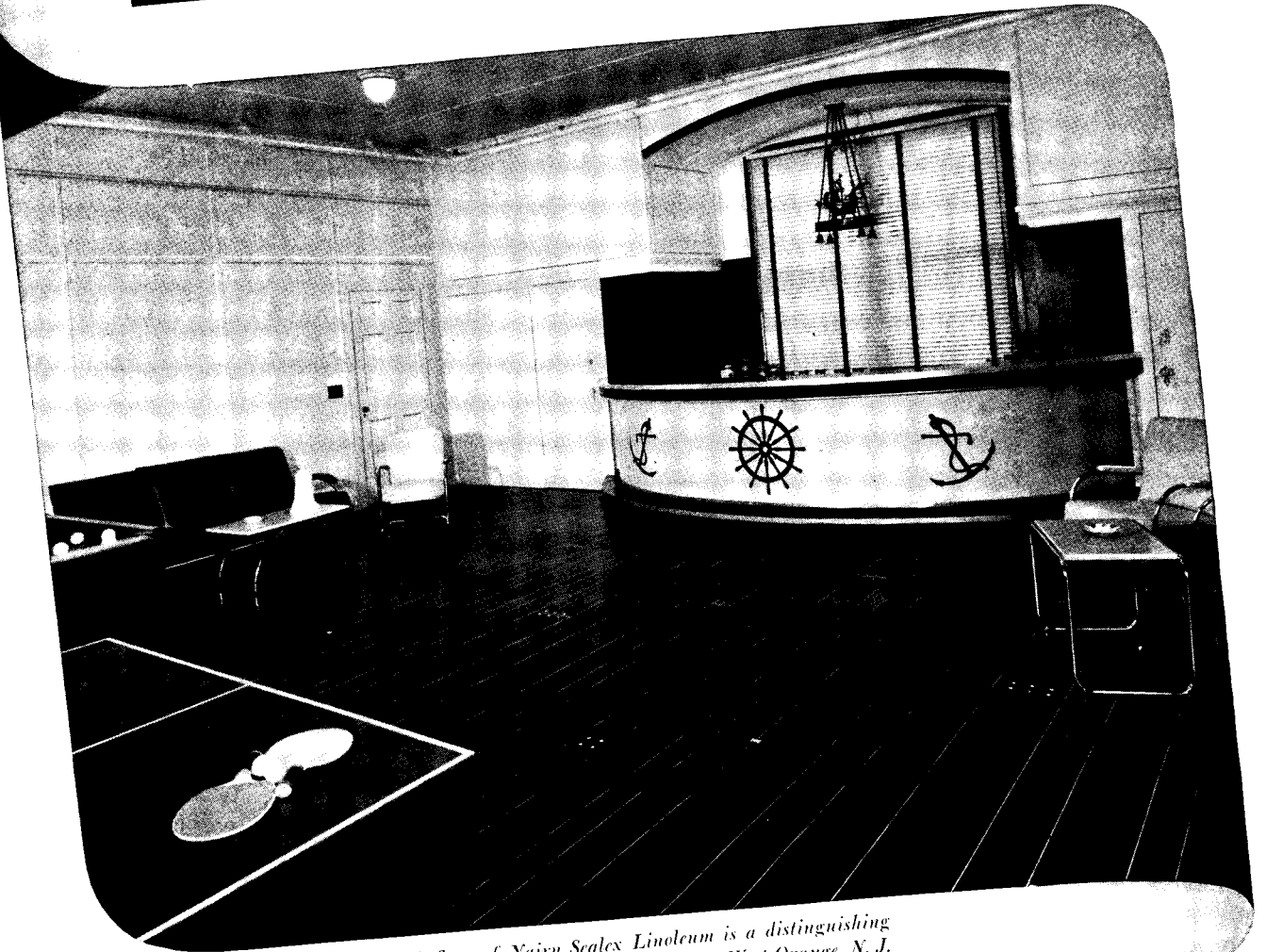

*A plank floor of Nairn Sealex Linoleum is a distinguishing feature of the Maxon Residence playroom in West Orange, N. J.*

**Y**ou will find Nairn Linoleum the ideal solution to the problem of "how to get attractive floors for residential rooms." Flexible, easily workable, Nairn Linoleum gives you complete freedom of design in creating interesting, distinctive interiors. And from the angle of beauty, there is a wide range of plain and all-over Veltone colorings to harmonize with every decorative scheme.

**Your clients** will find Nairn Floors remarkably foot-easy and quietizing. Easy to clean, because of its satin-smooth surface. Sanitary, because there are no cracks or crevices to catch dirt. And with long wear an inherent characteristic of Nairn Linoleum, it is easy to see why Nairn Floors offer both you and your clients more floor value than any other type of material obtainable. Installed by Authorized Contractors, Nairn Linoleum is fully guaranteed.

CONGOLEUM-NAIRN INC., KEARNY, NEW JERSEY

**NAIRN**  
TRADEMARK REGISTERED  
**LINOLEUM**  
**Floors and Walls**

*Congoleum-Nairn Inc. have complete catalogues and sample folders for your AIA file use. Ask us to send them to you.*

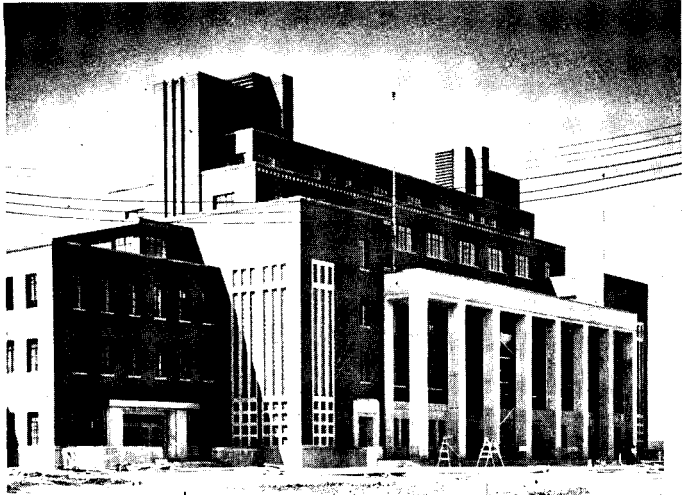

TEN VOTES: Coffman Union, U. of Minn. C. H. Johnston, Architects and Engineers; R. C. Jones, Advisory Architect.



NINE VOTES: Tri-State Telephone Building at St. Paul; by the firm of C. H. Johnston, Architects and Engineers.



EIGHT VOTES: Natural History Museum, on the campus of the University of Minn.; also designed by the firm of C. H. Johnston.

## Twin Cities Vote on Recent Architectural Examples

WINGING NORTHWARD with the trend of bird flight, the Record Poll this month takes in Minneapolis and St. Paul, the Twin Cities. As a possible demonstration of the happy mutuality traditional between the two, the new Coffman Memorial Union, at the University of Minnesota, Minneapolis, drew from both cities a nearly equal number of lay-citizen nominations as the outstanding example of recent architecture in the region; the University also furnishes a noteworthy runner-up.

The following lay citizens submitted nominations: *W. E. Brockman*, banker; *A. N. Christensen*, university professor; *Mrs. John S. Dalrymple*; *Gustave W. Krollmann*, artist; *Alexander Masley*, instructor of design and painting; *Neil R. Messick*, hotel manager; *William T. Middlebrook*, university comptroller; *Fred V. Nash*, real-estate man; *Laurence Schmeckebier*, chairman, university fine arts department; *De Forest Spencer*, government administration officer; *G. W. Reynolds*, D.D.S., university instructor; *T. M. Thompson*, member Board of Education; *Rolj Ueland*, lawyer—all of Minneapolis.

From St. Paul: *Harry Barnes*, executive; *C. H. Bigelow*, manufacturer; *Moritz J. Blomquist*, lawyer; *Edward C. Brown*, banker; *R. S. Kennedy, Jr.*, selling agent; *Dr. Theodore Leonard*, minister; *Thomas W. Larimore*, musician; *George F. Lindsay*, executive, honorary member AIA; *W. R. Mahood*, savings and loan executive; *Arthur S. Milinowski*, consulting engineer; *C. T. Peterson*, building editor; *Carl T. Schuneman*, executive; *John Socha*, muralist; *Robert O. Sullivan*, lawyer; *J. Allen Wilson*, M.D.

Twin Cities buildings receiving a number of votes, but less than the pictured winners are: R. W. Brink residence (*W. M. Ingemann*, Architect); Church of the Nativity (*O'Meara & Hills*); Greyhound Bus Terminal (*Lang & Raugland*); Hamline University Field House (*Slifer & Cone*); Harold's Women's Store (*Liebenberg & Kaplan*); C. H. Loomis residence (*W. M. Ingemann*); William Luyten residence (*Close & Scheu*); Minnesota Mining & Mfg. Co. (*Toltz, King & Day*); N. W. Bell Telephone Bldg. (*Hewitt & Brown*); Pioneer Hall, U. of Minn. (*C. H. Johnston*, and *William Ingemann*); St. Barnabas Hospital (*Hewitt & Brown*); St. Thomas College Gymnasium (*Ellerbe & Co.*); J. S. Shaw residence (*P. M. Havens*); White Bear Yacht Club (*C. H. Johnston*); Woolworth Store, 7th and Nicollet Ave. (*Larson & MacLaren*).

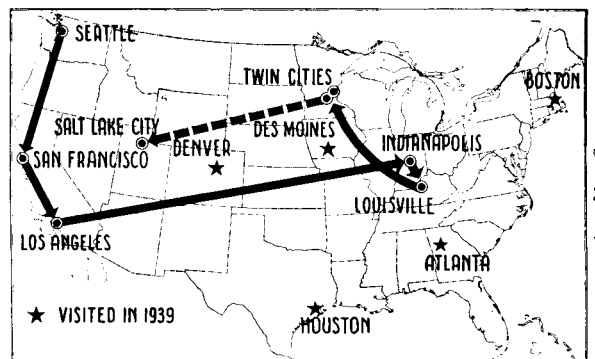

In July the Record Poll will visit Salt Lake City.

(More winners on over page)



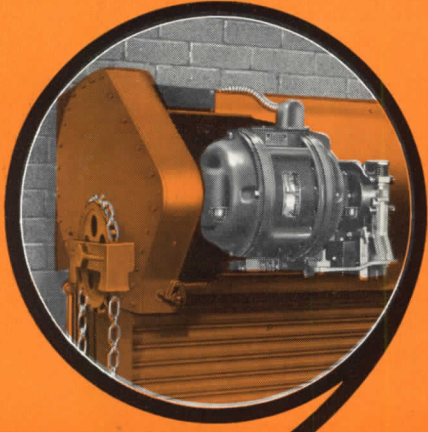

# Rolling Steel DOORS

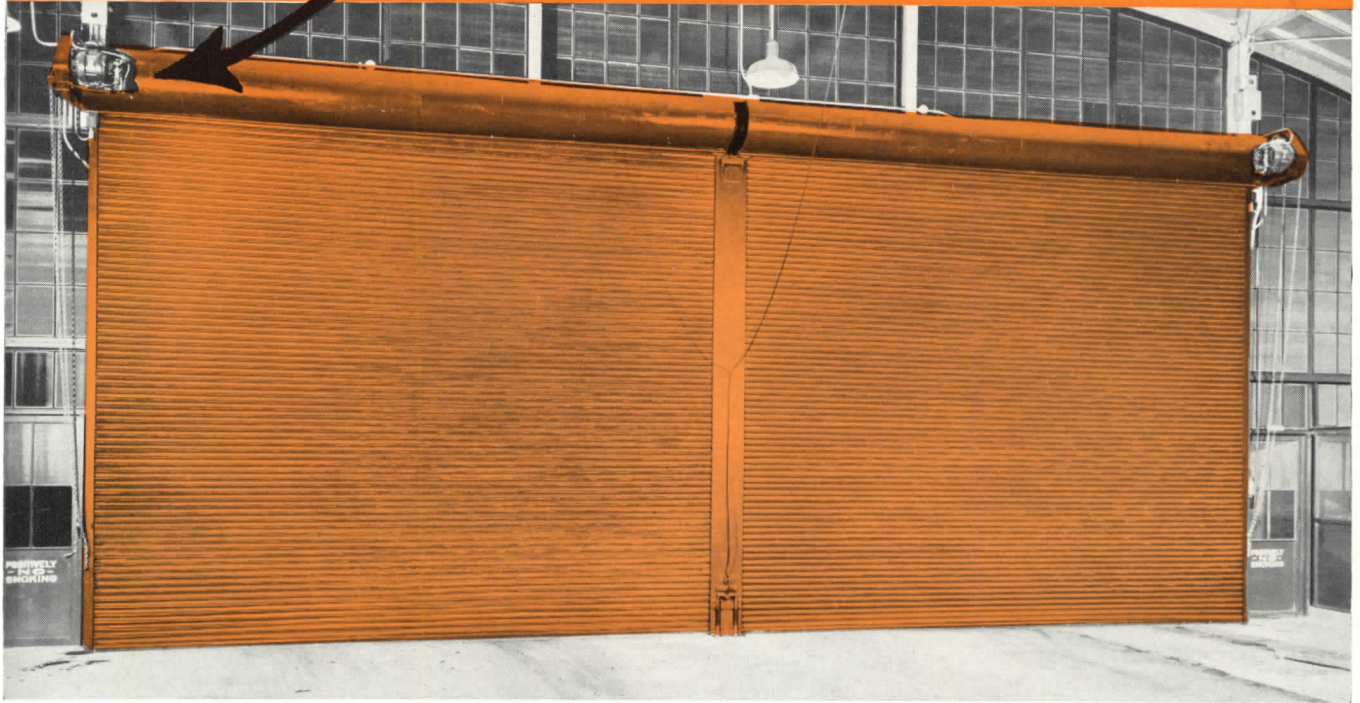

For openings in industrial and commercial buildings, Mahon Rolling Steel Doors offer the greatest economy in space and the ultimate in permanence and easy, reliable operation. They are built to last a lifetime, and have many outstanding and very desirable built-in features which are not obtainable in any other doors of this type. In the installation at the Bus Garage of the Indianapolis Street Railway, illustrated above, two Mahon power-operated Rolling Steel Doors, with a hinged post between,

were installed in an unusually wide opening. This method of handling wide openings offers distinct advantages in cases where the entire opening is only required at certain times . . . it permits opening either door independently of the other, or, both doors may be opened and the hinged post, which is also power-operated, may be swung up, leaving the entire opening clear from jamb to jamb and from sill to lintel. For complete information write for catalog or see Sweets.

## **THE R. C. MAHON COMPANY, DETROIT**

*Representatives in Principal Cities*

**Manufacturers of Rolling Steel Doors, Shutters and Grilles; Kalamein and Tin Clad Doors,  
Steel Roof Deck and Cast Iron Roof Sumps**

# MAHON

Record Poll in the Twin Cities (continued)



SEVEN VOTES: The St. Paul Courthouse, by Ellerbe and Co., Architects; Holabird and Root, Consultant Architects.



SIX VOTES: The Catholic Church of St. James, St. Paul; it was designed by the architectural firm of Slifer and Cone.



FIVE VOTES: The W. H. Lang residence, Crocus Hill, St. Paul; designed by C. H. Johnston, Architects & Engineers.



FIVE VOTES: The residence of Dean Malcolm M. Willey, Minneapolis, for which Frank Lloyd Wright was the architect.



FOUR VOTES: The St. Louis Park Theater in Minneapolis; Perry Crosier was the architect; the interiors were designed and decorated by Miss Clow.



FOUR VOTES: Uptown Movie Theater in Minneapolis, Liebenberg & Kaplan, Archs.

FOR STRIKING  
MODERN MURALS

*PC Architectural Glass*



HERE IS AN outstanding example of how PC Architectural Glass may be used for sculptured glass murals of distinction. These panels add beauty and interest to the entrance of the new Banker's Life Company Building in Des Moines, Iowa. Architects... Tinsley, McBroom and Higgins.

MANY architects and designers have deplored the fact that they cannot actually model in glass. But today, they can do almost as well—they can produce murals of the same striking originality and delicacy by having their own modeling in clay or plaster faithfully reproduced in exquisite sculptured panels of PC Architectural Glass. For murals, cornices, friezes and many other purposes, pieces of this glass as large as 1 foot by 1 foot can be used to reproduce a single design. Or a number of sculptured pieces can be joined to create a larger, overall pattern or design.

PC Architectural Glass is also available in a wide range of attractive standard shapes. Send the coupon for free literature giving additional facts about this modern material.

At the New York World's Fair, visit the Glass Center Building and the Pittsburgh House of Glass

*"PITTSBURGH" stands for Quality Glass*

Pittsburgh Corning Corporation  
2147 Grant Bldg., Pittsburgh, Pa.

Please send me, without obligation, your free literature on PC Architectural Glass.

Name \_\_\_\_\_ Address \_\_\_\_\_

City \_\_\_\_\_ State \_\_\_\_\_



ARCHITECTURAL  
GLASS

Distributed by  
PITTSBURGH PLATE GLASS COMPANY  
and by W. P. Fuller & Co. on the Pacific Coast

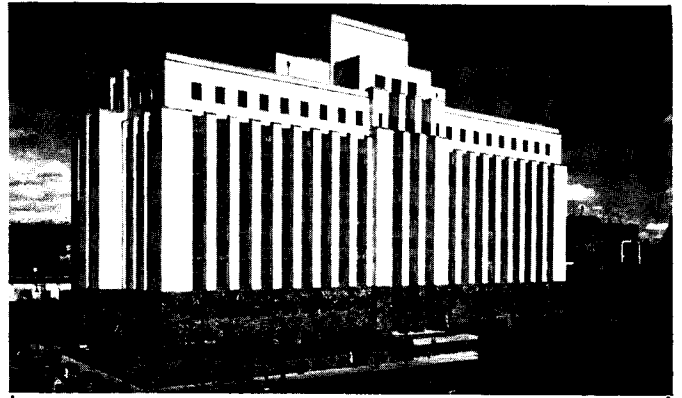

BANKERS LIFE BUILDING, DES MOINES, IOWA

A "Natural"  
for VESTAL



FLOOR TREATMENTS and  
MAINTENANCE PRODUCTS

All of the floors in this beautiful building were finished with VESTAL products.

Because, like most modern buildings today, it had all types of floors—

- RUBBER TILE
- TERRAZZO
- ASPHALT TILE
- WOOD
- CEMENT

And the architect and owners knew that VESTAL products were approved by the manufacturers of the different types of flooring.

Therefore, when they selected VESTAL products they were assured of the proper original treatments to preserve, protect and beautify all of the floors in the building. Their VESTAL maintenance program provides for minimum labor hours of upkeep.

LOOK AT THE "VESTAL FINISHED" FLOORS

See pages 55 - 68

IF YOU EXAMINE THEM IN 1950

You will find the true test of all maintenance materials is in years of actual living conditions. VESTAL products protect floors against wear and deterioration.

FOR FURTHER  
INFORMATION



For Complete Satisfaction Specify VESTAL

VESTAL CHEMICAL  
LABORATORIES, INC.

NEW YORK - ST. LOUIS - CHICAGO



# THE STORY BEHIND THE STORY ON THE BANKERS LIFE BUILDING

Date: April 4, 1939  
 From: Mr. W. A. Fischer, Dodge Salesman in Des Moines

To: Editor of ARCHITECTURAL RECORD  
 The architectural firm of Tinsley, McBroom and Higgins, of Des Moines, Iowa, has under construction for the Bankers Life Insurance Company in Des Moines a million and a half dollar office building. It will include all of the latest items and methods of construction and materials, as Mr. McBroom of this organization has spent considerable time and money in research for this type of a building. I am wondering whether or not your office has written to Mr. McBroom asking for an exclusive story and pictures for this building at the time that it is completed. I am sure that Mr. McBroom will co-operate with you and the ARCHITECTURAL RECORD as much as possible.

Date: April 12, 1939  
 From: W. A. Fischer  
 To: James M. Fitch, Jr.

Your letter to Tinsley, McBroom & Higgins was received enthusiastically and in talking with them today, I feel sure that we have placed the foundation for an exclusive story for the ARCHITECTURAL RECORD.

Date: May 27, 1939  
 From: Claude B. Riemersma, District Manager of ARCHITECTURAL RECORD, Chicago, Ill.  
 To: James M. Fitch, Jr.

I spent practically all of last Thursday with Mr. McBroom of Tinsley, McBroom & Higgins, and Mr. McCarroll, Advertising Manager at Bankers Life. This job, from every angle, is ideally suited for AR because of its very unique and unusual technical problems. The

performance requirements laid down by the owner, and the architect's approach to the solution of the problems set up by those requirements, make this job one which I am sure you would not want to pass up. There are a lot of things about this building which make it outstanding in an architectural and engineering way. Just to mention a few of the things which impressed me, I might point out the following:

1. There is practically no plaster in the entire building. All interior walls are made of metal.
2. On six floors there is an office space 230' x 53' branching into "L" 90', without a single visible supporting column.
3. The heating and air-conditioning system is extremely unusual in that heat radiation will come from pipes imbedded in the walls, and the air circulation will be made possible through special invisible ducts running through the ceiling.
4. There are several unusual factors connected with the design of the washrooms. For instance, the toilet stalls are suspended from the ceiling instead of set on the floor.
5. All outside walls are insulated with cork.
6. This building has been designed primarily to establish ideal working conditions for more than 600 employees and special attention has been given to proper acoustics, color, atmosphere, etc., for employee efficiency.
7. I believe it is the largest commercial building being constructed in the United States today with private capital and although it might cost well over a million and a half dollars, Mr. McBroom can prove quite positively that it is an economical investment for the company.

Date: June 1, 1939  
 From: James M. Fitch, Jr.  
 To: Claude B. Riemersma

Thanks for the swell piece of reporting you did on the Bankers Life Building. We will definitely schedule the Bankers Life for a big play in ARCHITECTURAL RECORD. I am making a loop through the West beginning June 16 and I shall make the necessary detours to Des Moines and sew the job up with Mr. McBroom.

Date: August 1, 1939  
 From: James M. Fitch, Jr.  
 To: Mr. Leland McBroom, Tinsley, McBroom & Higgins, Architects

In accordance with our conversation of yesterday, I am forwarding you the following material:

- I. Although subject to plenty of change between now and next March, I think the following will serve as an outline for the finished story:
  - A. **Planning:** Work areas, recreational areas, public areas
  - B. **Structure:** Foundations, skeleton, envelope (walls, floors, and roof)
  - C. **Operational systems:** Heating, ventilation, lighting, acoustics, communication, circulation, transportation
  - D. **Equipment:** Desks, cabinets
- II. I shall need from you at the earliest possible moment a list of all equipment and materials used in the structure. I shall also want, as soon as possible, the description of the building which you prepared for the press, in addition to the names and addresses of all specialists involved in:
  - A. Foundation and structure design
  - B. Heating, ventilating, and refrigeration
  - C. Lighting
  - D. Sound
  - E. Landscaping, etc.

As I told you, my purpose is to get from the specialists a fairly detailed description of the design and performance standards of their

(Continued on page 30)

## BANKERS LIFE BUILDING IS EQUIPPED WITH **HAUGHTON ELEVATORS** OF THE GEARLESS TYPE WITH AUTOMATIC CONTROL

**HAUGHTON  
 ELEVATOR  
 COMPANY**  
 TOLEDO, OHIO

◆ ◆  
**SALES AND SERVICE  
 BRANCHES:**

Akron	Lansing
Buffalo	Lima
Canton	New York
Chicago	Philadelphia
Cleveland	Pittsburgh
Columbus	Raleigh
Des Moines	Rochester
Detroit	Saginaw
Flint	St. Louis
Harrisburg	St. Paul
Indianapolis	South Bend
Jackson	Washington

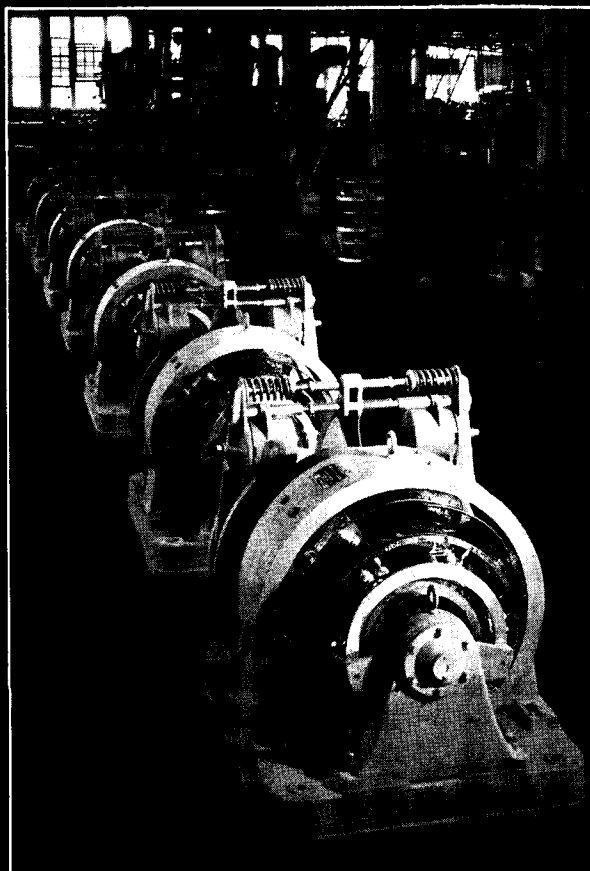

# HUNG FROM THE CEILING



● These photographs show how they did it in Des Moines. Notice how easy these floors and partitions may be cleaned. They're Vitrolite, of course, from head to foot. Tinsley, McBroom & Higgins, Architects, Des Moines.

Use Vitrolite in your plans and specifications, either for new construction or in modernizing the old. We're willing, equipped and ready to cooperate with unusual design problems. Write for our latest Vitrolite Color Chart and any information you may desire. Vitrolite Structural Glass for other purposes is covered in Sweet's Catalog. For details of the new suspended construction write . . . Libbey-Owens-Ford Glass Company, Toledo, Ohio.



LIBBEY • OWENS • FORD

# VITROLITE

COLORFUL STRUCTURAL GLASS

**NEW VITROLITE SUSPENDED PARTITIONS IMPROVE SANITATION—LEAVE FLOORS CLEAR FOR EASY CLEANING—LOWER MAINTENANCE**

● Look at these sparkling Vitrolite toilet partitions in the new Bankers Life Company Home Office Building, Des Moines, Iowa. Suspended from the ceiling, they are an obvious improvement over previous practice.

No partitions interfere with cleaning the floor. Partitions and walls are clean as the deck of a battleship cleared for action. They're Vitrolite—the colorful, easy-to-clean structural glass.

Walls, wainscots and toilet partitions of lustrous Vitrolite offer many advantages. Because *Vitrolite is Glass*, it is proof complete against moisture, temperature changes, odors—keeps bright, new and sanitary with a little soap and water.

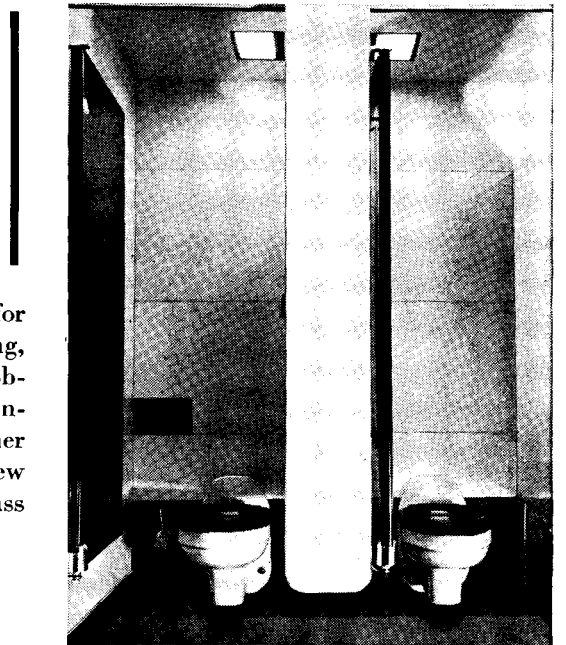

## STORY BEHIND THE STORY

(Continued from page 28)

respective systems. Where these were done by your office (rather than with outside assistance), will you please see that I get the same sort of material?

III. I am sending a series of tear sheets which illustrate the general techniques that I should like to employ in the presentation of this story. I think the chap to whom you finally delegate this work can get a very clear idea of what I am driving at by studying them. For the present, I shall leave the selection of specific items up to him, counting upon filling in the gaps as the material is sent in and the layout "fills." For example, it is obvious that a series of combined photographs and black-

and-white drawings could be started on the typical exterior wall bay; or, again, isometric skeletal drawings, showing the main work in recreational and public areas, plus the transportation and communication systems, could be begun. The same thing goes for the steel framing whose peculiarities in terms of extra-long spans, cambered girders, and special wind-bracing, etc., can best be told by diagrams.

IV. The question of a photographer whose experience and equipment is adequate for a building of this size also rears its head. For a first-rate photographic coverage of the finished building, I should like to recommend Hedrich-Blessing of 737 North Michigan Avenue, Chicago, Illinois. It seems to me that this firm is well equipped to cover the building from the standpoint of the owners, the architect, the manufacturers, and the magazine.

Date: August 10, 1939

From: Leland A. McBroom

To: James M. Fitch, Jr.

I am enclosing a description of the building. I would appreciate it very much if you emphasize the fact that the building was designed to be the most efficient building to house the workings of an insurance company that we could conceive, as well as one which in the long run would be most economical. For instance, I think we can justify an expenditure for cork thermal insulation over the entire outside shell of the building and our double windows on the grounds of real economy over a very reasonably estimated life of the building. Before air conditioning, thermal insulation of walls could only work during the heating cycle, but now with air conditioning, it functions and saves money in both the summer and winter cycles. See if you agree with me that that sort of an approach is the most interesting one. It certainly is one which the Bankers Life and ourselves would appreciate.

Date: February 3, 1940

From: Leland A. McBroom

To: James M. Fitch, Jr.

Everything is working out perfectly swell in the building, and we hope to have the Company all moved in before the first of April. I have never seen a piece of architecture which seems to meet with such universal approval by all types of people. Needless to say, it gives us quite a kick.

Date: February 29, 1940

From: James M. Fitch, Jr.

To: Kenneth Hedrich, Hedrich-Blessing Studios, Photographers

The sum and substance of our problem is this: to get prints of all the shots which we shall need for the magazine as early as possible.

The second point is color. Obviously these shots should be taken as early as possible since at least three weeks must be allowed for engravings.

- (a) one vertical shot of the south (main) front
- (b) one shot of the main lobby
- (c) one horizontal shot of a typical work room
- (d) one vertical shot of the compressor room from the spectators' gallery

The first three shots could be taken before April 13 since McBroom says the company will be moving in around March 20. But the last shot of the compressor room will probably have to be delayed up until the last moment because Micky doesn't think the room will be finished until then. What is your suggestion as to timing these shots? Also what is your opinion on four-color separation. . . . Would four-color separation be more expensive? The reason I ask is that engravings made from separations are always cheaper and sometimes more accurate.

Date: March 2, 1940

From: James M. Fitch, Jr.

To: J. H. McCarroll, Advertising Manager, Bankers Life Building.

Things really are beginning to move. My attached letters of March 2, to you, and February 29, to Hedrich, are slightly antedated by yours of the 29th, to Mr. Hedrich, which I just received. However, we are not too far apart at that. If you feel that the photographs you need can be taken between March 18 and March 25, that is of course OK with us. That will leave you plenty of time for your black-and-white engravings and—if the four-color engravings are to be made in Chicago—would just about give you time to have the four-color engraving of the main front.

(Continued on page 32)

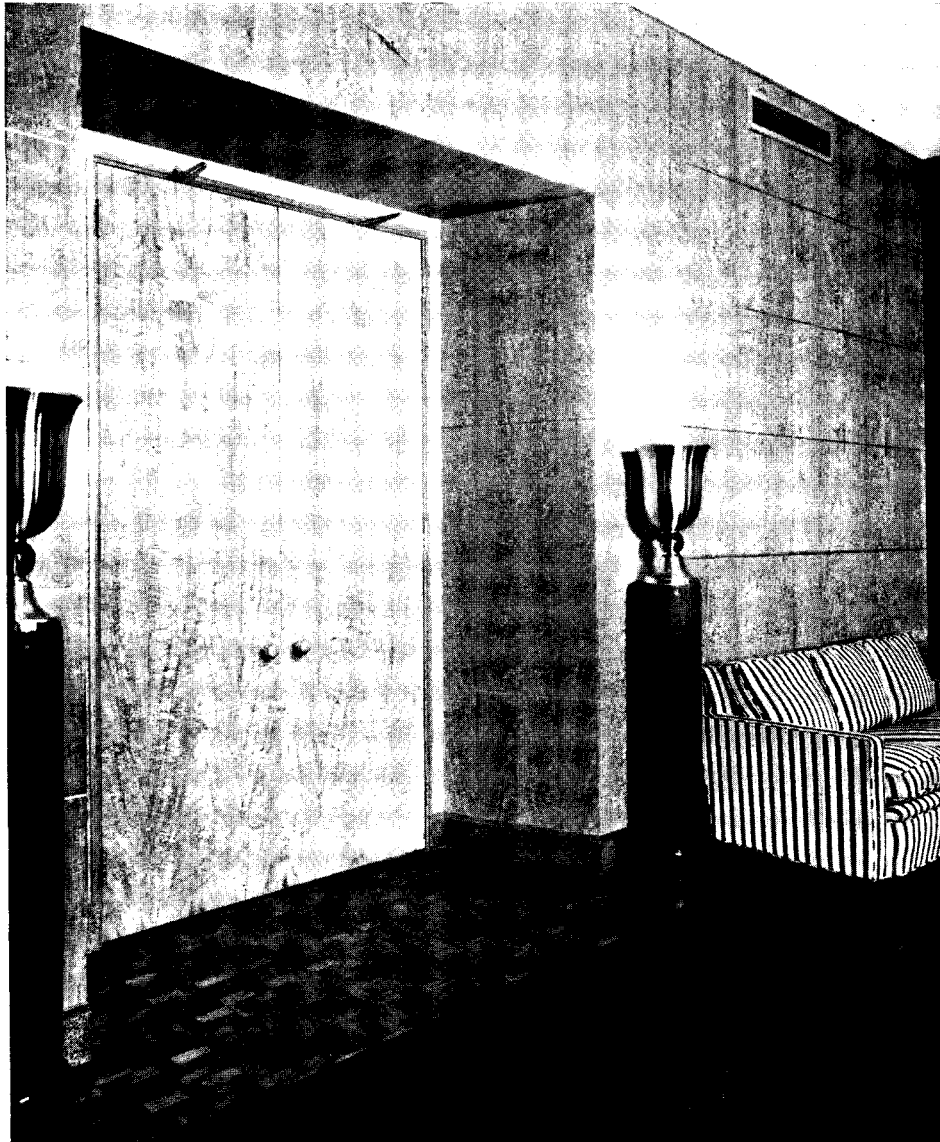

### Elsie N. SAYS: "Here is Modern Door Control as Seen in the 'Bankers Life' Building . . ."

"For the interior doors of this splendid new home of the Bankers Life Company, architects Tinsley, McBroom & Higgins chose LCN 303 closers concealed-in-door, shown above. Thus smooth, unobtrusive and reliable operation of such doors is one of the many superior features of the building." Would you like to know how these closers are installed? See *Swee's*, section 16/25, or write Norton Lasier Company, 466 West Superior Street, Chicago, Illinois.

# LCN



# BANKERS LIFE COMPANY, HOME OFFICE BUILDING

DES MOINES, IOWA

TINSLEY, McBROOM & HIGGINS, *Architects*

W&J SLOANE, *Collaborators*

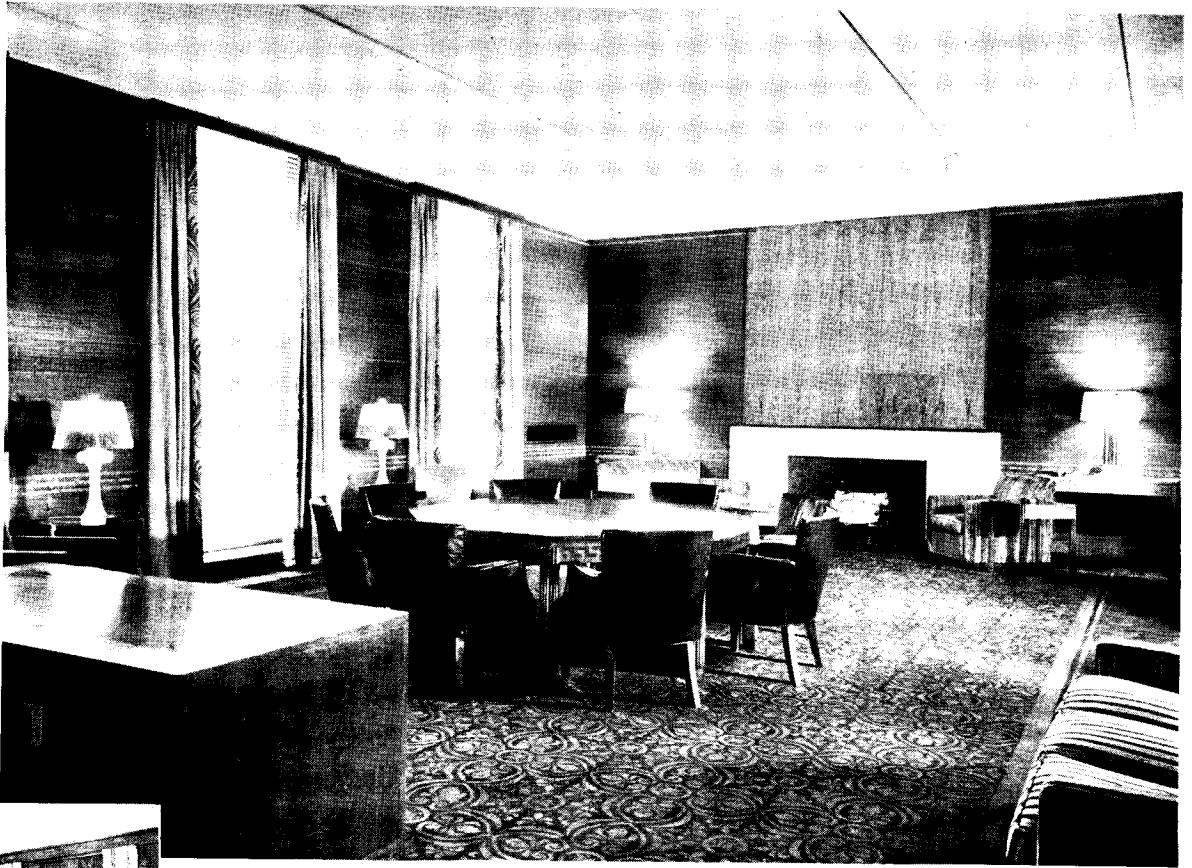

● *Directors' Room with burl inlaid walnut and oak furniture in American Contemporary design.*



● *A specially designed carpet in the president's office sets the color scheme for the draperies.*

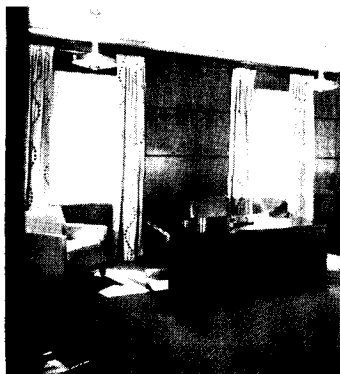

● *Like the other executive offices, the vice-president's has individually selected draperies.*

A great new building soars up in the Middle West. Its design...structure... features are the pacemakers for office buildings for the next decade. And W. & J. Sloane get the contract to do every one of the twenty-eight executive offices, including those of the president and vice-president.

It was a test of mettle to work out the decorative plan for such a building. W. & J. Sloane were one of several firms competing. They were chosen because they not only have the facilities to cover every phase...but they also have the talent to think ahead of their time!

Sloane styled decorative schemes to dovetail with this new type of office building. All furniture was specially

designed and made. So were many of the carpets. To keep costs down, only the president's office was treated as a separate unit. Except for draperies, the remaining executive offices were done exactly alike.

How successfully Sloane did this major furnishing and decorating job is reflected in a letter from the president of the Bankers Life Company.

*"...We concluded to procure our furniture, carpets, draperies, and other equipment from you because of the completeness as well as the quality of the service you render....The associations we have had with you have been highly satisfactory, and we are well pleased with the service rendered."*

*Wholesale FURNITURE Division*

**W&J SLOANE**

575 FIFTH AVENUE • NEW YORK, N. Y.

# WEST DODD LIGHTNING PROTECTION safeguards new . . . .



**W**HEN those who know the most about lightning and its hazards install lightning protection equipment ON THEIR OWN BUILDINGS . . . that's a seal of approval that should carry weight.

Numbered among them is the Bankers Life Company. Its new building in Des Moines is the most modern of insurance home offices. Every detail of design, construction, departmental arrangement and choice of materials and equipment was carefully planned for economy and efficiency of operation. And, as you would expect from an insurance company, every sound precaution was taken to make it fire-safe. Significant that this building is equipped with a modern, inconspicuous West Dodd Lightning Protection System.

Other more recent West Dodd installations include

**BANKERS  
LIFE COMPANY  
HOME OFFICE**

the General Electric Exhibit Building, the model Fire Safe House and the Electrified Model Farm . . . all at the New York World's Fair.

Experience has proved that taking a chance with lightning is taking a grave risk. Yet the National Fire Protection Association states, "There are few fire causes against which so reliable a defense is available." A West Dodd System is so inconspicuous as to be practically unseen and its cost is modest.

It pays to consider lightning protection. And it pays to SPECIFY West Dodd.

*Write for Architects' Detail Folders, or refer to Sweet's.*



In the General Electric Building at the New York World's Fair, G-E exhibits man-made lightning, and West Dodd guards the building against nature's lightning.

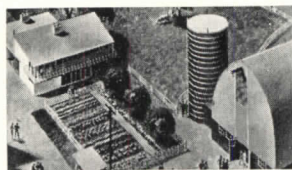

The Electrified Farm, sponsored by the Electric Utilities Industry at the New York World's Fair was also West Dodd protected.



West Dodd also installed the lightning protection system on the Fire Safe House sponsored by the Home Insurance Company and featured at the New York World's Fair.

**WEST  DODD**  
**LIGHTNING CONDUCTOR CORP.**  
**GOSHEN, INDIANA**

## STORY BEHIND THE STORY

(Continued from page 30)

Date: April 6, 1940  
From: Charles S. Leopold, Engineer  
To: Leland A. McBroom

The ARCHITECTURAL RECORD sent me an advertisement on the Bankers Life. I suppose you have a copy. On the second page they state:

"The structural design incorporates a number of features which will be treated in some detail. Two of the owners' requirements—that the building be organized vertically and that major work areas be free of all interior columns—led to a steel frame of extraordinary interest."

I am somewhat surprised at the statement that the owners made the demand that there be no columns in the work spaces. Even if this is true, I do not think it should be featured because the outstanding characteristic of this project was that the architect, owner, and engineer all *forgot their own peculiar functions* and pitched in to make a good job—and I think it is important enough to note . . . in an architectural publication.

Date: April 25, 1940  
From: James M. Fitch, Jr.  
To: Kenneth Hedrich

The transparencies arrived this morning and they're really tops. If these are the discards, I can't wait to see proofs on the real ones. Having seen them it is easy to come to two decisions. First, that we'll use the four interiors—the typical office space, the compressor room, the auditorium, and the women's recreation room. And second, that instead of various size cuts we will use all four at the same size as the originals—4 $\frac{5}{8}$  by 6 $\frac{5}{8}$ .

Date: May 7, 1940  
From: James M. Fitch, Jr.  
To: Mr. Charles S. Leopold

Your manuscript and drawings arrived OK. Will you please check me on the following:

Can you say in general terms what temperature and humidity you plan to maintain in the winter? In the summer? (In other words, a sort of synthetic performance factor which would include the effect of either heated or cooled walls.)

As soon as the story begins to take physical form, I will either send you page proofs or arrange for you to come up and check it.

Date: May 13, 1940  
From: Charles S. Leopold  
To: James M. Fitch, Jr.

The point raised is quite pertinent, but rather involved and I do not think it can be properly covered in the scope of your article. In brief, in winter by warming the wall we obtain a uniform sensation of comfort across the room. This makes a minor change in the requirements of the room as a whole and also eliminates the need of raising the general floor temperature above the desired point in order to take care of the local areas adjacent to the windows; but it should be noted that there are other radiant surfaces to be considered, notably that of the ceiling, so that the one wall does not tell the complete story. As I tried to point out in my outline of May 4th, we are not depending on the warm wall to the extent that one would in the conventional radiant heating system. At the present time one of the research committees of the American Society of Heating and Ventilating Engineers, of which I happen to be a member, is investigating the correlation of our previous work on temperature and humidity with the radiant effect, and this data will be published shortly. However, until it is published I do not feel at liberty to quote it and I think the entire question is a little too involved for presentation in this type of paper.



# ONCE IN A GREAT WHILE

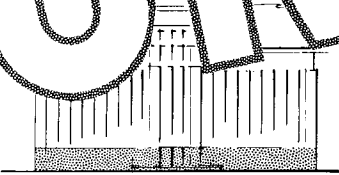

Perhaps every decade or so—a farsighted and fortunate architect finds an equally farsighted client with whom he is able to work in so unhampered and constructive a way that the resultant building actually sets a new standard and serves as a challenge to all concerned with architectural progress. In the judgment of RECORD editors, such architects were Tinsley, McBroom & Higgins; such a client was the Bankers Life Company; and such a building is the new home office of this insurance company in Des Moines, Iowa.

The basic problem involved was to design a building "for economical and efficient line production of insurance policies under the most favorable conditions possible for the workers within the building." Analyzed as a whole or in part, the building shows how successfully the architects met this challenge.

Performance efficiency and maintenance economy are, in fact, the controlling factors in design, not only in plan but in every aspect of the building—its structural scheme, its air-conditioning, lighting, and acoustical systems; its materials and equipment; its decoration and furnishing.

This much might be said of many new buildings. But rarely does one appear where all these various elements are so closely coordinated and integrated to produce the finished design. The exterior architectural treatment here is no sentimental wrapping superimposed on and disguising the structural and functional features of the building. The beauty of the finished structure, rather, derives from and grows out of the highest respect for these features.

We devote unusual space to this project, not because we feel that a large number of our readers will have the opportunity of designing an insurance company's home-office building, but because the architects have skillfully solved so many specialized problems which cut across *all* commercial buildings. For that reason, emphasis is placed upon aspects of advanced design technique rather than on plan features that relate solely to the operation of the insurance business.

The presentation is divided into four parts: 1. Planning, pages 52-55; 2. Facilities, pages 56-59; 3. Structure, pages 60-63; and 4. Systems, pages 64-68.

All of the photographs in this presentation of the Bankers Life building (except construction photos on page 63) were specially taken for Architectural Record by Hedrich-Blessing Studio, Chicago.





Heidrich

**LELAND A. McBROOM** of the architectural firm of Tinsley, McBroom & Higgins, Des Moines, Iowa. "I would appreciate it very much," Mr. McBroom writes, "if you emphasize that the building was designed to be the most efficient building to house an insurance company that we could conceive, as well as one which in the long run would be most economical." The following pages are documentary proof of this high standard from start to finish.

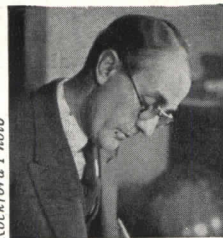

Rockford Photo

**DR. PAUL E. SABINE** of Riverbank Laboratories, Geneva, Ill., was the acoustical engineer. Dr. Sabine comments: "The acoustical problems presented in the Bankers Life building covered in a degree practically the whole field of architectural acoustics." In the application of the various materials and systems, there is an unusual integration with both the air-conditioning and lighting systems. Description of this aspect of the building appears on pages 66 and 67.



# Home Office Building THE BANKERS LIFE COMPANY

TINSLEY, McBROOM & HIGGINS, Architects



**CHARLES S. LEOPOLD**, of Philadelphia, was the consulting engineer for heating and air conditioning. The novel system he worked out, combining a perimeter warming and cooling system with a centralized air-conditioning system, is described on pages 64, 65. "The outstanding characteristic of this project," says Mr. Leopold, "was that the architect, the owner, and the engineers all forgot their own particular functions and pitched in to do the best possible job."

JUNE 1940

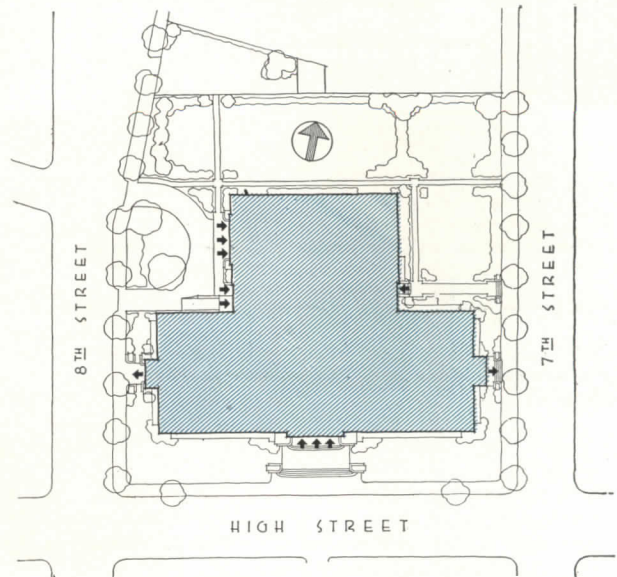





ARTHUR H. NEUMANN & BROTHERS, Inc., General Contractors; CHARLES S. LEOPOLD, Heating and Air-Conditioning Engineer; B. E. LANDES, Mechanical Engineer for Plumbing and Electric Wiring; DR. PAUL E. SABINE, Acoustical Engineer

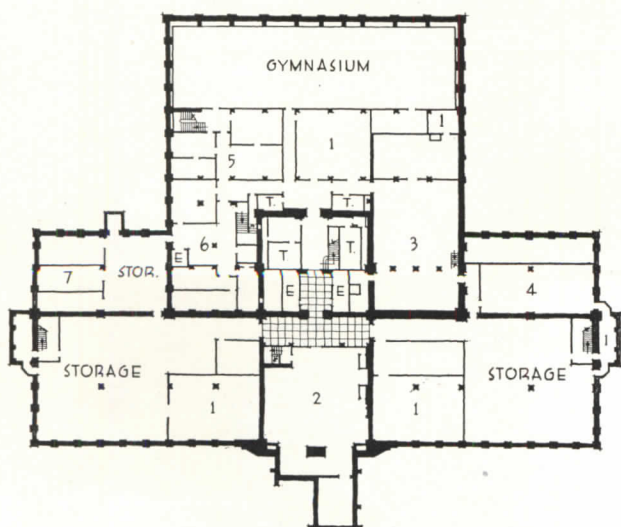

**Basement:** 1. Fan room. 2. Refrigeration equipment. 3. Boiler room. 4. Mechanical equipment. 5. Service and maintenance shops. 6. Supply room. 7. Transformers. E. Elevators. T. Toilets.

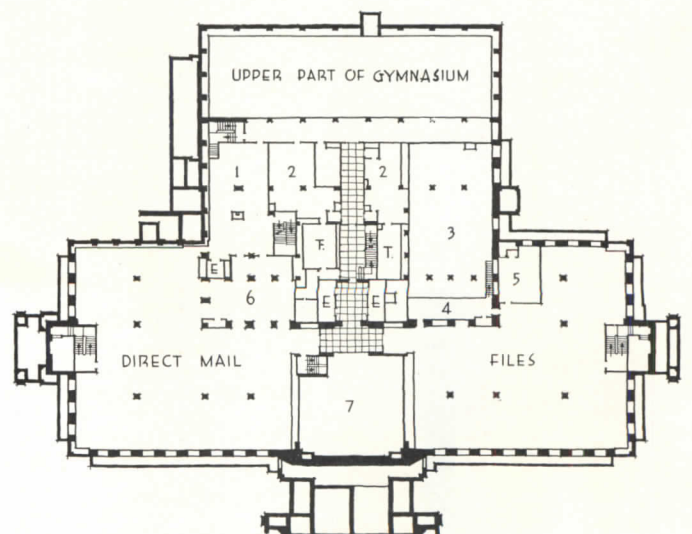

**Ground floor:** 1. Supply room. 2. Locker room. 3. Upper part, boiler room. 4. Visitors' balcony. 5. Superintendent. 6. Pneumatic-tube station. 7. Upper part, refrig. equip. room. E. Elevators. T. Toilets.

# BANKERS LIFE BUILDING

TINSLEY, McBROOM & HIGGINS, Architects

FROM GROUND LEVEL to the highest point, the building rises 145 ft., with six floors, the penthouse, and cooling tower above grade. Including the auditorium, the structure covers 33,875 sq. ft. and contains approximately 100,000 sq. ft. of working floor space.

Exterior surfacing materials include a 23-ft. base of rainbow granite with limestone above. The bronze-framed glass-block panels, with clear-glass insets are separated vertically by spandrels of extruded bronze.

For the conduct of the insurance business, the front portion of the building is organized according to desirable relationships between the several departments and the relative need for accessibility—as close to an assembly-line system of production as the character of the insurance business allows. Basement and ground floor contain utility, storage, and supply rooms, direct-mail advertising department, and files for dead and semi-inactive documents and reference. Also located in this area is a gymnasium for employees' use. The public has little need to reach any of these areas.

From the first through the fifth floors are the public lobbies, large work areas for the routine of the insurance business, file space, secretarial and transcribing areas, tabulation and accounting rooms, etc. Most of the top executive offices are located on the sixth floor, along with conference rooms and a law library. In the seventh-floor penthouse is a private executive suite, including cloak room, foyer, and the directors' room. The plan and description of this penthouse floor appears on page 58.

At the rear of this block, as seen in the photograph opposite, is the auditorium. This is accessible both from the main lobby of the building and from its own separate entrance and lobby. The exterior treatment of the auditorium wing corresponds to that of the main building.

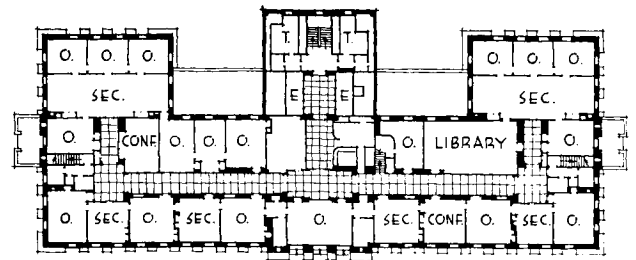

Sixth floor: O. Private office. E. Elevators. T. Toilets.

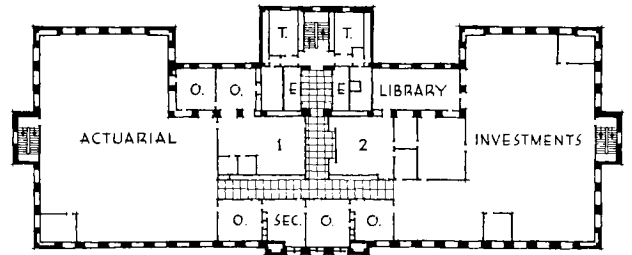

Fifth floor: 1. Personnel. 2. Waiting room. O. Private office. E. Elevators. T. Toilets.

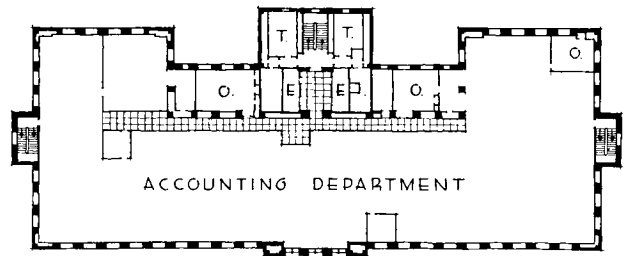

Fourth floor: O. Private office. E. Elevators. T. Toilets.

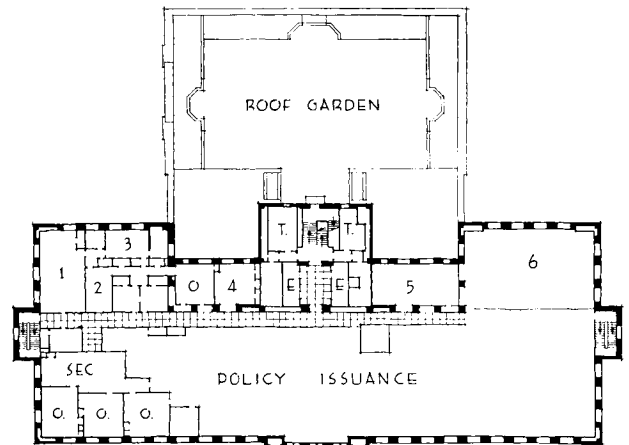

Third floor: 1. Women's rest room. 2. Medical department. 3. Laboratory. 4. Conference room. 5. Photostat room. 6. Dictaphones. O. Private office. E. Elevators. T. Toilets.

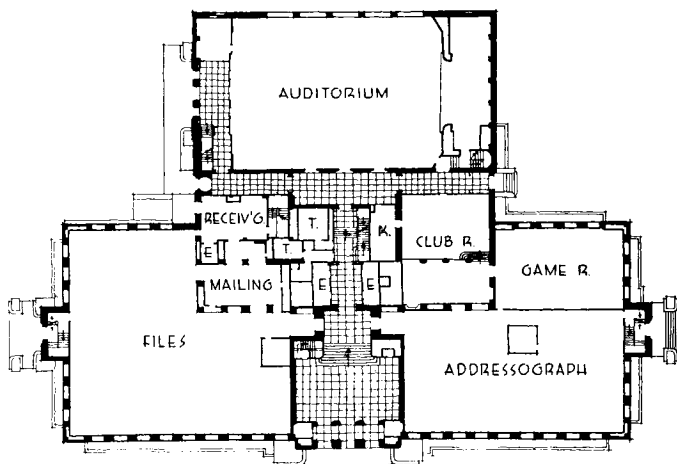

First floor: K. Employee Kitchen. E. Elevators. T. Toilets.

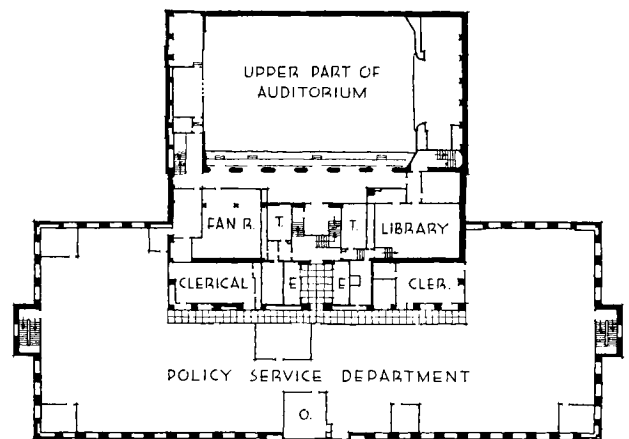

Second floor: E. Elevators. T. Toilets.



# 1. PLANNING



Just as the organization of departments is based on maximum operational efficiency and economy, so with every plan element. Planning is the result of an objective study of needs, an analysis of means to satisfy those needs, and the design of forms to solve each problem most effectively. Typical of this process is the auditorium shown above.

THE AUDITORIUM, with a capacity of 1,100, including the balcony, is equipped for flexibility of use. Two kinds of seating are provided. For large crowds, there are folding chairs that may be quickly placed in position, and as quickly put away. These also take care of incidental meetings and uses (for badminton, basketball, and other employee recreational activities) where a quick change from lecture-hall to open-floor arrangement is necessary. For greater comfort, there are opera chairs arranged in panels of four.

This handsome room, thoroughly treated for acoustics, is brightly lighted by twenty-four 6-ft. coffers (which also serve for ventilation) set in the perforated copper-colored acoustical ceiling. Side walls are of plaster; the floor is of hard maple.

On the roof of the auditorium are terraces and a roof garden for the use of employees at lunch time.

In the organization of separate departments, the architects have even gone so far as to recognize and capitalize certain seasonal fluctuations in the conduct of the insurance business. Wherever possible, departments with different seasonal peaks have been paired on the same floor. Thus when one is having its "off" season and the other, its busiest, the latter simply expands its work area into that of the former and vice versa. A case in point is the adjacent placement of the actuarial and investment departments on the fifth floor, as seen on the adjoining isometric drawing.

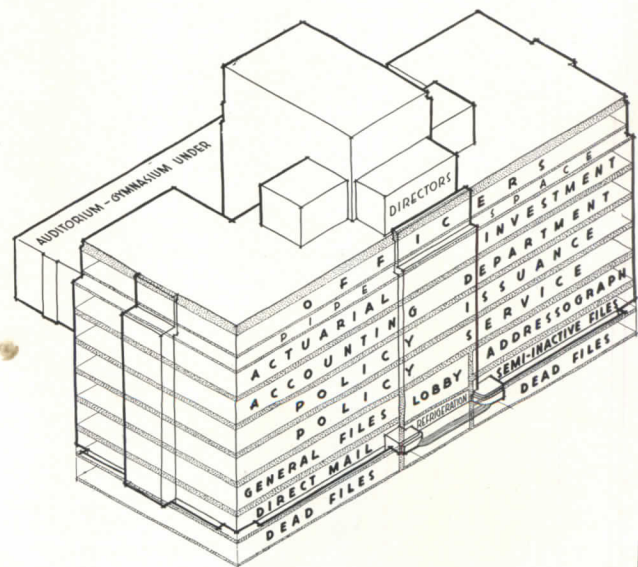



# BANKERS LIFE BUILDING

TINSLEY, McBROOM & HIGGINS, Architects

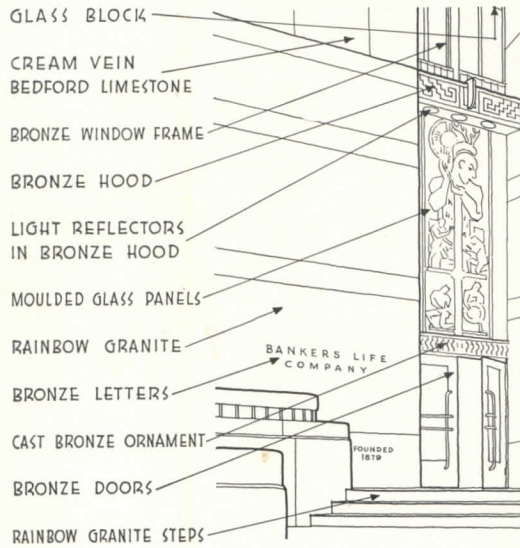

Front entrance

Quite as important as efficient departmental organization was the problem of providing circulation and communication—i.e. the easiest possible flow of people, things, and ideas. On this and the two succeeding pages, provisions for the circulation of people are discussed. Communication systems that facilitate interflow of things and ideas are outlined on page 68.

Chief entrances and exits are shown on the schematic diagram below, with accompanying photographs. The main entrance, shown at top, is used by both employees and the public. The three decorative moulded-glass panels above the doors, symbolic of Iowa history from Indian days to the present, are the work of Artists Lowell Houser and Glenn Chamberlain.

The center photograph shows the entrance to the auditorium at the rear of the main structure. This entrance with its separate driveway approach makes it possible to use the auditorium entirely independently of the rest of the building. The doorway shown at bottom is actually used as an employee exit. A similar one occurs in a parallel position at the other end of the building.

The extended drawing at the top of the page shows construction and finish details described more fully elsewhere in the presentation.



Auditorium entrance

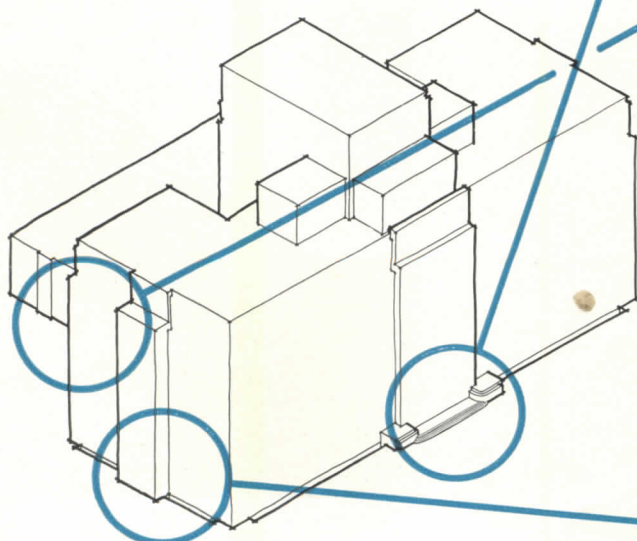

One of the exits



# PLANNING



Main lobby

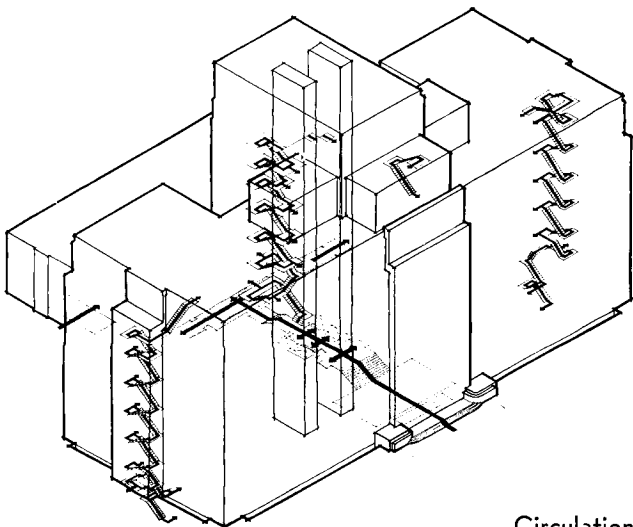

Circulation



Laboratory

ENTRANCES, lobbies, elevator shafts, hallways, and stairs are grouped for minimum cross traffic and conflict. The diagram at lower left shows the main vertical block at the center of the building with its elevator shafts and adjacent stairs. At either end are the secondary stair wells leading to exits. Construction details of these end stair halls are shown at right above.

Direct traffic flow is a primary consideration. The main entrance leads into the dignified central lobby, shown in the large photo, and up a few steps to the elevator lobby. The latter is detailed in the cutaway combination photograph and drawing at bottom right. Typical of the unusual consideration given to each detail of planning and finish is the subdued but harmonious surface treatment of these lobbies. The floor is of travertine, with a wide central traffic path of wear-resistant, non-slip greenstone, which shows as the dark-toned central strip in both the main- and elevator-lobby photographs. Walls are of polished travertine, with walnut-paneled recesses to the right and left of the main entrance. These alcoves are used for the waiting room and receptionist's desk. Above the paneling at either side, the wall spaces are decorated with mural maps—on one side, a map of the world, on the other, a map of the United States—designed and executed by Rambusch Decorating Company, under supervision of the architects.

At the rear of the elevator lobby, in a direct line with the main entrance, is the side entrance to the auditorium. If an employee meeting is held in the auditorium, the elevators bring the workers to this entrance, and they enter the assembly hall without crossing the traffic flow from the building's front entrance and lobby.

Indicative of the numerous other specialized areas within the building are the fully equipped medical laboratory on the third floor and the photostatic copy room, also on the third floor, shown in the photographs below.

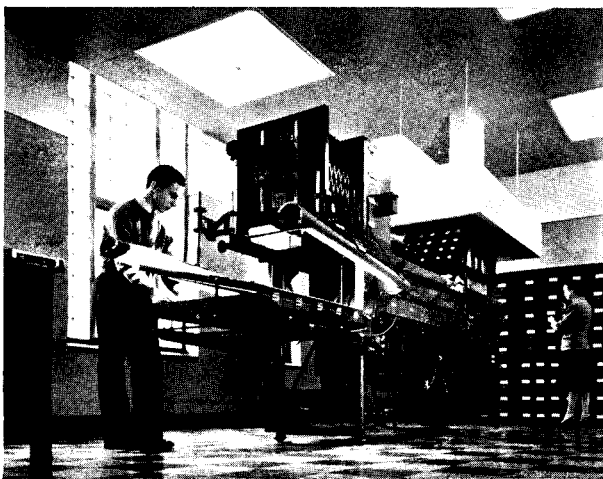

Photostat room

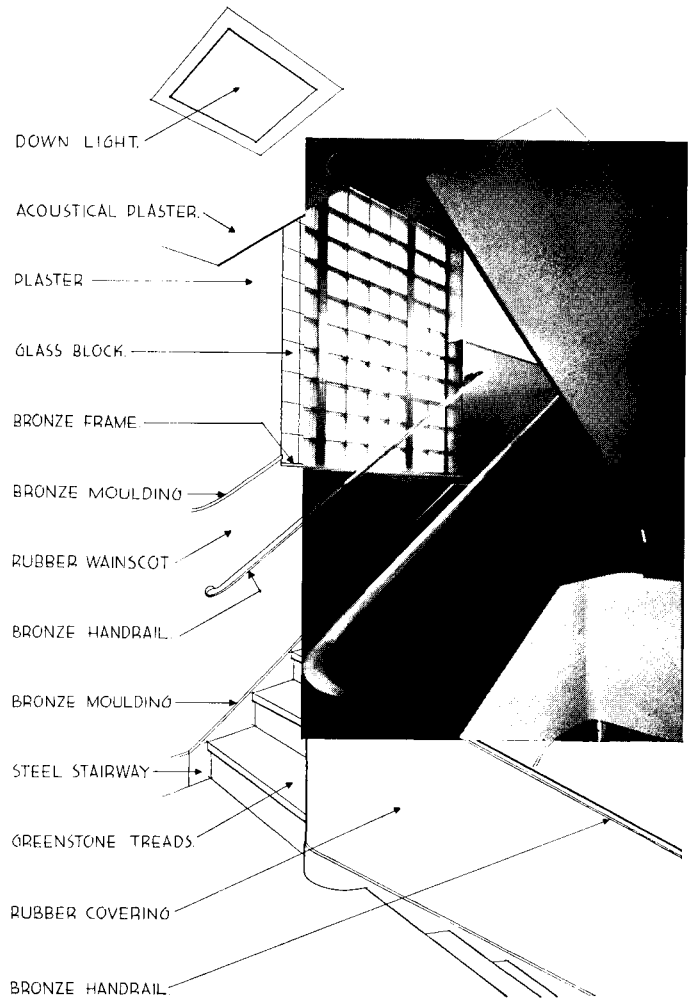

Stair hall

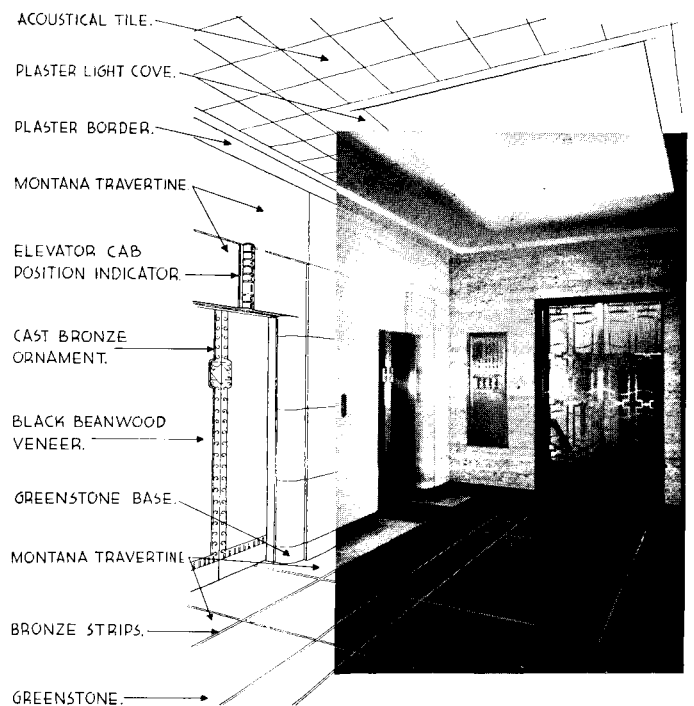

Elevator lobby



## 2. FACILITIES



From the outset, the Bankers Life Company insisted that every facility in the building be designed to produce the most favorable conditions possible for those working in the building. In generous areas set aside for the service, welfare, and recreation of employees, therefore, the building is exceptionally noteworthy. One of the best examples is the colorful and comfortable club room, shown above.

THE CLUB ROOM, located on the main floor, is planned as a pleasant place where those employees who bring their noon lunch with them may eat. In combination with the adjoining game room, it also offers ample facilities for reading, rest, and relaxation. Adjoining the club room is a small modern kitchen that is used both for the convenience of those bringing their lunches and for departmental social affairs where the serving of food is involved.

Occupying a portion of both the basement and ground floor is a well-lighted gymnasium. The room is equipped for basketball, badminton, and volley ball. Nearby are locker and shower rooms, with floors specially treated to discourage foot infections.

The great auditorium is principally used for salesmen's schools of instruction, meetings of employees, and similar sessions. But at other times it is also available for dances and social functions.

Other facilities provided for employee welfare are the roof terrace above the auditorium, dustproof wardrobes for hats and coats, and rest rooms on each floor for men and women. The latter are remarkable in a number of respects. The toilet partitions of structural glass are hung from the ceiling; all fixtures are wall attached so that the cleaning of terrazzo floors is greatly simplified. Large panels of glass block flood the rooms with light, and all fixtures are of the finest quality.



Employees' kitchen

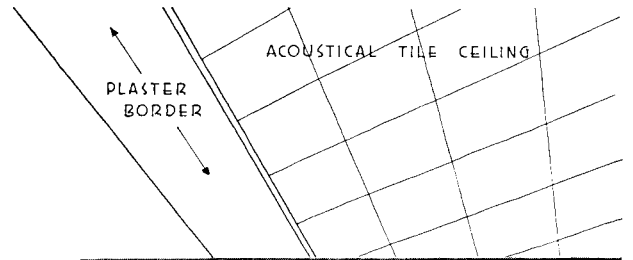
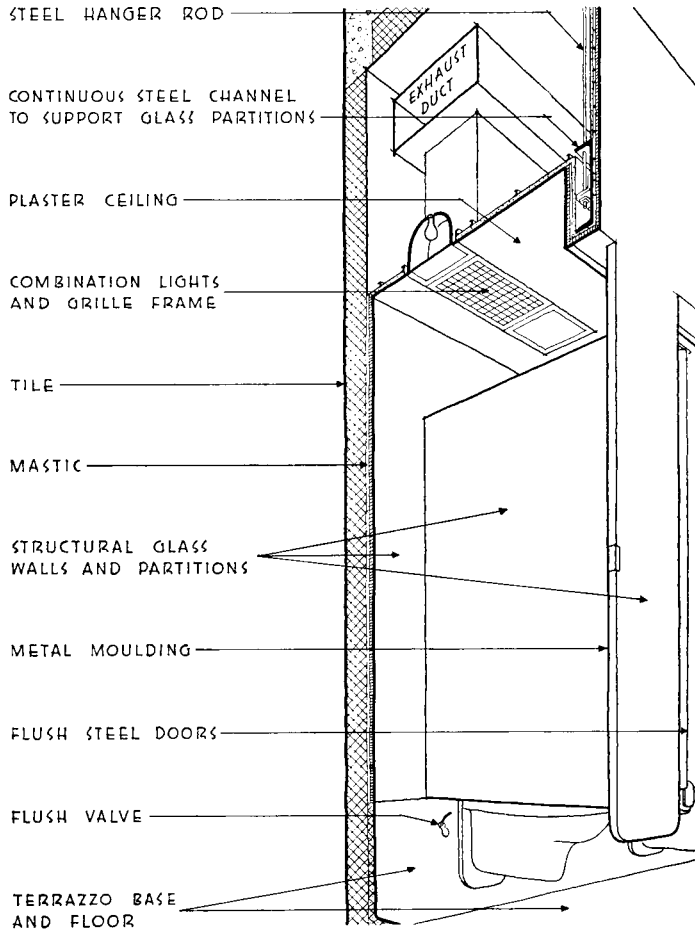

Toilet partition detail



Dustproof wardrobes

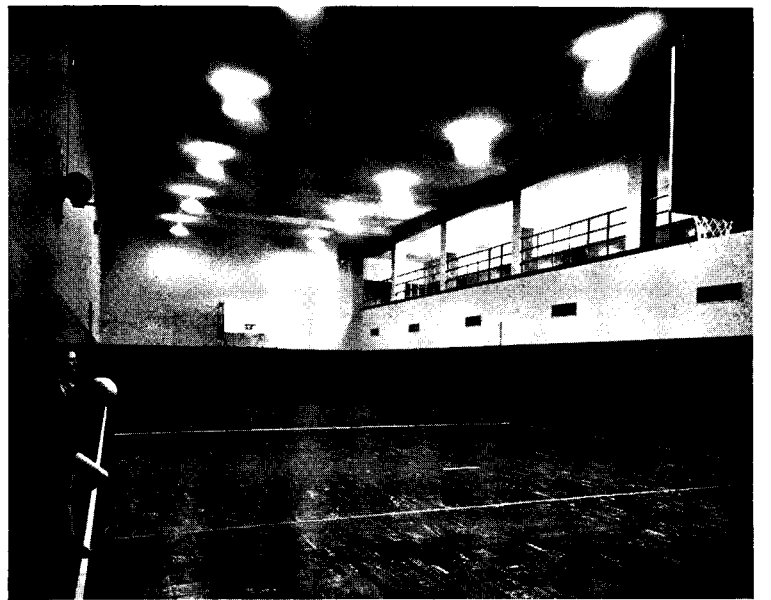

Gymnasium



# FACILITIES

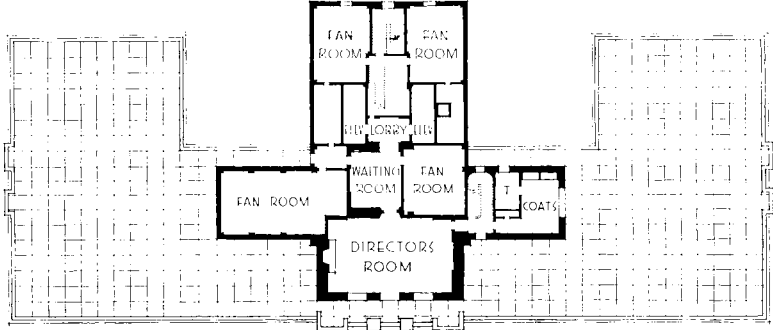
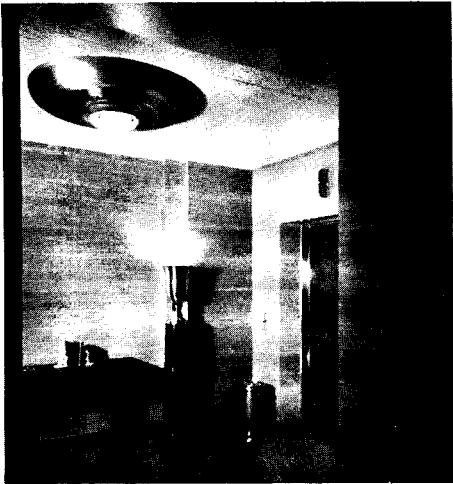

Plan of seventh-floor penthouse

At left, penthouse foyer; below, the directors' room



ON THE SIXTH AND SEVENTH floors are the accommodations for head executives. Here, of course, finish and furnishings are rather more luxurious, but the straightforward handling and restraint in design that is typical of the entire building holds here as elsewhere. The seventh or penthouse floor is occupied by the directors' suite—foyer, cloak room, toilet, and large board room. The latter room (below, on facing page) is handsomely finished with walls of walnut and teak. The rich color scheme is made up of two-tone wine all-over carpet, beige draperies, and chairs of walnut, upholstered in leather. All furnishings were specially designed and fabricated by W. & J. Sloane under the architects' supervision.

The private executive offices on the sixth floor are equipped with their own secretarial offices. Conveniently at hand, the law library and two conference rooms are also located on this floor.

In the central position at the front of the building is the president's office, generously daylighted by three windows on the south. The room has walls of an unusual East Indian laurel veneer, with a burl-inlay decorative band. A plaster border and cornice surrounds the acoustically treated ceiling. And the room is carpeted in dull gray-blue, with a formalized pattern.

Vice-presidential offices are finished with similar restraint and dignity. The walls of the one shown here are of walnut-veneer panels. The furniture is also of walnut, upholstered in leather. The all-over carpet is green.

Significant in finish treatments throughout the building was the consideration of ease of maintenance. The inner walls of most of the building—in the large work areas on all lower floors, for instance—are of paneled steel, which is easy to install, easy to keep clean, and not subject to cracks. Partitioning, likewise, is of steel-panel construction. The corners of all work rooms are rounded, which eliminates difficult-to-clean right-angle corners. On the floors of work areas, rubber tile is used. The borders of the floors and the cove base are an integral unit, mounted on metal backing. This still further reduces the "housekeeping" burden.



The president's office



A vice-president's office



# 3. STRUCTURE



The Bankers Life Building is an outstanding example of a structure designed from the inside out, and its physical structure is best understood by studying it on that basis. For example, the desirability of uninterrupted work spaces such as the one shown above was a determining factor in the design of both the steel frame (pp. 62, 63) and the heating and air-conditioning systems (pp. 64, 65).

IN THE DESIGN OF everything in the building, from foundations to wall surfacing, the logical functioning of the finished structure was in each case the starting point. In structure, economic use of space, provision for likely future expansion, working comfort of employees are just as much elements in the system as are bending moments, dead and live loads, or weatherproofness.

In studying the typical wall section opposite, the extraordinary degree of integration of structural elements, systems of control, and architectural treatment is particularly noteworthy.

All outside walls and roofs of the building are thoroughly insulated with 2-inch-thick cork. In the glazed openings, either glass block or double windows are used. Due to this tight structural skin, heat loss in winter and heat gain in summer at the walls and windows were reduced to a very low point. This structural determinant gave rise to the unusual perimeter wall-warming and cooling system that is shown on the page opposite and described in detail on pp. 64, 65.

**FOUNDATIONS:** Two factors in particular conditioned the design of the foundations—a difficult soil condition and the need of providing now for future expansion of the building.

*Soil condition:* Test holes revealed at one level a desirable

continuous layer of highly compacted gravel, over a stratum of highly compressible blue clay. Below this was sand of different types and, at a depth of approximately 50 ft., blue shale. A foundation system was devised that equalizes the load over the clay by placing a spread footing on the granular gravel stratum, and tying the footing into a continuous reinforced basement wall so that the footing and wall act together as a beam, equalizing any tendency toward cracking or unequal settlement.

*Future additions:* The fact that additions are contemplated at a later date (to form a hollow square around the present auditorium) led to a design for footings that will take care of this added load with a minimum of change and expense.

The footing is divided into alternate sections, with only those portions which carry the present building connected. Sections that do not carry any present load are separated from the load-carrying ones by mastic pads and from the concrete wall above by a space. Between the tops of these footings and the bottoms of the walls, are large steel wedges (see diagram, p. 62), one connected with the footing, one connected with the wall above. When excavation is made for the addition to the building, all that will be necessary is to tear out a waterproof covering over the wedge and screw up the wedge as the new load is applied, thereby bringing the now unused portion of the footing into play.

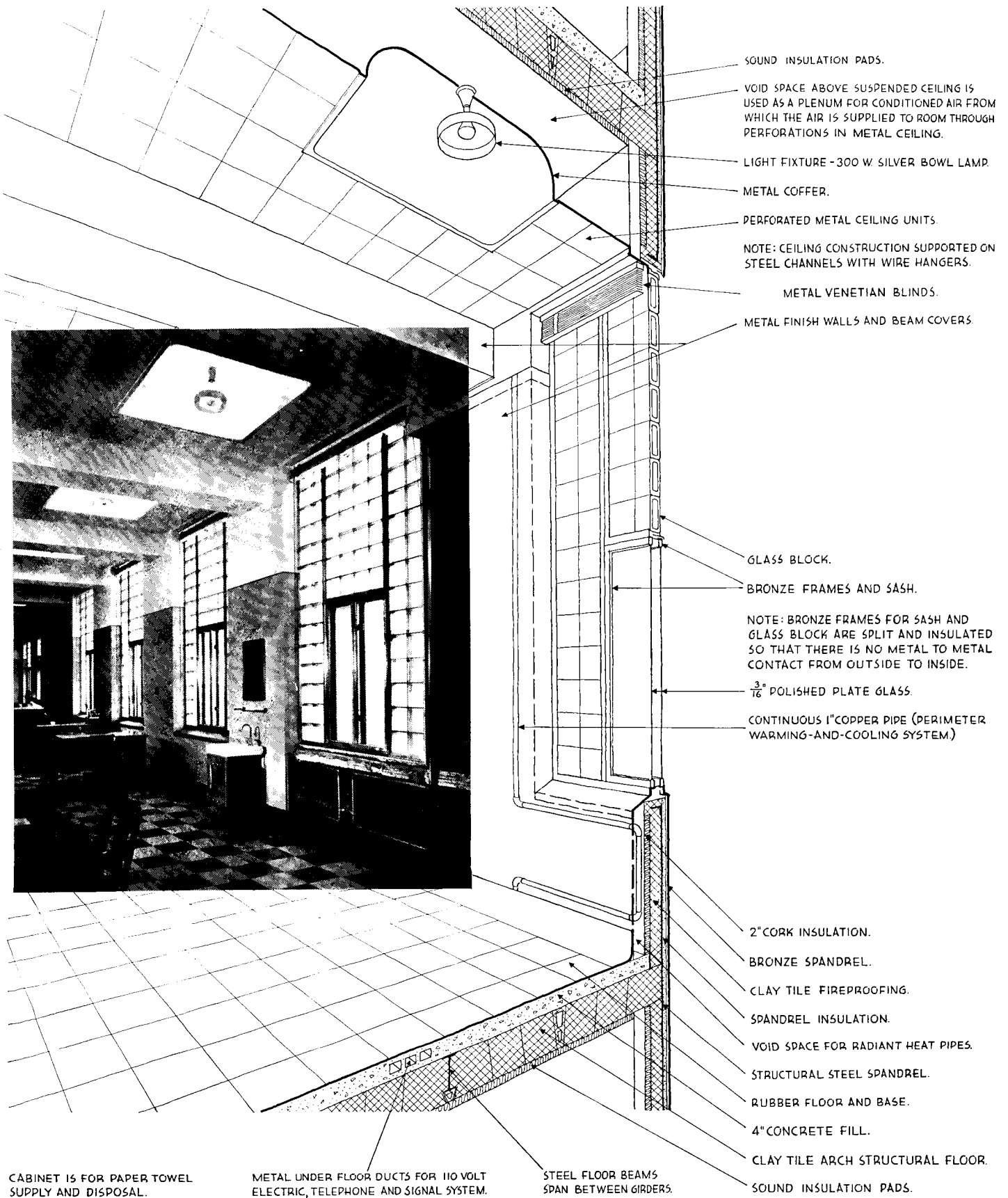

Typical structural detail





Typical workroom. Elimination of columns provides maximum flexibility for arranging desks or rows of file cases (at left).

**FRAMING:** From the first through the fifth floor, beams, 9 ft. 8 in. on centers, span 53-ft. widths without intermediate supports for the entire 235-ft. length of the rooms. Steel-panel partitions may be installed at almost any point. Underneath the floor surface, a network of service wiring makes it possible to connect signals, telephones, or machine power wherever needed.

Had simple beams been used for the 53-ft. spanning, the steel would have been excessively heavy. So a special beam was designed, built up of plates and angles with a camber on both upper and lower chords, with the camber of the lower greater than that of the upper. Connections to columns were made rigidly, throwing a portion of the moment on them that resulted in a slight distortion in the columns. As dead load was applied, the camber in the upper chord flattened out, the residual camber on the lower chord being retained for its optical effect.

The smaller beams which support the flat tile arch construction are connected across the 53-ft. beams by weld plates on top and welded angles at the bottom connection, which give continuous action through the length of the building. This not only gives the building great rigidity, but saves considerable steel tonnage. In the central-tower portion, the floor is of reinforced concrete slab-and-beam construction which acts as a stiffener for the entire structure.

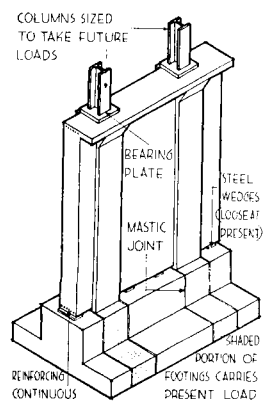

Detail of footing

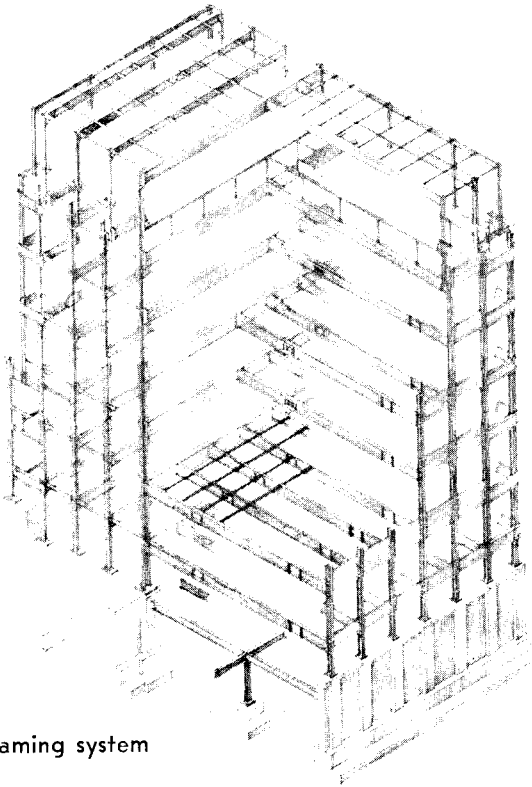

Framing system

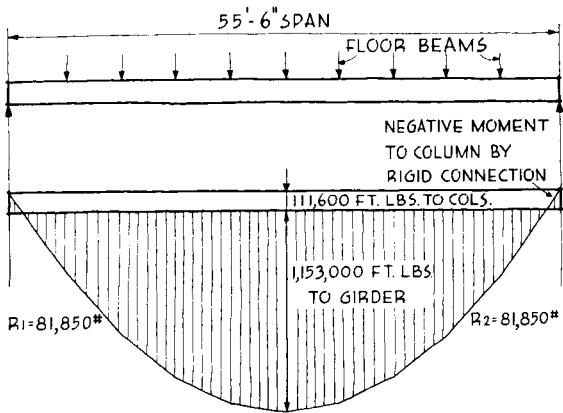

MOMENT DIAGRAM  
TYPICAL FLOOR GIRDER - 2ND TO 5TH FLOORS

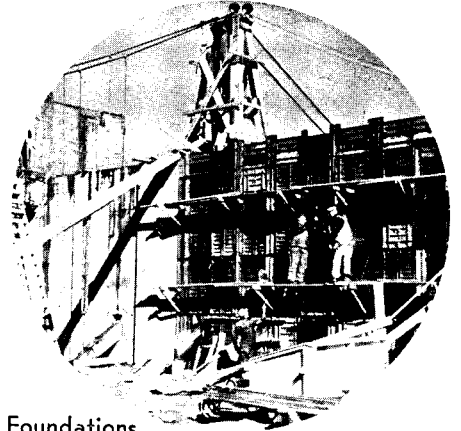

Foundations

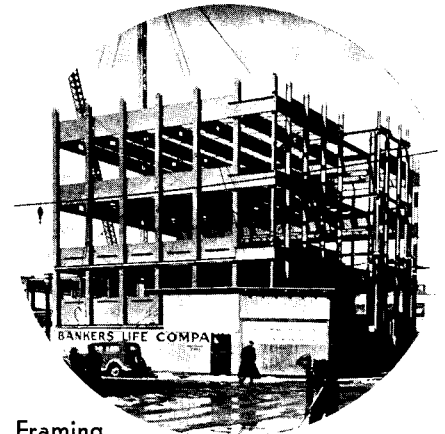

Framing

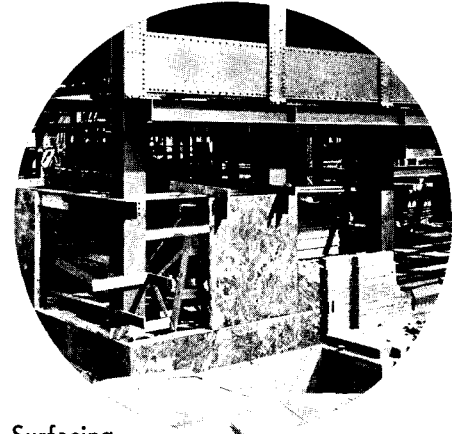

Surfacing

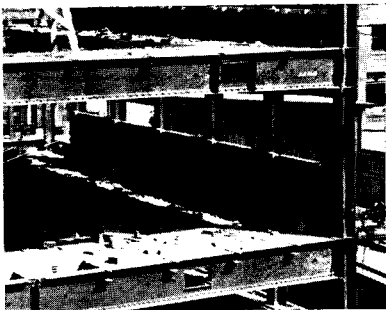

Close-up details of steel framing

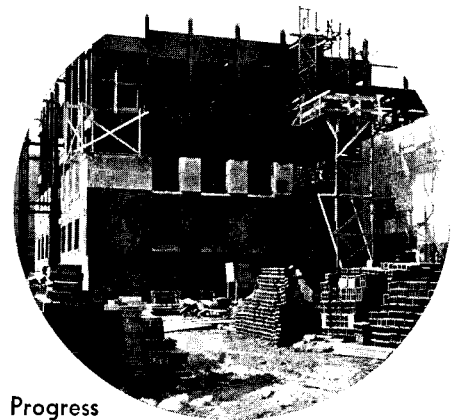
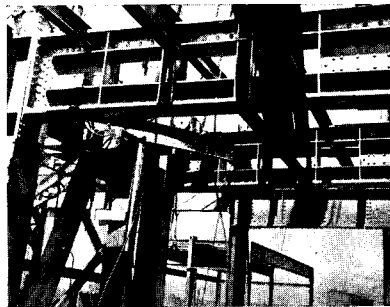

Progress



# 4. SYS ELS

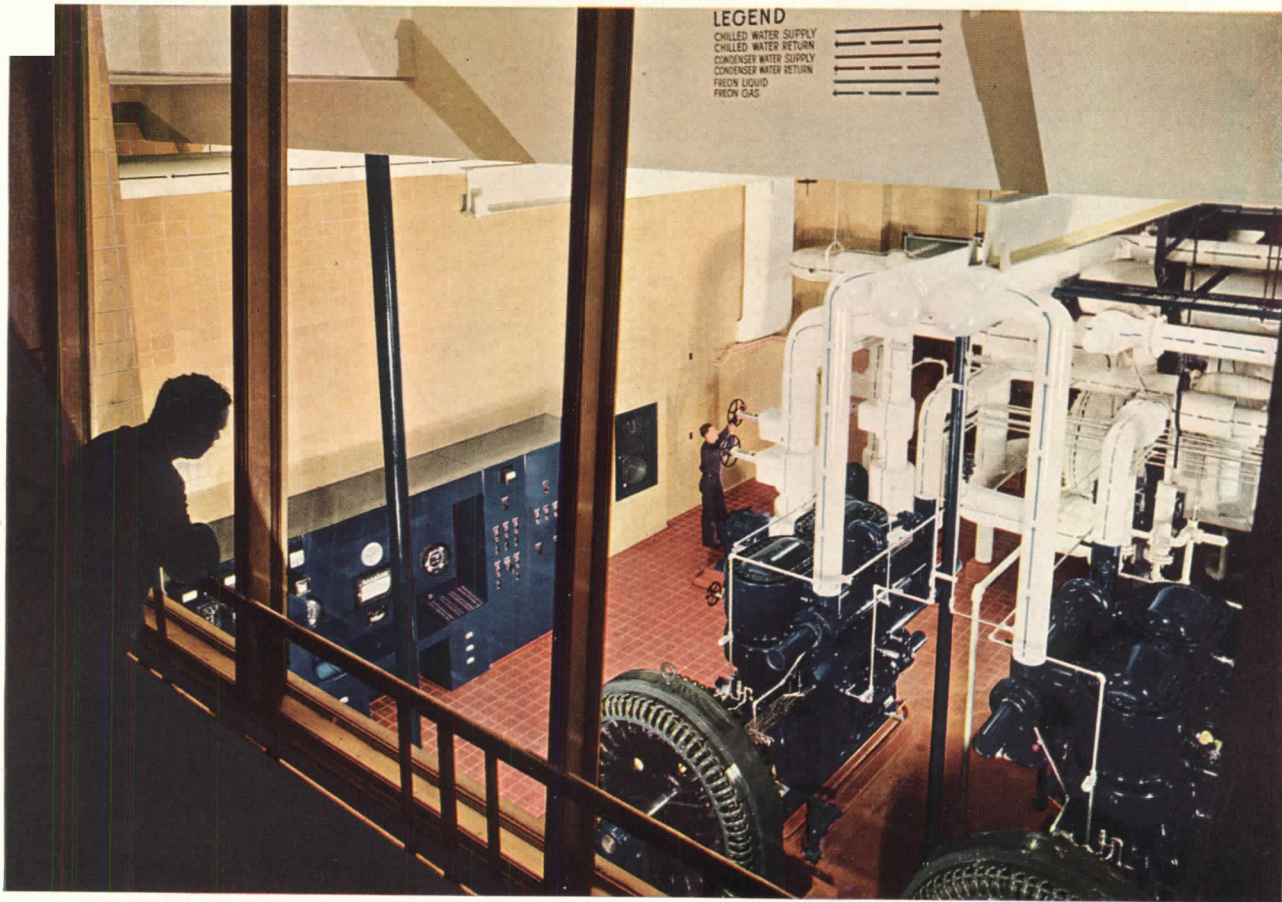

Control systems were designed to aid efficient flow of office work. The competent organization of this complex equipment is nowhere more dramatically apparent than in the compressor room, seen (above) from the visitors' balcony. Described here are the systems for control of atmosphere (pp. 64, 65), light (p. 66), sound and communication (pp. 67, 68).

**ATMOSPHERIC CONTROL SYSTEM:** In essence, this consists of two major elements—a *perimeter warming-and-cooling system* (continuous 1-in. copper pipes in all exterior walls) within whose envelope operates a *centralized air-conditioning system*. Two factors led to this novel design: (1) the extreme annual temperature range in Des Moines, which made summer cooling desirable, and (2) the loss of effective work space around the perimeter of a space heated by standard radiation.\*

Refrigeration for cooling water (to condition air for distribution through the perforated ceilings, and for circulation through the walls) is handled by three Freon compressors, two 4-cylinder and one 2-cylinder. Each of the 4-cylinder machines is directly connected to its own evaporator and condenser, and the 2-cylinder machine may be used in conjunction with either evaporator and condenser unit, or the entire plant may operate as a unit. Thus, the failure of any one element would not seriously impair functioning of the building.

**HEATING:** Both steam (for the air conditioning) and hot water (for circulation through the walls) are provided by a bank of three boiler units burning Bunker-C oil under complete automatic control. Each boiler is provided with an operating panel showing pressure, over-fire draft, and the degree of smoke.

**WATER COOLING AND SOFTENING:** Because of local water conditions, all water used on make-up for the cooling tower and for all circulating systems is softened. The cooling tower is designed as an integral part of the building (see p. 50).

**CLEANING AND WASHING:** Air from outdoors, together with a portion of the return, passes through suitable preheaters and then through an electrostatic precipitator where from 85% to 90% of all dirt is removed. This equipment was selected to remove smoke particles, which cannot be effectively removed with ordinary filters, as well as the air-borne dirt and pollens usually present. This air mixture then passes through an air washer where the moisture is removed or added as required. In the summer, cooling is simultaneously effected.

\*The wall-warming system located between the inner and outer membranes of the exterior wall (see page 61) "is not to be confused with radiant heating, although in some respects its objectives are the same," according to Mr. Leopold. "The term radiant heating is generally used to describe a type of heating system in which the ceilings, and in some cases the walls, are heated to a degree that will permit comfort of the occupants at a general room temperature substantially below our present accepted standards. In systems of this type the heating pipe is usually imbedded in the building material and the building surface raised to temperatures in excess of 100°. In the Bankers Life building it is necessary to heat the walls only to a temperature at which the average radiating temperature of the windows and exterior walls will limit the rate at which the human body loses heat by radiation: this required temperature is in the vicinity of 70°. With this installation local sensations of warmth or coolness from interior partition to outside wall are practically eliminated."



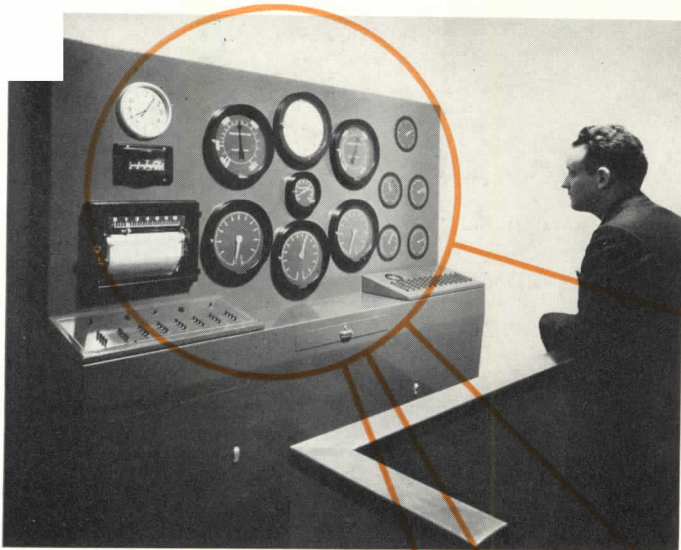

Master board in superintendent's office

**DISTRIBUTION OF CONDITIONED AIR:** Two main conditioned-air fans and the fan used for return and exhaust are located in the penthouse adjacent to the elevator equipment. The duct distribution of conditioned and return air is substantially vertical through the utility shafts of the building. In the major work areas the system is controlled in accordance with zones corresponding to the sun exposure, and the air is delivered through perforated ceilings. The ceiling construction differs from the usual in that sound absorption has been placed in the underside of the slab of the floor above. This method was selected in order to limit heat transmission through the floor and to make the systems less dependent on the tightness of plenum spaces, as well as to provide easy access to various piping and mechanical equipment located within the ceiling.

**PERIMETER WARMING AND COOLING:** Throughout the major work areas the heat required at outside walls is supplied by a perimeter system in back of the finished wall, carrying hot water (in the winter) and chilled water (in the summer) under forced circulation. Although the air-conditioning system proper is capable of heating the structure, in a climate such as that of Des Moines it was thought advisable to provide separate means of heat adjacent to the window and wall areas in order to counteract a sensation of cold. But it was also desirable to eliminate the concentrated source of heat, as well as the grilles and openings, usual in conventional radiators. With the wall and window losses compensated by insulation (p. 61) and the perimeter heating-and-cooling system, air delivered by the conditioning system will vary from room temperature downward, even in the winter. The wall-warming system is also used during winter nights when the building is unoccupied, and serves to keep the building at temperature so that minimum time is required to reach proper conditions in the morning. Although the system is equipped so that chilled water can be circulated in hot weather, it was not considered advisable to increase the surface to compensate fully for heat transmission and sun effect in summer.

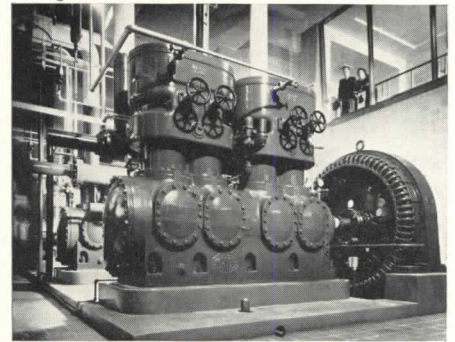

REFRIGERATION

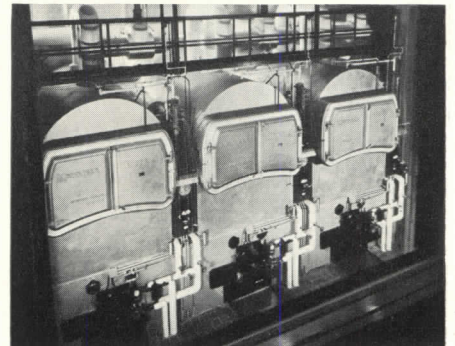

HEATING

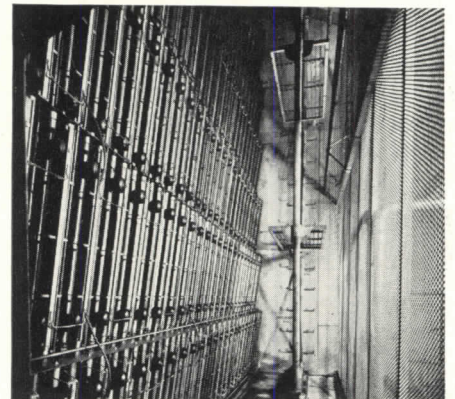

CLEANING

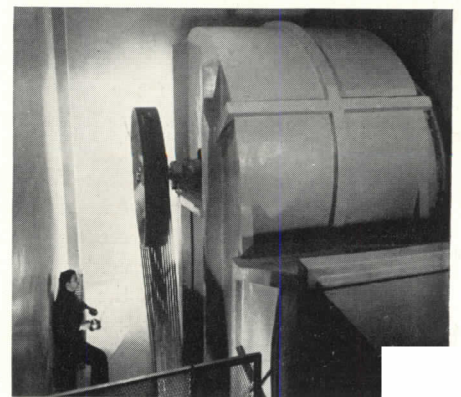

DISTRIBUTION



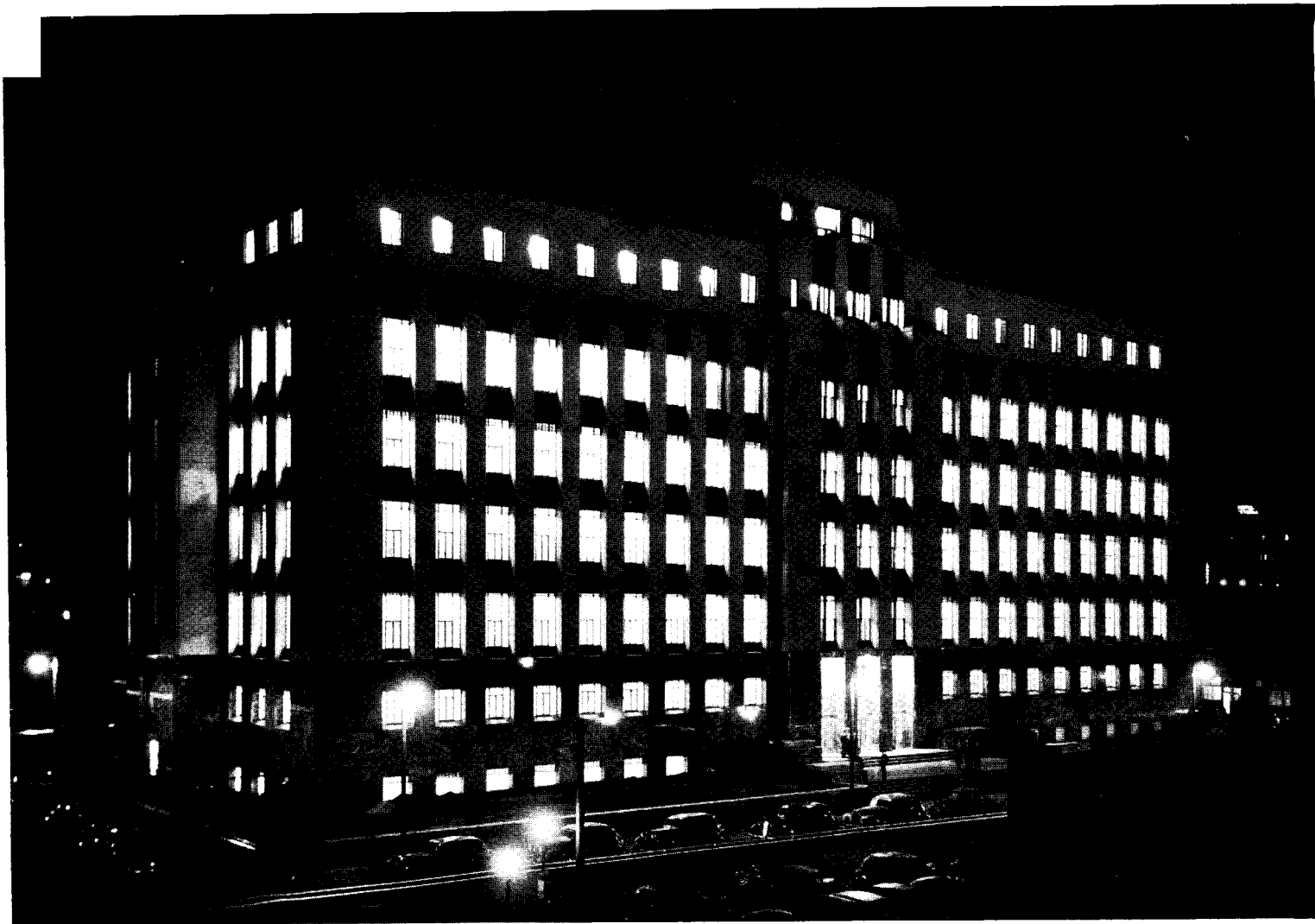

**ARTIFICIAL ILLUMINATION:** Although there are many specialized lighting sources throughout the building (right), the basic system used in all major work spaces consists of a series of prefinished metal coffers recessed flush with the hung ceiling. From this coffer hangs a 300-watt frosted silver-bowl lamp. Around the lamp is a vertical louver to conceal the bulb brightness from the employees. Tests have shown that this system achieves an average illumination level of 35.9 footcandles at desk height; that it is approximately 40% more efficient than conventional indirect lighting; and that the quality of light is very much superior to the direct or semi-indirect lighting. Eliminated is the inverted forest of hanging fixtures; also the cost of cleaning fixtures is drastically reduced.

**NATURAL ILLUMINATION:** Although glass-block panels set in bronze frames are used throughout the building, it was felt that it was psychologically important for employees to be able to see out. Thus—in all principal work spaces—double casement windows center the glass-block panels. By aligning these panels with the interior wall surface, the designers were able to exploit the deep reveal resulting from the framing system described on pp. 60-63. Orientation studies indicate that this reveal protects glass-block panels on south and west from a large portion of the heat-and-light load of the sun. Venetian blinds are used throughout to reduce excessive brightness.

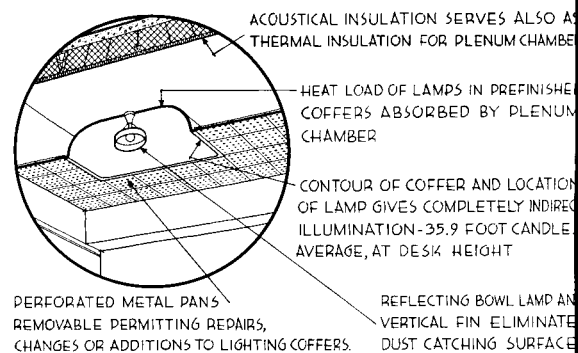

Light-coffer detail

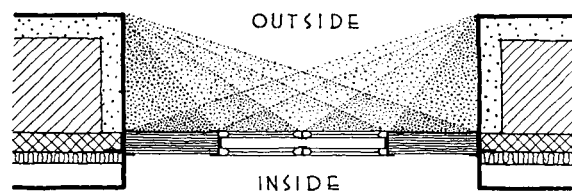

Typical window section

**ACOUSTICAL CONTROL:** Several distinct types of acoustical problems arose and were admirably solved in the design of this building.

(a) *The quieting treatment in the major work spaces was to be integrated with the air-conditioning and lighting systems used.* Laboratory tests have shown that a perforated metal surface with only a small percentage of perforations transmits almost 100% of the sound energy which strikes it. Further it was known that due to the diffraction of sound waves, the lighting coffers, which for optical reasons should be continuous high-reflecting surfaces, would not materially reduce the acoustical efficiency of sound-absorbing material placed back of them, provided there was an open space between, through which the sound waves could pass. Thus, by carrying the perforated metal ceiling and the lighting coffers on a hung steel construction, suspended some 18 in. below the structural ceiling, to which the sound-absorbent pads (having a noise-reduction coefficient of 80%) were attached, and by using this space as a plenum for incoming air, it was possible to meet air-conditioning, lighting, and noise-quieting requirements with a single construction.

(b) *Corridors and public space were to be rendered reasonably quiet.* For all corridors and public spaces where acoustical treatment and air conditioning were not combined, acoustical plaster and/or acoustical tile were specified.

(c) *Executive offices and directors' room were to be effectively insulated from machinery noise and building vibrations.* Noise from the ventilating and air-conditioning equipment on the two top floors presented a problem in sound isolation, since the directors' room is located in this part of the building. For quiet operation, resilient mountings for all heavy machinery were used. Heavy 6-in. walls of fairly absorbent tile, unplastered on the machine-room side and separated by an air space from the walls of the directors' room, served to prevent the transmission of vibrational energy and also afforded a high degree of insulation for air-borne sounds.

(d) *The auditorium, designed for the use of employees and company agents, was to be rendered acoustically good for a wide variety of uses.* An acoustical analysis of the auditorium was made with a view to effecting the best possible compromise between the desirable conditions for its varied uses. A mineral-wool blanket faced with perforated hard board on ceiling and rear wall was the treatment finally adopted. Draperies for the auditorium stage were selected with a view to securing proper sound reflection to the audience.

Various types of acoustical plaster and tile.

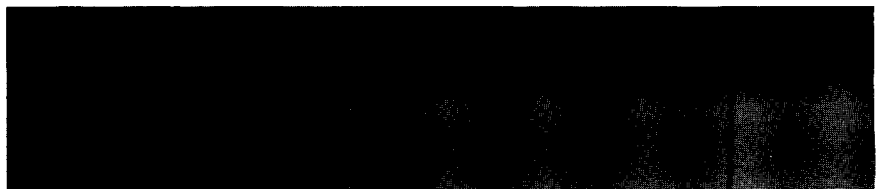
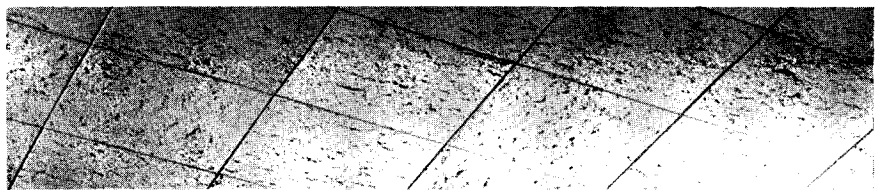
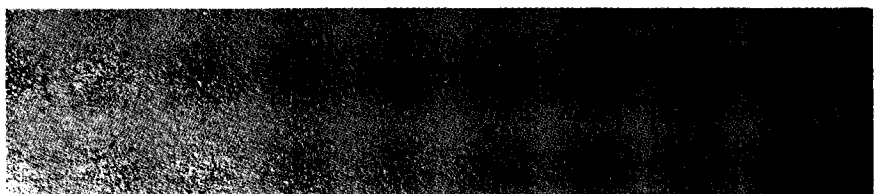
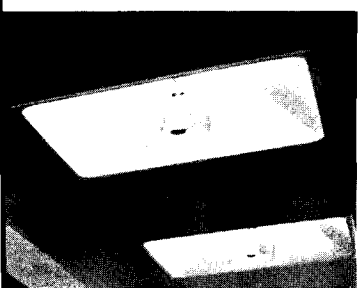
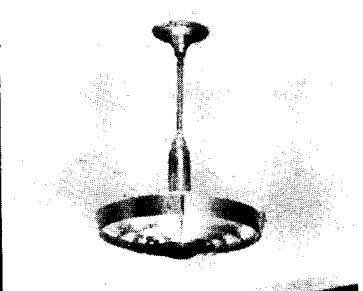
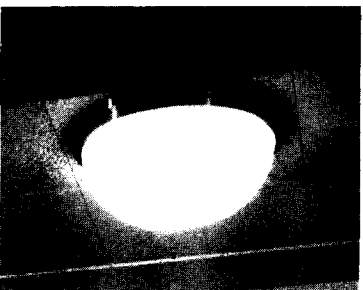
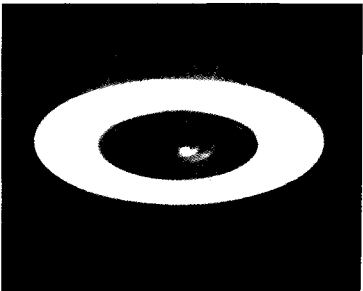
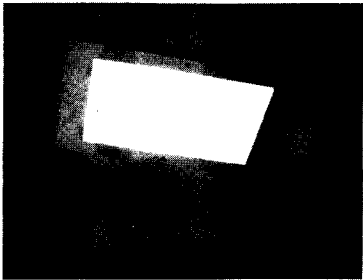
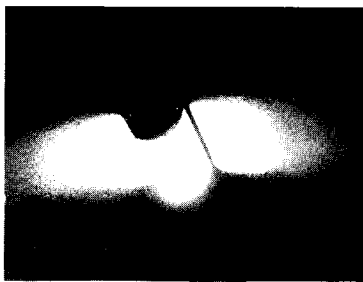



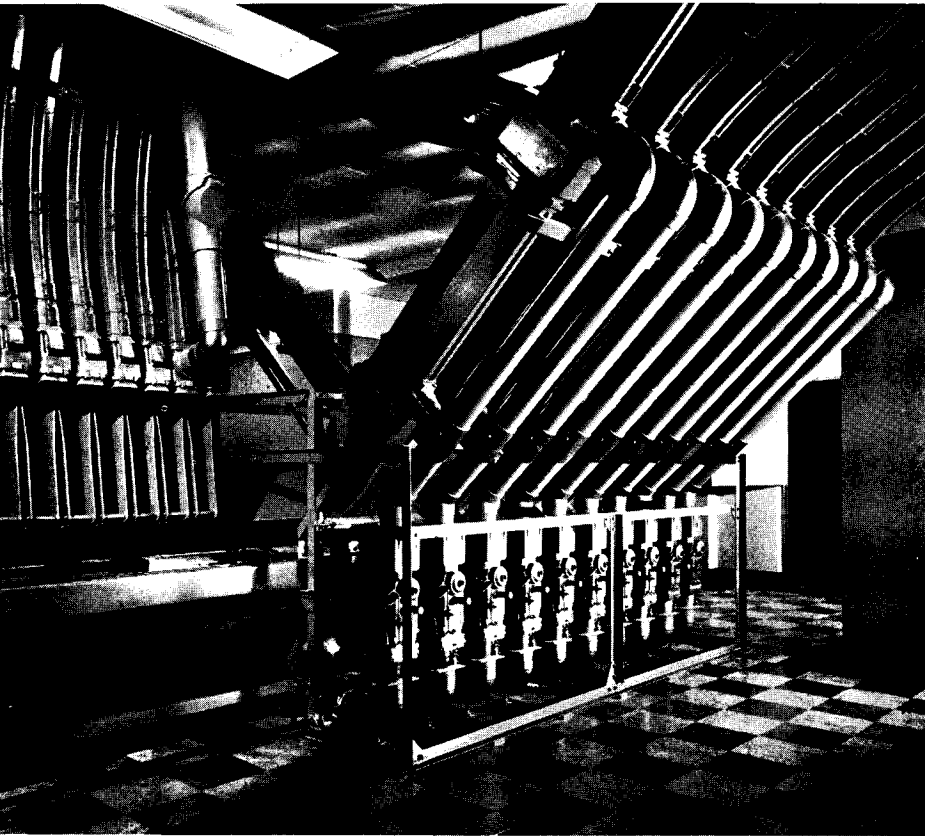

**PNEUMATIC TUBES:** The system serves two stations on each floor. Tubes and cartridges carry fully loaded standard company file folders.

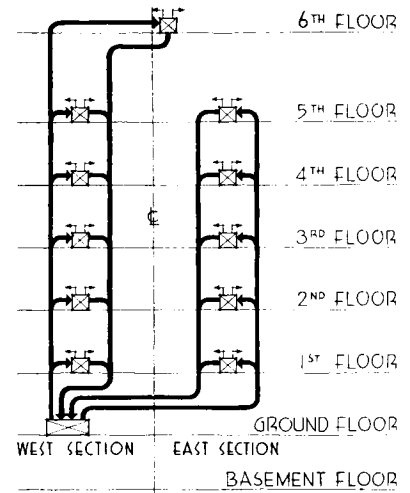
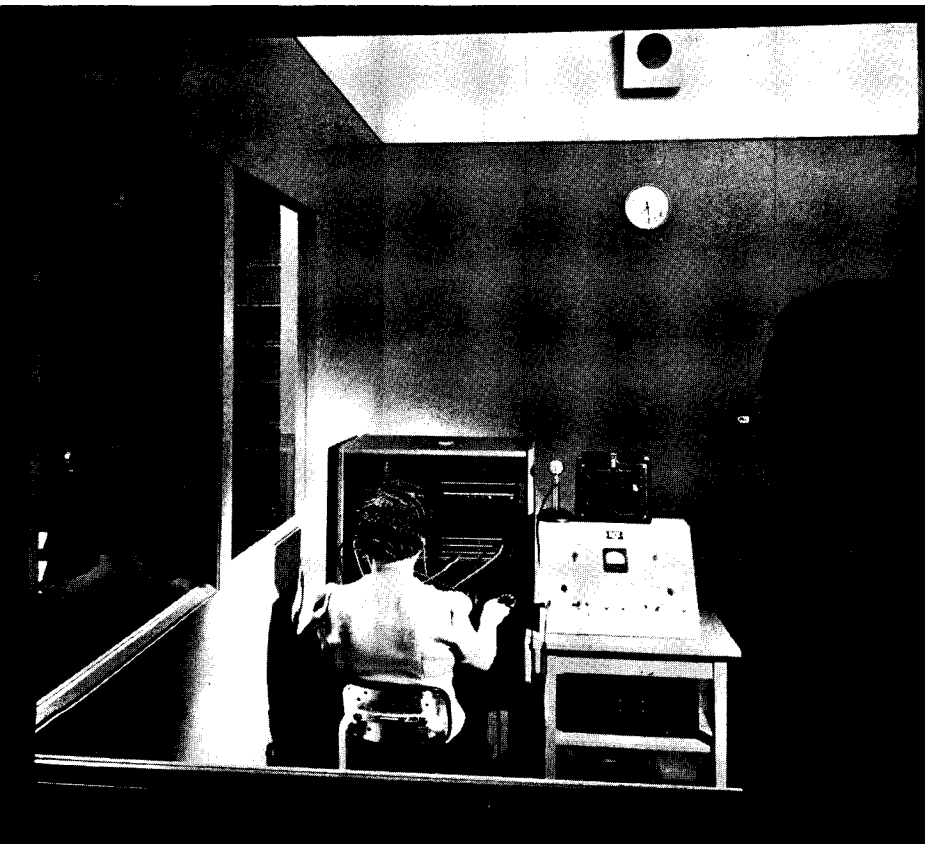

Diagram of pneumatic-tube system



**TELEPHONES:** 10 trunk lines to outside, with a capacity of 145 instruments; dial system completes both office and outside calls without operator.

**COMMUNICATIONS:** A notable effort has been made to simplify and speed up circulation (movement of people, see pp. 54, 55) by a flexible communication system (movement of ideas and things).

**Sound:** The complete installation, built around two interconnected 50-watt commercial sound units, serves a multitude of uses throughout the building. A paging system operating from the main telephone switchboard (left) is connected with 42 speakers located in all parts of the building.

Connected with the paging system, one of the 50-watt amplifiers is used for sound reinforcement in the auditorium. This may be used to amplify radio broadcasts, recorded music, voice, or programs on the auditorium stage. Five unidirectional microphones assure satisfactory sound pick-up for all occasions.

Two sound projectors for "talkies" are installed in the auditorium projection room. These have their own sound apparatus and have no connection with the public-address system. A photophone high-fidelity speaker is built into the wall over the proscenium opening and is concealed from view.

Through connection with the paging system, any activity in the auditorium may also be transmitted to any part of the building. Microphones have been placed in auditorium and telephone exchange, as well as in the directors' room on the seventh floor, so that officials may speak to an audience in the auditorium or to the entire building. Conduit was also extended to the top of the building with the idea that the company may at some time want to broadcast time signals, Christmas carols, etc.

A deluxe recorder operating at both 33 $\frac{1}{3}$  and 78 r.p.m. is connected with the auditorium system so that any speech or program may be permanently recorded.

# HOUSES WITH FOUR OR MORE BEDROOMS

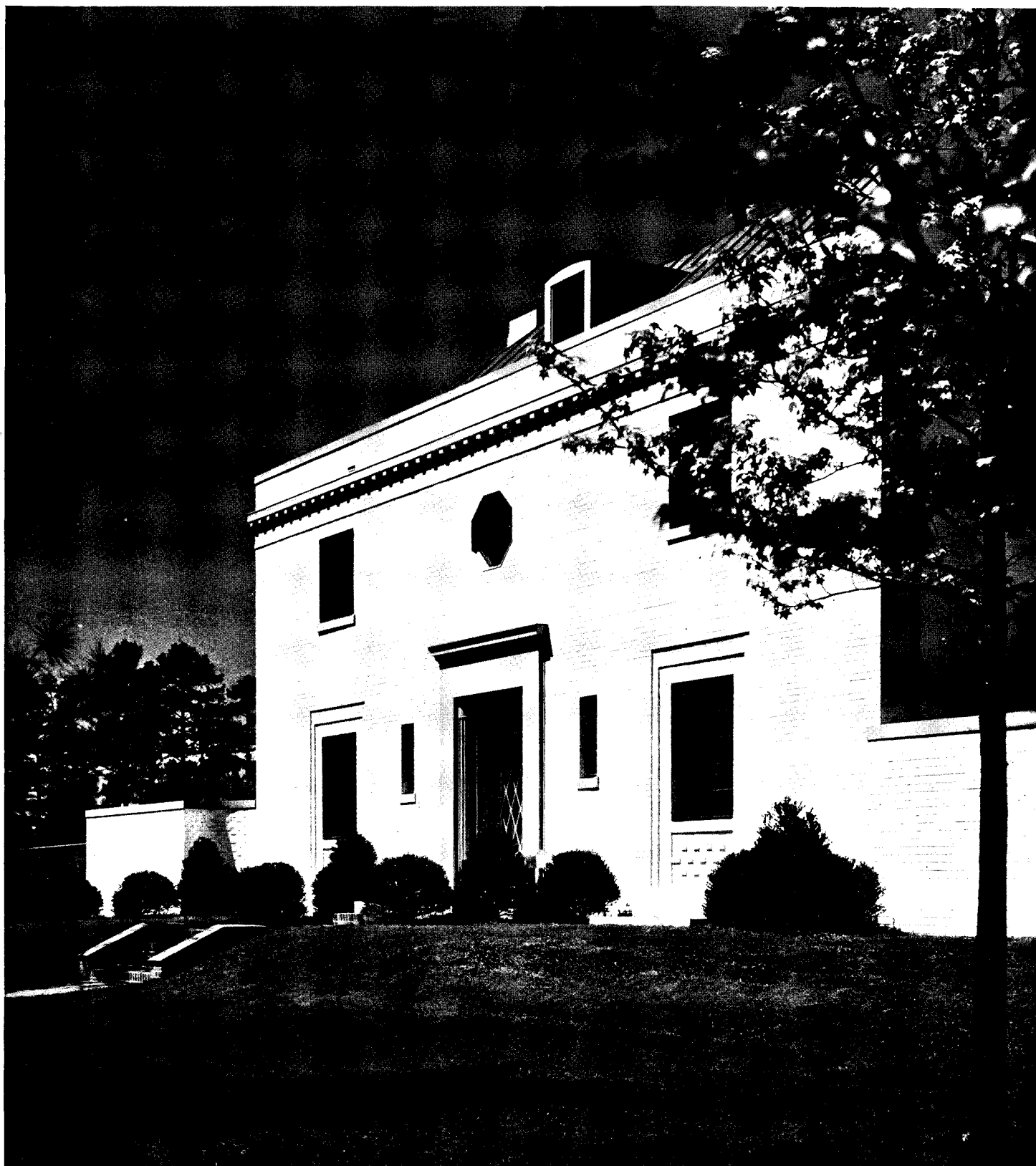

Ernest Graham

Presented on the following pages are a group of houses whose basic design problem was the provision of at least four bedrooms. Although these houses are located in widely separated parts of the country, they have a common denominator in that all are in suburban districts. The house section this month leads off with a residence in North Carolina for which GEORGE WATTS CARR was architect.





## CONTEMPORARY DESIGN BASED ON REGENCY STYLE

This residence near Durham, N. C., a contemporary expression of the style known as Regency, was designed by Architect Carr for Mr. and Mrs. William Muirhead and their two children. Although traditional in origin, the design eliminates unnecessary detail, relying instead on simple mouldings and an occasional variation in the brick texture.

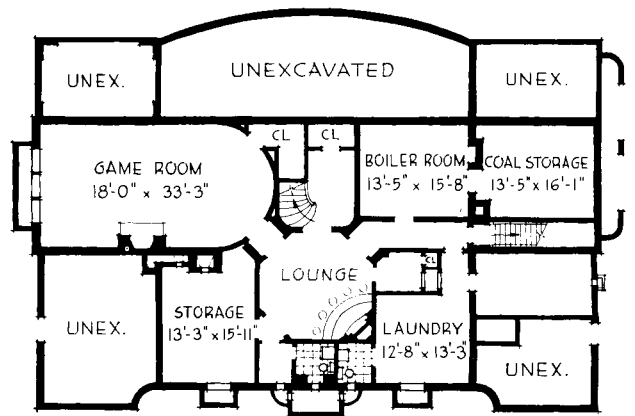

BASEMENT

THE FAIRLY LEVEL plot on which this house is situated is part of the Forest Hills development near Durham. The house faces a road, but stands well back from the street. The plan is an interesting one—unsymmetrical on the first floor, symmetrical on the second. Garage and part of the living room extend beyond the wall line of the central portion of the house, and make possible a variation in mass. Only the central portion has more than one floor above ground level. Considerable space is devoted to vestibule, reception hall, and stair hall, which constitute the principal means of circulation on the first floor and materially increase the spaciousness of the living area. The kitchen, conveniently located near the front entrance, has its own service entrance and court, and is connected by a large pantry with dining and breakfast rooms. Bedrooms for the three servants are in the attic. The house is of fireproof construction up to the second floor; from there up brick veneer on frame was used. The main roof is of copper.

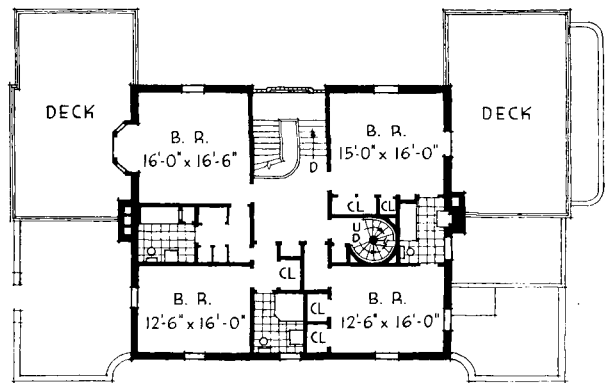
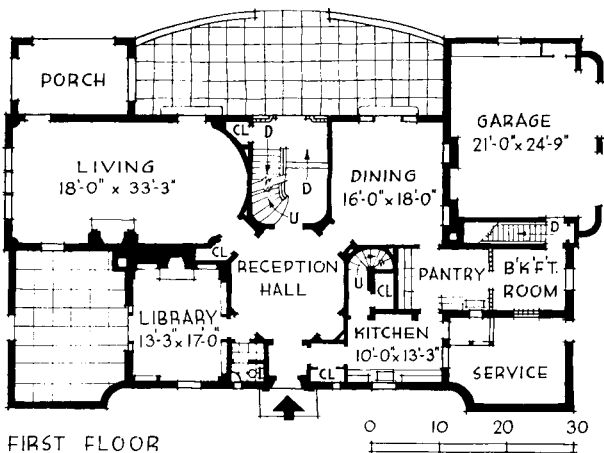

FIRST FLOOR

SECOND FLOOR



HOUSE IN NORTH CAROLINA

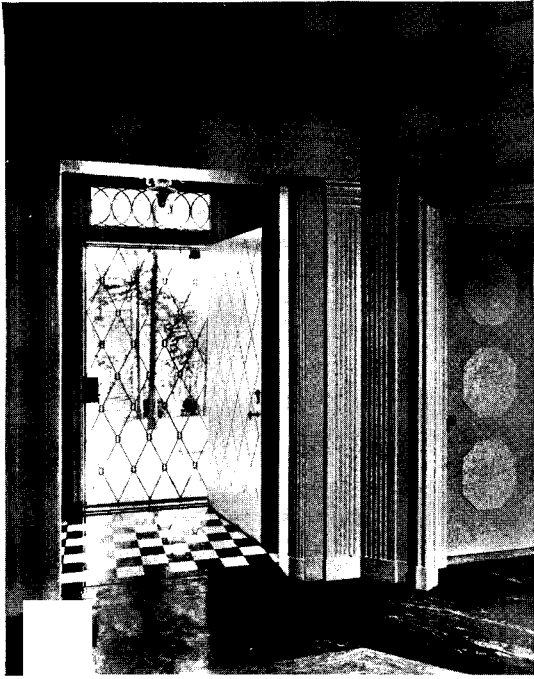

View from reception hall looking toward vestibule and main entrance



Photos by Ernest Graham



Main feature of living room is the fireplace set on a mirror panel; right, view from breakfast room toward pantry.

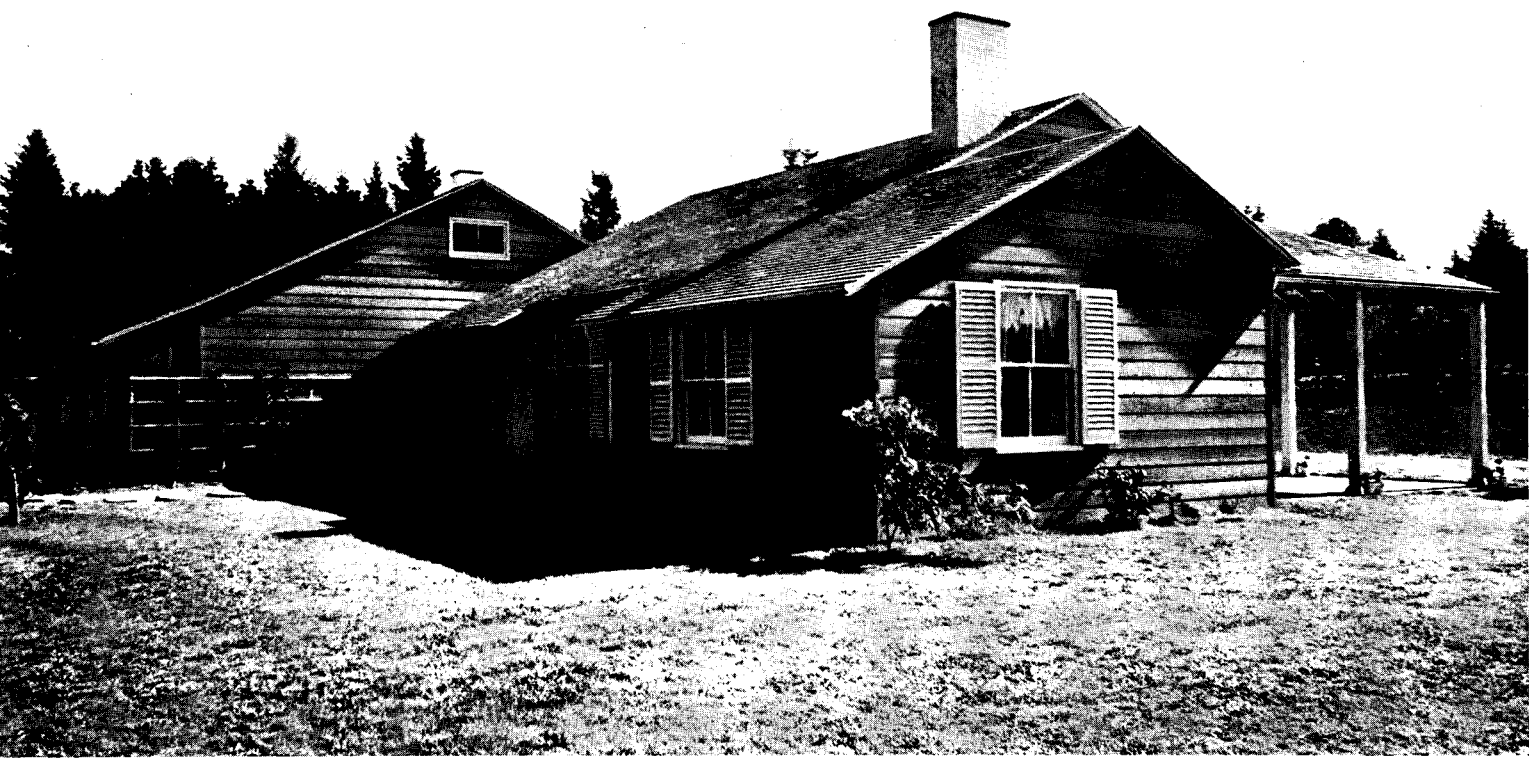

Photos by Roger Sturtevant

## DESIGNED FOR INFORMAL LIVING

Located on a 5-acre plot of rolling country near Portland, Oreg., this house for Mr. and Mrs. Paul Westernoff was designed by Architect HAROLD DOTY. The particular requirements were that the house be of the informal farmhouse type, and provide plenty of open living space, both inside the house and around it, for the family of four.

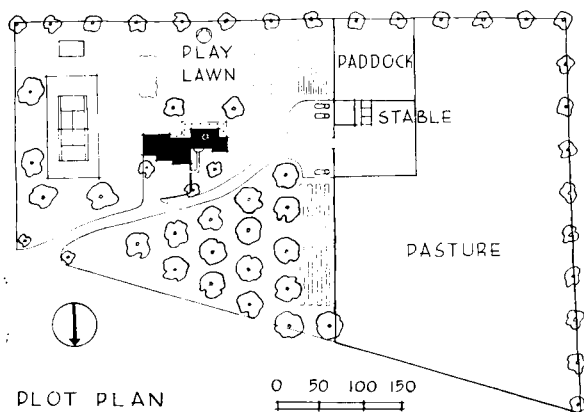

PLOT PLAN



Entrance, with garage and auto court at left

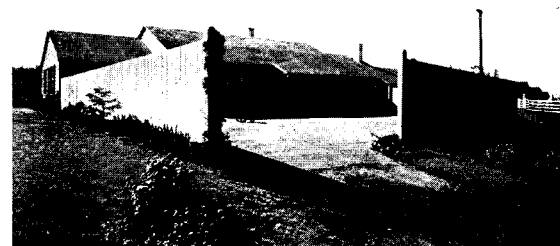

View toward the auto court from private road



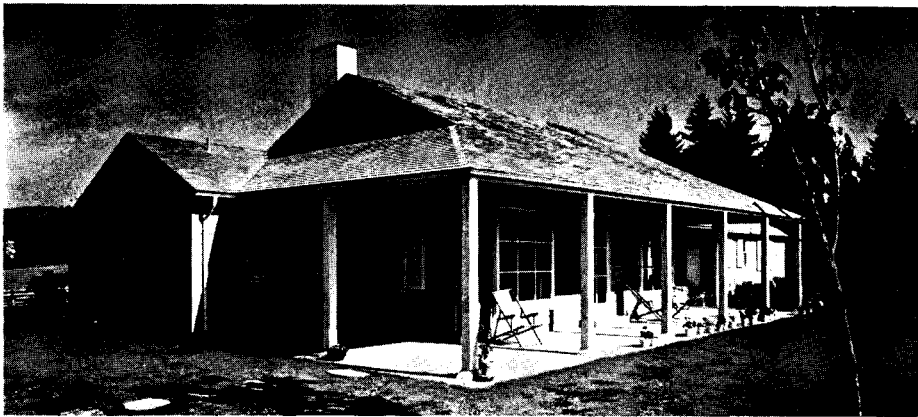

Photos by Roger Shurtevant

## HOUSE IN OREGON

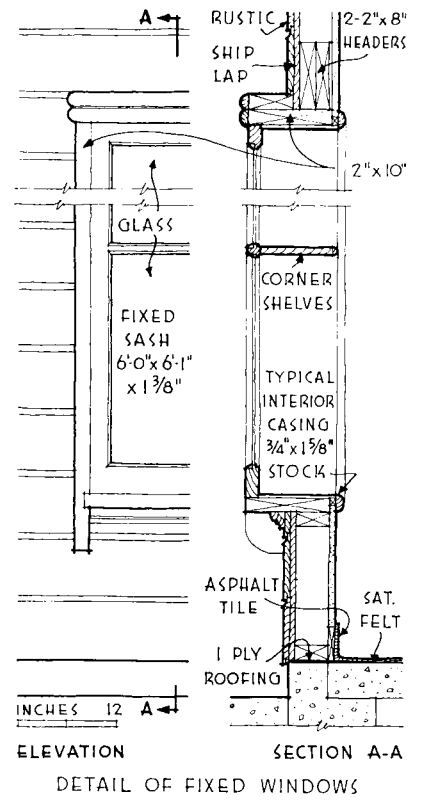

Three views of the rear: top, low lines give the informal character specified by the clients; center, the porch faces the play lawn and is accessible from main rooms and the kitchen; below, detail of porch, showing the door into the living room.

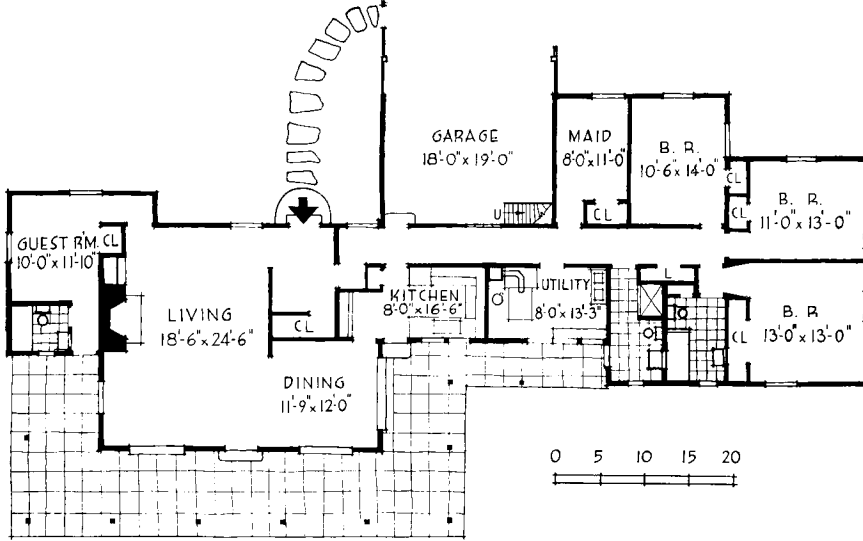

**HAROLD DOTY, Architect**

ORGANIZATION of elements played an important part in planning this house. For instance, living space is located at one end of the house convenient to the play lawn and parking area; the service area acts as insulation for the sleeping quarters which are at the opposite end from the living room. The guest room, used only occasionally, opens off the living room and is quite independent of the rest of the house. A staggered arrangement of doors, leading from the lobby to the living room and to the corridor, cuts off direct view from the living room to service and sleeping areas.

The house is of frame construction, on a 4-in. concrete-slab foundation, poured on a 3-in. crushed-rock fill. Floors in the main rooms are of tempered composition board; elsewhere they are of asphalt tile. The car shelter has a macadam floor; the local climate and protecting fence permit elimination of garage doors. Cost of the house was \$9000.

The living room (top, right) has walls and ceiling of white sand-finish plaster; fir trim and doors are enameled in white. The dining space (below) is actually an alcove off the garden end of the living room.





## OWNERS' HOBBIES DETERMINE PLAN FEATURES

The residence of Mr. and Mrs. John Taylor Snite in Deere Park, near Chicago, Ill., was designed by Architect JEROME ROBERT CERNY to meet two requirements. Mr. Snite is a sportsman and wanted the house to reflect his interest in yachts—hence the large ship room. Mrs. Snite enjoys entertaining, and this accounts for the spaciousness of the first floor. Special quarters for the three small children are located on the third floor.



THE HOUSE IS located on a high bluff on the shores of Lake Michigan, and the principal rooms all overlook the lake. "It was quite a problem," says Mr. Cerny, "to make the house conform with the bluff elevation and to subordinate its height as seen from the shore." Although strongly reminiscent of both French Manoir and Georgian, the house achieves a transitional character from its sparing use of mouldings and other decorative motives. Exterior walls are of common brick, painted white; the base is painted gray-green. Shutters are of wood, painted French powder-blue. The entrance doorway is of lead, painted terra-cotta; all metal trim and copings are also lead, natural color. Superstructure of the building is reinforced concrete and frame. Typical of the interior character of the house is the dining room (shown on next page). Walls above the dado are covered in blue cloth; dado and trim are painted white.



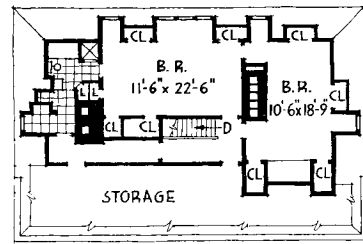

THIRD FLOOR

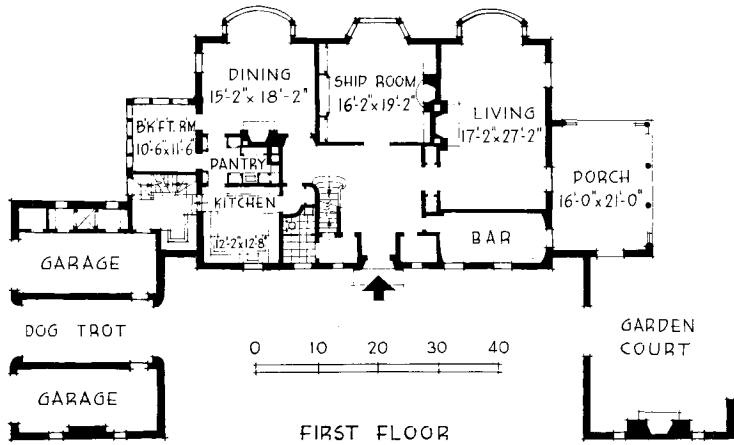

FIRST FLOOR

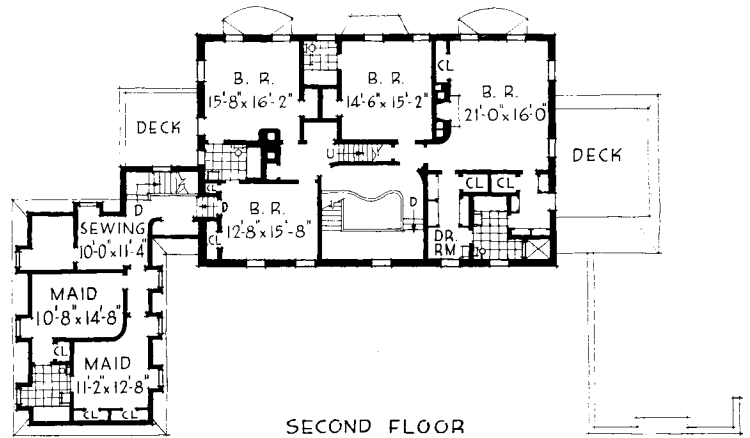

SECOND FLOOR



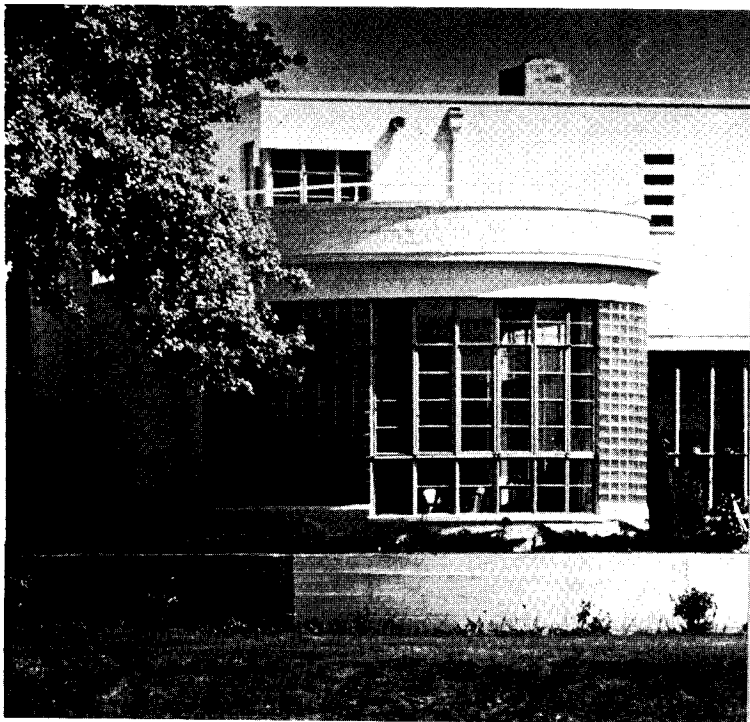



# PLANNED TO CATCH PREVAILING WINDS

Just beyond the city limits of Tulsa, Okla., is the residence of Mr. and Mrs. Darwin Kirk, designed by Architect DONALD McCORMICK. The property slopes gently but uniformly to the south; and, as prevailing winds are from the south, all main rooms face in this direction. To the north, the land is developed for orchard, vineyard, and vegetable garden.

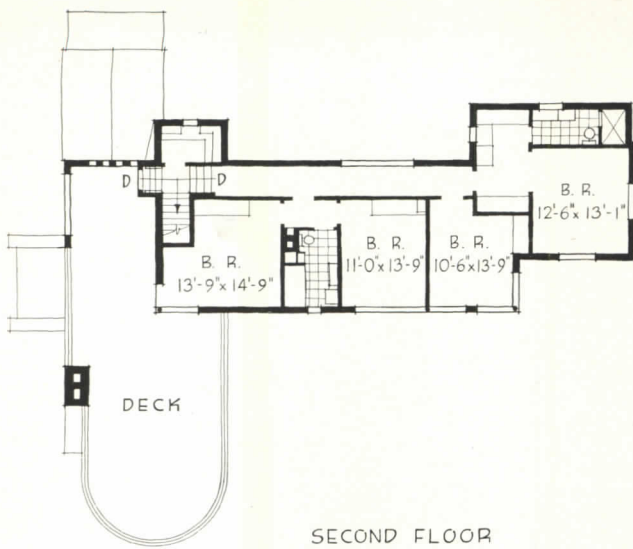

SECOND FLOOR

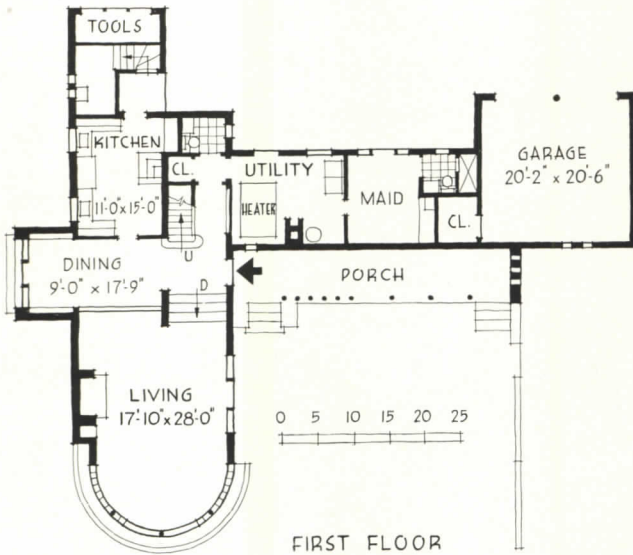

FIRST FLOOR

IN DESIGNING THIS HOUSE the particular problem that confronted the architect was to develop a plan which would be comfortable in the local climate. Hence the open planning of the living area, with only a low partition between dining and living rooms, and the large windows in these rooms. In addition, by placing the garden on the south side, a pleasant outdoor living room is obtained. (The ground to the north of the house could be sold separately, should it become desirable to do so because of increased taxes due to possible inclusion of the property within the city limits; the house is planned so that this would entail no loss of privacy.) Bedrooms, as well as main first-floor rooms, have southern exposures, and can be cross ventilated by leaving open the doors into the corridor. One of the features of the house is the roof deck over the living room, in which an interesting method of construction was used. "No effort was made to waterproof the concrete deck," says Mr. McCormick. "The deck was laid on galvanized iron which served as forms; the iron projects into the gutter and drains off any water that seeps through the slab." The entire first floor is of reinforced concrete; exterior walls are of 5 by 8 by 12-in. concrete hollow tile. Cost of the house was \$16,500.





HOUSE IN OKLAHOMA

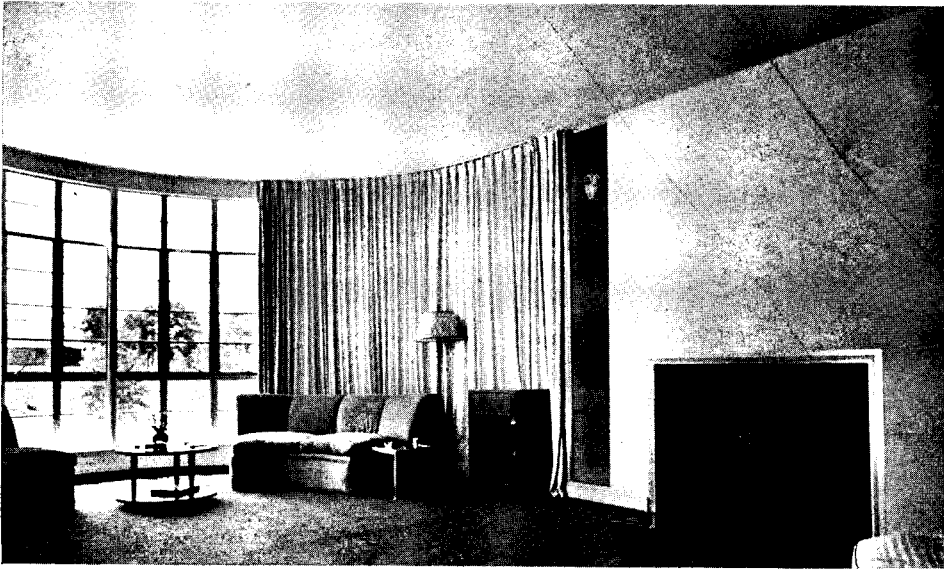

Sheer curtains around the entire glazed bay temper daylight for the living room.



Low partition and curtains separate living room (left) and dining room (right).

# KITCHENS

are an admittedly knotty planning problem for the architect. Much reference data have been collected and published on kitchen plan types; therefore, on the following pages are shown examples whose fresh approach to the well-known problem makes them noteworthy. Among these are a number of kitchens in which an informal eating place is an integral feature of the plan.



Roger Sturtevant

## 1. VAN EVERA BAILEY, Architect

THE CHARACTER OF this kitchen derives not only from its pleasantly contrasting black and white surfaces, and the handling of the corner window, but also from the plan organization. Relation of sink to range and refrigerator is the familiar triangular one. Among the gadgets that this kitchen boasts are a small hanging cupboard above the counter (extreme right of picture) for filing bills, recipes, and notes; a sliding tray-like shelf (see detail); and a specially designed towel-drying drawer, which serves as a solution to an ever-present problem.

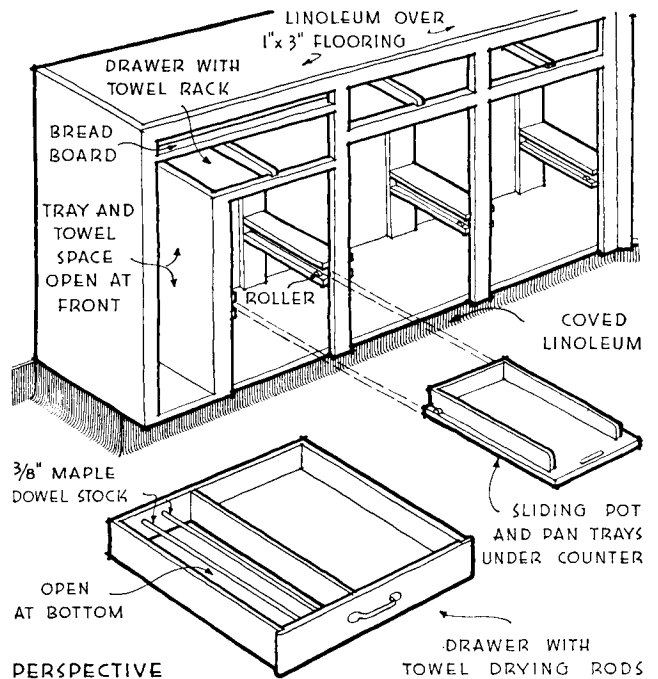
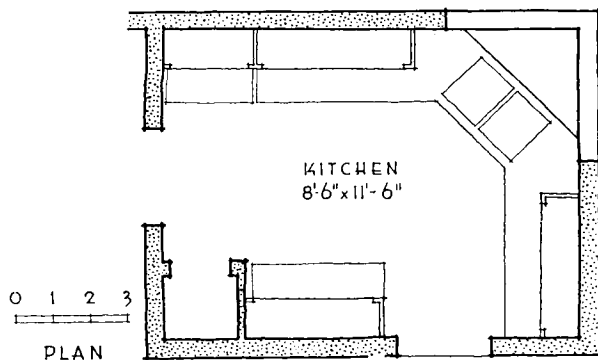

# KITCHENS

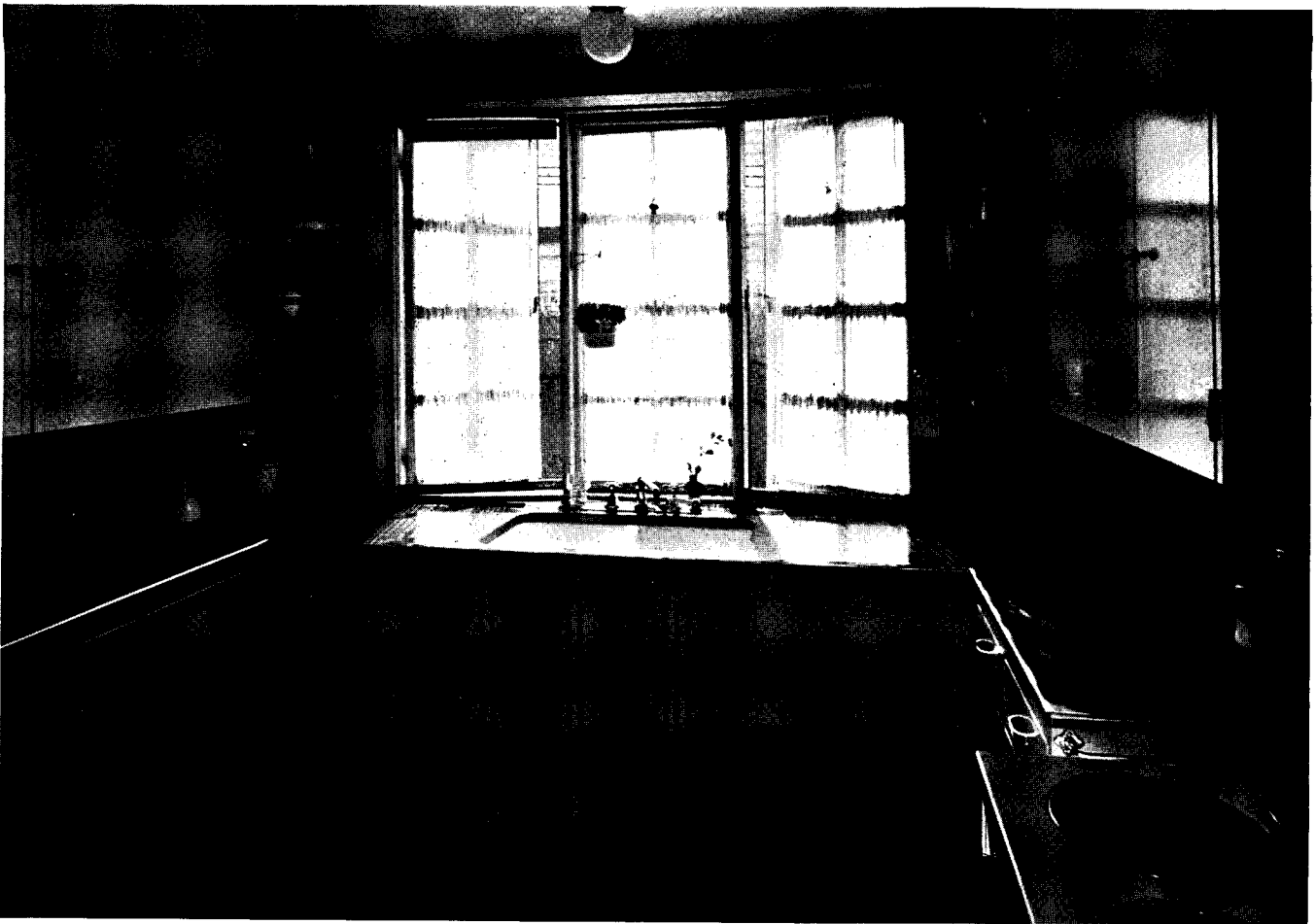

Roger Sturtevant

## 2. HOLLIS JOHNSTON, Architect

INCLUDED IN the equipment of this kitchen are special-purpose closets (pots and pans, table leaves, etc.) and a delivery hatch near the window. The kitchen is interesting for its compact plan and its relation to other parts of the house. A breakfast room to the right of the kitchen is convenient for serving, and leads into the dining room. All cabinets are of wood and are painted white; flush doors are of plywood with vertical-grain fir-veneer faces and solid edges for hinges. Counter top and floor are of linoleum. The sink is of stainless steel; drainboard is linoleum.

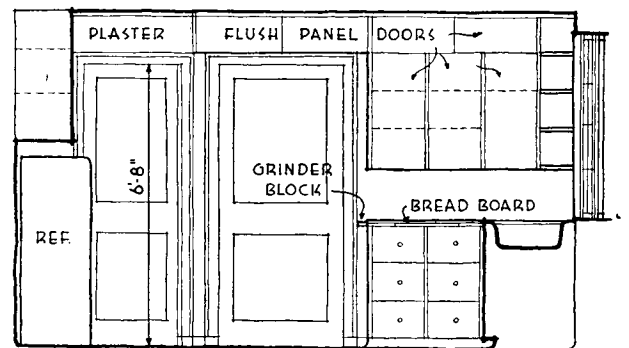
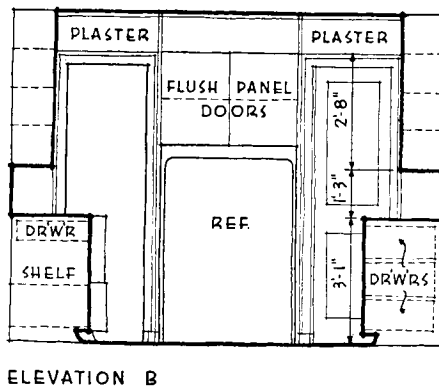
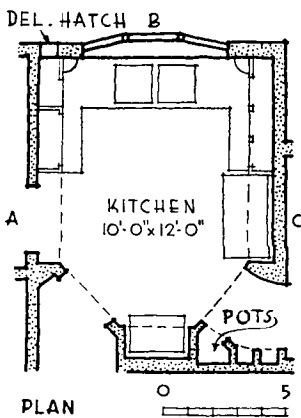

ELEVATION A

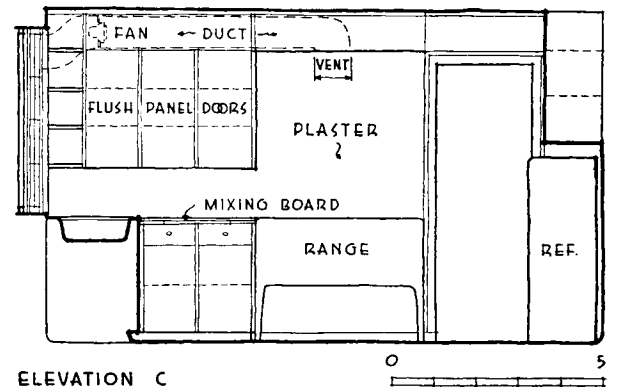

ELEVATION C





### 3. DONALD DWIGHT WILLIAMS, Architect

IN A MINIMUM amount of space this kitchen offers plenty of work space and cupboards. In addition, the breakfast counter at right solves the breakfast-room problem in a minimal way. The small drawers built into the counter serve as storage space for table linen and tableware. The ceiling is flat white, with walls and cupboards painted oyster white. Interiors of the wood cupboards are painted wine. The wall just above the sink is wine-colored tile, and the arms of the sink are white tile with wine nosing and trim. The floor is covered in blue linoleum.

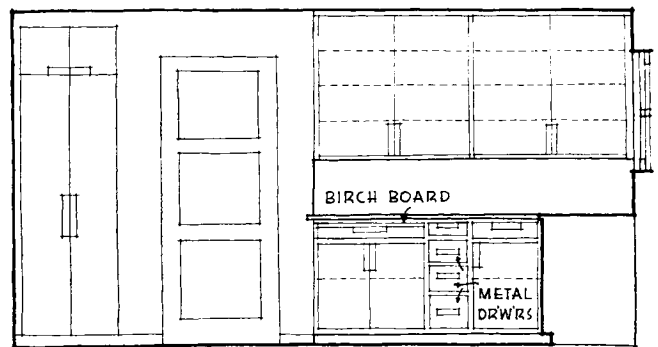

ELEVATION A

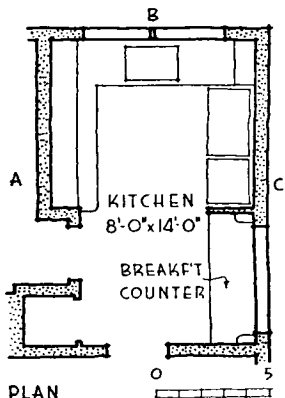

PLAN

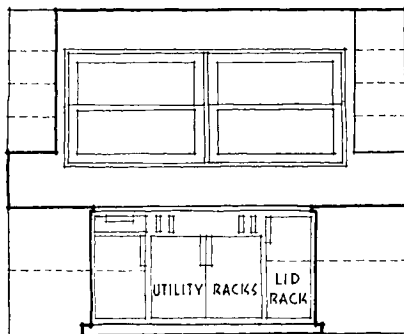

ELEVATION B

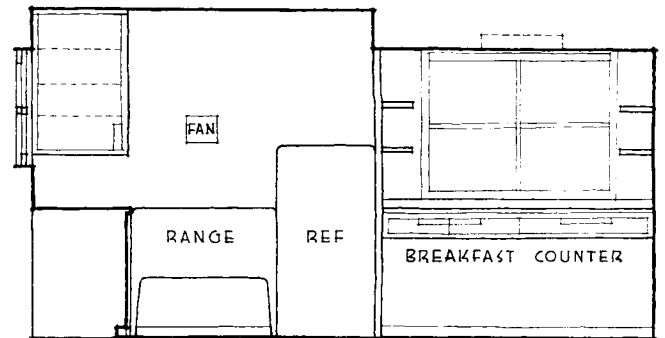

ELEVATION C

# KITCHENS

The Lima Photo-Engraving Co.



## 4. E. L. BAKER, Designer

FOR CONVENIENT serving of light meals, this kitchen boasts a breakfast bar with seats on the side away from the kitchen proper. As a means of further separating these two elements, the bar is slightly elevated above the kitchen floor level. Because the actual work center is at the sink end of the room, the bar does not interfere with any of the necessary operations. The service entry is conveniently located near the refrigerator; a hall connects kitchen and dining room. Both sink and electric range have tubular lighting fixtures. Work tables on either side of the range have tile tops; splash backs are also of tile. The bar top is blue linoleum with red and yellow strips; floor is red linoleum with yellow strips. Plaster walls are also yellow.

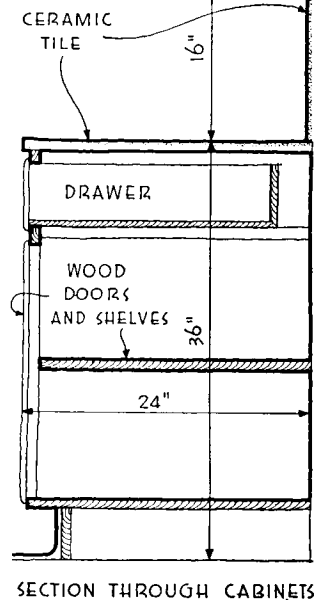
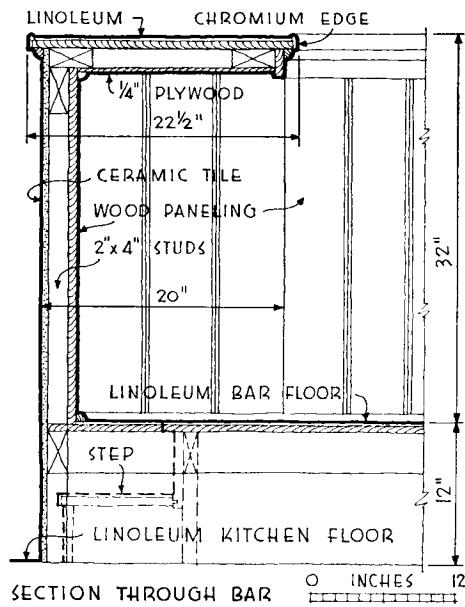
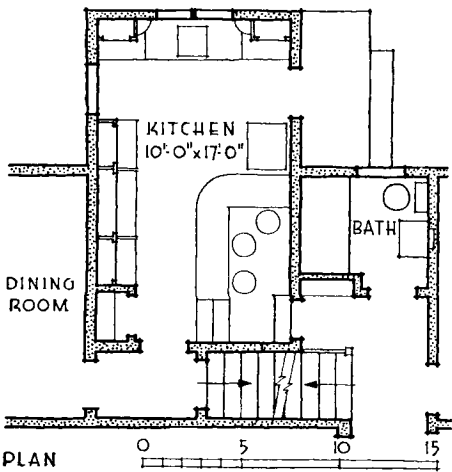
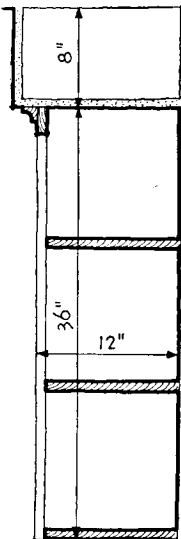

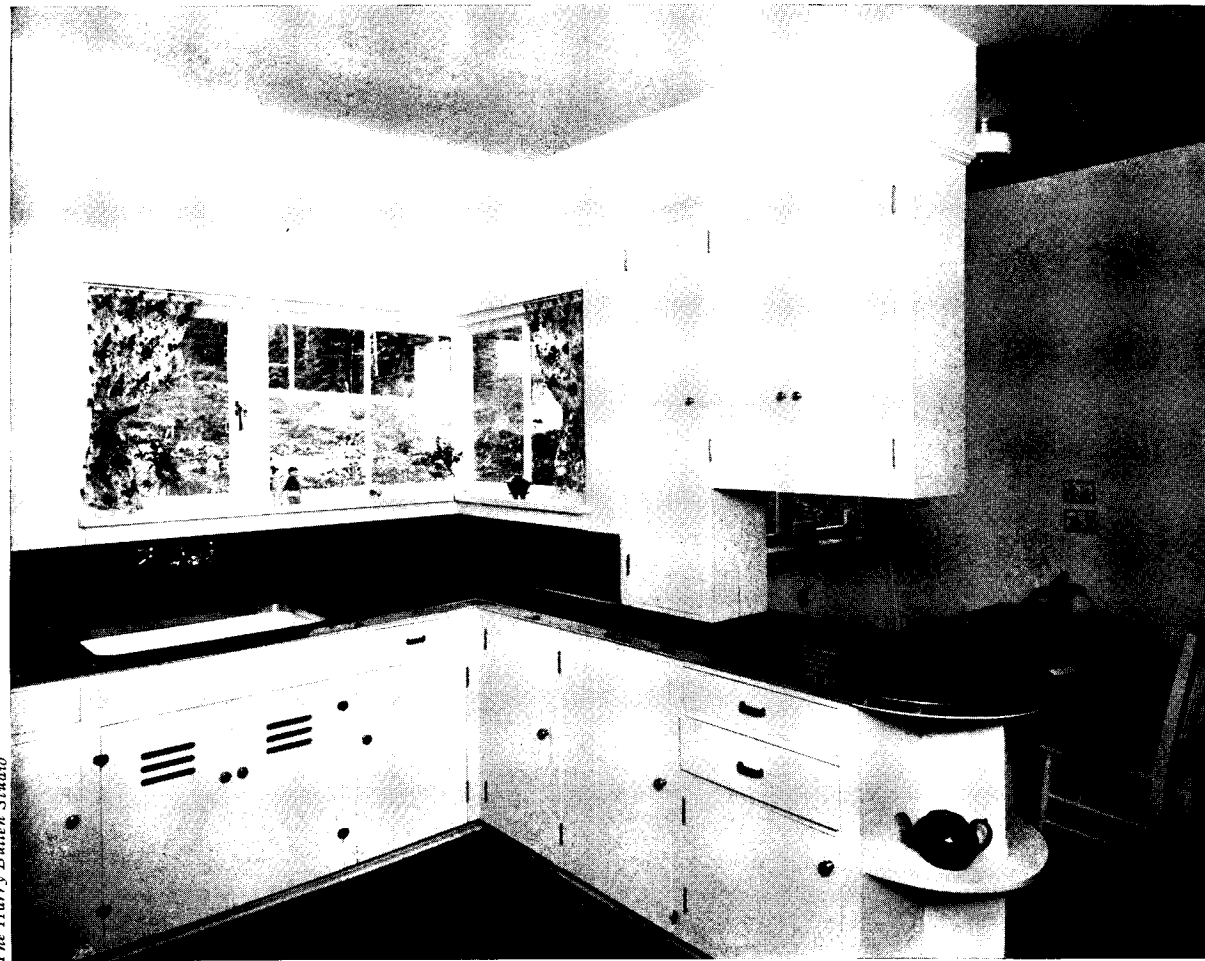

**5. ROBERT A. BERWICK, Architect**

IN THE PLANNING OF THIS kitchen, provision of storage space was as important as organization of work and service areas. Included in the equipment is a cooler (see detail at right); this inexpensive means of preserving food is especially adapted to cool climates. In addition there are closets of special design: one is for brooms and cleaning equipment; another, for pots and pans, with racks for storing lids. At the left of the plan is the service entry; on this same side of the kitchen a delivery hatch is provided. The dining nook has a folding table; the open counter facilitates serving. Walls are yellow; ceiling, cupboards, and woodwork are ivory; floor is blue linoleum.

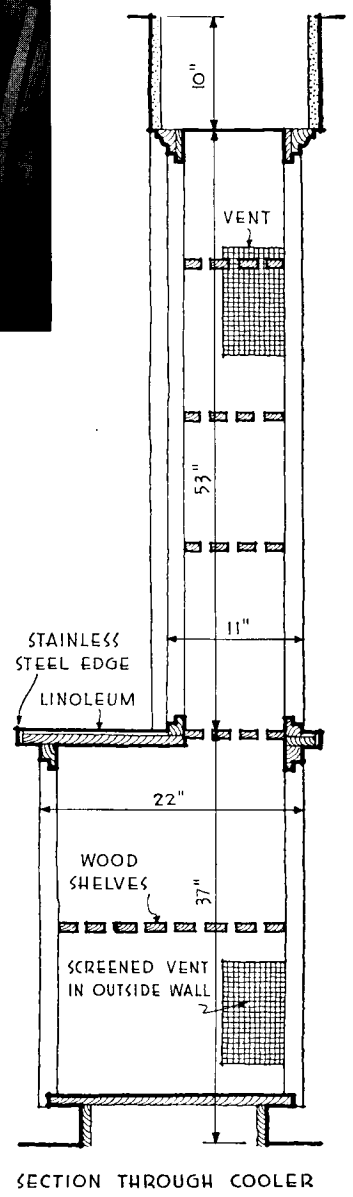
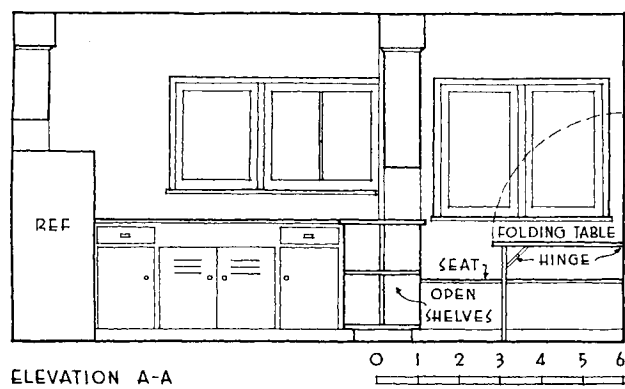
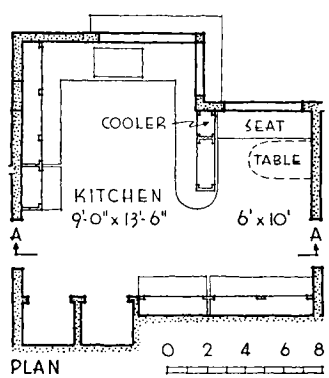



# KITCHENS



Daniel Reynolds Merrill

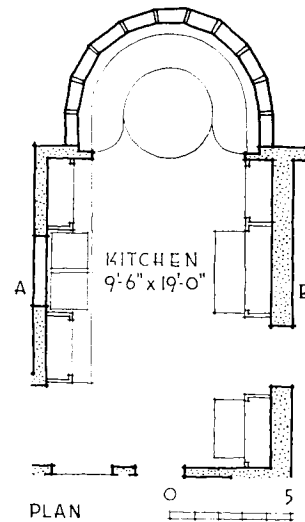

## 6. J. LLOYD BERRALL Architect

AMPLE LIGHT AND air are obtained in this kitchen from the window over the sink and from the glazed bay in which is located the breakfast table. The kitchen proper is arranged for convenience: refrigerator is placed on a line with the service door at left: to the right is a door to the dining room: the third door leads directly to the entrance hall. The floor is covered with mottled green linoleum. Cabinets and trim are of wood, painted white; work counters are finished with green linoleum. The table has a Chinese-red plastic top; bench cushions (not shown), of leather, are also Chinese red.

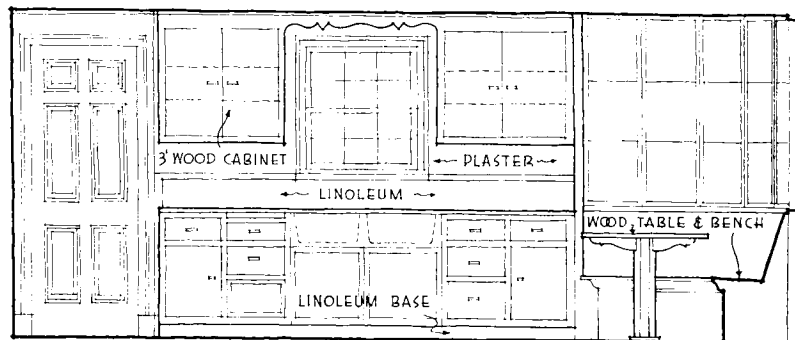

ELEVATION A

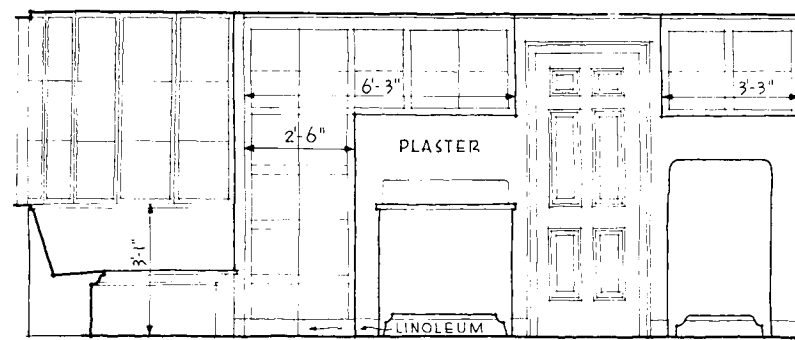

ELEVATION B

# Design for Industry Suggests A BROADER HORIZON FOR THE ARCHITECT

In this article, DOUGLAS HASKELL explores potential opportunities for the architect in a field closely allied to architectural design. That architects are interested in this field of industrial design is evident from the results of a survey (AR 5/40, pp. 75-79) posing this question: "Do you believe you could improve your economic position if existing ethical restraints were liberalized, thereby permitting you to duplicate all services offered by industrial designers?" Most answered affirmatively. But what are the opportunities in this field for the architect? What qualifications has he for working in this field? At least a partial answer is found in two exhibits (see pp. 88-95) now current in New York City—"Contemporary American Industrial Art" at the Metropolitan Museum of Art, and "America at Home" at the World's Fair.

AMONG THE numerous exhibitions of design in the field of useful objects, only one in a blue moon helps to clarify the situation for designers. The field is one that many architects would like to enter. They have both the gifts for it and the time. The question is where to start and what to do. This question is one that such exhibitions as the Metropolitan's, however fine are many of the objects displayed, and however inspired some of the arrangements, leave only half answered.

What the Metropolitan does suggest to the prospective architect-designer is a good point of departure. Household furniture and accessories form the content of its show, and surely no one is better qualified to finish out the house with such accessories and furniture than the architect who has already done the shell. The accessory design technique, once mastered, permits unlimited expansion into larger areas. Indeed, the design of household objects led historically to the creation of the whole realm of "industrial design." A book such as Teague's "Design This Day" betrays that the "industrial designers" themselves have added contributions worth only about a stickful of type to the basic concepts that stem mainly from architects and students of architecture.

Yet although the exhibition at the Metropolitan suggests what to start with, it leaves open the next question of what to do. What to do, or how to point the design effort, is determined by the market. The public itself is confused when "industrial" art is presented with such a "luxury" air. Strictly speaking, the Metropolitan addresses itself not to the luxury market alone but to three separate markets, which at best can lie side by side, like the layers of a club sandwich, but can never coalesce. It is important to any designer to know what these three markets are. In the design of any single type of object the standards they set are often mutually exclusive and contradictory.

## What Is Industrial Art?

To begin with, the very name "Industrial Art" needs clarification because it is currently used to cover the entire field in the design of useful objects when in fact it covers only a part. What is it that makes a design "industrial?" Not the mere fact of utility, since useful objects can be individually made. Not machine work: for, as Mr. Bach of the Metropolitan points out, machine work and hand work coexist today all along the line. Not industrial materials. It is scarcely possible today, excepting a sod house, to fashion a useful article out of materials other than industrial ones.

Again, commercial manufacture does not suffice to make an article an industrial one: the commercial manufacture has to be on a *large scale*. It is large-scale production that is industrial production: not just mechanical production, or commercial production, or production using industrial materials. The mass market is what makes industry big. Production for the mass market is industrial production. Production for the limited market is specialty production. Production for the individual purchaser is craftsman production. These are the three basic markets, separated here not for the purpose of making a catalog, but of pointing out that, to repeat, the requirements they set before the designer vary greatly, being often contradictory and mutually exclusive.

## Three Kinds of Approach

The three markets might graphically be represented in a line, with the craft market at the left, specialty market in the middle, and industrial market at the right, with an arrow from left to right pointing out the usual direction of development or progression. Of course such a presentation ignores many complexities. Yet it has performed its service if it illustrates basic differences in approach.

The typical craftsman's approach is found in a curious stair shown at the Fair: a set of heavy wedge-shaped pegs driven spirally into a heavy carved post; intrinsically a piece of wood sculpture (illustrated on page 132). Here fancy and caprice as an approach are not only no detriment to the result but are of the essence of the project. There is a single client to be pleased; if he likes his stair, no one else needs to; and if he falls and breaks his neck for lack of a railing, the risk is his alone.

Wholly different is the designer's responsibility for, say, a wash basin or chair in the scheme (also at the Fair) for a typical apartment in a New York City housing-authority project. Such a product must be safe enough for use by anyone; it must proffer convenience, comfort, strength, along with low cost of production, distribution, and maintenance, to uncounted people. The conditions approximate those of tool design; on top of that, the appeal of the article must be both wide and relatively stable.

As for the specialty field, it lies midway between the craft field and the industrial one, and the designers who choose it can therefore face either way. They can concentrate on smart individualism or general serviceability. This field is

(Continued on page 132)

# CONTEMPORARY AMERICAN INDUSTRIAL DESIGN

On display at New York's Metropolitan Museum of Art is an extensive exhibit of modern house furnishings shown against specially designed backgrounds. The work of a collaborating committee of architects and industrial designers, the exhibit was organized and produced under the direction of RICHARD F. BACH, of the Museum. Since manufacturers also cooperated with the Museum and designers, and will shortly make available objects currently being shown, the exhibit is a coordination of the work of craftsmen and quantity-producing industry. Like the 14 previous exhibits of house furnishings at the Museum, this one emphasizes the value of art in industry.

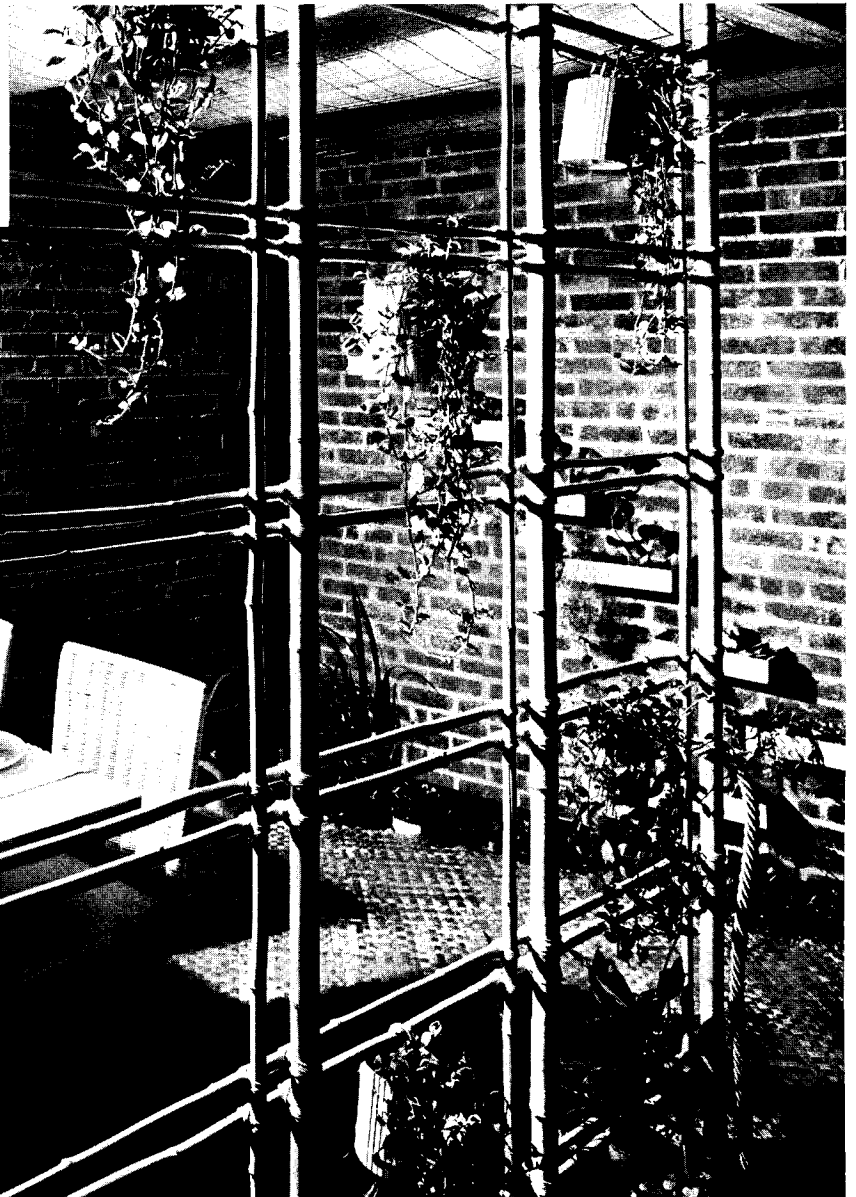

Photos by Ezra Stoller



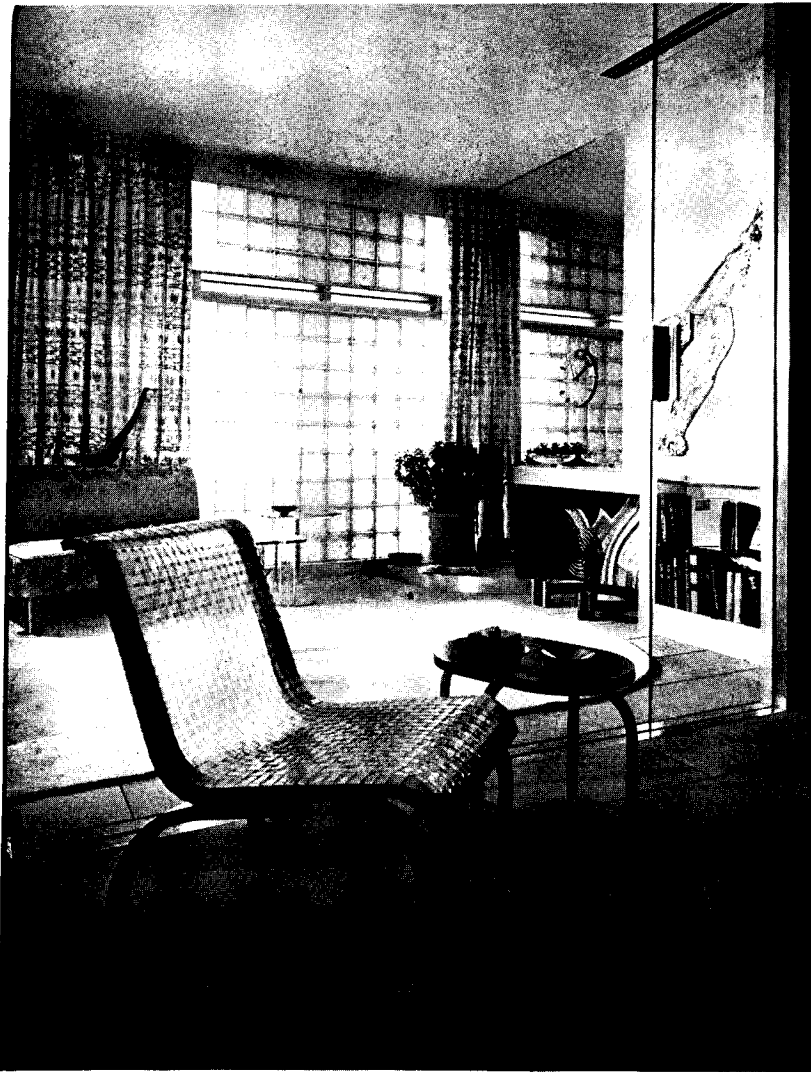

3

1. Sound-absorbing cork tile lines the radio niche in the living room by Industrial Designer GILBERT RHODE, ERNEST FEIBELMANN, Collaborator; it is intended to decrease the amount of sound transmission between rooms. The adjacent wall is surfaced with resin-impregnated woven-wood veneer.

2. For informal dining Architect EDWARD D. STONE designed this semienclosed porch, in line with today's trend toward eliminating boundaries between indoors and outdoors. At the base of the brick wall and of the trellis are plant beds; ranged along the wall at right are metal pans containing growing flowers, over which flows a small steady stream of water to form a wall fountain. The tambour door under the china cabinet makes a direct connection with the kitchen.

3. Shown in the foreground is a chair of plywood and woven colorless plastic material, by WALTER VON NESSEN, Designer, and MARGARETTA VON NESSEN, Collaborator. Beyond it is a living room by EUGENE SCHOEN, and FRITZ MELLION, Assistant. The glass-block panel admits light during day; artificial light sources behind louvers illuminate room indirectly at night.

4. This room, entitled "Corner for Living", was designed by Architect RALPH WALKER, with DAVID C. COMSTOCK collaborating. The feature of the room is the indirect lamp with its suspended reflector. The reflector, made of limewood, can be adjusted for height; the ball counterbalances the reflector.



4

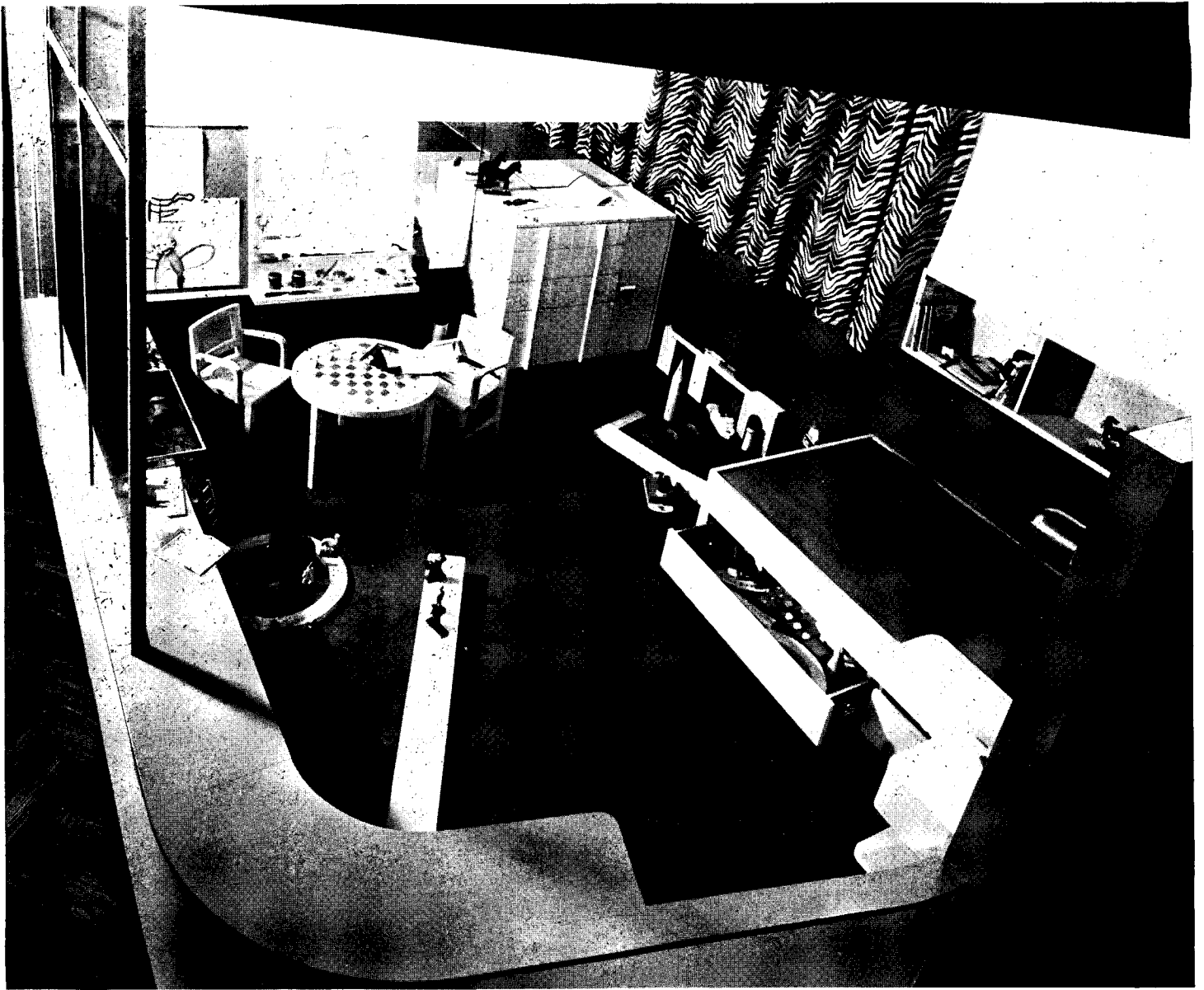

1



2

Photos by Ezra Stoller

1. Designed to the scale of a child of four, this room by WILLIAM LESCAZE, Architect, provides ample floor space for playing, a cork wall on which to tack drawings, an easel with rack for paint jars, and open shelf space (over bed and under counter) for toy storage. Dado is orange red; floor is blue.

2. Color transparencies set flush in a wall panel are used in this room by RAYMOND LOEWY, Designer. Behind the panel (which is removable) are light sources. A protective panel of plate glass covers each of the transparencies.

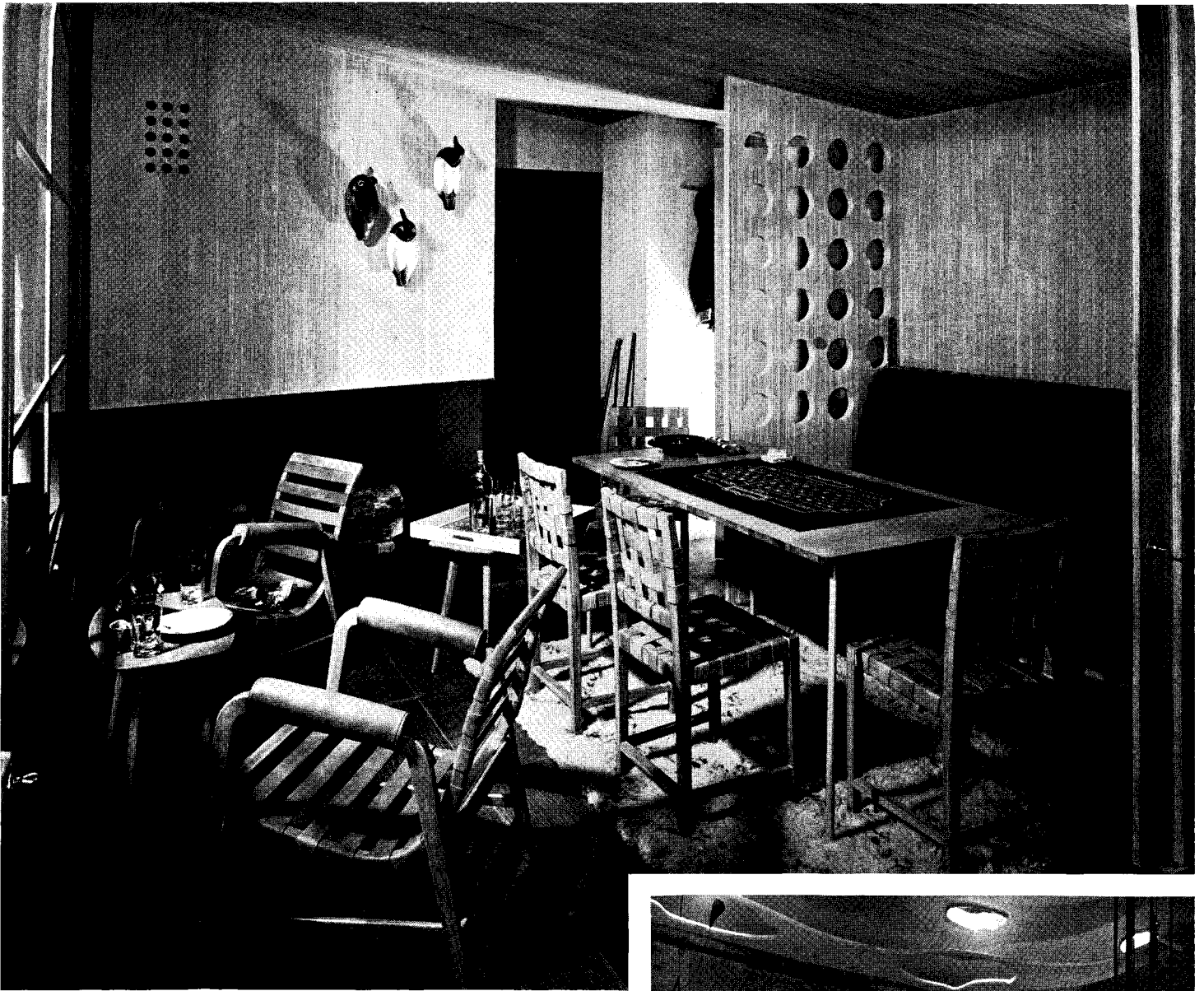

3. For his prefabricated cabin interior, Industrial Designer DONALD DESKEY uses plywood with a special surface texture. The built-in seat can be converted into a double-deck bunk, as the back swings out to a horizontal position and forms the top bunk.

4. This hall of a country residence, designed by Architect WALLACE K. HARRISON, with A. B. SHAW, III, and T. G. CRAPSTER, JR., collaborating, and E. H. HARRISON as consultant, provides a place where the sportsman can clean up before entering the house proper. Note the foot pedal, instead of manually operated faucets, in conjunction with the wash basin. The closet has a copper frame; copper wire strung across a plywood back forms a decorative surface for one side of the closet.

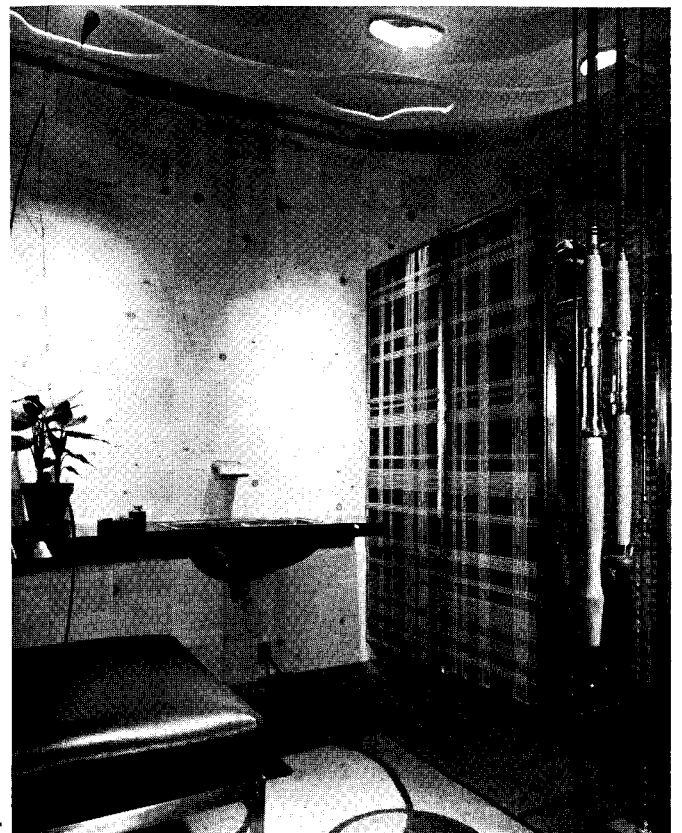



# AMERICA AT HOME

Representing the work of architects and designers from all sections of the country, this exhibit at the New York World's Fair includes designs for living on budget as well as luxury terms, for continual and also occasional occupancy. Each participant designed the furnishings for his project, using materials and products from any or all of the three markets: mass production, specialty, and craft. The exhibit, of which Mrs. LOUISE BONNEY LEICESTER is director, was designed by SHEPARD VOGELGESANG.



1



Photos by Richard Garrison



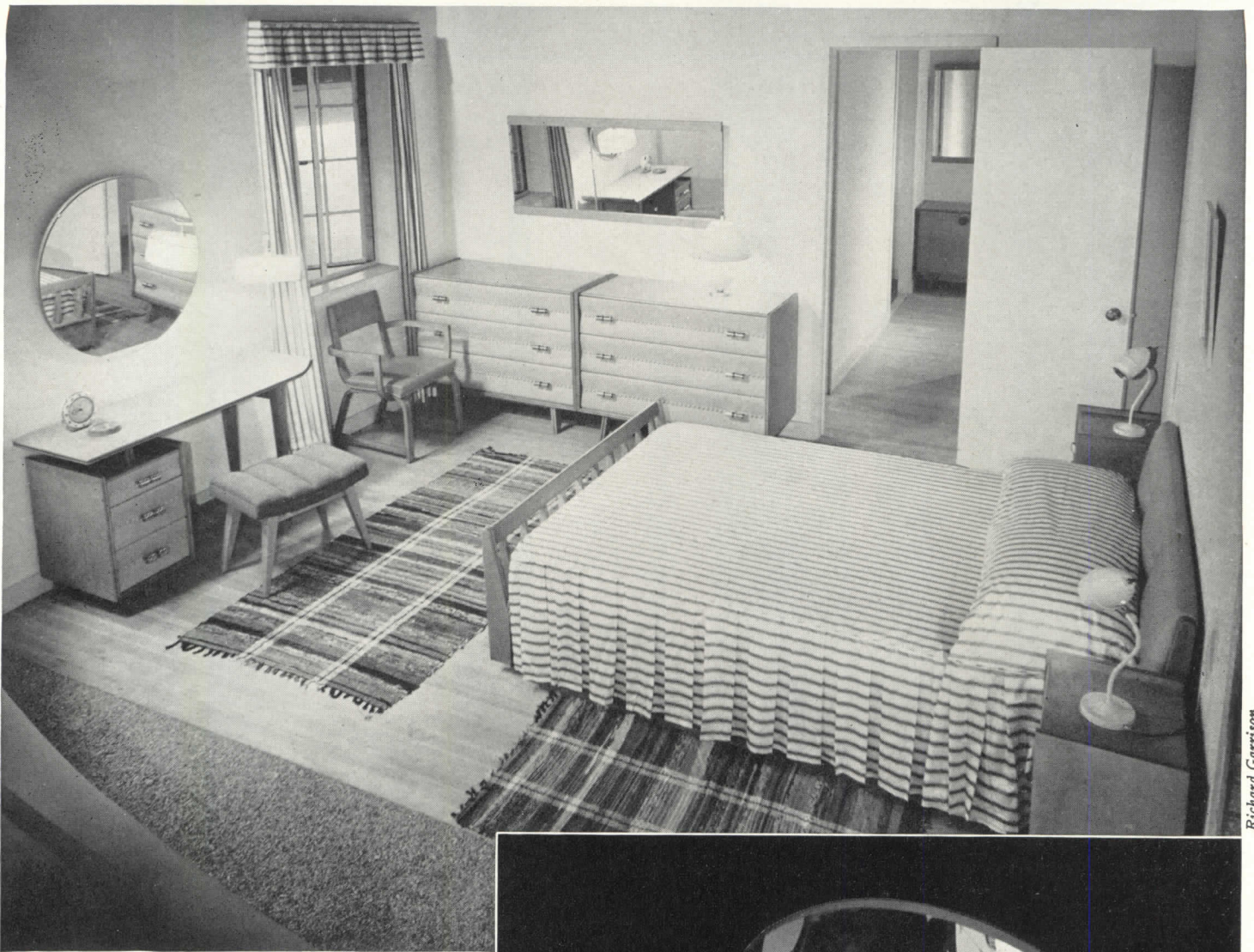

Richard Garrison

2

1. Designed by HARWELL HAMILTON HARRIS in association with CARL ANDERSON, all furniture in this combined living-dining room is light, easily movable, and adaptable to other than its obvious use.

2. Bedroom in the "Unit for Living" by GILBERT ROHDE, Industrial Designer. The unit is reproduced from an actual apartment in one of New York City's USHA projects. Furniture, designed by Mr. Rohde for maximum comfort, is intended for mass production and a low purchase price.

3. Prominently located at the center of the exhibit is the "Unit for Living". A huge mirror, suspended at an angle over the apartment, reflects the four rooms.

3

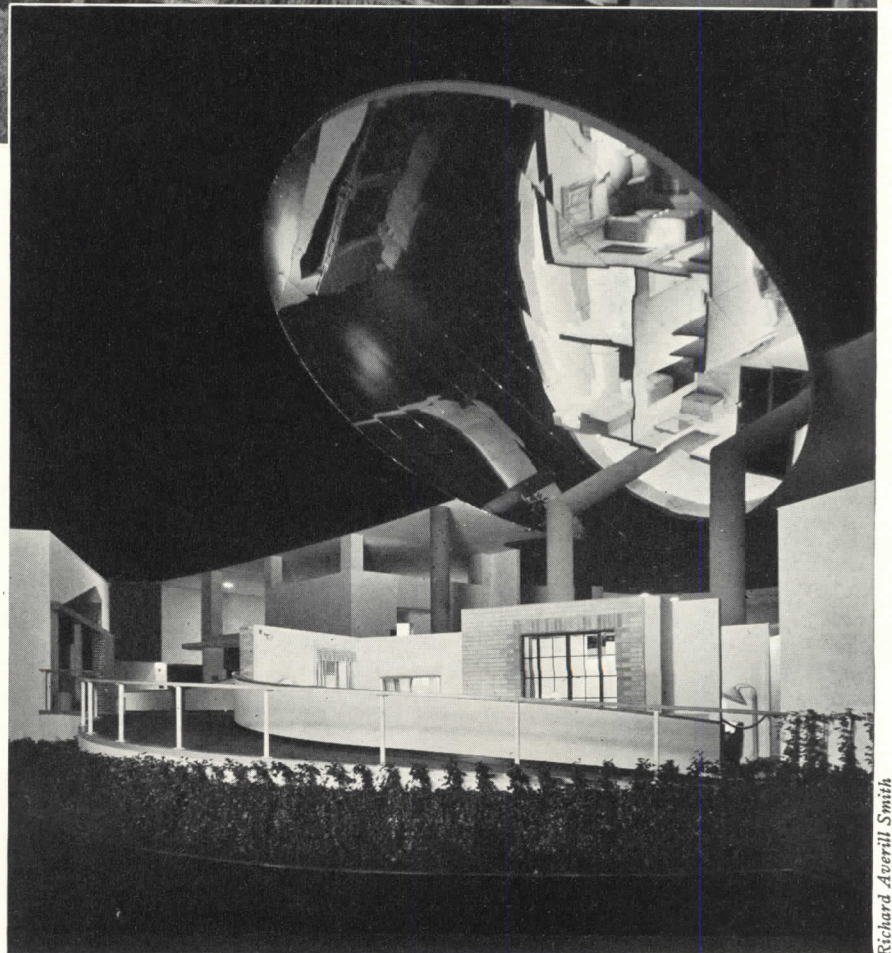

Richard Averill Smith



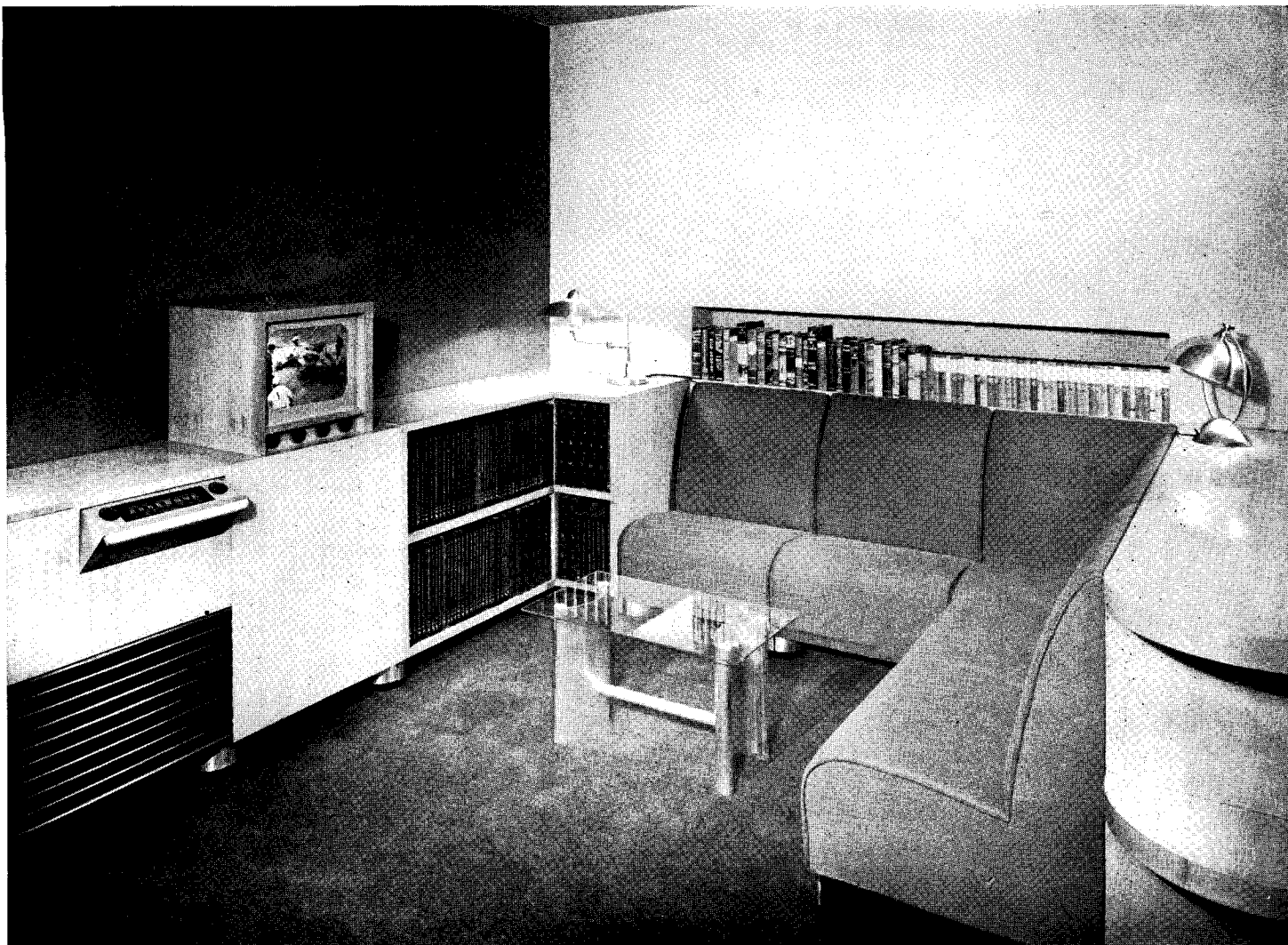

## AMERICA AT HOME

1. This 20th-century music room is by JOHN VASSOS, Industrial Designer; it contains—in cabinets specially designed as separate, movable units—radio-phonograph, record library, movie projector, and television sets. The units are adaptable to a number of other arrangements.

2. Using cloth-backed, wood-veneer surfacing material, Architect MICHAEL HARE and Interior Designer JOHN B. MANGER designed a variation on the cubical aspect of the usual apartment room. In one corner of the room is the desk shown at right; note additional work and shelf space obtained by the convex curve.







3

Richard Garrison

3. The living-dining-sleeping unit is a special problem; here Decorator VIRGINIA CONNOR has designed a room which combines all of these functions. The table has extensible legs for conversion to dining height. The walls and carpet are grape grey; for accent lime-green and persimmon-colored fabrics and objects are used.

4. Of particular interest is the cork floor in this child's room by Industrial Designer THEODOR MULLER; the pattern (suggesting river beds, roads, and fields) is pictorial enough to intrigue the child when very young, abstract enough not to seem too infantile to him at a later age.



4

Richard Averill Smith

# CURRENT TRENDS OF BUILDING COSTS

Compiled by Clyde Shute, Manager, Statistical and Research Division, F. W. Dodge Corporation, from data collected by E. H. Boeckh & Associates, Inc.

CURVES INDICATE trend of the combined material and labor costs in the field of residential frame construction. The base line, 100, represents the U. S. average for 1926-1929 for residential frame construction.

Tabular information gives cost index numbers for the nine common classes of construction. The base, 100, in each of the nine classes represents the U. S. average for 1926-1929 for each particular group. The tables show the index numbers for the month for

both this year and last.

Cost comparisons, as percentage differences for any particular class of construction, are possible between localities or periods within the same city by a simple process of dividing the difference between the two index numbers by one of them. For example: if index for city A is 110 and index for city B is 95 (both indexes for A and B must be for the same class of construction), then costs in A are approximately 16% higher than in

$B \left( \frac{110-95}{95} = 0.158. \right)$  Conversely it may be said that costs in B are approximately 14% lower than in

$A \left( \frac{100-95}{110} = 0.136. \right)$

Similar cost comparisons, however, cannot be made between different classes of construction since the index numbers for each class of construction relate to a different U. S. average for 1926-1929.

## CONSTRUCTION COST INDEX U. S. average, including materials and labor, for 1926-1929 equals 100.

### ATLANTA

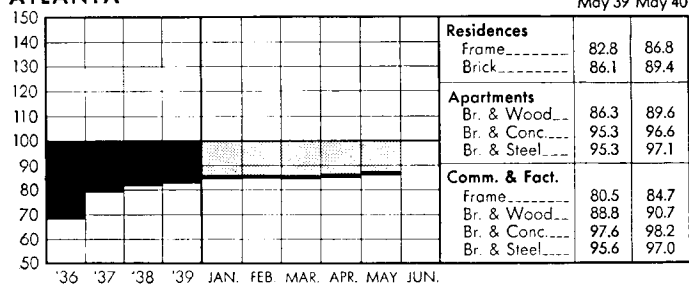

### CHICAGO

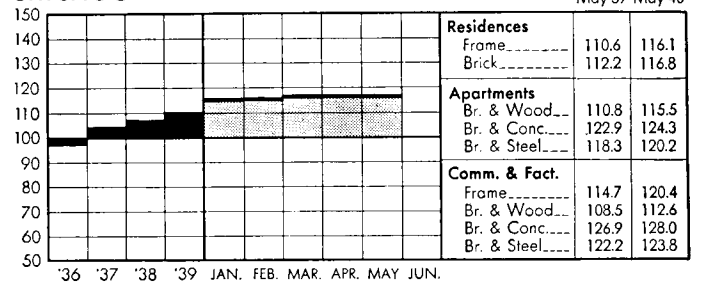

### BALTIMORE

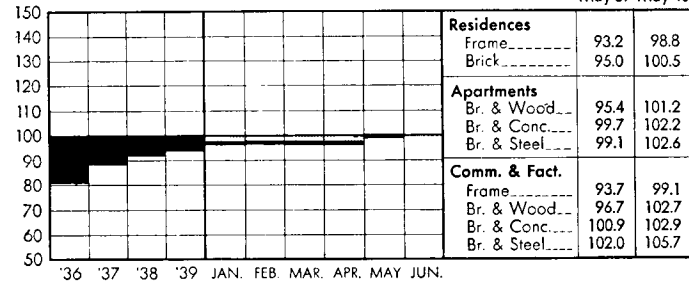

### CINCINNATI

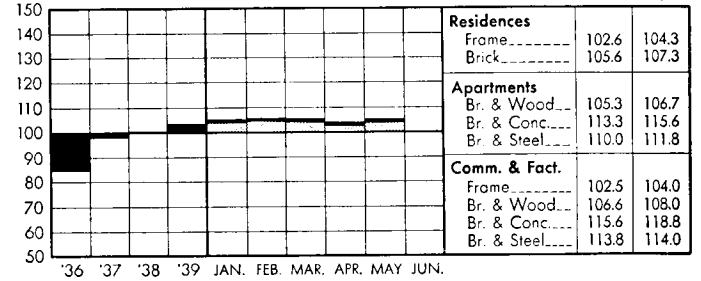

### BIRMINGHAM

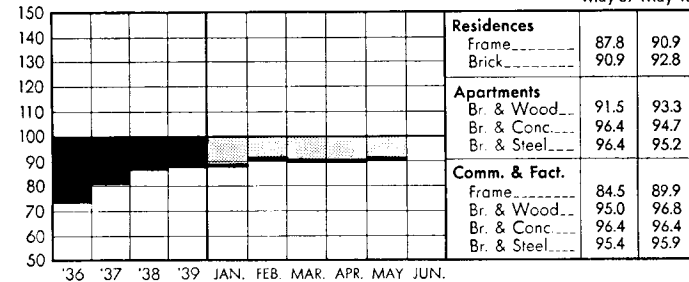

### CLEVELAND

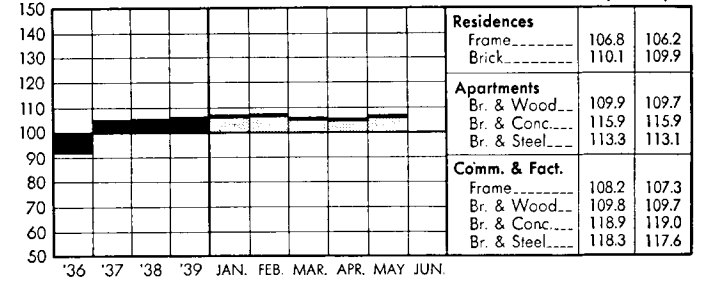

### BOSTON

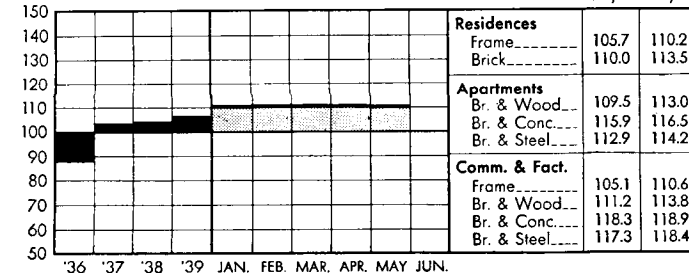

### DALLAS

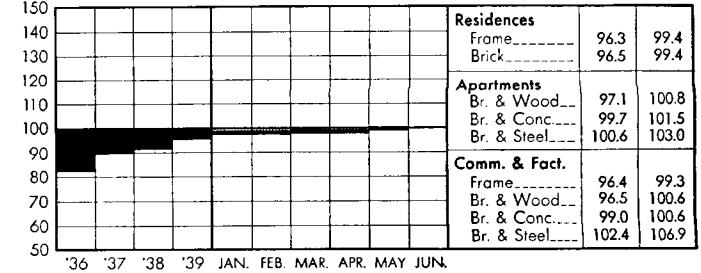

**DENVER**

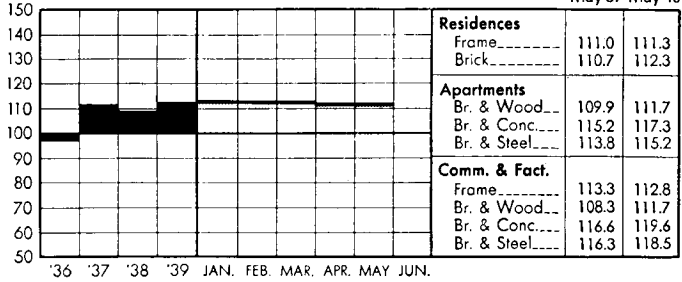

**NEW YORK**

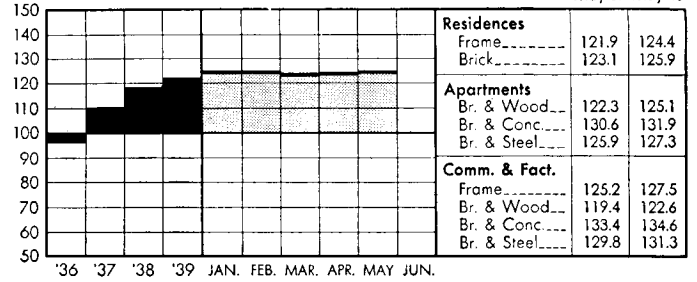

**DETROIT**

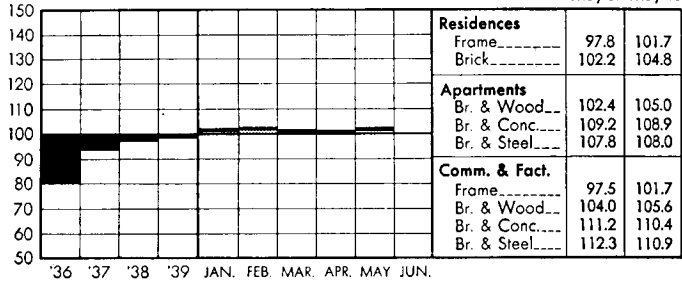

**PHILADELPHIA**

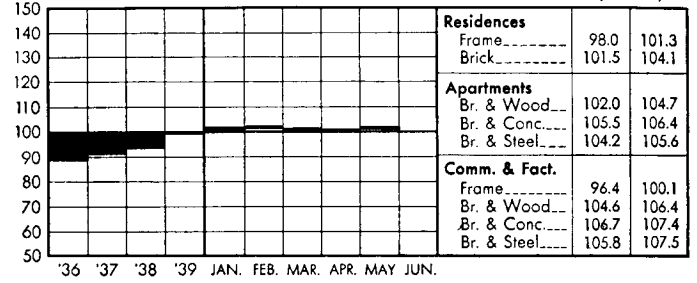

**KANSAS CITY**

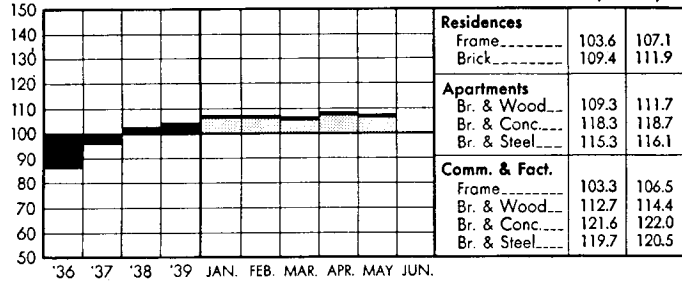

**PITTSBURGH**

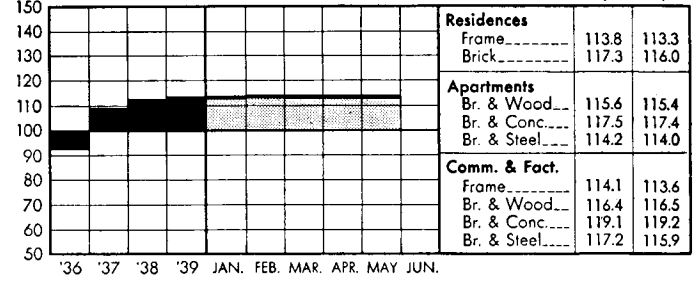

**LOS ANGELES**

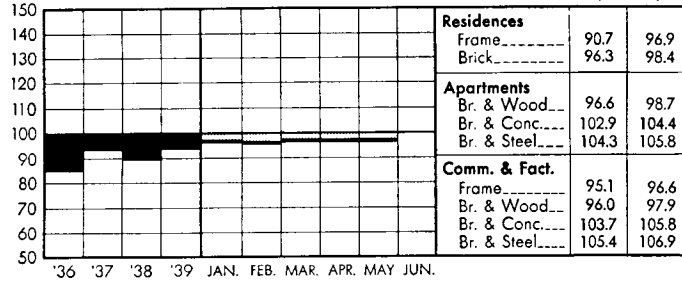

**ST. LOUIS**

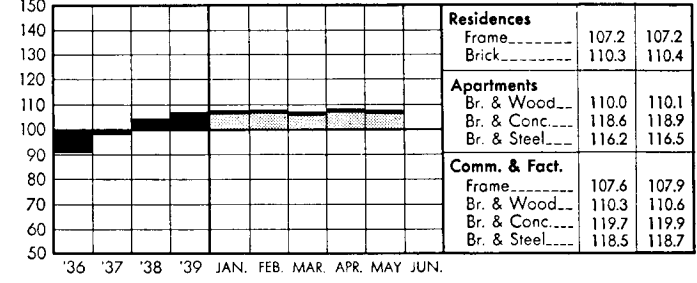

**MINNEAPOLIS**

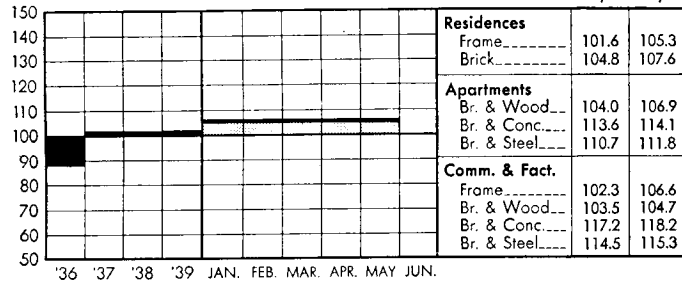

**SAN FRANCISCO**

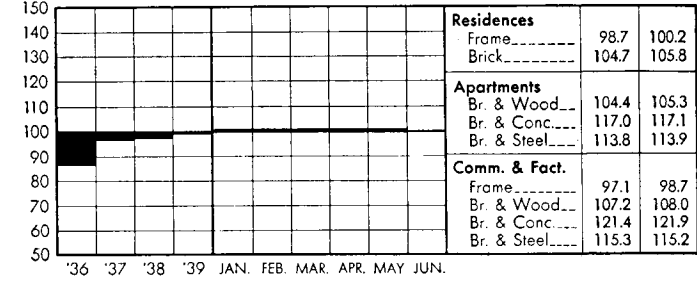

**NEW ORLEANS**

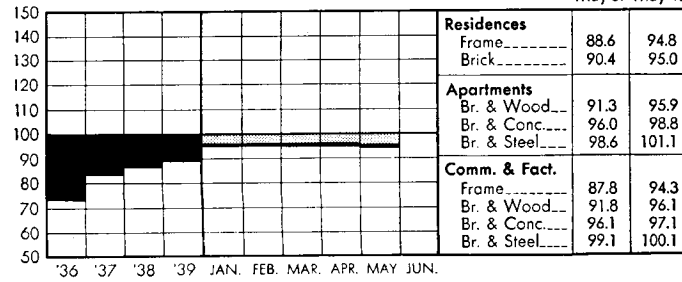

**SEATTLE**

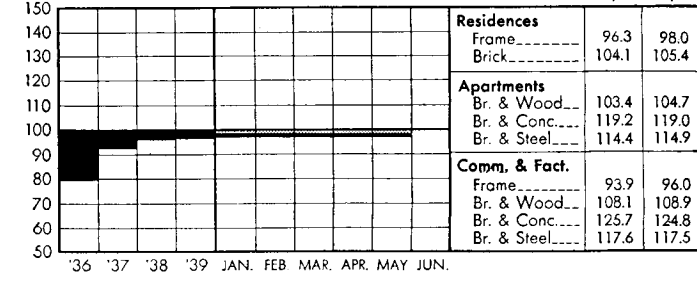



# REVIEWS OF CURRENT BOOKS

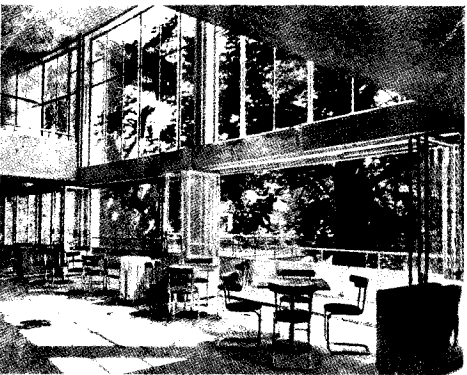
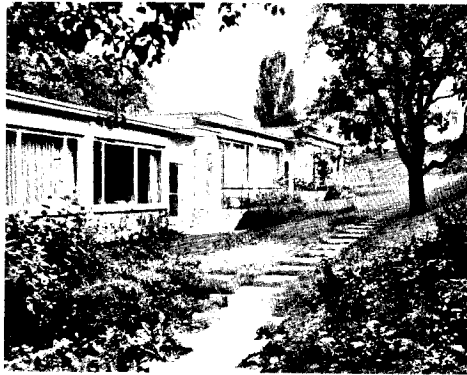
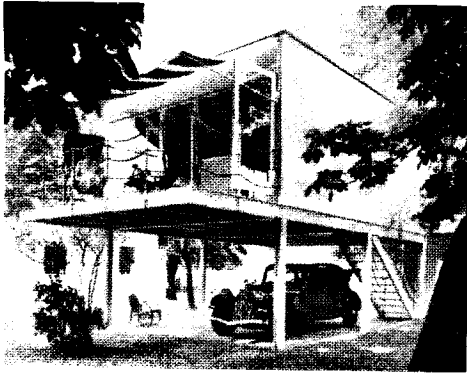

**THE NEW ARCHITECTURE.** By Alfred Roth. Published by Dr. H. Girsberger. Zurich, 1940. 233 pages. Illustrated.

THIS WORK is presented as "a contribution towards establishing the present state of the development of the New Architecture." As such, it is not historical in scope (an approach which the author purposely leaves to the historian) but presents, instead, a compendium of the New Architecture's best examples in different countries, with an inquiry into its general validity and its possible future developments.

Twenty characteristic types of buildings are examined, these including apartment houses, multistoried blocks of flats, office buildings, factories, broadcasting studios, week-end houses, libraries, prefabricated houses, exposition pavilions, health centers, open-air schools, baths and swimming pools, and such community projects as garden cities and co-operative farms.

Each structure is considered with respect to the following four points: *spatial planning*, or the general layout, location, and orientation to the immediate environment; *technical details*; *economic factors*, or the cost of construction, etc.; and the *aesthetic aspects*. The researches covered by these four points are based on material furnished by the architects concerned, including their own estimates, plans, photographs, reports, and general descriptions.

While the examples here published represent the chief architectural tasks of our time, Mr. Roth regrets the absence of examples within the vaster field of modern town-planning, of which there are but few in the world today, and these only in the form of partial solutions. He must, of necessity, be content with stressing the enormous importance of modern town-planning, extended to regional and national planning, and encompassing *all* architectural tasks, as urged by the International Congresses for Modern Architecture (the CIAM).

In considering these tasks in their broader aspects, Mr. Roth's statements bear the impact of tremendous *human* implications. "The New Architecture is not exclusively the work of architects, for which reason our researches cannot be conducted from the point of view of architectural and technical considerations alone. Its sphere of action includes all human problems and acquires

its ideas and contributions from the most varied sources provided by science, technics, economy, art, etc."

This New Architecture can be rich, lofty, and beautiful, he says elsewhere, for "the premises are plentiful enough in human, natural, and technical domains." Since the realization of great ideas requires courage to master prevailing conditions, "the further development of the new architecture can be borne into the future only by a capable and animated generation of architects in full consciousness of our times." In this connection, Mr. Roth pays tribute to the Bauhaus school, which placed the curriculum of architecture right into the centre of reality," and contributed so richly and extensively to the arts of our time.

It is Mr. Roth's wish that this book might also "contribute towards the training of your architects and give them a number of suggestions and fruitful ideas." In the examples illustrated throughout this book, they should be able to find such suggestions and ideas; in Mr. Roth's exposition of the subject, they should discover vision, with intelligent direction.

**STORE INTERIOR PLANNING AND DISPLAY.** By A. Edward Hammond. Chemical Publishing Co., Inc. New York, 1939. 247 pages. Illustrated. Price, \$5.00.

AS IN ALL OTHER FIELDS, the turn of the century was to bring great changes in the physical aspects of retail stores both in Europe and America. From the shop of the past—with its clumsy counters, its dark and monotonous shelves, and its windows crowded with merchandise like auxiliary stockrooms—to the modern shop interior, a metamorphosis has taken place in coordination with the changing conditions of life itself during the period.

It may be observed that these changes have been greatly accelerated during recent years, not only due to improved standards of living and to changes in fashions and buying habits, but above all to increased advertising and to the intensification of retail competition—factors which have profoundly affected the tempo of selling. Mr. Hammond observes that these transformations have been more numerous since 1930 "than in the whole of the first quarter of this cen-

(Continued on page 136)

# COMMUNITY SHOPPING CENTERS

Over 103 million dollars were spent on store construction during 1939 in 37 eastern states, and over 29 million in 1940's first quarter, report F. W. Dodge statisticians . . . Community shopping-center planning takes into account strong forces—population shifts, transit facilities, use of automobiles, protection of neighborhood values—which change urban and suburban patterns . . . In addition to discussions of such factors this study contains Case Studies and Time-Saver Standards on stores and parking areas.

*McLaughlin Aerial Surveys*

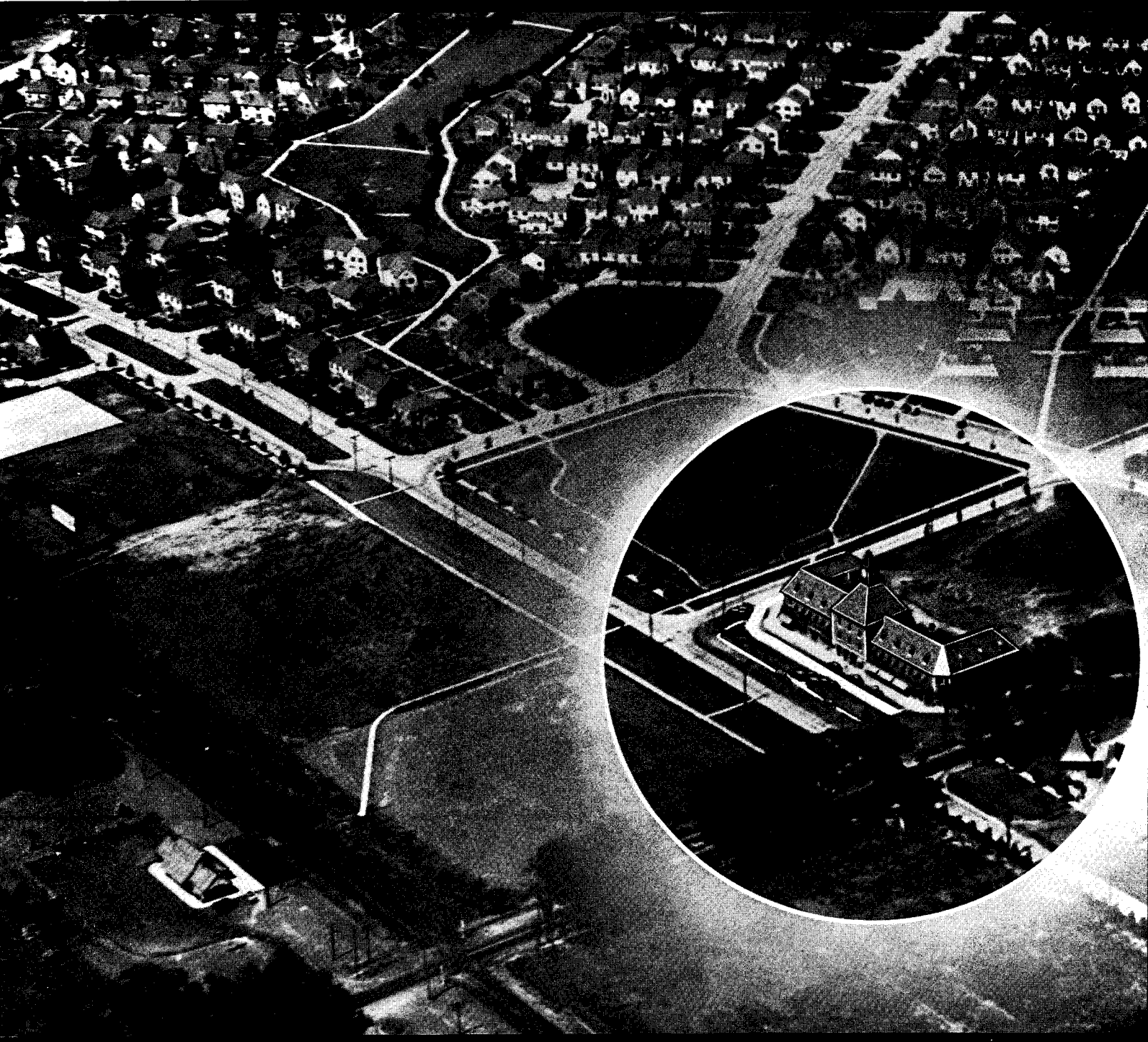

## BUILDING TYPES



# TODAY'S HOUSEWIFE

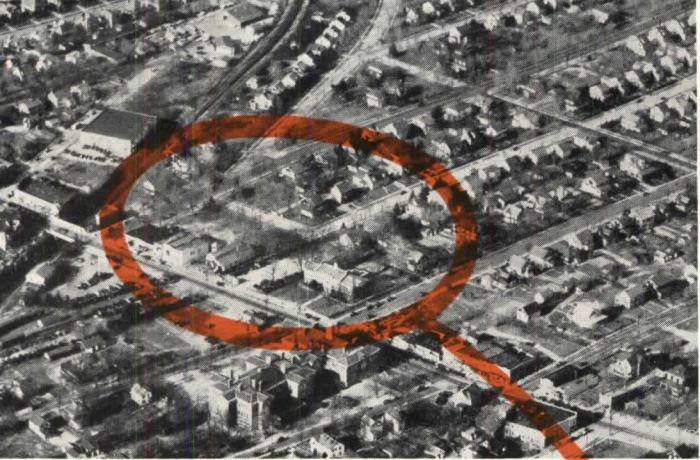

Fatchild Aerial Surveys

Drawings by Elmer A. Bennet

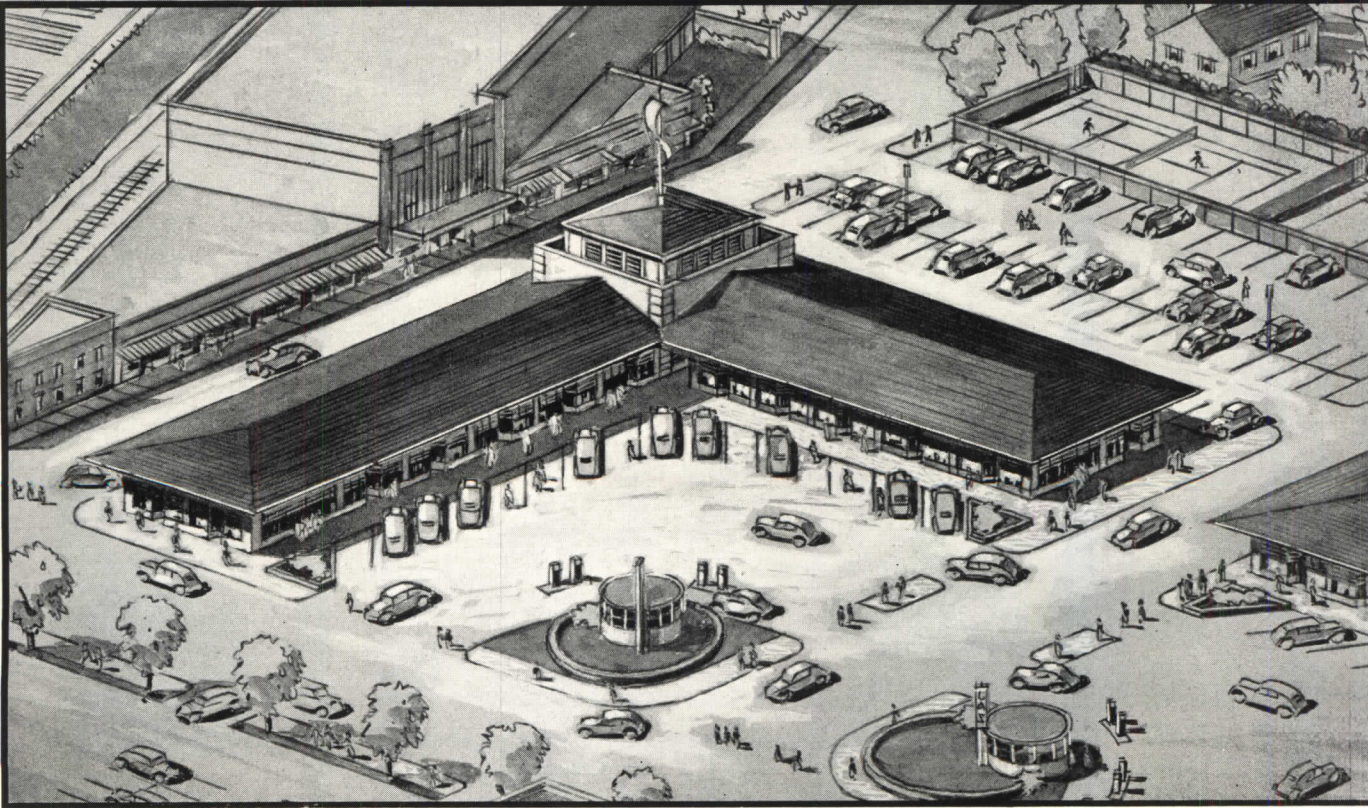
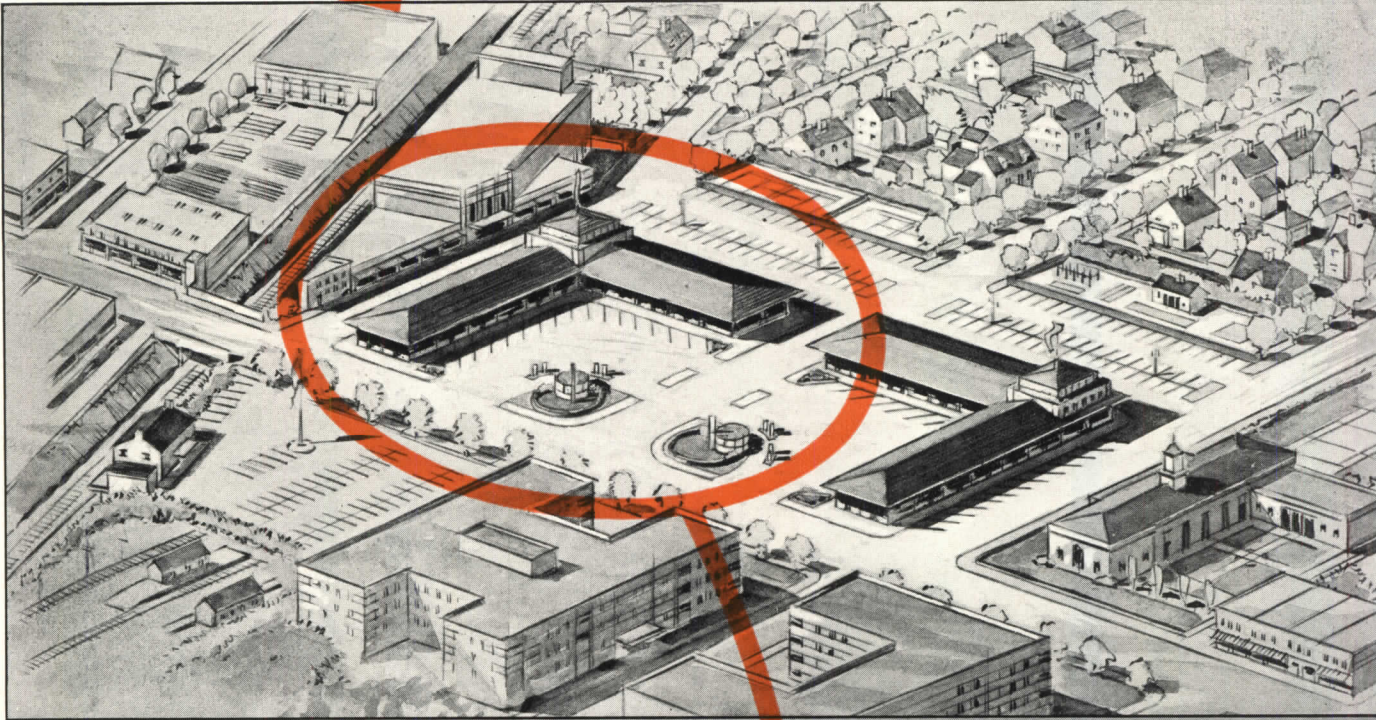



# DRIVES TO HER NEIGHBORHOOD SHOPPING CENTER

—and many such developments have arisen in recent years to make it easy and safe for her to "park-and-shop." The small shopping center which serves the immediate needs of an outlying residential area usually benefits by a certain uniformity of treatment, and by precautions against the creation of adjacent blighted neighborhoods. On these pages an officer of New York's Regional Plan Association outlines principles of shopping-center design, and a real-estate editor of Los Angeles' "Daily Times" reports local experience.

## DEVELOPING THE SHOPPING CENTER

By C. EARL MORROW, Planning Engineer, Regional Plan Ass'n.

**The residential neighborhood:** The general character of the residential areas tributary to a local shopping center largely determines its success. To create, among other things, the stability so essential to business, a new pattern of a residential area has evolved, known as the neighborhood unit.

The neighborhood-unit development envisions a method of building and rebuilding self-contained neighborhoods in, or just outside, urban areas, under unified ownership and management, providing facilities necessary for well-rounded family living. These include schools, parks, playgrounds, parking areas, shops, library, theater, and a street system which is both convenient and safe. Local stores are grouped on peripheral main and secondary streets—not express highways—with adjacent automobile parking space.

Normally the business section of a neighborhood unit would locate at the intersection of two boundary highways, that is, at one corner of the unit. If this point were at, or near, a subway or railroad station, the four corners of the intersection would constitute the principal shopping district for the four neighborhood units that come together at that point. There might be minor shopping areas at other intersections of the highways bounding the neighborhood.

**Over-all dimensions:** For a self-contained community in which practically all of the shopping is done locally, there are normally about 50 ft.\* of local retail-business frontage for each hundred of the population. In an urban or suburban neighborhood, allowance must be made for that part of the shopping which is done in the city, as well as the more general business and commercial activity that may locate in the neighborhood.

In a survey of the relation between retail business and population in the Chicago region†, it was found that in 54 cities and villages there was an average of 51.8 front feet of business per 100 population. The business frontage per 100 people ranged from 28.3 in River Forest to 86.5 in Burlington. In general the further in time or distance the community is from Chicago, the more business frontage it has per unit of population.

On the average, about 5,000 people constitute an urban neighborhood unit in a large city. If four neighborhood units converge at one point and have relatively little other business on their borders, there would be something like

\*In Southern California, preferred ratio is 80-100 ft. of gross frontage per 100 population.

†Chicago Regional Planning Association.

20,000 people to count on serving with the community shopping center. It remains to know how many people are served by the different stores. (For a tabulation see page 105.)

**Planning principles:** Many forces in a business center work against each other and require balancing. Business tends to locate where there are a lot of people passing. If many people pass in automobiles and congestion becomes acute, shoppers may go elsewhere. Again, the shopper likes a compact center where she doesn't have to walk very far or cross a wide thoroughfare. On the other hand, she wants to park her car in front of the store; this necessitates a wide street.

The most important fact to remember in the design of a shopping center is that old street systems were not adapted to the use of the automobile and new streets tend to keep too closely to obsolete patterns. Shopping centers have to be arranged for the convenience of the motor-car shopper.

**Parking:** Some motorist may want to park her car only a few minutes while she shops. Another may want to park all day while he goes to the city or works in the local hardware store. For some stores, trucks have to park at the store door while merchandise is being unloaded. It is reasonable that short-time parkers should have the most convenient places to park.

On main streets, where there is considerable through traffic, the area for parking may be protected by the sidewalk, which may also serve as a safety island. On secondary streets which have business frontage, parking is preferably at the curb. Traffic supposedly is moving slowly and the danger of moving in and out of a parking space is more than offset by the convenience.

Three points in designing a center-block parking space are to be noted. First, the entrances and exits for cars must be carefully considered in relation to both vehicular and pedestrian traffic. Blind corners are apt to create a serious traffic hazard.

A second point is convenient footpaths for pedestrians. The parking area may be just behind a row of stores on Main Street, but if the shopper has to walk around the block to get to the parking area she may refuse to use it. In addition to separate footpaths, the individual stores adjacent could well have rear entrances.

The third point is not the least important—it is a question of the looks of the parking area. If the parking area created inside has a forbidding look, or is visually difficult to enter, at least the women shoppers will have as little to do with it as possible. Since all the rears of buildings cannot be revamped at once, the best bet is landscaping.





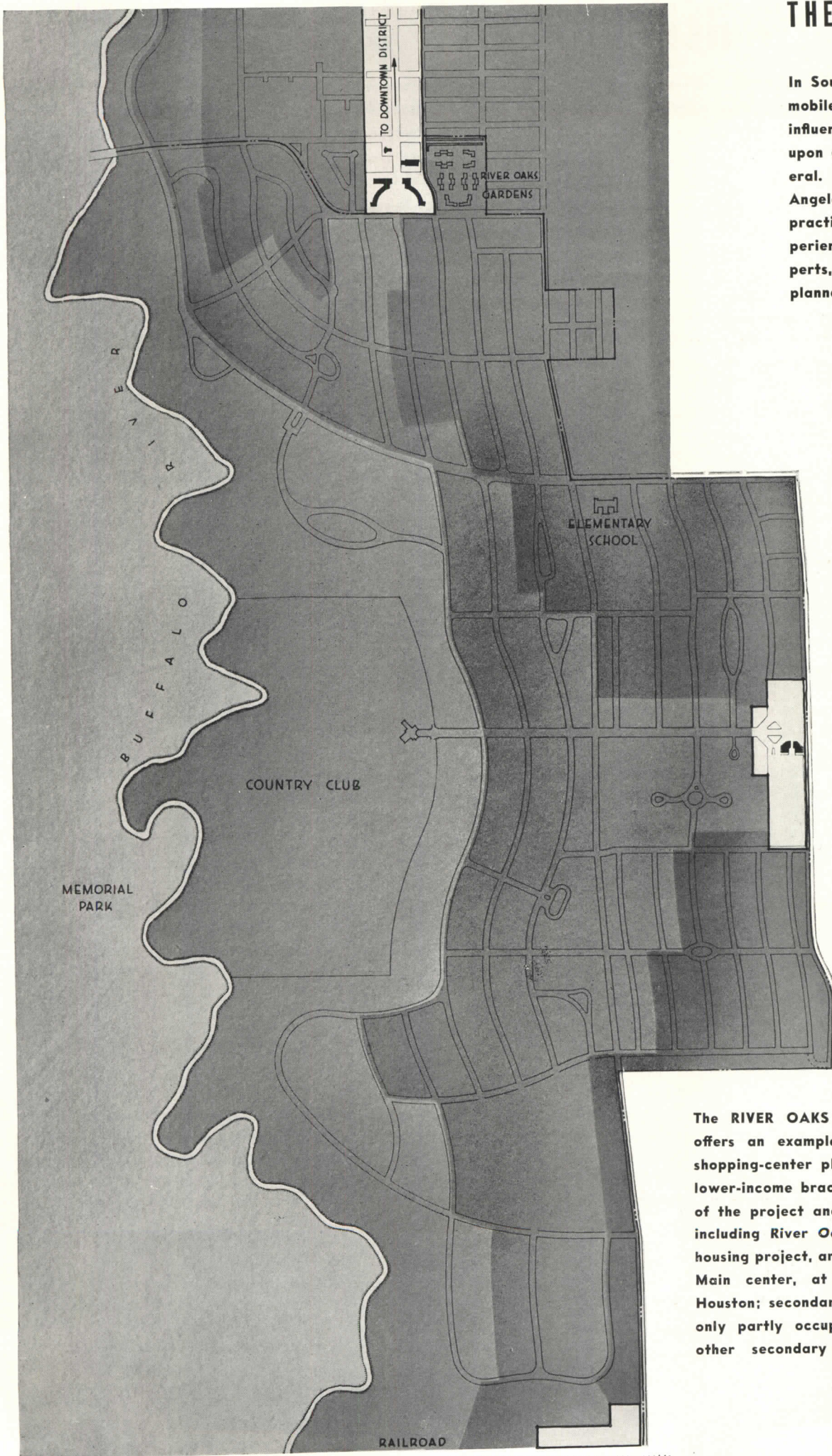

# THE FAR WEST PUTS

In Southern California the automobile has exerted a tremendous influence on shopping habits, and upon community planning in general. DON TAYLOR, of the "Los Angeles Times", here assembles practical data based on the experience of several California experts, including architects, city planners, planning commissions.



SENIOR  
HIGH  
SCHOOL

## LEGEND

- Shopping Center 
- Public Lands 
- Large Estates 
- Medium-Priced Homes 
- Inexpensive Homes 

The RIVER OAKS development in Houston, Tex., offers an example of controlled community and shopping-center planning. Homes for those in the lower-income brackets, both within the boundaries of the project and in adjacent developments, and including River Oaks Gardens, the local multiple-housing project, are closest to the shopping centers. Main center, at top, is closest to downtown Houston; secondary center, at right, is at present only partly occupied. Land is reserved for another secondary shopping center, at bottom.



# INTO PRACTICE THE PRINCIPLES OF SHOPPING-CENTER PLANNING

ESTABLISHMENT of a community shopping center is feasible as soon as there is sufficient population in the surrounding trading area to support a representative group of merchants. However, it is desirable to start tentative planning for the shopping center as early as is practical. For a deliberately created community—such as a new real-estate promotion, a government project, or settlement project by some other agency (large manufacturing concern, for example, such as Ford's River Rouge plant)—the center may be planned coincidentally with the whole community.

In cases of old-established static small communities, any factor which presages imminent growth—construction of factories, development of new real-estate tracts, establishment of a university, etc.—is a signal that plans should be made for a shopping center that will protect contiguous properties from becoming blighted areas because of uncontrolled growth, that will protect life by eliminating traffic hazards, that will aid merchants by providing efficient, pleasant shopping conditions.

It is theoretically advisable to pool all the properties in an area of four to nine square miles so that the whole may be handled as a unit (without, of course, surrendering actual ownership). When there is a community government such pooling may be effected by ordinances.

**Location:** In planning a shopping center, the interests of merchants require as much consideration as those of residents and property owners. For this reason stores must be as accessible as is practical. The community need not completely surround the center, but shops must be so located, relative to residences of people in various income groups, that they are readily accessible by the usual means of local transportation. Multi-family buildings and low-income-bracket private homes have to be within easy walking distance. These areas, too, have greatest need for mass-transportation facilities (buses, trolleys, etc.) which are routed close to the shopping center.

The center is preferably close to, but not traversed by, major highways, with rapid-transit systems routed to the periphery of the center.

**Level sites** are considered advantageous for three reasons: Shoppers (75% or

more of whom are women) don't like to climb hills; cost of construction is held to a minimum; safety is increased because level streets are safer for both pedestrians and motorists.

Maximum economical area of the entire shopping-center site is governed by the distance shoppers are willing to walk from parked cars or mass-transportation terminals. It appears that 3 blocks square is the practical maximum in communities where the automobile is the prime means of transportation to and from home. When shopping centers are too large, they tend to develop in a disorganized manner, often along their own periphery, and to depreciate within. The shopping area can be protected against adverse influences (such as undesirable developments within or adjacent to the center) by restrictive leases, by a continuing control over the selection of tenants, or by zoning ordinances drawn in accordance with a master plan.

**Amount of land needed** for stores, parking, service stations, and other units within the center: Determination of exact land uses is ordinarily resorted to only in the event that space can be pre-allocated. Generally it has been found that a combination of factors (necessary sidewalk traffic, proportionate rentals, etc.) acts to foster a correct allocation by the tenants themselves.

It is sometimes estimated that there should be 50 ft. of business frontage for every 100 persons in the community. In Southern California this is deemed insufficient; the preferred ratio is 80 to 100 ft. of gross frontage in the business center for every 100 customers.

Parking space in the center has been found satisfactory when it equals in area the land occupied by business. One successful chain of supermarkets recommends 60% parking, 40% store area for their outlets. It has been found advisable to locate large parking areas to serve groups of stores rather than individual parking for each store (an exception is the supermarket, which may require its own parking area). Group parking areas facilitate the practice of leaving cars and touring shops.

**Location of buildings; and distribution of parking space** around store buildings: A satisfactory arrangement places the store

on one corner of the site so that parking areas surround it on three sides. Large parking areas, situated right on the street and involving no shoestring alley entrances, appeal to women shoppers. Large rear areas have been found good if they are extremely accessible.

**Gas stations** are logically located on the periphery of a shopping center, nearest to major traffic arteries and out of high-rent districts. The tendency is to allow plenty of room for gas stations, 30,000 sq. ft. being common.

**Other buildings:** It would seem logical to locate units which are patronized when stores are closed (theaters, recreation facilities, etc.), so that deserted parking areas can be used.

**Shapes of buildings** are largely determined by locality, climate, and topography. However, there are maximum depths for various types of stores: approximately 25 ft., 100 ft., and 150 ft. Shallowest stores are candy stores, bakeries, etc.; 100-ft. depths are favored for the greatest number (shoe stores, dress shops, etc.); 150-ft. depths are desirable for department stores, large variety stores, markets, auto showrooms and service garages.

**Future expansion:** If the center attracts more business than its allocated area can accommodate, it is deemed better to establish a new center some distance away than to expand the existing center. If it is definitely assured that the center will be restricted to its original boundaries, owners of adjoining residential property will be encouraged to develop their properties fully because of the sense of security they will have. Otherwise blighted areas may develop just outside the shopping center.

**Appearance:** Landscaped parkway strips down the middle of the center's main thoroughfare are favored by women shoppers. Aside from agreeable appearance, these induce a sense of safety in crossing streets because traffic need be watched in only one direction.

**Architectural attractiveness:** Most people are agreeably influenced by good design in buildings and environment, just as they are by attractive merchandise. The practice of permitting a diversity of architectural expression may tend to loss of attractiveness.



This check list is based upon replies to a questionnaire submitted to a number of carefully selected city planners, realtors, Federal agencies, and architects experienced in shopping-center planning. It contains in brief notes the main practical considerations which influence a shopping center's design, and is presented for use during the formative stages of planning. Its headings can be expanded to suit requirements of particular projects.

## 1. SITE AND TOPOGRAPHY

Level sites are preferred, particularly in localities where sleet and ice make winter driving unsafe. It is generally considered desirable to locate buildings parallel to contours, especially in small projects. For ultimate financial success, and for convenience of pedestrians, a site close to a main thoroughfare, but planned so that merchandise trucking need not traverse residential areas, is preferable to locations on express highways.



McLaughlin

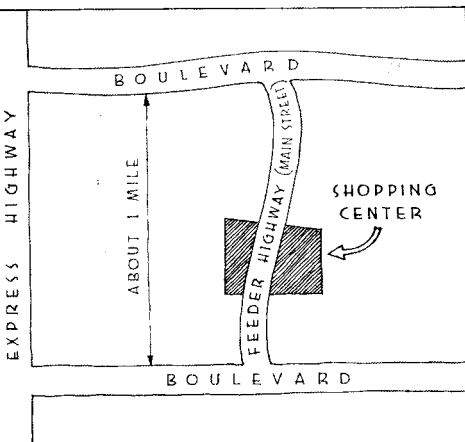

## 2. TRAFFIC

For small projects it is considered best not to have the principal thoroughfare run through the center, to avoid congestion and increase safety. In some cases it may be desirable to use both sides of the principal thoroughfare in order to double shop frontage. A common practice is to locate the project at the side of the principal thoroughfare, usually on the "home-going" side. A setback from the street is usually desirable, and auto traffic within the shopping center is preferably, though not necessarily, one way. Pedestrian traffic needs control for safety and to increase accessibility of shops. In some cases complete separation is found desirable. Other methods include arrangement of parking facilities to eliminate cross lanes; establishment of safety islands, lanes, and sidewalks adjacent to shops; overhead walks and underpasses; and control of automobile traffic by traffic lights, stop signs, etc.

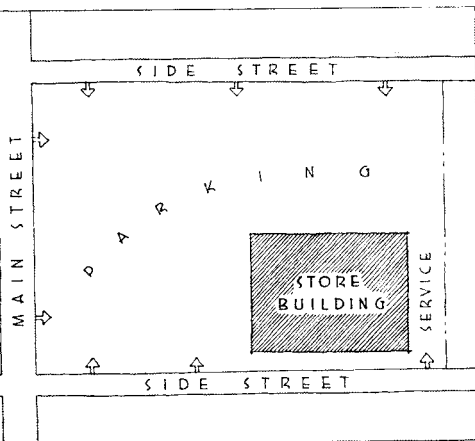

## 3. PARKING

Parking at street curbs is not ordinarily recommended unless street can be widened locally. Extension of sidewalks to form parking bays helps. Parking entirely off street is considered most desirable. Parking areas in rear of buildings require extremely accessible entrances. Local building codes often govern widths of driveways, sidewalks, streets, etc. Parking parallel to curbs requires least space, but in some localities diagonal parking, either at curbs or in lanes within parking area, is considered more satisfactory because of greater ease of maneuvering. Recommendations for parking-plus-traffic dimensions vary greatly; usual minima are indicated in Time-Saver Standards on page 110. For small projects, with one-way traffic, a single entrance and a single exit are preferred. For larger projects more than one exit and entrance may be desirable, bearing in mind the needs of pedestrian safety.

## 4. LANDSCAPING

Requirements for ground cover include low cost, easy maintenance, and high resistance to traffic. Grass is used in many cases, although it has been the experience of numerous observers that low shrubs, creeping plants, flagging, or pavement are more satisfactory. Gravel is sometimes recommended although it is often hard to maintain and has been found to damage shoes of women shoppers. Tall plantings have to be carefully selected and placed, perhaps pruned above eye level. In general, increased attractiveness provided by landscaping is considered financially worth while.



Russell B. Harding

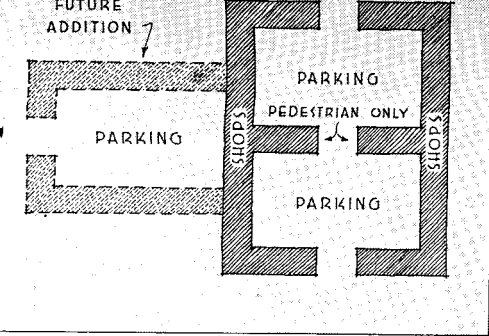

## 5. EXPANSION

Future expansion has to be considered at the time of the original planning. The type of provisions varies with local conditions. Building restrictions, zoning ordinances, and, in cases of individual ownership or collective action, a restriction of the type of tenant can be employed to prevent incursions by nonconforming elements. Buffer strips, such as parkways, have sometimes been placed around shopping centers to prevent formation of blighted areas immediately adjacent. Recreational areas, and nurseries where children can be cared for, may be similarly located.



## 6. CIRCULATION

It is considered advisable to establish some means of control of pedestrian circulation at entrances and exits of shops, parking areas, recreation areas, etc. Drive-through parking areas are uniformly preferred. These restrictions, however, should not interfere with free access to shops. Recommended sidewalk widths, for general circulation, range from 4 to 10 ft., and, for sidewalks directly in front of shops, from 6 to 15 ft.

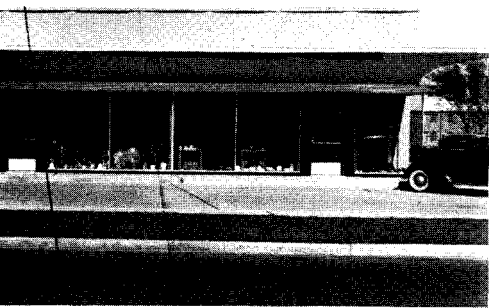

Harry L. Starck

## 7. TYPE OF BUILDING

One-story and basement buildings are ordinarily preferred, with two stories desirable for parts of the project only. If there is parking space on both sides of the store block, entrances are usually required in front and rear. In many cases display windows on the rear are considered valuable. Harmony in design with the general character of the neighborhood is highly desirable; in some cases projects can establish their own character of design. Some form of protection from the elements, such as continuous marquees, is necessary, but any architectural form (such as an arcade) which tends to decrease the effectiveness of display windows has been found to decrease store sales. Within the building it is possible to preallocate certain types of stores. To some extent preallocation of space can determine column spacing, etc., but complete reliance on forecasts has been found generally undesirable.



## 8. TYPES OF RENTABLE SPACE

Frequency of and Average Population per Business Concern*					
Type of Concern	Population	Type of Concern	Population	Type of Concern	Population
1. Grocery	641	11. Hotel	4,494	21. Millinery	6,531
2. Meat market	1,023	12. Furniture	4,522	22. Hardware	6,647
3. Restaurant	1,406	13. Dry goods	4,552	23. Cleaner & dyer	6,928
4. Druggist	1,681	14. Cigar & tobacco	4,957	24. Delicatessen	7,568
5. Garage	2,185	15. Undertaking	5,590	25. Laundry	7,772
6. Merchant tailor	2,204	16. Coal	5,599	26. Musical instruments	9,785
7. Plumber	2,259	17. Shoe	5,619	27. Bank	10,836
8. Confectionery	2,714	18. Clothier	5,656	28. Furrier	20,467
9. Bakery	2,749	19. Florist	6,117	29. Typewriter	34,421
10. Fruit & vegetable	3,728	20. Jewelry	6,416	30. Sporting goods	38,241

\* The above tabulation from data obtained by the New York Regional Plan is based on surveys of seven representative cities. Other types of shops usually included in a shopping center are barber and beauty shop, electrical supplies, household furnishings, men's and women's clothing and furnishings, novelty shops, newsstands and stationery stores, painter and decorator, real-estate office, tearoom, department store.

## 9. ADAPTABILITY

Some form of skeleton construction, within which partitions can be shifted as requirements change, is a necessity. The type of store required by the neighborhood may not change radically, but individual stores undergo periodic changes.

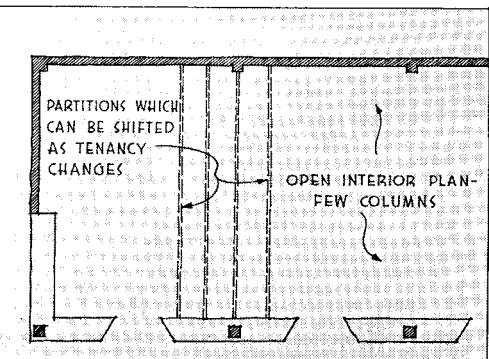

## 10. CONSTRUCTION

Materials and systems to be used depend to some extent upon local conditions, such as code requirements, availability, costs, permanence of development, etc. In general, concrete foundations, reinforced where necessary, masonry or frame walls, concrete floors, and shingle, slate, composition, etc., roofing are used. The structural system should be of a type which is highly fire resistant.

## 11. DURABILITY

Recommended life expectancy of such a building is usually short (15 to 20 years) due to technical improvements, changes in merchandise, and possible changes in trading areas. However, when buildings are flexibly planned and built of materials that satisfy requirements of fire safety, etc., life expectancy has been estimated as high as 50 years. Alterations to interior and exterior finish are to be expected. Ease of maintenance, low cost, advertising value are factors bearing on the selection of finishing materials. Satisfactory surfaces include tile, "stainless" metals, structural glass, concrete, etc. Plastered ceilings are commonly used and acoustical treatment is considered valuable when costs are not too great. Style, durability, and low maintenance costs are considered more important than low first costs.

## 12. HEATING, AIR CONDITIONING,

Automatically fired boilers are ordinarily installed in northern states, with a central heating plant preferred over individual plants. This depends somewhat on the size of the project. In southern states individual unit air conditioners are sometimes included. If a central air-conditioning system is installed, or forced-air system with washing and cooling, supply and return ducts have to be located independently of partitions.

## 13. ELECTRICAL EQUIPMENT

Most electrical codes require use of rigid-conduit systems in commercial buildings. BX cable is usually considered satisfactory where codes permit. The usual building service is 110-220 volts; sometimes 440 is required. Individual meters are usually preferred. However, in some large projects, project master meters with sub-meters for tenants have been found to work satisfactorily. Signs and sign lighting require exterior weatherproof outlets, and there is a need for night lighting for buildings and grounds. An important consideration in connection with both signs and lighting of grounds is the possible effect of too great a display on the surrounding residential neighborhood. In some projects means have been found to light indirectly parking areas, signs, shop fronts, etc., and overhead lighting has been confined to gas stations. Similarly it has been found advisable to limit sign locations to conform to the architectural design of the entire project.

## 14. PLUMBING

Municipal or private disposal systems have to be planned with possible future expansion in mind. Corrosion-resistant piping is desirable. The exact type (copper, brass, iron, etc.) depends upon characteristics of the local water supply.

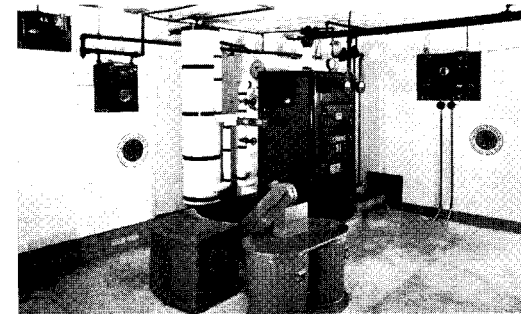

Johnson's Studio



Wm. W. Thomas

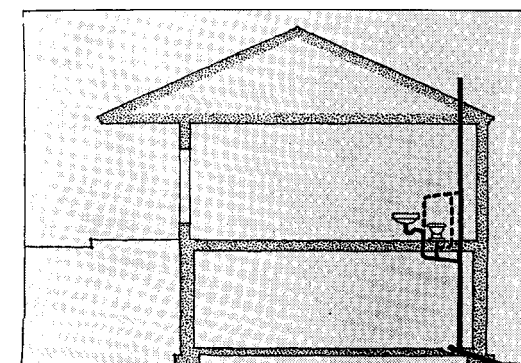



# PLANNING UNITS FOR RETAIL STORES: 1—BARBER SHOP AND TAILOR

On this and the two following pages are presented space requirements for typical small retail shops which are ordinarily found in a neighborhood shopping center. Where over-all sizes or areas are given, dimensions are those which experience has proved to be economically satisfactory. Local conditions may cause some variation from these optima. The information is intended to form a

basis for design which can be adapted to the designer's needs. Data were compiled by Richard S. Hertzberg. The architectural firms of Tannenbaum & Eisen, and Telchin & Gina, contributed substantially to the completeness of the presentation. Numerous manufacturers of equipment around which the stores are planned also contributed.

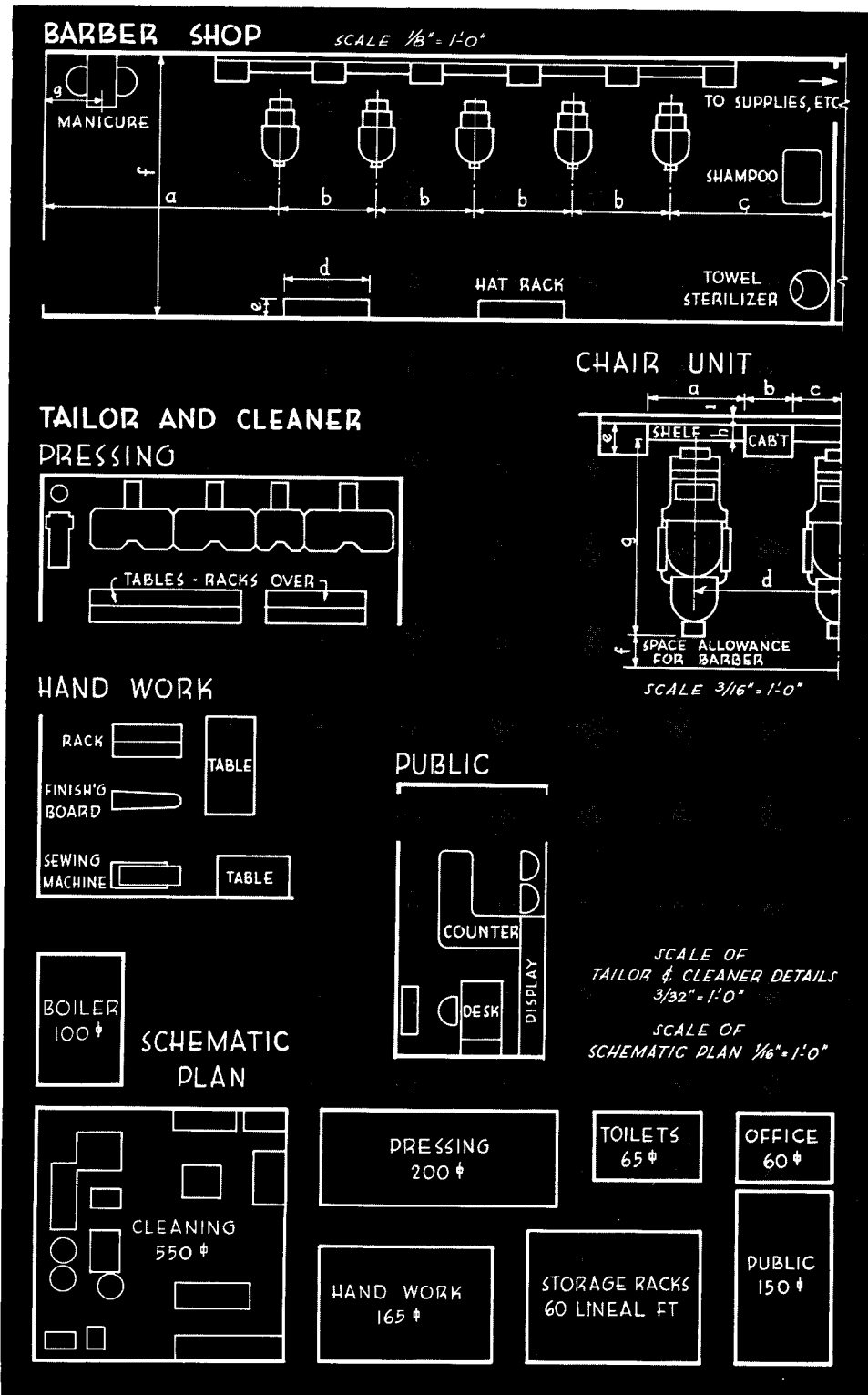

## BARBER SHOP

The typical five-chair barber shop can be accommodated in a store 14 by 42 ft. in size. A shop for a small community ordinarily has a single shampoo basin; if individual basins are required at all barber chairs, space requirements have to be slightly increased.

## SHOP CLEARANCES

- |           |                                      |
|-----------|--------------------------------------|
| a. 10'-9" | e. 0'-10"                            |
| b. 4'-6"  | f. 12'-0" to 14'-0"                  |
| c. 7'-6"  | g. 2'-6"                             |
| d. 4'-0"  | <b>Manicure table: 1'-4" x 2'-6"</b> |

## CHAIR UNIT

- |          |          |          |
|----------|----------|----------|
| a. 3'-0" | d. 4'-6" | g. 6'-0" |
| b. 1'-6" | e. 1'-0" | h. 0'-6" |
| c. 1'-6" | f. 1'-0" | i. 0'-3" |

## TAILOR AND CLEANER

The schematic plan here presented shows areas required for the various functions in a complete small tailoring and cleaning establishment. If a tailor's shop is the only requirement (for pressing and repairs) and cleaning work is sent out, cleaning and boiler-room areas may be omitted.

## PRESSING UNIT

**Vacuum steam unit:** 2'-6" x 5'-9"  
**Pressing machine:** 5'-9" x 3'-0", 5'-0", or 6'-0"  
**Tables and racks:** 2'-0" wide, 15 lin. ft.

## HANDWORK AREA

**Tables:** 3'-0" x 6'-0", 2'-6" x 5'-9"  
**Sewing:** 3'-6" x 6'-0"  
**Finishing board:** 4' x 0" x 6'-0"  
**Hanging rack:** 2'-0" wide, 4 1/2 lin. ft.

# PLANNING UNITS FOR RETAIL STORES: 2—FOOD SUPERMARKETS

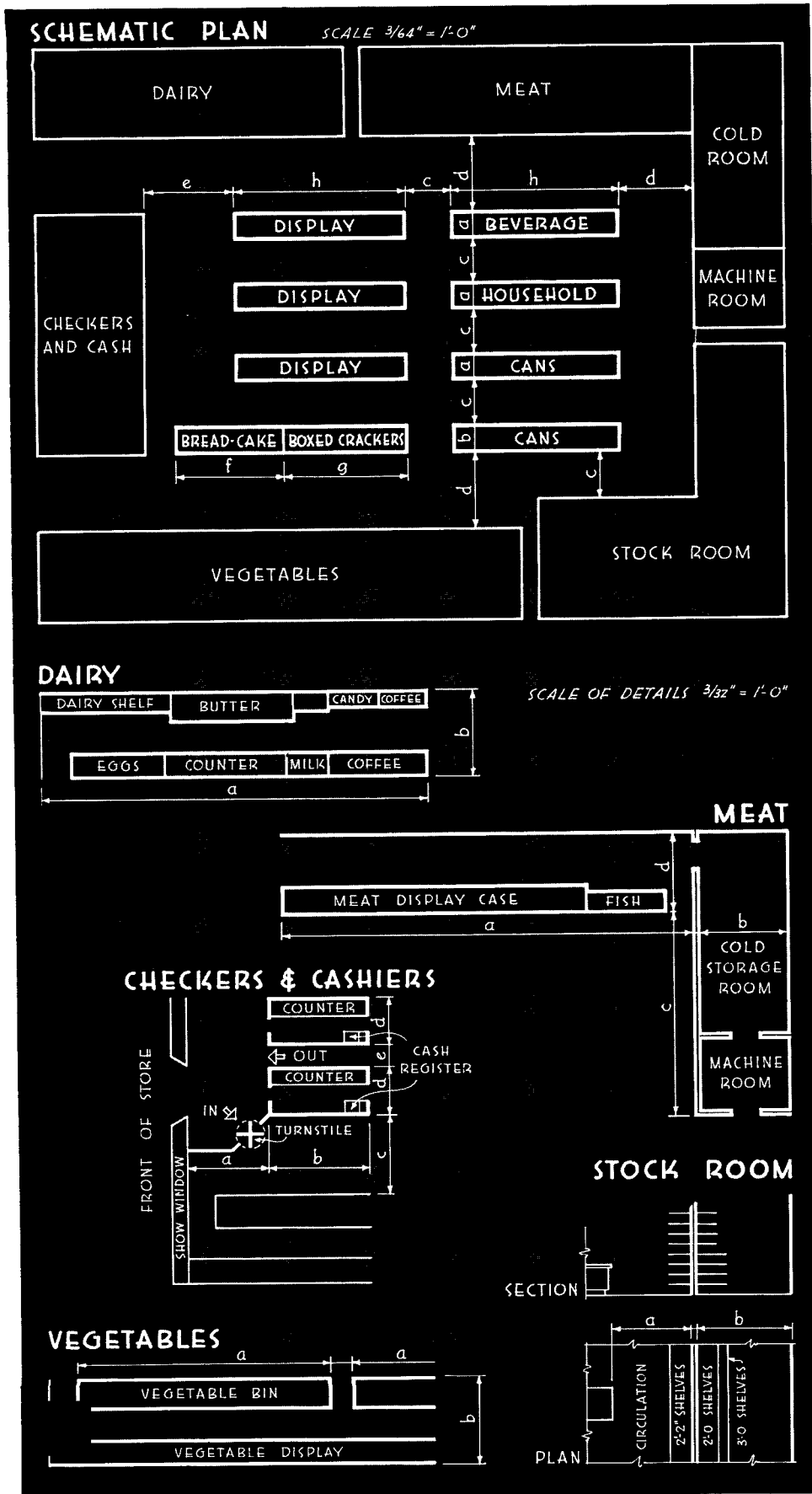

The modern supermarket, which incorporates self-service in several departments, includes most of the types of food stores to be found in the average community shopping center. Dimensions and clearances given here can be applied to individual store-planning problems.

The typical successful supermarket contains approximately 7,000 sq. ft., and is 100 to 150 ft. deep. General circulation, checking and cashier space, not including aisles for grocery or other departments, totals 1,270 sq. ft.

## GROCERY DEPARTMENT

**Type of service:** Self-service  
**Location:** In center of store  
**Area:** 2990 sq. ft.

### Dimensions:

- a. 3'-4" to 3'-6"
- b. 3'-9"
- c. 6'-0"
- d. 8'-0" to 10'-0"
- e. 12'-0"
- f. 14'-0"
- g. 16'-0"
- h. 22'-0"

## DAIRY

**Type of service:** Counter  
**Location:** Close to entrance  
**Area:** 470 sq. ft.

### Dimensions:

- a. 35'-0"
- b. 8'-6" min.

## BUTCHER

**Type of service:** Counter  
**Location:** At rear of store  
**Area:** 800 sq. ft.

### Dimensions:

- a. 40'-6" to 48'-0"
- b. 9'-0" min.
- c. 19'-0" min.
- d. 8'-0"

## CHECKER AND CASHIER

**Type of service:** Counters where packages are lifted from carts and packed  
**Location:** At front of store

### Dimensions:

- a. 5'-4"
  - b. 10'-0"
  - c. 5'-4" to 10'-0"
  - d. 4'-9"
  - e. 2'-0"
- Show window:** 1'-0" to 1'-6" deep

## VEGETABLES

**Type of service:** Self-service, with clerks  
**Location:** Near front of store  
**Area:** 740 sq. ft.

### Dimensions:

- a. 25'-0" to 35'-0", with 2'-0" passage between units, 2'-8" clearance to show-window back
- b. 8'-10" average

## STOCK ROOM

**Location:** At rear of store  
**Area:** 730 sq. ft.

### Dimensions:

- a. 8'-2", for circulation, shelving, etc.
- b. 9'-6", for uncrating, shelving, etc.

# 3—BEAUTY SHOP, SHOE-REPAIR SHOP, DRUG STORE

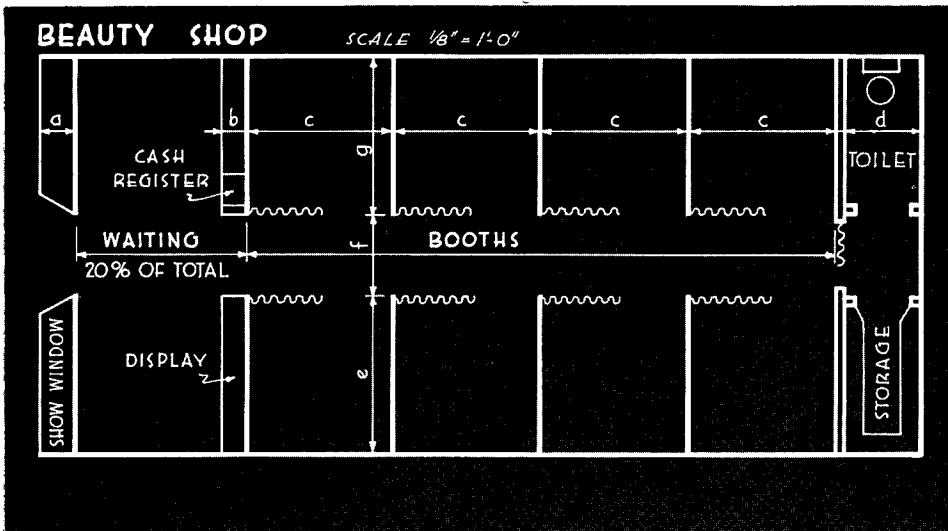

## BEAUTY SHOP

The typical small beauty shop has to contain at least six to eight booths in order to do enough business to be successful. If manicuring is to be done in booths, 20% of the shop's total area is devoted to waiting room. If manicure tables (15 by 30 in., with 5 ft. between tables) have to be placed in waiting space, the 20% proportion may have to be enlarged.

### DIMENSIONS

- |  |                   |
|--|-------------------|
| a. 1'-0" to 1'-6"                                      | d. 3'-0"          |
| b. 1'-0"   | e. 6'-6" to 7'-0" |
| c. 5'-0", 6'-0", 7'-0"<br>(for standard wall cabinets) | f. 3'-6" to 7'-0" |
|  | g. 6'-6" to 7'-0" |

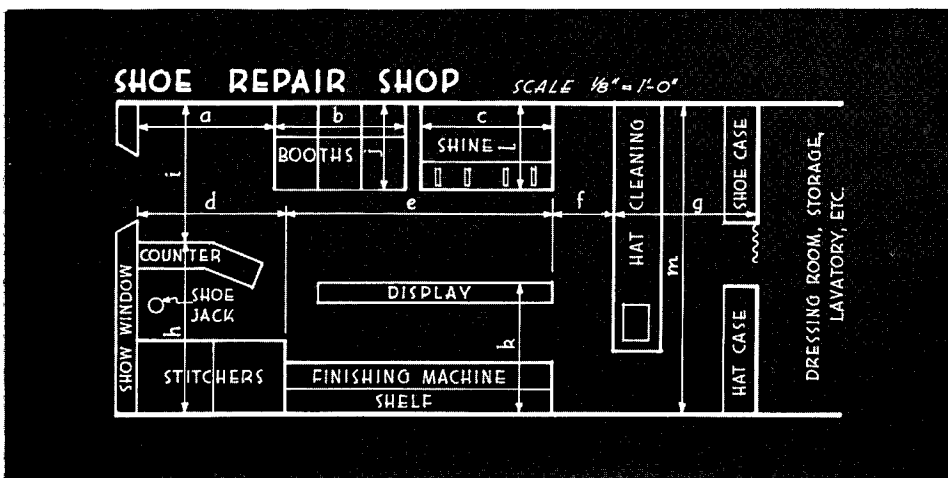

## SHOE-REPAIR SHOP

Data are based on requirements for a one-man shop, possibly with helper. Door is always at one side of show window; small window is sometimes omitted. Large window contains 10- to 12-inch-wide workbench. Booths for "while-you-wait" are standardized at 1 ft. 8 in. wide, with 2-in. arm rests between; depth is variable. Shoeshine benches are never placed opposite waiting booths.

### DIMENSIONS

- |   |           |           |
|---|-----------|-----------|
| a. 5'-6"  | d. 6'-0"  | i. 6'-0"  |
| b. 5'-8"  | e. 11'-0" | j. 3'-6"  |
| c. 5'-0" std. for 2 chairs; 6'-0" size also available | f. 2'-6"  | k. 5'-6"  |
|   | g. 6'-0"  | l. 3'-6"  |
|   | h. 7'-0"  | m. 13'-0" |

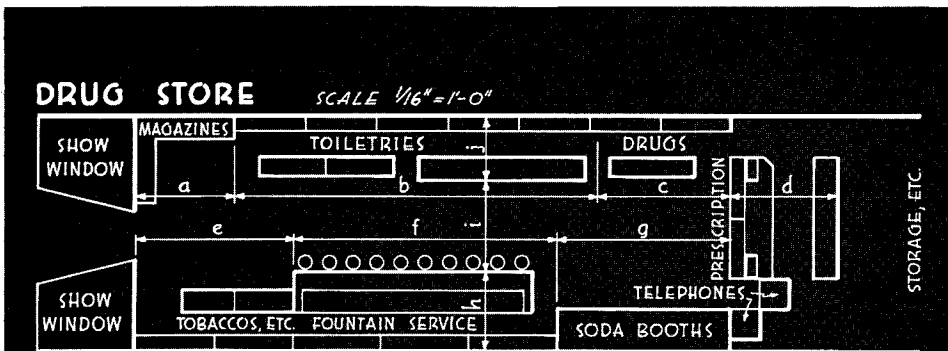

## DRUG STORE

The drug store requires large, deep show windows near the entrance, and is preferably in a corner location. An additional entrance is often provided into or close to the rear storage room. An increasingly common practice places a large plate-glass window between the pharmacist's working space and the store proper, in order to display the laboratory. Preferred disposition of departments in relation to the principal entrance is indicated on the diagram.

### PLAN DIMENSIONS

- |  |  |
|--|--|
| a. 8'-6"   | f. 21'-6"  |
| b. 32'-6" (wall cases, counter, stepped counter) | g. 14'-6"  |
| c. 10'-6"  | h. 6'-9" to 7'-0"                                |
| d. 9'-0"   | i. 5'-9" to 8'-0"                                |
| e. 13'-0"  | j. 4'-6" to 5'-8"<br>(varies with counter depth) |

### SODA BOOTHS

- |          |               |
|----------|---------------|
| a. 1'-4" | c. 4'-8" min. |
| b. 2'-0" | d. 3'-6" min. |

### PRESCRIPTION DEPT.

- |   |                     |
|---|---------------------|
| a. 3'-6" min., with glass partition down center | b. 3'-4" to 3'-6"   |
|   | c. 1'-6" to 2'-0"   |
|   | d. 10'-0" to 12'-0" |

SCALE OF DETAILS 1/8" = 1'-0"

### SODA BOOTHS

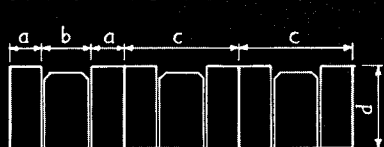

### PRESCRIPTION

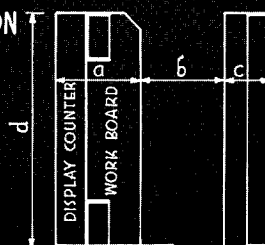



# PARKING SPACES AND DRIVEWAYS FOR COMMUNITY SHOPPING CENTERS

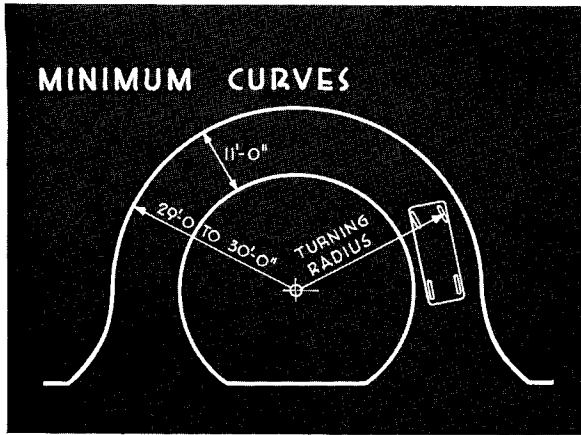

Data for this presentation are based on principles developed by Ernest Irving Freese, correlated with the findings of traffic engineers in respect to clearances for safe driving and parking. From the bases here illustrated, solutions may be found to parking and traffic problems in connection with shopping centers.

## PROPERTIES OF AUTOMOBILES

Unless an automobile is driven in a straight line, rear wheels do not follow exactly in the tracks of front wheels, because front wheels only are controlled by the steering gear. Hence, on curved driveways, the inner rear wheel may track off a roadway if the inner radius of the drive is too great. The outer front wheel may track off if the outer radius is too small.

Determination of the minimum width of driveways for various radii (and vice-versa) depends on three properties of an automobile: "tread," "wheelbase," and "turning radius." To these properties are added inside and outside clearances to provide a margin of safety, so that both front and rear bumpers, fenders, trunks, etc., will safely clear shrubbery or curbs.

The "**tread**" of a car is the distance center-to-center of the front or rear wheels. The tread varies both between the front and the rear wheels and with the make or year of the car. The tread of the rear wheels, being a constant on curves and normally greater than that of the front wheels, is used in driveway calculations.

The "**wheelbase**" is the distance center-to-center between front and rear axles. It also varies.

The "**turning radius**" is the radius of the circular track of the outer front wheel, also variable.

All of these factors have been taken into account in dimensions and clearances given in the accompanying diagrams, which will accommodate most automobiles sold in the years 1936 through 1940.

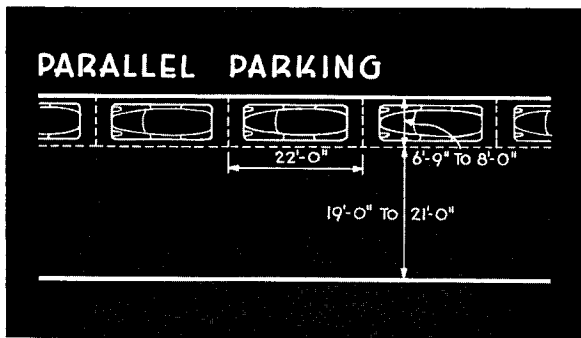

## PARKING

**Parallel** parking space may be slightly less in length than the 22 ft. shown in the sketch. This dimension is based upon the space required for an automobile to come into position parallel with the curb. In general, 8-foot-wide lanes are preferred for parallel parking.

**Perpendicular** parking requires slightly more width than diagonal parking, and slightly less length. Individual parking spaces as narrow as 6 ft. 9 in. are considered advisable only when attendants are available to park cars.

**Diagonal** parking is considered easiest and safest for parking spaces in which owners park their own cars. However, narrow parking spaces (6 ft. 9 in. to 7 ft.) are not advisable unless attendants park the cars.

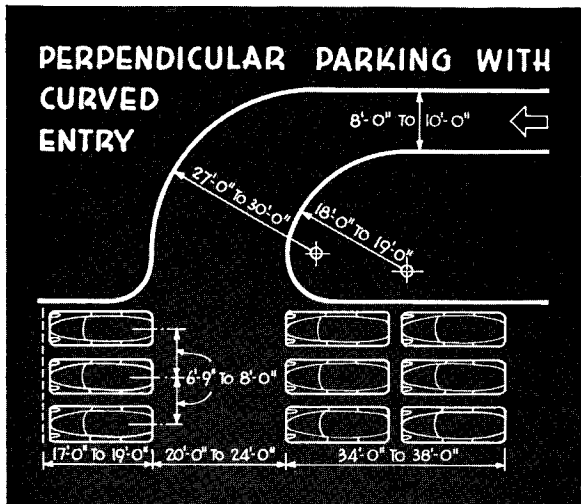

## TRAFFICWAYS

One-way traffic, with one entrance and one exit, is considered best for small projects, or in portions of projects where areas are restricted. This does not mean that entrances and exits are to be alleys between buildings; generous openings, with no obstructions to vision, and with actual driveway entrances segregated by safety islands or by extensions of sidewalks, are both safer and most likely to be voluntarily used.

**Entrance widths** (and exits) are preferably not less than 15 ft., even for one-way traffic. This aids in eliminating some of the hazards attendant upon driving from a parking space into a traffic-laden street. Maximum width is sometimes controlled by local ordinances, and should not exceed the width of secondary streets commonly used in the neighborhood. This precaution is advised so that pedestrians can estimate the length of time needed to cross an entrance or exit almost subconsciously, from their experience in crossing nearby streets.

**Parking-plus-traffic:** Minimum dimensions are given in the accompanying diagrams. For *parallel parking*, the 19 to 21-ft. dimension shown allows room for one line of traffic, and for maneuvering space; for two lines of traffic, plus one line of parking and maneuvering space, add from 10 to 11 ft.; for two lines of traffic, plus two lines of parked cars and maneuvering space, double the dimensions shown. If there is little or no through traffic, and parking-plus-maneuvering space is all that is needed, 18 to 20 ft. (total from curb to curb) will suffice.

Clearances indicated for diagonal and perpendicular parking are based upon requirements for maneuvering. It is usually uneconomical of space to provide additional traffic lanes within parking areas; these are preferably eliminated or restricted to the areas' boundaries.

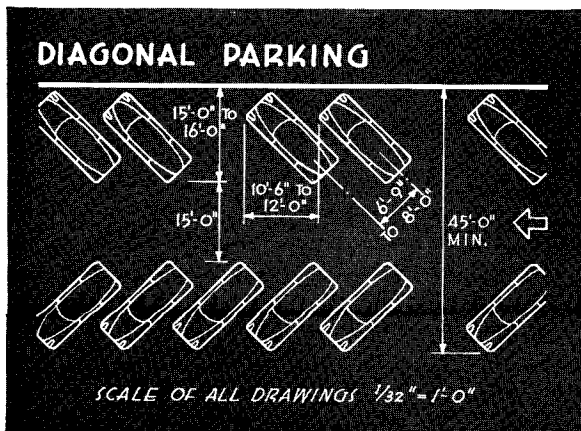

# ARCHITECTURAL RECORD TIME-SAVER STANDARDS

Photos by Russell B. Harding



## UNIFIED CENTER SUCCEEDS IN EASTERN TOWN

**The Locatelli Building in Winchester, Mass., consists of a number of closely related structures which were unified architecturally by JOHN EDMOND KELLEY, Architect. The development has proven so successful financially that there is constant demand for its store space, and the sponsors are planning a larger edition of the building in a nearby community.**

THE COMPLETED LOCATELLI BUILDING is the result of progressive developments, each of which was initiated as the preceding step began to pay its way. The first unit was that shown in the foreground above, facing on Main Street, Winchester. This building was extensively remodeled from an existing taxpayer. Second came the unit in the right of the view above, which faces partly on Main Street, partly on adjacent Thompson Street. Here the original building, whose Main Street face projected some 11 ft. beyond that of the first unit, was demolished and a new one

constructed in line with the first to provide additional curb parking space.

The last step comprised buildings along a pedestrian right of way, visible at the left of the photograph below. Old residences were here replaced with store, office, and apartment space.

In the Main Street building, which consists of the first two steps outlined, there are at present 10 stores, 11 offices, basement bowling alleys, and janitors' quarters. In the other portion there are 9 stores and 4 second-floor studio apartments. Below is a view from the Aberjona River.





## LOCATELLI BUILDING

JOHN EDMOND KELLEY, Architect

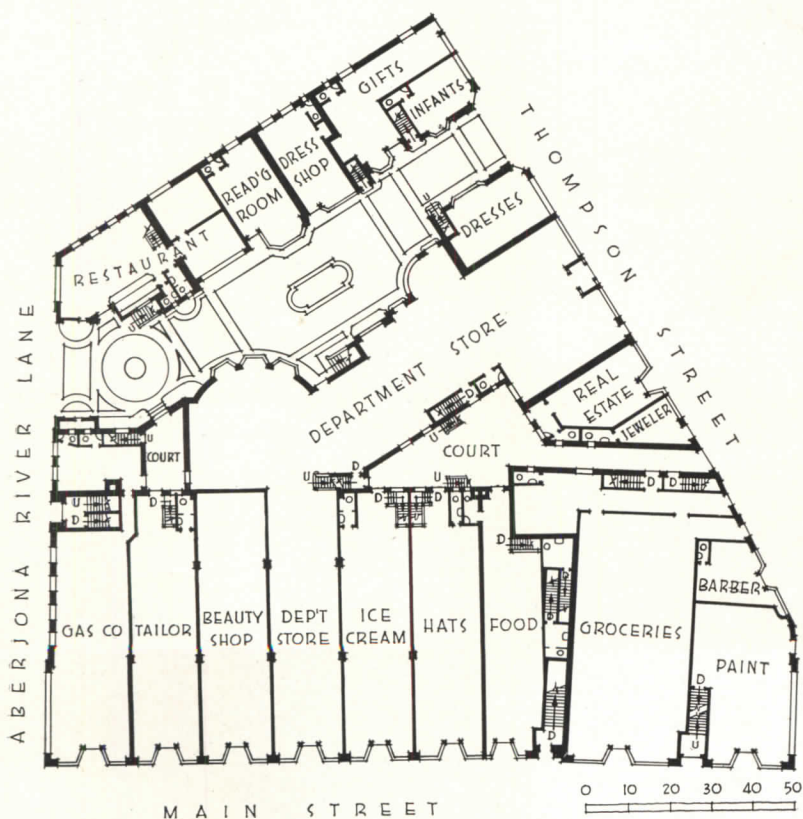

THE ACCOMPANYING PLAN shows the arrangement of the first floor. The portion indicated as "department store" is occupied by a branch of Filene's large Boston store. In the basement, besides bowling alleys, are storage spaces for all stores.

Second-floor offices all face on Main or Thompson Streets. The apartments have individual roof terraces, and a separate roof garden is provided over the restaurant.

Parking space is available on both boundary streets. The lane along the bank of the Aberjona River, to which Winchester Terrace (the pedestrian passage through the building) leads, is part of a landscaped development which adds to the attractiveness of the building's setting.

The structure is of concrete, brick, cast stone, wood, and steel. Main office entrance, on Main Street, and hall leading to offices are paneled with knotty pine. Offices have rubber-tile floors and are equipped with Venetian blinds.





Above, view of the latest development, showing the arched entrance from Thompson Street into Winchester Terrace. Below, shops and apartment entrances along the Terrace





*Paul Peters*

## A LONG-CONSIDERED SCHEME DEVELOPS

In the environs of Houston, Tex., the community of River Oaks has grown up where a few years ago there was open country. When the development started, the owners recognized a future need for a community shopping center. Land bordered by multifamily and low-priced detached house sites (see map, page 102) was set aside, and a scheme was developed which needed only minor later changes. STAYTON NUNN and MILTON MCGINTY were the architects, with OLIVER C. WINSTON, consulting architect.

RIVER OAKS SHOPPING CENTER lies on one side of Shepherd Drive, a belt artery, and is bisected by West Gray Avenue, which leads to downtown Houston. Bus lines, used principally by domestic servants, traverse these two highways and another which parallels West Gray some blocks to the south. Almost every family in the surrounding developments has at least one automobile. It is planned to expand this center several blocks eastward, as conditions demand, along West Gray Ave.

There are at present two one-story store buildings, with offices in two-story blocks; two gasoline stations at the principal intersection and one further east; and a theater immediately east of the stores.

Before definite plans were undertaken, several conditions were set up: (1) the center should be neighborly in character with the adjoining community; (2) corner locations should be reserved for service stations, which were to be planned without sacrificing maximum visibility for the set-back stores; (3) front parking space, and direct delivery access in the rear, were to be provided, with large additional parking spaces so disposed that patrons would not hesitate to use them; (4) form and construction of each shop space were to be adaptable for use either with or without air conditioning; (5) costs were to be kept as low as was compatible with reasonably good construction. Appearance of all buildings was to be unified, with restrictions on signs, displays, and lighting.



*Sigurd Fischer*

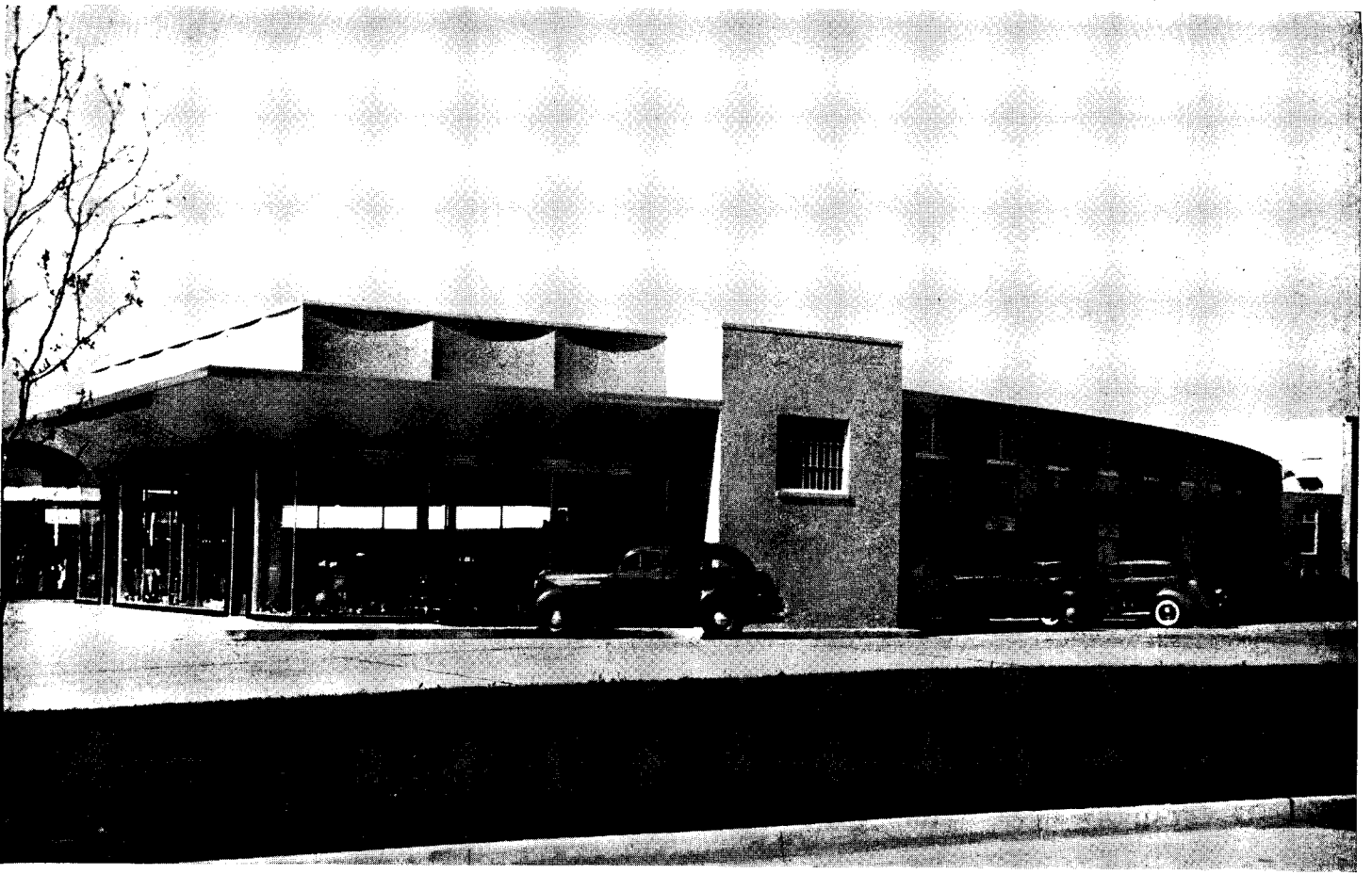

Exterior walls are brick and hollow clay tile, load bearing, stuccoed, and painted warm sand color. Soffit of continuous canopy, and steel windows, are pale blue. Structural glass at shop fronts and entrances is black; show-window and door trim is extruded aluminum, alumilited. Most of the stores have taken advantage of the large show windows to make their interior arrangements count as exterior displays. Signs are beneath canopy.

Tenants include food and liquor stores, beauty and barber shops, drug store, tailor-cleaner, flower and gift shops, electric supply store, women's clothing, offices, etc. Interior partitions have light pressed-steel studs with metal lath and plaster on both sides, and are not load bearing. There is a stock room close to each store's service (rear) entrance. Passageways lead through each building from the rear parking spaces.

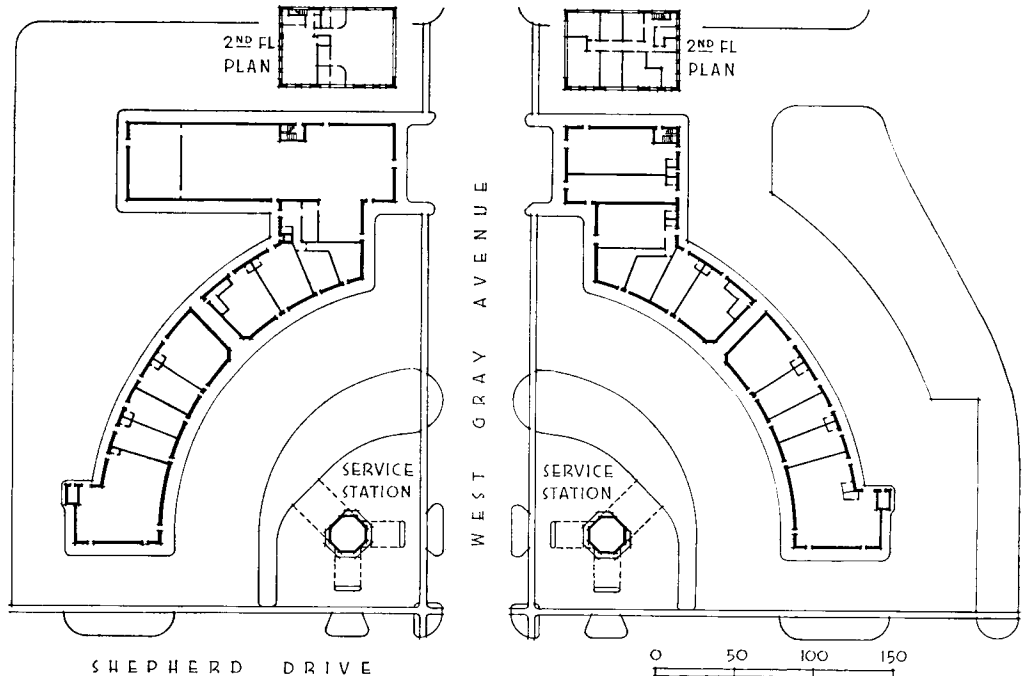



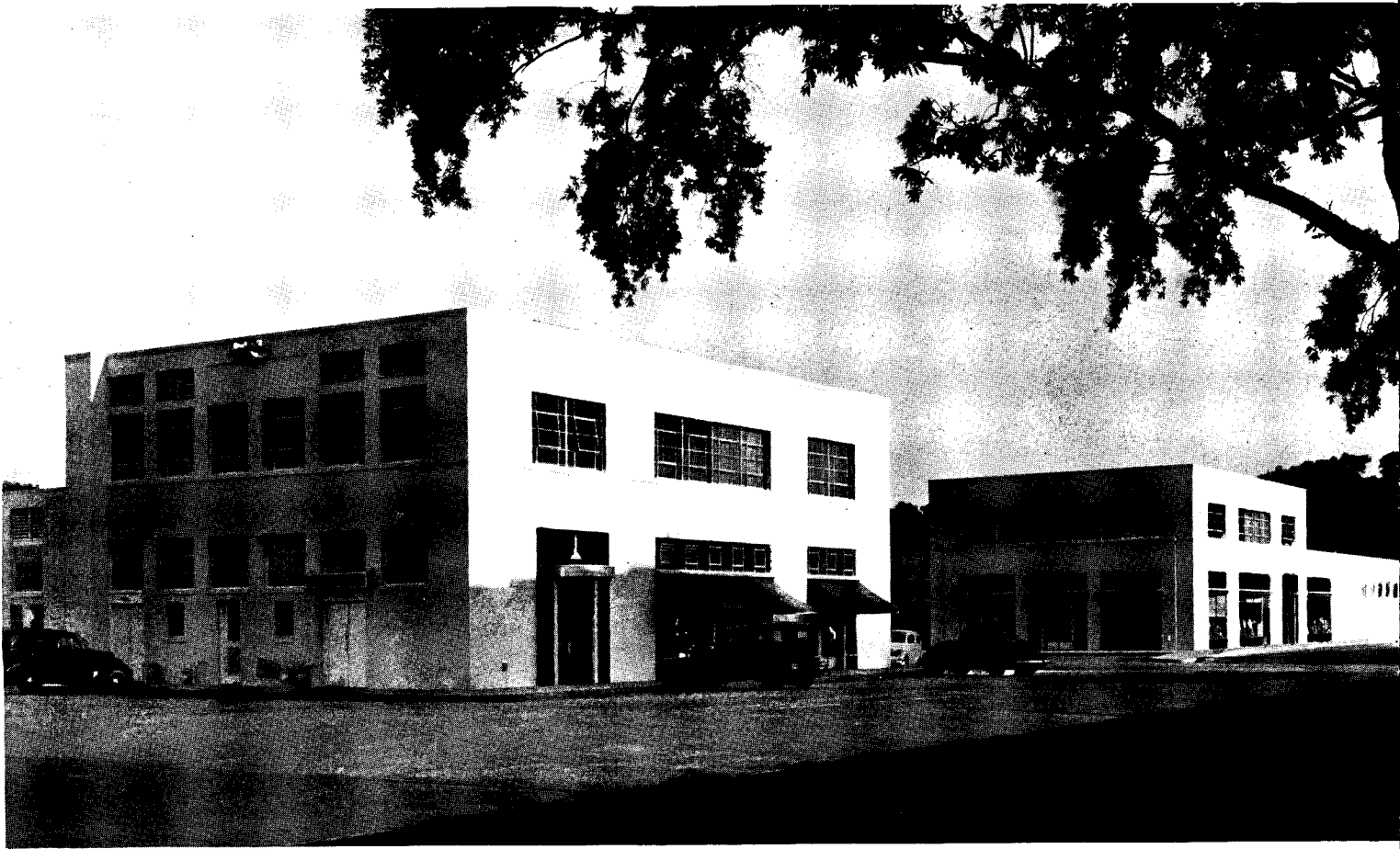

View from east, or Houston, side of the center, showing the two-story portion which houses dance studios and several architects' offices.

## RIVER OAKS SHOPPING CENTER

STAYTON NUNN, MILTON McGINTY, Architects; O. C. WINSTON, Consulting Architect

THERE IS NO basement; foundations consist of concrete beams resting on piers with spot footings. Roofs have steel bar joists supported on steel girders which rest on the masonry walls, or on steel columns at store fronts. Roof deck is of fiber insulation board with built-up surfacing; air-conditioned shops and offices have loose-fill insulation between roof decks and hung ceilings. First floor is concrete on fill with terrazzo finish; second floor is lightweight concrete on bar joists, with wood-block finish in dance studios, asphalt tile in offices.

Heating or air conditioning are provided as individual spaces require; at present, four shops and all second-story areas are air-conditioned.

Night photo, day photo, and section at right show use and construction of canopy. Light trough under canopy indirectly lights parking spaces and silhouette signs. Additional road-lighting units are on building walls, near ground; a few floodlights are mounted at copings; all are time-switch controlled.

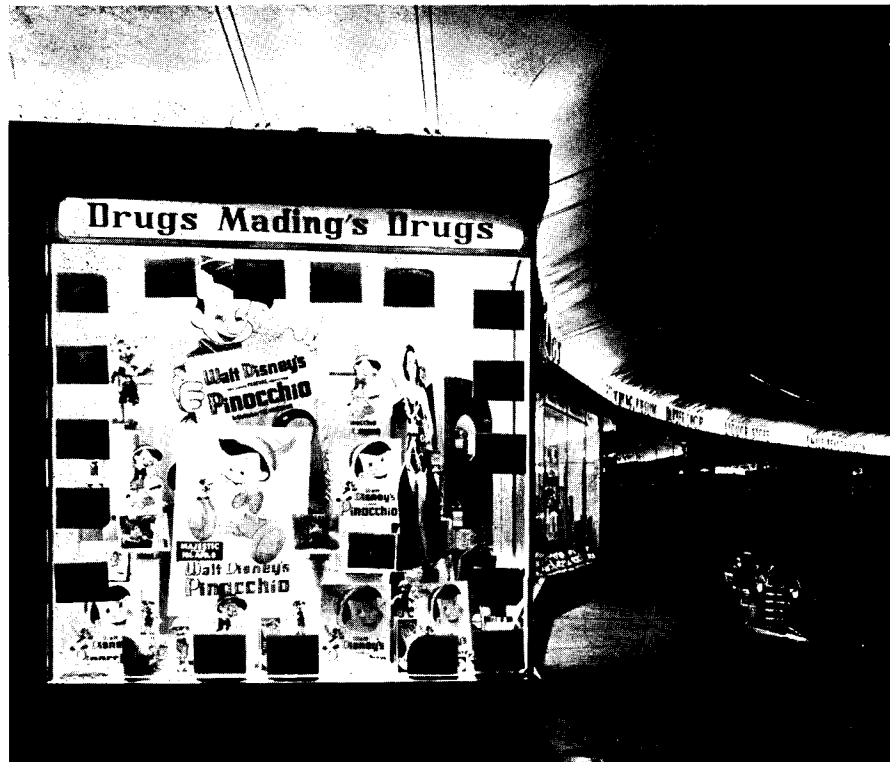

Sigurd Fischer

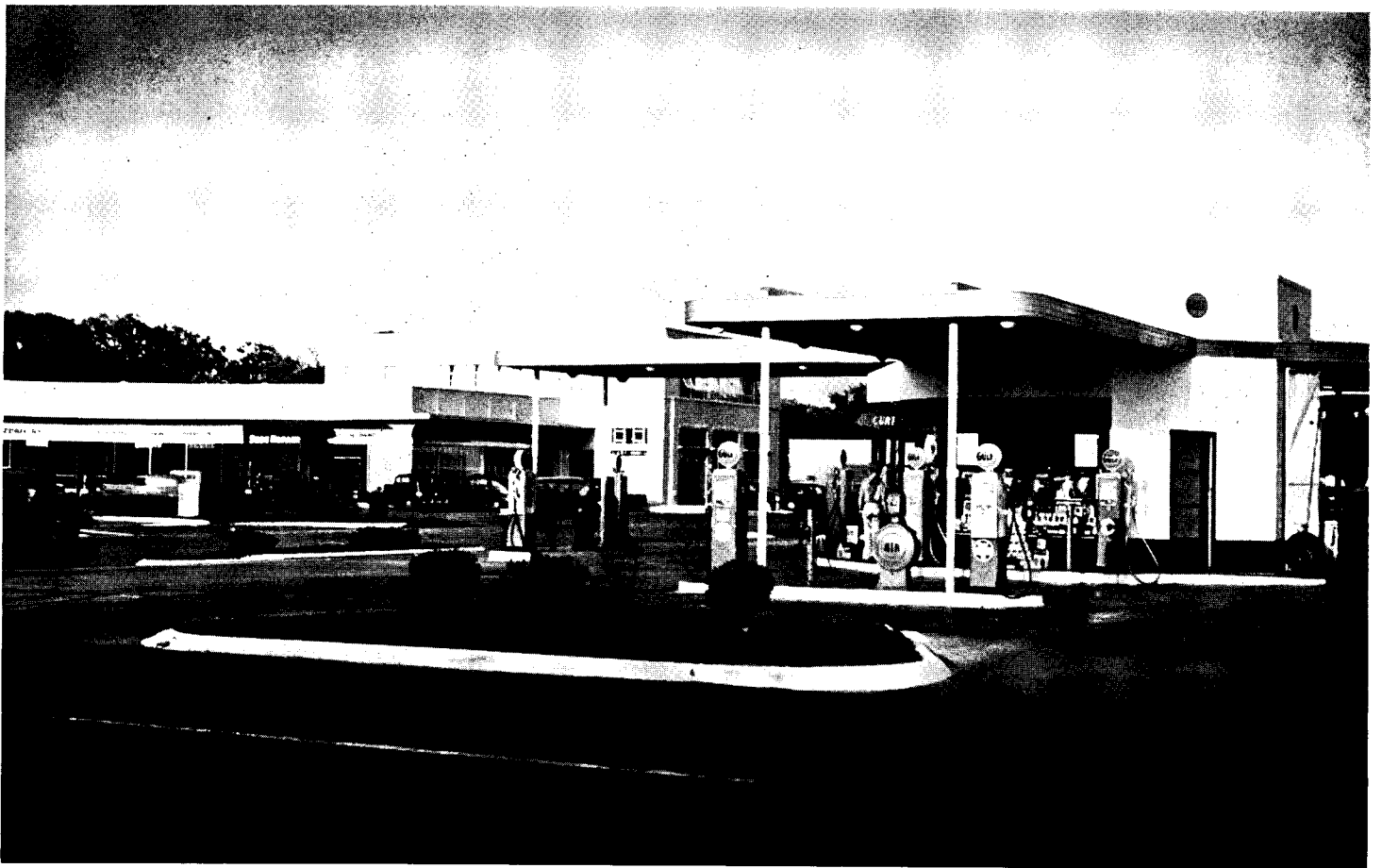

Gasoline stations are designed to offer minimum obstruction to visibility.

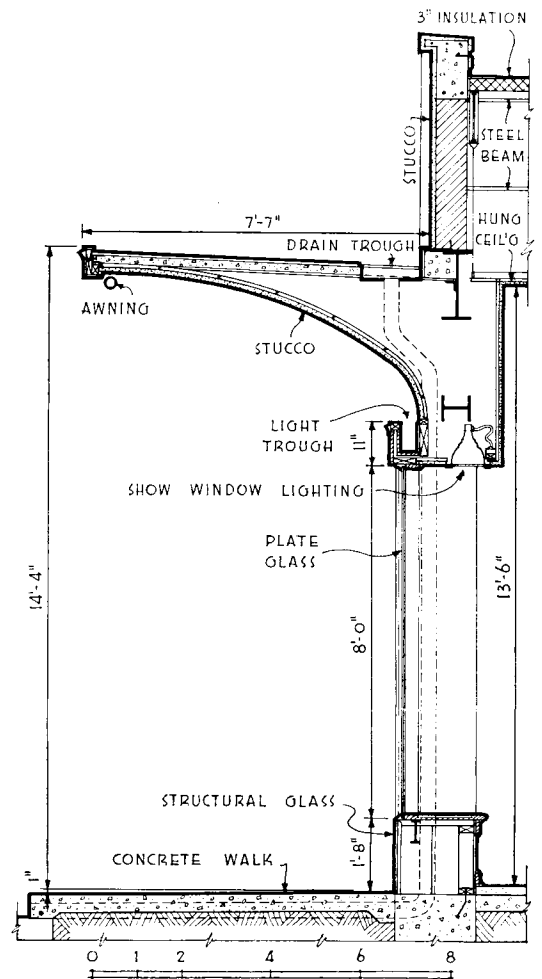
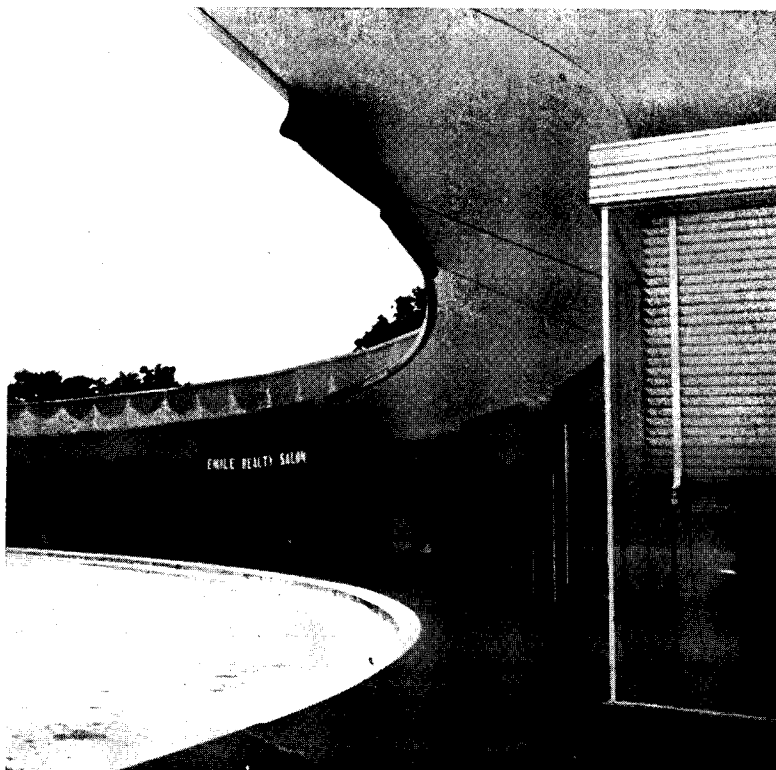

# RIVER OAKS SHOPPING CENTER

NUNN and McGINTY, Architects; O. C. WINSTON, Consultant



Interiors of two of the air-conditioned stores, a food shop and a drug store, show how duct work is handled as each job demands. No special provisions have been made for sound insulation beyond the fact that partitions between occupancies are double shells of metal lath and plaster. However, special acoustic treatment has been used on dance-studio ceilings.





## PARK-AND-SHOP BUILDING ALSO INCLUDES SPORTS FACILITIES

**Chevy Chase Park-and-Shop Stores have a steeply sloping site in Washington, D. C., which contained filled ground unsuitable for foundations. Excavation to original grade provided three rentable basement floors. JAMES F. HOGAN was the architect.**

THIS IS THE FIFTH center of the same general type designed for the same realtor. The Chevy Chase center has a frontage on Connecticut Avenue of 345 ft., and is 40 ft. deep. There are six stores at the Connecticut Avenue level, with ample parking space in front, separated from the street by a planted strip. In the basement and sub-basements, besides storage space for the stores above, boiler rooms, etc., are 57 bowling alleys and rooms for table tennis, archery, and a shooting gallery. The top floor contains an ice-skating rink 370 by 105 ft., with foyers, dressing rooms, check rooms, and skate- rental space. Above one end is a balcony for spectators.

The structure is of "fireproof" brick and concrete. Foundations are concrete, carried to bedrock. Roof is supported on long-span trusses, whose use permitted elimination of interior columns in the top story. The section below shows how the sloping site provided additional rentable space.



One of the 1-story wings contains a branch department store.

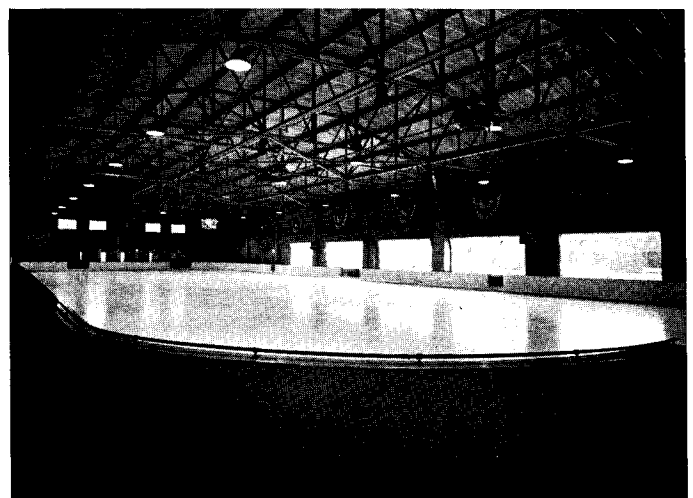
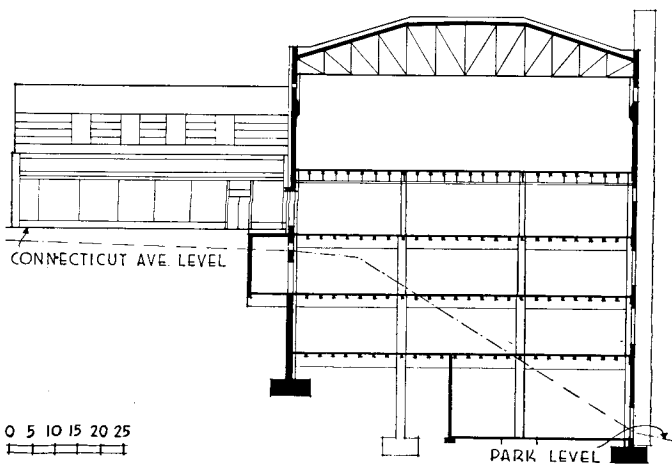

Continuous trusses span the top floor over the skating rink.

**CHEVY CHASE PARK-and-SHOP; JAMES F. HOGAN, Architect**

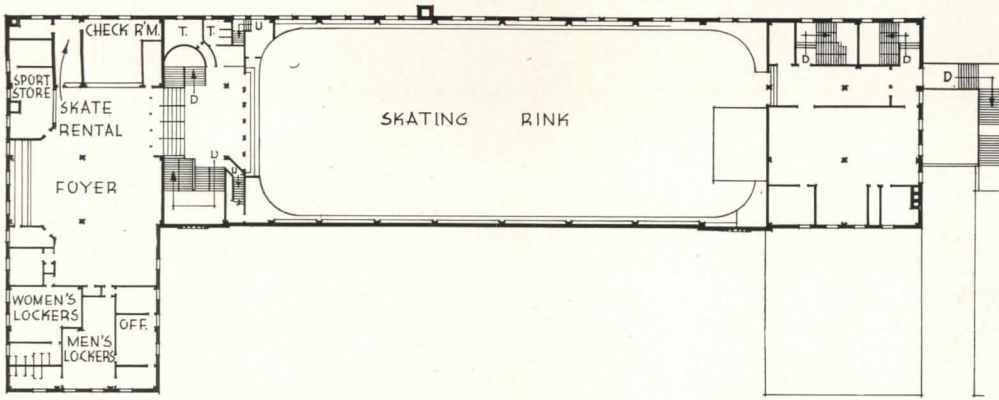

Top floor contains skating rink and accessory spaces, including a soda fountain and restaurant concession.

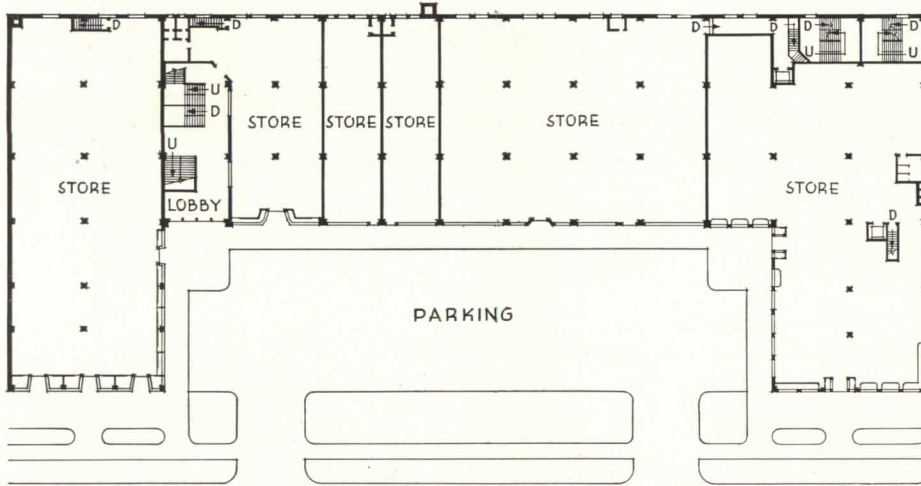

Street-level floor contains six stores and a lobby which serves both the upper and lower floors.

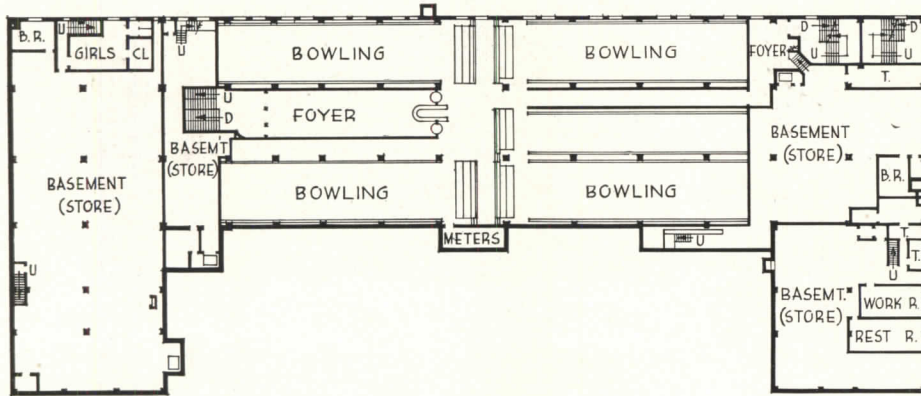

Basement houses stock rooms and bowling alleys. Three lower floors' windows overlook a park.

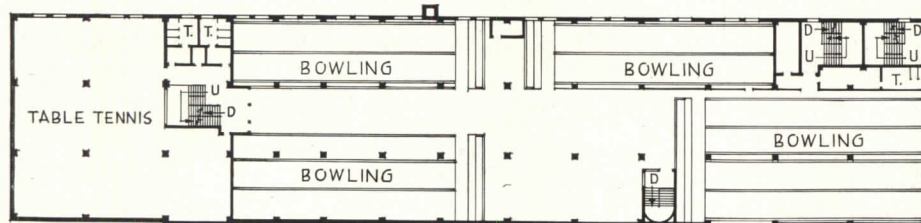

Sub-basement includes provisions for table tennis, bowling, toilets.

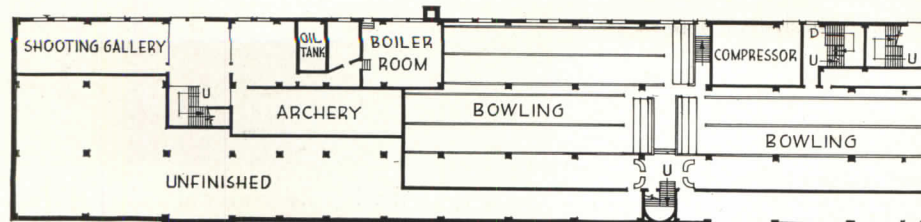

Boiler-room floor has space for building services, more alleys, and for archery and a shooting gallery, as yet not installed.

# Sloane-Blabon Linoleum

## Attracts Traffic — Resists Its Wear



*Sloane-Blabon Battleship Linoleum was specified in this modern Supermarket for its cleanliness and for its resistance to heavy traffic.*



*Here's a floor that helps draw trade the length of the store. It's Sloane-Blabon Plain Linoleum with inset borders and directional lines.*

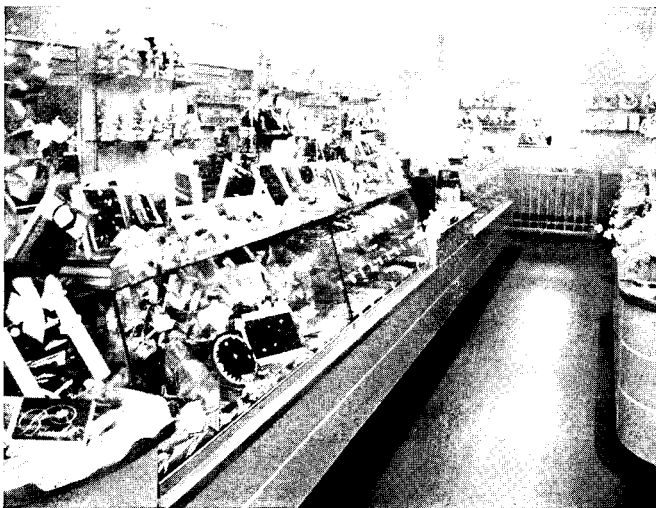

*The clean, fresh appearance of the Sloane-Blabon Linoleum floor in this attractive candy shop invites trade, aids sales, is quiet, clean.*



*Reception room in a smart beauty shop where Sloane-Blabon Plain Linoleum was utilized to complement the general decorative note.*

In shops and stores Sloane-Blabon Linoleum does double duty. Its beauty, quietness and resilience invite trade — its smooth, durable surface resists the wear of heavy traffic.

There are other factors to commend Sloane-Blabon Linoleum—its economy of maintenance, its cleanliness, its adaptability to the general decorative motif and to special inset floor designs. There is no other flooring, in fact, that offers so many practical advantages for store installation.

Why specify linoleums that have to be waxed after laying? Sloane-Blabon Linoleum is delivered to the job already mill-waxed—that means a very substantial saving to the owner in installation cost.

*Sloane-Blabon Linoleum is giving satisfactory service in thousands of commercial installations throughout the country. With distributors everywhere carrying complete stocks, it is quickly available whatever your specifications require.*

L I N O L E U M S

BY

**Sloane-Blabon**

C O R P O R A T I O N

295 FIFTH AVENUE, NEW YORK, N. Y.

A National Organization with Distributors Everywhere



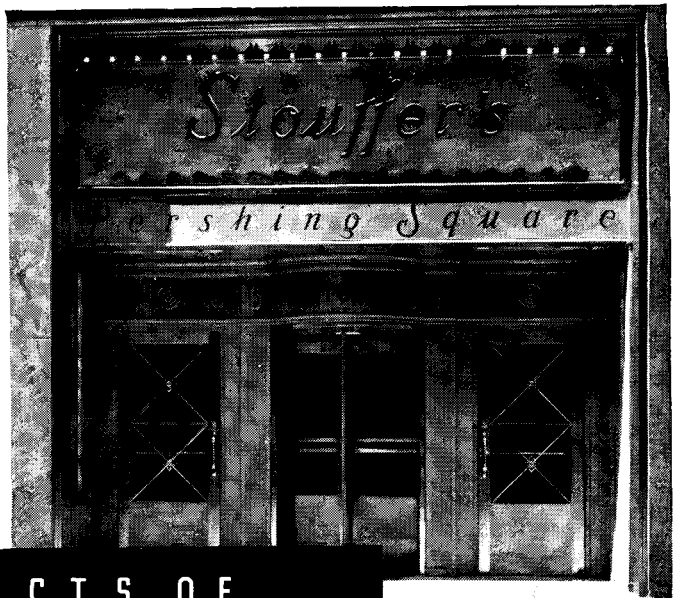
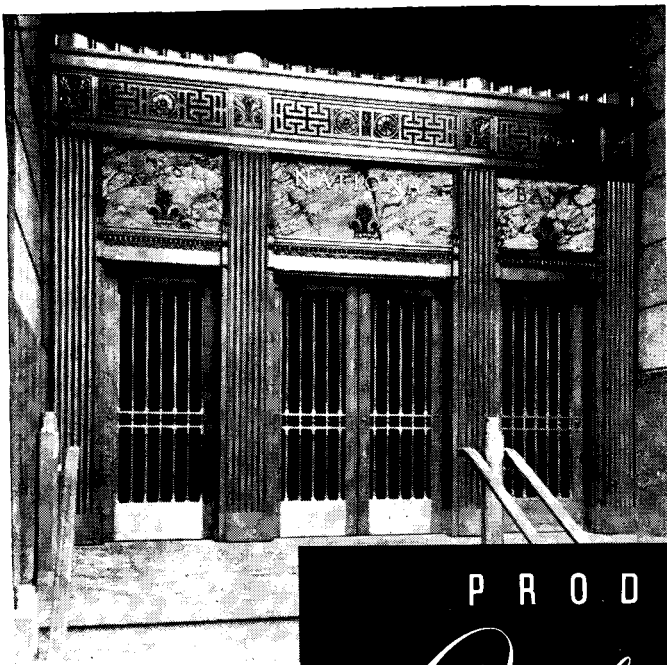

PRODUCTS OF  
*Craftsmanship*

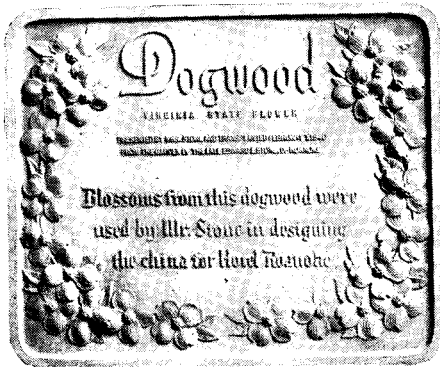

**ARCHITECTURAL  
METAL WORK**

**WINDOWS**

**REVOLVING DOORS**

**STATUARY**

**TABLETS**

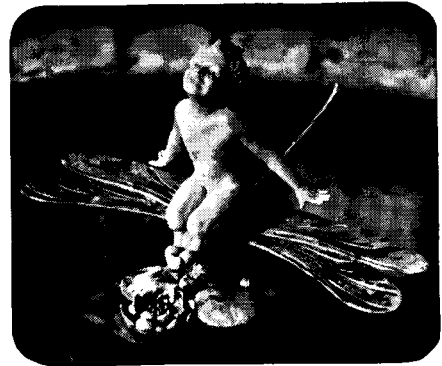

GENERAL BRONZE craftsmanship includes all non-ferrous metal products — for banks, institutional buildings, apartment houses, schools and private residences. Statuary,

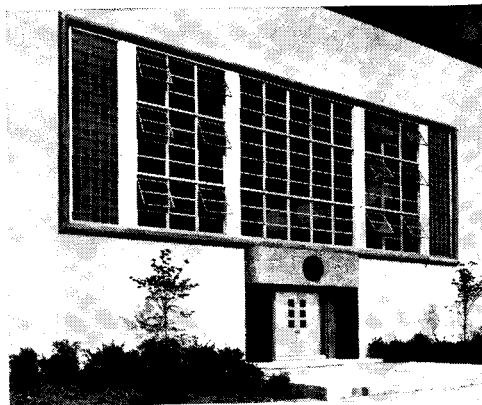

large or small, is executed by Roman Bronze Corporation, a subsidiary. For non-ferrous metal work of any type, we invite your inquiries. Our catalogs are filed in Sweet's.

**GENERAL BRONZE CORPORATION**

34-19 TENTH STREET



LONG ISLAND CITY, N. Y.

**FABRICATORS IN BRONZE · ALUMINUM · STAINLESS STEEL · NICKEL SILVER**

ARCHITECTURAL RECORD

# Concrete helps build for *Greater Retail Profits*



Another new Architectural Concrete Sears, Roebuck & Company store—at Houston, Texas, designed by Nimmons, Carr & Wright, Chicago. Knutson Construction Co., contractors.

The skill of the architect has given merchants a new kind of crowd-pulling, sales-booming store. It is designed for greater accessibility to all departments and for better display of goods.

And it is best built of *Concrete* throughout—for firesafety, spick-and-span appearance, structural efficiency, low first cost and low maintenance.

With Architectural Concrete the frame, floors, walls and ornament are cast as one strong construction unit. New, simple forming technique gives striking exterior appearance. Hundreds

of owners of new concrete buildings will tell you it is the ideal way to build your store, factory, warehouse, office building.

Let us help you consider concrete for your building. Write for your copy of illustrated booklet, "*The NEW Beauty in Walls of Architectural Concrete*," (free in the U. S. or Canada), or ask for a representative to call.

**PORTLAND CEMENT ASSOCIATION**  
Dept. 6-8, 33 W. Grand Ave., Chicago, Ill.

*A national organization to improve and extend the uses of concrete . . . through scientific research and engineering field work*

*Architectural Concrete* . . . COMBINING ARCHITECTURAL  
AND STRUCTURAL FUNCTIONS IN ONE FIRESAFE, ENDURING MATERIAL

# WHAT'S NEW IN MATERIALS AND EQUIPMENT

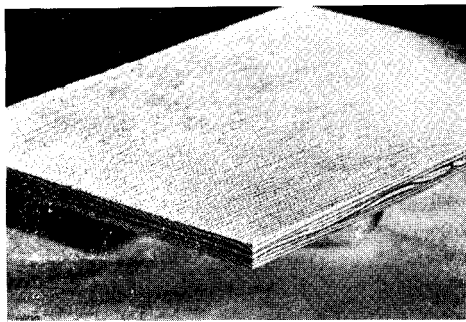

Fig. 1: Jointless wallboard



Fig. 2: Folding kitchen table

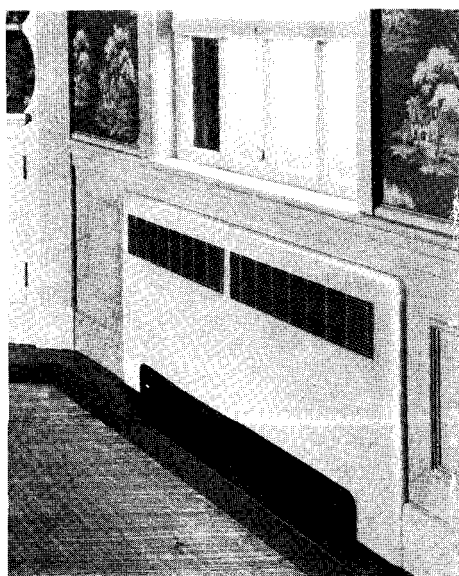

Fig. 3: Convactor radiator fronts

## Jointless Wallboard

"JUMBO SPEEDWALL" (Fig. 1) is a plywood panel for dry wall construction manufactured in sizes up to 8 by 20 ft. and faced with a fabric designed to take either paint or wallpaper. Because of its large size, one board ordinarily makes a room wall, thus eliminating joints. Doors, windows, and other openings are cut in on the job; panels are nailed or glued directly to the studs; and decorating can commence at once. According to the manufacturer, this system has made it possible to erect a five-room house, foundation to finish, in 40 days. The Speedwell Co., 5035 First Avenue S., Seattle, Wash.

## Folding Kitchen Table

"TABELETT" (Fig. 2) is a new wrinkle in kitchen cabinetry in the form of a small utility table that folds out of sight when not in use. Mounted on a pivot hinge which is placed at the top of a cabinet, "Tabelette" swings out and locks in position. When erected it is nearly 28 in. from the floor, a good height for comfortable work when one is seated. Also, it may be located at either side of the sink unit, or is available as a complete base unit to be placed wherever desired. It may only be used in conjunction with the manufacturer's standard line of kitchen fixtures. The Kitchen Maid Corporation, Andrews, Ind.

## Convactor Fronts

A NEW LINE of fronts (Fig. 3) of modern design has been announced by Tuttle and Bailey for installation with their convactor-type radiators. Rounded edges and a new grille are said to facilitate cleaning of the fronts as well as affording additional eye appeal. Tuttle and Bailey, Inc., New Britain, Conn.

## Foundation Ventilators

A NEW VENTILATOR designed for the proper ventilation of small-house understructures has been announced. Made of rustproof materials, it is said to add to the appearance of foundation walls. Its main feature, however, is a glass shutter which can be opened from outside the house, making controlled ven-

tilation possible. This has the added advantage of admitting sunlight under the house when the ventilators are closed, thus at all times discouraging fungus growths and the propagation of insect pests. E. L. Bruce Co., Memphis, Tenn.

## Inexpensive Room Ventilator

SELLING FOR LESS than \$100, this new room ventilator is designed for use in either homes or offices. It is said to afford effective filtration and circulation and has controls to regulate the volume, direction, and mixture (outdoor and re-circulated) of the air flow. The apparatus comes in two sizes, junior and large, and may be fitted into practically all types of windows or transoms. Carrier Air Conditioning Corp., Syracuse, N. Y.

## New Oil Furnaces

FOUR NEW WARM-AIR, oil-fired furnaces, designed for homes in the \$2,000-\$9,000 group and ranging in heating capacity from 40,000 to 120,000 Btu, have been announced. The smallest of these "Fastemp" furnaces requires no cellar because it is suspended from the joists and extends only 40 in. below floor level. Like the next in size, it depends on gravity for its air circulation, while the two larger units have forced-air delivery and filters. Humidifiers are available at extra cost for all four of the units. Norge Division, Borg-Warner Corp., Detroit, Mich.

## Stoker Air Conditioner

THE "HEATMAKER" is a self-contained winter air-conditioning unit of moderate price, complete with furnace, bin-fed automatic coal stoker, humidifier, circulator, and air filters. In bituminous models, the ashes are removed from the hearth and conveyed to a container located within the unit, while anthracite models are arranged so that the ash drops directly into a pit under the furnace. This pit may be made large enough to accommodate the ash accumulation for the entire heating season. Maximum output is 100,000 Btu per hour. Iron Fireman Manufacturing Co., 307 W. 106th St., Cleveland, Ohio.

(Continued on page 134)



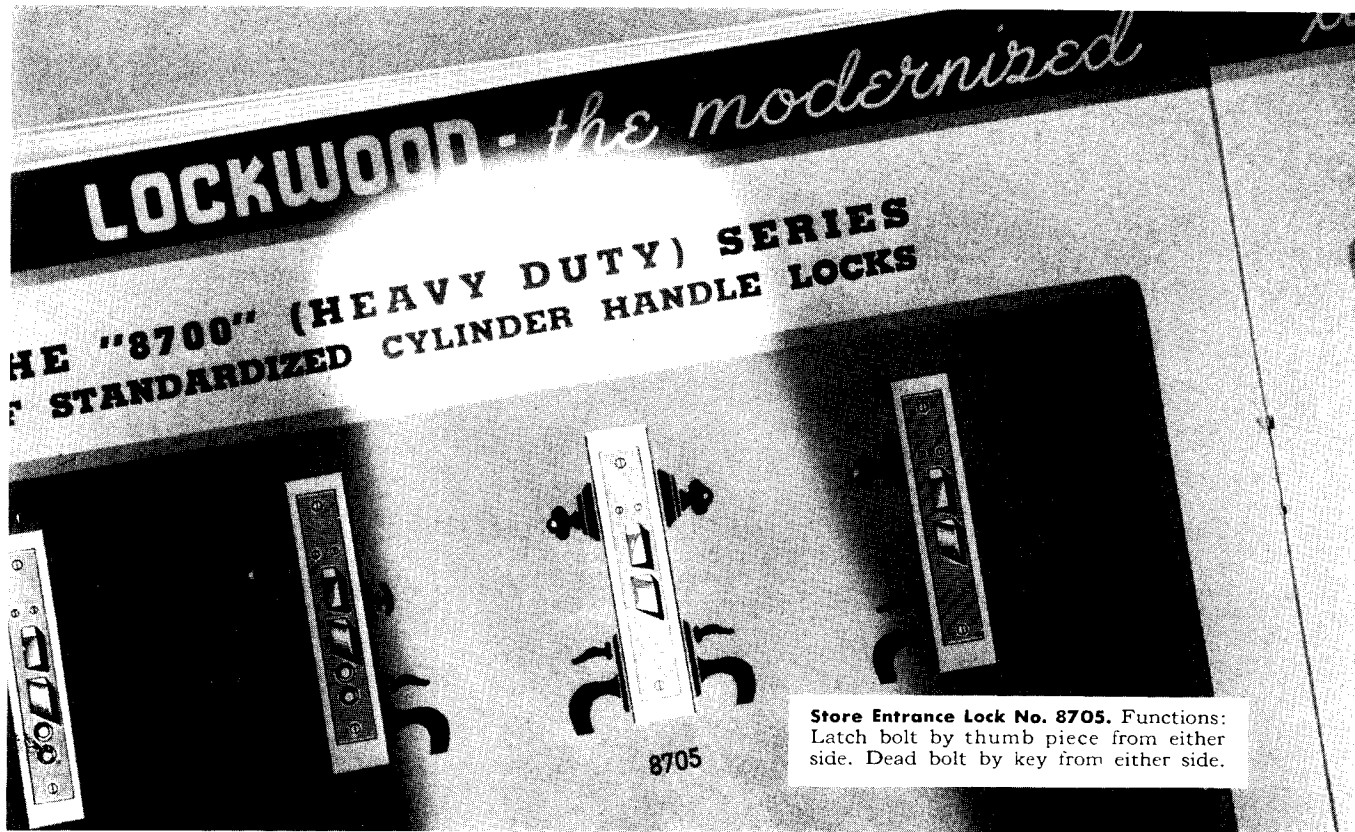

**Store Entrance Lock No. 8705.** Functions: Latch bolt by thumb piece from either side. Dead bolt by key from either side.

## New Light on Store Door Locks!

For Shops and Stores, Lockwood offers you No. 8705, in the Lockwood Modernized Line of Cylinder Locks. Ruggedly built for heavy duty, this lock is standardized and interchangeable in the same mortise, with other locks in the series. This is true of all other locks in this modernized line.

In construction, in function and in smooth operation, this is a superior lock. Especially interesting to you as an architect are the handle sets applicable to this number. The choice is very wide, allowing you to fit almost any interior or exterior motif in a standard set.

The new Lockwood Catalog—illustrating more than 300 different Cylinder Mortise Locks in an easy-to-read panorama style—will save you hours of reference time in specifying cylinder locks. We will gladly send you a copy with full information.

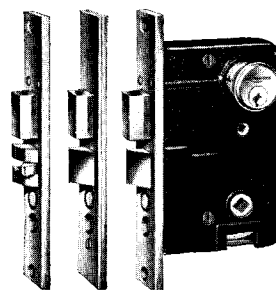

Plain front, plain latch bolt regularly furnished. Anti-friction latch bolt, armored front, rabbeted front—all are available when so ordered.

A wide variety of fittings is available for this lock. Lockwood suggests the modern Alamac Design in the elongated escutcheon type, as shown, or the striking Azex Design, illustrated, in the sectional type.

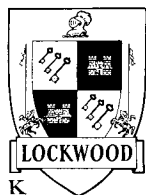
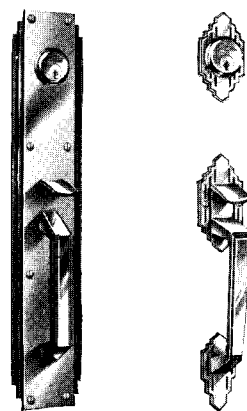

# Lockwood Hardware Mfg. Co.

*Division of Independent Lock Co.*

Fitchburg, Massachusetts

# We Believe—

---that the most desirable homes today are those in which attractive design is combined with comfort, convenience, and economy of operation.

---that you who provide or finance **General Electric equipped** houses not only give the utmost in eye appeal, freedom from household drudgery, and operating economy to buyers whose purchases indicate great trust in your judgement, but that at the same time you are providing more sales appeals which will influence more people to buy houses.

---that a fully G-E equipped home—carefully planned wiring system, automatic heating, complete kitchen with refrigerator, range, steel cabinets, dishwasher, and garbage disposall—is definitely a sounder business proposition to buy, to build, to sell, to finance.

## AND WE KNOW—

---that the added cost of complete General Electric equipment in new homes, when spread over the payments, is usually less than fifteen cents a day.

General Electric Home Bureau, Dept. AR-406  
1285 Boston Ave., Bridgeport, Conn.

Please send me information on your House Merchandising Plan.

.....I am an Architect.

.....I am building for resale.

.....I am building my own home.

Name.....

Address.....

City..... State..... County.....

The G-E Home Bureau offers an Architectural Engineering Service and a tested House Merchandising Plan that Architects and Professional Builders are using regularly and enthusiastically. Won't you send in the coupon for complete information, without obligation?

**GENERAL**  **ELECTRIC**

If you want greater latitude  
in Store Front Design —  
*Give the job to GLASS*

GLASS—in countless variety of forms —is a store front medium that never exhausts its design possibilities. It gives you a versatile tool to work with —one that provides you with a “new way” to meet any store front demand.

Architects in increasing number are employing glass in store front work—and achieving effects that are possible with no other medium. In

Pittco Products they find an ever-widening line of materials of top quality . . . materials that are available in identical quality throughout the country.

Recently, Herculite Tempered Plate Glass, Suede-finish Carrara Structural Glass, PC Architectural Glass and PC Glass Blocks have taken their places with the other Pittco

products. Striking achievements already accomplished with these new kinds of store front glass indicate that their scope in creative store front design is practically limitless.

Drop the coupon at the bottom of this page in the mail. We'll be glad to send you, without obligation, more detailed information about Pittco Store Front Products.



*Morris Ketchum, Jr. designed this truly distinctive front in New York City. He employed glass in new and striking form — to give it its individuality. The fascia, piers, and the walls of the vestibule are of gray Carrara, suede finish. And the attractive entrance door is of Herculite Tempered Plate Glass.*

**PITTCO STORE FRONTS**  
**PITTSBURGH PLATE GLASS COMPANY**  
*"PITTSBURGH" stands for Quality Glass*

Pittsburgh Plate Glass Company  
2358 Grant Bldg., Pittsburgh, Pa.

Please send me, without obligation, your new book entitled "How to Get More Business."

Name.....

Street.....

City..... State.....



# EVERY ACCEPTED MEASURE OF HEAT LOSS PROVES SIDEWALLS NEED INSULATION



... and Economy Says—

**INSTALL IT WHEN BUILDING!**



*Russell Mills, arch., planned this handsome home for D. O. Robinson, Reno, Nev. Sidewalls and top-floor ceilings are safeguarded by Celotex Insulation.*

## CELOTEX GUARANTEED INSULATION REPLACES OTHER MATERIALS — PROVIDES STRUCTURAL STRENGTH, INSULATION, VAPOR SEAL, AT ONE COST!

**S**IDEWALLS represent definitely large heat-loss areas in a house. They need insulation if the owner is to realize economy of fuel. And economy of construction calls for installing sidewall insulation *at the time the house is built*. By building with Celotex Vapor-seal Sheathing and Celotex Vapor-seal Lath—*both of which replace other materials at small extra cost*—this vital sidewall protection is permanently assured, at minimum expense!

This fact has been emphasized to millions of magazine readers by the current Celotex advertising campaign. That campaign has been planned *to make it*

*easier for you, the architect, to persuade your clients to include sidewall insulation when they build.*

By providing structural strength, insulation, and vapor seal—all at a single cost—Celotex Vapor-seal Products are enabling thousands of owners to enjoy the *complete protection* they might otherwise neglect. Further advantages include permanent protection against termites and dry rot, provided in all Celotex cane fibre products by the exclusive, patented Ferox Process—and the famous *Celotex written life-of-building guarantee*.\* Mail the coupon for full details.

\*This guarantee, when issued, applies only within the Continental United States.

# CELOTEX

REG. U. S. PAT. OFF.

## BUILDING PRODUCTS

THE CELOTEX CORPORATION AR 6-40  
919 N. Michigan Ave., Chicago, Ill.

Please send complete details about Celotex Guaranteed Insulation.

Name .....

Address .....

City .....

County ..... State .....

The word Celotex is a brand name identifying a group of products marketed by The Celotex Corporation, including  
**CANE FIBRE INSULATING SHEATHING, LATH, INTERIOR FINISH  
ASPHALT SHINGLES, SIDING, ROLL ROOFING • ROCK WOOL  
BATTS, BLANKETS • GYPSUM PLASTERS, LATH, WALL BOARDS**

Sales Distributors Throughout the World

# An Architect speaks of



## OIL BURNING SYSTEMS FOR STORE BUILDINGS

Ely Jacques Kahn, a foremost figure among American architects and designer of many store buildings, says, "I have always found that my use of oil burning systems was a wise choice for store buildings, for they have resulted in efficiency in performance and economy in operating costs. My recommendations for oil systems are fortified by the experienced advice of engineers with whom I have consulted. In regard to the Petro Oil Burning System, which I have often used, it has proved thoroughly satisfactory to myself and my clients."

In successful store planning, proper heating is as obviously vital to customer comfort as heating economy is vital to store profit. A store's heat demand varies with hour-to-hour fluctuations in volume of store traffic. Wide experience proves that Petro oil burning systems meet these variations automatically, with resultant major economies in fuel cost. Automatic operation naturally eliminates labor cost. The result is a comfortably heated store that pleases the public, with a low heating cost which pleases the management.

Major contributions to this result are: Petro's practice of completely engineering each installation; the mechanical excellence of Petro burners; and the reliability and efficiency of the Thermal Viscosity System for proper combustion of the heaviest and cheapest fuel oils.

Using pre-heated No. 6 (Bunker C) fuel oil, the Thermal Viscosity System insures reliably automatic operation in: (a) "Cold starts"; (b) Fuel pumping—with integral pump; (c) Instant meeting of load fluctuations; and (d) Literally and wholly automatic control of the supply of oil to the burner at flow-rate and temperature correct for maximum combustion efficiency.

Unless a burner or system includes all four of these operating characteristics and performs them properly with pre-heated fuel oils, it would be an obvious misnomer to call it "automatic".

*Petro Industrial Burners for Automatic operation (with pre-heated No. 6, or No. 5 and lighter oils) are available in seven sizes, Models W2½ to W8 inclusive. Each burner is a self contained assembly of motor, fan, pump, rotary cup atomizer and interlocked air and oil adjustments. The illustration shows how soundly this burner is designed.*

**CAPACITIES: to 100 gal. per hr.—336 boiler h.p.—  
47,000 sq. ft. steam E.D.R.**

Semi-automatic and Manually controlled Model W burners and "Mechanical type" units are also available to meet circumstances which do not require automatic operation.

*Petro's Engineering Division will gladly answer questions. The Petro Industrial Equipment Catalog will be sent promptly on request.*

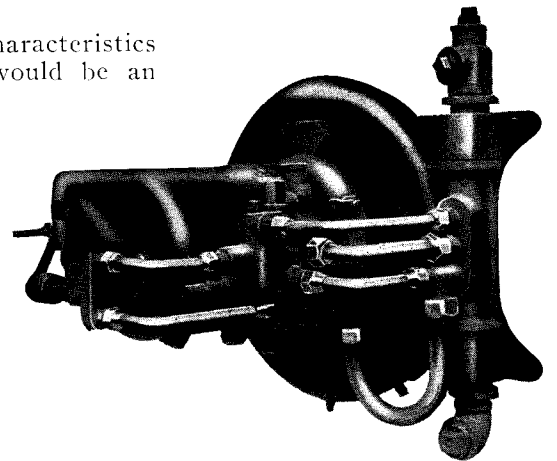

# PETRO

for Stores



**PETROLEUM HEAT & POWER COMPANY**  
**STAMFORD** —Makers of good Oil Burning Equipment since 1903— **CONNECTICUT**

Mr. Voorhees stressed the fact that in property-management work, rehabilitation and replacement of buildings and the ability to advise in the determination of budgets are most appropriate within the architect's scope. The responsibility requires a trained office staff and, when developed, returns a moderate but steady income to the architect.

Other round tables investigated specialized aspects of the architect's poten-

tial services and spheres of influence. The need to step over the lines that heretofore circumscribed private professional practice was pointed out in a meeting devoted to "Regional Enhancement," conducted by *Frederick Bigger*. In the salvaging of depreciated and blighted areas, all parties concerned—real estate, financial, government, legal, and architectural—must learn to co-operate if a successful program is to result.

Equally significant was a discussion of "Incomplete Architectural Services," with *Charles Frederick Cellarius* presiding. *William Stanley Parker* of Boston stated the basic problems. *James R. Edmunds, Jr.* of Baltimore commented on the architect's relation to the housing authority, and *S. B. Marston* of Pasadena, Calif., specified some of the pitfalls and losses in partial service.

Apart from these round-table discussions, the convention, as in previous years, looked at other related trends.

A seminar was held on "Architectural Education and Registration," led by *John Bakewell, Jr.*, chairman of the Committee on Education; *Richard Koch*, chairman of the Committee on Allied Arts; and *C. Julian Oberwarth*, chairman of the Committee on Registration Laws.

Trends in architectural-school programs were reviewed in a symposium to which the following outstanding educators contributed: *Mies van der Rohe*, Armour Institute; *William Frank Hitchens*, Carnegie Institute of Technology; *Frederick V. Murphy*, Catholic University of America; *Prof. Ernest Pickering*, University of Cincinnati; *Leopold Arnaud*, Columbia University; *Gilmore D. Clarke*, Cornell University; *Rudolph Weaver*, University of Florida; *Walter R. McCornack*, Massachusetts Institute of Technology; *Roy Childs Jones*, University of Minnesota; *Ellis F. Lawrence*, University of Oregon; *George Simpson Koyl*, University of Pennsylvania; *Arthur C. Weatherhead*, University of Southern California; *Walter Thomas Rolfe* of the University of Texas, and *Harlan Thomas*, University of Washington.

Another symposium, led by *Richmond H. Shreve*, reviewed the subject "New Materials." This discussion was arranged and conducted, as heretofore, in collaboration with the Producers' Council, holding its convention in Louisville concurrently. *A. W. Varasse*, of the Architectural Relations Department of the Pittsburgh Plate Glass Company, discussed "Glass Blocks." "Exterior Decorative Metals" were reviewed by *Dr. Bruce W. Gonser*, Supervisor of the Division of Non-Ferrous Metals, Battelle Memorial Institute, Columbus, Ohio. *L. H. Meyer* of the United States Plywood Corp. discussed the development, growth, and use of "Architectural Plywood." And "Plastics" was the subject of a paper by *J. Roger White*, Assistant to the President of the Formica Insulation Co., Cincinnati, Ohio.

# 44 YEARS HEAT TRANSFER EXPERIENCE

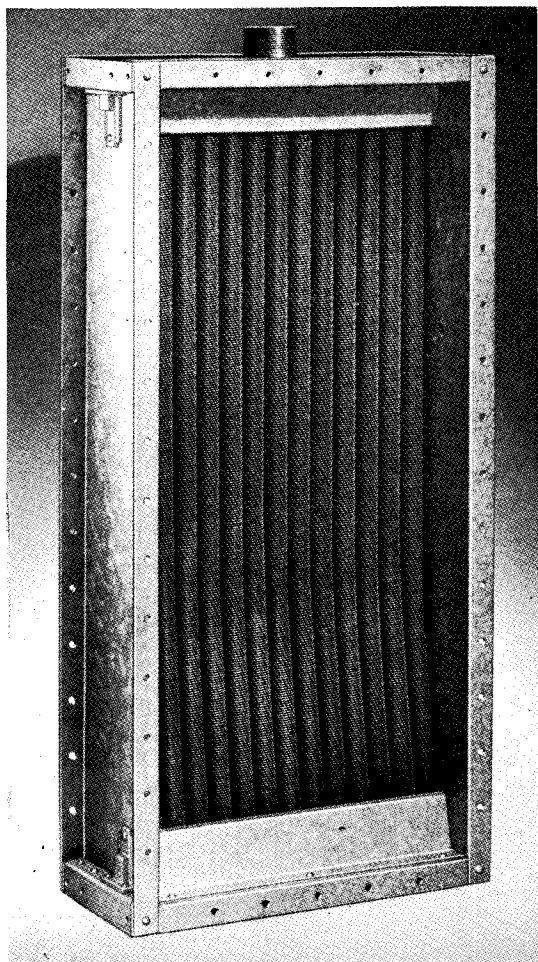

## stand behind Fedders Type K HEATING COILS

Fedders Type K Heating Coil design is the cumulative result of 44 years of specialized experience in heat transfer.

Copper fins bonded to copper tubes . . . patented, full-floating relief of expansion stresses between heating coil and casing . . . "knee-action" relief of differential expansion between neighboring tubes . . . heavy, forged bronze expansion guides . . . large plenum-type steam headers . . . integral orifices and scale breakers—those are some of the advanced engineering features of Fedders Type K Heating Coils.

Husky, rigid ARMCO ZINC-GRIP casings provide protection against piping stresses and coil distortion.

Complete data is given in new Catalog AC-601. Write for your copy right now.

FEDDERS COOLING COILS  
New Complete Range of Sizes for Refrigerants and Cold Water

FEDDERS UNIT AIR CONDITIONERS  
Seven Base Models from 1½ to 25 Tons Capacity

FEDDERS SERIES 4 UNIT HEATERS  
Full Range of Models from 75 to 1100 EDR

**FEDDERS MANUFACTURING CO., INC.**

Air Conditioning Division

47 Tonawanda St., BUFFALO, N. Y.



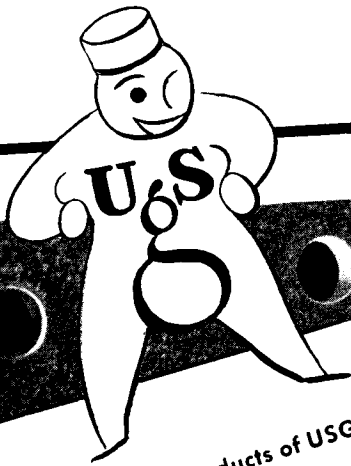

These two products of USG research  
 — Perforated Rocklath and Red Top  
 Plaster — make it possible for you to  
 specify better, safer walls and ceilings.

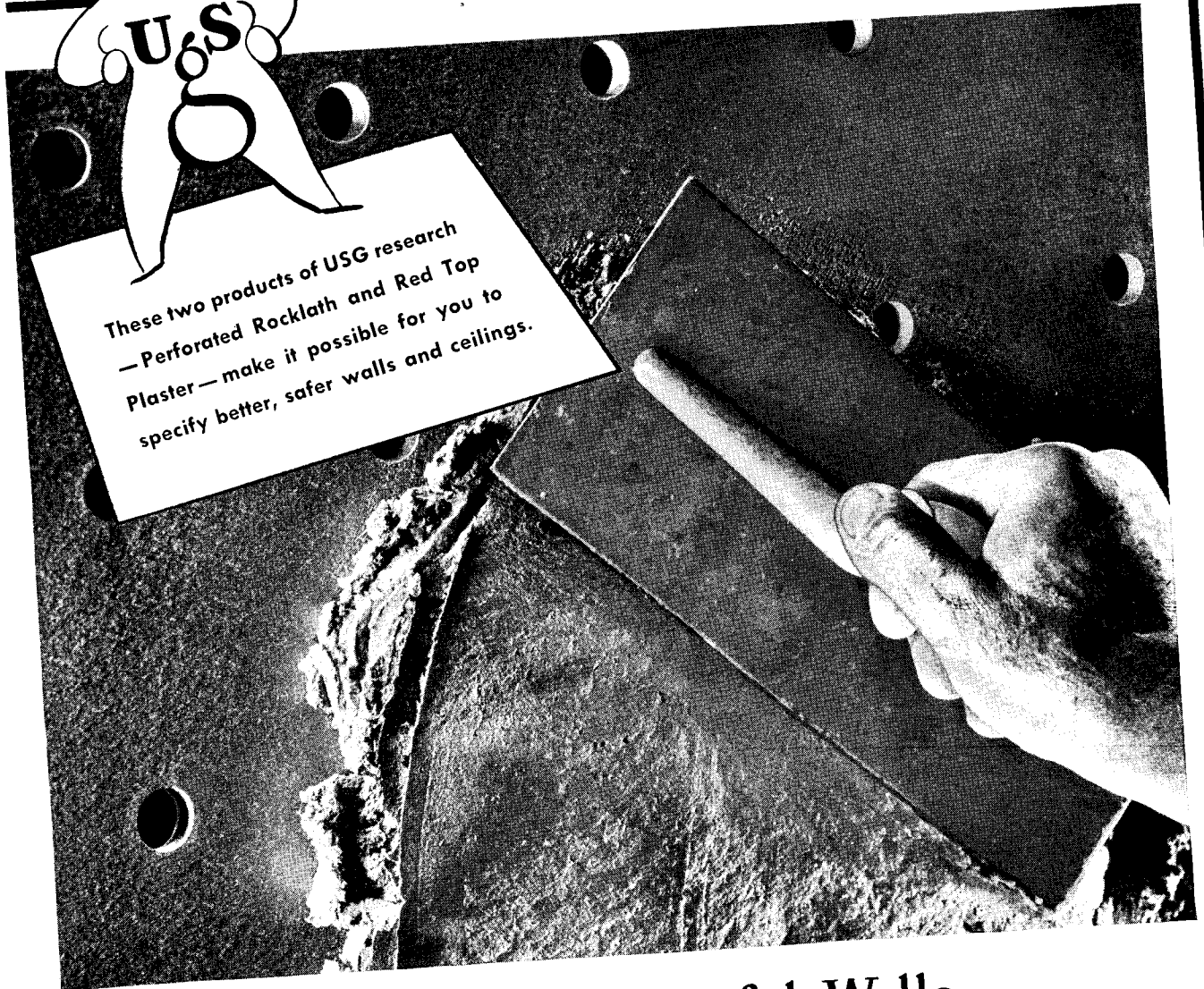

## Sculptor of Beautiful Walls

**H**ANDS and trowels like these are making better walls and ceilings all over America, using modern materials to make beautiful surfaces in today's homes. Smooth, unblemished plastered walls and ceilings fit any style of architecture, take any decoration. The art of plastering is as old as civilization. But the right combination of plaster base and plaster has taken years of experiment to develop.

Look at this picture. The plaster base is fire-proof Perforated Rocklath. Its holes were

punched to make a stronger wall! It doesn't warp, buckle, pull away from the plaster or leave lath marks. A plastered Perforated Rocklath partition has passed fire tests to show that it will hold fire at bay for one full hour! The plaster is Red Top Plaster, tailored for each community to blend properly with the sand and water with which it is mixed. Together these two make a combination that cannot be equalled for beauty?

During 38 years, the United

States Gypsum Company has been making quality building materials. As a result of continuous research in home construction, United States Gypsum has developed many improved materials which contribute greatly toward giving your home more fire protection and greater year-round comfort.

USG has assembled many valuable facts about homeownership and home modernization in two

**UNITED STATES GYPSUM COMPANY**



*-where research develops better, safer building materials*

**USG advertisements like these are selling better building to America. USG advertisements appear in SATURDAY EVENING POST, BETTER HOMES & GARDENS, AMERICAN HOME, GOOD HOUSEKEEPING, AMERICAN MAGAZINE, LIFE, COLLIER'S, PARENTS' and others.**

# International Studio Art Corporation



## EXHIBITION

June 24 through July 12

## XII-XIX CENTURY STAINED GLASS of French, Flemish, German, Austrian, and Spanish provenance



This comprehensive collection is one of the most varied and interesting ever made by either an individual or an institution. It illustrates supremely the evolution and history of the craft. Included in the exhibition are three very fine XIII century French panels; the central one, predominantly a rich deep blue, with a medallion of Christ robed in brilliant red and bearing the cross, is bordered with an early Gothic motif. It is interesting to note that this exceptional panel is very similar to the celebrated "Tree of Jesse," in the Cathedral of Chartres.



*Stained glass acquired by*

**William Randolph Hearst**



Inquiries invited; address Department G  
15 East 57 Street, New York City

## A BROADER HORIZON FOR THE ARCHITECT

*(Continued from page 87)*

a good one for beginners. They can co-operate with small shops and local craftsmen wherever they are. As a vehicle, specialty design is like a cub plane, "fool-tolerant," yet serviceable in training for more exacting tasks.

### A Big Future Demands a Broad Base

All three of the design fields just described extend indefinitely into the past and the future; all three are necessary and honorable. All will gain when clearly delineated, and when it is recognized that the trend in any one object or design is from the craft to the industrial field and seldom the reverse.

From this standpoint the show entitled "America at Home," at the Fair, makes a big stride forward. It improves the designer's public relations. Though the published program is concerned with "regional design" rather than "industrial" or nonindustrial design, this show is laid out so as to revolve unmistakably around the apartment already mentioned, one that belongs clearly to the mass-industrial market. Like a menu centered upon meat and potatoes, such a presentation has a down-to-earth breadth and reality, and even the hors d'oeuvres gain in significance and flavor. The emphasis upon strict serviceability is the more welcome because so much American modern furniture is notoriously styled on drawing boards—with European chassis as models, at that—and is rarely built to well-considered programs.

When truly architectural methods are introduced into the general design field it will be possible to write a program for a chair as it is written for a \$10,000 house—the problem is no less difficult—and then the public will have assurance that the trick materials really work and the smooth lines can really be sat on, and the demand for architect-designed articles will be large and secure.



Richard Garrison

"Interior of a Pennsylvania Hill House" by GEORGE HOWE, Architect, and WHARTON ESHERICK, Sculptor. Typical of the artist-designer craftsman approach are spiral stair and carved wood lighting fixture.

# The Shower Head They'll Praise You for Specifying . . .



## Speakman **ANYSTREAM** Self-Cleaning

### SHOWER HEADS

HERE'S why your clients will commend your selection of "ANYSTREAM" . . . It gives the bather any type of spray he wants . . . it can't clog up . . . it's self-cleaning in open position . . . it's economical in water consumption—and it's built to last a lifetime with ordinary care. There are no holes to get clogged up in "ANYSTREAM." Instead, there are tapered grooves in the plungers which assure full, unbroken

sprays. The position of the plungers controls the type of shower you get.

Schools, colleges, hotels, apartments, clubs, etc., as well as modern homes, where performance, design and durability are essential, are the places where you will find the perfect use for Speakman Anystream Self-Cleaning Shower Heads.

We promise their users will sing your praises.

SPEAKMAN COMPANY • WILMINGTON, DELAWARE

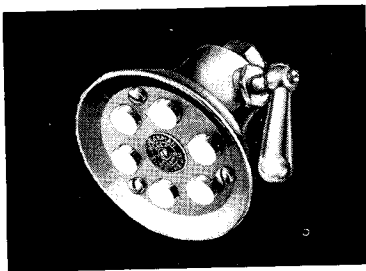

S-2250—Anystream Self-Cleaning Shower Head with Lever Handle Control (Patented) 1/2-inch I. P. S. Inlet, provides choice of spray to suit bather. Economical water consumption. Also obtainable with Lockshield Control (S-2255).

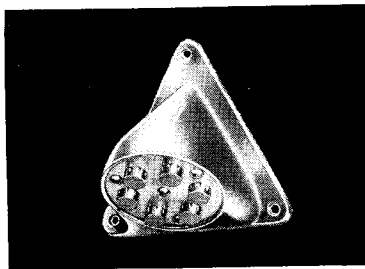

S-2260—Anystream Self-Cleaning Shower Head, 1/2-inch I. P. S. back Inlet. Vandal proof type. Fits flat against wall. Hexagon wrench for operation furnished with head. Also obtainable with side inlet for exposed installation (S-2265).

#### ALL FROM THE SAME "ANYSTREAM" HEAD

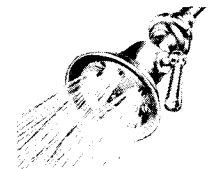

A quarter turn of the lever handle gives a fine "Needle" spray.

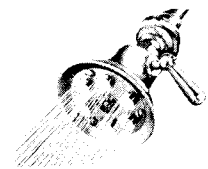

A quarter turn further provides a "Normal" gentle spray.

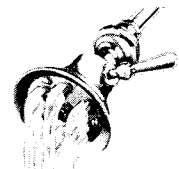

A further turn to above position gives a "flood" spray, flushing out all sediment.

SINCE  
1869

# S P E A K M A N

SHOWERS • SHOWER HEADS • BATH FIXTURES • SI-FLO (SILENT) FLUSH VALVES  
LAVATORY FIXTURES • SINK FIXTURES • INSTITUTIONAL AND INDUSTRIAL FIXTURES



# Profit-Planning AIR CONDITIONING WITH CONTROL BY JOHNSON



Above: Meyers Department Store, Greensboro, N. C. York Ice Machinery Corp., air conditioning contractors, Charlotte, N. C., and Atlanta, Ga.

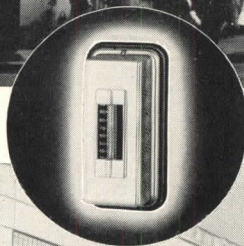

Below: Belk's Department Store, Greensboro, N. C. Charles C. Hartman, architect; Air Conditioning Corp., contractors, Greensboro.



## SALES THROUGH COMFORT

Business in general benefits when air conditioned comfort is available to patrons, through correct automatic control devices. When "control by Johnson" performs the important job of comfort selling demanded by department stores, architect, engineer, contractor, and owner are assured of dependable performance. The Johnson organization covers the entire continent and engages in just one line of business—the design, manufacture and installation of automatic temperature and air conditioning control systems.

# JOHNSON

*Automatic* TEMPERATURE AND AIR CONDITIONING *Control*

JOHNSON SERVICE COMPANY; MILWAUKEE, WIS. AND DIRECT BRANCHES IN PRINCIPAL CITIES

## NEW MATERIALS AND EQUIPMENT

(Continued from page 124)

### New Method of Calculating Air-Conditioning Installations

D. C. WILEY and John McElgin have formulated a new method of calculating extended heat-transfer areas for air-conditioning applications in which both cooling and dehumidification are to occur. Their procedure is said to overcome the use of arbitrary correction factors heretofore employed in the selection of the cooling surface, which assigned false performance characteristics to the surface. At engineers' meetings held throughout the country, this new system of calculation was said to be "rational, precise, and a worthy advance." Details of the Wiley-McElgin method of selection are fully explained in a special publication (Number 223) in which work sheets and temperature charts are provided. John J. Nesbitt, Inc., Holmesburg, Philadelphia, Pa.

### Protective Surface for Aluminum

"COLONIAL CHEMODIZING" is described as a nonelectrolytic method of producing a hard, corrosion-resistant, colorless, and integrally fused surface on "Colalloy," aluminum, and their alloys. It is substantially a simple immersion process in which the use of heat is optional, and it is claimed that these metals, heretofore restricted in their uses in highly corrosive atmospheres, can now claim a rightful share of this business. It is also possible to impregnate the surfaces of the processed metal with anticorrosive materials specifically designed to resist certain types of corrosion. The Colonial Alloys Co., Chemicals Division, Philadelphia, Pa.

### Wallpaper Protection

WALLPAPER and other surfaces treated with a product known as "Denso-Gard" are said to become impervious to dirt, grime, grease, ink, mercurochrome, lipstick, etc. These and similar stains may be easily washed off with soap and water without damage to the original surface. The protective coating is applied with a brush and, according to its manufacturer, will not affect color or texture of surface to any noticeable extent; has no gloss; is odorless; and costs about \$2 to treat the average room. The Densol Paint Co., 7806 Rockside Road, South Park, Ohio.



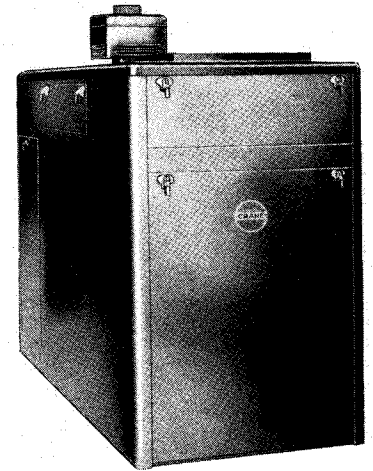
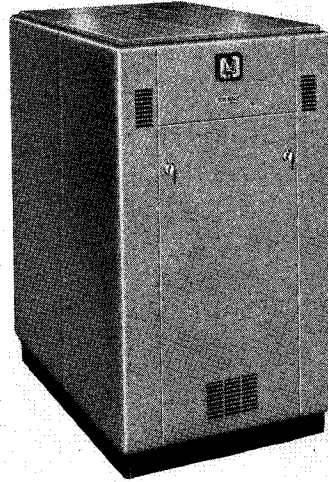
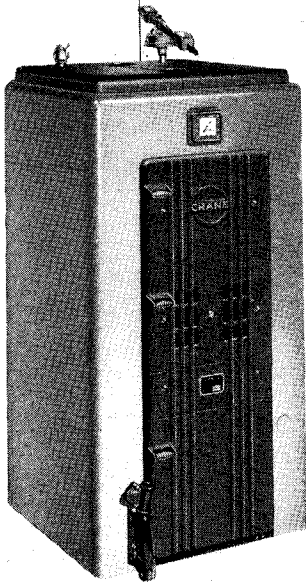
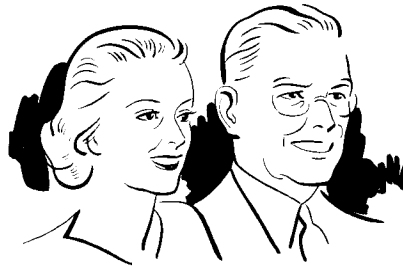
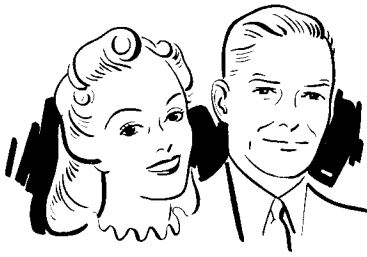

## DIFFERENT FAMILIES—DIFFERENT HOMES

# *the Crane Heating Line*

## INCLUDES A SYSTEM FOR EACH

THE Robinsons have steam heat—the Smiths have a hot water system—the Browns have a gas-fired furnace. One architect satisfied all these heating needs—from one heating line: Crane.

And every one of those clients will get better heating to suit his own special conditions . . . in his size of home . . . in his location! For whatever the heating need—whatever the type of fuel to be burned—whatever the locality—the Crane complete heating line fills all requirements!

Crane heating systems are many—but there's a single responsibility behind them all—a responsibility that extends to every part of the

system—boiler, furnace, radiators, oil burners, stokers, controls, valves and fittings. Crane systems, you see, are unified with every part designed to work harmoniously with the others for better heating satisfaction.

Crane advanced engineering assures your clients of getting latest heating advantages . . . special features that assure more complete combustion and lower fuel costs . . . whether the fuel is coal, oil or gas . . . whether the system is completely automatic, stoker-fired or hand-fired. A post card to us will bring you all the facts about the complete Crane heating line—without obligation on your part.



This symbol identifies a Heating Contractor able to provide complete Crane heating service.



# CRANE

CRANE CO., GENERAL OFFICES:  
836 S. MICHIGAN AVE., CHICAGO

VALVES • FITTINGS • PIPE  
PLUMBING • HEATING • PUMPS

NATION-WIDE SERVICE THROUGH BRANCHES, WHOLESALERS, PLUMBING AND HEATING CONTRACTORS

ture." And it is in his awareness of the persistence of change that his study of present and future trends in store and interior planning becomes interesting and valuable.

Among present trends in the fitting and layout of retail stores, one of the more common is that of simplification and specialization: the shop will be laid out on the simplest lines, with its departments specialized, for the purpose of quick service, attractive display, and to facilitate the movements of customers.

Obviously, the most effective layout will incorporate a maximum *visual* display of merchandise.

Future trends, as may already be observed in certain tendencies, will lead more and more towards flexibility and mobility, making it possible to adapt the shop interior to meet the needs of seasonal selling. The use of easily movable fittings or adjustable units, capable of being expanded or contracted to suit changing needs, would also serve to avoid expensive alterations or replacements. In addition, such adaptable units, light in weight and simple in

construction, would afford mobility between the various departments of an establishment.

It should be observed that in discussing these trends Mr. Hammond writes from observations of current practices, which his work substantiates in numerous illustrations and diagrams. Excluding the theoretical and basing itself upon concrete examples, the present volume, therefore, takes on the form of a work of reference in its field. Its treatment of both the small shop and the large department store includes such various subjects as store interior decoration, display, location of departments, counters, children's departments, self-serve shops, escalators and elevators, floor coverings, interior illumination, super-numerary services, and many other factors encountered in store planning.

*Store Interior Planning and Display* may be regarded as a handy guide-book, valuable as a source of information to architects, store designers, shop-fitters, and illuminating engineers, as well as to store executives and others.

**ARCHITECTURAL SPECIFICATIONS.**

By Harold Reeve Sleeper, AIA. John Wiley & Sons, Inc., New York, 1940. 822 pages. Price, \$10.00.

THE FUNCTION of this book is to provide, within one volume, specification material based on accepted modern practices, so that portions which are applicable to any one project may be easily selected for use and adapted to the specific problems involved, thereby aiding specification writers in their difficult task.

Though the intention of this book is to ease the problems of the specification writer, the author does not present his work as a universal panacea. Though it offers a thorough check list, as well as standard substance, it will not automatically serve to write a good specification. However, its real usefulness to architects and to the building trades should be self-evident.

The book is not the sole product of the author or of any one office, but the result of an analysis of the work of many specification writers in prominent offices and government agencies, and an examination of existing standards; of conferences with and letters from trade associations, manufacturers, contractors, and government agencies. Wherever definite trade standards have been published by reliable trade associations, they have been incorporated in this book, after checking with the associations.

## THOROUGH STORE CLEANING IS A JOB



*for your  
Architect  
and Engineer*

Don't wait until your building is built or remodeled. Don't expect your housekeeper to compete in cleanliness until you have installed cleaning equipment that is satisfactory to your architect and your engineer.

The Spencer Central Cleaning System has the necessary pulling power, flexibility, speed and stamina for your tremendous daily cleaning job.

Small store owners report 40% less cleaning time and twice as much dirt collected. Large stores are cleaned at the rate of 6000 sq. ft. per man per hour. In Wanamaker's, Philadelphia, and Macy's, New York, the Spencer System cleans nearly four million square feet of area every night.

Carpet life is increased, decorations and goods protected, less wax is required and even the mopping time is materially reduced.

Standards of cleanliness from the boiler room to the shipping room are automatically maintained, year after year.

Your Architect and your Engineer will recommend Spencer if you ask them. 181-B

BULLETIN No. 121-R describes Spencer Systems, shows a score of ways Spencer is used to save time and money in stores.



# SPENCER

HARTFORD

CENTRAL AND PORTABLE  
VACUUM CLEANING SYSTEMS

**THE SPENCER TURBINE COMPANY, HARTFORD, CONN.**