

RECORD

COMBINED WITH AMERICAN ARCHITECT AND ARCHITECTURE

	WIND ROSE FOR AIRPORT ARCHITECTS	65
	An Editorial . . . by Kenneth K. Stowell	
BUILDING TYPES STUDY No. 100 . . .	AIRPORTS	66
	GOOD AIRPORT DESIGN REQUIRES BROAD GRASP	66
	WHAT IS MEANT BY AIR TRAFFIC CONTROL	68
	By Julian Whittlesey	
	PORTS BEING RECLASSIFIED BY PURPOSE	69
	RUNWAY DESIGNS STILL IN EVOLUTION	70
	10 YEAR PLANNING FOR PRIVATE PORTS	72
	By Julian Whittlesey	
	TWIN CITIES' MODEL REGIONAL AIRPORT AUTHORITY	78
	DESIGNING THE LARGE TERMINAL	80
	By Albert F. Heino	
	SAN ANTONIO MUNICIPAL AIRPORT	84
	Atlee B. and Robert M. Ayres, Architects and Engineers	
	WESTCHESTER AIRPORT	88
	Alexander D. Crossett and Associates, Architects and Engineers	
	RESEARCH AIRPORT PROJECT	91
	The Austin Company	
	ATC AIRPORT DETAILS	94
	Charles M. Goodman, Architect	
	TEMPORARY CONSTRUCTION METHODS	96
	Charles M. Goodman, Architect	
	POSTWAR SCHEME FOR LOCKHEED AIR TERMINAL	98
	J. E. Dolena, Architect	
	AIRPORT PROFITS PROVE VALUE OF EXTRA FACILITIES 102	
	By Don Taylor	
	TIME-SAVER STANDARDS	107
	Airport Counter Details	107
	Airport In-Flight Kitchen	109
	THE RECORD REPORTS . . . News from the Field	7
	FOR BETTER BUILDING	20
	News of Materials, Equipment and Methods	
	REQUIRED READING	112
	INDEX TO ADVERTISEMENTS	186



H. JUDD PAYNE, Vice-President in charge of Magazine Division • Copyright 1945 with all rights reserved F. W. DODGE CORPORATION

EDITOR-IN-CHIEF, Kenneth Kingsley Stowell, A.I.A.; **Managing Editor,** Emerson Goble; **Associate Editor,** Douglas Haskell; **Associate in South America,** Edmund J. Whiting, A.I.A.; **Assistant Editor,** Jeffrey H. Livingstone; **Desk Editor,** Florence

A. van Wyck; **Art Director,** W. K. Allen. **CONSULTANTS:** Industry Relations Consultant: Thomas S. Holden. Statistical Consultant: Clyde Shute. Building Economics Consultant: Norbert Brown. Field Research Consultant: Clifford Dunnells, Jr.

Architectural Record (combined with American Architect and Architecture) is published monthly by F. W. Dodge Corporation, 34 No. Crystal St., East Stroudsburg, Pa., with Editorial and Executive Offices at 119 West 40th Street, New York, N. Y. Thomas S. Holden, Pres.; Howard J. Barringer, Vice-Pres. and Treas.; Irving W. Hadsell, Vice-Pres.; Chauncey L. Williams, Vice-Pres.; Sanford D. Stockton, Jr., Secy.; Walter F. De Saix, Asst. Treas.; Edwin H. Freed, Asst. Treas. Member Audit Bureau of Circulation and Associated Business Papers, Inc. Architectural Record is indexed in Reader's Guide, Art Index and

Industrial Arts Index. Subscription rates: United States and Possessions, Canada, Cuba, Mexico, Central and South America, \$3 the year, \$5 for two years, \$6 for three years; elsewhere, \$5 the year; single copy, \$1. Circulation Manager: Marshall Ginn. Every effort will be made to return material submitted for possible publication (if accompanied by stamped, addressed envelope); but the editors and the corporation will not be responsible for loss or damage. Other Dodge Services: Real Estate Record & Builders' Guide, Sweet's Catalog Files, Home Owners' Catalogs, Dodge Reports & Dodge Statistical Research Service.

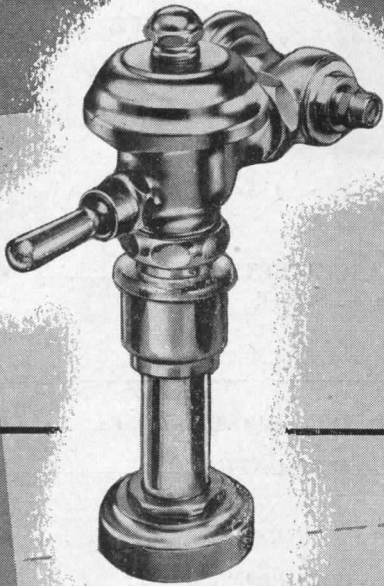

REPORT CARD

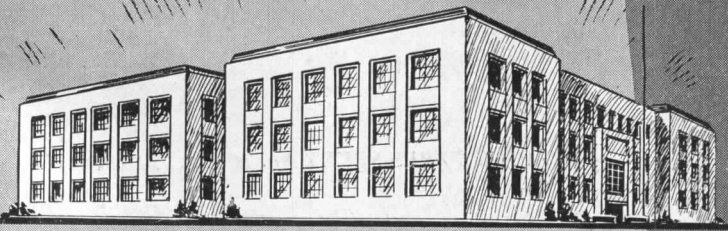

Dependability . . .

Thrift

*Ease of
Maintenance . . .*

*Silent
Operation . . .*

Schools give **WATROUS FLUSH VALVES** *. a good report card*

Letters received from schools acclaiming Watrous Flush Valves add up to a mighty fine report card. Let's take a look at the grades.

First of all, Watrous Flush Valves receive a top rating for their dependable, trouble free performance. Many of these valves have been giving faithful service for 10, 15 and even 25 years.

The self-cleansing by-pass, which guards against prolonged flushing, adds to their remarkable deportment.

In thrift, the simple Watrous Water-Saver Adjustment gives these valves a top rating wherever they are installed. It results in the saving of many thousands of gallons of water each year.

Maintenance men in particular give Watrous Flush Valves a high grade because of their convenient, single-step servicing feature.

And for installations where flush valves are to be seen but not heard, Watrous provides its exceptionally efficient "Silent-Action" feature.

Combine all these qualities in the flush valves for your new school or modernization program by choosing Watrous Flush Valves—a selection that will be a constant source of satisfaction over the years to come.

THE IMPERIAL BRASS MANUFACTURING COMPANY
1240 W. Harrison St., Chicago 7, Ill.

ARCHITECTS' VIEWS ON FLUSH VALVE APPLICATIONS

A survey of interesting trends in the selection of flush valves for postwar buildings is given in Bulletin No. 477—"How Architects Look at Flush Valve Applications." Write for your copy.

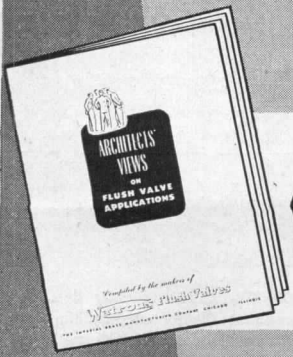

Watrous Flush Valves

THE RECORD REPORTS

Housing Outlook in Washington and Housing Activities in Congress • Wagner Bill • European Reconstruction

THERE'S a three-barrelled outlook on housing now developing in the National Capital:

1. WPB, with the Army and Navy on its neck for military supplies, keeps on hollering about the dark—even black—picture for the immediate tomorrow.

2. NHA and PBA, on the other hand, look beyond the present day. Immediate programs are routine.

3. Meanwhile, Congress is turning rapidly to the planning and drafting of housing laws.

WPB, with its neck pulled in after the Belgian Bulge upset last December, refuses to look beyond the present shortages of manpower and material. It drives home these points: lumber production hits a new low each quarter; more lumber is being used than is produced; only 75 per cent of the workers normally employed are available; 85 per cent of the lumber moved out of the forests is carried by trucks, and heavy duty tires and gasoline are going in greater lots to war.

Military Needs

Top flight officials keep right on: almost all material sent overseas is boxed or crated; when the war in Europe is won, ammunition and other equipment still will have to be boxed and crated, whether for shipment home or to the Pacific; temporary building of damaged ports takes huge quantities of lumber (to repair the port of Naples enough lumber was used to build 5,000 small homes).

The second quarter of 1945, NHA says, will see the final upsurge on temporary war housing. The agency's records show that priorities have been granted, where the manpower and material were available, for the construction of 17,000 homes—including 10,000 such grants since January 1. The Detroit grant of 5,000 and the Washington, D. C. grant of 1,500 are only the first of a gradually growing number to be authorized in congested areas throughout the country—as manpower and materials permit.

Community Developments

The Public Buildings Administration echoes the confident note sounded by NHA, and points to possibilities for group rather than individual planning. Although there is a tremendous back-

log of higher-priced better housing desired for postwar construction, officials believe that the predicted postwar servant shortage will cause a trend toward more community developments.

They present another strong argument for community development: the individual builder faces the danger, after selecting a favorable site and building what he hopes will be his permanent home, of an undesirable neighborhood growing up about him.

In this picture, PBA sees a rosy future for private, rather than government, architects. Private designers will be called upon to blueprint these community projects. To them, too, will go the drafting of plans for a gigantic industrial building program—fitted into general economic progress as well as into job-creating. Commercial factories, hospitals, and health clinics will be scheduled in every state of the Union. Temporary nature of most war plants makes their replacement a necessity.

European Reconstruction

Washington has been wondering about effects on U. S. building of reconstruction aid to devastated Euro-

pean cities. The Foreign Economic Administration indicates that such aid in the form of lumber or prefabricated dwellings is still in the talking stage. Tentative—and merely that, they emphasize—plans have been projected for Norway and Belgium, following the pattern of our token shipment to Great Britain of 30,000 houses. There has been some conversation, too, on such housing for Manila—but officials are positive that Manila will get no such aid while Navy shipping in the Pacific remains tight and critical. Belgium, which suffered comparatively little housing damage, thought earlier that she needed U. S. housing aid. Today, however, reports are that the Belgian government prefers to wait until permanent, durable, attractive housing can be built.

FEA has assembled estimates of the timber stand of the European countries from the viewpoint that the more over there, the less the drain on U. S. supply. Too, it is emphasized that their forests present one means for returning those nations to some semblance of an economy. Officials assume that German forests—the largest in Western Europe despite a reported over-cutting of about 50 per cent—will be used to some extent to rebuild continental cities.

Incidentally, FEA discloses that European countries, both those liberated and those still under the Nazi yoke, want technicians—architects with the know-how and the ability to communicate it to others—rather than material.

(Continued on page 10)



"Does everything in Bonnie Mawrs have to be regional?"

Drawn for the RECORD by Alan Dunn

Glass IN TOMORROW'S HOSPITAL

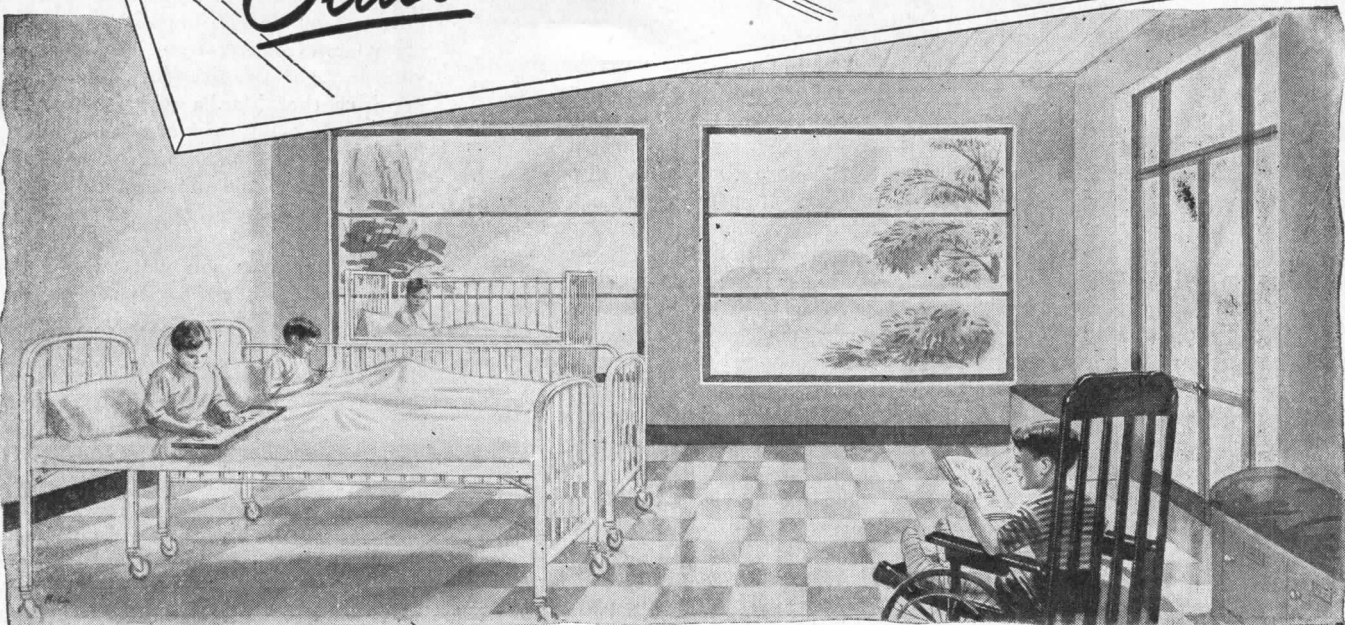

1. FOR DAYLIGHT ENGINEERING. Larger window areas are being drawn in the blueprints for postwar hospitals to provide rooms that are sunny and cheerful—rooms that boost the patient's spirits and thus help speed his recovery. This trend to larger windows for patients' rooms and solariums would create a problem

of excessive heat loss in many climates, were it not for Thermopane, the new Libbey-Owens-Ford windowpane that insulates. This sealed, double-glass unit provides heat-saving insulation without sacrificing outdoor views. And it helps prevent transmission of street noises. Write us for full information.



2. FOR CORRIDOR PARTITIONS. To prevent noises from a children's ward, or other rooms, from carrying down the hall to the annoyance of other patients, put a partition of clear or translucent glass across the hall.

3. FOR WAINSCOTING. Where cleanliness is of utmost importance...such as in the sterilizing room, sterile supply room, operating room, nursery or pharmacy... use glass for wall surfaces. It can be cleaned time and again without harm to its smooth, hard, lustrous finish.

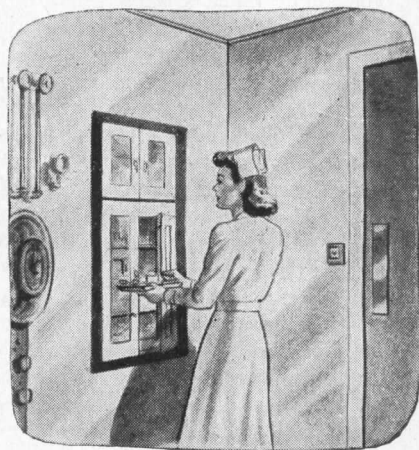

GLASS COMBINES beauty with many practical qualities. Its sparkling finish has remarkable resistance to weathering, chemicals, abrasion and corrosion. It can be tempered to give it amazing resistance to impact and thermal shock. You can have it clear, translucent

or opaque—colorful or colorless. These and many other properties of glass can be teamed up to help you make tomorrow's hospital building more beautiful and more efficient. Libbey-Owens-Ford Glass Company, 1645 Nicholas Building, Toledo 3, Ohio.

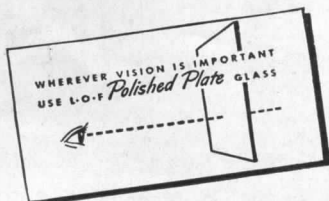

LIBBEY • OWENS • FORD
a Great Name in **GLASS**



MORTASEAL

The Lime that puts More in Mortar

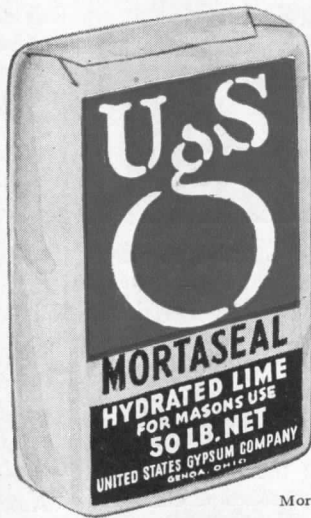

A better lime . . . a better mortar . . . a better result—that's the magic of Mortaseal. It puts *more* in mortar—more slip—more spread—18% more plasticity—19% more water retentivity—10% more sand-carrying capacity—over ordinary limes or so-called "patent mortars" when mixed with Mortaseal in recommended proportions.

All this adds up to more workability . . . easier laying of masonry units . . . easier filling of joints . . . more resistance to early stiffening of mortar . . . less need for retempering or wetting masonry units . . . more uniform bond . . . more water-tight walls . . . more economical on the job . . . and that's of interest to you and your clients. Write for specification and data chart.

Mortaseal is a trademark owned by United States Gypsum Company



United States Gypsum

For Building • For Industry

Gypsum • Lime • Steel • Insulation • Roofing • Paint

Housing in Congress

There is a current upswing in Congress on housing; nor does it seem to be just a case of getting on a bandwagon. Individual members cite the significance of the construction industry in the whole postwar economy: its importance to employment, its stimulus to business, its contribution to social welfare and the standard of living. They feel that a nation-wide building revival will help achieve the celebrated "60,000,000 jobs."

The housing stir on Capitol Hill centers around:

1. The comprehensive Wagner-Elender-Murray Housing Bill, word of whose preparation blew in with the gusty winds of March.

2. Hearings on future public works and construction by a House Postwar Economic Policy and Planning subcommittee.

3. Approval of amendments to the

National Housing Act.

4. Emphasis on hospital construction.

In addition, the House has voted to continue the Lanham subcommittee investigation of federal housing, which was under way last Congress. The Murray Committee in the Senate plans further inquiry into expansion of small business in the construction industry.

Wagner Bill

Most hub-bub arises over the so-called Wagner Bill, based on far-reaching studies by industry and government. Slated to become the legislative *pièce de resistance* in the housing field, it draws all eyes. Many consider it the major step in the postwar job set-up. Its terms, as set forth to date, while tentative, embody the framework on which the anticipated law is likely to rest.

This framework includes aids to

new construction, funds for rehabilitation (both urban and rural), subsidies for low public housing rents, a revolving fund for building loans. It would enable city purchases of slum districts, rezoning and new construction; it contemplates rural agency buying of submarginal houses with new construction on a lease-purchase plan.

Sponsors foresee little trouble for the omnibus measure in either the House or Senate; on the other hand, they expect careful attention rather than speed. As is so often the case in major bills, the final form, they think, will vary greatly from the initial language; changes by both the committees and chambers of the two houses are counted on. Despite this, members feel certain that fundamental aims of the legislation will remain unimpaired.

Postwar Planning

The House Postwar subcommittee on public works and construction in mid-March tackled its laborious problem of gathering suggestions on a postwar program, sifting through the proposals, and mapping out a blueprint of recommendations to the full Committee on Postwar Economic Policy and Planning and, thereby, to the House and the Congress proper.

Washington hearings came to a conclusion before Easter but in the post-Easter period the subcommittee set out to hear local groups in Chicago. It got strong testimony against federally-financed construction and against the use of public works as prosperity insurance. It contemplates making its report by mid-May.

In connection with postwar programming, the Senate wrote into the Independent Offices appropriations bill a provision for \$35,000,000 for loans to states and subdivisions for public works advance planning. The House had earlier agreed to only \$5,000,000. However, attempts in the upper Chamber to boost the amount to \$75,000,000 and to \$50,000,000 were beaten down. But it remains assured that such loans will be provided.

Defense Housing

Amendments to the National Housing Act, which moved without difficulty through the Senate, will accomplish three things. They will increase the present mortgage authority under the Act by \$100,000,000 which is expected to cover more than 24,000 defense housing units; they will extend FHA authority to insure these loans from next July to July 1, 1946; and they remove limitations as to time and amount on sale of properties acquired by FHA under its war housing insurance contracts.

(Continued on page 12)



Lillian Wald Houses, on New York's lower East Side, will house over 1800 families

HOUSING PROJECT

The petition filed by the New York City Housing Authority to have the city condemn the site of the Authority's proposed Lillian Wald Houses has been approved by the Board of Estimate, and plans for the project are going forward rapidly. Frederick L. Ackerman and Lafayette Goldstone are the architects.

The project, to house 1816 families, will be built on the 17 acres bounded by Avenue D, East River Drive, East 6th Street and East Houston Street. Approximately 27 per cent of the area has been acquired by private purchase. Total cost will be about \$12,000,000.

Plans call for 16 residential buildings and two non-residential, with a total land coverage of less than 20 per cent. Residential buildings will be of several types, will offer apartments of

from one to five rooms. Over half the apartments will be of four rooms. Special facilities include a number of play areas, several parking areas, craft rooms, a children's center and a health center.

The site, alongside the East River, has extremely poor foundation conditions, making it necessary to put all structures upon piles. Because of this, buildings will be limited to 10 and 14 stories in height. The high water level requiring extensive waterproofing were any of the buildings to be much below grade level, has resulted in the normal basement becoming an entrance or ground floor, and in a separate structure for the heating plant. The site plan takes maximum advantage of the location, however, affording the great majority of the apartments a direct view of the river.

design for lasting appreciation with Dow plastics

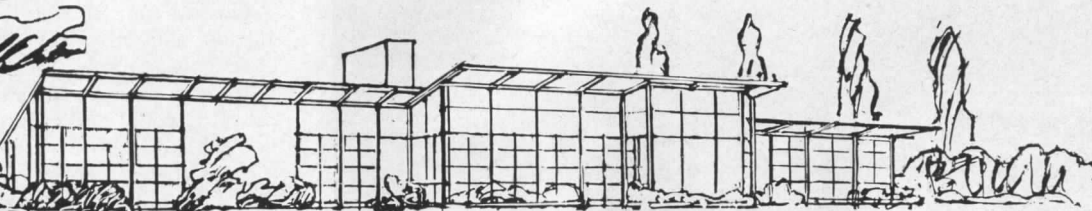

Screen from SARAN

Many an architect and builder now in the Pacific area has lifted an interested eyebrow at the amazing performance of screen made from Saran. He's watched it on duty day in and day out under conditions too tough for metal screen.

These men will insist on using screen from Saran in buildings and homes they plan after the war. They know from actual observation that it won't rust even in steamy jungle atmospheres (made of Saran plastic, it's not affected by salt air, rain, snow, fog, or acid fumes). They know how strong and resilient it is—how it resists dents and bulges (tensile strength 40,000 pounds per square inch). They have seen that it admits more light (it's translucent). They appreciate how easy it is to handle (about one-fifth the weight of metal).

Add to these important advantages the fact that screen from Saran won't be expensive after the war, and you can understand why it will be in wide use in hospitals, public buildings and homes. Why not get acquainted with screen from Saran now?

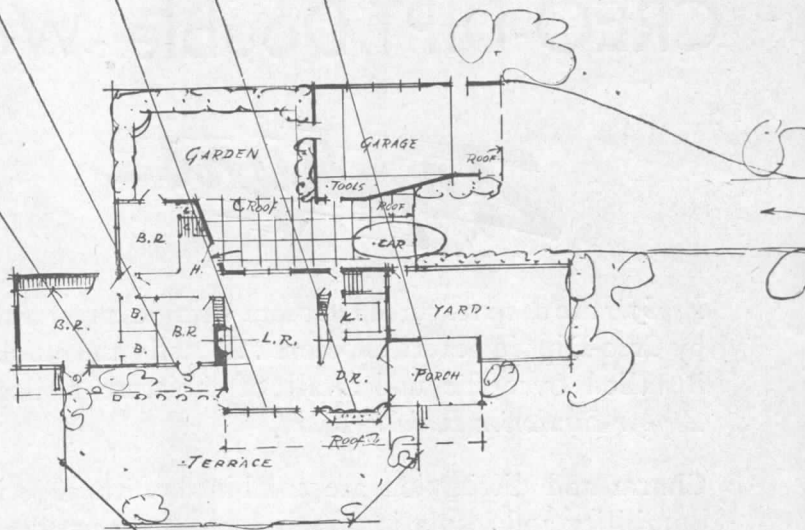

Designed by Wallace Frost, Architect, Birmingham, Michigan

Let's work it out together

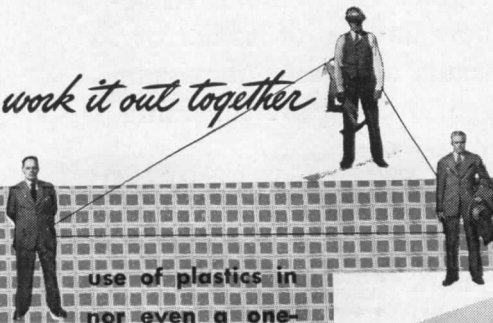

We at Dow feel that the successful use of plastics in architecture is not a one-man nor even a one-industry job. It calls for the combined skill and experience of architect plus fabricator plus raw materials producer. Working together, this team saves time and money and puts plastics to work successfully. Call us—we'll do our part.

THE DOW CHEMICAL COMPANY • MIDLAND, MICHIGAN
 New York • Boston • Philadelphia • Washington • Cleveland • Detroit
 Chicago • St. Louis • Houston • San Francisco • Los Angeles • Seattle



STYRON • ETHOCEL • ETHOCEL SHEETING
 SARAN • SARAN FILM • STRIPCOAT

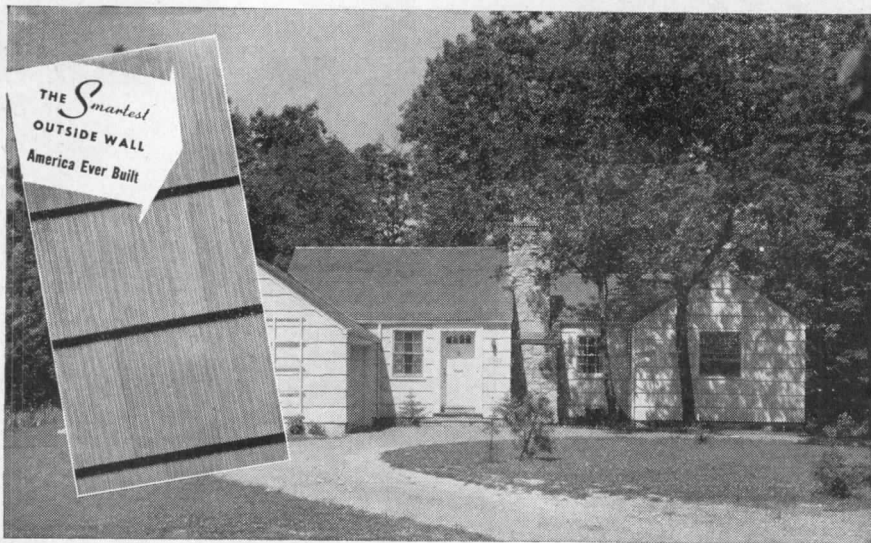

... from the Creo-Dipt Portfolio . . . the Double-Strength White treatment on Zephyrs plus a roof of Creo-Dipt red cedar shingles, pre-stained black or brown, impart an abundance of warmth and "home" color. Sewall Smith, Architect.

CREO-DIPT Double - Wall

Zephyrs

Zephyrs are deep textured red cedar shingles pre-stained by Creo-Dipt in beautiful colors . . . easily and quickly installed over the underwall of moisture resistant Zephyr Insulation Backing Board.

Charm and distinction are combined with superior durability and insulation qualities in this new Zephyr Double-Wall Method.

With their long exposure, heavy shadow lines, and luxurious colors, Zephyrs signify architectural refinement for the enduring new homes of tomorrow. Zephyrs also enhance the beauty and value of existing homes by applying them right over the present siding.

For a portfolio of photographs showing other attractive homes, and full information for Architects, write Creo-Dipt Company, Inc., General Offices: North Tonawanda, New York.  8b/7.

CREO-DIPT

Shingles and Stains



THE RECORD REPORTS

(Continued from page 10)

Hospitals

Hospital construction under the Hill-Burton Bill (S. 191) has received a close going-over by the Senate Education and Labor Committee. This measure would authorize grants, under the Public Health Service Act, to states for construction of hospitals. Primarily, it would stipulate \$5,000,000 for surveys and planning; this would be seconded by a total of \$100,000,000 for the fiscal year 1946 for construction of public and non-profit hospitals; an additional \$5,000,000 would aid state agencies in meeting administrative expenses. Provisions of the bill would be administered by the Surgeon General.

This bill is watched on Capitol Hill as a double-purpose item: social welfare, plus postwar construction stimulus. Prospects of its enactment remain unclear.



WPB NOTES

Construction Materials Low

Increased military demands, together with shortages of manpower, fuel and transportation facilities, have resulted in a marked reduction in the supply of construction materials, WPB has announced. This is especially true in the case of lumber and metals. Even for authorized essential production, WPB points out, caution must be exercised in specifying for use the tight materials listed below:

Lumber. Extremely tight with supply-requirements situation showing no improvement. Situation is expected to get worse.

Plywood. Particularly softwood, in very short supply. Entire production of softwood plywood is under controls and little is available for general construction.

Steel. Supply-requirements situation generally tight.

Masonry Products. Such products as brick, concrete blocks and clay tile in good supply except for occasional local shortages. The use of these is suggested for projects that must go ahead at this time.

Building Boards. Various kinds available, but some types are short, so local supply should be checked before use is specified.

Roofing Materials. Not a problem at present except for wood shingles, which are short.

Cement and Concrete Products. In ample supply.

(Continued on page 14)



“Janitrol
**KEPT
 ME WARM
 OVER
 EUROPE”**

HERE'S a flier on furlough, planning for the time when his dreams for a home of his own will become a reality. How natural in his selection of heating equipment, to look to the same manufacturer who today is providing our Armed Forces with the world's finest aircraft heaters.

But there's more than a friendly feeling behind this flier's preference for Janitrol. He knows that the same engineering skill and combustion research behind the Janitrol Aircraft Heater are also applied to Janitrol home heating units. Just as the aircraft heater was designed *specifically* to burn

gasolene as a fuel, all Janitrol industrial and domestic heating units are built *specifically* for the efficient combustion of gas. So it's a sure bet that Janitrol Gas-Fired Winter Air Conditioner the flier is planning on will be his best buy in performance and long lasting economy of operation.

Well, he's right. There's no other type of gas heating equipment which combines all the outstanding features Surface Combustion has engineered into Janitrol. Amplifire burners which concentrate the flame into a smaller, hotter space. Multi-thermex tubes which quickly transfer heat to the air stream. New automatic controls

to maintain accurate temperatures for greatest possible economy. Complete factory assembly on popular size models to save installation time and costs. And extreme compactness to save space in the modern home. These are only a few of the many Janitrol advantages which will give America's home owners new heating comfort and long-lasting liveability just as soon as critical materials are again available.

To help your clients with their postwar homebuilding plans, write Surface Combustion, Toledo 1, Ohio, for further descriptions and information.

Janitrol

**GAS-FIRED
 HEATING EQUIPMENT**



Winter Air Conditioner



Gravity Furnace

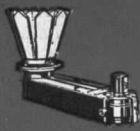

Conversion Burner



Unit Heater



Boiler

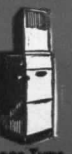

Floor Type Blower Unit

HI-DENSITY

LEAD in a DRAWING PENCIL

"Engineered" for Sharp, Clear-Cut Reproduction

Try a half-dozen Microtomic "Van Dyke" Drawing Pencils of the same degree one at a time. Notice how each draws the *same weight* line as the other. The reason: ALL HI-DENSITY "Van Dyke" Leads are identical...uniformly graded and "engineered" never to vary in any given hardness. Work goes faster, smoother with fewer sharpenings. Ask your Dealer to demonstrate today.

MICROTOMIC VAN DYKE

DRAWING PENCILS

The EBERHARD FABER
Drawing Pencil in 18 degrees,
7B to 9H—plus 6 degrees with
special Chisel Point Leads.

• **FREE SAMPLE** •

EBERHARD FABER PENCIL CO., Dept. AR-4
37 Greenpoint Ave., Brooklyn 22, N.Y.

Please send me a _____ degree MICROTOMIC "VAN DYKE"
with HI-DENSITY Lead.

NAME _____

POSITION _____

BUSINESS ADDRESS _____

CITY _____ STATE _____

THE RECORD REPORTS

(Continued from page 12)

Cement-Asbestos Items. Except for corrugated sheets, can be had with only moderate delay in deliveries.

Plumbing, Heating and Electrical Goods. All in short supply and extremely difficult to obtain.

Domestic Heating and Cooking Equipment (non-electric). Generally obtainable only on ration certificates issued by ration boards.

Screening. One of the tightest of all items; is obtainable for only the most essential users having very high priority ratings.

Warren Spencer Appointed

Appointment of Warren Spencer as director of the Building Materials Division of the WPB, to succeed John Haynes who was named director of the Construction Bureau late last December, has been announced by Harold Boeschstein, Operations Vice Chairman of WPB.

Mr. Spencer is a native of Washington, D. C. and has been engaged in the contracting business there since 1925. He went to the WPB Building Materials Division in December, 1942, having suspended operations of his company for the duration of the war. In the last year he has served as assistant director of the division, and, recently, as acting director.

New Building Materials

Use of farm and sawmill by-products and commercially unused fibers to make low cost, cement-bonded lightweight building materials will be possible as the result of research carried on by the Department of Engineering Research of the University of Michigan under contract with the Office of Production Research and Development of the WPB.

A report on development and tests of 225 different types of lightweight materials, including farm, forest, industrial and home wastes, which were combined with cement or concrete to produce hard setting aggregates, or compositions, has been completed by the University, WPB has announced.

Indications are that some of the mixtures developed are suitable for machine fabrication of insulating, weather- and fire-resistant building boards or wall, roof and floor panels. Other compositions appear particularly suitable for shingles or for siding in large sheet units that may be nailed directly to a building framework. Some heavier compositions could be used for

(Continued on page 16)



ALCOA Aluminum

FOR THE ARCHITECT

You'll find helpful data and suggestions for the use of aluminum in the 1945 edition of Sweet's Architectural Catalog. ALUMINUM COMPANY OF AMERICA, 2167 Gulf Building, Pittsburgh 19, Penna.



"Aluminum roof installed 1933, East Liberty Presbyterian Church, Pittsburgh."

RICHMOND PRODUCTS

— FOR CONCRETE WALL-WORK

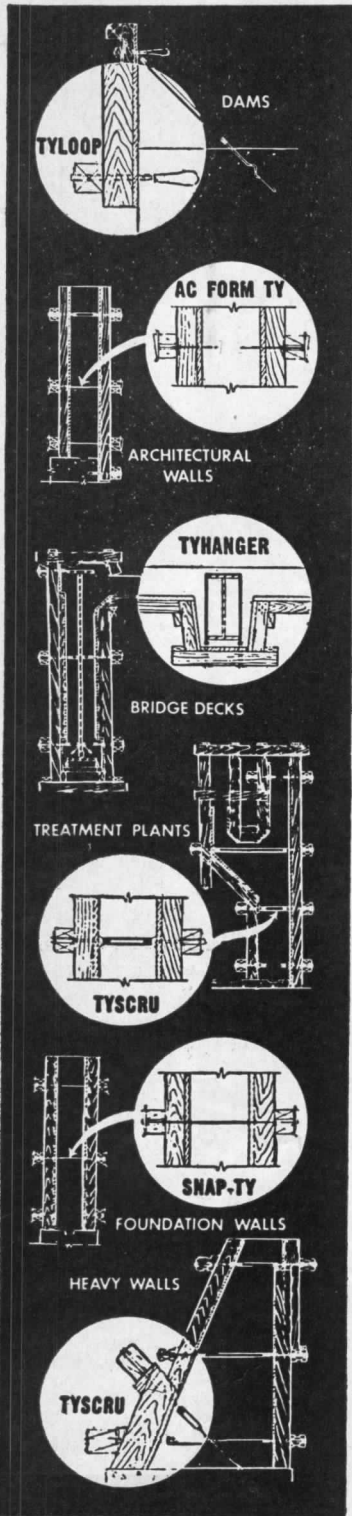

CORRECTLY ENGINEERED
TO SAVE TIME AND
LABOR ON YOUR JOB!

CONCRETE WALL WORK BUILT WITH RICHMOND PRODUCTS *Costs Less* THAN WALLS BUILT WITH WIRE, BAND OR ROD TIES

Richmond's Tyscru principle is that of a wire coil wound to the contour of a lag thread to receive and develop the full strength of the Richmond Tylag bolt. This bolt, by reason of its simple construction and fast thread, can be re-used indefinitely with no depreciation. For instance . . . 1/2" diameter Richmond Tyscru have a 5 turn coil (resistance welded) to each end of high tensile wires. These coils are 1" in length, hence they have 5 threads per inch as against 13 machine threads per inch on other tie systems. This is an immediate saving of better than 50% in tightening and stripping time per tie.

Richmond's policy of loaning its Form-Tie working parts (tools) free of any rental charge is a big factor in reduced costs because you only pay for lost parts, not for their usage.

JOB ESTIMATES AND FORM-TIE DETAILS
SUPPLIED • WORKING PARTS LOANED

SEE OUR
CATALOG IN
SWEET'S

RICHMOND SCREW ANCHOR CO., INC.

816-838 LIBERTY AVE. • Manufacturing Since 1911 • BROOKLYN, N.Y.



THE RECORD REPORTS

(Continued from page 14)

floor tile, water pipe and other products that require exceptionally strong, cheap and rigidly setting materials.

Concerning the strength of materials developed, the report says that in the density range of about 75 lb. to the cu. ft., some of the compositions developed compressive strength of above 4,000 lb. p.s.i. and tensile strength of about 750 lb. p.s.i. In the density range of 40 to 50 lb. to the cu. ft., approximating the weight of hardwood lumber, many of the compositions showed sufficient strength to be of practical use in building construction.

PRODUCERS' COUNCIL

Lower Downpayments Urged

To expedite the resale of existing homes, The Producers' Council has recommended that the National Housing Act be revised to permit downpayments on older homes to be as low as those on new dwellings and to authorize the FHA to extend as much loan insurance on existing dwellings as on new construction.

"The presumption that older houses offer a greater investment risk than new ones is not correct, provided there is a realistic valuation of the properties, provided the life of the mortgage is adjusted to the condition of the dwelling, and provided the same rules of eligibility are observed in making the loans," Irving W. Clark, chairman of the Council's Residential Committee, explains.

"Eliminating the provisions of the Act which deny to older houses the same favorable financing terms as are available for new residential construction will help to maintain the value of existing properties, reduce investment risks, and make home ownership more attractive to many families."

Mortgage Provisions

A major change in residential mortgage provisions, designed to aid home owners in improving dwellings, has also been proposed by Mr. Clark.

"The change would enable a borrower to obtain supplementary loans for the purpose of modernizing or re-equipping his home without having to pay the high costs involved in complete refinancing of the mortgage as is usually required at the present time," Mr. Clark said.

"The use of mortgages which contain provision for occasional additional advances under the existing first lien is now feasible in some communities

(Continued on page 118)

FOR YOUR NEW PUBLIC BUILDINGS . . .

Versatile in design, these Mesker Steel Windows for Public Buildings are an appealing compliment to your architectural design. More important, they provide these features not found in ordinary double hung windows: • No draft built-in sill ventilators. • Awning type weather protection. • Washed entirely from inside the building. • No weatherstrips to "sing" in high winds. • Steel: Always easy to open and close—no weight to lift, no friction to overcome.

Mesker Windows for Public Buildings

The Mesker Steel Windows for Public Buildings are composed of the Series 200 M and 200 P Casements. These windows are a full 1 $\frac{3}{4}$ " thick. Versatile in design they provide the perfect window for Civic Centers, Court Buildings, Airports, Police and Fire Stations, City Halls and other Government or Community Buildings.

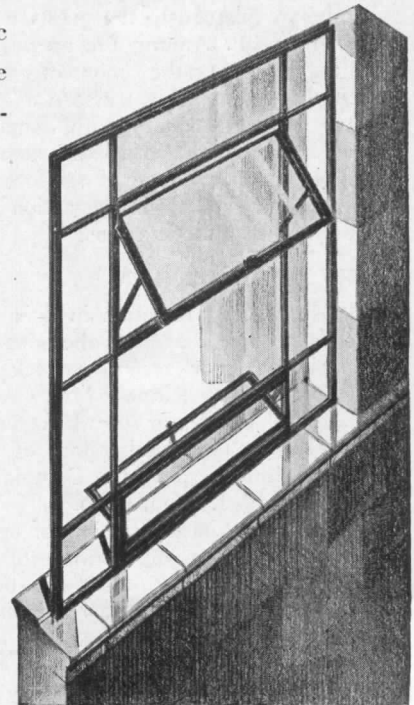
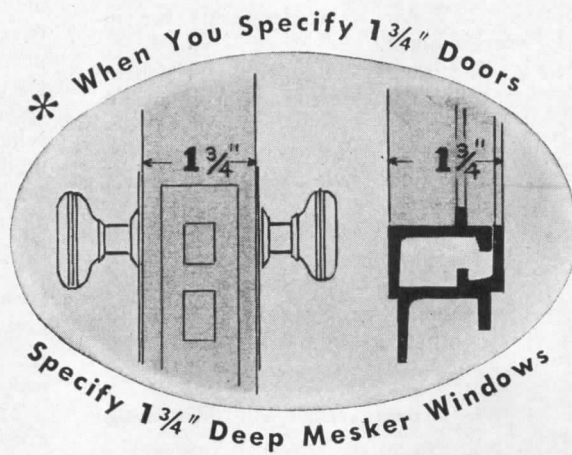
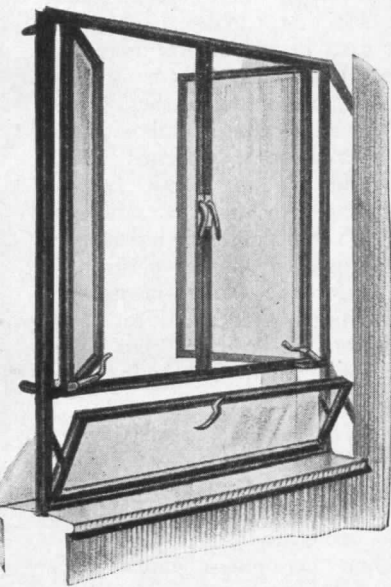

Mesker
STEEL WINDOWS

MESKER BROTHERS • 428 SOUTH 7th STREET (2) SAINT LOUIS

FOR BETTER BUILDING

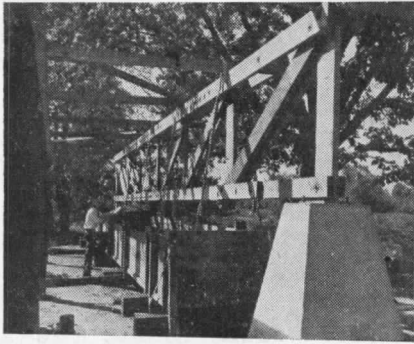

Large trusses are fabricated and tested outside the Lumber Industry Laboratory

LUMBER LABORATORY

Nearly 200 leaders of industry and government saw the lumber industry at work on the future when they inspected the newly completed Lumber Industry Laboratory in Washington, D. C. during its first "open house."

Hosts were the Timber Engineering Company, the National Lumber Manufacturers Association and the American Forest Products Industries, Inc. The work of the laboratory went on as usual during the "party," and staff members explained to the guests what was going on. Among the operations in progress at the moment were strength tests of a big truss on a 200,000-lb. testing machine, impregnated wood being turned on a lathe, demonstration of a new type of self-locking dowel, and actual impregnation of wood with synthetic resins.

NEW DOOR DESIGN

An interesting variation in door design is to be found in the airtight vertical lift door recently developed and built by The Kinnear Mfg. Co. of Columbus, Ohio, for the Unconventional Power Plant Laboratory of the Air Technical Service Command, Wright Field, Dayton, Ohio.

Although its basic principle of operation is similar to the various rolling or upward opening types of door manufactured by Kinnear, the new door incorporates several unusual features. It is spring counterbalanced and motor operated. Airtightness, when the door is closed, is accomplished by means of air inflated rubber tubes. Inflation of these sealing tubes is controlled by valves working in conjunction with the motor operating mechanism, which in turn is controlled by push buttons. The door can be raised or lowered for regular service purposes without putting the air-sealing mechanism into operation, but the mechanism is so interlocked that should the door be closed and sealed,

the motor operator will not start the door upward until the air-seals have been automatically deflated.

Because of the heavy-duty construction and airtightness of the door a blow-out panel is provided to let loose or blow outward in case of the slightest gas explosion inside the building, to relieve inside pressure.

PAINT PREDICTIONS

Wartime research and development in the paint industry has resulted in many new products and improvements of old products, Austin O. Allen, vice-president in charge of manufacturing and research of Vita-Var Corp., Newark, N. J., told the New Jersey Council of Painting & Decorating Contractors of America at a recent meeting.

Highlights of Mr. Allen's predictions:

1. Greatly improved protective qualities of metal paints.
2. Spar varnishes of improved durability and faster drying time.
3. Good durability and surface characteristics in exterior emulsion paints for use on concrete, stucco and brick.
4. Interior flat finishes that can be applied in one coat over any surface, that will give complete hiding and perfect uniformity of appearance.
5. Perfect gloss finishes accomplished in two coats over the most porous surfaces.
6. Much faster drying properties; real four-hour enamels.
7. Water reducible paints for interior finish.
8. Fire retarding paints for general use on wood, textile and composition surfaces.
9. Acid, alkali and chemical resisting coatings for industrial and chemical plants.
10. Fume-proof enamels far superior to those of the past.
11. Insecticidal paints that will keep the home free from flies, mosquitos and other insects for probably a year or more. Not toxic to human beings.

New airtight vertical lift door design

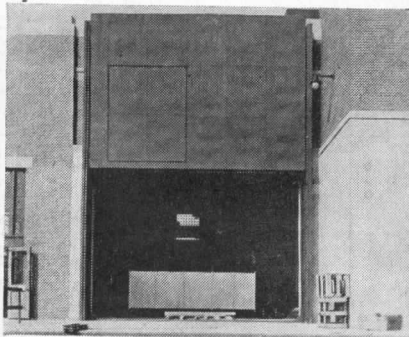

PLASTICS

Class-Base Plastic

Now being produced is a glass-base plastic made in sheets, known technically as *glass melamine laminate*. It is made from a fine weave, continuous filament fiber-glass fabric with melamine thermosetting resin which is said to be unusually resistant to flame and to arcing.

The material is available now in sheets, tubes and rods, is specially designed for electrical applications which require a high order of flame and fire resistance, together with a high arc resistance and high mechanical strength. The Formica Insulation Co., Cincinnati, Ohio.

Flame-Resistant Plastic

The development for the Navy of a plastic combining the qualities of fire-plus shock-resistance and easy molding properties has been announced by General Electric Co., New York City.

Navy specifications, set by the stresses and strains of battle action, called for a plastic that was relatively fire-resistant and non-toxic, and had good electrical properties, high impact strength and easy moldability. Because it was found to be impossible to use any appreciable amount of organic filler in a laminated plastic or molding compound to fit these specifications without obtaining a material that gave off toxic gases in case of fire, inorganic filler-type of materials such as asbestos and glass were indicated. Asbestos was finally selected because it embodied all of the specifications. Asbestos fibers were bound together with certain phenolic resins to make a series of plastics with various shock resistances.

Glass is used in another plastic development for the Navy—in a type used as panel boards on ships. It is made by bonding layers of glass cloth together with melamine resin in high-pressure presses.

Powdered Resin Glue

Just announced is a new powdered resin glue for which many exceptional properties are claimed.

This new hot-press phenolic glue, *Plaskon 810-12*, is extensible with wheat flour and said thus to permit unusual economy while meeting strict performance standards in plywood and furniture panel stock.

Used without extension, the new glue is said to meet the most rigid requirements in water and weather resistance. Plywood made with it, it is claimed, can be used under prolonged or constant extremes of temperature and humidity. Under the most severe service conditions the unextended glue

(Continued on page 22)

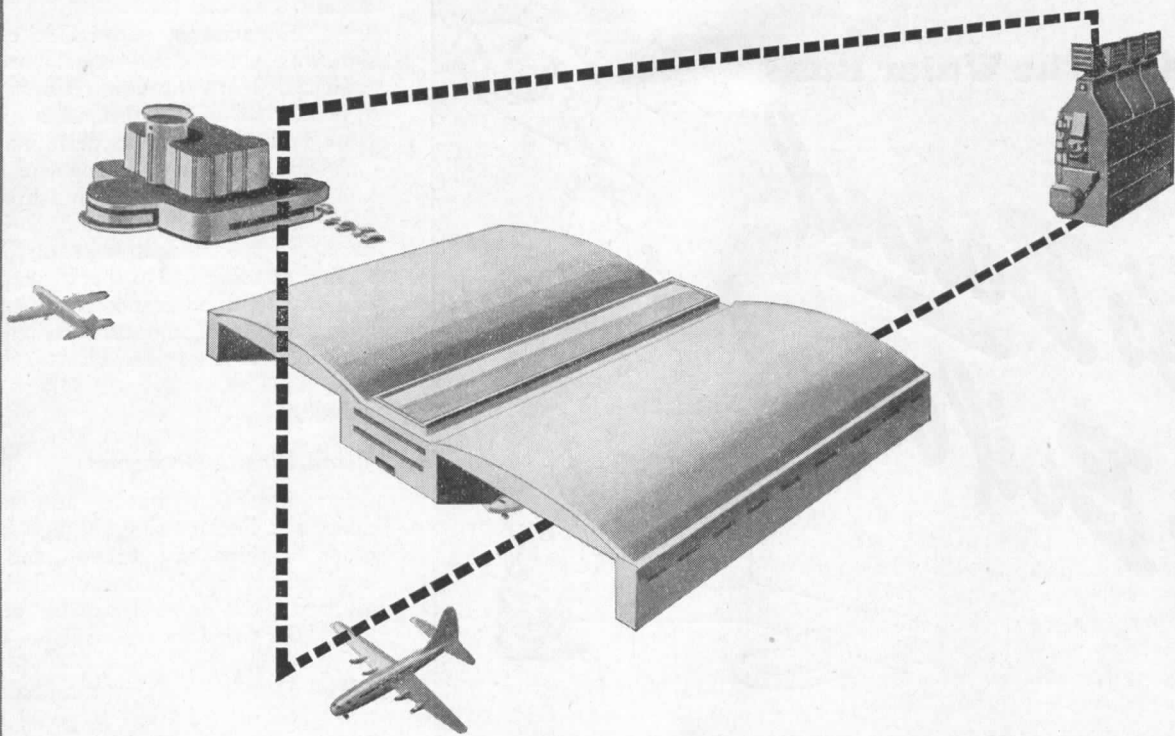

Why buy a complex solution for a simple heating problem

Airport hangars and buildings are ideally suited to Dravo Direct Fired warm air heating—as simple and inexpensive a heating method as you could wish for!

Dravo Direct Fired heaters deliver their warm air direct, without employing the medium of steam with its complex distributing system. Heat can be discharged directly

• • •

If your project is in blueprint or even preliminary plan stage ask for a Dravo Building Survey Report. Properly filled out this report will organize the data on which an estimate of installation and operating costs of Dravo Heaters may be based.

into the hangar space and supplied to offices and waiting rooms by ducts. When gas or oil is the fuel, operation is automatic at the press of a button, and it is so simple that any 'port employee can handle the heating in a few minutes a day.

We're not guessing at these points! In the past few years Dravo has supplied heaters with a combined hourly output of 347,380,000 Btu's in more than eighty airfields in the U. S. and at advance bases! With that wealth of experience we recommend that every flier, execu-

tive or city official who will have an interest in tomorrow's airports learn the facts about Dravo Direct Fired warm air heaters—they produce cleaner heat, are less expensive in first cost and in operation, and require practically no attention—a truly simple solution to the space heating problem presented by the inherent features of airport design.

Ask for Bulletin 509—address DRAVO CORPORATION, Heater Department—300 Penn Avenue, PITTSBURGH, PA.

heating analysis...

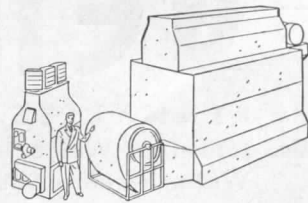
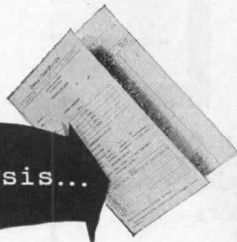

300,000 TO 4,000,000 B.T.U. CAPACITY PLUS
UNITS COMBINE FOR ANY DESIRED OUTPUT

When The Tap Says



And The Water Runs



He's Bound
to Boil over!



Don't let this happen to your customers! Make sure they get "unlimited" hot water morning, noon and night by recommending a GENERAL Tankless Heater.

This compact, self-contained tankless unit hooks up directly with any type of automatic-fired boiler. It costs less to install, ends the storage problem of old-fashioned tank-type heaters...

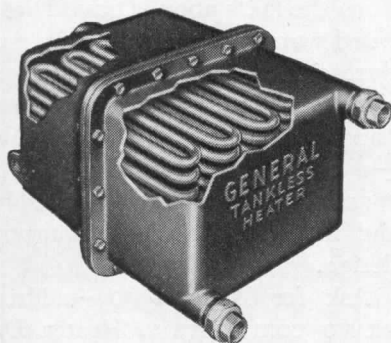

yet supplies 3½ to 35 gallons of piping hot water per minute—every minute! The seamless copper tubings mean mountain-clear, sediment-free water... and they mean longer, trouble-free operating life.

Yes, tomorrow's homes will have all the good things that make home sweet home—and among them will be GENERAL Tankless Heaters. Plan now to give your clients this modern hot water heating method... send for Catalog 16. General Fittings Co., Department C, 123 Georgia Ave., Providence 5, Rhode Island.

UNTIL VICTORY—a major part of our output is precision war work: torpedo and bomb parts, fuse setters, special Navy water heaters.

GENERAL

TANKLESS WATER HEATERS

- Also Tank-Type Water Heaters • Thermostatic Mixing Valves
- Water-Hammer Silencers • Live-Steam Heaters
- Coil-Heated Tanks • Pipe Unions

FOR BETTER BUILDING

(Continued from page 20)

outlasts the wood itself.

At its maximum permissible extension with wheat flour—equal parts of resin and flour—the new resin assures a bond that will withstand a three-hour boil test without delamination.

A dry, water-soluble powder, Plaskon 810-12 is said to be much more stable in storage than liquid phenolic resin. No special skill is required for mixing or using it. No special preparation of the wood is necessary, and a wide latitude of moisture content in the wood is allowable. Plaskon Division, Libbey-Owens-Ford Glass Co., Toledo, Ohio.

Blind Plastic Grommet

For insulation and protection of cables and lines passing through bulkheads of ships and aircraft, and for hundreds of applications of electrical insulation, the non-flammable plastic blind *Des-Grommet* is said to offer many advantages.

The *Des-Grommet* is composed of two parts molded from a special non-flammable formula of Lumarith, prepared for the manufacturers by the Celanese Corporation. The two parts are so designed that they may be applied from one side only by means of a special tool.

The new grommet is furnished in a wide range of sizes to accommodate cables and tubes from ¼ in. through 2 in. in diameter. Two sizes for wall thickness are supplied, one to accommodate ⅛ in. to ½ in. and the second for bulkheads ½ in. to 1 in. in thickness. Victory Mfg. Co., South Pasadena, Calif.

HAND MAGNIFIER

An innovation in hand magnifiers, the *Twin Reader*, is now in production. The unit is of the binocular type, incorporating scientifically matched and balanced dual lenses of fine optical glass. The lenses are mounted in a holder which folds back into a compact and attractive plastic handle, the whole unit when folded being about the size of the average spectacle case.

Because of its design, *Twin Reader* can be held in a viewing position with either hand. Eldroy Products Co., 480 Lexington Ave., New York 17.

INSULATING MATERIAL

A new non-metallic, permanent, sound-proofing insulating material known as *AlexitE*, is a very light type of vermiculite, easily applied, and said to be vermin-proof and economical.

(Continued on page 24)

Photogenic...

that's us!

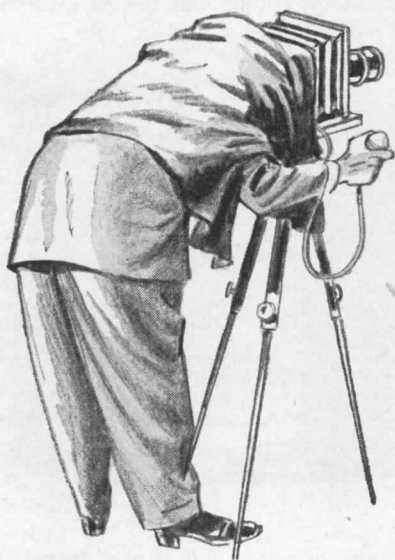

ARTISTS ADMIRE the camerability of the Eagle "Chemi-Sealed" TURQUOISE pencil. Its deep black marks photograph to perfection . . . and retain every subtlety of the original drawing through any process of reproduction.

DRAFTSMEN DELIGHT in the extreme opacity of TURQUOISE lines. They guarantee sharp reproduction of your tracing by blue print, black print, or other method of duplication.

Here's the reason:

The particles of Electronic graphite in TURQUOISE leads are refined to 1/25,000th of an inch . . . formed under enormous pressure . . . and vitrified at white heat. The result is a cellular structure so extremely fine and uniform that the point deposits *more graphite* more evenly on the paper.

EAGLE PENCIL COMPANY
703 E. 13th St., New York 9, N. Y.
Eagle Pencil Company of Canada, Ltd., Toronto

FOR PERFECT REPRODUCTIONS

try Eagle TURQUOISE. Write us for a free sample, naming this magazine, your dealer and the grade you desire. Ernest Eagle will be glad to send it, with our compliments.



"CHEMI-SEALED"

(SUPER BONDED)

TURQUOISE

DRAWING PENCILS AND LEADS

PORTLAND-CEMENT PAINT

an armor of beauty

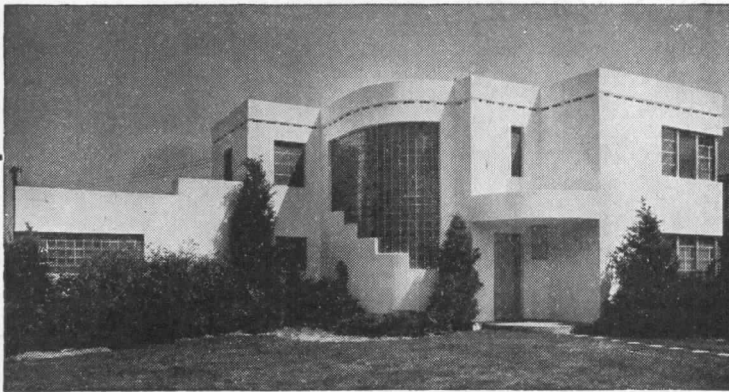

A sparkling finish of portland-cement paint, made with Atlas White cement, adds beauty and durability. And this dependable paint does more . . . it provides an effective shield against moisture and attacks of the weather!

Applied to concrete, concrete masonry, stone, hollow tile or brick . . . this finish penetrates the pores to form a lasting bond. It provides a surface that can be easily cleaned. Frequent repaintings are unnecessary.

Scientifically mixed portland-cement paints, made with Atlas White cement, are prepared by a number of manufacturers in a wide range of colors. They're conveniently packaged . . . ready for mixing with ordinary tap water on the job!

For further information, write to Atlas White Bureau, Universal Atlas Cement Company (United States Steel Corporation Subsidiary), Chrysler Building, New York 17, N. Y.

Factory-prepared paint is preferable



ATLAS WHITE CEMENT
FOR PORTLAND CEMENT PAINT

FOR BETTER BUILDING

(Continued from page 22)

When expanded to 10 to 15 times the original size of ore, the material contains about a million little insulating air cells to the cubic inch, and is said to have an insulation and fire-proofing quality equal to the best materials now commonly sold.

The AleXitE Engineering Co. of Colorado Springs, Colo., recently opened two Colorado mines and are now beginning to ship carloads of ore, cleaned and ready to be expanded in furnaces, to building supply dealers and others throughout the country.

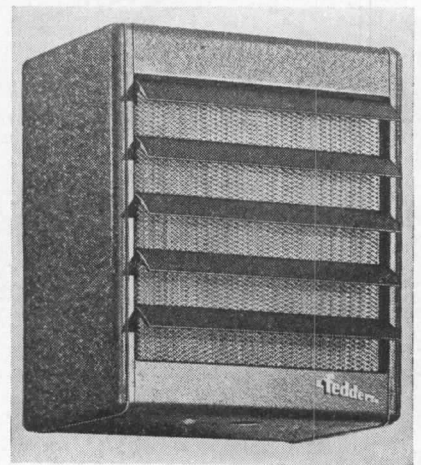

One of a new line of unit heaters

UNIT HEATERS

A new line of *Series 15 Unit Heaters* with streamlined copper tubes and fins has been announced. Pointed out as a special feature is the design of the deep brazing flanges which are extruded into the headers, to provide an unusually abundant area of contact between tubes and headers.

Complete relief of expansion stresses is said to be provided between heating element and cabinet as well as between adjacent tubes. Quiet, broad blade fans, large BTU capacity and low final temperatures provide maximum distribution and comfort in the working zone, the manufacturers report.

The line is built in 10 sizes ranging from 100 to 1000 EDR capacity with corresponding 24,000 to 240,000 BTU capacity. Fedders Mfg. Co., Inc., 57 Tonawanda St., Buffalo 7, N. Y.

STANDARDS

Prefabricated Homes

Recommended Commercial Standard for Prefabricated Homes, TS-3888, is now being circulated to the trade for written acceptance. The purpose

(Continued on page 128)

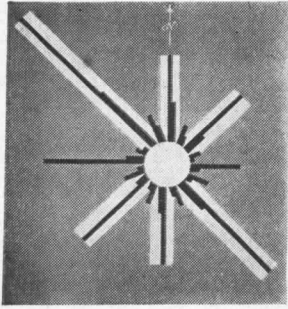

Wind Rose for Airport Architects

◆ Strong and shifting winds are blowing across the field of airport design, as well as across the air fields themselves. Changes in the design of airport buildings are being brought about by changes in plane size, type and design, and by theories of efficient runway patterns designed for maximum capacity and ease of control. Electronic control of incoming and outgoing planes is developing apace. Cross-wind landing is increasingly possible. Both imply consequent changes in flight strip patterns and in the placing of airport buildings. Such trends in planning must be understood before buildings can be started. Many experts are at work, new principles are in the making or in the proving, and many points of view must be taken into serious account before the architect can start contract drawings, or even sketches.

◆ The architect is likely to find himself between the upper and nether millstones of municipal authorities and airline representatives, the former seeking a profit-making monument to attract crowds and to dine and amuse them, the latter searching for efficient ways to handle passengers, freight and planes with the least effort and lost motion.

◆ For such reasons basic training for architects who contemplate airport designing should include the art of persuasive and logical debate as well as familiarity with prevailing winds in aeronautical thought, theory and practice. Very few decisions regarding airport design can be made without a succession of conferences with representatives of all of the factors involved. Their name is legion, their opinions are sometimes rather fixed, and their objectives often divergent.

◆ Good airport design is therefore really a team job with many minds, much experience, and varied skills needed. Analysis, synthesis and administrative coordination are essential for the most successful airport design. Even the best combination of brains and experience can make mistakes in a field as new and as rapidly developing as air transportation. Many an airport that a few years ago was hailed as a wonder of perfection is now being altered, added to or superceded. This is to be expected. Unexpected developments are to be expected. And these developments alter the architects' design problems.

◆ Wise designers are therefore striving for the utmost in flexibility, alterability and expansion. Naturally some decisions must be made. Ports' plans must be made ready for early postwar construction. But even these should be tempered with the knowledge that the future development of planes, in methods of propulsion, in landing devices, in loading techniques, in traffic and in flight control, yes, and in passenger psychology—all will mean necessary mutations in port facilities and in architectural planning.

◆ Airport design offers opportunities to be sure, but it also carries heavy responsibilities that require foresight, imagination, ingenuity and a modicum of humility—for the air-transportation industry is in its infancy. It is growing so fast that there is the greatest necessity for familiarity with current trends—technical, economic, social and political—that enter into the design of the ports that will serve this new industry. The articles which follow will, we hope, serve as preliminary “wind rose” indicating the direction of the strongest prevailing thought on many of the basic problems of airport design.

Kenneth K. Stowell
EDITOR

GOOD AIRPORT DESIGN



requires, not a kit of rules but a broad grasp
of basic requirements and relationships

AIRPORTS

Architectural Record's Building Types Study Number 100, in collaboration with AERO DIGEST

AVIATION is under a terrible debt to mankind. Foolish rulers compelled the use of planes to shatter countless communities. Can planes, under wise guidance and planning, build peaceful communities anew? And will our air-age growth make amends for the past horror, by achieving a dignity, orderliness, and comeliness that will retrieve the "sad conquest of the sky"?

This is the problem that is dealt with here in work-a-day terms. The editors, in their own preliminary study of the airport subject, found it essential to learn about the place of ports in a comprehensive scheme of things—the technical aviation picture, the transport scheme, the adaptation of flying to commerce and pleasure, the picture of cities and regions. It was this kind of information, therefore, that was asked of authors, as a preliminary to examples and discussion bearing on direct problems of design.

We stand at the threshold of major peacetime aviation development. Therefore, in this introductory study, there is more emphasis on overall planning, and on service to people and communities, than on facilities for servicing planes. Moreover, on the latter subject more information is already at hand. Further discussion, in later issues, will deal with hangar design, cargo handling, commercial airport design, and airport problems in detail

On innumerable questions involving policy, it was

found that there were divergent interests and schools of thought. In a rapidly growing art, this condition is healthy. The editors have endeavored not to go "all out" for any one approach, but to point out where opinions seem to differ. One characteristic of airport planning will be instantly apparent to the reader: preliminary schemes are *not* overly modest.

In shaping this airport study, there has been useful conference with the publisher and editors of AERO DIGEST. High honor goes to this leading aviation publication for recognizing the part of the architect and helping to set up a useful alliance between the profession and the industry. In December, both publications printed a discussion by the AERO DIGEST editors of the relationship between airports and the operating characteristics of modern planes. In the March 15th issue of AERO DIGEST there appears an article by the editors of ARCHITECTURAL RECORD entitled "Ports also serve *People*." This puts before the aviation industry the attitude and ability of architects in making ports humanly workable and attractive in the community, and, as a corollary, in developing ports to produce the full income which is their essential sustenance.

Airports are not just for airplanes—they are for people flying. They also serve all those activities at the port and in the community that grow up around the development of flying. Wherever people come into the picture, architecture comes in with them.

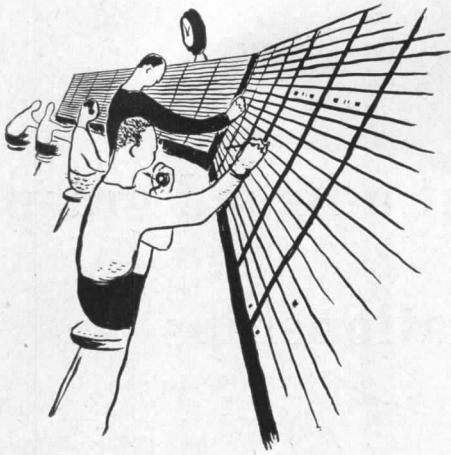

Airway Traffic Control Center

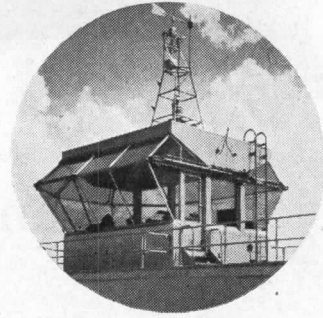

Local Tower

All ports must fit our strictly limited airways

AIR TRAFFIC CONTROL DOMINATES AIRPORTS

By Julian Whittlesey*

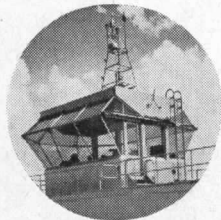

Local Tower

ALTHOUGH the air is apparently limitless, its actual plane capacity is strictly limited. And although we talk of owning 400,000 planes ten years after the war, there are estimators who declare that, today, we could fly not more than 22,000 planes at a time without major catastrophe in instrument weather.

Traffic control and scheduling have therefore become an established fact and a continuous system—locally, regionally, nationally, and now world-wide. Much rests on what the airport designer provides as to spacing, field layout, service, passenger, mail, and cargo layout. Spending a day backstage in any federally operated Air Traffic Control Center, as well as in a locally operated airport tower, will send the planner away with a keener understanding of basic airport planning.

There are 23 ATC regions in this country. Service was begun some years ago at the instance of commercial airline operators, has since circled the globe, and is available to any flyer with a radio. All others must abide by its rules. Three miles from the local control tower, coming or going, flyer is given a course which is practically collision-proof and weatherproof. Within the three-mile limit the pilot is directed by the local tower.

The Civil Airways in this country measure about 35,000 miles long by 10 miles wide by 2 miles high. They are defined by continuous audible radio signals emitted from

range stations along the way. Each range station is identified by a cone of silence and by a nearby "fan marker" or audible interruption of the range signal. Scheduling of planes is done in terms of lateral, vertical and time separation. Ten-minute headway in instrument weather implies that a 180 m.p.h. plane is a "box of air" 30 miles long, 5 miles wide and 1000 feet high, and when circling over the airport is a pancake about 3 miles in diameter and 1000 feet thick. In bad weather, the airport control tower operator talking directly to the pilot stacks his traffic up in layers and then, pulling them off from the bottom, lands his planes one at a time.

There are two types of flight regulations: contact and instrument. The "contact" flyer, usually one without radio, need file no flight plan with the ATC, but must generally keep low, is responsible for himself in maintaining proper distance from other craft and in finding good weather; and, unless he has instrument rating, he cannot fly in bad weather at all. Nine out of ten airlines, therefore, take advantage of the ATC instrument flight plan even in good weather. Thus an ATC Center through its radio station reports keeps a complete moment-to-moment visual



Local Tower

record of every flight. Traffic approaching heavy weather can be grounded or held "stacked" over ports, and, if required, be held outside by neighboring regions. Poor weather and heavy traffic is the setting for hard work at the control center, and for the men at the local towers.

The details of the operation are fascinating, and may be studied in CAA booklets. Traffic control rather than airport capacity may become the limiting factor in flying, despite radar and other new techniques. From the spacing and siting of ports to the layout of the field right down to the front door, airport design has a direct bearing upon the extent to which air traffic can be kept solved.

*Mayer and Whittlesey, Planning Consultants and Architects

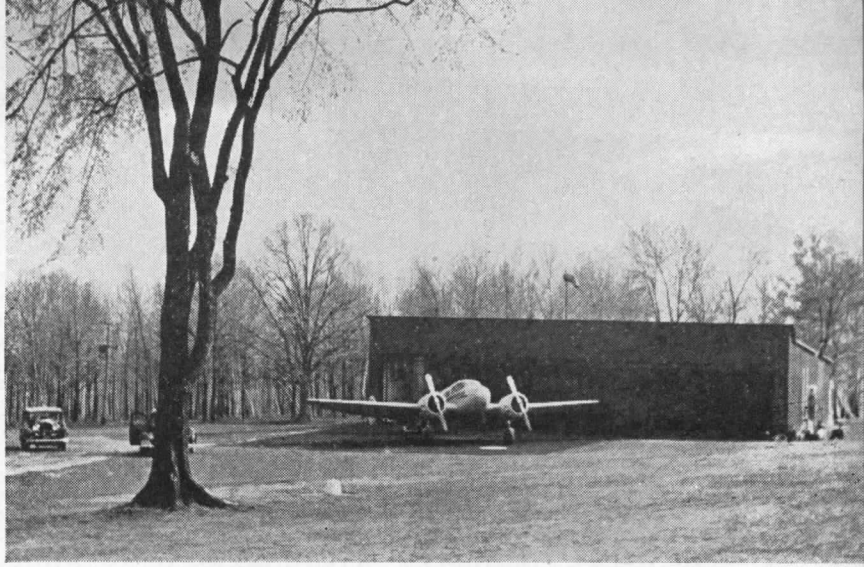

Ports are classified for different purposes

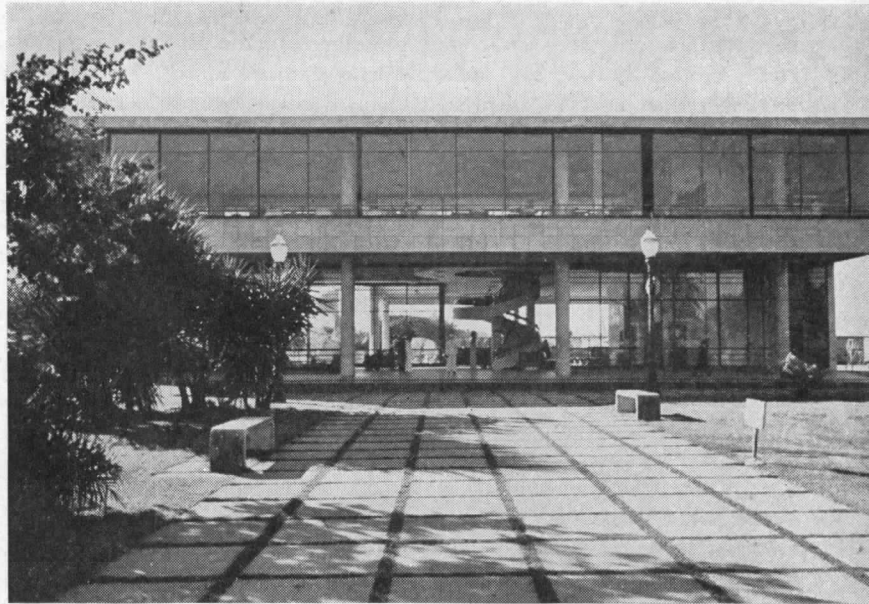

Pan-American

PORTS used to be described very simply as Class I, II, III, IV, or V by the standards of the Civil Aeronautics Administration. These are based on runway capacity, i.e. *size*. They grew out of mixed operations. They are still an index to the port's *availability* for general use.

But the maturity of flying has brought sharp differentiations. In a booklet now in press, the CAA Urban Planning Section lists airports by *use*: "(1) transport, including scheduled airline passenger-carrying, cargo, and feeder-line operations; (2) private flying; (3) miscellaneous commercial activity, which includes plane sales and service, testing, maintenance and repair; flight instruction, charter service, plane rental, etc.; and (4) military and naval flying." Each type of flying profoundly influences design and type, and in any region all kinds of ports must exist in balance.

Transport alone now recognizes international terminals, regional ones, main-line stops, feeder stations.

Private ports in their turn are subdivided by the Personal Aircraft Council of the Aeronautical Chamber of Commerce, Washington, D. C., into flight stops, air strips, air harbors, air parks. As for the commercial ports of "fixed-base" operators, their uses are innumerable.

For regional spacing purposes, the Minneapolis-St. Paul Metropolitan Airport Commission has found it sufficient to distinguish between instrument ports and ports for contact flying. (Page 77.)

All these sets of standards are good to know, since ports must fit the general transportation pattern, air transport, airways requirements under ATC, commercial and private flying purposes, and regional patterns of land use. All affect planning and design.



Aero Digest

Basic runway designs are still in evolution

RUNWAY patterns are of supreme importance to the airport architect, but he can usually occupy himself more profitably than in trying to design them. Runway design is an exacting science, complicated by special interests.

The first point of contact between runway design and airport architecture is the crucial one. It relates to land purchase. Innumerable airport sites are cramped for building space because of the current belief that "airports are for airplanes." This mistaken attitude results in choosing sites barely adequate for a runway pattern, and then trying to build on whatever space is "left over." An almost perfect example is the Westchester airport shown on page 88, for which the site was chosen by the Army. Building space is jammed against a state line, and the architects have been compelled to make the best of it. Such planning ignores the fact that airports are not just for airplanes but for *people flying*, and for *all the other human activities* that grow up in connection with flying. To ignore this is to invalidate the usefulness of the port, and, as a corollary, to starve it of its possible income.

A second point to be noted is that runway patterns tend to become too big and elaborate, again robbing the port of funds that might better be applied to making flight pleasant and attractive in the interest of a broader public. The latest CAA recommendations tend toward smaller, rather than larger, runway patterns for the average airport.

The complexity of the factors bearing on runway design is indicated by the adjoining summary. The runway patterns shown on the opposite page are chosen not as examples to be followed but as signposts indicating the many-sidedness of the runway problem.

MAJOR FACTORS IN RUNWAY DESIGN

Plane Requirements. Glide angle free of obstacles; easy approach from stack of waiting planes (e.g. only left-hand turns are permissible); runway length adequate for safe movement in relation to load factors, braking, "assisted takeoffs," possible engine failure; negotiable angle to wind (includes possibility that landing-gear improvements will permit safe cross-wind landings); visi-

bility and quick intelligibility of the pattern; runway arrangements that permit latitude in event of simultaneous landings under instrument control.

Control Tower Requirements. Limit in number of plane-movements-per-hour is set by control-tower handling capacity; new radar devices are increasing capacity and safety; clear view, either natural or by radar, must be had of all planes; ground-movement control affects efficiency of big ports.

Environmental Factors. Prevailing winds; freedom from atmospheric interference such as smoke or prevalence of fog; topographic contours and bearing power of soil; drainage; pattern of neighboring airports; airway pattern of Air Traffic Control.

Economic Factors. Savings in land cost balanced against cost of access highways and distance from urban centers; balanced also against operating savings—some patterns necessitate excessive taxiing of planes; flow lines between plane stations (maintenance, fueling, loading, unloading); personnel, passenger and cargo flow lines.

Sources of Basic Airport Data

The latest booklet on AIRPORT DESIGN of the Civil Aeronautics Administration is dated April 1, 1944. (Superintendent of Documents, 15 cents.) In press is an important booklet of the CAA Urban Planning Section, entitled AIRPORT PLANNING FOR URBAN AREAS. Due for summer publication is the next CAA booklet on airport building design. All will be obtainable from the Superintendent of Documents.

The National Aeronautical Association, 1025 Connecticut Ave., Washington, D. C., issues a monthly abstract of articles in its AIRPORT DIGEST.

Other current sources are the Aeronautical Chamber of Commerce of America, especially in its Personal Aircraft Council; and the Air Transport Association, both in Washington, D. C.

Leading periodicals of the aviation industry should also be consulted for various phases of industry developments.

These alphabet patterns are for modest airports. Their economy in land and construction cost increases availability to a larger number of flyers, but tends to limit flying to favorable weather in proportion to the simplicity of the design.

The Army's favorite triangle design (2) minimizes the effect of possible bomb damage, in contrast with the CAA design (3) which one well-placed bomb would put out of action, and which economizes land at the cost of crossed movements. Fully developed as in (4), the CAA scheme permits simultaneous movement on each of three runways in each of three directions, but is close spaced and involves many crossings

Schemes 5, 6, and 7 are all closed schemes, for many simultaneous movements. All involve access tunnels unless handled like Idlewild (ARCHITECTURAL RECORD, Dec. 1944, p.82). No. 5, patented by Hans Lubig, permits four simultaneous movements in calm weather, two in instrument weather. Taxiing is from far corners. Plan 6, by Austin engineers, also dependent on widely spaced parallels. Plan 7 was the first scheme submitted by American Airlines as a "tangential" rather than "parallel" plan. Because runways diverge, planes have much more latitude in making instrument approaches. Inclusion of 16 runways was a deliberate exaggeration. It would theoretically permit four simultaneous approaches on adjacent runways and four departures on runways opposite—more than any tower today could handle. Plane taxiing distances, however, are short, and the root idea is important

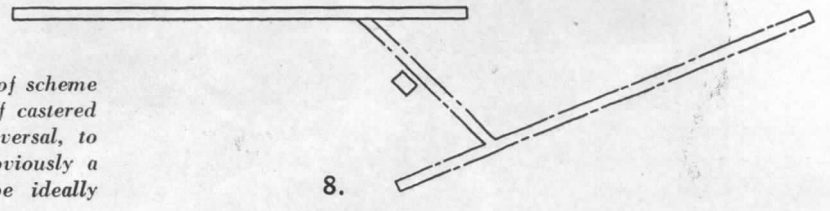
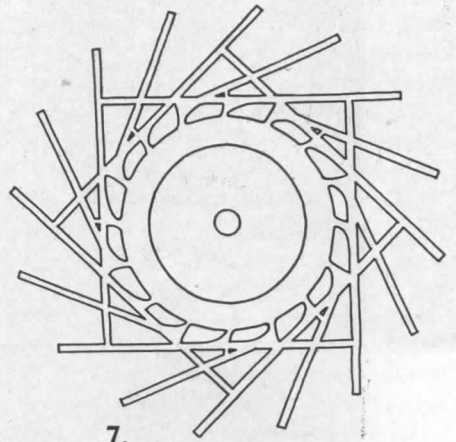
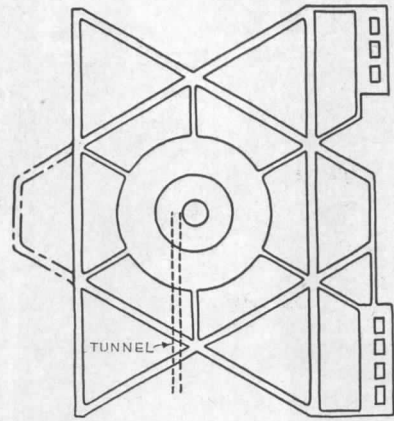
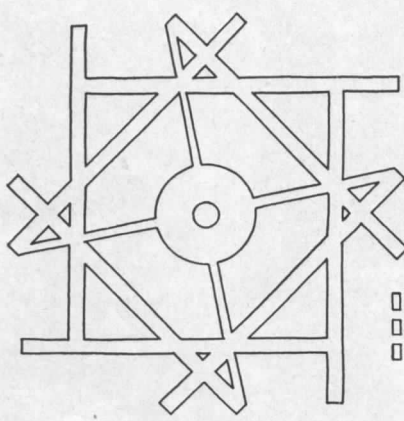
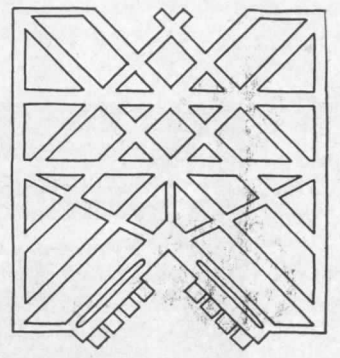
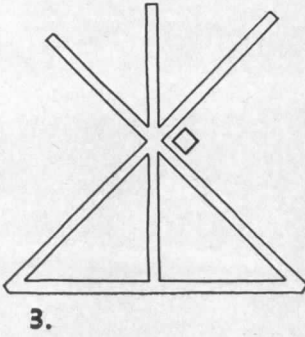
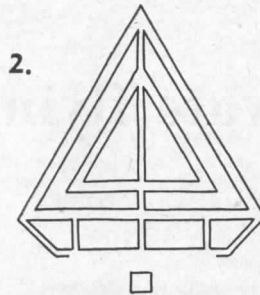
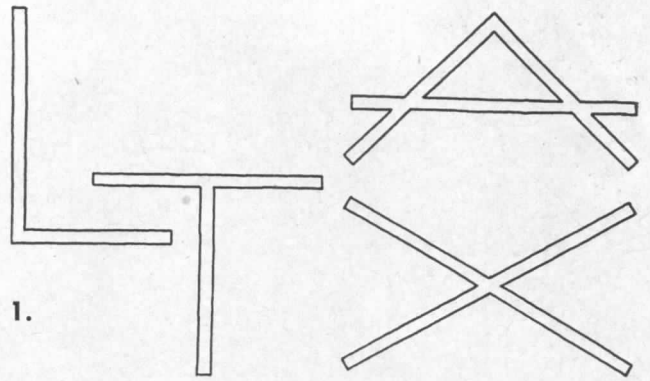

So far as known, this is the first presentation of scheme (8). It shows what future airports might do if castered landing gear were developed and made universal, to permit crosswind landings in all weather—obviously a pipe dream. But taxiing distances would be ideally short, building placement free, land cost low

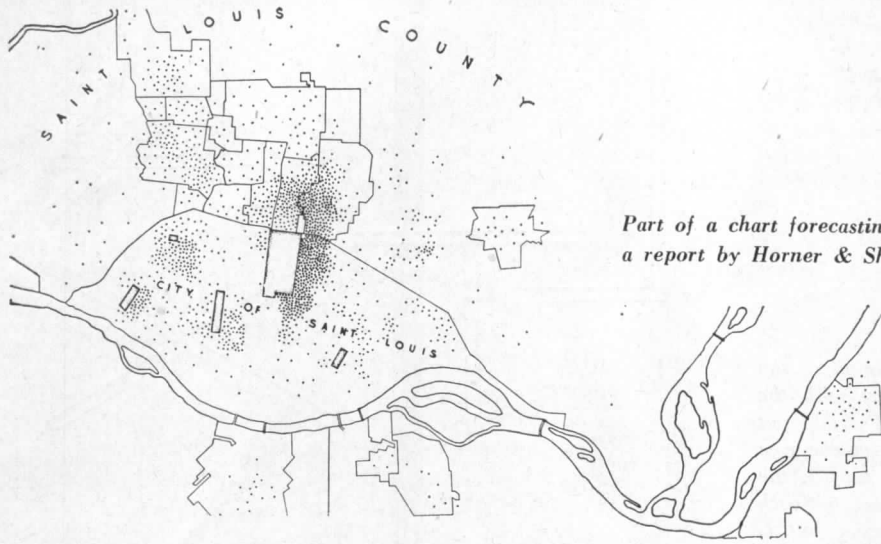

Part of a chart forecasting private-plane ownership, St. Louis (from a report by Horner & Shifrin and Harlan Bartholomew Associates)

Ports for private flying outnumber all others



10-YEAR PLANNING FOR PRIVATE-FLIGHT PORTS

By Julian Whittlesey

Mayer and Whittlesey, Planning Consultants and Architects

in the airport program



Groenhoff

WHETHER the architect designs only the buildings for an airport or designs the entire field, he should know the how and why of its existence and of its location. By what reasoning if not by what figures did the city planner and other agencies foresee the need and come to find or approve its location? And if the architect hopes to be an inceptor of airfield work, he will continually think in these terms. At the one extreme, there are the cowboy planners who promise to land planes anywhere, everywhere and anyhow; at the other extreme are planners who hesitate to take their foot off first base to run for second.

National Airport Program. Airports for private flying will be mostly small ports, "Class I" and "Class II" in the CAA classification system. If these are not built in large quantity, private flying will not materialize and the aviation industry will shrivel up. This is not going to happen. The industry has a potent sense of self-determination in this matter, as have also the American public and GI Joe with regard to private flying and all the business of it, from it, and to it. So we have The National Airport Plan; and seven possible bills face Congress as this is written. How well these bills do for small ports, and how well the present and proposed civil air and airport regulations do for the private flyer as compared to the commercial, are the hot spots in aviation talk today.

National Estimates. Plug line in the CAA-sponsored National Airport Program is the estimate of 400,000 civil aircraft 10 years after the war. The lion's share will be for private and unscheduled flight. This figure was pulled out of the hat. Whether it is true for 5, 10, or 20 years after the war is of no consequence. The ports on which air traffic lands must be permanent. Otherwise the investment, the zoning and the planning for airports may as well later be spelled: speculation, penalty and whimsy. This is the strongest argument for public control or ownership of ports and of future sites. This is no less true for the small port than the large, because either one can support or throttle the other, either can influence or be influenced by what is on your land, and either can make or break the pattern or pocketbook of the city. By and large the town will follow rather than shun the airport. Therefore the present siting of ports is the planner's broadest chisel, the realtor's greatest hope or fear, and the city's most potent anchor to windward.

The National Airport Plan with its 27 planes per million population breaks up into Regional Plans of one or more states, and then into metropolitan areas covering one or more towns and cities. Its indication of ports—new, improved, enlarged or dropped—is merely a broad reflection of population or its expected change, or of special needs such as use by a college, resort or industry, or impediments to surface transportation, or the influence of particularly favorable flying conditions. The National Plan is thus merely a hint from which to take off. And this is where we come in, the job being to forecast and locate the small ports for the great number of private planes. This article does not discuss the criteria of site selection except as it may be involved in three controversial topics to be discussed, namely:

- Estimating the Number of Small Ports
- Minimum Spacing
- Minimum Dimensions

On each of these topics there is a variety of methods and

a growing criticism of published and oft accepted recommendations. Depending on how these topics are resolved, the planner is thrown sharply one way or another.

Tentative Computation of Ports

A widely circulated, if not recommended, method of reaching a tentative regional figure for the needed private flying ports is as follows: The number of potential private plane owners is first estimated by relation to income groups as found from residential rent (or its equivalent). The number of planes so indicated is then divided by the peak hour capacity (say 100 planes) for an average small port. This results in a profligate number of ports and is analagous to golf clubs being so many that none need have a membership in excess of the players who could play at one time. The method seeks, however, to avoid flyers being forced to hold aloft at the risk of fuel exhaustion. It assumes that all private planes in the whole area may arrive or depart within one hour, or that private plane registration is a direct measure of total plane movements per hour. Neither assumption appears valid. The objective of the private port operator will be to secure as extensive a patronage as possible. Except in special instances, the private flying field will be limited by hangar and parking capacity before it will be limited by peak-hour capacity. A Parks Air College study indicates a possible optimum of about 450 planes to make a good go of the operation of a small port. Many, however, will be designed to operate with 100 or less, due to scattered plane ownership or to size limitation in congested areas. Thus a figure of 250 average capacity is reasonable, and I prefer to divide potential plane owners by 250 *storage capacity* than by say 100 *peak hour capacity*. I find this to be in agreement with the method used by St. Louis' city planners Harlan Bartholomew Associates and Engineers Horner & Shifrin.

Scheduled Commercial and Non-Scheduled Commercial classes of ports, however, must be limited by peak-hour capacity rather than storage. Here one divides the total peak-hour expected plane movements of each class by the expected peak-hour capacity of the type of airport to approximate the number of ports for each class.

In some metropolitan areas the scarcity of port sites and the likelihood that commercial traffic will congest the sky makes the computation of the number of private flying ports pointless. In this case it is not useful to continue the estimate computation beyond the point where it shows the *relative* number of plane owners in various areas. This may be a guide to locating the fewest possible private flying fields to be of greatest avail to the most people.

Estimating Private Plane Potential. Determination of private plane potential from income groups is obviously open to as much question as how the shiny Cadillac came to be parked outside of the \$3000 house. Naturally we would prefer the method available in the field of commercial scheduled flight. This is to estimate the number of plane movements from the estimated traffic and to design ports sized and controlled for the number of expected peak-hour movements. To work this out for private flying involves analysis of the cost of flight, its utility, its variations and its application to as many uses as there are walks of life and temperaments. The computation becomes meaningless. To the extent that the income-rent method is valid, it has the advantage of mapping the

Small ports will outnumber large terminals by at least three to one. Some private ports will have no buildings beyond hangars; others will add club houses; while still others will run the gamut of commercial "fixed-base operations"

general location of potential plane owners. An estimate of plane potential is of little use to airport planners unless it can somehow be tied up to a map.

Plane Ownership-Income Map. The plotting and computation follow this procedure. Two or three residential rent levels are assumed, say, \$50 to \$75, \$75 to \$100, \$100 and over. For places which have been screened from the 1940 Housing Census these can be plotted on the map. They will cluster in localities having distinctly different characteristics of density, surface transportation, land use, wealth distribution and availability of airport sites. These factors will affect the incidence of plane ownership and accordingly may be graded into three or four zones. For example, the incidence of plane ownership among high rent payers in localities of high density, good surface transportation and low site availability might be put at only two planes per 100 households, whereas in an outlying locality the same high income group might be expected to develop an ownership of 10 to 15 planes per 100 households. By this method the relative location and number of plane owners is forecast by spots plotted on a regional map and from here on it is a question of finding and designing sites that are within 15 to 30 minutes of each collection of spots. When this is done, it will generally be found that the number of required ports will be greater than the tentative number found by the first tentative computation described earlier.

Allowance for Rental Planes. To the potential private planes must be added an allowance for rental planes, for which there is no satisfactory method of estimating. However, St. Louis bravely attempts it through an estimate of its available trained pilots for 1950 and 1960. From this they deduct the number of plane owners already computed by their income-rent survey and give the balance (in this case 10,000 out of 15,000) a one-hour flight per week. Each plane sees eight-hour service per day, but three-fourths of this rental flying occurs over weekends. By this they account for 450 possible rental planes in 1950, and 700 in 1960.

Training Planes. The number of training school

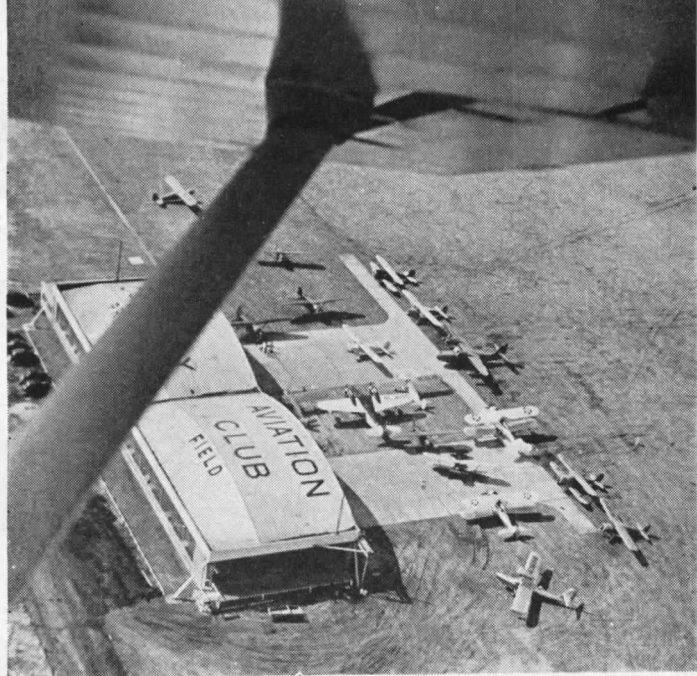

Groenhoff

fields should be estimated on a plane storage capacity basis as indicated by the school and college aviation instructor needs. By the nature of their work these fields should be separate from other fields.

Special Commercial Planes. Special-use commercial planes for photography, mapping, crop dusting, seeding, fishing, pest control, fire patrol, advertising, etc., cannot be estimated. Their utility is very promising, but their effect on traffic should not be significant.

Non-Scheduled Commercial Planes. The volume of non-scheduled commercial flight (i. e., for company-owned private business, for chartered trips and sightseeing) is not dealt with here. The number of fields for them will be governed and computed by peak-hour operation rather than by storage capacity. Some private planes and special commercial planes can be expected to take up the excess storage space on these fields, assuming that they will be able to give way to the peak commercial hours.

Scheduled Trunk and Feeder Line Planes. This discussion of private fields is not concerned with the volume of scheduled trunk and feeder line traffic except to say that 10-year plans for the private flyer must be drawn with the commercial estimates as a background. Estimated movements and peak-hour capacities for commercial flight will show when and to what extent commercial traffic will force the private flyer off the proposed or present commercial fields. A growing "scheduled" field will oust the private flyer rather than install double runways in order to keep him.

Capacity of Private Fields

Traffic capacity of airports is a function of runways and their layout. A single runway taking traffic in and out is considered to have a maximum capacity of about 40 movements per hour in contact weather. Where runways are doubled so that one takes only landings and the other only departures, each can handle 60 movements per hour and the field capacity is thus 120, assuming good separation and a proper taxiing layout. The foregoing figures

are for commercial traffic having the advantage of a control tower to direct planes within a wide radius of the port, and assume no interference from planes of another port. For private flying without control tower, no runway can be assumed to take over 40 planes per hour. When wind conditions and layout permit the use of more than one runway direction at a time, or permit several cross landings, or when the length of a field or the use of special landing gear permits cross-wind landings, the capacity is correspondingly increased.

Capacity in instrument weather is about one-third of that in contact weather with the present method of instrument approach pattern. This pattern holds planes over the field in layers of circling flight 1000 ft. apart vertically. New instrument-approach patterns to permit straight-in approaches are being studied. This will cause the instrument approach more nearly to resemble the contact weather approach not only as to pattern but as to speed or capacity. Traffic control is a young and active science which promises to meet in the air the speediest layouts we can devise on the ground. Instrument weather has heretofore pretty much ruled out private flying. Comparatively few private planes are fully equipped for instrument control. Even though the private flyer has an instrument rating, the complexity of commercial control in instrument weather will probably keep him grounded in any busy area. In any event he will be most vulnerable.

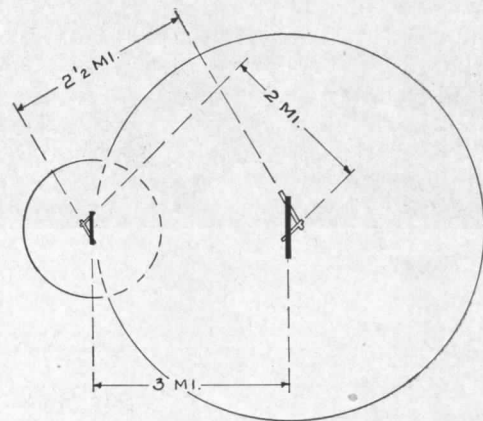

Special case permitting closer airport spacing—Same major wind prevails (north 75 per cent) for both ports; in contact weather both ports operate; in instrument weather only the larger one

Spacing of Ports

There appears to be wide suffering among planners in metropolitan areas on the score of the recommended minimum spacing between ports as published by the CAA. This is as follows: 3 mile radius for maneuvering of the larger transport planes—this would apply to Class III and IV ports up—and 1½ to 2 miles radius for Class I and II ports handling lighter, more maneuverable craft. Nobody familiar with traffic control and with the pilot's job in worsening weather in a congested area will deny that these radii are desirable *minima*. This places major ports at least 6 miles apart on center, minor ports 3 to 4 miles apart, and keeps a minor port 4½ to 5 miles on center away from a major. Faithful or blind adherence to this may rule out an otherwise possible site for a minor port for private flying. There is great pressure for these ports near areas of high density and wealth distribution, and if

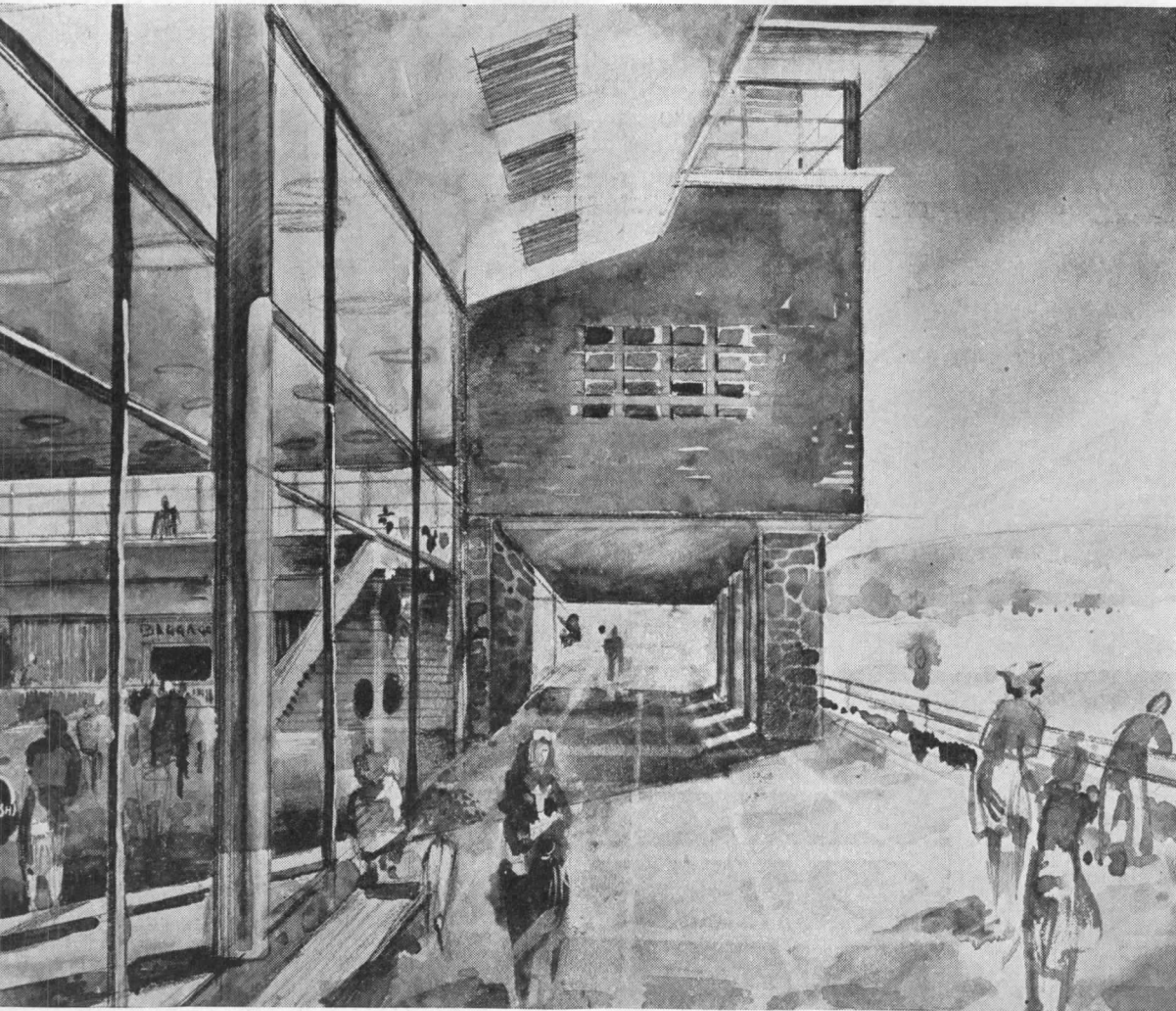

LARGER FEEDER PORT, EMPHASIZING PRIVATE FLYING

Ely Jacques Kahn and Robert Allan Jacobs, Architects.—The “grandstand” quality of the interior is well expressed in the elevations, use being made of a big drop in levels. Note the provision for overnight stopping en route of flying guests, the “look seer,” and provision for outdoor dining

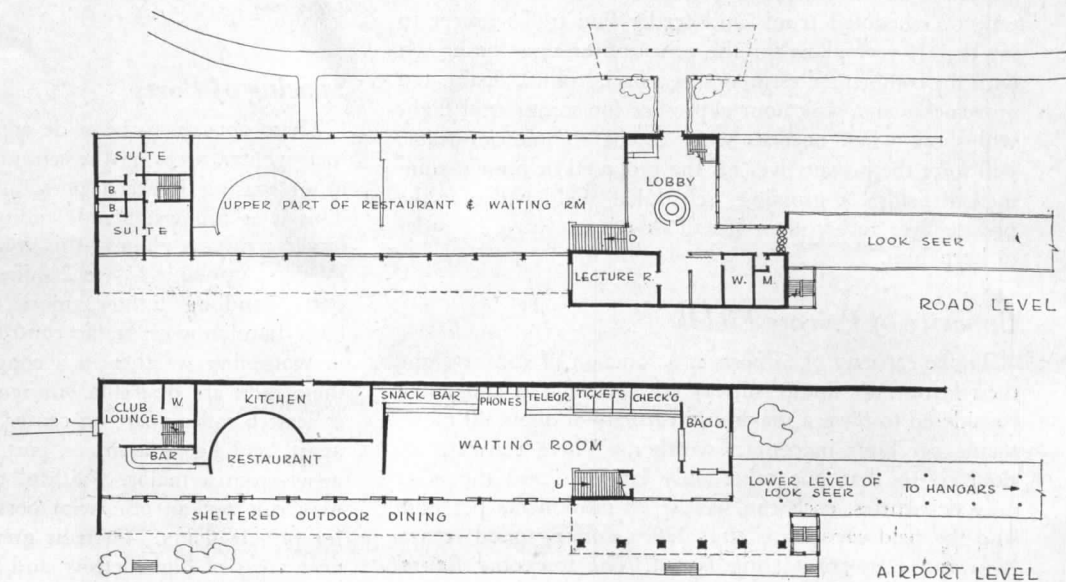

all such ports are to be forced out into the country, the utility of private flying will be greatly diminished, says the anxious manufacturer of these planes.*

Minor Port Alongside a Major Port. Without denying the objective of wide spacing, there are some exceptions which do occur and can even be designed for as follows: If the wind rose is identical for two nearby port locations and the primary wind prevails say 75 per cent, a minor port can operate alongside the big port if the smaller one is so placed that its major runway on the same wind condition is tangent to the 3-mile turning radius of the big port. Obviously this situation suggests that the minor port be a single runway affair. The approach pattern when both ports are in operation would be similar to that for a field having parallel runways 1000 or more ft. apart which is entirely practical in itself for simultaneous movements. Should the minor port need and have room to build another runway for a next most prevailing wind at 45 degrees from the primary wind (wind rose being the same for each port), the layout can still be such that both ports operate simultaneously in contact weather. Instrument weather is another matter. If the straight-in instrument approach method is successfully developed, an approach scheme very similar to that for contact weather may permit two such related ports to operate even during bad weather. A diagram illustrating this layout will suggest that a careful study of wind and of runway layouts may be rewarding where the planner is up against it for a better alternative. But I do not advise his going too far without expert aeronautical advice.

Minneapolis - St. Paul Spacing. On February 5th of this year the Metropolitan Airport Commission's Planning Committee issued a spacing recommendation in a report which, considering the complexity of this controversial subject, is notable for its brevity (three pages), its lucidity and its horse sense. The report arose from a serious study and close attention to several conferences of airport users concerned with this subject.

Firstly they claim the ability—and the right—to classify their own ports by use regardless of size, insofar as it is use, not size, that creates the need for more or less spacing. For instance, they have a certain port which by its size is Class IV to the CAA, and which according to the CAA requires at least 3-mile radius spacing because, so far as that agency is concerned, Class IV is "suitable for main line transport planes, etc. . . ." (not to mention

heavy bombers). The report asserts that this particular so-called Class IV port never did and never will serve any but small planes nor would there ever be justification for instrument-control installation and that to prevent any other port being closer than 4½ or 5 miles from this port would penalize the area concerned.

Obviously there can be two sides to such questions. Insofar as local planning and self-determination do not cross the grain of a national plan or interfere with national defense present or future, the Minneapolis point of view deserves attention. Take Fulton, N. Y., a little town 18 miles north of Syracuse on a fine road. It inherits a military port the size of Class IV, and the future of this port and how it should effect the spacing of others is certainly problematical. This disturbed world may yet need bomber bases—and with plenty of turning room.

So Minneapolis would classify its present and future ports according to use—certainly they cannot be located or designed from any other point of view. Their "A" airports, of various sizes, would be for instrument-controlled operations and be capable of serving large planes. Their "B" airports, also of various sizes, would be for non-scheduled, non-instrument conditions and serve predominantly small planes. For the "A" ports they desire a turning allowance of 4 miles radius. For "B" they are satisfied with 1½ but choose 2 miles for margin of safety, and for the following good reasons. In the event that 1 mile later proves to be an adequate circle due to improved techniques, they reason that a third port may later be inserted between two ports built 4 miles apart; whereas if they now build two ports 2 or 3 miles apart and future traffic calls for more rather than less separation, one of these ports would have to be sacrificed. This reasoning is as conclusive and satisfying as a checker game well won.

Airport Dimensions—Controversial Subject*

Heretofore increasing runway length requirements are due for retraction—quite aside from assisted take off, reverse propellers etc. Although pay-load profit will continue to be a function of wing loading and power ratio—and hence of runway length—there are other practical operational and economic factors which operate to reduce currently published standards. Actual flight characteristics of our most modern planes support this and may be found in CAA's recent Technical Developments Report No. 40. Secondary runways used only in stronger winds are certainly due for shortening. Careful study of these trends coupled with expert aeronautical advice may make the difference between a site being possible or impossible.

* More extended treatment under title "Need Airports Be So Large" by the same author will be found in American City for June.

*The CAA is now circulating new recommendations which call for on-center spacing between Class I ports of 2 miles; Class II ports, 2½ miles, Class III, 3 miles; and Class IV, 4 miles. Simultaneous operation of adjacent ports in instrument weather calls for 14-mile spacing.

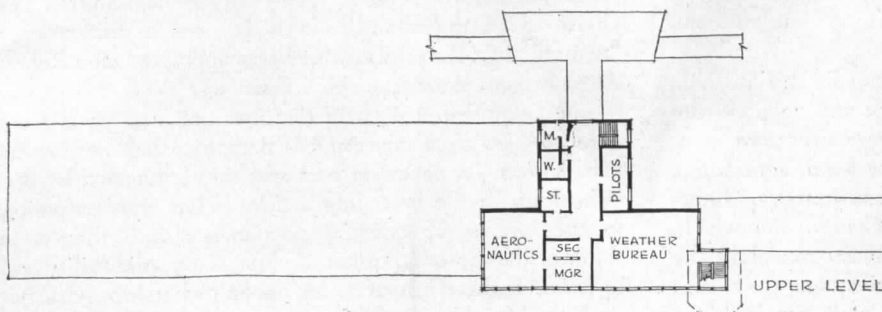

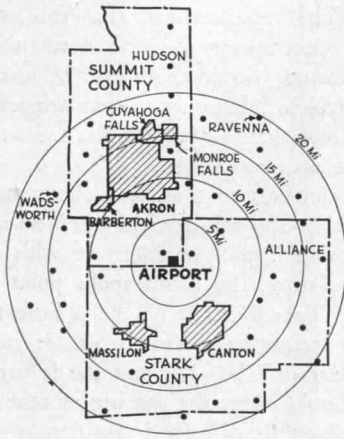

Regional airport serving three Ohio cities

The wide radius affected by airports makes

AIRPORT planning has to be a regional matter. A single port affects the use of both ground and air within a radius of anywhere from a mile to 14 miles or even further. So any system of ports quickly spans the city. Where two or more communities, large or small, lie within a few miles of one another, their airport systems instantly interlock, and the smallest planning unit that can be dealt with effectively becomes the district or region.

This is a situation that needs to be fully understood. The federal government cannot and should not regulate local airport planning except for very limited purposes. Indeed, CAA recommendations, though freely available through an overworked field staff, are not binding except where ports are built with federal aid.

Failure to take regional factors into account can only lead to misapplication of useful funds. For example, if there are two or three large cities within a radius of some 20 miles, main-line scheduled stops are extremely unlikely to be scheduled by airlines at more than one port for the group. Two of the three had best spend their money not on huge airports of their own but on a combination of feeder-port development and first-class access highways to a joint terminal, so placed as to serve all **three** communities. Unhappily this outcome is too often blocked by local pride, which positively insists on exercising the right to go bankrupt. Nor is the situation any more pleasant when two neighboring rival communities exercise authority over closely spaced ports for private or commercial flying.

The story of the Twin Cities, Minneapolis and St. Paul, is welcome evidence that common sense and goodwill can find a workable solution. If there were ever two communities where difficulties might have been anticipated, these were the two. Instead, they have acquired a Minneapolis-St. Paul Metropolitan Airports Commission which, by common consent, is the most advanced model in the U. S. of a regional authority with adequate scope and power. Within a 25-mile radius from each city hall, the

Commission has effective jurisdiction over all airports, either public or private, present or future.

The planning policies of the Commission are implemented by instrumentalities of zoning, and now of licensing. The Commission also has power to acquire ports on its own account for present or future operation. Uniquely, the Commission has the right to issue up to \$15,000,000 in bonds, and it sets up an operating budget allocated between the two cities in shares of two-thirds and one-third. The State Aeronautics Code was passed as a sister law to the act creating the Metropolitan Commission, and both were intermeshed as to their provisions.

Such harmony did not grow overnight. Each city began not only with its own pride, but with a field of its own. St. Paul had Holman Field, Minneapolis had Wold-Chamberlain. When Northwest Airlines, for reasons of convenience, discontinued passenger service in 1940 to St. Paul's Holman Field, the first response was feverish activity on the part of each city to plan a separate and all-dominating port system. The war supplied a welcome interruption, during which cool heads were able to get together. The catalyst was Governor Stassen, the useful precedent was a law passed some years earlier and operating successfully to provide joint metropolitan sewage disposal. Thus helped from above and below, the conferees agreed to minor modifications of an act which the Governor put before them, all ready for the legislature. The chairman of the commission is by law a citizen of a "neutral" city. As director there was appointed able Robert Aldrich from American Air Lines.

The Commission declares that "we are in airports *from here on.*" Its chief concern has been to create permanent installations. Its policy on port spacing is discussed by Mr. Whittlesey in the preceding article. It has another policy, in the interest of essential permanence, and that is to think of the more important airports as a public utility and to press, in these instances, for public ownership. Airways, declares Mr. Aldrich, differ in essence from railways, in



regional control indispensable

that everybody uses them. Important landing facilities are therefore like a public road. But a sharp distinction is drawn between this landing area and the adjoining *building area*, which is more like a business block adjacent to the road, so that there is no compelling reason why such development may not be private.

Whatever opinions there may be on such points of policy, there is no dissent as to the value of the work of the Commission in insuring to Minneapolis and St. Paul an orderly and reasonable air future. Perhaps it was not without significance, in the arrival at an orderly procedure, that Mayor Marvin L. Kline of Minneapolis is an architect.

Far from avoiding the vicinity of airports, first-class residential developments have gravitated to ports in many cities. This imaginary diagram, from the forthcoming CAA booklet on Airport Planning for Urban Areas, suggests how planning areas can be tucked in between runway approaches and separated by parkways. By the Urban Planning Section directed by Edgar N. Smith

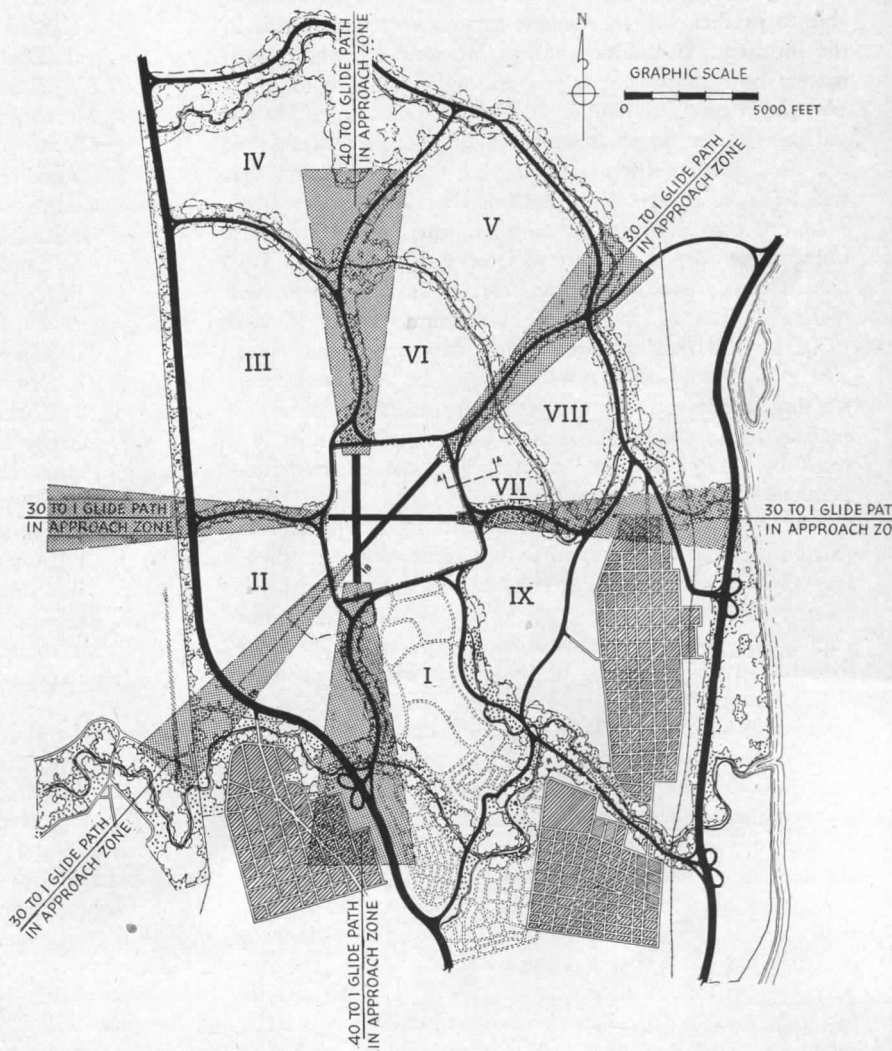

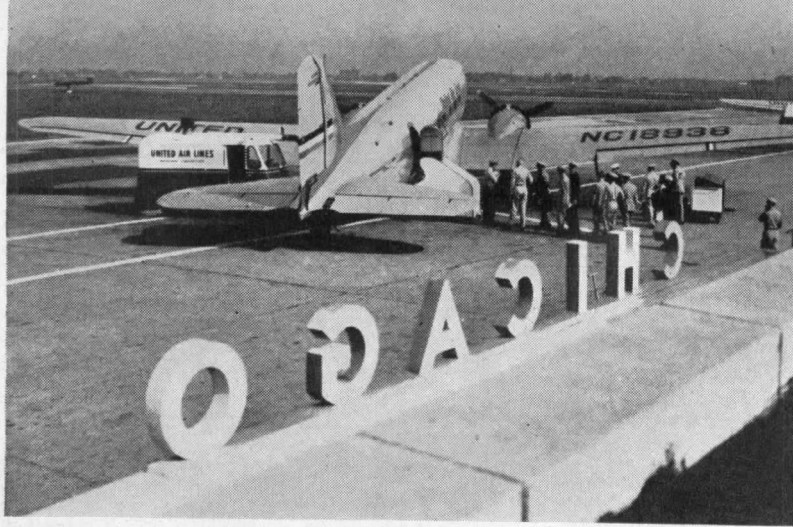

Ports serving several airlines may be based

DESIGNING THE LARGE TERMINAL

WE HAVE PASSED through the pioneer and early development stages of air transportation and a certain amount of consolidation has taken place. For instance, we are now able to predict with reasonable accuracy, certain trends in the industry. Economic analysts can now tell us approximately how many passengers and what volume of cargo we may expect to handle at a given point in 1950 and will also make an estimate for a 10 year projection. We are now able to foresee types and sizes of aircraft that will be handled at our airports of the future.

In order to plan an air terminal intelligently we must know what sort of aircraft will serve that terminal. Will they be large multiple-engine craft or small twin-engined planes? What will be the physical characteristics of these planes? Will they be low or high wing, and what span? These and many other questions must be answered before starting the layout of the building facilities. We must realize that if the terminal is to do this job completely it must be designed to the aircraft and not entirely independent of its consideration.

The airplane is entirely different from any surface carrier. It has a greater minimum dimension, occupies a large area approximating a square, and therefore must be treated differently at the terminal. Airline committees engaged in the design of major air terminals have established an average spacing of 150 ft. for aircraft parked on the apron in front of the building. This average allows plane sizes up to, and including, the Constellation. It also permits four twin-engine craft to be parked in the space required for three four-engine planes. A little simple mathematics indicates that it does not take many planes to spread the terminal over great distances and beyond the reasonable limits of pedestrian traffic.

When a Mainliner lands on the airport and taxis to its berth at the terminal many operations and services must be performed before it again taxis to the end of the runway to take off. An analysis of these services and the facilities needed to house them provides the best argument in favor of general decentralization of the plan. The principal operations to be performed are:

1. Unload and load
 - a. Passengers
 - b. Baggage
 - c. Mail
 - d. Express
2. Refuel and oil
3. Mechanical check
4. Cleaning
5. Replenish cabin supplies
6. Commissary service
7. Ground crew service
 - a. Apply and remove blocks
 - b. Connect heating or air-conditioning
 - c. Tie down plane (during high winds)
 - d. Operate battery starter
 - e. Sanitary service
 - f. Check and adjust pressure in tires
8. Change crews (division points)
9. Paper clearances
 - a. Passenger service (manifest)
 - b. Ramp chief (load computation)
 - c. Dispatch (weather clearance, etc.)
 - d. Priorities (wartime only)
10. Radio clearance (instructions for take-off, from control tower to pilot)
11. Salute

From the above it is obvious that the number of operations to be performed will require large building areas close to the airplane. Remote control centers for each of these functions can only result in increased ground time and inferior service to the public. The problem is further complicated by the differences in operating procedures of the various airlines, no two of which are the same.

After an extensive study of plan types to serve the needs of the airlines and all other operators at the airport the writer proposed to the industry that terminals be designed with a decentralized *parti*. This proposal recommended separate airline *unit terminals* interconnected and developed around a public center.

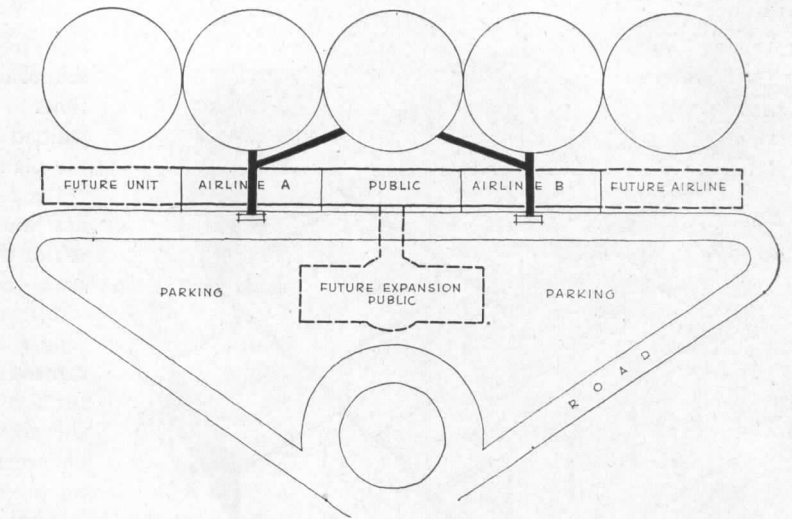

on the "unit terminal" idea

By Albert F. Heino, A.I.A.

As architect for United Air Lines, Mr. Heino presented the first version of the "unit terminal" idea before the Midwest Airport Managers' Conference at Fort Wayne, Ind., in February, 1944. This makes him, so far as the editors know, the earliest as well as one of the most potent advocates of this new approach. A contrary view is represented at New York, where the mayor seeks to guide all passengers through a central concession area. Many designers steer a middle course, but none can ignore the cogency of Mr. Heino's reasoning

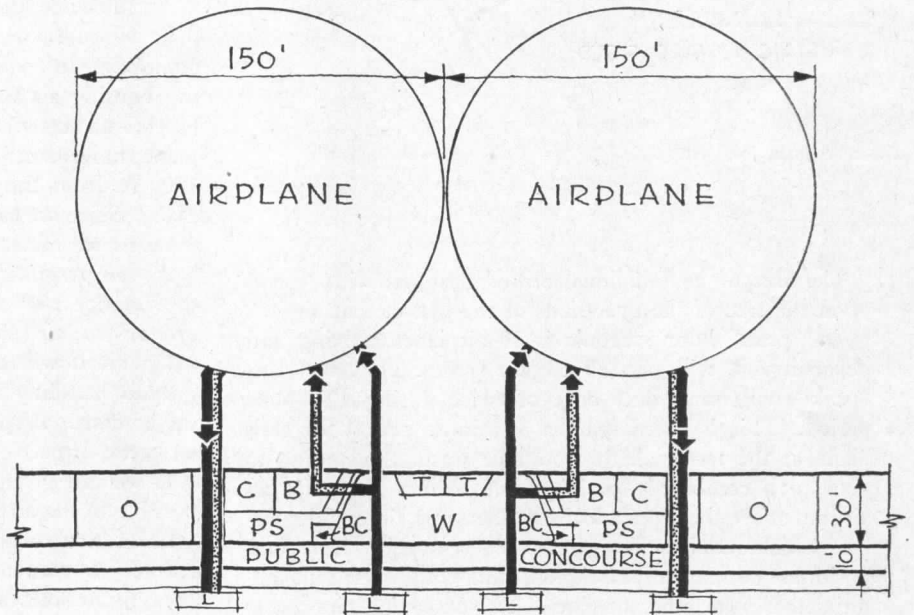

Reading from the bottom up, the diagrams illustrate the method of developing transportation airports up to any desired size, by multiplying and varying "unit terminals." The basic unit is seen in the small diagram, to the left at the bottom of the page. Beside it is the plan, developed for use either at a small port or by an airline using a single plane station at a larger port. The diagram next above shows a "duplex" plan to serve two plane stations, either for a single line or for joint use by two lines. At top of page is seen the complete airport as planned for initial use by two airlines, with a public concourse between them, containing the port concessions. Dotted lines show the possibility of multiplying unit terminals as other airlines or plane stations are added. The public space is then made central to the whole terminal group

- LEGEND
- W = WAITING
 - T = TOILETS
 - B = BAGGAGE
 - C = CARGO
 - BC = BAGGAGE CHECK
 - PS = PASSENGER SERVICE
 - O = OPERATIONS
 - L = LIMOUSINE
 - ▬ = PASSENGERS
 - ▨ = BAGGAGE

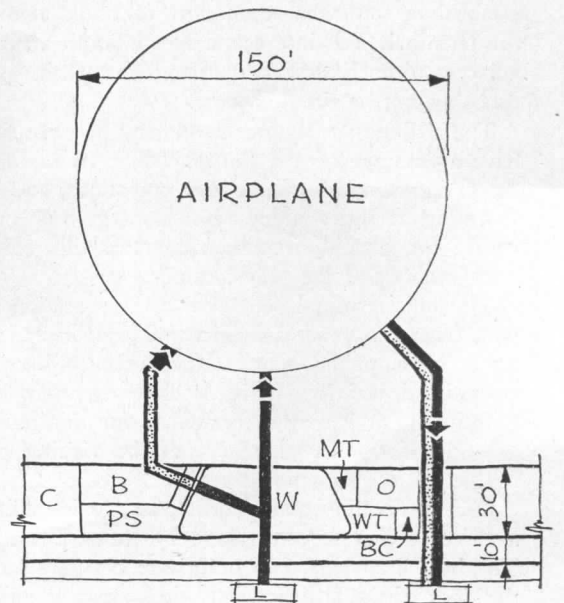
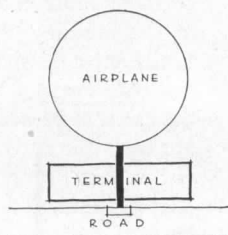

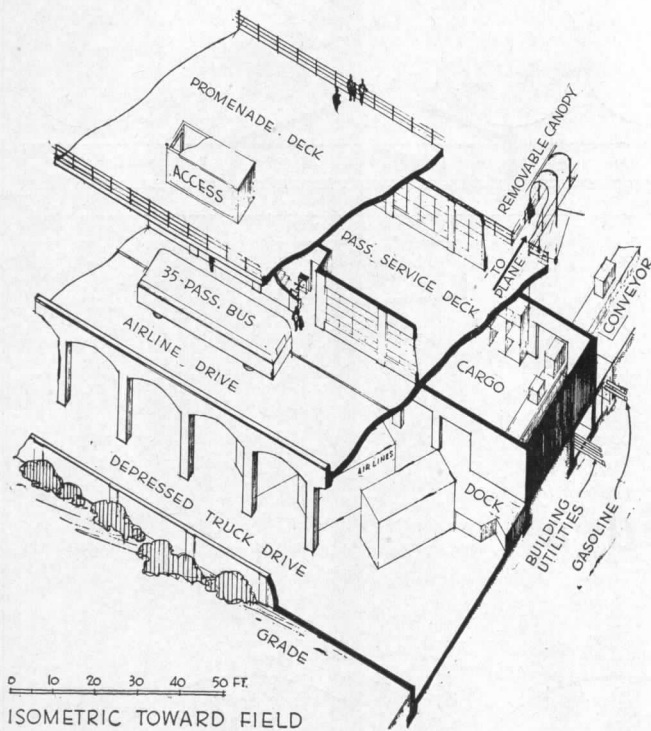

The size of an individual airline terminal will depend upon the size of the operations of the line at that airport. If its "peak" hour schedule is 10 airplanes arriving and departing, it will need five gate spaces. However, this "peak" will occur only once or twice during a 24-hour period. This is based upon a 30-minute period for each plane at the terminal. It would be wasteful planning to plan to a combined "peak" of all airlines since not all airlines meet their peak loads at the same time. The airline which requires five gates could reasonably have four positions permanently assigned, and could berth its additional trips at adjacent gates. Assignment of gate spaces should be based on a study of their "peak" hours so as to establish a somewhat even flow of traffic at all parts of the terminal. For instance, a North-South airline may be adjacent to an East-West operator, since their "peaks" will probably not be simultaneous.

The airline that has four permanent gate positions would have a frontage of 4 x 150 or 600 ft. Its building would be designed to distribute the operations and passenger handling facilities along this frontage. A public concourse for general circulation connects this unit terminal with others and the public center.

The unit terminal plan permits a separation of passengers from the general public and, conversely, a development of a public center independently of the airline operational activity. This development may be on the grand scale or it may be limited to the minimum services necessary for the convenience of the visiting public and airline passengers who have time to spend at the airport.

Decentralization of the airline terminals makes possible a direct access to *each* plane by ground transportation. The bus, limousine, taxi or private car may be driven to the door of the airline, where the passenger alights a few

feet from his airplane. He there finds efficient personnel to speed him on his way by air within a minimum time. A porter takes his bag and checks it while he validates his ticket and he proceeds immediately to board the plane.

Let us assume for the moment that all airline functions are housed in a single building as has been the custom. All of the functions enumerated above must be performed from this building. This means great distances over which to haul passengers, baggage, mail, express, passenger supplies, food, to the remote airplanes. We must remember that the building we are planning is to last for several years and well into the "Age of Flight" when the airplane will be the medium for mass transportation, and methods of the present have become obsolete. Based on projected volumes of traffic, this central building will become so large that it will be very inefficient and its operation will break down because of resultant delays of aircraft. In my opinion we shall eventually be forced into an orderly separation of functions whether we like it or not. We are passing the day when *all* persons going to an airport must go through *the* front door.

At Idlewild, for instance, we are planning for an ultimate 90 gates, or 13,500 linear ft. of airplanes! Imagine attempting to conduct this operation from a central building housing all airline facilities. You say, Idlewild is the exception, but even in a plan for a 20-gate terminal (80 plane movements per hour) you would have to walk 1500 ft. from the center of the gate line to the remotest plane. Since we cannot bring all airplanes to the terminal, it seems we must take the terminal to the airplane.

An air terminal is a machine and its principal job is to simplify the transfer of passengers and cargo from ground to air transportation. If this statement seems axiomatic it will emphasize the importance of improving ground handling speed and minimizing ground time of the aircraft. Airplanes are non-productive when resting on terra firma.

If we can group all the functions necessary as close as possible to the airplane we shall be able to get the ground time of that airplane down to the minimum. It is not feasible or economical to move the airplane so we must concentrate our efforts in an attempt to work out an efficient grouping of the servicing functions. We must make full use of the vertical dimension as well and design the facilities to the airplane. This has never been done and is the cause of the principal defects in our present terminals.

Separation of levels is needed

Separation of the passenger and cargo handling by levels is desirable at all times and necessary where traffic is heavy. Passengers may be served on the upper deck and the entire cargo operation conducted on the grade or field elevation. Low-wing airplanes of the future will have tricycle landing gear, and the cabin deck will be 10 ft. or more above the ground. By nosing the plane up to the building it seems logical to load passengers practically on a level from the upper deck. Aeronautical engineers have not yet given us an airplane with access to the cabin at or near the nose of the ship. However, studies are now being made of such an airplane and I believe that our service to the public will demand this convenience. Aircraft designers have developed the airplane to a high degree from the standpoint of aerodynamics. Now they

must begin to give additional study to the ground handling problems of their creations. At present air terminals are anything but terminals for airplanes. We deplane from a beautiful plane interior into a driving rain and make a dash for cover and when we get there we find beautiful confusion.

With passengers loading from the upper level the entire grade level may be devoted to air freight, express, parcel post, baggage and mail. Airline operations offices and headquarters for the functions listed above may also be located here. Trucks may have direct access to the individual airline handling areas. An elevated road would provide vehicular access to the passenger level and a truck road below at field level. If the budget does not permit, passengers may be conveyed by means of escalators to the ticketing locations of each airline. In the early stage of a terminal development all functions may have to be included in a one-story structure but dividends will be paid if it is planned for an ultimate expansion to two stories.

The airline unit terminal building should be continuous along the entire gate frontage. It need not be more than 35 to 40 ft. wide, for the great length required provides adequate building areas for all necessary functions. In addition to airline direct uses there must be large areas for public waiting rooms and simple necessities that may be located near the enplaning gates. The large concessions are in the public center but in a large terminal certain of these may be located in the airline building. It is also possible to combine airlines in duplex units with two airlines sharing a joint public waiting room. This plan is being followed in the new Chicago temporary terminal structure where the eight airlines are paired in four waiting rooms. In this plan a certain saving may be attained in waiting room areas but, in general, this arrangement is not to be desired because it destroys some of the flexibility of the unit terminal plan. We are going to experiment with this type of terminal at Chicago in a temporary structure and no doubt it will be a valuable laboratory for the industry.

Vehicular traffic pattern

The ground-surface vehicular traffic pattern is very important and must provide a segregation of the various types of traffic with a minimum of interference. In this connection, the size of the aircraft and the length of building required provide a good curb length for the loading and unloading of ground vehicles. Large public parking areas are necessary and should be located so as to cause no interference with the smooth traffic flow around the terminal. This is basic in large and small terminals alike. The roadway design should include a simple intra-airport circulation for buses or tractor-trains which will transport people from one end of the terminal to the other.

The roof of the airline terminal building provides an ideal public observation deck from which may be viewed the greatest show on earth. Gaily colored parasols and awnings will add to the festive spirit of the public which will flock to airports in the Age of Flight.

A public concourse extending the entire length of the airline unit terminal building connects all units and the public center. This concourse should be on the road side of the building, allowing all functional offices and facilities to open onto the apron.

The public center is the nucleus of the plan. Airline occupancy of this building is limited to traffic offices and a general information center. The building or buildings should be designed as a truly public building and contain a great variety of conveniences for the general public and the air traveler. The city here puts its best foot forward and creates a first impression of its life and culture. The architecture should take on a local color and be representative of the home, industrial and commercial life of the community. It is to be hoped that we shall have no baroque, renaissance or classic air terminals. Here is an opportunity to develop an American aviation architecture, and I am sure that American architects will not miss the chance.

It is not intended that this philosophy of air terminal design should result in stereotyped structures throughout the country. It must be remembered that a good functional plan is the first requirement and it must be expandable in all its separate parts, independent of others. We do not yet know all the answers and we need a good factor of safety.

Ports are community developments

The "Grand Plan" or community development around the airport offers many opportunities to the imagination of the architect. Housing for airport personnel, shopping centers, cinemas, amusement buildings, recreational areas, etc. all should be integrated with the master airport plan as the center of the "Airport City Plan." A combination of the several forms of transportation at the nucleus is desirable, if possible. It would be ideal to have a bus terminal, railroad station and rent-a-car service centered at the airport. Hotels for air travelers and personnel of the industry, including airplane crews, are a necessity and should be given proper consideration in the early development. Offices for government agencies, airlines (general) and fixed-base operators should be planned in office buildings and not as part of a general building. It is not necessary, and in my opinion, highly undesirable, to plan multi-storied terminals to house a variety of functions.

Now, a few words about so-called concessions (I think "public services" is a better term). These include dining rooms, drug stores, barber shops, beauty parlors, nurseries, souvenir shops, etc. It is my belief that they should be decentralized as the business potential indicates a profitable operation. One needs only to note the experience of the railroads to major terminals to find a rather complete decentralization of these services. There is no reason why every visitor and all passengers should be forced to jam into a single "concession" area. Regular needs such as smokers' supplies, magazines, newspapers, candy, gum, etc., should be located in many places and probably in the various airline waiting rooms. Greater revenue should accrue to the operator of these services by reaching a greater number of people.

The magnitude of the coming expansion in air transportation will challenge the best brains in the architectural profession to find successful solutions of the airport community plans. The ideas advanced by the writer seem basic to any future planning and may be applied to any terminal under consideration, large or small. The profession can render great service to air transportation in the immediate years ahead. We cannot fail in this responsibility.

SAN ANTONIO MUNICIPAL PORT

Atlee B. and Robert M. Ayres, Architects

To shorten distances, passengers and cargo may

THIS highly regarded pioneering plan provides for two-level instead of one-level operation. All emplaning and deplaning of passengers occurs at the upper level, reached by ramps that are prominent in the views of the model. All baggage, mail, and express, incoming or outgoing, is handled at grade, on the lower level, which is used also for servicing planes. Spiral chutes at the ticket counters drop all outgoing baggage to a cargo room for assembly on trains of dollies going to the planes; incoming baggage dollies, on the other hand, are lifted by elevator to checkrooms at the upper level. These rooms are so placed that the incoming passenger can pick up his baggage and proceed directly to a taxi without detouring through the waiting room.

The two-level scheme agrees with the prescriptions of Mr. Heino

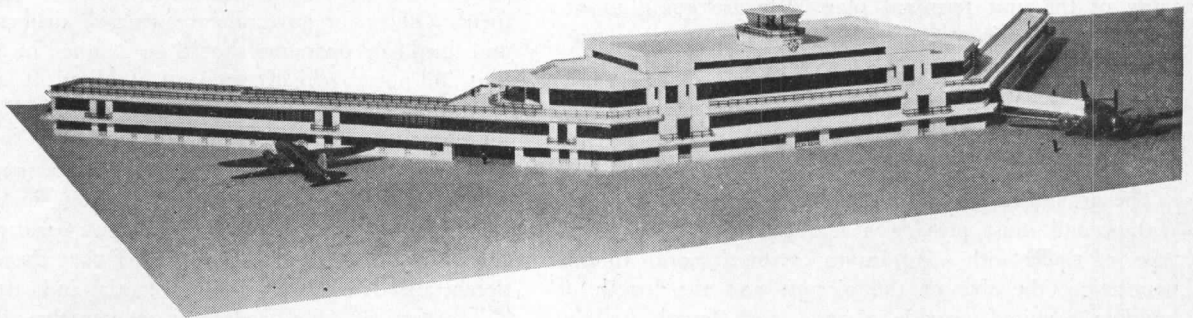

Future design is based on emplaning and deplaning by means of a telescoping and folding ramp as suggested in model, above

(page 80) but instead of complete "unit terminals" there are separate operating units for the airlines and a central ticket lobby. This puts San Antonio midway between the decentralized Chicago plan and the fully centralized plan being worked out at Idlewild.

Twelve plane stations are scheduled in the first building phase. Long "fingers" (see plot plan) can eventually be extended to accommodate 28 plane stations. In that event the main terminal will continue on the centralized system but the fingers will be decentralized.

Some discrepancies will be found between the plot plan, seen on the opposite page, and the models and building plans. This is because at the last minute a whole set of revised drawings was received, too late to redraw anything but the plot plan. However, since revisions in no way affect the basic *parti*, it was decided not to omit this important terminal from the airport issue but to follow with revised details later.

The central structure will be steel frame with concrete floor and roof slabs; walls of fingers of light-weight metal studs and steel lath.

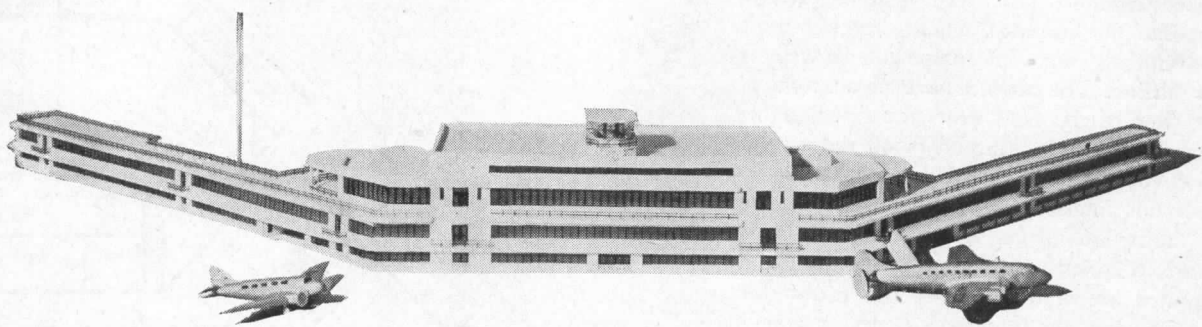

be loaded at separate levels

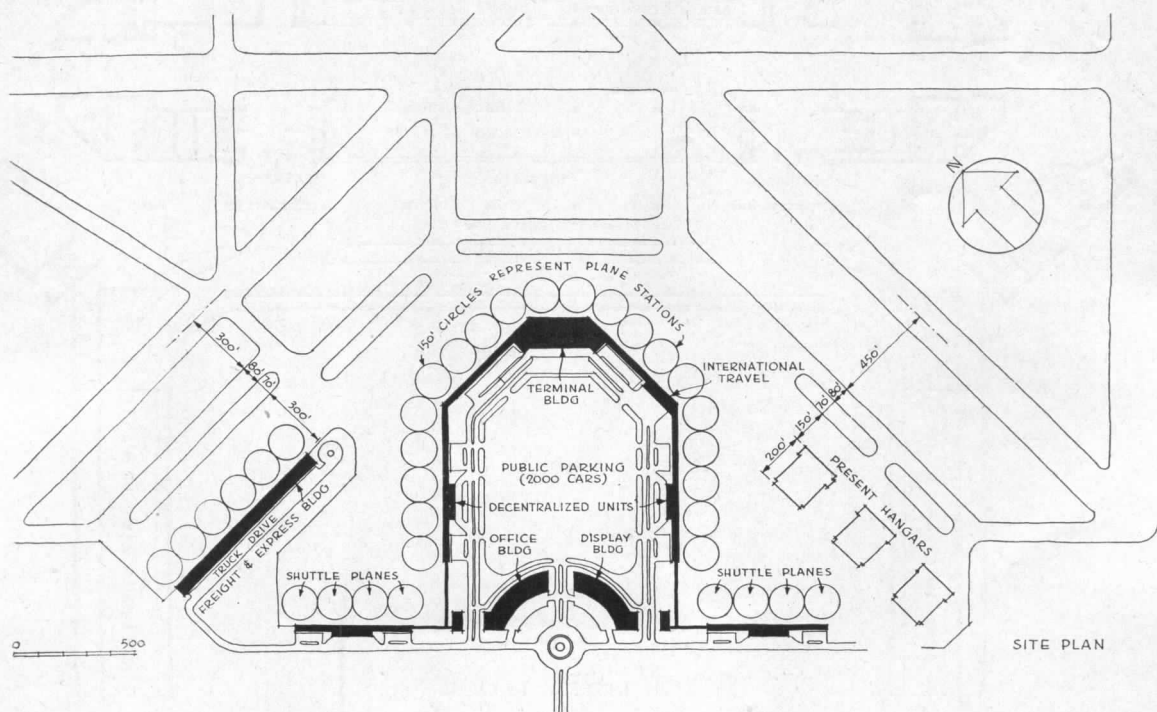
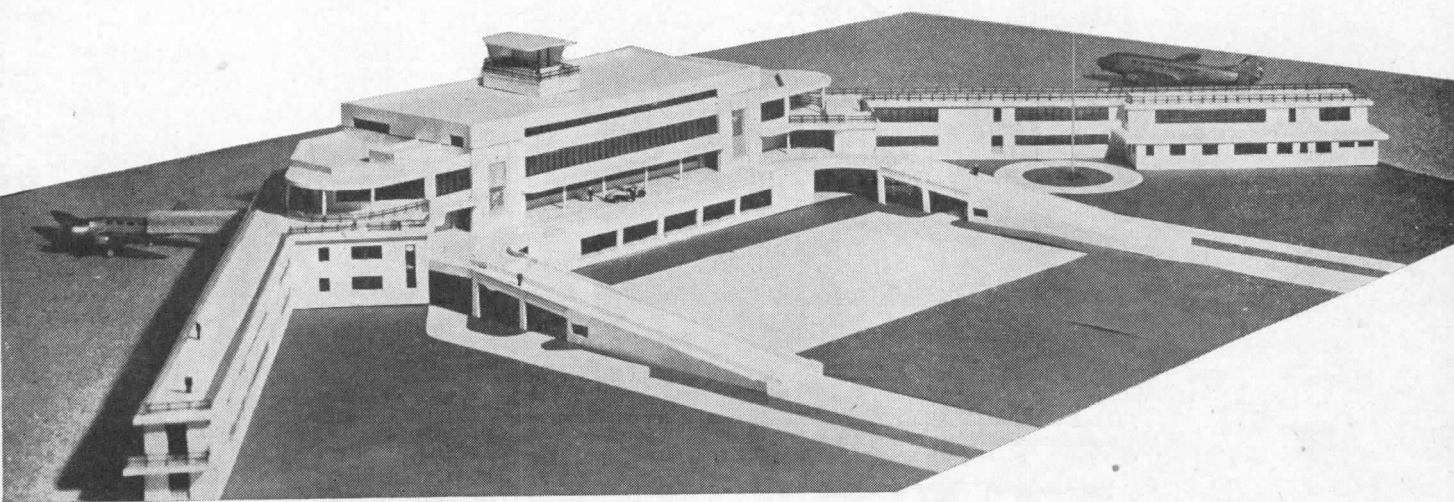

At passenger level (bottom plan), the ticket counters are seen placed directly opposite the entrance, where they can most conveniently serve the passenger as well as the airline. The absence here of a spectacular view of the field steers the casual sight-seer up to the waiting room on the second floor (opposite page, lower plan) where he does not interfere with the flow of traffic. A dining room for leisurely enjoyment is above; a quick coffee shop below. Note the repeated use of the same operating unit for airlines, and the provision (extreme right) for international travel direct to this inland terminal facility.

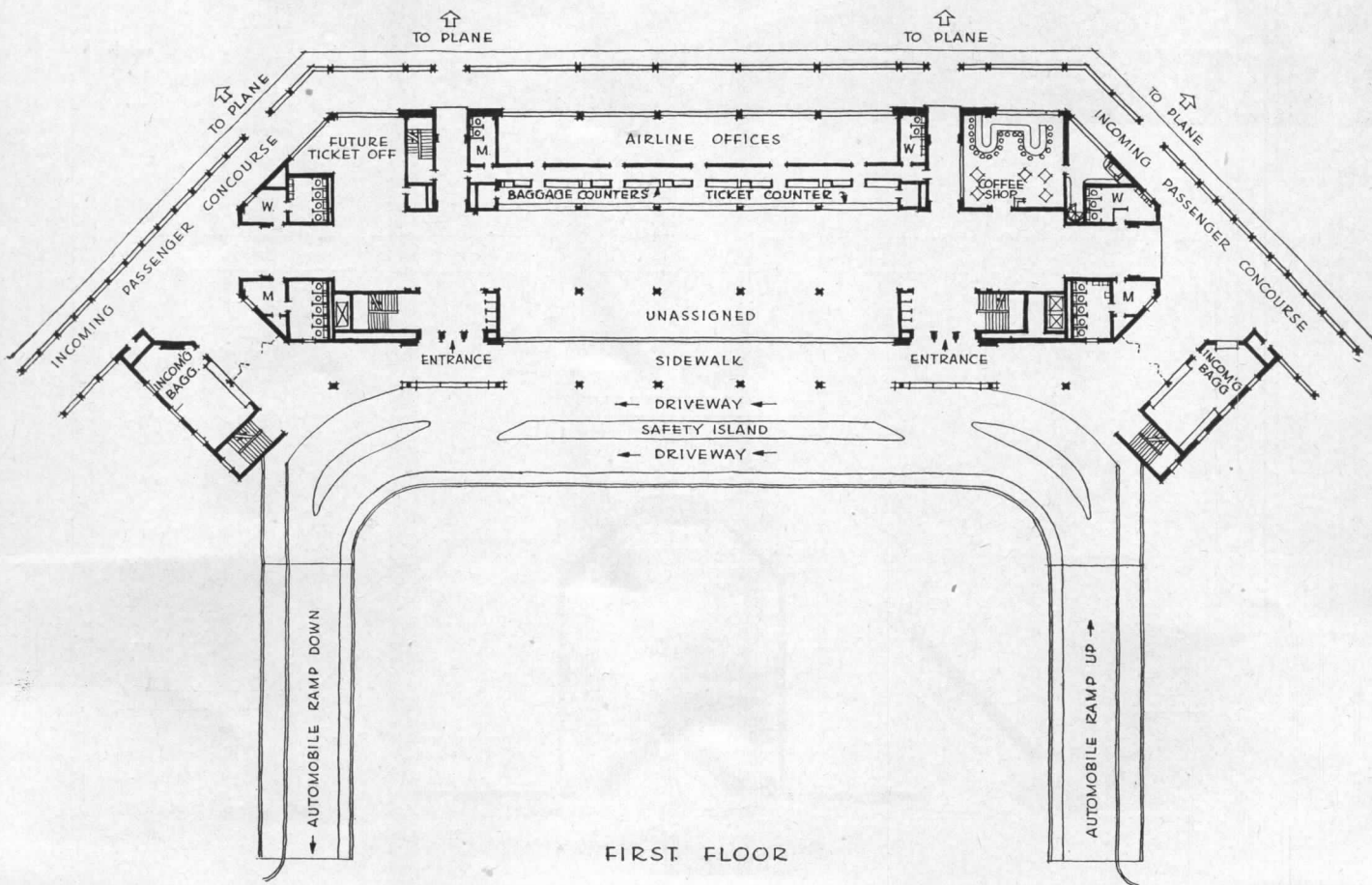
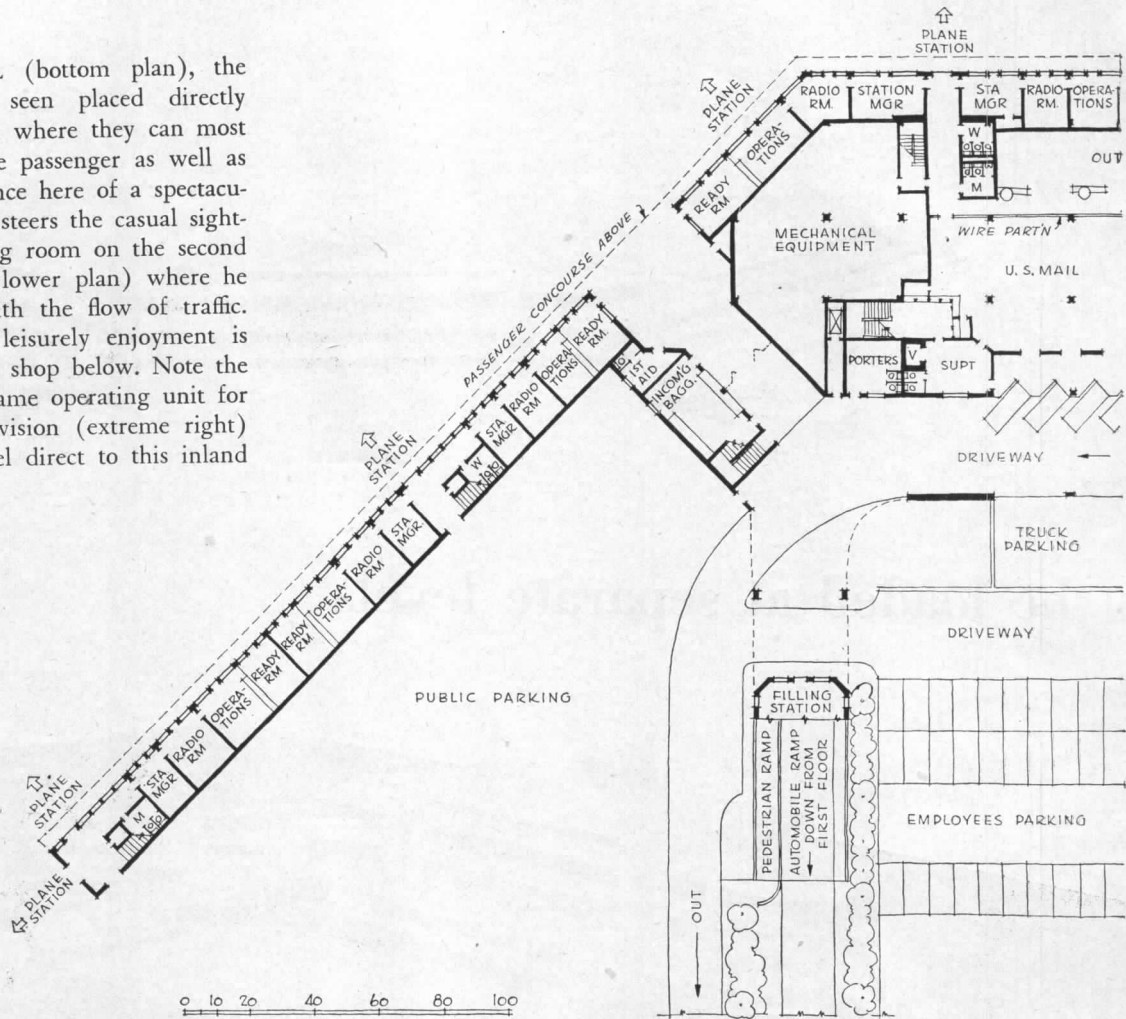

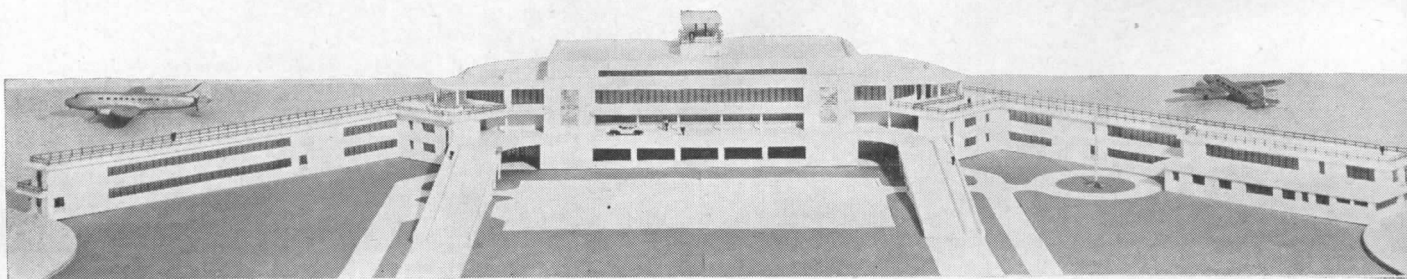
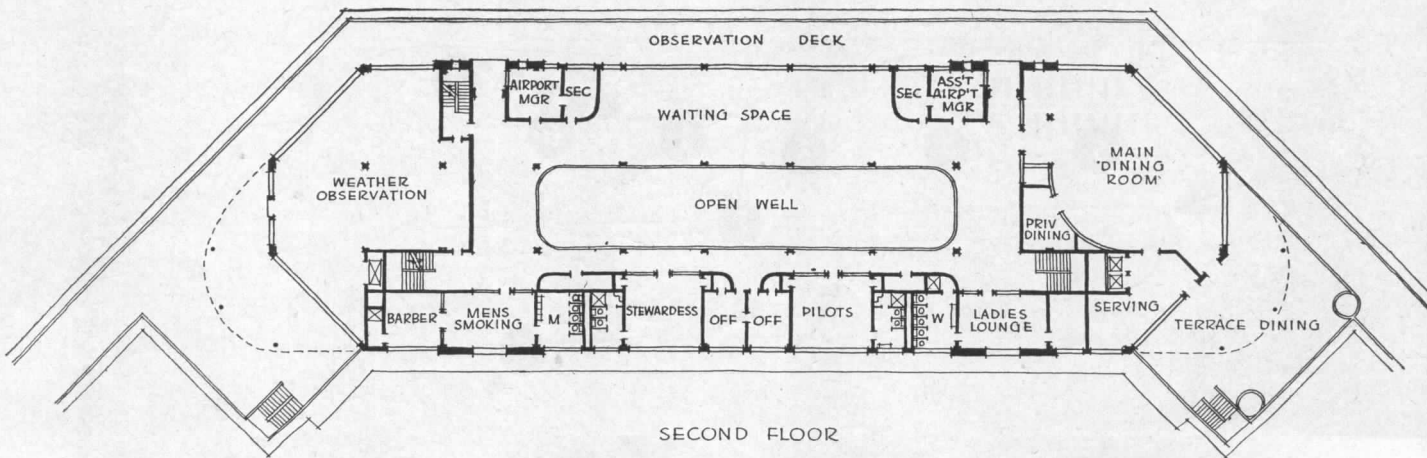
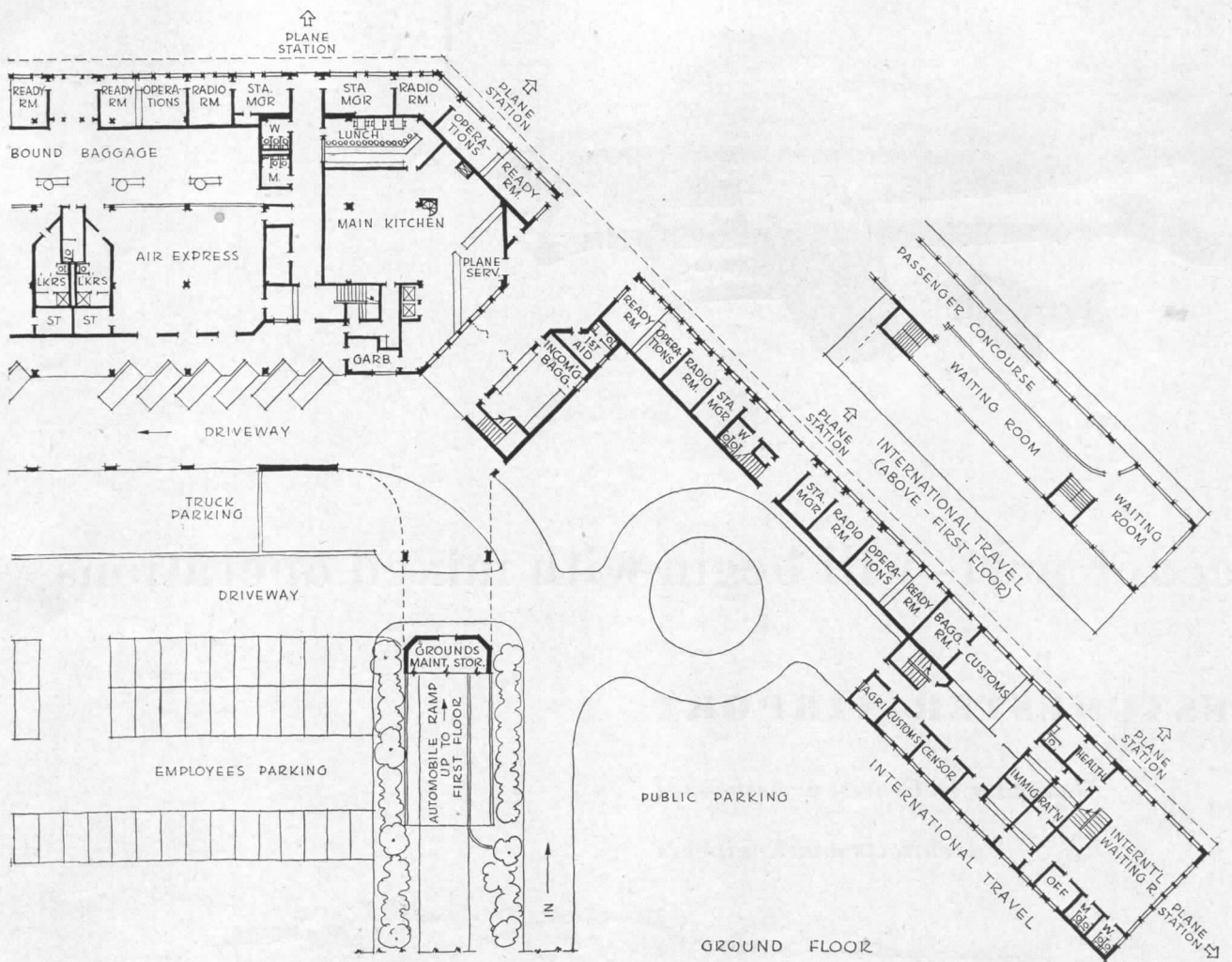

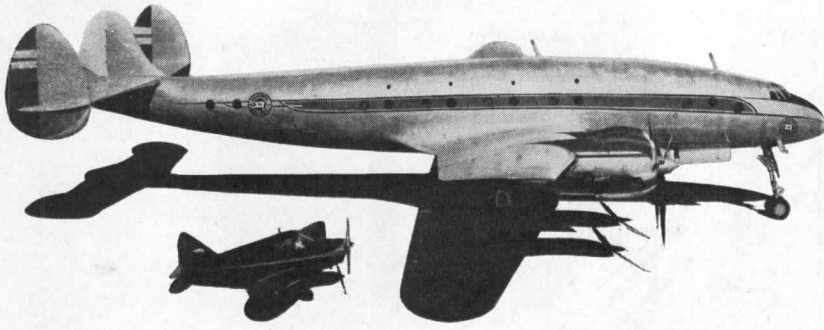

Feeder ports will begin with mixed operations

WESTCHESTER AIRPORT

Alexander D. Crosett & Associates

Architects and Engineers

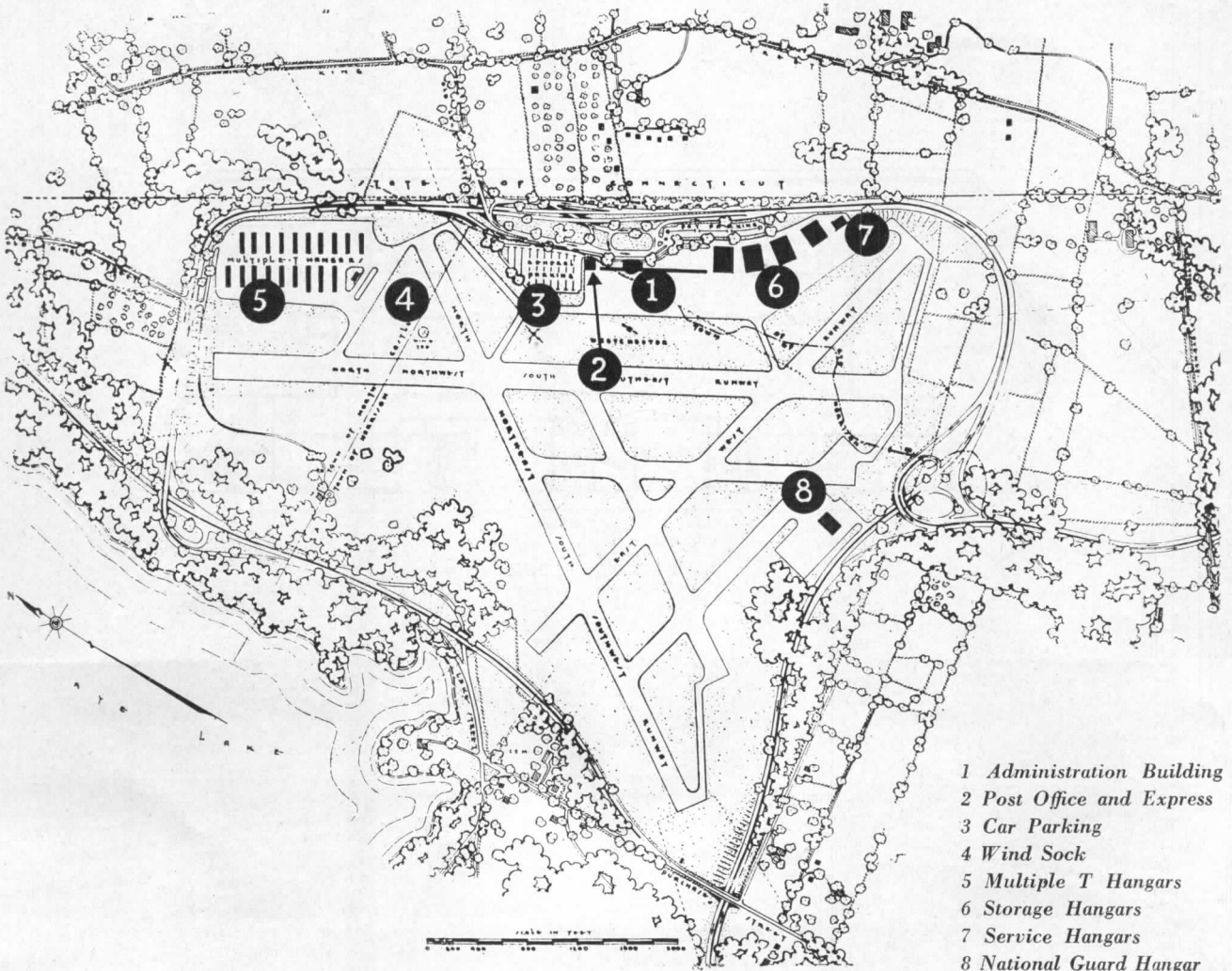

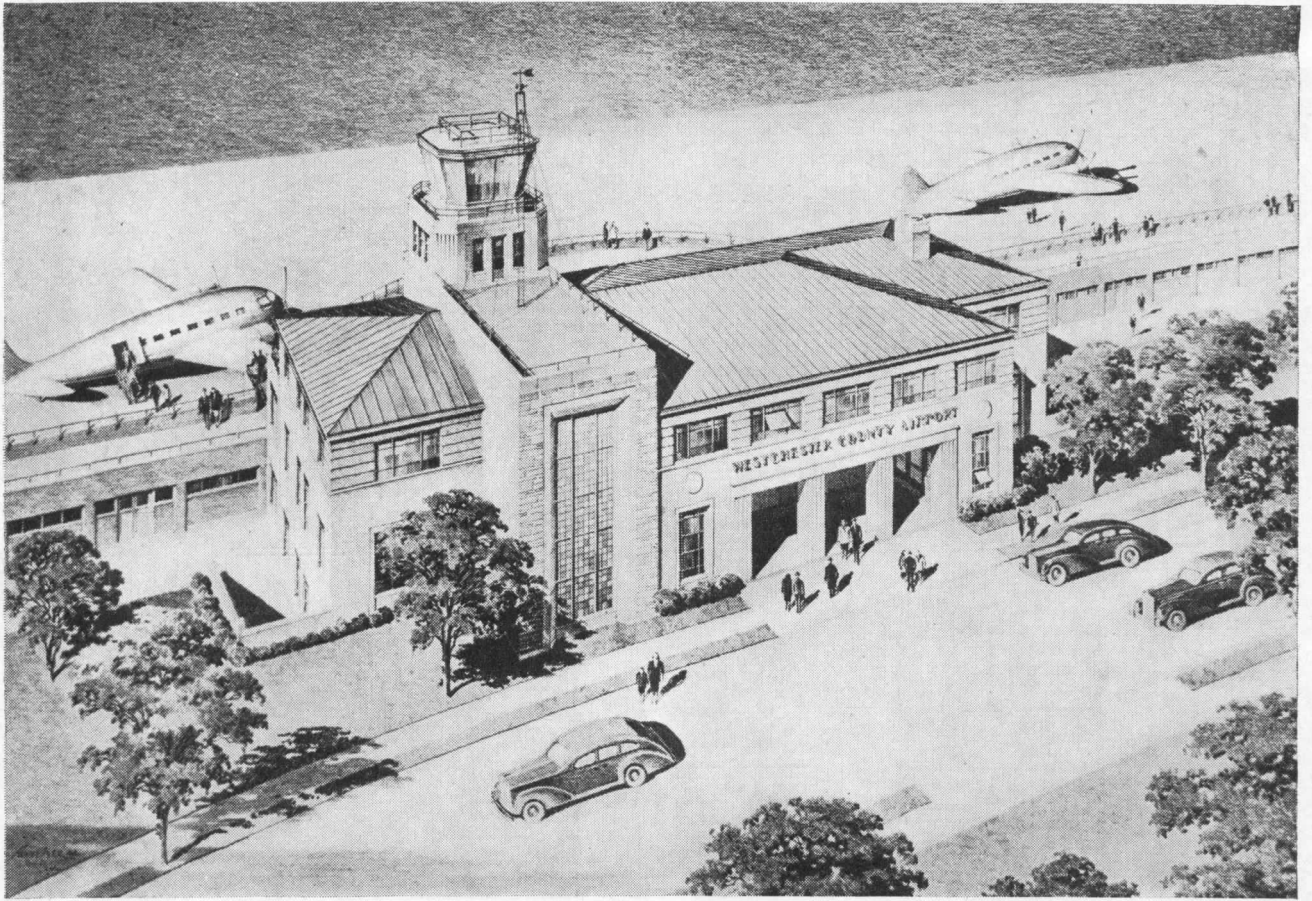

AMONG the many troubles that beset Westchester County officials, and their architects, in the planning of their port at Rye, N. Y., was the unanswerable question: how much airline business could be expected at a "feeder" port? The situation was the fairly typical one in which there is a logical volume of airline business, but the airlines are making no commitments as to service. In wealthy Westchester the private plane activity is expected to be large; also convenience dictates either direct routes from this port or feeder service to New York terminals. The plan reflects the compromise that seemed logical. It also reflects considerable confidence that commercial traffic will eventually bulk large. As a matter of fact, Westchester County officials found their own answer by turning over the field to private management, through taking bids and renting to the highest bidder. The winner was the Gulf Oil Corp., which will build terminal and hangar facilities and operate the port through a subsidiary. It is interesting to note that their estimates of the port's potential business ran more than twice those of two other bidders, but was very close to that of still another. Such are the estimates on which airport planning must presently be based.

At any rate, here is a scheme—generally considered a good one—for the combination private and feeder port. As a port its expansibility is limited; its hurried beginning as an Army "interceptor" base guided the land purchase. The terminal building, however, is planned for double use, with the combination of facilities for airline passengers and for private plane operators. More significant, perhaps, is the fact that it can be expanded for either use, should future experience dictate a change in emphasis.

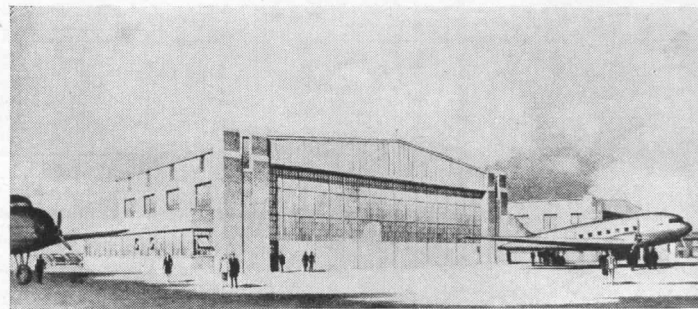

Standard hangar design proposed. In addition there would have to be storage and service hangars for small planes

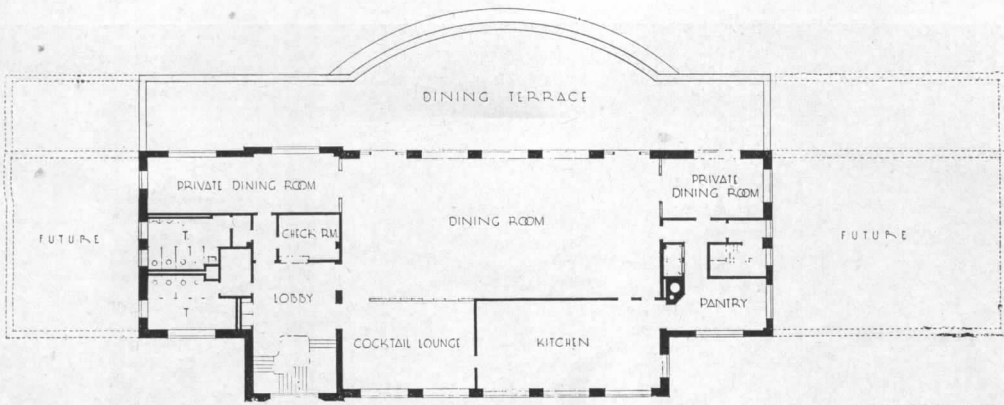

UPPER LEVEL

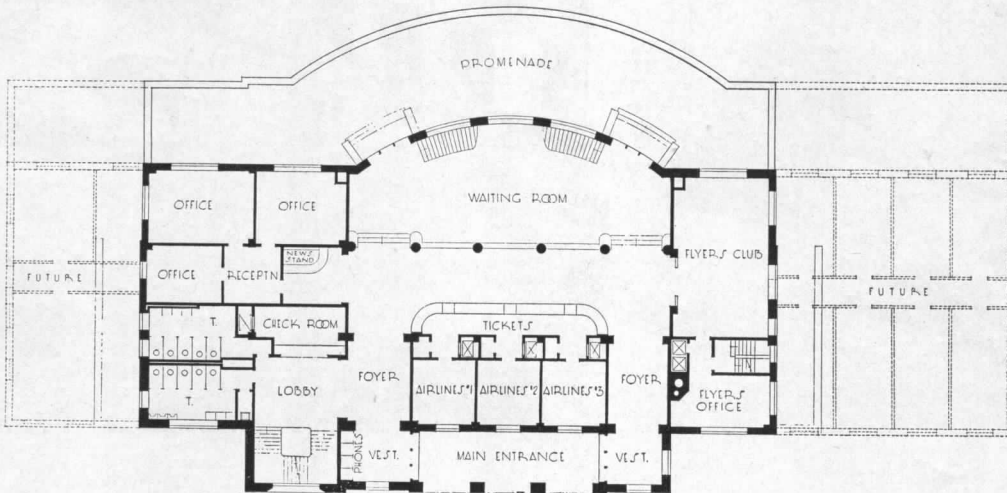

ROAD LEVEL

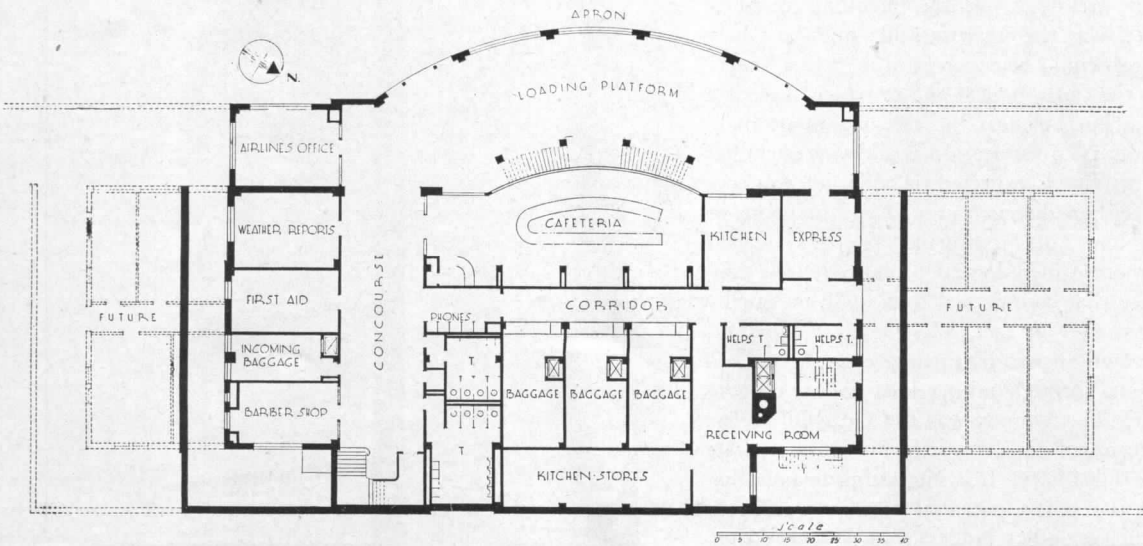

PLANE LEVEL

A decisive drop between the level of the access highway and the level of the flying field is capitalized in these plans. The main access (middle plan) leads to a lounge-like waiting room and the promenade, well adapted to mixed operations, including flying-club use. Most operating facilities (including a quick-service cafeteria) are placed below; while leisurely enjoyment can be had of the view from top-floor dining rooms

First phase

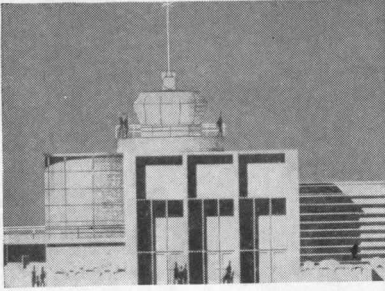

Second phase

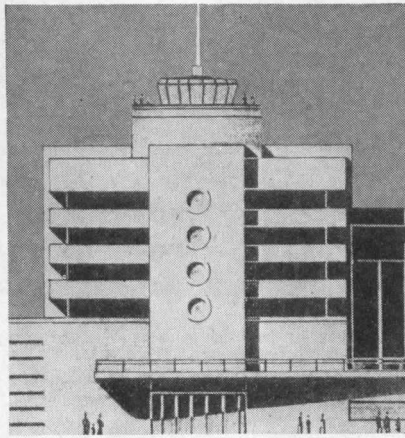

Many programs call for step-by-step growth

MID-CONTINENT TERMINAL

Austin Company, Designers and Engineers

THE two plans on this page are manifestly those of a moderately sized terminal building. The smaller of the two elevations above gives some indication of the scale. The righthand elevation, with its vastly larger scale, indicates that far greater things are seen ahead; it represents not the first building but an entirely separate, later unit. The full relationship between the two becomes clear when one turns the page. In the plot plan, bottom of page 92, the first, smaller terminal has become the "Operations Building" at the center of the circle; the larger unit is the new "Administration Building."

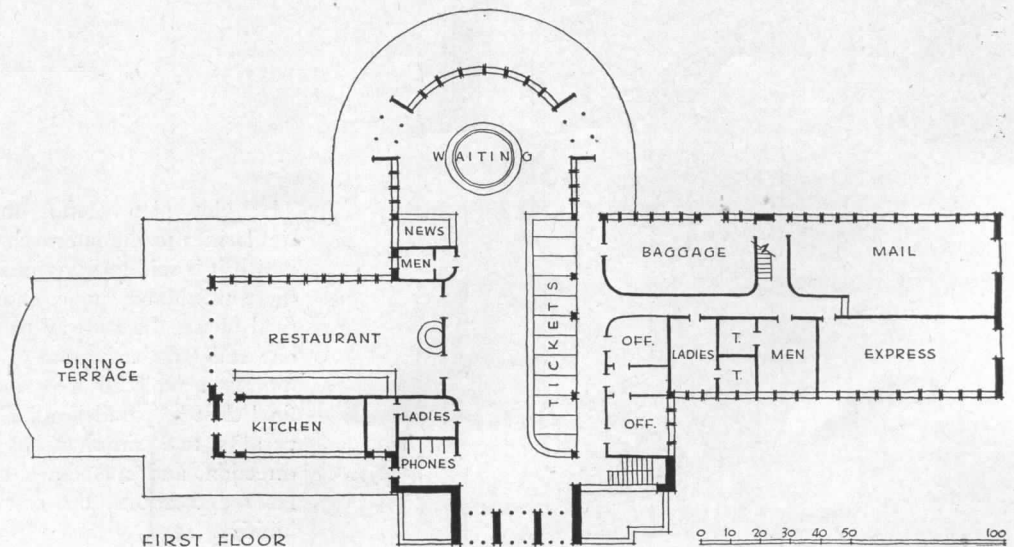
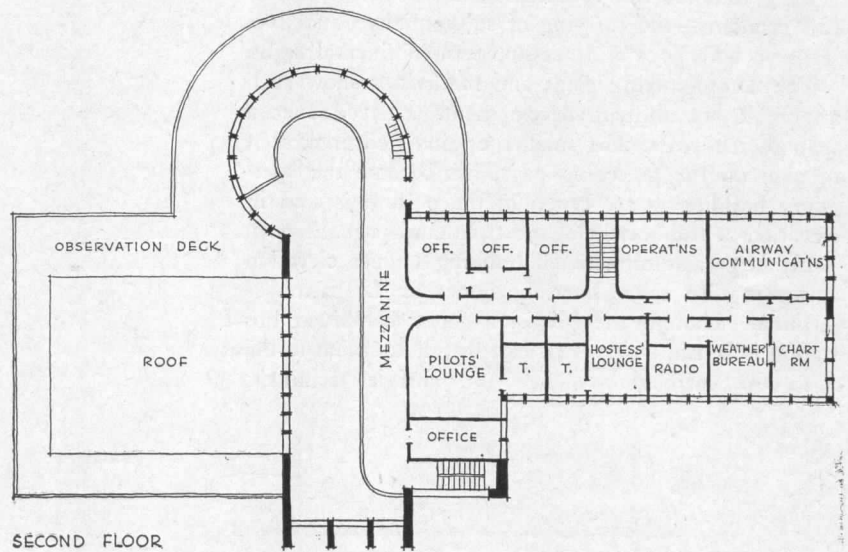



The huge Administration Building seen in this elevation and plan is a mere pin-prick in the plot plan, bottom of the page

THE grandiose "mid-continent plan" is predicated on fuel economy—the carrying of substantially equal fuel loads on both hops of a one-stop transcontinental flight. The accompanying plans and renderings show such a port in its ultimate development, achieved over a span of ten years. The smaller original terminal, seen in plan on the preceding page, has become the operations building at the center of the port. It is seen in elevation at the bottom of the righthand page. A new, vastly larger, administration building (upper elevation and plan) has taken over the duties of the passenger terminal. Though the provision for a combined bus station is lavish, it serves at least to call attention to the need for correlation of air and surface terminals.

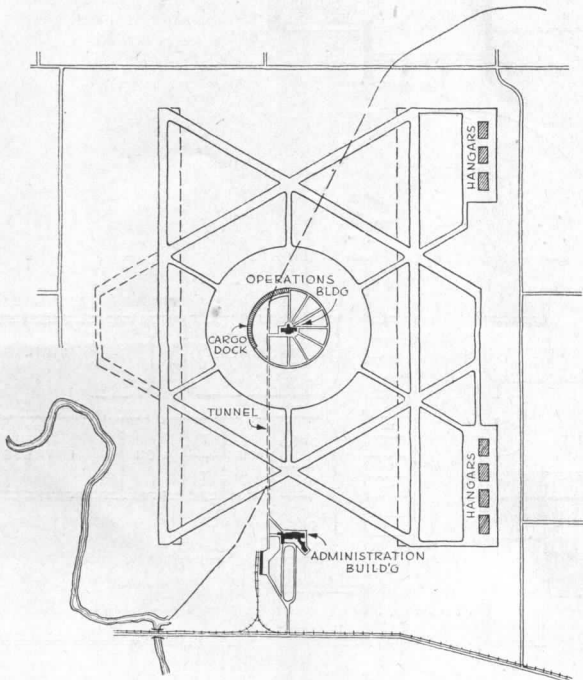
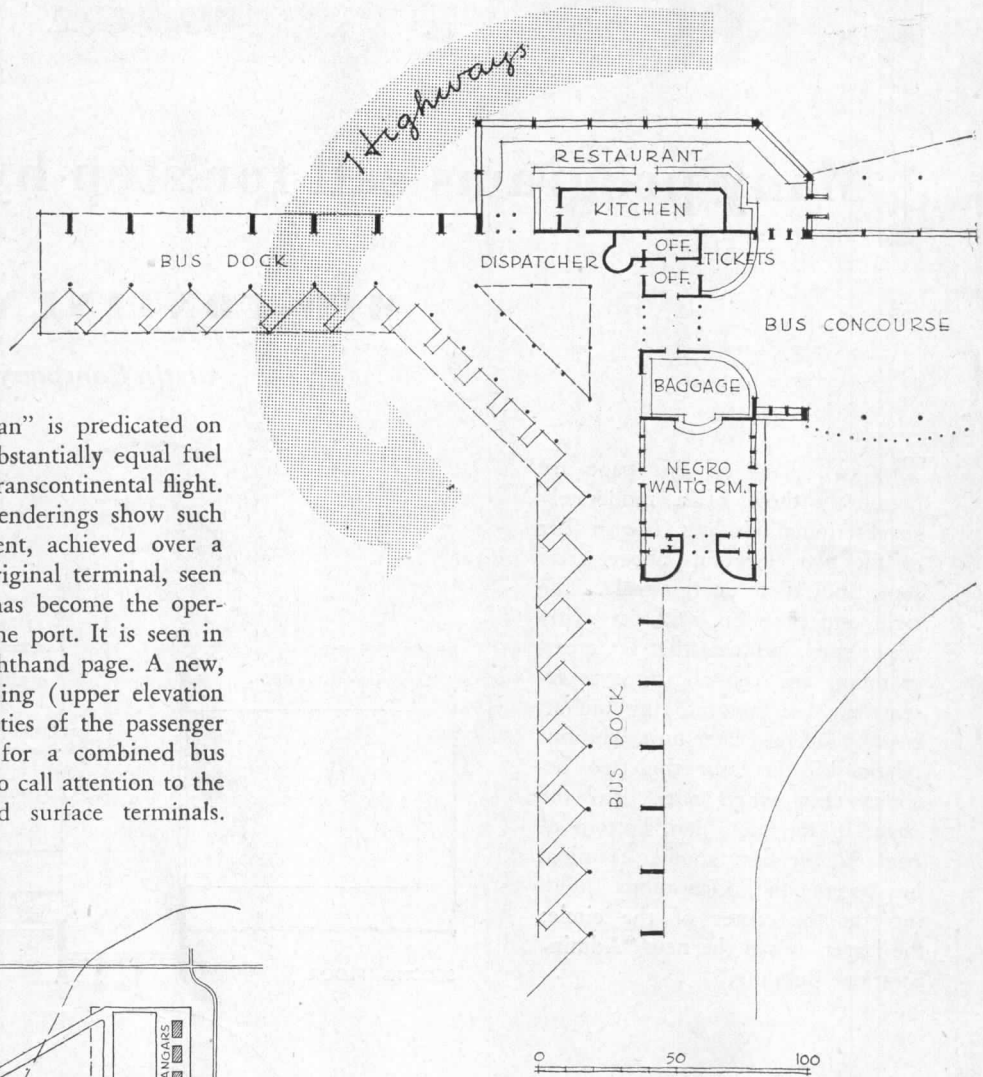

The plot plan (left) under full development has similarities to the latest scheme at Idlewild, New York, which it is said to have influenced. In the earlier phases, there would be single, shorter runways. Up until the final phase, the runway pattern would be held open at one end (to the bottom of the drawing) for an access highway, replaced later by the 3,600-ft. tunnel. The final closed, "parallel-radial" runway pattern is compact, permits two simultaneous plane movements in any direction, and cuts down taxiing of planes. Except in favored locations, the cost of tunnels might be prohibitive.

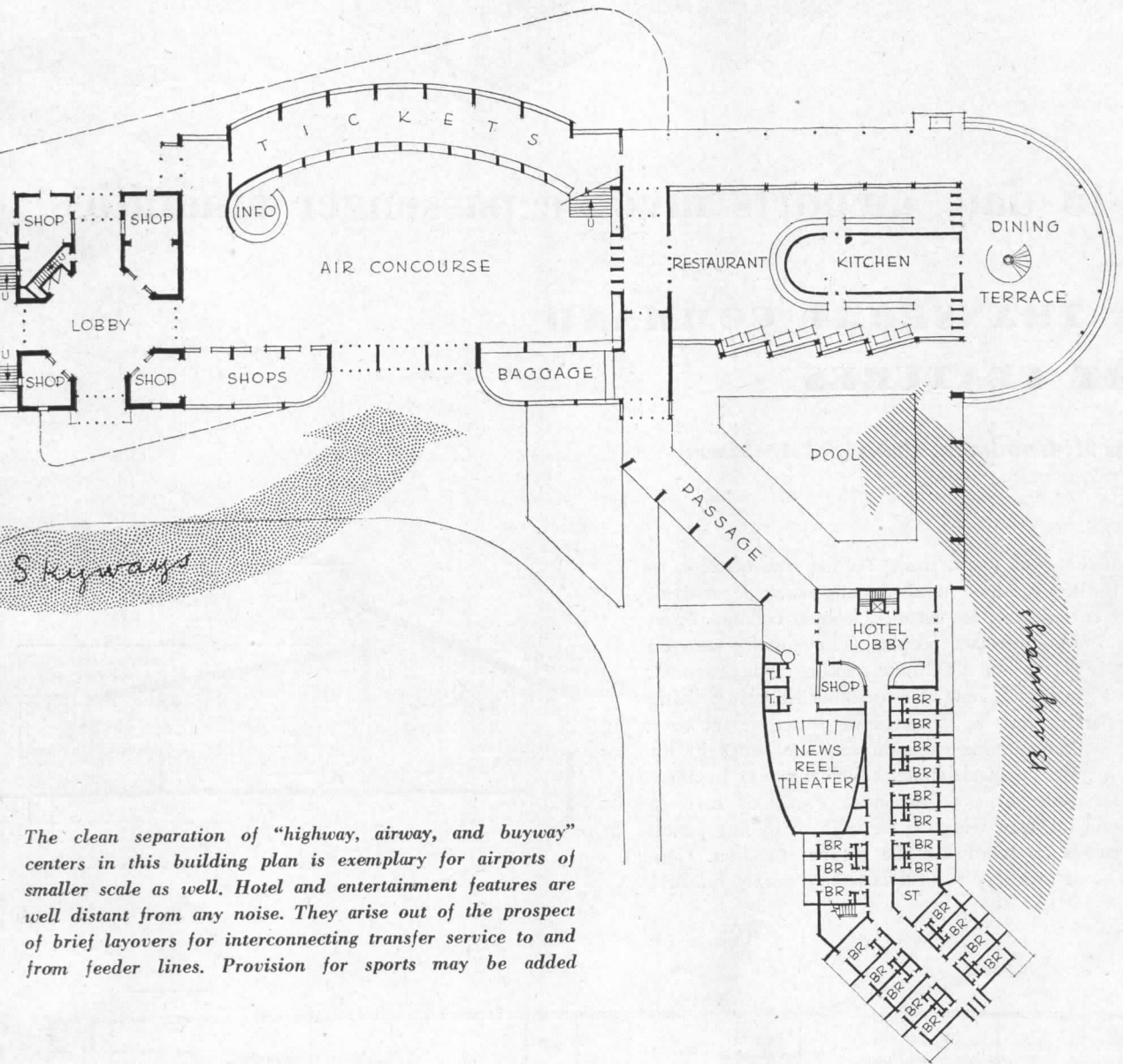
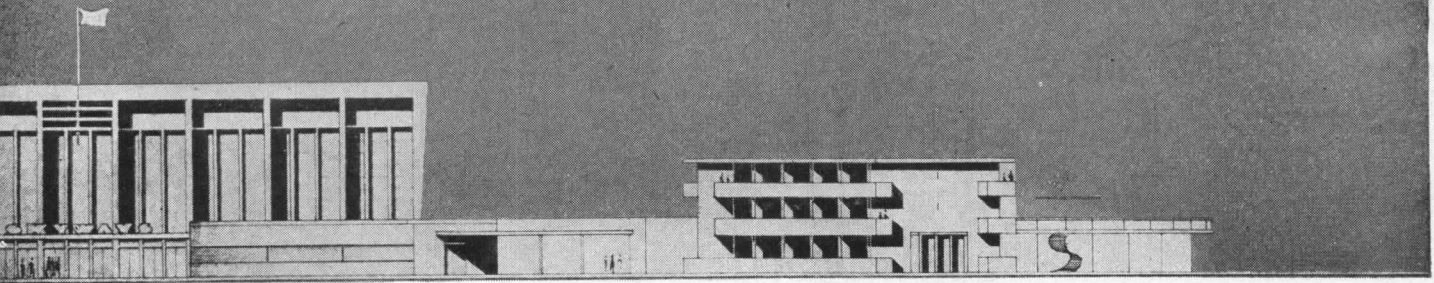

The clean separation of "highway, airway, and buyway" centers in this building plan is exemplary for airports of smaller scale as well. Hotel and entertainment features are well distant from any noise. They arise out of the prospect of brief layovers for interconnecting transfer service to and from feeder lines. Provision for sports may be added

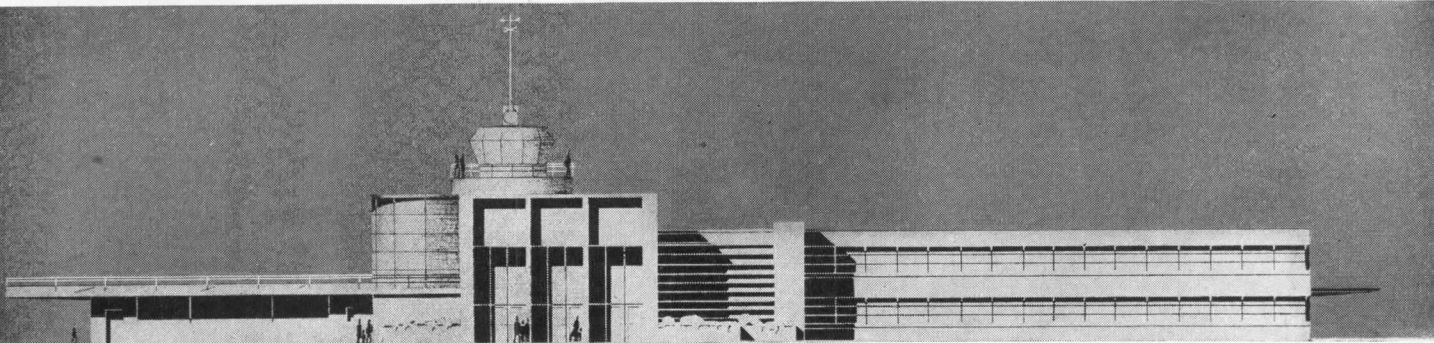

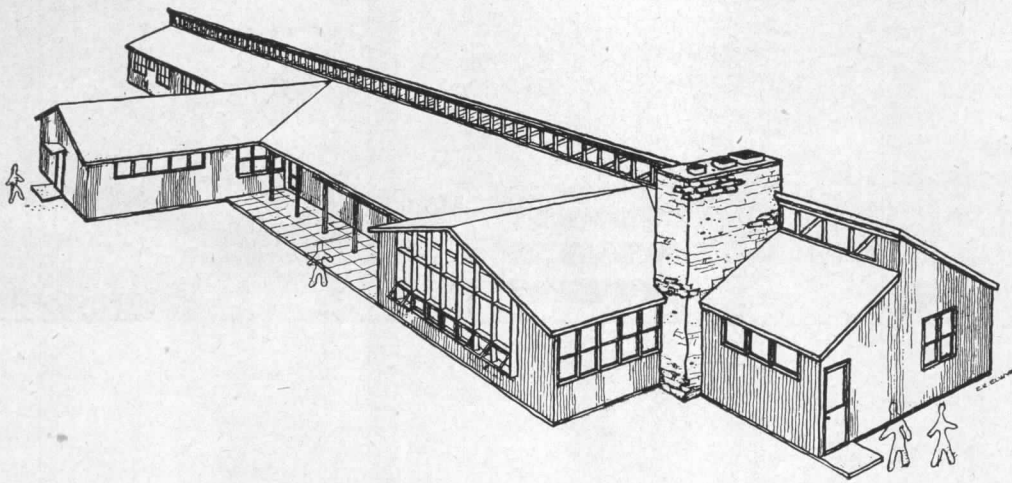

Up-to-date airports involve passenger amenities

AIR TRANSPORT COMMAND PORT FEATURES

Charles M. Goodman, Principal Architect

IN its current war work, the ATC has had occasion to provide for the need of many passengers, some of them people of considerable importance, known colloquially as VIP's or "very important people." The hostelry seen on this page is part of an ATC base making such provision. It suggests graphically how clubs or other temporary living accommodations may be designed in peacetime for comfort but without undue expenditure. The suites in the south wing are fairly elaborate, suitable to use by those staying for some time on business. Partitions between bedrooms in the west wing can be built of folding panels so that two such rooms can be thrown together. Construction is of ordinary vertical boarding simply finished.

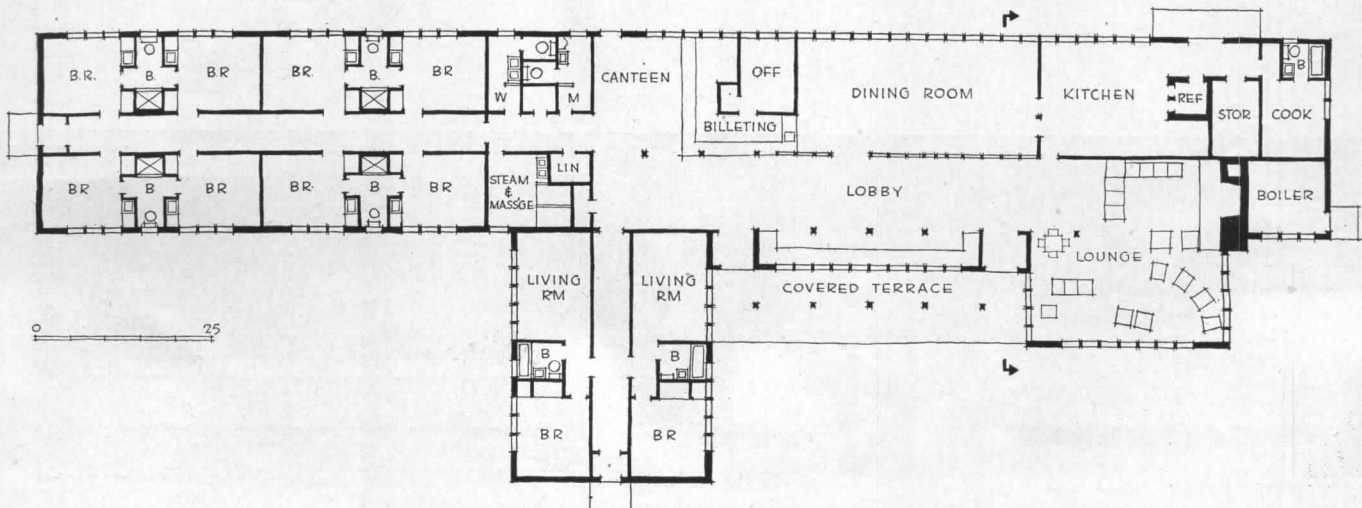
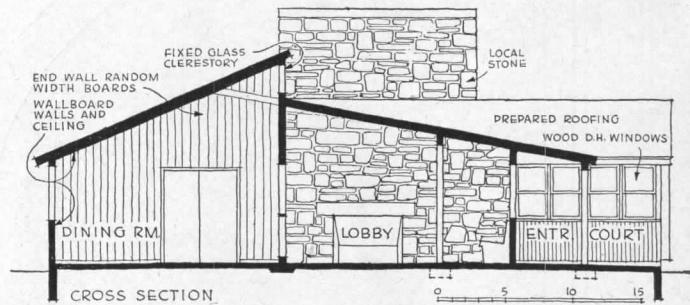

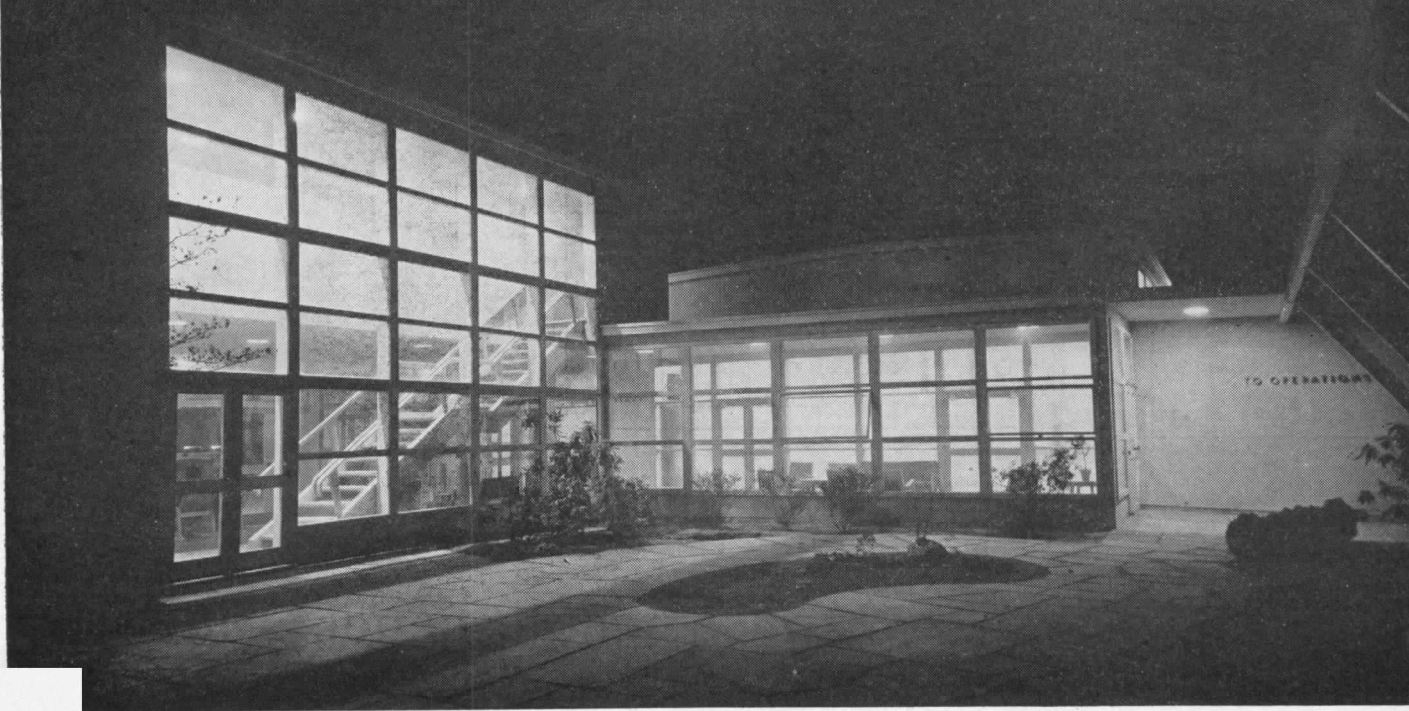

Photographs on this page show details of the Washington port of entry of the ATC. The top view is of one of the landscaped courtyards; center view, a lounge; bottom view, the "passengers' briefing room."

"Passenger briefing" is a quick education on the potentially vital subject of "Life on a Raft." The design for this is compact, clear, and cunning. At the front of the room there is a tilted, full-sized rubber-raft; the panel behind it is used for a highly realistic motion picture from a rear projector. No fewer than 11 display boxes, inset into side and rear walls, are needed for a clear separation and display of the incredible number of supplies packed in a lifeboat. By groups, these are: equipment relating to the "Mae West" and "Gibson Girl"; to first aid, signal devices, water, and subsistence; to navigation, "motivation," and raft repair; to oxygen and requirements of medical aid.

By their clear presentation, the architects manage to instill confidence and competence in passengers, where these qualities are most needed

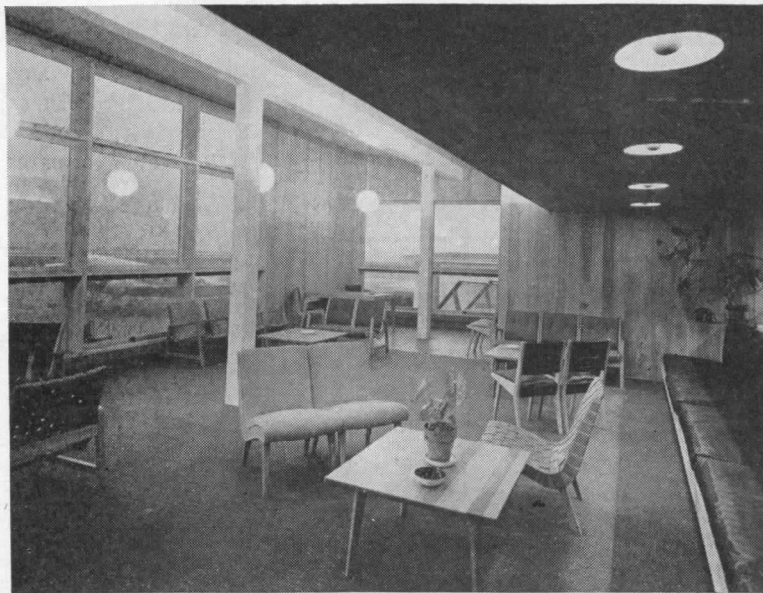

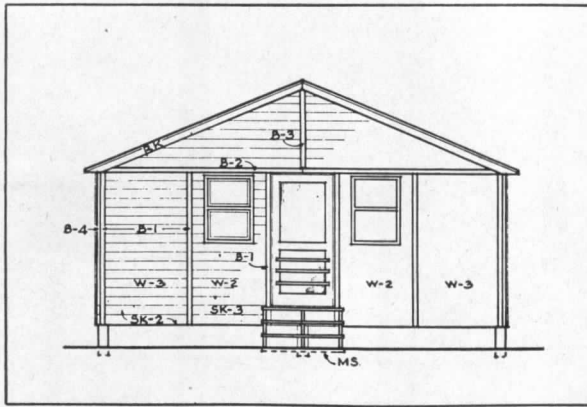

Prefabricated barracks panels

To insure against obsolescence, there are

**AIR TRANSPORT
COMMAND STRUCTURES**

Charles M. Goodman, Principal Architect

AIRPORT designers have usually worked in fear, lest a careful design in immutable materials be rendered obsolete by technical change on the day of opening. By contrast, the Army Transport Command has never been inhibited by any demand for monumentality. Very often it has been expected from the beginning that a site would be rendered inactive in a matter of months, as American arms carved out shorter air routes. Yet operating stand-

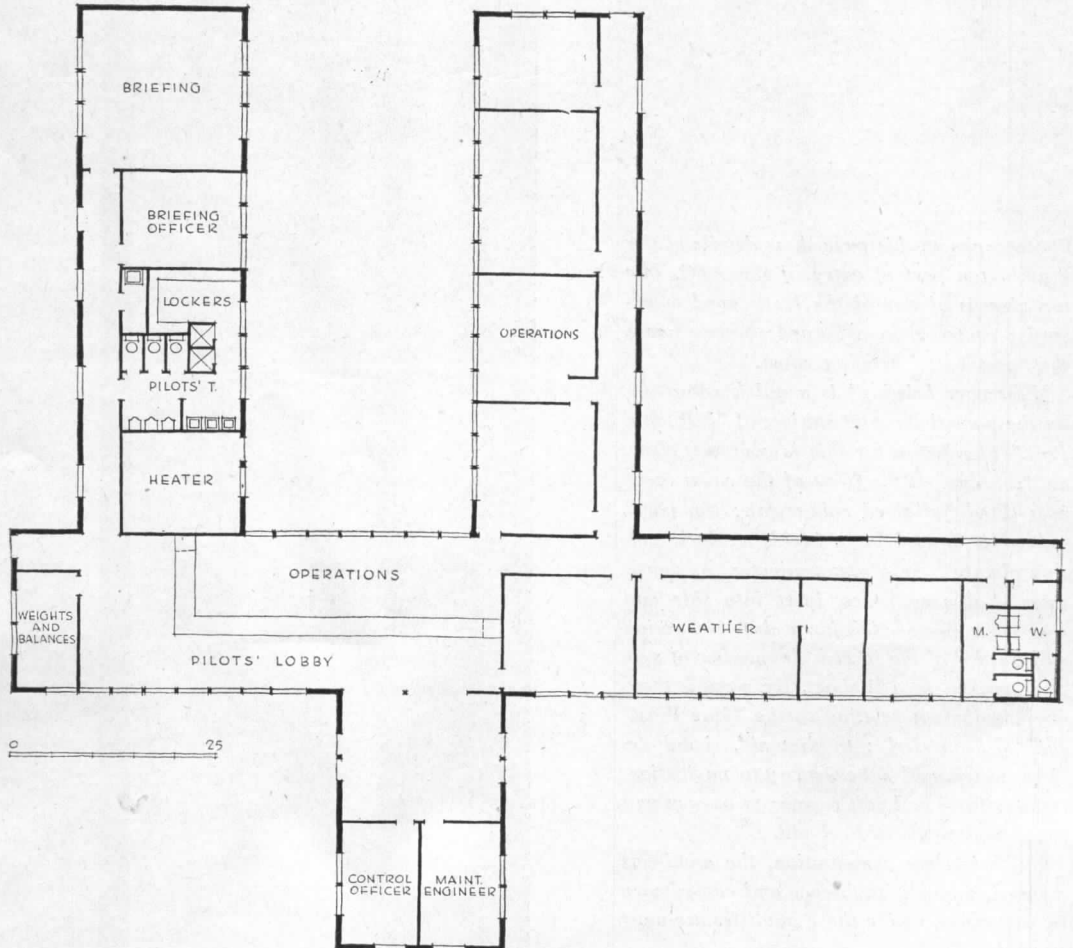



ATC's Washington terminal is based on 16-ft. unit bays, subdivided into three 5 ft. 4 in. design units

advantages in temporary construction

ards have been exacting. Climates have ranged from winter in Alaska, where every engine might have to be warmed under a hood prior to departure, to the steaming tropics. Moreover, among the assignments of the ATC has been the transportation of very important goods and some "VIP's," or "very important people."

This exacting work had to be fulfilled with whatever materials were available and transportable. To assure flexibility in plan, unit planning was used throughout. At the Washington terminal, shown above, the unit was a 16-ft. bay set by standard Army spacing; subdivisions were 5 ft. 4 in. wide, suited to double doors. Structural details were adapted to the unit design. The plan below, on the other hand, shows planning and construction adapted entirely to the common, or barracks variety, of prefabricated panel and roof truss.

Considering the design quality of the unit panels, the architects have achieved a surprisingly good result, based largely on good general building proportions and on the rhythmical grouping of units. The design method is full of suggestions for postwar design for temporary airports.

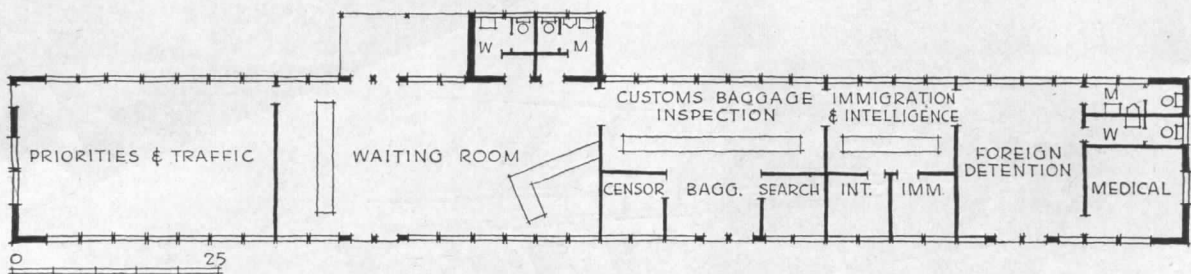
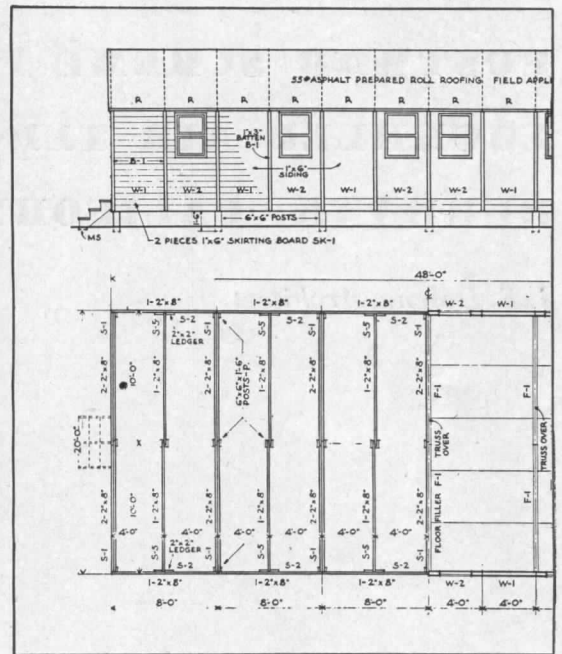

The operations unit (across-page) and the passenger unit (above) of two ATC terminals are both built entirely of prefabricated units, of the humble variety portrayed in the detail drawings on these two pages. By good grouping and good building proportions they have been rendered agreeable in effect. They indicate that solutions can be found for all kinds of airport structures in temporary construction

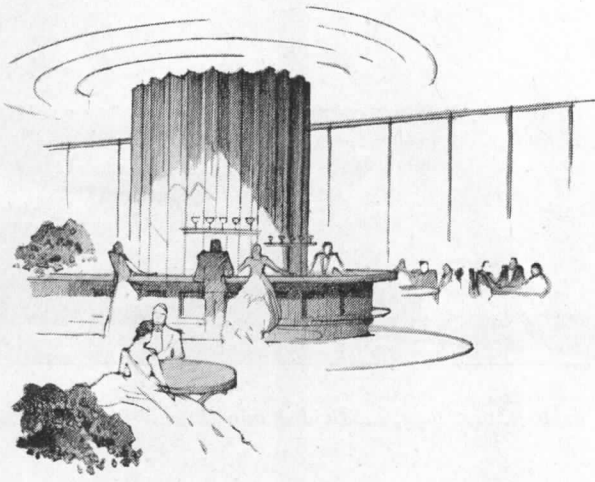

Experience suggests that a major air terminal

**POSTWAR SCHEME FOR
LOCKHEED AIR TERMINAL
BURBANK, CALIFORNIA**

J. E. Dolena, Architect

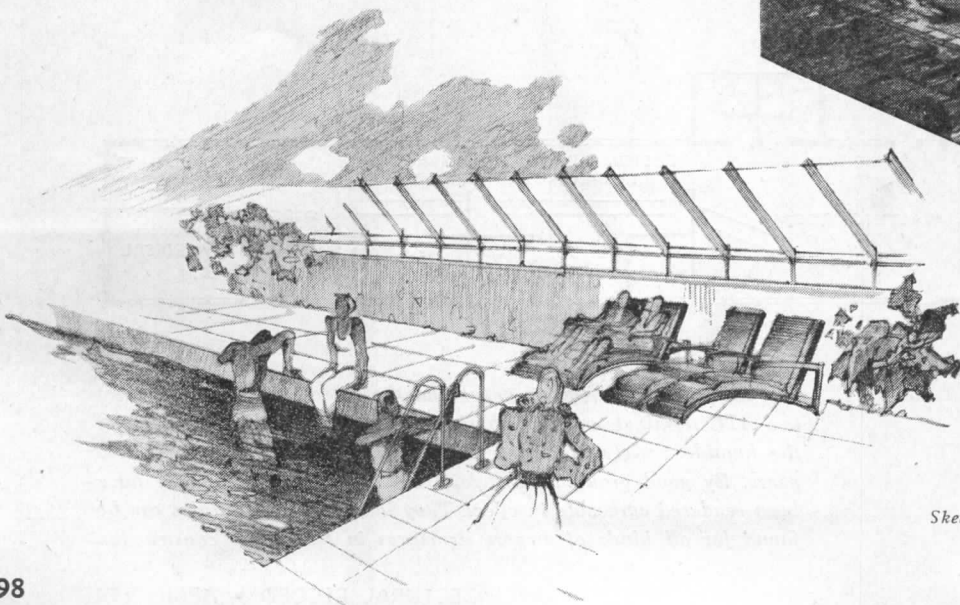
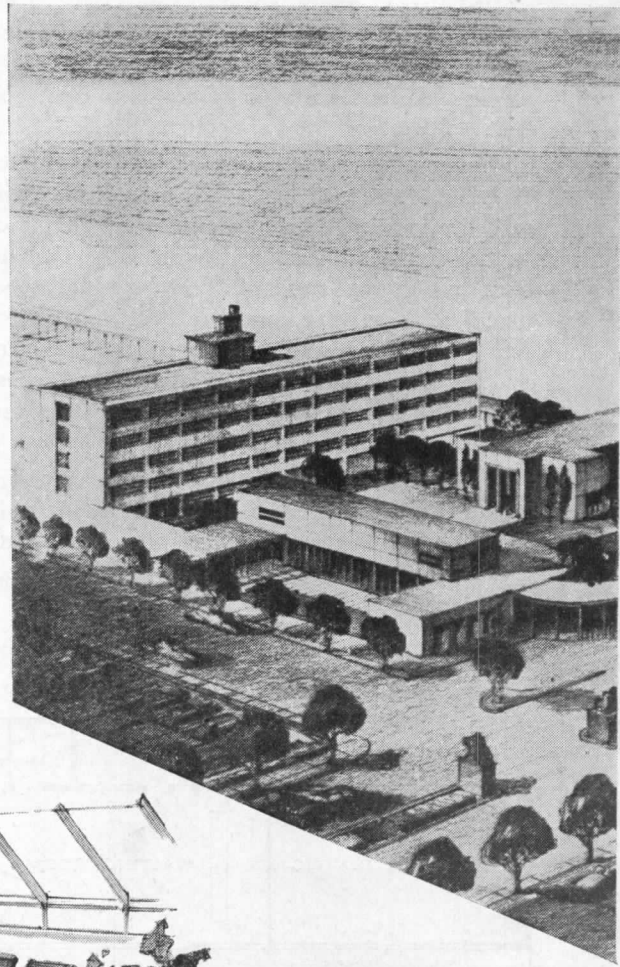

Sketches by J. E. Dolena

AMONG the many imponderables in airport planning, there is one question which was answered quite positively in this projected port. That is the one often stated simply: are airports for planes or for people? While New York's fiery mayor holds out for the view that ports are for people—meaning in his case sightseers—and demands an imposing central terminal building, he has had opposition from many interested parties who want to concentrate on planning for planes and who have little concern for people unless they are passengers. At the Lockheed Air Terminal the whole question of planes or people has long since been resolved in favor of people; hence the rather imposing array of facilities and services proposed in this scheme. If it seems to be as much a business and recreational center as an airport, that is exactly the idea. And the idea is based on a fairly substantial foundation in the records of the present terminal building, which does more business with people than with planes (see page 102). The Lockheed management knows full well that it is planning for people—not just passengers, or even just sightseers, but people who may only be looking for a good meal. The present terminal building

may become a city in itself

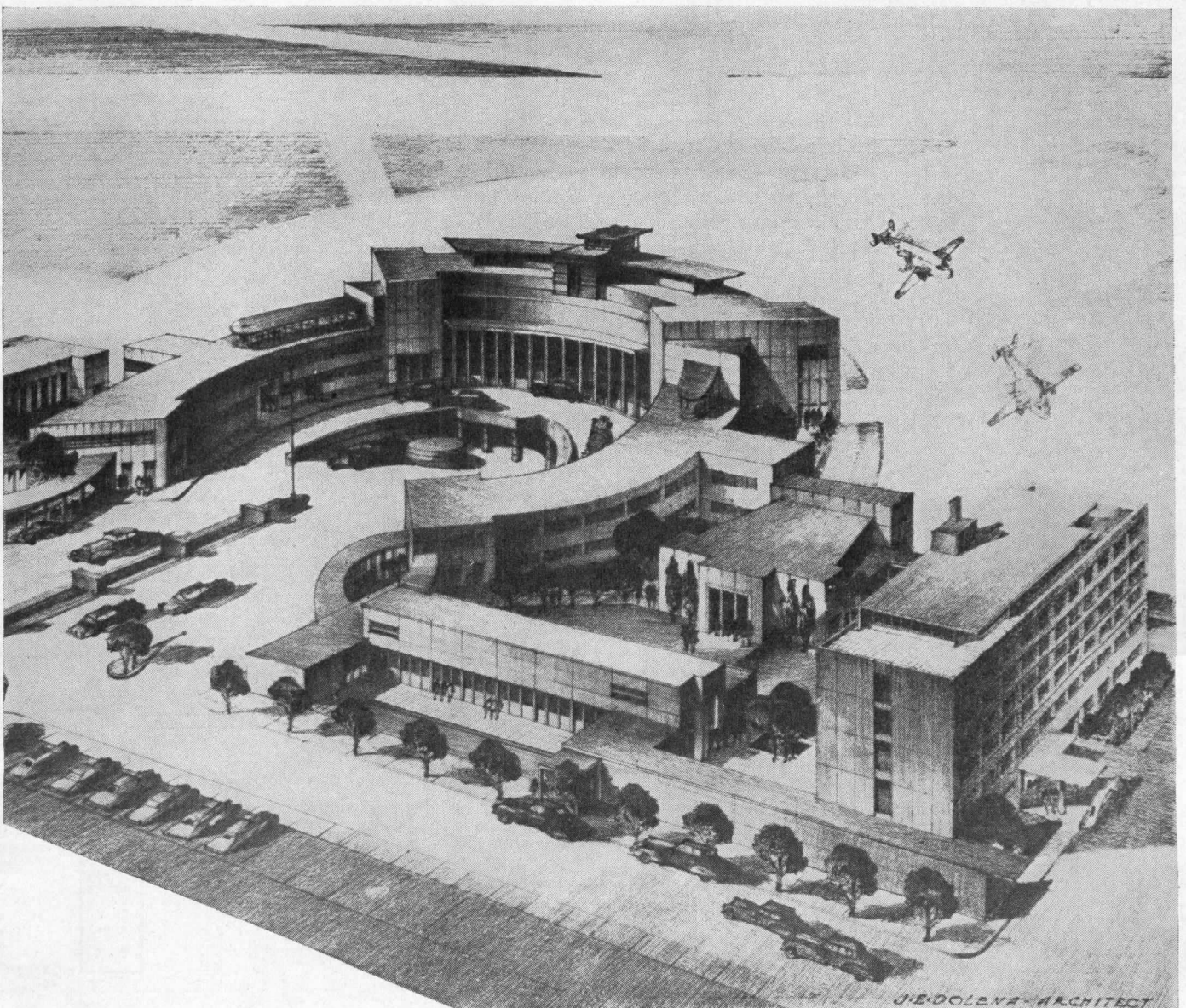

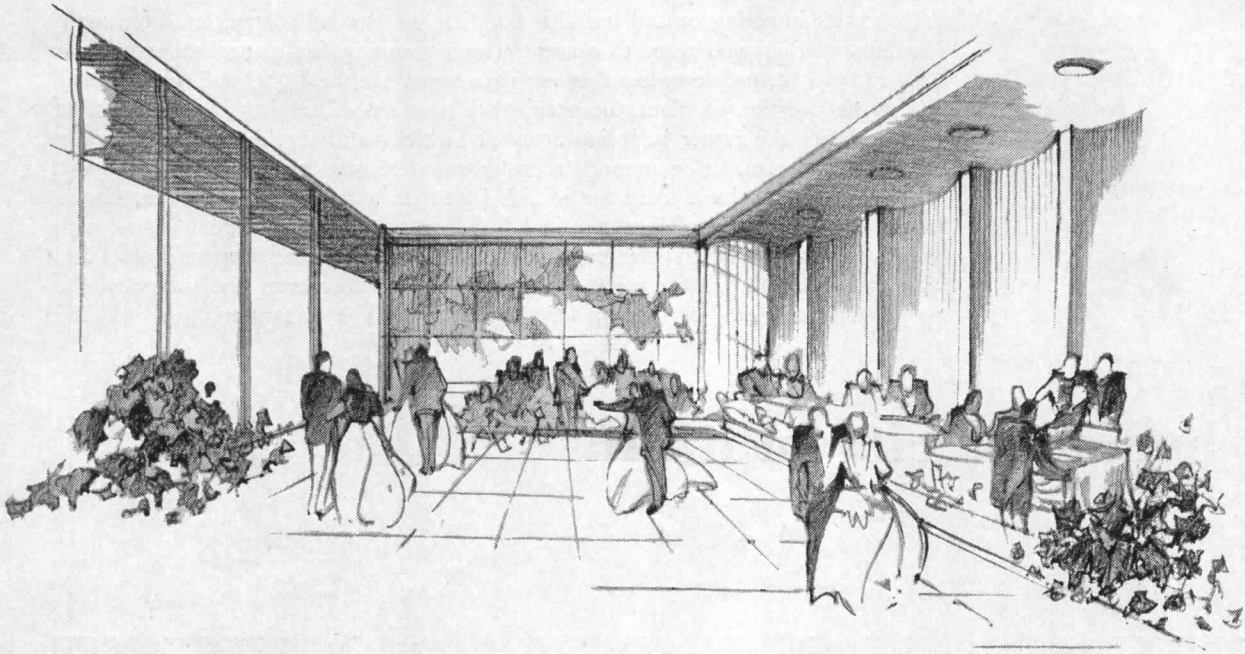

is seriously inadequate in relation to potentials that have been uncovered by a manager alert to ways to make an honest dollar. Every little corner of the building is crowded with ticket counters, phone booths, gift shop, even Turkish baths. So the postwar terminal group purposes to provide plenty of space not only for the services already found profitable, but also for many new ones to attract even more of the casual visitors—a hotel, a newsreel theater, shops, and recreational facilities.

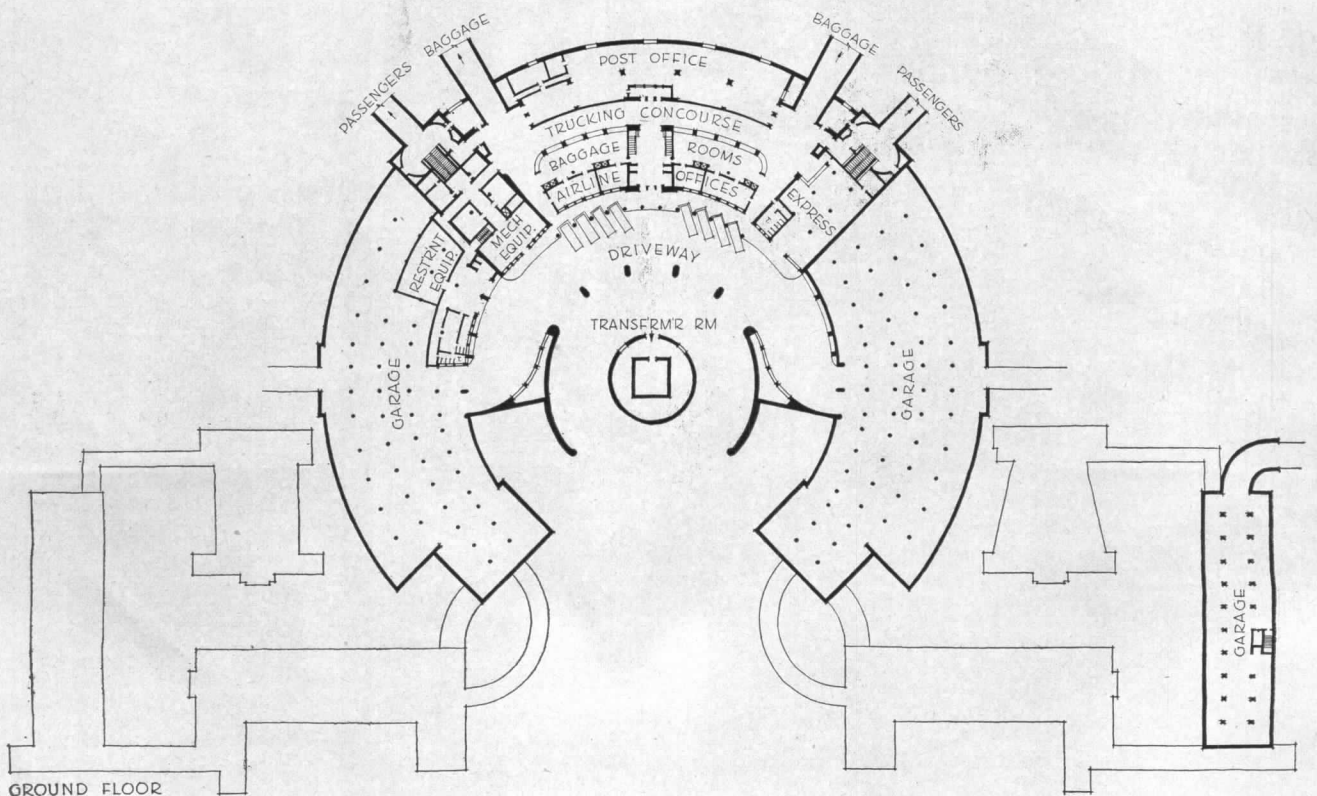

GROUND FLOOR

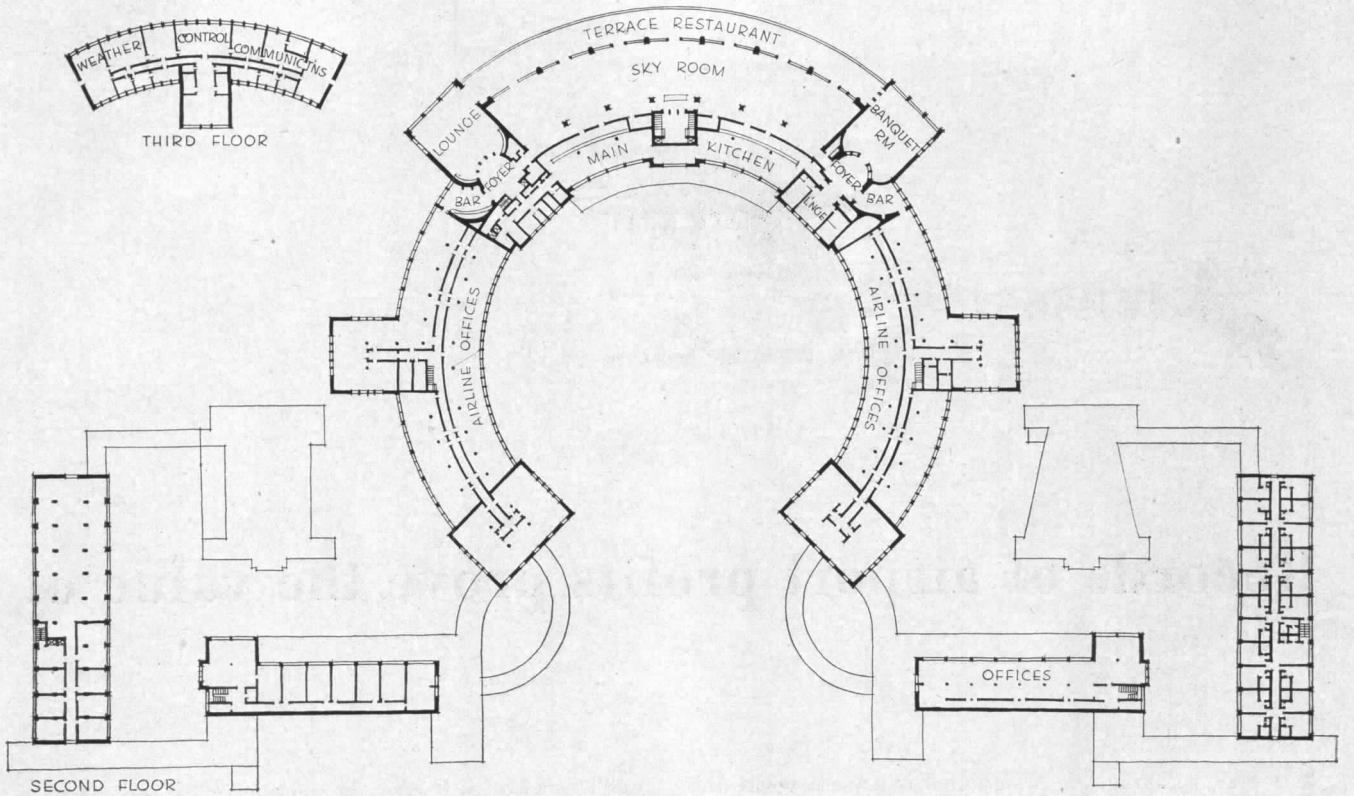

The central terminal school of thought is here represented in a building focused toward the field, for passenger and spectator alike. Especially noteworthy are the extensive facilities for serving the public, and for making a dollar thereby

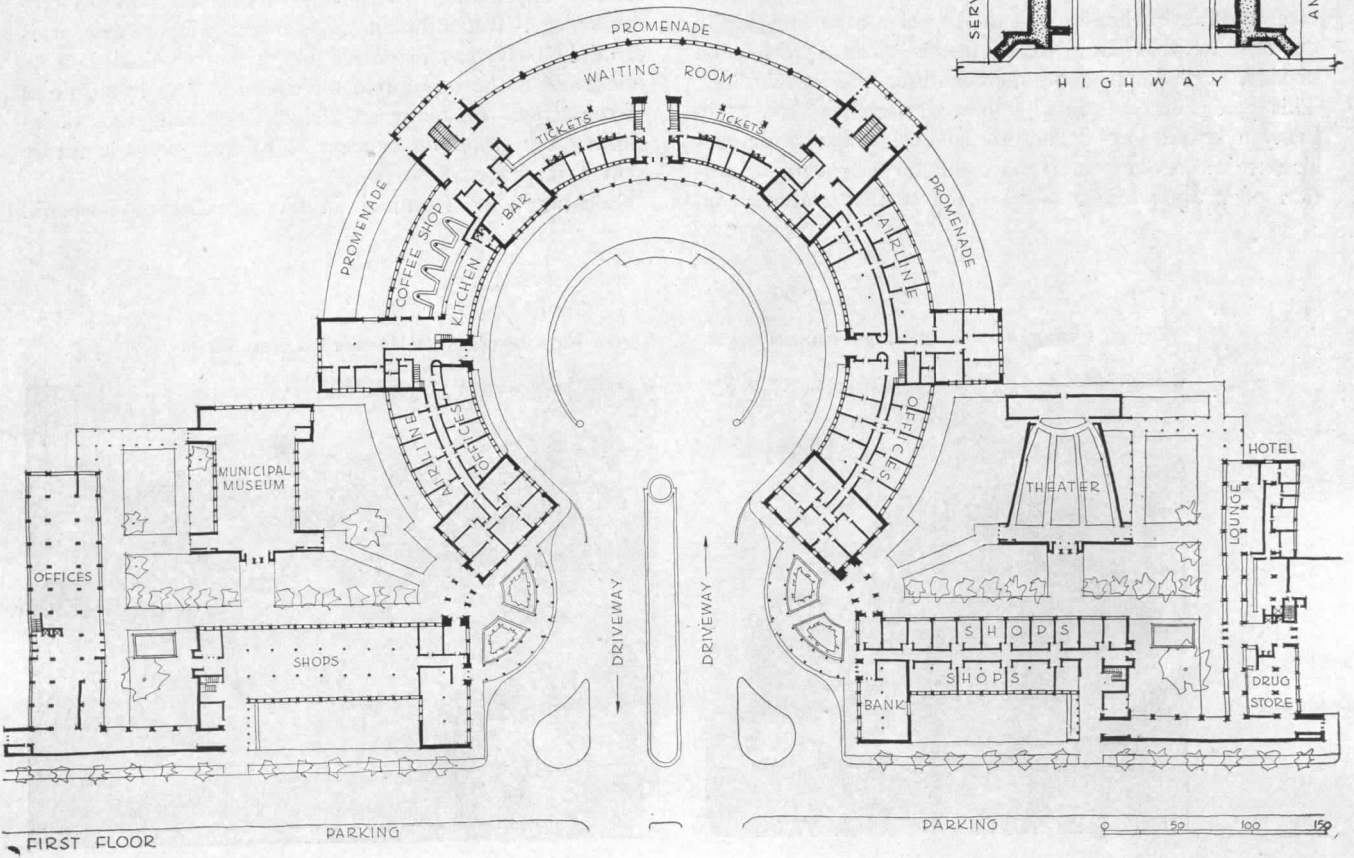
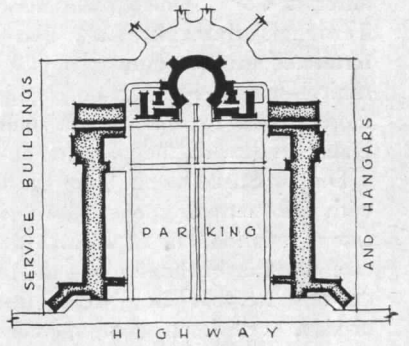

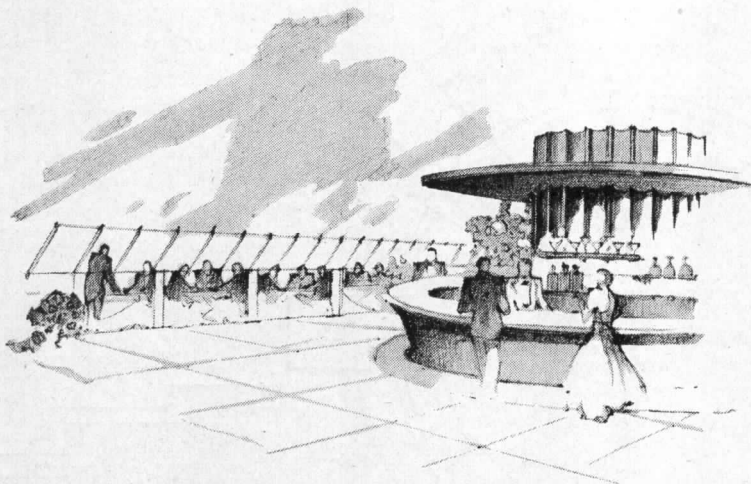

Records of airport profits prove the value of

STRICTLY speaking, an air terminal is a place where the public makes connections with airlines. But to Lockheed Aircraft Corp., which owns and operates Lockheed Air Terminal, Burbank, Cal., one of the largest public terminals in the country, it is a public relations opportunity—one of its functions being to help Lockheed sell more planes by making the public more familiar with planes and with the pleasure of traveling by air.

Dudley Steele, manager of the terminal, sees eye to eye with this company policy. "An air terminal is the showcase of aviation," he explains. "It should be a clean 'showcase' (he ran his hand along the top of a high molding to demonstrate that 'clean' really means 'clean,') with good display, well kept, good merchandise, smiling service." This policy of exceptional public service, has brought in many a resounding dollar, to the extent that traditional air terminal revenue sources account for only a minor portion of gross receipts. Steele believes that emphasis on

public service will soon be recognized as necessary to profitable air terminal operation. "An airport," he declares, "that depends on airline rentals to the extent of more than 40 per cent of its gross revenue, is pretty certain to be running in the red."

Lockheed Air Terminal, opened in 1930 under different management, is not the integrated, eye-satisfying architectural specimen that might be inferred from a resume of its features. It grew piece by piece as one idea after another was adopted. Moreover, of late all considerations of exterior appearances have been subordinated to military camouflage. But although no esthetic prize-winner, it is certainly busy, has pioneered many air terminal innovations, and is the inspiration for countless "super terminals of tomorrow" on many an architect's drawing board, including the ambitious concept of its own postwar future shown on page 98.

Lockheed Air Terminal, in the outskirts of Burbank,

Tiny gift shop does surprising business



Coffee shop serves 67,000 meals each month



Lockheed Air Terminal, Burbank, Cal., a main port for airlines as well as for company planes, has crowded revenue-producing facilities into every possible corner. Extra income has grown until airline rentals now are but a small fraction of the total. If the port manager has profited from a unique situation, he has also established a precept for airport planning

extra facilities

By Don Taylor

Cal., a suburb of sprawling Los Angeles, is 17 miles from downtown Los Angeles. The site was selected originally by Boeing Air Transport Corp. which operated an airline between Seattle and Los Angeles, and was chosen principally upon the recommendations of weather experts whose records and observations indicated it to be the site freest from fog and adverse winds. The San Fernando Valley in which it is located provides the best meteorological conditions for flying of any locality near Los Angeles.

The terminal is served by major highways well marked with directional signs, public transportation being provided by bus lines. It is the principal public air terminal of Southern California. Operating from Lockheed Air Terminal are United Air Lines, Western Air Lines, American Air Lines, Pan American Airways and Transcontinental & Western Air. Privately-owned charter planes also use the terminal as well as private pleasure planes. Currently 118 airline flights are scheduled daily.

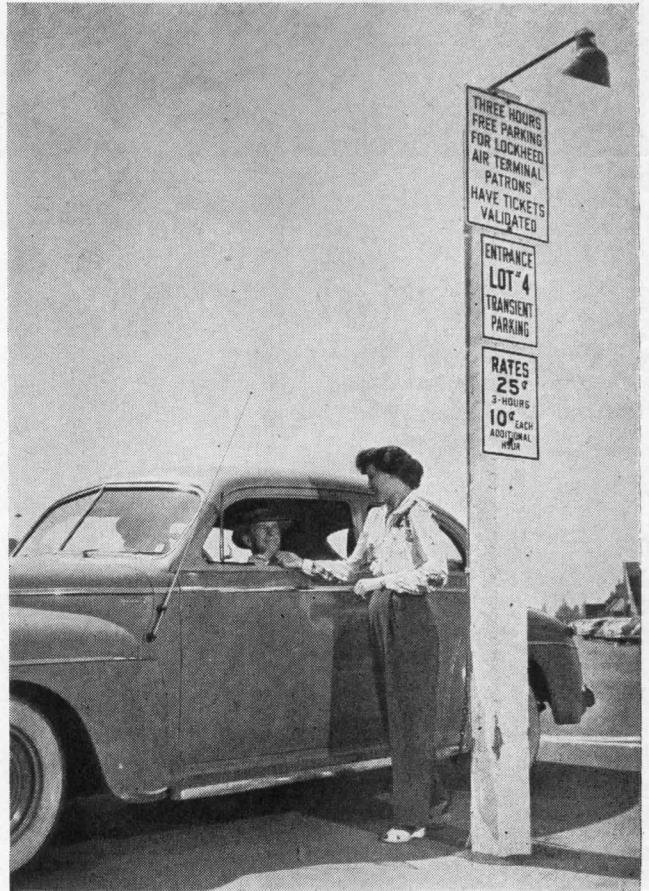

Passengers, spectators, casual visitors and employees keep barber shop and Sky Room restaurant busy at all hours

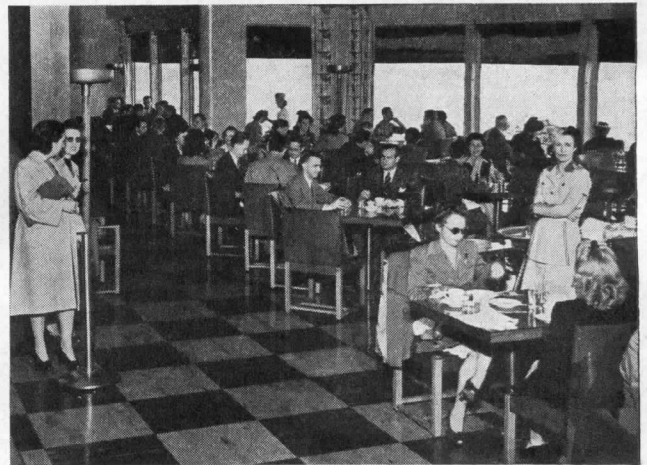
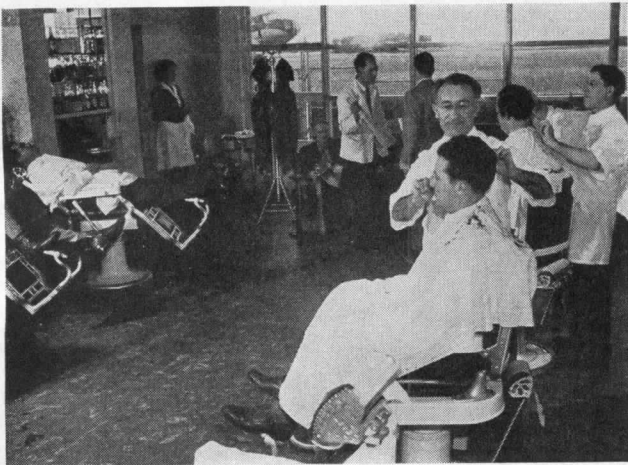



Parking lot (under wartime camouflage) accounts for almost 5% of port income

Records maintained during 1944 indicate the following record of plane flights and passengers:

Year	No. of Passengers	Lb. of Baggage Carried	No. of Visitors (Including Passengers) (estimate)
1940	210,896	8,435,840	527,240
1941	260,854	10,434,160	652,135
1942	296,068	11,842,720	740,170
1943	374,472	14,978,880	936,180
1944	540,382	21,615,280	1,350,995

The administration building group (nucleus of the terminal) is located back from main thoroughfares and is reached via private approaches. It is more than 1,000 ft. from the nearest public thoroughfare. This layout is to permit control over all activities pertaining to the airport. For example, there can be no free parking because the only places to park are in the parking lots. Traffic, both auto and pedestrian, can be controlled so effectively that there has been only one minor traffic accident at the air terminal in the past seven years. Location of an eating place (privately operated) and a service station along the highway at entrance to the terminal is not accidental—they are intended to help attract attention to the adit. Similarly deliberate is placing of garages so that all traffic must pass them.

The remarkably high proportion of gross income (90.8 per cent last year, exclusive of aviation gas and oil sales) accruing from sources other than airline rentals can be credited to intelligent catering to non-passenger visitors to the terminal. At first these non-passenger visitors were people coming to "see friends off" or were the merely curious. As services were installed, however, many people came to avail themselves of these services, until now a considerable number of those patronizing the terminal are not concerned with the airline end of the business at all.

At first, the terminal leased many of the services to independent operators on a percentage basis. Revenues under this system were not particularly satisfactory, and the terminal did not have direct control over the very factors upon which it was depending for good will. Steele is now convinced that an air terminal should itself operate all but the most highly specialized concessions (such as Roman baths, gift shop, etc.)

How services to the general public overbalance the rentals from airlines is shown in the table below:

Sources of Revenue (1944)	Per Cent
Sky Room Restaurant and Coffee Shop	39.0
Airport ground rentals (including landing fees from airlines)	14.5
Cocktail lounges	12.6
2 garages (150 cars)	11.2
Parking lots (5 in all)	4.7
Other buildings (4) (offices)	4.6
Hangar rentals (5)	4.3
Cigar and newsstand	4.0
Automotive service station	2.0
Electric power sales	1.9
Public telephones	.3
Gift Shop (sale of novelties)	.2
Western Union telegraph	.2
Barber shop	.2
"Good Humor" (exclusive right to sell all frozen confections)	.1
Baggage storage lockers	.1
Steam bath and massage department	.1
	100.0

Restaurant and Coffee Shop: The Sky Room restaurant extends virtually the whole length of the second floor of the Administration Building, is characterized by dependably excellent food and service, and commands a fine view of the airport. It has been a "hit" almost since

its inception. When originally opened it was estimated that cost would be amortized in 2½ years; original cost was actually amortized in 11½ months! It has since been enlarged several times in an attempt to keep pace with increasing popularity, but is still unable to accommodate its patrons without keeping them waiting. It now seats 275.

The coffee shop is on the first floor, off the main waiting room. With but 58 stools, it serves the amazing total of 2,600 to 2,700 customers a day—each stool being used approximately 41 times.

Average Monthly Meal Service

Sky Room, dinners	17,000	per month
Sky Room, lunches	13,000	" "
Coffee Shop, breakfast	19,500	" "
Coffee Shop, lunch	25,000	" "
Coffee Shop, dinner	23,000	" "

Total 97,500 per month

Cocktail Lounges: There are two cocktail lounges, one upstairs adjoining the Sky Room and commanding a fine view of the airport, the other on the main floor. The two lounges serve approximately 15,000 customers a month.

Sales of Aviation Gasoline and Oil: This income source at Lockheed Air Terminal cannot be taken as a criterion for other airports because of unusual circumstances—first, private flying has been forbidden on the West Coast from beginning of the war until very recently; second, sales of gasoline and oil to the Army and to Lockheed-manufactured aircraft being tested at the airport are away out of proportion to normal expectations.

Garages: The two garages have proved an unusually satisfactory source of income. They are continuously busy on profitable major repair work, particularly for airline passengers who leave them to be repaired or repainted



This hungry line is more interested in the Sky Room restaurant than in flying activities outside. Below: airline passengers frequently leave cars to be serviced while they are away

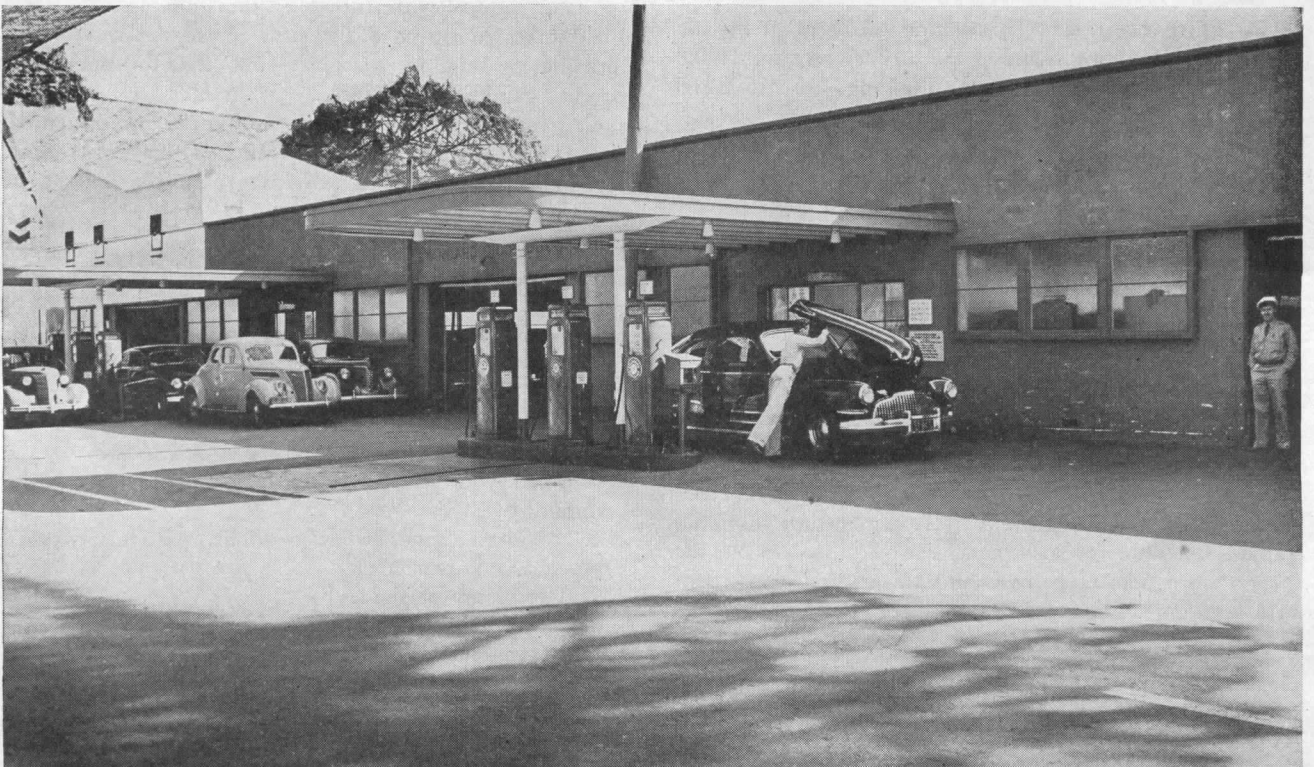



Necessary public services have encroached on lobby and waiting room space

during their absence. "By all means operate your own garages," Steele advises.

Parking Lots: The volume of business handled by five affiliated parking lots is astounding. Accommodating 1,500 cars, the lots turned in receipts of \$87,000 last year despite the fact that 160,000 parking tickets were validated without charge because the drivers were customers either of the airlines or the Sky Room. A major source of revenue to the lots is the terminal's personnel, the lots being the only convenient places to park their cars.

Building Rentals: In addition to offices in the administration building, some of the airlines rent individual buildings adjoining the terminal. Buildings are also leased for private commercial enterprises.

Public Telephones: These are so popular that "Out of Order" signs frequently have to be hung because coin boxes are full.

Gift Shop: Occupying only 61 sq. ft., this little shop nevertheless does a nice business in small-size gifts with retail values of up to \$400 per item. Good merchandise sells best.

"Good Humor" Concession. Granting exclusive privilege to sell frozen confections and parking privilege near to main entrance.

Charter Plane Operators: With regular commercial flights "booked solid," there is lively demand for chartered planes. Operators of such planes are permitted to use the airport on a percentage basis and are allotted office room in a building adjoining the administration building.

Other sources of income include: Hanger rentals, cigar and newstand, service station at highway entrance,

sales of electric power, barber shop (with shower service), steam bath and massage, telegraph office, and baggage and parcel storage.

Many other services could logically be a part of an air terminal, Steele points out. Among these could be mentioned: branch bank; shops (men's and women's sportswear, drug store, etc., but not too many or they will monopolize too much space); hotel; movie theater for short subjects and news-reels; beauty parlor, sports—swimming pool, bowling, miniature golf, ping pong, etc.; spectator ramps with turnstile admission (La Guardia Field takes in up to \$6,000 and \$8,000 a day from its turnstiles); vending machines—but NOT "one-armed bandit" gambling machines.

Generous use of directional signs, lighted and unlighted, characterizes highways in the vicinity of the air terminal. Signs also publicize some of the unusual attractions of the terminal.

Nine Pertinent Points, summed up by Manager Steele:

1. Merchandise the terminal—make it the community center.
2. Remember it's the "showcase of aviation," keep it clean and use plenty of paint.
3. Maintain direct control of all sources of revenue.
4. Develop all possible sources of revenue from the public.
5. Make your services outstanding among those of the community.
6. Maintain good public relations, particularly with press and civic personnel.
7. Use plenty of signs.
8. Have frequent inspections with regard to maintenance, an outstanding safety record is important.
9. Know your costs, keep complete records.

AIRPORT COUNTER DETAILS

From Air Transport Command Airport at Washington, D. C., Charles M. Goodman, Principal Architect

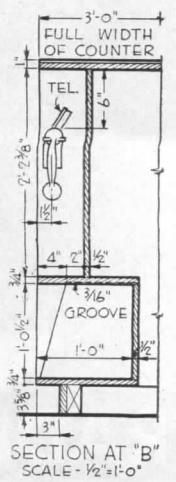
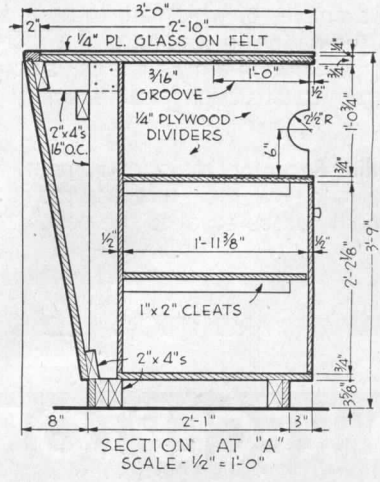
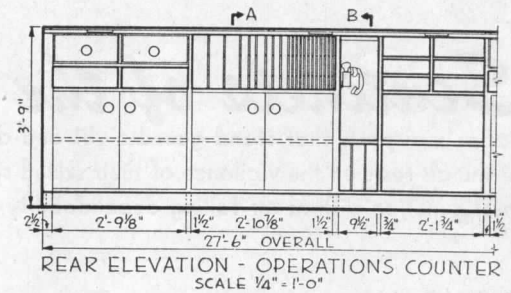
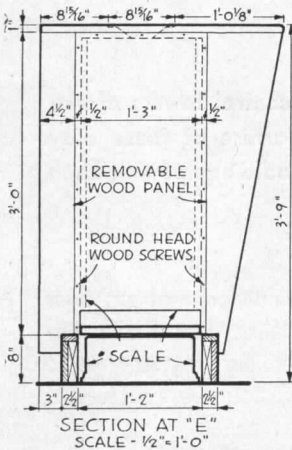
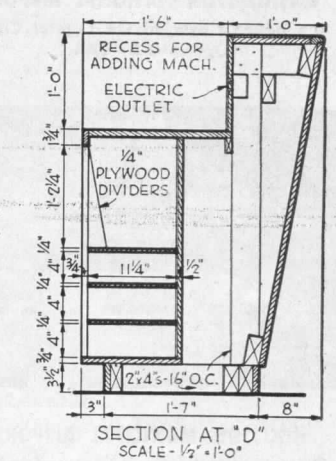
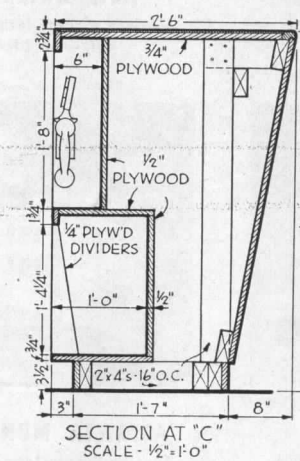
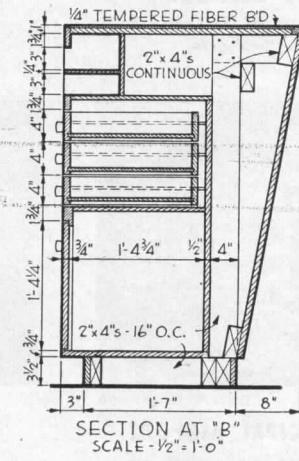
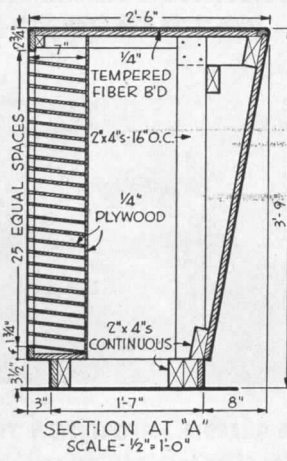
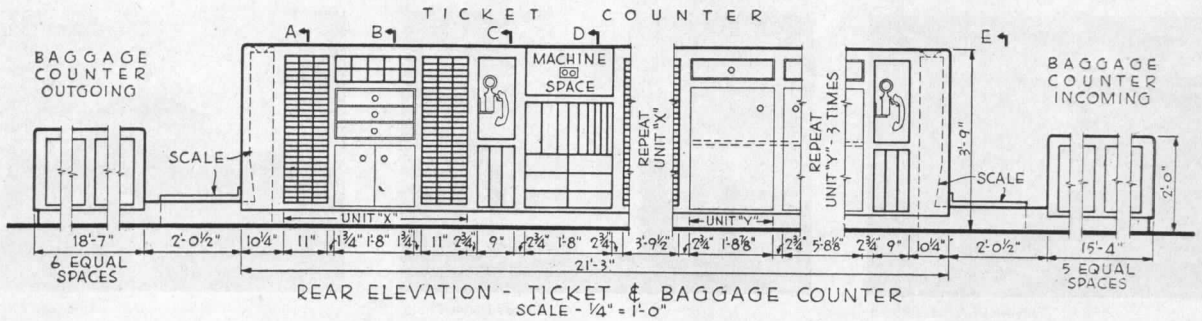

Part of the ticket and baggage counter scheme includes use of platform scales having registering face flush with the counter top. This arrangement permits easy handling of baggage and recording of weight.

The operations counter is similar in many ways to other counters except that special compartments have been included to aid in handling pilots' requirements.

Towers that Talk!

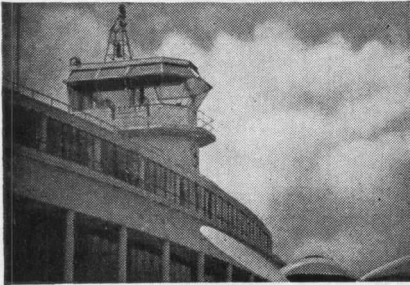

American Airlines Photo

WASHINGTON NATIONAL AIRPORT

The nation's own, at the Capital City—
Operated by CAA.

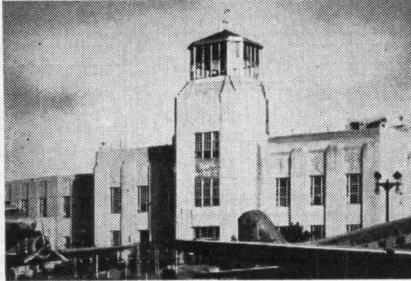

Delta Airlines Photo

NEW ORLEANS AIRPORT

Modern airport terminal at the Crescent
City—an architectural gem.

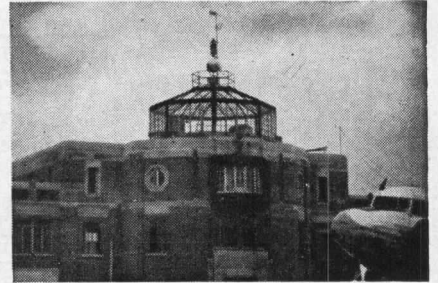

American Airlines Photo

LOUISVILLE'S BOWMAN FIELD

Pride of the Blue Grass State.



Braniff Airways Photo

HOUSTON MUNICIPAL AIRPORT

Gateway to Mexico and Central America.



Delta Air Lines Photo

ATLANTA MUNICIPAL AIRPORT

Serving the metropolis of Southeastern U.S.



American Airlines Photo

LA GUARDIA AIRPORT, NEW YORK

One of the world's largest and busiest
airports.

Sentinels of the Sky . . . the control towers of the nation's airports that stand guard night and day. Each safe arrival and departure at these busy terminals rests on the vigilance of their skilled staffs and the reliability of their radio equipment. Each must function with never failing dependability—in peace as in war.

Radio Receptor airport traffic control radio equipment, examples of which are to be found throughout the nation in leading civil airports, and around the world in army airfields, is noted for its rugged construction and reliability in operation.

Specify **Radio Receptor** radio equipment for your airport and you may rest assured that your equipment will be equal to the best.

It is not too early to plan for that postwar airport for your municipality. Let **Radio Receptor** aid you. Send for our Airport Radio Questionnaire — no obligation. Dept. RA-4.

Highways of the Air — a review of fact and opinion on the importance of radio in aviation — sent on request to those interested in airport design, construction and operation.

CONSULTATION WITH ARCHITECTS, CONSULTANTS AND CONTRACTORS INVITED



RADIO RECEPTOR CO., INC. 251 WEST 19th STREET
NEW YORK, 11 N. Y.

Engineers and Manufacturers of Airway and Airport Radio Equipment • Communications Equipment • Industrial Electronics • Electronic Heating Equipment

S I N C E 1 9 2 2 I N R A D I O A N D E L E C T R O N I C S

AIRPORT "IN-FLIGHT" KITCHEN

An Air Transport Command Base Design • Charles M. Goodman, Principal Architect

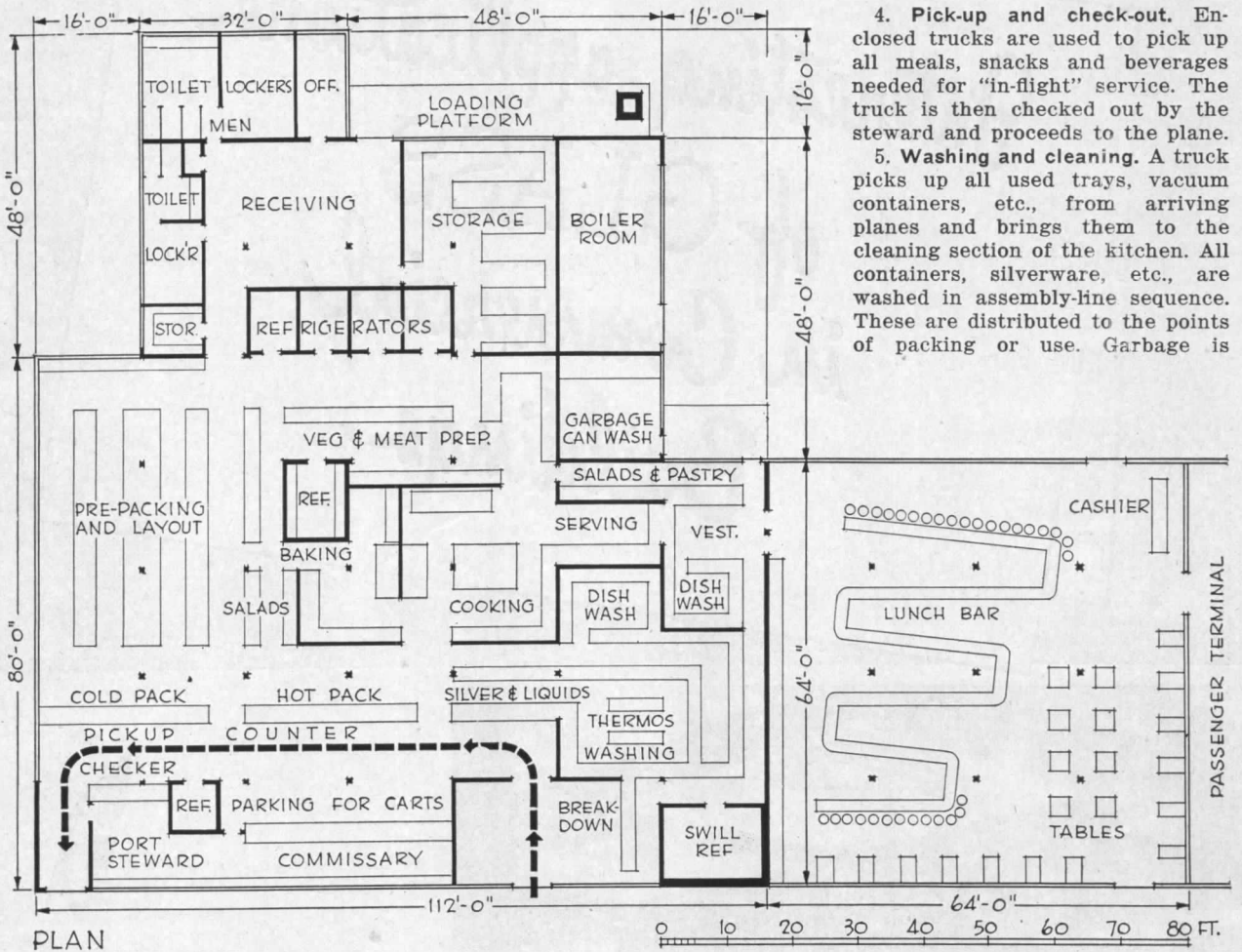

4. **Pick-up and check-out.** Enclosed trucks are used to pick up all meals, snacks and beverages needed for "in-flight" service. The truck is then checked out by the steward and proceeds to the plane.

5. **Washing and cleaning.** A truck picks up all used trays, vacuum containers, etc., from arriving planes and brings them to the cleaning section of the kitchen. All containers, silverware, etc., are washed in assembly-line sequence. These are distributed to the points of packing or use. Garbage is

The purpose of the "in-flight" kitchen is to prepare food for plane passengers only. There are several ways of feeding passengers in transit; cold snacks or hot meals in flight, and quick meals served at a lunch bar or restaurant during a fueling stop-over. In this plan provision has been made for both in-flight and ground meals. The principles here shown can be adapted to "in-flight" kitchens of any size—and it is best to plan for plenty of expansion.

Experience has shown that wherever possible passengers should be fed on the ground while the plane is being refueled. Combining food preparation for plane meals with a lunch bar permits economical operation. The 80 stools in this scheme—allowing 15 to 20 minutes eating time—permits a peak of 240 servings per hour.

The in-flight kitchen is planned for production-like economy of time, effort and space. There are five well-integrated major sections, as shown on the plan:

1. **Receiving and raw storage.** This includes checking in office and storing of dry or refrigerated goods.
2. **Basic food preparation.** Here raw vegetables, cooking, meat roasting, baking and salads are prepared, each in its place.
3. **Packaging and Layout.** Food containers and complete meals are packed and set out on trays. The capacity of this department is usually determined by the length of setting-out tables available. At a peak period, personnel from other sections may be brought in to help if sufficient table space has been allowed.

stored in a refrigerator until the end of the day.

The truck continues on to pick up silver, hot beverages, newly-packed trays, containers, etc., in a proper time-saving sequence. On the way out the steward checks each truck for the prescribed number of trays, hot packs, silverware, etc.

If the flight is to be longer than a one-meal hop, the truck picks up canned and preserved goods, dry staples that can be mixed with hot water, and sandwiches. Passengers on the plane may have a snack any time between meals. On a long hop there will probably be one hot meal, one meal of cold sandwiches and beverages, and later a meal consisting of soup, canned preserves and cake. The next stop on the ground will again be a full meal.

INTERESTING APPLICATIONS
OF GLASS
IN COMMERCIAL
BUILDINGS



HEAVY PLATE GLASS has proved itself to be one of the most versatile materials yet employed in the creation of eye-catching interiors. In this interesting application, tall panels of Plate Glass are used, accordion fashion, to give beauty and appeal to a store interior. *T. H. Robsjohn-Gibbings, designer—René Brugnoli, architect.*

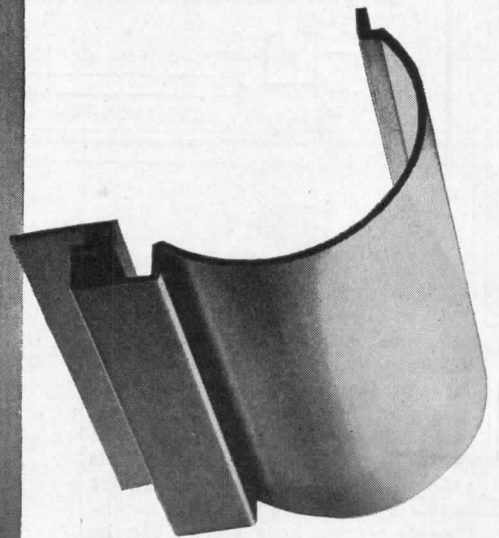

STURDY, RUGGED STRENGTH is a marked characteristic of the Pittco De Luxe line of store front metal. This is an extruded metal construction, which combines an unusual ability to withstand hard usage with an exceptional purity of line and clean, sharp contours. Thus, Pittco De Luxe offers the architect both beauty and strength to assist him in designing store fronts and interiors of distinction and durability.

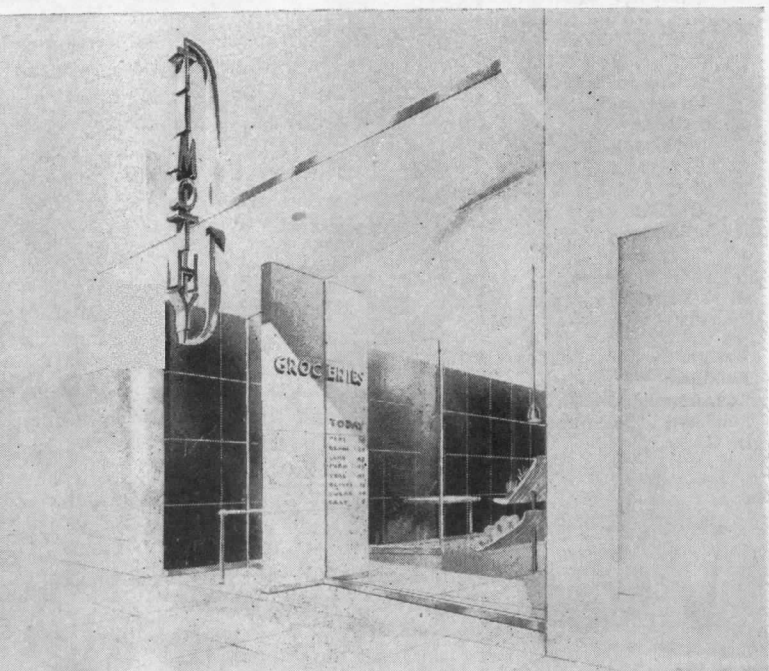
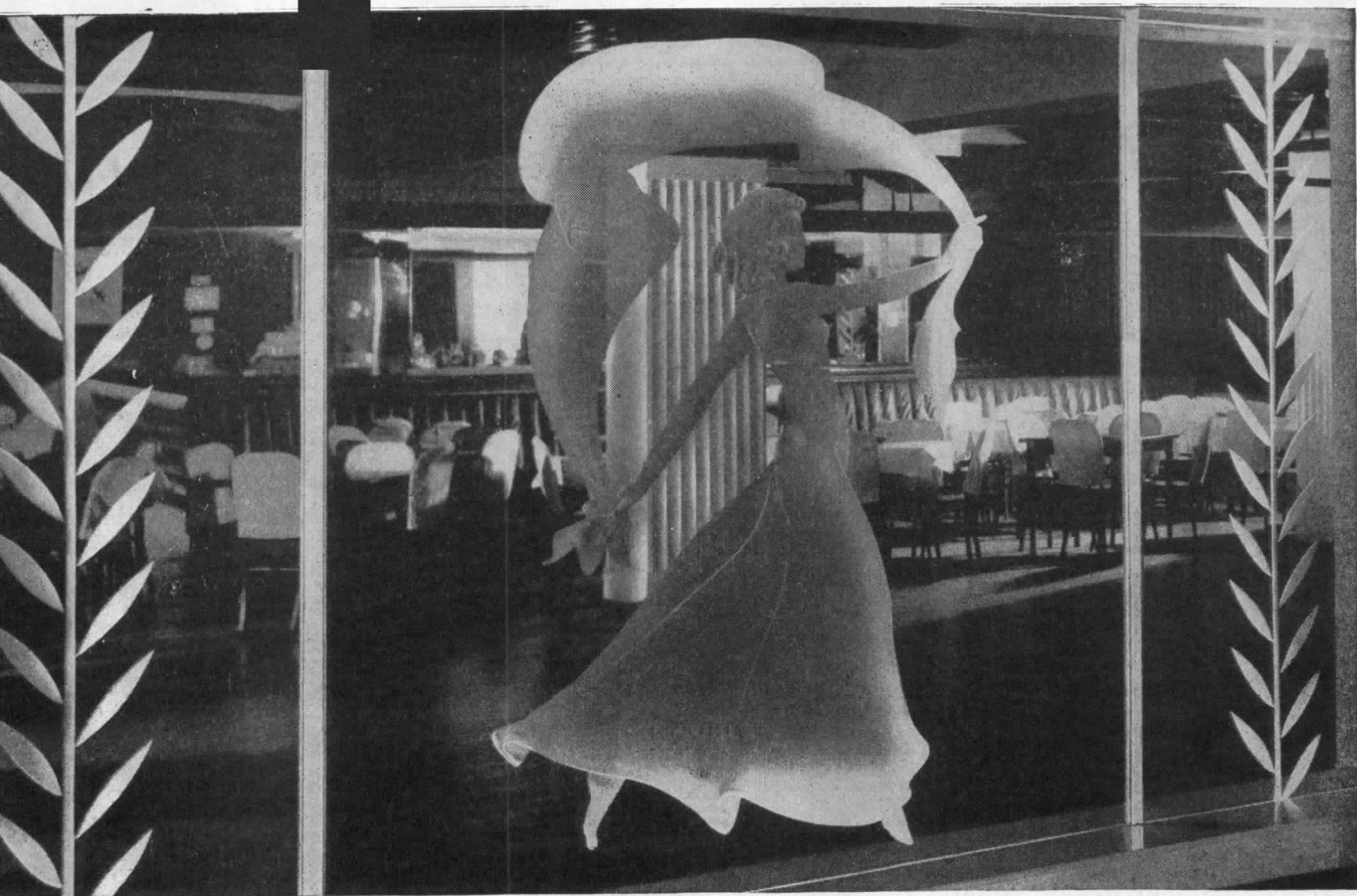

▲ **LIFE-SIZE MURALS** of edge-lighted, decorated Plate Glass are now practical. For hotel, restaurant, store and theatre interiors, they offer a new design medium to architects. In the edge-lighted mirror panel shown, the sand-blasted figure is full life-size; the mirrored panel 7 feet square.

◀ **GLASS, SKILLFULLY USED**, has played an important part in creating the present trend toward "open vision" in store design. Long the leaders in the store field, Pittsburgh Glass and Metal Products assure the satisfactory execution of the architect's design—the maximum effectiveness of the store front and interior as advertising and sales-building media. *Store design by Skidmore, Owings and Merrill, architects.*

We believe you will find much to interest you in our new illustrated booklet of ideas concerning the use of Pittsburgh Glass in building design. Send the coupon for your free copy.

Design it better with

PITTSBURGH GLASS

*The Accepted Line
for Every Architectural Use*



"PITTSBURGH" stands for Quality Glass and Paint

PITTSBURGH PLATE GLASS COMPANY

2068-5 Grant Building, Pittsburgh 19, Pa.
Pittsburgh Plate Glass Company

Please send me, without obligation, your new booklet entitled: "Ideas for the Use of Pittsburgh Glass in Building Design."

Name.....

Address.....

City..... State.....

REQUIRED READING

THE NEW CITY

By L. Hilberseimer. *Chicago 2 (5 North Wabash Ave.), Paul Theobald, 1944. 8 1/2 by 11 in. xv + 192 pp. illus. \$5.95.*

How did cities first begin? Prof. Hilberseimer sketches their origin from the nomads' tent colonies and the Romans' camps down through the fortified city of olden times to the present-day sprawling metropolis. He draws a clear line between the two contrasting types of city—the organic,

characteristic of the soil-bound peasant with his centrifugal concept of space, and the geometrical, typical of the nomad whose feeling for space was centripetal. From this historical outline he proceeds with an unusually thorough discussion of city planning.

Prof. Hilberseimer is concerned primarily with the human aspects of city planning—with the benefits of sunlight and fresh air, with prevailing winds, with aesthetic appeal and con-

venience. On this concept of a city he bases his theories of street layout and traffic control, and compares them with the theories of other planners. Much of what he discusses in detail, such as room insulation, is usually either skimmed over very briefly or completely ignored in a discussion of city planning. Numerous illustrations—photographs, plans and diagrams—make his points clear.

One of the best parts of Prof. Hilberseimer's book is his analysis of the problems inherent in the replanning of a city. Here he gets down to the proverbial "brass tacks." Any permanent solution for a city's problems, he says, must include the elimination of *all its defects*. A tall order! But not an impossible one, according to the professor. To demonstrate how it can be done, he examines the history and problems of two small industrial cities and one metropolis (Chicago). In addition, London and New York are given a brief analysis each. The actual procedure of rebuilding a city is illustrated with diagrams showing the piece-by-piece following of the over-all plan.

"There are two schools of thought in city planning," Prof. Hilberseimer sums up. "One takes into consideration only parts of a city, without connecting these with the whole. 'Little' things are thought about, and little parts are changed. Everything is done on a 'sound basis.' This is the school of the practical man. Paradoxically, this practical work, which considers economy first, eventually reveals itself as impractical and unsound. The expense it entails is futile expense. The city so tinkered with remains essentially the same.

"The second school thinks about the city as a whole, its zone of influence, its function in the region, and in the nation. It takes everything into consideration and tries to conceive of the needs and function of the city as an entity.

"This school is often regarded as impractical and theoretical. It is indeed accused of being destructive, eager to tear everything down. Its real purpose, however, is to reconstruct the city, according to a plan, building everything in its proper place.

"Such a plan should be completely flexible. It should provide for future growth or future shrinkage in the city without disintegration of its unity. It should plan to use buildings as long as they are useful and to replace them when they become obsolete. . . . The city could be changed step-by-step by the careful and patient following of such a plan."

Take New York, for example. Prof. Hilberseimer would continue Central

(Continued on page 114)

KITCHEN PLAN NO. 22. Twenty-second of a series of successful mass-feeding kitchen plans.

This competent installation feeds more than 6,000 daily at a Washington, D. C. government building.

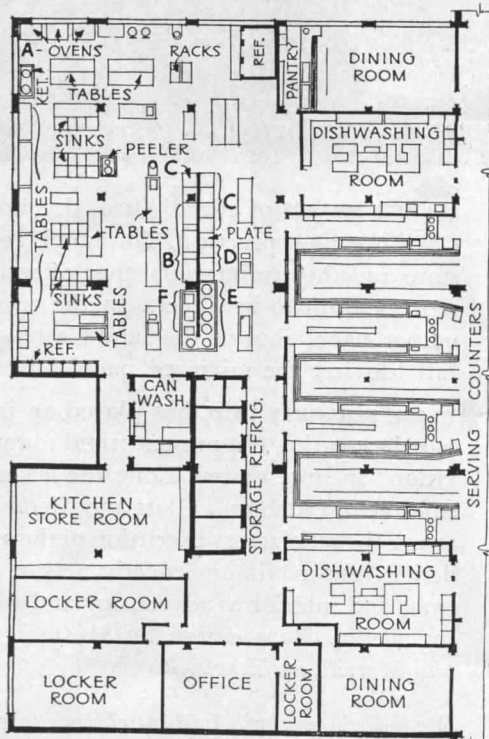

**KEEP FOR
HANDY
REFERENCE!**

Bake Shop:

- (a) 3 No. 982 BLODGETT GAS-FIRED BAKING OVENS
- 2 Trunnon kettles
- 2 Confectioners' furnaces

Main Galley

- (b) 3 No. 959 BLODGETT GAS-FIRED ROASTING OVENS
- (c) 5 Ranges
- (d) 2 Fryers
- (e) 6 Stock kettles
- (f) 3 Vegetable steamers

Designed by Public Buildings Administration. Installed by S. W. Stinemetz, Washington, D. C.



THE THREE NO. 982 BLODGETT BAKING OVENS have six two-deck sections, each separately controlled, with 24-pan, 144-pie capacity at each load. Six 7" decks and three 12" decks, with 83 square feet of shelf area, having more than 1200 lbs. capacity, are provided in the three No. 959 Blodgett Roasting Ovens. For details and specifications of Blodgett Ovens, consult your equipment house or write

The G. S. BLODGETT CO., Inc.

53 Maple Street



Burlington, Vt.

Reprints of this new series will soon be available to architects on request.

USED AS INDIVIDUAL UNITS  . . . USED

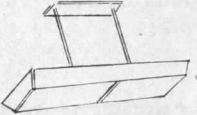
AS CONTINUOUS STRIP INSTALLATIONS  . . .

. CEILING  OR
SUSPENSION  MOUNTED

USING  OR 
FLUORESCENT LAMPS PER UNIT.

WESTINGHOUSE
COMMERCIAL
FLUORESCENT
LUMINAIRES

PROVIDE
THE LEVEL OF
ILLUMINATION
YOU NEED

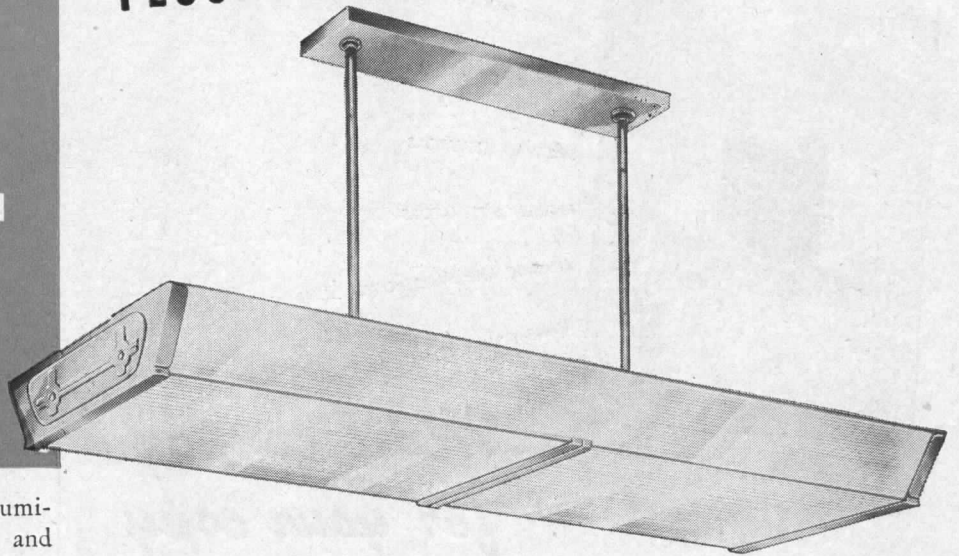

Getting the correct level of illumination for good seeing in offices and drafting rooms is often a problem . . . especially when a variety of tasks are performed in one general section.

To simplify your ordering and installation Westinghouse now offers a complete new line of Commercial Fluorescent Luminaires to provide high level, glareless lighting over a wide range of intensities. Four attractive models, designed for either individual or continuous strip application . . . for suspension or ceiling mounting are available.

Ask your Westinghouse lighting distributor for full details or write for bulletin B-3332. Westinghouse Electric & Manufacturing Co., Dept. 7-N, East Pittsburgh, Pa. J-04001.



Westinghouse
PLANTS IN 25 CITIES . . . OFFICES EVERYWHERE

Lighting Equipment

Park both north and south, making the whole heart of Manhattan (and the Bronx as well) a great beautiful green strip through which hotels and apartment houses were located in "very spacious arrangement." Commercial buildings and stores would be located outside of this residential green belt, separated from it by traffic strips for both local and express traffic. It looks very feasible in the diagram, and—who knows?—it *might* work.

THE MAGIC POWDER

History of the Universal Atlas Cement Company and the Cement Industry. By Earl J. Hadley. New York (2 W. 45th St.), G. P. Putnam's Sons, 1945. 5¾ by 8½ in. xiv + 382 pp. illus. \$3.50.

That there is romance in every phase of human endeavor is abundantly proved in this history of the cement industry. Mr. Hadley tells the story well; his lively style and his skillful use of imaginative detail and local color succeed in creating and main-

taining throughout a reader-interest that one would not expect in a book of this kind.

"From the time an American opens his eyes in the morning until he closes them again at night," Mr. Hadley begins, "the hours of his day are virtually filled with the services of cement. . . . When he runs the bathroom faucet, the water with which he washes his face may have come from a concrete dam. . . . His egg may have been laid in a concrete hencoop. . . . The cream for his coffee was shipped, presumably, from a concrete dairy structure. . . ." That for a starter. Then, taking his American out of the house, Mr. Hadley has him walk down concrete steps to the concrete curb, etc., etc., ending up the day after office hours (in a building with a concrete foundation) by playing tennis on a concrete court, or going for a quick swim in a concrete pool!

"The mortar binding the stones of the pyramids by the Nile and the concrete face of the Grand Coulee Dam near the Pacific Ocean," Mr. Hadley continues, "tell, in brief, the story of cement." Greek and Roman use of it, its loss in the Middle Ages, and its rediscovery and further development make absorbing reading. Then comes the story of the founding of the Universal Atlas Cement Company, the origin of the rotary kiln, and the development of the cement industry. Naturally, most of the book is a history of Universal Atlas, but such chapters as "Beauty in Concrete" and "The Industry Grows Up" are a far cry from the usual limited viewpoint of a company historian.

FOR ARCHITECTS AND ENGINEERS PLANNING TODAY FOR TOMORROW

Standard Elevator and Dumb Waiter Specifications



- FREIGHT ELEVATORS
- HOSPITAL ELEVATORS
- SIDEWALK ELEVATORS
- RESIDENCE ELEVATORS
- ELECTRIC AND HAND POWER DUMB WAITERS
- HAND POWER ELEVATORS

Mail coupon for your copy

Here's a 24-page, easy-to-read, helpful elevator and dumb waiter specification book for postwar planning* architects and engineers. It contains complete specifications covering the Sedgwick line of electric and hand power elevators and dumb waiters—describes in detail the machine, motor, brake, operation, control and lists other per-

tinent information needed by those who specify vertical transportation equipment.

This book of "Standard Specifications for Elevators and Dumb Waiters" will be mailed—without obligation. Just mail the coupon for your copy.

*At present Sedgwick Elevators and Dumb Waiters are available only on suitable priority.

SEDGWICK MACHINE WORKS, 142 W. 15th St., New York 11, N. Y.
 ELEVATORS • ROTO-WAITERS • SPECIAL LIFTS • DUMB WAITERS

Sedgwick Machine Works
 West 15th Street, New York 11, N. Y.
 Gentlemen: Please send me a copy of "Standard Specifications For Elevators And Dumb Waiters"

NAME.....
 COMPANY.....
 ADDRESS.....
 CITY..... ZONE..... STATE.....

MEMORANDUM ON URBAN PLANNING

Washington 6, D. C. (1741 New York Ave.), Washington Chapter, A.I.A., 1945. 5½ by 8¼ in. 16 pp. mult.

A clear and concise discussion of many of the problems in urban planning, this memorandum is the result of discussions held in meetings of the Washington A.I.A. and its special Postwar Committee. It is full of good common sense, and should be helpful in clarifying the needs and methods of planning.

Chief points made are: (1) that urban planning is the responsibility of the local community; (2) that plans should be based upon an analysis of the social and economic problems of the locality; (3) that plans should cover the whole of the metropolitan locality. These are the points stressed by almost every competent city planner today—a unanimity of opinion which is definitely encouraging. The more frequently these precepts are laid down, the more

(Continued on page 116)

LARGER PLANES,
Greater Runways
 DEMAND
 BETTER
EXPANSION & CONTRACTION JOINTS



SERVICISED PARA-PLASTIC COMPOUND INSURES SMOOTH, WATERPROOF JOINTS IN CONCRETE

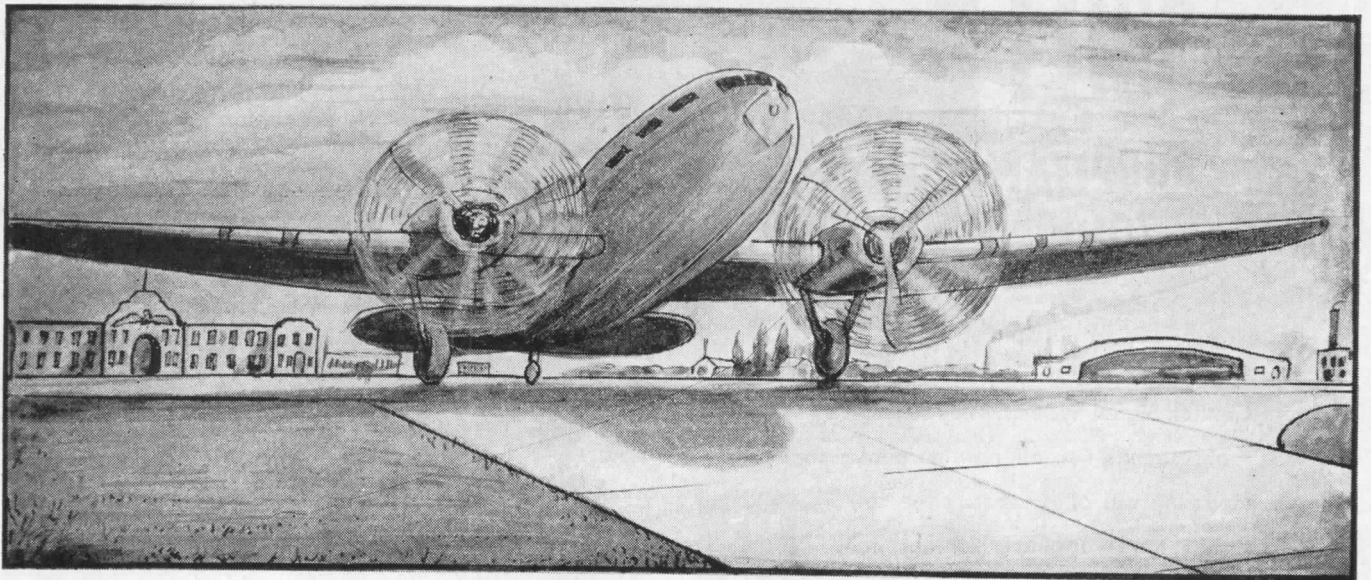

PARA PLASTIC EXPANSION & CONTRACTION JOINTS

USED IN SCOTT FIELD, ILL.

Have all Maintained Bond and are still found in good condition throughout the past three winters. All concrete runways equipped with Servicised Para Plastic joints are assured of waterproof slabs. Eliminating infiltration and cracking of joints.

Para Plastic Is Extendable and



Maintains BOND IN
 SUB-ZERO WEATHER

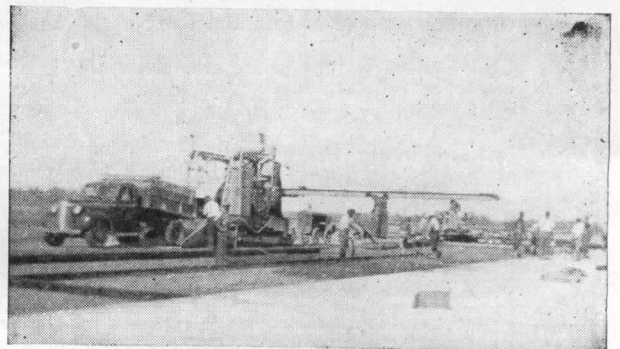

SERVICISED PRODUCTS CORP.
 6051 West 65th Street, Chicago, Ill.

apt they are to be acted upon. And so with another familiar point—that the widest possible citizen participation in planning should be encouraged.

Arguments are rife, however, on the subject of land acquisition methods. Here the Committee is specific: it proposes “that there be created local public land agencies with powers of eminent domain to assemble land for private or public redevelopment . . . [and] that means be found that will

permit leasing the reassembled land at a price approximating its reasonable use value.” The Committee would prefer municipal ownership of land to acquisition of development rights, and it foresees that ultimately a “large proportion” of all urban land will be municipally owned.

As for housing, another controversial subject, the Committee recommends: (1) that a housing laboratory be established to develop “a less expensive

product which can be afforded by more citizens”; (2) that methods of financing be studied for possible improvement; and (3) that public housing be provided for “those families for whom private enterprise cannot provide adequate housing in a decent neighborhood either in new or old houses.”

THE LIGHTING OF BUILDINGS

By the Lighting Committee of the Building Research Board of the Dept. of Scientific and Industrial Research. Postwar Building Series No. 12. London, W.C. 2 (York House, Kingsway), H. M. Stationery Office, 1944. 6 by 9½ in. 164 pp. illus. 2s. 6d.

SOUND INSULATION AND ACOUSTICS

By the Acoustics Committee of the Building Research Board. Postwar Building Series No. 14. 80 pp. illus. 1s. 0d.

Here are two more of the excellent Postwar Building Studies which the British Ministry of Works is bringing out. The first of them is not only a complete manual on lighting, but includes what the Lighting Committee calls “detailed and precise standards of natural and artificial lighting for dwellings . . . in a form which could be translated into Codes of Practice.” Similar standards for the lighting of schools are also given.

The second study, on sound insulation, likewise puts forward standards, but the best feature is probably the discussion of individual problems in various types of buildings—dwellings, hospitals, hotels, office buildings, factories, schools. A separate section deals with auditorium acoustics.

RECREATIONAL RESOURCES

Of the Denison Dam and Reservoir Project, Texas and Oklahoma. Washington 25, D.C., U. S. Govt. Prtg. Office, 1944. 9 by 11¼ in. xvi + 98 pp. illus. 45c.

“Recreation is being increasingly recognized as an important collateral use of water-control projects developed primarily for flood control, irrigation, power generation and navigation,” Newton B. Drury, director of the National Park Service, points out in his foreword to the report. The report itself is the result of a survey made by the N.P.S. at the request of Congress; it inventories the resources of the area and makes recommendations for their protection and utilization.

Among the recreational facilities proposed are boat basins and marinas, locker units, swimming pools and beaches, picnic areas, overnight cabins, administration center, concession buildings, etc. A particularly interesting feature to architects is the fact that an architectural style is definitely suggested in the various plans and sketches.

(Continued on page 130)



Quiet, the essence of good hospital service, is the substance of Cannon Signal Systems. They summon by sight—not sound. For all new hospitals—for remodeling old ones—specify the call system made originally for hospital use. The Cannon Paging System* calls four doctors at a time—gets maximum attention with no distraction. The Nurses Call System is fool proof and dependable. Both systems may be installed in old wiring or with surface mounted wiring.

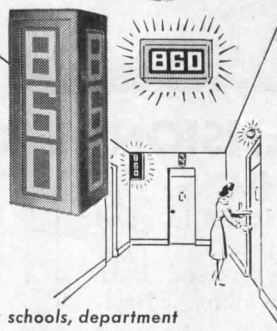

*Ideal for schools, department stores, auditoriums, public buildings—any place where “silence is golden.”

Cannon Signal Systems include a complete line of . . . Calling Stations, Annunciators, Paging Systems and In-and-Out Registers for Hospitals, Department Stores, etc. Cannon also manufactures Experimental Switchboards, Sectional Terminals, Multi-contact Electrical Plugs and Receptacles.

SEE OUR CATALOG IN SWEET'S ARCHITECTURAL Write for latest bulletin. Address Department A-312

CANNON ELECTRIC

CANNON ELECTRIC DEVELOPMENT COMPANY, LOS ANGELES 31, CALIF.

MANUFACTURING SIGNAL ENGINEERS



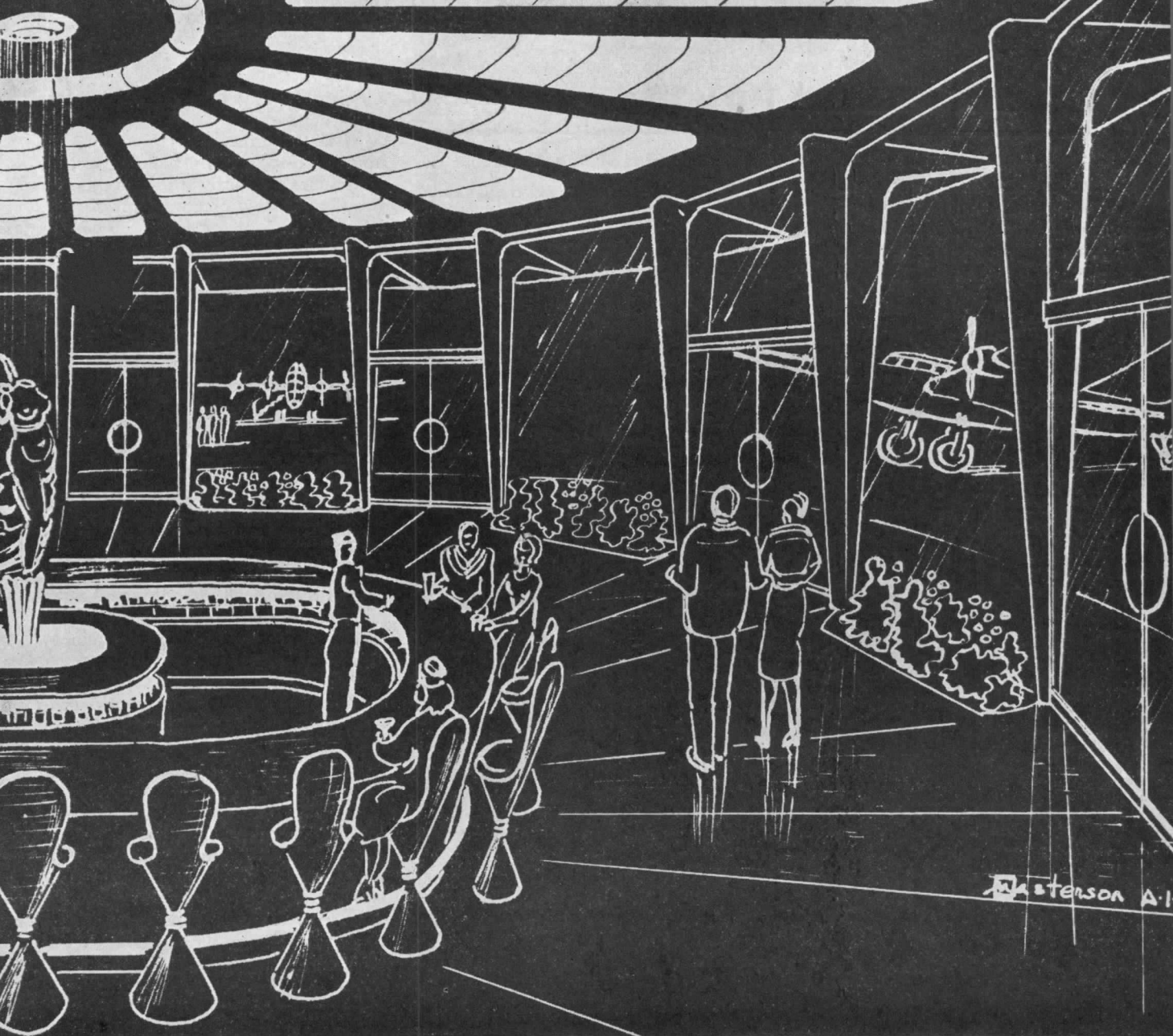

Plastics...in Airports

The General Electric Company offers architects, designers and engineers the service of its plastics technicians. These experienced men can give you technical advice and information on the use of all plastics materials—laminates, compression, injection and extrusion molded, low pressure and cold molded. The General Electric Company molds and fabricates all compounds that are on the market today and because of this is not limited to one particular material or manufacturing process. For further information write section E-16, One Plastics Avenue, Pittsfield, Mass.

The following list suggests the possible applications of G-E plastics in airports.

- WALL SURFACING AND DOOR MATERIALS • PARTITIONS • FURNITURE MATERIAL • HARDWARE
• LIGHTING FIXTURES • ELECTRICAL SUPPLIES • COUNTERS • SIGNS AND SPECIAL PARTS.**

Hear the General Electric radio programs: "The G-E All-Girl Orchestra" Sunday 10 P.M. EWT, NBC. "The World Today" news every weekday 6:45 P.M. EWT, CBS. "G-E House Party" every weekday 4:00 P.M. EWT, CBS.

GENERAL  ELECTRIC

PD-16

INSURE YOUR FUTURE BY BUYING WAR BONDS

but is not general at present. Such mortgages would supply a highly desirable means of financing additional loans needed for costly major improvements of types which add considerable value to the properties.

"This method of financing would not be used except for more extensive home improvements such as re-roofing, installing new heating plants, modernizing plumbing systems, constructing garages, or building additional rooms."

Introduction of New Materials

There is little likelihood that plastics or new materials will be substituted for standard structural building materials in the early postwar years, according to the latest technical bulletin issued by the Producers' Council.

"Introduction of the new materials will be gradual because it takes a number of years to establish their performance characteristics, to secure wide distribution, and to teach building trades

mechanics the necessary techniques for using the products," the bulletin states.

"Meanwhile these new products will appear principally in building accessories such as hardware, lighting fixtures and domestic equipment, or will be substituted for established products which can be used in the same manner as the materials they replace."

Among the postwar building products presented to designers in the bulletin is a complete line of new modular sizes of metal windows, coordinated with the dimensions of other building materials as a means of reducing costly cutting and fitting in construction.

In addition, the bulletin presents new designs in bathroom fixtures made from non-critical vitreous materials, improved methods of baseboard panel radiation to maintain more even temperatures from floor to ceiling in homes, awning type windows with simple controls which open and close all panes simultaneously, and standard sizes of household shower cabinets manufactured complete with precast receptors.

Other products which the Council expects to be generally available as soon as restrictions on manufacture or private building are liberalized are: threadless, non-ferrous pipe and fittings to be assembled with the use of solder; lumber especially treated to resist attack by fire, insects and rot; an improved form of asphalt tile which is adapted for heavy-duty service and provides resistance to denting and a non-sparking, non-slip surface; light-steel sections for use in residential construction and many types of commercial structures, and improved insulation for electrical wiring which increases the current carrying capacity and decreases the size of the conduits and fittings.

NEW BUS TERMINAL FOR NEW YORK

The Port of New York Authority has presented to interstate bus company officials its proposed plans for New York's first and the world's largest union bus terminal, to be built by the bistate Agency in mid-Manhattan as soon as materials become available. The proposed \$13,000,000 structure will occupy the entire 200 by 800 ft. block extending from 40th to 41st Streets between Eighth and Ninth Avenues, and will be connected with the Lincoln Tunnel by overhead ramps. The Lincoln Tunnel handles 75 per cent of all buses entering Manhattan.

The proposed terminal would replace the eight individual terminals now scattered from 34th to 51st Streets as far east as Sixth Avenue. Short-haul buses which make up 85 per cent

(Continued on page 120)

Know your
WIREMOLD
FUNCTIONAL WIRING
FOR BUILDINGS OF TODAY AND TOMORROW

WHAT TO USE.

No. 1500
Capacity: 4 No. 12's

No. 2600
Capacity: two 26-pair
telephone inside wiring
cables.

WHERE TO USE IT:

Wherever overfloor installation of wiring for light and power or telephone circuits is required and frequent changes in location and number of outlets is expected...in offices, drafting rooms, factories, etc. Especially designed to meet telephone company requirements.

HOW TO USE IT...

The diagram shows section of a typical office layout for telephone connections to desks. Wiremold is quickly and easily installed. A few, well designed fittings take care of all requirements. Cross section of Pancake is very compact with low ramp angle... safe, strong and trip-proof.

HOW TO GET MORE DETAILED INFORMATION

Write THE WIREMOLD COMPANY HARTFORD 10, CONN.

We shall be glad to send you Pancake Bulletins and Engineering Data Sheets covering installation. Write direct to

**THE WIREMOLD COMPANY
HARTFORD 10, CONN.**

SEE OUR CATALOG IN SWEET'S

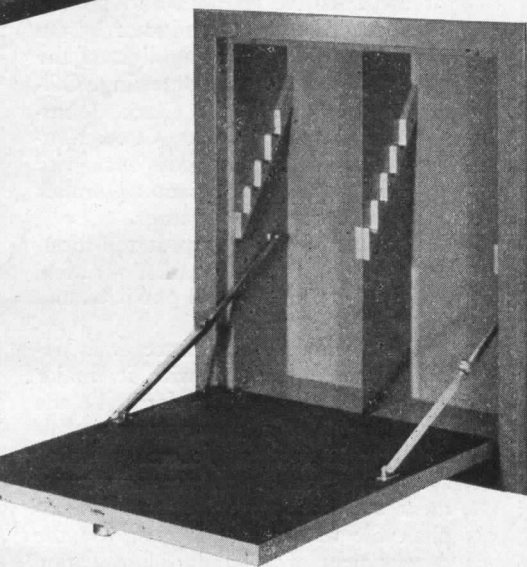
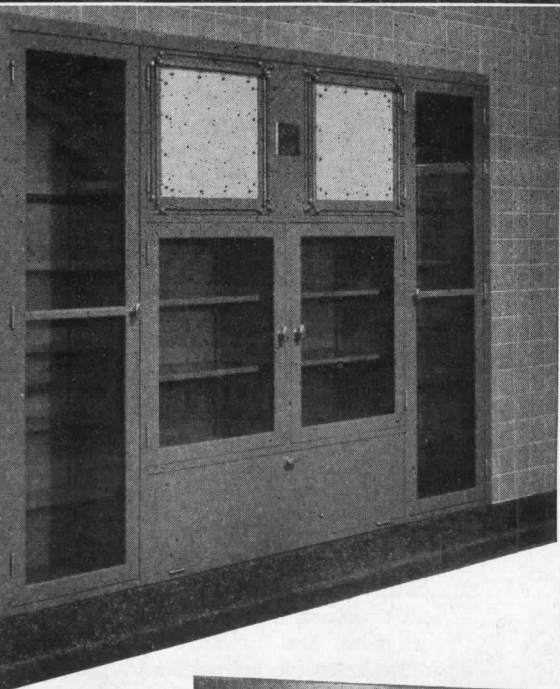
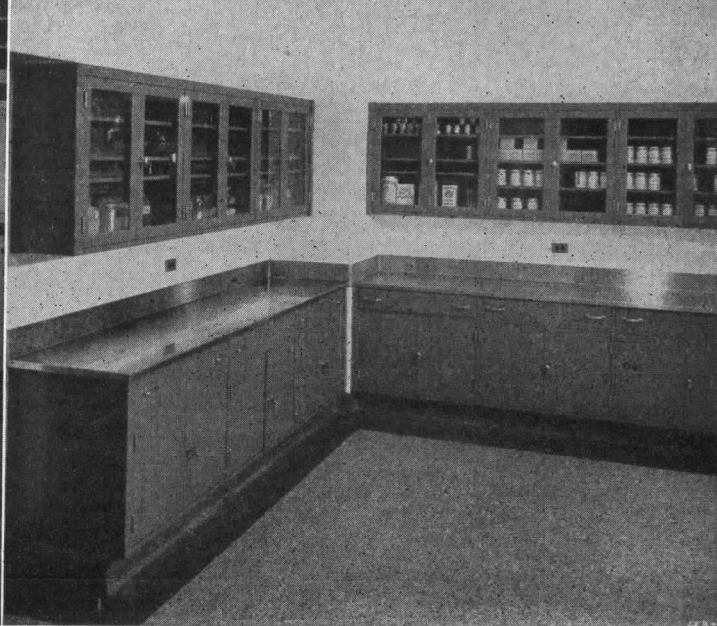

GF FURNITURE *Built* **IN ANY METAL**

GF Metal Furniture is built by skilled craftsmen in any metal desired, and is designed for many requirements.

For the hospital there are built-in metal cabinets and shelving, both custom made and standard. Goodform Aluminum Chairs and Tables meet all hospital specifications for utility, comfort, beauty and sanitation.

GF library equipment is equally dependable. There are multiple tier stacks, free standing units, card record cases, files, desks, and Goodform Aluminum Chairs and Tables.

GF also builds special metal furniture for laboratories, public buildings, institutions and all the broad field of architectural endeavor.



THE GENERAL FIREPROOFING COMPANY
YOUNGSTOWN 1, OHIO

METAL DESKS • GOODFORM ALUMINUM CHAIRS • METAL FILING CABINETS • STEEL SHELVING • FILING SUPPLIES • SAFES • STORAGE CABINETS

THE RECORD REPORTS (Continued from page 118)

of the traffic would be handled through the terminal without stopping for street lights or touching the surface streets.

The building is planned on a generous scale, giving ample room for expansion. The roof will be flat for a distance of 500 ft. from the Ninth Avenue end so that it might be developed for helicopter or flying bus use in the future.

The terminal will consist primarily of three levels: a ground floor level

containing loading and unloading platforms for long-distance buses; an upper level for suburban short-haul buses, reached by overhead ramp from the Lincoln Tunnel plazas and nearby streets; and an intermediate concourse level for distribution of passengers for both the short-haul and the long distance lines to the stairways and escalators.

The long-distance level will provide 38 loading berths for normal operation,

with 45 for peak periods. The suburban level will provide space for 60 buses at one time.

PRODUCT EXHIBIT

Macy's "Preview of Tomorrow," an exhibit of postwar products, is now scheduled to open on September 4th, to remain on view for four weeks. Over 50,000 sq. ft. on the fifth floor of the New York department store will be devoted to the show. Present plans call for division of the exhibit area into various sections—the home, transportation, apparel, etc.

There will be three types of exhibit: (1) new and different products that are or will be immediately available; (2) products which, because of delay in reconversion or continued production for military use, will be marketed in the future, but can be shown now; (3) products which will be available only in the distant future and which will be presented through the medium of drawings, scale models or mock-ups.

Macy's staff of more than 100 buyers will search the market for all new products of interest to the public. In addition, a limited number of industrial concerns will be invited to discuss the possibility of their having special exhibits.

For further information, address Bert Bacharach, Director of Exhibit, Macy's, Herald Square, New York 1.

ASPHALT TILE

GROUP ELECTS

Election of officers and the establishment of five committees to develop detailed plans and methods of operation for the extensive research and promotional program to be conducted by the Asphalt Tile Institute highlighted the Institute's recent annual meeting. Officers elected are: E. F. Clark, Johns-Manville Corp., president; C. A. Neumann, David E. Kennedy Inc., vice president; Ralph Boligiano, Duraflex Corp., secretary and treasurer.

The committees set up at the meeting are the technical, market research, statistical, promotion and publicity, and the tariff and traffic.

The technical committee was reported well underway with its major task of compiling data for: (1) the development of a grease-proof asphalt tile specification for federal building agencies; (2) a list of necessary equipment and other requirements for asphalt tile testing laboratories; (3) the development of a standard installation and maintenance specification; (4) the development of a specification for an adhesive for the installation of regular and greaseproof asphalt tile; (5) standard specification for installing asphalt

(Continued on page 122)

Mo-Sai

REG. U.S. PAT. OFF.

ARCHITECTURAL SLABS

QUICK FACTS

- Thin, 2" Thick.
- Large Units up to 100 sq. ft.
- Large Integral Returns.
- Fewer Joints.
- Light Weight, 25 lbs. p.s.f.
- Economical, Easy to Erect.
- Balanced Reinforcing.
- 7,500 p.s.i. Compressive Strength.
- Absorption Less Than 6%.
- Low Expansion and Contraction.
- DECORATIVE.
- Exposed Aggregate Finish.
- Unlimited Color Combinations.
- Inlaid Ornament and Lettering.
- As FORMING for monolithic Concrete Buildings

It acts as the finished PRE-INSPECTED facing.

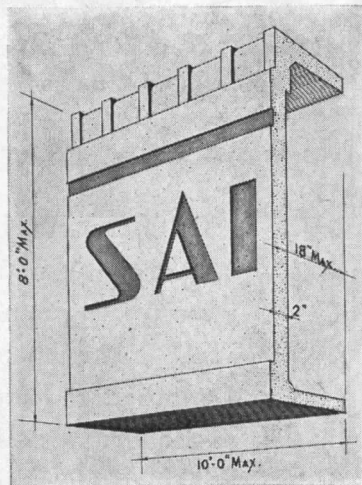

Modern

Colorful

Decorative

Mo-Sai

offers a "NEW FREEDOM" in design

See our catalog in SWEET'S

MO-SAI ASSOCIATES

New Haven, Conn.....The Dextone Company.....P. O. Box 606
 Boston, Mass.....Cambridge Cement Stone Company.....156 Lincoln St.
 Philadelphia, Pa.....Formigli Arch'l Stone Company.....R. E. Trust Bldg.
 Richmond, Va.....Economy Cast Stone Company.....P. O. Box 1223
 Greensboro, N. C.....Arnold Stone Company, Inc.....P. O. Box 477
 Oshkosh, Wis.....Badger Concrete Company.....191 Marion St.
 Salt Lake City, Utah.....Otto Buehner & Company.....640 Wilmington Ave.

MO-SAI ASSOCIATES, founded to standardize and improve architectural slabs.
 The registered trade mark "Mo-Sai" is the property of the Dextone Co.

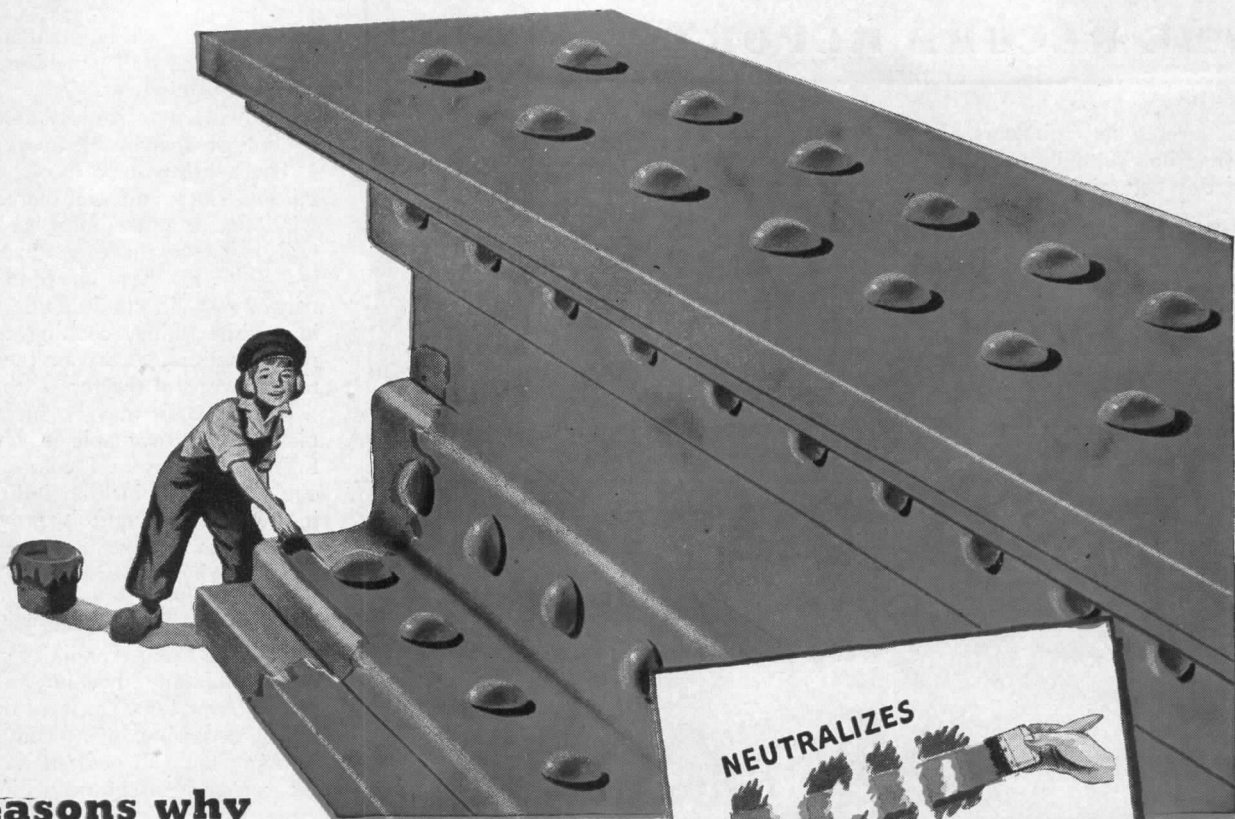

2 Reasons why

RED LEAD

means Extra Rust Protection . . .

Why is Red Lead so widely accepted throughout industry as *The* metal protective paint?

Why are paints containing Red Lead so generally specified for safeguarding metal surfaces from the costly ravages of rust?

The reasons are many, but none are more noteworthy than Red Lead's ability to counteract acid conditions and to halt electrochemical action—both prime causes of rusting—as explained at right.

Still another important advantage of Red Lead is that it partially combines with the usual vehicles to form compounds generally known as "lead soaps." Due to their composition and the individual way in which these compounds form, the film obtained is highly water-resistant. In addition, lead soaps contribute to the formation of tough, elastic films that "stick on the job."

Remember, too, that Red Lead is compatible with practically all vehicles commonly used in metal protective paints, including phenolic and alkyd resin types.

Specify Red Lead for ALL Metal Paints

The value of Red Lead as a rust preventive is most fully realized in a metal paint where it is the only pigment used.

2 Another outstanding reason Red Lead means *extra* rust protection is the unique way it shields metal surfaces with a protective film. Rusting is fundamentally an electrochemical process in which weak currents are generated which cause iron to become soluble in the lowest state of oxidation. Red Lead has properties through which this iron is rapidly converted to a stable compound that forms an adherent film. The formation of this protective shield halts electrochemical action, thus preventing further corrosion.

NEUTRALIZES



1 Red Lead has the ability to counteract acid conditions which are recognized as accelerators of rust. Structural steel is exposed to such environments because acid forming compounds are carried by the atmosphere in the form of gas, smoke and moisture. Red Lead has a neutralizing effect on these conditions as it is essentially a *basic* pigment with the ability to develop and maintain, for a prolonged time, a mild alkaline environment at the surface of the metal. Authoritative tests show that, as a result, Red Lead inhibits the process of corrosion. In short, metal paints, too, should "stay on the alkaline side."

Write for New Booklet

"Red Lead in Corrosion Resistant Paints" is an up-to-date, authoritative guide for those responsible for specifying and formulating paint for structural iron and steel. It describes in detail the scientific reasons why Red Lead gives superior metal protection. It also includes typical specification formulas. If you haven't received your copy, address nearest branch listed below.

* * *

The benefit of our extensive experience with metal paints for both underwater and atmospheric use is available through our technical staff.



NATIONAL LEAD COMPANY: New York 6, Buffalo 3, Chicago 10, Cincinnati 3, Cleveland 13, St. Louis 1, San Francisco 10, Boston 6 (National-Boston Lead Co.); Pittsburgh 30 (National Lead & Oil Co. of Penna.); Philadelphia 7 (John T. Lewis & Bros. Co.)

However its rust-resistant properties are so pronounced that it also improves any multiple pigment paint. No matter what price you pay, you'll get a better metal paint if it contains Red Lead.

DUTCH BOY RED LEAD

tile over wood sub-floors. E. H. Berger, Johns-Manville Corp., is chairman of this committee.

"DWELLING MACHINES"

R. Buckminster Fuller's famous Dymaxion house is to be mass produced after the war by Dymaxion Dwelling Machines, Inc., of Topeka, Kansas, a new company in which Mr. Fuller is chairman of the board of directors. The first prototype of the so-called

"dwelling machine" is now under construction in Wichita through the cooperation of Beech Aircraft Corporation in providing facilities at Krehbiel Plastic Products, a sub-contractor.

The house will be built from the inside out, with all utilities and equipment arranged in a central dynamic mast. Features will be spacious rooms and the possibility of movable walls for changing room sizes or adding rooms. All closets, cupboards, bureaus

and bookcases will be manufactured directly into the wall panels, and will be standard equipment. New floor coverings will curve slightly at the walls, to eliminate inaccessible dust collections.

The house will be round, with aluminum sides and transparent plastic windows. Into the mast, or "engine" will go factory-made, economically fitted units for heating, plumbing, refrigerating, air conditioning, laundering, dishwashing, cooking and bathroom facilities. A streamlined ventilator will conceal the top of the mast.

Interior walls may be surfaced with plastic fabrics available in a variety of finishes, designs and colors. Elective equipment will include indirect lighting with color controls providing instantaneous change in interior color and intensity as desired.

Mass production methods, utilizing aircraft assembly line techniques, are expected to bring economies permitting the small-family dwelling machine to provide over 1,000 sq. ft. of floor space, which, according to the company, will be more than 50 per cent larger than the conventional house selling in the same price class. Larger dwelling machines will be available covering more floor area on one level, in addition to two-story models.

NEW YORK A.I.A. PRESENTS CITATIONS

At the 77th Anniversary Dinner of the New York Chapter, A.I.A., citations were issued to five members of the chapter who have distinguished themselves in fields outside of the profession. The five men so honored were Ernest Flagg, Jacques Andre Fouilhoux, Daniel Paul Higgins, Archibald Manning Brown, and Wallace Kirkman Harrison.

CONTRACT TERMINATION

The Joint Army-Navy Termination Regulation is the "Bible" for war contractors to be used in the rapid settlement of war contracts. A recent survey discloses that less than 40 per cent of the war contractors circularized had availed themselves of this publication. A Joint Army-Navy Distribution Center has been established at 90 Church Street, New York City, to distribute the Regulation, together with other printed material pertaining to contract settlement.

It is imperative that contractors holding war contracts be placed on the mailing list for the Regulation and all subsequent changes, the War and Navy Departments emphasize. There is no charge for any publications distributed by the Center. Requests for copies should be sent to the Center at above address, "Attention Lt. E. P. Lull."

(Continued on page 124)

SISALKRAFT
Worthy of Your Skillful Design



Note absence of batten strips and tears in this SISALKRAFT application. This reinforced paper is strong enough to pull around corners.



As a moisture barrier back of plaster, SISALKRAFT protects wood frame and insulation from moisture condensation. Photo shows plaster base being applied over SISALKRAFT.

**FAITHFUL
IN ITS PERFORMANCE!**

Added assurance of performance in construction and long-lasting comfort are yours when you specify SISALKRAFT over the sheathing — as flashing around window and door openings — as the moisture barrier beneath plastered surfaces. The *intact application* of this sisal-reinforced, asphalt bonded building paper shuts out wind and weather—assures maximum protection of the wood structure and absence of drafts.



As flashing, SISALKRAFT is economical to use and easy to install.

Samples of SISALKRAFT may be secured from your local lumber dealer — or write direct.

THE SISALKRAFT CO.
205 W. WACKER DRIVE - CHICAGO 6, ILL.
NEW YORK - SAN FRANCISCO - LONDON - SYDNEY
In Canada Write to: Alexander Murray & Co., Limited, 47
Montreal - Toronto - Halifax - Saint John - Winnipeg - Vancouver

Manufacturers of SISALKRAFT, FIBREEN, SISAL-X,
SISALTAPE AND COPPER-ARMORED SISALKRAFT

... and Then Myrtle Opened Her Purse



1 Though the street outside is stifling,
Inside Heatter's store it's worse.
Myrtle, in no mood for trifling,
Hastens out with tight-closed purse.



2 In McCool's the fagged-out lady
Trades her frown in for a smile.
Air that hints of palm trees shady
Bids her stop and shop a while.



3 End that long "war of attrition"—
Don't send folks out with a grouse!
Keep your air in peak condition—
Modernize — with Westinghouse!

It pays to be sure that your clients have correct air conditioning . . . that temperature, humidity, circulation and ventilation are scientifically blended for the comfort of customers and for personnel efficiency . . . that air cleanliness is complete for protection of merchandise and furnishings.

Be sure your clients get it. Call for Westinghouse application assistance early in the planning of new or modernized commercial or industrial buildings. Phone your nearest Westinghouse office or write Westinghouse, 150 Pacific Avenue, Jersey City 4, N. J.

THE SERVICE-PROVED HERMETICALLY-SEALED COMPRESSOR

These Westinghouse economy-satisfaction advantages have been proved by years of service in thousands of installations:—

No Shaft Seals. During wartime refrigerant shortages, few Westinghouse systems were ever "down." Why? Because seal leaks are the cause of a large percentage of all system failures.

Few Parts to Wear . . . Direct-Drive Efficiency . . . Space-Saving Refrigerant-Cooled Motor.

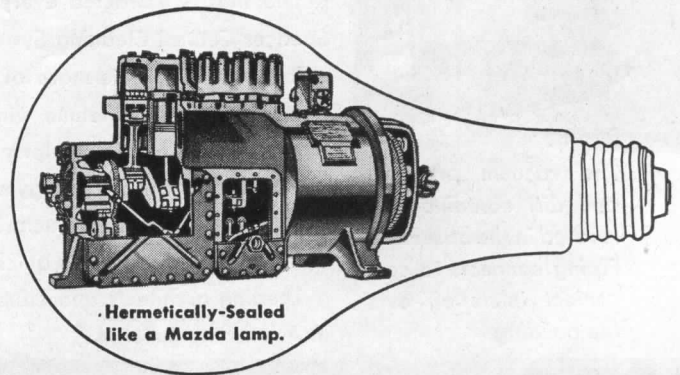

Hermetically-Sealed
like a Mazda lamp.

Westinghouse **CORRECT** Air Conditioning

PLANTS IN 25 CITIES . . . OFFICES EVERYWHERE

Westinghouse Presents John Charles Thomas • Sunday, 2:30 E.W.T., N.B.C.

**BUILDING COUNCIL
RECOMMENDED**

Creation of a "Building Council of America" to help meet postwar problems of the building construction industry has been recommended by Daniel Paul Higgins, of Eggers & Higgins, architects.

Mr. Higgins suggests that the council comprise "all elements of free enterprise within the construction industry, both public and private," includ-

ing representatives of the architectural and engineering professions, labor, owners, producers and fabricators, and perhaps with government being invited to name representatives. He proposes also that the Council have headquarters in Washington.

BIGGER LOANS NEEDED

Among the many declarations made in favor of a larger appropriation for public works advance planning before

the Senate settled on the compromise sum of \$35,000,000, was one by H. E. Foreman, managing director of the Associated General Contractors of America. Urging that the Senate increase the House appropriation of \$5,000,000 to the \$75,000,000 recommended by the FWA, Mr. Foreman said that \$5,000,000 would prove entirely inadequate.

"Under the \$5,000,000 appropriation some states would receive loans of only \$24,000," Mr. Foreman said. "Since the average cost of planning is about 5 per cent of the entire estimated cost of a construction project, not counting the cost of any land that may be acquired, the local governments in states receiving loans of only \$24,000 could develop plans for less than a half million dollars worth of public works projects.

"An appropriation of \$75,000,000 would provide loans of not less than \$375,000 for any state, and would provide for the planning of public works in all states to the total amount of \$1,500,000,000."

POSTWAR PUBLIC WORKS

Seven recommendations on postwar public works construction have been presented to the House Subcommittee of Public Works and Construction, a part of the Special Committee on Postwar Economic Policy and Planning, by Edward P. Palmer, chairman of the Construction and Civic Development Department Committee of the Chamber of Commerce of the United States.

In normal times, Mr. Palmer pointed out, public works construction accounts for only one-third of the total volume of construction, the other two-thirds being privately financed. "Important as the contribution of public works has been and will be to the industry, and hence to the national economy," he said, "it is evident that measures to encourage privately financed construction are even more important."

Briefly stated, Mr. Palmer's recommendations are:

1. Sponsorship of various classes of public works by federal, state and local governments should be clarified.
2. The federal tax structure should be revised so as not to hamper the ability of state and local governments to achieve financial independence.
3. Congressional scrutiny of federal public works projects should be broadened to include careful consideration of the over-all budgetary picture.
4. Construction through competitive contracts should be more widely used to assure economy and clarify costs, in order to assure better consideration of needs, costs, etc.
5. State and local governments

(Continued on page 126)



"PAY DIRT" IN SCHOOLS

Dirt and dust can be very expensive if not promptly removed. It endangers health, destroys books, decorations and equipment and lowers the morale of the students.

The real "Pay dirt" is that extra ounce or pound that is extracted every day with the Spencer Central Cleaning System.

It saves time, gets more of the dirt, and because it lasts a lifetime with low maintenance, it costs less in the long run.

Also cleans chalk trays, gymnasiums, radiators, boilers, filters, projectors and a dozen other hard-to-clean spots quickly and easily.

Leading architects and educators endorse it. Ask for the Bulletins.

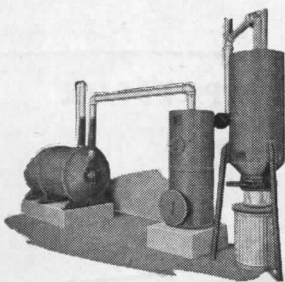

The vacuum producer and dirt container are located in the basement. Piping connects to convenient inlets all over the building.

SPENCER VACUUM
HARTFORD
CLEANING
THE SPENCER TURBINE COMPANY, HARTFORD 6, CONN.

"Penny-pinching" destroyed this Business

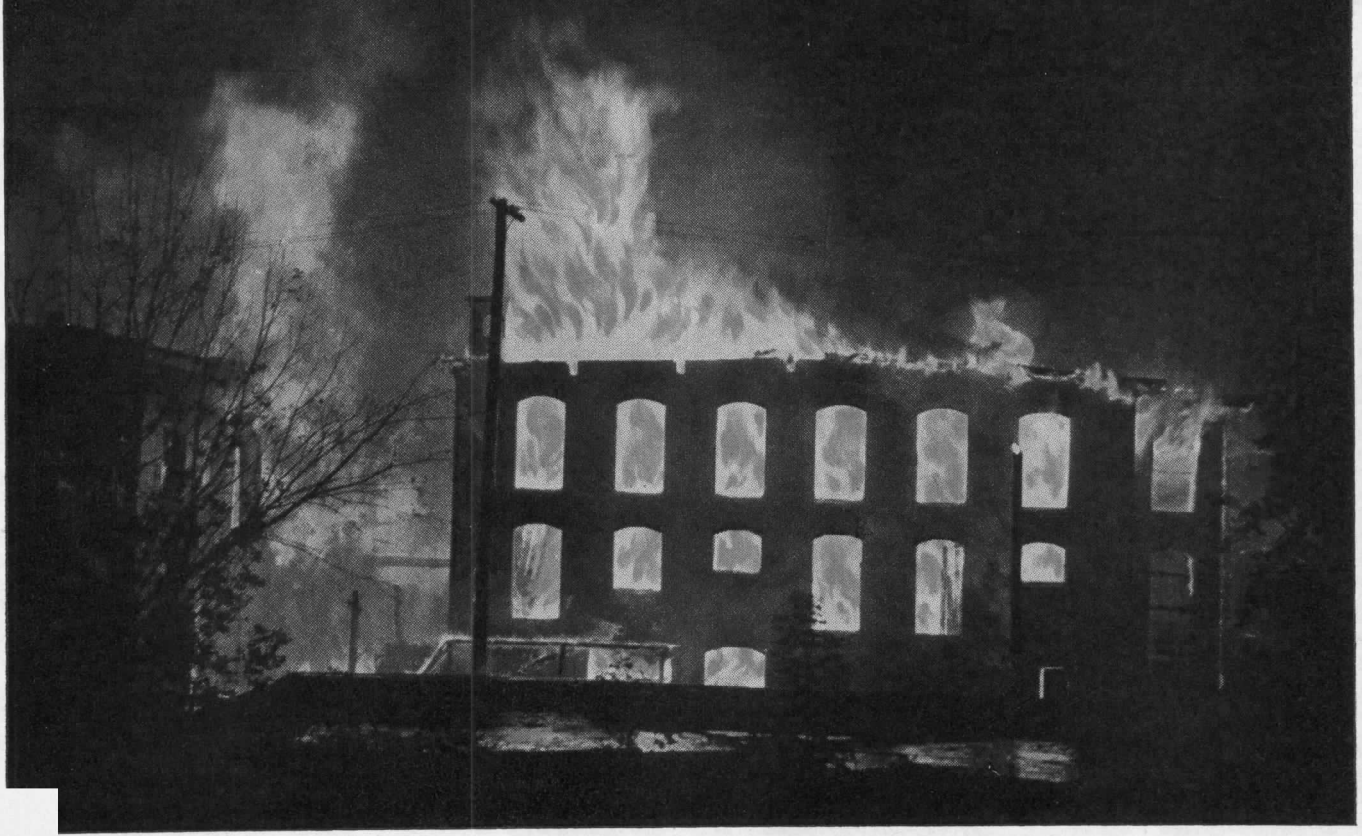

A FEW DOLLARS WERE SAVED in refitting this former textile mill for plastics manufacture by failing to restore the automatic sprinkler system.

THIS DISASTROUS "PENNY-PINCHING" ignored one of the most common hazards of business . . . fire. Result: a plant and its equipment destroyed—a promising new enterprise out of business.

FIRE HAZARDS HAVE MULTIPLIED and losses today are almost irreplaceable. No amount of insurance will save buildings or their valuable contents, or bring back lost customers. Experience shows that 2 out of every 5 burned-out businesses never resume operations. What precautions have you taken to protect what you have built up?

FIRE CAN BE CONTROLLED This needless destruction can be checked *at the source, when it starts*, with a Grinnell Automatic Sprinkler System. During the past ten years over 8000 fires in Grinnell protected buildings have put themselves out before major damage could occur. See that your property has this 24-hour-a-day protection before fire strikes. Experienced Grinnell Engineers will help you plan the type of dependable protection you need.

QUESTIONS AND ANSWERS about Automatic Sprinkler Fire Protection



Q. What about water damage from many open sprinklers?

A. A record of 61,408 fires shows opening of 5 sprinklers or less in 75% of them, 2 sprinklers or less in 52%.



Q. My building is metal; its contents are non-combustible. Why should I have sprinklers?

A. A metal mill burned to ruins in an afternoon. Oil vapor had condensed on inside walls.



Q. Will my plant have to shut down while you're installing sprinklers?

A. No. A Grinnell System is prefabricated in our plant, installed in your plant by men so expert they've equipped hospitals without disturbing patients.



Q. How much will a Grinnell System cost me?

A. In a typical case the insurance premiums were \$5000 a year. With Grinnell Sprinkler Protection the premium reductions paid for the system in 8 1/3 years. Then it paid the owner \$3000 a year.

GRINNELL  COMPANY

Executive Offices, Providence 1, R. I.
Branch offices in principal cities



GRINNELL

AUTOMATIC SPRINKLER FIRE PROTECTION

should cooperate with the federal government in the advance planning of public works in order to be ready for the transition period when materials will be available and additional employment essential.

6. The federal government should collect and make available continuously current statistics on both public and private construction volume and employment as a practical first step to-

wards stabilizing construction activity.

7. Private construction should be stimulated by revising tax policies to remove deterrents to expanding activity. Specifically, provision should be made for accelerated depreciation, deferred maintenance, postwar reserves for reconversion construction and planning, and liberalization of the provisions for averaging net operating losses over a period of years.

SCHOLARSHIPS

The American Institute of Architects will receive proposals of candidates for Edward Langley Scholarships until April 30, 1945. Awards will be announced in May or June.

These scholarships are awarded annually for advanced work in architecture through study, travel or research, as the candidate elects. They are open to all residents of the United States and Canada who are engaged in the profession of architecture: architects, architectural draftsmen, and teachers and students in architecture. Awards will be made upon a competitive basis from the standpoint of character, ability and need of each candidate; the purpose of the grant; potential contribution to professional knowledge or welfare; and amount of grant required.

Any architect in the United States or Canada may propose any other architect or architectural draftsman residing in the same country. The faculty or head of any architectural school in either country whose standing is satisfactory to the committee may propose any teacher or student in such school. Proposals must be made in duplicate on A.I.A. Form S70, which may be obtained from the A.I.A., 1741 New York Ave., Washington 6, D. C.

APPOINTMENTS ANNOUNCED

Raymond F. Leonard has been appointed Chief of the Division of Land Planning, City Planning Commission of Philadelphia, and Hans Blumenfeld has been selected as Senior Land Planner. Both Mr. Leonard and Mr. Blumenfeld won top place on civil service eligible lists for the respective positions, following competitive examinations held concurrently in 20 cities.

A CORRECTION

Our apologies to Frank Wynkoop for the misspelling of his name in our March issue (page 74).

OPPORTUNITIES AVAILABLE

PRODUCT DESIGN ENGINEER: Graduate architect or industrial design engineer, under 35 years of age, to initiate and develop new consumer product designs in glass. Should have manufacturing experience and ability to coordinate his work with Sales, Production and Research departments.

Here is a real opportunity to join America's leading glass manufacturing company. This is a new position, with excellent prospects for the man willing and able to do creative work. If not now engaged in essential war work, write Personnel Department, giving complete description of education, professional experience, draft status. Enclose recent photograph. Salary commensurate with abilities. All replies confidential. Corning Glass Works, Corning, N. Y.



Barcol OVERdoor FOR RESIDENCE GARAGES

What a beauty! We wish we could sell Barcol OVERdoors like that, for good-looking new homes like that, so they could be opened and closed so easily by pretty girls like that — but naturally we can't until our vital war work is done and restrictions are lifted. In the meantime, YOU CAN PLAN on Barcol OVERdoors for after the war with full assurance that you will get all the outstanding Barcol features — tailored twin-torsion counterbalancing springs, self-latching bolts, roller-crank closing action that means easy operation without sticking, and continuous vertical track brackets for safety and strength. Be sure our data sheets are where you can find them. If you haven't any, write!

*Barcol OVERdoors
Electric Door Operators
Switch Controls
Radio Control*



FACTORY-TRAINED SALES and SERVICE REPRESENTATIVES IN PRINCIPAL CITIES

BARBER-COLMAN COMPANY

102 MILL ST. • ROCKFORD, ILL.

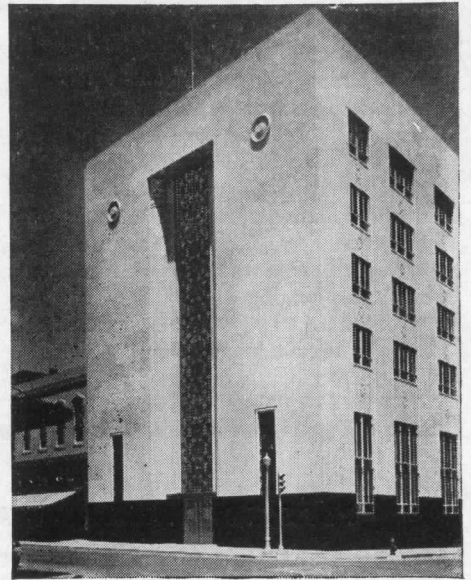
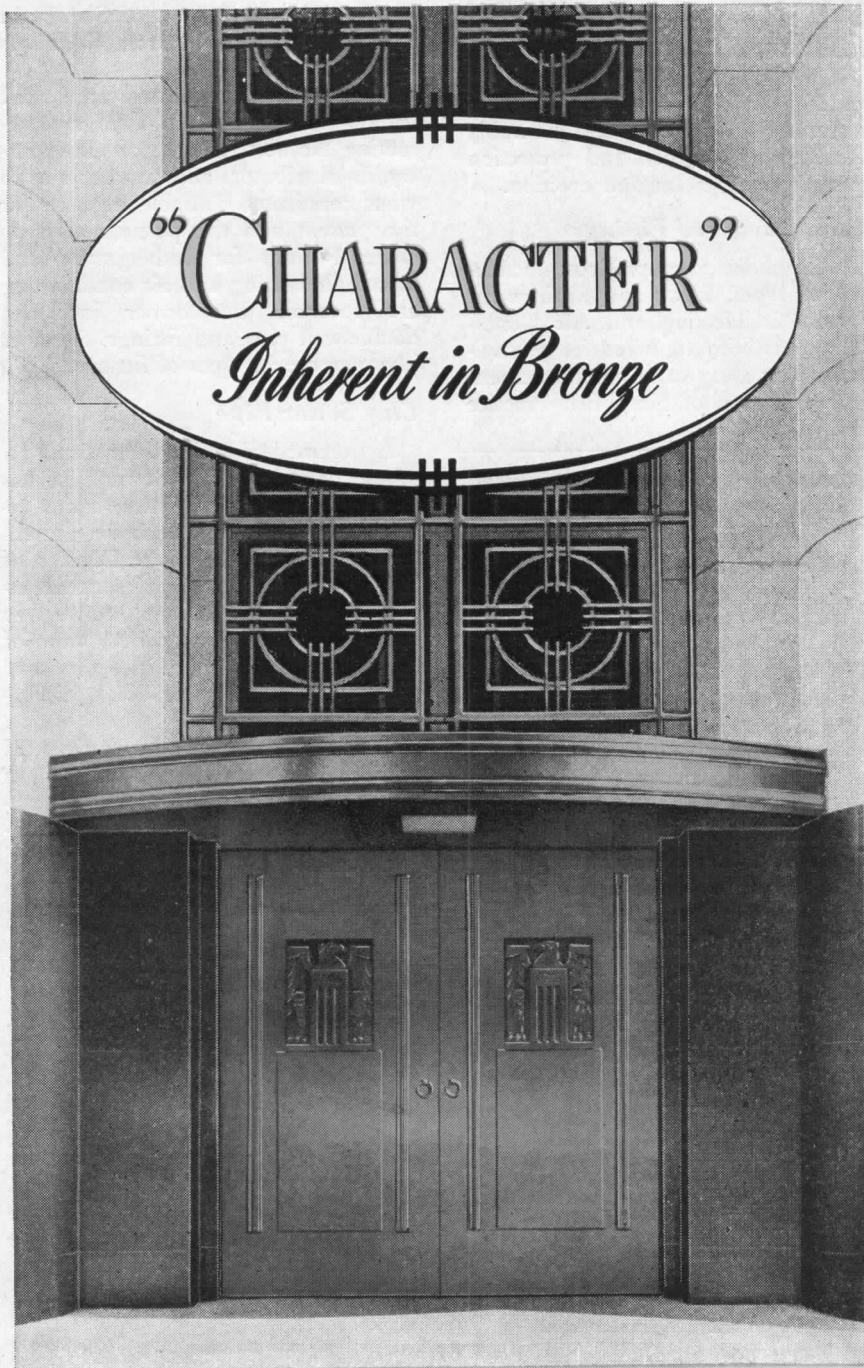

These photographs show the Anaconda Extruded Architectural Bronzework on the Victoria Bank and Trust Company Building, Victoria, Texas. The continuous bronze grille extending upward five stories above the Main Entrance is believed to be the largest single frame in the country. The Benson Manufacturing Company of Kansas City, Mo., executed the entire bronze installation . . . Architects—C. H. Page & Son, Austin, Texas.

A glance at the illustrations reveals how the impressive "character" motif of this bank building was carried out by using Anaconda Architectural Bronze. At the same time, the air of charm and distinction it lends is also apparent. But there's more to bronze than appears on the surface.

Besides its beauty and remarkable adaptability to design, bronze offers the double economy of durability and ease of fabrication. Its moderate cost is a further reason why so many leading architects have specified this ageless metal.

The American Brass Company has for years been the leading supplier of Architectural Bronze, Copper and Nickel Silver in all wrought forms for ornamental work of every description.

4593

**BUY WAR BONDS . . .
Saved Dollars Mean Saved Lives**

FOR ORNAMENTAL WORK



Anaconda Bronze

THE AMERICAN BRASS COMPANY—General Offices: Waterbury 88, Conn.

Subsidiary of Anaconda Copper Mining Company • In Canada: ANACONDA AMERICAN BRASS LTD., New Toronto, Ont.

of the standard is to establish a measure of quality for prefabricated homes.

The standard provides minimum requirements for one, one and a half, and two story prefabricated homes. It covers structural strength of the various component parts, requirements for light and ventilation, and recommended requirements for foundations, chimneys, heating, plumbing, insulation, and electrical wiring. It includes general requirements for material,

workmanship as provided by the manufacturer, site erection and assembly of prefabricated units, and protection during transportation and erection.

Pipes, Ducts and Fittings

A Simplified Practice Recommendation for Pipes, Ducts and Fittings for Warm Air Heating and Air Conditioning has been approved for promulgation, according to an announcement of the Division of Simplified Practice

of the National Bureau of Standards. It became effective March 1, and is identified as R207-45.

The recommendation sets up a stock list of pipes, ducts and fittings representing the best thought of the industry, its distributors and customers as to what constitutes desirable practice for the present and the postwar days to come. Fittings for both gravity and forced air heating and air conditioning are covered, the former including double-wall pipe and fittings. Sketches illustrate the 91 types of fittings.

Clay Sewer Pipe

A proposed Simplified Practice Recommendation for Clay Sewer Pipe has been submitted to all interests for acceptance or comment, according to another announcement of the Division of Simplified Practice. It represents an effort on the part of the industry to retain in the postwar period some of the benefits of simplified practice which resulted from the WLB Limitation Order L-316.

The proposal lists the variety of standard-strength and extra-strength pipe and fittings that should be considered as stock items. If the recommendation as proposed or as adjusted is found to be generally satisfactory, it will become effective on the expiration of Limitation Order L-316.

Western Hemlock Plywood

Recommended Commercial Standard for Western Hemlock Plywood, TS-3836 (see ARCHITECTURAL RECORD, Jan., 1945, p. 118) has been accepted by the trade and is now a recorded standard of the industry, effective for new production from March 5, 1945. Printed copies of the standard, identified as CS122-45, will be mailed to non-acceptors only on specific request.

DRAFTING AIDS

Just announced by one company are two new aids for draftsmen: an adjustable triangle, and a tissue-thin transparent film for protecting, preserving and repairing tracings, drawings, etc.

The triangle, made of heavy, but highly transparent plastic with molded-in calibrations of half degrees, can be quickly adjusted for any angle from 0° to 90°.

The transparent film is *Dulseal*, a cellulose acetate sheet with a mat surface. Can be written on with either pencil or ink; corrections can be made by erasing or rubbing with a moist cloth. Applied with light hand pressure, *Dulseal* forms a permanent protective covering that is waterproof, dust-proof, greaseproof and washable. Charles Bruning Co., Inc., 4754 Montrose Ave., Chicago 41, Ill.

PLASTIC-FINISHED MARLITE WALL PANELS

for Faithful Reproduction of

Design Ideas

If it is a note of friendliness; a cheerful, festive design; a pattern of grace or symmetry; or a stately, dignified atmosphere you want to capture for a room interior you're planning—then you'll want the character, warmth, color and beauty of Marlite wall paneling to bring your creative designs to purposeful life.

Marlite is manufactured in a wide variety of colors and patterns. Large, wall-size panels range from plain-colors to genuine wood-veneers, permitting full freedom of decorative originality and design ingenuity. Harmonizing moldings in plastic, wood,

presdwood and metal are available.

Marlite's pioneer high-heat-bake-finish is impervious to the penetrating effects of dirt and moisture, and retains its original lustre and beauty for many years. Marlite is moderately priced and serves equally well for new construction or remodeling—for all types of rooms in all types of buildings.

★

These two photos typify the ultra modern and attractive interiors possible with Marlite paneling. Genuine Marlite wood-veneers provide the setting for the hat shoppe with plastic-finished Marlite (mirror black finish for walls and white Marlite for ceiling) in the bedroom.

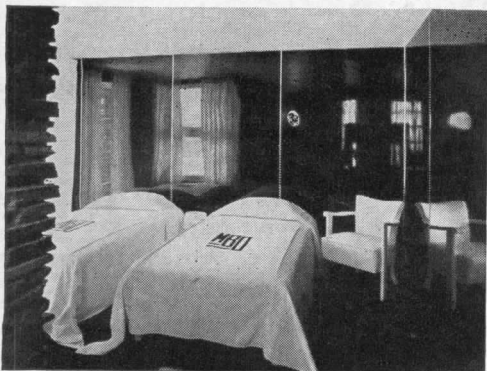

MARSH WALL PRODUCTS, INC. • 45 MAIN STREET, DOVER, OHIO

PLASTIC-FINISHED WALL PANELS • FOR CREATING BEAUTIFUL INTERIORS



Of course the Sheik is confused by Laytex-insulated wire. He's one of the countless number of men now seeing wire for the first time. In hot deserts and tropical jungles, in distant islands and freezing arctic lands—places where electricity has never before been harnessed, Laytex is demonstrating its marvelous properties as a wire. To many of the people in these lands, wire henceforth means Laytex.

But to us here at home, Laytex is *more* than the average wire. Under the strain of world-wide war, Laytex gives better performance than was ever expected of any wire under such gruelling conditions.

Military needs now take the entire output of Laytex Wires and Cables. But we hope the day is not far off when manufacture will be resumed for Residential and Commercial Building, Police and Fire Alarm Systems, Communications, Signalling, Power Control and other exacting services.

Rubber Insulation at Its Best

U.S. Laytex

**ELECTRICAL
WIRES AND CABLES**



Serving Through Science

UNITED STATES RUBBER COMPANY

1230 SIXTH AVENUE • ROCKEFELLER CENTER • NEW YORK 20, N. Y. • In Canada: DOMINION RUBBER CO., LTD.



Better Heating With Rationed Fuel

There's only one way to obtain better heating with less fuel... One way to assure even heat throughout your building. And that's by installing an automatically controlled steam heating system... One that will stretch your rationed fuel to every part of the building.

The Webster Moderator System of Steam Heating is automatically controlled. There's never any waste of rationed fuel, because just enough steam is delivered to each radiator to keep you comfortable at that particular time. Even temperatures are always maintained.

The Webster Moderator System has just four control elements—an Outdoor Thermostat, a Main Steam Control Valve, a Manual Variator and a Pressure Control Cabinet. These "controls" of the Webster System assure increased comfort and economy in modern steam heating.

More Heat with Less Fuel

Seven out of ten large buildings in America (many less than ten years old) can get up to 33 per cent more heat from the fuel consumed. This is the result found from thousands of surveys made by Webster Engineers.

If you're interested in learning how profitable it can be to change your present system into a Webster Moderator System, write for "Performance Facts". This free booklet describes 268 Webster System installations and the savings they are effecting. Write Department AR-4.



The Webster Outdoor Thermostat automatically changes heating rate when outdoor temperature changes.

WARREN WEBSTER & CO., Camden, N. J.
Pioneers of the Vacuum System of Steam Heating
Representatives in principal Cities: : Est. 1888
In Canada, Darling Brothers, Limited, Montreal

Fuel-Saving
Starts With
CONTROL

AUTOMATIC
Webster
Steam Heating

REQUIRED READING

(Continued from page 116)

IN BRIEF

STRUCTURAL STEEL

Technical and Commercial Developments in Light Gage Structural Steel. By Milton Male. New York (101 Park Ave.), American Institute of Steel Construction, 1944. 8½ by 11 in. 23 pp. illus.

An address made by Milton Male at the annual convention of the American Institute of Steel Construction last November. Discusses properties of light gage, flat rolled steel, its durability, design specifications, commercial developments and applications. Includes a number of photographs of buildings using light gage steel construction.

POWER DISTRIBUTION

Electric Power Distribution for Industrial Plants. New York (33 W. 39th St.), The American Institute of Electrical Engineers, 1944. 7¾ by 10⅞ in. 109 pp. illus. \$1.00.

Although developed by the A.I.E.E. Committee on Industrial Power Applications, this is not an A.I.E.E. standard, but a report outlining engineering principles of power distribution in industrial plants. Includes a discussion of equipment selection.

PUBLIC HOUSING IN NEWARK

Newark 4, N. J. (57 Sussex Ave.), Housing Authority of the City of Newark, 1944. 7 by 10 in. 39 pp. illus.

A report on Newark's public housing program which is intended eventually to replace an estimated 40,000 slum dwellings with modern, low-rent housing. To date only 2,736 units have been completed.

NEW EDITIONS

PLASTICS CATALOG: 1945

New York 17 (122 E. 42nd St.), Plastics Catalogue Corp., 1945. 8 by 11 in. 1178 pp. illus. \$6.00.

If anyone still has any doubts of the important part plastics will play in the postwar world, let him look at the 1945 Plastics Catalog. Almost 200 pages longer than last year's edition, it shows an astounding variety of products ranging from buttons to boats, roller skates and a guitar, bandages and rope.

An innovation in the 1945 Catalog is industry statistical information; figures show almost fantastic growth throughout the industry. Other new features are the first over-all price list of plastics and a section detailing

(Continued on page 132)

TALK OVER YOUR FENCING PLANS



WITH
Stewart
ENGINEERS

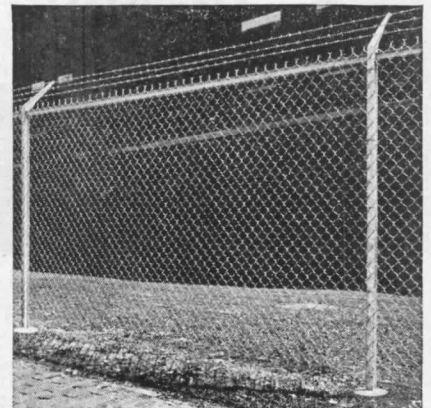

● Whether you plan a small home, a large estate, a public building or a factory, our engineers will be glad to talk fence requirements with you, and give you the benefit of many years' experience. There is no cost or obligation whatever. ❑ Restrictions still preclude the manufacture of most fence, but some Chain Link Wire Fence and other Stewart wire products are available NOW for certain protective purposes. On request, we'll be glad to tell you more about this.

The Stewart Iron Works Co., Inc.
1277 Stewart Block Cincinnati 1, Ohio

Stewart IRON and WIRE
FENCES

A REPORT on the Performance of MINWAX WOOD FINISH-

after 9 YEARS of SERVICE

Hillside Homes, Bronx, N. Y.
Clarence Stein, Architect
Starrett Bro. & Ekin, Builders
R. S. Truax, Flooring Contractor



ARE-APPRAISAL of materials and methods is an essential part of post-war planning. Believing that past performance furnishes the most reliable evidence of worth, we reproduce here a recent letter from the Operating Superintendent of Hillside Homes, Bronx, N. Y., a limited dividend project comprising 1416 apartments, completed in 1935.

All the floors were finished with MINWAX Wood Finish. During the years since that time, the MINWAX has given satisfactory service, despite hard wear and tear. The tenants have been pleased with the beautiful color and finish, and the management has found maintenance requirements exceptionally low, with no re-scraping necessary.

Results like these are possible because MINWAX is a *penetrative stainwax* finish. MINWAX cannot chip, mar or scratch white. Worn spots where traffic concentrates can easily be "patched"

HILLSIDE HOUSING CORPORATION

3480 Seymour Avenue
Bronx, New York

November 17, 1944

MINWAX Company, Inc.
New York 18, N. Y.

Gentlemen:

In reply to your inquiry, I would advise that during the past nine years the finish produced by your material has proved most satisfactory.

The oak floors throughout our 1416 apartments were finished with MINWAX Flat Finish when the project was built. The results can be summarized as follows:

1. The tenants like the finish both from the standpoint of appearance and serviceability.
2. The cost of maintenance remains low, and, as we advised you in October, 1938, we find that a simple touch-up of worn spots, which can be done without showing laps, and rewaxing when tenants change are all that is required.

ements in our previous letter of October 4, 1938 are ay, and after approximately nine years service, we are ly satisfied with the results.

Very truly yours,

Charles J. Lawrence
Charles J. Lawrence
Operating Superintendent

(retouched), with a little more MINWAX; therefore re-scraping is never necessary.

This serviceability is typical of MINWAX performance, and, we believe, assures that it will answer the requirements of the most exacting post-war developer or home owner.

For full information refer to our catalog in Sweet's, or write to MINWAX Company, Inc., 11 West 42nd St., New York 18, N. Y.

For the 27th consecutive year our
COMPLETE CATALOG IS IN SWEET'S
FOR FINAL VICTORY...BUY—AND HOLD—WAR BONDS!

MINWAX
WOOD FINISHES
Floors • Paneling • Trim
OTHER MINWAX PRODUCTS
Waterproofings • Dampproofings • Caulkings • Protective Coatings

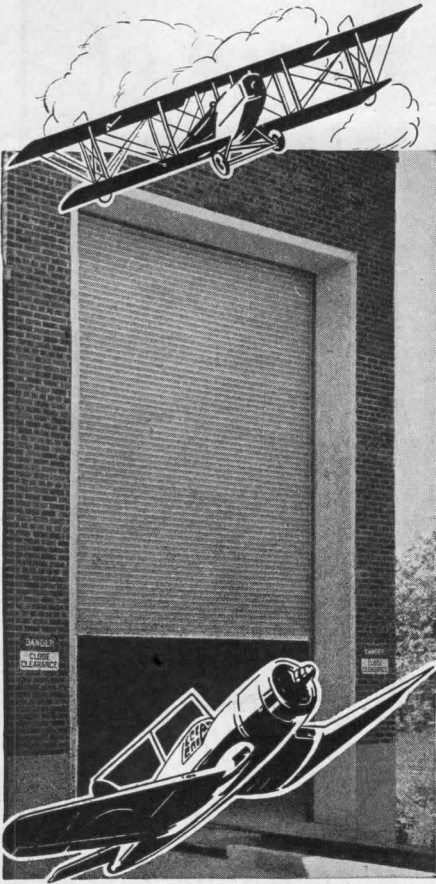

STILL GOING UP
... Because the Principle
is RIGHT!

Even in the days when airplanes first began to prove their efficiency, Kinnear Rolling Doors had "won their wings." Their principle of coiling upward action had long been proved. Supplemented by the interlocking steel slat curtain—originated by Kinnear—they afforded the most efficient door design ever developed. And they still do!

Kinnear Rolling Doors clear the entire opening with one quick, smooth, easy operation. They open completely out of the way, out of reach of damage! There are no overhead tracts to obstruct the use of conveyors, cranes, or similar equipment!

In fact, no other doors save more usable floor, wall, and ceiling space!

Kinnear Rolling Doors also combine rugged, all-steel durability with a degree of flexibility—they "absorb" many blows and impacts that damage ordinary doors.

They are built in any size, for old or new buildings, with motor or manual control. Write today for further information on money-saving, production boosting Kinnear Rolling Doors! The Kinnear Mfg. Co. Factories: 1860-80 Fields Ave., Columbus 16, Ohio and 1742 Yosemite Ave., San Francisco 24, Calif.

Offices and Agents in Principal Cities



REQUIRED READING

(Continued from page 130)

A.S.T.M. standards. New articles on recently developed materials include Silicones, Pollectron, Polyethylene, Furan Resins, Resorcin-formaldehyde resins. The article on Styrene also takes in the new high temperature resistant forms of styrene as well as Polyfibre.

Other additions to the contents of the Catalog are new articles on engineering design and plastic models. New information on cementing is included in the article on Compression Methods and Equipment. Extruding Machines and Molding Plant Equipment are both treated in revised articles.

The section on Laminates, Plywood and Vulcanized Fibre has been brought up to date and expanded to give all the latest information on low pressure and "no-pressure" molding and treated wood including the new Methylolurea impregnated wood. All of the latest information on synthetic rubbers and rubber-like plastics has been completely revised. The synthetic fibers receive expanded treatment, as do the coatings. Under the latter heading is a new article on Organic Coatings for Metals.

Eight charts of tabular information are included: (1) Plastics Properties; (2) Plastics Identification; (3) Chemical Formulae; (4) Plastics Materials Manufacture; (5) Solvents; (6) Plasticizers; (7) Plastics Used in Liquid Coatings; (8) Synthetic Rubbers.

WOOD TECHNOLOGY

By Harry Donald Tiemann, New York 19 (2 W. 45th St.), Pitman Publishing Corp., 1944. 2nd ed. 6 by 9 in. viii + 328 pp. illus. \$4.00.

In his preface to this new edition of "Wood Technology," Mr. Tiemann expresses regret that the wartime paper shortage prevented inclusion of "topics and illustrations which might add to its completeness." It is difficult, however, to imagine what these topics and illustrations might be, for the book as it now stands is, to say the least, comprehensive. It runs the whole gamut of wood technology from what wood is through its structure, identification of species, its chemistry, to methods for drying and gluing, mechanical and physical properties, and distinguishing features of American woods.

But the main purpose of the revision, Mr. Tiemann explains, was not the addition of new material but, rather, general over-all simplification of treatment. The result is a book as uncomplicated and direct as it is interesting. Everyone from a high school biology student to a skilled cabinet maker will find it profitable reading.

NEW ARCHITECTURE IN MEXICO

- Hospitals**
- Town Houses**
- Country Houses**
- Office Buildings**
- Store Groups**
- Factories**
- Schools**
- Apartments**
- Workers' Houses**

Modern Architecture below the Rio Grande, with its straight line, unornamented flat surfaces, presents a dramatic contrast to the old, heavily ornamented Spanish Colonial buildings. Yet Esther Born, in her book "THE NEW ARCHITECTURE IN MEXICO" has delineated in text, photographs and colored diagrams, including supplementary text on mural painting, sculpture, and pottery, how perfectly acclimated it has become to its background.

This new volume is a reference source for building designers everywhere, and contains a complete assemblage of the progressive thought of architects and engineers of the Aztecs and the Spanish Americans. Reduced price \$2.50.

ARCHITECTURAL RECORD
 Book Dept.

119 West 40th, New York 18, N. Y.

Enclosed is a check or money order for \$2.50. Please send me **NEW ARCHITECTURE IN MEXICO.**

NAME

ADDRESS

AR 4-45