

# ARCHITECTURAL RECORD



APRIL 1957

BUILDING TYPES STUDY 245 : SCHOOLS

*At Hollins College, Va.*



## **MODERN, AUTOMATIC FIRE PROTECTION FOR CENTURY-OLD BUILDINGS with Grinnell Sprinklers**

"The difficulties of installing a sprinkler system in buildings which have old, but beautiful, rooms were met with complete success by Grinnell," reports John R. Everett, president of Hollins College.

"We have never had as excellent a group of workmen. Your engineers amazed all by fitting thousands of feet of pipe without damaging walls or soiling paint and paper. I can't imagine having the job done better."

These, then, are some of the practical considerations of having Grinnell install an automatic sprinkler system. But what of the intangible advantages? Things like peace of mind in knowing that students are protected

at all times . . . and that old, hallowed buildings are completely safe. Again, Grinnell Automatic Sprinklers provide the perfect answer.

For records show that fires which do start in schools (and there are an average of five a day) can be controlled wherever and whenever they start, day or night, with automatic certainty, by Grinnell Sprinklers.

There is a moral obligation upon architects and school superintendents for the utmost in protection of lives and property. For your own sake be sure the schools for which you are responsible have Grinnell Sprinkler protection. Grinnell Company, Inc., 269 W. Exchange St., Providence, R. I.



# **GRINNELL**

**PROTECTION AGAINST EVERY FIRE HAZARD**



*Manufacturing, Engineering and Installation of Automatic Sprinklers Since 1878*



April 1957 Vol. 121 No. 4

Copyright 1957 by F. W. Dodge Corporation, with all rights reserved. Copyright not claimed by F. W. Dodge Corporation on color illustrations on page 173. ARCHITECTURAL RECORD (combined with AMERICAN ARCHITECT and ARCHITECTURE) is published monthly, except May 1957 when semi-monthly, by F. W. Dodge Corporation, 10 Ferry Street, Concord, New Hampshire. Editorial and executive offices: 119 West 40th Street, New York 18, New York. Western editorial office, 2877 Shasta Road, Berkeley 8, California.

## STAFF OF ARCHITECTURAL RECORD



**H. Judd Payne**, Publishing Director; **Robert F. Marshall**, General Manager; **John Knox Shear**, A.I.A., Editor-in-Chief; **Marshall T. Ginn**, Circulation Manager; **Emerson Goble**, Managing Editor; **Frank G. Lopez**, A.I.A., Senior Editor; **James S. Hornbeck**, A.I.A., Senior Associate Editor; **Elisabeth Kendall Thompson**, Senior Associate Editor and Western Section Editor (Berkeley, California, Office); **Robert E. Fischer**, Associate Editor (Engineering); **Florence A. van Wyck**, Associate Editor; **Jeanne M. Davern**, Associate Editor (News); **Herbert L. Smith, Jr.**, A.I.A., Associate Editor; **Ernest Mickel**, **Dan Street** (Washington), **John Caulfield Smith**, M.R.A.I.C. (Canada), Contributing Editors; **Grace M. Anderson**, Assistant Editor; **Margaret R. Fuerst**, Assistant Editor (Engineering Assistant); **Helen E. Cook**, Editorial Assistant (Production); **Dianne Thomas**, Editorial Assistant; **Eugene H. Hawley**, Design Director; **Thomas L. McArthur**, **Mary Ann Godfrey**, Design; **Sigman-Ward**, Drafting Consultant; **Thomas S. Holden**, Industry Relations Consultant; **Clyde Shute**, Statistical Consultant; **George Cline Smith**, Economics Consultant; **Clifford Dunnels, Jr.**, Field Research Consultant; **Daniel J. Howe, Jr.**, Public Relations Consultant.

## TABLE OF CONTENTS

### The Record Reports

Perspectives	9
Buildings in the News: A.I.A. Cites 20 Buildings, Six for Top Honors, in 1957 Awards Program	10
News of Architecture Abroad: Danish Entry Wins International Competition for Sydney Opera House	16
Art for Architecture: <i>Sculpture by Lin Emery</i>	16B
Meetings and Miscellany	21
A Beginning Remembered: February 23 in New York	28
A Washington Report. What Kind of Architecture for Public Buildings? <i>By Ernest Mickel</i>	32
News from Canada. <i>By John Caulfield Smith</i>	36
Washington Topics. <i>By Ernest Mickel</i>	48
Required Reading	54
Construction Cost Index	58
Calendar and Office Notes	352
Current Trends in Construction	428

### Planning a New Section of Stockholm

A new community planned and developed from scratch as a balanced entity added to an existing city. <i>Vallingby. By G. E. Kidder Smith</i>	173
---	-----

### Deeper Knowledge: Better Design

Knowledge is not a substitute for architectural imagination, but it is the raw material for creative design . . . "what we want is specialist knowledge freely available, not specialised Men." <i>An article by Richard Llewelyn Davies</i>	185
---	-----

### An In-the-Family Office Group

Administration Group for General Motors' Milford Proving Ground, Milford, Mich.; Smith, Hinchman and Grylls, Inc., Architects and Engineers	192
---	-----

### Research Laboratory and Office Building

A two-unit scheme designed especially to facilitate the mental concentration and long-sustained effort of pharmaceutical research. Wyeth Laboratories, Inc., Radnor, Pa.; Skidmore, Owings and Merrill, Architects	195
---	-----

### One Hundred Years of Significant Building

11. Commerce	201
--------------	-----

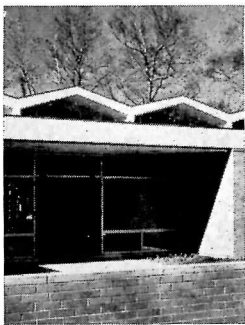

Cover: Kissam Lane School, Glen Head, N. Y.; Vincent G. Kling, Architect; Lawrence Williams photo

**Spacious Privacy on a Small Corner Lot**

Residence for Mr. and Mrs. Sam B. Short, Jr., Baton Rouge, La.; Short & Murrell, Architects 205

**Penthouse Occupies Unusual Site**

An economical office suite built atop an existing six-story garage.  
Bond & Starr Inc., Pittsburgh, Pa.; John Schurko, Architect; Fraioli, Blum & Yesselman, Engineers 211

**Carl Koch Plans Yacht Interior**

Planning the interior of a small yacht for family cruising and ocean racing proves to be a challenging and rewarding experience for a "land architect." 215

**Building Types Study Number 245 — Schools**

The Importance of Quality in School Building Design. <i>By Frank G. Lopez, A.I.A.</i>	219
Five Primary Schools, Andrews, Tex.; Caudill, Rowlett, Scott & Assoc., Architects	222
Addition to High School, Norman, Okla.; Caudill, Rowlett, Scott & Assoc., Perkins & Will, Architects	229
Kissam Lane School, Glen Head, N. Y.; Vincent G. Kling, Architect	236
Herbert Hoover Jr. High School, San Francisco, Calif.; Ernest J. Kump, Architect	245

**Architectural Engineering**

Sound Systems. Article 2: A Survey of typical applications. <i>By J. F. McPartland, Jr.</i>	251
Night Ventilation Cuts Cooling Costs	255
Technical Roundup	259
Product Reports	261
Literature	262
Time-Saver Standards: Fine Hardwoods for Architectural Uses — 13, 14 & 15	265

**Index to Advertising** 426

**OFFICERS OF THE F. W. DODGE CORPORATION**

James McV. Breed, *Chairman of the Board*; Paul Abbot and Thomas S. Holden: *Vice Chairmen of the Board*; Howard Barringer, *President*; Irving W. Hadsell, Chauncey L. Williams: *Executive Vice Presidents*; Howard M. Thompson, *Vice President and Treasurer*; Julius T. Little, Robert F. Marshall, T. Oliver Morgan, O. O. Paulsell, H. Judd Payne, George Cline Smith: *Vice Presidents*; Carl S. Bennett, Clinton C. Bennett, Ralph M. Hairston, Roy J. Hard, Arthur D. Prior, Richard H. Ray, John M. Williams: *Regional Vice Presidents*; Edwin H. Freed, *Assistant Vice President and Comptroller*; Walter F. DeSaix, Clifford G. Dunnells, Jr., Gault Eastman, Clyde Shute, Marc Wayne: *Assistant Vice Presidents*; Sanford D. Stockton, Jr., *Secretary*; William C. Breed, Jr., George W. Morgan, Jr.: *Assistant Secretaries*; Irving B. Satin, *Assistant Treasurer*.

**OTHER F. W. DODGE SERVICES**

Dodge Reports — Dodge Statistical Research Services — Sweet's Catalog Services — Dodge Books — Dodge Mailing Service — The Modern Hospital — The Nation's Schools — College and University Business — Hospital Purchasing File — Chicago Construction News — Daily Pacific Builder — Denver Daily Journal — Real Estate Record & Builders Guide.

Members of Audit Bureau of Circulations and Associated Business Publications. ARCHITECTURAL RECORD is indexed in Art Index, Industrial Arts Index and Engineering Index.

Every effort will be made to return material submitted for possible publication (if accompanied by stamped, addressed envelope), but the editors and the corporation will not be responsible for loss or damage.

Subscription prices: Published monthly except May 1957 when semimonthly. U. S., U. S. Possessions and Canada: \$5.50 per year; other Western Hemisphere countries, Spain, to those who by title are architects and engineers, \$9.00 per year. Single copy price except Mid-May 1957 issue \$2.00; Mid-May 1957 issue \$2.95. Beyond Western Hemisphere, excluding Spain, to those who by title are architects and engineers, \$9.00 per year for 12 monthly issues not including Mid-May 1957 issue. Subscriptions from all others outside U. S., U. S. Possessions and Canada for 12 monthly issues, not including Mid-May issue, \$24.00 per year. Change of address: subscribers are requested to furnish both old and new addresses, sending if possible stencil impression from magazine wrapper; allow four weeks for change.





# THE RECORD REPORTS

## P E R S P E C T I V E S

**SAVE THE ROBIE HOUSE!** A nationwide crusade appeared to be in the making last month to save a twentieth century architectural masterpiece from demolition. As the protests mounted, and various alternatives were proposed, it began to appear that Chicago Theological Seminary officials might be able to modify their original assumption that their urgent need for a dormitory site made demolition of Frank Lloyd Wright's Robie house, which they now own, inescapable. At any rate, they could not fail to be impressed with the quality and quantity of opinion which cried that some other site **MUST** be found. And when the National Trust for Historic Preservation added its voice to this chorus, a milestone in architectural preservation had been reached: for the Robie house was the first building erected in this century the National Trust had ever moved to help protect.

**PHI DELTS TO THE RESCUE?** It happens that Frank Lloyd Wright was a Phi Delta Theta man in his student days at the University of Wisconsin, and this rather unlikely fact may save the Robie house. Phi Delta Theta's Chicago chapter late last month offered to trade its site, three lots north, for the Robie house site; its neighbor, Zeta Beta Tau, two lots north of the Robie house, would then exchange *its* site for the house the

Seminary is currently using to house the students for whom the new dormitory is wanted. The resulting site would provide for the new dormitory an area equivalent to the Robie house site, and still adjoining the first lot north of it, also owned by the Seminary. The Robie house would then be occupied as the Phi Delta Theta chapter house, with a section reserved as a Wright museum. The wealthy Phi Delt, reputedly with the enthusiastic backing of their national headquarters, were at least a finger in the dike.

**CAN WE HELP?** Chicagoans, who have fought this battle before, had rallied quickly (and numerously) to the cause, with A.I.A. Chapter President Samuel Lichtmann, Chairman Earl H. Reed of the national A.I.A. Committee for the Preservation of Historic Buildings, and William F. Deknatel, leader of the successful 1941 Committee for the Preservation of the Robie House, in the forefront of the effort. The Committee was hastily reactivated and began conferences with Seminary officials and others concerned looking to three objectives: to prevent demolition; to find an acceptable substitute site for the dormitory; and to find a new owner willing to preserve and maintain the house. At almost the same time, a second committee, the Arts Committee for the Preservation of the Robie house, was organized by

a group of architects, artists, art historians and writers who elected as chairman William S. McDonald, producer-director of WWTW, Channel 11, Chicago Educational Television Association. Then came a proposal, in the form of a letter to Mr. Reed from President Richard Howland of the National Trust for Historic Preservation, that an "alert committee" be formed to preserve the Robie house under the official joint sponsorship of the A.I.A. and the Society of Architectural Historians, with Mr. Reed, as chairman of the A.I.A.'s preservation committee, as its head. While the National Trust could not itself initiate or sponsor such a program, Mr. Howland said, he would aid one started by others "in all ways I can, both as an individual and as an officer of the National Trust." Mr. Reed said the existing committees in Chicago in effect constituted such an alert committee, and he doubted the need for any more. But the impulse to help was in many places. . . . At Yale, for example, 250 students in Yale College and the architectural school had contributed to a fund started by a few students in one of Vincent Scully's classes; the *Yale Daily News* made a campaign of it and was trying to get the editors of the Harvard and Princeton dailies to join it—even though the Yale fund had, so far, no place to go. . . . "If necessary," wrote Architect Charles A. Nitschke of Columbus to the editor of the *RECORD*, "let's organize a nationwide campaign, project or crusade to buy, restore and protect the Robie house. . . . Can we help?"—the answer at the moment, for all who feel the same, appears to be letters expressing concern, the more the better, to President A. C. McGiffert Jr., of Chicago Theological Seminary (carbons to William F. Deknatel, 25 East Jackson Blvd., Chicago, for the information of the Committee, would be helpful).



## THE RECORD REPORTS

### BUILDINGS IN THE NEWS

#### FIRST HONOR AWARDS

*Chapel of the Holy Cross (right), Sedona, Ariz.; Anshen and Allen, Architects (AR, Oct. 1956, pages 173-182). Below left: St. Anselm's Priory, for the Benedictine Fathers, Tokyo, Japan; Antonin Raymond and L. L. Rado, Architects (AR, Nov. 1956, pages 187, 192-196). Below right: Edgemont Junior-Senior High School, Town of Greenburgh, Scarsdale, N. Y.; Warren H. Ashley, Architect (AR, Sept. 1956, pages 205-210)*

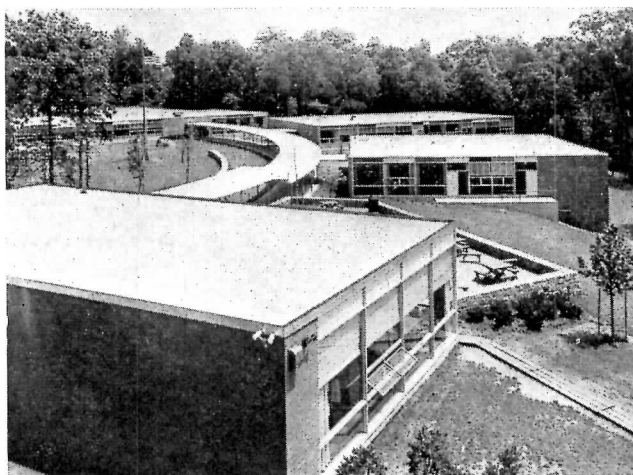
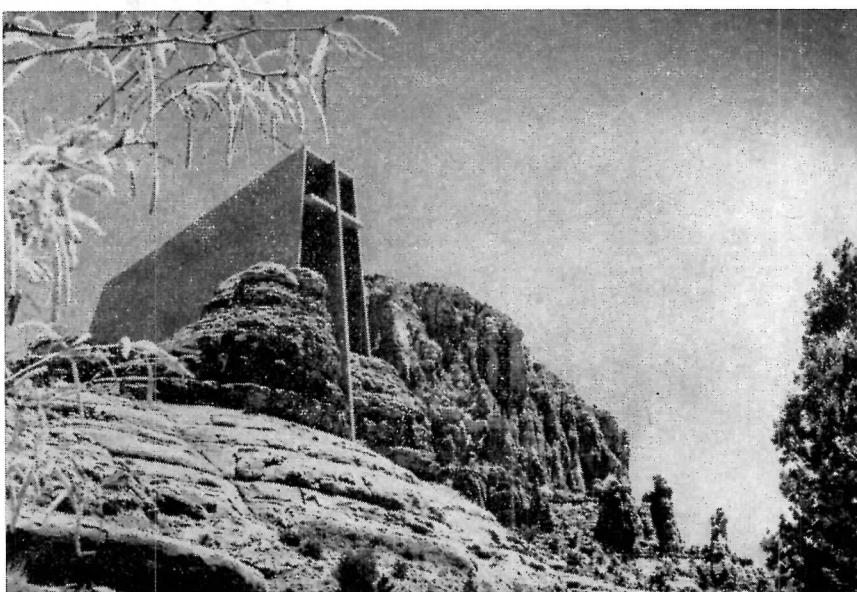

#### FIRST HONOR AWARDS

*House for Mr. and Mrs. Eliot Noyes (above left), New Canaan, Conn.; Eliot Noyes, Architect (AR, Record Houses of 1957, forthcoming Mid-May issue). Above right: Middlesex Mutual Building, Waltham, Mass.; Anderson, Beckwith and Haible, Architects (AR, Feb. 1957, pages 177-182). Right: Brazos County, Tex., Courthouse and Jail; Caudill, Rowlett, Scott and Associates, Architects (AR, Jan. 1957, pages 149-154)*

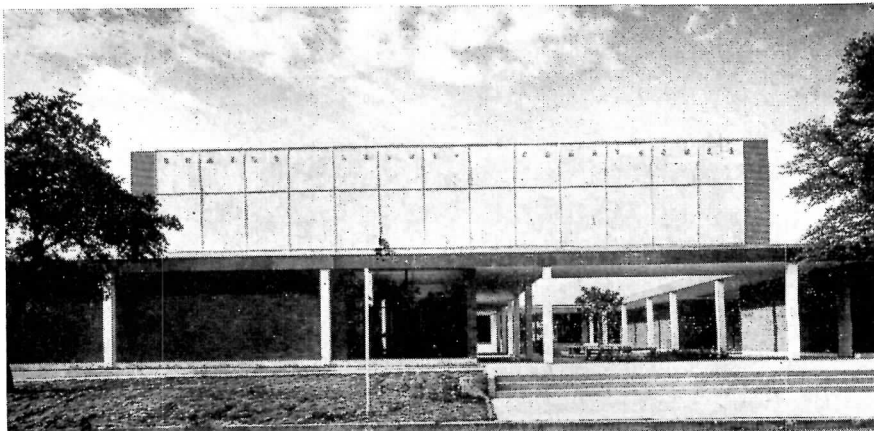



## A.I.A. CITES 20 BUILDINGS, SIX FOR TOP HONORS, IN 1957 AWARDS PROGRAM

Winners in the ninth annual Honor Awards Program of the American Institute of Architects, the year's major architectural competition, were selected last month. Of 20 buildings premiated, six (across-page) were given First

Honor Awards and 14 (on this and following page) Awards of Merit; there were 344 entries. Judgment was held at the Octagon in Washington March 4-6. Members of the Jury of Award were architects Philip D. Creer of

Providence, R. I.; Alden B. Dow of Midland, Mich.; James M. Hunter of Boulder, Colo.; Roy F. Larson of Philadelphia; and John Knox Shear, editor-in-chief of ARCHITECTURAL RECORD. Winners will be shown at A.I.A. Convention.

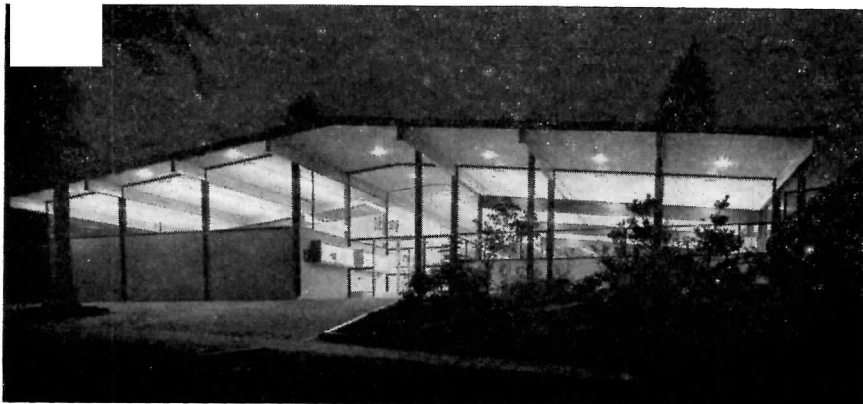
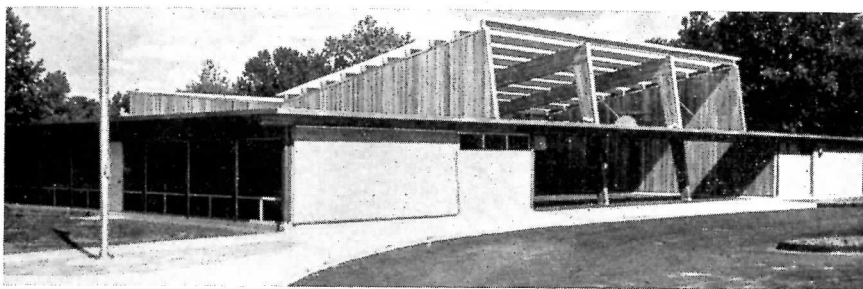
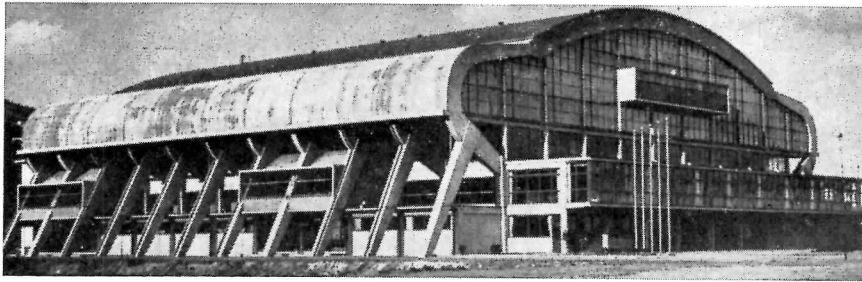
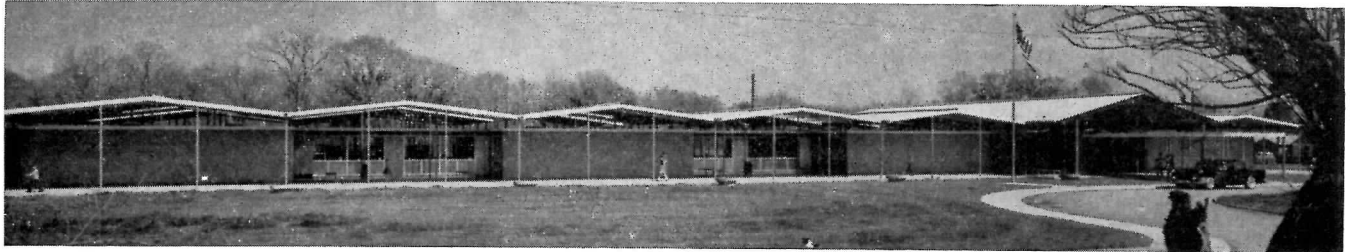

### AWARDS OF MERIT

(Counterclockwise from top of page) San Jacinto Elementary School, Liberty, Tex.; Caudill, Rowlett, Scott and Associates, Architects (AR, July 1956, pages 151-160). Memorial Hall for Japanese Steelworkers, Yawata Arena, Kyushu, Japan; Antonin Raymond and L. L. Rado, Architects (AR, Oct. 1956, pages 195-200). Residence-Studio for G. and K. Matsumoto, Raleigh, N. C.; George Matsumoto, Architect (AR, Record Houses of 1957, forthcoming Mid-May issue — cover house). Tokeneke Elementary School, Darien, Conn.; Kilham and O'Connor, Architects (to be published soon in AR). Northeast Branch Public Library, Seattle; Paul Thiry, Architect. Medical Towers Office Building, Houston; Golemon and Rolfe, Architects



(Continued on page 12)

# THE RECORD REPORTS

## BUILDINGS IN THE NEWS

(Continued from page 11)

### AWARDS OF MERIT

*Rich's Department Store* (right), Knoxville, Tenn.; *Stevens & Wilkinson, Architects*. Below left: *Residence for Mason B. Wells, Belvedere, Cal.*; *Edward B. Page, Architect*. Below right: *Residence for Mr. and Mrs. Frederick B. Emmons, Pacific Palisades, Cal.*; *Jones and Emmons, Architects* (AR, *Record Houses of 1956, Mid-May issue*)

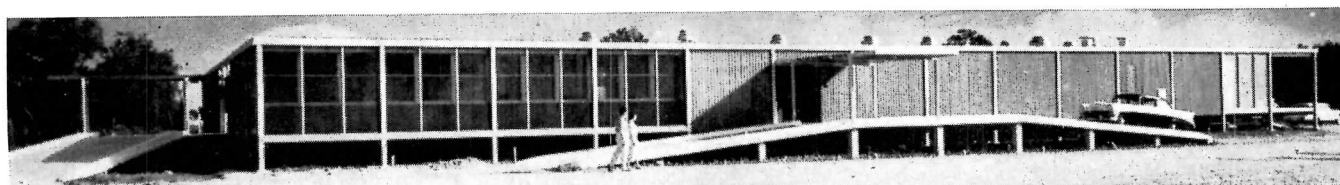
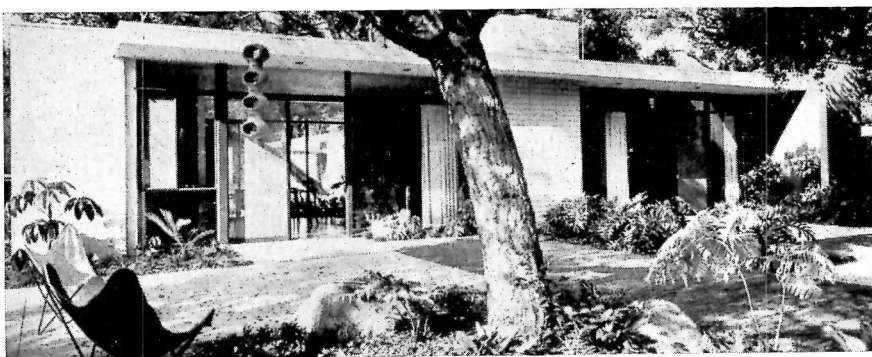

### AWARDS OF MERIT

(Clockwise from above) *Our Lady of the Sea General Hospital, Golden Meadow, La.*; *Curtis and Davis, Architects*. *Residence for Mr. and Mrs. Quincy Jones, Los Angeles*; *Jones and Emmons, Architects* (AR, *Record Houses of 1956, Mid-May issue*). *Research Laboratory and Office Building for Wyeth Laboratories, Inc., Radnor, Pa.*; *Skidmore, Owings and Merrill, Architects* (AR, *April 1957, pages 195-200*). *Addition to Mark Thomas Inn, Del Monte, Monterey, Cal.*; *John Carl Warnecke, Architect*. *Wilson Junior High School, Charlotte, N. C.*; *A. G. Odell Jr., Architect* (AR, *Oct. 1956, page 246*)

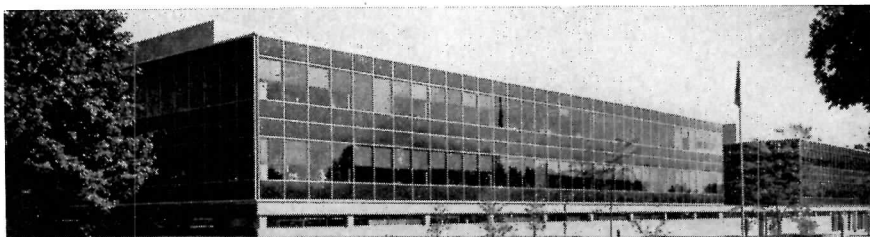
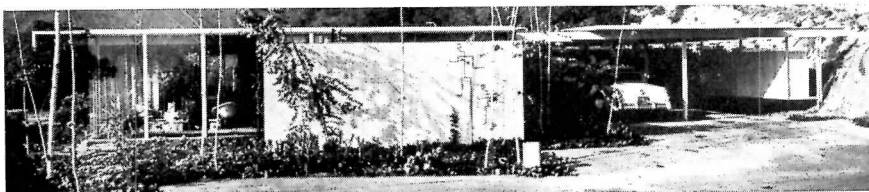

(More news on page 16)



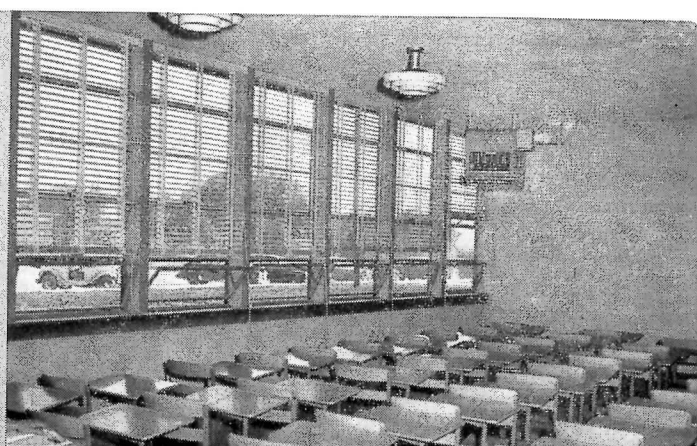
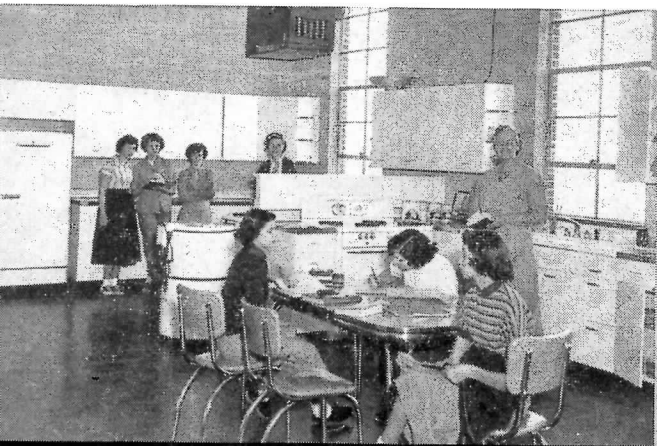

"WE SAVED ENOUGH TO BUILD WITHIN OUR BUDGET BY USING JANITROL GAS UNIT HEATERS INSTEAD OF A CENTRAL SYSTEM", states Mr. James Dawson, Sup't. of Schools, Crawford County, Bourbon, Mo. Each heater is thermostatically controlled. The architectural firm of Barnes and Snipes writes, "The reason for using Janitrol equipment included economy of installation and flexibility of handling the heating problem." Janitrol Gas Unit Heaters are designed for dual fuel operation, save floor space, reduce maintenance costs.

A TYPE OF INSTALLATION FAVORED BY MANY ARCHITECTS incorporates a Janitrol Horizontal Winter Conditioner suspended from the ceiling in each room. Warm air is directed parallel to outside walls and across glass areas. A built-in centrifugal blower provides quiet, even air circulation. This unit is also approved for use with a duct system, and is available in models for 65,000 to 150,000 Btu/hr. inputs. Installation illustrated is at Rosen Heights School, Fort Worth, Texas. Architect is Stanley Brown, Dallas.

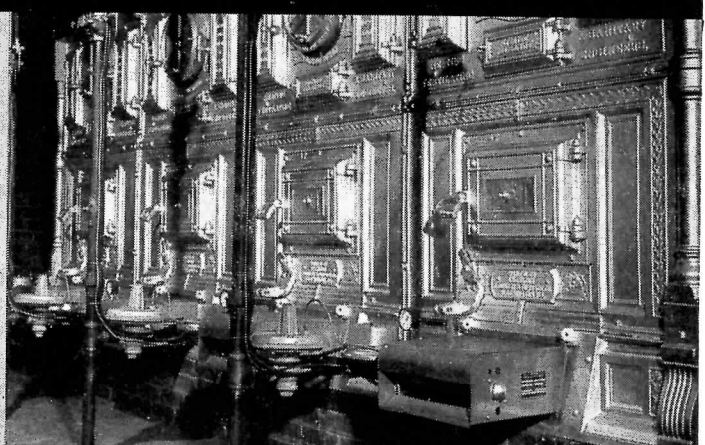

LOUVERED CEILING PANELS of the venetian blind type serve a three-fold need at West Columbia School, near Houston, Texas. They conceal the Janitrol blower-type unit heater. They effectively diffuse the heat, preventing it from blasting on the occupants below. They diffuse and distribute light from the saw-tooth roof windows. This type of application is recommended for areas where "cold floor" problems are not encountered. Architect: Donald Barthelane, Houston, Texas. Contractor: The Warren Co., Houston.

MANY SCHOOL-HOUSE TYPE FURNACES HAVE BEEN CONVERTED FROM COAL TO CLEAN, EFFICIENT GAS by installation of Janitrol SC-05 large capacity burners, which are designed for input capacities up to 750,000 Btu/hr. each. The Janitrol SC-05 Conversion Burner fits furnaces or boilers with an ashpit opening not less than 15 1/8" wide by 7-5/32" high and in which the depth of the burner throat does not exceed 4". Shown here: Installation at Bridgeport High School, Bridgeport, W. Va.

**Janitrol**

JANITROL HEATING & AIR CONDITIONING DIVISION  
SURFACE COMBUSTION CORPORATION  
COLUMBUS 16, OHIO

IN CANADA: MOFFAT HEATING & AIR CONDITIONING DIVISION  
MOFFATS, LTD., TORONTO 15

Also Makers of Surface Industrial Furnaces, Kathabar Humidity Conditioning, Janitrol Residential Heating and Cooling Equipment.

*winter conditioners  
adaptable for summer cooling*

. . . with installation of Janitrol's new air-cooled cooling system that uses no water, eliminates water service and maintenance costs. May be installed concurrently with winter conditioner, or any time later, without additional duct work.

DANISH ENTRY WINS INTERNATIONAL COMPETITION FOR SYDNEY OPERA HOUSE

Prizewinners have been announced in the international architectural competition for a National Opera House for Sydney, New South Wales, Australia, sponsored by the Government of New South Wales. The competition, which offered three prizes the equivalent of \$11,250, \$5000 and \$2250, attracted 222 entries from 21 countries, including 61 from Australia, 53 from the United Kingdom, 26 from Germany, and 24 from the U. S. A.

The international jury was unanimous in its choice of the first-prize design. In a joint statement accompanying the report of their decision, the jurors said:

"The drawings of the winning design were simple to the point of being diagrammatic. Nevertheless, we have returned again and again to the study of these drawings. They have the merit of great simplicity of arrangement and unity of structural expression.

"One of the most difficult problems of opera house design is to relate the stage tower to the separate and surrounding buildings. The solution suggested is that the two auditoria should be roofed by a series of interlocking shell vaults in which the high stage is one of a series of separate shells.

"This creates a striking architectural composition admirably suited to Benelong Point. The white sail-like formations relate as naturally to the harbor as the sails of its yachts. The dynamic form of this vaulted shape contrasts with the buildings in the background.

"A massive base emphasizes the character of Benelong Point. The auditoria are arranged like Greek theaters in this rising base. The approach and auditoria steps form a rising plateau in which the highest point of seating is about 40 ft from the ground. This solves the complex needs of emergency escape."

Cost estimates obtained before the final decisions were made indicated that the first-prize design would be the most economical (at about \$7,840,000) to erect; estimated costs for the others — \$12,096,000 for the second-prize design and \$17,096,000 for the third.

Mr. Utzon, who works in partnership with his two brothers, has won twenty architectural awards in Denmark and Sweden, including six first prizes. He has been a member of the Danish Institute of Architects since 1942.

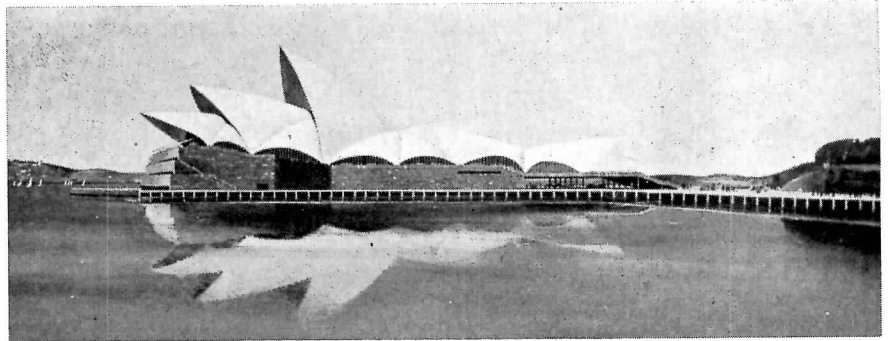

*FIRST PRIZE* went to Joern Utzon, 38, of Helleback, Denmark, for this design with its spectacular roof of light, suspended concrete shells above a massive but simple three-story building. The shells are to be whitewashed on their exteriors, gold-washed within; the suggestion for exterior walling is cream white sandstone. Inside, the auditoriums will be on rising levels to a height of 40 ft from the ground; they will be approached from a broad tiered walk, 300 ft long by 150 ft wide, or from beneath the pillared tiers. The spreading shells will protect the audience along the tiered approach; they will also shelter restaurants and bars and vantage points for views over the harbor: the dramatic site on Benelong Point was highly stressed in the program

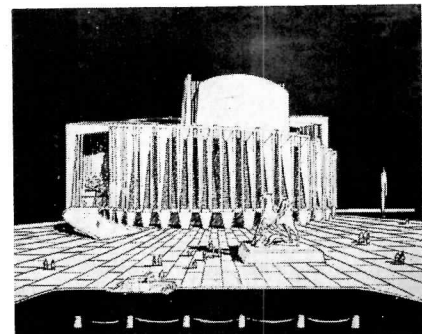
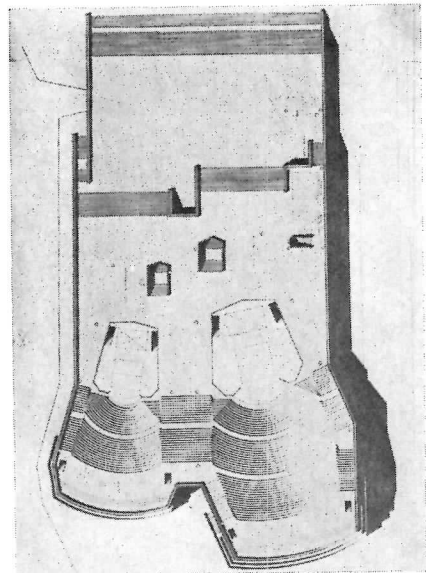

*SECOND PRIZE*, for the design above, went to a group of seven Philadelphia architects — Joseph Marzella, W. W. Cunningham, William Weissman, Milton Brecher, Leon Loschetter, Robert L. Geddes, and George Qualls. *THIRD PRIZE*, for the design at right above, went to a London architectural firm, Boissevain and Osmond. *JURY* (right) was composed of Eero Saarinen of the United States; Cobden Parkes of New South Wales; Prof. H. Ingham Ashworth of Sydney University; and Prof. Leslie Martin of Cambridge University, England



(More news on page 16B)



Today's smartest floors wear KENTILE

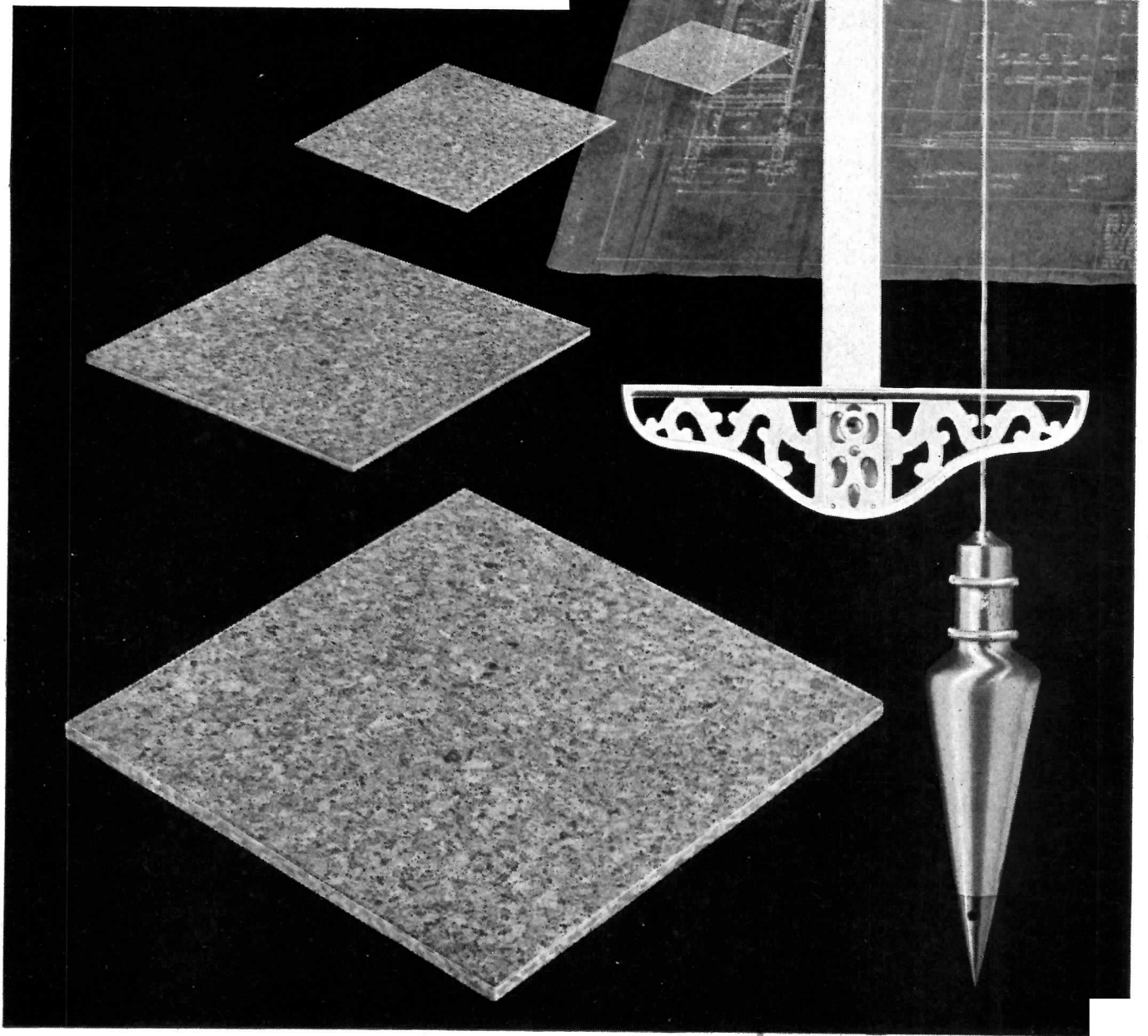

## This is KENTILE® cork tile

for the most luxurious yet practical floors ever! So resilient! So slip-resistant! So long-wearing!

### KENTILE FLOORS

available in Cork, Solid Vinyl, Vinyl Asbestos, Cushion-back Vinyl, Rubber and Asphalt Tile... over 150 decorator colors.

#### SPECIFICATIONS

**SIZES:**  
6" x 12", 9" x 9", 12" x 12".  
12" x 24" (not available in 1/8" gauge.)

**THICKNESSES:**  
1/8", 3/16", 5/16", 1/2" (on special order.)

**COLORS:**  
Kentile cork tile (KenCork®) is available in separately packaged cartons of light shades, medium shades and dark shades. Has a factory finish--a specially prepared plastic fortified wax applied while hot, at the factory.

# THE RECORD REPORTS

(Continued from page 16)

## ART FOR ARCHITECTURE: SCULPTURE BY LIN EMERY

A young sculptor whose interest in expressing "the basic ideas that underlie the visual surfaces" can produce work as diverse as the examples shown here had her first "one-man" show in New York this winter. Lin Emery, a native New Yorker who now divides her time between New Orleans and the Sculpture Center in New York, has already had seven architectural commissions and is working on another. In her work at the Center, Miss Emery has been especially interested in the possibilities offered by welding; the show included nine weldings as well as reliefs, terra cottas and bronzes.

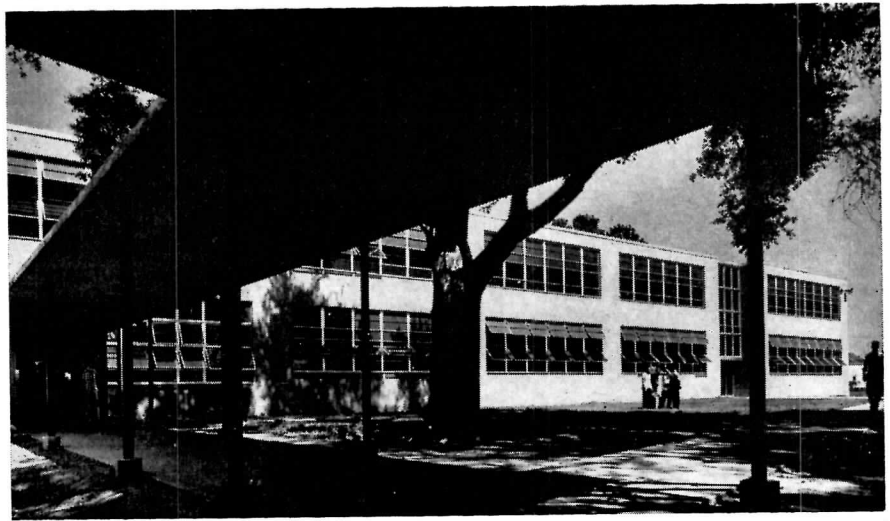

*PIETA* in Holy Cross High School, New Orleans (Nolan, Norman & Nolan, architects), is "designed to be read as a silhouette." Life-size figures are of cast cement over welded steel framework that "makes possible the openness of the composition"

RECENT EXHIBIT of 23 pieces of Lin Emery's work at Sculpture Center in New York included (above) "Archangel Michael," two- by four-ft relief in magnesite and plastic aluminum, and "King and Queen," fountain in welded bronze

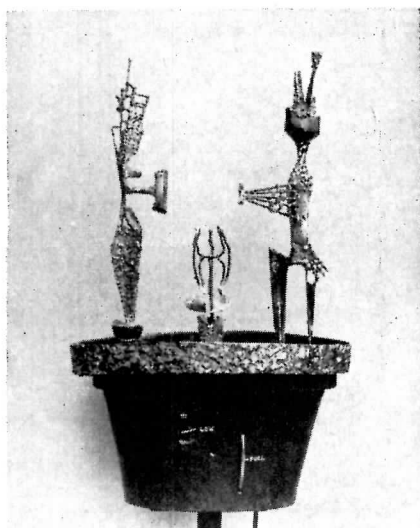
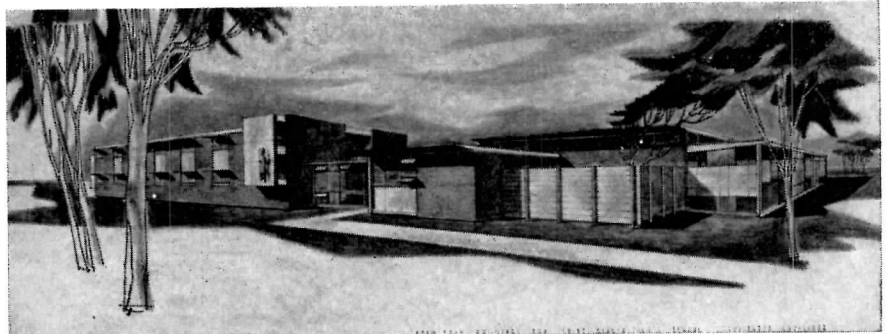

*ST. SCHOLASTICA STATUE* on exterior of St. Scholastica Academy, Covington, La. (Burk, Lamantia & LeBreton, architects) is lifesize, of rose-colored cast stone with dove of welded bronze. Direct welding technique makes dove light and strong enough to attach by tail feathers



(More news on page 21)



# Inlock Structural Weather Strip . . . the **NEW NEOPRENE WEATHERPROOF** setting member . . . for today's architecture!

Inlock Structural Weather Strip is designed to provide a simple, positive leakproof setting member for use with curtain walls, ribbon windows, separate or continuous sash, or windows in combination with insulated panels. Inlock is usable for skylights; ventilator, picture, and divided lights, in addition to many other structural components used in today's construction.

Inlock is the architectural answer to the

watertight setting of glass, metal sash, panels and other construction materials with durable surfaces. Inlock remains tight . . . rattling and vibration are eliminated . . . sounds deadened . . . panels are free to "move" . . . will not deteriorate. Standard sections are available, or Inland will design to your specifications. Mail the coupon for complete information. Also see our catalog in Sweets Architectural File, 3e/In.

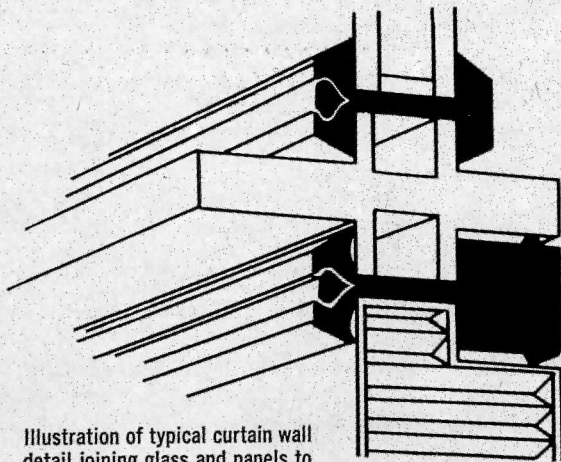
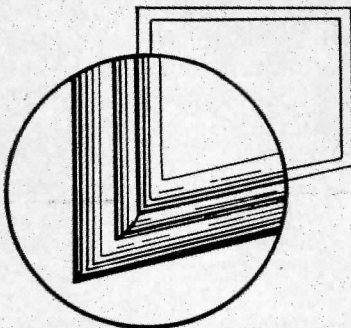
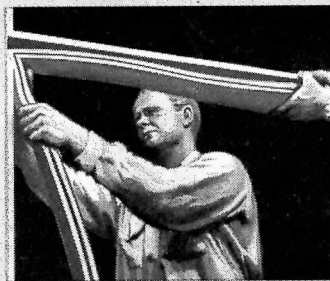

Illustration of typical curtain wall detail joining glass and panels to extruded aluminum members.



All angles and corners are injection molded. Mitered corners and joints are eliminated. Perimeter of Inlock Weather Strip is fused into a continuous, one-piece, cushion-sealed setting member.



Fast, easy and economical method of installing . . . A machine-made product . . . not affected by human elements.

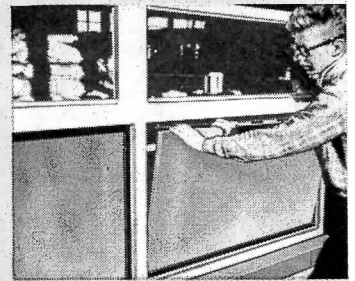

Inside installation saves time, labor costs and scaffolding; aids removal and replacement of glass or panels.

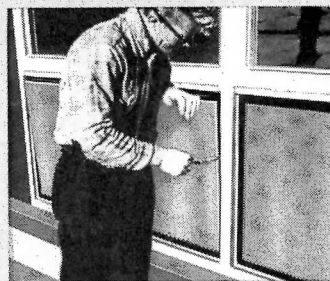

Inlock permits installation of "units" without special clamps, frames, cement or binders. Filler strip creates a powerful compression, clamping "units" permanently in place.

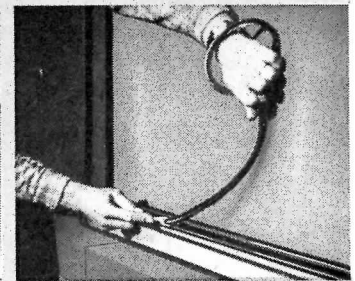

Filler strip "zips" into locking channel for a tight, leakproof, lasting seal. But replacement is as easy as original installation, and gaskets are reusable, thereby eliminating material costs.

Specify . . .

## **INLOCK** STRUCTURAL WEATHER STRIP



INLAND MANUFACTURING DIVISION  
General Motors Corporation, Dayton, Ohio

**INLAND MANUFACTURING DIVISION**

General Motors Corporation  
2733 Inland Avenue, Dayton, Ohio  
Send complete information and catalog.

Name \_\_\_\_\_

Title \_\_\_\_\_

Company \_\_\_\_\_

Address \_\_\_\_\_

City \_\_\_\_\_ Zone \_\_\_\_\_

State \_\_\_\_\_

## WHAT KIND OF ARCHITECTURE FOR PUBLIC BUILDINGS?

*Some Important Esthetic Questions Tossed (Lost?) at a Congressional Hearing Considering — After “Temporary Deferral” of Lease-Purchase Program — How (and How Much) U. S. Should Build*

The public buildings program of the Federal government was up for discussion last month in the wake of the General Services Administration's abrupt announcement that its (lagging) lease-purchase program would be “temporarily deferred” in deference to the tight money situation and the President's policy of postponing all postponable Federal expenditures to avoid adding fuel to the fires of inflation. Not surprisingly, there were immediately a good many Congressmen who didn't agree that all public buildings (including, of course, those in the home district) were postponable; but most surprisingly, the inevitable hearings which aired these views also turned up two Congressmen — Frank Thompson Jr. (D-N. J.) and Henry S. Reuss (D-Wis.) — who appeared to be worrying only about the *quality* of public buildings and who had a proposal for making such concern part of any future Federal building program.

There was a serious attempt in Congress to kill off the lease-purchase program completely and use the direct appropriation method only; the Thompson-Reuss plan, presented in the form of a proposed amendment to a direct-appropriations bill, would enlarge the scope of the Fine Arts Commission by applying its advisory services to all the Federal structures in the Public Buildings Service province. The Commission now consults with PBS only on buildings to be constructed in the District of Columbia area.

Both Senate and House committees had held hearings on all the developments in lease-purchase, accumulating a record which generally showed industry groups — including the American Institute of Architects — in support of the contract-purchase method of providing Federal buildings for the nation. Just about everyone agreed that it was cheaper to acquire these structures by the direct appropriation method, but would Congress add such money to the President's already much-criticized high budget for fiscal 1958? Few observers thought so.

When might the lease-purchase program be resumed if Congress decides to extend its authority beyond the July expiration?

There was no quick answer to this one, either. General Services Administrator Franklin G. Floete told the Senate's subcommittee that increased cost of construction and high interest rates, two factors that caused the program to break down, would have to reverse themselves to some extent before he would be willing to begin again. This would probably not be in the “foreseeable future,” he told the group: a statement interpreted by some to signify that the program was actually dead as of the February 13 date when GSA announced it was “temporarily deferred.”

As the House Public Works subcommittee conducted its hearings, on HR 6460, a bill to authorize a five-year \$1.5 billion direct appropriation program, it received from Congressmen Reuss and Thompson their proposal that the Fine Arts Commission advise and consult with GSA in establishing the highest possible standards of architectural design, style, and ornamentation for Federal public buildings, and methods of achieving such standards.

This was interpreted to mean that under its terms the Commission would have a hand in the selection of architects (private architects) to design the public buildings to be built everywhere in the United States.

The implications were clear. The Fine Arts Commission would have to be expanded, given funds for broader operations. And an important separate part to it would bring the agencies for which any building is planned into advisory positions with GSA.

The main objective was to centralize the Federal building program in the GSA while at the same time bringing in the agency which would inhabit the building for its advice and consent on building design.

The Reuss-Thompson statement outlined the following points as being among the questions involved in setting standards:

1. To what extent should Federal public buildings take into account local customs and traditions?

2. What percentage of the cost of various buildings should go into decorative art?

3. To what extent should the building

be tailored to the user, rather than be a general purpose building?

4. When should architectural competitions be used, and how should they be set up?

5. What should be the policy of decentralization, both as regards the District of Columbia and nationwide?

6. How should Federal buildings be fitted in with modern trends in city planning, traffic, civil defense, urban redevelopment?

7. What types of construction will result in the lowest maintenance costs?

8. What are suitable proposed life spans for various types of buildings?

“Answers to these questions,” said the pair of lawmakers proposing the change, “can hardly be expected either from the civil servants of the regular staff of GSA, or from the architects that are retained on an *ad hoc* basis to construct a specific building.”

The Reuss-Thompson suggestion came as an amendment proposed under a bill introduced by Representative Robert E. Jones (D-Ala.) which would terminate the lease-purchase program in all its applications except as to Washington, D. C., buildings already in the program, and use the direct appropriation method exclusively. It was thought the amendment had a fair chance of going through as a part of the Jones bill, but was not strong enough to stand up on its own as a separate measure.

GSA officials refused to comment on the proposal in advance of their own testimony before the Committee; but there was a quick exception from W. E. (“Bert”) Reynolds, formerly GSA's Public Buildings Commissioner, and father of the lease-purchase act. He told ARCHITECTURAL RECORD that PBS, through its research staffs, had studied buildings extensively, was competent to judge life-expectancy, etc. He “doubted this knowledge would be readily available from the Fine Arts Commission.” Mr. Reynolds would be very much in favor of any move to bring the agencies back to the GSA for the design and construction of their buildings. He made the point that it is difficult for the agency to build up design and research divisions for a limited number of buildings — a curtailed program.

# For a Protected Learning Environment

## COLD WINDOW WALLS CREATE 2 PROBLEMS

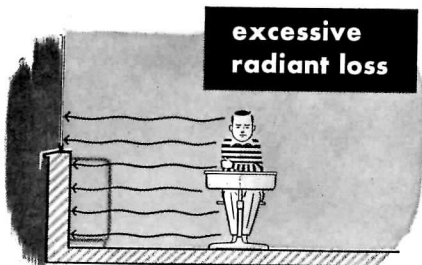

Without Wind-o-line, pupils seated near the cold walls are uncomfortable because of excessive body heat loss—even with a 70° room air temperature.

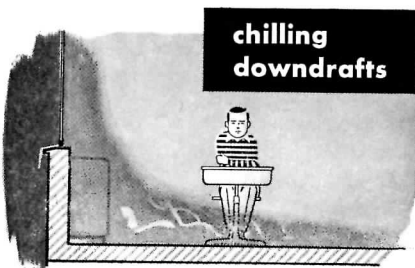

Downdrafts from the cold window wall add to the discomfort, forming pools of chilling air around the ankles of pupils seated near the cold surface.

The Nesbitt Series Hot Water Wind-o-line System provides the protected learning environment at proven lower costs.

WIND-O-LINE RADIATION MAKES THE DIFFERENCE!

You cannot ignore the need for protective radiation along the full length of cold window walls. Remember that indoor thermal comfort is related not only to the room air temperature, but to the temperature of the surrounding floors, windows and walls as well. For the fully protected thermal environment in your school, specify Nesbitt Syncretizers with Wind-o-line Radiation.

## WIND-O-LINE RADIATION SOLVES BOTH PROBLEMS

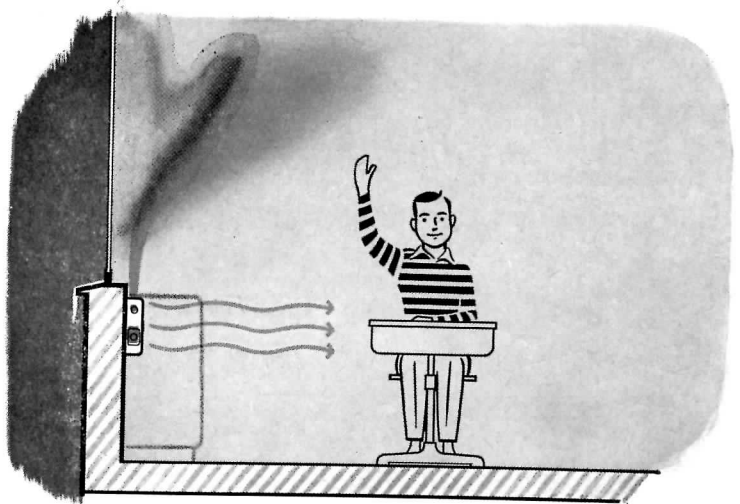

With Wind-o-line installed along the exposed surfaces, floor, window and wall temperatures are raised; radiant heat protects against excessive loss of body heat; convected heat all along the sill warms the chilling downdraft, diverting it above the heads of the pupils. Wind-o-line Radiation functions only when and as needed, augmenting the work of the Syncretizer unit ventilator to provide a *fully protected learning environment*.

For more complete information send for Publication 101—*more learning per school dollar.*

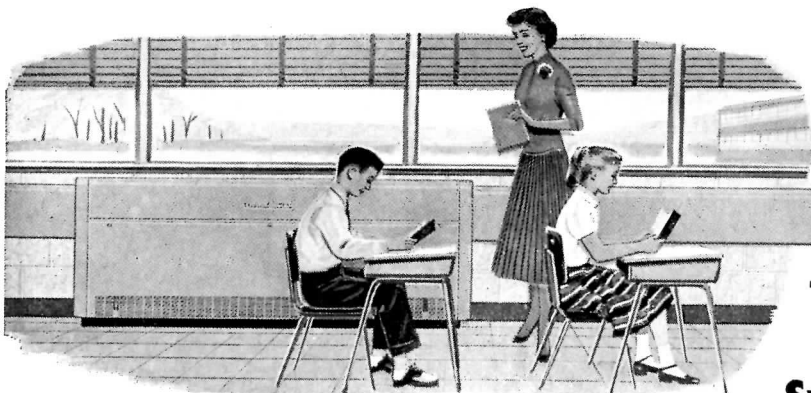

# Nesbitt

## Syncretizers with Wind-o-line

Made and sold by John J. Nesbitt, Inc., Philadelphia 36, Pa. Sold also by American Blower Corporation and American-Standard Products (Canada) Ltd.



**FOGARTY FOR ARCHITECTS,  
DECRIES PACKAGE DEALING**

The architectural profession found a somewhat unexpected champion in Rep. John E. Fogarty (D-R. I.), who has hitherto been famous for his impassioned views on metal and glass design in last year's Congressional controversy over Air Force Academy design. Now, Mr. Fogarty has expressed deep concern over any efforts to by-pass the services

of the architect in favor of certain "mass production" methods.

Paying a Centennial Year tribute recently to the American Institute of Architects, Mr. Fogarty said the package dealer who offers school and church committees "cheaper prefabricated buildings" is offering a fantasy. Prefabricated package buildings do not properly fit the land sites, soil conditions, climates, and requirements of individual

communities any more than a single stock prescription for eyeglasses would fit a nation of nearsighted citizens, he observed, adding that the architect's skill is needed as urgently as the doctor's or lawyer's.

"Any attempt by promoters of package buildings to bypass the architect will, in the long run, be just as disastrous as replacing the family doctor with the quack," he declared. The efforts and professional competence of the architect are needed, Mr. Fogarty said, to give communities the most enduring, the most economical buildings "the creative genius of our people is able to erect."

Largely through the efforts of the A.I.A., Mr. Fogarty added, the architect is fully conscious of these responsibilities and challenges, and is meeting them in a manner deserving appreciation and gratitude.

**EXTENSION NOW TO 1962  
ASKED FOR HILL-BURTON**

Extension of the Hill-Burton hospital construction law for another three years beyond its 1959 expiration was proposed by Sen. Hubert Humphrey (D-Minn.).

A two-year extension to 1959 was provided last year, but this period is not long enough, Senator Humphrey maintains, to allow states and local communities adequate time to plan and construct needed hospitals. It was pointed out that frequently two or more years of planning are required by a community to develop a project and then a year or more to construct it.

Senator Humphrey also wants more money for Hill-Burton. The President has asked \$100 million in general hospital construction grants for the program for fiscal 1958 but Senator Humphrey doesn't think this is enough. He advocates \$150 million for hospital construction and another \$60 million for the so-called special categories — diagnostic treatment centers, nursing homes, etc.

"In actual fact, the Administration is asking for funds for the coming year which will permit a level of Federal assistance little more than half the level of eight years before," he asserted. "Yet the need is far greater."

It was estimated that Congress would have to appropriate \$172 million for fiscal 1958 just to match the \$150 million program permitted by the 81st Congress in 1950 because of increased construction costs. Senator Humphrey

(Continued on page 388)



known for **QUALITY...**  
respected for **DEPENDABILITY**

**MORE TROUBLE FREE LIGHT YEARS  
WITH MITCHELL LIGHTING**

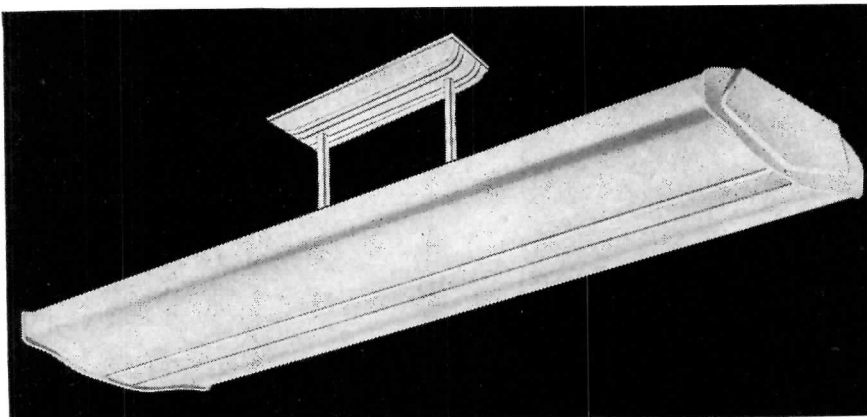

*lume-glow*

Distinguished commercial interiors deserve Mitchell's "Lume-Glow" luminaires. "Lume-Glow" fixtures with the "Evenglo" diffusing shield combine abundant light output with low surface brightness... providing comfortable reflected semi-indirect lighting. Streamlined in styling... "Lume-Glow" luminaires are manufactured in Mitchell's modern manufacturing facilities to Mitchell's recognized high standards of quality and dependability. Write for complete specifications.

**MITCHELL LIGHTING COMPANY**

a division of COMPCO CORPORATION

2263 W. ST. PAUL AVE., CHICAGO 47, ILL.



Interior designs by John and Earline Brice.

Give any interior this fresh new beauty  
**BEGIN WITH A BEAUTIFUL BACKGROUND**  
 of plastic wall tile



"Begin with a beautiful background of plastic wall tile." This is the theme for the big '57 Dow advertising and promotion program for dealer-guaranteed plastic wall tile made of Styron®. Dramatic interiors like this delightful "checker" laundry area will be featured in full-color national magazine advertising and in exciting promotion material.

Play up Styron plastic wall tile in your homes in any price range. Make the most of its extensive color range and versatile shapes . . . its unlimited decorating possibilities. Above all, stress its *guaranteed quality*. Your certified dealer can help you create new buyer preference with dealer-guaranteed plastic wall tile made of Styron. THE DOW CHEMICAL COMPANY, Midland, Michigan, Plastics Sales Department PL1553Q.



**IDEA!** Make a focal point of stripes in Styron plastic tile to underscore modern kitchens.

YOU CAN DEPEND ON



# THE RECORD REPORTS: CONSTRUCTION COST INDEXES

Labor and Materials

U. S. average 1926-1929 = 100

*Presented by Clyde Shute, manager, Statistical and Research Division, F. W. Dodge Corp., from data compiled by E. H. Boeckh & Assocs., Inc.*

**NEW YORK**

**ATLANTA**

Period	Residential		Apts., Hotels Office Bldgs. Brick and Concr.	Commercial and Factory Bldgs. Brick and Steel		Residential		Apts., Hotels Office Bldgs. Brick and Concr.	Commercial and Factory Bldgs. Brick and Steel	
	Brick	Frame		Brick and Concr.	Brick and Steel	Brick	Frame		Brick and Concr.	Brick and Steel
1930	127.0	126.7	124.1	128.0	123.6	82.1	80.9	84.5	86.1	83.6
1935	93.8	91.3	104.7	108.5	105.5	72.3	67.9	84.0	87.1	85.1
1939	123.5	122.4	130.7	133.4	130.1	86.3	83.1	95.1	97.4	94.7
1946	181.8	182.4	177.2	179.0	174.8	148.1	149.2	136.8	136.4	135.1
1947	219.3	222.0	207.6	207.5	203.8	180.4	184.0	158.1	157.1	158.0
1948	250.1	251.6	239.4	242.2	235.6	199.2	202.5	178.8	178.8	178.8
1949	243.7	240.8	242.8	246.4	240.0	189.3	189.9	180.6	180.8	177.5
1950	256.2	254.5	249.5	251.5	248.0	194.3	196.2	185.4	183.7	185.0
1951	273.2	271.3	263.7	265.2	262.2	212.8	214.6	204.2	202.8	205.0
1952	278.2	274.8	271.9	274.9	271.8	218.8	221.0	212.8	210.1	214.3
1953	281.3	277.2	281.0	286.0	282.0	223.3	224.6	221.3	221.8	223.0
1954	285.0	278.2	293.0	300.6	295.4	219.6	219.1	223.5	225.2	225.4
1955	293.1	286.0	300.0	308.3	302.4	225.3	225.1	229.0	231.5	231.8
1956	310.8	302.2	320.1	328.6	324.5	237.2	235.7	241.7	244.4	246.4
Nov. 1956	313.2	304.0	324.4	334.9	329.4	239.8	238.1	245.5	248.1	250.8
Dec. 1956	316.0	306.6	327.9	338.7	332.0	239.8	238.1	245.5	248.1	250.8
Jan. 1957	315.7	306.2	327.8	338.7	331.9	239.8	238.1	245.5	248.1	250.8
Jan. 1957	155.6	150.1	150.8	153.9	155.1	177.8	186.5	158.1	154.7	164.8

**ST. LOUIS**

**SAN FRANCISCO**

1930	108.9	108.3	112.4	115.3	111.3	90.8	86.8	100.4	104.9	100.4
1935	95.1	90.1	104.1	108.3	105.4	89.5	84.5	96.4	103.7	99.7
1939	110.2	107.0	118.7	119.8	119.0	105.6	99.3	117.4	121.9	116.5
1946	167.1	167.4	159.1	161.1	158.1	159.7	157.5	157.9	159.3	160.0
1947	202.4	203.8	183.9	184.2	184.0	193.1	191.6	183.7	186.8	186.9
1948	227.9	231.2	207.7	210.0	208.1	218.9	216.6	208.3	214.7	211.1
1949	221.4	220.7	212.8	215.7	213.6	213.0	207.1	214.0	219.8	216.1
1950	232.8	230.7	221.9	225.3	222.8	227.0	223.1	222.4	224.5	222.6
1951	252.0	248.3	238.5	240.9	239.0	245.2	240.4	239.6	243.1	243.1
1952	259.1	253.2	249.7	255.0	249.6	250.2	245.0	245.6	248.7	249.6
1953	263.4	256.4	259.0	267.6	259.2	255.2	257.2	256.6	261.0	259.7
1954	266.6	260.2	263.7	273.3	266.2	257.4	249.2	264.1	272.5	267.2
1955	273.3	266.5	272.2	281.3	276.5	268.0	259.6	275.0	284.4	279.6
1956	288.7	280.3	287.9	299.2	293.3	279.0	270.0	288.9	298.6	295.8
Nov. 1956	289.3	280.7	289.5	300.6	296.5	282.6	272.8	295.8	306.8	302.9
Dec. 1956	289.7	281.2	289.9	300.8	297.2	281.9	271.9	295.6	306.6	302.5
Jan. 1957	289.7	281.1	290.8	302.0	297.2	283.1	272.7	297.2	307.6	303.5
Jan. 1957	162.9	162.7	145.0	152.1	149.7	168.1	174.6	153.2	152.3	160.5

Cost comparisons, as percentage differences for any particular type of construction, are possible between localities, or periods of time within the same city, by dividing the difference between the two index numbers by one of them; i.e.:  
 index for city A = 110  
 index for city B = 95  
 (both indexes must be for the same type of construction).

Then: costs in A are approximately 16 per cent higher than in B.

$$\frac{110-95}{95} = 0.158$$

Conversely: costs in B are approximately 14 per cent lower than in A.

$$\frac{110-95}{110} = 0.136$$

Cost comparisons cannot be made between different types of construction because the index numbers for each type relate to a different U. S. average for 1926-29.

Material prices and wage rates used in the current indexes make no allowance for payments in excess of published list prices, thus indexes reflect minimum costs and not necessarily actual costs.





3. Next the slab is poured—and that's it! From experience National Homes finds it has protection from cold and damp for the lifetime of the house.

## for lifetime perimeter insulation

There are good reasons why this is so. The same reasons that can help you enhance your reputation.

Styrofoam\* (a Dow plastic foam) is a homogeneous insulation with a remarkable combination of properties. This rigid insulation contains millions of noninterconnecting air cells. As a result, it can't absorb water. It provides true protection against dampness and water. Its low thermal conductivity stays low. In addition, it resists rot, mold, deterioration. And

having no food value, vermin and rodents won't bother it. But what makes Styrofoam even more outstanding is its unparalleled performance in such fields as low-temperature and plaster-base construction . . . industrial equipment . . . roofs, cavity walls and wall panels. This clean, odorless, lightweight insulation has many applications that are well worth your investigation. You'll find Styrofoam pays off in lifelong efficiency and economy.

\*Styrofoam is a registered trademark of THE DOW CHEMICAL COMPANY

For further information, contact your nearest distributor: CALIFORNIA, Colma: Western Foam Products, Inc. • CALIFORNIA, Los Angeles 13: Pacific Foam Products Company • FLORIDA, Tampa: The Soule Company • GEORGIA, Atlanta 8: Badham Sales Company • ILLINOIS, Chicago 11: The Putnam Organization, Inc. • KANSAS, Kansas City: Styro Products, Inc. • MASSACHUSETTS, Ipswich: Atlantic Foam Products Company • MICHIGAN, Detroit: Par-Foam, Incorporated • MICHIGAN, Midland: Floral Foam Products • MINNESOTA, Minneapolis 8: Edward Sales Corporation • MONTANA, Billings: Madden Construction Supply Company • NEW YORK, Rochester 20: William Summerhays Sons Corp. • NEW YORK, Long Island City 1: Styro Sales Company, Inc. • OHIO, Cincinnati: The Seward Sales Corporation • OHIO, Cleveland 13: Structural Foams, Inc. • PENNSYLVANIA, Plymouth Meeting: G & W H Corson, Incorporated • TEXAS, Houston: The Emerson Company • UTAH, Salt Lake City 10: Utah Lumber Company • WASHINGTON, Seattle 9: Wiley-Bayley, Inc. • WISCONSIN, Milwaukee: S & S Sales Corporation • CANADA, Kitchener, Ontario: Durofoam Insulation, Ltd. Or write THE DOW CHEMICAL COMPANY, Midland, Michigan—Plastics Sales Department PL1740Y.



YOU CAN DEPEND ON



"This is Los Angeles, the 'most up-to-date city in the world,' the 'pattern for 20th-century living,' and hence a likely forecast of England in the 1970's or 1980's. . . . Is there a way out? We believe that there is. . . ."



THE WAY OUT: A BLUNT PRESCRIPTION

By PAMELA COTTIER FORCEY

*Counter-Attack.* By Ian Nairn. The Architectural Press (9-13 Queen Anne's Gate, London, S.W. 1, England), 1957. 81 pp, illus. 12s. 6d.

American pride may be hurt when the horrified English enter Los Angeles as an exhibit in a kind of chamber of horrors and say, "We mustn't let this happen here," but when the English then proceed to show just *how* to prevent further urban and rural stagnation and blight, we should swallow our pride and listen. The problem is perhaps more acute in tiny Great Britain, but even our vast spaces are proving to be anything but limitless; indeed, certain areas of the United States have already been transformed into great subtopias.

"Subtopia," formed from "suburb" and "utopia," is the word coined in *Outrage* (reviewed in ARCHITECTURAL RECORD, November, 1955), to which *Counter-Attack* is the sequel. Both are book-form reprints of issues of *Architectural Review*. (*Counter-Attack* was the December, 1956, special number.) Subtopias have, according to *Counter-Attack*, insidiously formed themselves as a result of a visionary emphasis on suburbs as an ideal. "The crime of

(Continued on page 58)

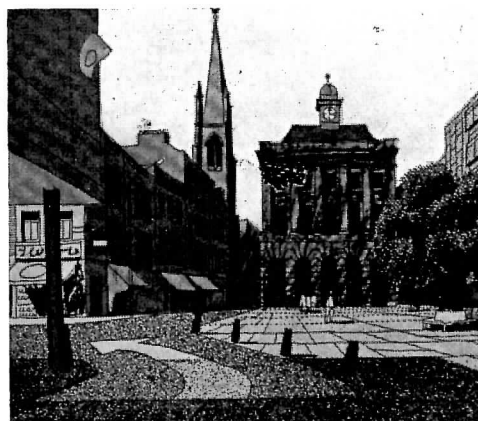
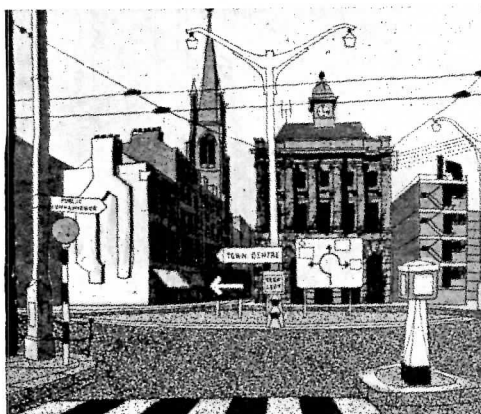
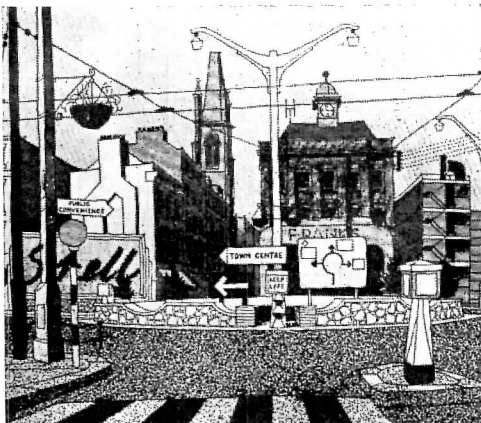

A square in "rock-bottom subtopia" (upper) on the way to improvement (left) and "rescued," transformed into an ideal town (right).



YOU GET  
SOMETHING  
**EXTRA**  
WITH  
**BRYANT**



*Yerba Buena Plaza, San Francisco: Architect, Ambrose & Spencer, San Francisco; General Contractor, Theo. G. Meyer & Sons, San Francisco; Electrical Engineer, G. M. Simonson, San Francisco; Electrical Contractor, Grandt Electric Co., San Francisco.*

## 14,000 Reasons for Dependability and Economy

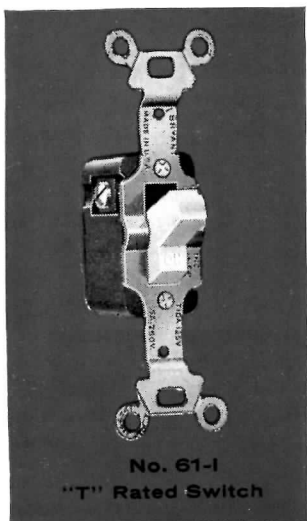

Fourteen thousand residential type switches and outlets are used throughout the 2,659 rooms of Yerba Buena Plaza, apartment development of the Housing Authority of the City and County of San Francisco. Low maintenance cost and ease of installation were major considerations in choosing Bryant quality wiring devices for this modern West Coast project located in two sections of the city.

Economical but dependable No. 6122 outlets, with double-sided contacts, and No. 61 single pole and No. 63-I three-way "T" rated switches were installed. Bryant's full line of once-installed, stay-installed quality wiring devices is designed to meet any specification — residential, commercial, or industrial.

Listed by Underwriters' Laboratories, Inc.

**THE BRYANT ELECTRIC COMPANY**  
Bridgeport 2, Connecticut • CHICAGO • LOS ANGELES



J-99979A



## Keeping industry bright with **ABolite**

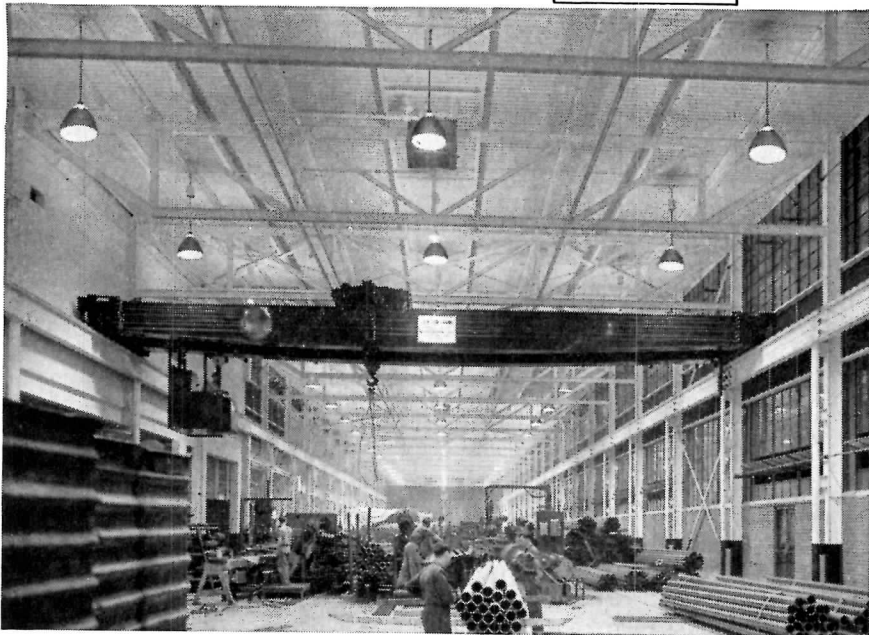

AMERICAN METAL PRODUCTS COMPANY  
Detroit, Michigan

Design and Construction:  
The Austin Company  
Electrical Contractor:  
Hall Engineering Company  
Electrical Distributor:  
General Electric Supply Company

*The Austin Company specified...*

### **Abolite uplight mercury units for economical high bay lighting**

Plans for this new plant called for high bay illumination without objectionable shadows between lamps and ceiling. That's why Abolite aluminum uplight mercury units were specified. The unique open-top design of this reflector provides 18% uplight, washes out ceiling contrasts, gives excellent overall illumination. Cleaner, cooler lighting, longer lamp life, less maintenance also result from the open-top feature.

You can make important savings with these new Abolite uplight mercury units. Compare their performance and cost with other type fixtures. For full details write *Abolite Lighting Division, The Jones Metal Products Co., West Lafayette, Ohio.*

# ABOLITE



#### LIGHT DISTRIBUTION CURVE

24" DIA. ALUMINUM REFLECTOR  
LAMP H 400-RC1

Installation data: 69 units, using General Electric H 400-RC1 color-improved mercury lamps. 35' ceiling, 28' mounting height, spaced on 20' centers. 35-foot-candles average initially.

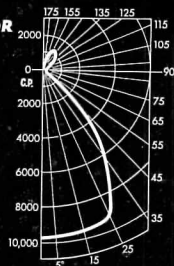

#### REQUIRED READING

(Continued from page 54)

subtopia is that it blurs the distinction between places. It does so by smoothing down the difference between types of environment — town and country, country and suburb, suburb and wild."

*Counter-Attack*, aimed at the layman on the sensible premise that average citizens must stir themselves if anything basic is to be done, offers a four-point sequence of reform: 1) Identify the type of environment in question — wild, country, arcadia (used instead of "suburb" because the latter is often actually subtopia), town, and metropolis. 2) Reduce clutter; cut out useless verticals, tidy up in general. 3) Relate the now well-designed elements to one another, while not wasting any ground. 4) Camouflage interruptions and eyesores that must inevitably remain.

These injunctions are made graphically specific in the "casebook" sections of the volume. Here illustrations and text are ingeniously combined and inter-related to show the proper kind of components for each type of environment. This is no theoretical treatise that scorns "unimportant details." Seats, railings, walls, street furniture, lettering, street lighting, wires, road signs, parking lots, the correct way to prune a tree — these are some of the "little things" that are shown to be vitally important in eradicating subtopia. The more obvious topics, such as monuments, advertising, and parks, are, of course, also included.

One of the study's central messages is: a town is a town, and country is country, and there should be a clean break between. Following these precepts literally, one *would* come up with compact towns and villages surrounded by pleasant fields and parks. But the shining bulk of the automobile obtrudes itself. Rightly or wrongly, our civilization has now decided that there must be space for parking, both on-street and off-street, and space for garages near houses and apartments. This is undoubtedly more true here than in England, but even so, it is a problem that *Counter-Attack* perhaps does not face squarely. Again, another problem that is probably more pressing here is the desire of each householder for his own yard and garden. "Outdoor living" at home and the attempt to have one's own car constantly available are two reasons why subtopias have multiplied here. Almost insuperable obstacles would be faced by American planners who urged

(Continued on page 416)



# VÄLLINGBY

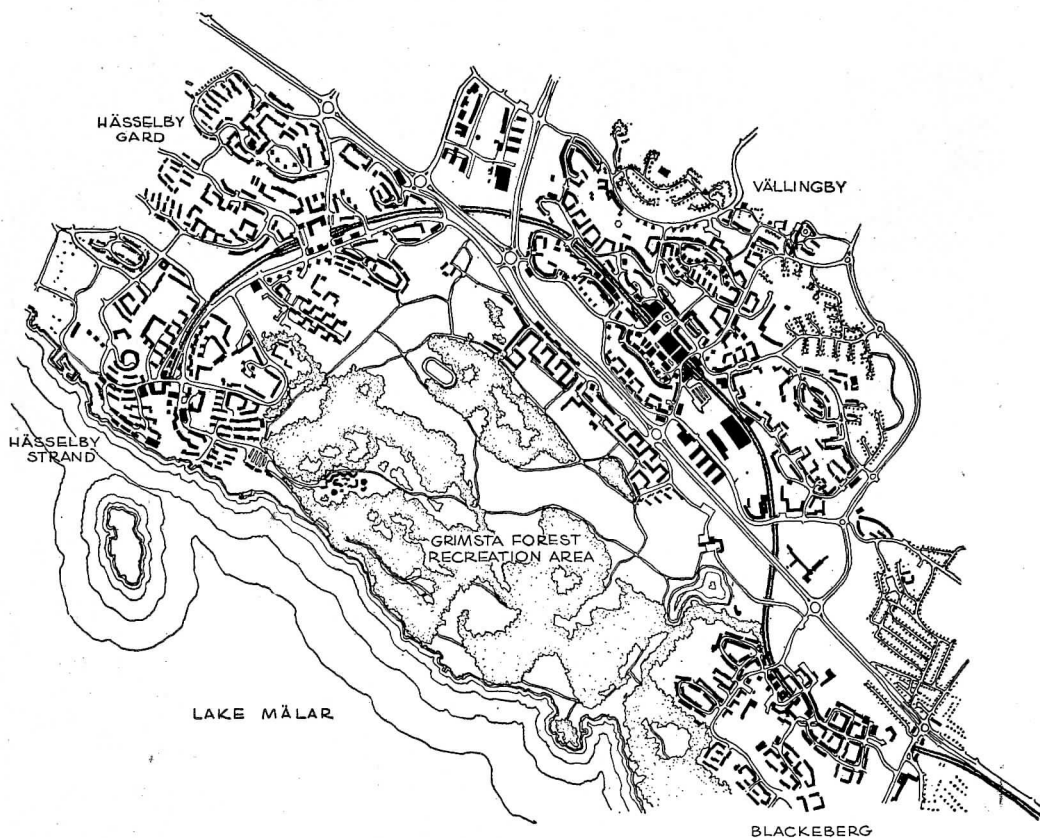

## V Ä L L I N G B Y

THE NEW SECTION OF STOCKHOLM\*

by G. E. KIDDER SMITH

*VÄLLINGBY, the new town section in west Stockholm, probably has more planning lessons to offer the cities of our time than any recent urban development within my knowledge. By beautiful example, it shows how the suburbs which increasingly envelope the world's cities can be well planned, park-like, viable centers — not haphazard accretions strangled by transportation, mired in shopping, desperately in need of adequate schools and public amenity. Here, where cows grazed and corn grew only five short years ago, there is a city of 23,000 in which every road, every building location, every need of the inhabitants was carefully planned before first ground was ever broken. Vällingby is the embodiment of Sweden's intimate relationship between architecture and the land. Where has this idea been more beautifully expressed?*

\* An expanded version of this article will appear in a greatly revised 2nd edition of *Sweden Builds*, just published by Reinhold, New York. These photographic illustrations are by Mr. Smith, who collaborated also in designing these pages.





VIRTUALLY ALL the major decisions in the moulding of Vällingby were good ones: strict preservation of the landscape; free planning in space with fingers of green everywhere; separation of pedestrian and motor traffic; integrated transportation, parking and shopping; complete cultural and entertainment facilities; a great variety of housing types; one central plant for heat and power. One might quarrel with minor decisions — especially with some of the architecture — but the basic concept and its execution are decidedly superior. Why and how did Vällingby come about?

A few years ago further expansion of Stockholm was imperative. The City Planning Commission, under Sven Markelius' brilliant direction, decided that a complete town section — a microcosm of the city — would be sounder in principle than the usual dormitory suburb. They conceived Vällingby as an important experiment in character and in size. Its character was

set by the inclusion of a modified commercial and industrial base capable of employing 25 per cent of the resident population. Its size would exceed anything in Scandinavia. Indeed there are few new developments anywhere which can approach it in scope.

The site — nine miles from central Stockholm — comprised four square miles of unspoiled farmland which the city had foresightedly bought in 1930. In addition to accommodating its own 23,000 people, Vällingby was planned as the shopping, amusement and employment center for 60,000 additional people grouped in surrounding developments. Each of these would be intimately related to the large Grimsta Forest Recreation Area and to Lake Mälaren, the southern border of the complex. The entire development is a magnificent concept as well as an effective demonstration of the foresight and virtues of Stockholm's municipal land ownership and large-scale planning.

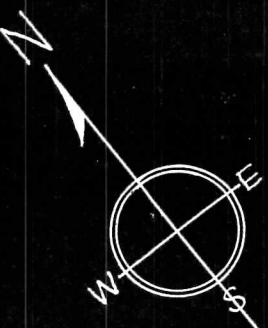

SCALE:  
50 100 200 300 400 M.  
100 200 300 400 500 600 700 800 900 1000 1100 1200 FT.







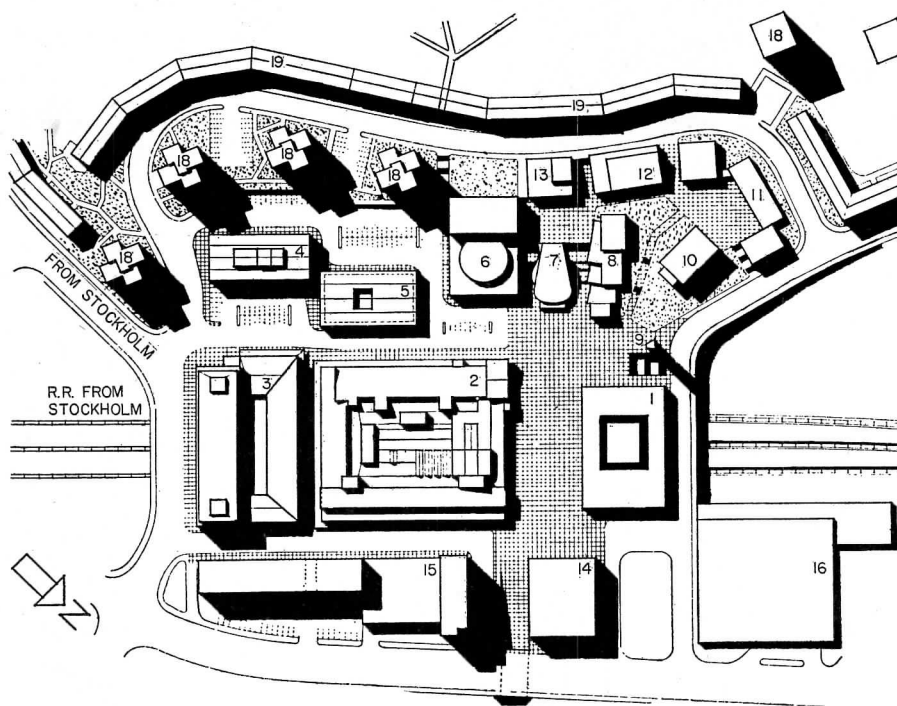

- 1 Rapid Transit Station
- 2 Department Store
- 3 Shops
- 4,5 Offices
- 6 Theater
- 7 Cinema
- 8 Meeting Rooms
- 9 Clock tower
- 10 Church
- 11 Town Hall
- 12 Library
- 13 Youth Center
- 14 Shops (Projected)
- 15 Offices and Shops (Projected)
- 16 Garage (Sunken)
- 18 High rise Apts
- 19 Low apartments

Nordisk Arkitektur, 1950-54

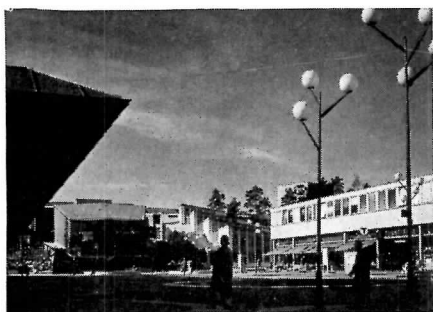

**VÄLLINGBY / CENTRUM** The core of Vällingby combines the commercial, amusement and cultural activities of the 80,000 people in the entire three-community development. It is built directly over the Rapid Transit Lines and is surrounded by parking. Deliveries and servicing for most of the seventy shops are from below. No vehicles are allowed on the piazza: the pedestrian rules here. Public buildings (most of which were designed by Backstrom and Reinius) are grouped along the slight hillside and step down to the main shopping mall. With its fountains, gay mosaic paving and rampant lamps, the mall is very festive, although the space is a bit rigid. Furthermore it is doubtful if the disposition of the major buildings gives enough weather protection in a latitude which bisects Siberia. The general atmosphere is stimulating and conducive to spending, despite the shockingly tasteless signs — typical of many Scandinavian commercial buildings.



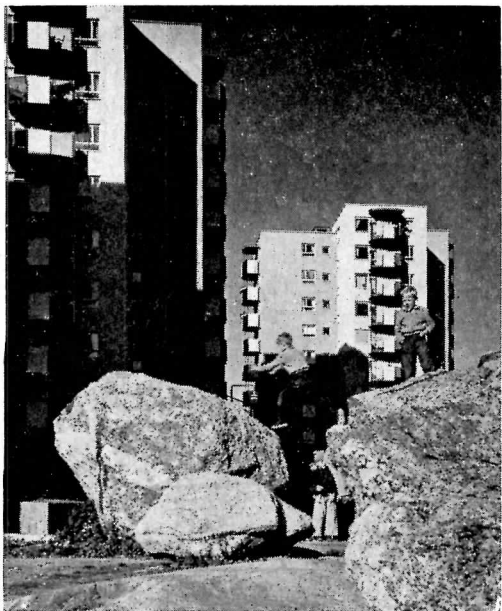

**VÄLLINGBY / HIGH RISE APARTMENTS** In planning the community one of the basic decisions was to group a concentration of ten to twelve-story apartments about the centrum. As distance from the core increases, density and building height diminish. This places the greatest number of people near shopping and next to the rapid transit station. Special flats for older persons are appropriately located near the centrum. For families with children, who welcome intimate contact with nature, and for those with cars, walk-up apartments, row-houses and cottages are available farther out. An interesting feature of the Vällingby concept is the extraordinary variety of accommodation available: one can get anything from a twelfth floor penthouse to a prefabricated cottage. And no matter what the type each unit will be surrounded by greenery.

(H. Klemming was the architect for the buildings shown on these two pages.)



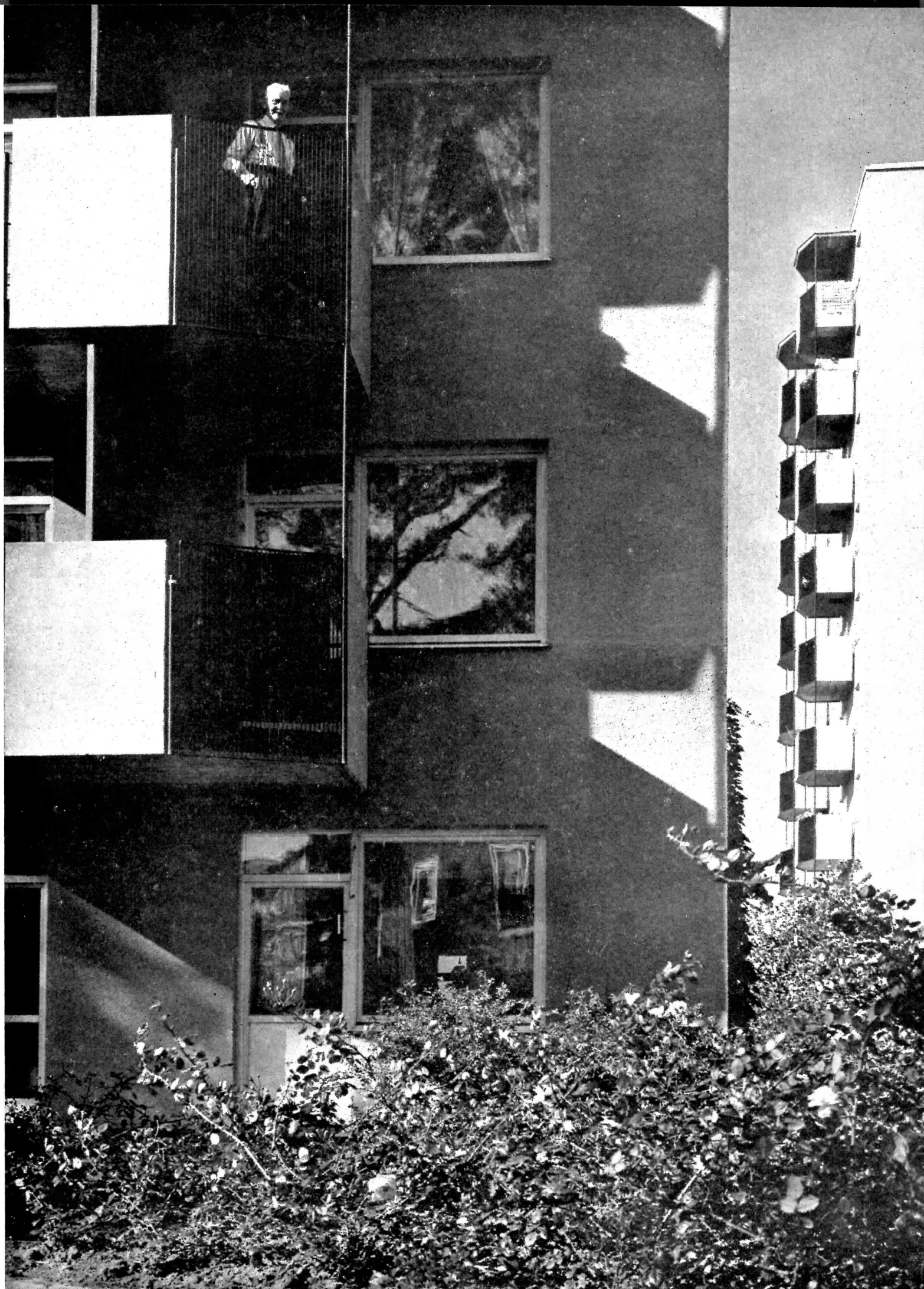

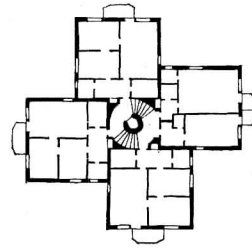

**VÄLLINGBY / LOW HOUSING** Three and sometimes four-story walk-up housing forms the major building type, but there is by no means a single pattern for this, as can be seen in the sketch above and photograph at upper right. Its finest expression is shown in the sketch and plan above (by Paul Hedqvist). These are well planned, spaciouly deployed dwellings, intimate with the land. The three story strip (or lamella) housing is Vällingby's commonest type. Sometimes it is well designed (as at right, by H. Klemming), sometimes not — as in the dreary, clumsy southwest corner of the city (see plan, bottom of p. 174). Note — above right — that tree preservation, landscaping and playgrounds are integral with the architecture. Landscaping goes hand in hand with construction here, and is not treated as an afterthought with an afterthought's results. The attached houses at lower right are skillfully tied to their setting (by Höjer and Lundqvist).



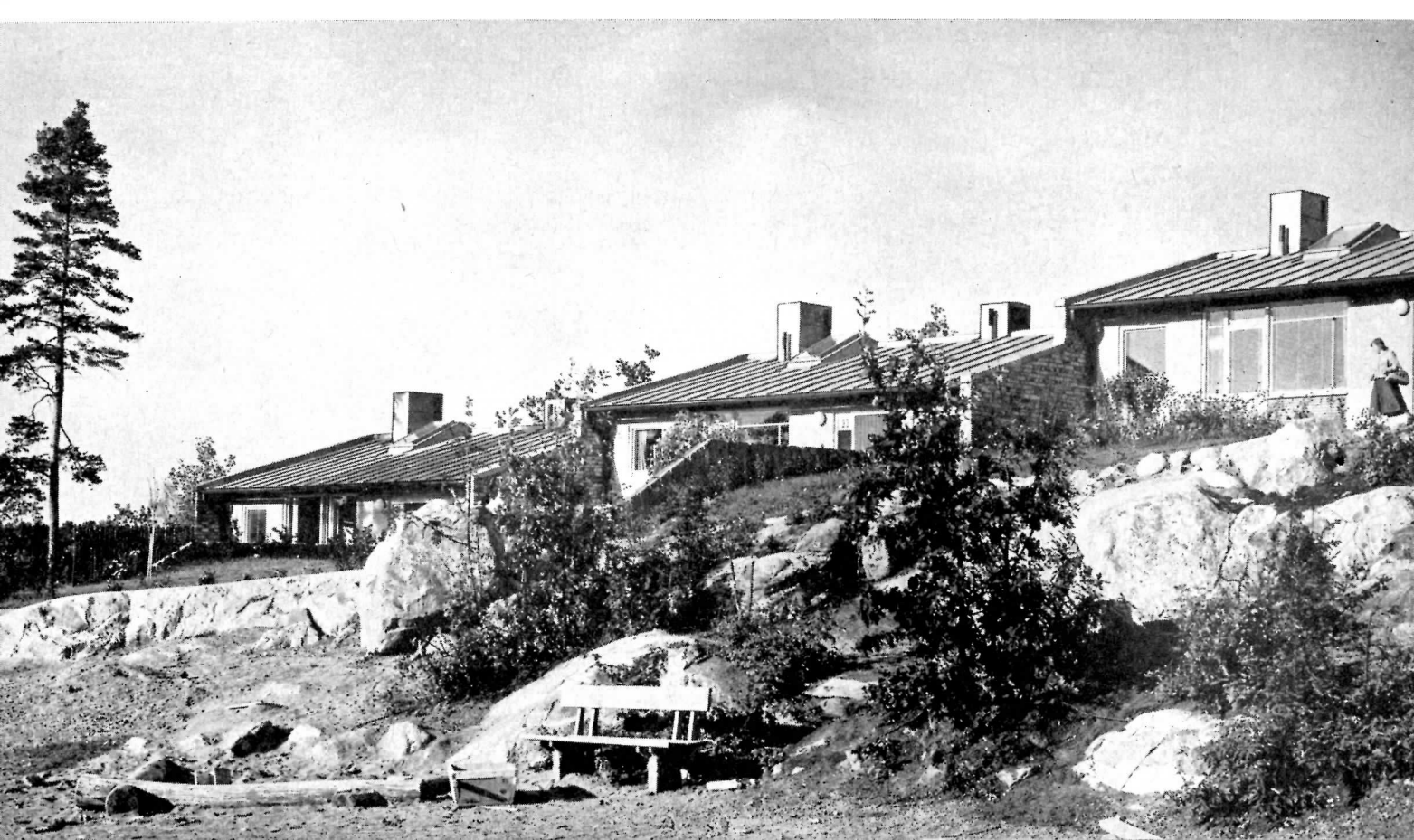





VÄLLINGBY

# DEEPER KNOWLEDGE: BETTER DESIGN

by RICHARD LLEWELYN DAVIES

*Director, Division for Architectural Studies, The Nuffield Foundation, London*

*Knowledge is the raw material for design. It is not a substitute for architectural imagination; but it is necessary for the effective exercise of skill and imagination in design. Inadequate knowledge handicaps and trammels the architect, limits the achievements of even the most creative, and depresses the general level of design. This article discusses the means whereby our profession can seek to broaden and deepen the basis of our knowledge, not as an end in itself, but in order to give more power and freedom to creative design.*

— R. L. D.

THE WORK of some of the greatest living architects illustrates the difficulty of achieving all round, comprehensive design under today's conditions. Very often, in order to achieve their success, these architects seem to ignore or brush aside one or more important parts of the architect's task. For example, the immense contribution of Mies van der Rohe has been achieved by ruthless concentration on certain structural and formal aspects of design to the exclusion of nearly all others.

Many architecturally distinguished buildings are a poor fit with the lives and needs of the people who use them. If you visit these buildings some years after they have been completed you rarely find them being used as the architect had envisaged. They have generally been altered, often disfiguringly, to make them fit with life. There are very few modern buildings with that flavour of simple, inevitable rightness and appropriateness which is characteristic, not of merely individual masterpieces, but of a great range of buildings of other periods.

Our current failure to master the knowledge we need comes out again in the tendency amongst some architects to write off whole fields of building as being too complicated to give any scope for creative design. I have heard it said that good architecture is impossible in hospital work, because the complex requirements of hospital function make a straitjacket from which no creative designer can escape. Even if this view is rejected in principle (as I am sure it must be), it remains true that most hospital design — and equally the design of other buildings with a complex social purpose — is uninspired at its best. Most of these buildings look, in fact, as though their designers had been defeated by the difficulties.

The problem is most acute in countries such as the United States and England, where progress has been most rapid and turbulent. In countries like Sweden where change has followed a much slower and steadier tempo, and where the violent convulsions of the industrial revolution were damped, architecture has been more successful in keeping step. In Sweden the architectural profession has had more time to re-think its philosophy and adapt its training, and it has not slipped so far behind. The visitor to Sweden from England or

the United States cannot fail to be impressed by the high general standard of design, and the pervading good sense and appropriateness of current architecture. There is nothing in Sweden comparable with Le Corbusier's chapel at Ronchamp or the Mies van der Rohe apartment blocks in Chicago, but I don't think this is any criticism. Dramatic masterpieces occur rarely, they are the work of inspired individuals and are just as likely to occur in a country where the general standard of design is high as in a country where the general standard is low. (There has in fact been at least one example in Sweden, the Stockholm Crematorium by Asplund.)

The life and work of Alvar Aalto is an illustration of our present crisis. Aalto is an architect who is profoundly interested in achieving that overall rightness — that inevitability — which is the mark of an all-round mastery, and which is so conspicuously lacking in most modern work. Aalto worked in the United States; he taught at M.I.T., and had as much private work as he cared to accept. He tried, in the hostel building he designed for M.I.T. students, to break away from the dominant pattern of city architecture, which he saw as rather narrow and mechanistic. He tried to design a building which would reflect not only the dynamism of American technique, but also the human and social needs of a group of students, a building in which every room would have an individual character instead of being No. 877 on the eighth floor. He failed, but it was a glorious failure. For himself, Aalto solved the problem by giving up his M.I.T. appointment, leaving the United States, and returning permanently to Finland. He went back in order to escape from what he felt to be the insuperable difficulty of doing creative work under the complex pressures acting on the architect in the United States. He returned deliberately to a simpler, less advanced society where he felt he could master the problems of design, and produce work which would satisfy himself. In this he has succeeded triumphantly as can be seen in his most recent buildings. Aalto's personal solution is of course no answer for us, who work in rapidly advancing and changing countries. We must face, and try to solve, the problem of knowledge.

## A New Kind of Architect

The problem which we have to solve is a new one for which there is no precedent in the history of architecture. In order to understand it it is necessary for us to look back a little and see how we have come to our present position and to our present attitudes.

It is only comparatively recently that the sum of knowledge has become too great for the individual architect to master the whole of it. Palladio's famous treatise<sup>1</sup> contains pretty well the whole of the knowledge needed for practice in his day. Even as late as 1880, Gwilt was able to put most of the necessary knowledge into one large volume.<sup>2</sup> The Renaissance ideal of the architect was *Uomo Universale* — the Universal Man — with the whole of contemporary knowledge and culture in his head. The lives of men such as Alberti and Leonardo da Vinci show that this was no empty ideal. They really mastered the total range of knowledge and made triumphant use of it. Christopher Wren, a distinguished scientist as well as an architect, was also a Universal Man in the Renaissance sense. He was perhaps the last, but the ideal remained valid and attainable until the beginning of the nineteenth century.

The leaders of architectural thought around the end of the nineteenth century were the French architects, centred round the Ecole des Beaux Arts. They saw that a dramatic expansion was taking place in the range of knowledge needed for architecture. On one hand, building structure, with the coming of steel and reinforced concrete, was becoming the field of specialist engineers. On the other, social change was throwing up a demand for many new types of building for which there was no historical precedent. They could not see that the flood of new knowledge could inspire and free architecture; they feared it as a menace. They met the threat by retreating into a very narrow professionalism. They redefined the role of the architect in such a way as to exclude, or make unimportant, areas of knowledge which had previously been thought necessary. They introduced the concept of the architect's *programme*. Previously there had been no need for a programme, that is a written schedule or instructions from the client to the architect.

From the Renaissance to the end of the eighteenth century the architect remained close to contemporary culture, and shared with his clients an unconscious, automatic understanding of the functional needs he had to meet in his design. He did not need a programme before designing a church or a villa; he knew perfectly what such buildings had to do. The Beaux Arts concept of the programme absolved architects from the need to

study building function, and excluded at one blow a considerable range of knowledge.

At the same time the Beaux Arts teachers began to codify and catalogue *elements* of building.<sup>3</sup> They built up a limited vocabulary of forms which could be assembled in various ways to meet the requirements of any programme. By this means they hoped to keep engineering in what they believed to be its proper place — a technical service to the architect. The architect selected an appropriate form and the engineer was then called in to construct it. On this basis, engineering has no role as a contributor to design, and it followed that there was no need for the architect to understand the relationship of engineering knowledge to building form.

Thus architecture was reduced to the manipulation of a number of *elements*, in accordance with the rules of composition, to satisfy a programme. The very technique of teaching at the Beaux Arts reflects this philosophy. When the programme for a design *subject* was given out at the studios, each student was required to make an *esquisse* (a quick sketch) of the solution. For this he was only allowed one day, during which he was not allowed to discuss the problem with his fellow students. Often he was shut up in a special cubicle. In subsequent work on the development of the project he had to remain within the boundary set by his first *esquisse*, or his design was disqualified. This method of teaching dramatically symbolises the Beaux Arts concept of the architect: operating in isolation from life, within the narrow limits of a programme written by others, and using a closed vocabulary of forms.<sup>4</sup>

Few will nowadays defend the theories of the French Beaux Arts or its methods of teaching but, more than is often realised, its spirit marches on. Many architects acquire in the course of their training a rather isolationist picture of their own role: they tend to feel that qualification as an architect endows a man with a special power and that he can design any building, providing he is given a clear-cut programme. The programme never is clear-cut, and for this he is apt to blame his client, whereas in fact the difficulty is a much bigger one, a general failure of communication between our profession and the society it serves.

The modern movement in architecture had, as its central objective, the re-establishment of this communication. It has only partially succeeded, and our problem today is to carry forward the work, begun by Gropius and others, into areas which they did not reach. Gropius, at the Bauhaus, was especially concerned to bring architecture into touch with industrial production. He, also, was probably the first to see the need to link up with the social sciences, in order to get back to some under-



“. . . most of this new, scientific knowledge  
is not an addition to our total stock;  
it is a replacement.”

standing of the pattern of life, which architecture has to express and heighten. Le Corbusier in his first book tells architects to open their eyes to the impact of engineering on form — apparent everywhere in ships, cars and airplanes — but invisible to the French architects still working for their Beaux Arts catalogues.<sup>5</sup>

Unfortunately the early impetus, the drive to reintegrate architecture with life through its related professions and sciences, has not been kept up. Instead the forms used by the great pioneers, forms often highly experimental, and appropriate only in their context, have been copied and reproduced, while the ideas behind them have, to a great extent, been forgotten.

Their buildings were the prototypes for a new architecture; they often had to base design on guesswork. Gropius, for his experimental house at Weissenhof in 1927, had to imagine a prefabrication industry, and forecast its effect on design. Le Corbusier was guessing at the social and economic patterns likely to control city life when he planned the apartment block at Marseilles. Thus the work of the pioneers can be seen as an imaginative projection of modern architecture. They have shown that design must spring from the realities of building need and building method, and have given us some inspired examples. But we have to expand and consolidate our knowledge before we can effectively put into practice what they preach.

### *Function is Little Understood*

Before discussing how we should go about the task of consolidating our knowledge we must review the field we have to cover. It is convenient to divide it into two halves; one concerned with the *means* of building, i.e. structure, materials and technique; and the other with the *needs*, i.e. functional and physical requirements. Both were seen as of equal importance when the modern movement began thirty years ago, but our achievement has been all on one side. We have made real progress in integrating design with construction, but very little in integrating it with function.

Within the field concerned with the means of building, structural theory stands out as a subject in which a dramatic advance has taken place. This advance is the result of research made by the engineers, working within their own profession. But architects have been quick to pick up each new development and exploit it architecturally. We have succeeded in building into our teaching some understanding of the relationship between form and structure. We have assisted the engineers by giving them opportunities for demonstration

and experiment with new techniques. This pattern of co-operation between the two professions has been one of the most fruitful developments of recent years, and much of what is best in modern architecture stems from it.

We have been so successful on this side and, comparatively, so unsuccessful on others, that we have come to lean too heavily upon structure as an inspiration for design. The eagerness of architects to seize and exploit the newest engineering development, such as shell concrete or the space frame, exposes the poverty of our knowledge in other, equally important aspects of architecture.

Knowledge of building materials and methods, both old and new, has expanded immensely in recent years. Most countries now have substantial establishments for building research, where chemists, physicists and engineers investigate the properties and performance of materials. Their work covers an immense range, from the chemistry of cement to performance tests on walls, roofs or complete buildings. A great mass of valuable, scientific material pours out from research centres every year. Architects are aware of the importance of this new knowledge, and of the need to absorb it into thinking and practice. But we have found it very difficult to do so, because of the bulky and indigestible form in which it reaches us. There is one important point to be remembered: most of this new, scientific knowledge is not an addition to our total stock; it is a replacement. It replaces the old rule-of-thumb princi-

---

<sup>1</sup> *Andrea Palladio*. ARCHITECTURE. 2nd English Edition. London, 1738.

<sup>2</sup> *J. Gwilt*. ENCYCLOPAEDIA OF ARCHITECTURE. London, circa 1880.

<sup>3</sup> *J. Guadet*. ELEMENTS ET THEORIE DE L'ARCHITECTURE. Paris, circa 1880.

<sup>4</sup> An interesting parallel can be drawn between Beaux Arts theories of architecture and theories of classical ballet and cookery, developed at about the same date. In ballet, a limited number of movements, perfected for all time, could be assembled only according to certain rules. Similarly Escoffier reduced cookery to a very short repertoire of basic flavours and sauces, each of exquisite perfection, and gave rules for combining them into the various dishes of classical cuisine.

<sup>5</sup> *Le Corbusier*. VERS UNE ARCHITECTURE. Paris, 1924.

ples of building construction, derived from trial and *error* and accumulated experience. Once we have accepted this we shall be better able to absorb the new knowledge, which implies the substitution of card-indexes and scientific abstracts for the craftsman's know-how.

Structure, materials and methods are aspects of traditional building. Beside them we must now put production engineering. Factory produced components are slowly but steadily displacing sitework, and the impact of this change on architecture is already marked. Aalto found that in the United States he could not get doors and windows in special sizes, except at prohibitive cost, and felt this to be an intolerable infringement of his freedom as a designer. On the other hand, close co-operation between architects and industry, as in the recent English programme of prefabricated schools, results in new and exciting forms, perhaps even a new aesthetic.<sup>6</sup> We cannot stop the drive towards factory production, nor evade the issues it raises for architecture. It will be negative and restrictive in effect if we stand aside, but positive and creative if we understand it and cooperate with it. If we are to do so we must include knowledge of the potentialities and limitations of production engineering as part of our job.

The study of structure, building materials and methods is energetically pursued by engineers, scientists and builders, and our main problem is to make sure we have effective means of communication and collaboration with our professional colleagues. When we turn to the other major field of knowledge, which deals with building needs, the picture is very different. We lack knowledge about the functioning of most forms of human organisation, and there is little to go on in planning buildings, except of the very simplest type. It is almost impossible to find a modern building where real architectural inspiration has been derived from an understanding of its social purpose. There is one significant exception, the private house, built for a client whose pattern of life is similar to that of his architect. Here the architect really understands the requirements, and can achieve creative expression, within the limits of his skill.

The main difficulty is that it is nobody's special job to study the functional requirements of building design. The social sciences are those most nearly concerned. Housing and city planning are already recognised fields for social study, and considerable advances have been made in these subjects by joint teams of architects and social scientists. Within the last few years we have begun to apply sociological methods to other types of buildings, and the statistician, and the methods-study

engineer, and others are contributing to our picture of what goes on in buildings. But we are still far from having the knowledge we need.

There is special need for more historical study of building design in relation to use. Our social patterns change more rapidly than we can pull down and re-erect our buildings, and quite a few of today's patterns of living and working reflect yesterday's architecture. Very often our clients, quite unconsciously specify their requirement for a new building in terms of an old one. They find it hard to free their thinking from habit and attitudes conditioned by an existing architectural environment. The historian can help us to break out of this vicious circle, which blocks both social and architectural progress.

Apart from the study of function, we must now include the scientific description of physical environment as a branch of architectural knowledge. This covers a whole range of subjects including lighting, heating, ventilation, acoustics and colour. It is the province of engineers, physicists, physiologists and psychologists, and has been one of the principal growing points in the last five years. Of the various branches of knowledge bearing on architecture, this is one of the most fertile and stimulating. It is increasingly giving us the means to measure, and discuss quantitatively, aspects of design which formerly lay entirely in the subjective field. The volume of knowledge is already considerable, and is increasing rapidly, but it is absolutely vital for architects to understand the principles involved.

### *Specialist or Architect?*

One reaction to the problem set to our profession by the mass of knowledge has been an increased tendency towards specialisation. Too often it is assumed that before long all architects must become specialists, each in a particular field of building. We should then have school architects, hospital architects, factory architects, rather than general-practice architects. The demand for more efficient building has already forced many architects into some measure of specialisation, and there are today many firms in the United States and in other countries which have specialised on one or other type of building. The very large firms, though doing a variety of work, are as a rule highly specialised internally. Specialist firms build up a private fund of knowledge and experience and usually turn out a more efficient job in their own field than can be had from a general practitioner. One or two have done outstanding work and contributed to knowledge in their field.

“ . . . we have made real progress in integrating design with construction, but very little in integrating it with function.”

While specialisation in some form, or at least some differentiation of role between different kinds of architects may well be essential, it will be disastrous if we follow the path to specialisation to the point where each architect is concerned only with a particular type of building. It would be disastrous for two reasons. First because architects, to develop their most important gift — the power of creative design — need a variety of experience. For the architect, detailed knowledge is a good servant, indeed an essential one, but a very dangerous master. There is plenty of evidence that architects who are engaged too long in solving the same design problem over and over again lose their imaginative spring, and become stultified. Any picture of the future of our profession which does not allow the majority of architects to remain general practitioners is therefore very black. What we want is *specialist knowledge* freely available, not *specialised men*.

The second reason why mass specialisation is not the answer is that it would not ensure that the knowledge we are going to need becomes available. Specialised practice is out-of-date as a means for advancing knowledge. This task has now been taken over in almost every profession, by organised research. It is no longer feasible for the man engaged in daily practice to find the time, the money, or the contacts with other sciences and professions that are necessary to make an effective extension of the boundaries of knowledge. Again, such discoveries and developments as are achieved within the framework of individual practice are not necessarily passed on for the benefit of others. Indeed there is some economic incentive to treat them as trade secrets. Specialisation by all or most architects is therefore a dangerous path. We shall find ourselves forced down it under the pressure of demand for more efficient building unless we can find, and put into practice, an alternative solution.

There are alternative solutions. Other professions beside our own have had to face this problem, particularly medicine. In medicine, by the beginning of the seventeenth century, developments in knowledge and technique were already leading to a certain measure of specialisation. Peter Chamberlen and his family, inventors of the obstetrical forceps, were perhaps the first professional specialists in history.<sup>7</sup>

The problem for medicine has been to reconcile specialisation needed in the interests of progress, with the equal need to maintain an all-round approach to the care of a sick human being. While this dilemma has not yet been solved, a general pattern has appeared which goes some way to solve it, and has analogies for architecture. The essence of this pattern is a division of

role between the great majority of the profession, who are engaged in practice, and a small minority, who are engaged principally in research. Those in practice are not all highly specialised, indeed many of them are engaged in general practice. Research is the role of the highly specialised man, and his task is to operate on the frontier of knowledge. The results of his work are fed back to the practising members of the profession through publications, conferences, and postgraduate teaching.

Similar patterns can be seen in professions other than medicine. For example, in structural engineering, theoretical advances are today mostly made by highly specialised workers, in universities or other research institutions. The practising engineer keeps himself up-to-date in very much the same way as the doctor, by reading and postgraduate courses.

While there is some time lag in the dissemination of knowledge, on the whole it has been found possible for the practising doctor or engineer to be kept sufficiently well-informed; and the standard of practice advances reasonably close behind research. It is worth noting that what was a highly specialised technique yesterday is very often a common-place of practice today, and that some previously essential knowledge becomes out-of-date. Thus, although the total volume of knowledge has expanded vastly, the stock needed by the man in practice may not be so much larger now than it was in the past. The vital thing is that his knowledge should not stagnate. It should be moving on, in step with the expanding horizon of knowledge.

Some pattern of this sort is essential for any profession which intends to keep abreast of its responsibilities. The pattern for architecture will not be the same as that for any other profession. It must, however, provide for organised, specialised research, developing and expanding our knowledge, and for the effective communication of this knowledge to the practising architect, both during his training and afterwards.

---

<sup>6</sup> R. Llewelyn Davies and Weeks. THE HERTFORDSHIRE ACHIEVEMENT. *Architectural Review*. London, June 1952.

<sup>7</sup> In accordance with the craft attitude of the time, the Chamberlen family kept their invention secret. When called in to assist at a birth, they insisted that the patient should be covered with a voluminous black cloth. Carrying a large bag, which clanked mysteriously, a member of the family disappeared under the cloth and in due course the baby was safely delivered. The secret of the forceps was thus maintained, for nearly one hundred years.



### *Pattern for Advancement*

In fact the new pattern is already visible. There are already many significant achievements, and some lessons for the future.

Perhaps the most important development is the emergence of a new concept: research focussed on a particular kind of building, such as schools, laboratories or hospitals. This approach contrasts with the earlier concept of research into subjects such as brickwork, or ventilation, applying to all types of building. The older approach is typical of building research, as opposed to architectural research, and can often be carried on within the bounds of one scientific discipline. Research into a building-type, on the other hand, essentially involves a multi-disciplinary approach.

Pioneer work has already shown how fruitful research of this sort can be. One example has been the work of the schools development team set up by the British Ministry of Education. In a few years this team has revolutionised school design in England, fostering a new and much more human approach to school planning, and stimulating industry to develop flexible, architecturally acceptable, forms of prefabrication. It has also effected a reduction in the cost of school building in England, at a time when building costs were rising sharply. Most important of all, it has succeeded in spreading its knowledge amongst architects, so that school design, formerly the preserve of a few specialist firms, is now open to the whole profession. Very similar achievements have been made in the United States by the group which studies hospital design under the Department of Health, Education and Welfare in Washington. It has built up an impressive body of knowledge on hospital design, and its publications are used all over the world as reference material by hospital planners.

These teams are both government sponsored. It is a measure of the failure of the normal machinery of architectural practice that governments have felt the need to set up and maintain expensive research teams. They have only done so because they found that buildings of acceptable standard would not otherwise be forthcoming. But direct government sponsorship is in some ways an unsatisfactory background for research. There is inevitably some tendency for research conclusions to be confused with administrative decisions, taken partly on politico-economic grounds. Sometimes the iron hand of financial control is felt to lurk inside the velvet glove of scientific advice. It is therefore all the more remarkable that these teams have been so successful in winning the confidence of architects. Both have published excellent bulletins, and the English team has gone further;

it has designed and erected several prototype schools. These demonstration buildings have proved a first-rate form of communication with practising architects. As a profession we are poor readers, but we have a built-in capacity to learn from actual buildings. Most architects will cheerfully travel hundreds of miles to see a new building, but will resent spending ten minutes on looking up published data.

Both these teams had an operational task; they had to meet deadlines if they were to do their job. They were mainly composed of architects, assisted and advised by committees or consultants from other professions. While they looked critically at design and construction, they were not staffed to look very critically at function. They accepted a digest of the best current practice, in education or medicine, as a basis for design.

Valuable as this work has been, we also need more fundamental studies, which will enable us to look further ahead. Buildings designed around today's functional patterns may well be out-of-date before they are finished. The natural place for fundamental studies is a research institution or a university department. As yet there is very little genuine research within our schools of architecture, but there are significant beginnings, both in the United States and in Great Britain.

Meanwhile, the Nuffield Foundation has established in London a Division for Architectural Studies, expressly to promote fundamental work on architectural problems. The Nuffield teams have assumed that function and design must be studied simultaneously. This has meant a fully multi-disciplinary approach. One team, which studied hospitals included a doctor, a nurse, a medical historian, an accountant, statistician, and sociologists, as well as architects, and each profession had equal status in the team. Each team member contributed in two ways — by professional research within his own discipline, and as part of the whole group. The result of focussing intense study from many angles on a single problem — as, for example, the out-patient clinic — was to open up completely new architectural possibilities. New forms of human organisation, new attitudes and methods of work emerged simultaneously with new design concepts. The conclusions of the study were therefore revolutionary.<sup>8</sup> They are now undergoing practical test in many new experimental hospital buildings, designed by the research team. Other Nuffield teams are engaged in the study of scientific laboratories<sup>9</sup> and of farm buildings, by the same method of all-round attack.

The publications of the Nuffield teams are as much concerned with methods of study as with actual results. Until very recently most bodies engaged in architec-

“ . . . buildings designed around today's  
functional patterns may well be out-of-date  
before they are finished.”

tural research have published their conclusions without any account of how they were reached. This prevents critical discussion, and makes it difficult to apply the conclusions with any confidence under changed circumstances. Methods are often more important than results, and much of the Nuffield work is directed to discovering techniques whereby architects and their clients can work out their own needs, rather than to finding supposedly ideal solutions.

These three examples are not isolated cases; they are the highlights of a general development, in the United States, Great Britain, and many other countries. The work at the Nuffield Foundation is giving us new knowledge, particularly about use and function, where it is most lacking. Existing knowledge is being organised and packaged, in a form particularly useful to architects, by other teams. This re-arrangement of existing material arises almost automatically from the focussing of research on to a particular building type, and is showing us how to absorb and master the valuable but hitherto intractable data produced by building science.

We can now consider how this new pattern is likely to affect the structure of our profession, our training and our practice. We must expect to see a certain division of role amongst architects. With proper access to knowledge developed and organised by research, the great majority of the profession can avoid excessive specialisation. But we shall also need a limited number of architects to man our research organisations. These will be men who are prepared to specialise, and to devote themselves to an activity which has a smaller proportion of actual, creative design than falls to the majority of their colleagues. Their satisfaction must come from the fact that their work is advancing the subject of architecture. Experience in multi-disciplinary teams has already shown us how important it is that these men should remain architects first and foremost. They have to learn a great deal about other subjects, but they must not become a sort of hybrid, half-physicist, or half-sociologists. If this happens, their value to the team largely disappears.

It is therefore very important that architects working in research should have as much opportunity as possible to engage in design. This need is partly met by the experimental, prototype buildings, which are now an accepted part of most research projects. It is also desirable that they should do some consultant work, in association with practising architects. This has the very healthy result of bringing the research worker into direct contact with a practical design problem, to which he has to make a contribution on the basis of his special knowledge.

We shall need a certain change of emphasis in the training of the architectural student. This must now have the object of giving him a broad grasp of the whole field of knowledge, and of teaching him those attitudes and methods of work, already developed in the sciences, whereby the details of a subject can be fairly quickly learnt, so long as its essential principles have been understood. In practice, this will mean a broadening in undergraduate courses. This will be much easier to achieve if research architects can be brought into the schools of architecture. These are the men whose work will extend our boundaries of knowledge, and it is vital that they should contribute to teaching. Here again, we may have something to learn by looking at the structure of the medical profession, which has managed to adjust its system of rewards so as to bring together advanced research, consulting practice, and teaching. Many of the best men in medicine are engaged in teaching, because in the teaching hospitals they have facilities for research, and can establish themselves as consultants.

We shall not need very many research architects, but we must develop some system for selecting and training them. We have little or no advanced postgraduate training in architecture today, comparable with that in other professions. (Most of our postgraduate courses are merely an additional year on top of the normal undergraduate course.) The Nuffield Unit of London is experimenting in advanced postgraduate training, by the establishment of two-year fellowships, attached to research projects in progress.

These new developments in research, teaching, and the communication of knowledge have the same ultimate aim: to give the individual architect more power, and more freedom in design. As our knowledge becomes more complete, better organised, and easier to get at, so it will become more possible for the architect to see his design problems from all round. Then, he will be able to draw inspiration from a total view, and not from an isolated aspect only.

Our aim should be that each architect's achievement is limited only by his own creative power, and not, as so often today, by an inadequate basis of knowledge.

---

<sup>8</sup> STUDIES IN THE FUNCTIONS AND DESIGN OF HOSPITALS. Oxford University Press. London and New York, 1955.

<sup>9</sup> R. Llewelyn Davies. DESIGN OF RESEARCH LABORATORIES. *Journal of the Royal Institute of Chemistry*. 13th January, 1957.

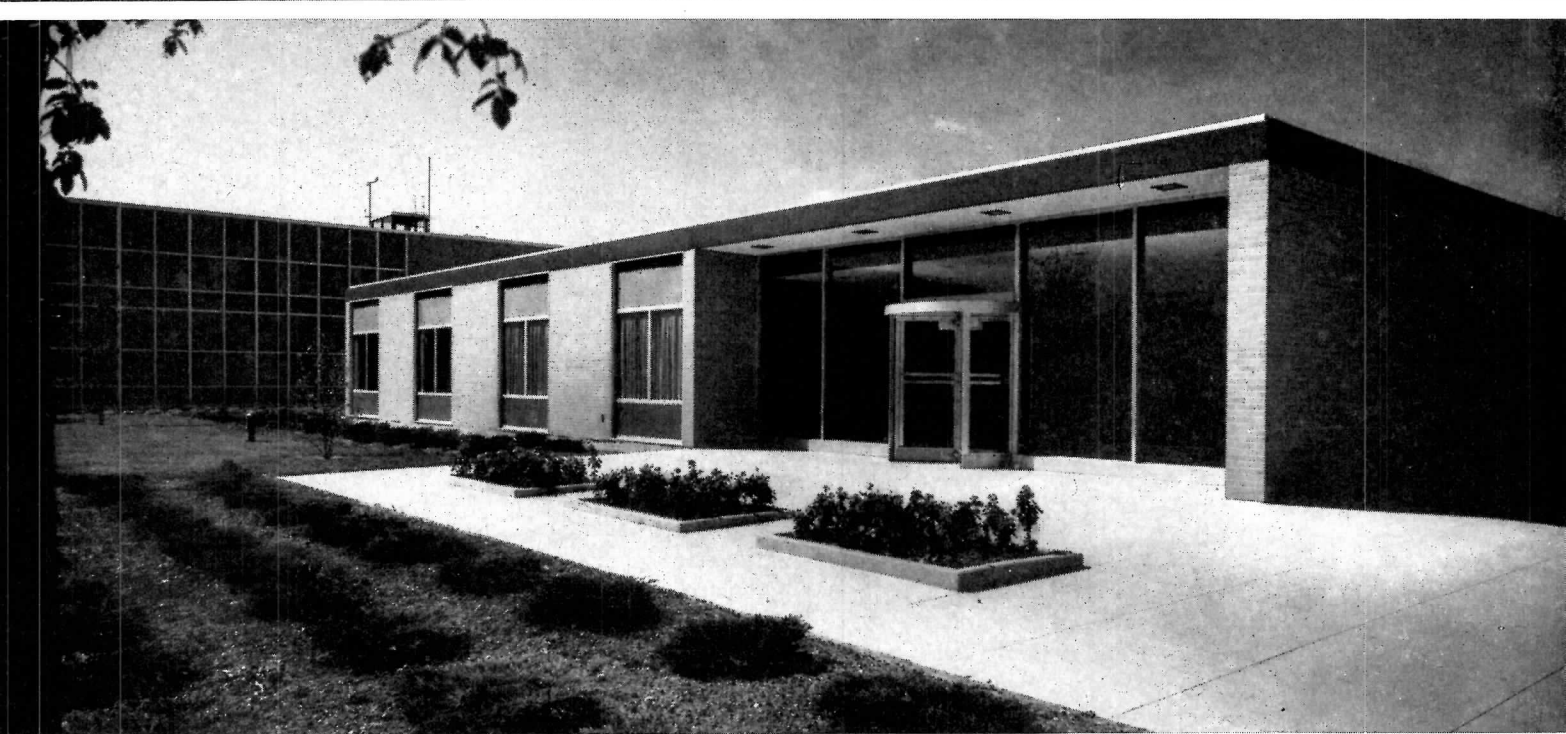



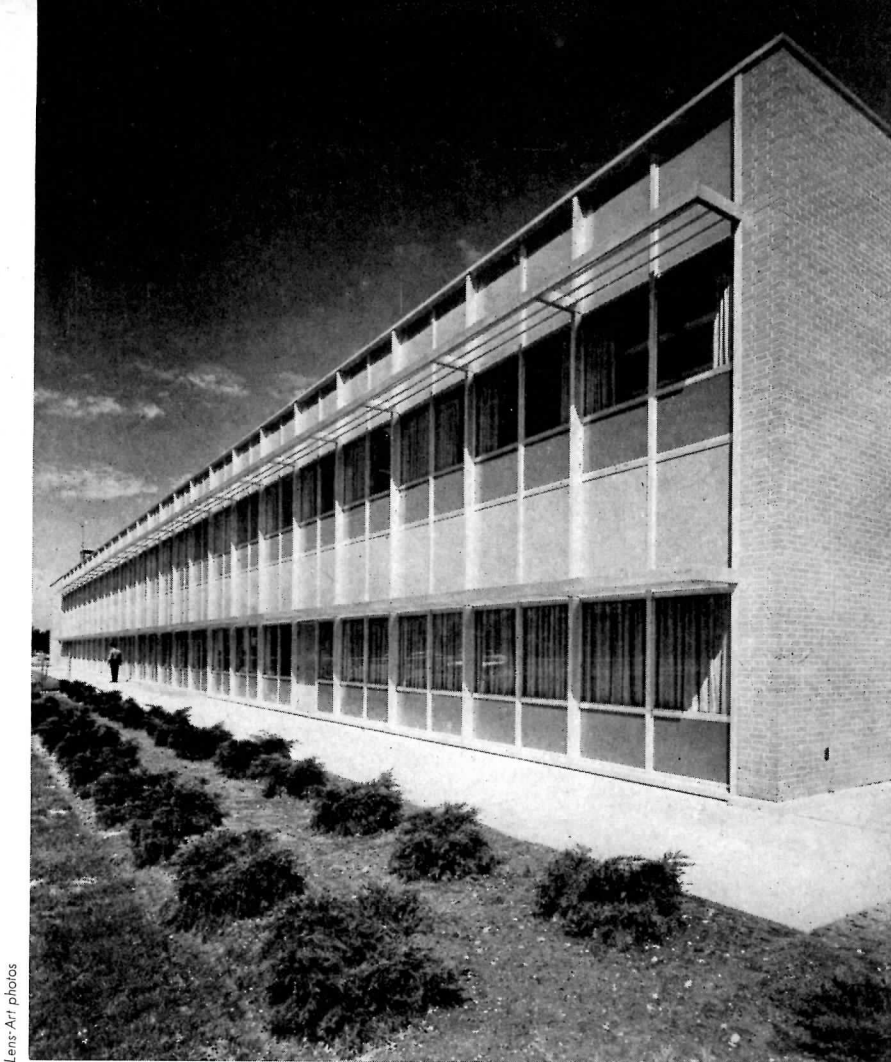

Lens: Art photos

*Conceived not as a showplace but as a strictly in-the-family service group, these buildings certainly represent the family rather well. Economical they may be, but they manage to be fairly assertive, speaking confidently of the purpose and order of manufacturing, and developing the esthetic qualities of this orderliness*

## AN IN-THE-FAMILY INDUSTRIAL OFFICE GROUP

*Administration Group for General Motors' Milford Proving Ground, Milford, Mich.*

*Smith, Hinchman and Grylls, Inc., Architects and Engineers*

ESTABLISHED IN 1924, this proving ground has grown until it now has some 950 engineers, test drivers and other personnel. Though the site comprises 3873 acres of rolling hills in the most scenic part of Michigan, the location was chosen rather for its testing terrain than for its beauty, however pleasant it may be for workers.

The new buildings include an administration building, and a control unit, which is a reception center and medical clinic for the employees. The project included also a 900-ft tunnel connecting this group with engineer-

ing buildings without the necessity of crossing test roadways.

The administration wing houses general offices, a conference room and projection room, plus a weather station. Designed on a four-foot module, the building is framed with steel, with concrete floors poured on corrugated steel forms. The roof is precast concrete tile. Exterior walls are metal curtain with porcelain panels and aluminum extensions.

Amedeo Leone and Ross W. Pursifull were the architectural team in charge of the project.

## GENERAL MOTORS PROVING GROUND



Lens-Art photos

*Control unit reception lobby has full height glass walls overlooking approaches and control gates. Conference room is finished in blached walnut, has fluorescent tubes in ceiling lighting panel. Drafting room shows typical office space, with everything from lighting to air conditioning maintaining the four-foot module of exterior walls*

# RESEARCH LABORATORY AND OFFICE BUILDING

*Wyeth Laboratories, Inc., Radnor, Pa.*

*Skidmore, Owings and Merrill, Architects*

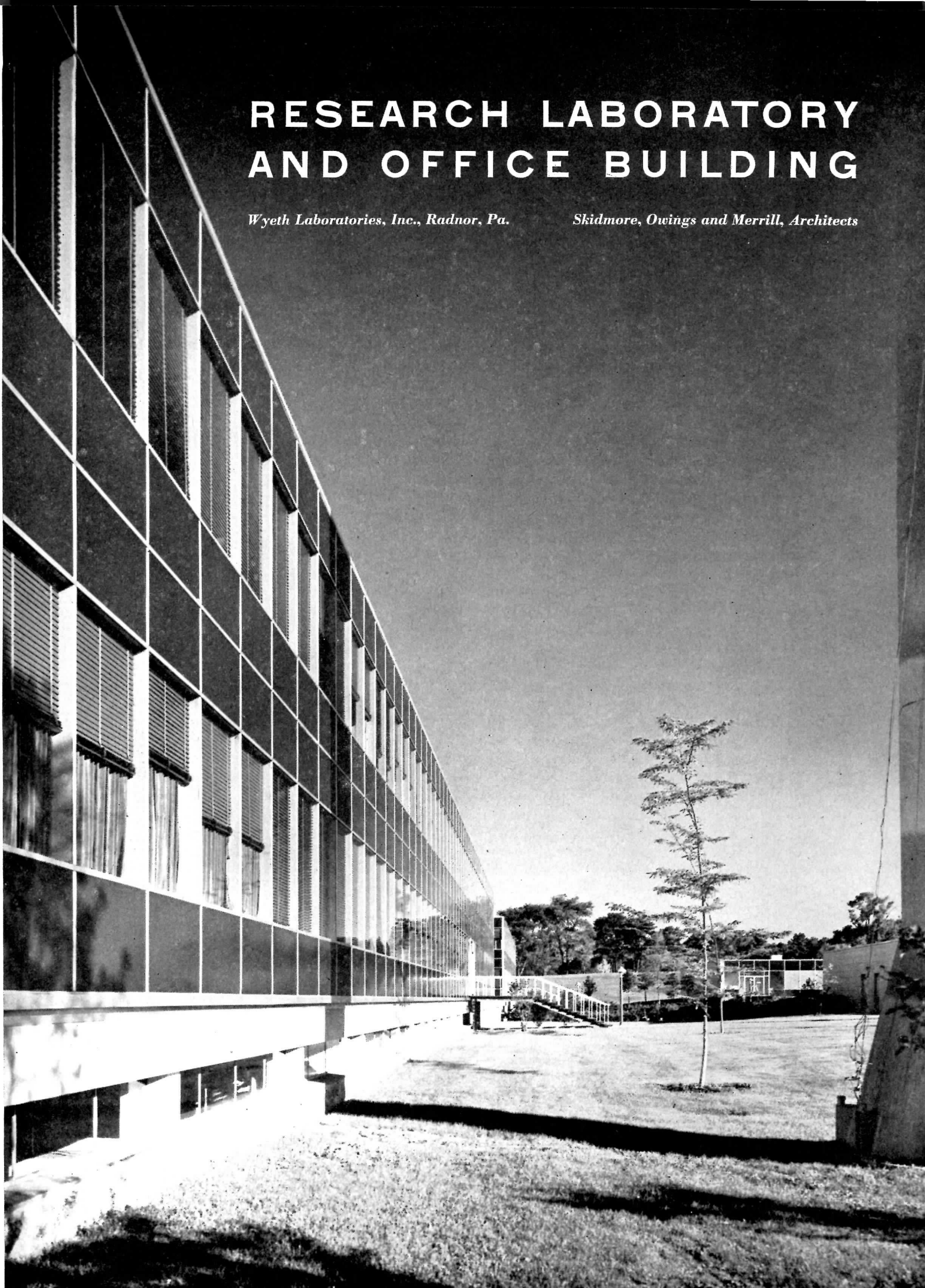



## WYETH RESEARCH LABORATORY

*Pharmaceutical research is both idea generation and an exacting, tedious chore demanding long periods of concentrated effort. An environment for success in such work must sustain and uplift the spirit of the workers. At Wyeth, architecture is fashioned to complement nature to that end, and the result is good. Skidmore, Owings & Merrill, Architects; Robert W. Cutler, partner in charge; Robert K. Posey, project manager; Roy O. Allen, associate partner in charge of design; Seelye, Stevenson, Value & Knecht, Engineers; The George A. Fuller Company, General Contractors.*



All photos © Ezra Stoller

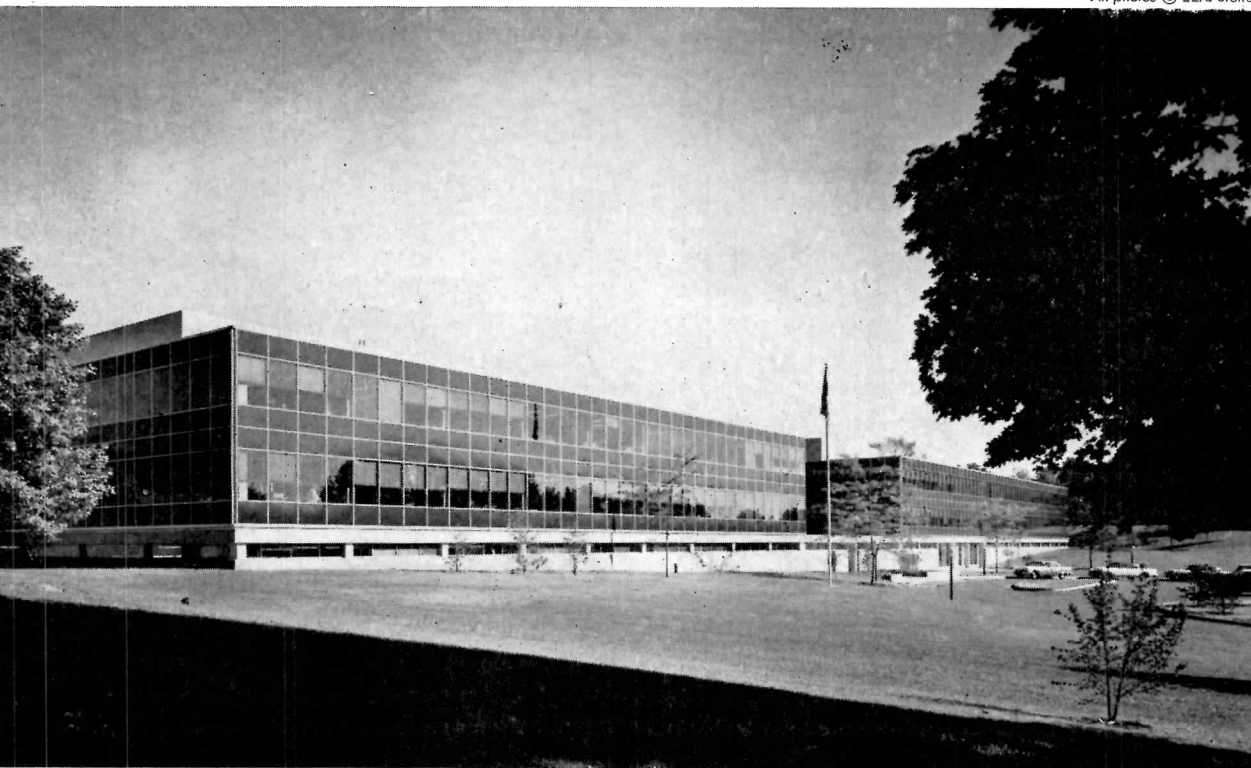

THERE WERE THREE main requirements: a 70,000 sq ft research laboratory; an 80,000 sq ft office building; plus such auxiliary structures as a special laboratory, garage, and record storage building.

The suburban site, 26 acres of the wooded, softly rolling country typical of Philadelphia's Main Line, is flanked to the east by an Interurban Railway and to the west by a main highway. Its configuration suggests a western saddle, with the two rises north and south of a central low point — the whole thing tipped gently from east down to west.

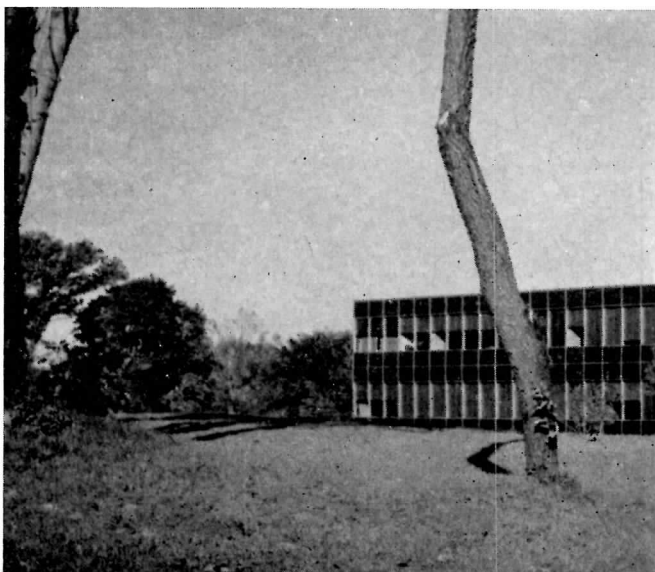

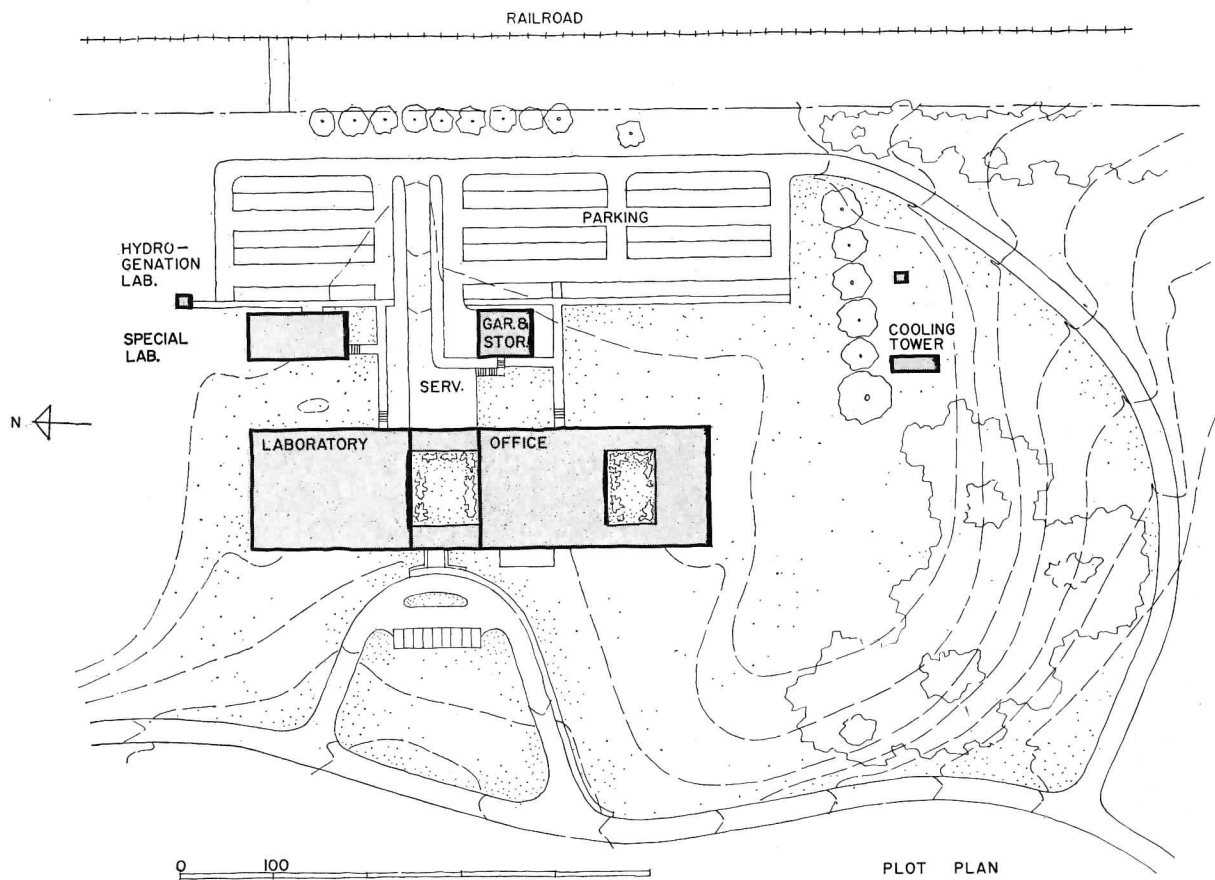

## WYETH RESEARCH LABORATORY

The architects placed the laboratory on the north knoll, the office building on the south knoll, and connected them at lower level with a one-story, glass-enclosed reception lobby across the central swale. An open stair connects the visitors' entrance to upper floors, while employees enter from their rear (east) parking area at the middle level of each building for a minimum (one-flight) walk up or down to their stations. The scheme focuses on a landscaped court between the two buildings; an area visible

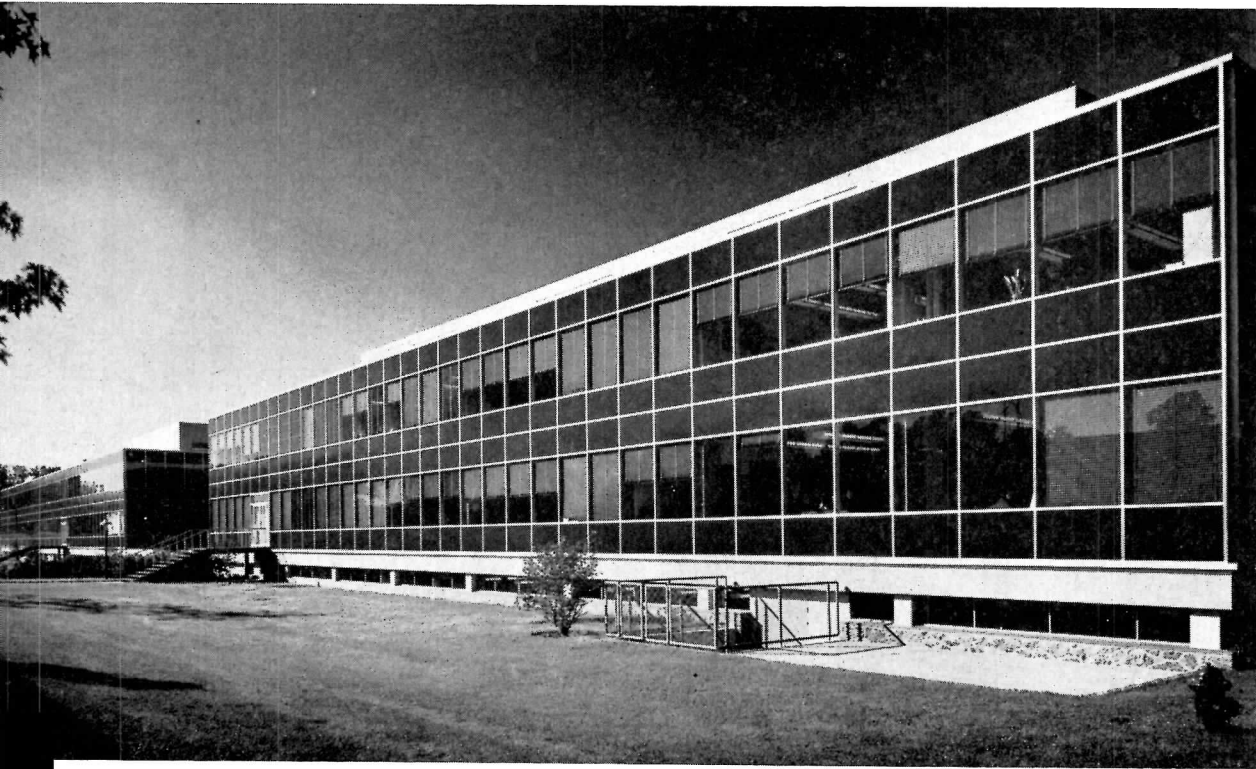
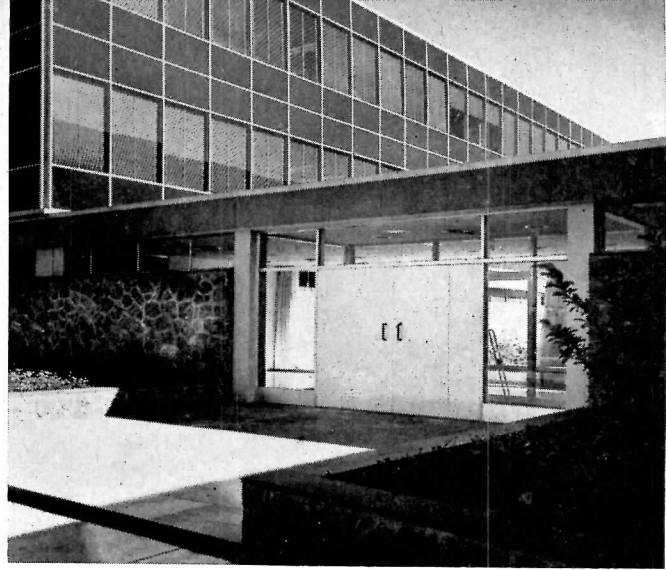

through the glass as one enters the lobby. The employee's dining room, lounge, and south terrace, as well as the lobby, are separated only by floor-to-ceiling glass panels and can readily be thrown together for special social functions.

The research building rings its outer laboratories about an inner group of special services, while the office building — contrawise — groups its "pool" areas about a second open court for worker amenity.

The entire concept features a modular pattern of framing, lighting, and air conditioning to provide ready flexibility and future expansibility.







© Ezra Stoller

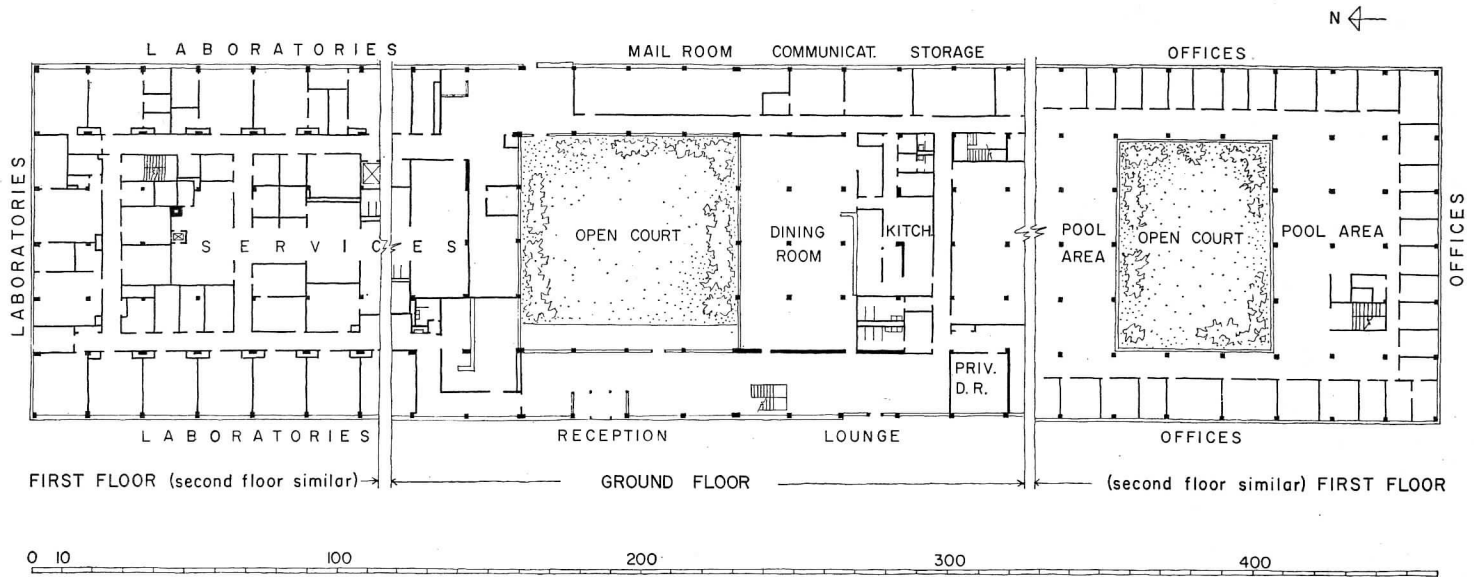

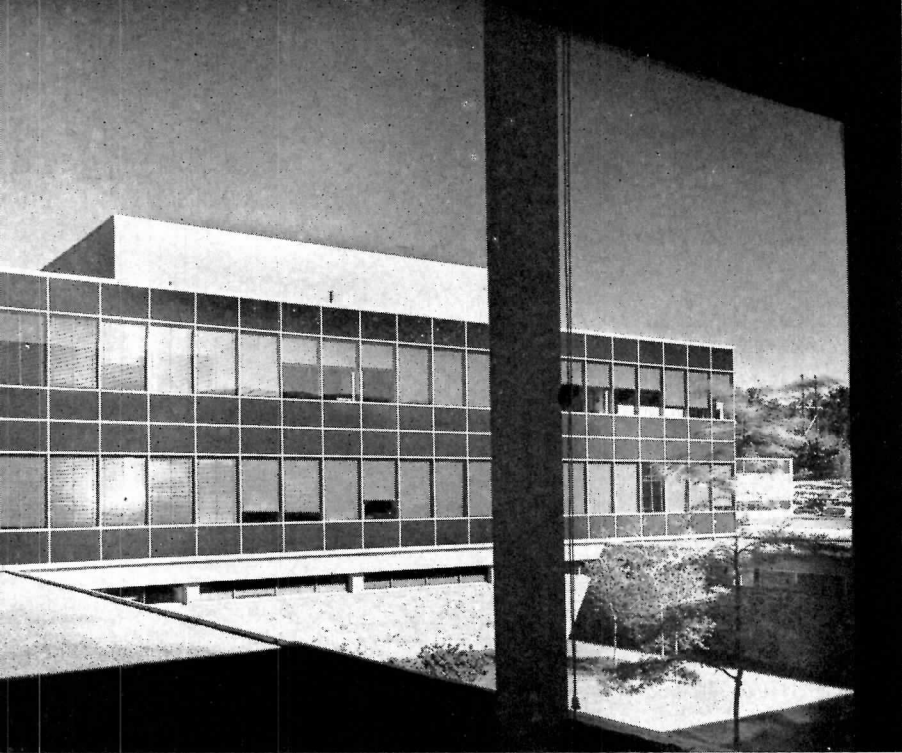

© Ezra Stoller



## WYETH RESEARCH LABORATORY

*The buildings are faced with fixed sheets of blue-green, heat-absorbing plate glass and porcelain enameled panels held in place by a pattern of delicate, natural aluminum surrounds. The porcelain panels are deep blue-green. At the base of the curtain-wall treatment, a strong horizontal band of structural steel, painted white, visually separates upper and lower levels. The latter is enclosed in local fieldstone rubble surmounted by strip-windows.*

*Top left: looking from the second floor of the office building across the court to the laboratory. Center left: the court from the employees' cafeteria. Bottom left: the special laboratory building to the east.*

*The Wyeth firm, founded in 1860 as a drug store on Walnut Street in Philadelphia, has grown steadily since and is now a leader in the ethical drug field, with a vast network of domestic branches as well as foreign affiliates in a total of 68 different countries*



WAINWRIGHT BUILDING, St. Louis  
Louis Sullivan

CARSON PIRIE SCOTT STORE, Chicago  
Louis Sullivan

ROCKEFELLER CENTER BUILDINGS, New York  
Reinhard & Hofmeister; Corbett, Harrison  
& MacMurray; Hood & Foulhoux

LEVER HOUSE, New York  
Skidmore, Owings & Merrill

TRINITY CHURCH, Boston  
H. H. Richardson

PHILADELPHIA SAVINGS FUND SOCIETY  
BUILDING, Philadelphia  
Howe & Lescaze

GENERAL MOTORS TECHNICAL CENTER, Detroit  
Saarinen & Saarinen

LAKE SHORE DRIVE APARTMENTS, Chicago  
Mies van der Rohe

S. C. JOHNSON & SON, INC., ADMIN. BLDG., Racine  
Frank Lloyd Wright

MONADNOCK BLOCK, Chicago  
Burnham & Root

DAILY NEWS BUILDING, New York  
Hood & Howells

TVA NORRIS DAM & POWER HOUSE, Tennessee  
Roland Wank, Architect-in-charge

BOSTON PUBLIC LIBRARY, Boston  
McKim, Mead & White

STOCK PAVILION, Raleigh  
Nowicki & Deltrick

CHRISTIAN SCIENCE CHURCH, Berkeley  
Bernard Maybeck

WOOLWORTH BUILDING, New York  
Cass Gilbert

CROW ISLAND SCHOOL, Illinois  
Saarinen & Saarinen,  
with Perkins, Wheeler & Will

MANUFACTURERS TRUST BUILDING, New York  
Skidmore, Owings & Merrill

UNITY CHURCH, Oak Park  
Frank Lloyd Wright

NEBRASKA STATE CAPITOL, Lincoln  
Bertram G. Goodhue

S. C. JOHNSON & SON, INC., LABORATORY, Racine  
Frank Lloyd Wright

UNITED NATIONS SECRETARIAT, New York  
Wallace K. Harrison & Consultants

LINCOLN MEMORIAL, Washington  
Henry Bacon

M.I.T. AUDITORIUM, Cambridge  
Eero Saarinen

EQUITABLE BUILDING, Portland  
Pietro Belluschi

ALLEGHENY COUNTY BUILDINGS, Pittsburgh  
H. H. Richardson

UNIVERSITY CLUB, New York  
McKim, Mead & White

CRANBROOK SCHOOLS, Michigan  
Eilol Saarinen

MINERALS & METALS RESEARCH BLDG., I.I.T., Chicago  
Mies van der Rohe

ALCOA BUILDING, Pittsburgh  
Harrison & Abramovitz

MUSEUM OF MODERN ART, New York  
Goodwin & Stone

PENNSYLVANIA STATION, New York  
McKim, Mead & White

EXPERIMENTAL SCHOOL, Los Angeles  
Richard Neutra

DODGE TRUCK PLANT, Detroit  
Albert Kahn

100 MEMORIAL DRIVE APARTMENTS, Cambridge  
Kennedy, Koch, DeMars, Rapson & Brown

CENTRAL LUTHERAN CHURCH, Portland  
Pietro Belluschi

**HOUSES**

F. C. ROBBIE, Chicago  
Frank Lloyd Wright

E. J. KAUFMANN, Pennsylvania  
Frank Lloyd Wright

TALIESIN WEST, Arizona  
Frank Lloyd Wright

HENRY VILLARD, New York  
McKim, Mead & White

WATTS SHERMAN, Newport  
H. H. Richardson

AVERY COONLEY, Illinois  
Frank Lloyd Wright

W. W. WILLITTS, Illinois  
Frank Lloyd Wright

D. R. GAMBLE, Pasadena  
Greene and Greene

PHILIP JOHNSON, New Canaan  
Philip Johnson

WALKER GUEST HOUSE, Florida  
Paul Rudolph

ELLEN SCRIPPS, La Jolla  
Irving Gill

WESTON HAVENS, Berkeley  
Harwell Hamilton Harris

LOVELL "HEALTH HOUSE", Los Angeles  
Richard Neutra

EDITH FARNSWORTH, Chicago  
Mies van der Rohe

## ONE HUNDRED YEARS OF SIGNIFICANT BUILDING

### 11: COMMERCE

THE LAST INSTALLMENT of this series of fifty buildings presents — as did the first — buildings whose functions, in at least a broad sense, are all commercial. The eleven office buildings — Carson Pirie Scott, although a store, was included because it belonged in the structural type — were featured initially because among them were the two Sullivan buildings that led all others in the voting and because the office building as a type seemed our most significant contribution in the past one hundred years of significant building. It seems appropriate to close, as well, with four buildings which variously serve commerce and industry, for together with the offices, the General Motors Technical Center, and the two Johnson Wax buildings (which were grouped under "Research and Administration"), commercial functions occupy eighteen of the thirty-four most frequently nominated non-residential buildings.

This is where our strength has shown itself; here evidently we have been most concerned and most sure. The Norris Dam and Power House is a telling witness. Standing at the meeting ground of architecture and engineering, it represents in this voting not only the whole of the vast TVA program (in which there were perhaps several finer but later examples), but all of the quasi-architectural, superb engineering monuments across the country.

The Manufacturers Trust Building is long removed in time and space and architectural attitudes from Louis Sullivan's fine midwestern banks, but once again that large segment of the world of commerce is represented by a building possessed of genuine and unified character.

Curiously, transportation has not recovered its once vigorous voice in architectural expression. Until just last year at the St. Louis Airport (too recent to have yet made the impact it eventually will), flying had given us nothing comparable to the great early examples of the railroads, which themselves have not produced much of high order since the powerful but split-personality Pennsylvania Station in New York.

The Dodge Truck Plant must be interpreted as being a significant prophet of the host of un-self-conscious and ubiquitous factories which, perhaps even more than the office buildings, are the good American architecture most frequently found and most frequently found to be better than good.



ONE HUNDRED YEARS OF SIGNIFICANT BUILDING

*TVA Norris Dam and Power House, Tennessee, 1936,  
Roland Wank, Architect-in-charge. (Tied for ninth)*

“Anyone who stands in the shadow of the TVA Norris Dam and subjects himself to its visual influence will readily realize that he is in the presence of plastic architectural forms which have a compelling attraction and for which history offers no parallel. The Norris and Boulder Dams supply us with a new and unprecedented esthetic. They are demonstrations of pure engineering structure, generated by natural forces, such

as hydrostatic balance, gravity, compression, thrust, and counter-thrust. Norris Dam embodies the spirit, freshness, and sparkle of a new architecture. Here it is engineering architecture with undisguised use of materials and with shapes that are a result of calculated structural need.”

*A. Lawrence Kocher*

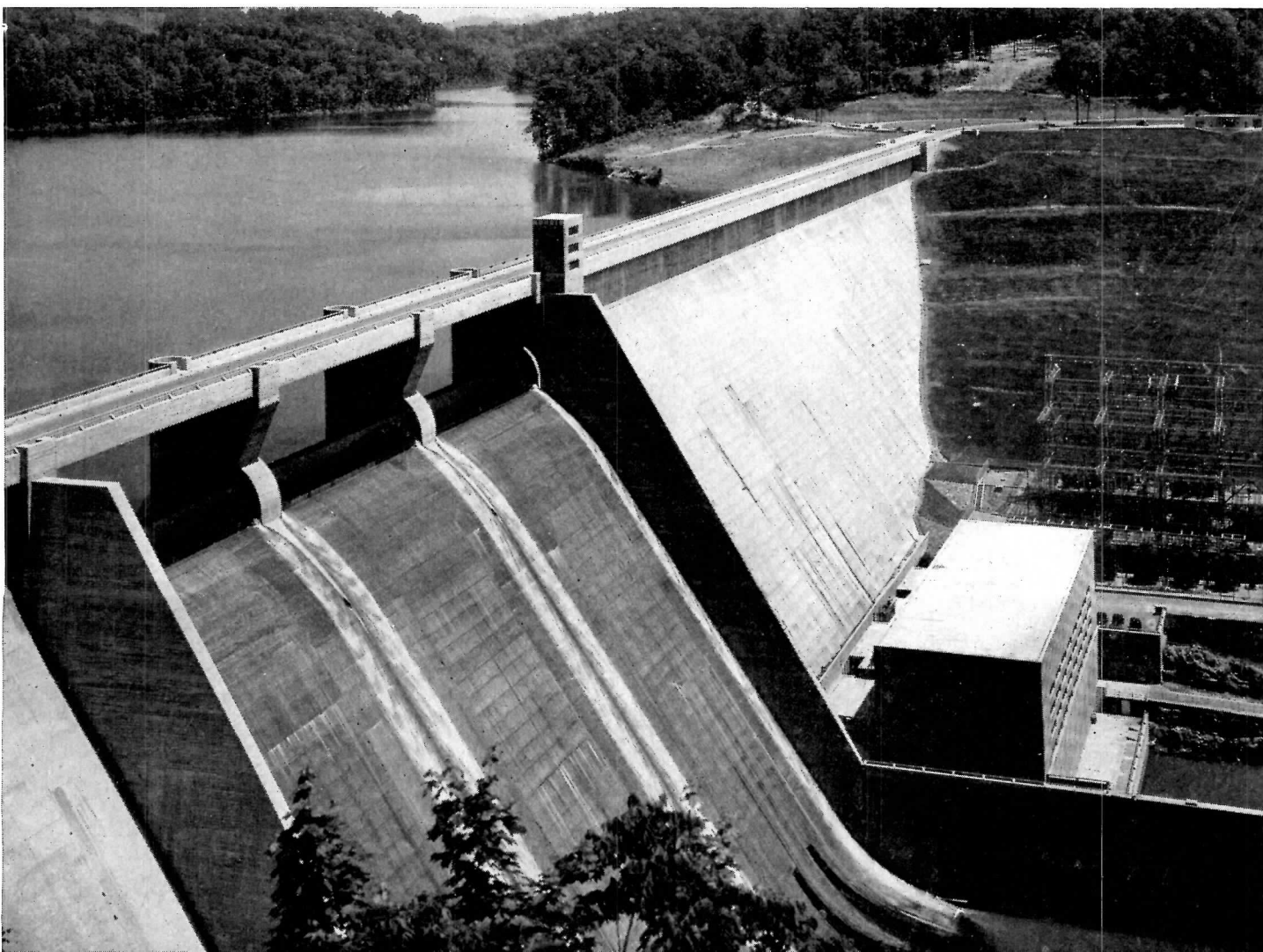



*Manufacturers Trust Building, New York, 1951, Skidmore, Owings & Merrill. (Tied for twelfth)*

"The new Manufacturers Trust Building at the southwest corner of 43rd Street and Fifth Avenue has been described by one of the deans of the New York architectural profession as resembling a jewel on the breast of a beautiful woman. This description is quite perfect for this all-glass bank, surrounded as it is by masonry buildings.

So much New York architecture consists of flat façades, which we are used to viewing as little different from the two-dimensional drawings from which they were built, that it is refreshing to have such an aggressively three-dimensional building in our midst. This effect is consciously maintained even during the day by drawing the eye into the brightly lighted interiors to such an extent that one not only sees, but enjoys, the gold-sculpture wall and many other details at the back. In this respect it represents the epitome of showmanship without losing any of the dignity which this little building so very obviously possesses." *Alan Burnham*

"One of our leading architects said, when the Lever Building was completed, that steel and glass had reached the ultimate; it could go no further. But in the Manufacturers Trust in the hands of the same designer, Gordon Bunshaft, the tradition of expression in glass has actually been carried further and with far greater significance. Here the inappropriateness of the classic temple as a prototype for the modern bank has yielded to a glass form which invites the confidence and interest of the public." *Arthur C. Holden*

"Manufacturers Trust is an elegant and beautiful product of our technology and wonderful in contrast to the masonry buildings on Fifth Avenue. It is certainly the most exciting show window on a street of show windows and one which gives us a fine glimpse into the esthetics of our times." *Minoru Yamasaki*



*Pennsylvania Station, New York, 1906, McKim, Mead & White. (Tied for twentieth)*

“McKim, Mead & White’s New York Pennsylvania Station rightly belongs in the significant buildings list. There Roman grandeur and the travel necessities and amenities of other days have been magnificently united. Moreover an astonishing, freshly used element, the fine steel-and-glass roofed concourse, was included. Though eclectic, the Station is a

great architectural monument, classically done with rich materials, and over-generous circulations. Dependence on natural ventilation and lighting imposed spacious volumes, and many original plan practicalities still suffice in the fifty-year-old Station.”

*Earl H. Reed*



*Dodge Truck Plant, Detroit, 1938, Albert Kahn Associated Architects & Engineers, Inc. (Tied for twentieth)*

“This assembly plant for half-ton trucks, and particularly its export unit, was singled out on several occasions within five years of its building as typical of the best in our factory designs. It may not be the outstanding specimen of its kind or even of the office that produced it, but certainly it must stand as a splendid example of that kind of direct, spare, and

efficient response to the essential facts of the program which somehow generates in its plan and profiles, its structure and its light penetrations, a sensuous pleasure almost independent of its rational satisfactions. Clearly it and its brothers have taught us significant lessons applicable beyond the confines of their commercial matrix.”

*John Knox Shear*



# SPACIOUS PRIVACY ON A SMALL CORNER LOT

*Residence for Mr. and Mrs. Sam B. Short, Jr., Baton Rouge, La.*

*Short & Murrell, Architects*

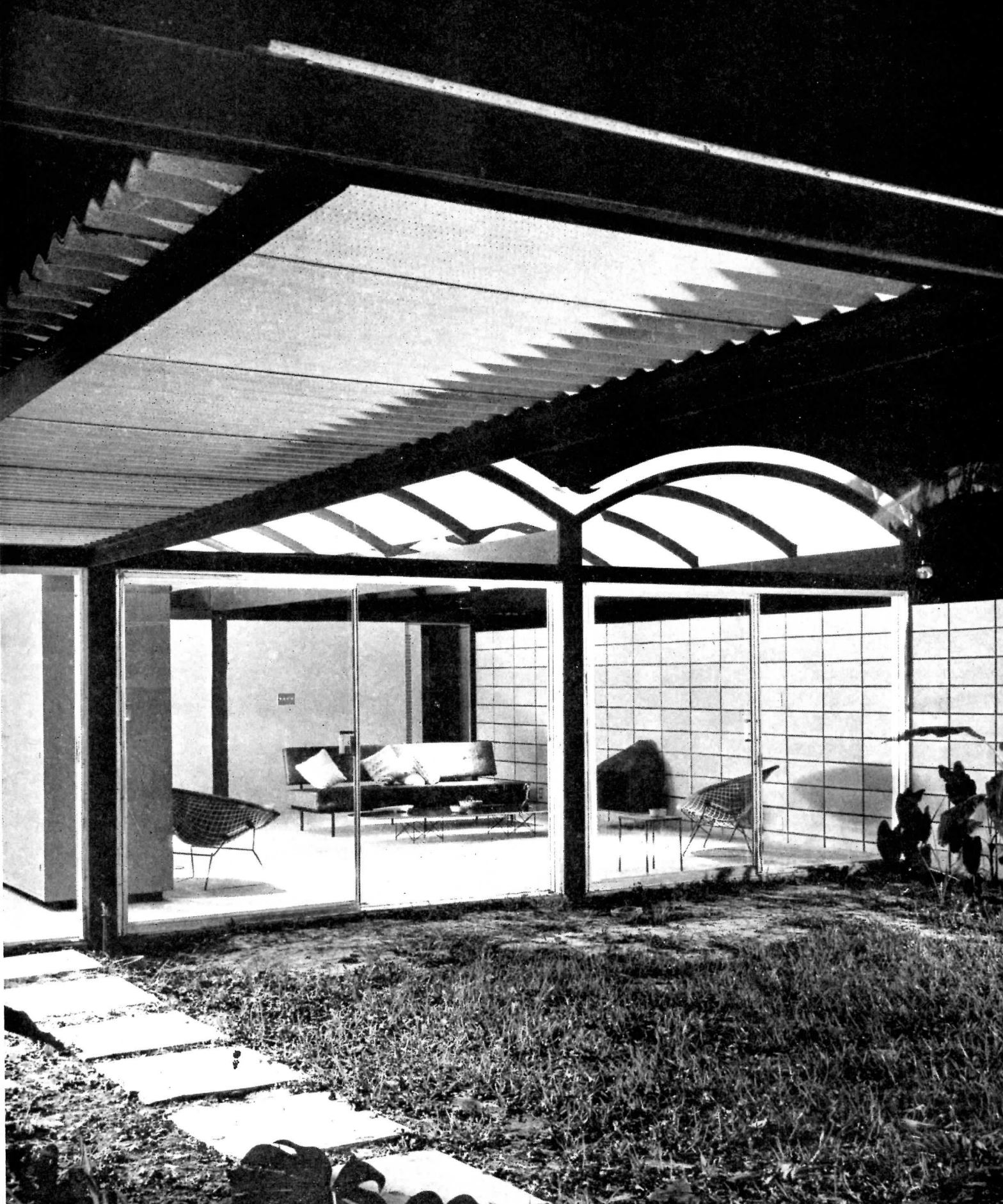



Frank Lotz Miller

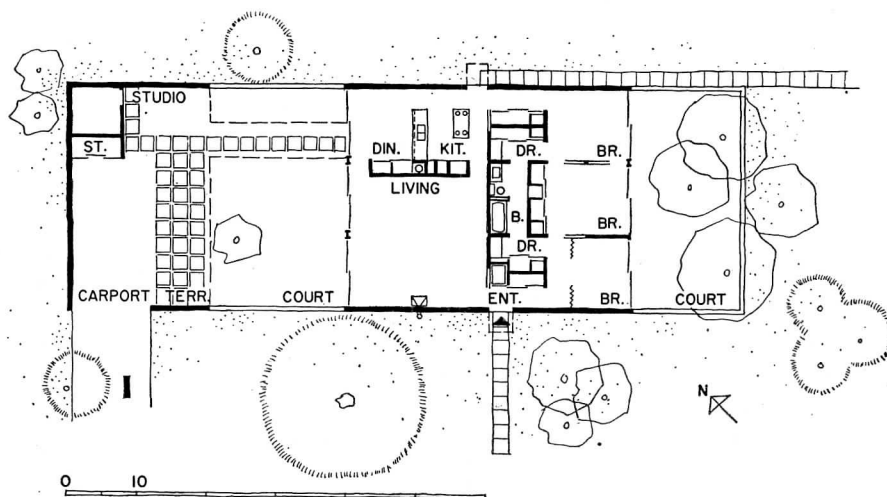





### SPACIOUS PRIVACY

*Here is an unusual and imaginative solution to the problem of a small corner lot in a southern city. Complete privacy for all parts of the house has been achieved economically and with maximum use of the 50 by 120 ft site: the entire area is walled in to permit two large outdoor living areas which visually and almost actually double the square-footage and a triple-vaulted ceiling increases the sense of space within the house itself.*

**T**HE HOUSE WAS PLANNED for a family of three and an occasional over-night guest. There were no special requirements other than outside play and entertainment areas and a studio for the architect-owner, but the budget was limited to \$20,000. A carport for one car was to be provided, and the house was to be air conditioned.







Frank Loiz Miller

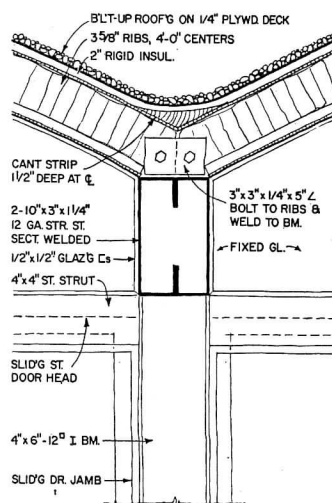
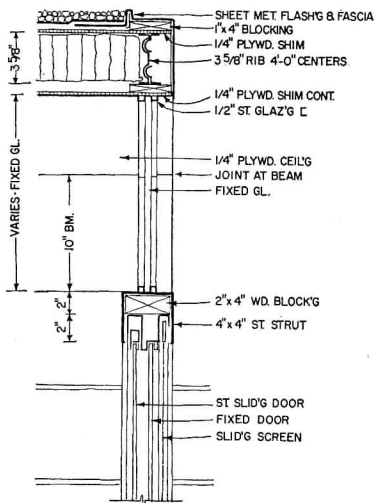
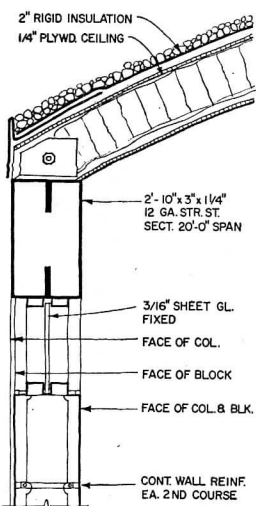

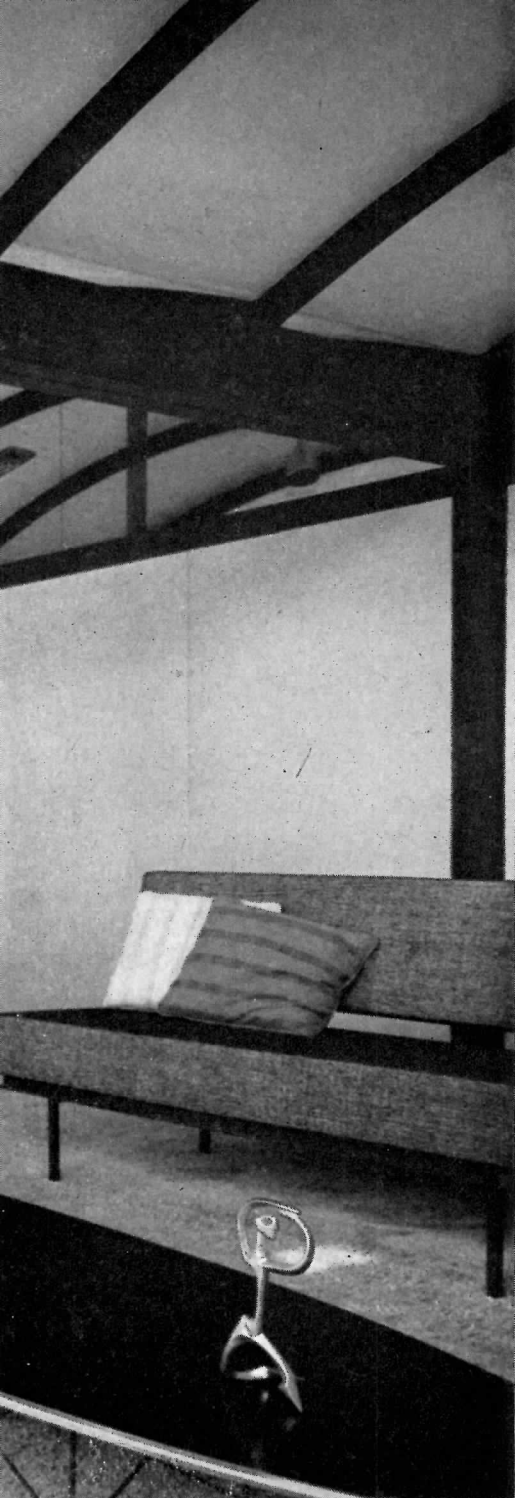

### SPACIOUS PRIVACY

The house is characterized chiefly by an airy spaciousness deriving in part from its triply arched ceiling and in part from its large glass areas opening to lawn or garden. Neither exterior nor interior gives a hint of budget considerations, yet the final cost was held to \$400 below the budget.

The simple rectilinear plan and a careful choice of construction materials were the chief factors in keeping the costs down. But quality was in no way sacrificed: exterior walls are limestone concrete block; interior partitions are precast limestone masonry units, sliding glass doors or wax stained fir plywood on 2 by 4 studs; floors are finished with plastic tile or cotton carpet; cabinets are wax stained gum plywood; ceilings are fir plywood. The structural system consists of 4 by 6 in. steel H columns on 10.5 by 20 ft centers, with two 4 by 10 in. steel "c" sections welded together to span 20 ft on 10.5 in. centers. Ribs are steel spanning 10.5 ft on 4 ft centers. Fir plywood ceiling is nailed to ribs; insulation includes 2-in. fiber glass, and the roof is finished with marble chips.





### SPACIOUS PRIVACY

*Every room in the house opens to an outdoor living area: for example, dining room (left above) and study (left). Foundation is reinforced concrete with 4-in. concrete slab footings; framing is 4 by 6 in. steel H columns and nailable steel ribs. The mechanical system consists of a 2½ ton forced air year-round air conditioner with ducts in floor slabs. Kitchen equipment includes built-in freezer, oven, dishwasher, food disposer and clothes washer-dryer unit*





Molitor

## PENTHOUSE OCCUPIES UNUSUAL SITE

*John Schurko, Architect*

*Fraioli, Blum & Yesselman, Engineers*

*Mellon-Stuart Company, General Contractors*

*Albert Lange Studios, Interior Decorator for Federal Home Loan Bank*

A SIX-STORY reinforced concrete parking garage in Pittsburgh is now in a class by itself, for it is graced by an office penthouse perched on the roof to take advantage of a location and a view, and to solve a parking problem. The advertising men and bankers who occupy this space, as well as their clients, customers and employees, may drive their cars directly into the garage from the street, proceed up the ramps and park conveniently on the roof under the penthouse. From there they take the elevator up one flight to the penthouse lobby and enter offices from which they behold three rivers, a fountain and some steel clad buildings.

The architect's original client, Bond & Starr Incorporated, wished as an advertising agency to identify itself with Pittsburgh's postwar commercial rebirth. The group of three office buildings, erected since the war, which define the boundary of Point Park and face the conjunction of the Monongahela, the Allegheny and the Ohio rivers are known as the Gateway Center and have become Pittsburgh's best known symbol of its

commercial progress. Both architect and client hoped to find a site nearby, but available spaces in this highly developed "premium land value" area were hard to discover. The architect noted that the garage occupied a choice spot, conceived the penthouse idea, and later convinced the Federal Home Loan Bank of the advantages of the site. Both tenants have since found the dramatic position and appearance of the structure to have the public relations value they had hoped for. Their square foot occupancy cost is considerably less than that of competing space in the Point area.

Because the penthouse was to be built on an existing garage, there were many structural problems. The major advantage in overcoming these difficulties was that the local building code, which ten years ago required 150 pounds per square foot live load in parking garages, had recently been reduced to 50 pounds per square foot. This reduction enabled the engineers to use the difference in weight to make it possible to build the penthouse in complete compliance with the local building

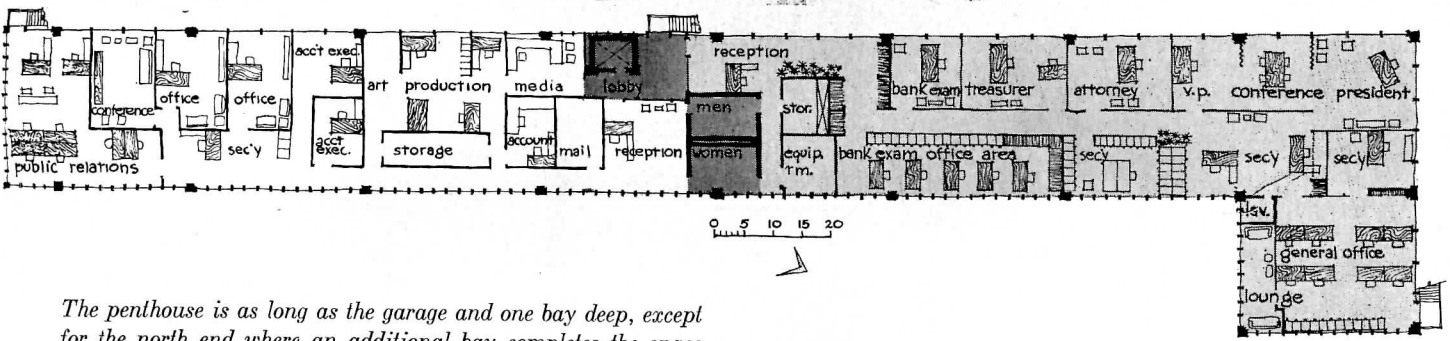

The penthouse is as long as the garage and one bay deep, except for the north end where an additional bay completes the space requirements. The section shows the separate pedestrian entrance from the Gateway Center Park into a private elevator lobby

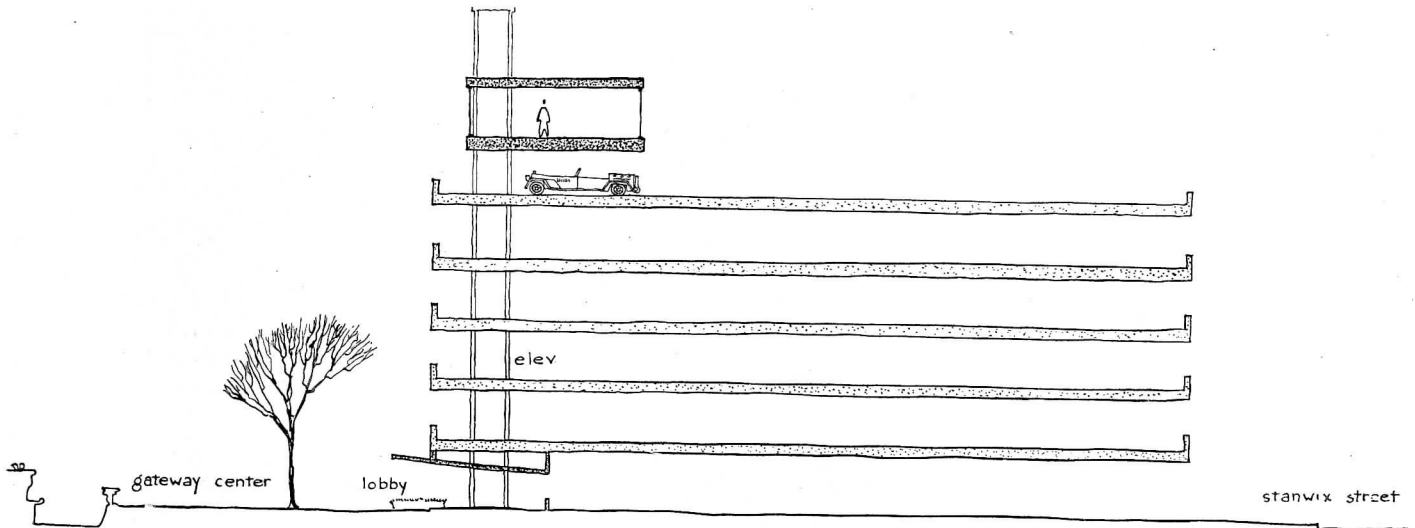

**GATEWAY PARK PENTHOUSE**

code. The problem of weight also dictated the use of the lightest possible materials.

The building is steel frame and on all four sides is sheathed in glass set in redwood sash. The view side is insulated glass which runs from floor to ceiling; the other walls are double glazed in translucent panels of colored corrective glass and architectural glass.

Fluorescent lamps are mounted above a suspended ceiling of corrugated translucent acrylic plastic which creates a plenum under the roof, allowing all of the conditioned air (ventilating, cooling and heating) to be forced through the plenum, and to be diffused throughout the tiny air spaces that occur where the edge of each corrugation rests on the supporting channel. This duct free, fixture free ceiling produces a very uniform system of air distribution. The floor is also a plenum through which all of the return air is sent back to the equipment room. Thus the entire area is cooled, heated and ventilated by creating an "envelope" of controlled weather, on all four sides of the occupants.

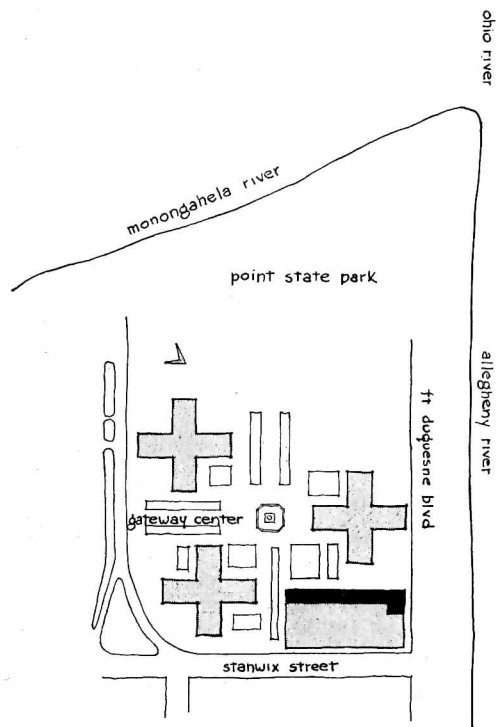

Plot plan shows the relation of penthouse to site. Opposite page, top — penthouse as seen from Gateway Center, bottom — the office of the bank president. Ceiling used throughout building is of corrugated plastic which diffuses conditioned air, makes fluorescent light continuous and even.

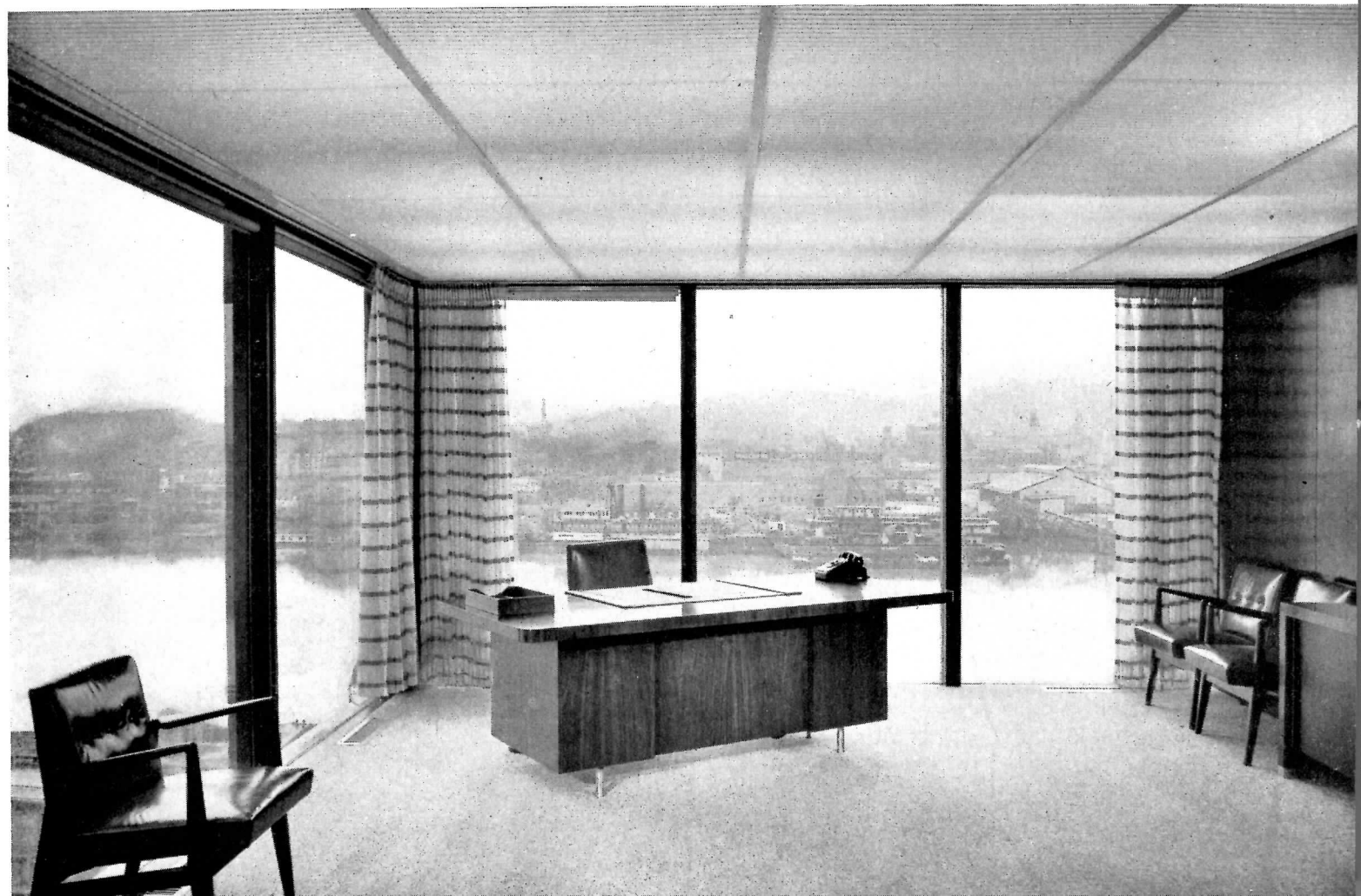





Molitor

## GATEWAY PARK PENTHOUSE

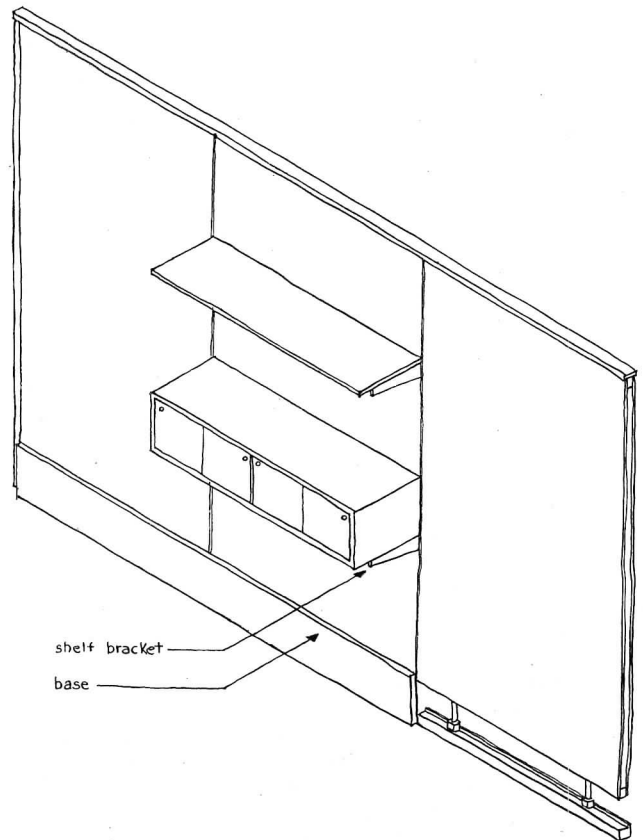
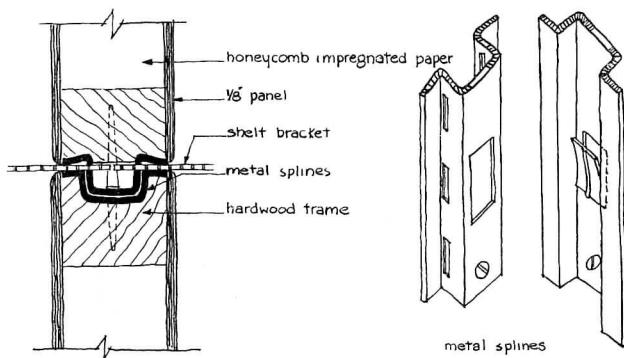

Photograph above, reception area of the advertising agency. Note the double glazed translucent exterior wall. Drawings above and to the left are details of prefabricated hollow paper honeycomb core panels used for all interior partitions and surfaced with cherry veneer or enameled hard board. Metal splines lock panels together and provide slots for interchangeable shelf brackets

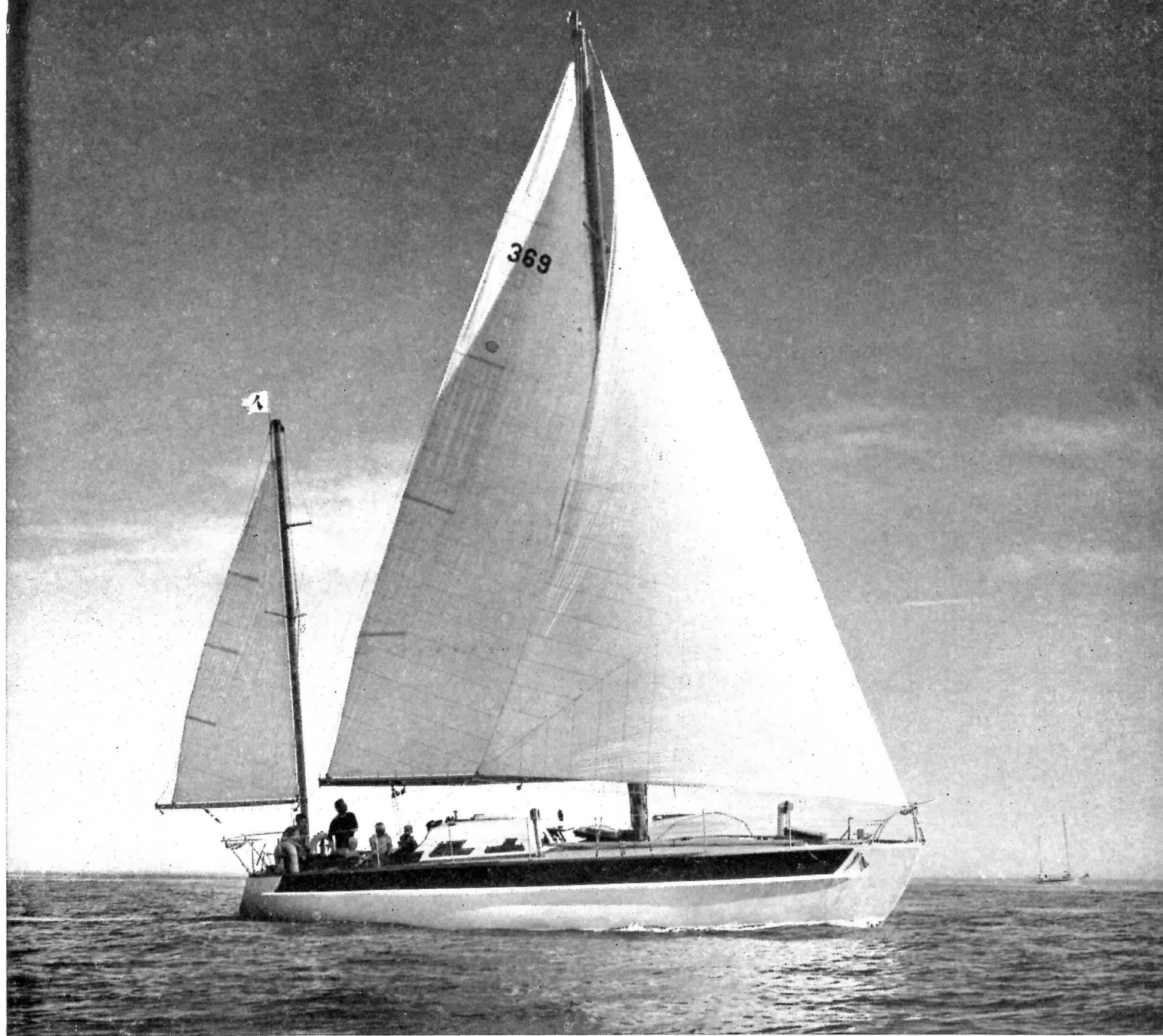

## CARL KOCH PLANS YACHT INTERIOR

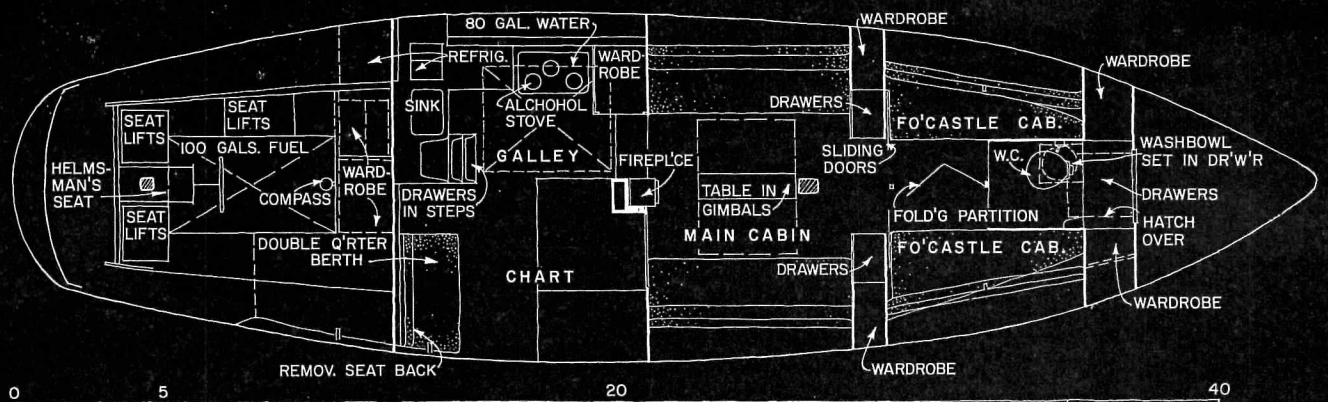



All photos, including p. 215, © Ezra Stoller

## DESIGNING THE "JEN"

By Carl Koch

DO LAND ARCHITECTS and naval architects have problems in common? And is a study of such problems mutually rewarding? A three-year period of spending every leisure moment on the planning and building of my 40-foot yacht, "Jen," suggests a most emphatic "yes" to each of those questions.

The first thing I discovered was that you have to plan in three dimensions to fit a human being and his requirements into a curvilinear shape. It takes quite a bit of doing, believe me, to project a plan in such a way that it recognizes the fact that for every inch you go up or down you arrive at an entirely different plan. Shapes and sizes change rapidly within the confines of a 40-foot boat — particularly at the fore and aft extremities and close to the keel.

Secondly, I was up against the seemingly impossible job of providing a summer home for two adults and six small to teenage children in a yacht 40 feet on the waterline which could be sailed single-handed and do well in ocean racing.

Building the "Jen" was, furthermore, a constant exercise in estimating the strength of materials and their fastenings. Boats,

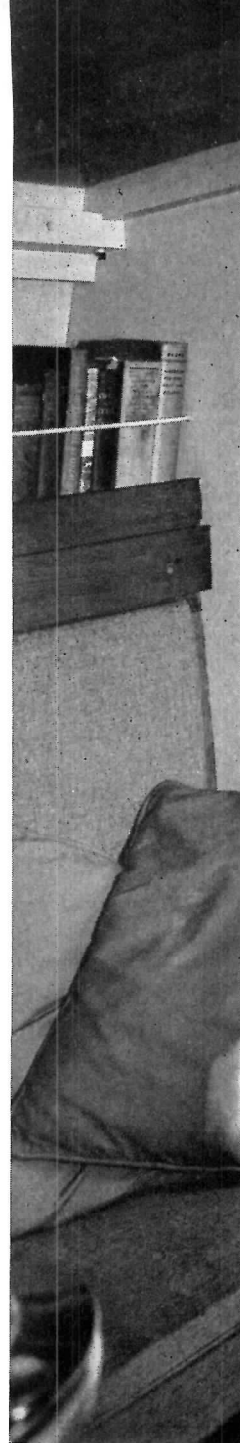



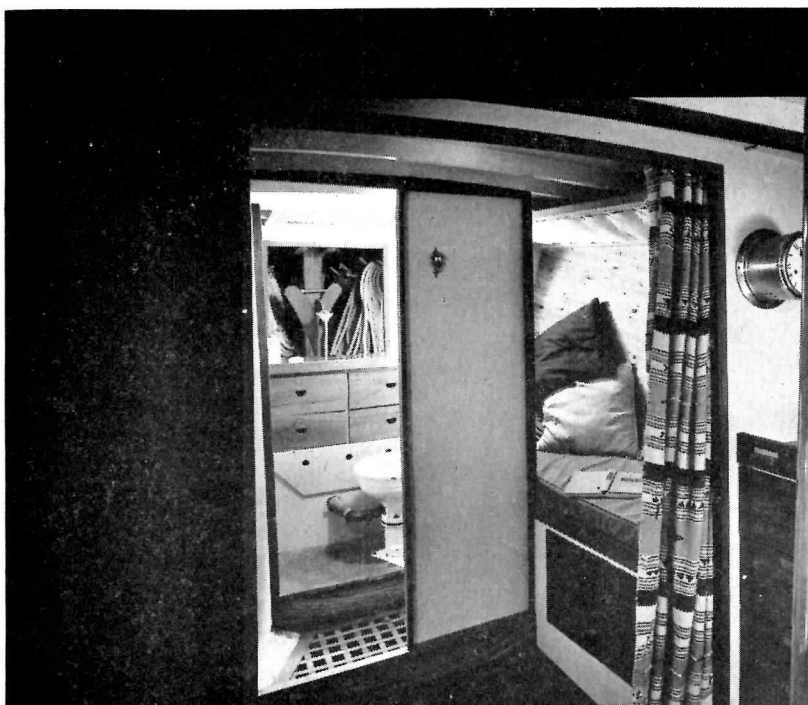
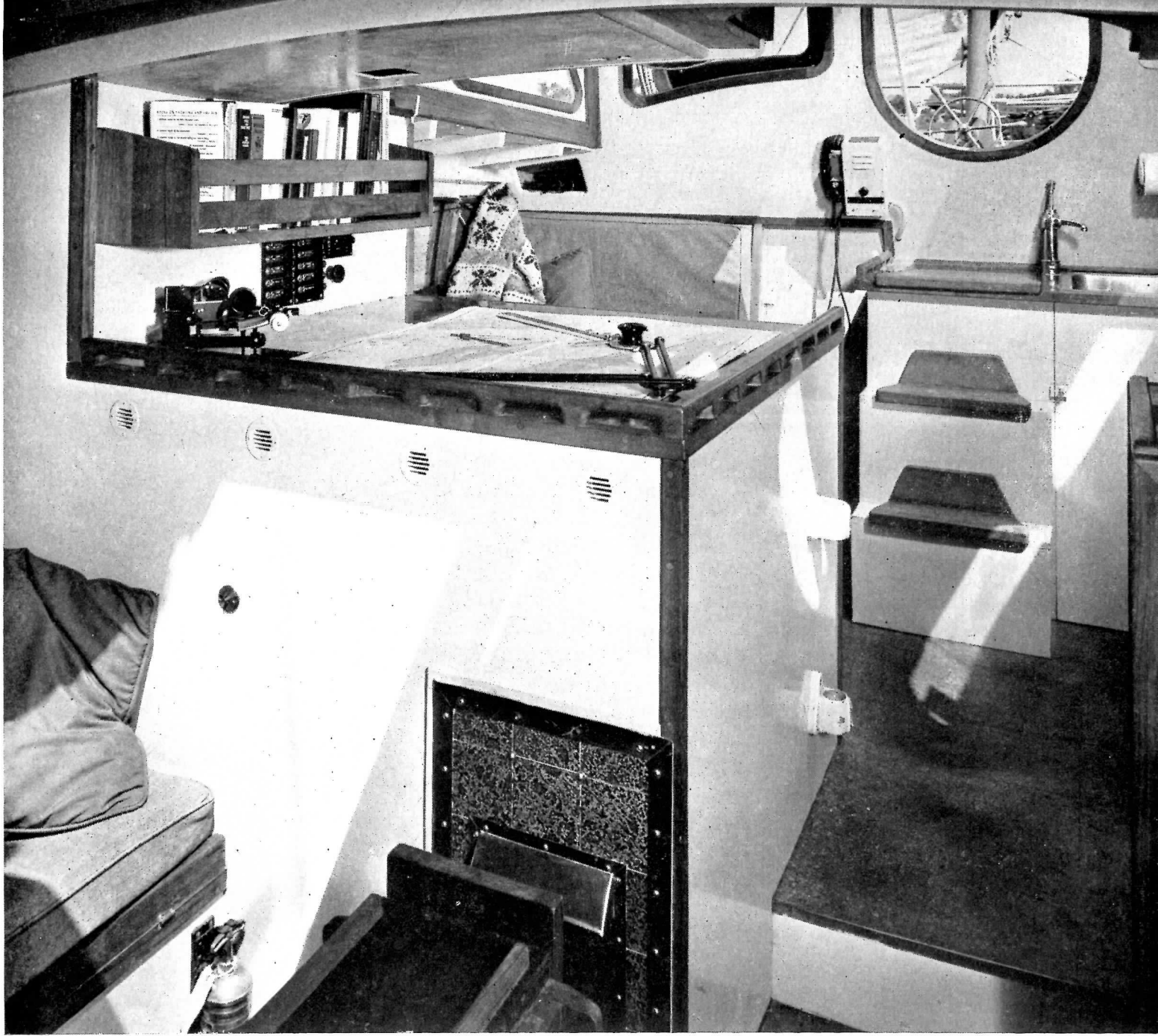

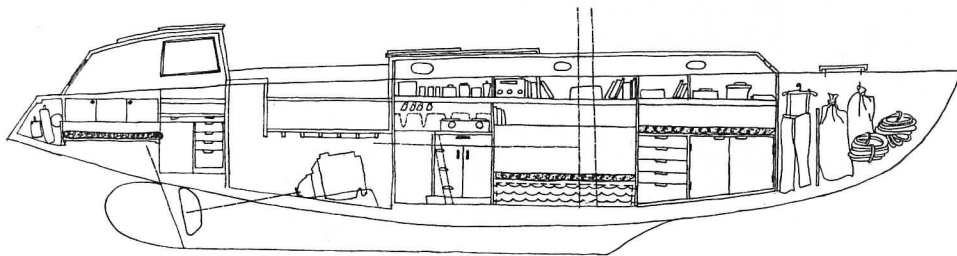

## DESIGNING THE "JEN"

even those not intended for the rigors of racing, are designed to a close tolerance of weight and shape; the survival at sea of the vessel and her crew may depend on the selection of construction materials and essential rigging.

I take no credit for the lines, sea-keeping qualities, rig and structure of the "Jen." These are the work of Laurent Giles of England, the only top-ranking naval architect I could find who was willing to concede that a boat such as I had in mind actually could be built. In addition, valuable suggestions as to rig and fittings were contributed, with Giles' approval, by Olin and Rod Stephens, well-known naval architects and racing yachtsmen in this country. I was, however, almost completely responsible for the interior arrangements and detailing.

In working on the "Jen" I found that my experience in the design of small houses, prefabricated structures and interiors — the things on which a land architect spends much of his time — was directly applicable to laying out the interior of a boat. The basic requirements are much the same at sea and on land, but in yacht design you have to remember that many normal activities sometimes have to be carried on at an angle of 45 deg, and that in assuming that the hull will stand all the sea can do to it from the outside, the inside of the entire vessel is subject to violent motion while equipment is being used.

The cabin layout as finally adopted (see page 215) is one large  
(Continued on page 348)

*Original plan was to have large owners' cabin aft separated by the cockpit from main cabin and forecabin. This scheme, shown in upper two sections, was finally abandoned (bottom section) as wasteful space division in a boat only 40 ft long*

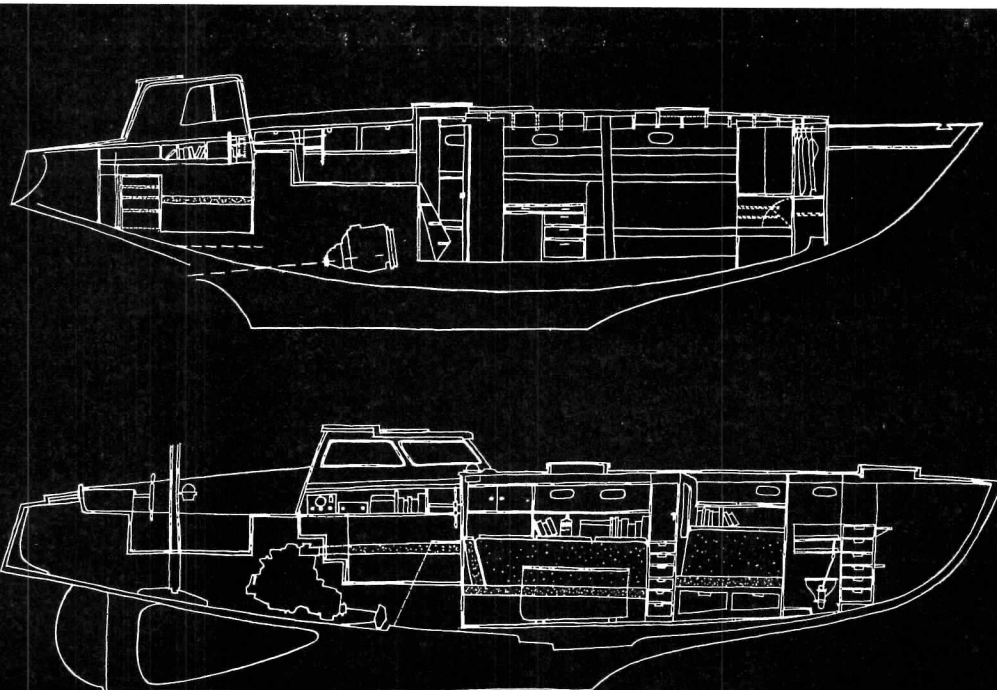

# THE IMPORTANCE OF QUALITY IN SCHOOL BUILDING DESIGN

by FRANK G. LOPEZ, A.I.A.

THE VALUE OF QUALITY is particularly hard to judge in relation to design. The purist might ask, justifiably, whether there can truly be design of poor quality; whether such a state does not indicate a lack of design. But we, not assuming purity, recognize that human imperfection exists in varying degrees which are inevitably reflected in quality of design.

Quality of construction or finish is another matter. We have seen many times the architectural monstrosity that is all too solidly built to last a lifetime, or the faultily conceived building so glossily surfaced that the faults are hard to perceive. When we speak of design quality in relation to school buildings the inherent difficulties are compounded because there is an interplay of educational and architectural philosophy and ideology to be expressed in a good school plant, and it is hard, perhaps even undesirable, to separate the two. Few types of buildings today must house and express such definite convictions, such positive directions, and at the same time such constant, change-inducing groping toward the ideal as the American school building.

Until such matters are examined thoughtfully it may seem strange that so few schools are highly rated as absolute architecture. There are several reasons. One of them, of course, is the evolutionary period through which our educational peers are now groping. It is hard to produce great architecture for uncertain premises, hard even to produce reasonably workable buildings. Yet there are motivations beyond the commercial and the esthetic — notions of the social importance of schools, an awareness just emergent of their economic value, the romantic appeal of doing something for youngsters — which have led many school architects to surpass themselves in surmounting the educator's philosophical shortcomings. We do have lots of excellent school buildings in both the architectural and the educational sense. We have very few that are superb. It is as if the architect can go only so far under his own steam; to go farther he requires the sureness and inspiration of a goal explicitly stated. So it is that, speaking only of school architecture, perfection continues to elude the architect practicing under pressure.



How high a quality can we justifiably seek? To answer that question we must tackle the definition we have so far avoided. Well, a judgment of quality in school design should be based, certainly, on appropriate mechanical functioning of the building; that is, on relationships between the elements and types of space-use encompassed, on comfortable circulation between them for both people and things, on provision for current or future equipment, furniture, furnishings, all the manifold items that today are essential if any structure is to function well. But mechanical function is no longer regarded as the supreme, sole desideratum; the schoolman has enthusiastically taken up the architect's cry for humanism in his buildings, which is something a long step beyond cool efficiency. To be human for children is, we have said in other words, romantically most appealing.

Function and humanism, then, are two components. In this specialized field there are others; for one, that susceptibility to improvement, growth or shrinkage which is called flexibility. For another, the client's ability to pay — though cost, per se, might better be judged in terms of economy of means (use of precisely the correct amount and type of material to achieve the desired end) rather than mere initial economy of dollars and cents. Any clod can build cheaply. He may have to repaint and repair and rebuild too soon, but he can build just as cheaply as he wishes. Any profligate can build wastefully, which is just as foolish and, curiously, often likely to be as expensive when it comes to maintenance and upkeep. Neither very often produces architectural quality. That comes when the architect knows just how much, of what degree of fineness, to include; where to use it to produce the best results; what the laborer and craftsmen are capable of pro-

ducing; and how to use it so it will not be expensive. In this direction lies true economy; we have published several articles on just this subject.

It would be interesting to speculate on just what has spurred so many of the country's good architects to doing precisely what has been outlined when they approach school problems. Though there is not room to discuss fully the motivations we have touched upon, the fact is that architects spend an unconscionable time on school design, assessing and developing techniques, systems, materials, equipments. This is one of the reasons school costs, however high they may be, have yet risen less, proportionately, than costs of many types of buildings.

Yes, this kind of economy is a criterion for judging quality. There is also the whole matter of custom, habit and appearance, the environment into which the school must fit without violence. There are the universal satisfactions of appropriate scale, proportion, texture, etc., that make a school building inviting or the reverse. Sometimes one factor, sometimes another or a complex of others dominates, and the school must be judged accordingly.

All apply in some degree no matter what the size of the building, the complexity of the program or the state of the client's pocketbook. The purpose is to provide as well as is possible for each child and every child. This is a peculiarly American ideal, one we are proud of. For this reason we have selected four examples that illustrate a wide diversity of situations. In two the same architects were involved; in two, the same educational consultants but different architects. Two are elementary, two are secondary schools. Two are in the southwest, one on the west coast, one on the eastern seaboard. One is a series of tiny buildings, another is small, two are quite large. One is



Lawrence S. Williams

*Utilitarian structure or play sculpture, children will use it whenever they can*

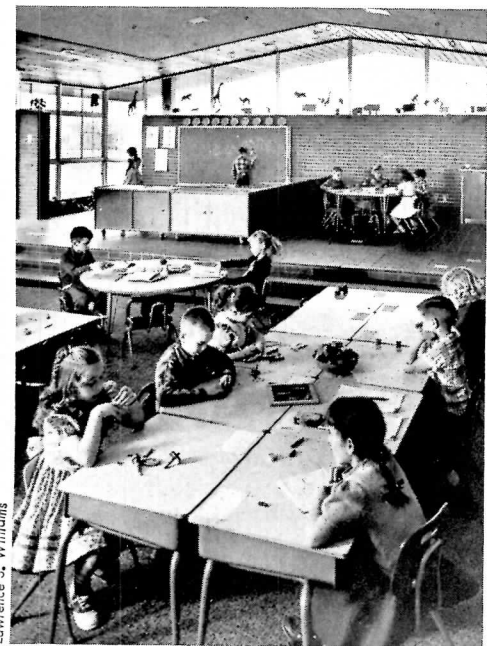

Lawrence S. Williams

suburban, another is in a small but growing town, another was built for a median sized city of more than average cultural attainment, another is distinctly urban in character. Three are new; one is an addition. In one way or another these four exemplify nearly all the situations in which American schools are being built.

Dissimilar as the examples are, they have this in common; all were recipients of devoted care during the design process. Sometimes this permeates the entire concept, sometimes it is apparent only in certain aspects. Always one knows by the results that the architect's function as designer has been exercised to the fullest degree that the situation and his talents combine to permit. While it would scarcely be possible to call any of these school structures superb architecture in absolute terms, some come close to that definition and all are fine, with a fineness that derives not only from workmanship, materials, space arrangements, finishes, etc., but also from the something of himself which, as designer, the architect has impressed into his work.

That is just about the point at which we started. At the risk of rounding another circle, it is to be said that another reason our school buildings lack the ultimate in stature may lie in our insistence on two premises which time may prove false.

About such immediacies one cannot presume to be certain, but consider that, 1, any school more than one story high is more apt to draw frowns than approving nods; and, 2, that almost all our schools are so consciously oriented toward the community as a whole that the most important occupant, the child, finds his building compromised in some respect.

Are these shocking notions? Frankly, we have no idea. Considered dispassionately, why is the one-story concept so sacred? Because we have lost the capacity to design anything taller in a fashion suitable to school aims? Should we so love this artistic (and practical!) strait-jacket? In tying the school to the community so closely what have we gained for what we've lost? For we have lost in the process; the gymnasium built primarily to satisfy a community's lust for basketball costs enough to raise more than a suspicion that something somewhere else in the school was sacrificed to make the gym possible. An auditorium as a teaching instrument is one thing; as a "little" theater for adult use it is quite another, and apt to be just as expensive as the gymnasium, to raise just the same suspicion.

Not that we advocate abolishing such school elements! However, when construction costs so much is it not wise to examine every item in the

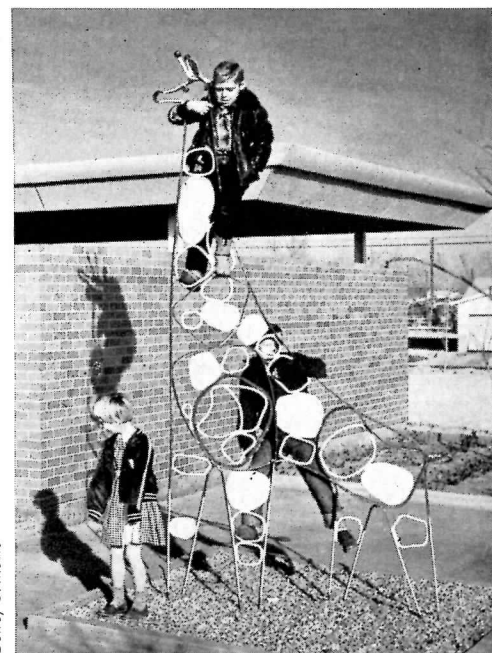

Dewey G. Meers

program with a jaundiced eye? Perhaps — and we know of several instances — the gym, the swimming pool, the community theater can be secured through the cooperation of another civic department, a private agency, a fund raised for the specific purpose. All these methods have been used. Sometimes the special-purpose structure is integrated with the school, sometimes the two are divorced.

At any rate, these are the kinds of problems the school designer faces in his pursuit of quality. Perhaps in describing them we have described the character of quality itself. That has been our aim, that and, since we are as romantic as the next fellow, a chance to state a firm belief in the necessity of attaining higher and ever higher quality in designing the buildings in which our young are formed.



Lawrence S. Williams

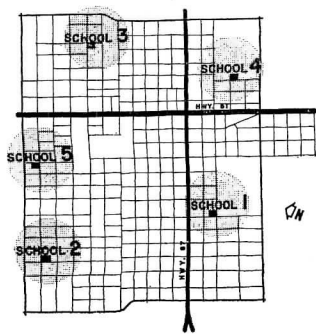

## QUALITY OF SCHOOL DESIGN: ANDREWS, TEXAS

**Five Primary Schools, Andrews, Tex.;** Caudill, Rowlett, Scott & Assoc., Architects. Andrews is in West Texas, 30 miles from the New Mexico border. It is small and, due to oil production, rapidly growing; in 1942 its schools had 280 students; in 1956 there were 2400. It is also progressive; of this, one manifestation is the community decision not to build a 10-room addition to the existing elementary school, but instead to erect the five primary schools of two rooms each which are shown here. This is the first step in an educational plan to decentralize the school plant. Although all five schools were located and designed as two-room kindergartens, each serving its restricted residential neighborhood on the periphery of the growing town, all are now being used for first and second grades. As the elementary school building program progresses, it is expected that these buildings will revert to their intended use. Individually each building is not a monumentally impressive piece of architecture, any more than the traditional little red country school-house was; against the background of the total educational place, and as the painstaking process of design is studied, each building both in itself and as part of the whole system is seen to be remarkable.



Dewey C. Mears







*Diagrammatic plan of Andrews at top of facing page shows location of 5 schools, two rooms each, in peripheral residential neighborhoods. Above and left, School No. 1*

**QUALITY: ANDREWS, TEXAS, SCHOOLS**

Even though the five primary schools are all in the same community and have the same climatic conditions to satisfy, and though all the sites are approximately level, soil conditions were found to be roughly the same, etc., each site demanded a different layout of the identical simple elements. Approaches to each site, the cold northwest winter winds, shape and size of each plot, contours and utilities all demanded individualized attention to achieve the double objective of properly functioning architecture at reasonable cost. Andrews' streets are laid out in a grid system; the corner sites represent all the possible combinations of street orientation. School No. 4 is approached from only one street. For these buildings the approaches were important since each classroom was to have its own entrance. The climate's effect is seen in the wide overhangs, roofed areas and the porches which shade the building against seasonal sunlight; and in the location of openings, use of free-standing walls, etc., to protect against Texas "northers."

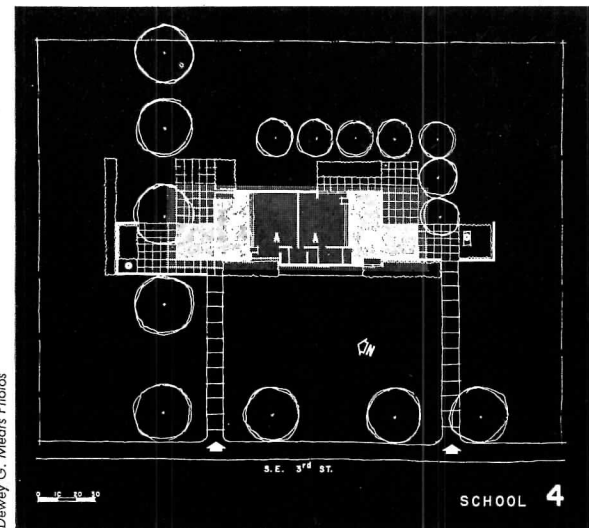
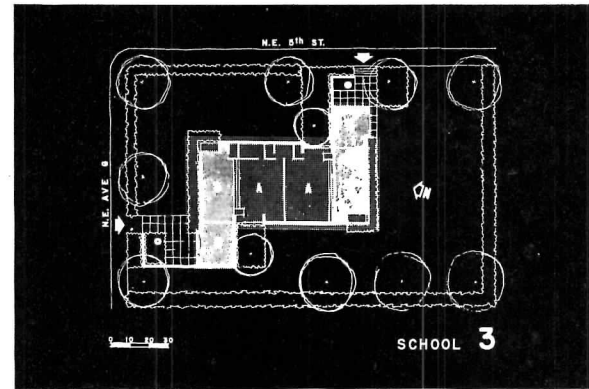
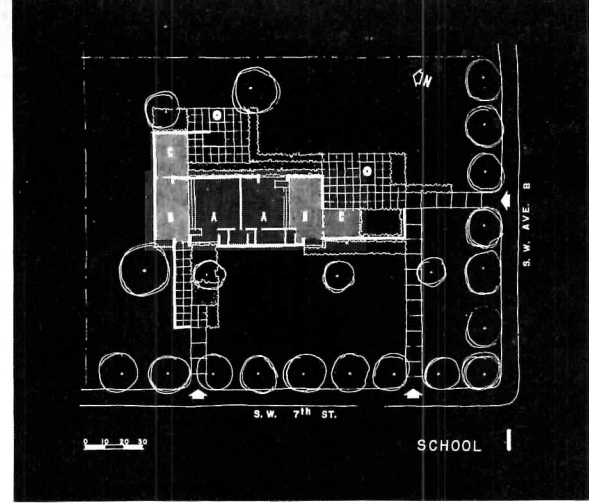

Dewey G. Meers Photos

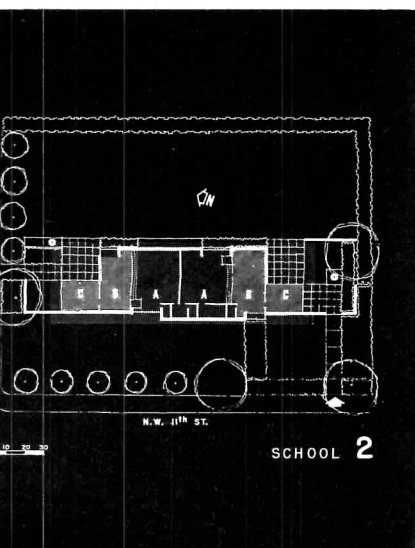

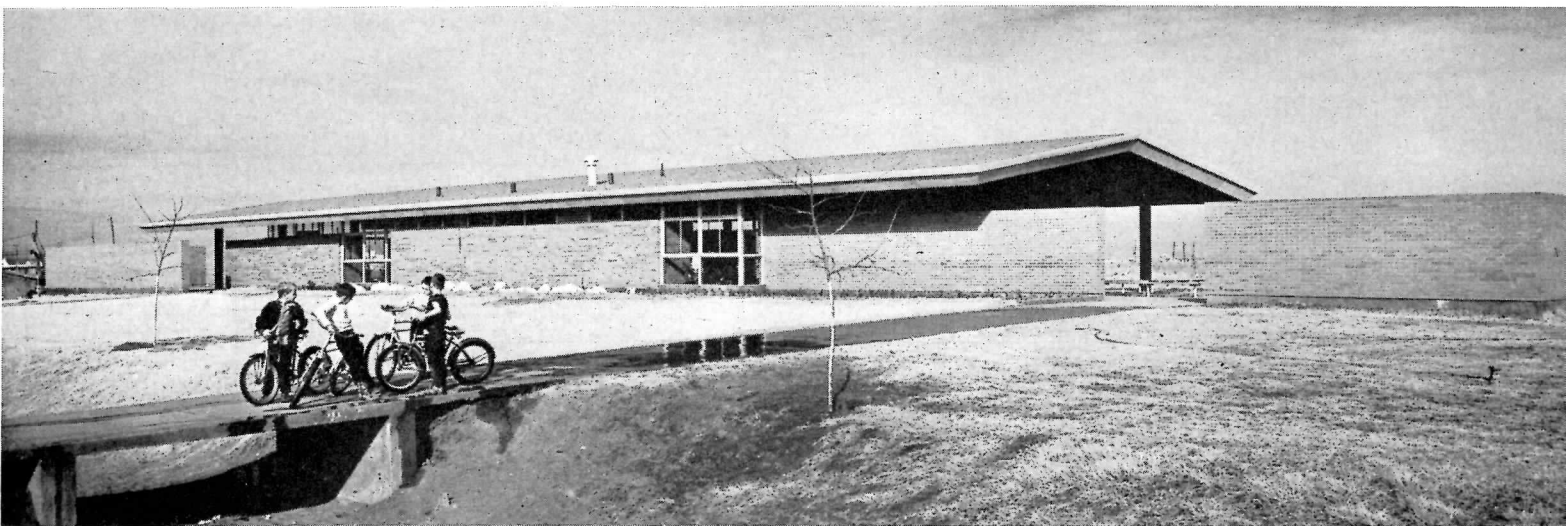
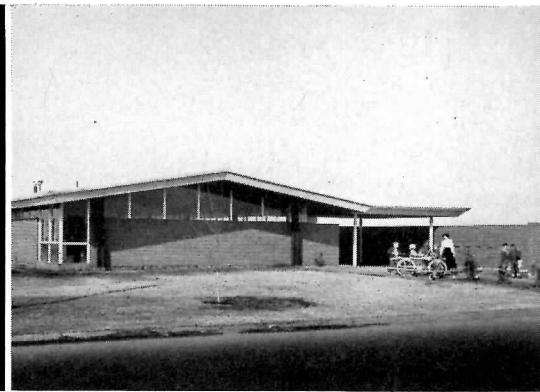
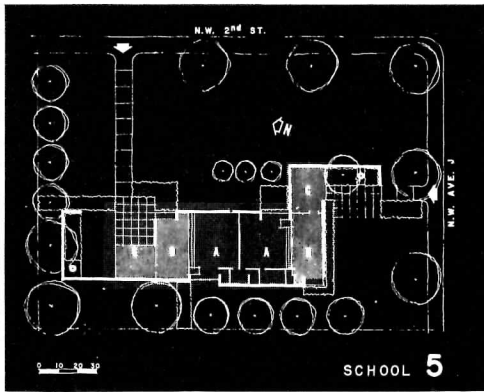
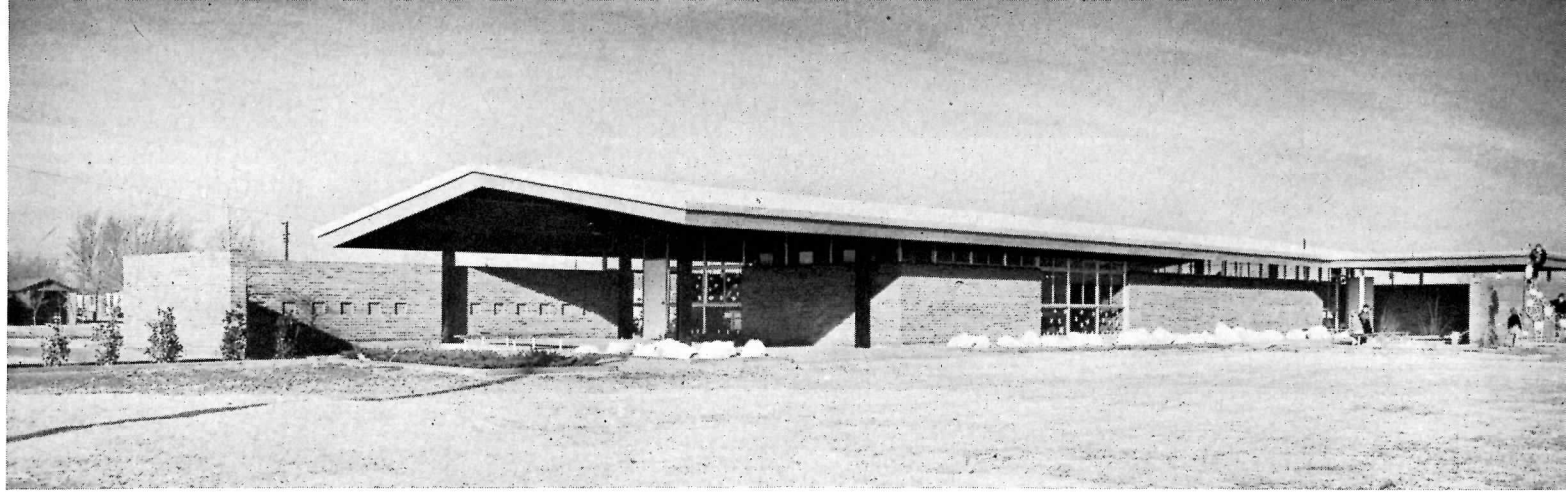

*All five buildings are in residential neighborhoods, so all are residential in character. This makes not only for buildings in harmony with their surroundings; it is also considered educationally appropriate for children of kindergarten or primary school age*



## QUALITY: ANDREWS, TEXAS, SCHOOLS

Basic unit in all five of these primary schools is a three-element classroom, whose parts are labeled A, B and C in the diagram below. A is an "academic" area; B a "work" area; C, outdoor covered area, a useful extension of both. By varying the positions of A, B and C considerable variation and adaptation to each site was achieved.

Within the academic area flexibility was required — movable seating, cabinets and storage units — so each

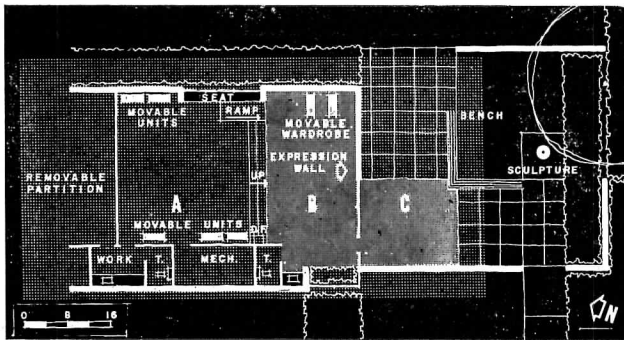

could be arranged as each teacher wanted and so each could contribute the maximum toward the educational readiness program. It was stipulated that the work area be not a separate enclosure, and an indoor garden was requested. The educational specifications statedly required outdoor surfaced area for work and play, at least partly protected from the hot sun. In practice, separating the indoor areas with steps has been a stimulus to ordinary classroom activities as well as to dramatizations.



Dewey G. Meers

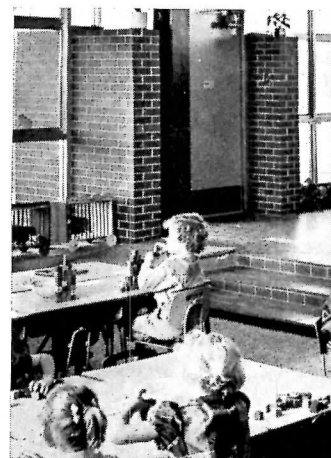

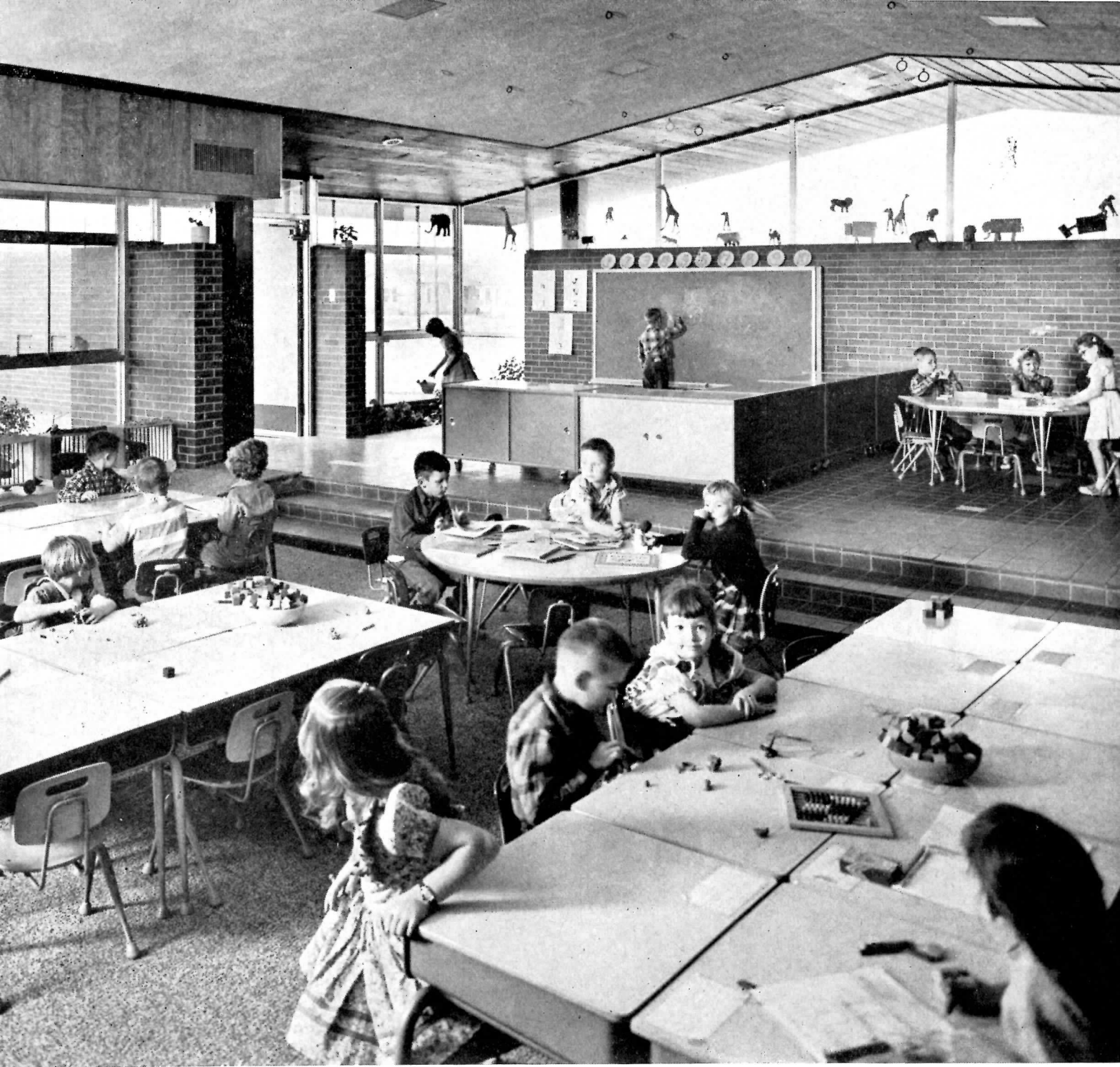

*Above and below, the two indoor areas in use in different fashions; note use of ceiling whence displays, children's ropes and swings, etc., can be hung from color-coded hooks of different sizes and capacities. Left, outdoor roofed area*



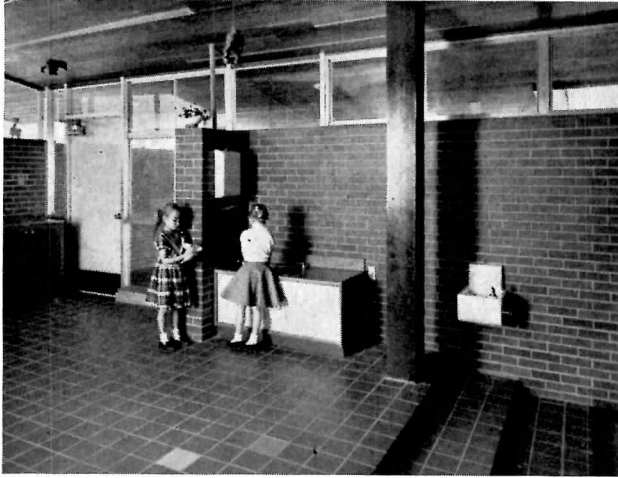

### ANDREWS, TEXAS, SCHOOLS

The thought expended on these five small schools has produced many refinements which, costing little, add to their effectiveness as teaching instruments. The stepped separations between parts of the classrooms provide seats for the children (who love to sit on curbs); they make good work benches; small fry like to look down (but rarely have the chance); the steps act as tiers for group singing; the upper level at times becomes a stage; the change separates flooring materials (in School No. 1, wall-to-wall carpet is being tested in academic areas). A ramp between levels facilitates moving cabinets. The wall between classrooms consists of removable panels of chalkboard, pegboard and corkboard, so the two rooms in each school can be united for the few occasions when parents gather to view a program. Doors connect the academic areas with the common teachers' workroom, improving the opportunity for the teachers to cooperate.

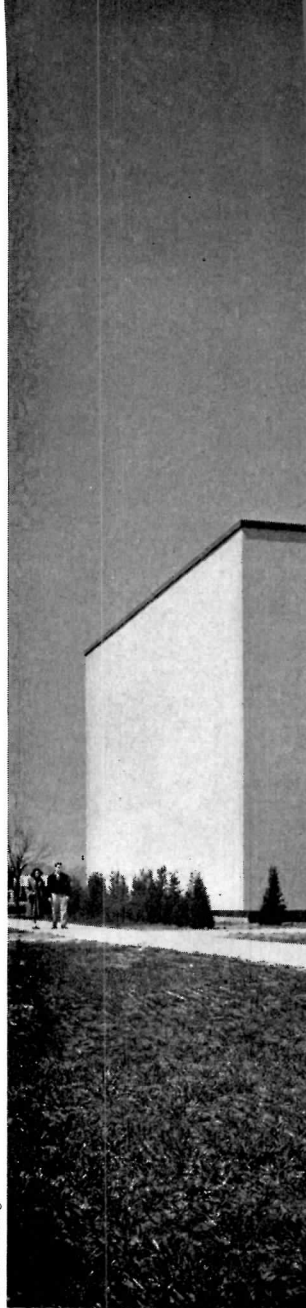

Hedrich-Blessing

## QUALITY OF SCHOOL



Dewey G. Mears Photos



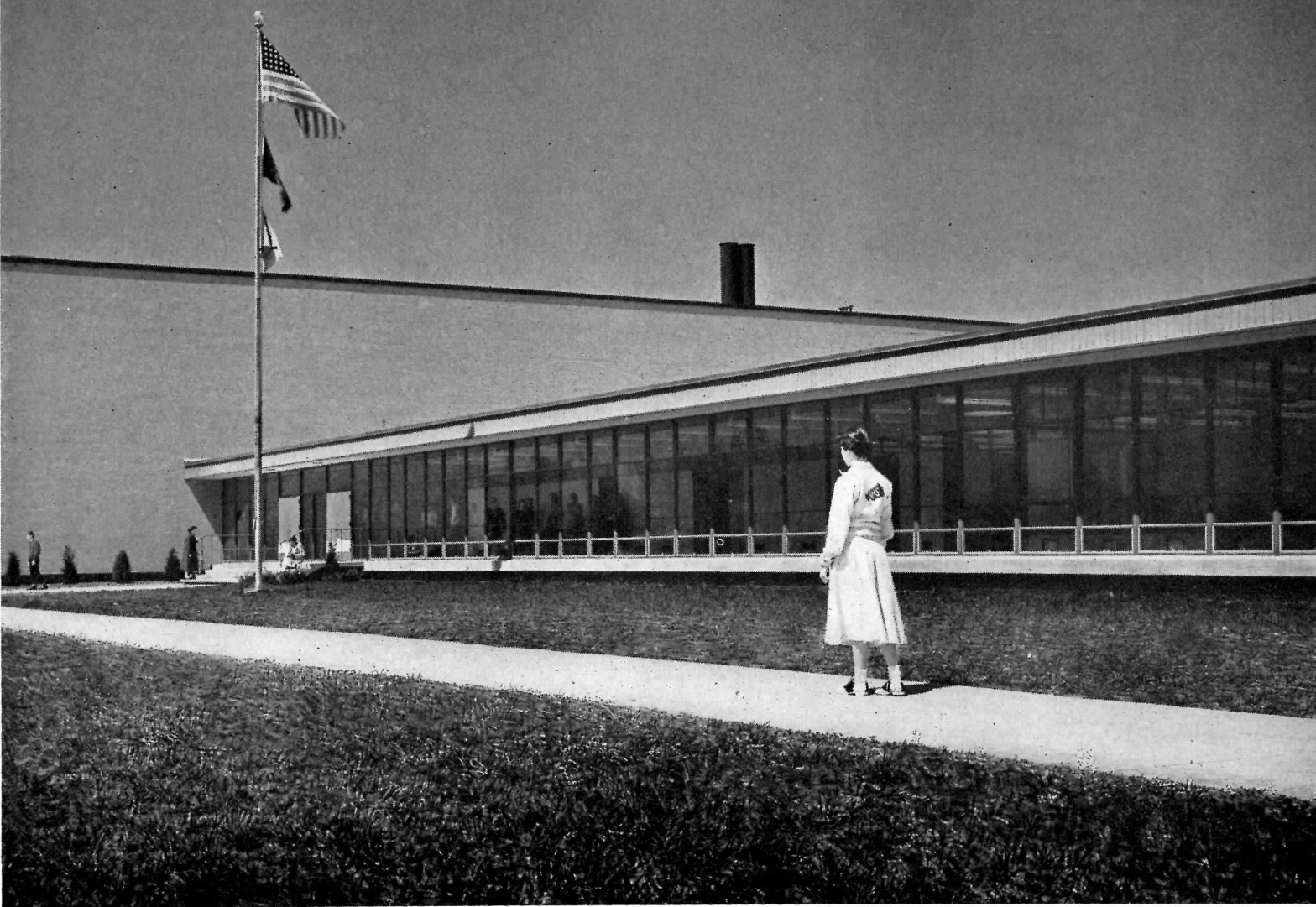

## DESIGN: NORMAN, OKLA.

**Addition to High School, Norman, Okla. Caudill, Rowlett, Scott & Associates, Perkins & Will, Architects.** The architects of the five small schools shown on preceding pages were here associated with another firm in the design of an addition to an already large high school. The original building, by the same team of architects, was published in *ARCHITECTURAL RECORD* for August, 1954. The school was expected to grow; currently the expectation is becoming reality. In designing the addition, the architects have found that the care taken initially to insure flexibility and ease of addition, and the thorough study of details, are now paying off. Although the proposed expansion plan (sketch at left) is being somewhat altered, enlargements and alterations are progressing smoothly.

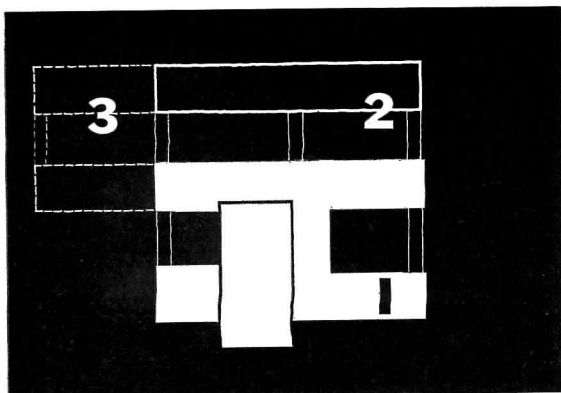

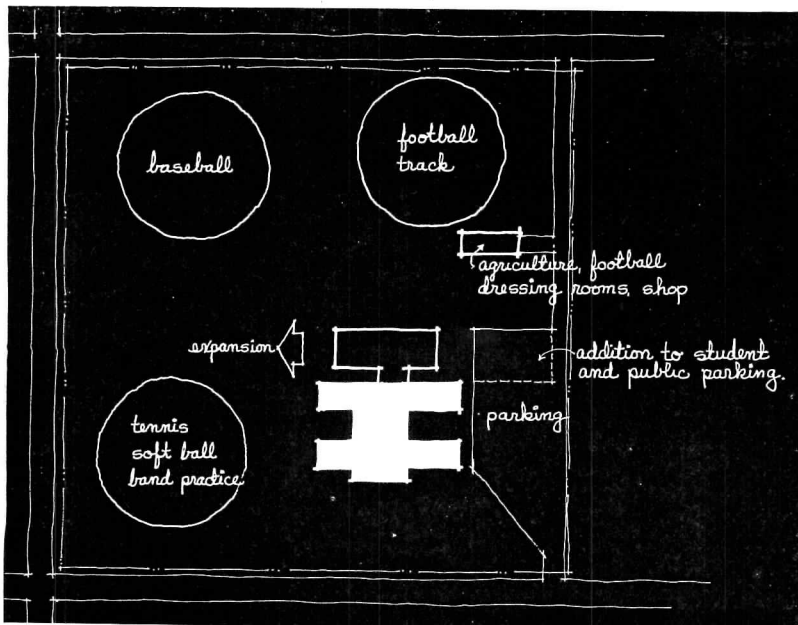
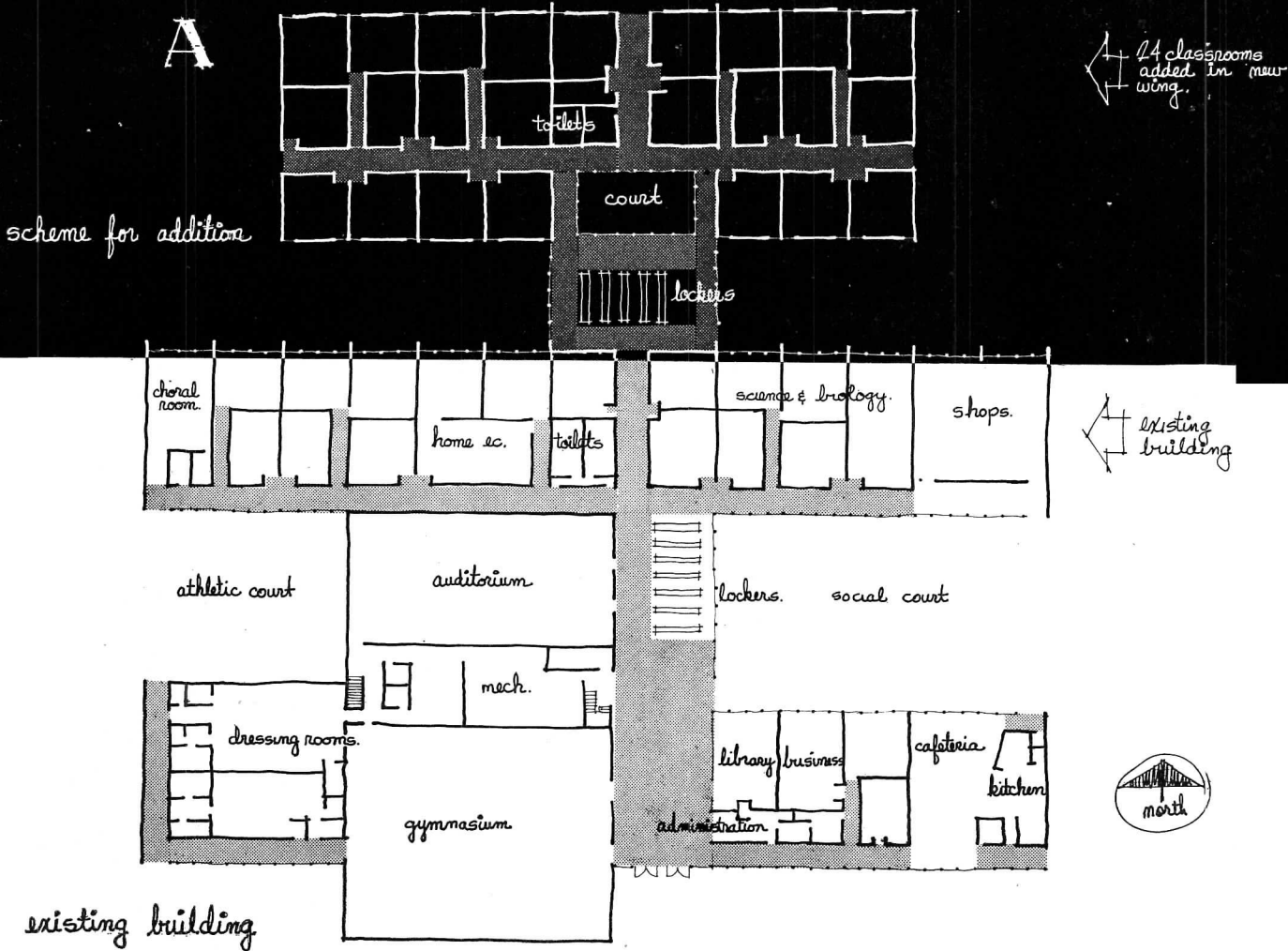

plot plan

the 40 acre site promoted flexibility in site planning in both the original scheme and subsequent planning.

QUALITY: NORMAN, OKLA., SCHOOL ADDITION

Design premises for the original Norman, Okla., High School included an expected growth of student body, changes in teaching techniques, importance of corridors, full student participation in classroom activities, all-year community use of plant. The original building was designed for 600, had a 1956 enrollment of 800; with the addition it will house 1050. To accommodate new teaching needs, several rooms in the original building were changed. New corridors, classroom shapes and sizes, even the entire site, have been thoroughly studied.

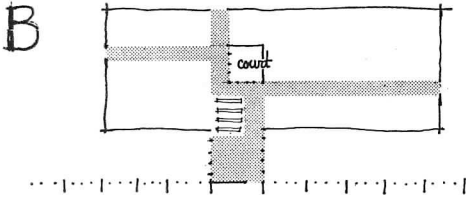

Phil Will suggested an offset corridor to correct bad effect of long corridor.

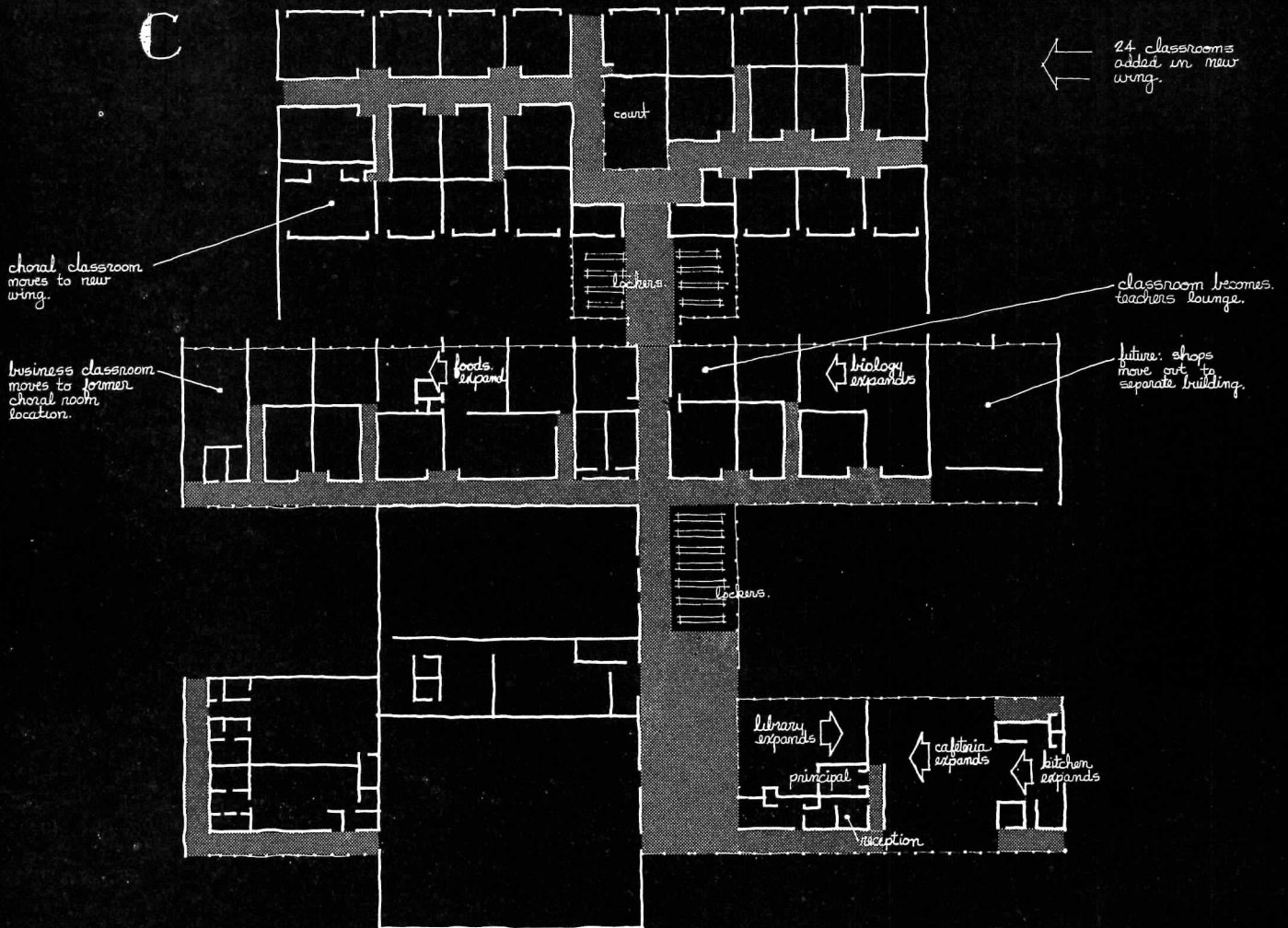

final plan of addition (incl. changes to existing bldg.)







Hedrich-Blessing

**QUALITY: NORMAN, OKLA., SCHOOL ADDITION**

School Superintendent Garrison and Principal Daniel found in using the original Norman building that interior classrooms were as well lighted and ventilated as those along exterior walls. This encouraged use of interior rooms to produce an extremely compact addition. But the advantages of initial insistence on flexibility and quality of design were both more fundamental and more detailed. On the one hand, the size of the site (40 acres) permitted almost unlimited flexibility of direction and extension of the addition; on the other, the original module (to which lighting, structure, window spacing and ceiling materials conform) provided utmost freedom in relocating partitions, and the readily accessible utility lines have required no more than direct extension — not change. There is no waste; in making the addition the only discards are two windows.

*In the original Norman High School the principal outdoor court (shown on this page) serves as an informal entrance and, in its deep penetration of the plan, not only as a source of light and air but also as a focus for many activities. In the addition, as plans on the preceding and facing pages show, the interior court will agreeably terminate vistas, eliminating over-long corridors. Something of this sort would seem essential for a building with a number of interior classrooms; yet how seldom is it achieved in such a school*

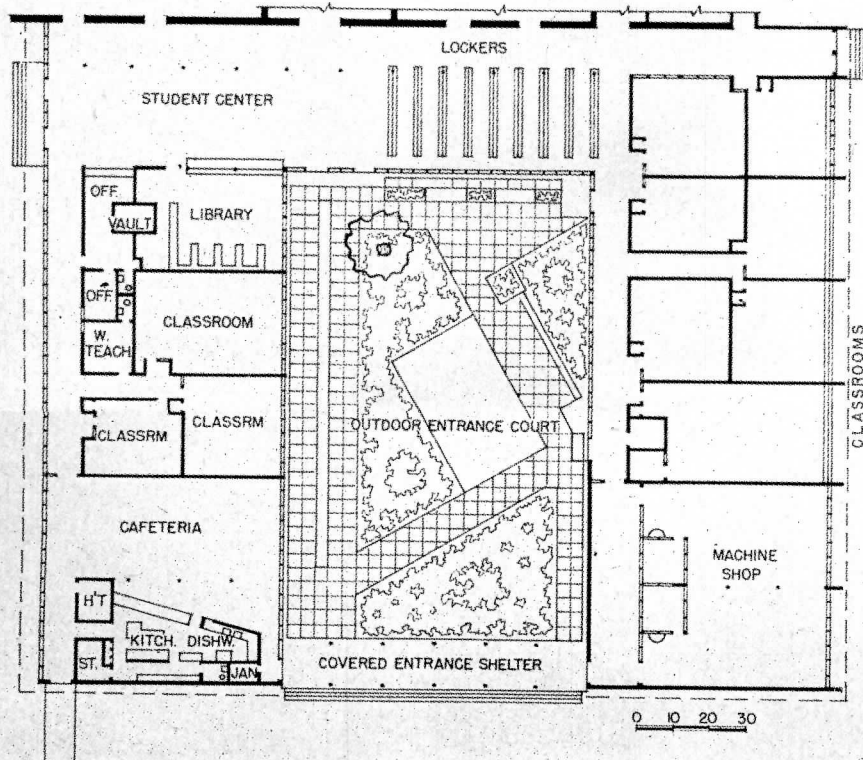

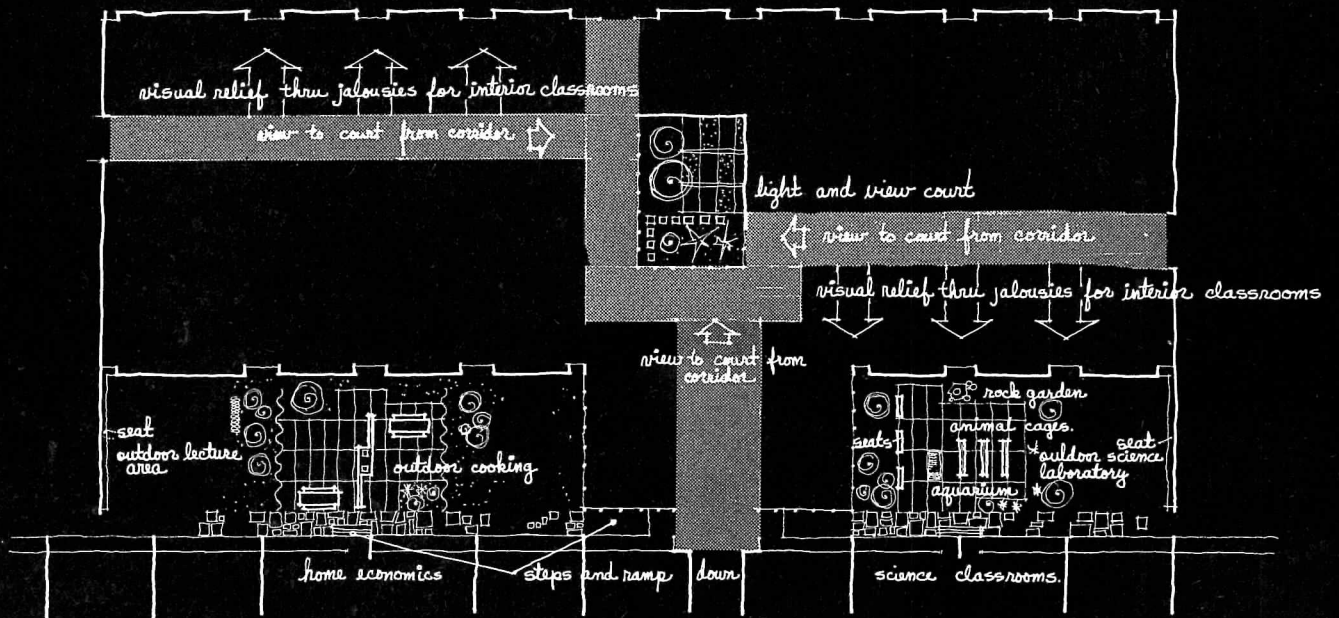
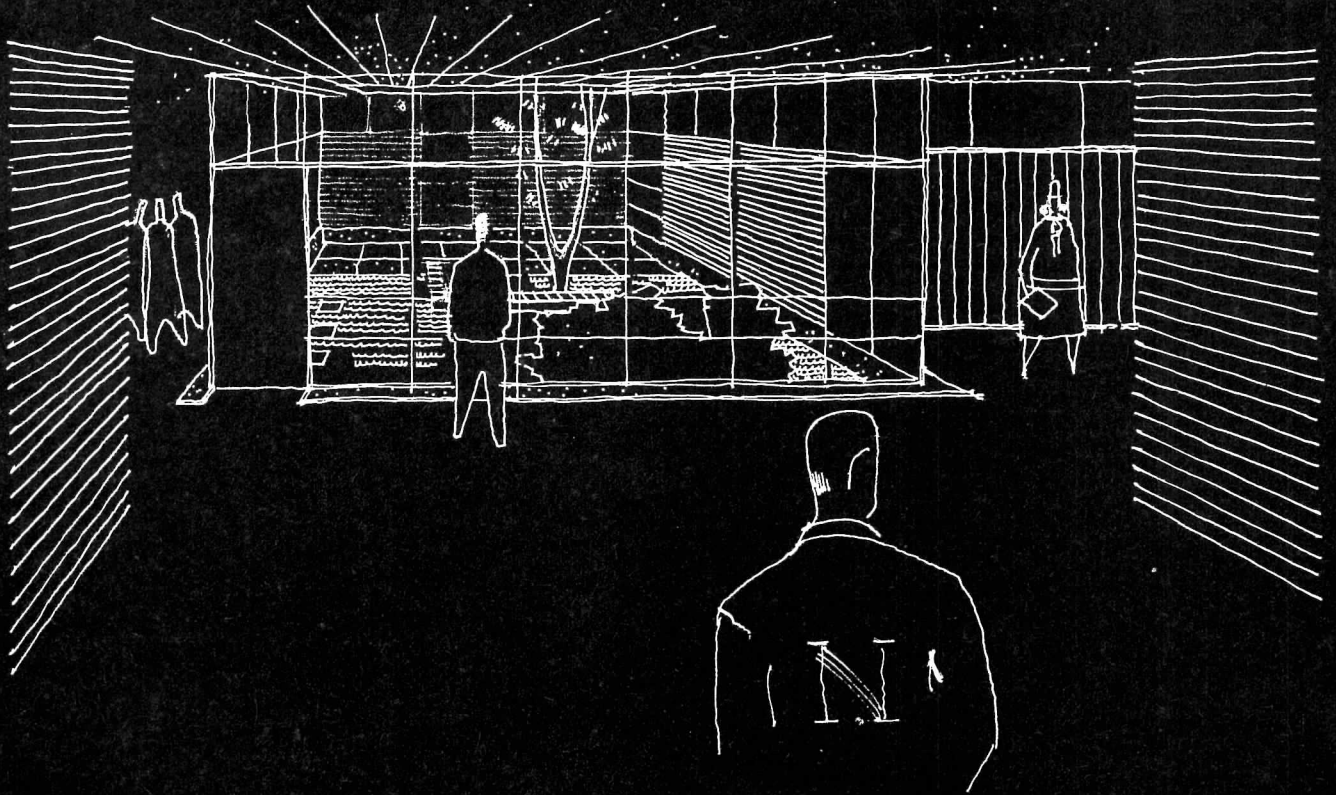

academic court development



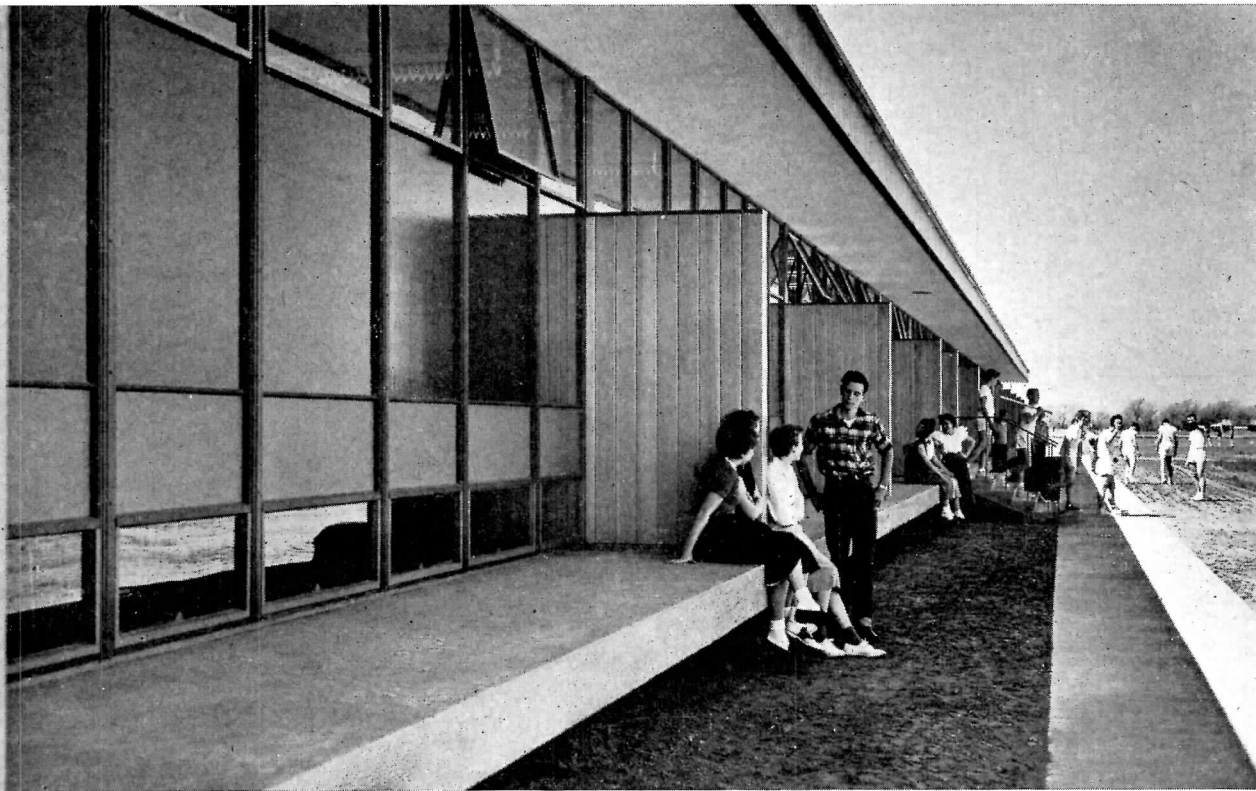

Hedrich-Blessing

**QUALITY: NORMAN, OKLA., SCHOOL ADDITION**

Thorough study of the original Norman, Okla., High School building to insure its flexibility has assuredly paid off. The sketches at the immediate right indicate how simply partitions are changed and utility outlets relocated, thanks to the interior rooms, to the non-load-bearing walls, and to the raised floor slab with utility mains in the crawl space beneath. A benefit from the completely modular design — one which is seldom advanced by proponents of the modular system — is illustrated on the facing page. At left is the existing wing, at right the new. Although it was considered advisable to use a brick rather than a glass panel in the new wing, the change of materials does no violence to the design. The module preserves harmony.

One of the original principal design considerations required that the school be a real social center for high school students. Observation of the school in action indicates a well mannered, well behaved student body, relaxed and happy with its surroundings. The materials of which the building is constructed have held up satisfactorily. It is obvious that the school has been appreciated.

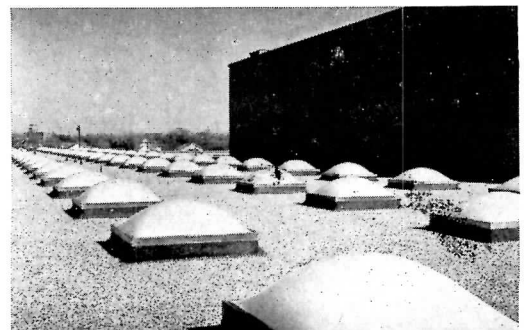
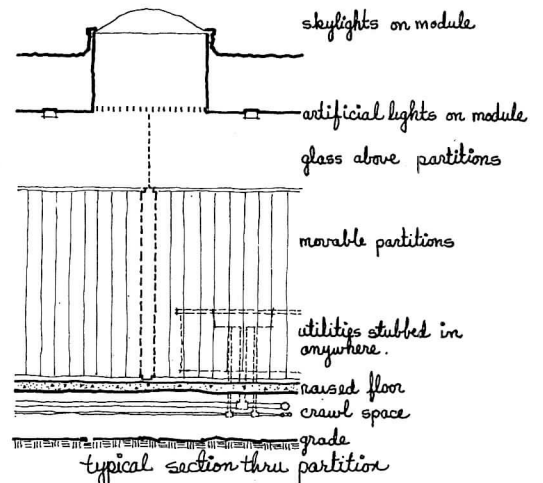



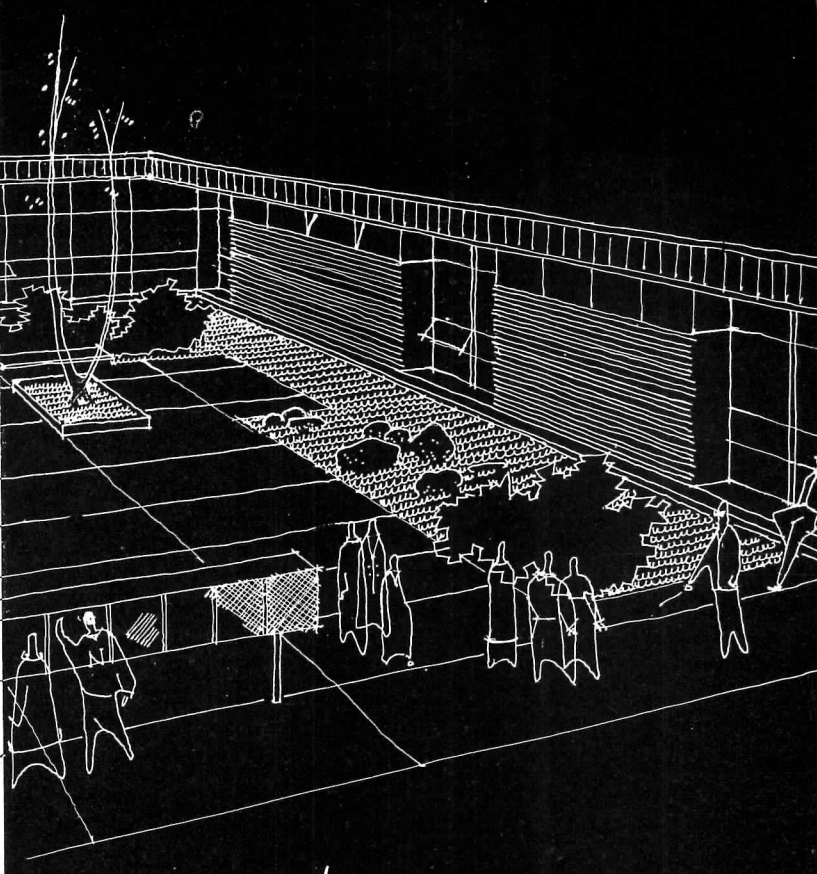
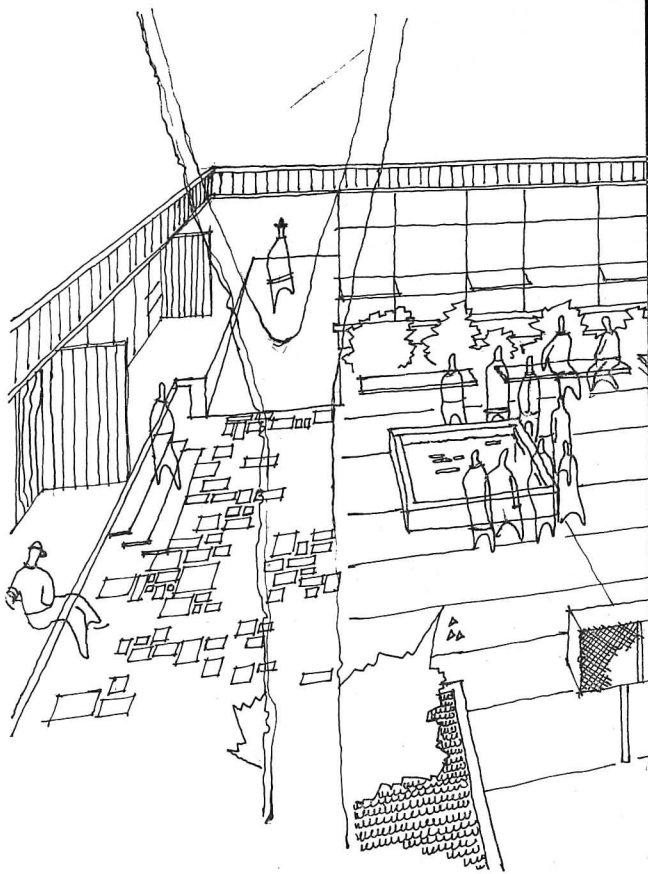

view of academic court.

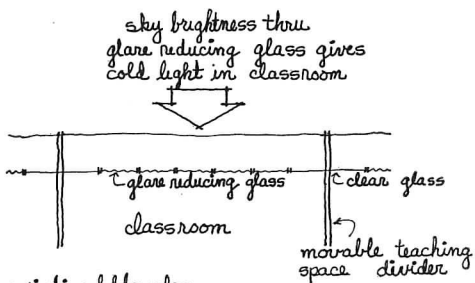

existing bldg. plan  
 large glass panel on north wall served as cold radiant panel.

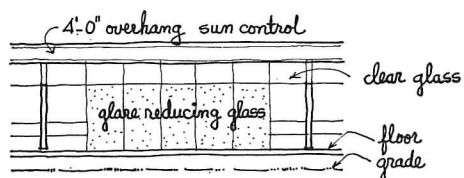

existing bldg. elevation

plan section of exterior wall



addition plan  
 12" brick cavity wall gives protection on north wall.

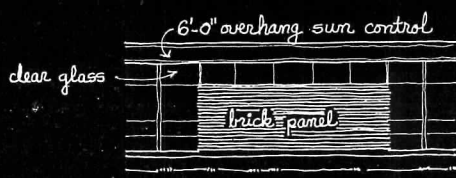

addition elevation  
 the glare reducing glass was replaced with a brick panel to eliminate cold light and cold radiation in the classroom.

SSAM LANE SCHOOL



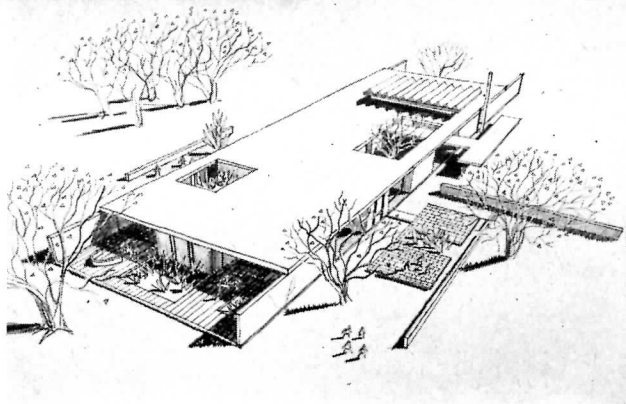

## QUALITY OF SCHOOL DESIGN: GLEN HEAD, N. Y.

**Kissam Lane School, Glen Head, N. Y., Vincent G. Kling, Architect; George Qualls, Project Manager; Engelhardt, Engelhardt, Leggett & Cornell, Educational Consultants.** In some respects easy to understand, in others difficult, the small Kissam Lane School has been the object of meticulous, very human care in design. It has only six classrooms, of which two are kindergartens; it houses children only through the second grade; it accommodates only 180 pupils; it is, like some others in this study, a neighborhood institution.

As an institution it could have accomplished all its purposes with utmost efficiency and yet have missed a prime target; many a school design ignores the pleasure which good architecture can afford. This is a school for the very young, who need to be brought carefully into contact with the large world into which they are growing up. So each schoolroom is here an entity in close rapport with the outside world, with a near view of a personal garden and, too, a distant horizon. The entire building follows this lead.



Lawrence S. Williams Photos



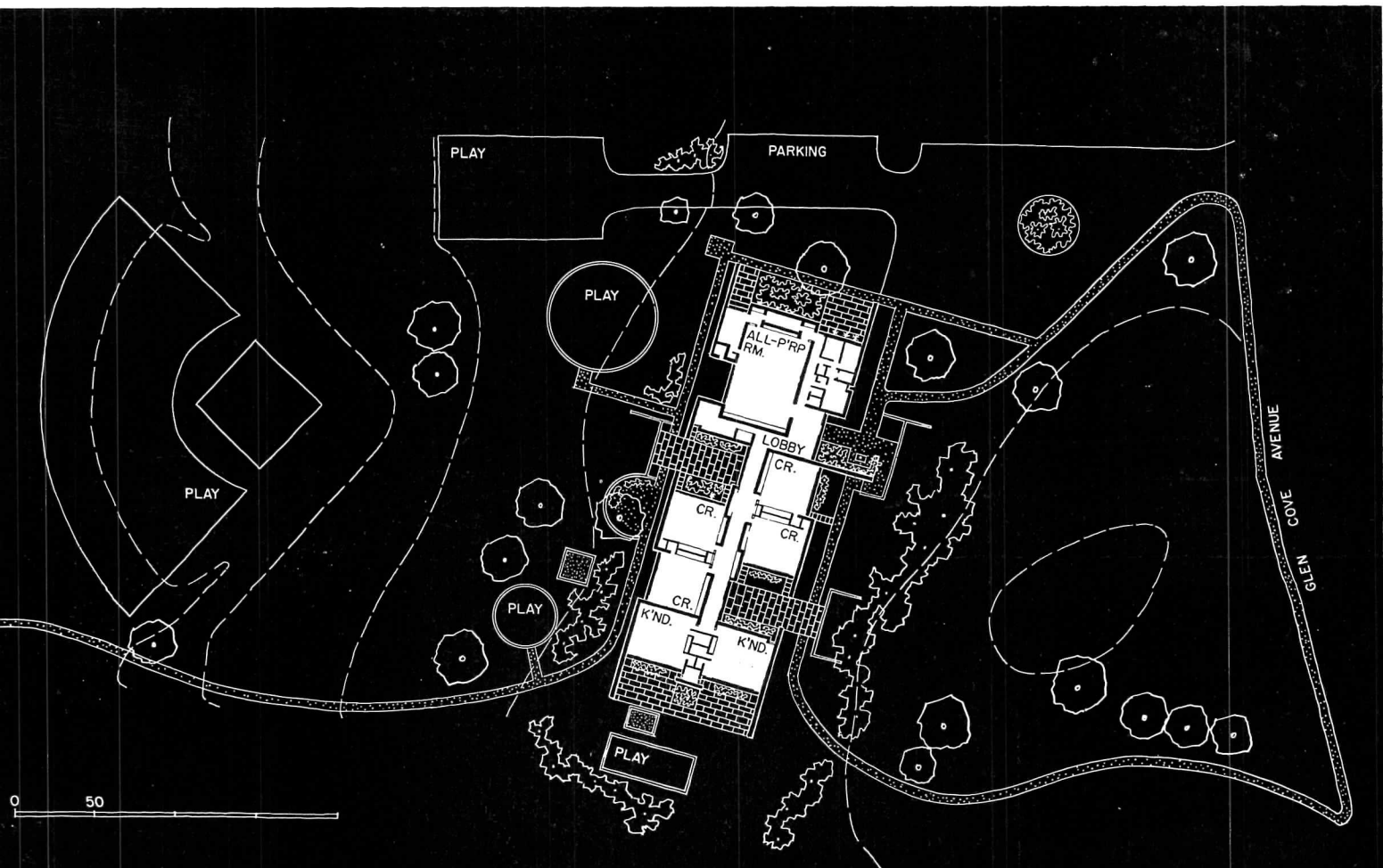



**QUALITY: GLEN HEAD, N. Y. PRIMARY SCHOOL**

*The school building has masonry bearing walls supporting a flat roof, with the roof of the all-purpose room raised in an accordion-pleated form both to provide playful relief and to admit light through clerestories*

The aim of the design of the Kissam Lane School, to ease the young child's transition from home to larger world, is realized through the siting, the arrangement of space internal and external, and the handling of architectural details. The heavily wooded setting was disturbed as little as possible, even to deploying the playgrounds in small units among the trees. Inside classroom spaces are defined in domestic scale; and although they are logically grouped, each, with its adjacent paved outdoor area, offers a fresh vista. Two of the exterior spaces form courtyards within the building and also bring sunlight and openness to the central corridor. The unpretentious walling of the courts protects without confining; the child is sheltered while he participates in enlarging experiences yet the experience is no less real. The building contains two kindergartens, four classrooms, an all-purpose room, a kitchen, health suite, teachers' room and essential utility and service areas.

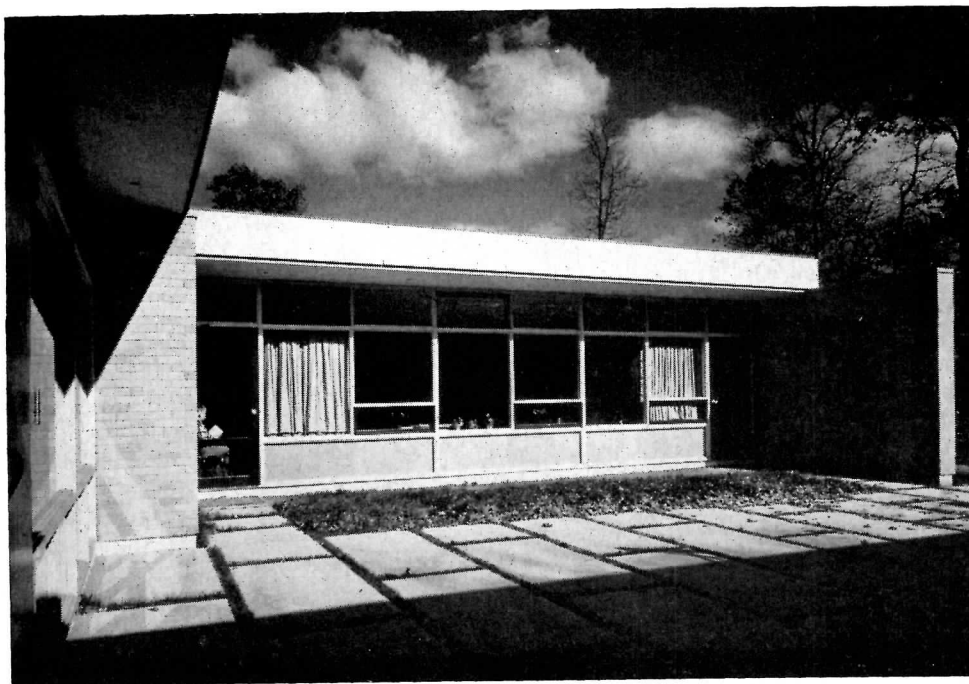

Lawrence S. Williams Photos



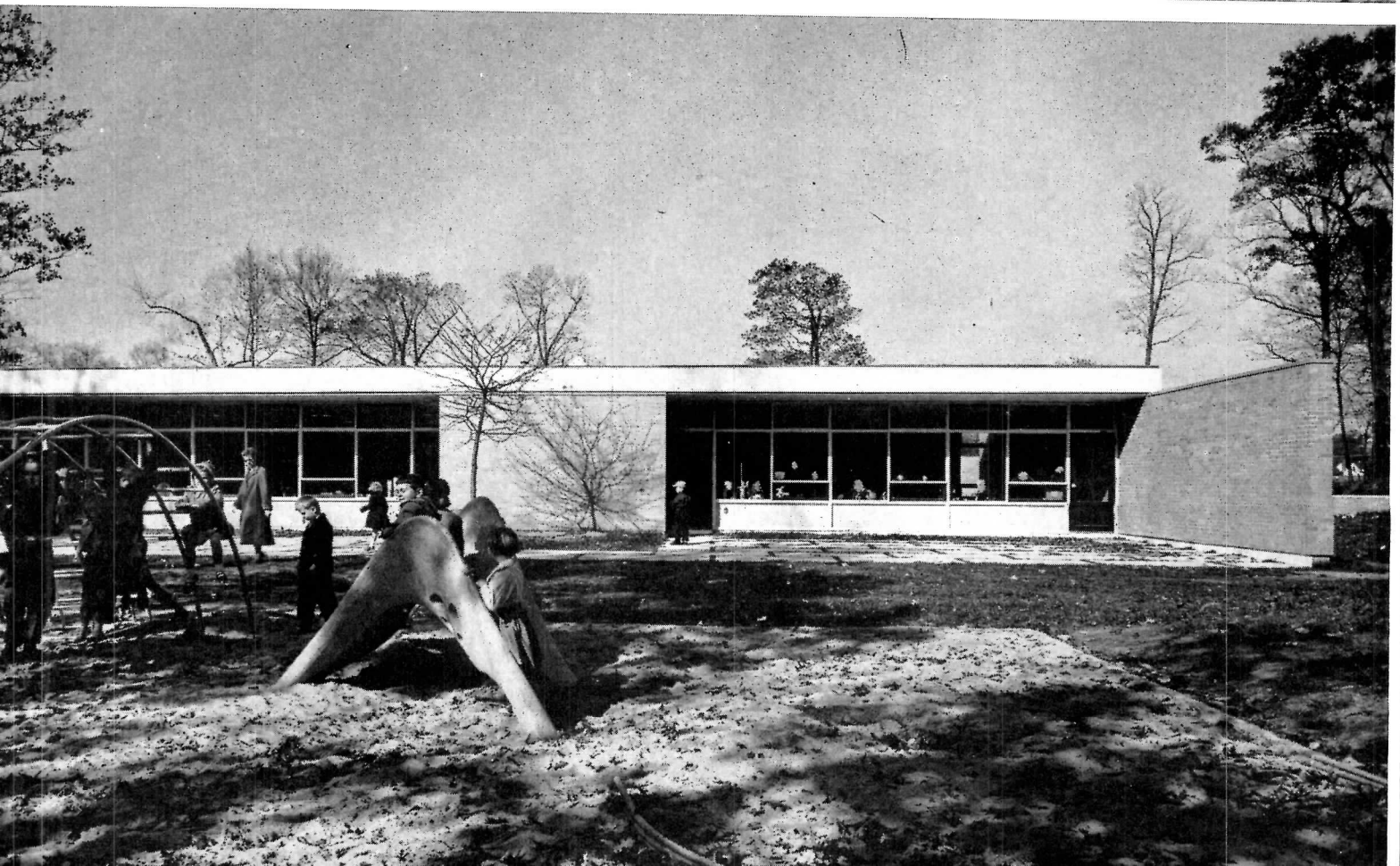



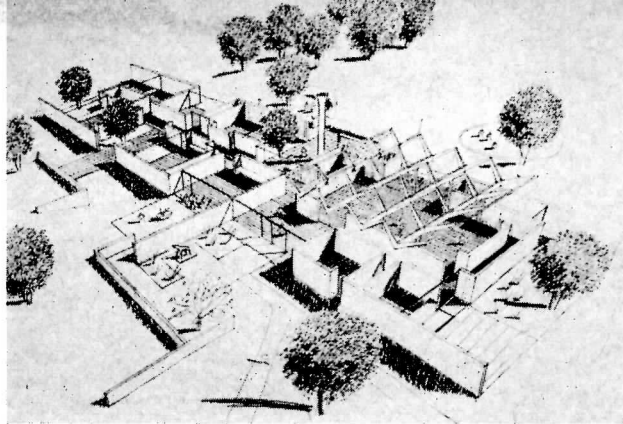

**QUALITY: GLEN HEAD, N. Y., PRIMARY SCHOOL**

The imaginative play equipment of the Kissam Lane School is easily identified with the building itself; both are sculpture in conception and execution. One consists of curved planes, penetrations and ladder-like pattern; the planes of the other are flat and the solid, three-dimensional structure they form is literally penetrated by courts and pierced for window-walls which, too, are similarly patterned by horizontal and vertical muntins. This is no accident; it is delicately balanced and controlled design. The average school façade is a monotonous expanse of repetitious window units; here the substantial brick walls alternating with voids, repeated in satisfying rhythm but never with exact uniformity, were undoubtedly more difficult to design. The elements are standard products, most of them from ordinary production lines; the artistry lies in their assembly.

*Photos at left show the kindergartens and their play equipment carefully disposed with apparent nonchalance under the trees. Sketch at top of page, in addition to explaining the building's organization, displays its sculptural nature. Sketch below, one of many studies, embodies a proposal to use walls to help define outdoor play-rooms*

*Lawrence S. Williams Photos*

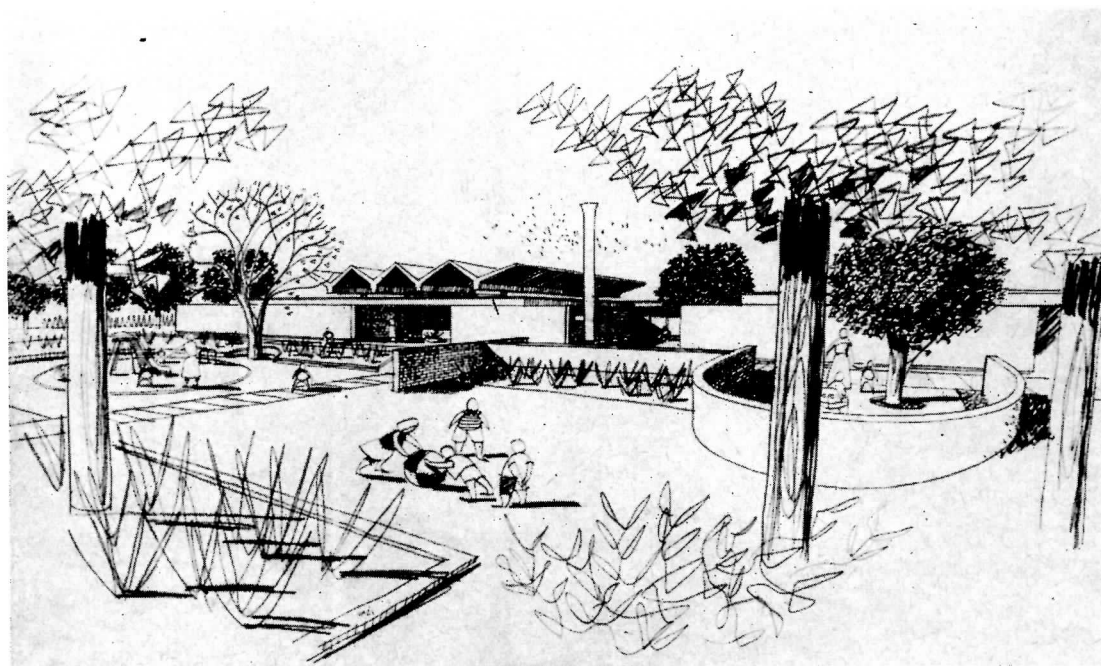



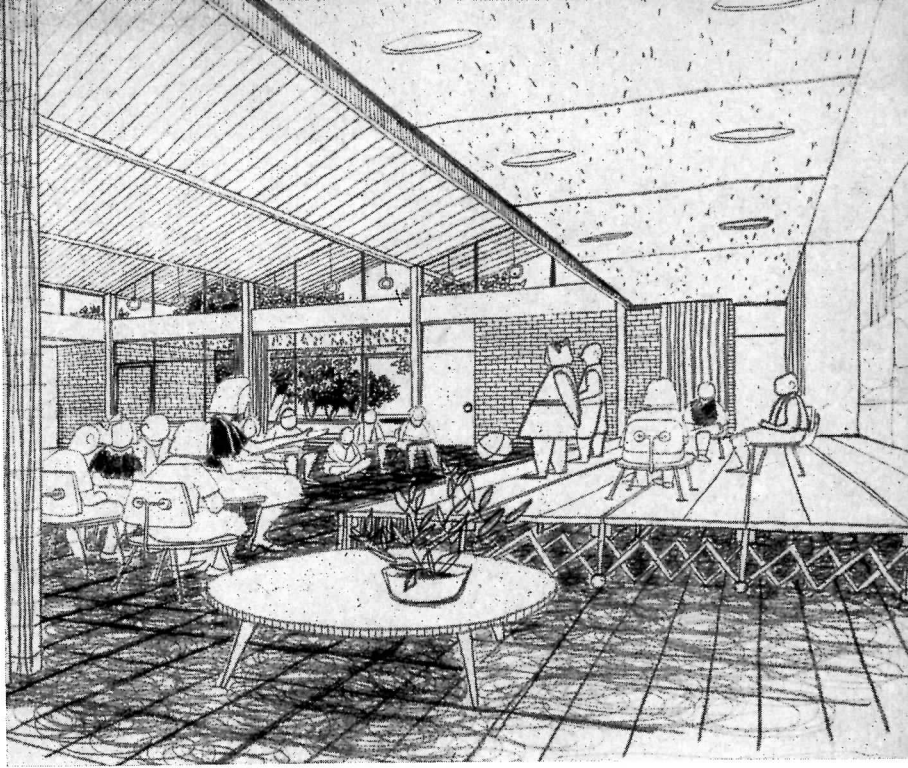

*Construction: masonry bearing walls, with cavities at exterior locations to protect against driving rains; steel roof joists; precast cement and wood fiber roof planks; structural steel frame for roof of all-purpose room. Ceilings are acoustical plaster; classroom floors, asphalt tile; corridors, terrazzo. Window walls have treated wood frames, metal operating sash. Heating: split system, warm water convectors (fin-tube) and forced tempered air from ducts over corridor. Lighting: incandescent domed fixtures with plastic louvers. Area: 16,000 sq. ft. Cubage: 200,000 cu. ft. Cost: \$300,000; completed in August, 1956*



Lawrence S. Williams Photos

#### QUALITY: GLEN HEAD, N. Y., PRIMARY SCHOOL

In the Kissam Lane School each classroom is fully equipped for teaching the very young. One wall consists of wardrobes, teacher's closet and storage units, executed in wood with applied cork surfaces for tacking up displays. Another wall, of brick, supports the chalkboard — a different color in each room. A third wall provides project work space: cabinets, sink and counter, with continuous tack surface above. The fourth is a window-wall. Between classrooms, facing on the corridor, is a cabinet for displaying student work. Although the rooms are logically arranged along the corridor the monotony of the usual "double-loaded" plan is strikingly absent; in part this is due to the deeply penetrating courts. Uses of the all-purpose room and its folding stage are shown above.





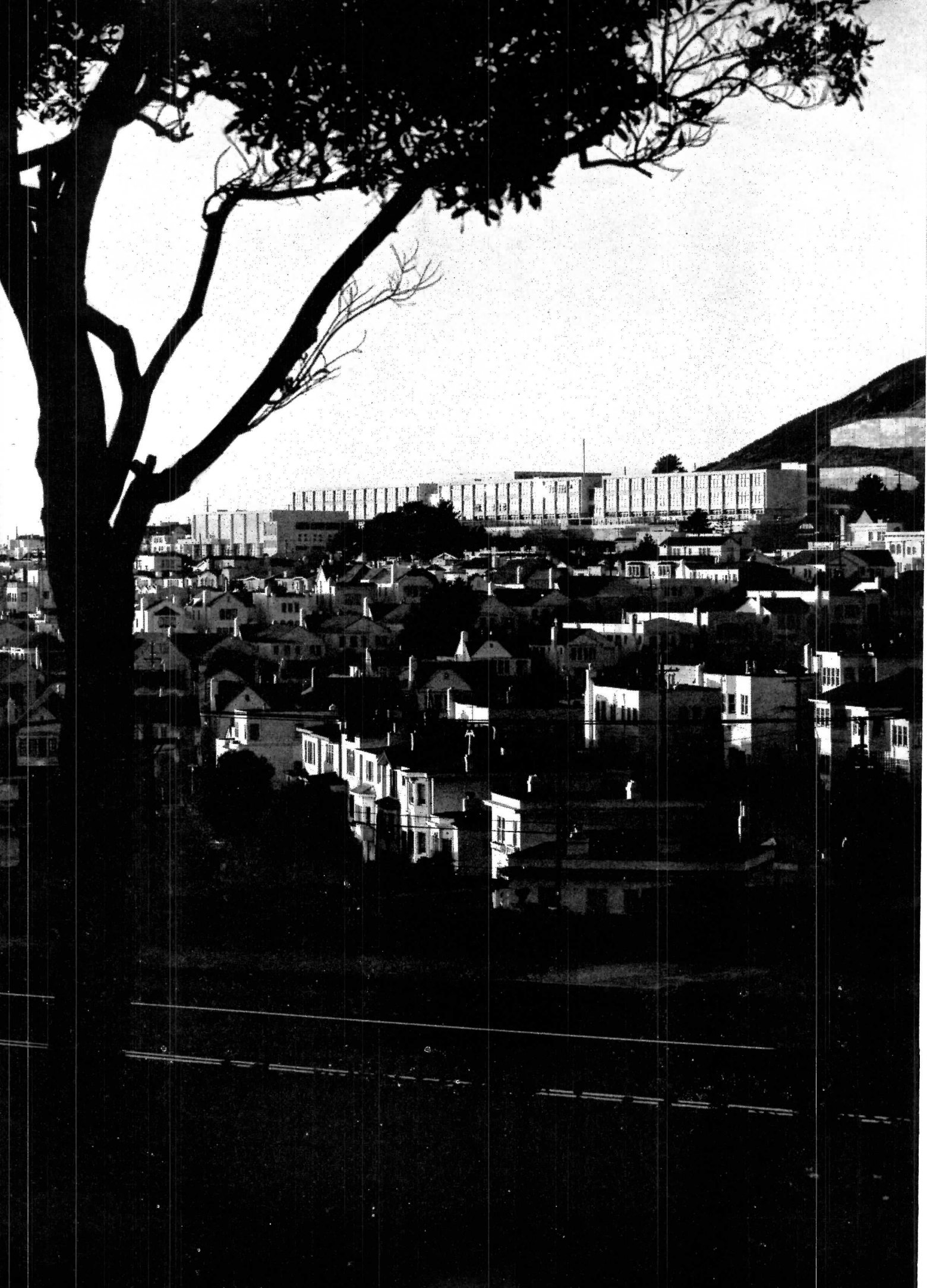



Roger Startevant Photos

## QUALITY OF SCHOOL DESIGN: SAN FRANCISCO, CALIF.

*Almost the only good thing about the site of Herbert Hoover Junior High was the view. Tailings from the quarry, covered with a layer of blown dune sand, formed a relatively level crescent roughly 100 by 50 ft. across the center of the hillside; this, somewhat enlarged, became the outdoor athletic area. Test borings revealed greatly differing depths to solid bearing; piles had to be driven to support the structure and the building had to become itself a retaining wall, with other retaining walls deployed up the slope to hold back the loose overburden.*

**Herbert Hoover Junior High School, San Francisco, Calif. Ernest J. Kump, Architect; Engelhardt, Engelhardt, Leggett & Cornell, Educational Consultants.** This was the first junior high built in San Francisco in 15 years — it was dedicated in June 1956. In the long interval since constructing the last previous one, residential development has crowded most of the land, leaving almost no school sites; and the earlier curricula have been outmoded. For its new schools for this important stage of adolescence the city's educators wanted a broader program than the typical California junior high school's. All the land available was a hillside too steep for normal use, a plot of less than 10 acres, much of it nearly vertical, with an abandoned quarry scarring its face and with almost no street access.



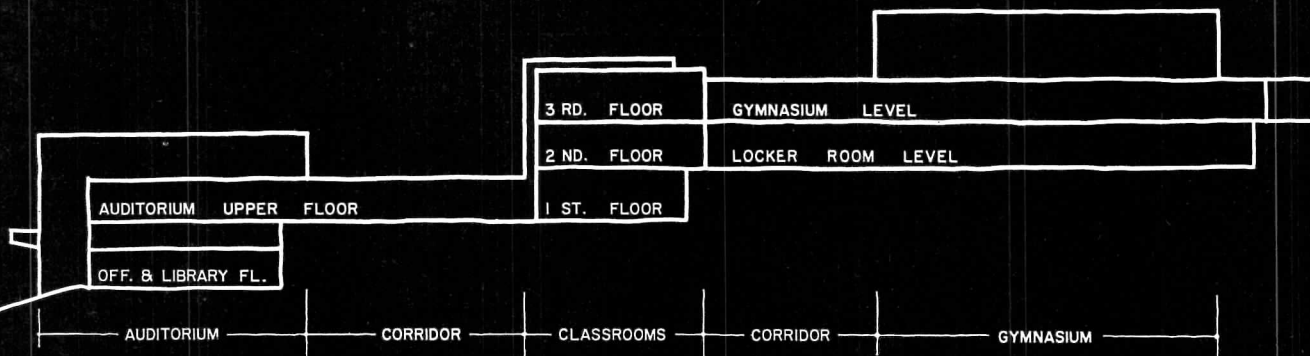

SECTION

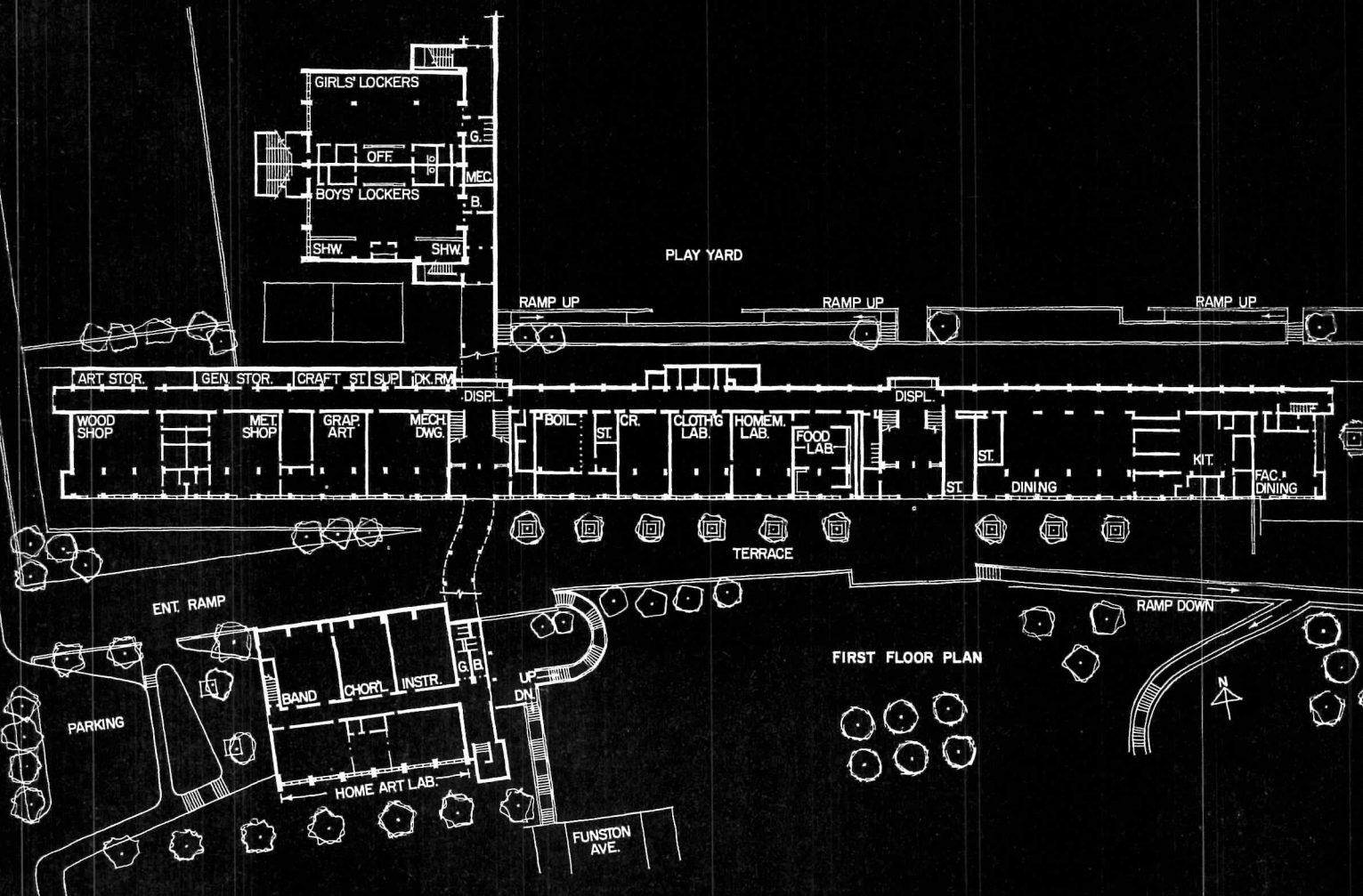

FIRST FLOOR PLAN



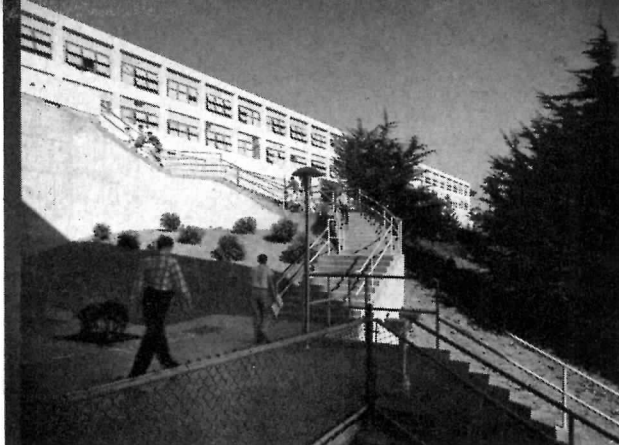

#### QUALITY: SAN FRANCISCO SCHOOL

*In terms of actual elevation the school has some five floors; however, no single structure has more than three. The main block paralleling the contours is in three roughly equal units linked by stairway elements for entrance, egress, vertical circulation, and to keep the scale of the whole within limits*

For this precipitous site Herbert Hoover Junior High had to be designed; the physical difficulties outweighed even the educational problems, exacting though these were after so long an interval between building programs; site problems loomed larger than the bothersome political situation which seems inevitable in an urban school building program. The number of design studies was prodigious. Even before they could be started it was necessary to probe deeply in order to arrive at certain fundamental architectural determinations. As noted, it was decided that the building should be placed on the slope to preserve what "flat" land was available for playfields. The decision to use multiple levels stepped up and down the hillside, so ascents and descents could be distributed rather than concentrated, required judicious organization of areas by types of activity as well as of circulation traffic patterns. Some solution had to be found to the problem of limited and vertically remote street frontage — nowhere was there enough street for a proper approach. The view — superb — must be preserved, the site protected against winds, areas useful for adult education made independently accessible.



Roger Surinchant Photos

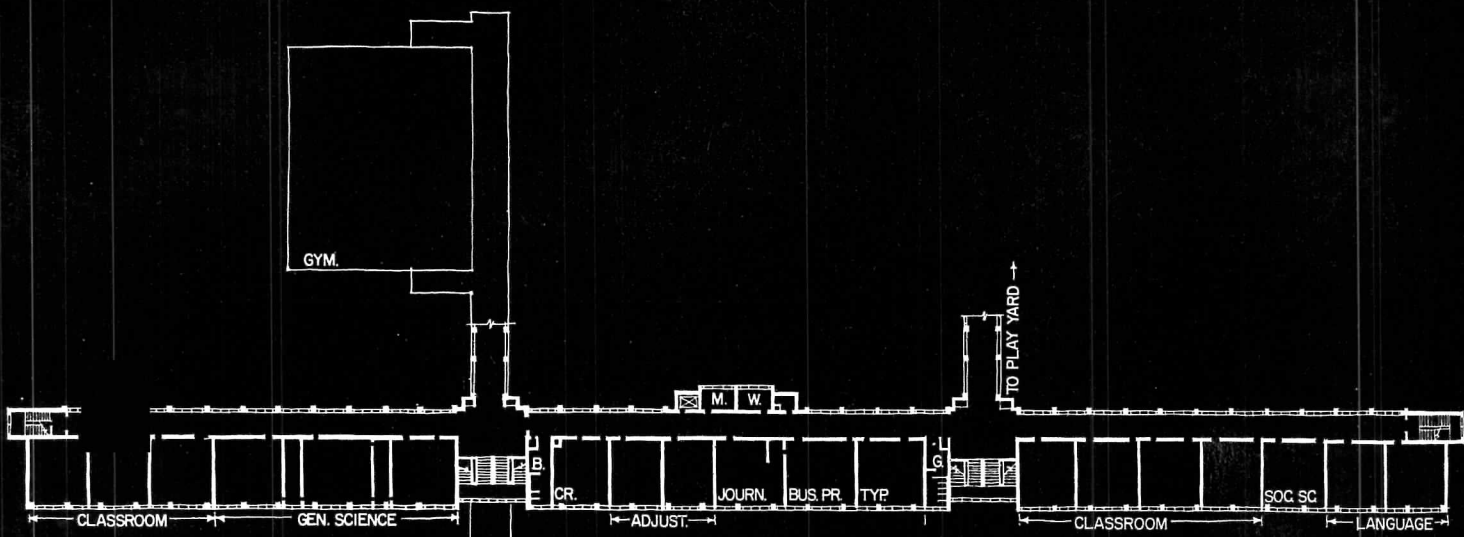

THIRD FLOOR PLAN

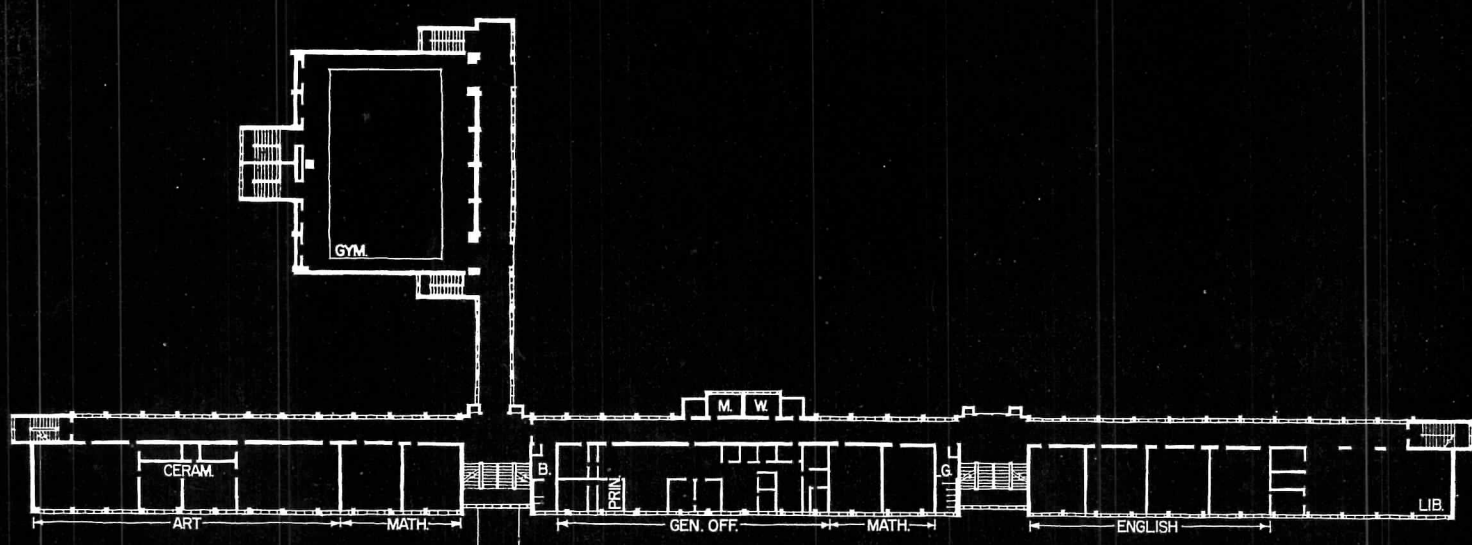

SECOND FLOOR PLAN

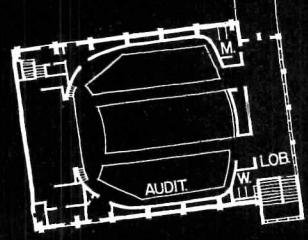



#### QUALITY: SAN FRANCISCO SCHOOL

The main, 3-story group of academic and laboratory facilities was notched into the hill below the relatively level area, its top floor level with the principal playground and the gymnasium floor. A single-loaded corridor scheme was used because it kept to a minimum the change in original grade across the building; because the ground floor could be completely below grade on the uphill side while upper floor corridors would be light and pleasant; because more of the potentially level land could thus be preserved for outdoor use; and because the classrooms could thus be protected against playground noise. The ground floor of the academic group was made wider to provide larger rooms for shops, home-making and cafeteria. Gymnasiums and dressing rooms occupy a separate two-story building located so it was possible to enlarge the level area at reasonable cost by using the buildings as retaining walls; athletic zones were further increased by cuts in the hill face and filling much of the old quarry. Auditorium, music and "homecraft" facilities, somewhat noisy and needing no access to playfields, were put in another separate building below the academic block.

*Placement of the buildings against the hillside made them windbreaks to protect athletic fields against the well known San Francisco wind; in addition, the buildings help hold fill in place and location of the auditorium unit yielded a dividend of a small, necessary off-street parking area. Total cost of the plant was \$3,052,504, or \$21.84 per sq. ft., including mechanical and electrical work and a substantial sum for site development*

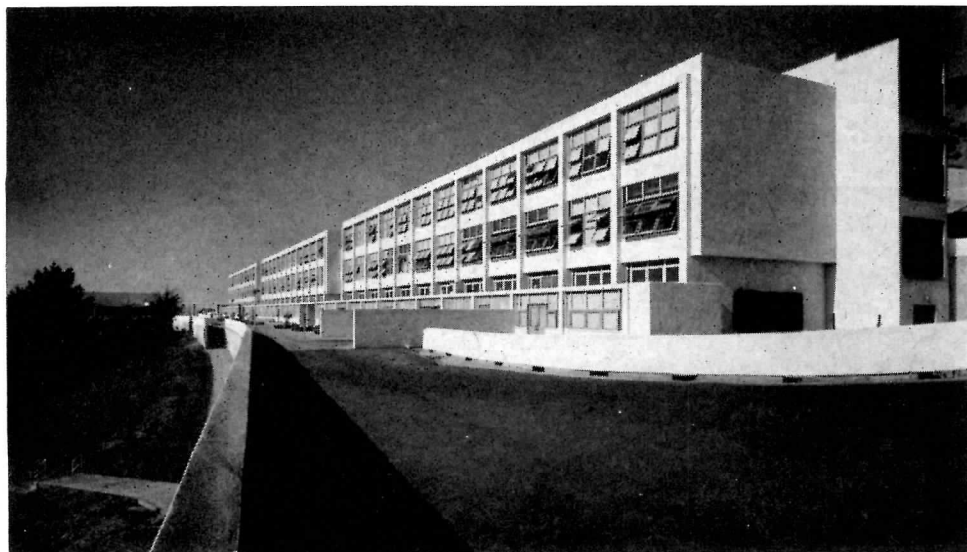

Roger Sturtevant Photos





Roger Sturlevant Photos

### QUALITY: SAN FRANCISCO SCHOOL

The upper-floor corridor, classroom and gymnasium of the Herbert Hoover Junior High, shown here, are perhaps not as "advanced" educationally as those some other school might boast; craftsmanship may not be the finest. This is a big urban school; it houses approximately 1100 pupils in 30 classrooms plus all its special facilities. To have built it on such a site, to have ensured its functioning and kept it reasonable in scale, and to have set it on its own terrace or plaza carved out of the slope, to have given it architectural organization and given every room a view — these are no small achievements.

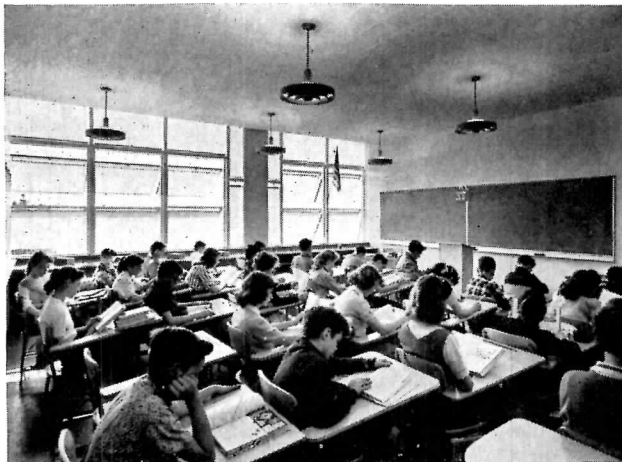

# SOUND SYSTEMS

## Article 2: A survey of typical applications

By J. F. McPARTLAND, Jr.

Engineering Editor, Electrical Construction and Maintenance

THE VARIOUS FUNCTIONS and operation of sound systems are straightforward, and were brought out in the first article; a fundamental understanding of what the components are and how they work must be had for intelligent planning. Perhaps just as important is a knowledge of the variety of ways in which sound systems can be employed.

The principal applications of sound systems break down into the following categories:

*Paging or Announcing:* locating individuals or transmitting spoken or recorded announcements over large areas.

*Intercommunication:* individual communicating facilities between two individuals at separated locations in the same or different buildings.

*Distribution:* extended transmission of voice or music over large areas.

*Reinforcement:* strengthening of sound from speaker, singer or other source in view of an audience.

*Instruction and Entertainment:* distribution of educational material or music to selected areas or to individuals.

*Signalling:* relaying instructions for emergency action or for indicating the beginning and end of work periods.

Some of these functions are frequently combined. Thus a paging system might also carry music programs, and be part of a signalling system as well. Right away this calls for microphones, an amplifier assembly and speakers; music requires recordings and playing apparatus and/or a radio receiver, or a leased wire music service; for signalling, a tone generator must be used.

Careful attention should be paid to the particular requirements of each installation. Sometimes it is the adequacy or lack of it in certain details that can make or break a job. It follows, then, that the architect and clients should have

a clear understanding of what the sound system is expected to do.

Take for example a school in which programs will be sent to selected classrooms, and in which the principal may want to talk to teachers in other classrooms, and the athletic instructor wants to give directions in calisthenics to a gym class — all of these at the same time. This will require not one amplifier, but three: a large one for general classroom and auditorium use, etc., a small one for intercom, and a small one for gym instruction (could be portable, if there were use for it elsewhere).

### General Benefits

Sound systems find wide and varied application in commercial, institutional and industrial buildings. Many of these are quite familiar, and therefore need be only touched upon. There are, however, some applications about which little is known, and, even less, appreciated.

Full and effective application of sound systems in industrial plants, for instance, is not as common as it might be although almost all of them use sound system equipment to some extent. A cogent point for sound in factories is the significant contribution to increased work output and quality of product because of the higher morale factor.

Schools and colleges represent another area where sound systems could be used still more extensively. Modern sound systems can greatly enlarge and vitalize instruction technique. Typical of the benefits which sound systems can offer to the students are a broader and deeper appreciation of music, a better understanding of the world in which they live, general increase in the scope of their interests, and quicker comprehension of their subjects.

Today sound systems are commonly

*Success of any sound system as it relates to a building depends on the designer having a knowledge of the performance of equipment in its various types and combinations, together with a careful analysis of what the client wants the system to do. Article 1 covered the basic components: microphones (and similar signal devices); amplifiers; and speakers. This article tells how they can make buildings function better and more efficiently*

being used in hospitals. Intercom and frequently paging are incorporated. More hospitals could take advantage of the capability of sound systems to contribute to recovery of patients: planned musical programs can be distributed to patients throughout a hospital to accomplish several beneficial results. Although no studies are known which establish the therapeutic value of music, it is recognized that music can add cheer to the hospital atmosphere and thereby serve to relax patients and release normal anxieties. It is believed that music improves the mental attitude of patients and can therefore contribute to speedy recuperation and recovery from many conditions of ill health.

From the foregoing, it is obvious that the real significance of sound systems in all types of buildings lies in the many benefits which they are able to provide.

### Industry

*Production.* The strongest argument that can be made for the use of sound equipment in industrial plants is the fact that studies show greater production can result from effective use of sound equipment. In a study made by Stevens Institute of Technology, it was found that proper programming of music distributed throughout a factory could increase productivity by amounts ranging from an average of 5 to 10 per cent. In some plants, production increases were noted to be as high as 30 per cent. This study also revealed that music distribution in one plant accounted for a reduction from 2.5% to .8% in the percentage of man hours lost due to early departures.

Other studies have brought in abundant evidence that music distribution is a very important stimulus to greater productivity. For instance, the Division



**DEPARTMENT STORES** interject "commercials" and announce sales through conveniently located speakers on each floor

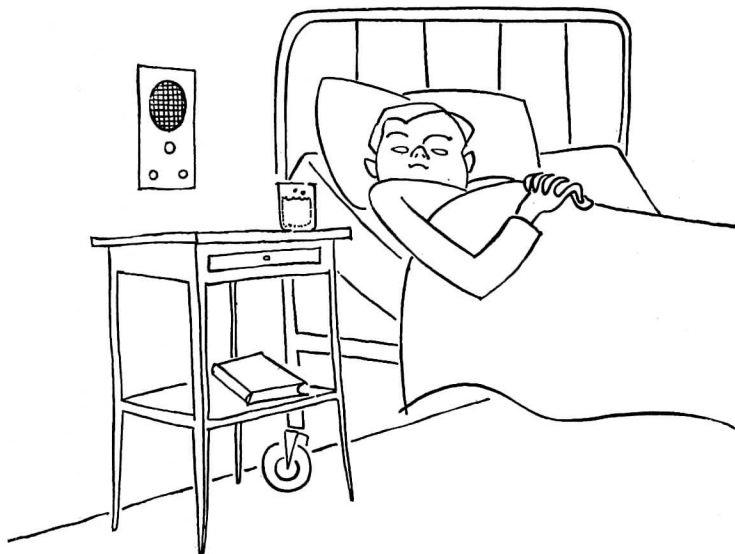

**HOSPITALS** can boost patients' morale by providing multi-channel loudspeaker outlets, allowing selection of radio programs

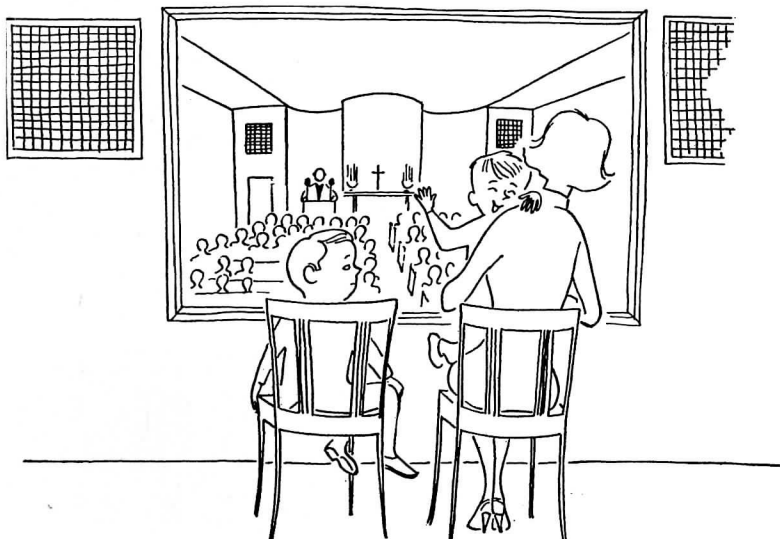

**CHURCHES** are being designed today with a soundproofed room, equipped with its own speakers, to isolate children's noise

of Labor Standards, the U. S. Department of Labor, reported in a study that of 100 plants surveyed in all sections of the country, most had experienced increased productivity due to the use of music distribution.

In other reports, the Medical Research Council of Great Britain found an 8 per cent increase in industrial productivity due to music distribution; a Canadian survey showed a 14 per cent increase; still another report rated 7.2 per cent increase for the day shift, and a 17 per cent increase for the night shift. In their conclusion all of the reports were unanimous: production can be increased; especially when a job is monotonous and repetitious.

*Coordination.* As a communication tool, a modern sound system is indispensable in sprawling industrial plants. By using the sound system, a switchboard operator or an executive can find any employee within seconds, regardless of his whereabouts in the plant. There are many other uses: production, warehousing and shipping activities can be closely coordinated; sales personnel can quickly and accurately determine the status of various orders without ever leaving their desks; development and research work can be more closely related; watchmen can maintain more effectively a security guard in a plant; emergency crews can be alerted instantly; appropriate instructions can be given for employee evacuation to avoid panic in time of disaster.

*Labor relations.* A very practical use to which a sound system can be put is in the area of labor management relations. A sound system makes possible many practices which contribute significantly to harmonious labor relations. Typical of these are: broadcasting congratulatory messages upon completion of a production schedule; announcing new sales records; extending personal greetings to individuals on special occasions.

Sound systems used in industrial plants are made up of various pieces of equipment and laid out as follows:

*Paging systems* are used throughout plants to call and locate individuals for answering telephones, attending meetings etc. A paging system consists of one or more microphones at one or more control centers. Typical control centers might be the receptionist's desk, telephone switchboard, the shipping office. The microphone or microphones would be connected into the amplifier system. It could be a shelf-mounted single chassis combination amplifier or amplifiers



mounted in a vertical cabinet rack. The amplifier equipment will generally be mounted close to the main control center. In offices, drafting rooms and engineering departments, the speakers will be cone type units in wall-mounted wood baffles.

*Music Systems* are used throughout the plant to distribute radio programs, recordings, announcements and entertainment derived from wired, central music systems. A music system uses the same amplifier equipment and same loud speakers as employed in the paging system. The input device will be a microphone in the case of announcements, a record or tape player in the case of recordings, a radio tuner for FM programs and a telephone line for wired music. In those areas of the plant where listening conditions permit fuller enjoyment of music programs, a speaker having better quality, wider, more faithful frequency response can be used.

There are certain features of sound system equipment which prove particularly effective in industrial applications. Typical of these is microphone precedence. This refers to the nature of the hookup such that all other inputs to the system are removed when a button is pressed on the microphone to make it operative. Another feature which can add much to an industrial system is a tone generator which produces signals to indicate start of work, lunch time, change of shift, etc. Still another feature is the use of talk-back switches on cone type loud speakers at various points in the plant. These switches enable the personnel to use the loud speakers as microphones to feed signals back into the system, providing two-way voice communication between the control center microphone location and the locations of the system speakers. Such a layout is used for dispatching, loading, and stockroom systems. It facilitates materials handling and shipping, permitting conversation between the shipping office and the loading platform or stockroom.

### Schools

Experiments and the experiences of many teachers have proved the unusual advantages of audio instructional equipment. While school faculty members may not be interested in the equipment itself, they invariably show keen interest in audio applications as an element of education technique.

There are many ways in which school curricula can be improved by the use of sound equipment. As an outlet for a wide range of talents, a sound system

can encourage effective speech and skill with musical instruments.

Courses in music appreciation, which have become very popular today, can be based on the use of carefully selected music programs in the form of records or prerecorded tapes and used on the system equipment. The music output of the system can be taken from loud speakers in selected classrooms, in the auditorium or in a music room.

Radio tuners and tape recorders can be used to bring to students talks by authorities on various subjects. The introduction of famous personalities into the classroom in this way provides a unique and popular instructional method, particularly valuable in small rural schools which have limited teaching staffs, and in which the students would not otherwise have an opportunity to hear the voices of famous people.

*Instruction.* Audio devices have proved of very practical value in developing in students a facility for understanding foreign languages. By use of recorded practice readings, a student can be aided in learning new vocabularies. He can tape his own practice for self correction. The same opportunity for self-criticism applies to a student who plays a musical instrument or one who is trying to overcome a speech difficulty.

The use of news program distribution to selected classrooms involves the system radio tuner, the power amplifier and the system loud speakers as supplied through area selector switches. Such broadcast news programs can be used to broaden the student's outlook and to help reduce educational isolation.

Documentary programs, for instance, can be easily tape-recorded and rebroadcast at scheduled times, using the switching flexibility of the system to select particular classrooms. Other job applications of the voice distribution facilities include broadcast appeal for voter support by candidates for school offices, distribution of forum type presentations dealing with various school problems. Basic equipment applications used for school sound systems are as follows:

Sound and radio distribution systems as used in modern schools usually consist of a control desk, microphones, loud speakers, amplifier equipment and a range of other input devices as described previously. The heart of the system is the control center which may be located in the principal's office or in a sound room. The control desk generally contains individual switches for each outlying speaker in classrooms, auditoriums, gymnasiums, athletic fields, etc. Other

equipment in the center will include a monitor speaker, microphones, record turntable, radio receiver and other control devices. Microphones are located at the control desk, principal's office and stage with outlets at other points as selected.

In larger schools, sound system equipment will be mounted in a console type cabinet which often is placed in a sound conditioned studio. As part of its equipment this studio probably will have microphones on desk stands and floor stands, recording and playback mechanisms, an FM radio tuner, a signal tone generator and associated amplifier equipment. Typical systems have several input connections to allow mixing of two or more input signals (for example people stationed at several microphones in a round table discussion or sound reinforcement of both voice and orchestra). In such cases, the two or more mixed signals are fed through the amplifier to the system loud speakers. If, however, two input signals are each to be delivered to different locations, a separate power amplifier channel must be provided for each signal. In most cases, though, a single power amplifier channel is used, permitting only one signal distribution at one time. If the main sound system voice-music distribution system or voice reinforcement system will definitely be used at times when communication with classrooms must be maintained, a small low-powered amplifier can be incorporated to handle the intercom function in conjunction with standard area selection switches on the console.

When microphones are to be used remote from the preamplifier input to which they are connected, only low impedance microphones should be used, connected by low impedance microphone cable to the amplifier inputs. In those areas where microphones are likely to be used, a realistic number and placing of low impedance microphone outlets should be provided on the walls.

Loud speakers should be located in classroom, gymnasiums, corridors, cafeterias and offices.

If desired, talk-back provision may be included in the system to permit conversation between the monitor speaker at the control desk and the loud speakers in any classroom. Special sound systems for use in schools are modifications on the basic voice distribution system. A lecture call system, for instance, is a talk-back voice distribution system between the stage in the auditorium and the projection booth.

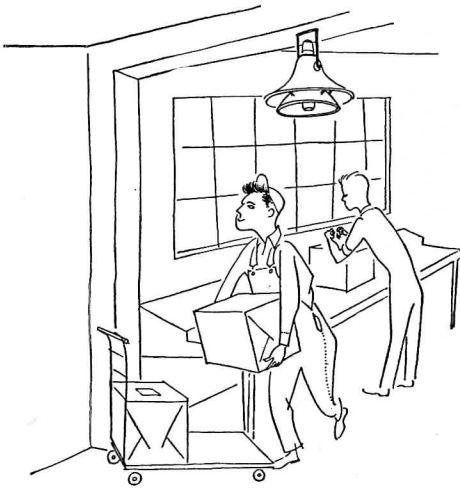

**FACTORIES** are reported to have higher production, fewer rejects when music is supplied as part of workers' environment



**PRINCIPAL'S OFFICE** frequently is the control center for the school sound system, having switches for various areas



**CLASSROOM** speakers may have a talk-back feature, working through the monitor speaker on the panel at the control center

One of the most unusual applications of sound in schools is that of high powered amplifiers in conjunction with special transducers (the transducer in this case is a special type of headset which delivers the energy to the ear region) to enable deaf children to hear sounds for the first time. The basic idea behind this system is that a sufficient amount of power if delivered to a transducer and having the characteristic variations of sound waves, can produce the sensation of sound by mechanical vibration through the head structure.

### Churches

The usage of sound in churches is limited to sound reinforcement; for this reason the basic layout of equipment in church follows a fixed pattern. The microphone is located in the pulpit, the amplifier equipment is located in the sacristy or a room off the sanctuary. The loud speakers, usually two of them, are mounted on either side of the front of the sanctuary high above the congregation.

A special sound system application which has come into wide use recently is that of the "cry room." This is a soundproof, sound conditioned room with seating provisions for parents with babies or children who might create a disturbance by their crying or talk.

This room usually has a large glass wall through which the occupants can view the service in progress, and includes a loud speaker which brings the audio portion of the service into the cry room.

In addition to its usual function of carrying the voice of the clergyman to the congregation, a voice reinforcement system can also serve to bring the audio part of the service to overflow audiences in some school classrooms, auditoriums and even on rare occasions, to the outdoors.

Still another unusual sound system application which has come to be considered essential is that of hand held hearing aids (ear phones) in certain pews in the church. These will be operated by the basic amplifier.

Recently it has been possible to synthesize electronically the sound of bells. In such a system, a small bell-synthesizing unit is located at the amplifier and connected to an input. The device injects a signal into the amplifier which corresponds to the sound of a bell. From the amplifier the signal is fed to the system loud speakers mounted in the steeple or bell tower of the church. Using this system, the loud speakers can produce a sound equivalent to that of a multi-

ton bell. The belfry loud speakers also can be used in reproducing carillons.

### Hospitals

The need for paging — nurse and doctor call systems — in hospitals has been understood and satisfactorily met for a long time.

The use of multi-channel sound systems to bring a choice of musical or instructional programs directly to bed-ridden patients can be an important therapeutic aid in hospitals. Effective use of a multi-channel sound distribution system can reduce boredom and create a generally healthier mental attitude on the part of patients. Regularly scheduled programs can be distributed covering religious services, sports news broadcasts and planned series of occupational and avocational talks.

The loud speaker or head phone used at the bedside location is usually connected to the system by a suitable plugging jack arrangement on a wall plate.

By the use of a microphone in the operating room, a surgeon can provide a running commentary on the procedure in an operation for the benefit of observing medical students who may be following the course of work either in the operating room itself or over a closed circuit television hookup.

Intercom systems find singularly effective application in hospitals. They can be used to effect better integration of hospital administration and operation, providing communication between emergency entrance and office, between office and nurses quarters, between ambulance, garage and office, and between each patient and his ward nurse.

Typical equipment applications for hospital sound system installations include the following: The basic paging system consists of loud speakers throughout the hospital connected to its own amplifier, and supplied by one or more microphones. Sound and radio systems in hospitals will find constantly wider application.

### Stores

Sound systems can be used to great advantage in all types of stores. Of course, department stores can use a paging-announce system for various sales and operating purposes, and for music distribution. Such a system can be made up of microphone, a wired music line, an amplifier unit and a low-level loud-speaker system. The size of amplifier and number of loudspeakers will vary with size of stores. Small shops can use a music system for atmosphere.

# NIGHT VENTILATION CUTS COOLING COSTS

**Comprehensive running record of temperatures and humidities in a new Louisiana college classroom building proves that operating fans only at night without refrigeration reduces air conditioning load**

FOR SEVERAL REASONS, cooling is becoming a much more critical factor in the design of school mechanical systems. Cooling by mechanical ventilation is considered essential in the north even in midwinter. This is due partly to the larger glass areas in common use, and partly to the higher intensity lighting loads, all added on top of the heat given off by room occupants.

During the winter, the daytime heat load can be absorbed in northern areas by pulling in varying quantities of outside air up to 100 per cent of the air handling capacity of the supply fans.

In warmer climates, chilled water cooling must be added to ventilation, if comfort is to be maintained in the late spring and early fall months. If it is a college building that is to be cooled, such as the one described here, located in the South, then cooling by refrigeration is the only solution to comfortable year-round operation.

For any air conditioned school building, the cooling capacity in terms of tons of refrigeration and air volumes must be sized to take care of the worst condition anticipated. But in the matter of operating costs, extensive tests recently conducted demonstrate potential savings through the use of "night purging." This simply means running the fans at night continuously to bring in 100 per cent outside air, while the refrigeration is shut off, to cool down the structure. This relieves the mechanical cooling system of a heating load left over from the previous day that has to be taken care of before comfort conditions can be re-established.

A comprehensive series of tests were run at Southeastern Louisiana College, Hammond, Louisiana (about 50 miles from New Orleans) to compare the resulting temperature and humidity conditions of "night purging" operation versus shut-down operation at night and their effects on the next day's operation.

While the potential cost savings in dollars and cents are not known, suffice to say that the cost of operating fans in unit ventilator equipment is only about 1/30 of that for driving the compressors, and running circulating pumps. The test results are convincing in the extent to which a building can be cooled when the fans are run 'round the clock, even in extreme climatic conditions as experienced in southern Louisiana. (It should be noted that cooling effects are likely to

M. Wayne Stoffle, Architect; Joseph E. Leininger and Associates, Consulting Engineers

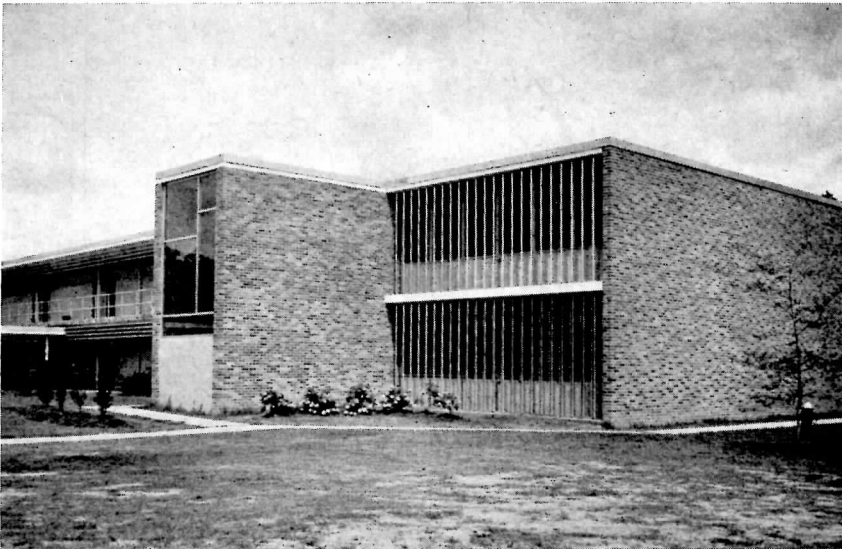

*The room with the most severe test conditions was the top, end classroom shown above. To keep sun off this south façade, the architect used vertical exterior blinds for the end rooms and shaded, open access balconies for the other classrooms (one of these was tested also). Lower photo shows relationship of the unit ventilator to the interior*

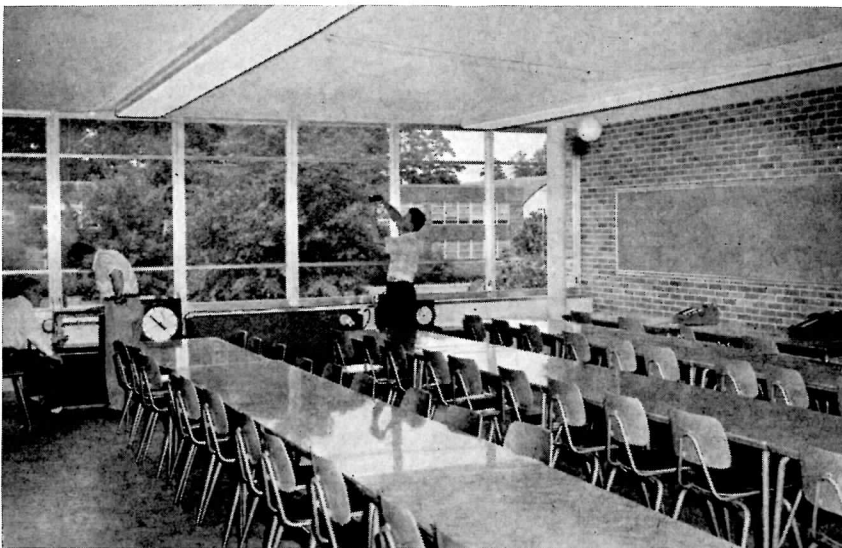



The test program described in this article was conducted by the Herman Nelson Division of American Air Filter Co., Inc., under the direction of their consultant, Henry Wright of New York City. Collaborating in the tests was the Johnson Service Co.

In the left-hand photo, a researcher is hanging the globe thermometer from the ceiling. Center photo shows outside humidity recorder. At right an engineer checks inside humidity. Other device measures control air pressure.



be more pronounced in structures having some mass as compared with light-weight buildings; so in connection with this phenomenon, weight is an advantage.)

Design and choice of construction for an air conditioned school building to minimize the effects of solar radiation are extremely important. This can be accomplished by means of proper orientation; general arrangement to take advantage of natural breezes; construction either to resist solar heat, or to allow removal of absorbed heat through ventilation of roofs and walls; and utilization of solar control devices.

The Southeastern Louisiana College classroom building was selected for test

purposes on the basis of (a) having chilled water cooling, (b) being in use in summertime and (c) being in one of the toughest spots in the country from a cooling standpoint.

#### Building Design

The classroom building was unusual in several other respects. Its orientation, east and west, was excellent from the standpoint of excluding direct solar gain. The summer sun path is almost directly overhead at this latitude so that the sun impinges mainly on the east and west walls and the roof.

The room picked for the most severe conditions was an oversize end room on the second floor having an exposed brick

cavity wall on the east side and glass across both ends. The roof was a 9-in. concrete slab with 1-in. insulation and built-up roofing on top, and acoustical plaster applied directly to the underside of the slab. The south side had exterior vertical blinds; heat-absorbing glass in the fixed portions of the north windows reduced diffuse solar heating and glare on that side of the building.

Since the design successfully excluded most direct solar heat, indirect solar heat, soaking through the structure, accounted for the greater part of the air conditioning load.

The other room tested was a standard classroom adjacent to the larger classroom, which thus had two interior walls

The charts at the bottom of the page show graphically the effects of "night purging" (running fans continuously for 7 hours at night with 100 per cent outside air) versus complete shutdown of the unit ventilators

from a little past 4 P.M. to about 5 A.M. the next morning.

#### PURGING (LEFT-HAND CHARTS)

On the night shown, the outdoor temperature went down to a low of about 73 F.

Seven hours of fan operation brought the room surface temperatures down to the outdoor temperature, thus relieving the refrigeration system of this load the following morning. The globe resultant tempera-

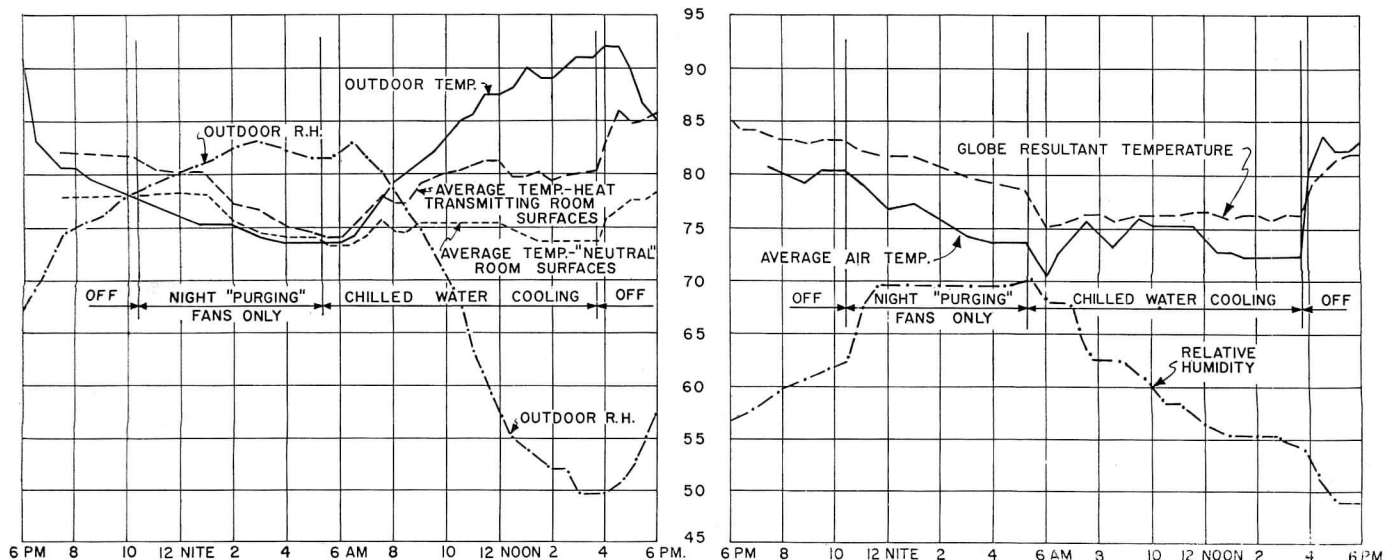

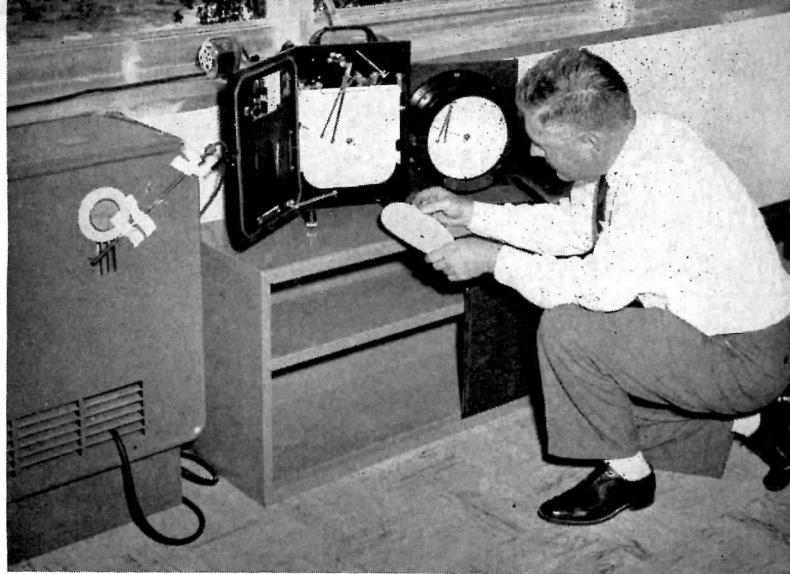

All photos courtesy Herman Nelson

and two glass end walls, the south one being shaded by an open access balcony fitted with aluminum louvers.

The test rooms were cooled by unit ventilators located in the middle of the north walls of each room. The unit ventilator in this case has a heating-cooling element with more tubes and fins than for heating alone, is thermostatically controlled to bring in varying amounts of outside air and requires: (a) insulated supply and return piping and (b) a third line for condensate.

Air conditioning engineers may be a bit surprised to learn that a satisfactory cooling job can be accomplished with a single inlet at one end of so large a room (24 by 37 ft). The reason for this

lies in the way in which air is distributed from the unit ventilator, the design of the unit taking into account that the cooling problem is more difficult than heating.

The high-velocity air stream from the unit ventilator is directed at the ceiling, from where it skims out in all directions, producing a fast-moving, radiating layer, a fraction of an inch thick at the center, and becoming gradually thicker and slower moving as it travels toward the walls. The bottom of this layer entrains room air, causing a mixing action. After the ceiling air hits the walls it turns down, hits the floor and turns out toward the center of the room, being gradually drawn up by the

entraining process already described.

At Southeastern Louisiana College, two continuous lighting fixtures attached to the ceiling and normal to the unit ventilator, confined the discharge of the unit to a sort of alley about half the width of the room, extending from end to end. The researchers felt that this may have been an advantage in the larger room, delivering more air to the south end where there were heat-producing windows. It also accounted for considerable variation in ceiling temperatures, and revealed what the temperature of the ceiling might have been all over if it had not been cooled by the unit ventilator discharge throughout most of its area. For example at 12 noon on August

ture curve shows the necessity for a low air temperature to keep the resultant temperature at the comfort level. There was slight cloudiness during the afternoon, keeping this from being a "maximum day."

NO PURGING (RIGHT-HAND CHARTS)

Despite a minimum outdoor temperature of 70 F, there was very little cooling of the structure. The room was not cooled so satisfactorily the following day, even

though the daytime temperature did not go as high as for the period recorded in the left-hand charts. The latent load due to the outdoor relative humidity was higher, however.

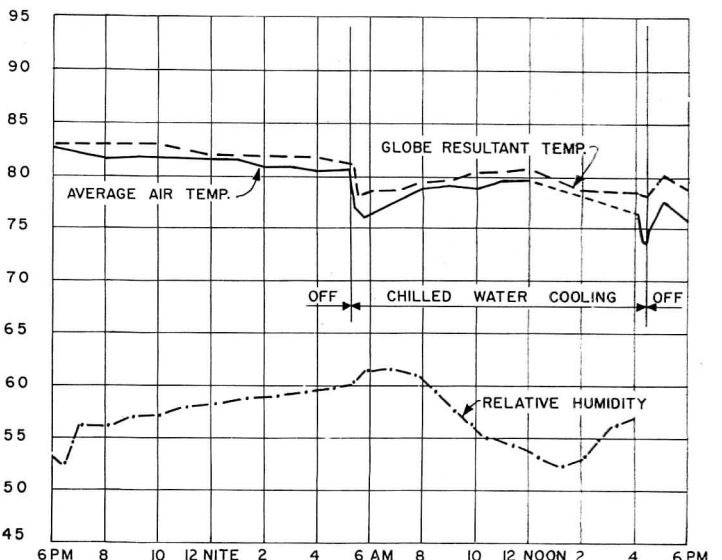
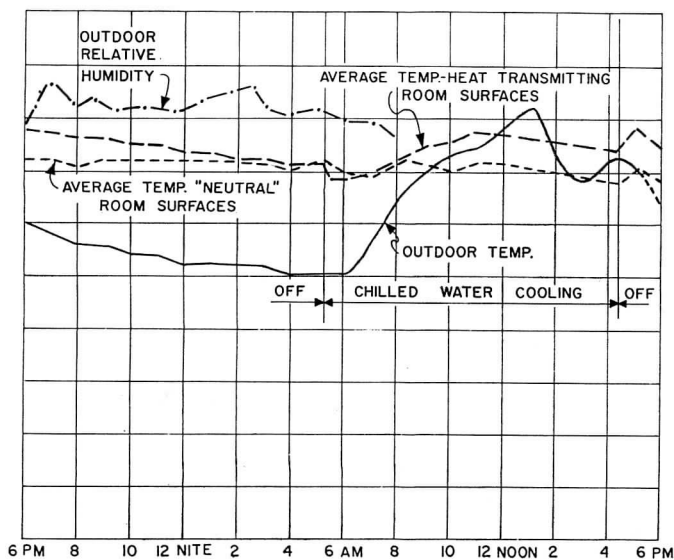

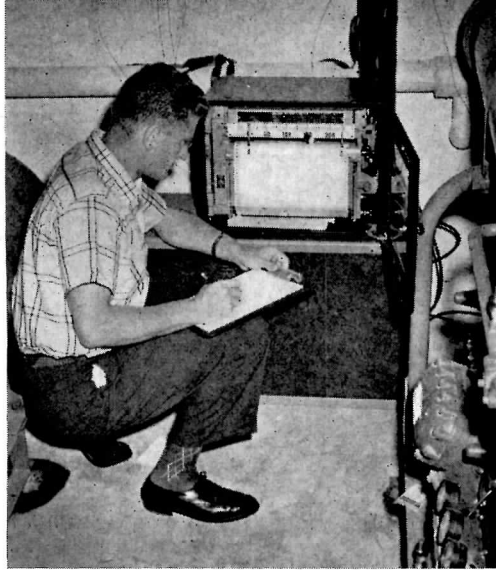
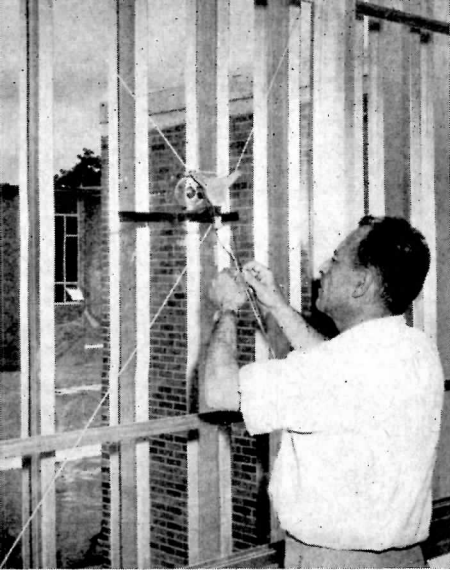

*At left, the pyroheliometer is being installed inside a south window to measure solar radiation. At right, a recording potentiometer charts the supply and return chilled water temperatures*

6th last year the ceiling at the east side of the room reached 84 F, whereas the center of the ceiling where the air was channeled was 74 F. The east wall was about 80 F at the same time.

The temperature of portions of the ceiling in the test room sometimes reached as high as 90 F, and the temperature of the east brick wall almost as high. The average temperature of the "heat transmitting" surfaces (exterior walls and roof) rose to 82 F during the time the room was being cooled, and would increase sharply to above 85 F after the cooling was shut off in the afternoon.

During the period that tests were being run, temperature of the 10-in. brick cavity wall would be about 80 F at 6 A.M. and rise about 1 degree per hour, reaching a maximum at noon to 1 P.M.

Glass surface temperature ranged typically between 75 and 80 F at night and 80 to 90 F during the day. On July 30, for example, the glass temperature rose from 75 F at 6 A.M. gradually to 85-90 F at noon, then dropping abruptly to 75 F by 3 P.M.

The ceiling above the unit ventilator was usually from 3 to 6 degrees cooler than halfway across the room and 6 to 9 degrees cooler than the ceiling at the far end. The ceiling outside the channel formed by the rows of lights was consistently warmer than any of the other ceiling points, in the order of 2 to 5 degrees higher than the ceiling at the end of the room away from the unit ventilator.

The method of using unit ventilators to direct a stream of cool air against the ceiling achieved satisfactory air distribution and uniformity throughout the room. The result was less than 2 F

temperature variation at the five-foot level throughout the room, as measured by sensitive thermocouples.

#### What the Tests Proved

1. The research group points out that both test recordings and occupant's reactions showed that the unit ventilators gave a comfortable environment under difficult conditions (large classroom, continuous windows at both ends and a solid roof slab). As mentioned before the maximum temperature difference at the 5-ft level was only about 2 F. Stratification was a maximum of 6 F from floor to ceiling. Indoor relative humidity was kept within proper limits during the occupancy period, despite the humid climate and high latent loading.

Before the tests were run there was some concern that the temperature advantage of "night purging" might be lost by an unfavorable build-up of humidity. The test results showed this not to be true. The relative humidity following night purging generally ended up at about 65 per cent, while without "night purging," it was about 60 per cent at the start of the refrigeration cycle.

2. Economical "night purging" of accumulated heat was feasible even in a continuously hot, humid climate.

3. The unit controls operated in such fashion as to maintain a satisfactory resultant temperature as measured by a globe thermometer (average of mean radiant temperature and air temperature), demonstrating that the unit thermostat responded to the radiant as well as air temperatures. The indicated mean radiant temperature of the room was sometimes 80 F or above, necessitating air temperatures as low as 72 F to maintain the resultant globe

temperature around 76 F for comfort.

4. The resultant temperature had a greater variation (about 3 F) between the north and south sides of the test room than the air temperature, showing that it would have been desirable to exclude a larger amount of solar heat.

Continuous records were made of the air temperature at five or six points in the room, generally at a 5 ft level, but also close to the floor and ceiling. The ceiling temperature was recorded at four different points. Other recordings included: (a) temperature of the inside of the heat absorbing glass, the clear glass, the discharge temperature of the unit ventilator, the return air temperature, temperature of supply and return chilled water, etc. Indoor and outdoor relative humidity was also recorded.

The data from which the charts were plotted, and conclusions drawn was exceptionally complete. The heart of the instrumentation was a pair of 16 point automatic potentiometers, each of which made 16 readings every four minutes or 5760 readings per day.

A basic instrument designed by the researchers was a globe thermometer, long used in laboratory comfort studies, but rarely used in field research. The globes are very lightweight, spun aluminum, containing fine wire thermocouples which register the non-directional "resultant temperature" at or near the center of the room — that is, the combined effect of air and surface temperatures, or, in other words, the combined influence of the "radiant" and "ambient" temperatures.

The Eppley "Pyroheliometer" which is used by the Weather Bureau to record solar radiation was one of the instruments employed in this series of tests.





## A ROOF—BUT NO WALLS: OLYMPIC STADIUM

BYPASSING CONVENTIONAL CONSTRUCTION in favor of a structural system that has been called "the nearest practical approach to a sky hook," the designers of the swimming stadium used for the 1956 Olympic games in Melbourne stripped the structure down to only two vigorously expressed components, and reversed the normal downward thrusts of the roof and seating to make these basic elements self-supporting. The visual effect is that of a conventional structure with the walls knocked away. Tiered seating juts outward under the protective roof, hovering over low concrete structures at ground

level without any apparent support.

The design, which was the winning entry in an Australia-wide competition, was authored by four young architects and an engineer, all of whom graduated from the University of Melbourne in 1949. They are John Murphy, his wife Phyllis, Peter McIntyre, Kevin Borland and William Irwin, who collaborated with the structural engineering.

Despite the unusual appearance of the structure, the designers are quick to point out that the final form was not determined by a desire for "ultra-modern style," but grew naturally from their efforts to meet the contest's rigid

requirements of economy and utility. Their report explains that the fundamental structural problem was to support and provide a roof over seating carried on sloping girders at 18 ft centers. The obvious solution — supporting the girders by a vertical reaction from below — was rejected because of the disadvantage of carrying a large compressive force in a long column. Also, if an arch roof were used, horizontal thrusts would be applied high above the ground, resulting in large overturning moments in the footings. The alternate solution arrived at was to support the girders by a horizontal tensile force at the top.



*"Prestressed" trusses and tension rods deliver their loads to the girders through three-way pin connections 51 ft above ground.*

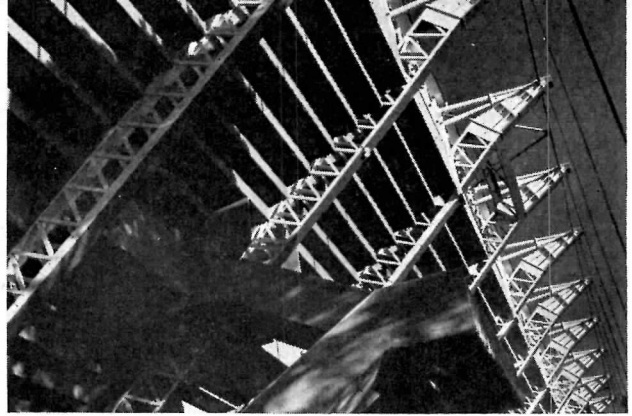

The tie used was a truss with a large proportion of the girder reaction thrown into the top chord to offset the compression under normal roof loads and lower the economical span/depth ratio of the truss. The fourteen welded tubular steel trusses used in the stadium span 240 ft, narrowing from a center depth of 20 ft to slim triangular box sections at the ends. These box sections fit into the upper ends of the girders, where 4 in. diameter pins receive the reactions from the trusses and the vertical tension rods that stabilize the structure against unsymmetrical wind and live loads. To maintain equal tensile forces in both chords of the trusses and prevent their sagging when they are not supporting the live load of spectators on the seating, the rods are given an initial tensile stress

which also overcomes the compressive forces that might be induced in the slender ties by live load on the seating, wind and internal suction, or temperature effects. Because of this "prestressing" and the high strength-weight ratio of the tubing, the trusses were fabricated with barely half the steel that would have been required for normal steel trusses of the same span without prestressing.

The tension rods, 2 by 2 in. mild steel sections with heavy springs at the base of each are anchored by four rods bolted to a plate set in the continuous footing. The girders, spanning 76 ft from pin to pin, are fabricated from 15 by 4 in. channels spaced 3 ft-6 in. apart and diagonally laced to resist shearing forces. In the center they are reinforced with

plates welded to the inside of the webs, while side plates and cross stiffeners at the lower ends provide the heavy reinforcement needed to transfer the loads to 5 in. diameter pins at ground level. Footings for the girders are triangular frames in reinforced concrete, braced horizontally by tie beams extending to the ancillary structures beneath the stadium.

The ground level structures house dressing rooms and club rooms under the main concourse leading to the seating. With the concrete seats and risers, their outside walls form the side walls of the stadium. The end walls are glass enclosed. Planned to seat 5500 spectators, the stadium contains two pools — one for swimming and water polo events, and the other for diving.

*(More Roundup on page 272)*



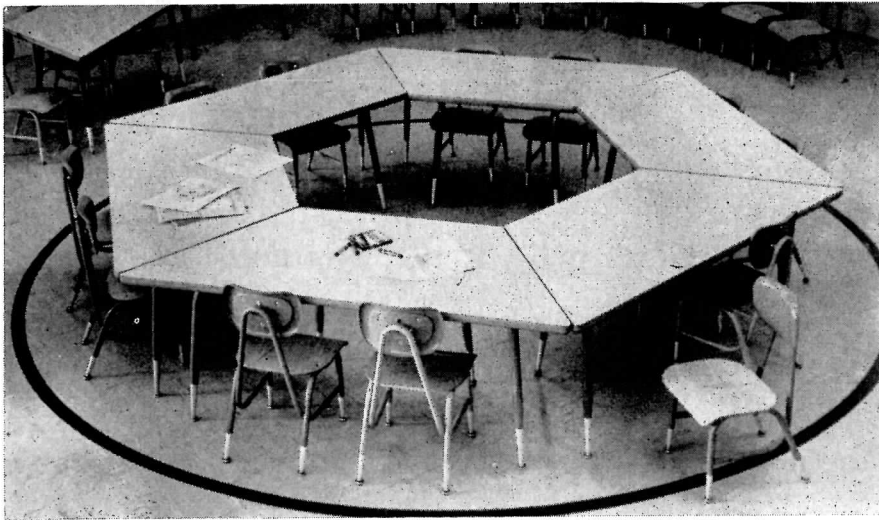

**CLASSROOM FURNITURE FOR KINDERGARTEN — OR COLLEGE**

THE GROWING TREND toward flexibility in classroom planning is reflected in the current offerings of school equipment manufacturers, with emphasis placed on adaptable, mobile furnishings which lend themselves to arrangement according to individual age and study needs.

A case in point is the *Samsonite* line of classroom furniture which includes tables, desks and chairs in a variety of sizes, shapes and colors for students from kindergarten through college.

Recommended for the younger set are informal groupings of tables and chairs in several sizes and shapes. The trapezoidal tables shown above may be used separately or placed in a circle for group storytelling, painting or craft sessions. For smaller groupings, round tables seat as many as four children, and individual children may have their own square tables or lift-lid desks.

Similar "activity tables" containing from one to six book boxes have also

been found useful for grammar school and high school students, particularly in libraries and study halls. Individual desks available for older students include a tablet desk chair with 290 sq. in. of writing surface, and a "noiseless, slam-proof, tamper-proof" lift-lid desk.

Matching contour chairs may be used with tables in the classroom, or alone in lunchrooms, music rooms, administrative offices, club rooms, etc. Rubber-cushioned glides permit them to be easily moved, and chair construction allows stacking four high to make room for group activities requiring a maximum of space.

Both desks and chairs come with strong tubular steel supports in a choice of woods and plastics. The available colors — grey, brown, turquoise, and terra cotta — may be combined for special color effects. *Shwayder Brothers, Inc., Samsonite Div., 1050 S. Broadway, Denver 9, Colorado.*



**ROLLING CART PUTS SCHOOL LIBRARY ON WHEELS**

THE TWO-TIERED BOOK CABINET shown at left is featured in a series of mobile storage units which the manufacturer hopes will "completely outmode fixed cabinetry in the schoolroom." This and the other cabinets in the series may be assembled in scores of door, shelf-divider and mounting combinations to meet variations in storage requirements. Its shelf dimensions are designed to accommodate the wide variety in shapes and sizes of books published, and the smooth

rounded edges on the shelves prevent damage to the volumes. The mobile book truck not only furnishes the teacher with storage space for classroom texts, but also provides her with a convenient means of distributing and collecting the books. Particularly helpful for library use are the interchangeable dividers which make it possible to categorize books as desired. *Brunswick-Balke-Clender Co., School Equipment Div., 623 S. Wabash Ave., Chicago 5, Ill.*

**MULTI-PURPOSE CABINETS PROVIDE EXTRA STORAGE SPACE**

ORIGINALLY DESIGNED as companion equipment for *Amervent* and *HerNel-Cool* heating, ventilating and cooling units, these versatile storage cabinets have found their way from the classroom into school shops, offices, libraries, work rooms and even boiler rooms. Available in 24, 36, and 48 in. lengths, they may be installed singly or nested

to provide extra storage space for textbooks and reserve supplies of the many odd-sized, odd-shaped items used in the modern school. The cabinets are easily moved and may be used either for wall storage or as work area separators. *Herman Nelson Unit Ventilator Products, American Air Filter Co., Inc., 215 Central Ave., Louisville, Ky.*

(More Products on page 284)





**BUILDING PRODUCTS LITERATURE COMPETITION**

Results of the Ninth Annual Building Products Literature Competition, co-sponsored by the AIA and Producers' Council, have been announced. In addition to the five Certificates of Exceptional Merit, forty-five Certificates of Merit and Honorable Mentions will be awarded at the forthcoming AIA convention in Washington, D. C. The competition, which annually recognizes product literature of outstanding value to architects, was judged by architects John R. Magney, Minneapolis, chairman; Grosvenor Chapman, Washington, D. C.; Howard G. Hall, Baltimore; Norman J. Schlossman, Chicago; and William B. Simvoli, Pittsburgh.

**CLASS 1**

*Literature concerned primarily with basic technical information*

**CERTIFICATE OF EXCEPTIONAL MERIT**

ALUMINUM IN MODERN ARCHITECTURE (2 Vols.) Reynolds Metals Company

**CERTIFICATE OF MERIT**

ALLOYS AND MILL PRODUCTS, Aluminum Company of America; REINFORCED CONCRETE FLOOR SYSTEMS, Portland Cement Association; METAL LATH, Metal Lath Manufacturers Association; WOOD STRUCTURAL DESIGN BOOK, National Lumber Manufacturers Association; FIR PLYWOOD, Douglas Fir Plywood Association; WOODWORK BROCHURE PORTFOLIO (A Series), Architectural Woodwork Institute, James Arkin, AIA, Editorial Consultant

**HONORABLE MENTION**

SOUND ABSORPTION COEFFICIENTS OF ARCHITECTURAL ACOUSTICAL MATERIALS, Acoustical Materials Association; TECHNICAL NOTES ON BRICK & TILE (A Series), Structural Clay Products Institute; TIMBER DESIGN & CONSTRUCTION HANDBOOK, Timber Engineering Company

**CLASS 2**

*Literature offering technical information confined to particular products of a single manufacturer.*

**CERTIFICATE OF EXCEPTIONAL MERIT**

GRANT SLIDING HARDWARE — CATALOGUE 1956, Grant Pulley & Hardware Corporation; BUILT-UP ROOF SPECIFICATIONS, United States Gypsum Company

**CERTIFICATE OF MERIT**

NOISE CONTROL PRODUCTS, Owens-Corning Fiberglas Corporation; TRUSCON CURTAIN WALLS, Truscon Steel; Division of Republic Steel; PITTSBURGH DOORWAYS, Pitts-

burgh Plate Glass Company, Batten, Barton, Durstine & Osborn, Inc. — Advertising Agency; FACTS & DATA ON RESILIENT FLOORS, Congoleum-Nairn, Inc.; INDUSTRIAL INSULATION MANUAL, Owens-Corning Fiberglas Corporation; BRICK SIZE VENTS IN CAST ALUMINUM, Construction Specialties, Inc., Thomas F. Clark Advertising Agency; FLOUR CITY METAL WINDOWS, Flour City Ornamental Iron Company, Ray C. Jenkins Advertising Agency, Inc.; CECO SHORTSPAN OPEN-WEB STEEL JOISTS, Ceco Steel Products Corporation

**HONORABLE MENTION**

KAWNEER ARCHITECTURAL METAL PRODUCTS, Kawneer Company; FENESTRA WALL PANELS, Fenestra, Inc.; TECHNICAL DATA — ARMSTRONG FLOORS, Armstrong Cork Company; SARGENT OF NEW HAVEN, Sargent & Company, DESIGN AND APPLICATION DATA, The Celotex Corporation, WESTINGHOUSE MICARTA, U. S. Plywood Corporation, Fuller & Smith — Advertising Agency; MILLS HOSPITAL CUBICLES AND UNIT SHOWERS, Mills Metal Compartment Co.; Division of The Mills Company, Meermans Advertising Agency; CRANE PLUMBING & HEATING FOR ARCHITECTS, Crane Company; INTERCEPTION OF WASTE MATERIALS, Josam Manufacturing Company, Allied Advertising Agency, Inc.; USG PRECAST GYPSUM ROOF DECKS, United States Gypsum Company; MILCOR RIBFORM, Inland Steel Products Company; TECTUM, Tectum Division; Peoples Research and Manufacturing Company, The Jay H. Maish Co. — Advertising Agency

**CLASS 3**

*Literature of primarily promotional character.*

**CERTIFICATE OF EXCEPTIONAL MERIT**

FIR PLYWOOD DESIGN IDEAS, Douglas Fir Plywood Association

**CERTIFICATE OF MERIT**

ACME BRICK IN COLORS, Acme Brick Company, Evand and Associates — Advertising Agency; BEAUTIFUL WALLS WITH CONCRETE MASONRY, Portland Cement Association; TONE (A Series), Armstrong Cork Company; CECO METAL PRODUCTS (A Series) Ceco Steel Products Corporation; FOR MODERN EXTERIORS, Masonite Corporation; PALOS VERDES STONE, Great Lakes Carbon Corporation

**HONORABLE MENTION**

KILNOISE ACOUSTIC PLASTER, Tiger Products Division; Basic Inc.; ARCHITECTURAL ACHIEVEMENTS (A Series), Alcoa; BRICK & TILE, Structural Clay Products Institute; FENTILE, Fenestra, Inc.

**CLASS 4**

*Space Advertising directed primarily to the Architect.*

**CERTIFICATE OF EXCEPTIONAL MERIT**

MINERAL ACOUSTICAL TILE, United States Gypsum Company

**CERTIFICATE OF MERIT**

CHARACTERISTICS OF FLOOR TILE (A Series), Kentile, Inc.; KNOLL PRODUCTS (A Series), Knoll Associates, Inc.; A SUCCESS STORY (A Series), Marble Institute of America, Moore & Company — Advertising Agency; EXPANDED METAL, United States Gypsum Company

**HONORABLE MENTION**

MAX SPIVAK DESIGNS (A Series), The Cambridge Tile Manufacturing Co., Wildrick & Miller Advertising Agency; VITAL STATISTICS ON STEEL FOR HOMES (A Series), Columbia-Geneva Steel Division; United States Steel Corporation, John O'Rourke Advertising Agency

*(More Literature on page 332)*

# "I'm a great fan of Inland TI-CO galvanized steel sheets,"

says Howard Houchens, Sheet Metal Contractor on the new Indiana Turnpike



A partner in Apex Heating & Ventilating Company of Hammond, Indiana, Howard Houchens stands in front of one of the five stations along the Indiana Turnpike, in which all the sheet metal work was handled by his firm.

The Indiana Turnpike job is one of the largest single projects Apex Heating & Ventilating Company has ever undertaken. Each station consists of two large buildings, one on each side of the highway. Each building houses a gas station, a gift shop and a complete restaurant. The entire installation required 65 tons of galvanized sheets. And it's all Inland TI-CO.

"We specified Inland TI-CO for the duct work and air handling equipment because it's dependable," says Mr. Houchens. "Its non-flaking quality keeps our labor costs down. With TI-CO, fabricating time in the shop is reduced to a minimum because there are no make-overs due to peeling of the zinc or splitting of the sheets, and machine down-time caused by zinc clogging is eliminated. Most important, TI-CO provides a more attractive, longer-lasting finished installation."

**TI-CO** is available in cut sheets or coils, in gages 8 to 30 inclusive and widths as great as 60 inches. TI-CO comes with dry, oiled or chemically treated surfaces. Consult your local steel distributor or Inland representative for your requirements.

#### **TI-CO Galvanized Sheets are now readily available!**

The terrific demand for this high quality sheet has kept TI-CO in short supply since its development. Now, additional production facilities have been completed making greater quantities available.

## **INLAND STEEL COMPANY**

38 South Dearborn Street • Chicago 3, Illinois

Sales Offices: Chicago • Milwaukee • St. Paul • Davenport  
St. Louis • Kansas City • Indianapolis • Detroit • New York



This is a housing for one of the air handling units being installed in a Turnpike building. On large prefabricated parts such as this, TI-CO's non-flaking feature pays off. They come out right the first time. No "do-over" operations because of peeling, cracking, or flaking along seams—no waste of materials. Thanks to TI-CO . . . no man-hours lost, in the shop or on the job!



Look for this brand—  
your assurance of  
non-flaking performance

(Continued from page 260)

**Nail-Glued Truss for Hip Roofs**

The popular — but difficult to build — hip roof can now be framed with a nail-glued truss system designed for the University of Illinois Small Homes Council. The hip roof truss, the newest in a series of truss designs using the nail-glued technique developed by the Council and Purdue University, is for a 3-in-12 inch slope. The University of Illinois truss system employs flat-top trusses spaced 2 ft on center, with the outriggers supported by a terminal truss. All members are small — mostly 2 by 4's — and the hip rafters and jack rafters necessary in conventional hip-roof construction are eliminated. Instruction sheets showing the geometry of the trusses and giving directions for assembling them for spans of 21 ft to 28 ft-8 in. have been prepared by architects Howard E. McCall and James T. Lendrum, and are available from the Small Homes Council.

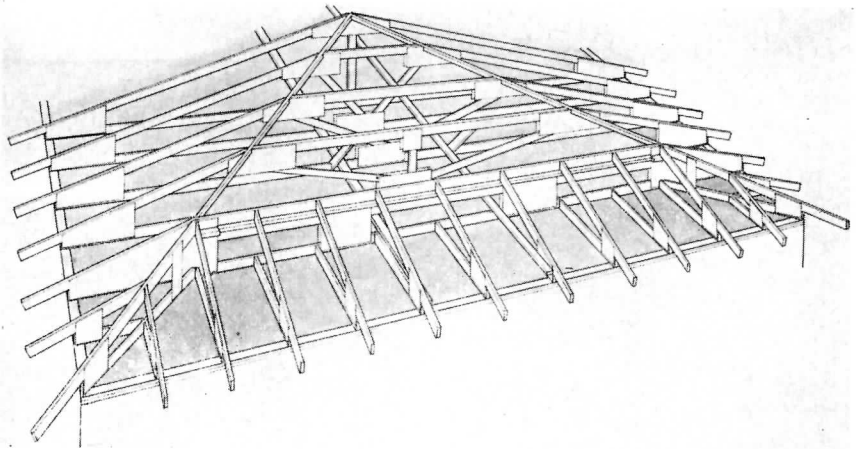

**PLASTIC HOUSES POURED FROM HELICOPTERS?**

Aircraft will soon invade the building field, according to a forecast made by Henry H. Reichhold, president of Reichhold Chemicals, Inc. Reviewing the growth of the plastics industry over the past decade and predicting its expansion in the next, Mr. Reichhold painted a picture in which trucks and tractors give way to hovering helicopters and low-flying "work horse" planes. The aircraft on the building sites of the future will be used in constructing the plastic homes that the industrialist foresees as a logical development of the growing plastics industry.

Walls and foundations of plastics in an unlimited range of colors will be funneled through hoses from helicopters fitted with the type of equipment now used for cement-mixing, while drive-ways and walks will be sprayed on by slow flying aircraft. Even such non-plastic items as laminated plywood or completely assembled garages may be parachuted to the site in Mr. Reichhold's air-powered building industry. Extra costs will be offset by the resulting speed of construction, with the added dividend of eased truck traffic in congested areas. "It may seem fantastic," he declared, "but so did spraying the crops from the air when it was originally suggested."

(More Roundup on page 276)

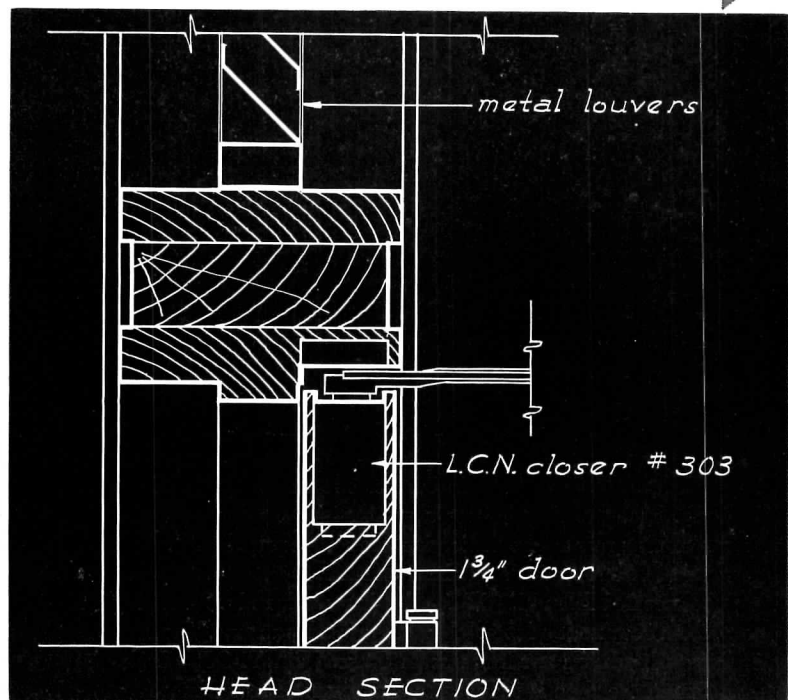

**CONSTRUCTION DETAILS**

for LCN Closer Concealed-in-Door Shown on Opposite Page

*The LCN Series 302-303 Closer's Main Points:*

1. An ideal closer for many interior doors
2. Mechanism concealed within door; flat arm not prominent, and provides high closing power
3. Door is hung on regular butts
4. Closer is simple to install and to adjust
5. Hydraulic back-check protects walls, etc. on opening
6. Practically concealed control at little more than exposed closer cost

*Complete Catalog on Request—No Obligation  
or See Sweet's 1957, Sec. 18e/La*

**LCN CLOSERS, INC., PRINCETON, ILLINOIS**



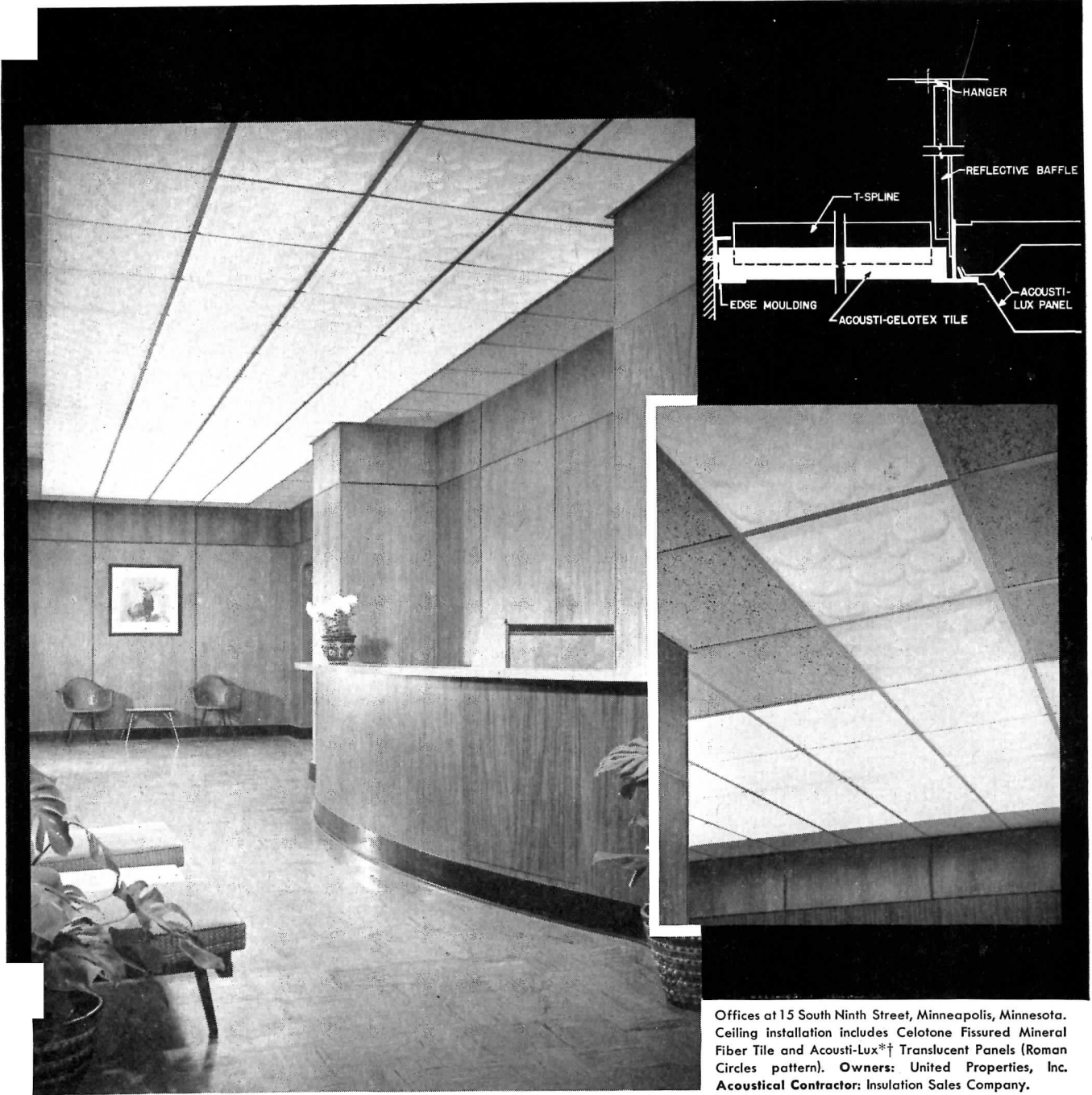

Offices at 15 South Ninth Street, Minneapolis, Minnesota. Ceiling installation includes Celotone Fissured Mineral Fiber Tile and Acousti-Lux\*† Translucent Panels (Roman Circles pattern). Owners: United Properties, Inc. Acoustical Contractor: Insulation Sales Company.

Shown here are outstanding examples of completely integrated ceiling systems in offices. Close coordination of architects with skilled contractors in related fields results in ceilings designed to be an active, working part of a modern building. Such ceilings, as those illustrated, provide balanced environments of light-, air-, and sound-conditioning . . . and are unusually attractive as well. Today, Acousti-Celotex Distributors are being consulted more and more in the *early planning stages* of buildings . . . because of their specialized knowledge of ceiling potentials. They stand ready to cooperate with you in all of *your* specific projects.

**FOR COMPLETE DETAILS** on Acousti-Celotex Sound Conditioning Tile, Acousti-Lux Translucent Panels, and their many installation system possibilities, write to The Celotex Corporation, Dept. B-47, 120 S. La Salle St., Chicago 3, Illinois.

\*REG. U. S. PAT. OFF. †U. S. PAT. NOS. 2,218,992 & 2,710,338



# ACOUSTI-CELOTEX

REGISTERED U. S. PAT. OFF.

*Sound Conditioning*

Products to Meet Every Sound Conditioning Problem . . . Every Building Code  
The Celotex Corporation, 120 S. La Salle St., Chicago 3, Illinois  
In Canada: Dominion Sound Equipments, Ltd., Montreal, Quebec

GIANT "SPIDER WEB" FORMS WIDE-SPAN TIMBER DOME

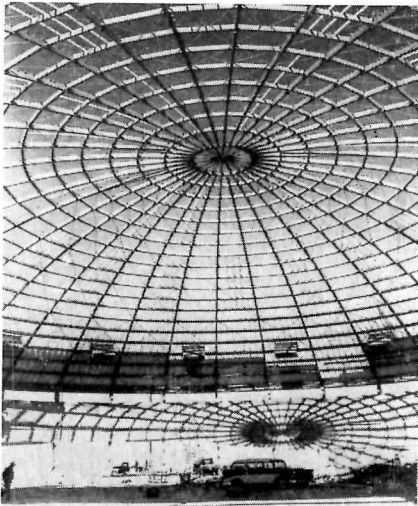

Glued laminated arches and purlins spin a web 300 ft in diameter over the new fieldhouse at Montana State College in Bozeman, Montana. The immense dome — thought to be the widest clear span

timber structure in the world — soars 92 ft at the center, forming a post-free space large enough for football and baseball practice and providing up to 15,000 spectators with an unobstructed view of arena sports.

According to the architects, Fred Willson & Oswald Berg, Jr. of Bozeman, the final selection of glued laminated wood construction was based primarily on a nine per cent saving over other materials — a factor particularly important to the student-body sponsors of the project. Availability of materials and time of erection were further considerations since the construction schedule called for completion in time for the opening of the 1957 basketball season. The timber dome, erected in only ten weeks, literally rose to the challenge.

The arch ribs are connected at their base to a circumferential tension ring supported on reinforced concrete pilasters outside the brick-colored concrete block walls that enclose the arena. The upper ends frame into a heavy compression ring. Nineteen lines of timber purlins spaced at 8 ft extend around the dome and carry a built-up roof over *Tectum* decking.

The giant arches, fabricated and

erected by Timber Structures, Inc. of Portland, Oregon, were manufactured in 51 ft segments and assembled on the site. Purlins, sub-purlins and cross bracing were placed with the arches lying on the ground in pairs. As the pie-shaped sections, each weighing about 4 tons, were completed, they were hoisted into place with two heavy cranes, and supported by pine poles until the dome was completely assembled.

The main arena, which includes a complete laundry; physical therapy section; kitchen and eight public concession areas; and television, press and radio booths in addition to accommodations for teams and spectators, will be supplemented by a two-story wing housing administrative offices and an entrance lobby.

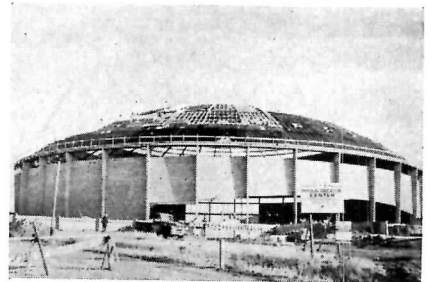

WHEN THE AIR SUPPLY IS VITALLY IMPORTANT

Specify

*Curtis*

and Relax!

Large fin area for quick and efficient air cooling—Timken Tapered Roller Main Bearing, adjustable for wear—Positive Centro-Ring pressure oiling system.

Available for prompt delivery

—With 103 years of engineering and manufacturing experience "built-in" you can be confident that there are no finer air compressors on the market than Curtis.

REMEMBER...YOU CAN COUNT ON

**CURTIS MANUFACTURING CO.**

OUR 103rd YEAR

**PNEUMATIC DIVISION**

1986 KIENLEN AVENUE • ST. LOUIS 20, MO.

CM-24

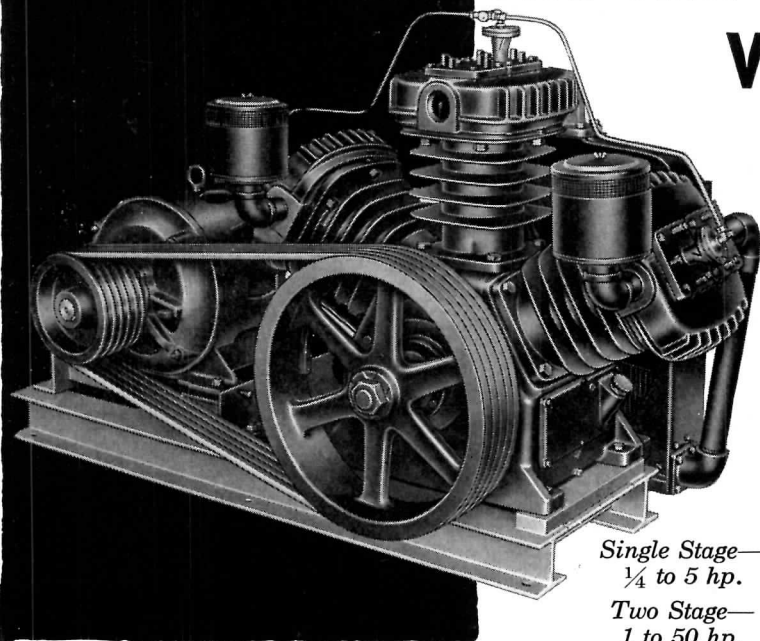

Single Stage—  
1/4 to 5 hp.

Two Stage—  
1 to 50 hp.

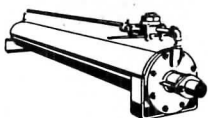

AIR CYLINDERS AND AIR HOISTS

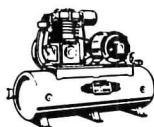

VERTICAL OR HORIZONTAL TANK MOUNTED COMPRESSOR 1/4 THRU 15 HP.

## WEATHER RESISTANCE OF PORCELAIN ENAMELS TESTED

The increasing popularity of porcelain enamel as an exterior finish for buildings has brought in its wake a need for specific technical information on the relative weather resistance of different types of enamels to supplement the backlog of practical experience. As a result of weathering tests conducted over a fifteen year period and recently completed, the National Bureau of Standards has compiled data that should prove helpful to architects and engineers in specifying the best weather-resistant compositions, as well as to enamel manufacturers in improving the weathering qualities of porcelain enamels.

The investigation, carried out by D. G. Moore and W. N. Harrison of the Bureau's enameled metals laboratory, exposed specimens of 14 types of enamels to four climatic conditions typical of various sections of the United States. Actual exposure at selected sites in Washington, D. C.; St. Louis, Missouri; Lakeland, Florida; and Atlantic City, New Jersey was supplemented by laboratory tests. Evaluation was made of such basic qualities as protection of the base metal, cleaning behavior, specular

gloss and color. In the first case it was found that where initial coverage was complete, there was no corrosion of the steel base regardless of the type of enamel used. However, in several cases insufficient coverage on the back of panels resulted in corrosion at the points of poor coverage and spalling of the enamel on the face side opposite them.

Studies of the remaining factors showed a general relationship between the acid-resistance of an enamel and its weathering properties, except in the case of a few of the red enamels which underwent color changes despite their high resistance to acid attack. Accordingly, the Bureau's recommendation for specification purposes states that, for architectural installations where general appearance, absence of fading, and ease of cleaning are important, only those enamels having class A or class AA acid resistance by the standard citric acid spot test should be used. In addition, for enamels containing the cadmium-selenium-sulphur pigment (red, orange, and yellow), only those compositions should be selected that will give a weight loss of less than 1.0 mg-cm<sup>2</sup> when subjected to a boiling solution of 10 per cent nitric acid for 2½ hours.

## RUST PROOFING STEEL BUILDING PRODUCTS

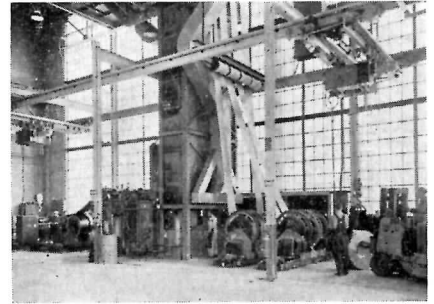

Rust proofing of steel building products prior to shop painting has become virtually a standard practice among manufacturers in the past few years. This is an important advance in the manufacture of light gauge forms and structural sections, and is just as necessary in this field as it is in the automobile and home appliance field where durable, protective finishes are imperative.

Rust proofing is a process of cleaning, phosphating, and chromating the metal surfaces to provide an integral rust-inhibiting bond between the metal and the protective coating of paint. It is best accomplished in special equipment

*(Continued on page 280)*

# IMPORTANT REASONS WHY

**Architects - Engineers -  
Contractors and Owners**

**prefer the CURTIS 50 Ton  
PACKAGED AIR CONDITIONER**

**INSTALLATION EASIER:** Line assembled at the factory—eliminates expensive field labor.

**PERFORMANCE KNOWN:** Curtis units are run-in at the factory and guaranteed to deliver their rated tonnage. Assures a **BALANCED SYSTEM**.

**DELIVERY ON TIME:** Curtis can meet your delivery requirements, a decided advantage over multiple supplier delivery promises!

YOU CAN COUNT ON  
REMEMBER...

# Curtis

OUR 103rd YEAR

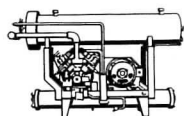

PACKAGED  
LIQUID  
CHILLER  
UP TO  
100 TONS



PACKAGED AIR  
COOLED UNITS  
UP TO 7½  
TONS

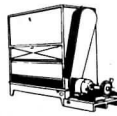

AIR HANDLING UNITS  
COOLING TOWER  
AND EVAPORATIVE  
CONDENSER  
TO MATCH

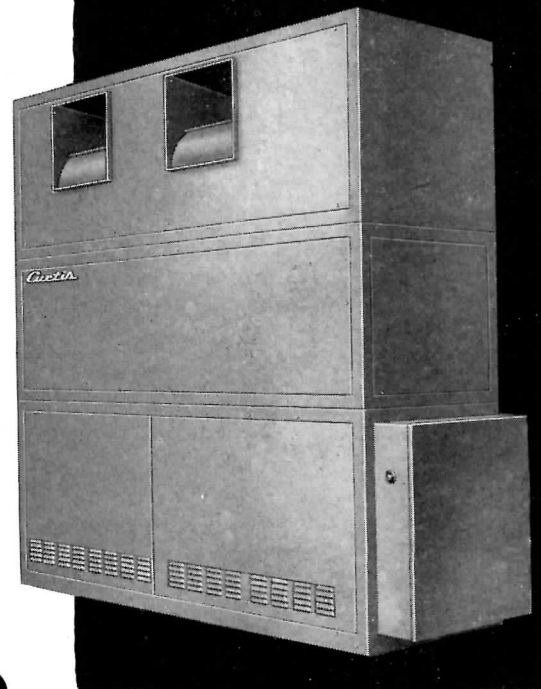

**MANUFACTURING CO.  
REFRIGERATION DIVISION**

1986 Kienlen Ave., St. Louis 20, Mo.

CM-23



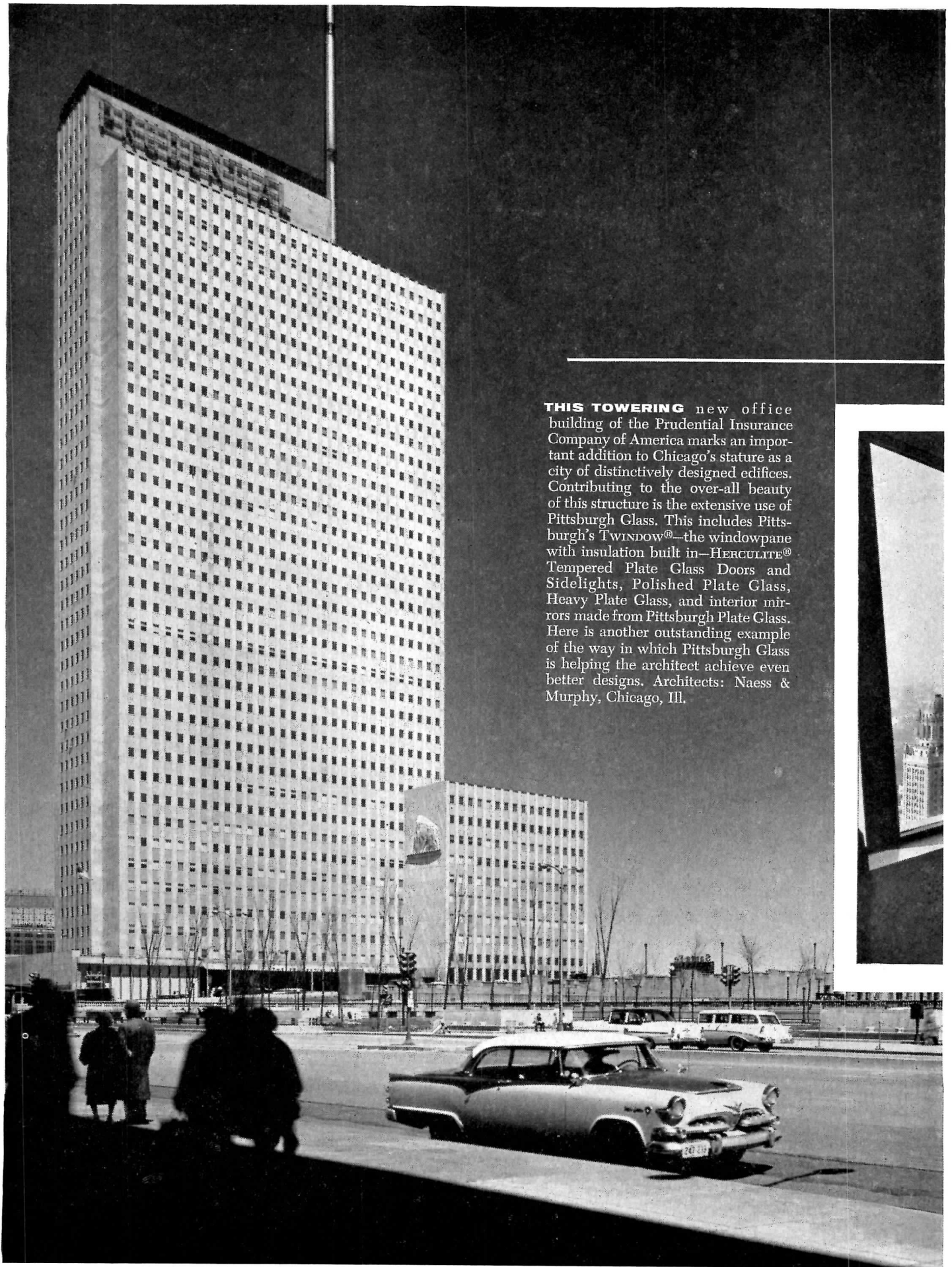

**THIS TOWERING** new office building of the Prudential Insurance Company of America marks an important addition to Chicago's stature as a city of distinctively designed edifices. Contributing to the over-all beauty of this structure is the extensive use of Pittsburgh Glass. This includes Pittsburgh's **TWINDOW®**—the windowpane with insulation built in—**HERCULITE®** Tempered Plate Glass Doors and Sidelights, Polished Plate Glass, Heavy Plate Glass, and interior mirrors made from Pittsburgh Plate Glass. Here is another outstanding example of the way in which Pittsburgh Glass is helping the architect achieve even better designs. Architects: Naess & Murphy, Chicago, Ill.

**Prudential Insurance Company of America's  
new and impressive building in Chicago  
utilizes the beauty and functional values  
of **PITTSBURGH GLASS****



**LARGE AREAS**, such as these, of Pittsburgh Plate Glass and Twindow Insulating Glass attract thousands of visitors. Clear-vision Plate Glass Twindow units offer a panoramic view of the surroundings and help to keep interiors more comfortable.

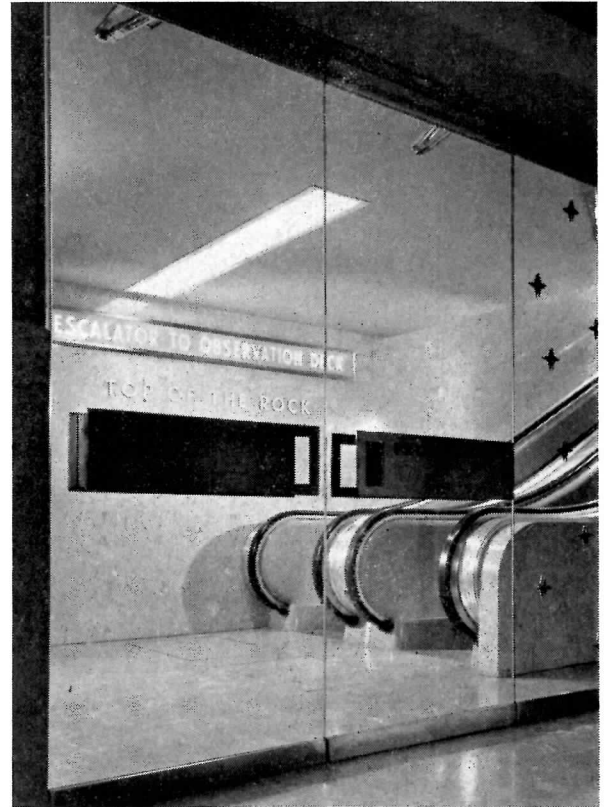

**HERCULITE DOORS**, made from Pittsburgh Polished Plate Glass, which has been specially tempered to make it four times stronger than ordinary glass of the same thickness, are featured at the entrances and on other floors of this new office building.

*Your Sweet's Architectural File contains detailed information on all Pittsburgh Plate Glass Company products . . . Sections 7a, 13e, 16d, 21.*

Design it better with

**PITTSBURGH GLASS**



PAINTS • GLASS • CHEMICALS • BRUSHES • PLASTICS • FIBER GLASS

**PITTSBURGH PLATE GLASS COMPANY**

IN CANADA: CANADIAN PITTSBURGH INDUSTRIES LIMITED

**NEW!**  
**Exclusive!**  
**Different!**

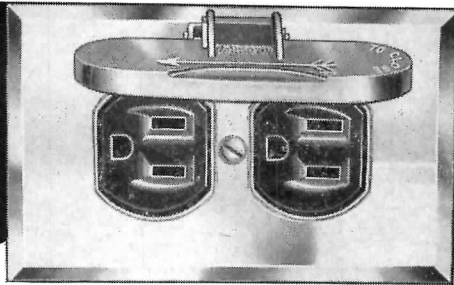

# BELL SAF-T-LOK (Pat. Pend.) Weatherproof OUTLET

FEATURING *Exclusive*  
**STAY OPEN**  
**SNAP-COVER**  
**ACTION**

**STOCK and SELL**  
**FAST MOVING**  
**BELL**

STAYS OPEN  
 IN  
 SAFETY-LOCKED  
 POSITION

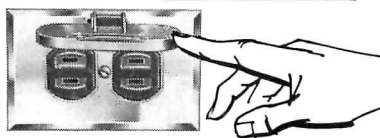
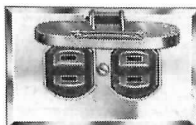

SNAPS SHUT AUTOMATICALLY  
 WITH SLIGHT PUSH

**No. 219 SINGLE SNAP-COVER  
 PARALLEL SLOT DUPLEX RECEPTACLE**

**No. 220 SINGLE SNAP-COVER 3-WIRE  
 GROUNDING DUPLEX RECEPTACLE**

Grounds metal parts of portable electrical tools, lawn mowers, etc. for safety in use with *Metallic* or *Non-Metallic* wiring systems.

## TECHNICAL ROUNDUP

(Continued from page 277)

which automatically controls the temperature of active solutions and rinses as well as the time-length in each of the various processing stages. The complete process normally includes a cleaning operation consisting of two washing stages, each of which is followed by a hot water rinse. In the next stage, the metal is flooded with a phosphoric acid solution which slightly etches the surface, leaving a granular finish with an integrated phosphate coating which provides an excellent paint grip and bond. Another hot water rinse follows to remove all residual matter. The final operation is a bath of chromic-phosphoric solution which further fortifies the metal against corrosion. The metal thus treated is then thoroughly dried in oven temperatures up to 350 deg F and, after cooling, is ready for painting.

The paint may be applied to the metal or finished product by any one of several methods. It may be sprayed on manually or electrostatically, or it may be rolled on. Some products must be painted by flow coating or dip-coating — the most economical method is usually determined by the size and physical characteristics of the products.

Most production painting in the building products field is done in specially designed conveyorized systems which include the cleaning and rust proofing, drying, painting, and finish-baking equipment — all of which is automatic or semi-automatic.

There are several rust proofing processes available which are similar in their action and produce similar results. The end result strived for by each is a painted steel product with a thoroughly bonded, permanent, corrosion-resistant protective coating which will prevent the spread of corrosion under the paint if the protective coating of paint or synthetic enamel should be scratched through to bare metal. In this respect, these so-called rust proofing processes have proved highly effective.

A NEW APPLICATION ENGINEERING STANDARD for air-conditioning multi-zone buildings in which varying degrees of cooling and humidity must be maintained has been issued by the Air Conditioning and Refrigeration Institute. The Institute said the publication is limited to the setting of minimum conditions and factors that form the basis of design load estimating and specification of performance for such installations.

...the most **COMPLETE** line  
 with **EXCLUSIVE** selling advantages

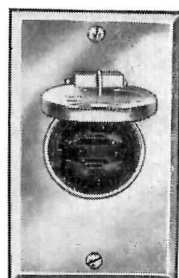

No. 210

*Exclusive SNAP-COVER locks open for easy, one-hand insertion of plug . . . yet snaps shut at a touch for weather-proof protection. Lid does not rest on wire or plug. Can't damage insulation if cord is jerked out. Cover cannot be loosened or pulled off.*

**No. 210—ONE-GANG SAF-T-LOK SINGLE RECEPTACLE**

**Bell—The Complete Line—The Only Line with SAF-T-LOK SNAP-COVERS OR SCREW COVERS in 1 or 2-gang Combinations.**

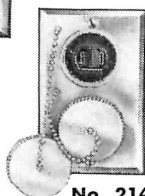

**No. 214**  
 Flush  
 Screw-Cover  
 Duplex  
 Receptacle



**No. 216**  
 Flush Switch  
 (Single pole,  
 T-rated)

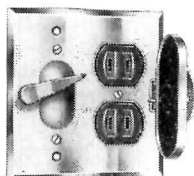

**No. 228**  
 Combination  
 Flush Switch &  
 Snap-Cover  
 Outlet

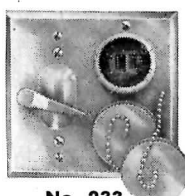

**No. 233**  
 Flush Switch  
 and Duplex  
 Screw Cover  
 Duplex Receptacle



U.L. APPROVED



Make BELL your one source for the best in weather-proof and No-Shok devices, and Metal Wall Plates. Write for Catalog and Prices today!

**BELL ELECTRIC CO.**

1844 West 21st Street • Chicago 8, Ill.



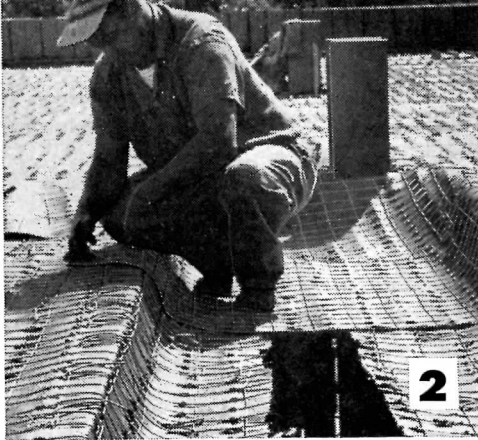

Photographs above and at right show some of Steeltex's money saving advantages. 1. Rods welded to joists eliminate diagonal bridging. Steeltex and concrete give joists lateral stability. 2 and 3. Steeltex, cut and bent easily and quickly, made it possible for one man to cover this special depressed area in a few minutes. John Casey, architectural superintendent, points to neat, finished job. 4. It's easy to fit Steeltex snugly around columns. 5. Round or irregular shapes pose no problems because Steeltex fits snugly, keeps concrete from dripping through.

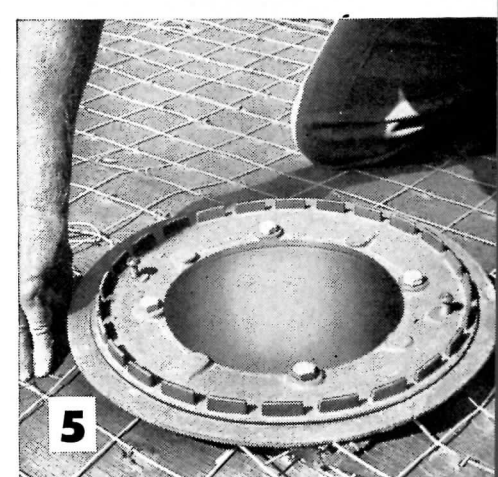

time savings possible.

To make the achievement even more remarkable, the Charlson men had never before used Pittsburgh Steeltex. But the workmen needed no other instructions than the printed directions which accompany every 125-foot roll.

**Steeltex, sold by the Pittsburgh Steel Products Division of Pittsburgh Steel Co., was specified by Giffels & Vallet, Inc., L. Rosetti, Associated Engineers and Architects, of Detroit, Mich.**

The specification pleased President K. H. Charlson of the Charlson Company, who said:

"Steeltex definitely was the best choice. It is a good product that is easier to cut and shape than other centering material. The paper backing reduces dripping and eliminates clean-up problems on the floor below.

"Steeltex is economical to buy, saves a lot of costly, time-consuming work and produces a high quality concrete slab with good reinforcing."

The Ecorse Elementary School job calls for the first segment now under construction to become eventually part of a much larger complete school unit, including a high school and a junior high.

Since the elementary school will have a second floor later on, its roof deck will become the floor of the planned second story.

That meant columns for the new roof had to be left protruding from the present roof. These columns offered no problem to Steeltex. It took one

workman only a minute or two to cut the mesh and fit it around each column as he came to it.

A long depression in the roof deck (see photographs) had to be left for sanitary facilities on the proposed second floor. One man covered this long gap, measuring more than 20 feet long and two feet wide.

**You, too, can reduce costs and pour concrete decks quicker while improving the quality of floors and roofs—when you use Steeltex.**

Special advantages of Steeltex can work as well for you as for this Michigan architect and the contractor.

A trained Pittsburgh Steel Products engineer, with lots of construction know-how, is available close at hand. Call him at any of the district sales offices listed here. Do it today.

See Sweet's Catalog Section 2-B

**Steeltex<sup>®</sup>**



## Pittsburgh Steel Products

a division of Pittsburgh Steel Company

Grant Building • Pittsburgh 30, Pa.

District Sales Offices: Atlanta • Chicago • Cleveland • Columbus • Dallas  
Dayton • Detroit • Houston • Los Angeles • New York • Philadelphia • Pittsburgh  
Tulsa • Warren, Ohio



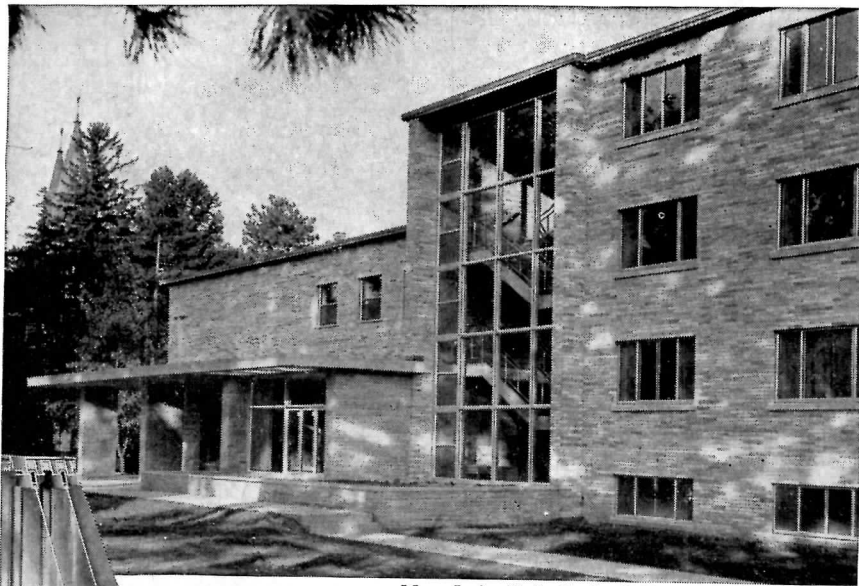

Mary Josita Hall, Clarke College, Dubuque, Iowa  
Architects: Barry & Kay, Chicago, Illinois



Section of Fleetlite Sliding Window showing exterior and interior sash, screen, and extruded aluminum frame.

## When only the finest is adequate . . .

*Architects specify  
Fleetlite Sliding Windows!*

Fleetlite windows offer unequalled economy and ease of maintenance. Self-storing double sash is safely cleaned from inside — provides added insulation to reduce heating and cooling costs. Windows are factory assembled and shipped ready for immediate installation.

Durability, Dependability and ease of operation make Fleetlite the preferred window for dormitories, hospitals and institutional buildings as well as the finest residences.



*Picture Window Beauty Plus Sliding Window Convenience!*

Combined Fleetlite picture and sliding windows make an attractive and practical unit, provide maximum light plus the benefits of controlled ventilation and double sash protection.



Distributed in Canada by: Crusader General Industries, Ltd., 86 Bloor St., West, Toronto, Canada

**ET OF AMERICA, INC., 2029 Walden Avenue, Buffalo 25, N. Y.**

**See us at Booth 17, A. I. A. Convention, Sheraton-Park, May 14-17**

### DESIGNING THE "JEN"

(Continued from page 218)

space with the chart table and galley at the after end, a central-main cabin with a gimbal-swung drop-leafed dining table bisecting it lengthwise and an expandable bunk on each side, and a forward cabin containing two bunks with a fold-up canvas quarter-berth over each. The "head" or toilet room is unusually large and well-lighted; it is accessible from either side of the forecabin, which, like the main cabin, can be divided into two rooms by a longitudinal curtain. An ingenious feature here is the wash basin which is a pull-out drawer with side pump and drainage into the toilet. The galley and chart house, where most of the time indoors is spent, are I believe, rather ideally located. Certainly the galley, in the most airy part of the ship, close to the cockpit, and where there is least motion, is in a very good spot. The reverse sheer and the raised deck give a great deal of extra space for storage and living amidships, where it is most useful. The clear way between the chart house and main cabin and forecabin contribute both to good ventilation (of vital importance at all times) and to the unusual sense of space apparent in the photos.

The hull is of edge-glued and strip planking construction on which I had considerable help from Farnham Butler and Cy Hamlin. I was anxious to use this method since in my experience with prefabrication and furniture design I have become very impressed with the strength and other good qualities of glued laminated construction. Wherever possible the bulkheads are walls used to form transverse strengthening members, and these had to be carefully scarfed and glued together since in many cases they required larger sheets of plywood than are made. We managed to make even the drawer cases, the bunk backs, the seats, certain minor subdivisions, counters, and other utilitarian parts of the boat serve a double purpose in strengthening the hull as well.

One last point: I definitely feel that the building of the "Jen" has been a valuable experience to me as a land architect. By the same token, I feel very strongly that comfort belowdecks frequently could be increased and the limited space on a small yacht used to better advantage by the land architect than by the marine architect who is, after all, more vitally concerned with speed, safety and dynamics than with comfort.

*Please send complete information on Fleetlite:*

- Double Horizontal Sliding Windows
- Double, Double Hung Windows
- Sliding Doors and Picture Walls
- Jalousie Windows and Doors