

ARCHITECTURAL RECORD

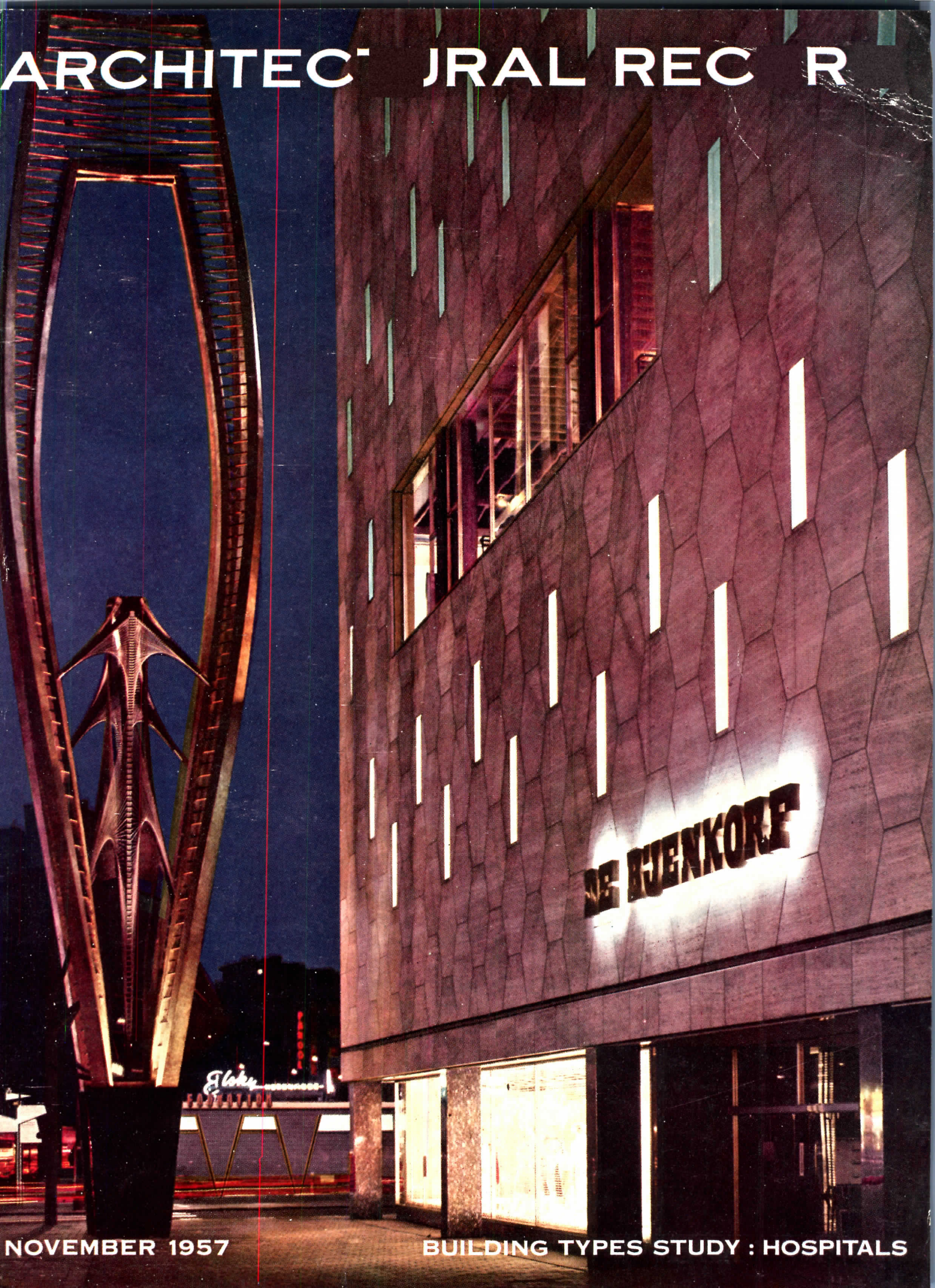

NOVEMBER 1957

BUILDING TYPES STUDY : HOSPITALS

auditorium • coliseum

Municipal Auditorium and
Coliseum, Charlotte, N. C.
Arch. — A. G. O'Dell, Jr.
& Associates,
Charlotte, N. C.
Struct. Engr. — Severud,
Elstad, Krueger,
New York, N. Y.
Contr. — Thompson & Street Co.,
Charlotte, N. C.
Pozzolith ready-mixed con-
crete — Concrete Supply
Co., Charlotte, N. C.

Below — view of 2500-seat
auditorium.

Bottom Photo — section of
13,500-seat coliseum.

Concrete of good appearance and other desired qualities with

POZZOLITH*

In the construction of this outstanding municipal auditorium and coliseum — as with many other important projects built since 1932 — Pozzolith proved a valuable aid in improving cohesiveness and plasticity, to enhance the appearance of exposed concrete.

Beauty and utility with architectural concrete is but one of the advantages obtained with Pozzolith . . . key to the control of:

1. water content . . . makes possible lowest water content for a given workability.
2. entrained air . . . provides optimum air content without sacrificing other desired qualities.
3. rate of hardening . . . provides desired handling and finishing time under widely varying job conditions.

Any one of our more than 100 seasoned fieldmen will be glad to demonstrate the full benefits of Pozzolith for your project, and to advise of the availability of Pozzolith Ready Mixed Concrete through more than 1000 qualified producers.

**Mr. Ready-Mix
Producer . . .**
this advertisement
appears in leading
national magazines
read by your
customers

*POZZOLITH — registered trademark of The Master Builders Company
for its time-tested water-reducing, air entraining admixture for concrete.



THE MASTER BUILDERS co.
DIVISION OF AMERICAN-MARIETTA CO.

General Offices: Cleveland 3, Ohio • Toronto 9, Ontario • Export: New York 17, N. Y.

Branch Offices In All Principal Cities • Cable: Mastmethod, N. Y.

STAFF OF ARCHITECTURAL RECORD



H. Judd Payne, Publishing Director; **Robert F. Marshall**, General Manager; **John Knox Shear**, A.I.A., Editor-in-Chief; **Marshall T. Ginn**, Circulation Manager; **Emerson Goble**, Managing Editor; **James S. Hornbeck**, A.I.A., Senior Associate Editor; **Elizabeth Kendall Thompson**, A.I.A., Senior Associate Editor and Western Section Editor (Berkeley, California, Office); **Robert E. Fischer**, Associate Editor (Engineering); **Florence A. van Wyck**, Associate Editor; **Jeanne M. Davern**, Associate Editor (News); **Herbert L. Smith, Jr.**, A.I.A., Associate Editor; **Mildred F. Schmertz**, Associate Editor (Design); **Ernest Mickel**, Dan Street (Washington), **John Caulfield Smith**, M.R.A.I.C. (Canada), Contributing Editors; **Margaret R. Fuerst**, Assistant Editor (Engineering Assistant); **Helen E. Cook**, Editorial Assistant (Production); **Dianne Thomas**, Editorial Assistant; **Eugene H. Hawley**, Design Director; **Thomas L. McArthur**, Mary Ann Godfrey, Design; **Sigman-Ward**, Drafting Consultant; **Thomas S. Holden**, Industry Relations Consultant; **Clyde Shute**, Statistical Consultant; **George Cline Smith**, Economics Consultant; **Clifford Dunnells, Jr.**, Field Research Consultant; **Daniel J. Howe, Jr.**, Public Relations Consultant.

TABLE OF CONTENTS

Construction Outlook for 1958

The annual analysis by *Thomas S. Holden*, with the collaboration of *George Cline Smith*, and *Edwin W. Magee Jr.*, and *Clyde Shute* of future construction potentials Opposite page 8

The Record Reports

Perspectives. The full report of the Consulting Architects on the Extension of the U. S. Capitol	9
Buildings in the News. Winning Designs for "Living with the Sun"; Revised Setting, and Revived Hope, for Saarinen's St. Louis Arch; "100 Years of Federal Architecture"	10
Architecture Abroad. Postwar Swiss Architecture On View in New Exhibit	16
Nuclear Energy and the Design Professions. A special report on a recent West Coast meeting. <i>By Elisabeth Kendall Thompson</i>	18
Meetings and Miscellany	21
College Building 1956-1970: Survey Yields Preliminary Cost and Structural Data. A Washington Report <i>by Ernest Mickel</i>	32
News from Canada. <i>By John Caulfield Smith</i>	36
Washington Topics. <i>By Ernest Mickel</i>	48
Construction Cost Indexes	54
Required Reading	58
Calendar and Office Notes	312
Reviewing the Record	358
Current Trends in Construction	374

COVER: *De Bijenkorf* Department Store, Rotterdam; *Marcel Breuer* and *A. Elzas*, Architects; *Sculpture* by *Naum Gabo*; *Frits Monshouwer* photo

Rectangular Houses

Shape is the most pervading of the visual characteristics of a house, and is commonly neglected in planning. Here is a group of houses which achieve simplicity if not greatness by maintaining a comprehensible, satisfying shape.

The Shape of a House. <i>By John Knox Shear</i>	151
House for John Black Lee, New Canaan, Conn.; John Black Lee, Architect	152
Alcoa Carefree House, Lafayette, Ind.; Charles M. Goodman, Architect	154
House for Mr. & Mrs. Irving Nuger, Edmond Park, Ill.; Robert Bruce Tague and Crombie Taylor, Architects	156
House for Mr. & Mrs. E. M. Gladrow, Baton Rouge, La.; Short & Murrell, Architects	158
House for Mr. & Mrs. Richard Lawrence, Great Neck, N. Y.; George Nemeny, Architect	160

ARCHITECTURAL RECORD

Continued from page 5

House for Dr. & Mrs. Harris Hosen, Port Arthur, Tex.; Bolton & Barnstone, Architects	162
House for Peres Farfante, Havana, Cuba; Frank Martinez, Architect	164

An Architecture for the Day and Night

Department stores leave the problem of fenestration which springs from the need for some daylight by which women can see fabrics, vs. the need for all possible wall space. The solution here is an intriguing pattern of slits in walls of upper stories, which fills both needs with nice visual effect. De Bijenkorf Department Store, Rotterdam; Marcel Breuer and A. Elzas, Architects	167
---	-----

Art, Artists and Architecture

The sculpture on the front cover sets a new high, in purpose as well as size. Sculpture by <i>Naum Gabo</i>	175
--	-----

Comfort and Amenities in Furnishings and Decoration

The author complains strongly against the emotional starvation diet of today. Article by <i>T. H. Robsjohn-Gibbings</i>	179
--	-----

Adventure in Structure

Thin shell roof for George Nakashima. Designed by Paul Weidlinger and Mario Salvadori	183
---	-----

Building Types Study 252 — Hospitals

Introduction by <i>Emerson Goble</i>	189
M. S. Kaplan Pavilion, Michael Reese Hospital, Chicago, Ill.; Loeb, Schlossman & Bennett, Architects	190
Proposed Berwick Hospital, Berwick, Pa.; Noakes & Neubauer, Architects	198
Methodist Hospital of Southern California, Arcadia, Calif.; Neptune and Thomas, Architects	202
Planning the Pediatric Nursing Unit	208
Planning the Physical Therapy Department	211

Architectural Engineering

Design of Teletherapy Units. By <i>W. R. Taylor, W. A. Mills & J. G. Terrill, Jr.</i>	216
Technical Roundup	221
Product Reports	223
Literature	224
Time-Saver Standards: Room for Cobalt 60 Facilities: 1, 2 & 3. By U. S. Department of Health, Education and Welfare — Public Health Service	227

Index to Advertising	376
----------------------	-----

OFFICERS OF THE F. W. DODGE CORPORATION

James McV. Breed, *Chairman of the Board*; Paul Abbott and Thomas S. Holden: *Vice Chairmen of the Board*; Howard Barringer, *President*; Irving W. Hadsell, Chauncey L. Williams: *Executive Vice Presidents*; Howard M. Thompson, *Vice President and Treasurer*; Julius T. Little, Robert F. Marshall, T. Oliver Morgan, O. O. Paulsell, H. Judd Payne, George Cline Smith: *Vice Presidents*; Carl S. Bennett, Clinton C. Bennett, Ralph M. Hairston, Roy J. Hard, Arthur D. Prior, Richard H. Ray, John M. Williams: *Regional Vice Presidents*; Edwin H. Freed, *Assistant Vice President and Comptroller*; Walter F. DeSaix, Clifford G. Dunnells, Jr., Gault Eastman, Clyde Shute, Marc Wayne: *Assistant Vice Presidents*; Sanford D. Stockton, Jr., *Secretary*; William C. Breed, Jr., George W. Morgan: *Assistant Secretaries*; Irving B. Satin, *Assistant Treasurer*.

OTHER F. W. DODGE SERVICES

Dodge Reports — Dodge Statistical Research Services — Sweet's Catalog Services — Dodge Books — Dodge Mailing Service — The Modern Hospital — The Nation's Schools — College and University Business — Hospital Purchasing File — Chicago Construction News — Daily Pacific Builder — Denver Daily Journal — Real Estate Record & Builders Guide.

Members of Audit Bureau of Circulations and Associated Business Publications. ARCHITECTURAL RECORD is indexed in Art Index, Industrial Arts Index and Engineering Index.

Every effort will be made to return material submitted for possible publication (if accompanied by stamped, addressed envelope), but the editors and the corporation will not be responsible for loss or damage.

Subscription prices: Published monthly except May 1957 when semimonthly. U. S., U. S. Possessions and Canada; \$5.50 per year; other Western Hemisphere countries, Spain, to those who by title are architects and engineers, \$9.00 per year. Single copy price except Mid-May 1957 issue \$2.00; Mid-May 1957 issue \$2.95. Beyond Western Hemisphere, excluding Spain, to those who by title are architects and engineers, \$9.00 per year for 12 monthly issues not including Mid-May 1957 issue. Subscriptions from all other outside U. S., U. S. Possessions and Canada for 12 monthly issues, not including Mid-May issue, \$24.00 per year. Change of address: subscribers are requested to furnish both old and new addresses, sending if possible stencil impression from magazine wrapper; allow four weeks for change.



THE RECORD REPORTS

P E R S P E C T I V E S

EXTENSION OF THE U. S. CAPITOL is the subject of a thoughtful and comprehensive report by Henry Shepley, John Harbeson and Gilmore Clarke, Consulting Architects to the Architect of the Capitol, J. George Stewart. The report was made public in the renewed storm of controversy that followed release of the Stewart report (AR, Oct. 1957, page 32) outlining a \$110 million program for extending not only the East Front of the Capitol but the West Front as well. As varying interpretations of the views of the Consulting Architects have further confused the issue, the RECORD here presents their report in full

THE CAPITOL is regarded as the most important building in the United States. It is a shrine in which many important episodes in the history of this country were enacted, as also Independence Hall in Philadelphia and Faneuil Hall in Boston are shrines. The Capitol, however, is unique in that it still remains the seat of the Government's legislative assemblies. Like the great Gothic cathedrals of Europe, the Capitol is not a creation but a growth; its high value lies in the fact that it never was and doubtless never will be finished.

The Capitol, in addition to serving many useful functions, is also a museum. With the growth in complexity of the Government it is inevitable that the building must undergo changes, now and in the future as well as in the past. The Government is in desperate need of more adequate space for the operation of those functions that must still remain within this distinguished building.

It is unthinkable that the legislative halls should ever be located elsewhere; they are what make the Capitol the seat of the Government; without them the building would be an empty shell and a lifeless shrine, much as Independence Hall is now a lifeless shrine, the seat of ghosts of a former important epoch but now merely a museum.

Ten thousand citizens visit the Capitol daily. They do so because it not only housed the deliberations of the law-makers of the infant nation, but continues to serve the same purposes today.

Architects Thornton, Latrobe, Bulfinch and Walter planned changes in the Capitol. Their combined effort is the building we all revere today. There is no reason, therefore, why changes, necessitated at this time because of the continuing growth of the Nation's legislative affairs, should not be as thoughtfully studied and as successfully achieved as before.

THE PROBLEM

The problem assigned to you of increasing the usable space in the Capitol and of making all areas more efficient and more serviceable to the Members of Congress, their staffs and the employees of the building, without marring its historic aspect or its unique architectural qualities of beauty and proportion, is a difficult one.

We commend the steps you have taken in the study of this problem, for example: the detailed measuring of the existing structure and of the Capitol grounds followed by the preparation of complete drawings of the building and of its surroundings; the taking of borings and digging of test pits to determine the condition of the foundations and the nature of the ground where the building stands; the investigation of the condition of the exterior stonework, of the wall construction and of the Dome; the survey of existing interior facilities, of the present shortcomings with respect to proper service for legislative functions to determine what is needed in the next twenty-five years. The study now underway aims to formulate a comprehensive plan to meet these requirements.

You have well chosen your Associate Architects Roscoe DeWitt and Fred L. Hardison; Alfred Easton Poor and Albert Homer Swanke; Jesse M. Shelton and Allen G. Stanford; they have pursued the studies they have undertaken thoughtfully and with ability to the end that the results are distinguished.

We agree with you that it is proper to consider also, as part of the program, the following:

1. To establish a north-south private corridor on each floor for the exclusive use of the Members of Congress and their staffs.
2. To provide additional elevator and escalator services.
3. To modernize and augment the lighting, air conditioning, and areas set

4. To provide an underground garage with suitable entrances for Members of the Congress and for the public including arrival area and distribution center for taxicabs and other vehicles.
5. To provide new and improved underground railways for Members of the Congress.
6. To eliminate the surface roads and automobile parking on Capitol grounds with the appropriate redesign of these areas to create a new plaza at the east front worthy of this distinguished building.

THE NEED FOR CIRCULATION

The architects who designed the various parts of the Capitol were men of taste and feeling, especially Thornton, Latrobe and Bulfinch, who composed the central, older part. When they worked on the plan there was no foreknowledge that in time the building would be required to accommodate large numbers of visitors in addition to the legislators. Consequently there is now no separation of the visitor or "shrine" circulation from that used by the Members of Congress and office staff. This fact causes much inconvenience with the result that the work of the Congress is not as effectively accomplished as it might be under more ideal conditions.

One of the most needed improvements, that your plans include, is the creation of a north-south corridor on each floor connecting the Senate and House wings for the exclusive use of Members of the Congress, their staff personnel and their guests, completely separated from the circulation used by visitors to the "shrine" features of this historic building. The problems created by visitors have arisen since the Hastings report of 1903; this is one of the reasons why Scheme B of that report is

(Continued on page 340)

THE RECORD REPORTS

BUILDINGS IN THE NEWS

FIRST PRIZE of \$2500 was awarded to Peter R. Lee, senior student in architecture at the University of Minnesota, for this design, praised for its "directness and sense of unity, and the logic of its solar equipment, which acts in the double capacity of shade lowers in the summer and heat collectors in the winter." In the competition, Mr. Lee was affiliated with Robert Lewis Bliss, A.I.A., senior partner of the Minneapolis architectural firm of Bliss and Campbell

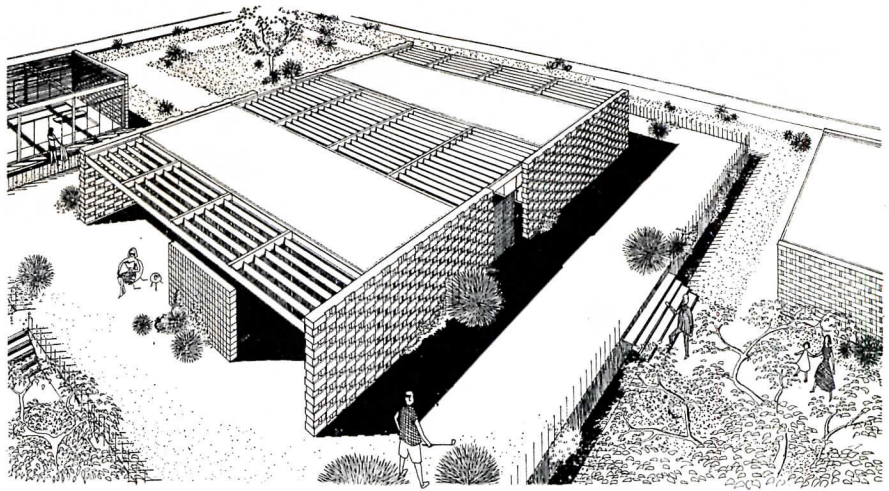

WINNING DESIGNS FOR "LIVING WITH THE SUN"

A senior architectural student at the University of Minnesota, Peter R. Lee, has been awarded the \$2500 first prize in the International Solar House Architectural Competition sponsored by the Association for Applied Solar Energy of Phoenix, Arizona.

The top design, four other prize-winners and three Honorable Mentions were selected from among 113 entries from 13 countries by a jury consisting of Dean Pietro Belluschi, F.A.I.A., of M.I.T.'s School of Architecture and Planning, chairman; Carlos Contreras, Hon. F.A.I.A., of Mexico City; Thomas Creighton, A.I.A., of New York, editor of *Progressive Architecture*; Nathaniel Owings, F.A.I.A., of San Francisco; and

James Elmore, A.I.A., of Phoenix. James M. Hunter, F.A.I.A., of Boulder, Colo., was professional adviser.

Besides the top three prizes, all shown on this page, fourth and fifth prizes of \$500 each were awarded to I. C. Christensen of Aarhus, Denmark, and Robert J. Pelletier of Beverly, Mass. Honorable Mentions went to designs submitted by Enis Kortan of New York, R. B. Maides and G. J. Shaw of Buffalo, and Morton Karp of Mill Valley, Cal.

Purpose of the competition was "to obtain original designs for a residence especially adapted to 'living with the sun' on an irrigated desert site" five miles north of Scottsdale, Ariz. The first-prize house is now being built and

will be put on public exhibition early in the spring. It will also serve as a "living laboratory" for the Association and will be the center of interest at the First Solar House Symposium, to be sponsored next September by the Association in cooperation with the University of Arizona and Arizona State College at Tempe.

In the prizewinning house, solar collectors will supply heat in winter, heat the domestic water and warm the swimming pool which is an integral part of the design. An electrically operated heat pump will supply auxiliary heating and provide summer cooling. Storage of heated water in winter and chilled water in summer will be in a large buried tank.

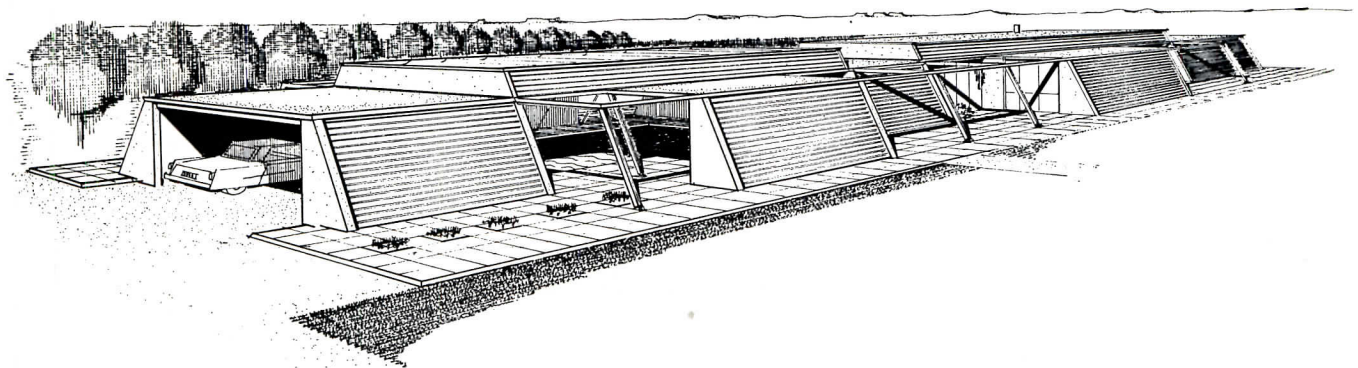

SECOND PRIZE of \$1500 went to Anna Campbell Bliss, junior partner of Bliss and Campbell, with the comment: "The main appeal of this design lies in the fact that the solar collectors themselves produce the architectural quality of the house. The disposition of these collectors keeps the house from becoming too severe . . ."

THIRD PRIZE of \$1000 was awarded for this scheme by John N. Morphett of South Australia and Hanford Yang of China, both former students of the Graduate School of Architecture at Massachusetts Institute of Technology

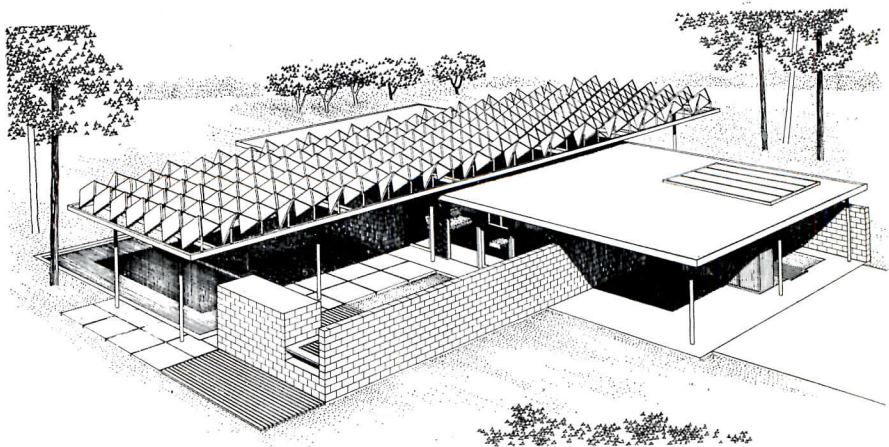

REVISED SCHEME, REVIVED HOPE, FOR SAARINEN'S ST. LOUIS ARCH

A modified plan for the Jefferson National Expansion Memorial on St. Louis' Mississippi riverfront was presented last month in St. Louis by Conrad Wirth, director of the National Park Service, and architect Eero Saarinen, whose design won the \$40,000 first prize in the nationwide architectural competition for the development in 1947 (AR, April 1948).

The revised proposal, presented in model (of which photographs are shown here) and drawings and described in a statement by Mr. Saarinen, appeared from initial reaction to meet one of the key objections which have so long delayed the project — relocation of two main line railroad tracks, now elevated on the riverfront, in a deep cut or ditch, part of which would be a covered tunnel. The earlier scheme, which would have put all tracks in a covered tunnel, had been opposed as prohibitively expensive.

The great stainless steel Arch towering to a height of 590 ft is unchanged from the original design. The changes are in the plan of the park, the setting for and approaches to the Arch and the placement of other buildings on the site.

"The spirit of the new design," Mr. Saarinen said in his statement, "is the same as that of the design which won the national competition ten years ago. . . . We have developed the plan into a greater unity; we have been able to give more dramatic focus to the important historic and symbolic structures — such as the Arch and the Church of St. Louis of France and the Old Court House; we have made compromises with the problems of railroad and vehicular traffic, which we believe will be of benefit to all concerned, and we have reexamined the Park in its relation to the city and the river fronts.

"We feel that we have now related all the major elements of the Park to each other in a more unified way. The stainless steel Arch — as the symbolic Gateway to the West — is the center and focus. It now stands on a raised base, as have all great vertical monuments of the past. Its dimensions, as you will recall, are 590 ft high with a span of 630 ft. Fifty-seven ft at the triangular bases, it tapers to 17 ft at the apex, from which the visitor will see out across the great plains and will, as William Wurster, dean of the School of Architecture at the University of California put it, 'face the monumental importance of the greatest of rivers.' On the levee side, a broad monumental stairway leads up to the

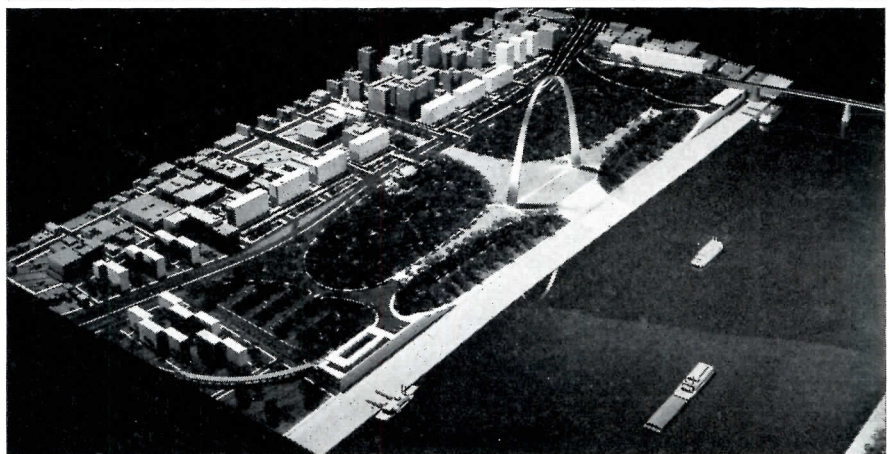
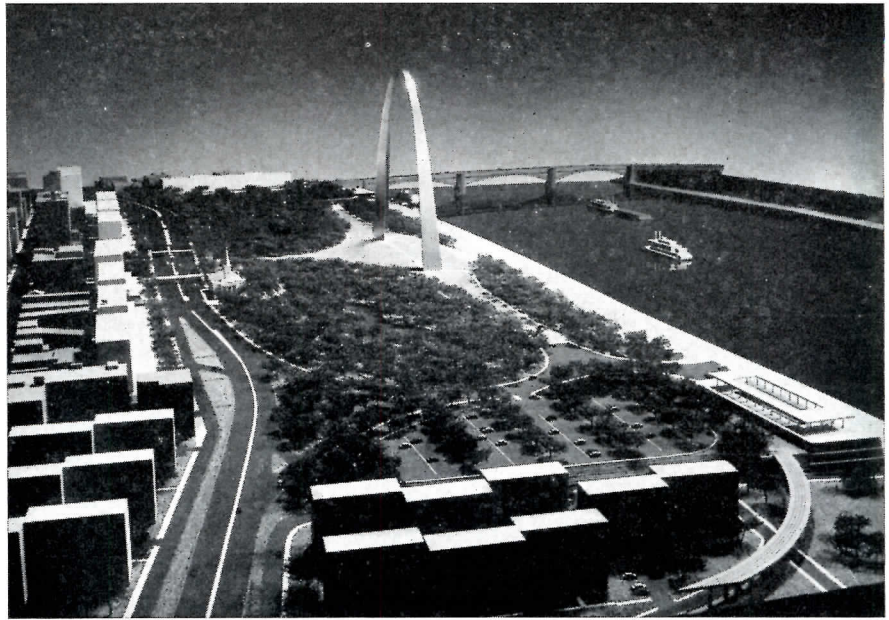

Arch. It is a symbolic stairway, as well as an actual one, for it symbolizes the movement of the peoples through St. Louis, the gateway.

"The axial relation between the Arch and the handsome, historic Court House, which it frames, is now much stronger and clearer. The new curvilinear form of the plaza on which the arch stands and of the roads which wind through the Park all belong to the same 'parabolic' family as does the Arch itself. Thus, the whole composition becomes a more mature and classic design.

"The formal elements of the plaza and the axial, tree-lined mall leading to the Court House are contrasted with the romantic forest areas on each side of the axis — areas in which we envision pools and rock out-croppings and pleasant, winding paths.

"The Historical Museum is now moved to the levee. This Museum on the south and the Restaurant on top of a retaining wall to the north serve not only

as anchors to the whole composition but are placed where they take greatest advantage of the marvelous view of the river front and where they are in most convenient relation to the parking areas. We envision the river boats and pleasure craft tied up at the northern and southern section of the levee. The more life and commerce on the river, the livelier the view from the observation decks and restaurant above. In the words of the great Luther Ely Smith: 'This should be a living monument.' . . .

"One cannot think of the Park alone. The Park, the City, the west side of the Mississippi and the east side — these are all parts of one composition. On the model, we have taken the liberty of showing a diagrammatic redevelopment on all three sides of the Park. . . . We have also included the east side of the Mississippi. . . . We would hope that this side of the river could be developed so that it, too, would become part of one great composition. . . ."

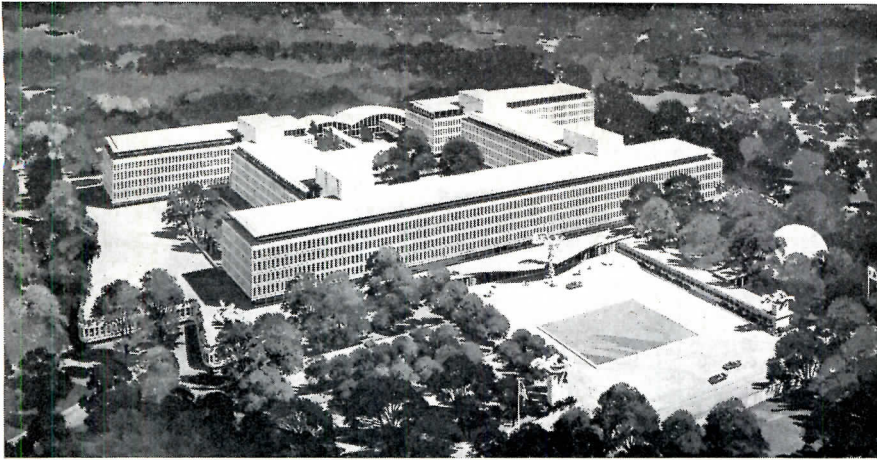

A LOOK TO THE FUTURE

“Modern architecture — the expression of our own time in our own vocabulary — has become accepted and customary for Federal and State as well as for private buildings. It is an illusion to expect continued ‘progress’ in a creative art; but we may, perhaps, be permitted to hope that our architecture will continue to evolve as an expression of our civilization”

WHAT KIND OF ARCHITECTURE FOR PUBLIC BUILDINGS?

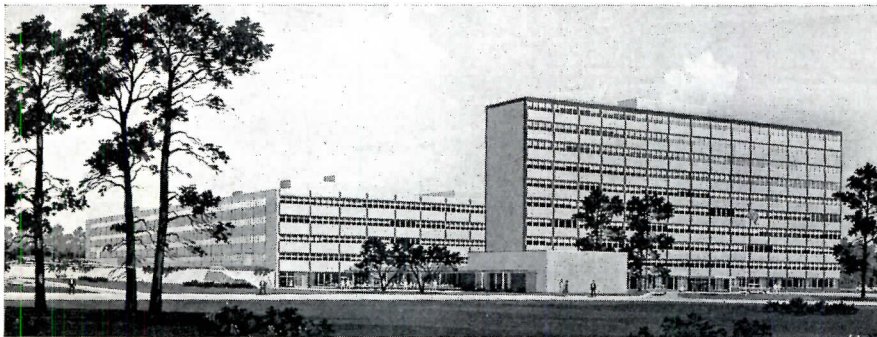

The Public Buildings Service of the General Services Administration, the U. S. agency responsible for all non-military Federal government building, made its contribution to the celebration of the American Institute of Architects' Centennial Year with an exhibition “100 Years of Federal Architecture” which opened at The Octagon in Washington during the A.I.A. Centennial Convention and remained on view throughout the summer. The exhibition, consisting of photographs from the National Archives and from PBS files, consisted of 40 buildings, including four (all shown on this page) still to be constructed, and was intended to document “the representative architecture of buildings constructed for the use of the United States Government in the ten decades since 1857.” In selecting the photographs for the exhibit, PBS had the advice of a panel of three members of the A.I.A. — Louis Justement, Leon Brown and Nicholas Satterlee, all of Washington, who also wrote the commentary.

(Continued on page XXX)

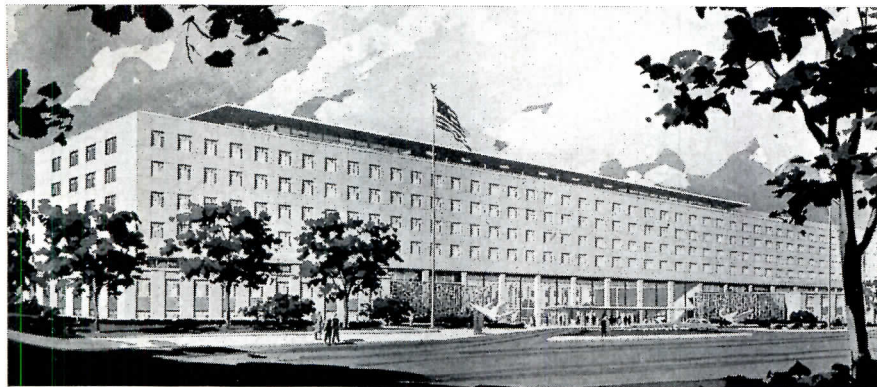

1. Central Intelligence Agency, Langley, Va.; Harrison & Abramovitz, Architects.
2. Bureau of Old-Age and Survivors Insurance (Department of Health, Education and Welfare), Baltimore; Meyer and Ayers, Fisher, Nes, Campbell and Associates, Architects.
3. Department of State Building Extension, Washington, D. C.; Graham, Anderson, Probst and White Inc., Harley, Ellington and Day Inc., Architects and Engineers — A. R. Clas, Associate Architect.
4. U. S. Post Office and Court House, Omaha; Steele, Sandham & Steele, Henningson, Durham & Richardson Inc., Kirham, Michael & Associates, Architects-Engineers

(More news on page 16)



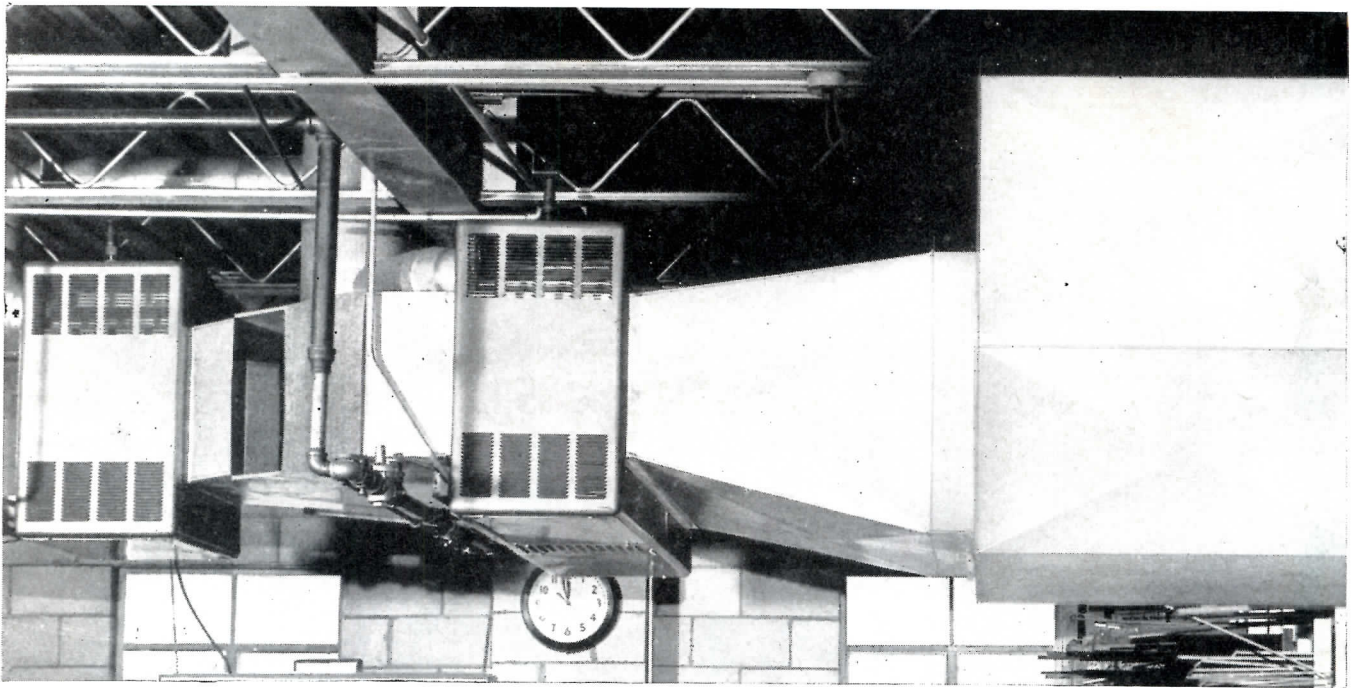

AT FREMONT TOOL & DIE COMPANY, Fremont, Ohio, drafts caused by exhausting the warm air were eliminated by bringing in outside air and "tempering" it with Janitrol Duct Heaters. Thrifty, year 'round office

comfort results from using the same duct system for summer cooling and winter heating. Unit heater blowers provide effective plant ventilation during the summer months.

STANDARDIZE TO PROFITS

Look into Janitrol gas-fired unit heaters for your next job. Our engineers will gladly work with you in developing complete specifications. Call your Janitrol office, or write Janitrol Division, Columbus 16, Ohio.

Winter conditioners adaptable for summer cooling

... with installation of Janitrol's new air-cooled cooling system that uses no water, eliminates water service and maintenance costs. May be installed concurrently with winter conditioner, or any time later, without additional ductwork.

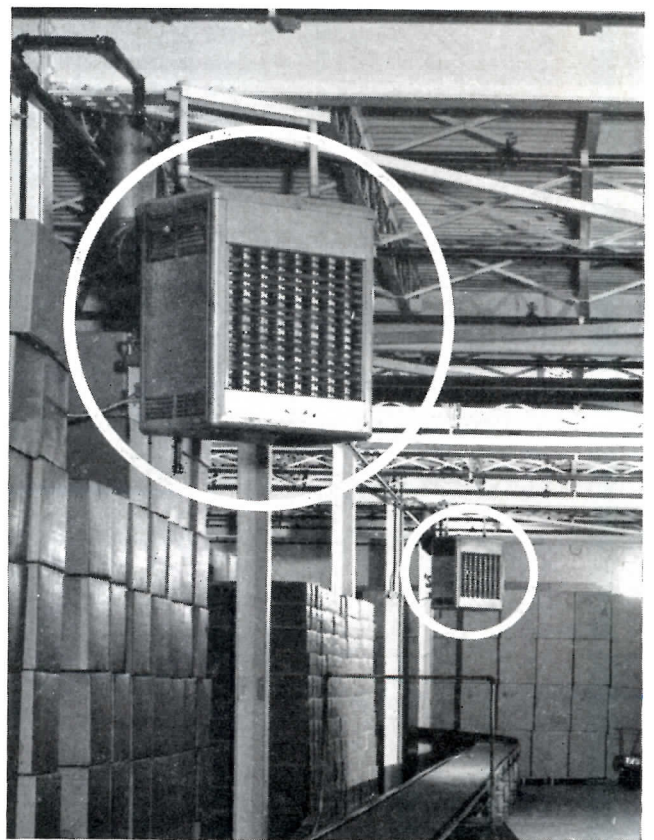

AT THE OHIO ART COMPANY'S plant with over 293,000 square feet of floor space for manufacturing and warehousing, 77 Janitrol unit heaters supply clean, automatic gas heat. As this company's toy manufacturing business grew, additional Janitrols were economically added to keep pace with heating needs. The company says maintenance on their Janitrol units is virtually zero.

JANITROL®

JANITROL HEATING & AIR CONDITIONING DIVISION
SURFACE COMBUSTION CORPORATION
COLUMBUS 16, OHIO

IN CANADA: MOFFAT HEATING & AIR CONDITIONING DIVISION
MOFFATS, LTD., TORONTO 15

Also Makers of Surface Industrial Furnaces, Kathabar Humidity
Conditioning, Janitrol Residential Heating and Cooling Equipment.

THE RECORD REPORTS

ARCHITECTURE ABROAD

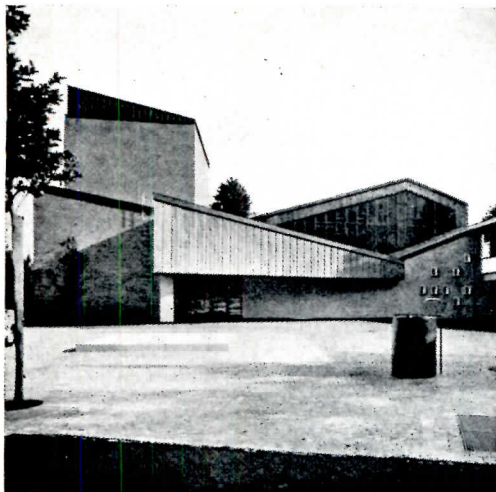

1

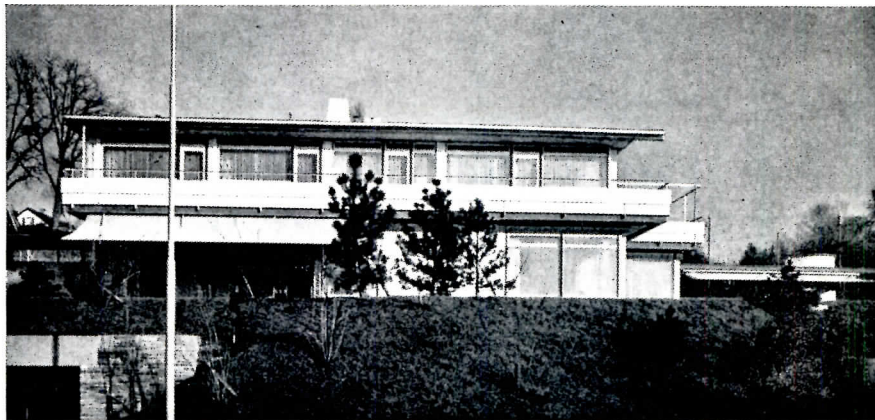

2

SELECTIONS FROM EXHIBIT

1. Theater with hotel and restaurant at Grenchen; Ernest Gisel, Architect. 2. One-family house at Kusnacht; Alfred Roth, Architect. 3. Primary school at Hergiswil; W. H. Schaad and E. Jauch, Architects. 4. Community auditorium at Niederurnen; Hans Leuzinger and Hans Howald, Architects

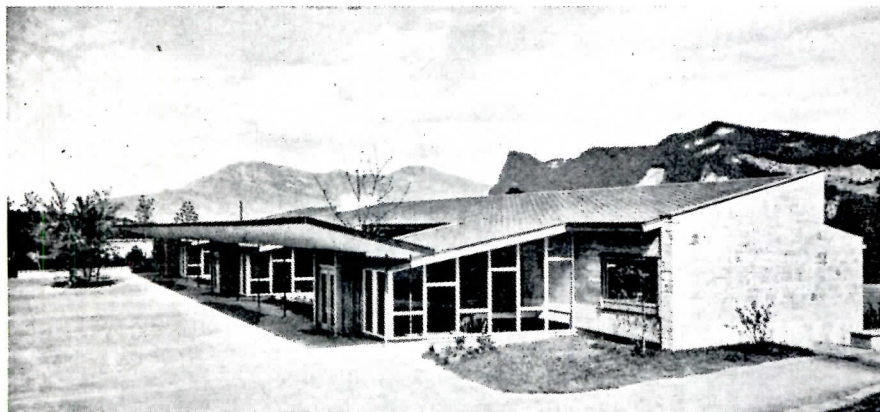

3



4

POSTWAR SWISS ARCHITECTURE ON VIEW IN NEW EXHIBIT

The U. S. gets its first good look at postwar achievements of Swiss architecture and design in the exhibit "Good Design in Switzerland," organized and designed by Architect Alfred Altherr, director of the Swiss Werkbund, and currently circulating in this country under the auspices of the Traveling Exhibition Service of the Smithsonian Institution (Washington 25, D. C.).

The exhibition, consisting mainly of photographic enlargements and including a few pieces of jewelry, toys, watches and samples of weaving, is divided into four sections: Planning in the Landscape (airports, roads and bridges and dams); Education, Training, Recreation (schools, theaters, baths and playgrounds); Work (office buildings, factories and industrial products); and Housing (single-family dwellings, apartment houses, interiors, furniture, textiles and appliances).

Swiss architects, like their American

counterparts, have practiced since the war in the context of a record economic boom and intense building activity. In his introduction to the exhibition catalog, Architect Alfred Roth, the current president of the Werkbund, remarks the relationships between American and Swiss design, which he attributes to similarities in the way of life, standards of industrial production and democratic heritage of the two countries. And, he adds, "Both the Americans and the Swiss have a strong feeling for the practical, the useful, and for sound technical execution and good, simple design."

Discussing the historic evolution of Swiss architecture, Mr. Roth notes that it has been influenced at various times and in various parts of Switzerland by German, French, Italian and Austrian sources and never developed as a uniform national style, even before the confusion of ideas and objectives that came

with the technological revolutions of the past century.

The adoption — and effective adaptation — by the Swiss of the principles of modern design was notably served by the organization in 1914 of the Swiss Werkbund, whose members are the leading architects, painters, sculptors, industrial designers, photographers, goldsmiths, potters and textile craftsmen.

"Today," says Mr. Roth, "it can be claimed that modern Swiss architecture is firmly established and has an unmistakably Swiss character. By that I mean the special methods and ways in which we Swiss architects adapt buildings to topography and landscape, develop buildings out of their particular functional requirements, apply our excellent building technique, and finally, aim at fresh and clear expressions of design. We are not interested in the sensational, but in the honest, the simple, the human."

(More news on page 16B)



BORDEN
First IN FLOOR GRATING

BORDEN MANUFACTURES EVERY TYPE FLOOR GRATING

IN FERROUS AND NON-FERROUS METALS

- **EASY TO INSTALL** — engineered in conveniently sized units for easy installation.
- **EXTRA STRONG** — reinforced, designed with maximum safety factor.
- **LIGHT WEIGHT** — approximately 80% open, reduces dead weight, allows greater live load.
- **SELF-CLEANING** — creates greater safety, economy of maintenance, no sweeping or washing required.

Write for complete information on BORDEN All/Weld, Pressure Locked, and Riveted Floor Gratings in this FREE 8-page catalog

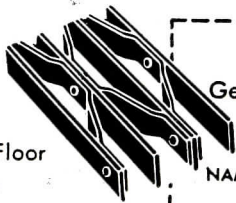

BORDEN METAL PRODUCTS CO.

822 GREEN LANE Elizabeth 2-6410 ELIZABETH, N. J.
SOUTHERN PLANT—LEEDS, ALA. — MAIN PLANT—UNION, N. J.

BORDEN METAL PRODUCTS CO.

Gentlemen:

Please send me BORDEN Catalog

NAME

TITLE

COMPANY NAME

ST. AND NO.

CITY AND STATE

ARCHITECTURAL RECORD NOVEMBER 1957 17

eliminates "breathing," stays clean

Custom Minaboard presents no maintenance problems. It can be cleaned with a vacuum cleaner or damp cloth. It can be repainted by conventional methods when necessary without appreciable loss of acoustical efficiency.

Your Armstrong Acoustical Contractor can give you complete data and specifications on this newest addition to the extensive line of Armstrong Acoustical Materials. For a free booklet on Custom Minaboard, write to Armstrong Cork Company, 4211 Rock Street, Lancaster, Pennsylvania.

Armstrong ACOUSTICAL CEILINGS

Cushiontone® • Travertone* • Arrestone®
Minatone® • Corkoustic® • Crestone®

Custom Minaboard*

NUCLEAR ENERGY AND THE DESIGN PROFESSIONS

West Coast Meeting Considers Present Problems and Future Potentials: A Special Report, by RECORD Senior Associate Editor Elisabeth Kendall Thompson, on a Joint Meeting of the Coast Valleys Chapter, A.I.A., and the San Jose Chapter, A.S.C.E., First Published in the Northern California A.I.A. Bulletin

Architects and engineers have much to contribute to the rapidly developing nuclear field, but two things stand in the way of their immediately accomplishing much. The first is that they are not as yet informed enough to tackle the problems of this new field and to provide creative answers to its highly specialized needs. The other is that the people who build the buildings in this field — boards of directors in private industry, govern-

and chairman of the Northern California Chapter's committee. On the panel were Ashton O'Donnell, manager for nuclear developments, Stanford Research Institute; Dr. Ralph Bennett, director, General Electric Vallecitos Atomic Laboratory at Pleasanton; Professor T. Y. Lin, A.S.C.E., Department of Civil Engineering, University of California; Dr. Hayden Gordon, A.S.M.E., chief engineer, University of California Radiation

been designed into the building. Several Bay area commercial firms manufacture accelerators for industrial and research application, and small reactors especially designed for use in instruction and training courses but adaptable to production of short lived isotopes and hence of potential value in hospitals, industrial and small research laboratories. Other firms manufacture radiological controls for personnel monitoring, offer radiographical services (for irradiation of materials or for inspection of castings), and provide waste disposal service.

Merchant shipping companies are furthering work on a reactor-propelled merchant ship at the same time that the Navy is building an atomic-powered submarine at Mare Island. Research on weapons development is under way at

a WASHINGTON report by Ernest Mickel

COLLEGE BUILDING 1956-1970: SURVEY YIELDS PRELIMINARY COST AND STRUCTURAL DATA

New details of future construction plans of U. S. institutions of higher learning are emerging from the continuing tabulation by the U. S. Office of Education of its College and University Facilities Survey, which has indicated an estimated expenditure for 1956-1970 construction of \$5.5 billion (AR, Aug. 1957, page 16). Some of the latest figures — still, however, "preliminary" — are shown in the accompanying tables.

Among types of construction, it will be noted, reinforced concrete (not unexpectedly) leads the field — it will build 1821 of the 6071 projects throughout the U. S. on which such information was provided by survey respondents. Next in incidence: masonry walls, steel construction (1587); load-bearing masonry walls, steel construction (1059); load-bearing masonry walls, wood construction (220); and reinforced concrete lift-slab construction (209).

The preliminary estimated cost summaries, which give an average per-sq-ft cost for the U. S. as a whole of \$20 for "instructional facilities" and \$17.20 for residential facilities, reflect the wide regional variations in construction costs. Per-sq-ft residential costs, for example, range from the \$14.70 average of estimates for the South to the \$19.30 average of Northeast estimates; and the range can be even wider within regions; compare Wyoming's \$11.20 with California's \$22.70, or Alabama's \$11.90 with the District of Columbia's \$19.60.

(Continued on page 332)

PRELIMINARY FIGURES from the College and University Facilities Survey of the U. S. Office of Education provide data on 1956-1970 plans of U. S. higher education institutions. Tables at right and below, covering both public and private institutions, are excerpted from preliminary summaries by Office of Education

ESTIMATED COST BY REGION AND STATE	INSTRUCTIONAL		RESEARCH		RESIDENTIAL	
	No. of units	Cost per sq ft	No. of units	Cost per sq ft	No. of units	Cost per sq ft
Aggregate U. S.	2058	\$20.00	177	\$26.00	1713	\$17.20
Northeast	384	23.80	23	26.20	375	19.30
Connecticut	20	18.60	2	21.30	17	19.10
Maine	18	18.20	—	—	11	16.80
Massachusetts	36	17.10	3	33.70	44	17.40
New Hampshire	6	18.20	1	6.00	7	18.00
New Jersey	37	19.50	—	—	22	19.90
New York	155	25.70	13	27.90	140	19.10
Pennsylvania	90	25.10	4	25.60	109	20.00
Rhode Island	17	16.20	—	—	15	21.70
Vermont	5	29.50	—	—	10	18.00
North Central	560	20.40	50	22.90	509	17.30
Illinois	54	18.80	13	17.90	72	17.10
Indiana	71	21.80	2	36.30	53	19.70
Iowa	24	18.70	3	19.30	28	17.50
Kansas	50	17.60	1	17.00	45	15.00
Michigan	76	24.30	10	27.90	47	19.20
Minnesota	24	19.10	5	20.80	37	15.90
Missouri	47	18.10	3	23.60	47	11.10
Nebraska	22	11.60	2	20.00	18	16.30
North Dakota	12	15.60	2	16.80	19	17.00
Ohio	100	20.80	3	20.80	76	19.20
South Dakota	16	15.40	—	—	19	14.90
Wisconsin	64	20.50	6	23.70	48	20.00
South	606	15.90	34	20.20	552	14.70
Alabama	51	14.10	1	71.40	42	11.90
Arkansas	14	19.10	1	25.70	16	17.30
Delaware	1	35.40	—	—	5	24.90
Florida	42	17.40	2	20.50	20	14.80
Georgia	43	18.90	2	18.90	35	12.70
Kentucky	29	17.70	1	8.30	41	16.70
Louisiana	28	21.10	4	17.60	46	15.20
Maryland	33	19.10	4	8.40	22	15.80
Mississippi	33	12.00	—	—	31	11.80
North Carolina	31	17.80	3	17.50	50	14.80
Oklahoma	55	16.60	2	18.00	25	14.60
South Carolina	14	14.30	5	16.60	26	13.90
Tennessee	38	9.70	—	—	55	12.40
Texas	133	16.00	5	18.40	73	16.00
Virginia	33	11.40	2	18.30	33	15.80
West Virginia	8	24.50	—	—	22	17.80
District of Columbia	20	10.80	2	32.60	10	19.60
West	475	20.70	69	32.10	254	18.10
Arizona	20	16.30	—	—	19	15.30
California	278	24.50	49	36.10	92	22.70
Colorado	25	17.10	2	17.40	23	16.70
Idaho	6	14.80	1	8.90	7	15.00
Montana	7	11.30	—	—	14	15.60
Nevada	8	8.20	3	20.50	3	14.90
New Mexico	31	13.80	4	19.30	31	11.80
Oregon	33	17.10	1	18.00	25	16.30
Utah	16	16.80	—	—	8	16.10
Washington	49	18.60	9	20.30	31	19.30
Wyoming	2	15.40	—	—	1	11.20

TYPE OF CONSTRUCTION	AGGREGATE U. S.		NORTHEAST		NORTH CENTRAL		SOUTH		WEST	
	No. of bldgs.	Cost (in thousands)	No. of bldgs.	Cost (in thousands)	No. of bldgs.	Cost (in thousands)	No. of bldgs.	Cost (in thousands)	No. of bldgs.	Cost (in thousands)
Wood frame	80	\$ 15,497	12	\$ 1,167	9	\$ 1,305	16	\$ 1,075	42	\$ 11,779
Wood frame, brick veneer	138	70,107	27	14,338	30	32,281	54	6,599	26	14,570
Load-bearing masonry walls, wood constr.	220	71,179	39	9,325	36	22,662	76	15,002	68	23,873
Load-bearing masonry walls, steel constr.	1059	592,884	244	163,512	319	182,660	390	179,056	106	67,656
Masonry walls, steel construction	1587	1,625,870	453	612,913	438	447,844	527	372,148	159	140,517
Reinforced concrete constr. (lift-slab)	209	190,904	32	37,456	55	44,888	54	29,727	61	71,476
Reinforced concrete construction	1821	2,077,732	274	306,211	466	617,693	460	403,583	564	658,657
Quonsets and temporary steel buildings	10	798	1	50	3	366	4	157	2	225
Other construction	146	55,736	12	5,103	25	8,429	52	14,020	54	27,914
Types of construction not reported	801	673,452	199	190,260	285	268,951	213	104,904	94	72,561

ALL-WEATHER FLOOR for Terminal Traffic



Color shown:
V-319, Coralite

Vina-Lux® FLOORS

WITH *Micromatic Veining*

Air, rail or bus traffic all begin with *foot* traffic — lots of it. Rugged and durable, Vina-Lux reinforced vinyl-asbestos tile withstands this punishment. Spilled foods, grease, muddy tracks present no problems, either. Tightly-textured Vina-Lux is easy to clean, economical to maintain.

And now, Vina-Lux with the subtle styling of *Micromatic veining* brings new beauty to busy floors — suggests dramatic design techniques for modern terminals. Specify Vina-Lux — solve tough floor problems. Reduce the cost per square foot per year. Samples are yours on request.



AZROCK FLOOR PRODUCTS DIVISION

UVALDE ROCK ASPHALT COMPANY

517A FROST BANK BUILDING • SAN ANTONIO, TEXAS



UNVEIL MASTER PLAN FOR MONTREAL'S PLACE VILLE MARIE

A master plan by I. M. Pei and Associates of New York City for a 21-acre business, commercial and entertainment center in the heart of Montreal (AR, Jan. 1957, page 36) has been made public by Webb and Knapp (Canada) Ltd., developers, and Canadian National Railways, owners of the site. In the first stage of development, which it is expected will get under way almost immediately, Webb and Knapp would lease about a third of the site to build "Place Ville Marie," a commercial complex set on a spacious plaza and dominated by a 40-story glass and metal skyscraper (also designed by I. M. Pei) which would be the tallest and largest building in Canada. In latter stages, additional office and parking facilities and a great transportation center for the area would be built; in this phase, C.N.R. said Webb and Knapp would "have no option or preference" with respect to the area but "will have equality of opportunity" in submitting proposals for its development.

The three-block site covered by the overall master plan, in the very heart of downtown Montreal, is bounded by Cathcart, University, St. Antoine and Mansfield-Inspector streets—the area around C.N.R.'s central station and above its tracks. The block to be developed by Webb and Knapp in the first phase is bounded by Mansfield, Cathcart, University and Dorchester streets. The proposed plaza, to be reserved for pedestrian traffic, will connect with St. Catherine Street by a tree-lined mall, extending the line of a widened McGill College Avenue and creating a vista terminating in the distance in the outline of Mount Royal. The master plan takes into consideration long-standing plans of the City of Montreal for widening of McGill College Avenue, Cathcart, Mansfield and University Streets.

Future developments proposed by the plan include a 20-story office building, a large five-story C.N.R. general office building, with parking for 900 cars on three levels beneath; a three-story transportation center to integrate all rail, air, bus and automobile facilities in the terminal area, with a roof designed as a helicopter landing area; and a two-way moving sidewalk, capable of handling 7200 people per hr in each direction, running along the spine of the whole terminal area, joining all three blocks.

(More news on page 40)

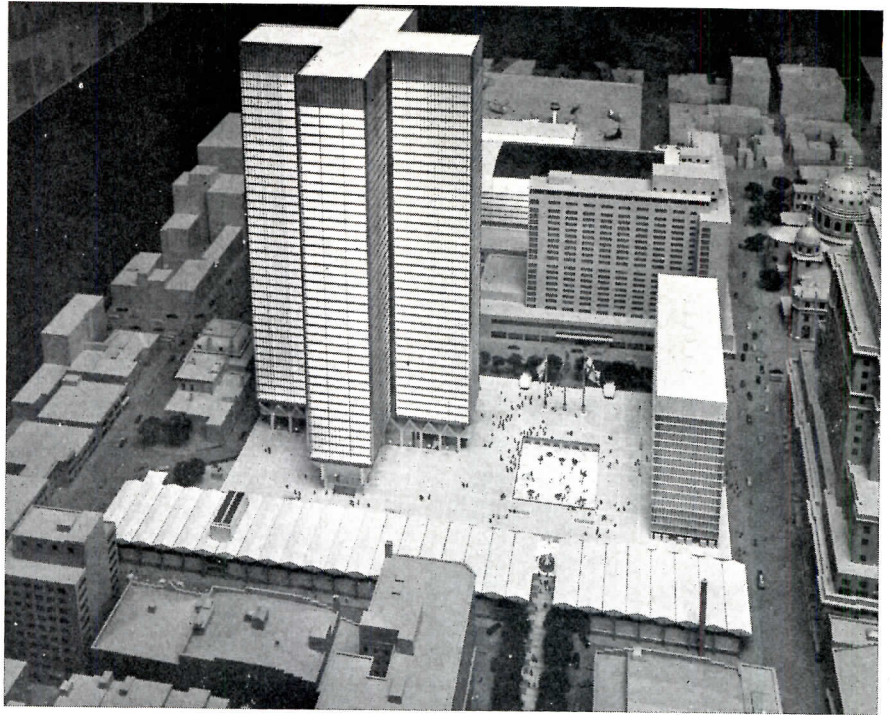

Master plan for development of 21-acre site around CNR Central Station in Montreal (overall view of model below) would begin with construction of "Place Ville Marie" complex (above) dominated by 40-story glass and metal office building which would be the tallest in Canada and including two-story shopping and theater building (foreground), 15-story office building (right) and sunken open air skating

rink and restaurant. CNR's Queen Elizabeth Hotel, now nearing completion, is in right background. View below looks north to Place Ville Marie, shows proposals for later construction — transportation center with helicopter landing area on roof (foreground); CNR general offices (convex-roofed building in center); and (opposite skyscraper) 20-story office block, with Queen Elizabeth Hotel at its left

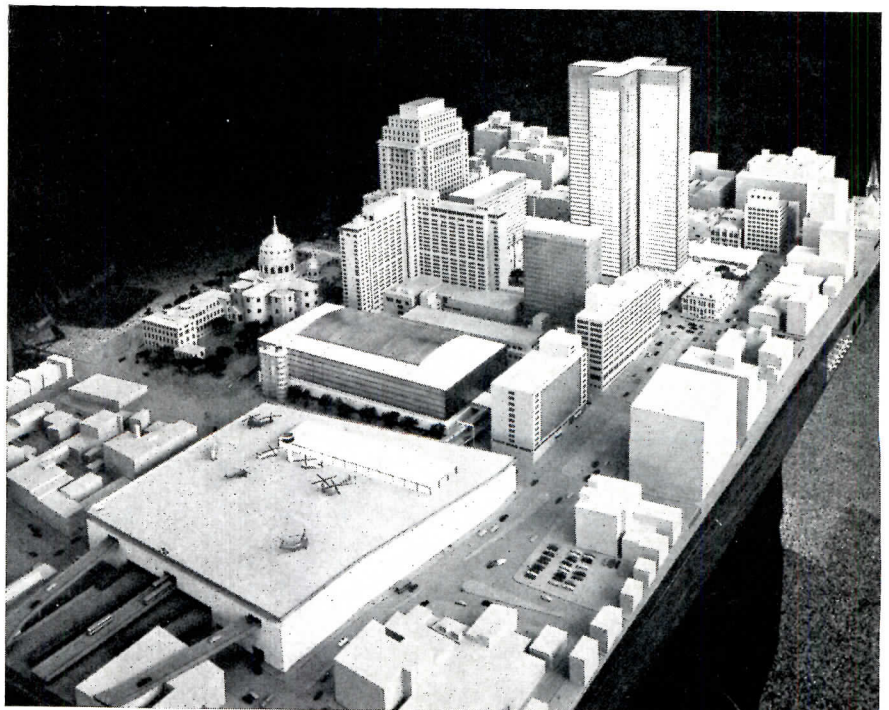

DELIVERED



IN NO TIME AT ALL!

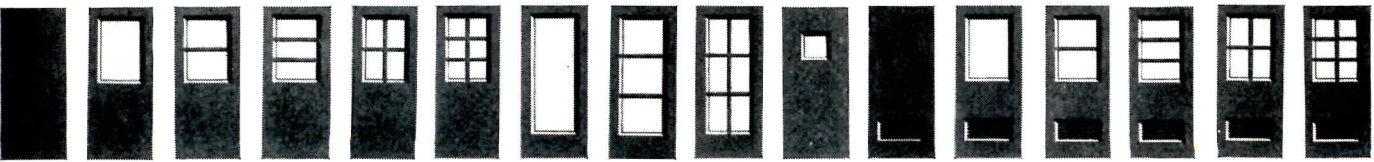
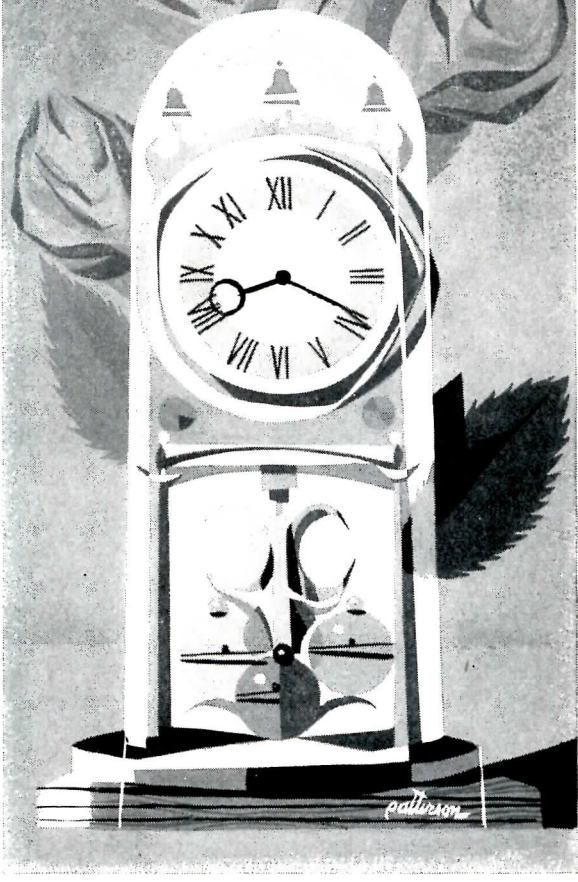

16 Basic Types. Over 200 type-and-size combinations of swing and sliding doors, featuring the completely flush door.

For commercial, industrial and institutional requirements, AETNAPAK types and sizes meet a wide variety of design, structural and installation requirements.

Avoid custom engineering delay. Specify AETNAPAK in-stock door-and-frame packages, complete with hardware. Send for full facts now.

AETNA STEEL PRODUCTS CORPORATION

730 Fifth Avenue, New York 19, New York Dept.-2-L

Please send detailed information on: AETNAPAK Custom Quality Stock Steel Doors, Frames and Hardware.

Individual _____

Firm _____

Street _____

City _____ Zone _____ State _____

THE RECORD REPORTS

NEWS FROM CANADA

(Continued from page 36)

VANCOUVER CHURCH DESIGNED TO MEET CHALLENGE OF SITE

In this project for the Highlands United Church, North Vancouver, B. C., reports architect R. William Wilding, "the site conditions provide a real opportunity to design a rather dramatic group of buildings, since it is deeply cut into by a year-round-running creek. The

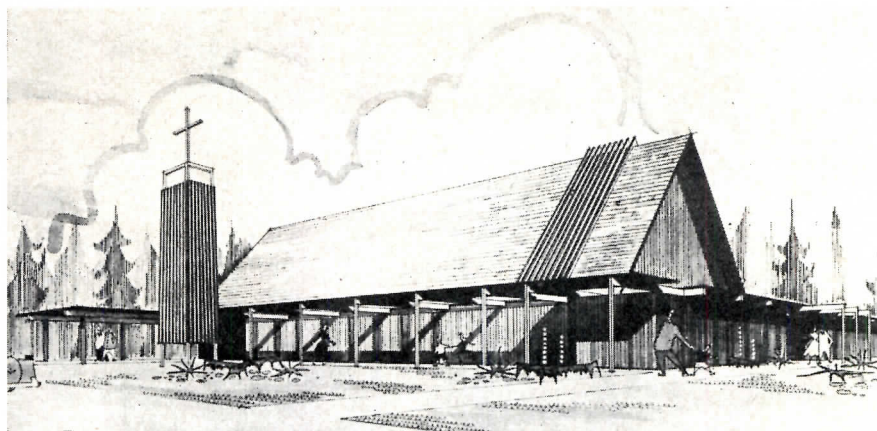

IT Floats!

Specially engineered and compounded GRS resilient pads are fabricated to underside of sleepers to cushion the floor and prevent sleepers from contacting slab.

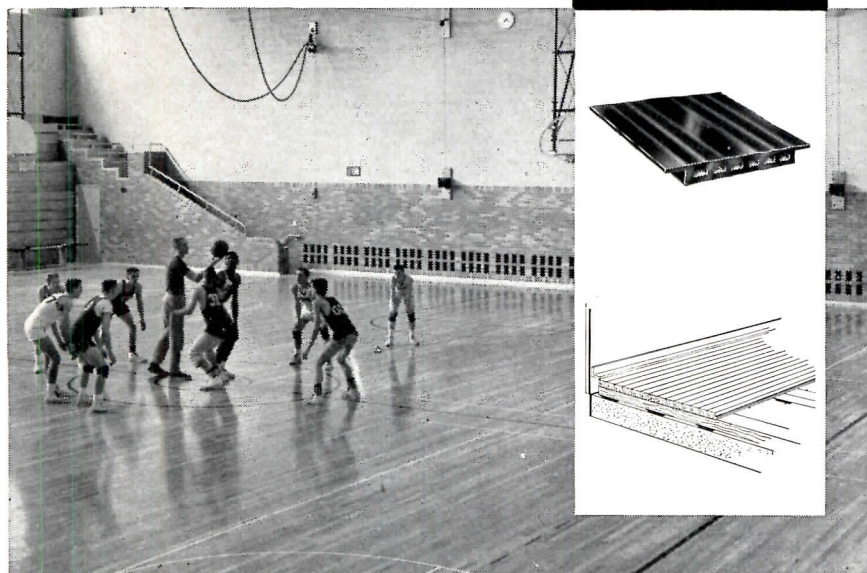

new permaCushion floor floats on resilient pads*

That's right, this floor floats. It's entirely separated from the slab and all other structural members. It actually rests on air channeled GRS cushioned pads to assure permanent resiliency and to prevent moisture transmission from slab to sleepers. With these pads and the void between flooring and wall, the floor system expands and contracts without buckling or cupping and achieves a degree of dimensional stability unmatched by virtually any other floor!

PermaCushion floor systems offer other benefits, too: the natural beauty and durability of hard rock maple, dry, cross-ventilated subfloor and remarkable long-run economy. When planning a gymnasium or auditorium, consider the advantages of the PermaCushion free-floating floor system. For details, write Robbins Flooring Company, Reed City, Michigan. Attn: Dept. AR-1157.

Available vacuum-treated with preservative by Dri-Vac method.

ROBBINS FLOORING COMPANY

Manufacturers of Ironbound* Continuous Strip* Maple Floors

*T.M. Reg. U.S. Pat. Off.

Reed City and Ishpeming, Michigan

two floors have ample light and ventilation with a view overlooking the wooded creek. The lower floor contains parish hall, Sunday School rooms, kitchen, lounge and heating room. The upper floor has the sanctuary, seating 350, with choir for 25 set to one side of chancel. Minister's study, church office and choir rooms and multi-purpose room are located at the rear of the chancel. Design features red cedar on all exterior walls, cedar decking on flat and pitched roofs and glulam arches in sanctuary. Special lighting effect is obtained with tinted cathedral glass in the sanctuary."

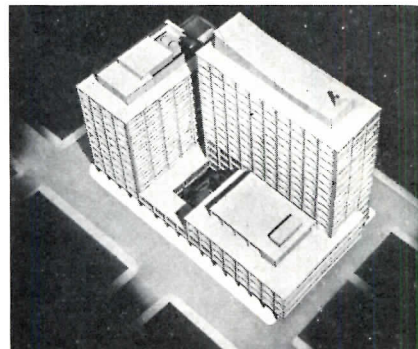

\$10 MILLION FEDERAL UNIT IS ANNOUNCED FOR TORONTO

The largest and the second costliest Federal building ever erected in Canada has been announced for Toronto; Shore & Moffat are the architects. To be known as the Mackenzie Building, the structure will occupy two thirds of a city block and measure 160 by 300 ft at the ground floor, extending upward in twin towers 12 and 15 stories high. Estimated cost is \$10 million. The center of the ground floor has been designed as a large open landscaped court accessible and visible from all three bounding streets and containing a central glazed block to house escalators and elevators. Structure is steel with exterior skin of porcelain enamel and anodized aluminum above a base of black granite. The new building will house the Post Office Department and other government offices.

(Continued on page 44)

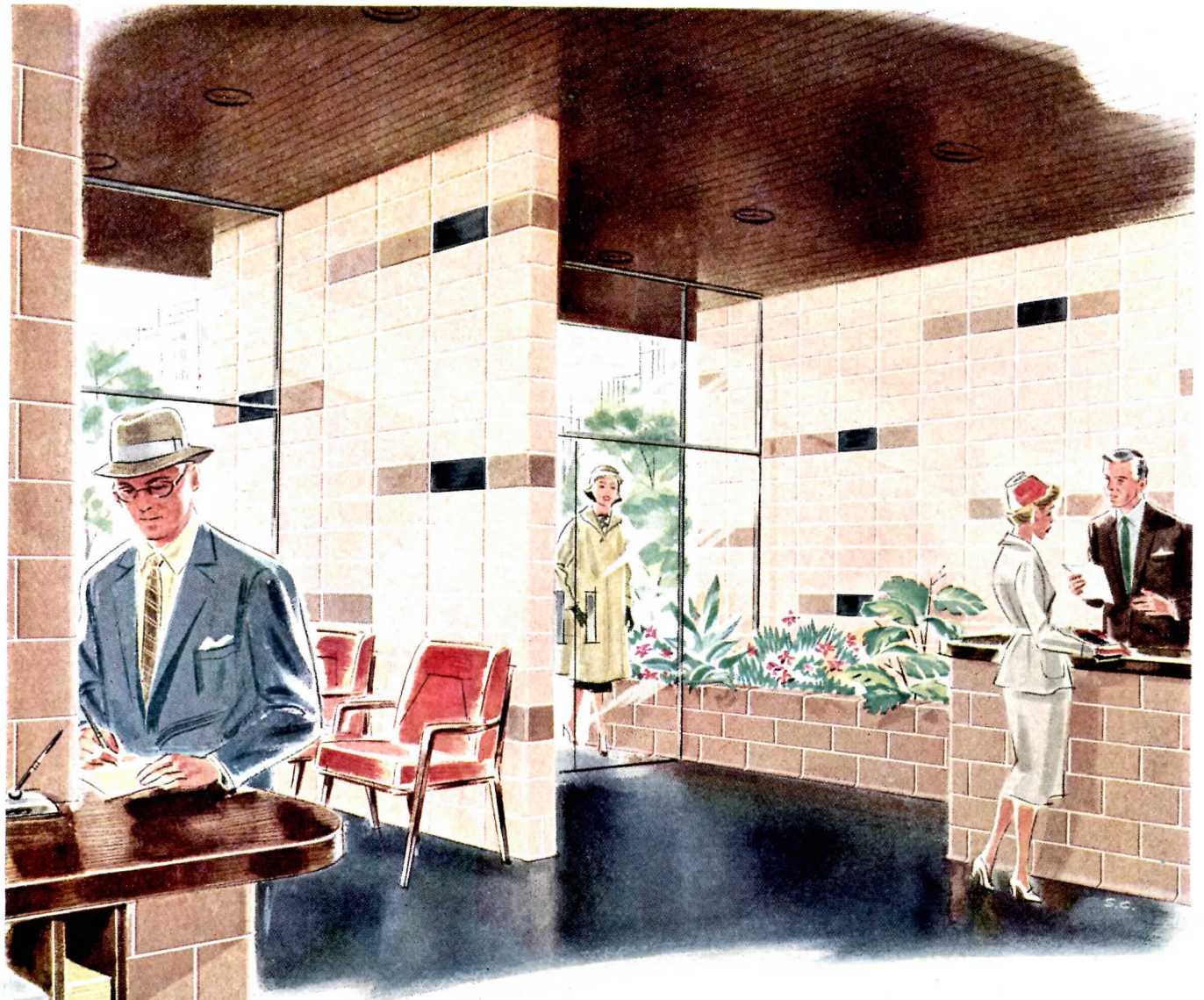

imitations never match genuine
STRUCTURAL CLAY FACING TILE

THERE IS NO "SUBSTITUTE"... Only Clay Facing Tile gives your clients advantages they want in structural walls, partitions and veneers. The most economical and durable walls in the world for schools, hospitals, commercial and industrial structures. Rich, permanent colors and smooth surfaces clean sparkling new with soap and water.

First cost is low. Modular sizes lay up fast. A single material and a single trade. Elimination of maintenance insures tremendous savings over the years.

Now—with increased production and faster deliveries, it's professionally wise to remember—*there is no substitute for genuine* Structural Clay Facing Tile.

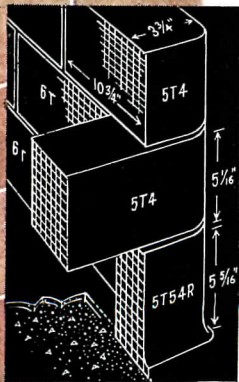

FACING TILE INSTITUTE

2556 Clearview Avenue, N. W., Glendale 5-5329, Canton 8, Ohio
 1520 18th Street, N. W., Hudson 3-4200, Washington 6, D. C.
 1949 Grand Central Terminal, Murray Hill 9-0270, N. Y. 17, N. Y.
 228 N. LaSalle Street, Randolph 6-0578, Chicago 1, Ill.



This seal is your assurance of highest quality Facing Tile.

In the interest of better Facing Tile construction these companies have contributed to this advertisement. CHARLESTON CLAY PRODUCTS CO., Charleston 22, W. Va. • THE CLAYCRAFT CO., Columbus 16, Ohio • MAPLETON CLAY PRODUCTS CO., Canton, Ohio • METROPOLITAN BRICK, INC., Canton 2, Ohio • McNEES-KITTANNING CO., Kittanning, Pa. • NATCO CORPORATION, Pittsburgh 22, Pa. • STARK CERAMICS, INC., Canton 1, Ohio • WEST VIRGINIA BRICK CO., Charleston 24, W. Va.

THE RECORD REPORTS NEWS FROM CANADA

(Continued from page 40)

Flying Dutchman Motel, Kitchener, Ont. — on a heavily traveled highway between Windsor and Toronto. Cost, \$250,000. Architects, Bragman & Hamann of Toronto

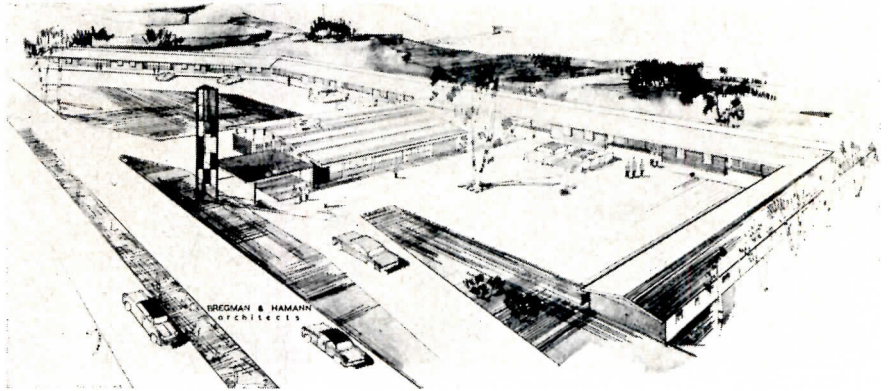

Monarch Door

Sold thru installing dealers only

SECTIONAL OVERHEAD DOORS

COMMERCIAL
AND
INDUSTRIAL
DOORS



Monarch Sectional Overhead Doors can be installed in any industrial plant, wherever an opening is available, interior or exterior. Monarch Sectional Overhead Industrial Doors are the finest that experience and engineering skill can produce. They are usually BIG doors, involving elements of operation and safety that only real "Know-How" can successfully master. Hundreds of such doors, including some of the largest ever built, furnish evidence that MONARCH means the ultimate in efficiency, safety and satisfaction.

Various types of MONARCH Sectional Doors and equipment involved in their construction and use are described in our 45 Page Catalog. Yours for the asking.

New York Office
400 West St.
Telephone WAtkins 4-6511

Manufactured by

THE MONARCH DOOR, INC.
FOLSOM, PENNA.

CONSULTING ENGINEERS IN CONCURRENT SESSION

The second phase of the annual meeting of the Association of Consulting Engineers of Canada Inc. (the first, including elections, was held in Montreal in February), occurred at the Banff Springs Hotel coincident with the annual meeting of the Engineering Institute.

Action was taken to set up a new, tri-province Prairie Chapter of the Association. N. Lawrence was named chairman, R. O. McLellan secretary, and E. H. Davis (Alberta), W. G. Mackay (Saskatchewan) and J. Sumner (Manitoba) councillors.

One hundred members and guests attended the annual dinner. Afterwards, matters relating to membership and activities were discussed. Vice President J. G. Frost of Montreal, took the chair in the absence in England of President James F. MacLaren.

ARCHITECTS CHOSEN BY THE LUCK OF THE DRAW

An unorthodox method of choosing an architect to design a \$200,000 office and warehouse was repeated recently in Hamilton, Ont.

At a dinner tendered by the company, Frank Doyle, vice president, merchandising division, Canadian Pittsburgh Industries Ltd., drew the name from a paint can. In the can were the names of a group of Hamilton architects, all members of the Hamilton Chapter of the Ontario Association of Architects.

Architects William R. Souter & Associates, whose name was drawn, were commissioned to design and supervise erection of the 25,000-sq ft branch office and warehouse.

Canadian Pittsburgh has used this method of choosing architects for many of its branch buildings. It has 50 warehouses, four paint plants, two mirror

(Continued on page 46)

How high velocity provides maximum comfort for schools

The *Anemostat All-Air High Velocity* system of draftless air distribution offers many important advantages for heating and ventilating schools. ● High velocity units, used with smaller than conventional ducts, save space and money. They substantially reduce sheet metal required, can be installed faster, at less cost. Since there are no coils in All-Air HV units, clogging and odors are eliminated. ● *Anemostat All-Air HV* operate entirely with air processed in the main equipment room; there is, therefore, no need to break through the walls of the building for prime air make-up. The *Anemostat All-Air HV* units eliminate fans, filters, and electric motors in the school rooms. Units are quiet, need a minimum of maintenance from custodians. ● On these pages are typical installations in which the *Anemostat All-Air High Velocity* system has been used successfully. Application data on your specific school heating, ventilating or air conditioning problem is available from Anemostat representatives or from the home office.

Write on your business
letterhead for your copy of

New Anemostat[®] *Selection Manual 60*

to Anemostat Corporation of America,
10 East 39th Street, New York 16, N. Y.

AC 1356

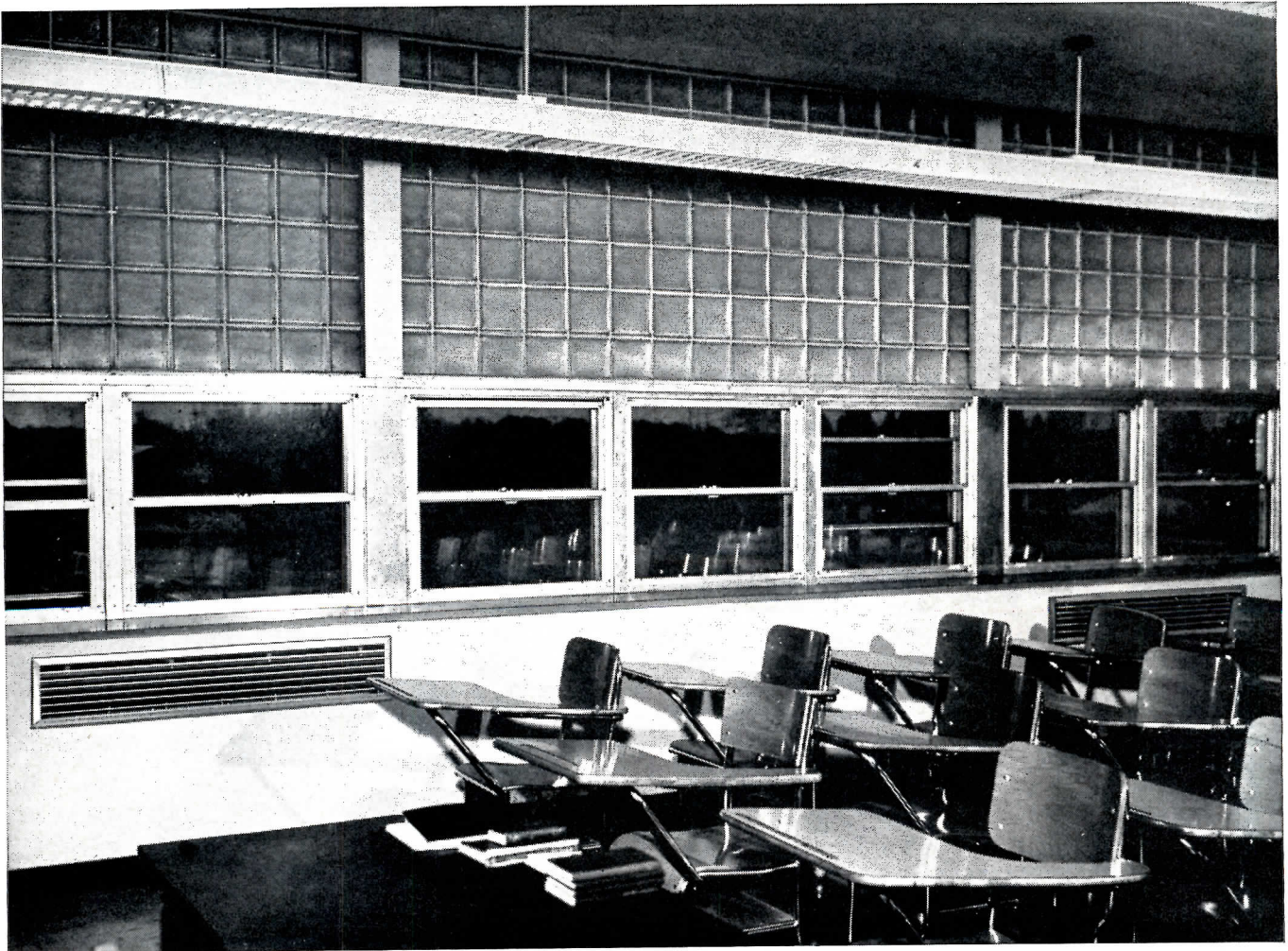

"Hey, let's speed up this line!"

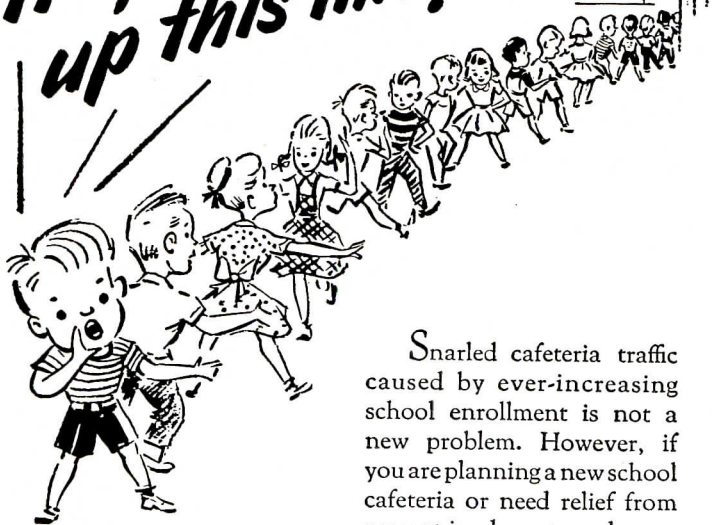

Snarled cafeteria traffic caused by ever-increasing school enrollment is not a new problem. However, if you are planning a new school cafeteria or need relief from present inadequate and over-

loaded facilities, it will pay you to consult your "Custom-Bilt by Southern" Dealer Now! Highly trained specialists in food preparation and serving equipment, they will gladly work with you to help solve your student feeding problems.

SOUTHERN SECTIONAL CAFETERIA COUNTERS

Available for immediate delivery in many different combinations, assembled from selected, matched, functional units of various materials and finishes.

For free catalog, call your "Custom-Bilt by Southern" Dealer or write Southern Equipment Company, 4550 Custine Ave., St. Louis 16, Mo.

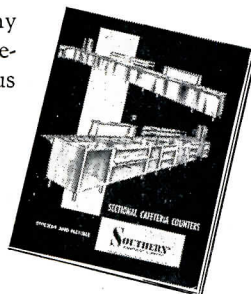

S 84 National Award Winning Installations
SOUTHERN
 EQUIPMENT COMPANY



"CUSTOM-BILT BY SOUTHERN" DEALERS: ALABAMA, BIRMINGHAM—Vulcan Equip. & Supply Co.; MOBILE—Mobile Fixture Co. ARKANSAS, LITTLE ROCK—Krebs Bros. Supply Co. COLORADO, DENVER—Arnholz Coffee & Supply Co. FLORIDA, DAYTONA BEACH—Ward Morgan Co.; JACKSONVILLE—W. H. Morgan Co.; MIAMI—J. Conkle Inc.; ORLANDO—Turner-Haack Co.; ST. PETERSBURG—Staff Hotel Supply Co.; TAMPA—Food Service Equip. & Engr. Corp. GEORGIA, ATLANTA—Whitlock Dobbs, Inc. ILLINOIS, PEORIA—Hertzel's Equip. Co. INDIANA, EVANSVILLE—Weber Equip. Co.; INDIANAPOLIS, MARION—National China & Equip. Corp. IOWA, DES MOINES—Bolton & Hay. KANSAS, WICHITA—Arnholz Coffee & Supply Co. KENTUCKY, LEXINGTON—Heilbron-Matthews Co. LOUISIANA, NEW ORLEANS—J. S. Waterman Co., Inc.; SHREVEPORT—Buckelew Hdw. Co. MICHIGAN, BAY CITY—Kirchman Bros. Co.; DETROIT—A. J. Marshall Co. MINNESOTA, MINNEAPOLIS—Aslesen Co.; ST. PAUL—Joesting & Schilling Co. MISSOURI, KANSAS CITY—Greenwood's Inc. MONTANA, BILLINGS—Northwest Fixture Co. NEBRASKA, OMAHA—Buller Fixture Co. NEW YORK, ALBANY—Lewis Equip. Co. NORTH CAROLINA, ASHEVILLE—Asheville Showcase & Fixture Co.; CHARLOTTE—Hood-Gardner Hotel Supply Corp. NORTH DAKOTA, FARGO—Fargo Food & Equip. Co. OHIO, CINCINNATI—H. Lauber & Co.; CLEVELAND—S. S. Kemp Co.; COLUMBUS—General Hotel Supply; TOLEDO—Rowland Equip. Co. OKLAHOMA, TULSA—Goodner Van Co. PENNSYLVANIA, ERIE—A. F. Schultz Co. SOUTH CAROLINA, GREENVILLE—Food Equipment Co. TENNESSEE, CHATTANOOGA—Mountain City Stove Co.; KNOXVILLE—E. Carleton Scruggs; MEMPHIS—House-Bond Co.; NASHVILLE—McKay Cameron Co. TEXAS, AMARILLO—Arnholz Coffee & Supply Co.; CORPUS CHRISTI—Southwestern Hotel Supply, Inc.; SAN ANTONIO—Southwestern Hotel Supply, Inc. UTAH, SALT LAKE CITY—Restaurant & Store Equip. Co. VIRGINIA, RICHMOND—Ezekiel & Weiman Co. WEST VIRGINIA, CLARKSBURG—Parson-Souders Co. WISCONSIN, MILWAUKEE—S. J. Casper Co.

THE RECORD REPORTS NEWS FROM CANADA

(Continued from page 44)

plants, one metal plant and a window glass plant located across Canada.

"It's the fairest way we know of to choose our architects, because architects are among our best friends," Mr. Doyle said.

ENGINEERS LAUNCH EFFORT TO UPGRADE TECHNICIANS

Six successful applicants for status as engineering technicians received their certificates from Premier Leslie Frost of Ontario last June 5.

A campaign to raise the standards of engineering technicians was launched by the Association of Professional Engineers of Ontario at its last convention. The idea is believed to be original, and is being studied in other provinces and the U. S.

There are approximately 20,000 technicians in Ontario who are eligible for official recognition. Successful applicants are certified by a board affiliated with the Association of Professional Engineers. The panel of examiners is composed of five members, two from the staff of Ryerson Institute of Technology and three from industry.

Premier Frost said that there is great interest in the program because it will help employers choose competent persons for specific jobs. "Skilled men without formal engineering education have played a full part in the development of the province," he said.

Contracts Awarded: Comparative Figures

(in \$ million)

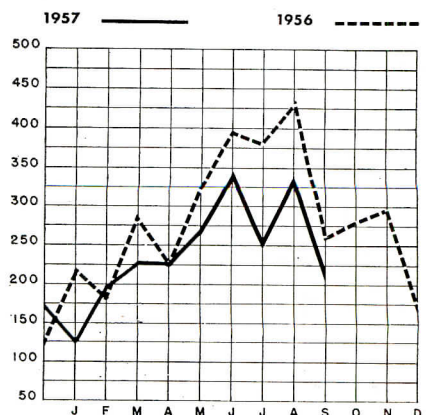

*Compiled by the Editor and staff of The Building Reporter, from information collected by Maclean Building Reports

(More news on page 48)



IBM's Handsome Washington Offices Comfort Conditioned By *Marlo*

At IBM's handsome offices in Washington, D. C., comfort never takes a holiday, with Marlo equipment on duty around the calendar.

Summer cooling and winter heating in this modern structure are provided by three types of Marlo equipment: three multi-zone air conditioners, the versatile units that can perform several different conditioning functions simultaneously; a remote room unit, horizontal recessed style; and an evaporative condenser.

Mechanical contractor on the project was John C. Grimberg Company. Architect was John Hans Graham & Associates, general contractor was Blake Construction Company, and mechanical engineer was Shefferman & Luchenburg.

Write today for complete information on the Marlo quality line of air conditioning and heat transfer equipment.

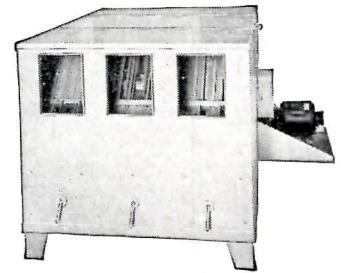

MULTI-ZONE UNIT

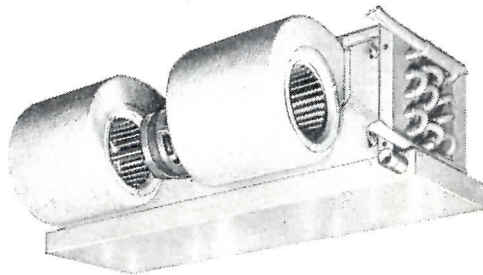

REMOTE ROOM UNIT

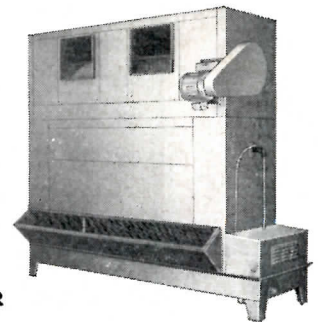

EVAPORATIVE CONDENSER

MARLO

coil co.

SAINT LOUIS 10, MISSOURI

Quality Air Conditioning and Heat Transfer Equipment Since 1925

THE RECORD REPORTS: CONSTRUCTION COST INDEXES

Labor and Materials

U. S. average 1926-1929 = 100

Presented by Clyde Shute, manager, Statistical and Research Division, F. W. Dodge Corp., from data compiled by E. H. Boeckh & Assocs., Inc.

NEW YORK

ATLANTA

Period	Residential		Apts., Hotels Office Bldgs. Brick and Concr.	Commercial and Factory Bldgs. Brick and Concr.		Brick and Steel	Residential		Apts., Hotels Office Bldgs. Brick and Concr.	Commercial and Factory Bldgs. Brick and Steel	
	Brick	Frame		Brick and Concr.	Brick and Steel		Brick	Frame		Brick and Concr.	Brick and Steel
1930	127.0	126.7	124.1	128.0	123.6		82.1	80.9	84.5	86.1	83.6
1935	93.8	91.3	104.7	108.5	105.5		72.3	67.9	84.0	87.1	85.1
1939	123.5	122.4	130.7	133.4	130.1		86.3	83.1	95.1	97.4	94.7
1946	181.8	182.4	177.2	179.0	174.8		148.1	149.2	136.8	136.4	135.1
1947	219.3	222.0	207.6	207.5	203.8		180.4	184.0	158.1	157.1	158.0
1948	250.1	251.6	239.4	242.2	235.6		199.2	202.5	178.8	178.8	178.8
1949	243.7	240.8	242.8	246.6	240.0		189.3	189.9	180.6	180.8	177.5
1950	256.2	254.5	249.5	251.5	248.0		194.3	196.2	185.4	183.7	185.0
1951	273.2	271.3	263.7	265.2	262.2		212.8	214.6	204.2	202.8	205.0
1952	278.2	274.8	271.9	274.9	271.8		218.8	221.0	212.8	210.1	214.3
1953	281.3	277.2	281.0	286.0	282.0		223.0	224.6	221.3	221.8	223.0
1954	285.0	278.2	293.0	300.6	295.4		219.6	219.1	233.5	225.2	225.4
1955	293.1	286.0	300.0	308.3	302.4		225.3	225.1	229.0	231.5	231.8
1956	310.8	302.2	320.1	328.6	324.5		237.2	235.7	241.7	244.4	246.4
June 1957	316.5	306.5	329.8	341.8	335.4		239.8	238.0	246.1	249.4	251.6
July 1957	321.0	310.7	336.8	349.5	344.6		243.6	241.3	252.0	255.6	258.8
Aug. 1957	321.0	310.7	336.8	349.5	344.6		243.6	241.3	252.0	255.6	258.8
Aug. 1957	% increase over 1939			% increase over 1939			% increase over 1939			% increase over 1939	
	159.9	153.8	157.7	162.0	164.9		182.3	190.4	165.0	162.4	173.3

ST. LOUIS

SAN FRANCISCO

1930	108.9	108.3	112.4	115.3	111.3	90.8	86.8	100.6	104.9	100.4	
1935	95.1	90.1	104.1	108.3	105.4	89.5	84.5	96.4	103.7	99.7	
1939	110.2	107.0	118.7	119.8	119.0	105.6	99.3	117.4	121.9	116.5	
1946	167.1	167.4	159.1	161.1	158.1	159.7	157.5	157.9	159.3	160.0	
1947	202.4	203.8	183.9	184.2	184.0	193.1	191.6	183.7	186.8	186.9	
1948	227.9	231.2	207.7	210.0	208.1	218.9	216.6	208.3	214.7	211.1	
1949	221.4	220.7	212.8	215.7	213.6	213.0	207.1	214.0	219.8	216.1	
1950	232.8	230.7	221.9	225.3	222.8	227.0	223.1	222.4	224.5	222.6	
1951	252.0	248.3	238.5	240.9	239.0	245.2	240.4	239.6	243.1	243.1	
1952	259.1	253.2	249.7	255.0	249.6	250.2	245.0	245.6	248.7	249.6	
1953	263.4	256.4	259.0	267.0	259.2	255.2	257.2	256.6	261.0	259.7	
1954	266.6	260.2	263.7	273.3	266.2	257.4	249.2	264.1	272.5	267.2	
1955	273.3	266.5	272.2	281.3	276.5	268.0	259.0	275.0	284.4	279.6	
1956	288.7	280.3	287.9	299.2	293.3	279.0	270.0	288.9	298.6	295.8	
June 1957	292.6	284.2	295.9	307.8	303.4	287.3	275.0	303.5	316.2	310.2	
July 1957	293.0	284.6	297.0	308.3	306.1	289.7	278.9	306.1	318.4	314.8	
Aug. 1957	293.0	284.6	297.0	308.3	306.1	288.3	276.8	305.0	318.0	314.2	
Aug. 1957	% increase over 1939			% increase over 1939			% increase over 1939			% increase over 1939	
	165.9	166.0	150.2	157.3	157.2	173.0	178.8	159.8	160.9	169.7	

Cost comparisons, as percentage differences for any particular type of construction, are possible between localities, or periods of time within the same city, by dividing the difference between the two index numbers by one of them; i.e.:
 index for city A = 110
 index for city B = 95
 (both indexes must be for the same type of construction).

Then: costs in A are approximately 16 per cent higher than in B.

$$\frac{110-95}{95} = 0.158$$

Conversely: costs in B are approximately 14 per cent lower than in A.

$$\frac{110-95}{110} = 0.136$$

Cost comparisons cannot be made between different types of construction because the index numbers for each type relate to a different U. S. average for 1926-29.

Material prices and wage rates used in the current indexes make no allowance for payments in excess of published list prices, thus indexes reflect minimum costs and not necessarily actual costs.

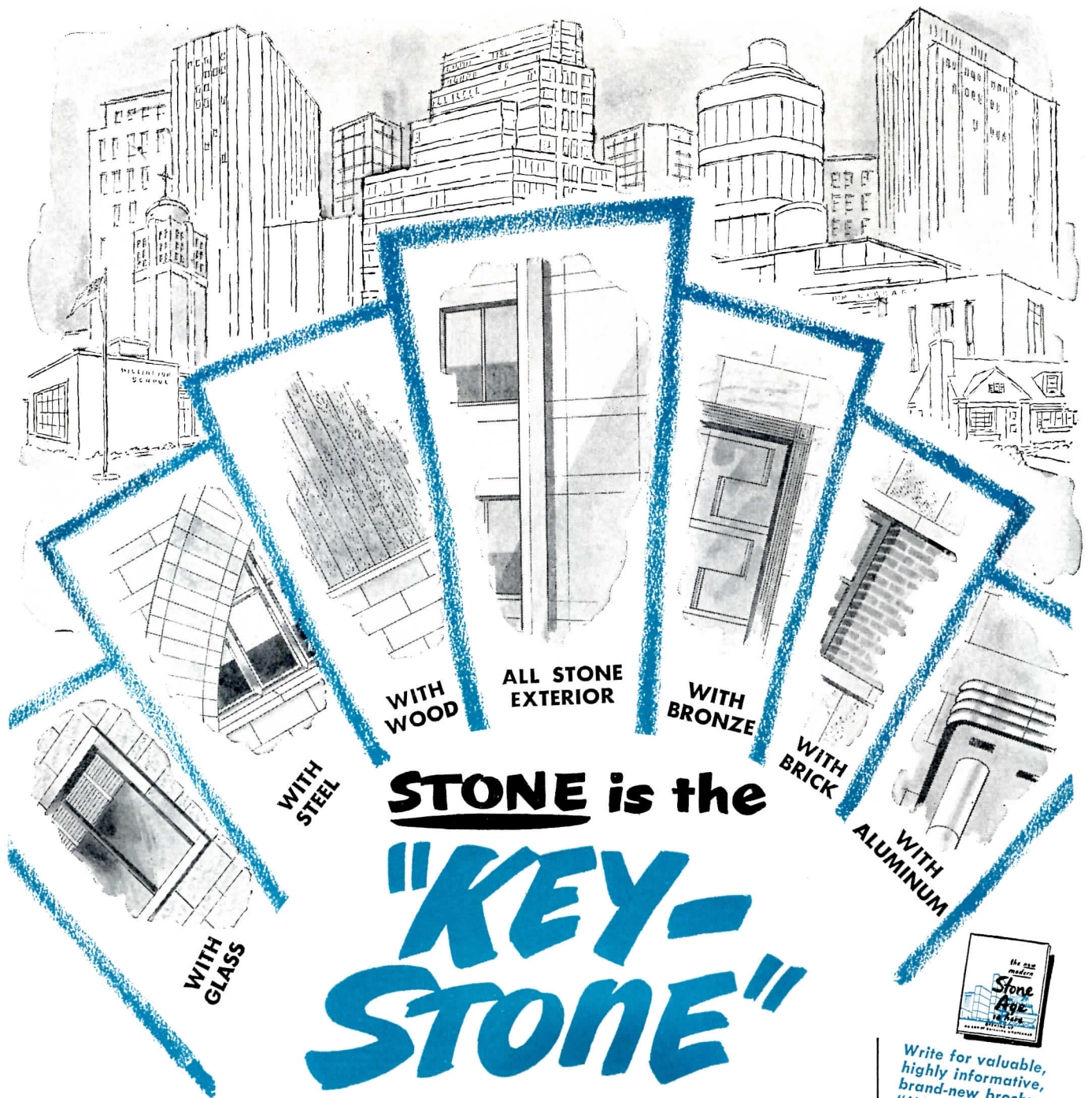

WITH WOOD
ALL STONE EXTERIOR
WITH BRONZE

WITH BRICK

WITH ALUMINUM

WITH STEEL

WITH GLASS

STONE is the "KEY-STONE"

**for NEW HORIZONS
in Contemporary Architecture**



Write for valuable, highly informative, brand-new brochure, "MODERN STONE AGE IS HERE." It's packed with new suggestions—yours for the asking.

Cut to any dimensions or split "as your imagination demands it"...natural stones possess limitless ranges of color and texture—lasting beauty! Permanent, no maintenance, easily available everywhere!

The Building Stone Institute gladly answers all queries about Natural Stone...its uses, varieties, characteristics... and mails booklets on specific types. See samples of stones in our offices.



420 Lexington Avenue
New York 17, N. Y.

NATURAL STONE IS "NATURALLY COMPATIBLE" WITH OTHER MATERIALS

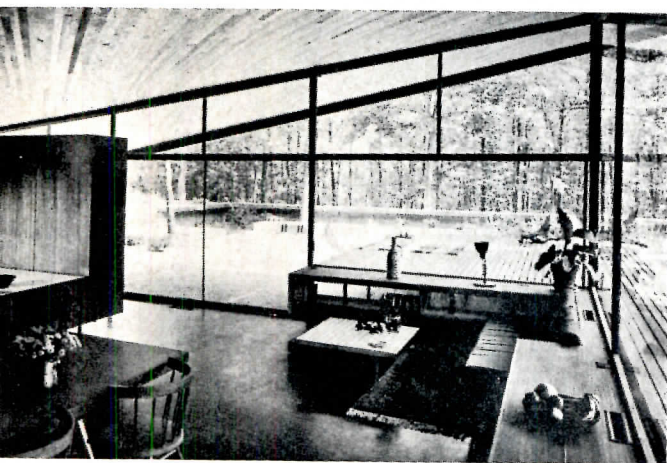

REQUIRED READING

COMPARATIVE INTERIORS

Betty Pepis' Guide to Interior Decoration. Reinhold Publishing Corp. (N. Y.), 1957. 215 pp. illus. \$6.95

Architects and interior decorators are seen carrying on a long-standing but friendly "war" in this interesting book. The strife between the two camps arises from their necessarily different attitudes toward interior decor.

As Miss Pepis herself puts it: ". . . In our own country, the two types of modern design coexist, develop on parallel lines. They satisfy different needs in different personalities. One is essentially sensual, soft, luxurious — this is 'decorator's modern.' The other is sparer but not necessarily sparse; it is more intellectual than emotional, more concerned with the structure than with the surface. This brand of modern (which can be luxurious) is the architect's domain." She adds that their very different training is the primary cause of the gulf between architects and decorators; nevertheless, they

(Continued on page 62)

Glass treatments by designer Edward Wormley, above, and architect Eduardo Catalano, below, "illustrate the intense differences between the . . . points of view."

TOWARD TOTAL PLANNING

Builders' Homes for Better Living. By A. Quincy Jones and Frederick E. Emmons. Reinhold Publishing Corp. (N. Y.) 1957. 220 pp., illus., \$8.95

Architects Jones and Emmons, whose firm in the seven years since its inception has won thirty-two national and regional awards of merit, have set out in this timely book to beat the blight of builder-house look-alikes and dreary suburbias.

It is frankly admitted in the book that (regardless how distasteful the prospect may seem to some architects and sensitive members of the masses) the speculative market for builder houses will probably continue to mushroom along with suburbs.

The authors see valid economic and social reasons for builder developments, so rather than waste words condemning them, they have sought to rid them of some potentially depressing and hazardous aspects by applying sound architectural and town planning principles.

Their proposal is for an early and effective coordination of builder, architect, engineer and site planner. In order to achieve this, they have shown builders, through a variety of examples, the economic value of good planning and good architecture.

(Continued on page 370)



CATERPILLAR ANNOUNCES

Another heavy-duty engine in the world's most advanced line of Diesels

D397	D375	D342	D339	D337	D326	D318 (SERIES G)	D315 (SERIES G)	D318	D315	D311
650 HP†	430 HP†	225 HP†	140 HP†	310 HP†	200 HP†	175 HP†	115 HP†	137 HP†	91 HP†	65 HP†

New D353
390 HP†

Length 75 $\frac{3}{8}$ "
Width 47 $\frac{1}{2}$ "
Height 69 $\frac{1}{4}$ "

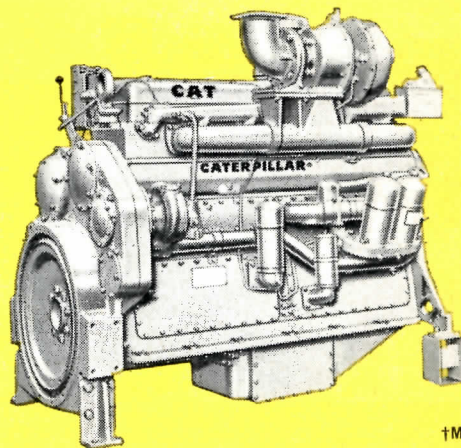

†Maximum output capacity

The engine that delivered outstanding performance in the famous D9 Tractor is now available as the D353 Industrial Engine, Electric Set and Marine Engine. Like all modern CAT* Diesels, the D353 incorporates in its design the advanced features developed by Caterpillar in a quarter century of diesel leadership. Its four-cycle design delivers the long, effective power stroke that puts power to more efficient use than other types of engines. Its fuel system requires no adjustment. There are no cylinder ports to clean. And it operates on a wide range of fuels including premium diesel fuels as well as low-cost No. 2 furnace oil *without fouling*. All these and other features add up to performance that no unit in its power class can match.

With the addition of the D353 to the Caterpillar Engine line, you now have an even wider choice than ever for your requirements. Engines are available up to 650 HP (maximum output capacity) and electric sets up to 350 KW (continuous duty). Either as original or replacement power, there's one among hundreds of different arrangements that exactly meets your needs. Leading manufacturers of machinery can supply these models in the equipment they build.

For complete information about the new D353 and other Cat Diesels, see your Caterpillar Dealer. Let him show you how diesel leadership based on a quarter century of experience can engineer the modern heavy-duty diesels of tomorrow.

The new Cat D353 Engine is a six-cylinder, four-cycle, valve-in-head turbocharged diesel. It is available as an electric set rated at 200 KW (continuous duty) and as a marine engine. A full line of matched attachments is also available — items such as air, electric and gasoline starting systems; clutches; bases; controls and governors; cooling systems and mufflers.

CERTIFIED POWER FOR CAT DIESEL ENGINES

Through the years, Caterpillar Engines have earned a reputation for *honestly rated power*. Now Caterpillar backs this reputation with a *notarized certificate* covering the horsepower capabilities of each engine. You have a right to demand *certified power* when you invest in an engine. You get it when you buy from your Caterpillar Dealer!

Caterpillar Tractor Co., Peoria, Illinois, U. S. A.

CATERPILLAR*

*Caterpillar and Cat are Registered Trademarks of Caterpillar Tractor Co.

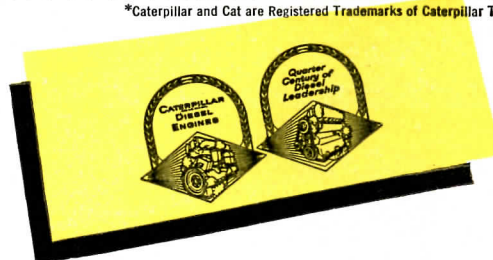

Specify **BURNHAM** Boilers

Since 1873

for heating as modern as your floor plan

Special engineering features give these cast-iron Burnham boilers outstanding fuel efficiency and long life. Vertical Flue Travel over boiler sections studded with hundreds of heat-grabbing fins achieves remarkable heat absorption . . . an 800° drop in flue gas temperatures! Quality materials, painstaking craftsmanship and meticulous factory testing assure dependability. Built-in tankless all-copper heaters provide plentiful year 'round hot faucet water, too. For the same lasting efficiency you design into your structure . . . specify Burnham.

JUBILEE

Wet Base Oil-fired Boiler

Good engineering, including its wet base design, helps this new Burnham cast-iron boiler give the utmost in comfort and economy. Wet base, vertical flue travel and rapid water circulation combine to give high fuel efficiency. Built-in all-copper tankless heater gives plentiful year 'round hot faucet water. Boiler can be installed on combustible floors. Two sizes . . . 445 sq. ft. and 500 sq. ft., net I-B-R ratings. Also available as JUBILEE-PAK pre-packaged boiler. Shipped in extra sturdy crate which has earned the National Safe Transit Label.

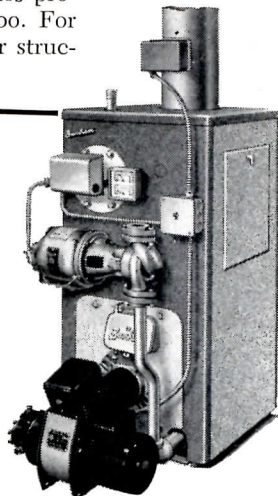

HOLIDAY

Advanced-design Gas-fired Boiler

Give your customers the most advanced design and performance features with HOLIDAY Gas Boiler. Plenty of hot faucet water from built-in Trufin copper tankless heaters is a Burnham "first" in the field. Vertical flue travel means high fuel efficiency. HOLIDAY'S handsome blue and gray two-tone extended jacket gives it beauty to match its performance, too. A wide range of capacities is available . . . from 300 to 1100 sq. ft. water and from 160 to 610 sq. ft. steam, I-B-R net ratings. A.G.A. approved. Also available as HOLIDAY-PAK completely packaged boiler.

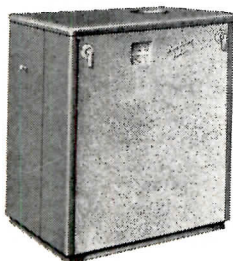

PACE-PAK®

Factory-assembled Oil-fired Boiler

Shipped completely assembled and ready to connect. This means big savings in installation time. Wiring, controls and equipment of this cast-iron oil-fired boiler are engineered, assembled and tested by Burnham. Built-in all copper tankless heaters for hot faucet water are available. Vertical flue travel. Shipped in sturdy skid-bottom crate. Attractive two-tone jacket. Made in capacities of 565 and 810 sq. ft. water, I-B-R net ratings.

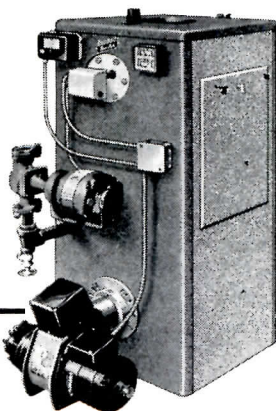

BURNHAM BOILERS WEAR LIKE IRON . . . BECAUSE THEY'RE MADE OF IRON

Burnham
Corporation

HEATING & COOLING DIVISION
IRVINGTON, NEW YORK
FIRST IN THE MANUFACTURE OF BASEBOARD HEATING



MEMBER OF BETTER HEATING — COOLING COUNCIL

Burnham Corporation
Irvington, New York AR-117

Please send me, without obligation, full data and ratings on:

JUBILEE PACE-PAK HOLIDAY

Name _____

Address _____

City _____ State _____

REQUIRED READING

(Continued from page 58)

can learn from each other. Industrial designers fill a middle role, but a minor one, as they rarely do residential interiors.

Actually, Miss Pepis has produced a book that itself could do much to foster mutual respect between architects and decorators. Impartially and thoroughly, she exhibits the work of both in many well-chosen photographs. Her authoritative descriptions set forth the strengths and the weaknesses of the two, as on one page she shows a room by, for instance, Dorothy Draper, and on another, one by John MacL. Johansen. And naturally, the dual talents of men like George Nelson and Eero Saarinen, known for their work in both architecture and design, are celebrated.

Miss Pepis, former home editor for the *New York Times*, now lectures at the New York School of Interior Design. Her wide experience and knowledge have enabled her to make of her book not only a guide, but also a history. A chapter showing changing styles of interior decoration since about 1900 is followed by chapters on various modern room types; furniture fashions and fads; Scandinavian, Italian, and Oriental influences; and the latest trends. In a final section she equates the present gradual modification of "modern" architecture with a new type of interior decoration, one that is eclectic, yet unified by modern colors and textiles.

All in all, Miss Pepis' book will be valuable to anyone who studies it, from architect to decorator to bewildered home owner. In developing taste about interior decoration, it is certainly true, as Miss Pepis says, that "knowledge helps because it presents a point of reference. . . . A sensitive and well-trained eye helps, too, by making one aware of intrinsically good and bad proportions, of use and misuse of decoration." These observations are equally applicable to architecture — as is much else in the book.

On the other hand, Miss Pepis quotes as "the truest axiom of all" the statement: "Taste is more a matter of conversation than conviction." This aphorism definitely applies to interior decoration, but can it be said of taste in architecture as well? Whatever the answer, conviction is likely to arise from the conversations engendered by Miss Pepis' guide.

P. C. F.

(More reviews on page 370)

THE SHAPE OF A HOUSE

IN A TIME of mixed architectural blessings it may be encouraging to reflect that our visual satisfaction in buildings does not derive solely from their shapes. For if it did, ours would be a near-starvation diet. We are fortunate in the sustaining — and distracting — power of size and color and texture, but a whole architecture must deal positively with all the basic visual characteristics, and of them all shape is the most pervading, the most involved in planning and structural decisions, and the most neglected.

Consider the house. The rank-and-file example today is a curious collection of bumps whose contouring in plan and profile distresses the eye and confuses the mind. The usual L-shaped house is as grotesque as an automobile on its side; badly related to its site, inefficient and uneconomical. It is an eroded rectangle; a remnant shape without hope of wholeness and foredoomed along with the T shapes and Split T's and Single Wings and all the unbalanced variations of a tricky offense against a defenseless public. No assortment of lumps and bumps can make these little houses seem larger or finer. They just get funnier.

To aberrations in plan shape add the contorted profiles of the typical Split-level house, an unnatural monstrosity barely justifiable even on a hillside. And for the ultimate in the shapeless and the hopeless regard the rash of miniature Ranch houses (for tiny commuting cowboys). In charity, and in truth, it must be said that the perpetrators of these deformities don't know any better. Nor are they often shown instructive examples. The houses of those who should know better continue to zig and zag and bump and grind across the lawns of suburban America — innocent of rhyme or reason. They widen and narrow as rooms change size (but never find a unifying rhythm); bend to reflect a contour or look at the sun (but make nothing more of the bending); move up and down in seeming response to slope (but level out great adjacent parking areas); detour with reverence around a tree (but then plant ecological strangers). Houses compounded of tentative gestures by haptics who, perceiving fragmentally, design parts without reference to the whole and seem content in achieving the picturesque as a substitute for good design.

Good shapes develop *vitality* from sources unique to their particular building program, and their *unity* through studied response to disciplines of universal ordering. Form and function are interdependent, but never in a fixed sequence. All shapes are generalized to a degree. The problem is to reach that degree at which the shape becomes comprehensible as a shape, and satisfying both in abstract and concrete terms. There are few houses in which this is ever achieved. We are offered the one or the other, and perhaps this must always be. But if we cannot be great we can be simple — that quality is never strained.

John Knox Shear

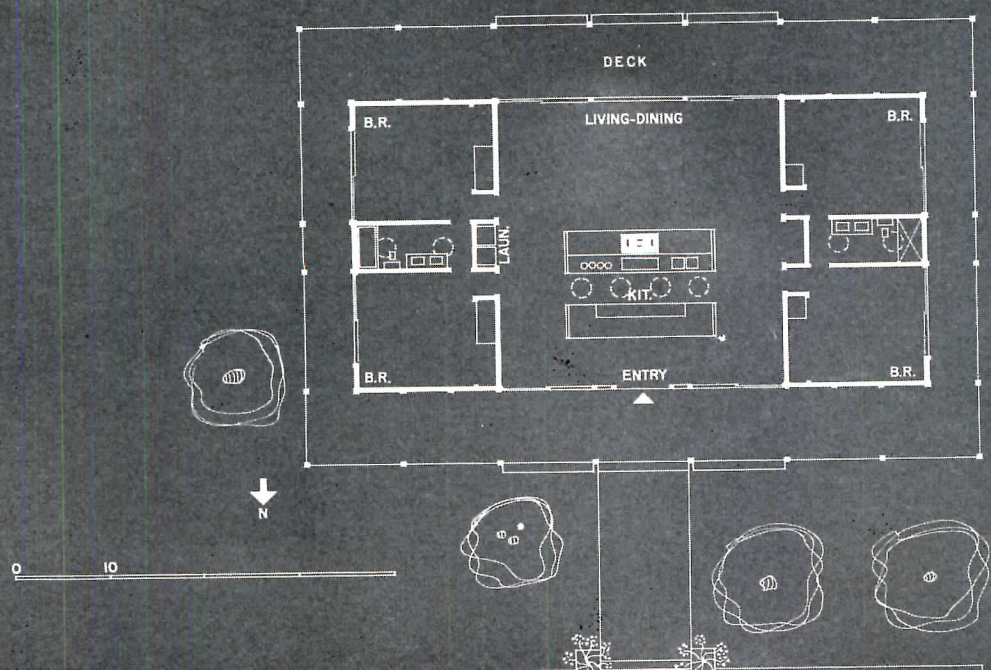

RECTANGULAR HOUSES

1. New Canaan, Connecticut: John Black Lee, Owner and Architect; Paschall Campbell, Landscape Architect

AXIAL SYMMETRY characterizes this small Connecticut house: front and rear façades are identical except for the main entrance; all four bedrooms (one designated as a study) are the same size; the two bathrooms mirror each other; and the chimney marks the center of the building.

Rectangular in plan — as is each of the six houses which follow — the children's bedrooms at one end and the master bedroom and study-guest room at the other are separated by a "commons" area which comprises living and dining room, and kitchen and entrance hall. This large central space measures 31 by 31 ft. has two all-glass walls and a perimeter clerestory. Sliding glass doors give every room in the house direct access to the encompassing veranda. The island kitchen shields the living area from the entry and forms a control center for the entire house.

Construction is wood frame on a poured concrete foundation. Exterior walls are ping pong table tops, painted white; flooring is oak except for tile in kitchen and baths. All interior doors are hollow core flush wood.

Enrichment of rectangle is provided in surrounding veranda whose columns, echoing the verticality of pine trees, contrast pleasantly with horizontal lines of house. Island kitchen serves as space-divider, permits supervision of children and/or entertainment of guests while meals are being prepared

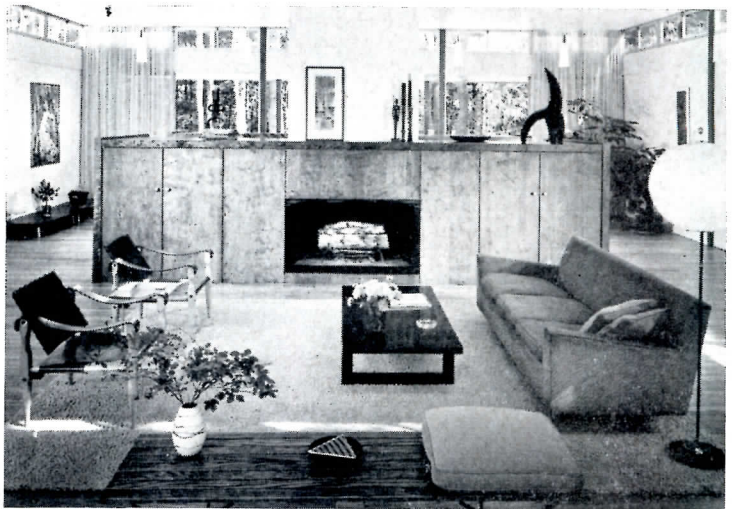
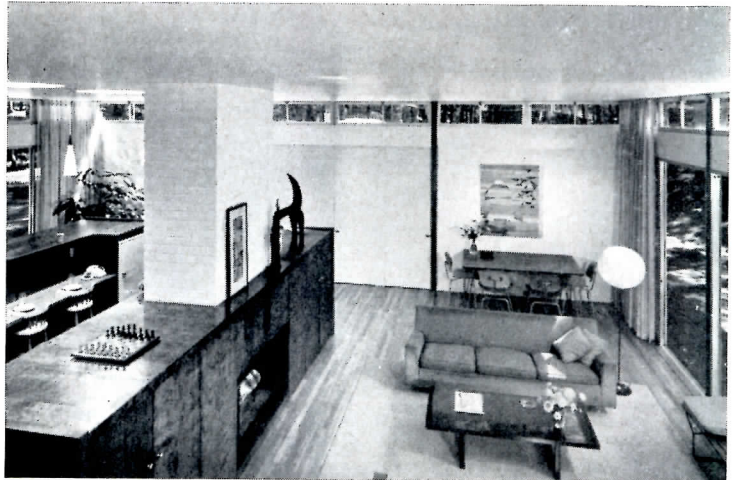
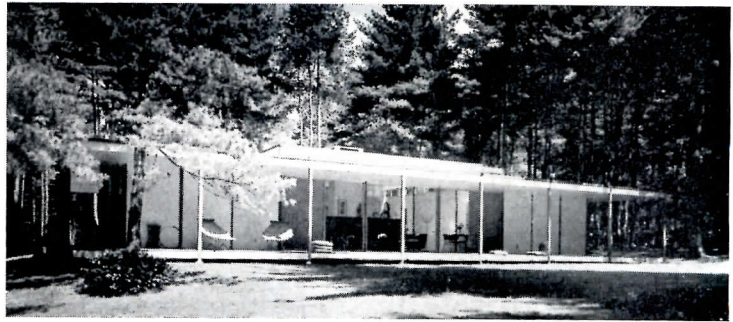

Joseph W. Molitor

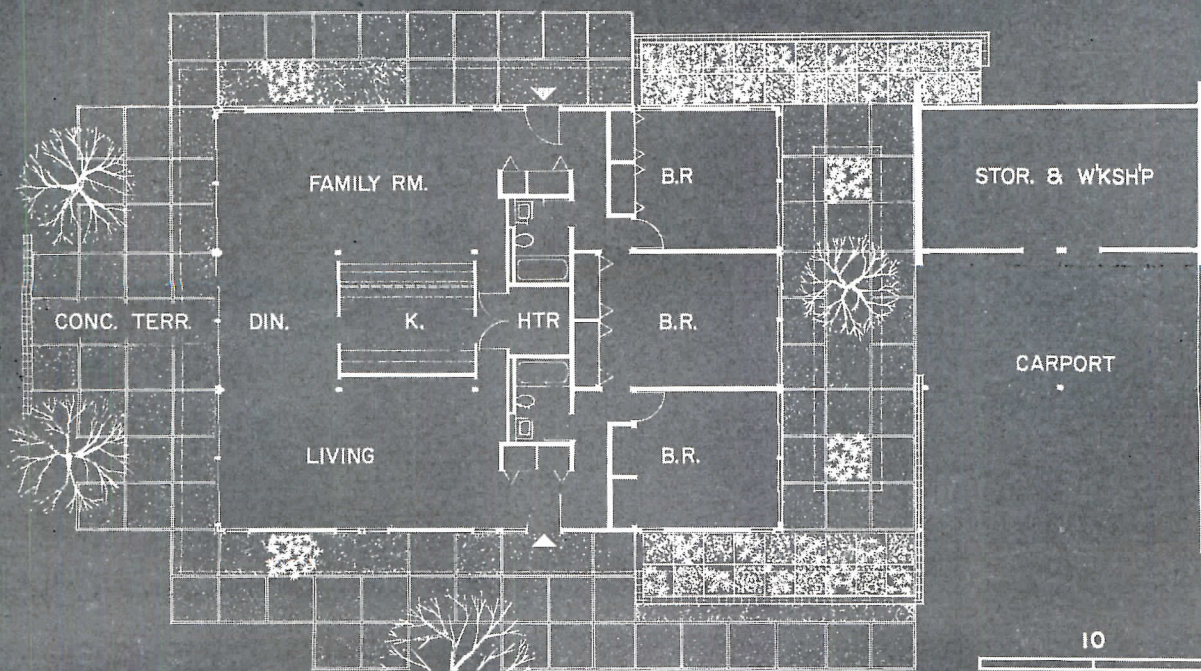

RECTANGULAR HOUSES

2. Lafayette, Indiana: Alcoa Carefree House; Charles M. Goodman, Architect

THIS HOUSE, like the one shown on the two previous pages, has one large living-dining-kitchen area, with the kitchen serving as a space divider. Here, however, the three bedrooms are all on one side of the house and the bathrooms, heater and kitchen form a central utility core. The large main room opens to terraces on three sides, and all bedrooms open to an enclosed patio.

Not unexpectedly since the house was built by Alcoa, aluminum is one of the principal construction materials. The roof is pebble-textured aluminum of batten seam construction, the exterior walls are 12- by 8-ft aluminum-faced panel sections, vertically ribbed and reportedly requiring no more maintenance than an occasional sprinkling with a hose. Exterior and closet doors are also aluminum as are the ornamental grilles over the glass areas, which swing open for easy cleaning.

The central fact in the house, however, is not its skillful use of metal but its use of space. Within the confines of a simple shape it offers a rewarding solution to the problem of reconciling rooms needed with area available.

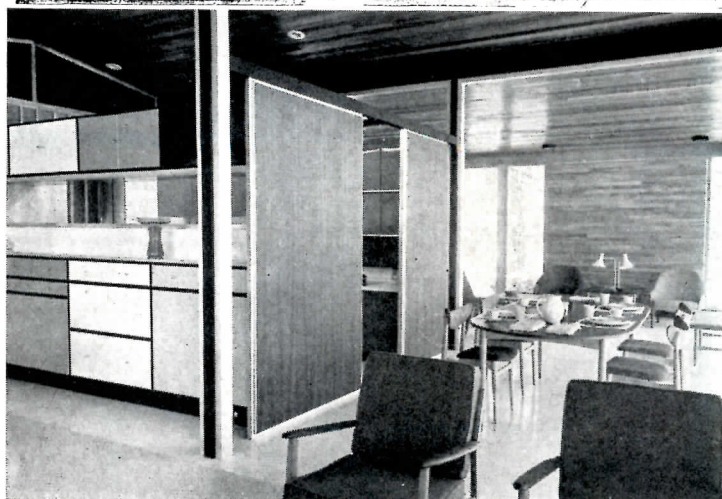
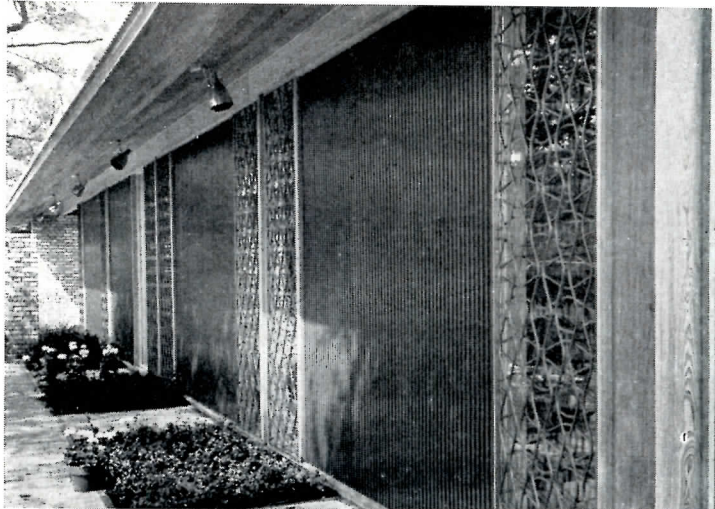
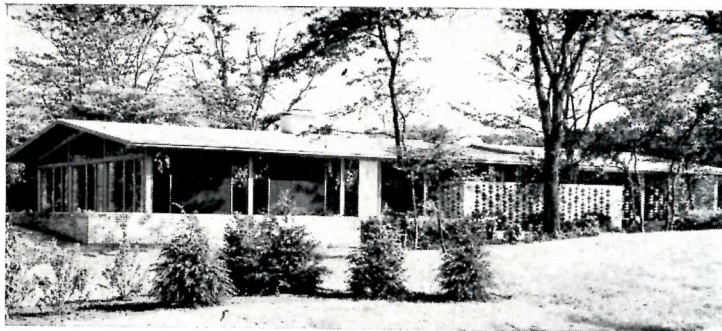

Rectangular plan is varied here by brick-enclosed terraces at front and rear. Bedrooms open to secluded patio and all living areas have adjoining terraces. Kitchen again is an island doubling as space-divider and control center

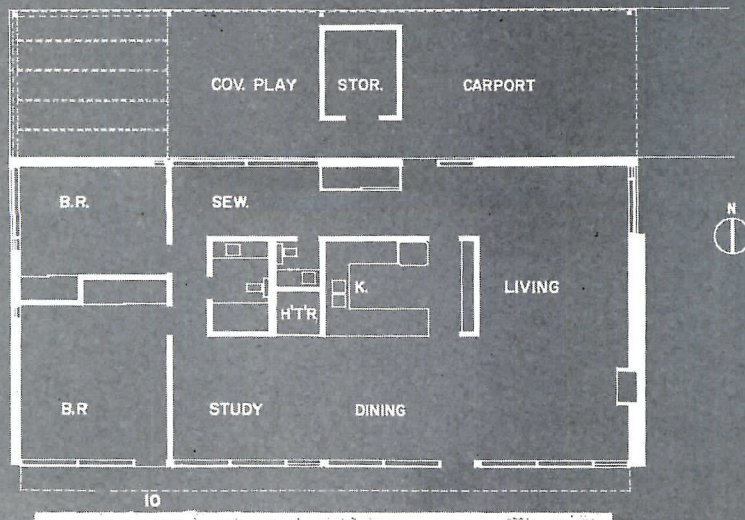
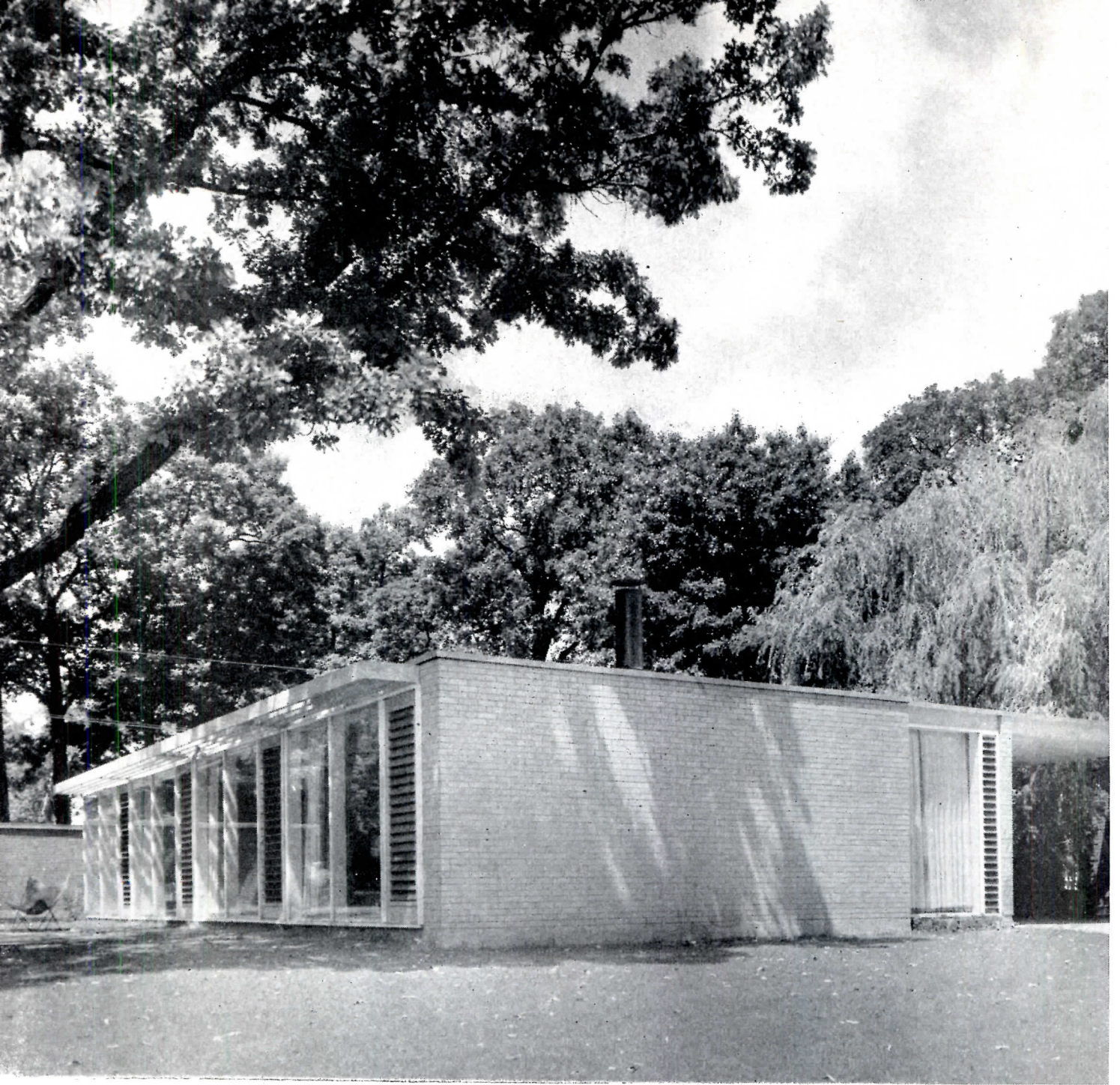

RECTANGULAR HOUSES

3. *Edmond Park, Illinois: Mr. and Mrs. Irving Nuger, Owners; Robert Bruce Tague and Crombie Taylor, Architects*

HERE IS STILL ANOTHER version of the versatile rectangular plan. In this case divided longitudinally into four approximately equal parts: one quarter is used for a master bedroom and a smaller bedroom for the young daughter opening to a covered play area; a utility core consisting of bathroom, lavatory, heater and kitchen occupy the center of the next two quarters, with sewing room and entry on one side, study and dining room on the other; the remaining quarter is the living area. Carport, outdoor play area, storage room and terrace are all under the one continuous roof.

Construction is wood frame with brick veneer (required by zoning code). Ceilings are plaster, interior walls are wood, plaster or brick. Heating is hot water radiant with iron pipe in concrete floor slab; floors are finished in cork or asphalt.

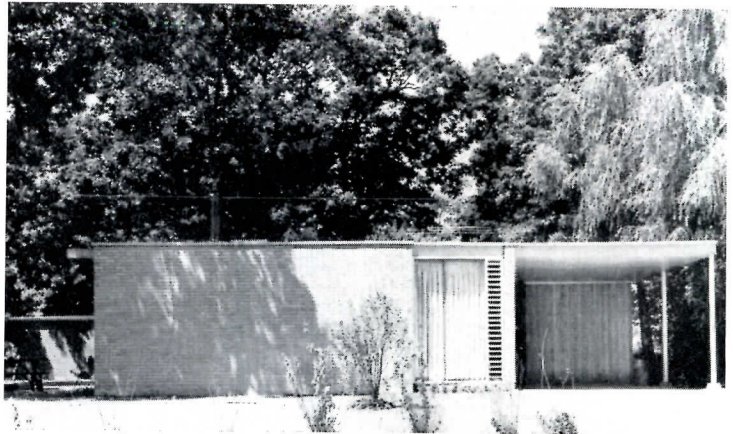
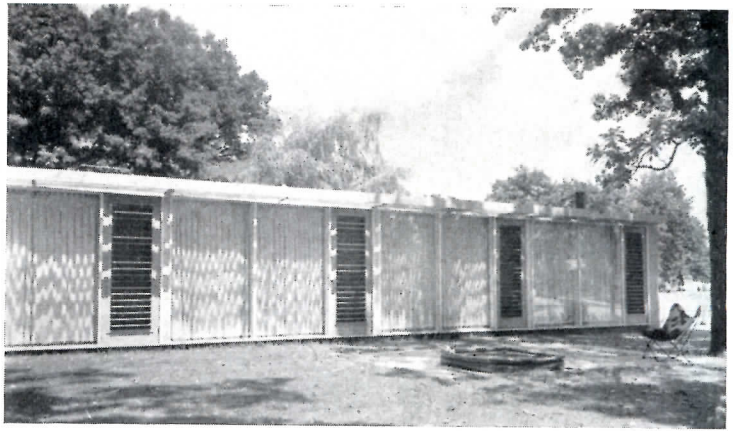

Hedrich-Blessing photo



South wall is floor-to-ceiling insulated glass with ventilating panels of adjustable wood louvers. Study, at one end of L-shaped living-dining area was planned as possible third bedroom with ready access to central bath. Off-center fireplace in living room in effect creates two separate entertainment areas

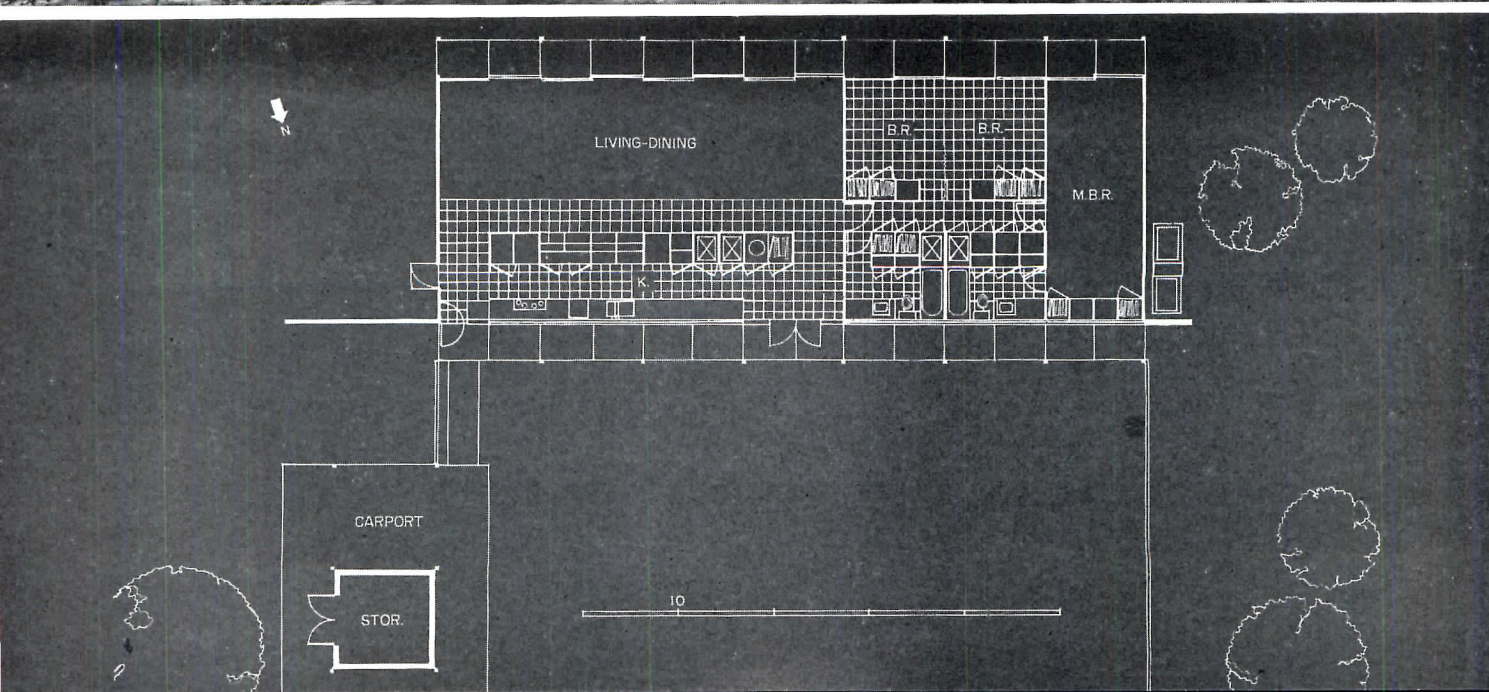

RECTANGULAR HOUSES

4. *Baton Rouge, La.: Mr. & Mrs. E. M. Gladrow, Owners; Short & Murrell, Architects; Barry J. Callari, Associate, Structural Designer*

THE SHAPE of the house here again is the predominant feature of plan and design. Interest is added and symmetry enhanced by the evenly spaced columns, the perfectly centered main entrance, and the adjoining second rectangle consisting of carports and storage room.

The site is a 100- by 200-ft interior lot overlooking a beautiful golf course at the rear. To secure privacy on the street side the entire front wall is stacked limestone masonry units 6 ft 8 in. high with 16-in. fixed glass above. The opposite façade is of sliding glass panels giving every major room a share in the view.

The long lines of the house are emphasized in plan by the unusual treatment of kitchen and storage units: the kitchen is a lengthy corridor, open at both ends, with stove, sink and breakfast bar on one side (the outer wall), cabinets and refrigerator on the other; clothes and storage closets are banked on either side of the bedroom hall. Living room and master bedroom are long and relatively narrow.

Framing is 3-in. square steel columns on 10- by 16-in. centers with 4 by 8 wood beams. Foundation is reinforced concrete slab and footings, roof is built-up and topped by white marble chips. Ceilings are fir plywood, interior doors are flush hollow core.

Projected landscaping, not begun when these photos were taken, will add warmth and color to entrance court (opposite) and rear terrace (top of this page). View-end of long master bedroom (second from top at right) is secondary living area for parents when daughters entertain or vice versa.

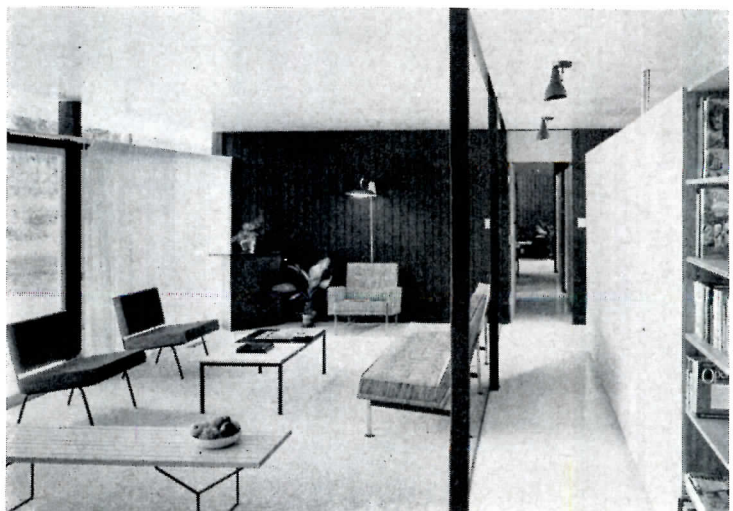
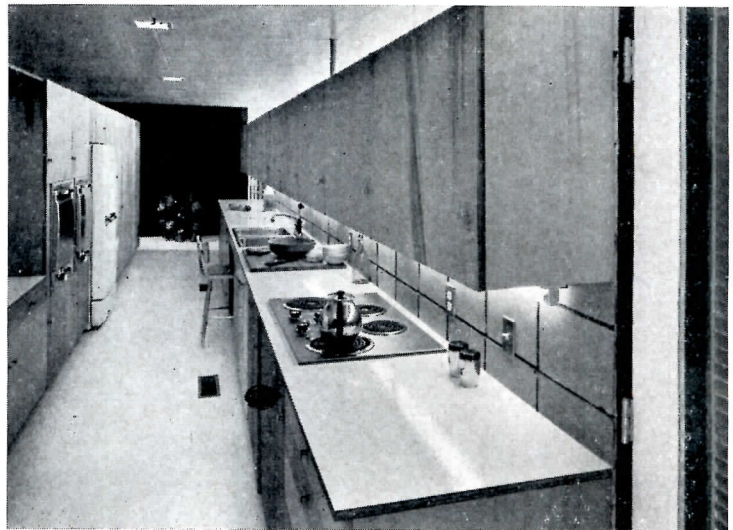
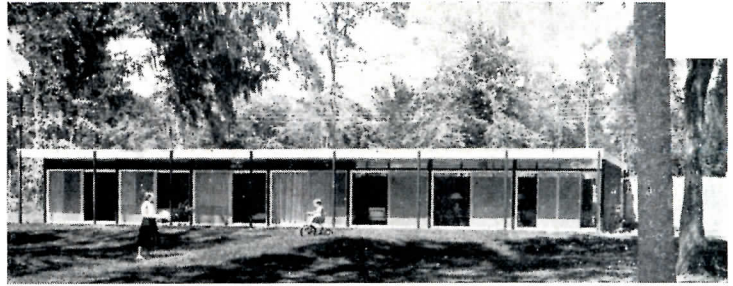

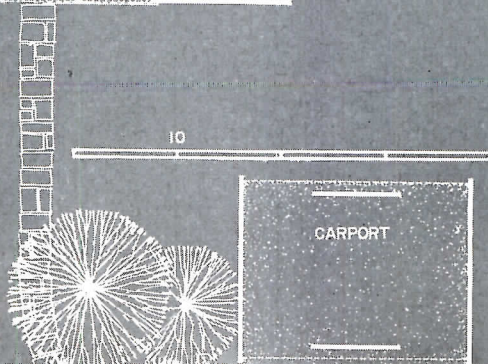
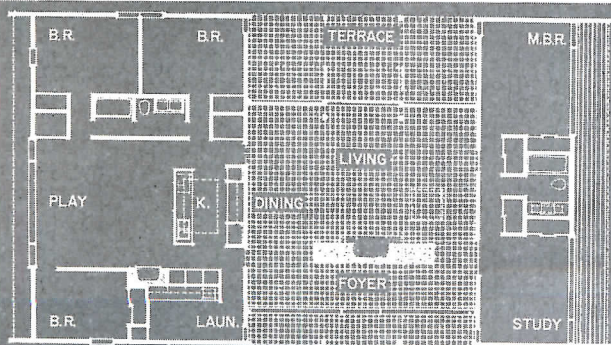

RECTANGULAR HOUSES

5. *Great Neck, New York: Mr. & Mrs. Richard Lawrence, Owners; George Nemeny, Architect; J. J. Levison, Landscape Architect*

ABSOLUTE SYMMETRY has been replaced in this most interesting house by an apparent or partial exterior symmetry which adds flexibility to the interior plan. The house is divided into three main areas: the children's bedrooms are grouped around the kitchen-family room at one end; the master bedroom and study at the other end; and the living-dining room in the center separated from the foyer by a massive stone fireplace on the north side and opening to a wide terrace on the south side.

Since the house was designed for a family with three young children and only part-time help, the kitchen was planned as a control point for the children's activities. Its interior wall contains built-in equipment and cabinets; facing this is a low island separating it from the glass-walled family room without shutting off the view of the outdoor play area beyond. The parents' suite at the opposite end of the house can be made into a completely private unit connected by an inter-communication system with the children's rooms.

Construction is wood frame on concrete block foundation. Exterior walls are cypress siding, stained; interior walls are cypress and plaster, flooring is quarry tile, plastic tile or carpet; ceilings are plaster.

Master bedroom and study, at secluded end of house share a balcony (opposite page and immediate right). Living-dining room area opens to sheltered terrace within rectangular frame of house (top two photos at right). Family room-kitchen has plenty of indoor play space and direct view of play terrace beyond

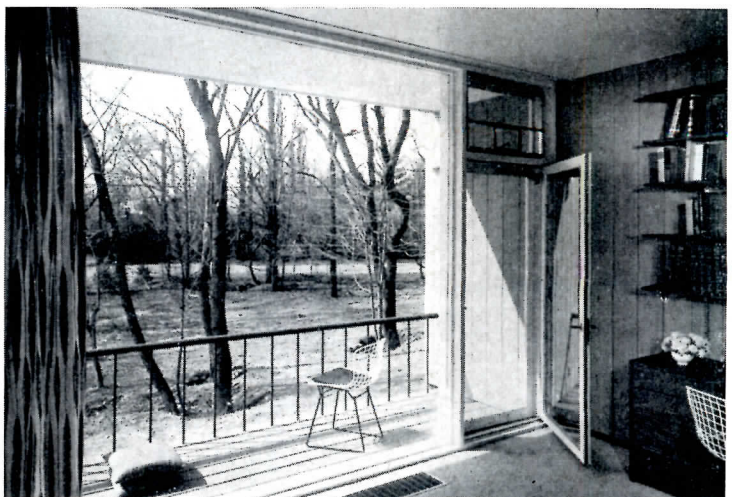
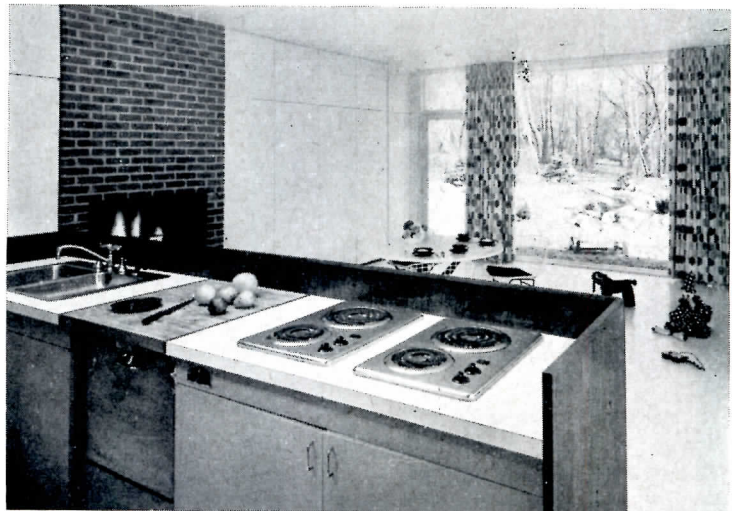

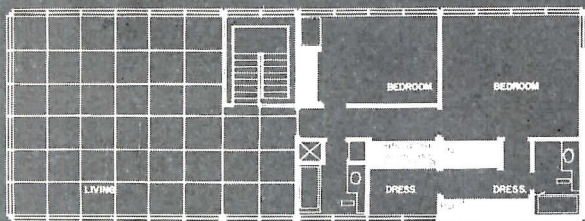

SECOND FLOOR

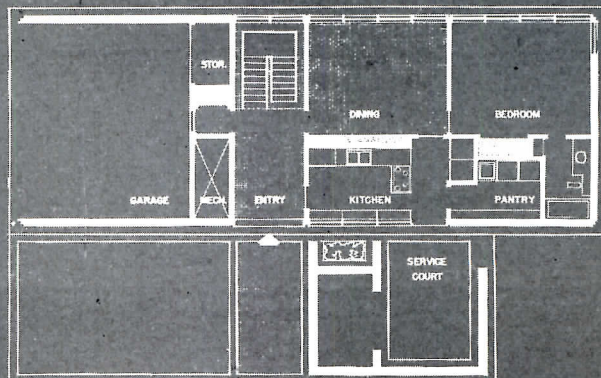

10

RECTANGULAR HOUSES

6. Port Arthur, Texas: Dr. & Mrs. Harris Hosen, Owners; Bolton & Barnstone, Architects

THE HEIGHT of a two-story house can either accentuate or play down the basic shape of the house. In this case it accentuates it despite a deliberate assymetry in façade and a lower floor which requires a large planting area to complete its rectangle.

The site is bordered on the front by a fashionable residential street and on the rear by a busy ship channel through which from five to ten ocean-going steamers frequently pass within an hour. Such a site strongly suggested a two-story plan with all main rooms on the upper level where the channel view would be more extensive and exciting. Since the owners specified a separate suite for their 19-year-old son, the logical solution was to place his quarters on the lower level with the master bedroom, younger daughter's room and living room on the upper level. Kitchen and dining area were located on the ground floor to eliminate unnecessary delivery and serving problems.

A major feature in the design of the house was the owners' extensive collection of antiques which had to be suitably housed. Another feature was anticipated entertaining on a large and rather formal scale.

Ceiling height was held to 8 ft on the ground floor but increased to 10 ft on the second to emphasize the importance of the main living areas and, in the architects' words, to "counteract the feeling of going upstairs."

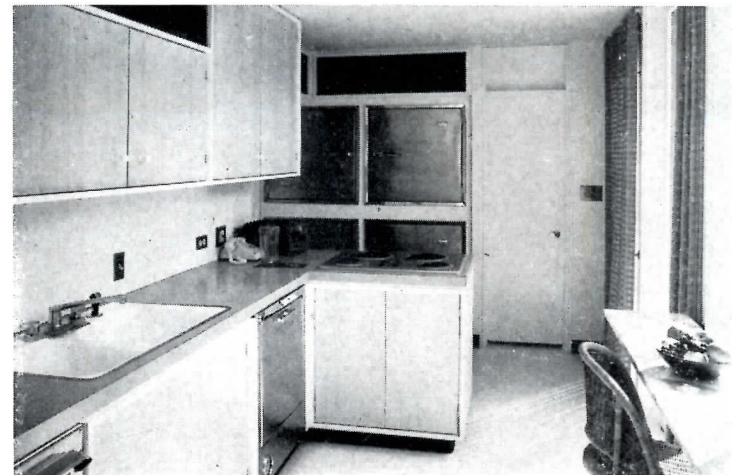
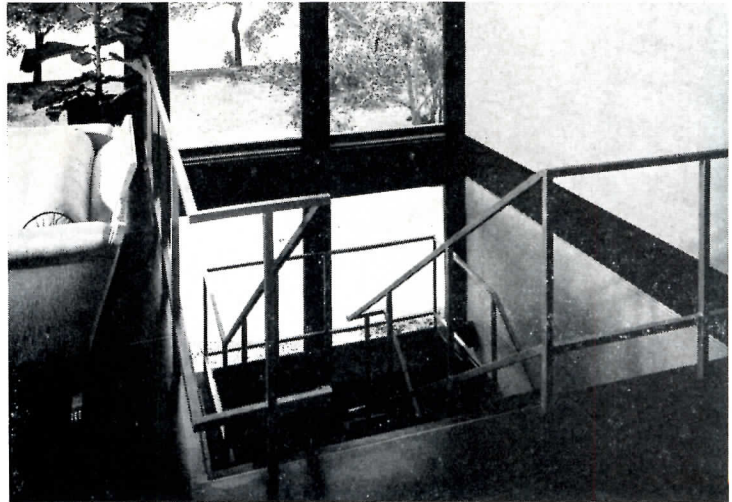
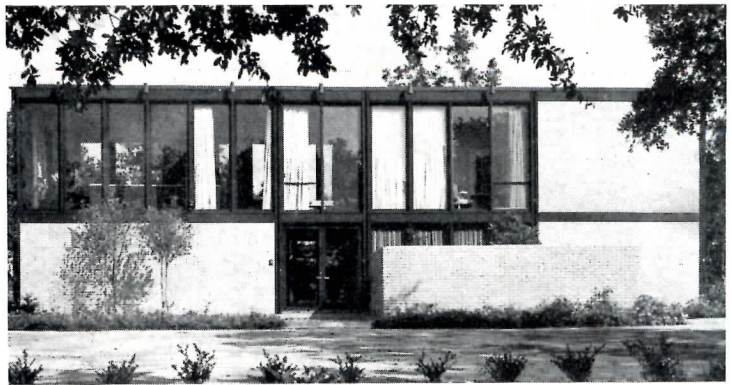

Construction is wood frame on concrete slab with brick exterior facing. Glass area is divided into a rigid module made up of fixed and sliding sections. Brick enclosed service area is covered with horizontal lattice to preclude view of yard from upper floor

Fred Winchell

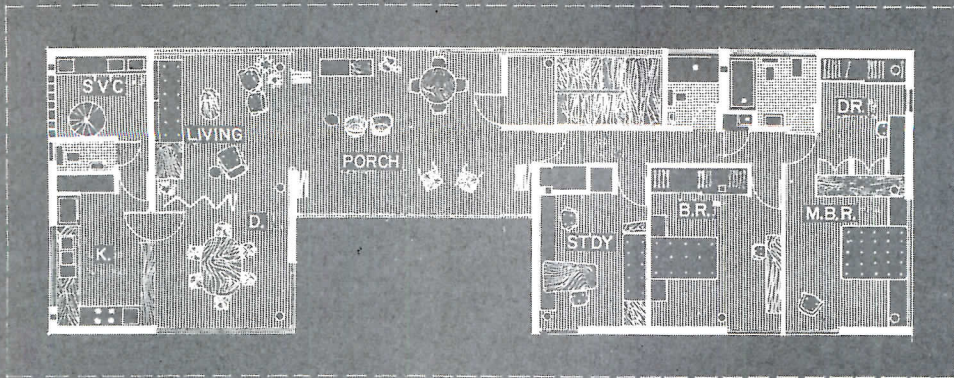

RECTANGULAR HOUSES

7. Havana, Cuba: Perez Farfante, Owner;
Frank Martinez, Architect

THIS LARGE and handsome Havana house, three stories in height, is faithful to the rectangular shape although at first glance it may not seem to be. It fits its semi-tropical setting well with its balconies, patios, open stairs and wide roof overhangs; a long second look is required to discover the symmetry of its plan.

The house was designed for two sisters, each of whom has her own apartment on a separate floor. The apartments, on the two upper floors, are identical with living and dining rooms and kitchen at one end, three bedrooms, study and bath at the other; the central portion of each floor is a large porch which can be enjoyed either open or closed.

The site was rather small and irregularly shaped, ranging from 91 ft at the front to 94 ft 3 in. at the rear, and from 55 ft 3 in. at one side to 64 ft 8 in. at the other. The slope of the land across the width of the lot permitted a basement area for servants' quarters, pump room and cistern. With the house built on stilts the street level was used for a double carport, utility room, and stair hall.

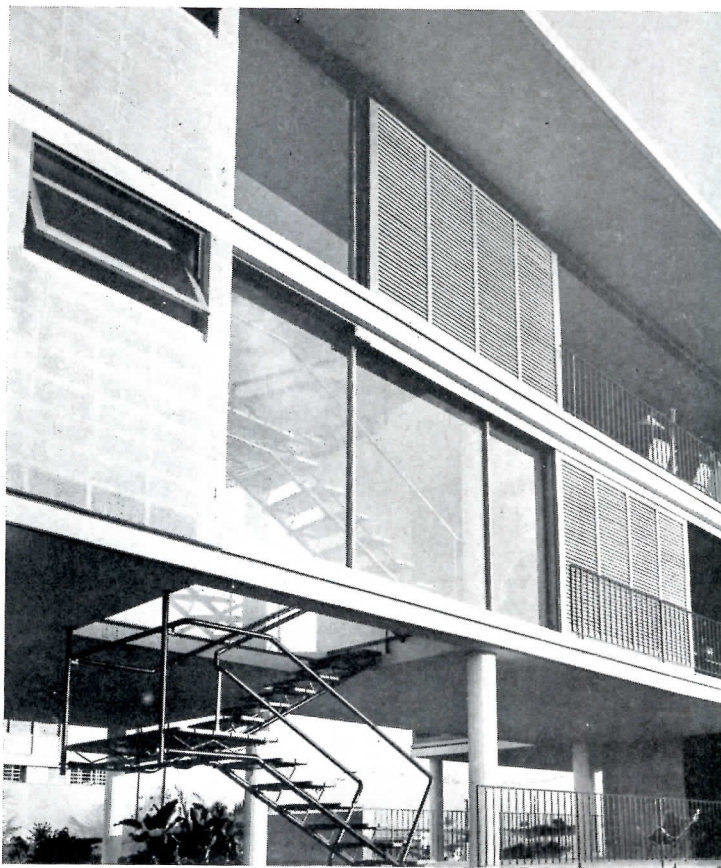
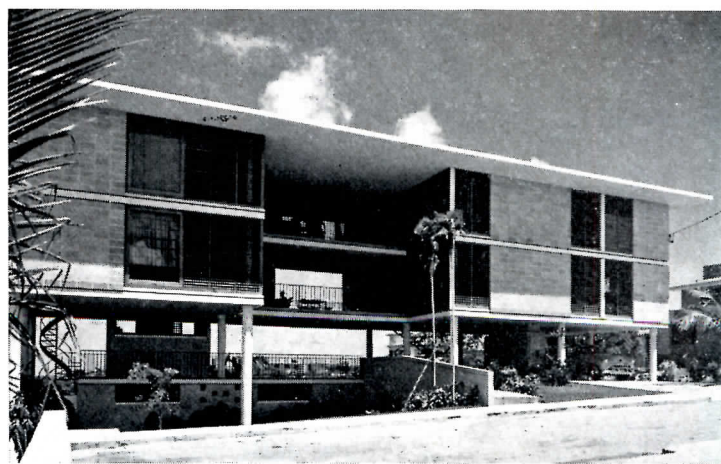

Sliding lowered panels are used to enclose porches when desired, and horizontal lowers are used throughout house for ventilation and sun control. Plan opposite is that of upper two floors; see next page for plans of lower floors

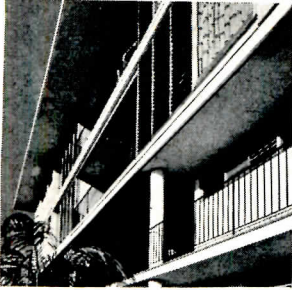

Muritz

RECTANGULAR HOUSES

7. Havana, Cuba: Perez Farfante, Owner;
Frank Martinez, Architect

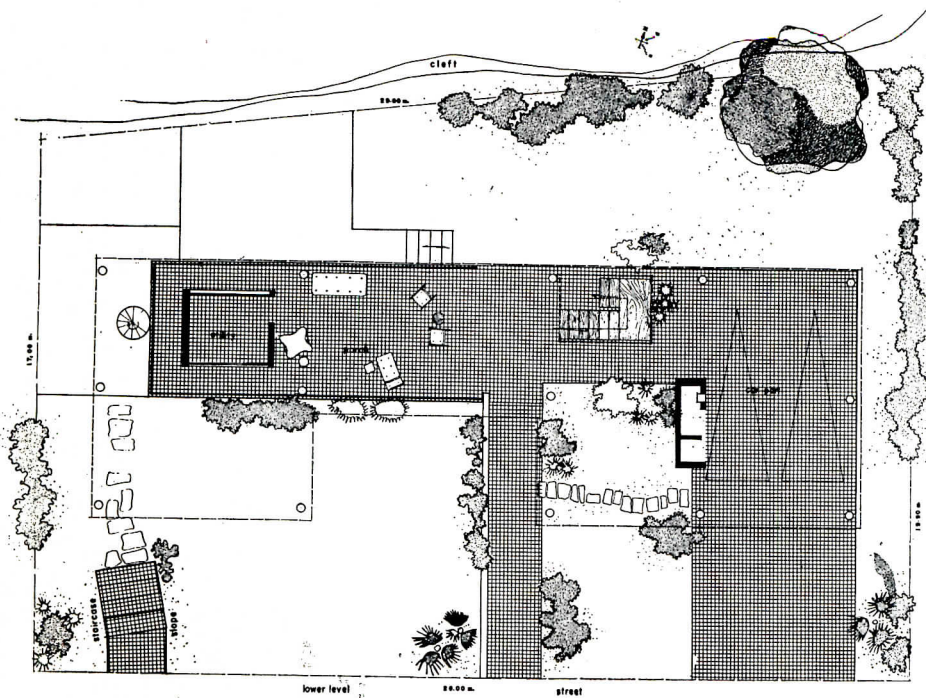

Street level

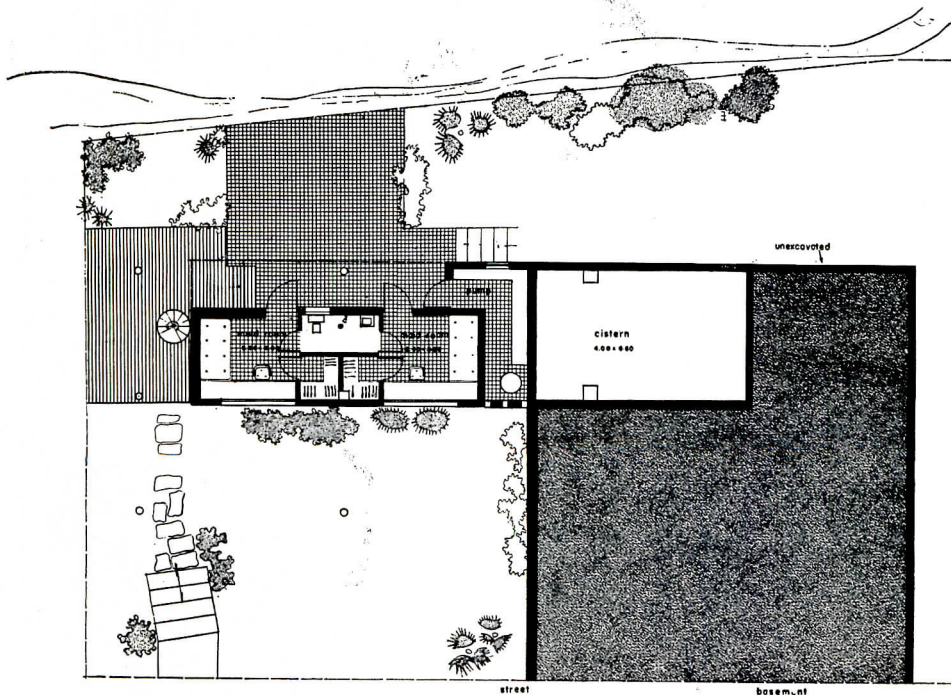

Basement level

DE BUENKORF

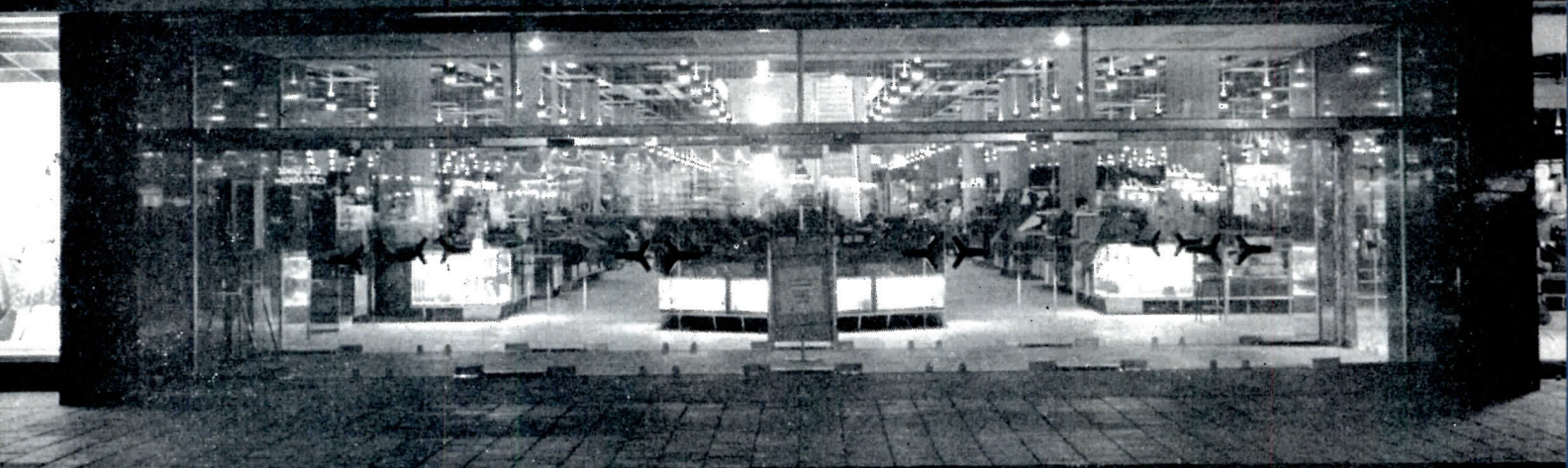

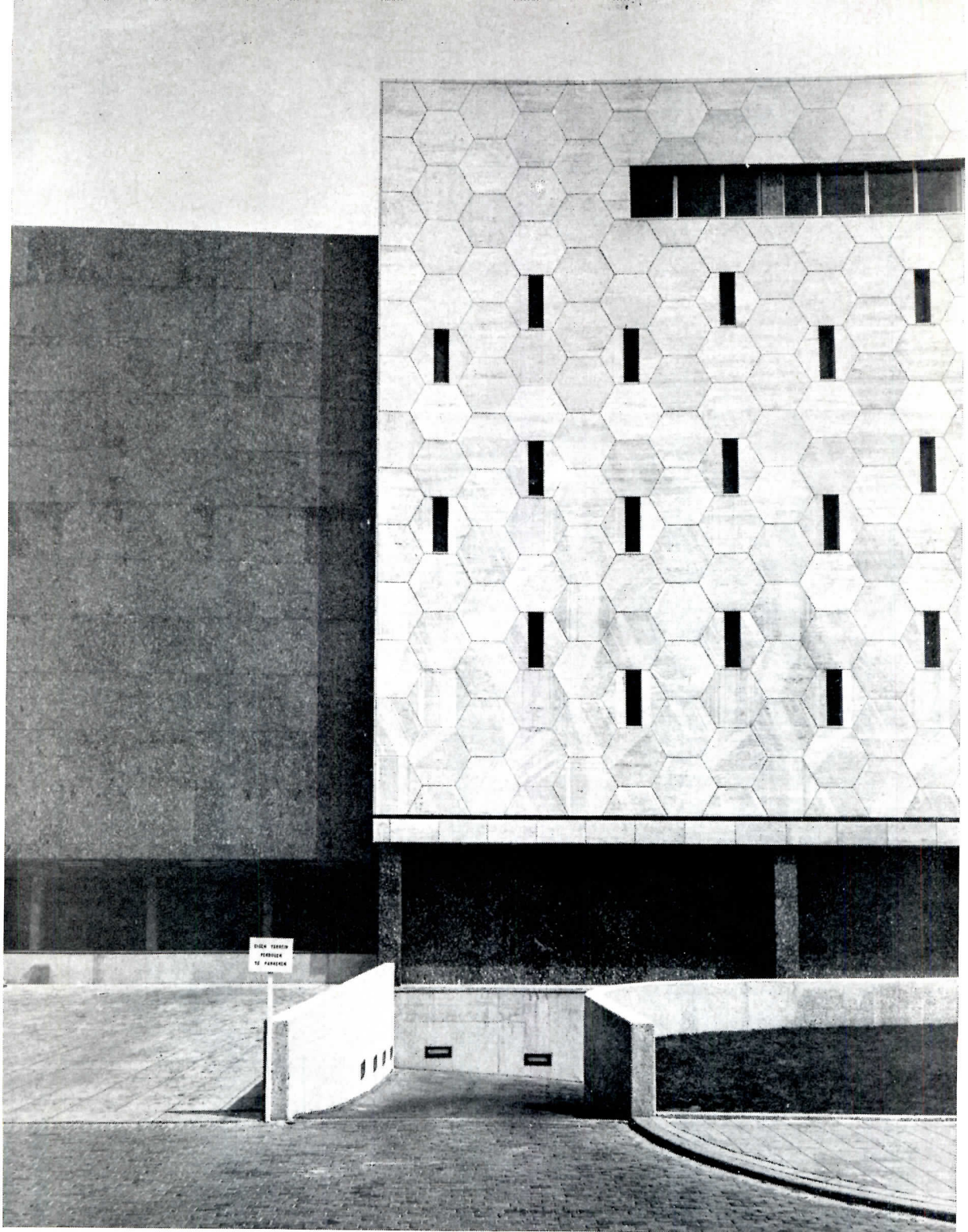

AN ARCHITECTURE FOR DAY AND NIGHT

De Bijenkorf Department Store, Rotterdam
Marcel Breuer and A. Elzas, Architects
Daniel Schwartzman, Consultant
Sculpture by Naum Gabo

THIS DESIGN OFFERS an intriguing answer to the architectural problem of how to sheathe the upper merchandising floors of a department store. Here, a fenestration pattern that interestingly and dramatically reverses itself from daylight to dark is set within a striated travertine curtain in hexagonal pattern. The glazed slits not only rob the wall of its nudity, but also give the customer the traditional prerogative of examining his purchase by natural light (important in Holland) without destroying the usefulness of the entire wall space for merchandising or storage.

The 82 ft. metal sculpture by Naum Gabo serves as projection at the corner, required by the plan for rebuilding the 650 acres of downtown Rotterdam destroyed in the 1940 air attack. The Cineac movie theater is faced in black brick and set back from the main facade line to form a small plaza.

The twin motor entrances, shown left and bottom, lead to the loading dock and to basement parking.

All photos these two pages: Frits Monshouwer. Photos, page 167, Top: Frits Monshouwer Bottom: Robert Doisneau

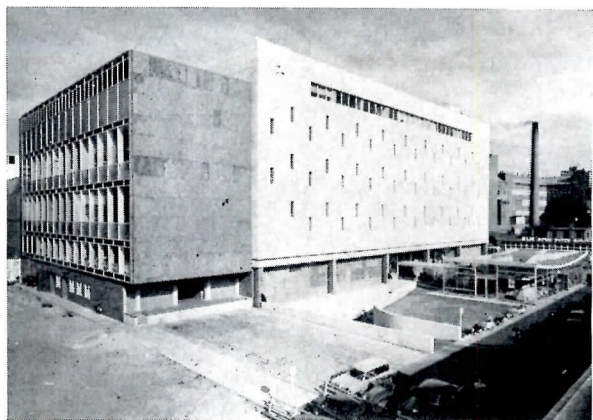
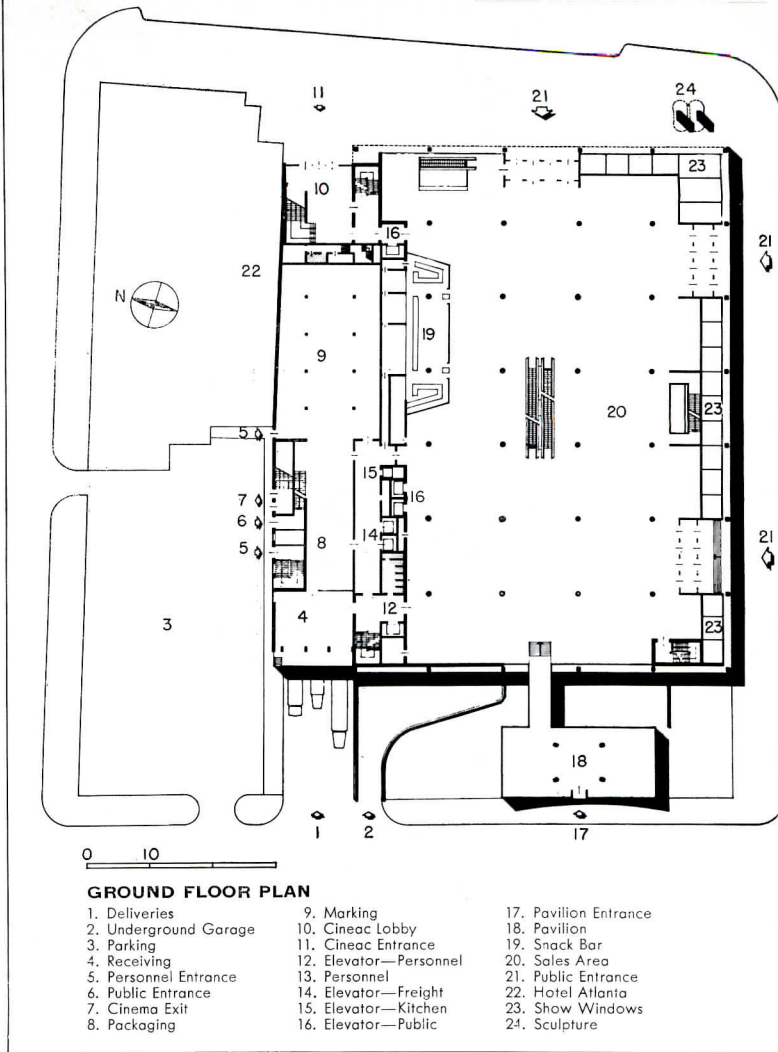



Frits Monshouwer

DE BIJENKORF

The solidity of the main parallelepiped — clad in travertine and resting on a base of gray granite — is nicely countered not alone by the fenestration pattern but also by the weblike, refined curtain wall enclosing the office and personnel sections, above, composed of aluminum, clear glass, frosted glass, and black glass; and by the delicate crystalline pavilion, far right, which serves as entrance to the store from the Lijnbaan mall. The catenary roof of the pavilion hangs from two reinforced concrete cantilevered beams which are supported on four central concrete columns.

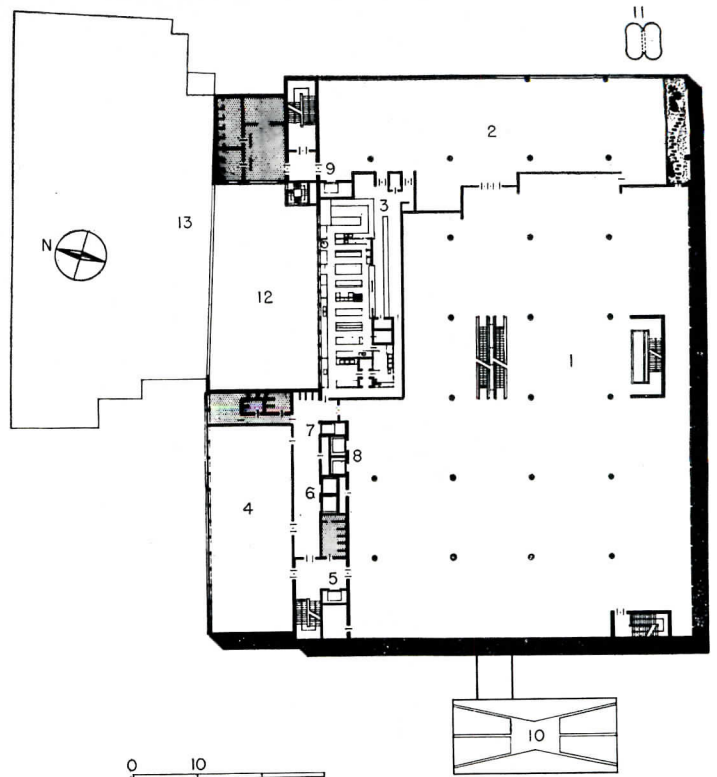
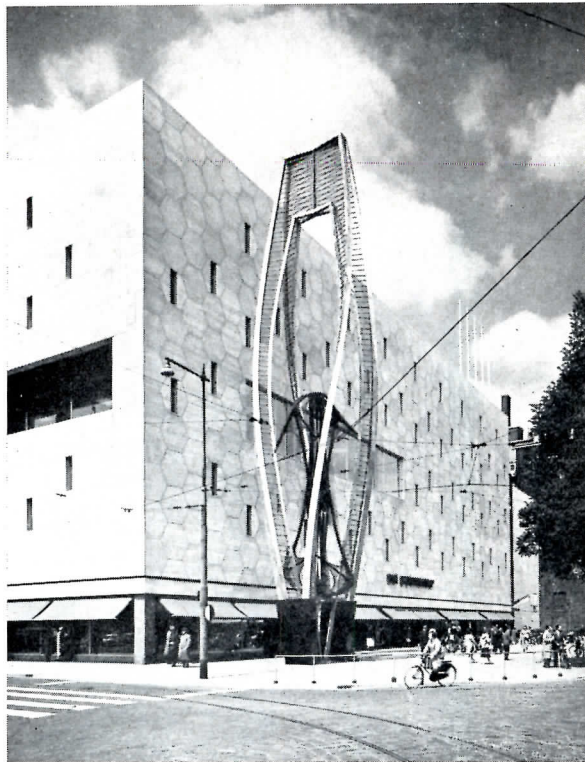

SECOND FLOOR PLAN

- 1. Sales Area
- 2. Restaurant
- 3. Kitchen
- 4. Shops
- 5. Elevator—Employees
- 6. Elevator—Freight
- 7. Elevator—Kitchen
- 8/9. Elevator—Public
- 10. Roof of Pavilion
- 11. Sculpture
- 12. Roof of Cineac
- 13. Hotel Atlanta

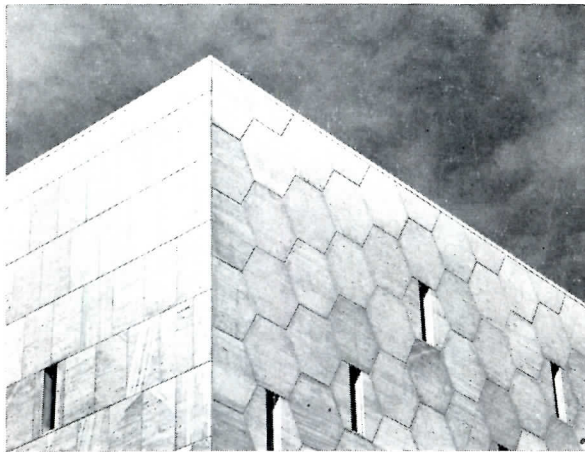

The striations in the travertine, left center, vary in direction to furnish texture and self-weathering; are calculated to let the stonework age gracefully.

From the second floor restaurant one looks out over the Henry Moore figure, at bottom, towards the 1930 store, designed by Willem Dudok.

Photo credits—Top: Spies, two at center: Robert Doisneau, Bottom: Frits Manshouwer

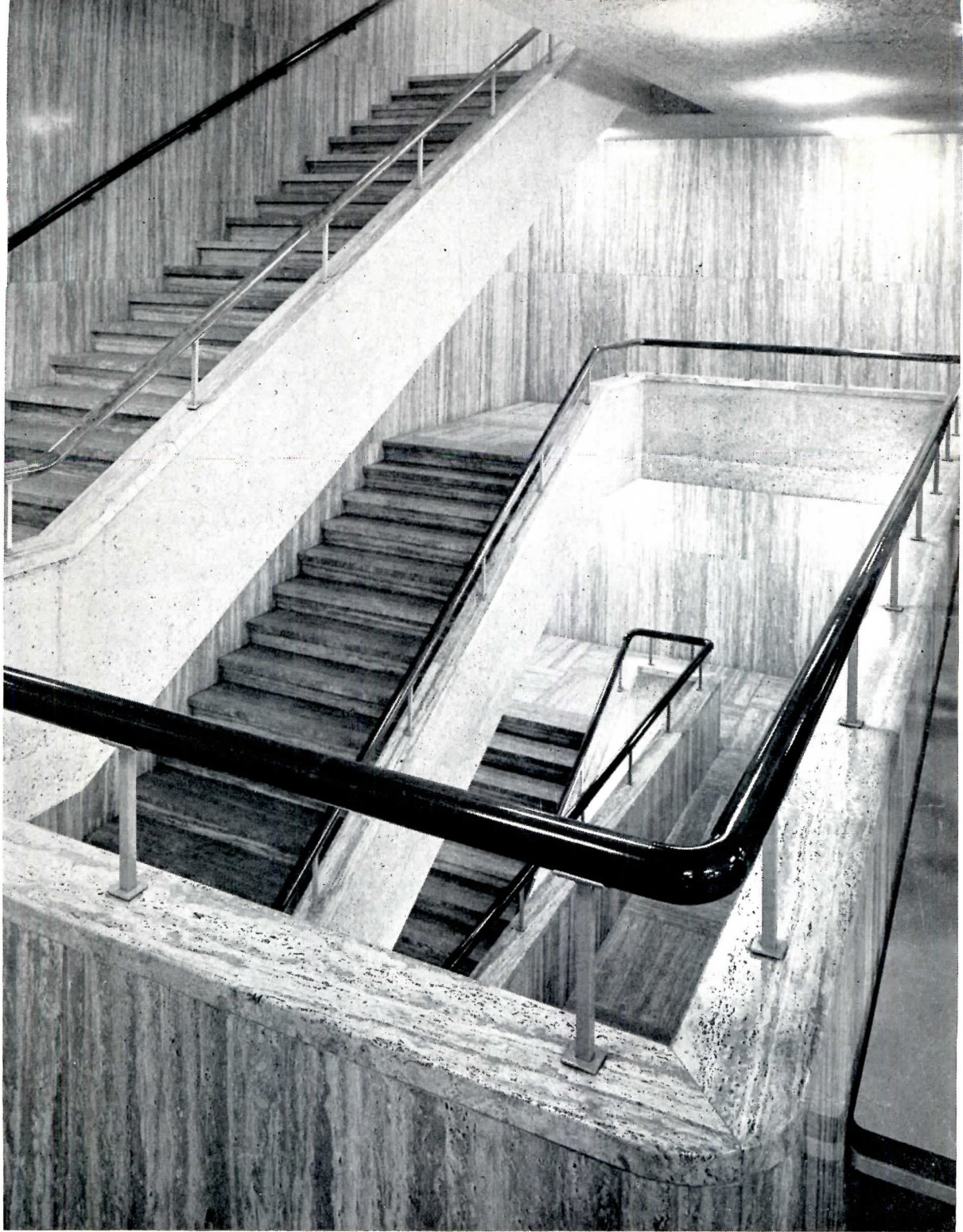

DE BIJENKORF

Above, one sees a main stairway, finished in travertine and with teak handrail. Typical interiors throughout are a well mannered combination of natural teak, travertine, light and dark gray, and cobalt blue — enlivened at each level by small areas or accents of orange-red.

For the sales areas, right, typical ceilings are composed of a suspended rectilinear pattern of wood members — teak for the ground floor and white painted wood above — which house fluorescent lighting panels and open to, yet conceal, the ducts and pipes (painted charcoal gray) above.

The employees' cafeteria and executive offices, at roof level, face out to garden-courts, one of which is shown directly below.

Point-of-sale fixtures, designed by architect Schwartzman, are shown in the three interior photos below. Left, china and glass department; right, cutlery department and wine shop.

The photograph on the page following is a view along the executive floor corridor.

Photo credits—Pages 172, 174, and top: Spies, Bottom: Frits Monshouwer

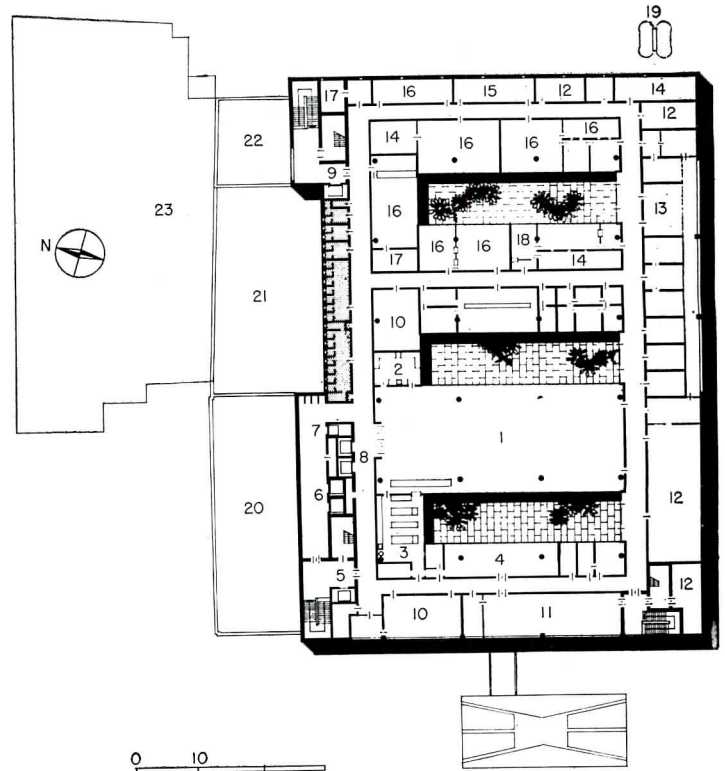
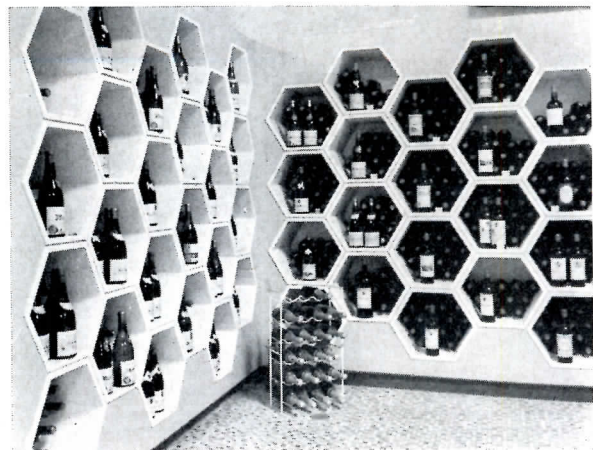
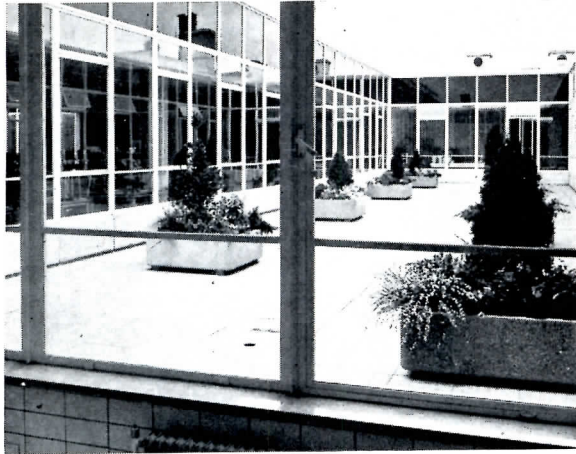

FOURTH FLOOR PLAN

- | | | |
|-----------------------|---------------------|--------------------------------|
| 1. Employees Dining | 10. Instruction | 18. Mail Room |
| 2. Dishwashing | 11. Workshop | 19. Sculpture |
| 3. Kitchen | 12. Storage | 20. Roof of Mechanical Section |
| 4. Kitchen Storage | 13. Conference Room | 21. Roof of Cinema |
| 5. Elevator—Employees | 14. Records | 22. Roof of Cinema Lobby |
| 6. Elevator—Freight | 15. Linen Room | 23. Hotel Atlanta |
| 7. Elevator—Kitchen | 16. Bookkeeping | |
| 8/9. Elevator—Public | 17. Vault | |





Frits Monshouwer



Alex Darrow



1957: Latest work is the monumental sculpture fronting Breuer's deBijenkorf Store, Rotterdam, Holland

SCULPTURE BY NAUM GABO

NAUM GABO achieves a dedicated aim — that of creating a monumental sculpture, not to ornament a building, but to complete it — with his huge and dynamic Construction for Marcel Breuer's deBijenkorf Department Store in Rotterdam, Holland. The work also represents the current synthesis of a strong and carefully developed philosophy: Gabo is an active, intense leader of the Constructivist movement in the arts, which developed along with other non-objective theories in the 1900's.

In practice, the Constructivists (so named by early Critics) explore and develop new spatial concepts in many contemporary materials — "Older sculpture was created in terms of solids — the new departure was to create in terms of space."

In theory, Gabo holds that "Abstract is not the constructive idea I profess . . . It is a mode of thinking, acting, perceiving and living . . . Any thing or action which enhances life, propels it and adds to it something in the direction of growth is constructive."

Gabo was born in 1890 in Briansk, Russia, and named Naum Pevesner. He later adopted the name Gabo to prevent confusion with his brother Antoine Pevesner, who is also a constructivist sculptor. He was sent to Munich to study medicine, but soon changed to his real interests — science and the arts. Stimulated by his contacts with all the advanced artists in Germany and Paris, he brought together, in 1913, an avant-garde group in Moscow of architects, engineers and artists. They sought a "significant affinity of the arts." With the change in the Russian artistic climate after the

Revolution, Gabo settled successively in Berlin, Paris, and England. In 1946 he moved to the United States and settled in Connecticut where he now works. Throughout these years, Gabo has progressively developed his work, as well as teaching and lecturing at such schools as the Bauhaus. His work has been widely exhibited, including a joint show with his brother at the Museum of Modern Art in 1948.

The illustrations shown here sketchily illustrate Gabo's developing theory, culminating in the Rotterdam sculpture. In his earliest work he stressed the idea that volumes and simple geometric shapes could be represented by edge planes, where you see into the volume thus defined; to demonstrate that more naturalistic images could be created in this manner, he made several heads in plastic. Next came studies and sculptures of spheric and more complex shapes, and the addition of movement. Actual motors were sometimes used to create the motion; this same changing effect was later achieved by linear constructions within the basic shape which changed aspect as the observer moved. The Rotterdam work incorporates all these concepts in a great tree-like structure: it is embedded in a concrete foundation connected to the building; above ground is a base of black marble clad concrete, from which spring eight twisted, tapered steel branches, joined at the top; the inner image is a web of bronze springs stretched over a stainless steel skeleton. A book of his work will be published shortly, and special exhibitions shown next spring in Rotterdam, Amsterdam, and London.



1916: Head described by edges was among Gabo's early sculptures

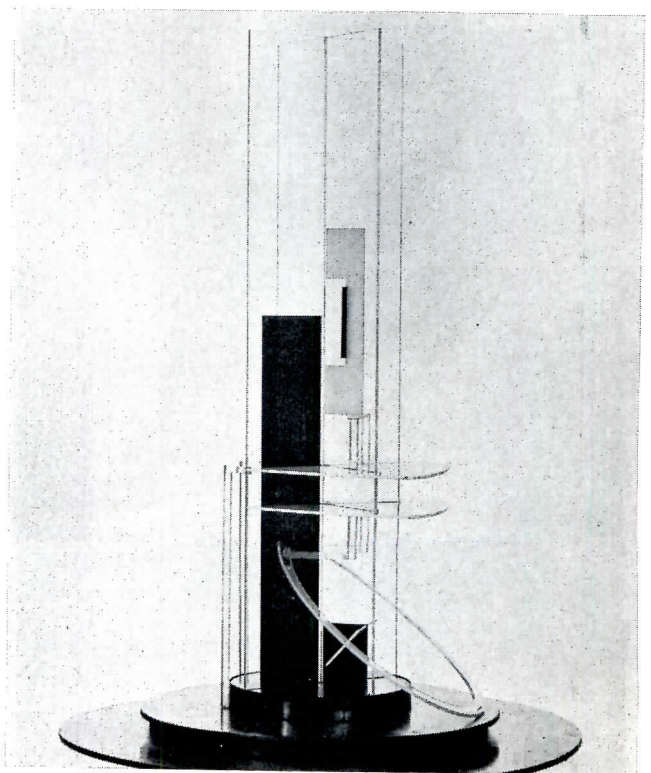

1923: Column now in Guggenheim Museum, New York City

1953: *Linear construction of plastic studies motion within a sphere*

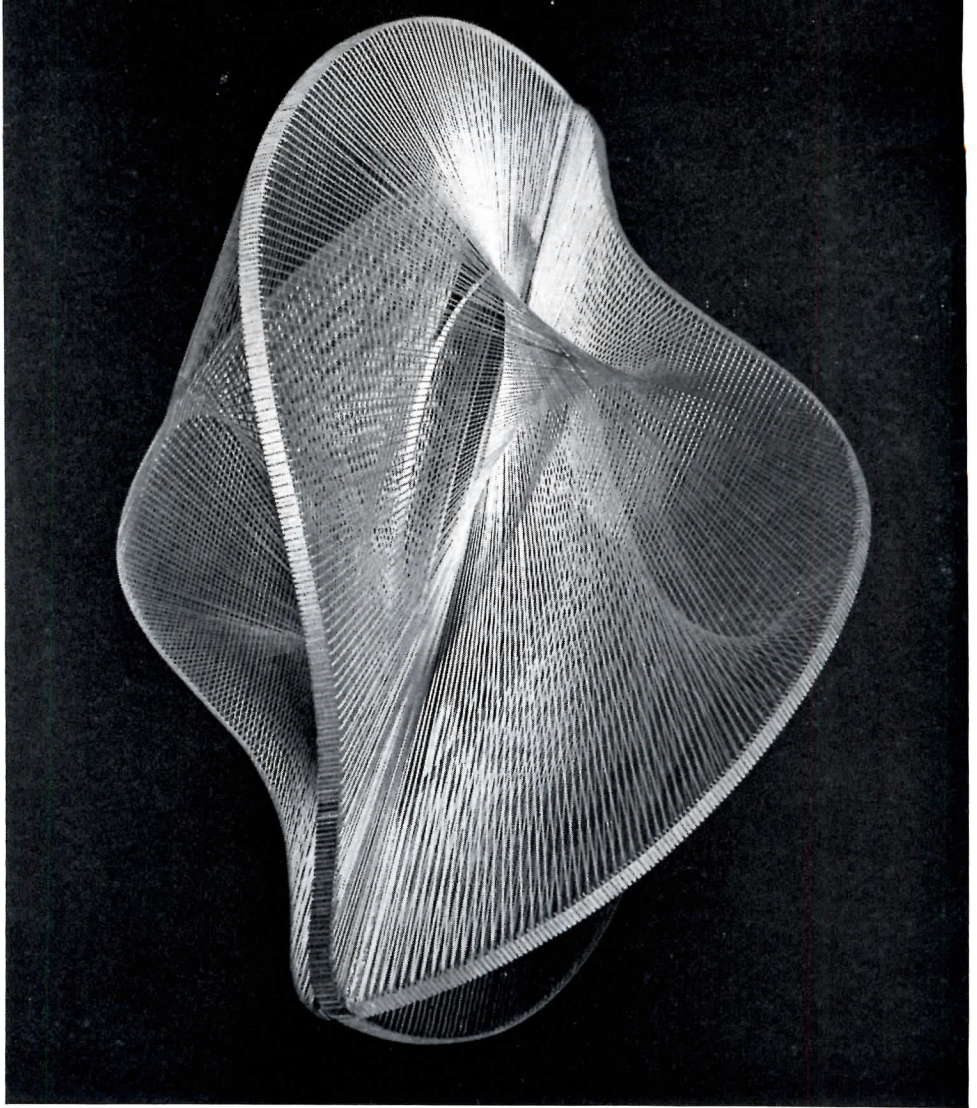

Rudolph Burchardt

NAUM GABO

1951: *Spheric volume, now at Guggenheim Museum*

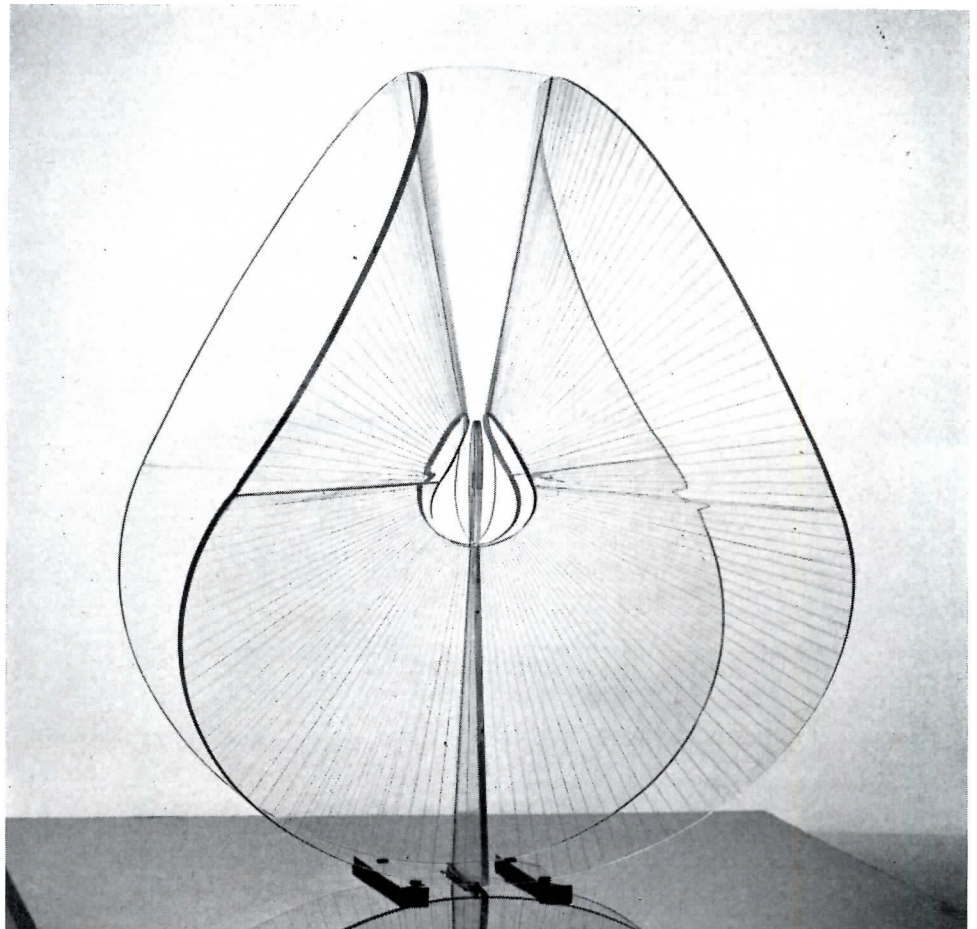

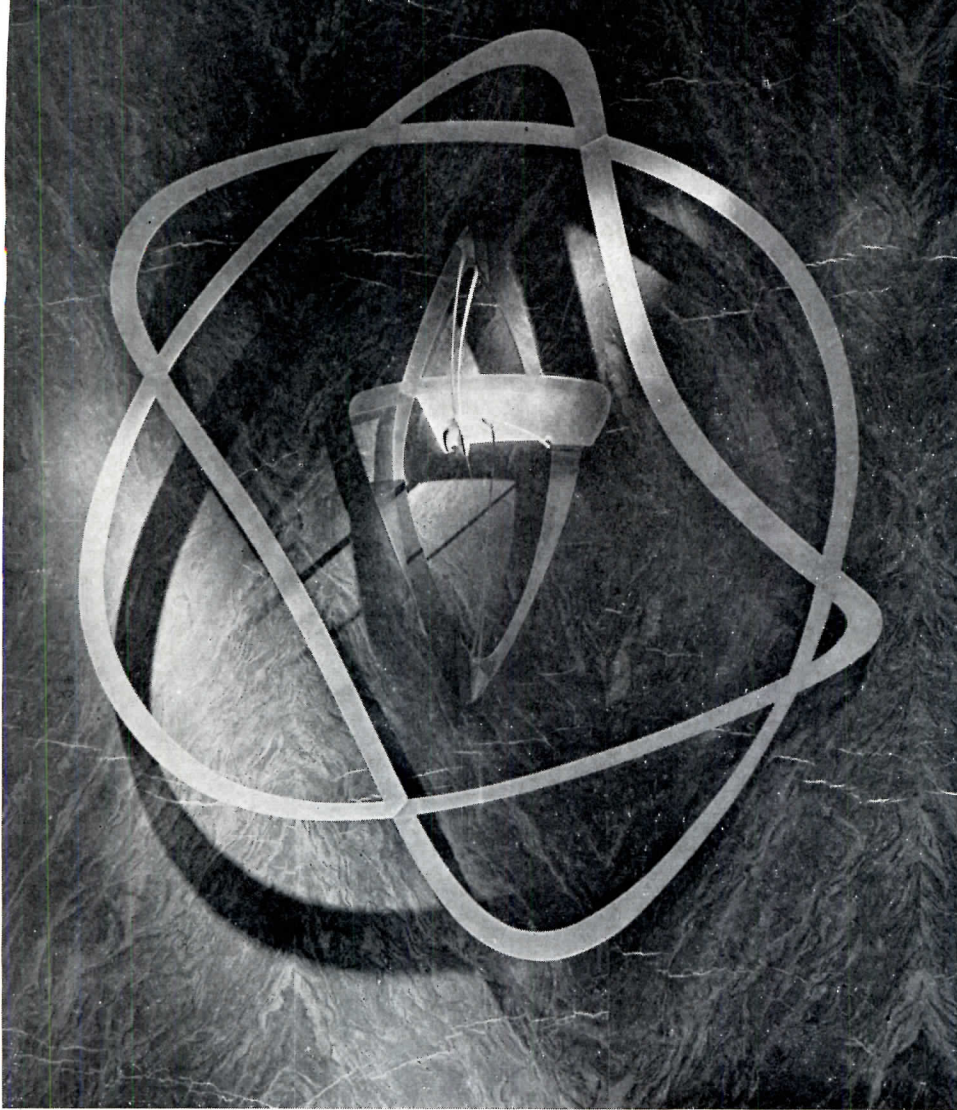

1955: Bas-relief for lobby of U. S. Rubber Company Building, N. Y.

NAUM GABO

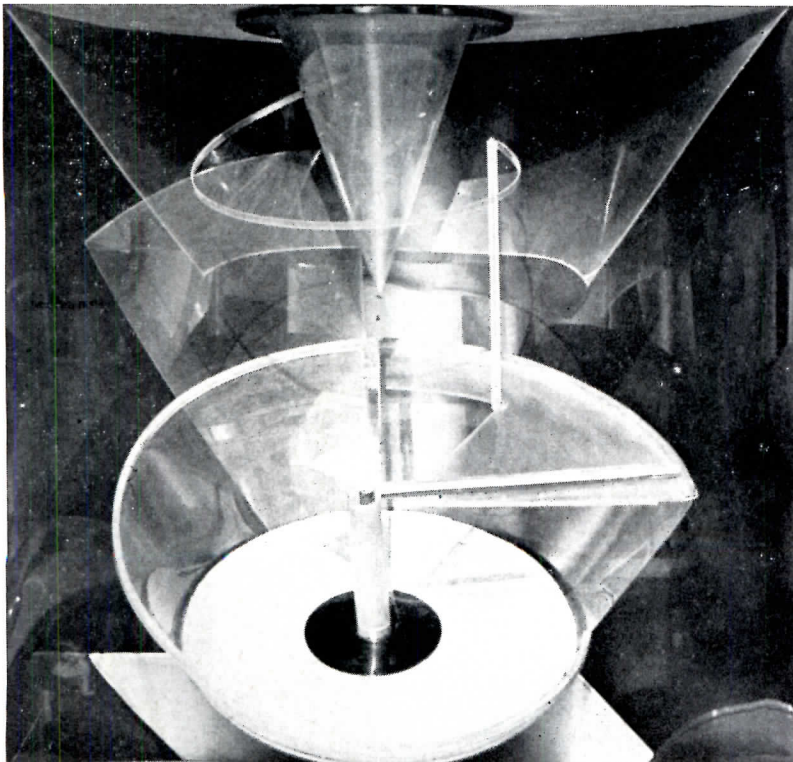

1930: Plastic construction for niche in wall of home for Architect Eric Mendelsohn

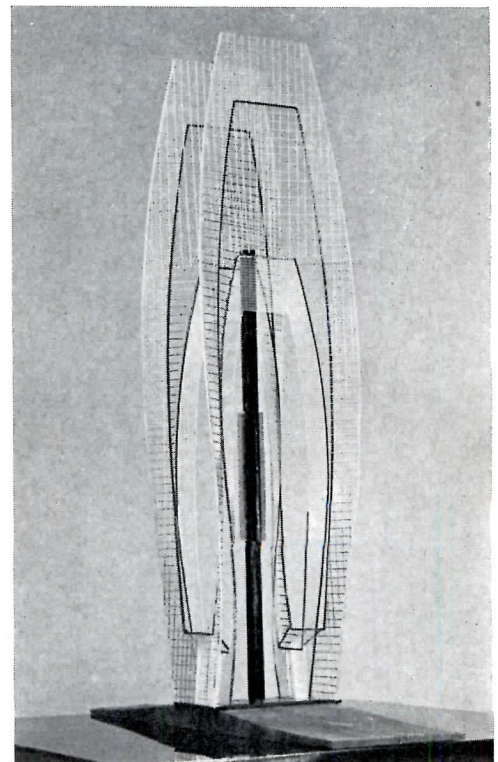

1953: Monument for Unknown Political Prisoner

COMFORT AND AMENITIES

By T. H. ROBSJOHN-GIBBINGS*

IF YOU SAY TO ARCHITECTS that modern houses are totally lacking in comfort, they look at you with pity, for it is one of the most firmly entrenched myths of our time that modern building is synonymous with human comfort.

I have never been impressed with mechanical conveniences. I take it for granted that houses have climate control, plumbing that works and facilities for cooking. And I take it for granted that each year these utilities will work more efficiently. Therefore, I propose to ignore them in tonight's discussion, for I also take it for granted that while these mechanical conveniences get better and better, the inhabitants of modern houses will continue without comfort in the true meaning of the word.

In my opinion true comfort does not come with any of this physical apparatus. Climate control, electric kitchens and lavish plumbing are only the bare necessities of life — cannonized no doubt for commercial reasons — but the bare necessities nevertheless. It is possible to have them all in their most deluxe form and be — as the dictionary defines discomfort — forlorn, desolate, cheerless and inconsolable.

We all have very profound emotional desires about our environment, and it is my belief that in addition to the fulfillment of physical needs, human beings find true comfort only when these emotions are satisfied. To be comfortable we must recognize these emotions and give them fulfillment. Modern architecture with its curious belief that man desires only increasing efficiency has ignored these emotions. Because of this I believe that modern building has never provided true comfort.

One obvious example of the emotional discomfort of modernity is the wall of glass. Living behind it, we must subconsciously feel we are being observed; and though we may not be consciously aware of it, waking or sleeping we are subconsciously insecure knowing that all that stands between us and the elements or an intruder is a transparent screen that can be shattered with one blow.

The open plan is the most uncomfortable fashion ever

*An address by the author before the Architectural League of New York.

COMFORT AND AMENITIES

devised on a drafting board. Sitting in the middle of it is the emotional equivalent of being trapped on a traffic island at the intersection of two main streets. Wherever you sit in an open plan — radiant heating and special windows notwithstanding — you are sitting, in my opinion, in an emotional draft.

The blame for the emotional insecurity produced by the modern house is not entirely due to architects. The furniture designer has contributed his share. Today private houses and public places are provided with identical furniture. Such furniture in a house subconsciously suggests the transitory and cold impersonality of public places instead of giving us the emotional security that we feel with furniture identified with the privacy of a home.

No one knew better than the eighteenth century designers that a chair to give emotional as well as physical ease should comfort the back and suggest security by enfolding the sitter. Too many of our spindly contraptions, barely reaching above the base of the spine, leave the occupant teetering in mid-air physically and emotionally.

I realize that the emotional dissatisfactions I have specified are obvious to all of you. There is however one particular feature of the modern environment that I feel is inducing a great part of our emotional discomfort. This is the subconscious loneliness and feeling of total

isolation that comes with an environment of newness.

To be emotionally at ease we must feel companionship with our surroundings. They must have identity with us. They must be a part of us. We are creatures of three dimensions. All the generations of the past are part of us as well as those we love in the present and those whose future extends beyond our own. The newness of the new house is one-dimensional. It claims it has no past and boasts of its future obsolescence. It takes the position of being immune to criticism because it is experimental — in other words we are asked to live in an experimental state of discomfort, and if we gripe about it we are sneered at for being unprogressive guinea pigs.

Houses have always changed, evolving from one form to the other, partaking of the new materials of structure and the evolution of social patterns. I am the last person to wish to turn back this tide of change and evolution, but I think today we have exchanged this valid process of change for mindless novelties; perhaps I should say mindless clichés. For as you know only too well the most banal eccentricities of modernity come simultaneously from the architectural drafting boards as tail fins come simultaneously from the assembly lines of Detroit.

What emotional satisfaction — what sense of emotional relationship to mankind — can we have when we



“ . . . no one knew better than the eighteenth century designers that a chair to give emotional as well as physical ease should comfort the back and suggest security by enfolding the sitter.”

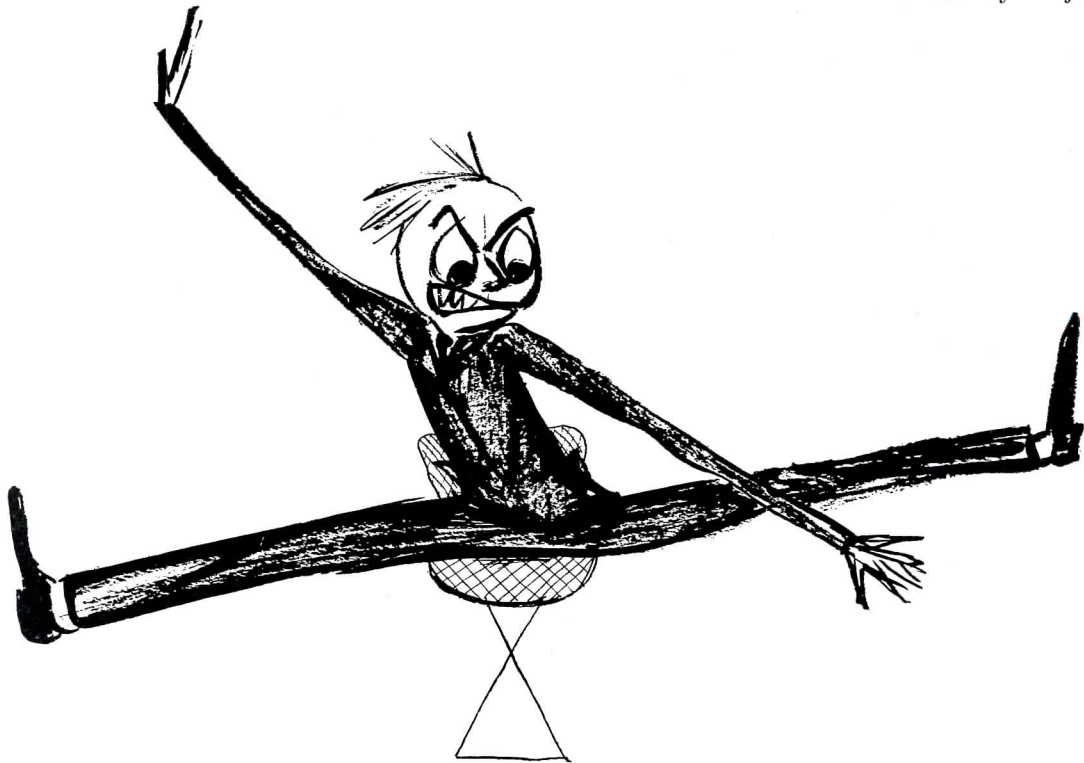

“ . . . too many of our spindly contraptions, barely reaching above the base of the spine, leave the occupant teetering in mid-air physically and emotionally.”

are housed in an environment that puts an iron curtain between us and all of the past to which we are so profoundly related?

In this historical sense the modern house is like a depot where we wait to change trains or an airport which we endure between flights. Who would want to stay in either place for long? In both these waiting rooms we feel for a short space of time as if our lives are in abeyance. We are emotionally withdrawn from our surroundings. This feeling is something we endure as best we can, knowing soon the journey will be resumed.

The same emotional state of limbo can be experienced in a modern house, with the added horror that the flight may never be resumed.

It would be an understatement to say the modern house has affected the amenities. It has practically destroyed them.

When a house is created primarily as an efficient machine indifferent to the emotional well-being and individuality of its inhabitants, we ought not to be surprised that the inhabitants are equally indifferent to the welfare of the house and of its furnishings. If you care little for the house you live in, you are likely to care still less for the amenities. The amenities as we knew them are fast becoming obsolete.

I think we can see this change illustrated most clearly in the present day promotion of household wares. In the

past manufacturers of household equipment endeavored to lighten the cares and the chores of the housewife by contributions to a way of life rightly described as “gracious living.” It was assumed in those happy times that these innovations were destined for people who loved and cherished their homes. In contrast to this attitude we find today that household equipment seems to be created and merchandised on the assumption that the consumers are a band of hooligans.

I first became aware of this strange new state of affairs when an expensive leather-covered couch of my design was photographed for an advertisement to promote the use of leather. When the advertisement appeared it showed a flaxen-haired moppet gouging her heels into the leather to prove its durability. Since then I have noticed ads for floor coverings over which tough gangs of small fry are tramping muddy feet or spilling bottles of ink. But it is not only floor coverings that are given to the joyful slaughter, there is also open season on walls and woodwork. The four-color ads now show undisciplined brats scrawling viciously over both with a beaming mother in the background joyfully anticipating her part in cleaning up the mess.

This household havoc, now taken for granted, is by no means limited to children. For there are abundant signs that in the new house there is a new type of adult. Only yesterday I saw an upholstery advertisement in

COMFORT AND AMENITIES

which two ladies are having a mid-day snack. The one with her feet up on the sofa has spilt her salad. The other, presumably the hostess, is beaming with joy. "Here," says the text, "is the ultimate in upholstery fabric. By gently blotting with a soft rag you can remove salad dressing, olive oil, mustard, ink, soft drinks, soil or baby oil."

Who are these new householders for whom furniture and equipment must be scuff proof, mar proof, spot proof, tear proof, dent proof — or, in other words, guaranteed slob proof?

What new form of amenity and what new type of householder would demand that a mattress before it is considered practical be given what a news report describes as a "torture test." "A five-ton roller," says the report, "ran back and forth over a standard mattress . . . all day long. After three hundred and eighty trips it was examined . . . and no signs of breakdown were visible." What new amenities must we anticipate from these new householders who expect their bedding to be capable of sleeping a herd of elephants?

As far as I can make out, the amenities are not merely changing — they are in a stampede. Here is a recent advertisement for sound proof ceilings. "Nobody," says the ad, "has to keep quiet in this sound-conditioned home . . . talk on the phone in the midst of a song fest . . . while mother vacuums the rug or turns on

household appliances without bothering a soul." As proof that this happy bedlam is possible, the illustration shows four characters yelling like maniacs while behind them a dame, identified as "Rita" in the ad, is trying to out-scream them on the telephone. On the right, a stylish stout, presumably mother herself, is setting up drinks for the house. If these are the new amenities, "togetherness" is getting out of hand to a degree not even anticipated by *McCalls*.

If you believe as I do that this form of advertisement reveals the free-for-all amenities of our times, it will come as no surprise to you to find that the graciousness of visitors is also in a state of flux. Take for instance the story of a departing visitor — as reported in the *Minneapolis Star* — who wrote in the guest book of her hostess, "Your dining room drapes are lousy."

What conclusions are we to draw from this changing scene? Frankly, I cannot tell you. All I can suggest is that when you return tonight to your "torture-tested" mattresses you do not let the thought of it all keep you awake.

We are an enduring race, quite capable of outliving modernity, capable of shaping our environment, capable of remaking architecture in the image of our true selves. When we have done all this — and we will — true comfort and fine amenities will be once again restored to us in full abundance.

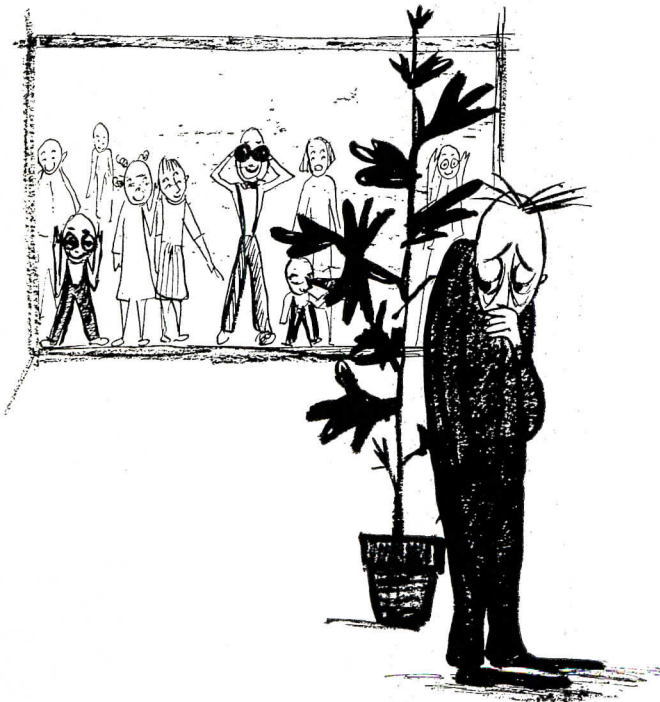

“. . . we must subconsciously feel we are being observed; and though we may not be consciously aware of it, waking or sleeping we are insecure . . .”

SEA SHELL ROOF

Robert Fischer

ADVENTURE IN STRUCTURE

GEORGE NAKASHIMA, WOODWORKER, wanted to build a shell. Paul Weidlinger and Mario Salvadori, engineers, wanted to build a conoidal shell. And thereby hangs a tale. Nakashima needed another building in New Hope, Pennsylvania where he has his home and workshops. "For some time," he said, "I had envisioned an arch on the edge of my property which drops off some 50 ft to a level area. A year ago I needed more space and thought of using a concrete shell. I had done some thin (35 mm.) concrete work in India in 1937. When Mario and I first talked, he suggested a conoid to fit our slope. It seemed logical and good. Also it lent itself well to an arch. Things seemed easy at first, but as we got into it, the more involved it became, structurally and design-wise." Weidlinger and Salvadori found stresses too high for a full conoid, so in a unique departure they recurved the conoid to take them.

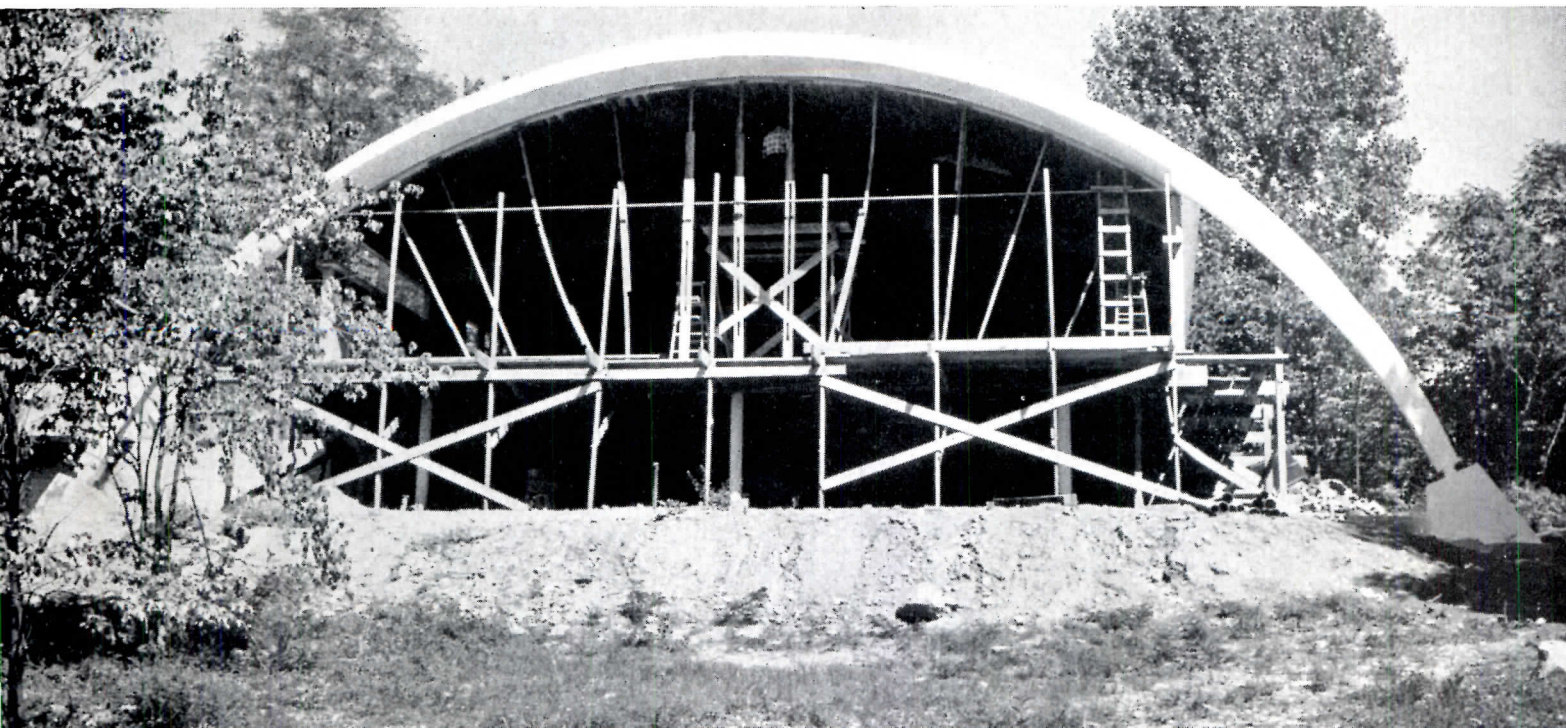
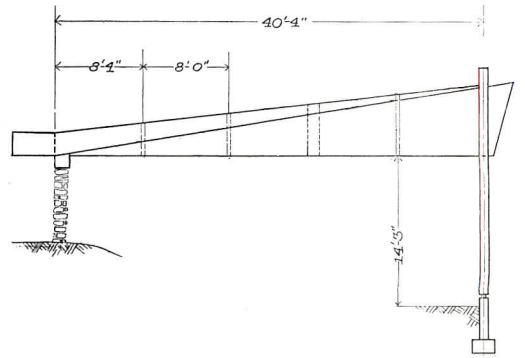
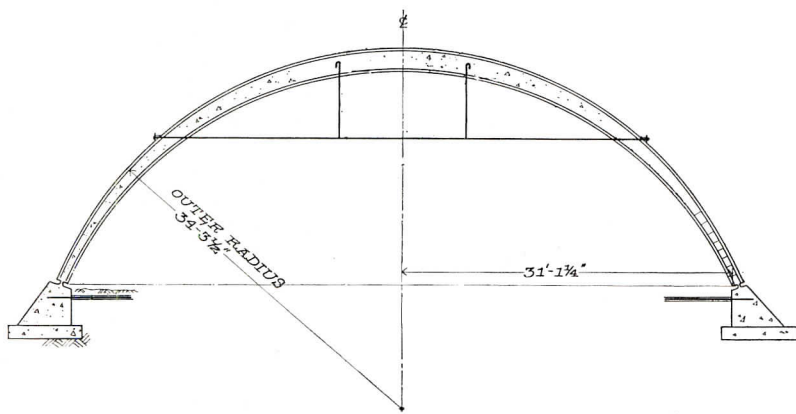
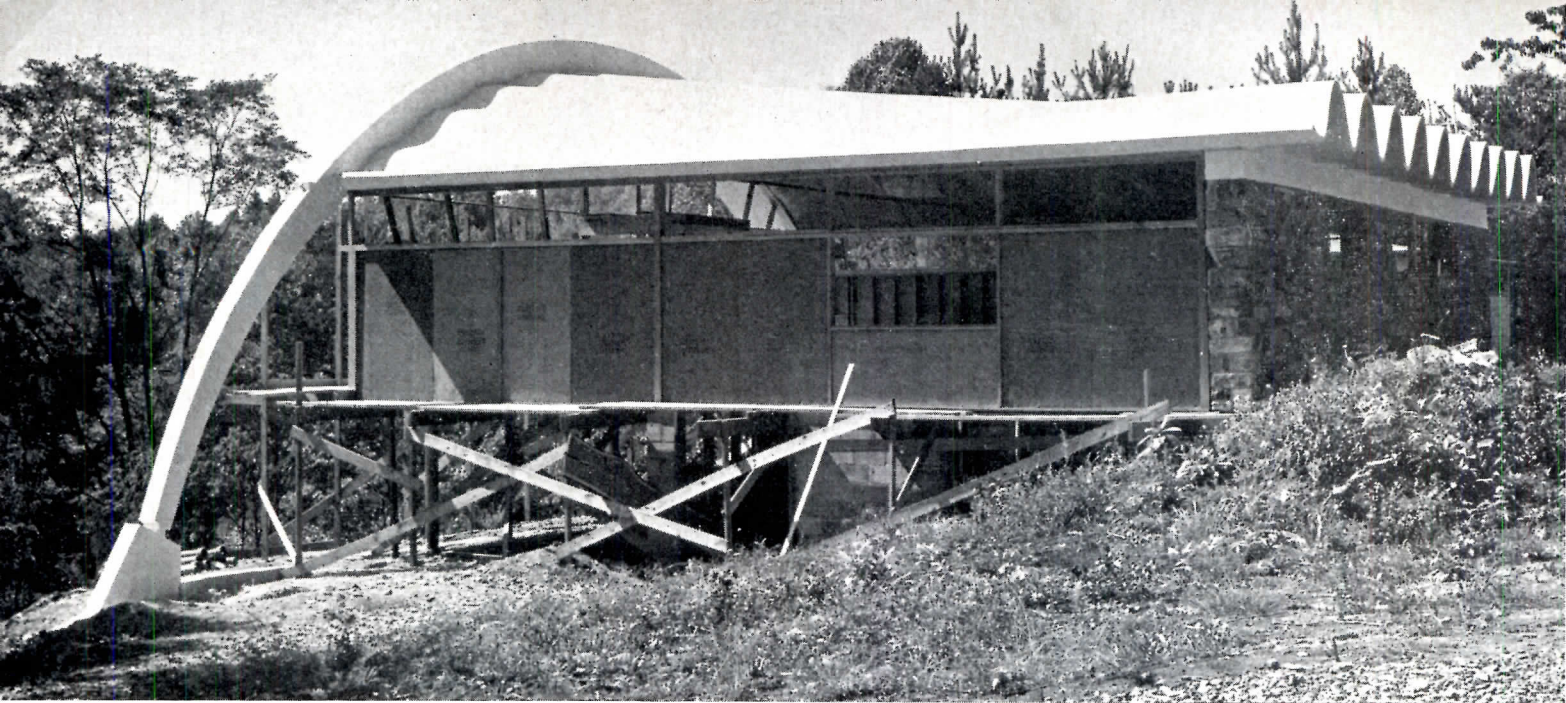

Owner-builder-designer: George Nakashima, New Hope, Pa. Structural designers: Paul Weidlinger, Consulting Engineer, Mario Salvadori, Associate, New York City. Consulting Builder, Joseph E. Heffernan & Son, Philadelphia. The shell spans from the light arch in front to a stone bearing wall in back. Side walls will be stucco with glass above. The front will be all glass. The roof is coated with a cold glaze concrete finish in white. Main floor of the building, which is to be a studio, projects out from block walls to pipe columns behind the arch, and then cantilevers 4 ft more to the back face of the arch. In front elevation note tie rod to take conoid thrust; in side elevation, intermediate stiffeners and stiffening arch are indicated, purpose of which is described later in the text. To satisfy his own curiosity about conoid shell behavior, Nakashima built a small shell in plywood. It will be a permanent building to house the heating plant, allowing the concrete shell to be unmarred by stacks.

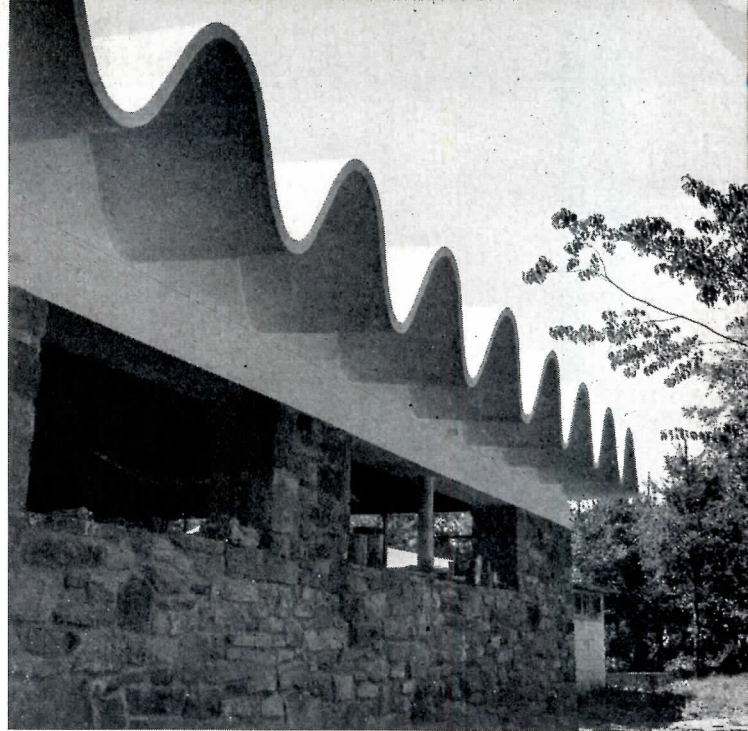

Charles Payne

SEA SHELL ROOF

It's a physical law that if a particular structural material cannot support a load when it is relatively flat, then its curvature necessarily must be increased. To illustrate, take a balloon with a weak spot. The spot will bulge and increase in curvature to be able to withstand the pressure. This basis for strength has been utilized in the Nakashima shell. An ordinary conoid has a doubly curved surface, and in its front portion, has considerable strength. But since its cross-wise curvature diminishes to zero at the back (a straight line), the stresses there, while not infinite, are exceedingly large. To cope with the problem, the engineers decided to run a series of small conoids from the back to the front of the roof, corrugating the surface so that it has somewhat the appearance of a sea shell.

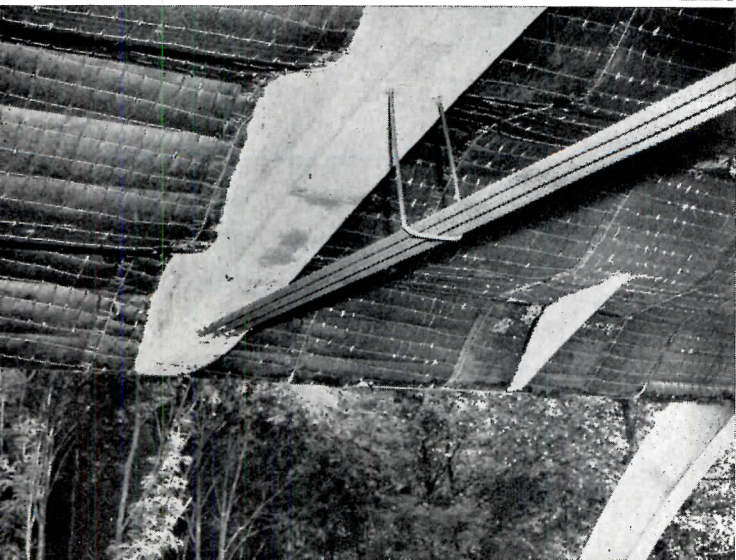
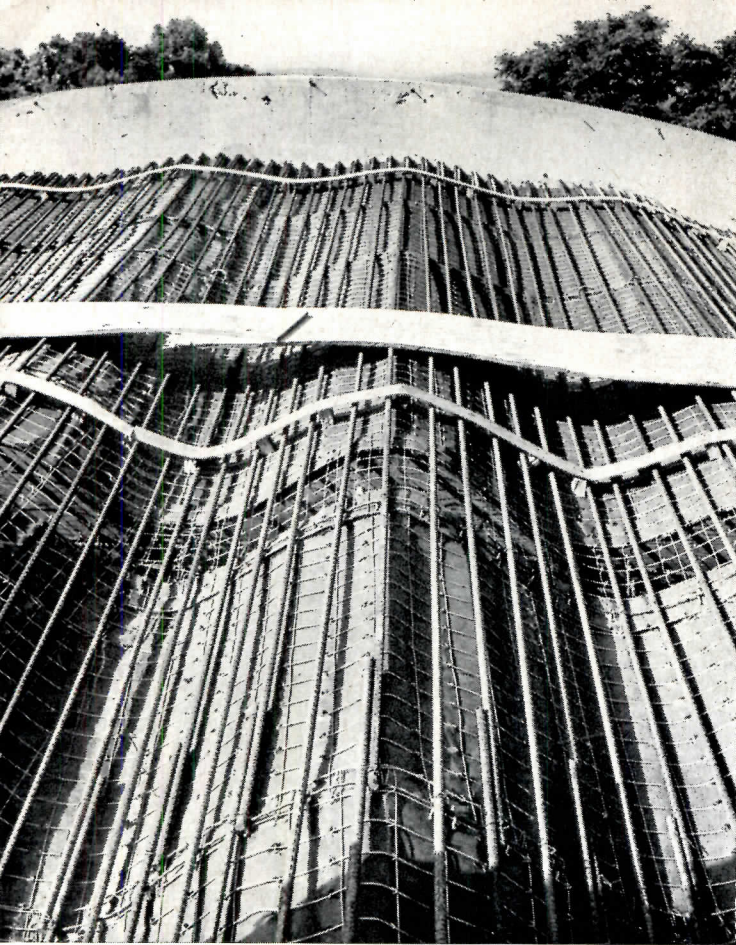

Welded wire fabric lath draped over stringers provided the form for bar reinforcement and concrete. At the back of the shell, where corrugations are deep, plywood was molded to get accurate curvature. The stiffening arch and its tie rods can be seen in the lower left photo; also one of the intermediate stiffeners. Rows of stiffeners are 8 ft on center, but due to staggering of the rows they are 16 ft apart in a longitudinal direction. The underside of the shell is intended to be coated with sprayed-on, asbestos fiber plaster. A sheath will enclose tie rods of the stiffening arch. Cost of both the main and experimental buildings is about \$30,000 for 3000 sq ft, including a half basement. Square foot costs were: formwork, 75 cents (not including labor); reinforcing \$1.08; concrete 60 cents; waterproofing 60 cents; insulating plaster, 25 cents.

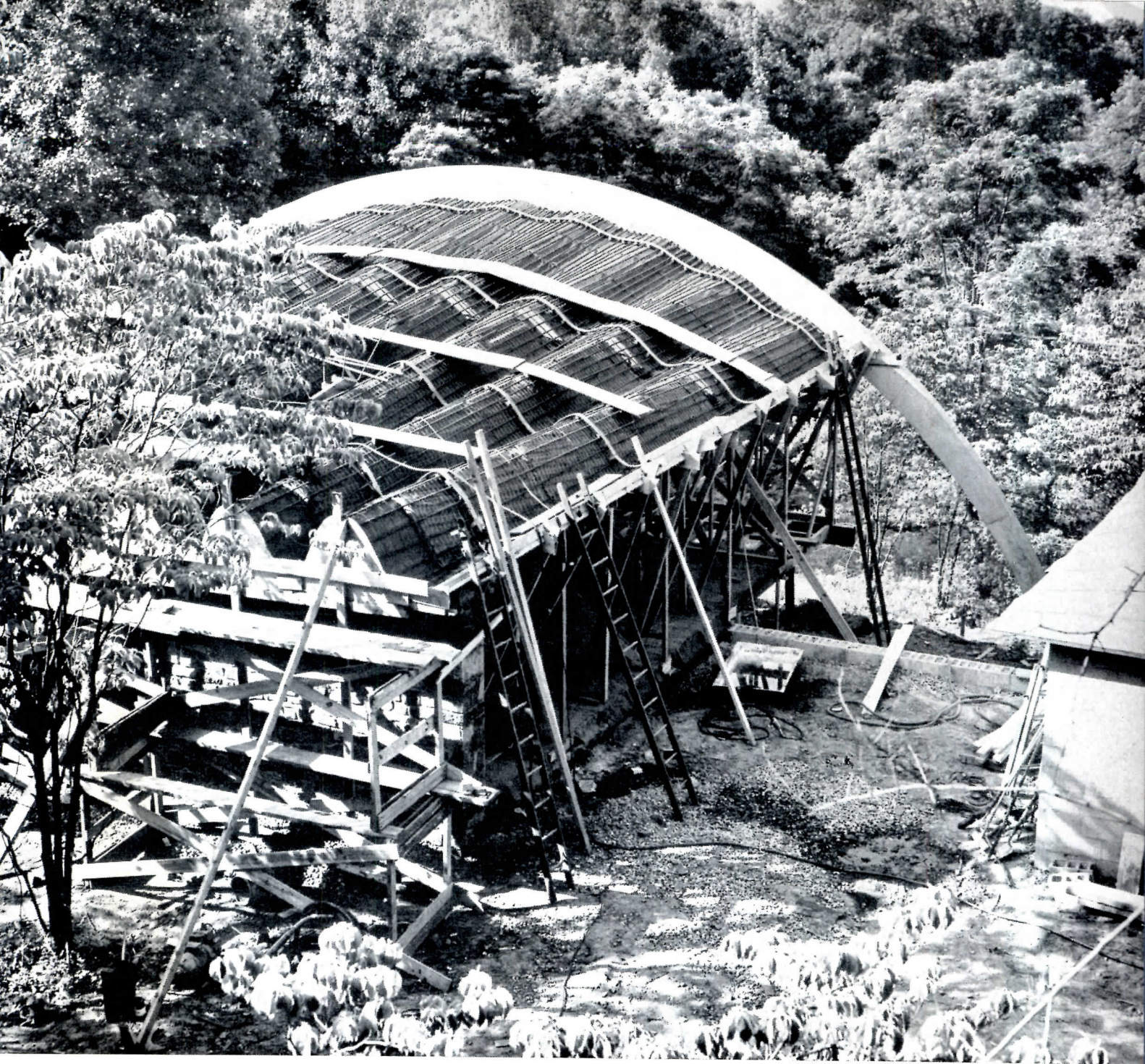

Charles Payne

SEA SHELL ROOF

The front 40 per cent of shell, wherein stresses are reasonable, was fixed to behave like a conoid by providing a stiffening arch 16 ft back of the front arch, both arches taking the thrusts of this section of shell. To insure cross-wise rigidity for transmitting thrusts, stiffeners were inserted halfway between the arches in alternate corrugations. (Making a shell wavy weakens arch action.) Since in any proper conoid, there is no support from walls along the sides, these edges necessarily act as beams. If there had been no stiffening arch, the edge would have had to be considerably thicker. The rest of the shell, with stiffeners used this time to maintain corrugations instead of giving cross-wise stiffness, works as a series of long narrow conoids.



EVOLUTION AND SIGNIFICANCE OF SHELL DESIGN

Conoidal shells are rarely used in the United States although in Europe (especially when used in multiple for monitored industrial buildings), they are encountered frequently. A conoidal surface is formed by moving a straight generator with one end on a straight line and the other on a curve such as a circular segment or a parabola. The resulting surface has two curvatures of opposite sign similar to those of the hyperbolic paraboloid, and for this reason exhibits related properties regarding strength and buckling. In ordinary applications, only the curved portion of the complete conoid is used, and the flat end where the curvature vanishes is cut off. Although an attempt was made to use the full conoid, the stresses near the flat end exceeded the allowable stresses in the concrete of the shell. To remedy this the main conoid was corrugated with small conoids sloping in the opposite direction to provide large curvatures at its flat end while diminishing to zero where the curvature of the main conoid is sufficiently large.

The resulting shell has an entirely new form and represents a new application of the conoidal shell. In more conventional types of reinforced concrete structures, it is customary to distribute the material in accordance with strength requirements of the member. This requires heavying up of the structures. In the present shell, however, instead of distributing the materials according to the strength requirements, the shell curvatures, so to speak, conform to these requirements, while its thickness is kept constant. In this regard, the shell illustrated here is a new departure in the design philosophy of reinforced concrete shells, inasmuch as a rigid geometrical form was not kept but rather modified to suit the particular application. The idea of modifying the shape of a shell in order to produce the required strength through form lends itself to a wide variety of applications. It must be presumed that two essential difficulties had previously prevented this application: the complicated calculations necessary to determine stresses, and the high cost of forms on which to pour the concrete. Both were overcome in the present case by thorough investigation of possible shell behaviors and by the use of welded wire fabric lath over stringers for pouring concrete.

The resulting shell has an entirely new form and represents a new application of the conoidal shell. In more conventional types of reinforced concrete structures, it is customary to distribute the material in accordance with strength requirements of the member. This requires heavying up of the structures. In the present shell, however, instead of distributing the materials according to the strength requirements, the shell curvatures, so to speak, conform to these requirements, while its thickness is kept constant. In this regard, the shell illustrated here is a new departure in the design philosophy of reinforced concrete shells, inasmuch as a rigid geometrical form was not kept but rather modified to suit the particular application. The idea of modifying the shape of a shell in order to produce the required strength through form lends itself to a wide variety of applications. It must be presumed that two essential difficulties had previously prevented this application: the complicated calculations necessary to determine stresses, and the high cost of forms on which to pour the concrete. Both were overcome in the present case by thorough investigation of possible shell behaviors and by the use of welded wire fabric lath over stringers for pouring concrete.

The resulting shell has an entirely new form and represents a new application of the conoidal shell. In more conventional types of reinforced concrete structures, it is customary to distribute the material in accordance with strength requirements of the member. This requires heavying up of the structures. In the present shell, however, instead of distributing the materials according to the strength requirements, the shell curvatures, so to speak, conform to these requirements, while its thickness is kept constant. In this regard, the shell illustrated here is a new departure in the design philosophy of reinforced concrete shells, inasmuch as a rigid geometrical form was not kept but rather modified to suit the particular application. The idea of modifying the shape of a shell in order to produce the required strength through form lends itself to a wide variety of applications. It must be presumed that two essential difficulties had previously prevented this application: the complicated calculations necessary to determine stresses, and the high cost of forms on which to pour the concrete. Both were overcome in the present case by thorough investigation of possible shell behaviors and by the use of welded wire fabric lath over stringers for pouring concrete.

The resulting shell has an entirely new form and represents a new application of the conoidal shell. In more conventional types of reinforced concrete structures, it is customary to distribute the material in accordance with strength requirements of the member. This requires heavying up of the structures. In the present shell, however, instead of distributing the materials according to the strength requirements, the shell curvatures, so to speak, conform to these requirements, while its thickness is kept constant. In this regard, the shell illustrated here is a new departure in the design philosophy of reinforced concrete shells, inasmuch as a rigid geometrical form was not kept but rather modified to suit the particular application. The idea of modifying the shape of a shell in order to produce the required strength through form lends itself to a wide variety of applications. It must be presumed that two essential difficulties had previously prevented this application: the complicated calculations necessary to determine stresses, and the high cost of forms on which to pour the concrete. Both were overcome in the present case by thorough investigation of possible shell behaviors and by the use of welded wire fabric lath over stringers for pouring concrete.

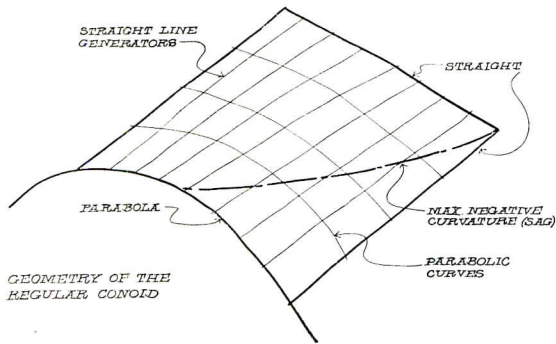

GEOMETRY OF THE REGULAR CONOID

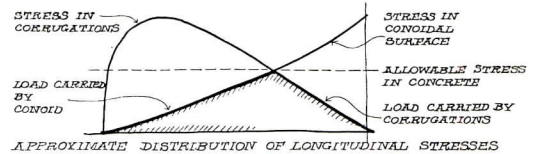

APPROXIMATE DISTRIBUTION OF LONGITUDINAL STRESSES

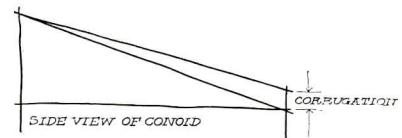

SIDE VIEW OF CONOID

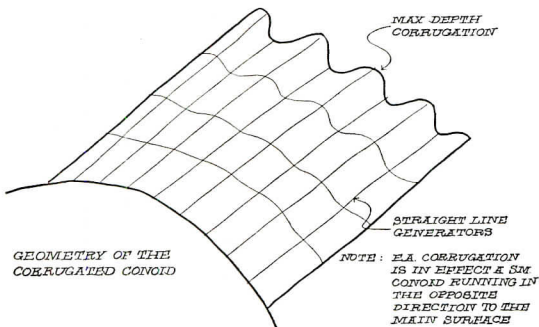

GEOMETRY OF THE CORRUGATED CONOID

HOSPITALS

AS A PLANNING ASSIGNMENT, hospitals would strain architects much harder than they do were it not for the extensive research material available. Not many types of buildings have been so thoroughly studied as hospitals were since, say, the early beginning of the Hill-Burton program. Before that hospital planning was studied only by a few architectural firms and a handful of medical consultants, and the know-how of hospital planning had scarcely left the realm of black magic. Now almost any architectural firm can safely undertake a hospital commission, confident that the hard background study of the subject has largely been done for them, and is well recorded in architectural literature. Current research is growing, moreover, especially under federal grants to various groups for specific studies.

The major study project was carried on in the U. S. Public Health Service, where the architectural and engineering branch undertook the mammoth job of researching hospitals department by department, marshaling and sifting the opinions, the data, the hopes, the needs of medical and nursing groups, and finally drawing plans for each element in the hospital. These elements have appeared in great numbers; all of them were published in these Building Types Studies in ARCHITECTURAL RECORD, were brought together in book form in 1953.* Under the late Marshall Shaffer, the architectural unit of the Public Health Service became a sort of world center of hospital planning. Nothing that came out of the office was ever regarded as mandatory, no plans were considered "standard," but rather all was regarded as background help for architects and hospital groups, toward the end of getting our money's worth in hospitals.

Three recent studies by PHS architectural group, now headed by August F. Hoenack, are reported in this Study: 1. a newly planned pediatrics nursing unit for a general hospital, as a sort of graphic focus for a new report by the American Academy of Pediatrics; 2. graphic studies of physical therapy department of a general hospital, these similarly going with a text study by joint committees of the American Hospital Association and the American Physical Therapy Association; 3. architectural details and lengthy text report on radiation and architectural considerations for Cobalt 60 units, developed by various Public Health Service specialists along with a committee of the American Hospital Association.

Rounding out this Building Types Study are three extra special hospitals, illustrating some of the advances that private architectural firms have been contributing as their share of the lengthening story of better hospitals for America.

— Emerson Goble

* *Design and Construction of General Hospitals*, by U. S. Department of Health, Education and Welfare, Public Health Service, F. W. Dodge Corporation.



A GREAT HOSPITAL BUILDS TO KEEP UP WITH THE TIMES

M. S. Kaplan Pavilion, Michael Reese Hospital, Chicago. Architects: Loeb, Schlossman & Bennett; Consultants: The Architects Collaborative; Medical Consultants: Dr. Jacob Golub; Mechanical Engineer, Robert E. Hallis; Structural Engineer: Alfred Benesch and Associates; Landscape Architects: Sasaki & Novak; Furnishings and Interior Colors: Watson and Boaler, Inc.

A FAMOUS OLD INSTITUTION on Chicago's South Side, Michael Reese Hospital, is registering advances to match those of its neighborhood. This is the great area along the lake front that is being completely redeveloped, with huge apartments. Michael Reese decided to do likewise, and is now engaged in a complete rebuilding program, which will eventually replace all its old buildings and will increase bed capacity from 700 to 1200. The Kaplan Pavilion forms the nucleus of the new campus scheme; its present 112 bed capacity will be

increased to 280 and its facilities will be added to.

The architectural solution strives to combine the many hospital activities, facilities and equipment into convenient functional relationships; and by the use of simple easily maintained materials, cheerful colors, pleasant, sunny exposures, and carefully proportioned spaces to create a pleasant non-institutional environment. To this end the interiors have been kept small in scale where possible. Most patient rooms face south, and windows extend from wall to wall and sill to ceiling, in order to provide a large expanse of glass and an open feeling; light and view are controllable by the patient, as suits season, lighting conditions or moods.

In this present building all food service comes from the kitchen of another building on the campus, by food truck through a tunnel. A later addition to this pavilion will house a new kitchen for the whole hospital.

This building is completely air conditioned. Minimal

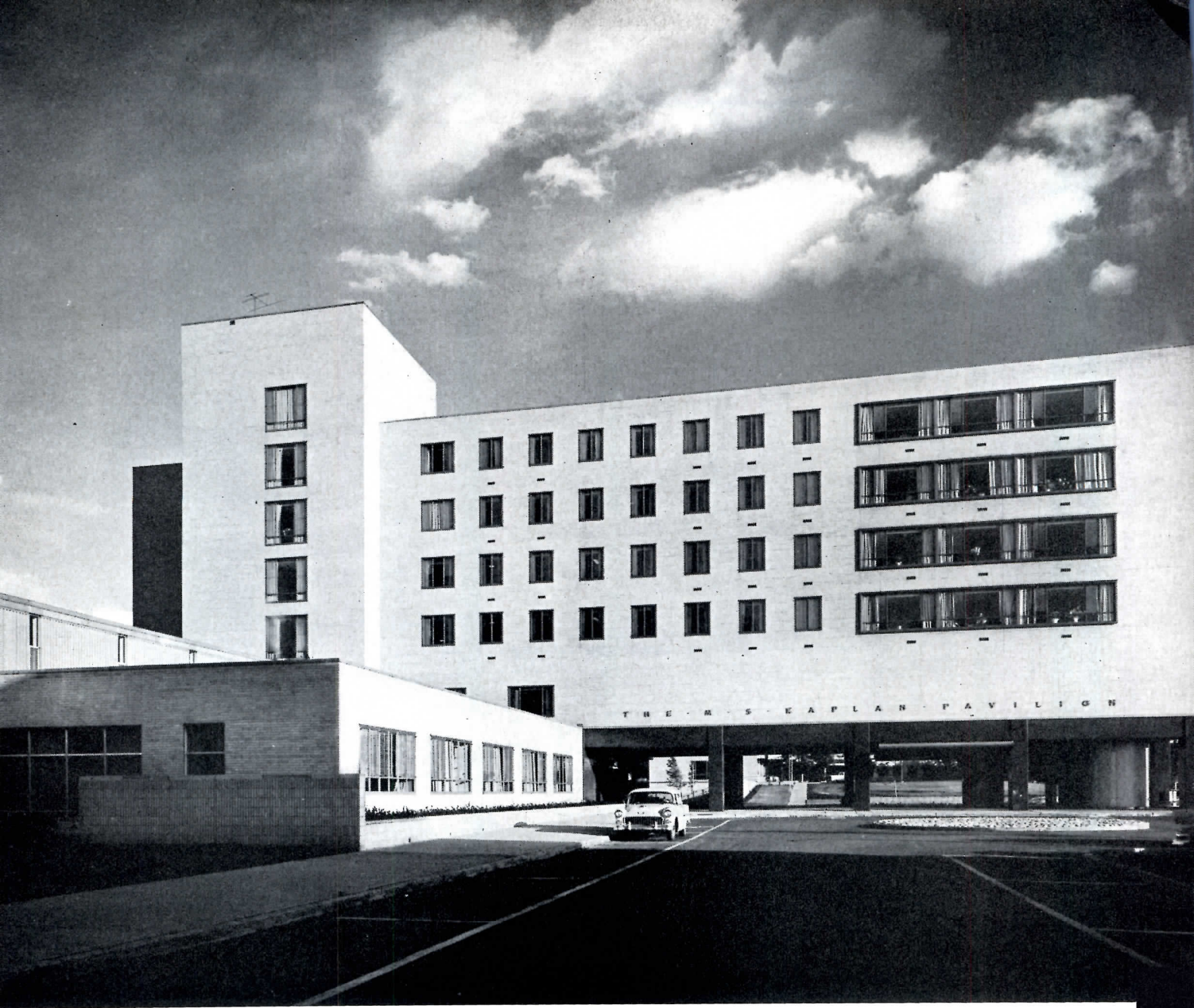

cost was achieved by using individual cooling and ventilating units in each room of patient areas. Each patient thus has been given individual control of his room conditioning. The same piping circulates chilled water in summer and hot water in winter.

A single-conduit type send-and-return automatic switch pneumatic type system interconnects the pavilion and all other buildings. The central doctor's call and message center also integrates all campus buildings and is so arranged that any doctor can register his arrival and departure from any point on the campus.

Expansion of this unit will be vertical; six added floors of nursing units are provided for in mechanical installations. The scheme also calls for a two-story wing to house central facilities for the whole campus, such as central record room (a present office wing is omitted in the plans here shown), main kitchen, new operating department, out-patient facilities and doctors' offices.

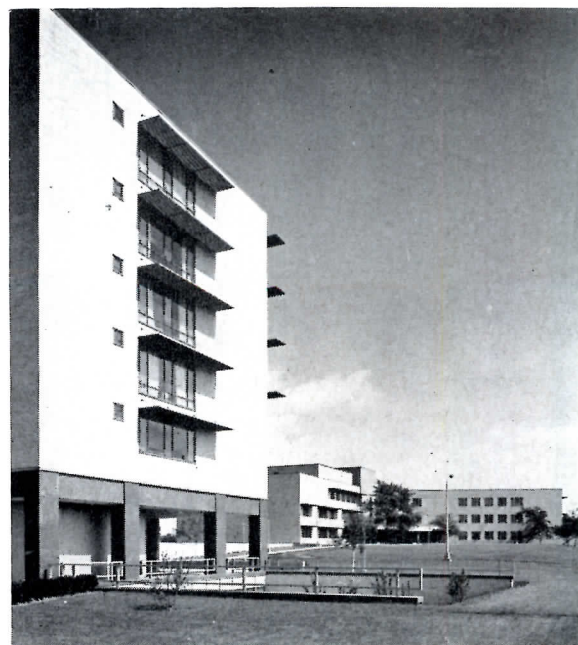

Hedrich-Blessing (Hube Henry)

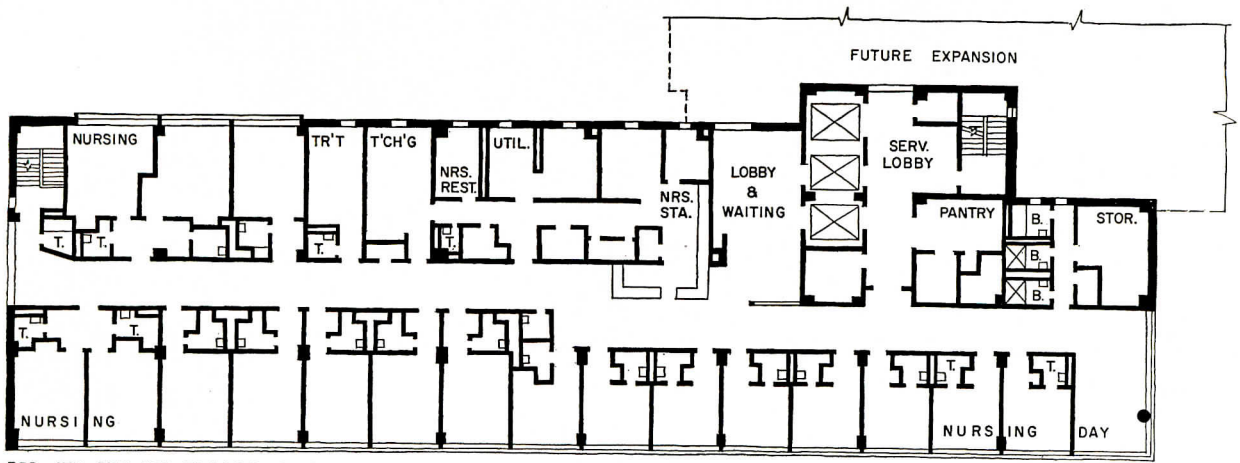

3RD, 4TH, 5TH, 6TH FLOORS PLAN

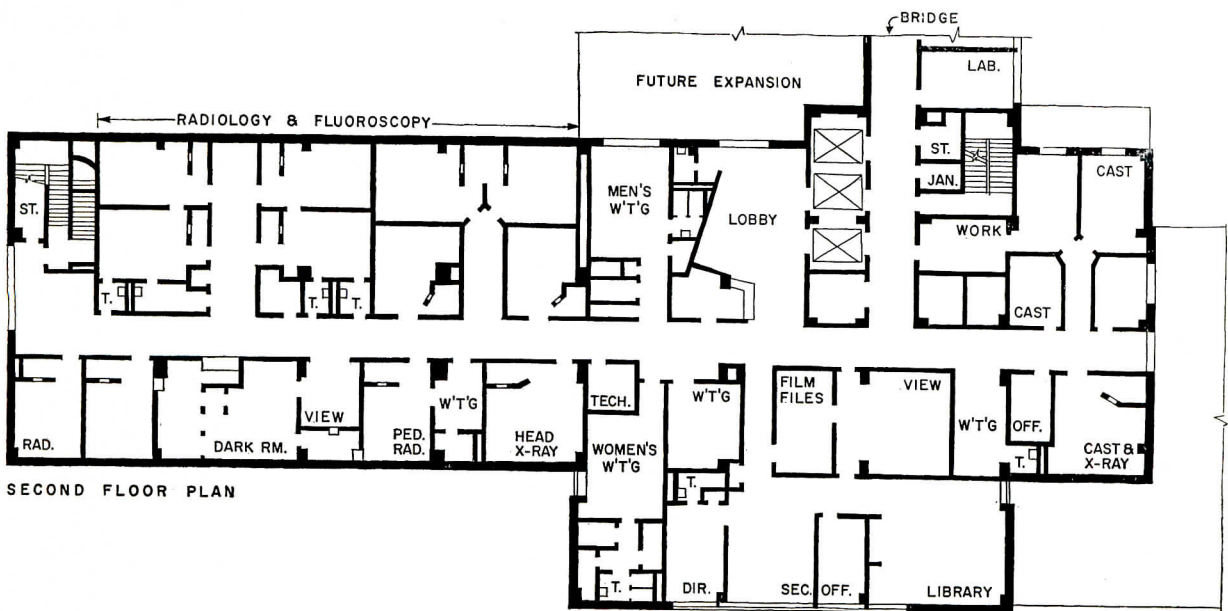

SECOND FLOOR PLAN

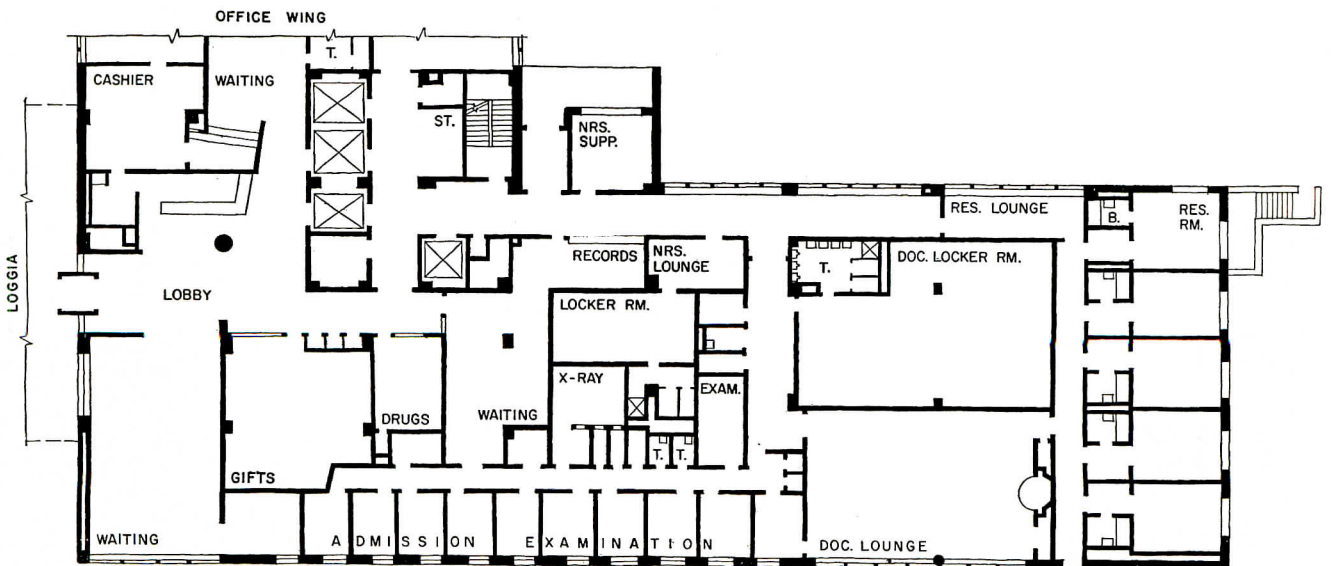

FIRST FLOOR PLAN





Above: doctors' lounge, first floor; below left: pediatrics waiting room, radiology suite; below right: reception desk, main lobby

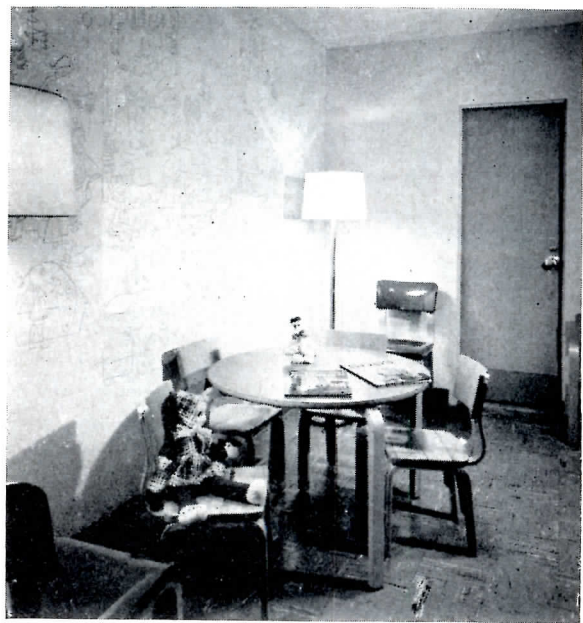

Friedrich-Blessing (Bill Engdahl & Hube Henry)



Left: each nursing room floor has a large, bright day room



Hedrich-Blessing (Bill Engdahl & Hube Henry)

Above and left: main floor waiting room is the most formal



Left: office wing has smaller waiting room, cashier counter



Right: staff dining room, basement floor, plan not shown

Right: administrator's office is large enough for meetings

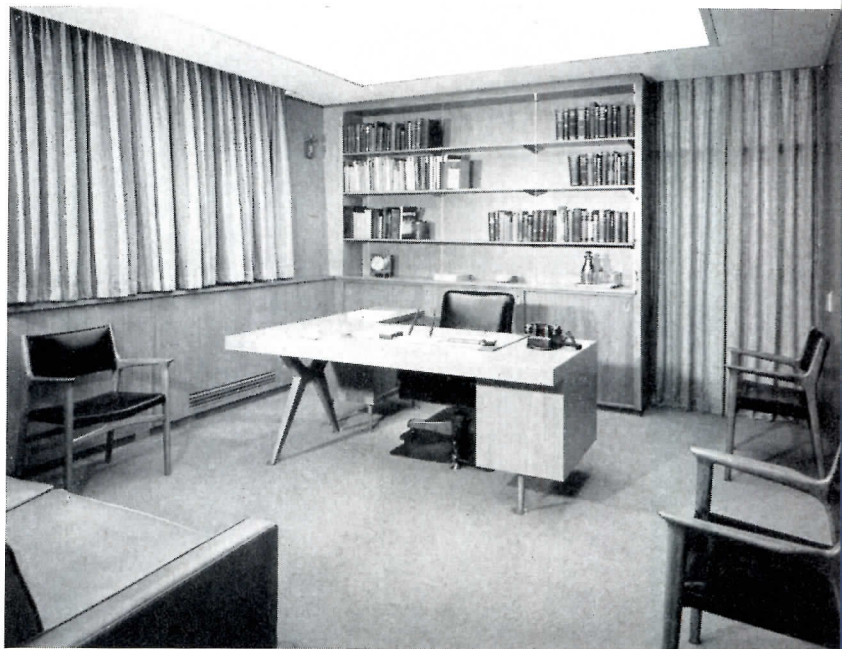

Below and right: pharmacy and gift shop off main lobby



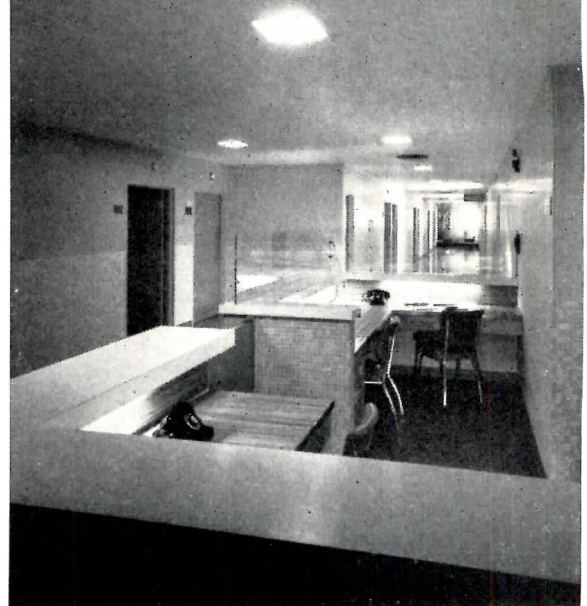

Hedrich-Blessing (Bill Engdahl & Hube Henry)

Above and left: nurses' station is roomy, has full view

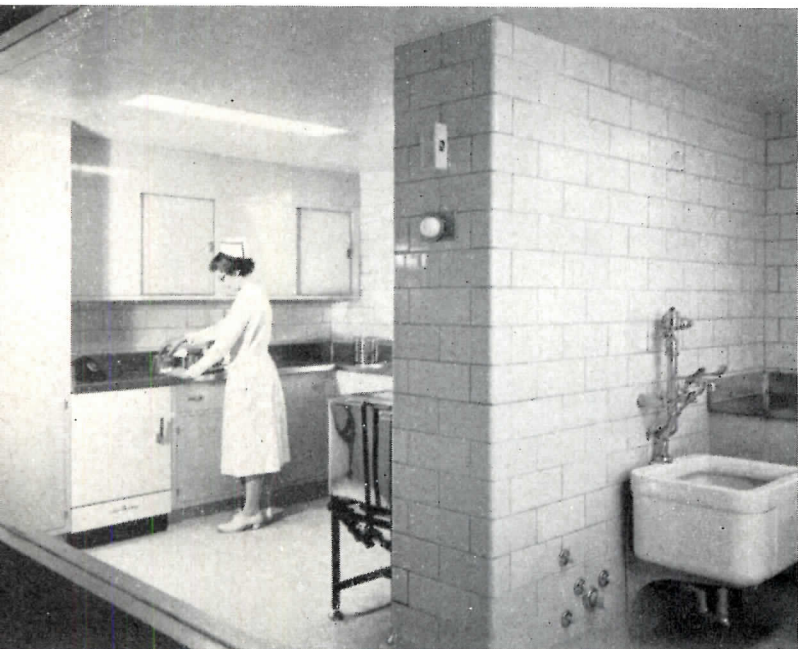

Left: utility rooms, part of nurses' station grouping

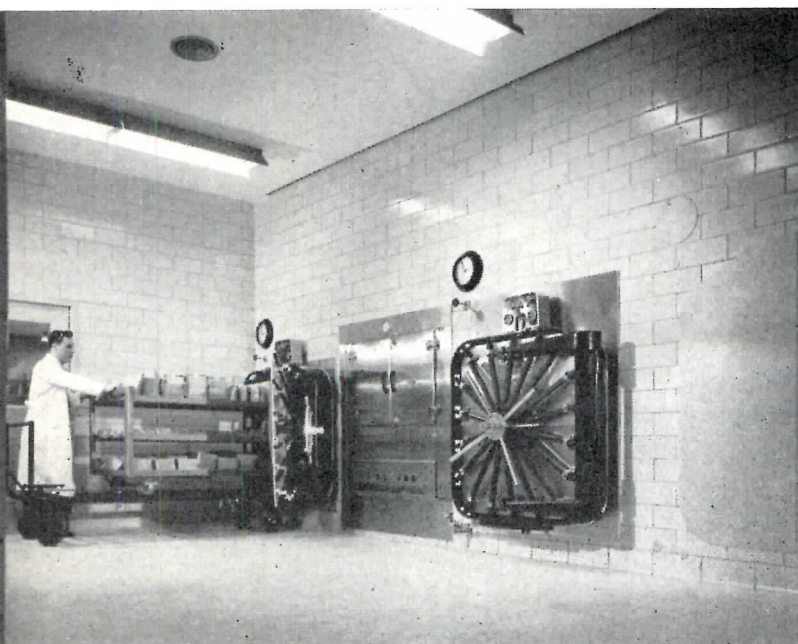

Left: sterilizing room, part of large basement work area

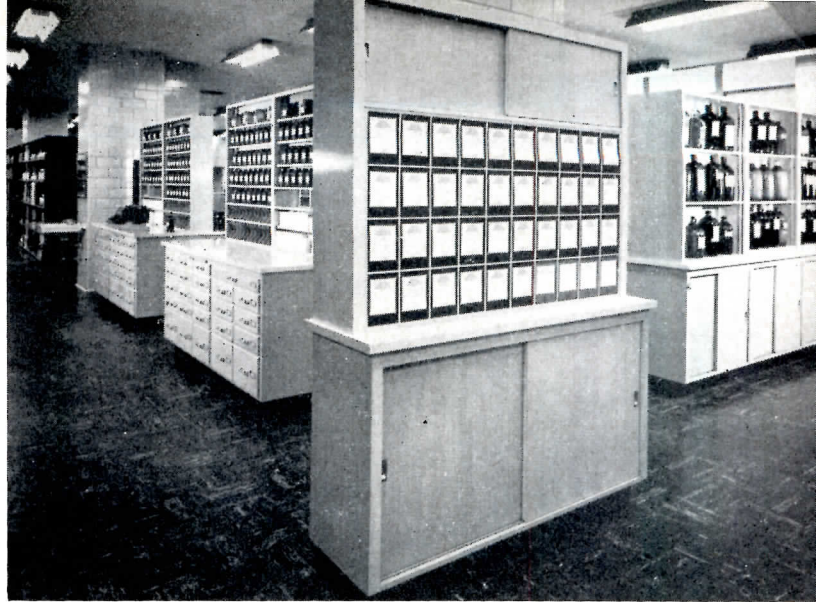

Above and right: large manufacturing pharmacy, basement

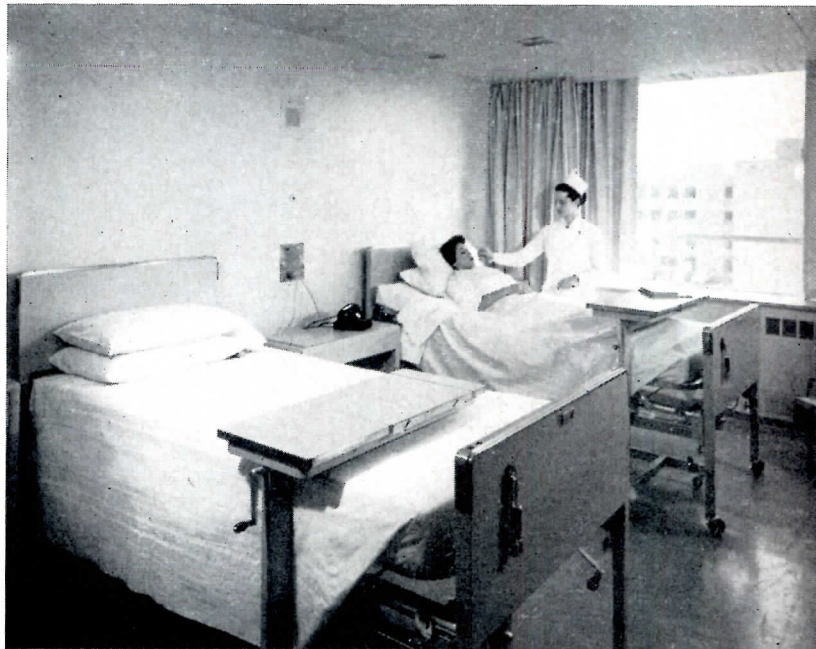

Right: typical two-bed room, beds aligned on one wall

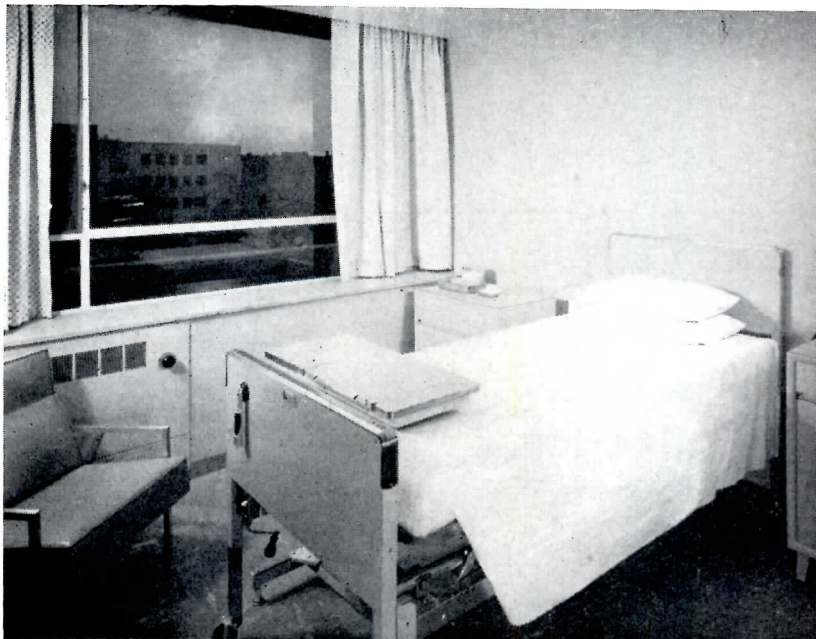

Right: single bed room illustrates window arrangement

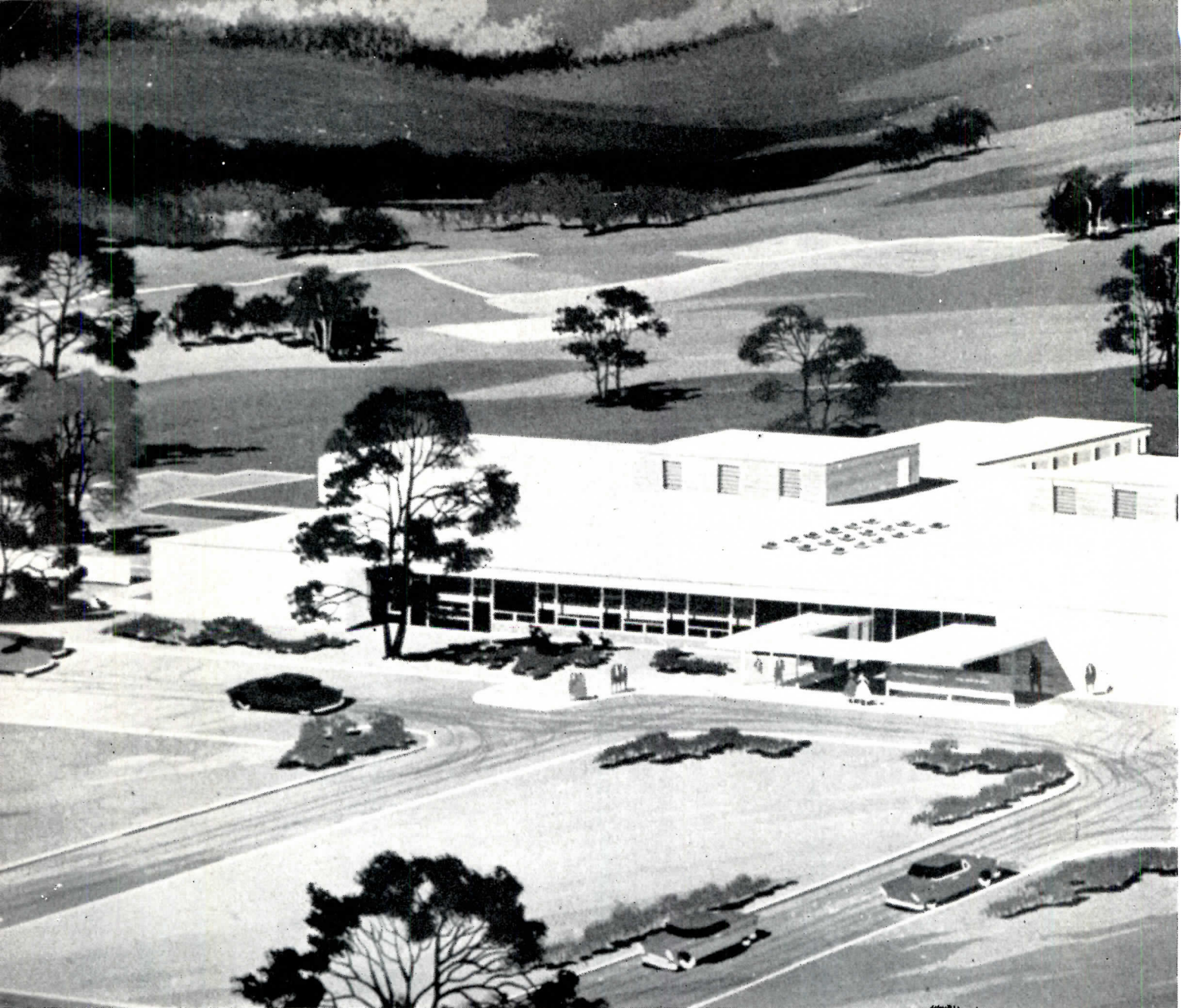

PREPLANNED SUPPLY SYSTEM PERMITS LOGICAL PLAN

Proposed Berwick Hospital, Berwick, Pa. Architects: Noakes & Neubauer; Associate Architect: Edmund George Good, Jr.; Medical Consultants: Gordon A. Friesen Associates; Consulting Engineers: Shefferman and Bigelson

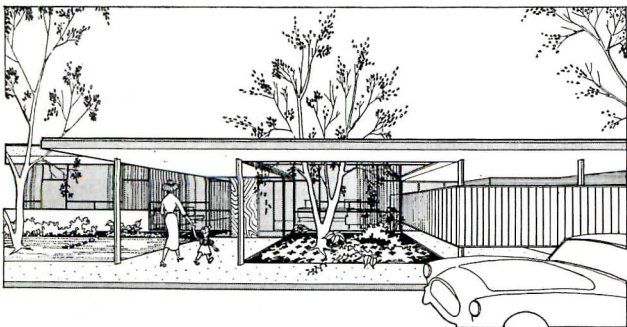

AN "AUTOMAT" SYSTEM of organizing and dispatching hospital supplies, developed by Consultant Gordon Friesen, has permitted Architect Edward Noakes to arrange a very interesting plan. A 92-bed hospital on one floor is a considerable expanse of complicated departmental dispositions, and the supply system of any hospital is an important determinant of the plan arrangements.

Friesen's supply scheme, developed from similar systems he used in the United Mine Workers hospitals, puts a dispatch center in the center of the building, where are grouped central sterilizing department, laundry, bulk and processed stores, laboratory, pharmacy



and linen rooms. From here, by special carts, supplies of everything needed in normal routines go out to every location in the hospital. The scheme is calculated to cut drastically a nurse's daily travel. Naturally the above listed grouping is a radical departure in hospital organization.

It doesn't require much study of the plan to see how logically various departments group themselves around the central supply department. The operating suite is perhaps most important; it is strategically placed with respect to supplies, laboratory, pharmacy, also x-ray and emergency. Incidentally, notice the unconventional arrangement of operating rooms with two-corridor approach — clean supplies separated from dirty, separate access for surgeons, and so on.

The delivery suite is well isolated, well separated from operating, but again close to the source of supplies. The maternity nursing unit takes off in its own wing from

the corner near the delivery group; it can expand toward the center of the building as required.

The nursing units cluster close around the central supply, coming to a focus in two nursing stations, well removed from traffic and noise.

The emergency suite is close to the main entrance, an idea Friesen rather insists upon. Notice that the receptionist can see into the emergency corridor, but waiting room guests are shielded from possibly unpleasant sights. This control from main desk would be very important in the wee small hours. So many people, in an emergency, naturally drive to the front of the hospital, points out Friesen, and how are they to know they should go around to the back, and then perhaps find only a locked door?

An especially good feature of this plan is the service entrance and short delivery corridor. The important departments to be served — boiler room, kitchen, stores,

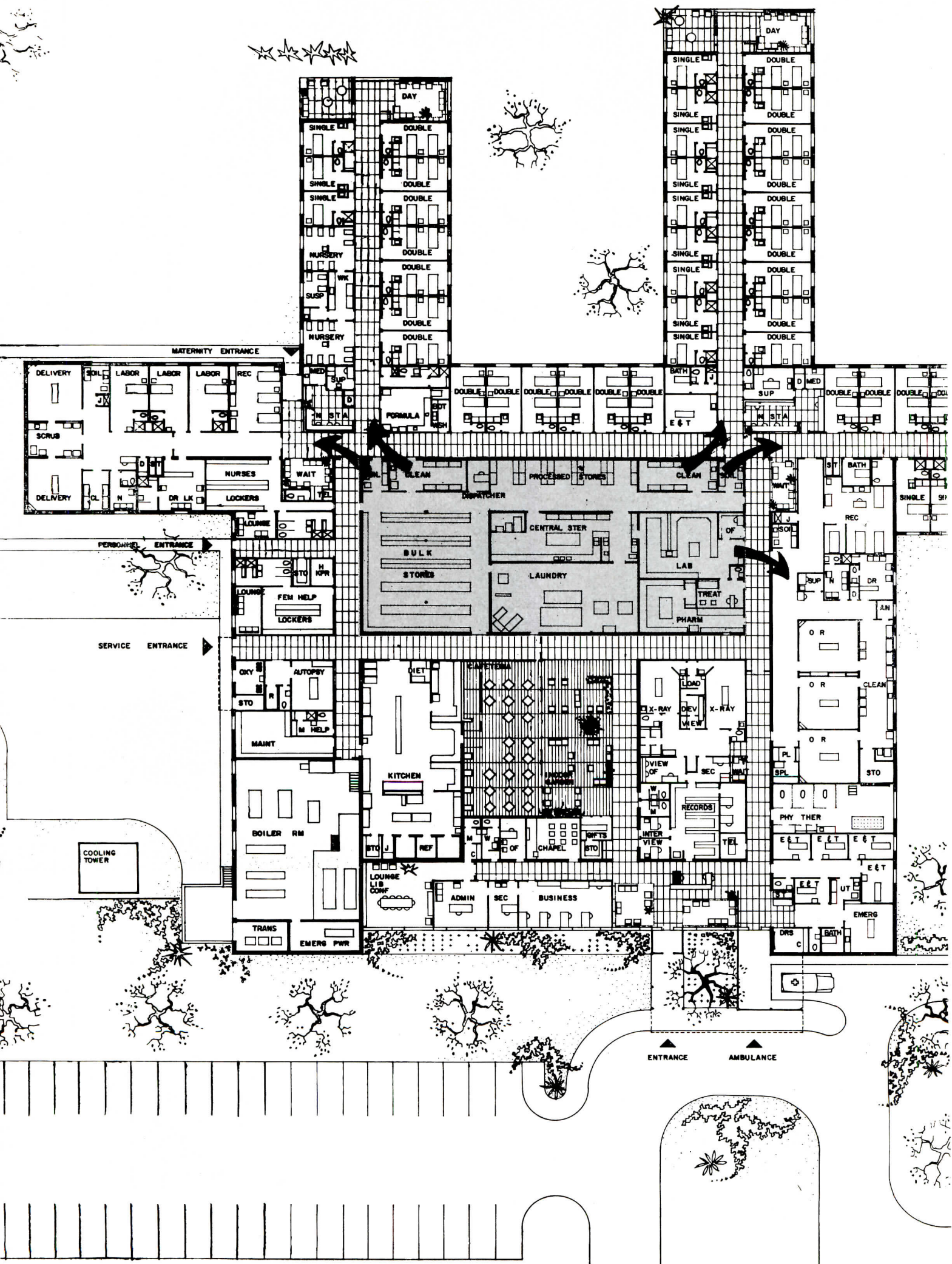

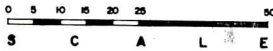
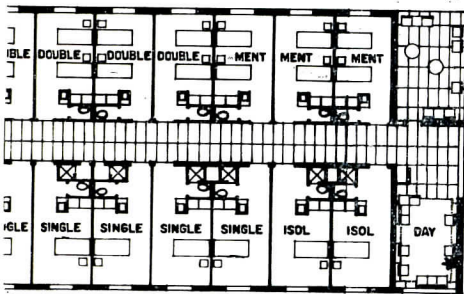
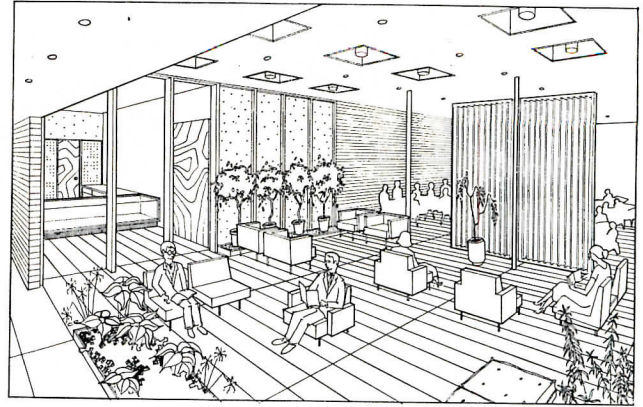
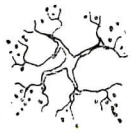

and so on, cluster neatly around this corridor.

The whole plan is worthy of study, representing an almost complete rearrangement of traditional groupings.

The architects express themselves as being quite happy about the cost data. The building itself came out quite reasonably — some 50 per cent of the total cost is represented by mechanical and electrical, allowing for future air conditioning of the whole plant. Total cost of the project, on the basis of bids, runs to \$1,284,600, or \$13,960 per bed for a capacity of 92 beds. The general construction contract puts this per bed cost at \$12,174, or \$18.24 per square foot, \$1.53 per cube. (This is going up to \$18.73 per square foot in a proposed change order involving air conditioning, the earlier figures representing air conditioning completely installed for only operating, delivery and nursery suites.) The total project cost included \$75,600 for Group I equipment. Group II equipment, not included, is estimated at \$88,800, though much Group II and Group III is being re-used, from their existing hospital.

Construction is masonry bearing walls, bar joist and poured gypsum roof construction, concrete slab on ground, concrete block partitions plastered.

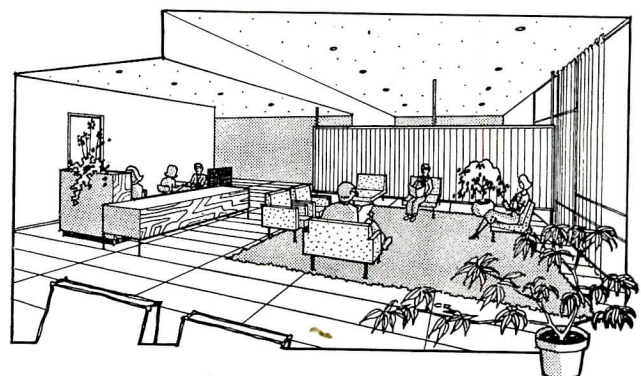
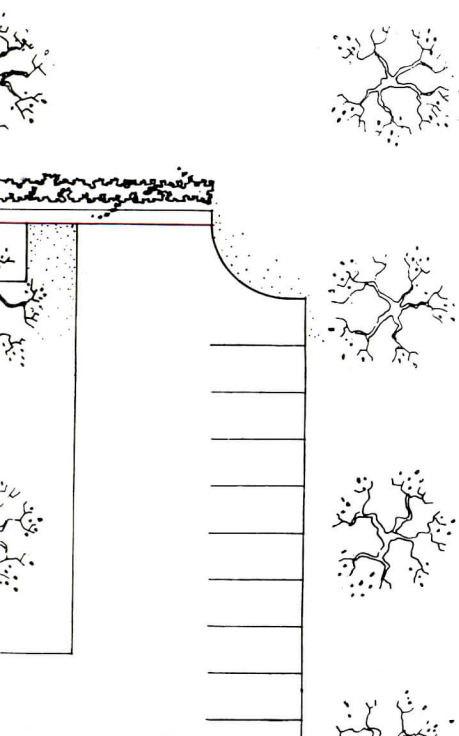



Julius Shulman

Methodist Hospital of Southern California, Arcadia, Cal. Architects: Neptune and Thomas; Structural Engineer: John Minasian; Mechanical Engineers: Levine & McCann; Electrical Engineer: John R. Kocher; Landscape Architect: V. H. Pinckney

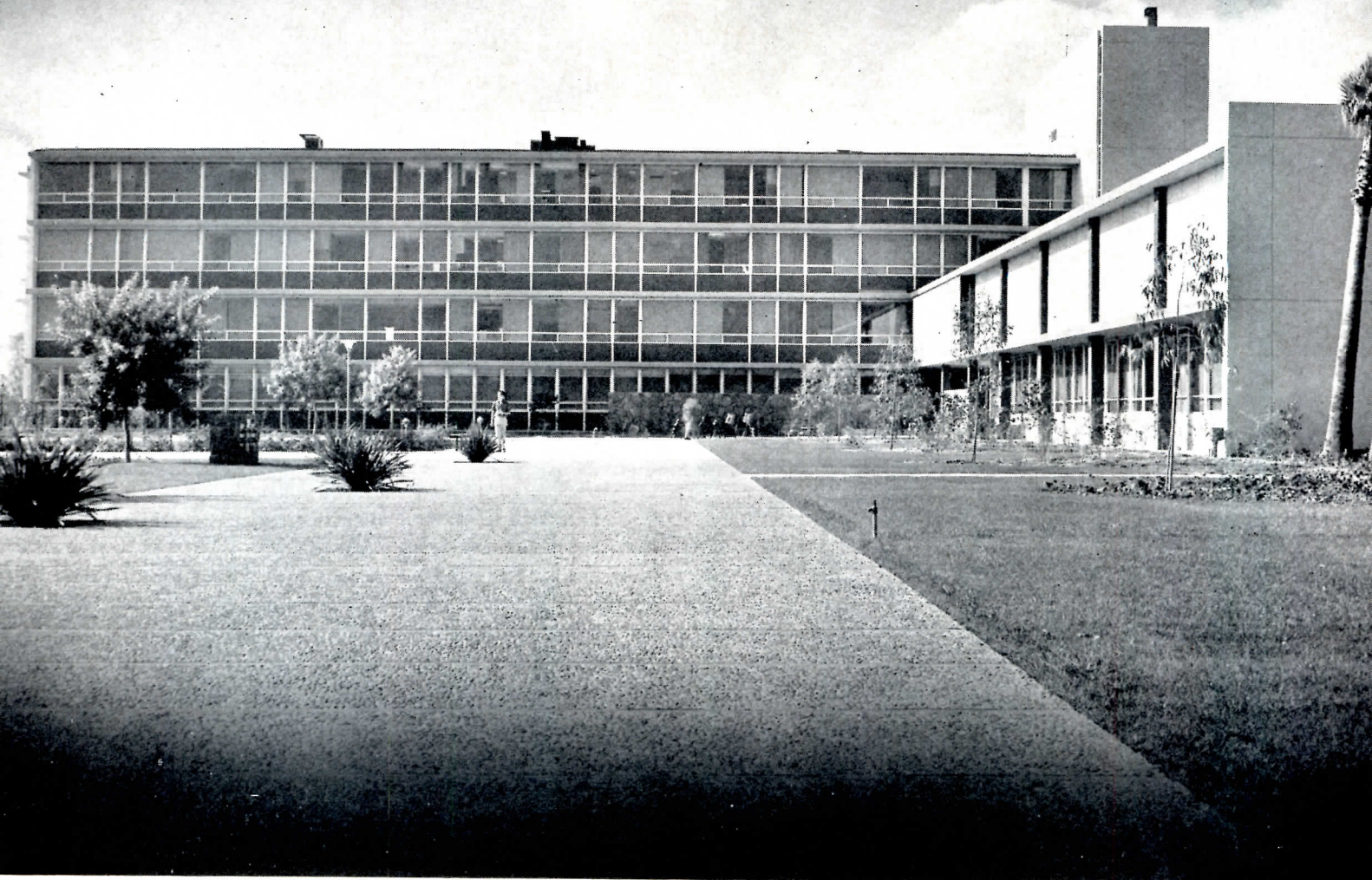

GENERAL HOSPITAL WITH UNIQUE PSYCHIATRIC UNIT

ONE OF THE ADVANCES registered in this hospital is the inclusion of a 25-bed psychiatric nursing unit, first in a California general hospital. Another first is a ceramic veneer panel for a curtain wall exterior, conceived by the architects for this building (ARCHITECTURAL RECORD, Oct. '56, p. 266).

The psychiatric unit is especially pleasant; it is on the first floor, and has two enclosed patios for use by patients; some of the patients' rooms open, through shatterproof glass, directly into the larger court. The unit is arranged for the isolation of a group of disturbed patients, with access to the smaller patio. A large day room occupies the space between the courts.

The hospital is planned in bi-nuclear fashion, with the nursing units stacked up in one section, surgical, administrative, in fact most non-bedroom spaces, grouped in a second portion. This scheme has the advantage, of course, of keeping, in at least the nursing

unit, all columns, mechanical systems, plumbing, and so on, in uniform stacks. It permits a great deal of pre-fabrication of plumbing assemblies on the ground. This placing of masses was also important to the economy of the structural system, since the building is done with lift-slab floors. Columns could be positioned for the floor system, and rooms uniformly designed around them, at least in nursing wings.

The architects, along with Walter R. Hoefflin, Jr., executive secretary of the hospital, worked out a non-conventional arrangement of delivery suite, operating department, recovery room and so on, that is worthy of some study.

The proposed expansion is planned as horizontal, rather than vertical, with another nursing wing added end-to-end to the first one. The building will then take the form of the conventional T, with elevators at the juncture, nursing units on either side.

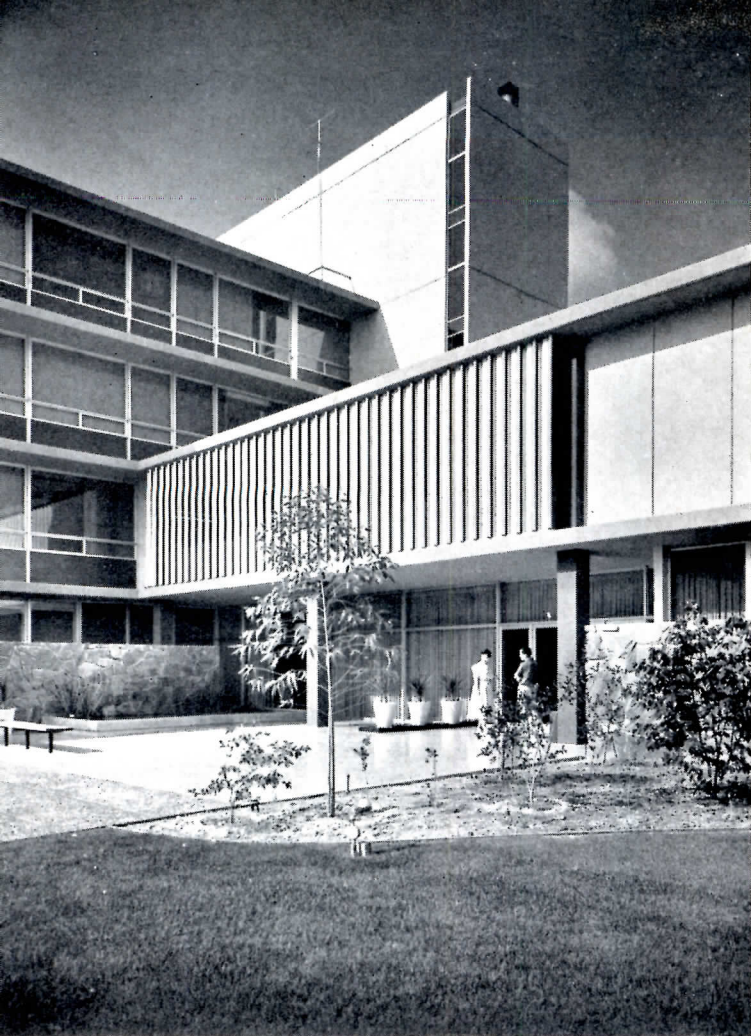

Julius Schulman

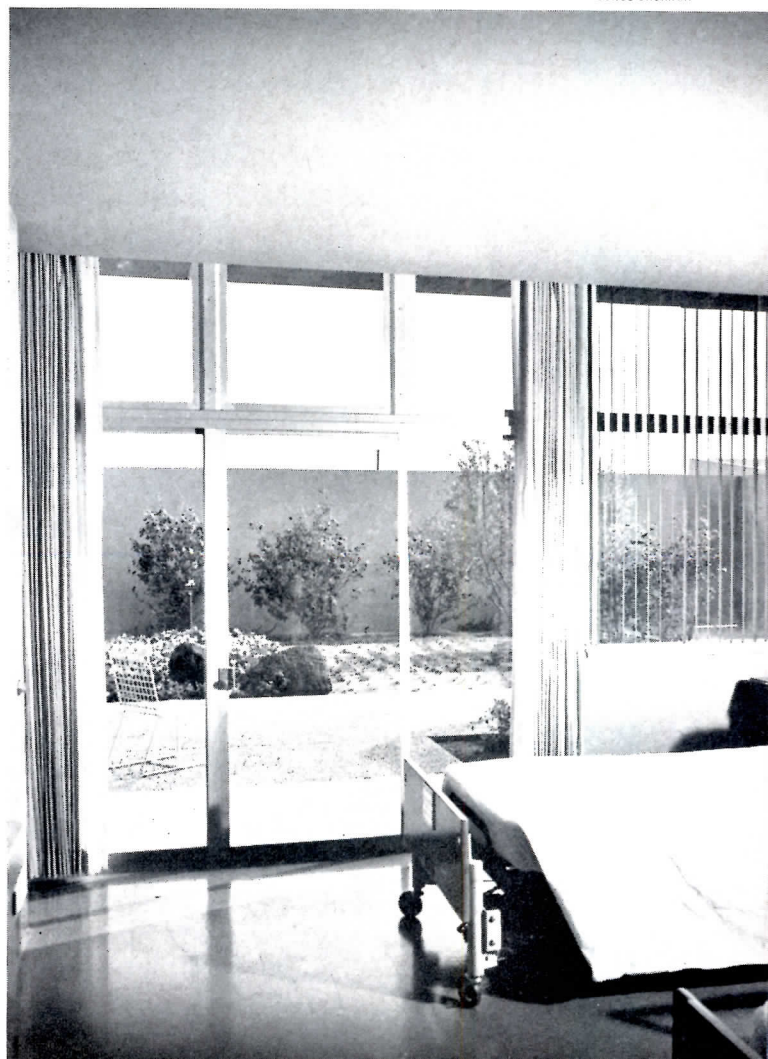



Above and left: staff dining room, and kitchen



Left: main waiting room; main entrance is behind



Left: typical solarium in nursing floors, near elevators

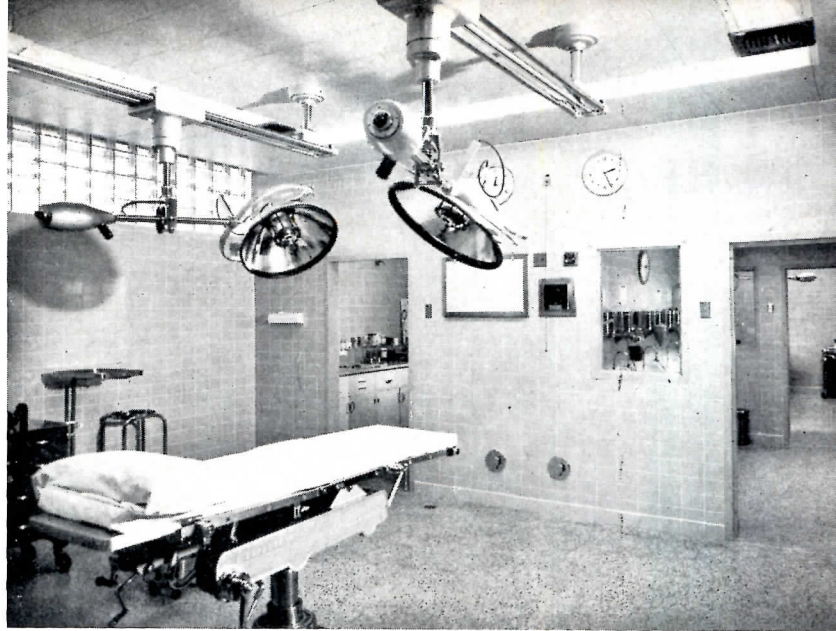
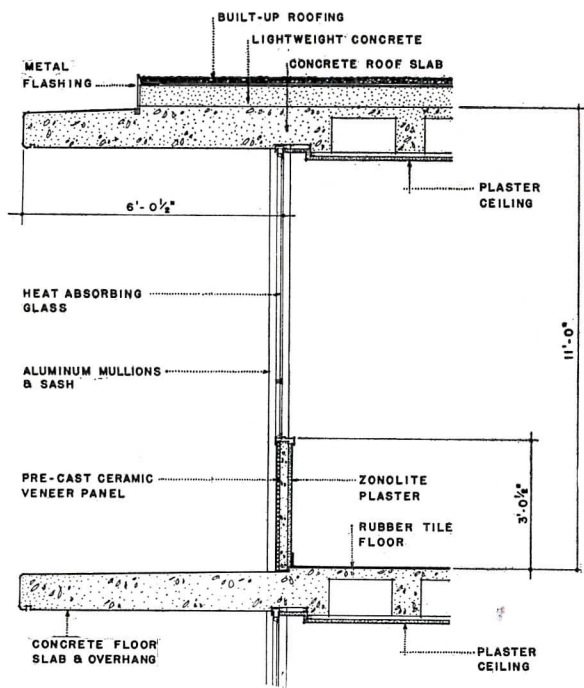

Right, top: operating room has conductive terrazzo floors

Right: corridor in nursing wing; nurses' station, right

Below and right: typical patients' bed room

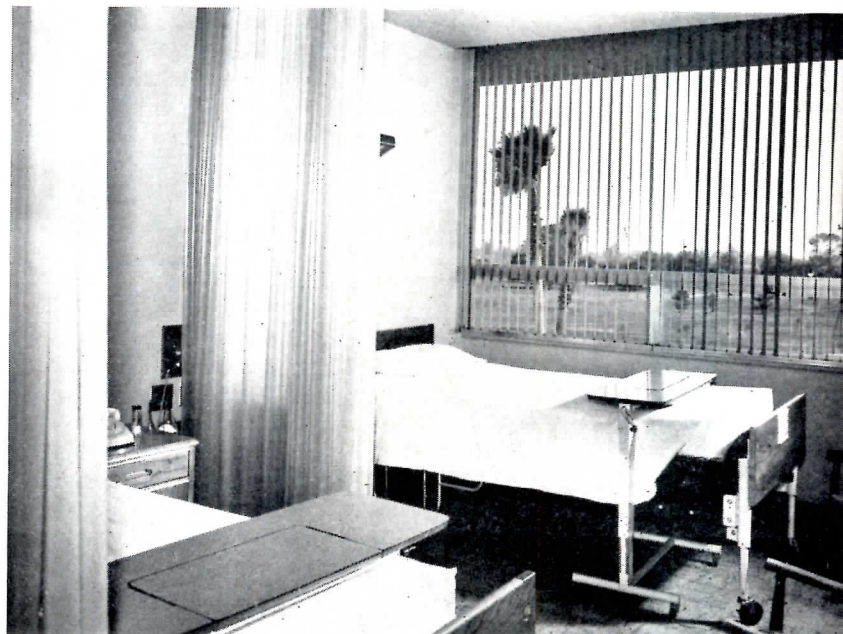
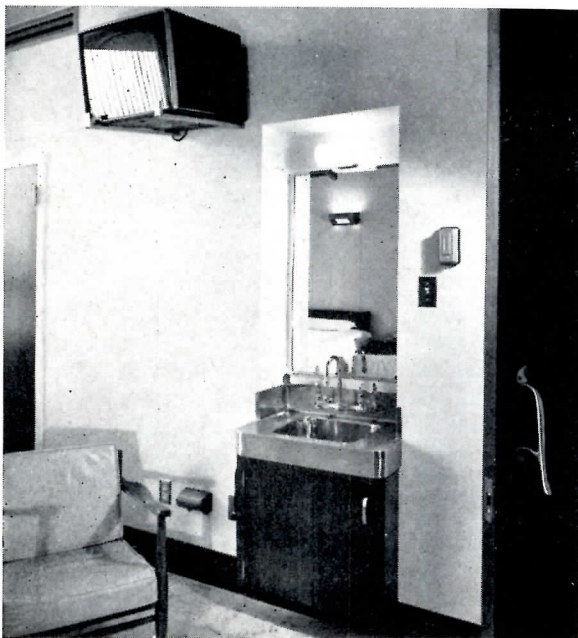

Julius Schulman

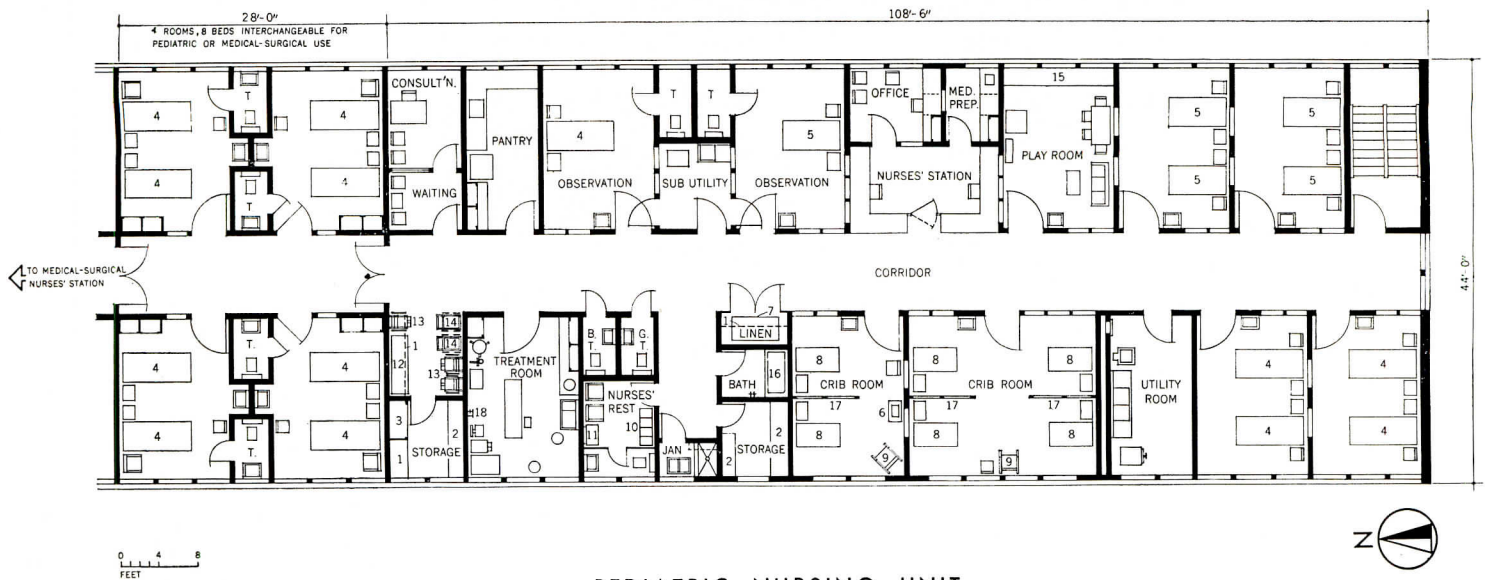

PEDIATRIC NURSING UNIT

This material was abstracted from the chapter of the same name which will appear in the forthcoming manual "The Care of Children in Hospitals" of the American Academy of Pediatrics. The chapter is the work of the Committee on Hospital Care for the American Academy of Pediatrics under the chairmanship of Dr. Lendon Snedeker, Assistant Administrator of the Children's Medical Center, Boston. The architectural consultant to the committee was Mr. Walter E. Campbell, A.I.A. of the firm of Campbell and Aldrich of Boston, Massachusetts.

Planning is by O. B. Ives, Hospital Architect of the Architectural and Engineering Branch, Division of Hospital and Medical Facilities, Public Health Service.

PLANNING THE PEDIATRIC NURSING UNIT

THIS SCHEME for a pediatrics nursing unit, the Public Health Service architects make clear, might have been done in many other dispositions. It is intended, like all similar schemes issued by the Service's architectural department, merely to illustrate a possible arrangement of rooms and facilities considered desirable. This one, for example, is drawn for a fairly typical hospital wing, on the assumption that it would be part of a conventional hospital; but for that imposition the facilities might be still more conveniently arranged. It does, nevertheless, illustrate desirable planning as well as facilities and equipment needed.

Flexibility is the first important objective. The four rooms at the left of the plan, with their own toilets, are intended to be part of the pediatrics nursing unit, or part of an adjoining adult medical or surgical nursing unit, as occasion demands. Double doors are positioned so that the corridor can be arranged as desired. In use presumably older children would be assigned to these rooms, and nurses would not have to exercise close supervision here.

Notice that nurses' station and utility rooms are centered for the shorter corridor, without these four rooms.

The smaller unit, with 16 beds, is close to a minimum, incidentally, for a special pediatrics wing, the number 14 being cited in the manual of which this plan is a part. A

pediatrics nursing unit could be larger, but should not be as large as an adult unit, since children need more care.

Bed Rooms

The one-bed rooms are required for critically ill patients, those who need quiet or those who are disturbing to other patients. When appropriately equipped, they may be used as isolation rooms for patients with known or suspected infection. They are useful also for very short-stay patients and for new admissions.

Preferably all, but at least some of the one-bed rooms, should be large enough to accommodate two beds, to provide over-night accommodations for parents. Infants and younger children, in particular, need their mothers during an illness.

It has been recommended that the minimum floor area for a one-bed room be 100 square feet and that for a two-bed room 160 square feet. It has been found in practice, however, that these areas are minimal and do not provide sufficient space for working around the patient and moving beds and stretchers. Recommended areas are 125 square feet for single rooms and 190 square feet for two-bed rooms.

Each room should be equipped with an adjustable hospital bed and an over-bed table for trays or toys. The hospital bed can be replaced by a crib or bassinet as required, but such

NURSING UNIT

1. Shelf, 5 ft. 3 in. above floor
2. Shelving
3. Storage Cabinet
4. Adjustable Hospital Bed
5. Adjustable Youth Bed
6. Infant Scale
7. Linen Cart
8. Crib
9. Rocking Chair
10. Lockers, 12 x 15 x 60 in.
11. Table with Mirror over
12. Stretcher
13. Wheel Chair
14. Stroller
15. Toy Storage
16. Raised Bath Tub, with controls on wall
17. Cubicle Partition, 7 ft. high with bottom of clear glass 36 in. above floor
18. Oxygen and Suction Outlets, 5 ft. 3 in. above floor

BED ROOM

1. Sliding Window Curtain
2. Straight Chair
3. Duplex Convenience Outlet
4. Nurses' Calling Station
5. Wall Light
6. Bedside Cabinet
7. Oxygen Outlet, 5 ft. 3 in. above floor
8. Telephone Outlet
9. Suction Outlet, 5 ft. 3 in. above floor
10. Curtain
11. Clear Wire Glass in Steel Frame (1296 sq. in. max.) bottom of glass 36 in. above floor
12. Waste Paper Receptacle
13. Lavatory, Gooseneck spout, Knee or Elbow Control
14. Wall-bracket light, switch controlled
15. Corridor Dome Light
16. Door, upper panel clear wire glass
17. Night Light, switch controlled
18. Adjustable Hospital Bed (Youth beds and cribs may be substituted as required)
19. Overbed Table
20. Cubicle Curtain
21. Clear Glass, bottom 36 in. above floor

UTILITY ROOM

1. Sanitary Waste Receptacle
2. Double Compartment Deep Sink in Counter
3. Clinical Sink
4. Dome Light and Buzzer, 5 ft. 3 in. above floor
5. Bedpan Washer and Disinfecter
6. Bulletin Board, 26 x 24 in.
7. Clear Wire Glass Vision Panel
8. Duplex Convenience Outlet
9. Drying Rod
10. Cabinet Pressure Sterilizer 16 x 16 x 24 in.
11. Ceiling Light

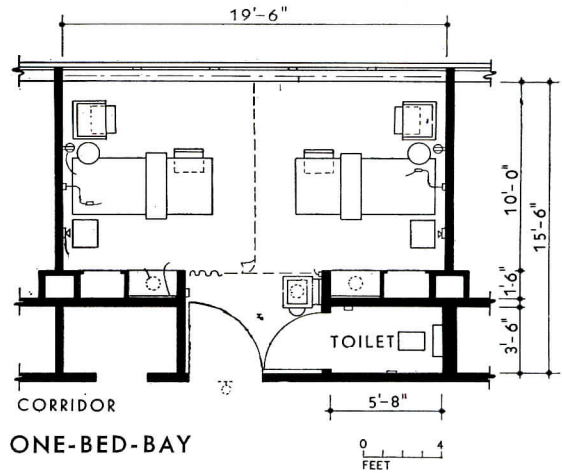

ONE-BED-BAY

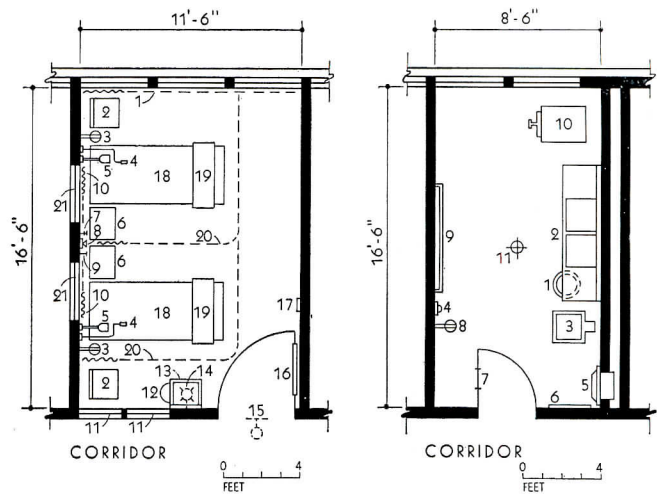

BED ROOM

UTILITY ROOM

flexibility is predicated on really adequate storage space. Two nurses' call panels should be installed for use when the room is occupied by two children. The call panel should be placed where it is not within too easy reach in rooms which will be used for pre-school children. There should be a bedside cabinet for articles needed in the nursing care of the patient on one side of the bed, possibly a cabinet for favorite toys or other familiar articles on the other side of the bed. This plan shows only the former. Clothing can be stored, to some extent, in this limited space, but it will be preferable in most instances to provide closet space or lockers for such articles.

Every room should have running water. An adult-sized lavatory with gooseneck spout, with either knee or elbow control, should be installed near the entrance. It is desirable that there be a toilet with bedpan flushing attachment and also a clothes closet for one-bed rooms. Cubicle curtains should be available when the room is occupied by two patients. Every one-bed room should have a comfortable chair and a waste paper receptacle.

Cubicles and Partitions

The use of partitions and cubicles in multiple-bed rooms is quite common but, if they are installed, those in charge of the pediatric unit should be aware of the reasons for their use.

Cubicles are undesirable in that they separate children who otherwise would be able to fraternize and have a happier hospital experience. At the same time it should be recognized that not all children benefit from this social approach.

Cubicles demarcate areas of potential infection, and facilitate the maintenance of precautionary technique, but they cannot be said to decrease airborne infection significantly. The practice of throwing toys from one area to another is discouraged, and visitors are encouraged to confine their attentions to one patient but cubicles increase the difficulty of moving patients. They are relatively expensive to install and keep clean, and in hot weather they greatly reduce air circulation and contribute to discomfort.

If cubicles or partitions are to be used they should permit visibility of patients by nurses and by patients in the same room. They should be made of shatterproof glass above the height of the mattress (36 in.). It is recommended that they be seven feet high and that they extend seven feet from the wall.

Isolation Rooms

It is essential that each pediatric unit be provided with one or more isolation rooms. These should be equipped in the same way as ordinary single rooms, except that they require facilities for maintaining isolation technique. When not utilized

for this purpose they serve as part of the regular unit, for severely ill children, for patients who need quiet, or for new admissions. It is desirable that they be remote from rooms for non-infectious cases but convenient to the nurse's station.

Each isolation room should have an adult-sized lavatory with knee action control, a hook strip for gowns near the corridor door and an individual toilet with bedpan-flushing attachments. It should be connected with a sub-utility room equipped with a sink and utensil sterilizer. The isolation room should be large enough to permit the use of an additional full-sized bed for a second patient with the same infection or for a mother to stay with her child.

Nurses' Station

Every pediatric unit will have its own nurses' station, preferably situated centrally within the unit. As a general rule, rooms designed for the use of the sickest patients and for young infants should be nearest the nurses' station. The location of the nurses' station may also be determined by the hospital's general plan for controlling visitors.

The requirements for the nurses' station in the pediatric unit are much like those in other parts of the hospital. A chart desk and rack, clock and bulletin board should be provided. The nurses' call system will need to be one which can be used by younger children. A television monitoring system for each room would be even more desirable if finances permit. This will, of course, allow visual as well as auditory control of the situation in each room. A medicine preparation room should be provided directly off the nurses' station. It should contain a counter with an acid-resisting sink, cabinets with a locked narcotics compartment above the counter and refrigerator and cabinets below.

A small private office for the supervising nurse should be provided off the nurses' station.

Examination and Treatment Room

Separate examination and treatment rooms but, more often, a combination of both, should be provided. A more satisfactory examination can be done in a quiet room with a good light, where the necessary equipment is easily available, and there are fewer distractions for both the child and the examiner.

It is important that all treatments, dressing or other procedures which are painful or disturbing be done where other children cannot watch. For this reason, the treatment room should be located away from patient rooms. If it is also to be used for doing admitting examinations, as will often be the case in the smaller pediatric unit, it should also be near the entrance to the unit.

Two requisites for a good treatment room are an adequate examining-treatment table and ample lighting fixtures. Pediatric diagnosis and treatment procedures are often difficult at best and next to impossible if these requirements are not met. Sound-proofing is another requisite.

Necessary equipment should include supply cupboard, instrument cabinet, bulletin board, nurses' call, clock, dispenser for soap or detergent, and a combination instrument and scrub sink with gooseneck spout and knee or elbow control.

Waiting and Consultation Room

A waiting room for the pediatric unit is desirable. It should be located close to stairs and elevators and its entrance should be visible from the nurses' station. Comfortable furnishings, soundproofing, and reading matter all should be provided. If possible toilet facilities should be nearby.

Wherever possible, there should be a consultation room for privacy in dealing with parents or children. This may be located near the waiting room and can serve as an office for resident or staff physicians.

The consultation room will often be the only place where nurses can demonstrate the care which the child will need when he goes home. Parent teaching is a very important function of the professional staff, and space must be provided for it. The visitor's room and the consultation and treatment rooms are usually grouped together for convenience in the admission and discharge of patients, but should be shielded from each other.

Playroom Space

Every pediatric unit should have a playroom. It should not be looked upon as a luxury or as a space where more beds may be placed in an emergency, but as a therapeutic adjunct for patients who are convalescent or ambulatory.

The present plan puts the playroom next to the nurses' station for control. If the hospital is able to provide adequate supervision, possibly by volunteers, the playroom might better be a porch at the outer end of the unit.

The playroom can be used for group activities and recreation — as a playroom for younger children, for games, occupational therapy and school work for older children, and a social room and library for adolescents. At meal time it is an ideal place for group feeding. There should be tables and chairs suitable both for food service and play activities. Storage closets and shelves for toys and other materials should also be provided.

Utility Room

The utility room should be centrally located in each nursing unit. This room requires ample cupboard and counter space, sterilizer, utensil cabinet, sink with drainboard, hot and cold water supply with elbow or knee control. Space will be required for a hot plate and a container for crushed ice for non-drinking purposes.

A bedpan washer and disinfectant and a clinical sink should also be provided with a recessed cabinet for specimens near at hand. Since individual bedpans and urinals are provided at each bedside, no rack is necessary.

Storage Rooms

Each nursing unit should have separate storage space for linen, supplies, cleaning equipment and such articles as stretchers and wheel chairs.

If the central linen room is large enough, that on the unit need only be large enough to accommodate one day's supply of linen. In the case of infants, a day's linen supply can often be kept in the bedside cabinet.

The stretcher closet should be adequate for the transportation needs of the unit. In a small hospital this area might even be used for the storage of beds of different sizes. A cupboard with shelving may be provided above the level of the stretchers and wheel chairs for additional storage space.

Oxygen Supply

In spite of additional expense in construction, some hospitals, even small ones, are providing an oxygen and suction outlet for each patient room because of the obvious advantage of having them where they are needed without having to move patients to an oxygen outlet. If only certain rooms can be so provided, those to be given high priority are isolation rooms and one-bed rooms where the sickest children are apt to be placed.

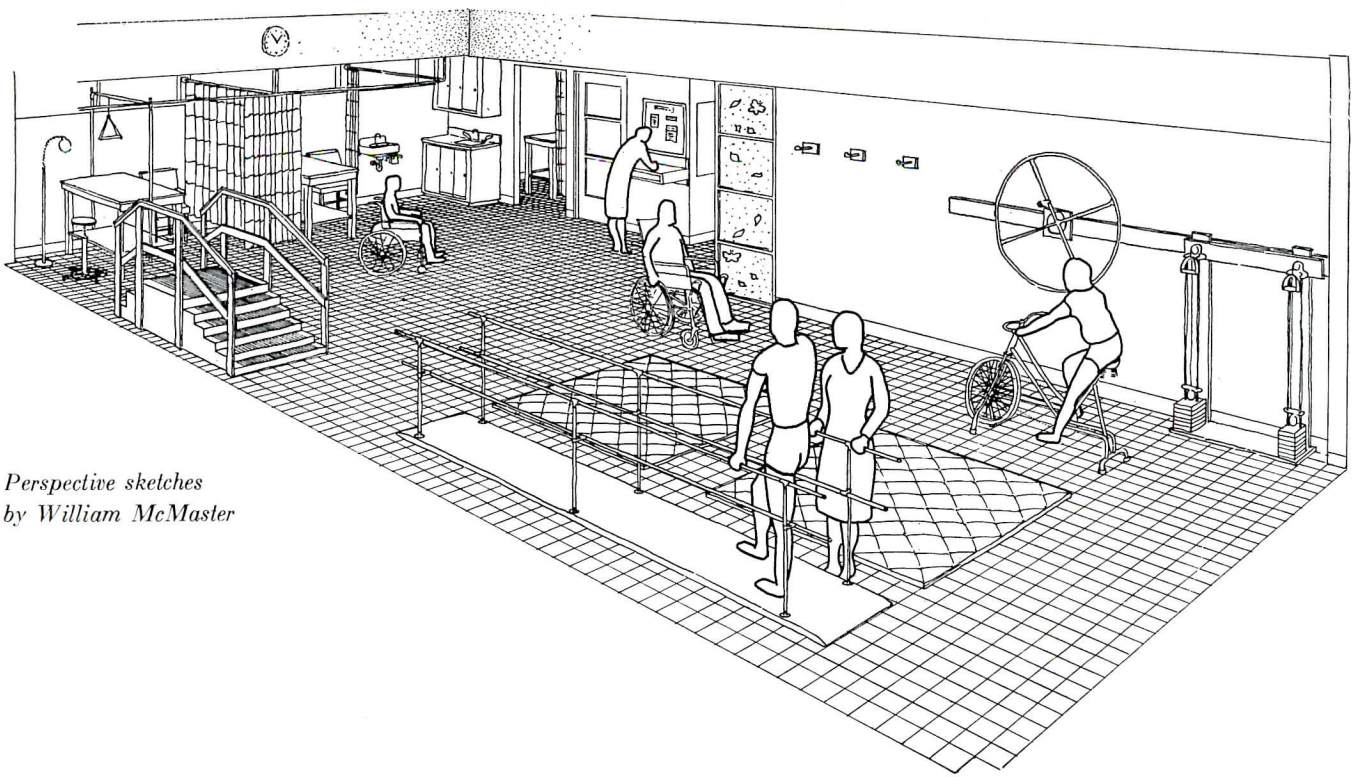

*Perspective sketches
by William McMaster*

This chapter, "Suitable Environment," is from the manual "Physical Therapy Essentials of a Hospital Department" prepared by the Joint Committee of the American Hospital Association and the American Physical Therapy Association.

Planning is by Thomas P. Galbraith and Peter N. Jensen, Hospital Architects of the Architectural and Engineering Branch, Division of Hospital and Medical Facilities, Public Health Service.

PLANNING THE PHYSICAL THERAPY DEPARTMENT

OF THE MANY environmental factors which condition the effectiveness of physical therapy service to patients, the most important are space, location and work areas. Ventilation, lighting, interior finish and related considerations also contribute toward providing a suitable environment. The keynote is function.

Location

Location is closely related to function. The area selected for physical therapy should be centrally located to minimize problems of transporting patients and to facilitate giving bedside treatment when necessary. At least half of the patients treated in a general hospital physical therapy department are likely to be out-patients. With this in mind, special attention should be given to accessibility, and to having as few steps as possible to climb, as few long corridors and heavy doors to negotiate. A ground floor location, convenient for both in- and out-patients and for access to an outdoor exercise area, is recommended.

Availability of daylight and fresh air should also be considered in selecting a location.

In new hospitals, physical therapy is frequently placed in an area which includes other out-patient services, social service, occupational therapy, recreation. It is particularly important that physical and occupational therapy be in close proximity.

Amount of Space

The amount of space needed depends on the number of patients treated, the kinds of disabilities and the treatments required. Also to be considered is the fact that some space-consuming equipment — such as a whirlpool bath, treatment tables, parallel bars, etc. — are minimum essentials for even a one therapist department. These pieces of equipment will not be multiplied in direct proportion to increases in staff and patient load.

Efforts to correlate bed capacity and physical therapy space requirements are not satisfactory. Hospitals with 50-100 beds may serve large numbers of out-patients. The amount of space given over to physical therapy in a small hospital is, justifiably, out of proportion to the bed capacity.

No absolute standard can be recommended as the amount of space needed for physical therapy in a general hospital. The most that can be said is that, if possible, it is desirable to plan for at least a thousand square feet of floor space, free of structural obstructions. About half of that should be exercise area.

This does not mean that a hospital cannot begin an effective physical therapy service in smaller quarters. Many have done so successfully, using to full advantage whatever space resources they had. But crowded quarters do subject the staff to strain and call for more than ordinary ingenuity and good

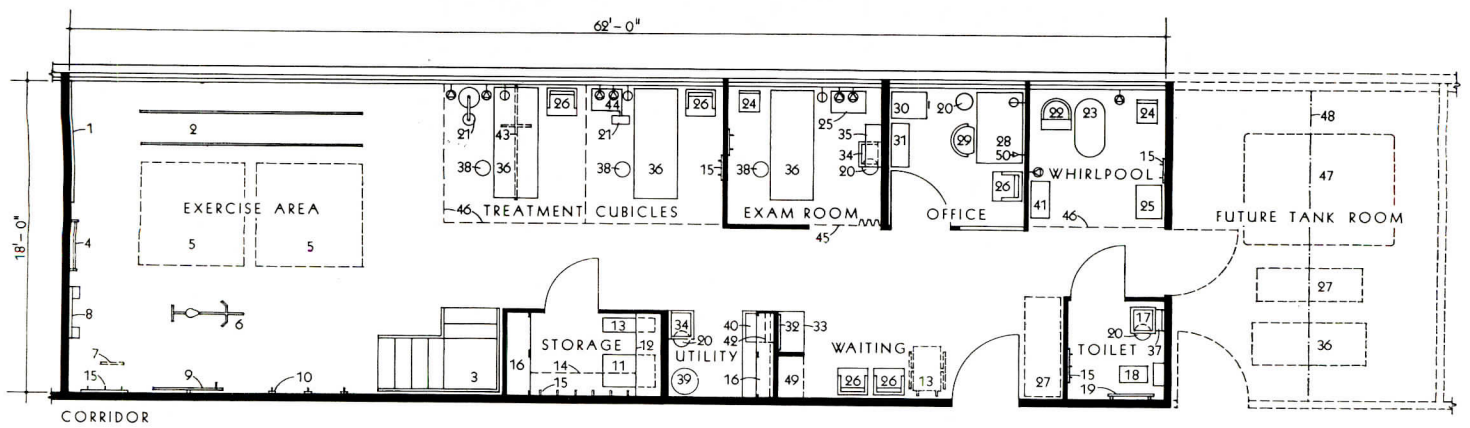

TYPE "A" PLAN

AREA 1116 SQUARE FEET

CEILING ANCHORS SPACED APPROXIMATELY 4'-0" THROUGHOUT
ENTIRE TREATMENT AREA DESIGN TO CARRY 500 LBS.

GRAPHIC SCALE 0 4 8 FT.

NOTE: MAJOR PIECES OF EQUIPMENT RECOMMENDED FOR ONE
PHYSICAL THERAPIST AND AID INDICATED ON TYPE PLANS

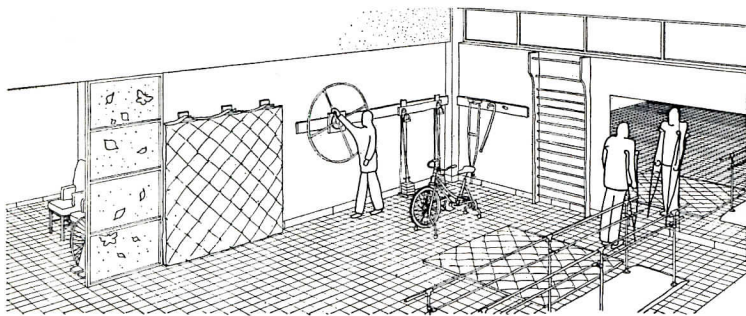

humor in order to make it possible for patients to obtain maximum benefit from treatment.

Work Space Components

Whatever the eventual size of a physical therapy department, from the very beginning plans must be made to provide certain kinds of work space. These essential components can be expanded, multiplied or refined as the physical therapy department grows but the fundamental requirements are the same for a small or large department. They include: (1) reception area, (2) staff space, (3) examining room, (4) treatment areas, (5) toilet facilities, (6) storage.

Experienced physical therapists have many suggestions for increasing the efficiency of physical therapy departments by giving attention to details of planning and arranging these component work areas. For example:

Reception area — accommodations for in-patients and out-patients, if possible. Adequate space for stretcher and wheelchair patients.

Staff space — private. Office space suitable for interviewing patients, attending to administrative and clerical duties, housing files, etc. Writing facilities for the staff adequate for dictation, record keeping. There should be space for staff lockers and dressing rooms separate from the patient area,

either within the department or near to it.

Examining room — floor to ceiling partitions for privacy. Arranged so that necessary examining equipment can remain in the room permanently. Possible to use this space for special tests and measurements or for treatment when privacy is desirable.

Treatment area — there are three types of treatment areas: cubicle (dry), underwater exercise (wet) and exercise (open). Each is designed to meet the particular requirements of the special equipment used for different kinds of treatment.

Cubicle — each unit large enough for the physical therapist to work on either side of the table without having to move equipment belonging in the cubicle. Preferably cubicles divided by curtains for easier access for wheelchair and stretcher cases, for expansion of useable floor area for gait analysis, group activity or teaching purposes.

Curtain tracks should be flush with the ceiling and curtains should have open panels at the top for ventilation when drawn. Both curtains and tracks should be sturdy. In or near the cubicles, out-patients need a place or locker for their outer clothing.

Underwater exercise area — all equipment requiring special plumbing and water supply concentrated in one section of the department but accessible and adjacent to other treatment areas. Should include a treatment table, especially in the room

1. Posture Mirror
2. Parallel Bars
3. Steps
4. Stall Bars
5. Gym Mat
6. Stationary Bicycle
7. Sayer Head Sling Attached to Ceiling
8. Pulley Weights
9. Shoulder Wheel
10. Gym Mat Hooks
11. Cart with Open Shelves
12. Open Shelves
13. Wheel Chair
14. Shelf
15. Wall Hooks
16. Wall Cabinet
17. Lavatory, Gooseneck Spout
18. Water Closet
19. Hand Rail
20. Waste Paper Receptacle
21. Portable Equipment
22. Adjustable Chair
23. Whirlpool
24. Chair
25. Table
26. Chair, preferable with arms
27. Wheel Stretcher
28. Desk
29. Swivel Chair
30. File Cabinet
31. Bookcase
32. Bulletin Board
33. Wall Desk (counter, shelf below)
34. Lavatory, Gooseneck Spout and Foot Control
35. Wall Cabinet with Lock
36. Treatment Table, Storage below
37. Mirror and Glass Shelf over Lavatory
38. Adjustable Stool
39. Laundry Hamper
40. Sink with Drainboard
41. Paraffin Bath
42. Glass Shelf over Sink
43. Overbed Trapeze
44. Three Single Outlets on separate branch circuits. 1 outlet 2-pole, 2 outlets 3-pole
45. Folding Door
46. Cubicle Curtain
47. Under Water Exercise Equipment
48. Overhead Lift
49. Coat Rack
50. Telephone Outlet

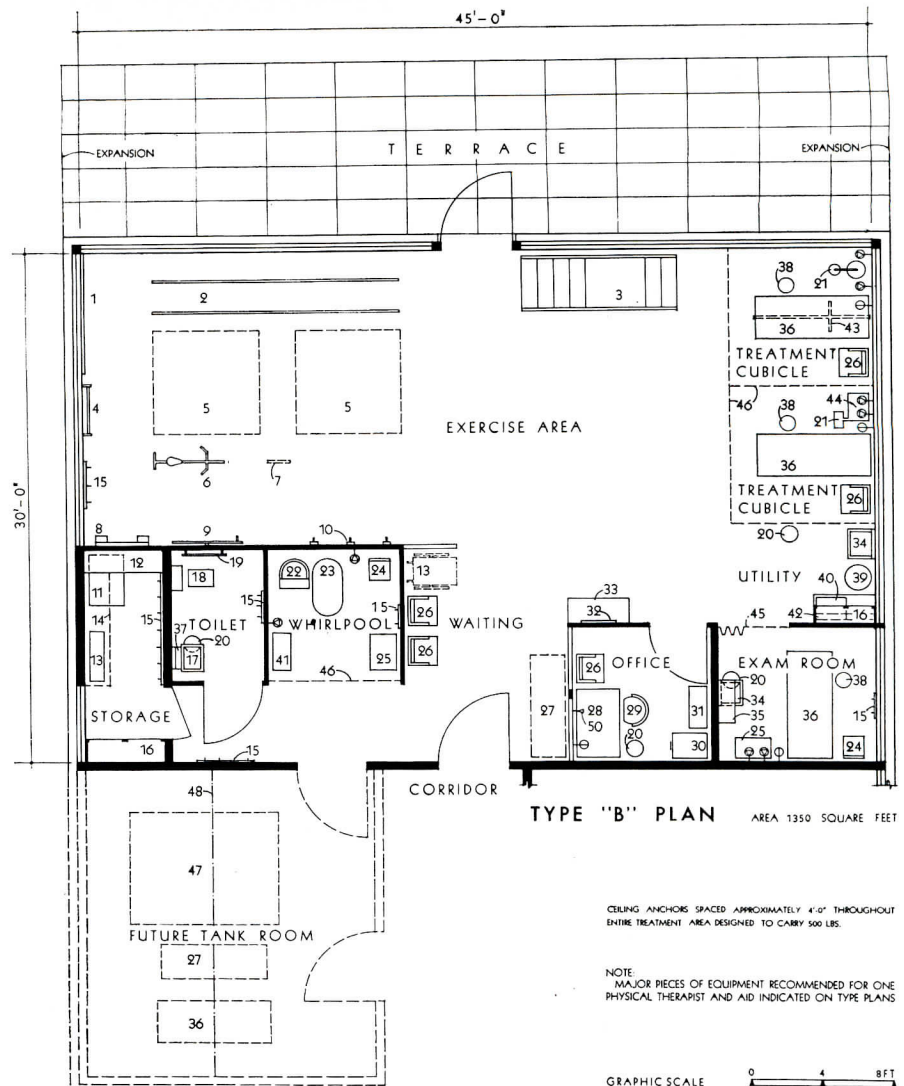

with a tank or exercise pool. Fixed overhead lifts are absolutely essential for the efficient use of tanks and failure to provide lifts severely limits the usefulness of this valuable equipment. Plumbing and other installation requirements, humidity and noise from motors call for special care and attention. Electrical and metal equipment in other treatment areas may suffer damage unless the underwater exercise area is carefully planned.

Exercise area — very flexible open space planned to accommodate patients engaged in diverse individual or group exercise activities. Used extensively by people in wheelchairs, on crutches or canes, or with other disabilities which limit their motion and agility. At least one wall should be reinforced for the installation of stall bars and similar equipment.

Toilet facilities — separate toilet facilities for patients and staff, if possible. Patient facilities should be designed to accommodate wheelchair patients. If the department serves small children, seat adaptors with foot rests should be provided.

Storage — designed to meet special needs in and near work areas. Should also be storage space on the wards for equipment and supplies usually needed for bedside treatments. For wheelchairs, stretchers, etc., it is best to plan "carport" space, not closets. All storage space should be accessible, simple, well lighted.

Special Considerations

Ventilation. Adequate, controlled ventilation is of extreme importance in a physical therapy department. Many of the treatment procedures require the use of dry or moist heat, or active exercise, which raise body temperatures. A continuous, reliable flow of fresh air is essential to the comfort of patients and staff. This includes protection from drafts.

Air conditioning, desirable for the entire department, will be a necessity for certain areas of the physical therapy department, in most sections of the country. The reduction of humidity for comfort, protection of equipment and reduction of the hazard of slippery floors makes air conditioning vital in the underwater exercise area. It has been demonstrated as desirable in the exercise area and in treatment cubicles, especially where heat producing equipment is used. Air conditioning engineers should be consulted before ventilation equipment is installed.

Sinks. Hospital hand washing laboratories with hot and cold water mixing outlets, preferably foot operated, should be located at the proper height in convenient places. At least one sink should be of sufficient width and depth to accommodate the care of wet packs and other special washing needs.

Interior finishes. The activity of patients in wheelchairs, on stretchers and crutches subject floors and walls to heavy wear. Materials which will stand up under such rough usage, remain

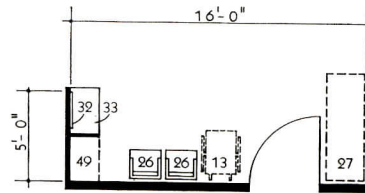
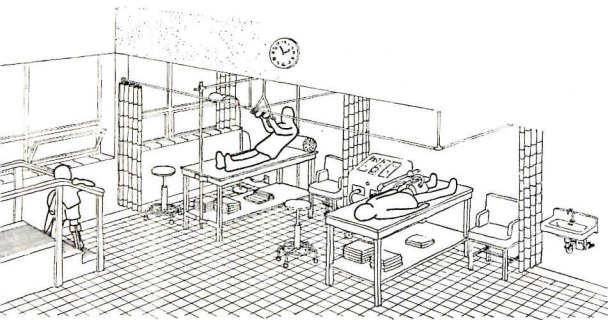

WAITING AREA

RECEPTION

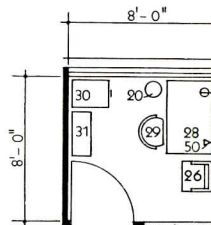

OFFICE

ADMINISTRATION

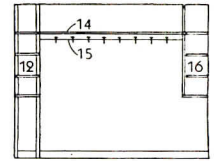

ELEVATION OF STORAGE WALL

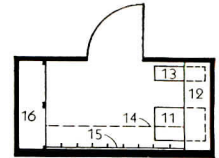

STORAGE

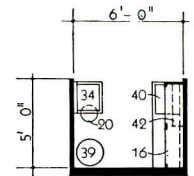

UTILITY

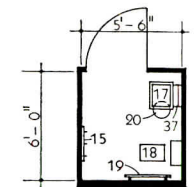

TOILET

attractive and require a minimum of maintenance should be specified despite higher costs.

All interior wall surfaces of the department should have a durable and attractive wainscot to protect them against damage by wheelchairs, stretchers and carts. Ceramic wall tile or glazed structural units will serve the purpose but they emphasize the institutional character of the hospital. In patient areas this should be minimized as much as possible. In the last several years vinyl wall covering has gained in popularity as a wainscoting material, and to some extent for the entire wall. Two weights of the material are available; the heavier weight for areas subjected to severe abuse, the lighter weight for other parts of the wall.

The use of decorative colors for interior finishes and equipment is, of course, highly desirable in this department as it is in other parts of the hospital. Research in "color therapy" for hospitals adds to decorators' ideas the therapeutic value of combinations of pastel colors. "Cool" pastels — green, blue, violet and their many derivatives — are considered mildly restful. Some light colors in general are stimulating and may be of advantage in the exercise area.

Doors. For accommodation of stretcher and wheelchair traffic, doors within the department should be at least 40 inches wide. Raised thresholds should be eliminated.

Ceiling moorings. These moorings, strategically located in

the ceiling in treatment areas, have been found useful for attaching overhead equipment such as hoists, pulleys, bars, counter balancing equipment, etc. They should be constructed and attached to joists in such a manner that each supports at least 500 pounds.

Layout

It is impossible to anticipate all of the practical problems of layout in a particular building or to say in advance that one plan or another is the right one. A few guidelines, however, may be useful in making decisions about layout.

Expect to expand and plan for it from the beginning. It is impossible to overestimate the value of the exercise area. Give it as many square feet of appropriate space as possible.

Note the need to have the underwater exercise equipment grouped in one area, separate but adjacent and accessible to the other treatment areas.

When deciding which units to place next to each other or group together, consider how they are used by patients, especially the flow of traffic from one unit to another. Try to avoid needless traffic. Try to conserve the energies of staff.

Visit other physical therapy departments and find out what the physical therapists like or would like to change in the layouts of their own departments.

1. Posture Mirror
2. Parallel Bars
3. Steps
4. Stall Bars
5. Gym Mat
6. Stationary Bicycle
7. Sayer Head Sling Attached to Ceiling
8. Pulley Weights
9. Shoulder Wheel
10. Gym Mat Hooks
11. Cart with Open Shelves
12. Open Shelves
13. Wheel Chair
14. Shelf
15. Wall Hooks
16. Wall Cabinet
17. Lavatory, Gooseneck Spout
18. Water Closet
19. Hand Rail
20. Waste Paper Receptacle
21. Portable Equipment
22. Adjustable Chair
23. Whirlpool
24. Chair
25. Table
26. Chair, preferable with arms
27. Wheel Stretcher
28. Desk
29. Swivel Chair
30. File Cabinet
31. Bookcase
32. Bulletin Board
33. Wall Desk (counter, shelf below)
34. Lavatory, Gooseneck Spout and Foot Control
35. Wall Cabinet with Lock
36. Treatment Table, Storage below
37. Mirror and Glass Shelf over Lavatory
38. Adjustable Stool
39. Laundry Hamper
40. Sink with Drainboard
41. Paraffin Bath
42. Glass Shelf over Sink
43. Overbed Trapeze
44. Three Single Outlets on separate branch circuits. 1 outlet 2-pole, 2 outlets 3-pole
45. Folding Door
46. Cubicle Curtain
47. Under Water Exercise Equipment
48. Overhead Lift
49. Coat Rack
50. Telephone Outlet

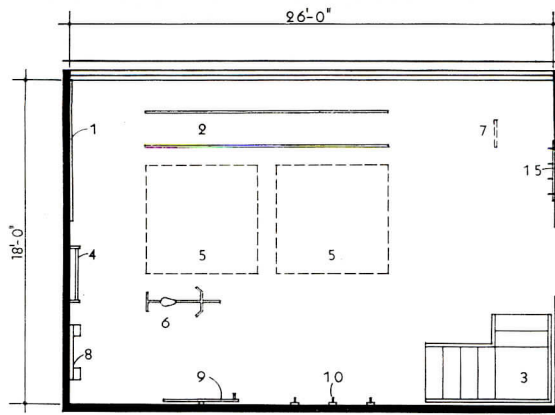

EXERCISE AREA

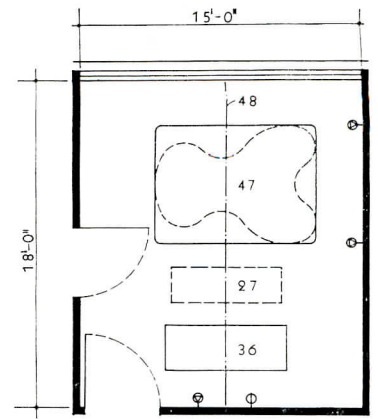

TANK ROOM

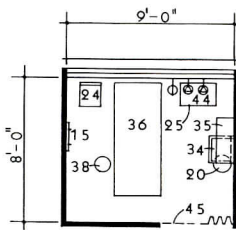

EXAMINATION ROOM

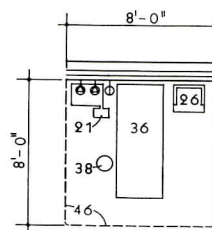

TREATMENT CUBICLE

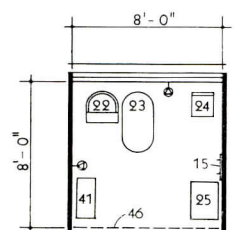

WHIRLPOOL

EXAMINATION AND TREATMENT

GRAPHIC SCALE 0 4 8 FT

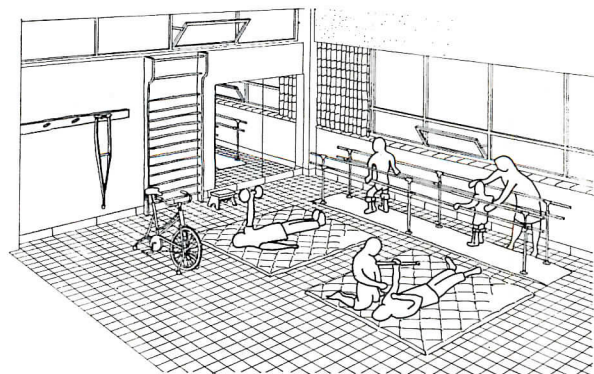
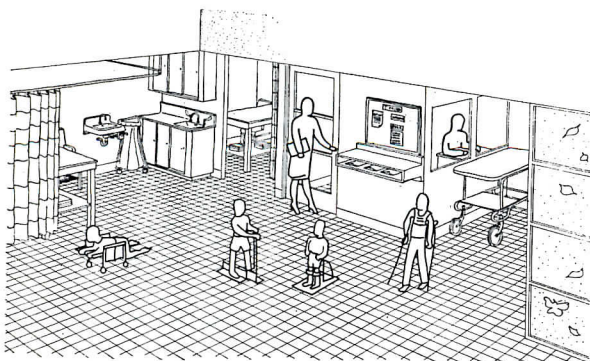

The "Atomic Age" has been felt in many fields of human endeavor, but perhaps one of the most important of these fields has been in the field of medicine. At the present time we are using atomic energy in medical tracer studies, as a source of internal and particular organ irradiation, and as an external treatment of disease. This article is concerned with atomic energy as a source of external treatment in teletherapy units. Details are shown in *Time-Saver Standards* starting on p. 227.

By the term teletherapy, we are restricting ourselves to the use of radiation at a distance; that is, the subject and source are separated by a distance of 50 centimeters or more. In particular, we are concerned with the use of the radioactive isotopes cobalt-60

and cesium-137 as sources of radiation in teletherapy units.

We have restricted our discussion to Co^{60} and Cs^{137} , primarily because they are the more familiar of the isotopes suggested for use in teletherapy units. We are not including the use of radium and high energy X-rays, since some of the problems associated with these are quite different in their solution and nature.

The primary purpose of this article is to furnish architects anticipating a teletherapy unit, information on basic radiation protection ideas and techniques, and to serve as a guide in the solutions of certain architectural problems. We are by no means attempting to evaluate the advantages and disadvantages of Co^{60} and Cs^{137} units against other types of units.

DESIGN OF TELE THERAPY UNITS

Radiation and Architectural Considerations For Cobalt 60 Units

by Wilbur R. Taylor, William A. Mills and James G. Terrill, Jr.*

IN PLANNING A COBALT INSTALLATION, it should be understood that each type of machine and its location within the building will present a different problem which will require an individual solution. Consequently, no one type plan can be designed which will take care of the various shielding requirements presented by the different machines and installations. The architect is dependent upon other professionals for specific technical information he needs before he can intelligently design a building containing a cobalt teletherapy unit. The problems incurred may materially affect the orientation, location, and structural and functional design of the building. Therefore, during preliminary design stages, close cooperation between architect, radiologist and radiation physicist is necessary to develop an efficient and economical layout.

It should be noted that the Atomic Energy Commission places responsibility upon the applicant for conditions of installation and use of the facility. Since the use of a facility is largely dependent upon the conditions of installation, it is to the applicant's advantage to secure the services of a radiation physicist at the inception of a project. His function is to advise the applicant and architect on radiation requirements, assume responsibility for the final design as to shielding

provided and furnish the supporting information required in Application Form AEC-313 relative to exposure rates in areas surrounding the teletherapy room and occupancy factors assigned.

Fundamental decisions as to: (1) the type of machine, (2) strength of the source, (3) desired location, and (4) the shielding required for floor, walls and ceiling must be made before the building's structural system can be designed. During the early design, it may be determined that the structural system cannot support the weight of the shielding, or perhaps soil conditions will not permit sufficient excavation for a sub-grade installation. It may then be necessary to change or alter one or more of the following: the machine or its operation, the source strength or the location of the room.

To those not familiar with such shielding problems, the included plans have been developed to illustrate the shielding necessary for three types of machines in specific locations. However, before considering the detailed plans, it may be desirable to discuss some of the general requirements of such facilities.

Location

The cobalt suite should adjoin the X-ray therapy department. This location permits the joint use of waiting, dressing, toilet, examination, work and consultation rooms. In addition, it offers the important advantage of having the staff concentrated in one area, thereby eliminating the considerable

*Wilbur R. Taylor is a Hospital Architect in the Division of Hospital and Medical Facilities, Bureau of Medical Service, Public Health Service, Department of Health, Education, and Welfare; and William A. Mills and James G. Terrill, Jr. are respectively Radiation Physicist and Chief of Radiological Health Program, Division of Sanitary Engineering Services, Bureau of State Services, Public Health Service.

loss of time involved in traveling to a remote location. This is an important consideration and justifies the cost of any additional shielding that may be necessary to achieve it.

A location below grade, unoccupied above and below, will require less shielding. However, if such a location separates the cobalt and the X-ray therapy department, it may be more costly in both loss of staff time and efficiency than the cost of concrete shielding amortized over several years. If, for example, twenty-five minutes per day are lost in traveling to a remote location, one additional patient could be treated in this time each day — or 240 patients per year. Assuming a staff salary of \$20,000 per year, this loss of twenty-five minutes per day results in an indirect salary loss of \$1032 per year, which would soon equal the cost of shielding in a new facility.

A corner location for the cobalt room is usually desirable since through traffic is eliminated, only two interior walls require shielding, distance to the property line utilizes the inverse square law to reduce shielding and the structural requirements are more easily solved.

Teletherapy Room Details

Size. The room size may vary to suit different manufacturers' equipment. A room approximately 15 ft by 18 ft by 9 ft-6 in. plus the necessary entrance maze, will accommodate most of the machines commercially available with the exception of the largest rotating models. For reasons of cost, the room should be as compact as possible after allowing space to install the equipment and to position the treatment table.

Shielding. The shielding necessary for a room must not only be considered in terms of floor, ceiling and wall shielding, but also such things as doors, windows, ventilation and heating ducts, and safety locks. Radiation that might escape through such possibilities could result in overexposure to personnel, if proper precautions are not taken.

Entrance. The primary purpose of specific entrance construction is to protect personnel. It should also provide sufficient space to admit a stretcher and the largest crated piece of equipment. In some cases, a considerable savings in cost of assembling equipment may be had by making the door and maze large enough to admit the crated assembled machine. For this purpose, some manufacturers specify a door opening of 4 by 7 ft and a minimum distance of 6 ft at the end of the maze.

Rather than add large amounts of lead to doors, the shielding problem may be solved to some degree by having the door to the teletherapy room open into a maze. This maze should be built so that no primary radiation could fall directly on the door. In designing doors for such a room, a good practice is to have a door of wood with a layer of lead. This lead can either be on the inside surface, or between layers of wood. Commercially available x-ray doors serve well for this purpose. The space between the door and floor can usually be shielded by using a lead strip under the door or by making a slight rise in the floor containing lead, on the outer side of the door. Lead shielding at the jamb and head between the frame and buck may be eliminated by the use of a combination frame and buck set in concrete.

For safety precautions, the door lock should be such that the door can be readily opened from inside the cobalt room.

Control View Window. It is standard practice to locate this window at a height which will permit the operator to be

seated during the treatment period, 4 ft-0 in. from the floor to the center of the window being an optimum distance. In plan, the window should be located in the area of minimum radiation and for convenient observation of the patient. This position, for a rotational machine, would be along the axis of rotation, and for a fixed beam unit, 90° to the plane of tilt. (*See Time-Saver Standards.*)

From the control view window the entire room should be in full view, using mirrors when necessary. The glass should contain lead or other materials in amounts which would provide shielding equivalent to the surrounding concrete. The frame is usually packed with lead wool and should be designed to offset the shielding loss of the reduced concrete thickness at beveled areas. The cost of such special glass and frame increases rapidly with size and an 8 by 8 in. window is considered an optimum size.

Heating and Air Conditioning. The only problem in relation to heating and air conditioning not encountered in other buildings is that of providing shielding where walls are pierced with supply and return ducts. The usual solution is to locate ducts and openings in walls which are least subject to radiation and offset the path of ducts through the wall, lead or other high density material being added, where necessary, to maintain the shielding value of the wall displaced by ducts.

Electrical. Electrical service required for the machine, will vary with each manufacturer's equipment. Voltage will vary from 110-single phase to 220-three phase for large machines.

Room lighting should assure good over-all illumination, preferably from cove lighting or an indirect type of fixture. It is essential that the operator be able to observe any movement of the patient during treatment and shadows produced by a rotating machine interfere with observation.

In providing a safety lock for the door, it has been found of great value to interlock the machine control with the door, so that opening the door automatically shuts off the machine.

Conduits should be provided for power and control wiring.

Environment. The general effect to be created in this department should be one of cheerfulness and restfulness. Use of color and even murals have been used effectively on the walls of the cobalt room.

The usual hospital finishes such as acoustical ceiling tile and resilient flooring are desirable in this area.

Remodeling. Unless previously designed for super voltage X-ray, remodeling an existing building can be expensive. It is often impossible to build in sufficient shielding which makes it necessary to control nearby occupancy and restrict direction of the beam, thereby handicapping the usefulness of the machine. Other problems such as relocating plumbing, heating, electrical services and disturbing the normal operation of the building during remodeling must be considered.

In new construction, concrete shielding is relatively cheap, but in remodeling the cost is high. For this reason the use of masonry units may be preferable since no form work is necessary and the work can be performed intermittently. Good workmanship, of course, is necessary to prevent voids in mortar joints.

In some cases it might be better to add to the building, rather than to remodel an existing portion. Normal hospital operation would not be interfered with, costs may be lower and a more efficient layout would probably result.

THIS ARTICLE WAS DEVELOPED at the request of the Committee on use of Radioisotopes in Hospitals of the American Hospital Association and as a result of many requests from architects and hospitals for information on the design of such facilities.

ACKNOWLEDGMENTS

The authors gratefully acknowledge the valuable assistance received on the text and plans from the following:

Alexander H. Bacci, Architect, firm of Schmidt, Garden and Erikson Architects and Engineers Chicago 3, Illinois

Richard P. Gaulin
Mechanical Engineer
Architectural and Engineering Branch
Division of Hospital and Medical Facilities
Public Health Service

Noyce L. Griffin
Electrical Engineer
Architectural and Engineering Branch
Division of Hospital and Medical Facilities
Public Health Service

August F. Hoenack
Chief, Architectural and Engineering Branch
Division of Hospital and Medical Facilities
Public Health Service

Frank E. Hoecker,
Chief, Architectural and Engineering Branch
Division of Hospital and Medical Facilities
Public Health Service

Frank E. Hoecker, Ph. D.
Radiological Physicist
University of Kansas

George Ivanick
Assistant Chief
Architectural and Engineering Branch
Division of Hospital and Medical Facilities
Public Health Service

Clinton C. Powell, M. D.
Chief, Radiological Health Medical Program
Division of Special Health Services
Public Health Service

Julian Smariga, Structural Engineer
Architectural and Engineering Branch
Division of Hospital and Medical Facilities
Public Health Services

Edwin G. Williams, M.D.
Chief, Radiological Protection Branch
Division of Hospital and Medical Facilities
Public Health Service

FUNDAMENTALS OF RADIATION PROTECTION

In considering a teletherapy unit, architects are immediately thrown into a world of new definitions, concepts and terms.

Listed in the Glossary are some of the more frequent occurring definitions that turn up during the course of a discussion on teletherapy units.

In addition to definitions and terms, one must become acquainted with new technical fundamentals having to do with the decay of radioactive isotopes, and the passage of the radiation through matter.

A very important law having to do with radioactive decay is stated simply by the equation:

$$N = N_0 e^{-\lambda t} \quad (1)$$

Where,

N = the number of atoms of the isotope present after a time = t ,

N_0 = the initial number of atoms present at a time equal to zero,

e = the base of the natural log = 2.718,

λ = the decay constant for the isotope.

This is usually written in the form of the given half-life for the isotope, and appears as:

GLOSSARY *

Absorption Coefficient: Fractional decrease in the intensity of a beam of radiation per unit thickness (linear absorption coefficient), per unit mass (mass absorption coefficient), or per atom (atomic absorption coefficient) of absorber.

Attenuation: The reduction of intensity of radiation due to an interposed medium (particle attenuation, energy attenuation).

Backscattering: The deflection of radiation by scattering processes through angles greater than 90 degrees with respect to the original direction of motion.

Build Up Factor: The ratio of the intensity of X- or gamma radiation (both primary and scattered) at a point in an absorbing medium to the intensity of only the primary radiation. This factor has particular application for "broad beam" attenuation. "Intensity" may refer to energy flux, dose, or energy absorption.

Curie: That quantity of a radioactive material having associated with it 3.7×10^{10} disintegrations per second.

Decay Radioactive: Disintegration of the nucleus of an unstable element by the spontaneous emission of charged particles and/or photons.

Decay Constant: The fraction of the number of atoms of a radioactive isotope which decay in unit time. Symbol: λ .

* All definitions are from the *Radiologic Health Handbook*.

$$N = N_0 e^{-\frac{0.693}{T} t} \quad \text{Where, } T = \frac{0.693}{\lambda}$$

For our purpose we will not speak of the number of atoms decaying in terms of N , but we will use the more familiar term of *curie*. Where, as defined,

1 curie = 3.7×10^{10} disintegrations/sec. This is approximately the disintegrating rate of 1 gm of natural radium atoms. In speaking of Co^{60} , we must keep in mind that each disintegrating atom results in the emission of two gamma rays, and each disintegrating atom Cs^{137} results in one gamma ray. We will discuss this in greater detail later in this paper.

Another important fundamental to which one becomes exposed is that pertaining to the intensity of radiation, and is expressed as:

$$I = \frac{I_0 B}{D^2} e^{-\mu x} \quad (2)$$

Where,

I = The intensity in mr/hr at a distance of D cm from the source

I_0 = The intensity at 1 cm from the source

D = Distance between source and subject in cm

Depth Dose: The radiation dose delivered at a particular depth beneath the surface of the body. It is usually expressed as a percentage of surface dose or as a percentage of air dose.

Direct Radiation: All radiation coming from one source, except the useful beam.

Dose (Dosage): According to current usage, the radiation delivered to a specified area or volume as to the whole body. Units for dose specification are roentgens for X- or gamma rays, reps or equivalent roentgens for beta rays. In radiology the dose may be specified in air, on the skin, or at some depth beneath the surface; no statement of dose is complete without specifications of location. The entire question of radiation dosage units is under consideration by the International Congress of Radiology. (See Rad).

Dose Rate (Dosage Rate): Radiation dose delivered per unit time.

Dosimeter: Instrument used to detect and measure an accumulated dosage of radiation; in common usage it is a pencil size ionization chamber with a built-in self-reading electrometer; used for personnel monitoring.

Electron Volt: A unit of energy equivalent to the amount of energy gained by an electron in passing through a potential difference of one volt. Larger multiple units of the electron volt are frequently used, viz: *Kev*, for thousand or kilo electron volts; *Mev*, for million electron volts

B = Buildup factor in the shielding material

μ = Total absorption coefficient of the shielding material in cm^{-1} .

X = Thickness of shielding material in cm. In utilizing such an equation as (2), one neglects the attenuation due to the air present between the subject and source. We will apply essentially this idea in designing of shields for personnel protection, in latter parts of this article.

Perhaps before one becomes involved in a situation of using either Co^{60} or Cs^{137} in a teletherapy unit, he should understand some of the basic characteristics of each of these isotopes.

First of all, we will look at the Co^{60} isotope. This isotope is produced in nuclear reactors, by subjecting naturally occurring cobalt (Co^{59}) to intense neutron bombardment. Naturally occurring Co^{59} is not radioactive, but by adding a neutron to its nucleus, it becomes the highly radioactive Co^{60} . This isotope has a half-life of 5.2 years and emits two gamma rays of 1.17 and 1.33 Mev. A close approximation of the dose rate delivered by Co^{60} is

$$R = 1.35 \times 10^4 \text{ Roentgens per hour at}$$

a distance of 1 cm from
1 curie source of Co^{60} .

When considering the use of Cs^{137} , one has a different source of radiation in that the half-life of the material is greater, but the radiation emitted per curie is not as large as for Co^{60} . Cs^{137} is one of the fission products produced in the process of operating a nuclear reactor, and this is one of the primary reasons it serves as a good source for teletherapy units. Of course, the expense involved in this material, is in separating it from the many other materials produced in the reactor fuel elements. However, the supply is increasing steadily. Cs^{137} has a half-life of 30 years and results in the emission of a 0.662 Mev gamma ray. The radiation produced from a curie quantity of Cs^{137} is

$$R = 0.39 \times 10^4 \text{ r/hr at 1 cm.}$$

SHIELDING

Now we would like to discuss the shielding necessary for personnel protection. In thinking about shielding, one is conscious of a statement made by Dr. K. Z. Morgan of the Oak Ridge National Laboratory, "radiation need not be feared, only appre-

ciated." This is a good basic idea to keep in mind when thinking about the shielding of dangerous quantities of radioactive material.

There are many different materials used in shielding of radiation, but perhaps the more useful ones are earth, lead and concrete. Such materials as water, steel and marble can make suitable shields depending on the type of radiation and the architectural circumstances. A rough rule of thumb in comparing different materials is that $\frac{3}{4}$ in. of lead, $1\frac{1}{2}$ in. of steel, $4\frac{1}{2}$ in. of concrete, $7\frac{1}{2}$ in. of earth and $10\frac{1}{2}$ in. of water are equivalent for shielding. In this paper, we will only explore the usefulness of concrete in the attenuation of radiation from sources of Co^{60} .

Perhaps before going further, we should examine the process of attenuation of gamma rays in shielding material. Gamma rays are electromagnetic waves, highly energetic, and can result in heat development. Thus, gamma rays in passing through a material lose their energy by various processes, but basically all result in an increase in heat of the material. However, the heat generated is insignificant.

(Continued on page 220)

and *Bev.* for billion electron volts. Abbreviation: *ev.*

External Radiation: Exposure to ionizing radiation when the radiation source is located outside the body.

Film Badge: A pack of photographic film used for approximate measurement of radiation exposure for personnel monitoring purposes. The badge may contain two or three films of differing sensitivity, and it may contain a filter which shields part of the film from certain types of radiation.

Gamma Ray: Short wavelength electromagnetic radiation of nuclear origin with a range of wave lengths from 10^{-9} to 10^{-12} cm, emitted from the nucleus.

Geiger-Mueller (G-M) Counter: Highly sensitive gas-filled radiation-measuring device which operates at voltages sufficiently high to produce avalanche ionization.

Health Physics: A term in common use for that branch of radiological science dealing with the protection of personnel from harmful effects of ionizing radiation.

Ionization Chamber: An instrument designed to measure quantity of ionizing radiation in terms of the charge of electricity associated with ions produced within a defined volume.

Ionizing Radiation: Any electromagnetic or particulate radiation capable of producing ions, directly or indirectly, in its passage through matter.

Isotope: One of several different nuclides having the same number of protons in

their nuclei, and hence having the same atomic number, but differing in the number of neutrons, and therefore in the mass number. Almost identical chemical properties exist between isotopes of a particular element.

Lead Equivalent: The thickness of lead affording the same reduction in radiation dose rate under specific conditions as the material in question.

Leakage (or Direct) Radiation: The radiation which escapes through the protecting shielding of an X-ray tube or teletherapy unit.

Linear Absorption Coefficient: A factor expressing the fraction of a beam of radiation absorbed in unit thickness of material. In the expression $I = I_0 e^{-\mu x}$, I_0 is the initial intensity, I the intensity after passage through a thickness of the material, x , μ is the linear absorption coefficient.

Mass Absorption Coefficient: The linear absorption coefficient per cm divided by the density of the absorber in grams per cu cm. It is frequently expressed as μ/ρ , where μ is the linear absorption coefficient and ρ the absorber density.

Maximum Permissible Dose (MPD): The dose of ionizing radiation that, in the light of present knowledge, is not expected to cause detectable bodily injury to a person at any time during his lifetime.

Milliroentgen (mr): The submultiple of the

roentgen equal to one thousandth (1/1000) of a roentgen. (See Roentgen.)

Primary Protective Barriers: Barriers sufficient to reduce the useful beam to the permissible dose rate.

Protective Barriers: Barriers of radiation-absorbing material, such as lead, concrete and plaster, that are used to reduce radiation hazards.

Rad: The unit of absorbed dose, which is 100 ergs/g. The rad is a measure of the energy imparted to matter by ionizing particles per unit mass of irradiated material at the place of interest. It is a unit that was recommended and adopted by the International Commission on Radiological Units at the Seventh International Congress of Radiology, Copenhagen, July 1953.

Radiation: 1. The emission and propagation of energy through space or through a material medium in the form of waves; for instance, the emission and propagation of electromagnetic waves or of sound and elastic waves. 2. The term radiation, or radiant energy, when unqualified, usually refers to electromagnetic radiation, such radiation commonly is classified, according to frequency, as Hertzian, infrared, visible (light), ultraviolet, X-ray, and gamma ray. 3. By extension, corpuscular emissions, such as alpha and beta radiation, or rays of mixed or unknown type, as cosmic radiation.

Radiological Health: The art and science
(Continued on page 220)

FUNDAMENTALS OF RADIATION PROTECTION

In designing shielding for radiation, one is concerned with two types of shielding, primary and secondary. Primary shielding is that needed to attenuate the direct radiation from the unit, and secondary shielding is that which is needed to attenuate the scattered radiation from the patient, primary barrier, etc.

What are the maximum values that we are "shooting" for in designing shielding?

According to a proposed revision of the National Bureau of Standards Handbook 59, "Permissible Dose from External Sources of Ionizing Radiation," for design purposes occupational exposures should not exceed 100 milliroentgens (mr) per week, and non-occupational exposures not over 10 milliroentgens per week. These are total body or critical organ exposures.

In this discussion we will allow the occupational exposure to be given over a work week of 48 hours.

In designing shielding for any teletherapy unit, there are many variables which one must consider. Such things as degree of occupancy, type of machine being considered, the source strength and actual running time of the machine will affect the amount of shielding necessary to give

proper protection. Two basic equations for primary and secondary radiation that consider some of these variables are

$$B = \frac{(MPD)D^2}{WT} \quad (3) \quad \text{and} \quad B_s = \frac{(MPD)S^2}{0.001 WT} \quad (4)$$

Where,

B = permissible transmission for the primary beam

B_s = permissible transmission for the secondary beam (scattered radiation at angles equal to or greater than 90°)

MPD = maximum permissible weekly exposure for occupational or non-occupational

D = distance from source to position in question

S = distance from scatterer to position in question

W = total weekly exposure for the primary beam at 1 meter from the source (obtained by multiplying the roentgens per hour at 1 meter by 48 hours of weekly operation)

T = the occupancy factor.

Graphs showing the permissible transmission values B and B_s versus the thickness of concrete required for protection are given in Figures 1 and 2.

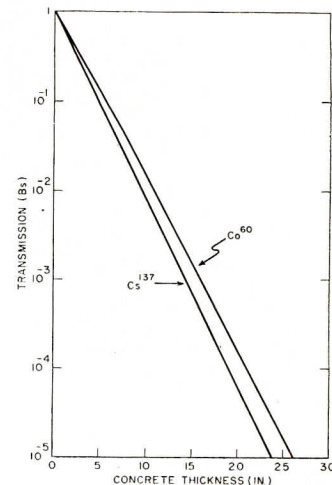

Figure 1

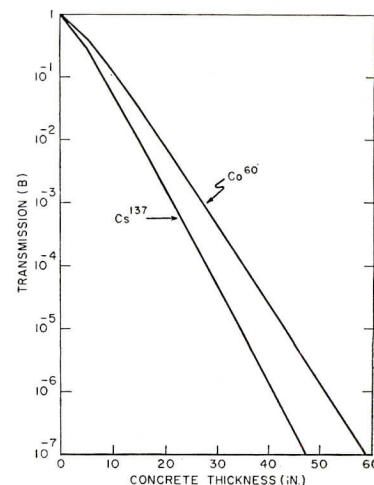

Figure 2

The curves shown above were extrapolated from National Bureau of Standards Handbook 54

GLOSSARY

of protecting human beings from injury by radiation.

Radiological Survey: Evaluation of the radiation hazards incident to the production, use or existence of radioactive materials or other sources of radiation under a specific set of conditions. Such evaluation customarily includes a physical survey of the disposition of materials and equipment, measurements or estimates of the levels of radiation that may be involved and a sufficient knowledge of processes using or affecting these materials to predict hazards resulting from expected or possible changes in materials or equipment.

Roentgen: The quantity of x- or gamma radiation such that the associated corpuscular emission per 0.001293 grams of air produces, in air, ions carrying 1 electrostatic unit of quantity of electricity of either sign.

Roentgen Equivalent Man (Rem): That quantity of any type ionizing radiation which when absorbed by man produces an effect equivalent to the absorption by man of one roentgen of x- or gamma-radiation (400 KV).

Roentgen Equivalent Physical (Rep): The amount of ionizing radiation which will result in the absorption in tissue of 83 ergs per gram. (Recent authors have suggested the value 93 ergs per gram.)

Rotation Therapy: Radiation therapy during which either the patient is rotated before the source of radiation or the source

is revolved around the patient's body.

Scattered Radiation: Radiation which, during its passage through a substance, has been deviated in direction. It may also have been modified by an increase in wavelength. It is one form of secondary radiation.

Scattering: Change of direction of subatomic particle or photon as a result of a collision or interaction.

Scintillation Counter: The combination of phosphor photo-multiplier tube and associated circuits for counting light emissions produced in the phosphors.

Secondary Protective Barriers: Barriers sufficient to reduce the stray radiation to the permissible dose rate.

Secondary Radiation: Radiation originating as the result of absorption of other radiation in matter. It may be either electromagnetic or particulate in nature.

Stray Radiation: Radiation not serving any useful purpose. It includes direct radiation and secondary radiation from irradiated objects.

Teletherapy: A method of using a radioisotope as a radiation source in which the radioelement is shielded on all sides except one, thus giving a directional beam of radiation which is directed at the area to be treated.

Useful Beam (In radiology): That part of the primary radiation which passes through the aperture, cone, or other collimator.

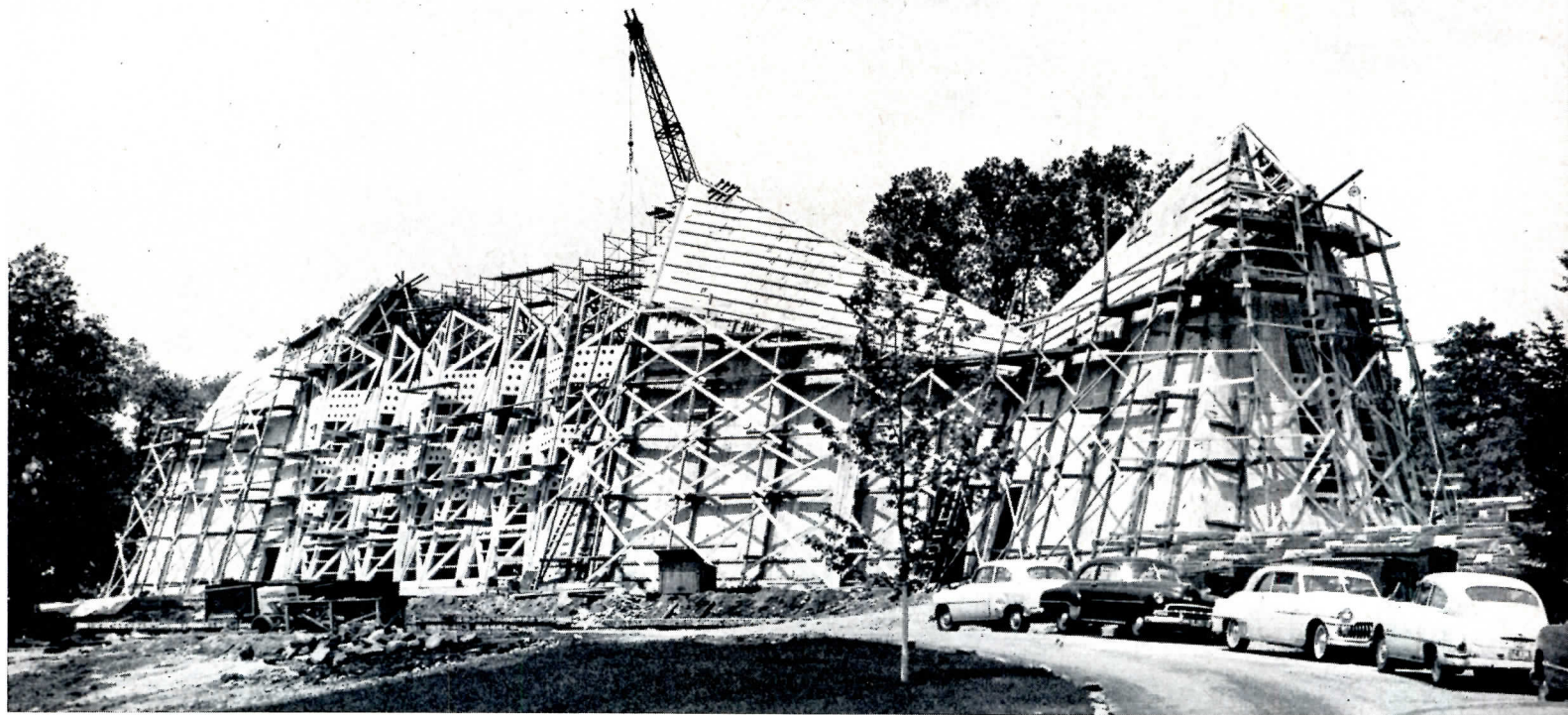

PRECAST SECTIONS FORM MONOLITHIC CONCRETE "WHALE"

BY TRANSLATING THE TIME-TESTED principle of the masonry arch and dome into a modern idiom, the designers of the new First Presbyterian Church in Stamford, Connecticut, have created a monolithic structure in which precast concrete panels serve dually as skeleton and skin, the mutually supporting walls and roof merging in a single integrated shell that is both structural and enclosing.

The church itself is 234 ft long and 54 ft wide at its widest point, with a nave seating 670. As can be seen in the illustrations on this page, the form bears a slightly more than coincidental resemblance to a fish — a shape which, apart from its Christian and biblical associations, produces a suitably soaring and

acoustically well-nigh perfect sanctuary space in the body of the whale. And the unique structural system further contributes to the quality of the interior space by freeing it of columns, beams, lintels or other visible supports.

A total of 152 members were used for the structure, all of them precast by assembly-line methods for maximum precision and quality control at minimum cost. Seventy-two of the elements are quadrilaterals cast in solid reinforced sections with a maximum size of 36 by 10 ft and a maximum weight of 10 tons. The others are triangles, some solid and some perforated, with a maximum length of 35 ft on the longest measure and a maximum weight of 5 tons.

Each of the basic shapes to be cast was laid out on a plywood bed, and the forms constructed to precise measurements, with aluminum castings forming the lens openings in the perforated triangular sections. The reinforcing members were then carefully positioned, and the poured concrete vibrated for maximum density. To permit faster form re-use, a high early strength concrete was used in casting all members.

Once formed, the reinforced wall and roof sections were delivered to the building site by truck, and, beginning with the long triangular side wall sections, were hoisted into place by crane. As each panel was lowered into position on the concrete footing, it was bolted in

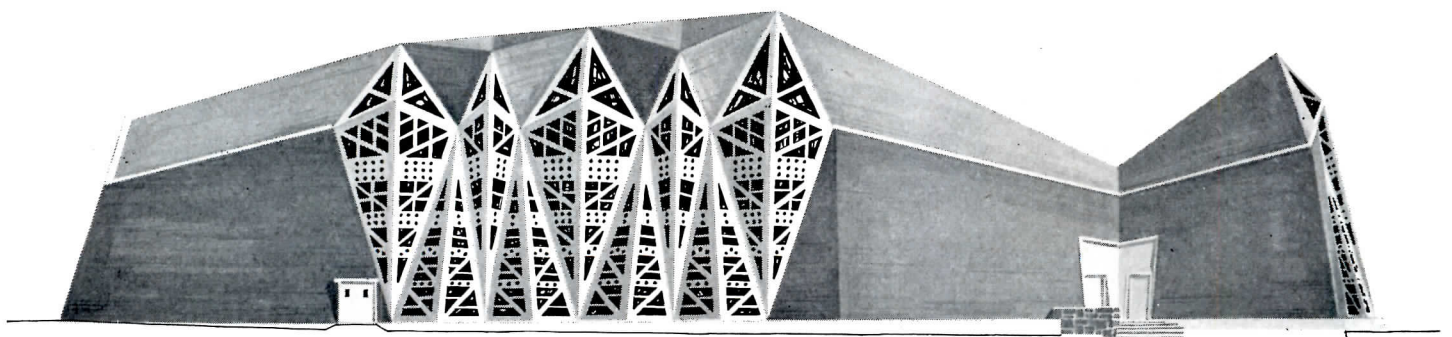

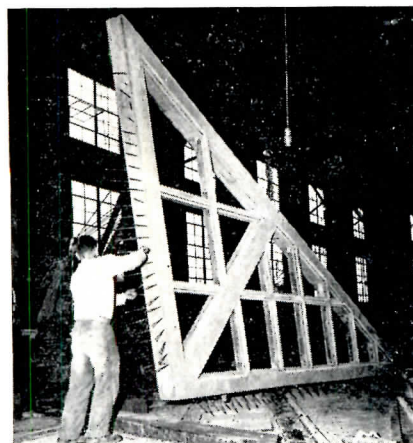
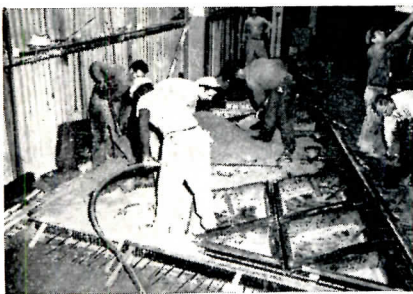
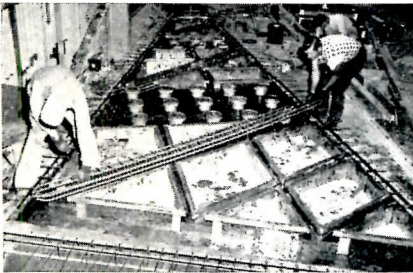
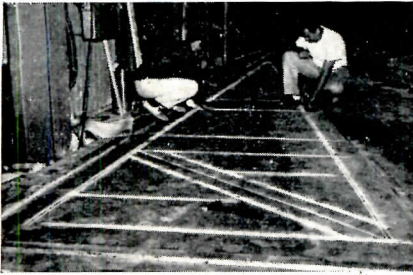

Assembly-line technique for precasting wall and roof sections for Stamford, Connecticut's First Presbyterian Church followed sequence shown at left. Forms were laid out on plywood beds, reinforcing positioned, the concrete placed and cured, and completed sections removed to allow re-use of forms. Panels were delivered to the site by truck and positioned by crane as shown above. Eight inch concrete seams join panels and foundation

place and an 8 in. concrete joint poured to make wall section and foundation continuous. Adjacent triangular sections were then lowered upside down into their inverted positions between the adjoining pairs of panels, and fastened to the footing in the same way. As construction proceeded, the solid triangular and quadrilateral sections were placed in a similar manner, their tops supported by falsework which remained in place until the roof panels had been lowered into position and the integrated wall and roof had become self-supporting. To assure a strong, rigid monolithic structure, 8 in. concrete joints were poured in place between all the panels.

The solid sections in both walls and roof are covered with slate shingles, while the perforated triangular panels

used for the side and rear walls and the center section of the roof are left exposed. Light enters the interior of the church through one inch thick panes of colored glass set in the vari-shaped apertures of the exposed concrete sections. These panes of emerald, sapphire and amber glass were made in France — in the same town that 700 years ago supplied the glass for Chartres Cathedral — from templates of the panels in which they were to be placed.

Associated architects on the project were Harrison & Abramovitz of New York City, and Sherwood, Mills & Smith of Stamford; F. J. Samuely of London, England served as consulting engineer, and Edwards & Hjorth of New York City as structural engineers.

(More Roundup on page 234)

CERAMIC PANELS: OLD FACE, NEW FORM

THE WEDDING OF AN AGE-OLD wall finish to a relatively new type of wall construction has produced a talented offspring whose inheritance includes many of the advantages of both. Ceramic tile has long been a familiar finish for both interior and exterior walls; curtain wall construction has in recent years proved its applicability to a wide range of building types. Now the color, texture and durability of tile and the structural advantages of the prefabricated, insulated curtain wall panel are combined in a single building product — lightweight, low-cost *RS Panels*.

Four standard types are being offered, the most interesting of which, the Series 1500, is constructed of lightweight reinforced concrete cast monolithically with an insulating *Styrofoam* core and faced with Romany-Spartan frost-proof ceramic tile. The other three, Series 1600, 1700 and 1800, are sandwich-type panels with aluminum skins bonded to an insulating core. Core materials include *Styrofoam* for the 1600 series, *Foamglas* for the 1700 and an aluminum or impregnated paper honeycomb for the 1800. All three are finished in frost-proof tile applied to the exterior skin with a water-resistant, organic adhesive.

To permit their use in a wide variety of standard and specially designed curtain wall or window wall frames, the panels are made in thicknesses of from $1\frac{3}{8}$ to $3\frac{3}{4}$ in., with edge thicknesses that can be varied from $\frac{1}{2}$ in. up to the overall panel thickness, as shown below. The regular panels are furnished in all sizes up to a maximum of 5 by 10 ft. However, specially reinforced and

thicker Series 1500 panels can be made as large as 5 by 15 ft for use in slab construction.

Although all of the panels are relatively light, their weights vary according to their thickness and construction. Lightest is the Series 1800 which weighs only 5.4 psf. when constructed with a 1 in. honeycomb; heaviest is the monolithic Series 1500 which weighs 9.3 psf. in the $3\frac{3}{4}$ in. panel thickness. The U factors vary according to the same criteria, ranging from a high of .28 for the $1\frac{3}{4}$ in. Series 1500 panel to a low of .08 for a Series 1600 panel with a 3 in. *Styrofoam* core.

Tile finishes may be chosen from the full line of Romany-Spartan frost-proof tiles in 1 by 1, 1 by 2 and 2 by 2 in. sizes and over sixty colors, including bright and matte glazed finishes and natural clay and porcelain unglazed finishes. If desired, the panels can be faced on both sides with ceramic tile — or the interior surface can be painted.

The tile on all *RS Panels* is grouted with a weatherproof, flexible latex grout which was chosen on the basis of cyclic weathering and differential temperature tests conducted at Pennsylvania State University. Dark gray grout is standard, but white or other colors will be used where specified.

Panel costs range from \$2.75 to \$4.50 per sq ft, depending on quantity, panel type, thickness, edge conditions, tile design and interior finish. In general, the Series 1500 and 1800 panels are least expensive. *Ceramic Tile Panels, Inc., 217 Fourth St., N. E., Canton 2, Ohio.*

(More products on page 258)

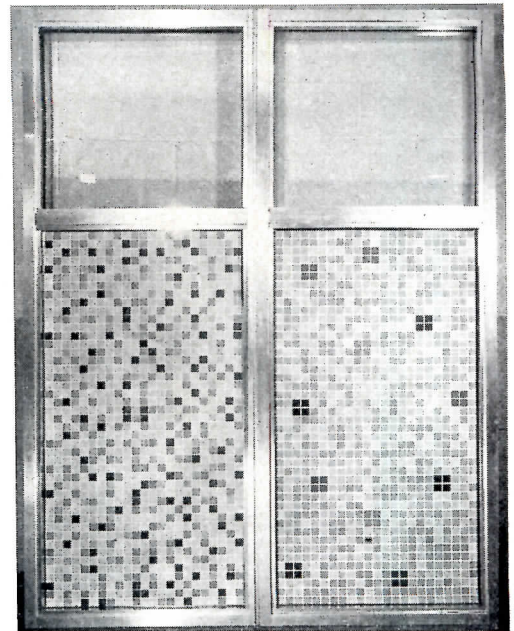

Insulated panels in basic types shown below combine appearance and permanence of ceramic tile finish with structural advantages of curtain wall construction

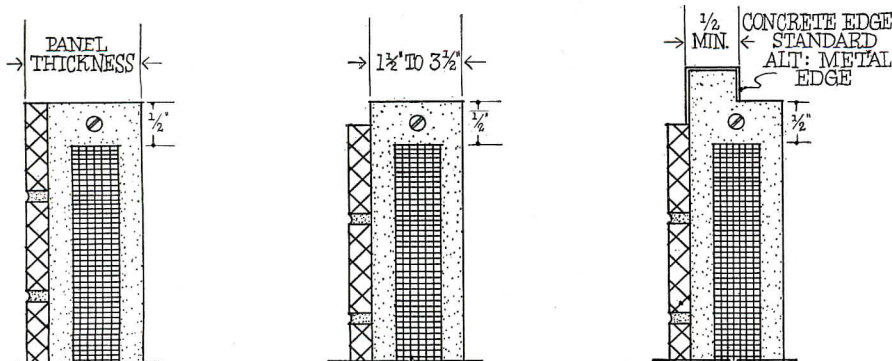
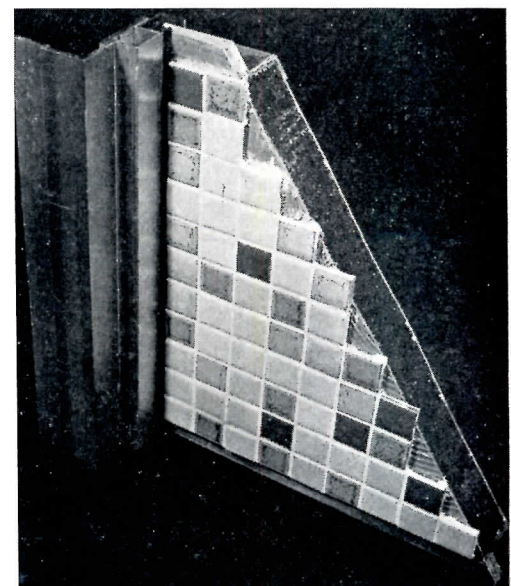
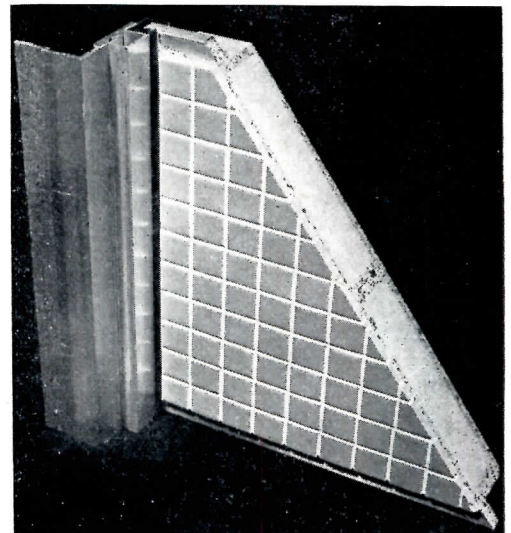

Alternate edge conditions Series 1500 (also applicable to 1600, 1700, 1800 Series panels)

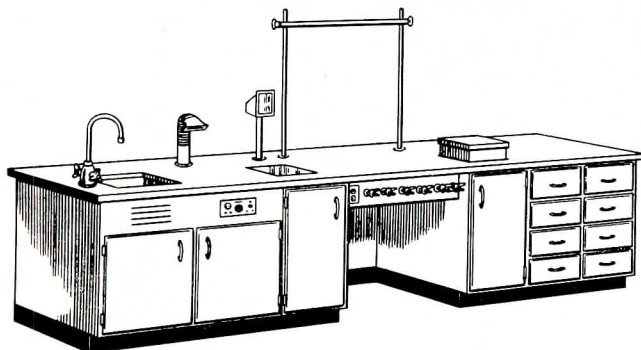

EDUCATIONAL SCIENCE EQUIPMENT

Catalog No. SUL-57 introduces *UNIT-LAB* educational science equipment, a versatile series of modular units designed to meet the specific requirements of every type and size of educational laboratory. Sketches, dimensions and brief descriptions of the full line of basic equipment, including demonstration tables, student work tables, storage units, sink units, fume hoods, and a variety of fittings and accessories, are presented on 16 double-size pages. *Laboratory Furniture Co., Inc., Old Country Rd., Mineola, L. I., N. Y.*

High Early Strength Portland Cement

Presents detailed information, test reports, comparative strength diagrams and other engineering data on *C.B.R. III*, a new Belgian high early strength portland cement. 12 pp. *Indussa Corp., 511 Fifth Ave., New York 17, N. Y.*

Fota-Lite (A.I.A. 31-F-237)

Bulletin L-110-F.G. presents product data, photometric data and calculations for *Fota-Lite* louvered glass lighting panels. *Lighting Sales Dept., Corning Glass Works, Corning, N. Y.**

Stationary Diesels

Bulletin 111 gives construction features, performance curves, specifications and typical applications for *Model 65 Superior* stationary diesels. 8 pp. *Adv. Mgr., White Diesel Engine Div., Springfield, Ohio*

Lightsteel for School Construction

(A.I.A. 13-G) Three sets of plans, in perspective, show typical classroom arrangements and illustrate uses of light steel structural sections in school construction. Details are shown in enlarged sections. 22 pp. *Penn Metal Co., Inc., 40 Central St., Boston 9, Mass.**

Contemporary Furniture Catalog

Photos and drawings illustrate complete line of light-scaled contemporary office furniture. Catalog #20 also details wood finishes and formica colors, legs and bases, and hardware available for the various modular components. 24 pp. *Robert John Co., 202 S. Hutchinson St., Philadelphia 7, Pa.*

Guide Specifications

... for *Typical Low-Pressure Commercial Heating Plant* (A.I.A. 30-A) covers recommended specifications for coal-fired heating plants over a range of 3000 to 24,000 EDR (steam) or $\frac{3}{4}$ to $5\frac{1}{2}$ million Btuh. 53 pp., 5 drawings. *Bituminous Coal Institute, 802 Southern Bldg., Washington 5, D. C.*

Convertible Wood Windows

(A.I.A. 16-L) Catalog D-57 gives selection data, installation and framing details, and specifications for *Series D* convertible wood awning windows. 6 pp. *Modernaire Corp., 8400 Kinsman Rd., Cleveland 4, Ohio.*

Varsity Pre-Cast Seats

Describes and illustrates typical installations of *Varsity* precast tread and riser seating units. Section drawings and specifications are also included. 8 pp. *Varsity Pre-Cast Seat Co., P. O. Box 5154, Oklahoma City, Okla.*

Walkerduct Systems (A.I.A. 31-C-62)

Catalog 354-P describes and illustrates Walker underfloor electrical distribution systems for concrete, steel deck, wood and radiant heated floors. 56 pp. *Adv. Mgr., Walker Bros., Conshohocken, Pa.**

Basic Safety Controls

... for *Low Pressure Steam Boilers* gives "why" and "how" of safety and automatic water level controls for low pressure steam boilers in closed heating and multiple boiler systems. 24 pp. *McDonnell & Miller, Inc., 3500 N. Spaulding Ave., Chicago 18, Ill.**

Wallites (A.I.A. 31-F-2)

Includes descriptions, specifications and installation drawings for *Wallite* line of wall-mounted lighting fixtures. 4 pp. *Gotham Lighting Corp., 37-01 31st St., Long Island City, N. Y.*

Engineered Lighting Surface Series

(A.I.A. 31-F-2) Engineering folio S-58 includes specifications, cross-sectional construction drawings, candlepower distribution curves and coefficients of utilization for a wide line of shielded fluorescent units. 16 pp. *Gruber Brothers, Inc., 125 S. First St., Brooklyn 11, N. Y.*

Stainless Steels

Offers descriptions, chemical composition, strength factors, physical properties and typical applications for a wide range of stainless steels, including the 200, 300 and 400 series. 32 pp. *Adv. Dept., Sharon Steel Corp., Sharon, Pa.*

Safway Spectator Seating

(A.I.A. 35-F-11) Describes complete line of *Safway* telescoping gym seats, with illustrations, detail drawings, selection data and specifications. 16 pp. *Safway Steel Products, Inc., West 63rd St., Milwaukee 13, Wisc.**

Commercial Boilers

Twelve page catalog includes diagrams, descriptive literature, capacities and dimensions for complete line of large-size commercial boilers. *Portmar Boiler Co., Inc., 193 Seventh St., Brooklyn 15, N. Y.*
* Other product information in *Sweet's Architectural File, 1957.*

(More Literature on page 300)

ROOM FOR COBALT 60 FACILITIES: 1 — Fixed Beam Unit*

By U. S. Department of Health, Education and Welfare—Public Health Service

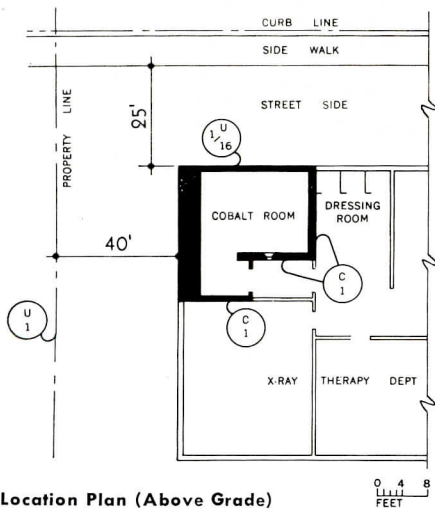

Location Plan (Above Grade)

SYMBOLS

- Full Occupancy Controlled
- Full Occupancy Uncontrolled
- Partial Occupancy Uncontrolled
- Occasional Occupancy Uncontrolled

For "Design Requirements" see Sheet 2

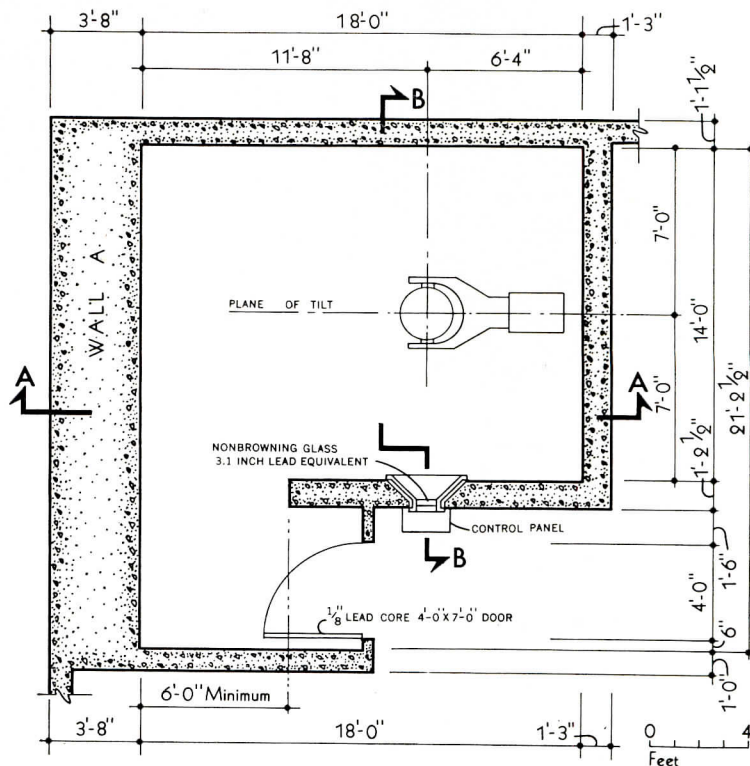

Plan of Cobalt 60 Room

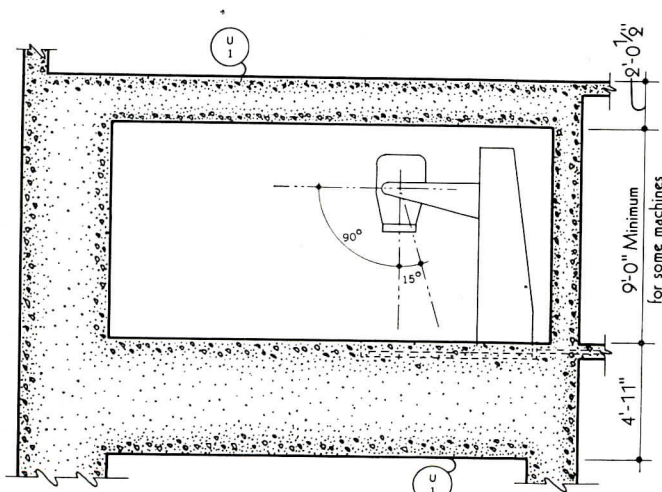

Section AA

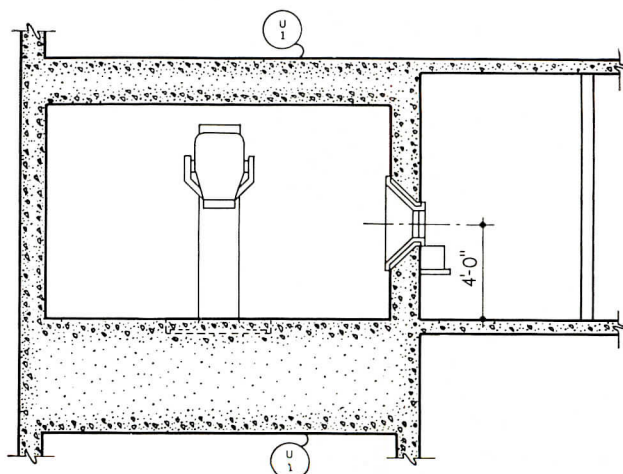

Section BB

The shielding indicated on the accompanying plans was computed on a basis of a 5,000 curie source. Because of its high cost, it is not now commonly used. Reduction of the source, however, does not decrease the shielding requirements significantly. For example, in the plan, use of a 2,000 curie source would result in a reduction of the thickness of wall

A by 3 in.; for a 500 curie source, a reduction of 5 in. more. Since greatest cost is in forming, such savings are relatively small.

In new construction, the cost of concrete shielding will, in most cases, be a small part of the total cost of the installation.

To illustrate the maximum required shielding for floor and ceiling, the thicknesses shown

have been computed for locations with full-time uncontrolled occupancy above and below. With controlled occupancy less shielding would be necessary and with no occupancy, these slabs could be reduced to the minimum structural requirements. An underground location is the only way, short of limiting the machine, of reducing the thickness of exterior walls.

*With Primary Beam Restricted to Floor and One Wall

New Jamison FROSTOP has Adjustable Temperature Control

to prevent icing and freezing shut of cold storage doors

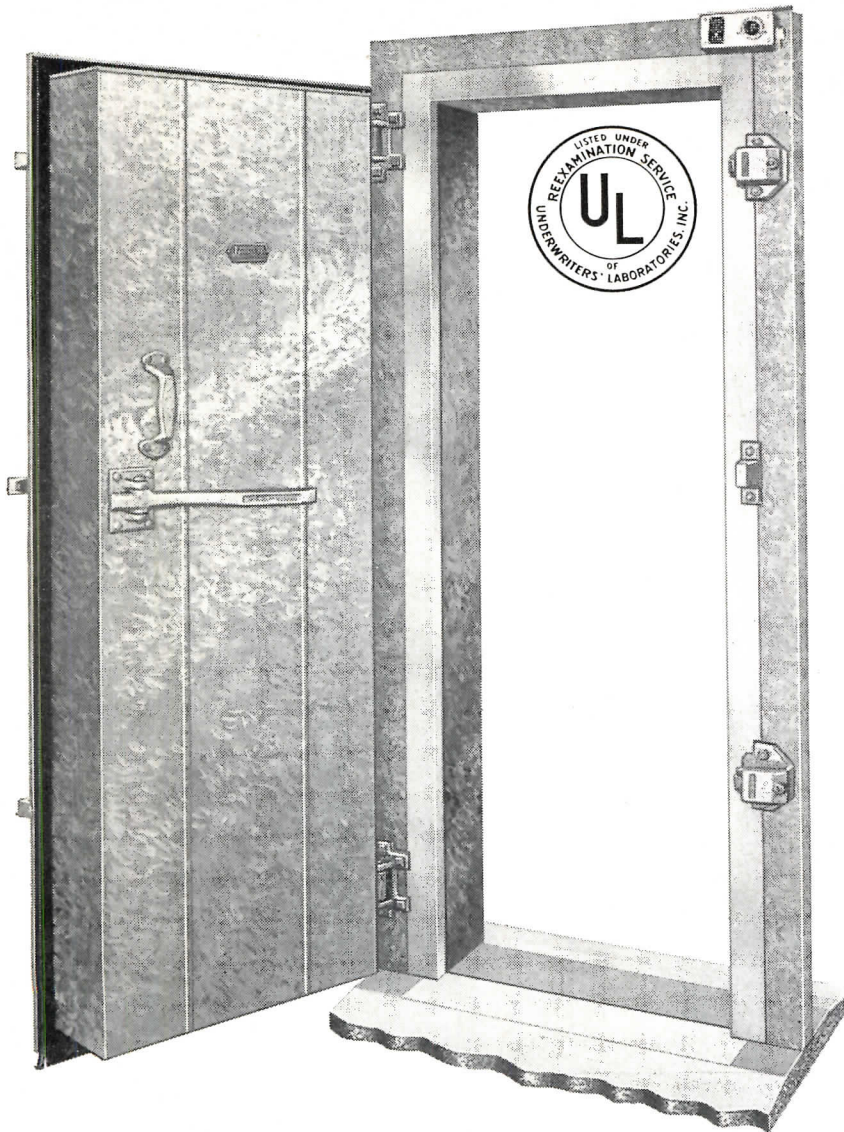

...thermoswitch-controlled temperature range eliminates dangers of overheating or condensation of moisture due to unauthorized shut off.

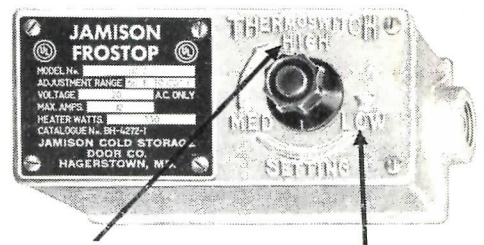

120°—above 120° excessive temperature damages frame and gaskets.

60°—below 60° condensation will form in cable channels on frame and sill areas.

Adjustable Frostop thermostwitch permits selection of any temperature between 60° and 120°.

BUILT IN SAFETY RANGE

With the new Jamison Thermoswitch Control, Frostop *cannot* be turned off at the unit, nor can heat be elevated beyond safe limits. Practical temperature range is from 60°F. to 120°F., which prevents moisture condensation or excessive heat.

Other approved features include Gasketed Control Box—water tight and drip proof; and Silicone-Glass Cable Insulation to give cable moisture and heat resistance and extra long life.

Specify Jamison's new Frostop for completely safe control of icing and freezing of doors. Write for new Frostop Bulletin. Jamison Cold Storage Door Co., Hagerstown, Md., U.S.A.

The new Jamison Frostop with adjustable temperature control is now available on Jamison Cold Storage Doors of many types and practically all sizes.

More JAMISON Doors are used by *more* people than any other Cold Storage Door in the world.

JAMISON

COLD STORAGE DOORS

ROOM FOR COBALT 60 FACILITIES: 2 — Rotational Unit with Primary Beam Absorber

By U. S. Department of Health, Education and Welfare—Public Health Service

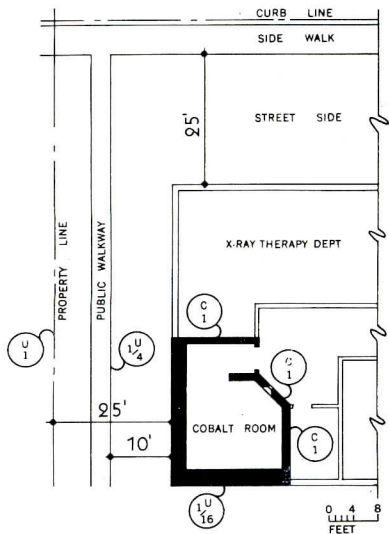

Location Plan (Above Grade)

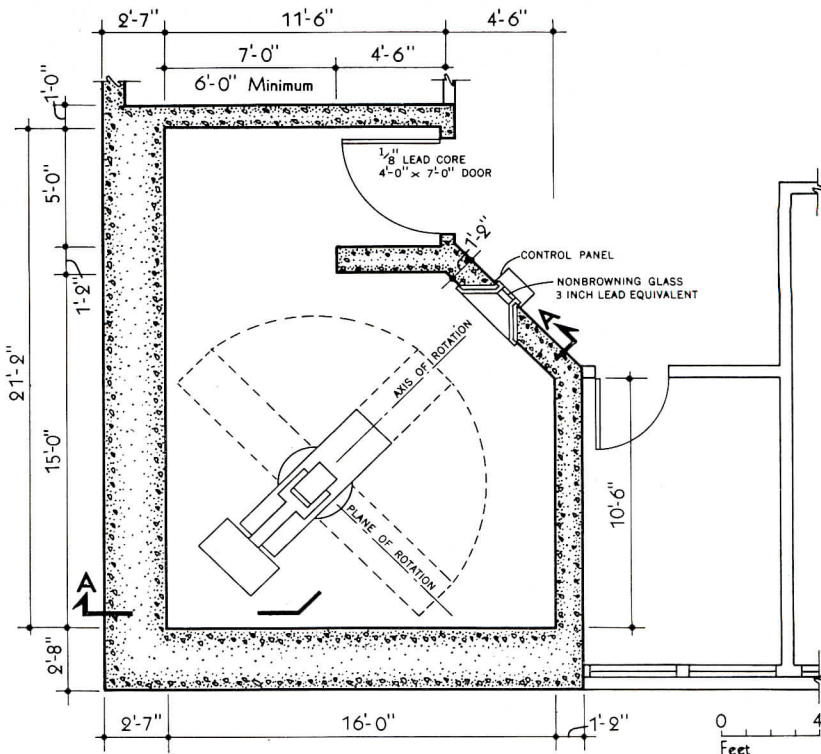

Plan of Cobalt 60 Room

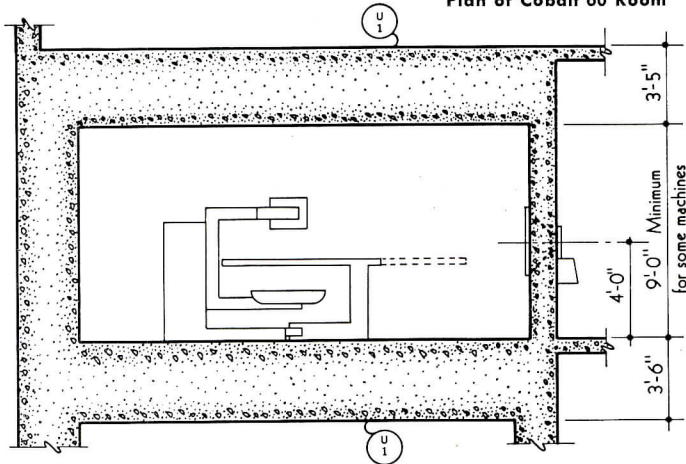

Section AA

SYMBOLS

- Full Occupancy Controlled
- Full Occupancy Uncontrolled
- Partial Occupancy Uncontrolled
- Occasional Occupancy Uncontrolled

DESIGN REQUIREMENTS

Controlled Area $MPD = 5.0 \frac{Rem}{Yr} = 5.0 \frac{Rem}{60 Wk} = 100 \frac{MRem}{Wk}$

Uncontrolled Area $MPD = 0.5 \frac{Rem}{Yr} = 0.5 \frac{Rem}{52 Wk} = 9.6 \frac{MRem}{Wk}$

Full Occupancy $T = 1$

Control space, residences, play areas, wards, office work rooms, darkrooms, corridors and waiting space large enough to hold desks and rest rooms used by radiologic staff and others routinely exposed to radiation.

Partial Occupancy $T = 1/4$

Corridors in X-ray departments too narrow for future desk space, rest rooms not used by radiologic personnel, parking lots, utility rooms.

Occasional Occupancy $T = 1/16$

Stairways, automatic elevators, streets, closets too small for future workrooms, toilets not used by radiologic personnel.

Source 5000 Curies

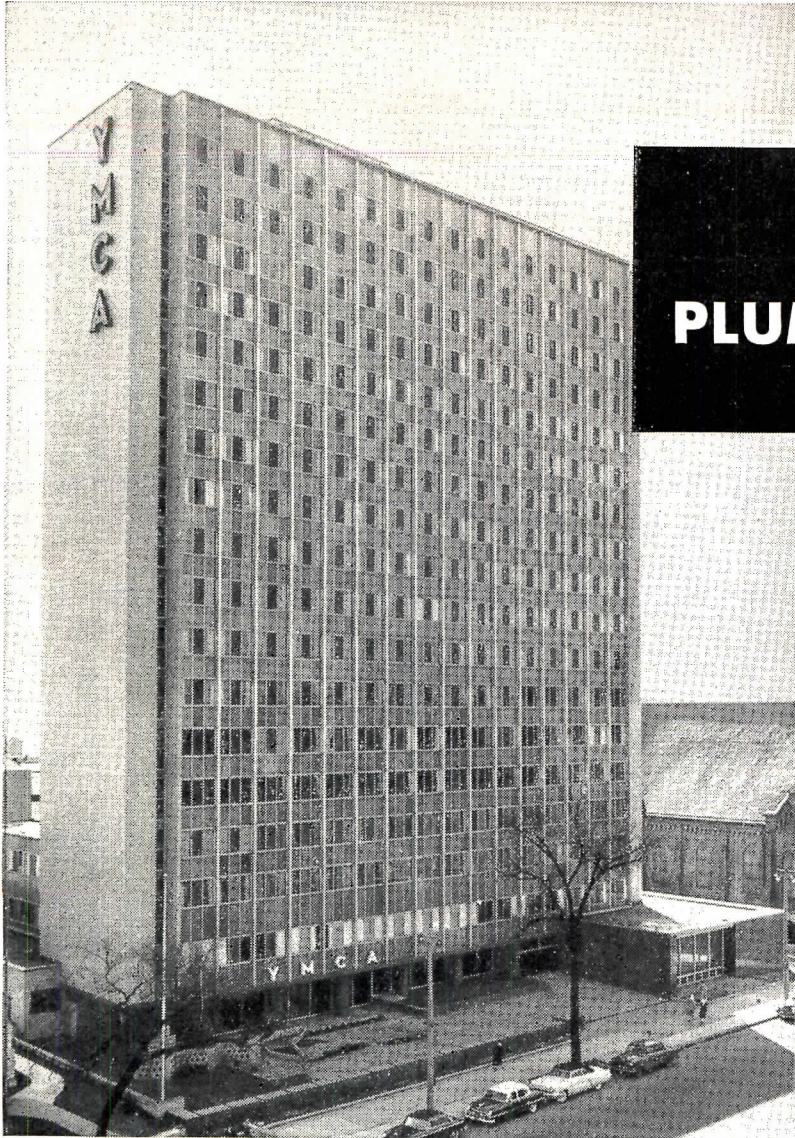

KOHLER PLUMBING FIXTURES

*installed
throughout
the new*

MILWAUKEE Y.M.C.A.

Among the many large scale institutions which have chosen Kohler plumbing fixtures and fittings for quality, appearance and serviceability, is Milwaukee's new \$6,200,000, 18-story Y.M.C.A.—outstanding in modern structural design, appointments and equipment.

More than a thousand Kohler fixtures with chromium-plated all-brass fittings were used. The Juneau vitreous china lavatories were selected for residence rooms and washrooms. The Juneau has special mounting features and extra wall-bearing surface that insure rugged stability without the need for additional support.

Completing the all-Kohler installation are Swift, Sifton and Stratton closets, Branham urinals, Rinse dental lavatories—all of vitreous china—and over 300 showers.



*Juneau lavatories,
Rinse dental lavatory*

KOHLER CO. Established 1873 KOHLER, WIS.

KOHLER OF KOHLER

PLUMBING FIXTURES • HEATING EQUIPMENT • ELECTRIC PLANTS
AIR-COOLED ENGINES • PRECISION CONTROLS

ROOM FOR COBALT 60 FACILITIES: 3 — Rotational Unit without Primary Beam Absorber

By U. S. Department of Health, Education and Welfare—Public Health Service

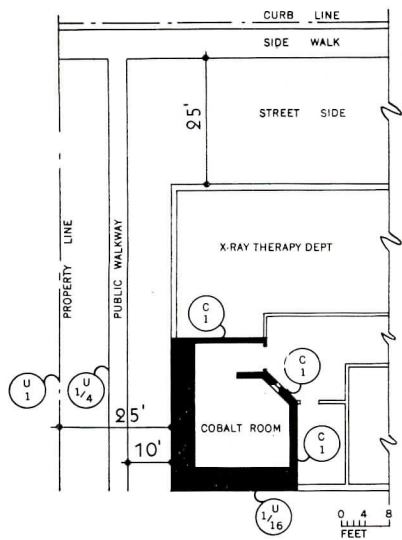

Location Plan (Above Grade)

SYMBOLS

- Full Occupancy Controlled
- Full Occupancy Uncontrolled
- Partial Occupancy Uncontrolled
- Occasional Occupancy Uncontrolled

For "Design Requirements" see Sheet 2

A primary beam absorber on a machine reduces the shielding requirements considerably. However, some radiologists prefer to use a machine without the absorber, because of its greater flexibility, and for this reason some machines are designed to be used with or without the absorber. Under these conditions the room shielding should be designed for use either way. The plan and section shown here illustrate the necessary shielding.

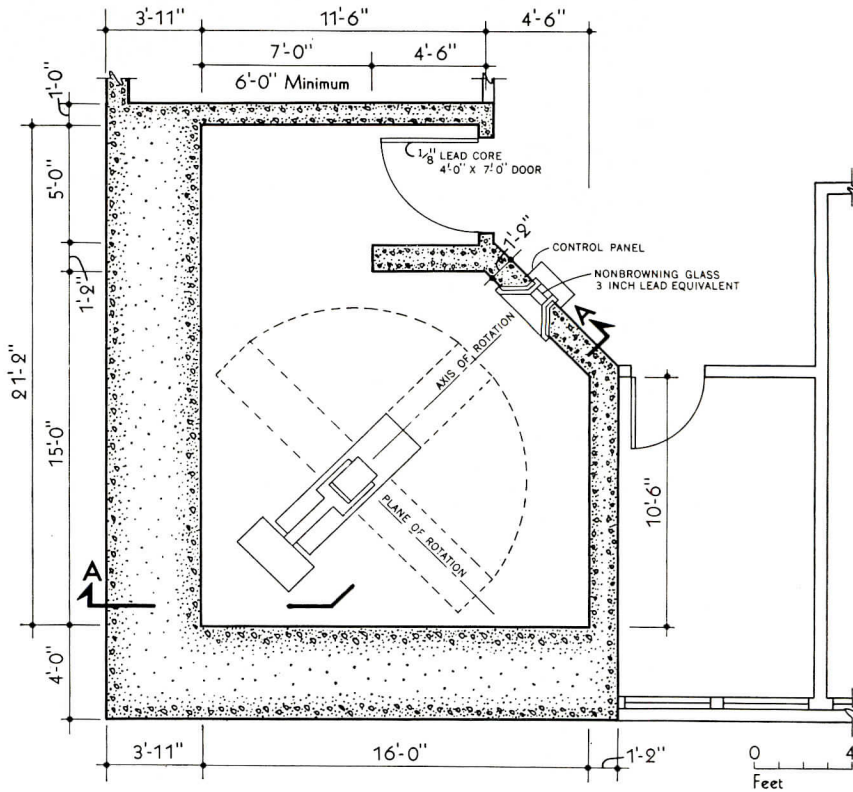

Plan of Cobalt 60 Room

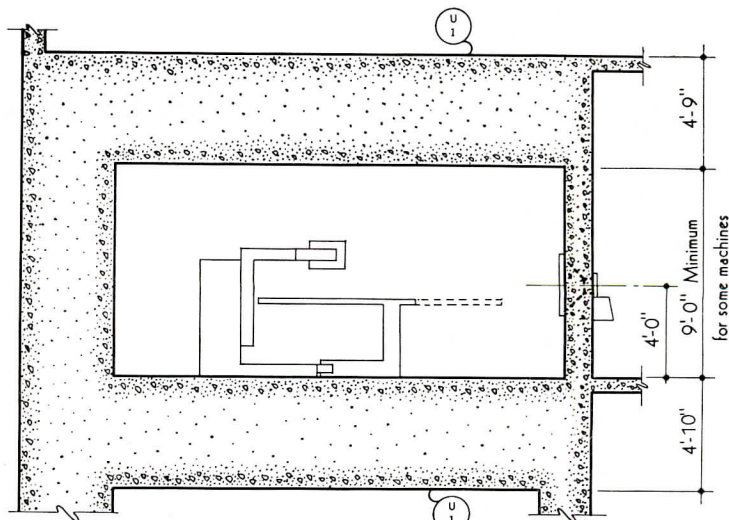

Section AA

BANK . . . LIBRARY . . .

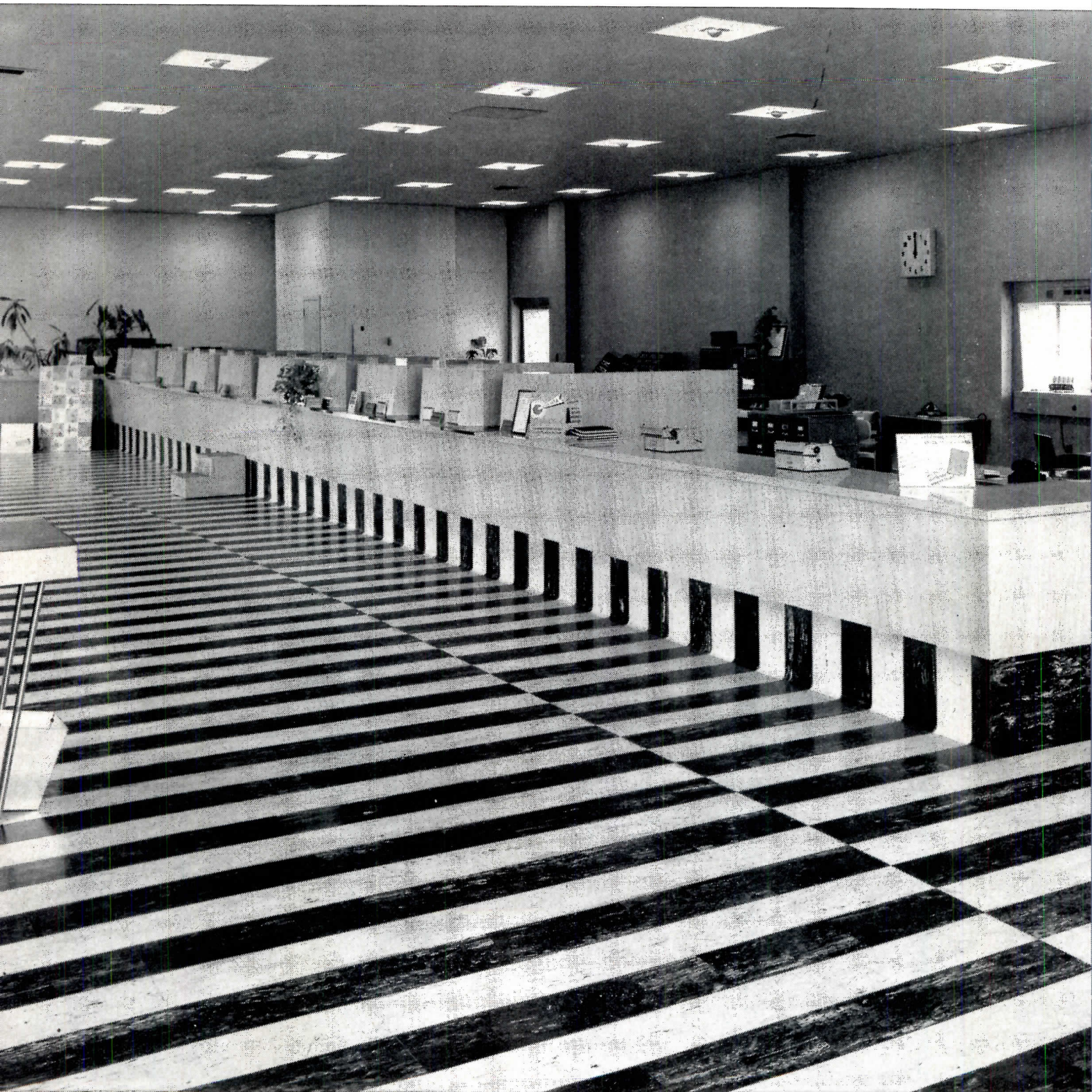

PRACTICAL STYLING

The choice of Armstrong Rubber Tile for the floor of this bank was made for its durability as well as for its rich appearance. The striking "zebra stripe" design gives a "furnished" look to an otherwise open floor area. Adding to the effectiveness of the design is the coving of the flooring up the counter fronts — a smart decorating idea that also is an aid to cleaning.

The Commercial Bank of Salem, Oregon

architect: Bank Building Corporation, St. Louis, Missouri

INTERIOR DESIGNERS' OFFICE . . .

the flooring spec: Armstrong Rubber Tile

QUIETNESS

Its exceptional resiliency makes Armstrong Rubber Tile one of the quietest floors to walk on, a natural choice for a library. Footsteps, chairs moving, things dropped don't disturb readers. In the children's reading room, shown here, Armstrong Rubber Tile withstands constant scuffing without permanent marks and indentations.

Maplewood Memorial Library, Maplewood, New Jersey

architect: Ray O. Peck, A.I.A. and Karl S. White, A.I.A., Associates



DECORATIVE BEAUTY

A modern custom floor is superbly achieved in this designers' office. The crystal-clear colorings of Armstrong Rubber Tile add elegance. Ecru and beige tiles, installed in a handsome fret design, make the office seem more spacious.

Interior Design Office, New York, New York
designers: Kim Hoffmann, A.I.D. and Stephen Heidrich, A.I.D.

Armstrong Rubber Tile is widely recognized for its clear brilliance of color and handsome graining — an ideal floor for the finest interiors. Mechanical reinforcement in its manufacture prevents shrinkage and expansion; chemical reinforcement assures exceptional resistance to grease, oil, and solvents. Inexpensive to maintain, Armstrong Rubber Tile withstands static loads up to 200 lbs. per sq. in. It is available in a wide range of colors in 1/8" and 3/16" gauges; in 6" x 6", 9" x 9", 12" x 12", and 18" x 36" sizes. Armstrong Rubber Tile can be installed over any suspended subfloor and even below grade and on grade with specified Armstrong adhesives.

Because Armstrong makes all types of resilient floors, unbiased recommendations can be made for every flooring need. For help on any flooring problems, call the Architectural-BUILDER Consultant in your nearest Armstrong District Office or write direct to Armstrong Cork Company, Floor Division, 111 Rock Street, Lancaster, Pennsylvania.



Armstrong FLOORS

Approximate Installed Prices per Sq. Ft. (Over concrete, minimum area 1000 sq. ft.)

20¢ to 35¢	Decoray® Linoleum Tile Asphalt Tile, 1/8" (A, B, C, D) Linoleum, light gauge Asphalt Tile, 3/16" (A, B)	35¢ to 45¢	Linoleum, standard gauge Asphalt Tile, 3/16" (C, D) Linoleum, 1/8" ("Batfleship") Greaseproof Asphalt Tile Cork Tile, 3/32"	45¢ to 60¢	Corlon® (Sheet Vinyl) Linoleum, 1/8" Cork Tile, 1/8" Excelon® Tile (Vinyl-Asbestos) 1/8"	60¢ to 70¢	Rubber Tile, 1/8" Cork Tile, 3/16" Linotile® Corlon (Hydrocord® Back) Linoleum (Cushion-Eze® Back**)	70¢ to 90¢	Custom Corlon Tile (Homogeneous Vinyl) 3/32", 1/8" Cork Tile, 5/16" Rubber Tile, 3/16" Corlon (Cushion-Eze Back)	95¢ to \$1.30	Custom Vinyl Cork Tile Imperial® Custom Corlon Tile
------------------	--	------------------	---	------------------	--	------------------	--	------------------	--	---------------------	--

**PATENT PENDING

THERMADOR

"Seven Leagues Ahead" in the science of electric heating



ALL NEW THERMADOR MASTER-DUTY BILT-IN FAN-TYPE ELECTRIC ROOM HEATER



Heats the "Living Zone"

"A heater in winter — a fan in summer"

- heat-speed efficiency greater than any other heater
- new ease of installation
- the ultimate in room-by-room thermostatic heat control
- new motor location in cold-air stream
- flush-to-wall installation projects less than 1 inch
- new type turbo-fan, quietest ever
- cleaner, safer, healthier—no soot—no flame—no fumes
- new heating element provides instant silent heat
- heat discharged at floor level—circulates thru "Living Zone"
- new Spanish Gold baked enamel finish blends with room interiors

A THERMADOR HEATER FOR EVERY ROOM

Remember, when Thermador is specified, installation is easier, profits are bigger, and customer satisfaction is greater.

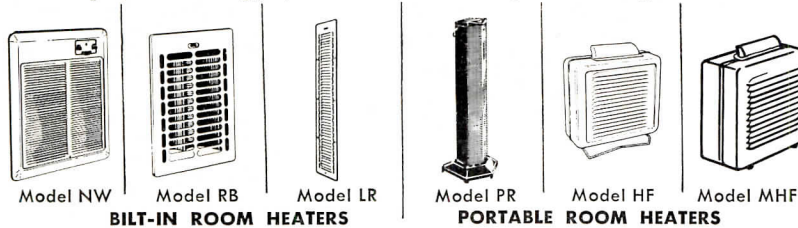

Model NW Model RB Model LR Model PR Model HF Model MHF
BILT-IN ROOM HEATERS PORTABLE ROOM HEATERS

The Originator of the Fan-Type Electric Heater



THERMADOR
ELECTRICAL MANUFACTURING COMPANY



Division of Norris-Thermador Corporation
5119 District Blvd. • Los Angeles 22, Calif.

Thermador Electrical Manufacturing Company 5119 District Blvd., Los Angeles 22, Calif.
A Division of Norris-Thermador Corporation Architect Electrical Contractor
Dept. AR-11-57. Builder Wholesaler Dealer Other

Name _____
Address _____
City _____ State _____

TECHNICAL ROUNDUP

(Continued from page 222)

NEW USE OF PRESTRESSED CONCRETE PARES WALL COSTS

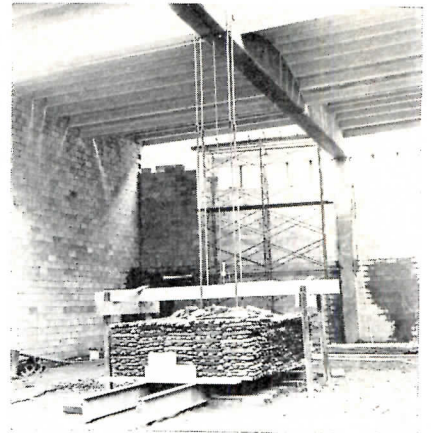

With the help of a little-used application of prestressed concrete, the recently completed St. Vitus School Auditorium in Cleveland, Ohio, shed 3 ft of its perimeter wall — and a correspondingly large chunk of wall construction costs.

Of four alternate schemes studied, a roof system of prestressed girders with a precast concrete roof deck proved most desirable from the standpoints of cost and appearance, and offered the added advantage of fireproof construction. To save expensive wall construction around the perimeter of the building, the beams were upset above the roof deck even though the top flange was then left unsupported. The design concept involved — that of built-in stability under final design loads for prestressed concrete beams with an unsupported compression flange — is one that has been given little study, and no test data was available. The analysis was therefore confined to the stability of the beam web under bending action of a flat plate, and corroborated by a field test of one of the beams after it was in place but before the roof slabs were connected to it. As shown above, a test load of twice the design load was applied as a single concentrated load in a way that simulated the actual condition of a laterally unsupported compression flange. After this loading had been maintained for 24 hours, the maximum deflection was 0.67 in., with a recovery of 100 per cent.

Architects for the project were John F. Lipaj & Associates; structural engineering was by R. M. Gensert & Associates, with Dr. John B. Scalzi of Case Institute of Technology collaborating on the design of the beam.

(More Roundup on page 238)

America Fore Insurance Group
Chicago, Illinois
Architects: Loeb, Schlessman
& Bennett, Chicago



Porcelain Enamel CURTAIN WALL PANELS

again featured on

Chicago's new skyline!

When *one* brand of porcelain enameled curtain wall panels continues to be chosen for new major structures on Chicago's changing skyline—the answer is superior quality at competitive costs.

You can expect that of ERIE panels on job after job. The fully enclosed box panel design offers the permanence of mechanical assembly, lifetime color, required insulation and ready adaptability to the framing system of your choice.

That's why Chicago's newest buildings are featuring ERIE Porcelain Enamel Curtain Wall panels. Why not let our sales engineers work with you on your next project. A phone call brings complete cooperation!

The **Erie**
ENAMELING COMPANY

ERIE, PENNSYLVANIA

CHICAGO • PHILADELPHIA

REPRESENTATIVES IN PRINCIPAL CITIES

WALLS AND ROOF DECK QUILTED FOR STRENGTH, INSULATION

In designing several structures — including a residence, a motel dining room and fifteen summer cottages — architect Francis J. Niven of Houston, Texas, has employed a unique structural system in which sandwich type quilted concrete slabs are used for both walls and roof deck.

For supports located not more than 6 ft on center, Mr. Niven recommends 4 in. slabs made up of a 2 in. insulating core of *Styrofoam* faced on both sides by a 1 in. layer of concrete blown-on over 2 by 2 in. 14 ga. galvanized wire mesh. Thicker slabs are necessary for wider spans, although the thickness may be reduced by the use of troweled-on oxychloride cement, a $\frac{3}{8}$ in. layer of which approximates the strength of a 1 in. layer of concrete. Because their strength increases as they approach a complete envelope around a structure, the slabs are continuous around building walls and over supports.

Primary among the advantages cited for this new building method is the speed of construction. Mr. Tom Notestine, who was associated with Niven's firm on the design of the cottages, believes that perfection of the construction technique will make it possible to erect similar structures in only three days' time.

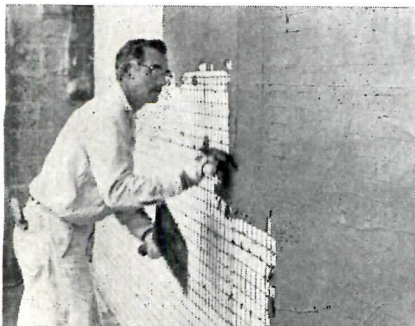
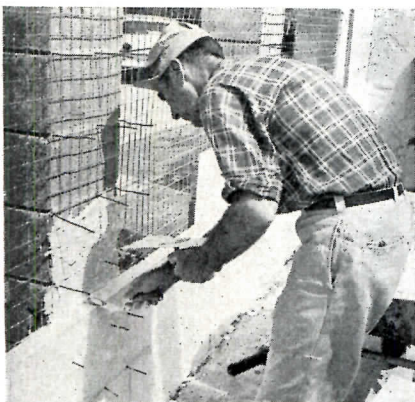
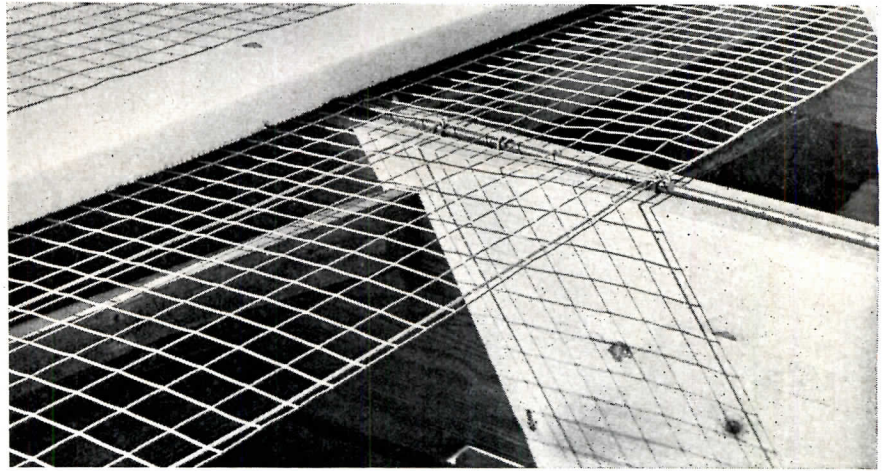

(More Roundup on page 242)

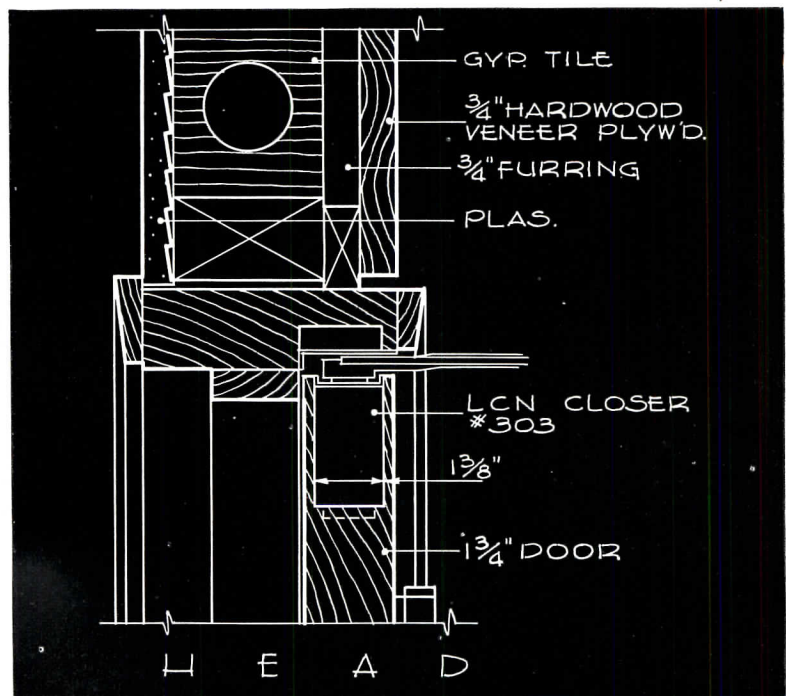

CONSTRUCTION DETAILS

for LCN Closer Concealed-in-Door Shown on Opposite Page

The LCN Series 302-303 Closer's Main Points:

1. An ideal closer for many interior doors
2. Mechanism concealed within door; flat arm not prominent, and provides high closing power
3. Door is hung on regular butts
4. Closer is simple to install and to adjust
5. Hydraulic back-check protects walls, etc. on opening
6. Practically concealed control at little more than exposed closer cost

*Complete Catalog on Request—No Obligation
or See Sweet's 1957, Sec. 18e/La*

LCN CLOSERS, INC., PRINCETON, ILLINOIS

Canada: Lift Lock Hardware Industries, Ltd., Peterborough, Ontario

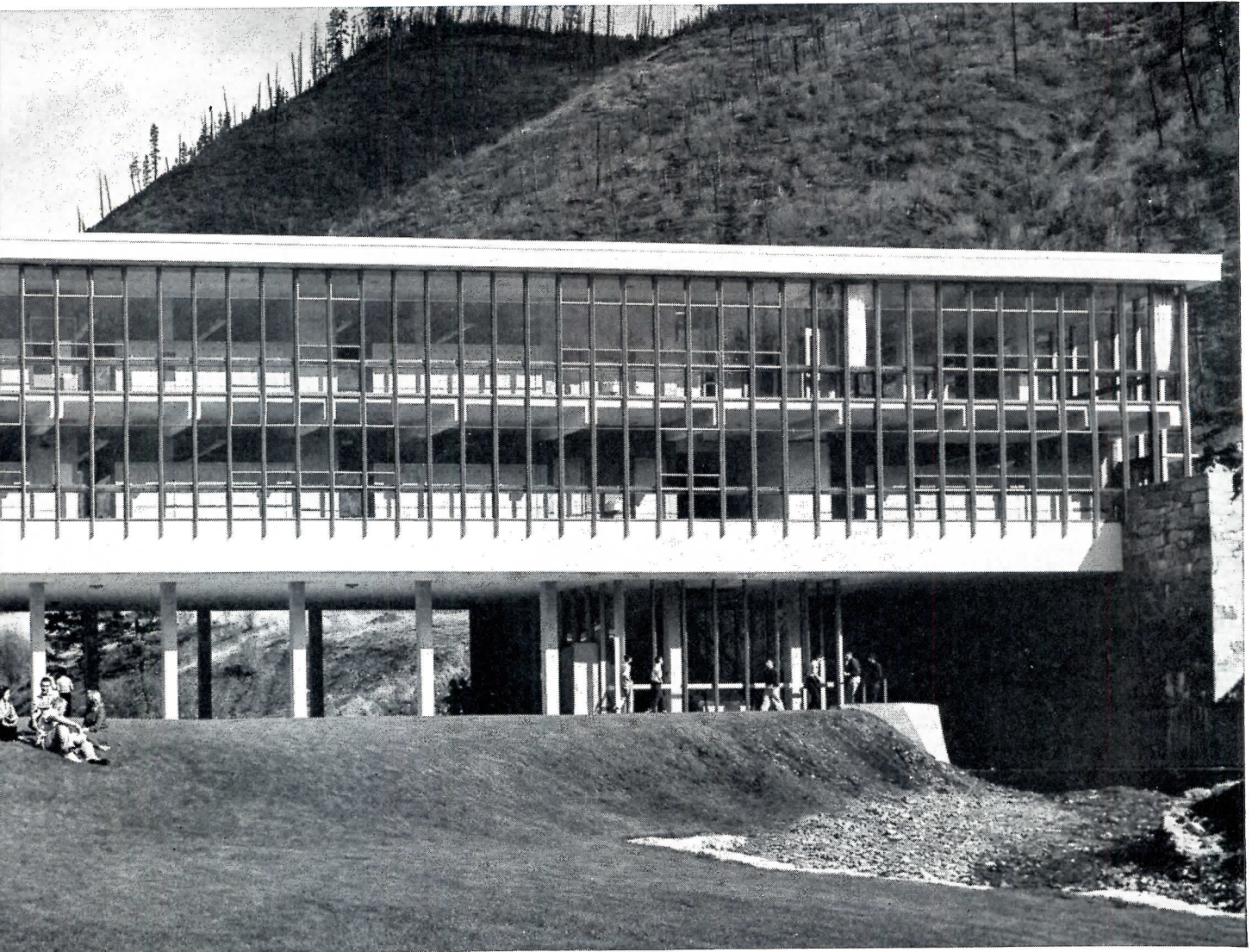

KELLOGG HIGH SCHOOL, Kellogg, Idaho. Architects: Culler, Gale, Martell & Norrie, Spokane, Wash.; Perkins & Will, Chicago, Ill. Contractor: Johnson-Busboom-Rauh, Spokane, Wash. Photograph by Hedrick-Blessing.

LUPTON METAL WINDOWS

bring maximum light and air to Kellogg High School

With this ultra-modern consolidation school the community of Kellogg, Idaho, voices its pride and civic-mindedness. Thanks to these walls of LUPTON engineered metal windows, bountiful ventilation and light are made available throughout the building.

Working together with school authorities to typify community solidarity, the architects conceived this building design which embodies a continuous wall of windows. Bright yellow-painted steel mullions and red muntins provide a joyful frame to the impressive view through the 513 LUPTON Steel Architectural Projected Windows.

Certain extreme climatic conditions (wind and dust storms; smoke from nearby Bunker Hill smelter; a wide variance in atmospheric temperatures) made the selection of materials unusually important. Ruggedness and simplicity characterize the construction, and are epitomized in the modern, precisely-engineered walls of tight-fitting LUPTON Windows.

The Kellogg High School project reflects a growing

movement towards the use of entire walls comprised of LUPTON Windows in schools, hospitals, and other modern buildings. LUPTON's 75 years' experience in metal-window and curtain-wall manufacture merits your complete investigation—look first in the *Architectural File* (Sweet's) for the Michael Flynn Catalog, and then consult the Yellow Pages under "Windows—Metal." Or write for specific additional information on LUPTON Metal Windows and Aluminum Curtain-Wall Systems.

LUPTON

METAL WINDOWS AND CURTAIN WALLS

MICHAEL FLYNN MANUFACTURING COMPANY
Main Office and Plant: 700 E. Godfrey Ave., Phila. 24, Pa.

CONGRATULATIONS, AIA! Michael Flynn Manufacturing Company joins the other members of the Producers' Council in extending best wishes on the occasion of your 100th anniversary celebration May 14-17.

**As people judge a car
by the "feel" of its doors...
So is a building often judged
by its sliding glass doors**

To an ever-increasing degree in home and commercial building, *the quality of the sliding glass door symbolizes the quality of the entire structure.* For this reason, more and more architects and builders are selecting Miller sliding glass doors. Visually, they make beautiful focal points. Structurally, there's durability and quality in every detail. Miller's engineered application of double-sealed, Schlegel woven wool pile weatherstripping (silicone-treated), together with Alumilite finish, permits the use of these doors in any climate. For single and/or dual glazing.

**GUILFORD DOWNS SELECTS
MILLER SLIDING GLASS DOORS**

"In planning our 700-home Guilford Downs development (on Columbia Pike, Route 29, Howard County, Maryland), we demanded nationally known quality materials in accordance with our high standards of construction," says Herbert A. Thaler, Pres. of Herbert Construction Co. "After exhaustive comparisons, we selected Miller doors because we found them superior in quality, ease of installation and over-all construction."
Thomas G. Jewell,
A.I.A., Architect.



Miller

There's sales sense in Miller sliding glass doors

Write for literature and Dealer's name
for the 3 complete lines in aluminum and steel.

Frank B. Miller Mfg. Co., Inc.
3216 Valhalla Dr., Burbank, Calif.

MEMBER OF SLIDING GLASS DOOR & WINDOW INSTITUTE

**INFRA-RED HEATING FOR THE
"FACTORY OF THE FUTURE"**

As high-bay buildings have grown in size and complexity of heating requirements, industry's need for an economical method of heating them has grown accordingly. Most promising of the techniques tried heretofore has been radiant heating — either by panel heating from floor or walls, or by infra-red heating from above. Although the latter system eliminates the expensive tubing needed for panel heating, infra-red generators themselves have been relatively inefficient, principally because their low operating temperatures did not produce infra-red of sufficient intensity. In addition, since typical units have utilized a standard gas burner to heat the infra-red emitter, an intermediate step in the heat-transfer process has further reduced their efficiency. Now, however, a radically new approach to generator design promises a solution to the problem.

Based on a technique developed by German scientist Guenther Schwank, and made in this country by Perfection Industries, a division of the Hupp Corporation of Cleveland, Ohio, the new units differ markedly from previous gas infra-red generators in that the structure which supports combustion is also the infra-red emitter. Higher operating temperatures (1650 degrees F) are achieved in the Schwank generator by combustion of gas on the surface of a perforated ceramic mat through which an air-gas mixture feeds. The gas is metered through an orifice, and passes through an air aspirating chamber and mixing tube to a distributing chamber under the ceramic unit. Because the gas is converted to infra-red energy in the wave lengths readily absorbed by most common materials, generators employing the Schwank technique are considered the most efficient and economical known today. In U. S.-designed generators, multiples of an eight-ceramic combination called a "rayhead" are grouped in an aluminum reflector which helps direct infra-red toward the surfaces to be heated. Although direct comparison with conventional space heaters is difficult, it is estimated that the gas-fired infra-red heating system can reduce heating costs by from 20 to 50 per cent. Under normal conditions, the units have unlimited life expectancy and maintenance requirements are almost nil.

(More Roundup on page 246)

two new plumbingware advances

a dynamic new design concept

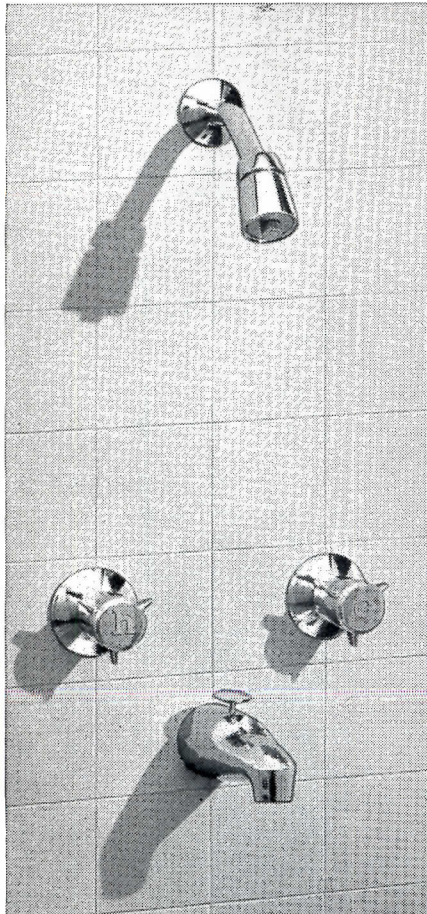

T-8116. Combination bath and shower fitting with automatic diverter valve in spout. 8" centers, self-cleaning shower head, shower arm with ball joint and flange.

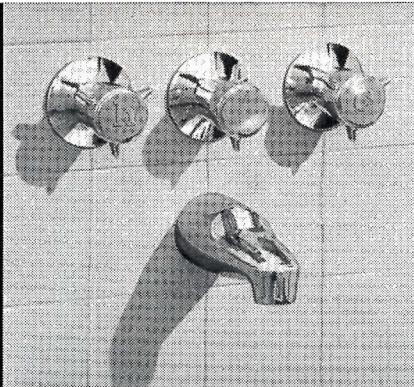

T-8106. Combination bath and shower fitting with manual diverter, 8" centers, self-cleaning shower head; shower arm, ball joint, flange.

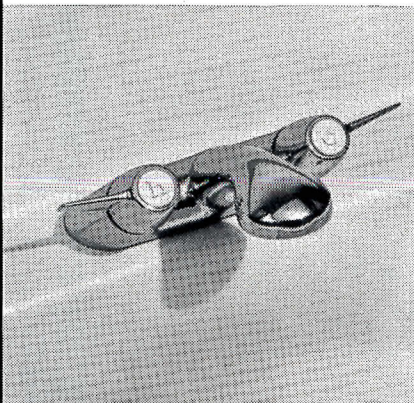

T-8722. Combination 4" centerset lavatory fitting with spray spout and strainer waste.

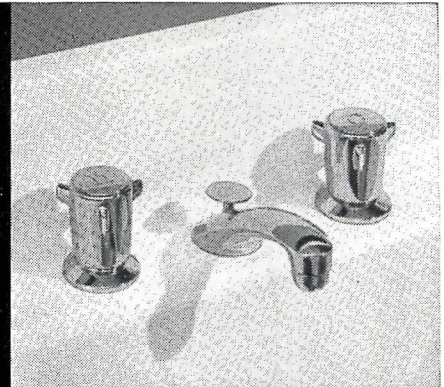

T-8710-S-8. Combination lavatory fitting, 8" centers, with aerator, pop-up drain, 1 1/4" tailpiece. Also available for 10" and 12" centers.

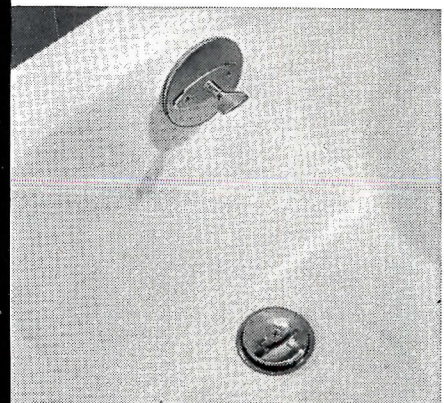

T-8401. Trip lever drain with 1 1/2" tailpiece. (overflow plate and drain plate illustrated).

A colorful new line of Beautyware Brass fittings for both residential and commercial use!

Briggs incorporates the "sculptured look" into its new Beautyware line of brass fittings in truly exciting fashion! This advanced styling by Harley Earl, Inc., is the perfect compliment to Briggs residential and commercial lines. In addition, new

Beautyware brass fittings incorporate unique, interchangeable colored inserts to match each Briggs color as well as chrome and white. Write now to Briggs for a colorful brochure with complete details and specifications.

BRIGGS MANUFACTURING COMPANY • WARREN, MICHIGAN

B E A U T Y W A R E

PORCELAINIZED ALUMINIZED STEELS: A NEW DESIGN TOOL

While porcelain enamel has been commercially applied to ferrous metals or copper and its alloys for over 100 years, the use of porcelain enamel on aluminum and light metal alloys has been developing only within the last decade. It was early found that porcelain enameled aluminum may be cut, sawed, sheared, drilled or punched without visible damage or raw metal edges, and that the extremely thin coating applied not only reduces the cost but improves such properties as impact, thermal shock and torsion resistance. In addition, an inherent characteristic of the group of low melting glasses suitable for coating aluminum alloys is that, when damaged, the enamel leaves the surface in powder form rather than in splinters as is the case with conventional steel enamel.

However, a drawback of enameled aluminum for some applications has been the lower tensile strength of the aluminum itself, although it has been claimed that the enamel layer increases the metal's tensile strength by about 50 per cent. In order to combine the greater rigidity of steel with the many desirable properties of the aluminum enamels, Dr. Paul A. Huppert, director of the Ceramic Coatings Department of Gulton Industries, Inc., Metuchen, New Jersey, undertook an investigation of the practicability of porcelainizing aluminized steel by a new process based on the mill addition of specially prepared lithium compounds to commercial frits.

The first practical development to emerge from this study was an artificial ceramic coated chalkboard with a predicted finish life of 72 years. Production experience on this item led to the development of three novel materials of particular interest to the building industry. These are the plain, corrugated and

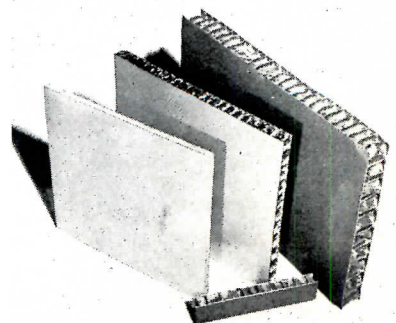

(Continued on page 250)

DUPLEX RECEPTACLE



Cat. No. 9595
10amps, 250volts
15amps, 125volts

"TOPPER" A. C. SWITCH



Cat. No. 1221
20amps
20-277volts



CHENANGO VALLEY CENTRAL JUNIOR AND SENIOR HIGH SCHOOL CHENANGO BRIDGE, NEW YORK

Architect:
A. T. Lacey & Sons
Consulting Engineer:
St. John, Platt and Carlson
Electrical Contractor:
Blanding's Inc.
each of the above firms is located in Binghamton, N.Y.

It pays to have good Connections

GROUNDING TYPE DUPLEX RECEPTACLE

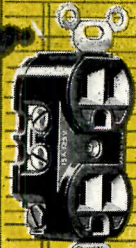

Cat. No. 5262
15amps, 125volts

4-WIRE STRAIGHT BLADE RECEPTACLE



Cat. No. 1250
20amps, 250volts

SCHOOL ASSIGNMENT:

... to build a fine new school at reasonable cost yet using dependable, safe, easy-to-install, good looking and long lasting materials and products.

Quite an assignment—until you stop to think that all of these qualifications are invariably associated with specification grade items, and that specification grade materials and products are *always* lowest in cost to service.

Hubbell specification grade wiring devices, for example, should be your economical choice for all new building projects because they can be depended upon to meet the rigid requirements of today—tomorrow.

HARVEY HUBBELL, INC.

BRIDGEPORT 2, CONNECTICUT

QUALITY WIRING DEVICES

FACTORY WAREHOUSE LOCATIONS

- Scarborough, Ontario, Can. 1160 Birchmount Road
- Bridgeport 2, Connecticut State and Bostwick Streets
- Chicago 7, Illinois 37 South Sangamon Street
- Los Angeles 12, California 103 North Santa Fe Avenue
- San Francisco, California 1675 Hudson Avenue
- Dallas 7, Texas 1111 Dragon Street

Bank of the Southwest, Houston, Texas, showing upper lobby ceiling installation of Acousti-Celotex Celotone® incombustible fissured Mineral Fiber Tile. Architect: Kenneth Franzheim. Acousti-Celotex Contractor: Strauss-Frank Company.

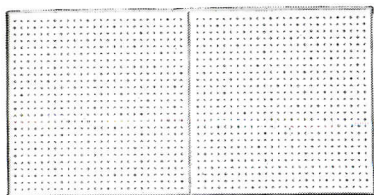
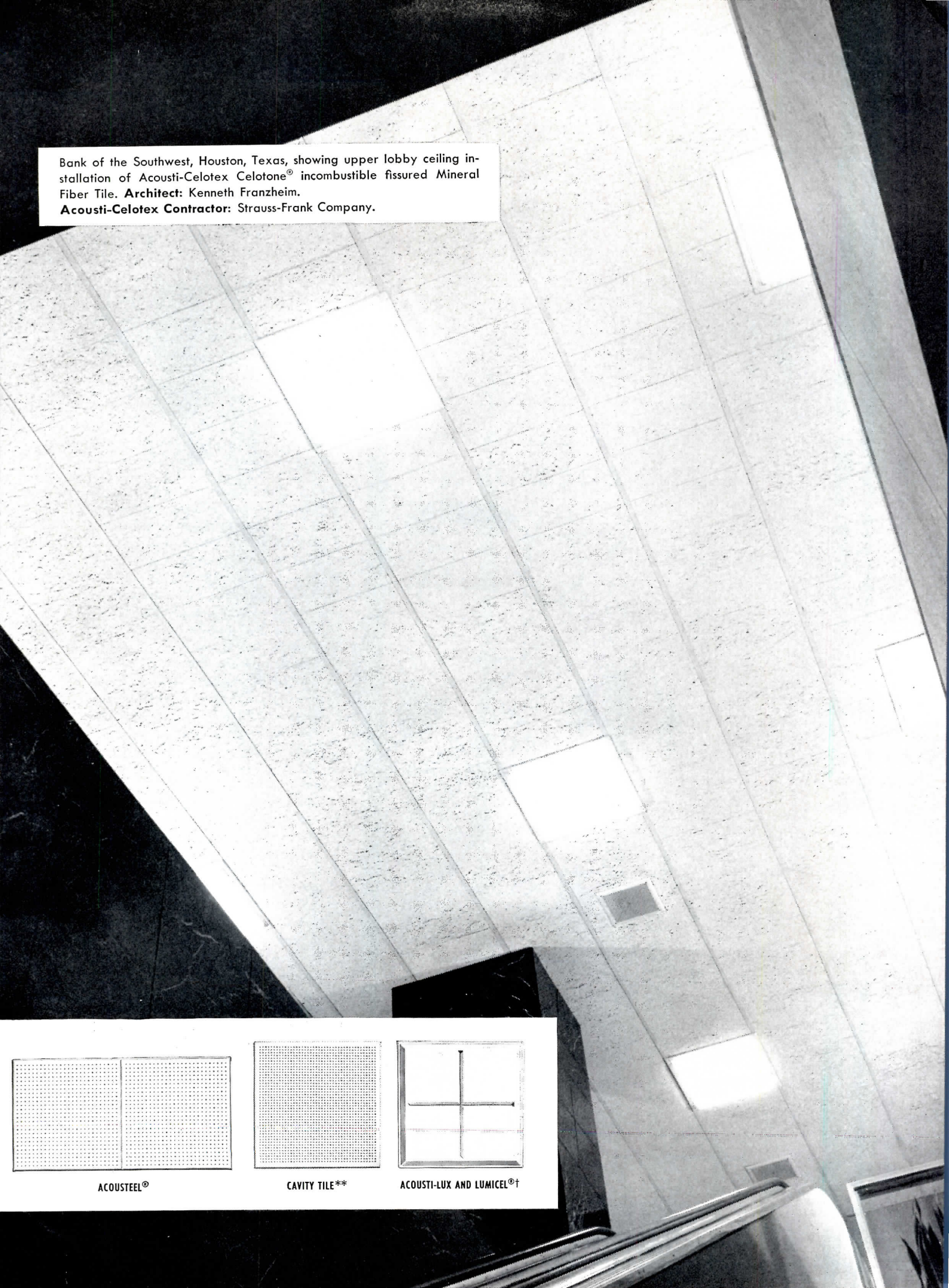

ACOUSTEEL®

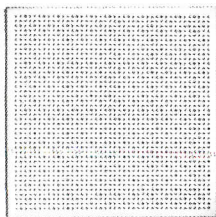

CAVITY TILE**

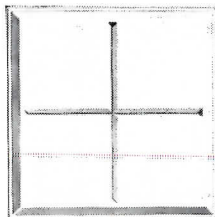

ACOUSTI-LUX AND LUMICEL®†

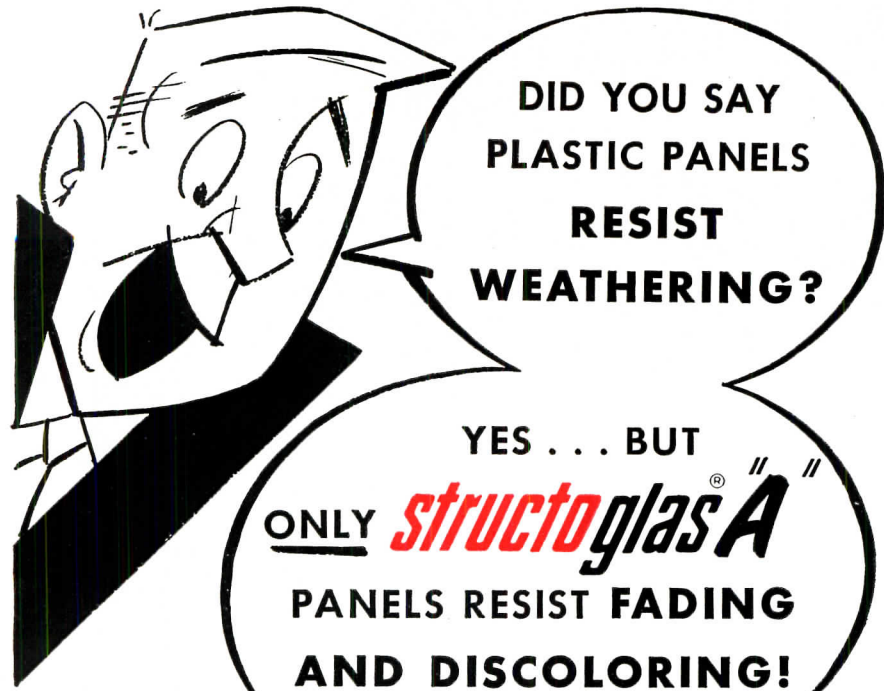

DID YOU SAY
PLASTIC PANELS
RESIST
WEATHERING?

YES . . . BUT
ONLY **structoglas[®] "A"**
PANELS RESIST FADING
AND DISCOLORING!

... AND
2-YEAR EXPOSURE
TESTS PROVE IT!

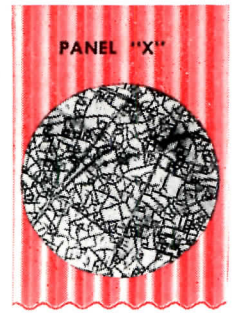

STRUCTOGLAS "A" . . . molded from a new extra-hard resin* . . . is the first reinforced plastic panel to offer proven resistance to weathering and discoloration. As shown in the above photomicrographs, STRUCTOGLAS "A" was virtually unchanged in surface gloss or color after 2-year outdoor exposure. In the same tests, PANEL "X" (like other competitive panels made from good light-stabilized resins) lost all gloss and "alligatored" so badly the glass fibers were exposed, which greatly reduced its ability to transmit light.

These results prove only STRUCTOGLAS "A" assures prolonged weather resistance, lasting beauty and consistent light transmission . . . at competitive prices!

*A product of Rohm & Haas Co.

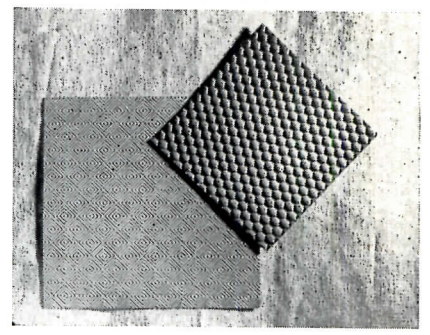
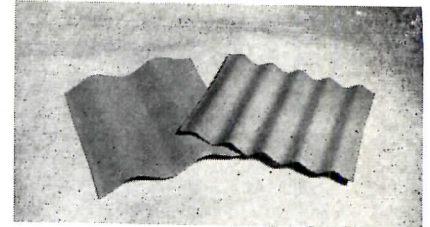
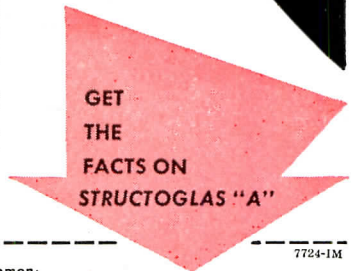
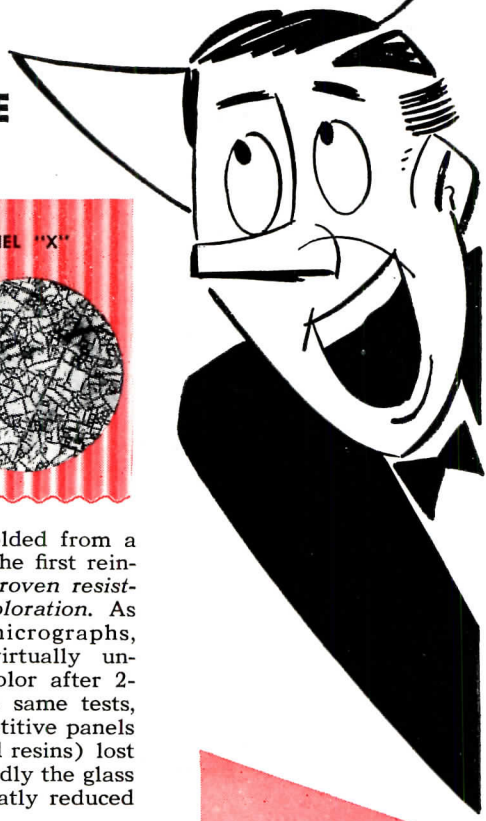

rigidized porcelain enameled sheets shown above and on the preceding page. All three are based on aluminized steel and require the type of porcelain enamel that may be applied to light metal alloys — and all three incorporate the inherent advantages of the aluminum enamels.

It was found initially that, while 16 and 18 gage metals must be used for architectural application of porcelain enamel on steel or enameling iron, the base metal for aluminized steel need not be heavier than 0.0265 in., with a resultant weight saving of from one to one and a half pounds per square foot. Although all types of surface finishes are available, the investigations emphasized the medium glossy and semi-matte finishes preferred by the architectural enamel trade. The weather resistance of the finishes was determined by the standard testing method of the Porcelain Enamel Institute. It was found that, while class B is generally acceptable for steel enamels, aluminum enamels can be developed which, depending on color, are in class A or even class AA. As far as the adherence of the coating to the base metal is concerned, all enamels applied to aluminized steel have successfully passed the general requirement of the accelerated spalling test which consists of withstanding a 5 per cent aqueous solution of ammonium chloride for a minimum of 96 hours at room temperature. The porcelain enameled aluminized steel may be cut or drilled without danger of edge corrosion, and may also be postformed by various methods, provided no bends of too sharp radii are applied.

(More Roundup on page 254)

structoglas[®]
division of

international molded plastics, inc.
4390 West 35th Street • Cleveland 9, Ohio

Gentlemen:
Please send me free, a complete Structoglas Data File.

NAME _____ TITLE _____
COMPANY _____
STREET _____
CITY _____ ZONE _____ STATE _____

7724-1M

...Architects, Engineers and Contractors prefer

ALLENCO

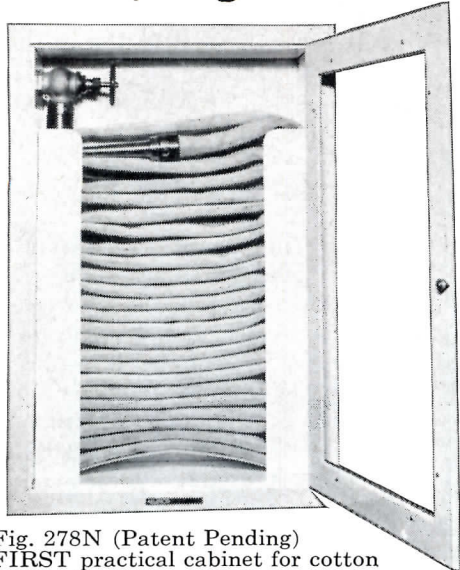

Fig. 278N (Patent Pending)
FIRST practical cabinet for cotton rubber-lined hose. Wall recessed, saves space; fully enclosed, resists attack by fumes, dust, etc. Cradles hose in soft folds, ready for instant use. Several models, sizes and hose-lengths.

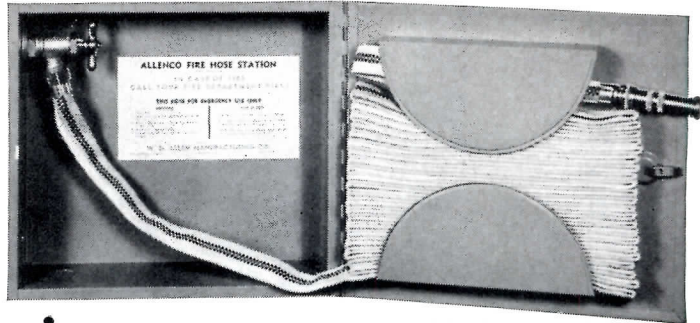

Fig. 7153 (listed and approved by Associated Factory Mutual Insurance Companies)—UNIQUE form of major fire hose cabinet, ideal for smaller structures. Steel cabinet no bigger than phonograph record album holds 30-40-50-75 feet of fire type hose. Recessed or wall hung.

Of the many distinct ALLENCO products and models, these are most widely specified and installed in the industrial field



Fig. 145 (UL and FM listed and approved)—Ryerson swinging hose reel with wall brackets or pipe clamps. Holds 50-100-150 feet of cotton rubber-lined hose out of way, yet swings and feeds instantly. To suit type, size and length of hose required.



Fig. 7170 (Patent Pending)—"Hozegard" reel combines protection with fastest way to get full pressure at nozzle in use. Best for linen or light-weight CRL hose, 50-75-100 feet in length, up to 1½" size. Adds years to hose life, fights fire faster.

ALLENCO

W. D. ALLEN MANUFACTURING CO.

Rm. 700 Allenco Bldg. 566 W. Lake St. Chicago 6

**TWIN HYPERBOLIC PARABOLOIDS
ROOF KANSAS RESIDENCE**

Shortly after the successful prototype of a straight line structural lattice in hyperbolic paraboloidal shape was built at the University of Kansas, (ARCHITECTURAL RECORD, August, 1956), Dr. Donald Dean, assistant dean of the University's School of Engineering and Architecture, began design studies and calculations for a similar structure to roof his own residence.

As completed, the roof consists of two hyperbolic paraboloids, each of which is a section of a regular hyperbolic paraboloidal saddle oriented so that the diagonals are in line with the principal parabols of the surface. The units are each 40 ft square in plan, and have a common center beam which joins the two edge beams at the front of the house to form a tripod that acts as a stable core for the structure. The edge beams are box sections with their top and bottom plates rabbeted to receive side members made up of 2 by 12's. Membrane for the shell is composed of two layers of fir 1 by 8's, laid in the direction of the generators at right angles with the edge beam in the horizontal projection, and fastened to the edge beams by a 2 by 4 nailer glued and nailed to the beams. All connections in the shell were made with glue, supplemented by nails at the edge beams and perimeter membrane connections and by screws at each intersection of the membrane boards. To finish the shells, one inch of rigid insulation was laid diagonally across the curve and faced with a three-ply built up roof. All holes for vent stacks and minor flues were cut without reinforcing the membrane, except in the case of the 18 in. fireplace flue which was cut through a 3/4 in. plywood plate glued and nailed to the membrane when the insulation was placed. At their downpoints, the shells are carried by three low piers poured on I-shaped footings. Proportioned primarily for overturning moment, the footings also provide a high safety factor against sliding, making foundation ties unnecessary.

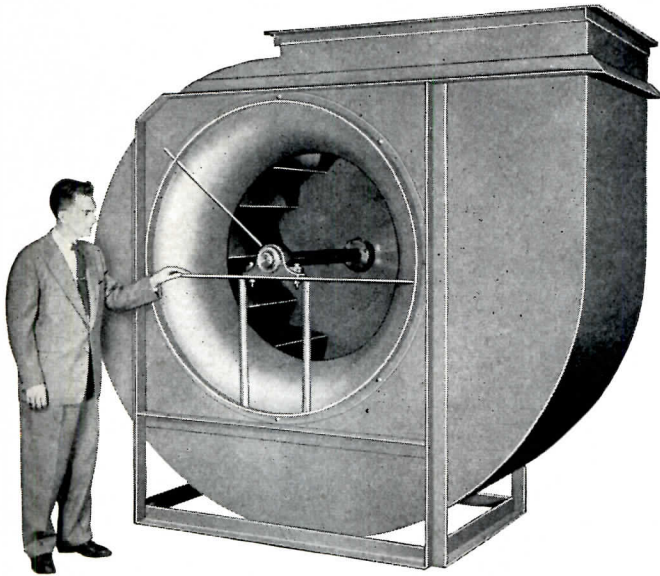
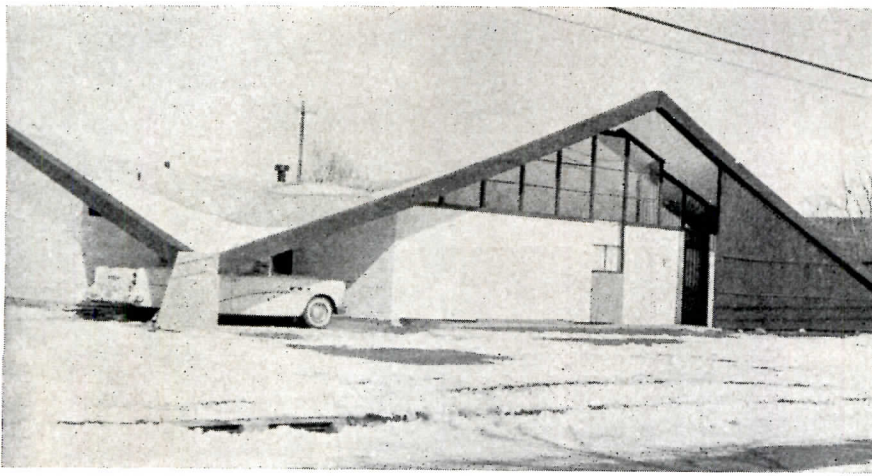

**BIG BLOWERS ARE BIG BUSINESS
WITH PEERLESS**

QUIET! • TROUBLE-FREE! • DEPENDABLE! • HEAVY DUTY! • GUARANTEED!

Versatility in size, application, and engineering has always been a Peerless strong point. Peerless builds its own motors and matches them to the specified blower requirements. Peerless blower frames and housings are usually heavier than any competitive products. Result—a quiet, vibration-free unit.

These are not "off-the-shelf" units, but built to customer rotation and discharge specifications. Each one receives 100% inspection before it leaves the Peerless factory. Each unit is built to NAFM standards. Motors are built to NEMA standards. Each unit is ready for operation when received at the installation site.

Write Today for Bulletins SDA-220, SDA-200 and SDA-160

Charter Member of the Air Moving and Conditioning Association, Inc.

FAN AND BLOWER DIVISION



THE Peerless Electric® COMPANY

1448 W. MARKET ST. • WARREN, OHIO

FANS • BLOWERS • MOTORS • ELECTRONIC EQUIPMENT

See Our Catalog in Sweets

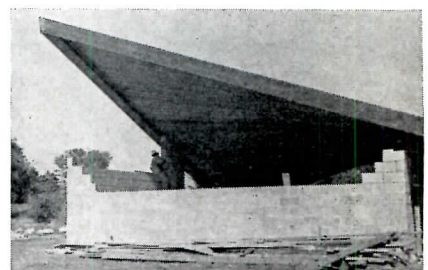

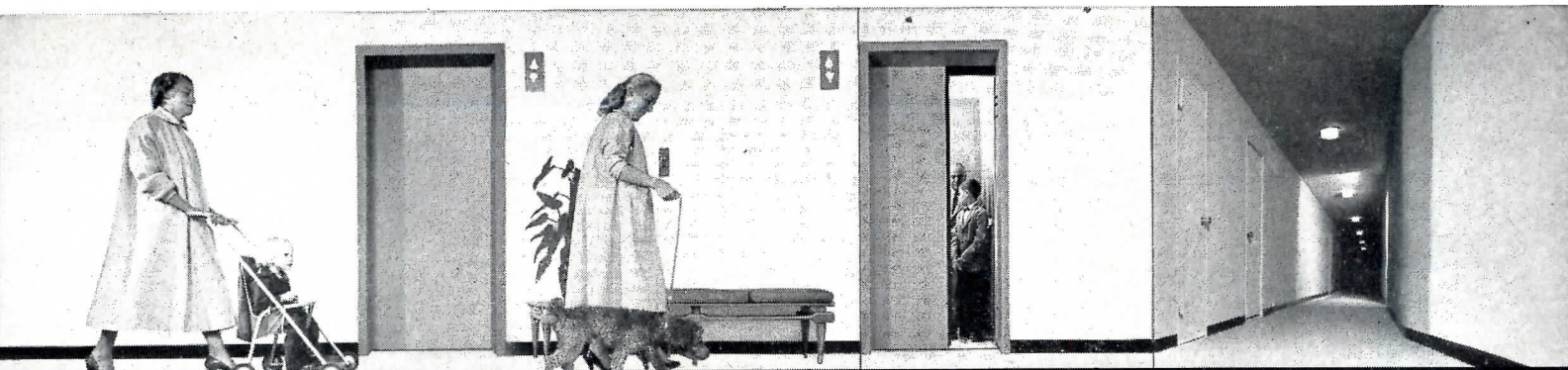

Elevator doors open quickly to unload passengers

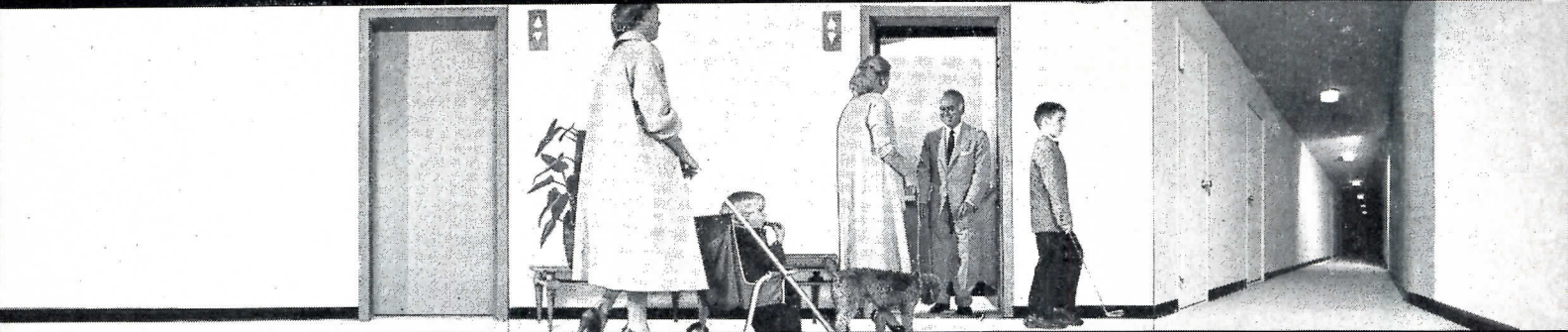

Doors stay open until last passenger leaves



No door threats here—doors remain motionless until car is loaded

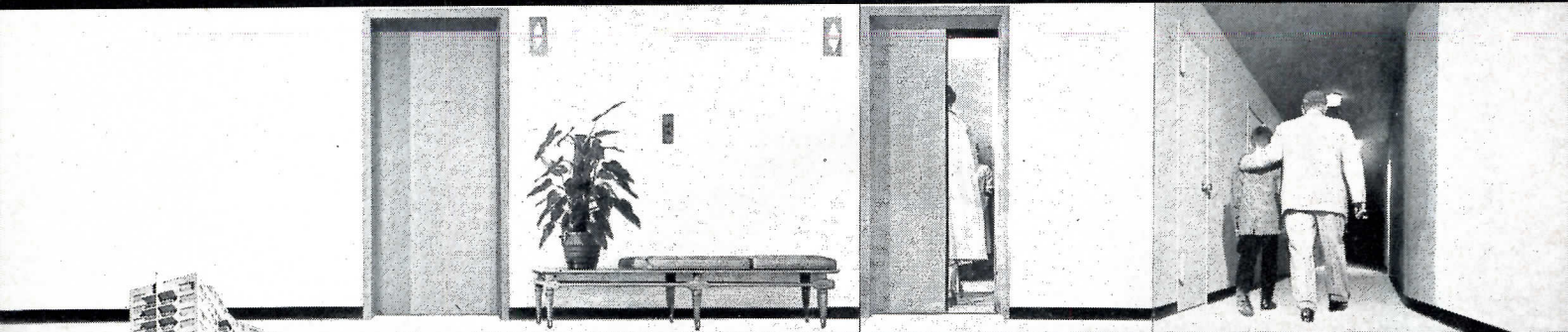

Doors close promptly when all are safely aboard

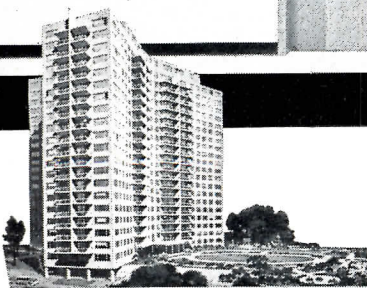

Beautiful Harrison Park Apartments in East Orange, New Jersey, feature Westinghouse Operatorless Elevators with tenant-pleasing Traffic Sentinel doors. Photos above were taken on location.

Architect: Romolo Bottelli, Jr., A.I.A.
 Harrison Park, Inc.—A. H. Padula, Pres.
 Harrison Park Construction Co., Inc.
 —W. T. Gotelli, Pres.
 Frank H. Taylor & Son, Inc.
 —Managing Agents

WESTINGHOUSE ELEVATORS WITH TRAFFIC SENTINEL® DOORS DON'T WASTE TENANTS' TIME

Operatorless elevators equipped with Traffic Sentinel doors are a boon to buildings that require fast and courteous traffic handling. This means *any* sizable building, new or existing, commercial or residential.

Traffic Sentinel, a Westinghouse original development, is an electronic device which minimizes the length of time doors remain open at floors to achieve *automatically* the most efficient loading and unloading of cars. The lighter the traffic, the shorter the door-open time. When traffic is heavier, door-open intervals adjust *auto-*

matically to the specific load demand. Results?—elimination of "poor elevator service" complaints—and a superior performing elevator system to which tenants and building management alike can point with pride. Ask the Westinghouse Elevator Division representative nearest you to show you operatorless elevators with Traffic Sentinel in operation.

YOU CAN BE SURE...IF IT'S
Westinghouse



Teak, background for elegance...a spirited graciousness

■ Dick Boyer, one of today's truly fine photographers, draws heavily upon the supreme elegance of a panel of Teak veneer by Stem for this self-portrait. "When we seek to impart a certain deft touch of sheer quality to a photograph, a richly done background of fine, rare wood has a way of accenting the elegance of a setting." In a living or working area, as in photography, rare wood from the forests of the world makes its noble presence felt by everyone who enters. Teak veneer, as only Stem can produce it, is that kind of material. Through the catalytic artistry of the architect, superb wood paneling and graceful living strike up a happy match. Wherever it is used, this incomparable wood casts a shadow of its

glorious past, and welds substance and spirit into exciting unity. Where there is rare wood, there is a spirited graciousness — a strength and beauty that dwell in every ripple of its meticulously finished grain. And yet, beautiful wood is the essence of peace; it brings serenity to a room in a way that is all its own. Now, Stem brings you, through the magic of modern factory methods, all the nobility, splendor and lifetime permanence of the finest veneer that tradition knows. And you can afford to be generous with this wood, for the cost is low.

*Chester B. Stem, Incorporated
185 Grant Line Road New Albany, Indiana
New York — Chicago — Dallas — Los Angeles*

RARE WOODS
FROM STEM





TERRAZZO...

**BEAUTIFUL FLOORING
WHEN IT'S SEALED WITH
HUNTINGTON TERRAZZO SEAL**

The beauty of terrazzo endures—if Huntington Terrazzo Seal is used to protect the floor. Even after years of hard wear, a Huntington protected terrazzo floor will maintain its original color and beauty! Huntington Terrazzo Seal provides a non-slippery, waterproof surface. It simplifies maintenance, preserves the surface against excessive cracks and chipping, and prevents damage from improper cleaning methods.

Easy to apply, Huntington Terrazzo Seal dries in twenty minutes. Floors can be used after 4 hours. Dirt, or even grease and chemicals, won't harm or stain terrazzo or marble that is protected with Huntington Terrazzo Seal.

If the floors you specify are terrazzo—keep them beautiful by specifying Huntington Terrazzo Seal.

Huntington Terrazzo Seal:

- Exceedingly durable.
- Protects all terrazzo and marble floors.
- Protects floors from stains.
- Dries in twenty minutes, ready for use in about 4 hours.
- Provides a safe, non-slippery floor surface.
- Prevents damage from improper cleaning methods.

HUNTINGTON LABORATORIES

Philadelphia, Pennsylvania

Huntington, Indiana

Toronto, Ontario

WRITE
TODAY FOR
FREE
INFORMATION
AND
PRICES

HUNTINGTON LABORATORIES, INC. Huntington, Indiana

- Please send me free information on Huntington Terrazzo Seal.
 Please have your representative call.

NAME _____ TITLE _____
FIRM _____
ADDRESS _____
CITY _____ STATE _____

PRODUCT REPORTS

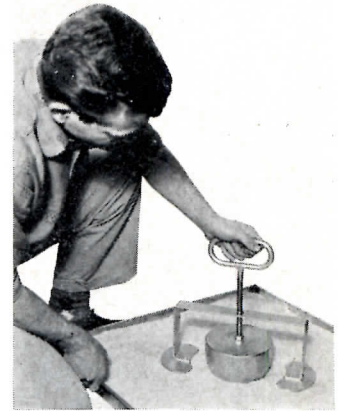

Ball Penetration Apparatus

A new ball penetration apparatus measures the consistency of fresh concrete by a method which is said to be comparable to the conventional slump test in accuracy, but faster and simpler. Made in accordance with ASTM Specification C-360, "Ball Penetration in Fresh Portland Cement," the device consists of a cylinder with a ball-shaped bottom and a handle weighing 30 lbs. A lightweight metal frame guides the handle and serves as a reference for measuring the depth of penetration of the ball. Concrete may be tested either in the forms or in a suitable container. Twice the ball reading is approximately equal to the slump of concrete. *Soiltest, Inc., 4711 W. North Ave., Chicago 39, Ill.*

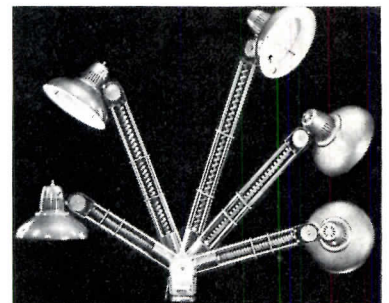

Glide-Action Lighting Unit

A new lighting unit which readily assumes almost any working position by gliding back and forth on its stem and rotating at the head is expected to find wide application by draftsmen, architects, engineers, artists, jewelers and others who require high level lighting over working areas. In addition to its flexibility of positioning, the *Trombolite* is said to achieve improved illumination by combining fluorescent and incandescent lighting in a single fixture. *Amplex Corp., 111 Water St., Brooklyn 1, N. Y.*

(More Products on page 296)

HOLLOW TREE SCHOOL

DARIEN, CONNECTICUT

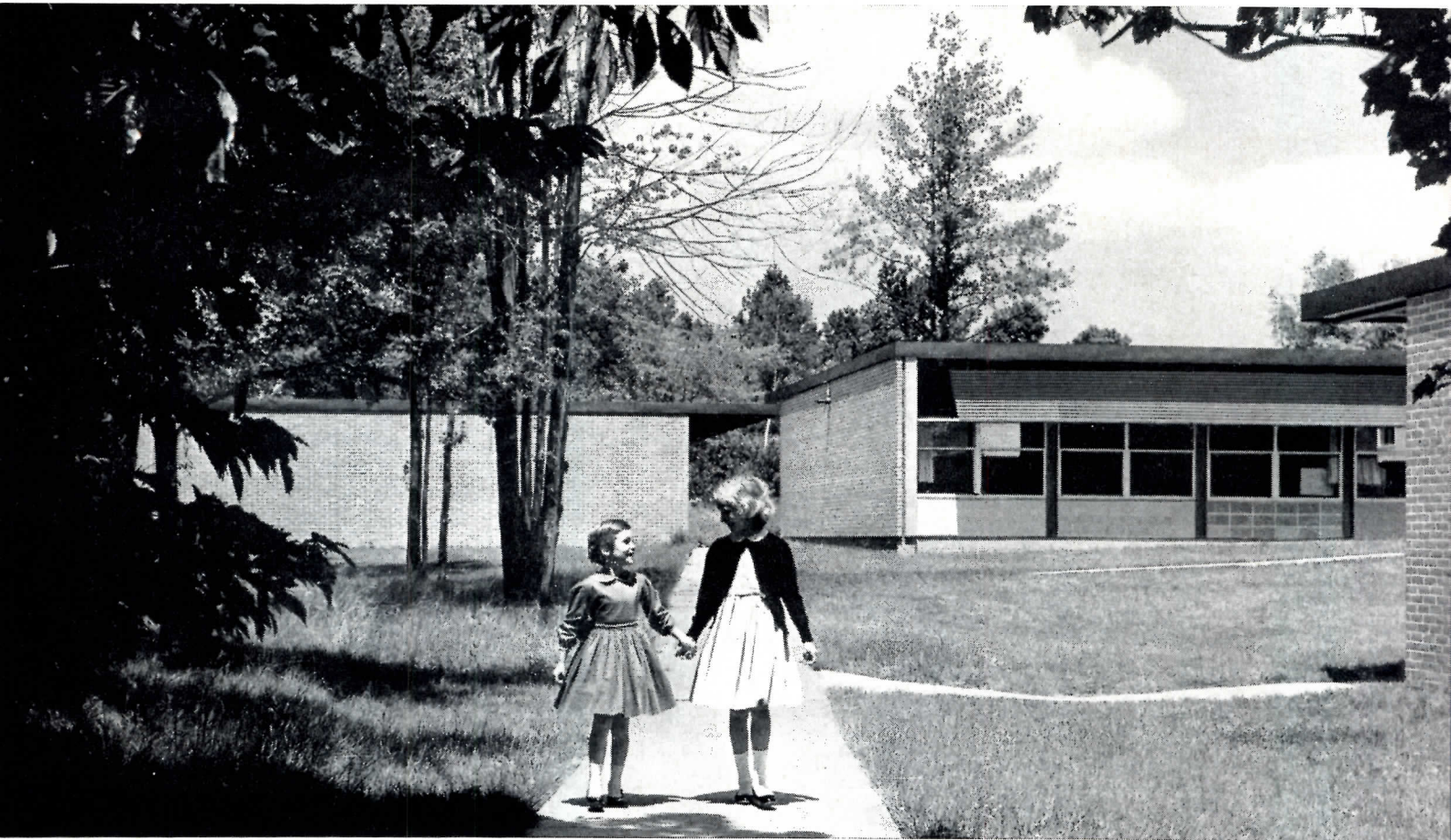
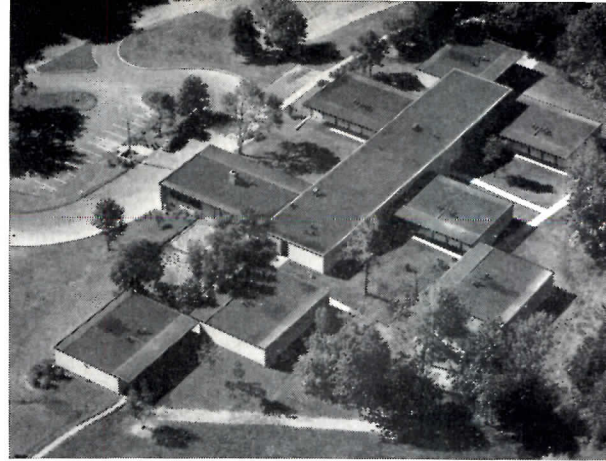

AWARD WINNER - 1955 Top Award "The School Executive"

"A part of the requirement for this school was 'deliberately to avoid any expenditures not related immediately to the educational program.' In our opinion, the steel framing which was used materially contributed to the economy achieved as well as to visual success of the buildings.

"An aspect of unity on uneven terrain was accomplished through simple, repetitive steel framing of constant spacing throughout the design. Variation from building to building of color on the exposed steel joists lends gaiety and identification to the 'home' of each age group. The children and teachers make continual use of the steel joists for suspending art work or decorations of the season in classrooms. As designers, we have a high regard for the versatility of structural steel."

General Contractor:
Sam Grasso Co., Inc.

Structural Engineers:
Severud, Elstad, Krueger

Steel Fabricator:
Port Chester Iron Works

Structural Shapes:
Bethlehem Steel Company

J. Stanley Sharp

Ketchum, Giná & Sharp, Architects

A SIGNIFICANT NEW STRUCTURE . . . FRAMED WITH STEEL

This is the second in a series by Bethlehem Steel Company, Bethlehem, Pa.

P E R S P E C T I V E S

(Continued from page 9)

no longer a valid solution to the problem. The location of a private corridor west of the Rotunda, which the public will not be required to cross to reach the historic features commonly visited by them, is a necessity.

DINING FACILITIES

Your Consultants approve the proposed new and efficiently designed spaces designated for use for Senate Dining Rooms, House of Representatives Dining Rooms, and service rooms

for Capitol employees; we concur that these rooms should be located in the terrace on the west side of the Capitol where views may be had along the Mall toward the Washington Monument (Scheme C). When the central portion of the terrace is rebuilt to accommodate these facilities, the space underneath them should, we believe, be arranged at the same time so that it can be developed as prime space in the future. In this connection we believe that the rebuilding of the west terrace in its entirety would be a most productive source of interior space in the Capitol at a relatively low cost; about 75,000

square feet per floor could be provided. Either one or two floors could be added below the present levels. The lowest would be without windows but could, of course, be air conditioned and could accommodate, with room to spare, all of the mechanical services and air conditioning equipment now on the upper terrace level. The terrace could be rebuilt one section at a time with little interference with the functioning of the Capitol itself.

Your Consultants believe that the scheme of obtaining added space in the Capitol by rebuilding the terrace might be considered as the next step to be taken in the improvement program. The windows in the terrace walls may be designed to be thoroughly appropriate in appearance; the rooms without windows could be artificially lighted to provide eminently suitable offices.

STONE WORK — CENTRAL BUILDING

Your Consultants have given much thought to the rebuilding or refacing of the central portion of the Capitol with marble. The sandstone, of which the east front was constructed, has been disintegrating for many years. Such disintegration is common in buildings made of soft stone. At no time during the last forty years have the Houses of Parliament, London, been without a scaffold on some part of the perimeter of that structure, where disintegrated stone was removed and replaced with new stone of the same size and shape. This is true of almost all old world buildings made of soft stone.

If the Capitol had not been painted, such a normal restoration would, without doubt, have been a standard procedure. Instead, because of the custom of painting periodically, cavities in plain surfaces (cavities in the faces of columns, for instance) have been filled with cement mixtures before repainting, while edges of dentils, coronas, etc., have been repainted in the condition to which disintegration has progressed.

Your Consultants believe that it would be undesirable to have the Central part match the wings inasmuch as the original central element was designed as an architectural entity to stand by itself. The esthetic function of the wings is to serve in a rather subordinate manner as a setting for the central element. The marble of the wings is not of a good color nor has it weathered attractively. The mortar joints are too wide and conspicuous and the effect is somewhat

(Continued on page 342)

KEEP IT CLEAN

Get crisper cleaner drawings
with **CASTELL**

In engineering, designing and drafting rooms all over America, skilled craftsmen are at work with the incomparable Castell—the only drawing pencil with all these qualities:

- Clean-Neat Tracings** — graphite-saturated CASTELL gives blacker, denser coverage that minimizes graphite stain, keeps your drawing crisp and clean.
- Easy Erasability** — CASTELL'S exclusive microlet milling produces graphite granules that strike an ideal balance between coverage and easy, ghost-free erasability.
- Unvarying Uniformity** — smooth, grit-free CASTELL gives identical degree of excellence in pencil after pencil, lead after lead.
- Correct Grading** — based on original standards established by world's foremost drawing lead manufacturer.
- Reproductive Supremacy** — the world's best natural graphite containing more than 99% carbon, gives a light-proof, impenetrable adhesion that produces the highest number of sharp blueprints.

Castell in 20 superb degrees — 8B to 10H — is the ideal working tool. Order from your Dealer today.

A.W. FABER-CASTELL
PENCIL CO., INC. NEWARK 3, N. J.



Again...



and Again...

ARCHITECTS WISELY CHOOSE

ASE STEEL FURNITURE

Today, more ASE Steel Furniture is specified in offices, schools, hospitals and institutions than ever before. Durable...flexible...beautiful...trend-setting ASE Steel Furniture has the qualities which find increasing favor with architect and client alike.

There's an ASE dealer near you.



Better Built for Better Business

ALL-STEEL EQUIPMENT INC.

Aurora, Illinois

(Continued from page 340)

harsh and drab. If the central element is to be refaced it should be of marble as beautiful and as warm as that of the Lincoln Memorial; and the workmanship should be as exquisite as that of the Lincoln Memorial or of the Mellon Gallery with the narrowest possible stone jointing, requiring that the stones be expertly fitted.

THE EAST FRONT

It was agreed between your Consultants and the Architect of the Capitol

that the question whether or not to move out the East Front would not be a matter for discussion as this had been decided already by an Act of the Congress. Your Consultants are therefore concentrating on the problem of how best to accomplish the will of the Congress within the limitations imposed by the Act in ways that will be least detrimental to the beauty and majesty of the East Front. They agree that these several requirements will be best fulfilled and very satisfactorily so by the design designated as Scheme C developed by your associate architects and based on a most carefully thought out study of the

needs of the Congress in the foreseeable future.

As to the matter of the extraordinary beauty of the East Front as it now stands, when Architect Walter added the Senate and House wings he brought them forward to the east far enough so that they do not compete architecturally with the original central portion; the wings are thus disconnected from the original Capitol building by the considerable length of their inner sides and so act as an enframing for it.

In his 1903 report on how to enlarge and complete the Capitol, Mr. Thomas Hastings stated that if the original central part of the East Front were to be brought forward as much as 36 feet, it would be so nearly in line with the wings that it would be effectively dwarfed by them. He insisted that if it were to be so brought forward it should be redesigned. In this redesign, the portico was planned to have ten columns instead of eight, the pediment was to be flattened and the front central steps widened some 20 feet.

Your Consultants are unalterably opposed to any redesign of the central portico and steps of the East Front as proposed by Mr. Hastings; they believe that the great beauty of proportion and historic importance of this central element should be preserved without any modification in the façade other than to move it forward as proposed.

In his study of this problem Mr. Hastings apparently did not realize that there is a way of retaining the magnificence of the central element of the East Front and keeping it from being dwarfed by the wings without redesigning it; and this is to move out the wings an equal distance with the central element.

It may be considered beyond the scope of this report to deal with the wings designed by Mr. Walter but we do not want to leave the Commission in ignorance of our considered belief that the present beauty of the Capitol can be kept only by moving out the whole East Front, wings and all, and not the central part alone. Accordingly we recommend that the moving out of the wings be considered part of the ultimate development of the Capitol in order that the present majesty and court-like effect of the Capitol may then be retained.

Lengthening the wings would require on the North and South sides the addition of three columns, but these could be taken from the inner row of the East portico and not be missed. Although the lengthening of the wings would be a relatively costly operation it would be less so proportionally than moving out

(Continued on page 344)

with emphasis on the

HORIZONTAL...

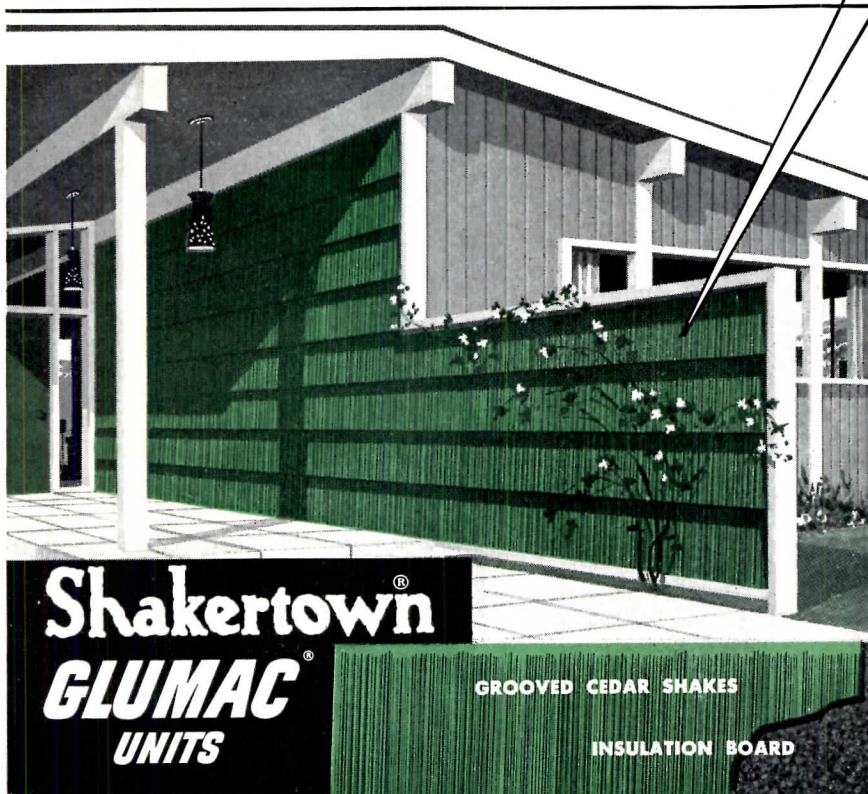

U.S. Pat. 2,232,786
Other U.S. and Foreign
Patents Pending

Generous butt lines create horizontal shadows to make a design "long and low." They lend a dimension of depth to enrich the texture of any exterior. When you specify Shakertown Glumac Units you are assured of superior quality in real wood, lifetime cedar.

Pre-stained in twelve exciting colors—including four new shades for 1957.

Write for your FREE "Shakertown Ideas - 1957"



Shakertown[®]
FIRST NAME IN CEDAR SHAKES

THE PERMA PRODUCTS COMPANY

20310 KINSMAN ROAD CLEVELAND 22, OHIO

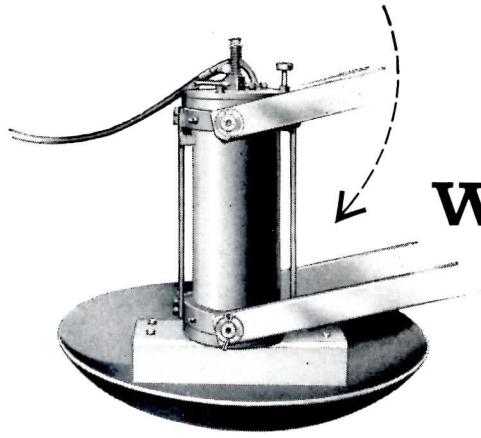

What is this?

**and what does it have to do
with this?**

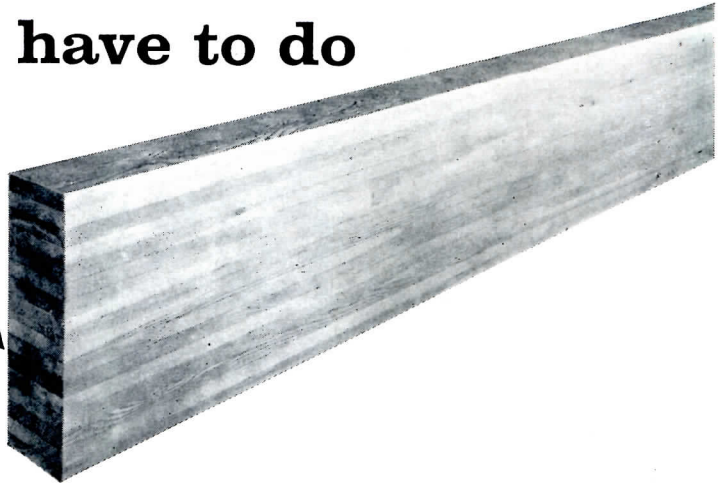

To answer the questions in order,

(1) The object that looks like a mushroom turned upside down is an *electronic moisture detector*. (2) It means that every laminated member by Timber Structures, Inc. is material of *uniform quality* that may be depended upon without question.

Every piece of laminating stock at Timber Structures, Inc. is electronically examined by this moisture detector. If a piece is improperly dried, the moisture detector marks it with a big red spot, and the piece is not used for laminating. Result: only properly seasoned material is used, and the glue bond between laminations is as permanent as the wood.

Such care is typical of the rigid quality control maintained at Timber Structures, Inc. over every step of manufacturing—grading materials . . . kiln drying . . . testing glues . . . surfacing lamina-

tions . . . glue application . . . clamping pressures . . . surfacing of laminated timbers . . . fabricating to full size pattern . . . protection during transit and erection.

Thus quality at Timber Structures, Inc. is an actual accomplishment made possible through continuing research and almost nagging quality control. Such safeguards, plus a record of 29 years experience, enables us to stand behind our product, knowing each timber is worthy of this continuing responsibility. No other kind of product is good enough!

TIMBER STRUCTURES, INC.

P. O. BOX 3782-A, PORTLAND 8, OREGON

Offices in Ramsey, N. J.; New York City; Boston; Philadelphia; West Hartford; Cleveland; Charlotte; Chicago; Centerline, Mich.; Kansas City; Kirkwood, Mo.; Minneapolis; Des Moines; Wichita; Memphis; Dallas; Houston; Birmingham; Seattle; Spokane; Denver.

Local Representatives throughout the United States and Canada.

TIMBER STRUCTURES, INC. OF CALIFORNIA
Richmond • Beverly Hills • Sacramento



P E R S P E C T I V E S

(Continued from page 342)

the central portion and it would materially increase the usable space within the Senate and House wings in the very places where space is most needed. It would, besides, provide space and desirable locations for the increased elevator installations and simplify access to the wings from the office building tunnels.

THE WEST FRONT

In the opinion of your Consultants the West Front of the Capitol is less success-

ful as an architectural composition than the East Front. Although adequate for the original building, it is not suited to the enlarged composition resulting from the addition of the wings and of the present dome. We recommend that the Bulfinch colonnade be extended across the entire central element to form a loggia, of noble proportions overlooking the Mall, as shown on the drawings. We believe that this conception of a broad loggia, together with the terraces that house the restaurants and other added facilities, would be the finest visual contribution that could be made to the Capitol by our generation.

The proposed façade would be related to the Mall stretching down to the eminence on which the Washington Monument stands. It has the qualities of Roman architecture of the Republican period that Thomas Jefferson felt "best fitted for adaption to the buildings of the new Republic of the West."

DOMES

It is the unanimous judgment of your Consultants that the cast iron dome of the Capitol is a distinguished and ingenious solution to a difficult problem by the bold use of cast iron, a material quite new at the time of building, in a way and at a scale never before attempted; they are of the opinion that it is a notable example of architectural and engineering pioneering.

Should the dome ever require reconstruction, your Consultants recommend that it be rebuilt in metal and painted, as it is now. For historical reasons, it is our judgment that it should not be changed from metal to masonry construction. A recent survey proves it to be in excellent condition structurally except for minor details that can easily be corrected.

THE "SHRINE" FEATURES

We concur in the suggestion that certain parts of the building of great interest to thousands of visitors daily, because of their historical connotations, be restored and maintained substantially in their original condition, for example, the Rotunda, the old Supreme Court Room, Statuary Hall and the central circulation of the basement and first floors.

THE EAST PLAZA

At present the East Plaza is given over, almost exclusively, to automobile traffic and to parking. Much of this automobile parking space is reserved by those who work in the Capitol, by visitors to the Capitol and by those who transact business in the Capitol.

This moving traffic and parked automobiles detract from the dignity, in fact it may be said to destroy its dignity completely. We concur in the recommendation that the Plaza should be redesigned so that no automotive traffic whatsoever can proceed through it nor park on it for any reason except as may be necessary when the President visits Capitol Hill to address a joint session of the Congress or when the head of another sovereign nation visits the Capitol on a ceremonial occasion.

THE CAPITOL GROUNDS

The Capitol of the United States has a distinguished site on a natural emi-
(Continued on page 346)

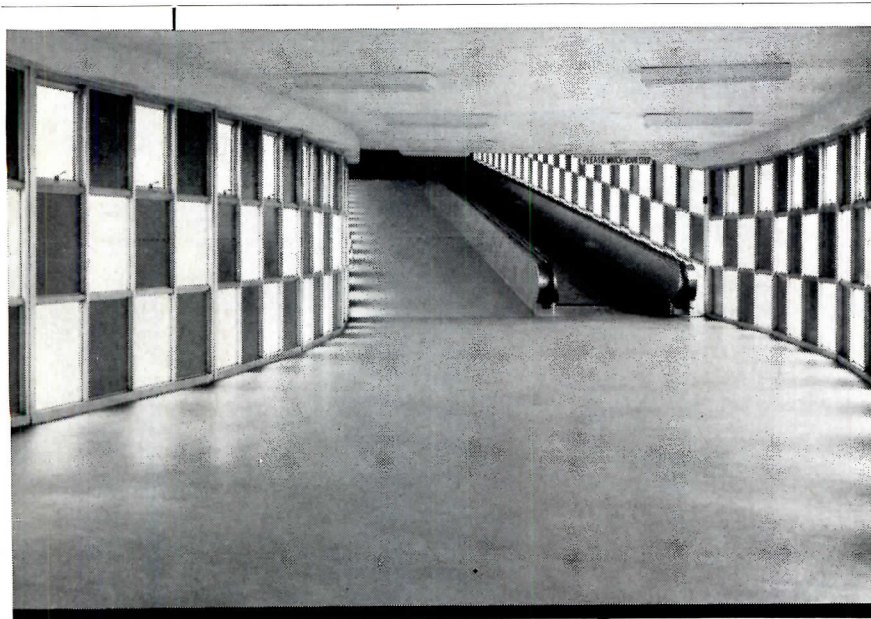

Bridge from parking lot to Houston Coliseum.

Walking Safely Over the Bayou in Texas

Thousands will walk safely over this ramp and passage way, bridging the bayou that separates the Houston Coliseum from its parking area. The surface has been made permanently non-slip — wet or dry — by ALUNDUM (CF) Aggregate in the cement. And there will be no sign of wear after years of heavy foot traffic because ALUNDUM Aggregate acts as reinforcement to concrete — making it stronger.

Whether ramp, level surface or stairways, places of public travel should be free from slipping hazards, as was wisely done by the authorities who specified ALUNDUM Aggregate for the great new Houston Coliseum.

Architect: Golemon & Rolfe, Houston, Texas
General Contractor: Fisher Construction Company,
Houston, Texas

NORTON

FLOORS

**NORTON COMPANY
WORCESTER 6, MASS.**

ALUNDUM AGGREGATE for Terrazzo and Cement • ALUNDUM STAIR and FLOOR TILE

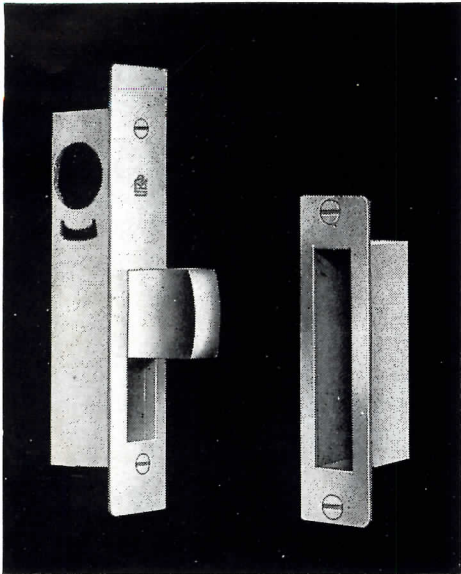

Maximum Security Narrow Stile Locking Devices

For New or Replacement Installations

Whether you specify, install, or sell narrow stile locking devices, you can be confident that Adams-Rite offers the utmost in design, construction, simplicity and safety. Check these advanced ideas that insure top performance and lasting customer satisfaction:

Illustrated above — Maximum Security 1850 Deadlock:

This is the unit that provides Maximum Security for modern narrow stile swinging glass doors. The pivoted bolt actually bridges the opening with a bar of steel, retaining as much bolt within the lock stile as is projected. Its protection is so great that forced entry is impossible without destruction of the door itself.

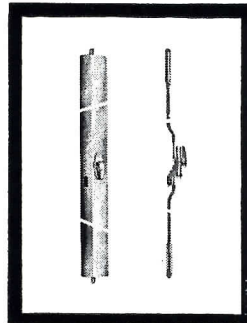

MS 1849 Two-Point Door Bolt:

The modern method for locking the inactive door of a pair of narrow stile doors. Top and bottom bolts are locked or unlocked by natural operation of an attractive turn conveniently located on the inside surface. Positive deadlock of both doors is automatically provided when cylinder deadlock is thrown.

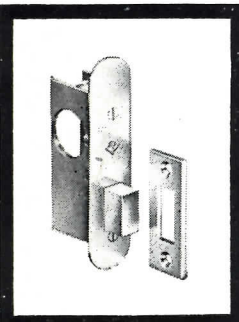

970 Minimum Backset Deadlock:

This unit provides economical deadlocking for rigid narrow stile swinging doors. Like all Adams-Rite narrow stile locks, the 970 Series operates with standard mortise type cylinders of any make.

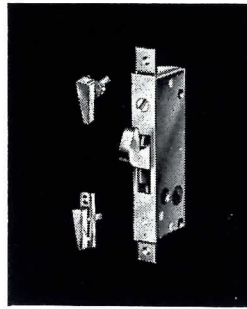

1848 Deadlock for Narrow Stile Sliding Glass Doors:

Every sliding glass door deserves the same protection demanded of any other exterior door. The 1848 gives security with an adjustable heavy hook type bolt with which turn and cylinder controls are used. For added safety, the bolt collapses if the door is accidentally shut while bolt is projected.

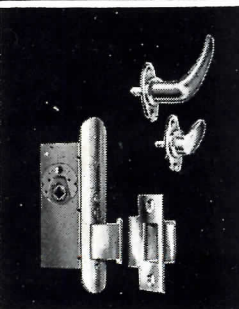

1450 Deadlocking Latch:

Traffic control is made possible in a narrow stile swinging door entrance by use of the 1450 Series Deadlocking Latch. Two-way traffic flow or restricted entrance is achieved by a simple selector. Ideal for any public area with a closing-hour problem, such as banks, markets, apartment houses, etc. It satisfies building and safety regulations.

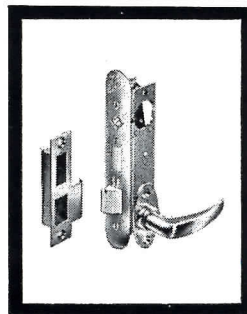

1340 Series, Deadlock and Latch:

Combination deadlock and latch for narrow stile swinging doors. A simple selector changes the unit from free swinging to latch action. The positive latch action helps prevent air losses when temperature control systems are used.

Specify, Sell, Install the Finest

ADAMS-RITE MANUFACTURING COMPANY

540 West Chevy Chase Drive, Glendale 4, California • Dept. AR-117

Specialists in Narrow Stile Locking Devices



Complete specifications and information on request.

(Continued from page 344)

nence; it demands a setting worthy of the building. It is your Consultants' considered opinion that the general character of the Olmsted 1874 Plan for the grounds of the Capitol should be retained insofar as possible. Frederick Law Olmsted was appointed landscape architect for the Capitol by Act of Congress on June 23, 1874. His first recommendation was for a "broad plaza east of the Capitol," which is shown on the plan that he submitted for the develop-

ment of the grounds reproduced in Glenn Brown's "History of the United States Capitol." Olmsted conceived the area around the Capitol as a single unified design in a spirit of balanced informality. The roads and paths sweep gracefully around the central architectural element in curved flowing lines that aid in giving great nobility to the rectangular plot, bordered by Constitution Avenue, 1st Street East, Independence Avenue and 1st Street West, in which the Capitol stands. We believe that the modified design should retain

all of the breadth and dignity of the old and continue to express the distinctive character that has marked the Capitol grounds for more than three quarters of a century.

We firmly believe that the same spirit should be retained in the design of the grounds at the East Front of the Capitol as obtained in the original plan, substituting for the carriage drives a distinguished plaza for pedestrian use only. The Capitol stands on a paved plinth; on the East Front, before the fine Bulfinch portico and its monumental steps and stretching across the Senate and House porticoes, there should be a broad open plaza of noble proportions; this should count as a single unbroken area rather than as an area made up of a series of smaller parts. It should be enclosed on its periphery, other than where the building itself stands, by a balustrade of sturdy proportions and simple lines framed by trees. The line of this balustrade on the east side should be a broad sweeping reverse curve, rather than made up of broken angles that destroy the more desirable flowing continuity of outline, particularly when seen in perspective from the Capitol steps or from 1st Street East. The present plan relationship of the East portico to the projection of the Senate and House wings is one of the Capitol's greatest charms. Your Consultants urge that the plan of the plaza provide appropriately for the restoration of that relationship by extending the Senate and House wings eastward approximately the same distance as the proposed extension of the central element. The concave composition of the East Front of the Capitol seems to us to call for the type of curved outline of the east side of the plaza hereinbefore described.

This report was written after the death, on July 7, 1957, of one of your consulting architects, Arthur Brown, Jr., of Burlingame, California, consequently Mr. Brown's name does not appear in connection with this edited copy of the Report. Mr. Brown, however, subscribed to the statements, contained in a preliminary draft, dated June 3, 1957, and we are of the opinion, that, inasmuch as the nature of the recommendations is substantially the same, he would have been willing to sign this latest copy.

We take this opportunity to express our appreciation to you, to the members of your staff and to your associate architects and engineers for their cooperation in assisting us to reach the conclusions herein recorded.

FROM START TO FINISH Michaels Curtain Wall Service is Complete

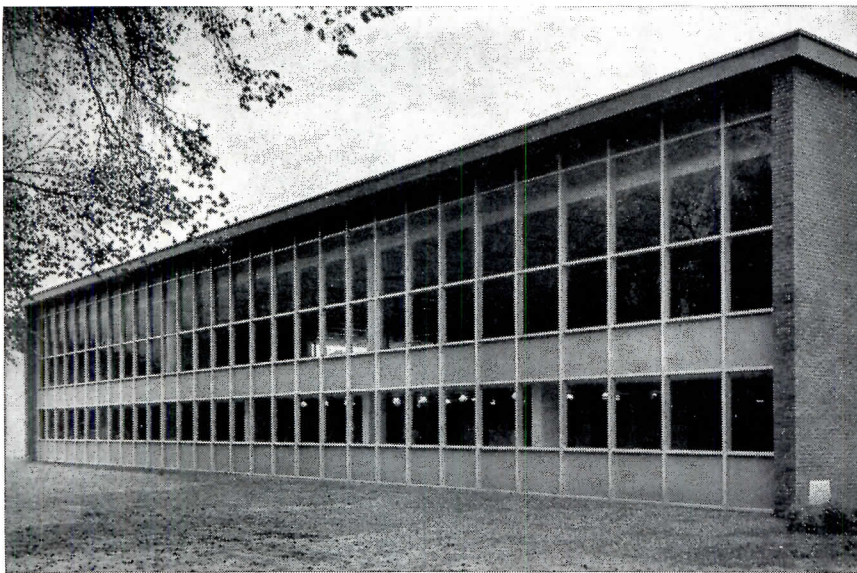

Michaels has the know-how and facilities to detail, produce and install porcelain enameled steel, stainless steel, aluminum or bronze curtain walls. One typical example is illustrated, the University of Louisville library building now under construction.

With Michaels Curtain Wall Systems, construction is faster and less costly. Curtain walls are insulated, weathertight, and will give you a lifetime of service.

In addition to curtain wall systems, Michaels manufactures many architectural metal building products in stainless steel, aluminum and bronze. We believe it will be to your advantage to contact Michaels on your next project. For additional information, look in Sweet's.

**MICHAELS PRODUCTS Architectural Metal • Curtain Walls • Tablets
Reversible Windows • "Time-Tight" Exhibit Cases • Memorials**

THE MICHAELS ART BRONZE COMPANY, INC.

P. O. BOX 668-R • COVINGTON, KENTUCKY

Experts in Metal Fabrications Since 1870

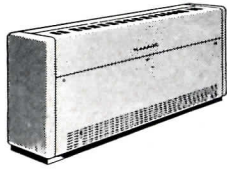

SYNCRETIZER UNIT VENTILATOR Sets today's comfort standard for classroom heating, ventilating and natural cooling. *Publication 101*

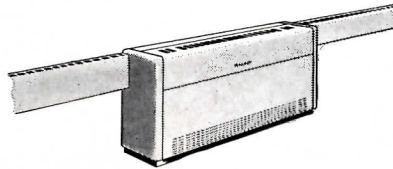

SYNCRETIZER AND WIND-O-LINE RADIATION Protects against window downdrafts and loss of body heat to cold surfaces. *Publication 101*

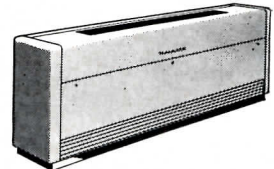

YEAR 'ROUND SYNCRETIZER A complete year-round air conditioning unit for classrooms, lecture halls and libraries. *Publication 11-1*

heating... ventilating... natural air cooling year-round air conditioning

There is a dependable Nesbitt product for every thermal comfort need in the classrooms, administrative offices and assembly spaces of public and parochial schools, colleges, and universities. From among the items shown here (plus the Nesbitt line of unit heaters and exhausters) your architect or engineer may select those exactly suited to your needs—whether for heating alone; heating, ventilating and natural air cooling; or year-round air conditioning. That he will do so is more than likely, for in 40 years of leadership the name Nesbitt has become synonymous with comfort, economy, durability, and service for the life of the building.



Are you ready to air condition your school rooms?

Authoritative answers to your questions about practicability, costs and procedures are contained in "An Analysis of Air Conditioning for Schools"—your copy free on request.

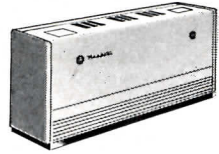

THE MAINLINER A quiet-operating heating and ventilating unit for classrooms in geographically milder climates. *Publication 12-1*

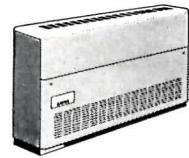

THE ROOMMATE A year-round cabinet air conditioner for use in lobbies, offices and administrative spaces. *Publication 600-1*

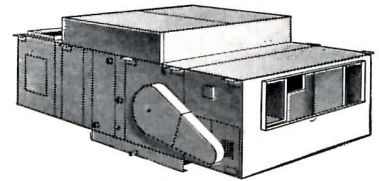

THE AUDICON A year-round air conditioning unit for quiet operation in auditoriums and high occupancy spaces. *Publication 22-1*

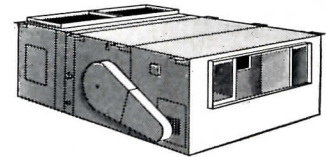

THE THERMOVENT A large-capacity, sound-insulated heating and ventilating unit for auditoriums, cafeterias, gyms. *Publication 20-1*

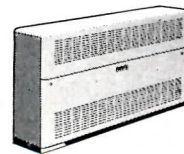

SERIES A CABINET HEATER Versatile, high-capacity heaters for use in foyers, corridors, stairways, rest rooms, etc. *Publication 403-2*



SILL-LINE RADIATION High capacity perimeter heating in attractive wall-hung enclosure for hallways, offices, etc. *Publication 30-1*

PLUS Nesbitt Unit Heaters and Exhausters

Learning begins only

when discomfort ends



FOR WALL BRACKETS

PRESCOLITE IS PREFERRED

HERE'S WHY...

"DieLux" DIECAST CONSTRUCTION THROUGHOUT

Thermal
shock and
vibration
proof



WB-25
150W
WALL
BRACKET

Beautiful,
hand-blown,
seamless
white opal
enclosing globes

Wide selection of styles to choose from.

Prescolite diecast wall bracket fixtures of rust-proof aluminum have set new, high standards for the lighting industry. They are suitable for either interior or exterior installation.



WB-2-2 DOUBLE
WALL BRACKET

WB-24 100W
WALL BRACKET

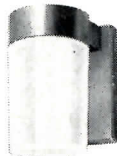

WB-125 WALL
BRACKET WITH
SCREW-IN
ENCLOSING GLOBE

WB-210 150W
WALL BRACKET



Units above are also available
as ceiling fixtures



CF-25



CF-10



CF-2

WRITE FOR YOUR COPY OF OUR
CATALOG ON THE COMPLETE LINE OF
PRESCOLITE LIGHTING FIXTURES.

PRESCOLITE MANUFACTURING CORP.

2229 4th St., Berkeley 10, Calif.
Easton Road, Neshaminy, Penna.

REQUIRED READING

(Continued from page 58)

One example shows the increased profit that went to a builder who wisely reserved a percentage of land for commercial and civic development which, at the same time, provided for its residents the required amenities for a full way of life.

The kind of community house builders should strive to create should, according to the authors, take the following points into consideration: (1) A good house is not enough for a good life. (2) The logical community is related to the place of worship of its residents. (3) The complete community provides facilities for education, worship, shopping and recreation. (4) The liveable community is based on considerations for pleasant esthetic experiences; (5) The well-planned community allows its families to live conveniently, comfortably and safely. (6) The well-conceived community is an integral part of the over-all city or regional plan.

Prospective house buyers would certainly be easier to sell this total kind of community, since buyers are not apt to resist a better way of life. The authors think far-sighted builders will recognize this and plan accordingly.

Even a small-scale builder can provide complete communities by employing one of four suggested methods. First, he might buy lots which are a segment of an *existing* total community, or secondly, lots which are a segment of a *proposed* total community. Third, he might join forces with a group of small builders and as a team they could develop the total community. Fourth, a team of small builders could commission the best available talent in the field of land and community development, to the advantage of everyone participating.

Several plans, sketches and photographs (rather choppy) illustrate proposals for related communities, solutions to site problems (landscaping, roads, sun control, privacy, etc.), and a remarkably inspiring collection of builder houses, many of which were designed by the authors.

It is good to discover such a constructive appraisal of the mass housing situation. Jones and Emmons have established themselves as pioneers in an effort to make the best and the most, architecturally, of what they think is inevitable, economically, on the American housing scene.

there's
so much
to
choose
from
at...



HOTEL CLEVELAND

Cleveland Room

Dine in the splendid old world setting of a grand dining room. The menu is varied, the service unexcelled.

Bronze Room

One of the brightest of the city's supper clubs. Dancing nightly from 9:00 p.m. Air conditioned, of course.

Rib Room

A true specialty restaurant . . . For Fabulous Roast Beef, roasted, carved and served to your order.

MEN'S BAR

Strictly stag — is this all male haven for good drinks, good food and good talk. Plus sports events on TV.

TRANSIT BAR

For rapid service in the most unique bar in the country . . . decorated with an outstanding collection of miniature trains.

the PATIO

Pause — in the relaxing, informal atmosphere of the gayly decorated Patio. It's a Cleveland habit to say — "Meet me at the Patio."

Coffee Shop

Service is brisk and decor cheerful in the modern, air-conditioned coffee shop. Enjoy a tasty sandwich or a moderately priced meal.

Hotel Cleveland
CLEVELAND, OHIO

WRITE OR CALL FOR YOUR RESERVATIONS NOW

Never before have so many architects and engineers turned to an architectural magazine for help in their work.

27,650 architects and engineers now subscribe to Architectural Record. (Source: June 30, 1957 A.B.C. Publisher's Statement.)

Never before has an architectural magazine offered building product advertisers such complete coverage of the men who year after year are responsible for planning four-fifths of all U. S. building.

Over 93% of the total dollar value of all architect-planned nonresidential building and 77% of all architect-planned residential building is in the hands of Record subscribers—a fact documented by Dodge Reports.

The cost per page per 1,000 of Architectural Record's unequalled architect and engineer circulation? Lowest of the three leading architectural magazines.

Compare . . . <i>Architect Circulation</i>	Architectural Record	17,826
	Progressive Architecture	16,424
	Architectural Forum	13,492
Compare . . . <i>Engineer Circulation</i>	Architectural Record	9,824
	Progressive Architecture	8,576
	Architectural Forum	4,614
Compare . . . <i>Cost per Page per 1,000 Architects and Engineers</i>	Architectural Record	\$25.32
	Progressive Architecture	\$28.40
	Architectural Forum	\$54.68

7 REASONS for putting Architectural Record at the top of your 1958 advertising schedule.

1. Editorial leadership — Edited specifically for architects and engineers. Most editorial pages. Largest staff of architect and engineer editors in the field. Five out of six editorial awards to architectural magazines by the American Institute of Architects.

2. Preferred readership—Architects and engineers have voted the Record "preferred" in 100 out of 110 studies SPONSORED BY BUILDING PRODUCT MANUFACTURERS AND ADVERTISING AGENCIES.

3. Top architect circulation.

4. Top engineer circulation.

5. Top verifiable building market coverage.

6. Lowest-cost coverage.

7. Advertising leadership. Year after year more advertisers place more pages of advertising in Architectural Record than in any other architectural magazine. (47% more than the second magazine in the field in the first 9 months of 1957, 59% more than the third magazine.)

Again in 1958 . . . advertising will work harder for you in the "workbook of the active architect and engineer . . ."

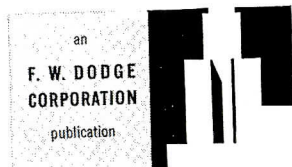

ARCHITECTURAL RECORD

119 WEST 40th STREET
NEW YORK 18, NEW YORK
OXford 5-3000

THE RECORD REPORTS: CURRENT TRENDS IN CONSTRUCTION

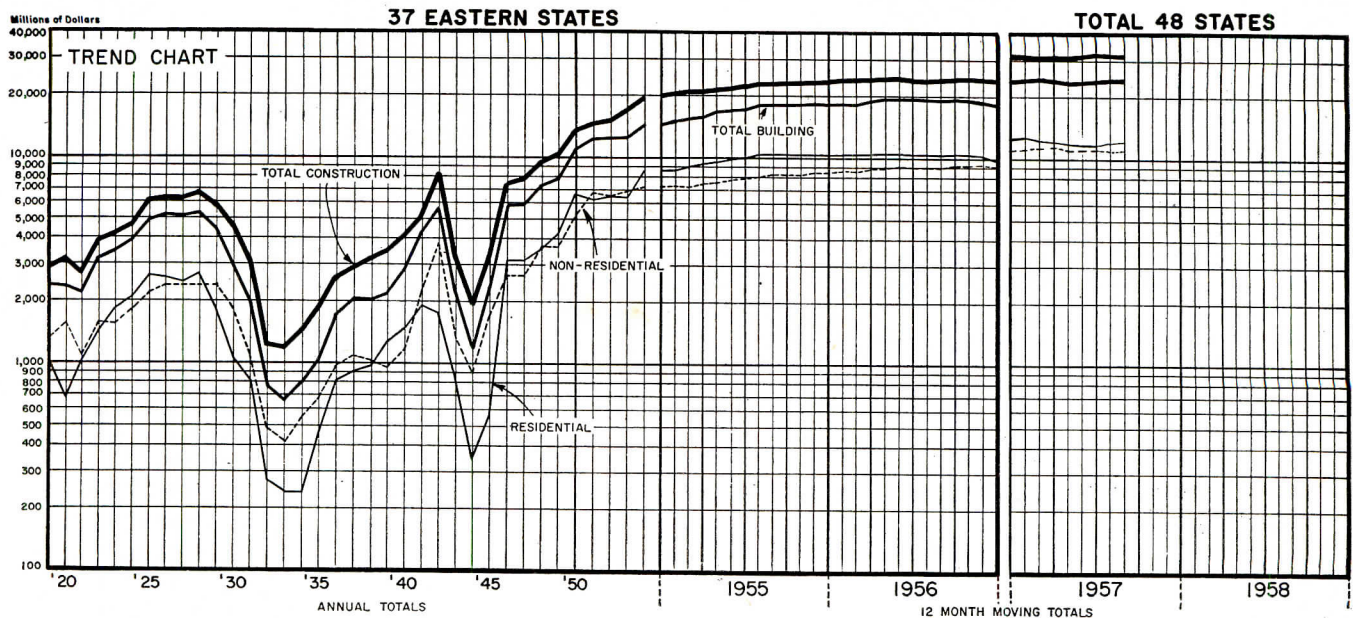

BUILDING UP, HEAVY ENGINEERING OFF

A 34 per cent decline in heavy engineering contracts in August offset gains of eight per cent in nonresidential building and five per cent in residential to leave the total for the U. S. of August contracts for future construction five per cent below August 1956, F. W. Dodge Corporation reported. The cumulative total for the first eight months of 1957, at \$22,676,652,000, was two per cent ahead of the corresponding period last year, with the nonresidential category up three per cent and residential down one per cent; for the eight-month period, heavy engineering gained seven per cent. Leading nonresidential building types in terms of dollar volume for eight months of 1957 were commercial buildings (\$2,318,332,000); educational and science buildings (\$1,994,684,000); manufacturing buildings (\$1,581,220,000); hospital buildings (\$603,872,000); and religious buildings (\$498,468,000). In terms of their percentage change compared with the 1956 period, hospitals made the largest gain (38 per cent); commercial and religious buildings were next (eight per cent each); and education and science buildings next (four per cent). In August, manufacturing buildings were up six per cent over August 1956.

Charts by Dodge Statistical Research Service

NONRESIDENTIAL BUILDING

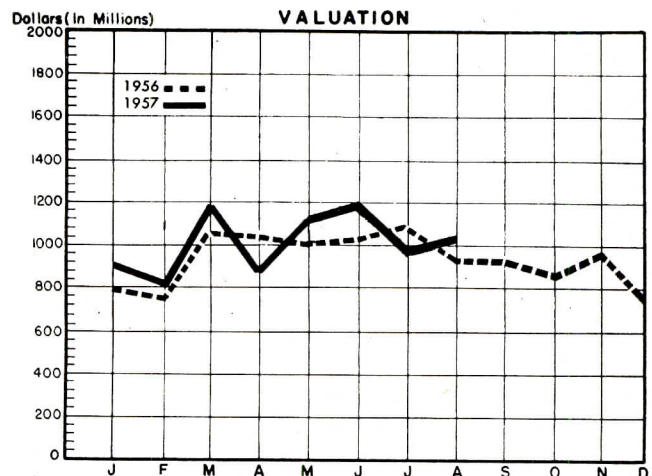

RESIDENTIAL BUILDING

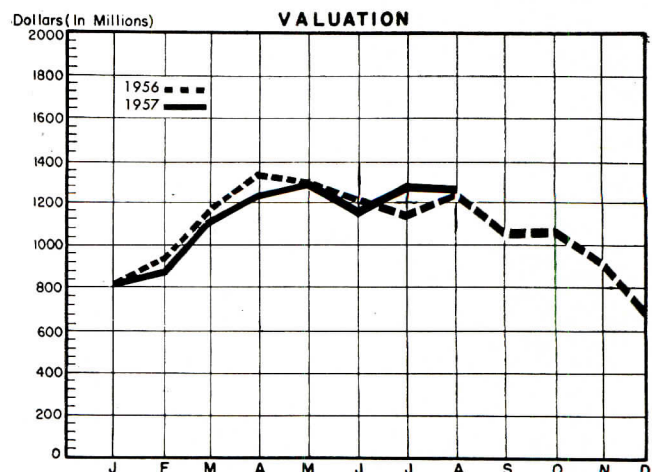

Source: F. W. Dodge Corporation

HOSPITAL BUILDINGS*

Construction Contracts—37 Eastern States

Valuation (in thousands)

Year	Annual Total	Monthly Average	Year	Annual Total	Monthly Average
1929	152,206	12,683	1951	580,782	48,398
1935	47,057	3,921	1952	443,709	36,142
1940	94,864	7,905	1953	433,634	36,136
1943	110,718	9,226	1954	518,819	43,234
1947	192,014	16,001	1955	474,589	39,549
1950	655,184	54,598	1956	559,024	46,585

1956		1957	
Jan. 49,737	July 75,780	Jan. 58,560	July 61,243
Feb. 18,830	Aug. 39,442	Feb. 62,065	Aug. 60,095
Mar. 25,527	Sept. 62,649	Mar. 53,781	8 mos. 517,597
Apr. 41,261	Oct. 58,828	Apr. 43,935	
May 53,157	Nov. 44,272	May 84,491	
June 51,333	Dec. 38,208	June 93,427	

*Hospital Buildings are the subject of Building Types Study No. 252 (pages 189-215).