

ARCHITECTURAL RECORD

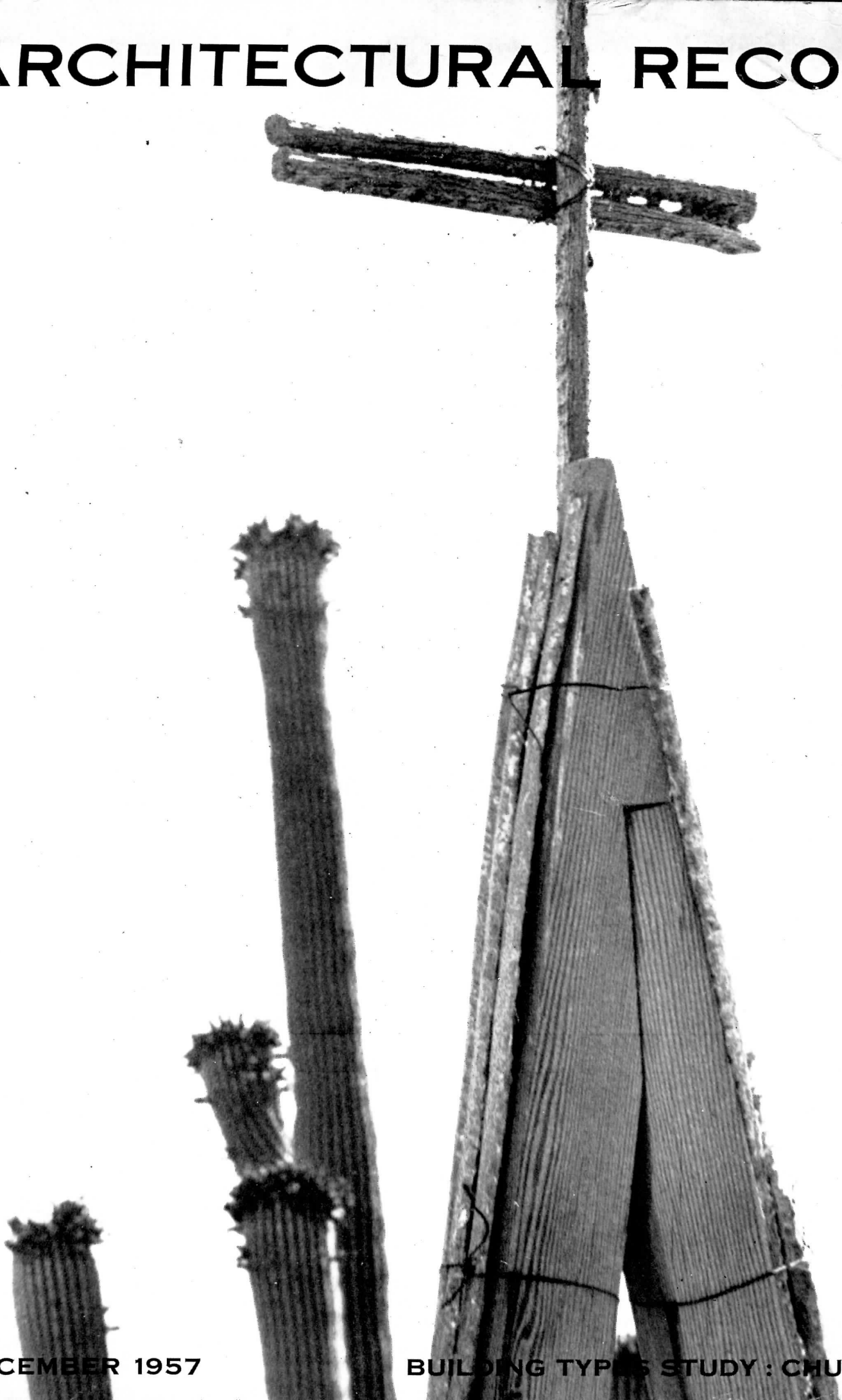

DECEMBER 1957

BUILDING TYPES STUDY : CHURCHES

For Fire Protection . . .
 National Housing Center chooses
GRINNELL SPRINKLERS



Showcase of everything that's modern in the home supply and building products field, the National Housing Center in Washington, D. C. is a meeting ground for architects, builders and home buyers.

The Grinnell Automatic Sprinkler System fits the modern design of this building most ideally. For example, the *ceiling-type* Grinnell Sprinklers employed are hardly noticeable. Extending but a scant inch and a quarter below the ceiling, they blend smoothly with interiors. More important, they are ready to stop fire anytime, any place . . . wherever or whenever it may strike, night or day . . . *automatically*.



Would you like assistance in selecting the proper fire protection system for buildings now on your drawing boards? If so, call in a Grinnell engineer. He is expert in all phases of fire protection design and engineering. Bear in mind, too, that a Grinnell System can make possible impressive economies through reductions in fire insurance. Write Grinnell Company, Inc., 269 W. Exchange St., Providence, R. I.



GRINNELL

PROTECTION AGAINST EVERY FIRE HAZARD



— Manufacturing, Engineering, and Installation of Fire Protection Systems since 1870 —

December 1957 Vol. 122 No. 6

Copyright 1957 by F. W. Dodge Corporation, with all rights reserved. ARCHITECTURAL RECORD (combined with AMERICAN ARCHITECT and ARCHITECTURE) is published monthly, except May 1957 when semi-monthly, by F. W. Dodge Corporation, 10 Ferry Street, Concord, New Hampshire. Editorial and executive offices: 119 West 40th Street, New York 13, New York. Western editorial office, 2877 Shasta Road, Berkeley 8 California.

STAFF OF ARCHITECTURAL RECORD



F. W. DODGE CORPORATION H. Judd Payne, *Publishing Director*; Robert F. Marshall, *General Manager*; John Knox Shear, A.I.A., *Editor-in-Chief*; Marshall T. Ginn, *Circulation Manager*; Emerson Goble, *Managing Editor*; James S. Hornbeck, A.I.A., *Senior Associate Editor*; Elizabeth Kendall Thompson, A.I.A., *Senior Associate Editor and Western Section Editor (Berkeley, California, Office)*; Robert E. Fischer, *Associate Editor (Engineering)*; Florence A. van Wyck, *Associate Editor*; Jeanne M. Davern, *Associate Editor (News)*; Herbert L. Smith, Jr., A.I.A., *Associate Editor*; Mildred F. Schmertz, *Associate Editor (Design)*; Ernest Mickel, *Dan Street (Washington)*, John Caulfield Smith, M.R.A.I.C. (Canada), *Contributing Editors*; Margaret R. Fuerst, *Assistant Editor (Engineering Assistant)*; Helen E. Cook, *Editorial Assistant (Production)*; Dianne Thomas, *Editorial Assistant*; Eugene H. Hawley, *Design Director*; Thomas L. McArthur, *Mary Ann Godfrey*, *Design*; Sigman-Ward, *Drafting Consultant*; Thomas S. Holden, *Industry Relations Consultant*; Clyde Shute, *Statistical Consultant*; George Cline Smith, *Economics Consultant*; Clifford G. Dunnells, Jr., *Field Research Consultant*; Daniel J. Howe, Jr., *Public Relations Consultant*.

TABLE OF CONTENTS

The Record Reports

Perspectives: Air Academy Chapel: what do architects think?	9
Buildings in the News: Architecture Salutes the American Cowboy: winning designs in the National Cowboy Hall of Fame and Museum Competition. Sarasota Exhibit Spotlights Architecture of Region	10
Architecture Abroad: New Zealand Holds First Architectural "Convention" and Exhibit	16
Preservation: New Challenge for Modern Architecture	18
Meetings and Miscellany	21
Chicago Dynamic: U. S. Steel Sells Architecture	28
Industry Advice Sought and Used in FHA Standards Revision. A Washington Report by Ernest Mickel	32
News from Canada. By John Caulfield Smith	36
Washington Topics. By Ernest Mickel	48
Construction Cost Indexes	54
Required Reading	58
Calendar and Office Notes	254
Current Trends in Construction	328

George Nelson 127

A report on the work of a combination of an architectural office and a group doing product, graphic and exhibition design, actually two different associations of talent doing frequently interrelated work.

The George Nelson Office	128
Experimental House	137

Berlin Congress Hall

A new concept of a "congress hall" type of exhibition building, a new structural system, a new way of selecting an architect, all wrapped up in an unusually successful architectural expression.

Hugh Stubbins and Associates, Architects	143
--	-----

Three Schools for Deaf Children

Tucker-Maxon Oral School, Portland, Ore.; Belluschi and Skidmore, Owings & Merrill, Architects	152
Hosford School Addition, Portland, Ore.; Belluschi and Skidmore, Owings & Merrill, Architects	154



COVER: Mission of Guadalupe, Ariz.; Ettore de Grazia; Erich Hartman of Magnum photos

ARCHITECTURAL RECORD

Continued from page 5

American School for the Deaf, West Hartford, Conn.; Louis J. Drakos, Architect 156

United States Embassy Office Building

In the ancient land of old masters, Walter Gropius has the role of old master carrying oil to Newcastle, doing the same old problem in the manner of a new age, but with a purpose not unknown in this land, "a building which should appear serene, peaceful and inviting . . ."

Athens, Greece; The Architects Collaborative 159

High Activity in Prospect for Schools, Colleges, Hospitals

A skilled observer in these fields analyzes factors and needs which promise still more buildings devoted to education and health.

An article by *R. M. Cunningham, Jr.*, Editorial Director, The Modern Hospital Publishing Co. 167

Building Types Study 253 — Churches

The Power of Positive Space 172

St. Elizabeth's Episcopal Church, Burien, Wash.; Durham, Anderson & Freed, Architects 178

Hope Lutheran Church, Tacoma, Wash.; Robert Billsbrough Price, Architect 182

East Shore Unitarian Church, Bellevue, Wash.; Bassetti & Morse, Architects 186

Engineering

Room Shapes and Materials Determine Church Acoustics. *By R. N. Lane* 190

High Frequency Lighting. *By R. D. Burnham* 193

Technical Roundup 196

Product Reports 197

Literature 198

Time-Saver Standards: House Anchorages 5, 6 & 7 201

Index to Advertising

330

OFFICERS OF THE F. W. DODGE CORPORATION

James McV. Breed, *Chairman of the Board*; Paul Abbott and Thomas S. Holden: *Vice Chairmen of the Board*; Howard Barringer, *President*; Irving W. Hadsell, Chauncey L. Williams: *Executive Vice Presidents*; Howard M. Thompson, *Vice President and Treasurer*; Julius T. Little, Robert F. Marshall, T. Oliver Morgan, O. O. Paulsell, H. Judd Payne, George Cline Smith: *Vice Presidents*; Carl S. Bennett, Clinton C. Bennett, Ralph M. Hairston, Roy J. Hard, Arthur D. Prior, Richard H. Ray, John M. Williams: *Regional Vice Presidents*; Edwin H. Freed, *Assistant Vice President and Comptroller*; Walter F. DeSaix, Clifford C. Dunnells, Jr., Gault Eastman, Clyde Shute, Marc Wayne: *Assistant Vice Presidents*; Sanford D. Stockton, Jr., *Secretary*; William C. Breed, Jr., George W. Morgan: *Assistant Secretaries*; Irving B. Satin, *Assistant Treasurer*.

OTHER F. W. DODGE SERVICES

Dodge Reports — Dodge Statistical Research Services — Sweet's Catalog Services — Dodge Books — Dodge Mailing Service — The Modern Hospital — The Nation's Schools — College and University Business — Hospital Purchasing File — Chicago Construction News — Daily Pacific Builder — Denver Daily Journal — Real Estate Record & Builders Guide.

Members of Audit Bureau of Circulations and Associated Business Publications. ARCHITECTURAL RECORD is indexed in Art Index, Industrial Arts Index and Engineering Index.

Every effort will be made to return material submitted for possible publication (if accompanied by stamped, addressed envelope), but the editors and the corporation will not be responsible for loss or damage.

Subscription prices: Published monthly except May 1957 when semimonthly. U. S., U. S. Possessions and Canada; \$5.50 per year; other Western Hemisphere countries, Spain, to those who by title are architects and engineers, \$9.00 per year. Single copy price except Mid-May 1957 issue \$2.00; Mid-May 1957 issue \$2.95. Beyond Western Hemisphere, excluding Spain, to those who by title are architects and engineers, \$9.00 per year for 12 monthly issues not including Mid-May 1957 issue. Subscriptions from all other outside U. S., U. S. Possessions and Canada for 12 monthly issues, not including Mid-May issue, \$24.00 per year. Change of address: subscribers are requested to furnish both old and new addresses, sending if possible stencil impression from magazine wrapper; allow four weeks for change.



THE RECORD REPORTS

P E R S P E C T I V E S

AIR ACADEMY CHAPEL: PROFESSIONAL OPINION

Congressmen are vociferously dubious; many religious leaders have enthusiastically praised it; what do architects think? The RECORD queried some leading architects, architectural deans and architectural critics. The responses follow.

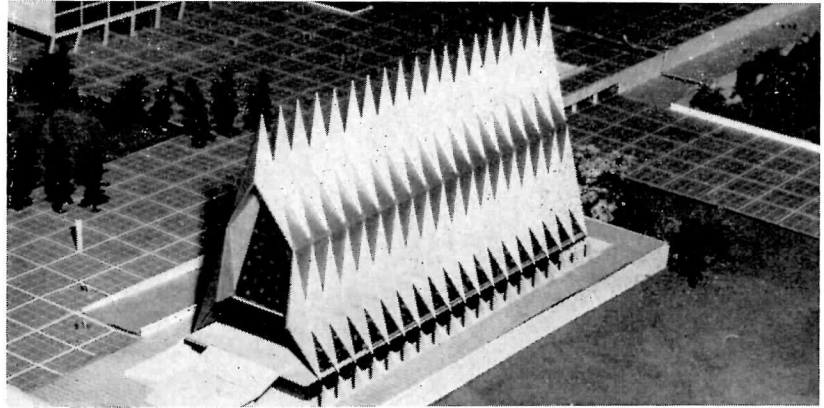

It is a combination of modern with medieval. Although the design is highly contemporary, it has a very definite ecclesiastical feeling. This is achieved by the buttress-like effect of the exterior and the rhythmic repetition of the aluminum "buttresses" and their surmounting pinnacles. The chaste use of a band of stained glass running vertically between the aluminum heightens this feeling.

Architecture should harmonize, if possible, with geographic surroundings and the pinnacles symbolize architecturally the sharp mountains which serve as the Academy's backdrop.

For young men being trained for modern aircraft and missiles, use of aluminum as the basic exterior material is far more fitting than would be a more traditional chapel of dark and heavy stone or ponderous, earthy materials.

— **Welton Becket, Architect**

The recent references to the proposed design concept for the United States Air Force Academy Chapel as a monstrosity were appalling to me.

It is incredible to think that the expressions of spiritual values in this age of atomic energy and the conquest of outer space should be so completely archaic, so inconsistent with the true meaning of an enlightened religious environment.

The proposed design for this chapel not only reflects and relates the symbol of religion to modern-day education,

but would have completely destroyed this synthesis if it had been constructed in a traditional style.

My heartiest congratulations to Skidmore, Owings & Merrill for their courage and honesty.

— **Mario J. Ciampi, Architect**

Religious idea and feeling are elements in every phase of human life and their expression in architecture is never inappropriate. Nevertheless there are measures of appropriateness. In every work of architecture there must be a just relationship between devotional expression and the purpose and character of the enterprise in which that devotion is a part.

The chapel of the Air Force Academy, set on its pedestal above rectangular and cloistered buildings — an aluminum flame over an altar of glass — will be more consistent in its expression with the life and temper of a monastery than with the cool disciplines of a military institution. The religion inherent in such disciplines must have an ethical emphasis — the religion of men who offer their lives in defense of the right — the religion that is instinct in the stoic simplicities of the academic buildings, the laboratories and the cadet quarters. The chapel contradicts that which these buildings teach.

Like the chapel at West Point the chapel in Colorado looks backward to a medieval pattern and yet dramatically exhibits a contemporary theory of archi-

ture. In that respect the design is resourceful, imaginative, opportune in its technologies and, in its scenic effects, superb. But the modern theory also includes a just expression of character.

Designing a chapel is a priest-like task.

— **Joseph Hudnut,**

Critic and former Dean,

Harvard Graduate School of Design

First of all it is my opinion that Congress has the right to question, investigate, and recommend, but not to judge, accuse, or condemn. This question was brought up not long ago in the McCarthy investigation in which he was criticized for exactly this reason. In that case it was his job to gather facts, leaving to the Justice Department the matter of actual judgment. We have no National Fine Arts Commission as a Federal bureau, nor is there a private professional advisory board such as set up to advise the State Department's Office of Foreign Buildings. Being commissioned myself to design an Embassy and working with this Architectural Advisory Board, I can say that it works with great effectiveness. It is obvious to me that we should have a Board of this kind to deal with controversies such as the Air Force Academy and for any and all such matters in the future.

As to the design concept, I hesitate to become involved in public criticism of the work by others in the profession. However, I will say that although not

(Continued on page 266)

ARCHITECTURE SALUTES THE AMERICAN COWBOY

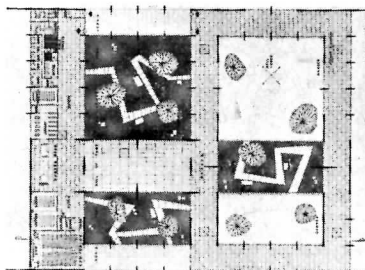
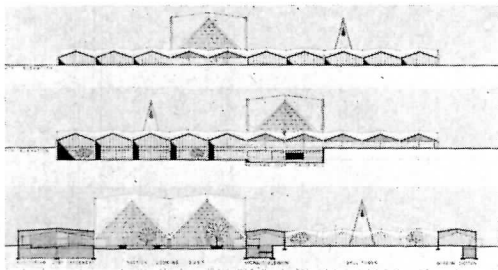
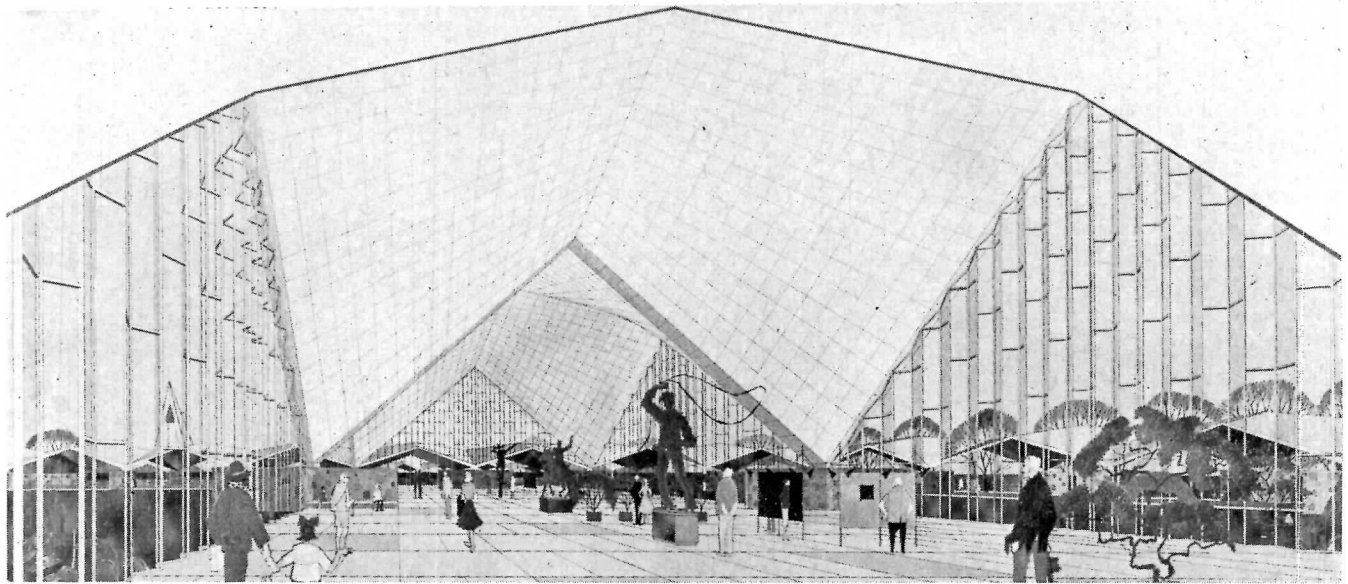

FIRST AWARD (commission) — H. J. Begrow and J. W. Brown, Birmingham, Mich.

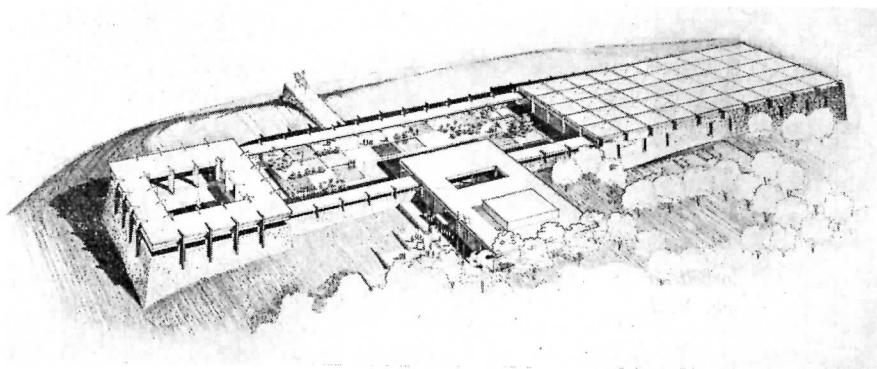

SECOND AWARD (\$3000) — Joseph D'Amelio-William I. Hohausser Inc., New York

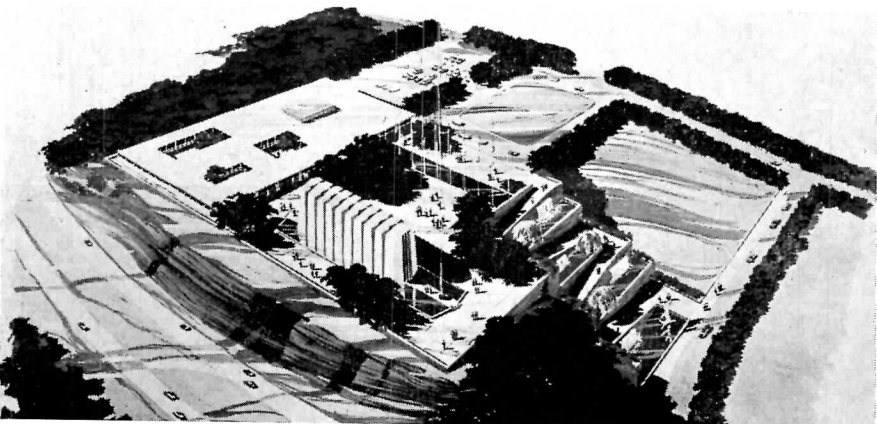

THIRD AWARD (\$2500) — Ambrose M. Richardson and Associates, Champaign, Ill.

Two young architects from Birmingham, Mich., Harold Jack Begrow and Jack W. Brown, won the First Award in the recent two-stage competition for design of the National Cowboy Hall of Fame and Museum to be built on a 37-acre site on the outskirts of Oklahoma City. Their prize is the commission for the project, expected in its first phase to cost \$1.5 million; a \$10,000 advance was paid with announcement of the award.

Sponsors of the competition, which had the approval of the American Institute of Architects, were the trustees of a non-profit corporation organized — mainly through the initiative of cattleman C. A. Reynolds of Kansas City — “to establish an enduring edifice to the memory of the cowboys and cattlemen who were influential in developing the West and in helping to create a great many of the tenets of the democratic philosophy on which the American way of life is based.”

Philip A. Wilbur, A.I.A., of Oklahoma City was professional adviser; the jury consisted of Frank N. McNett, A.I.A., Grand Island, Neb. (chairman); O'Neil Ford, A.I.A., San Antonio; John Carl Warnecke, A.I.A., San Francisco; and corporation trustees Albert K. Mitchell, Albert, N. Mex., and Roy J. Turner, Oklahoma City.

The program, which called for construction in two stages, required a design to consist of (1) the Hall of Fame, “the shrine or memorial devoted to the persons so honored”; (2) the Museum, “the repository of records, artifacts, paintings and memorabilia of the life and times of

the cowboy and his contribution to the expansion and development of the United States"; (3) other public spaces, including a library, meeting rooms for lectures and films, a donor's room "to provide proper recognition for those who make the enterprise possible," rest rooms and lounges and souvenir shops; (4) working areas, storage and service facilities; and (5) exterior circulation, parking and site development. The space requirements and construction funds for various facilities in both initial and ultimate stages of the project were specifically set out.

The competition attracted a total of 1081 applications from 47 states; 257 entries were received in the first stage, and ten of the competitors were then selected by the jury for the final phase.

In a verbal critique following the awards, a spokesman for the jury had these comments: "Probably the first consideration and one of the things on which we pondered most was the precedent for a building type for the National Cowboy Hall of Fame and Museum, and it was fairly well agreed that there were no particular historical building types for this particular grouping of buildings, although symbolically there might be certain expressions in past historical types that might fit it. The second scheme comes closer to this aspect. But when we really analyze the American cowboy and the pioneer of the West, he did not have buildings about him; his was a movement going West which evolved around open spaces and that of freedom, and not big heavy buildings. Therefore the whole concept of the winning design is a pioneering or new approach to museums or to a Hall of Fame — one that expresses an openness to both the inside and the outside, and creates within an environment which with certain modifications will enhance both the inside and the outside. The winning design is basically more flexible; it is the presentation of an idea that can easily be adapted to changes. It is easier to add on to. It will always be a completed building in any increment that is constructed. It has an overall continuity of structural design in increments that are small enough so that they can be added in big or small sections as required. . . . The whole Museum concept then is a series of these small cubicles or increments of construction which form a garden type of arcade which one wanders through and around; and looks at the museum objects and artifacts and can wander out into the garden, can rest in the garden . . . and/or continue through the Museum."

FOURTH PLACE AWARDS (\$1500 each)

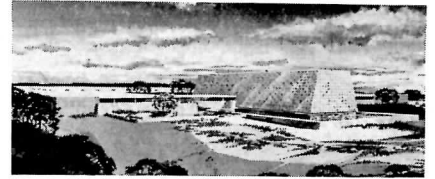

E. Davis Wilcox Associates, Tyler, Tex.

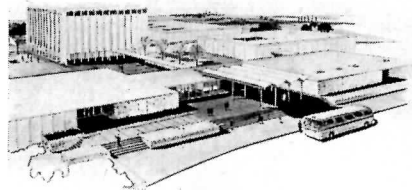

James Miller and Jack C. Durgan, Manhattan, Kan.

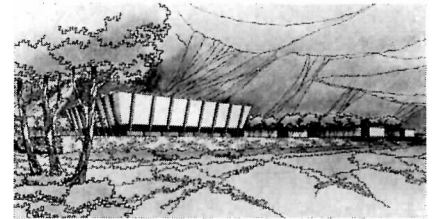

Moritz Kundig, Spokane

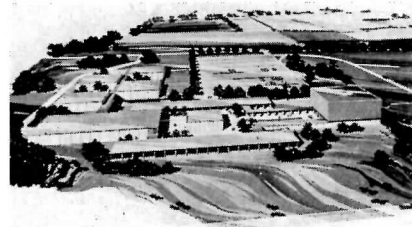

Bauer and Corbett and Kenneth M. Mitchell, Newark, N. J.

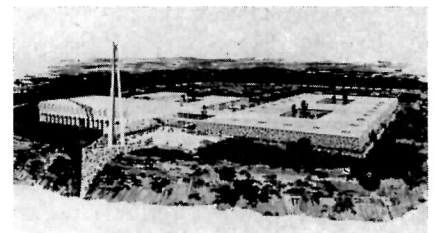

Hudgins, Thompson, Ball & Associates, Oklahoma City



Robert S. Swanson, Bloomfield Hills, Mich.

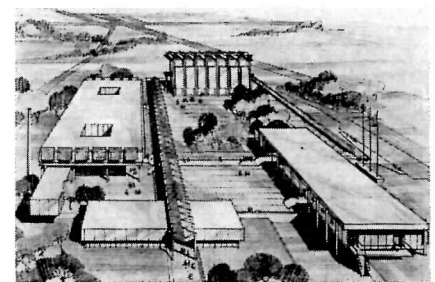

Kirk R. Craig and F. Earle Gauden, Greenville, S. C.

THE RECORD REPORTS

BUILDINGS IN THE NEWS

(Continued from page 11)

SARASOTA EXHIBIT SPOTLIGHTS ARCHITECTURE OF REGION

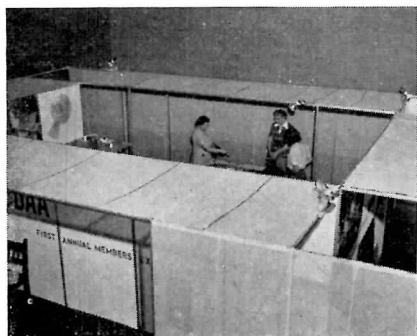

INSTALLATION consisted of cloth-covered aluminum framework especially designed for the exhibit; it is demountable and will be available for reuse

How effectively the cause of architecture can be promoted in small communities where architects may be very few in number and their organization funds correspondingly limited is strikingly illustrated by two highly successful projects of the Sarasota-Bradenton Association of Architects for the local celebration of the Centennial Year of the American Institute of Architects.

The first was the inauguration of what it is hoped will be an annual architectural exhibit of work of Association members, held last Spring at the Ringling Art Museum in Sarasota. The exhibit was seen by nearly 4000 persons during its two-week showing. It put local buildings "in the news" (some shown on this page), including work by Paul Rudolph, with John Crowell and Eliot Fletcher, Jack West, Carl Vollmer, Sidney Wilkinson, William Rupp, William

Zimmerman, John Crowell, Kanneberg and Hanebuth, Victor Lundy, Ralph S. Twitchell, E. J. Seibert, R. H. Slater, Sellev and Gremli, and E. B. Waters.

The second achievement was a 24-page special section of the *Sarasota Herald-Tribune*, published July 28, containing — as front page headlines proclaimed — "a presentation of the recent work of Sarasota-Bradenton architects in honor of the American Institute of Architects 100th anniversary celebration." It also included an article on the A.I.A. itself headlined "A.I.A. was Formed 100 Years Ago to Create Standards of Performance, Code of Ethics."

The Association, which has had the assistance of a professional public relations council, has 19 members of the A.I.A. As for community size: Sarasota — pop. 18,896; Bradenton — pop. 13,604 (1950 census).



4



3



2

AMONG PROJECTS ON DISPLAY
1. Sarasota Herald-Tribune Building, publishing plant for Lindsay Newspapers Inc.; Ralph and William Zimmerman, Architects. 2. Office Building, Bayshore

Gardens; Sidney Wilkinson, Architect. 3. "Canal House," Siesta Key, Sarasota; Jack West, Architect. 4. "Round House" (for the architect), Sarasota; Carl Vollmer, Architect



1

new California hospital more usable space

Easier, faster installation, long life, and low maintenance also important factors in choice of copper tube for Fairview State Hospital

Copper tube was specified for the sanitary drainage lines in the Hospital Building and Administration Wing of the new Fairview State Hospital now under construction at Costa Mesa, California, to eliminate wasted space in furred areas and to allow ample headroom in the basement. Equally important to the project owners, however, was the fact that copper tube drainage systems are easier to install, are long-lasting, and require less maintenance than other materials.

Copper tube was used also for the hot and cold water lines and for the radiant heating system.



Easy to connect. Preparing to solder an 8" to 6" cast-brass drainage Y-branch fitting. Solder-joint fittings help cut installation time one-third to one-half. No threading, no caulking. No heavy, cumbersome equipment needed.

TREND TO COPPER

"The factors important to us as mechanical contractors are the work-saving features of copper tube. It has proved to be easier to handle, more adaptable to space problems, less trouble to test, and, as a consequence, faster to install than other methods considered standard.

"Our firm is of the opinion that copper tube drainage systems will become standard in the place of those now in use, when the people who are associated with the construction industry become more aware of the many advantages."

B. J. Sabin, manager, E. O. Nay Co., Inc.,
plumbing contractor on Fairview State Hospital

Everyone benefits with all-copper plumbing. Architects have greater freedom in design to locate bathrooms and utilities where desired without sacrificing useful space. Contractors report that installation time has been reduced one-third to one-half—and their men prefer working with copper tube. Owners get plumbing that lasts—costs little to maintain.

Anaconda Copper Tubes — Types K and L for water supply and heating lines; Type M and the new lighter weight Type DWV for the sanitary drainage system. Anaconda wrought and cast solder-joint fittings in a wide range of sizes and types for pressure and drainage applications. Write for Publication C-33. Address: The American Brass Company, Waterbury 20, Conn. In Canada: Anaconda American Brass Ltd., New Toronto, Ont.

5754

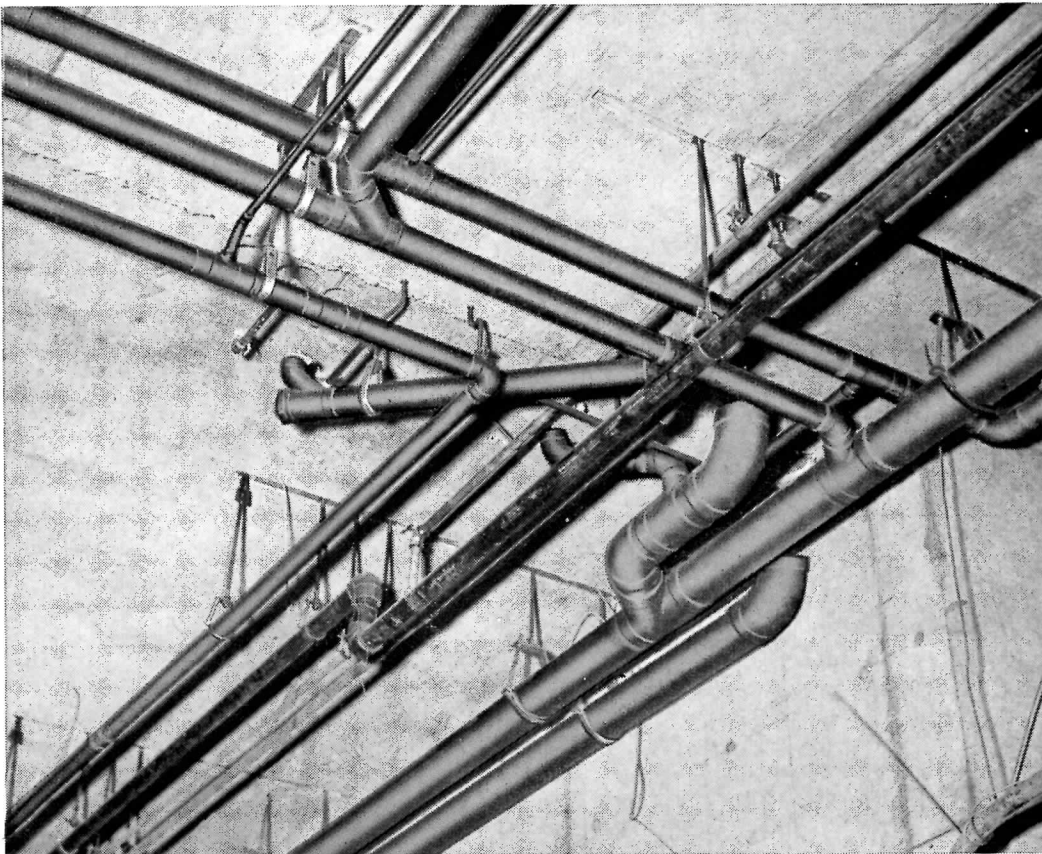

Close work like this is possible only with copper tube. Water and drainage lines hug the ceiling, giving ample basement headroom. Even in tight quarters, connections are easy to make. Sizes in this layout range from 3/4" water lines at top to 4" for drain and vent lines at right below.

ANACONDA[®] COPPER TUBES AND FITTINGS

Products of The American Brass Company • Available Through Plumbing Wholesalers

THE RECORD REPORTS

PRESERVATION: NEW CHALLENGE TO MODERN ARCHITECTURE?

Annual Meeting of National Trust for Historic Preservation And Expanding Program Reflect Wider Concern with a Problem Vastly Magnified by U.S. Urban Renewal and Highway Programs

An expanding program with increasing implications for architecture was reflected in the discussions and activities reported at the 11th annual meeting of the National Trust for Historic Preservation, held at Swampscott, Mass., in October. Attendance by some 450 delegates and members was more than double that at any prior meeting; and there was big news for this record gathering in the announcement of two grants totaling \$2.5 million to the National Trust from the Old Dominion Foundation and the Avalon Foundation: this started the Trust on the road to the \$10 million endowment needed to finance the broader service envisioned for it earlier this year in a report by a special Committee on Planning.

Two major developments:

(1) Announcement of a formal agreement with the National Park Service to continue and expand collaboration between the two groups, especially in connection with the Historic Sites Survey, and in the formulation and adoption of criteria and standards for the preservation and exhibition of historic sites and buildings.

(2) Authorization of a special committee, to be set up by The National Trust, consisting of the chairmen of the architectural control boards of the 15 (now 16) U. S. communities which have them: the committee to provide a forum for discussion at future National Trust meetings; a channel for exchange of information and experience; and a source of advice for new architectural control boards as they are set up.

The formal program was divided fairly evenly between tours of some of the historic landmarks of that history-rich area and speeches on subjects ranging from "McIntire and the Federal Style" to the current Federal highway program. James Parton, editor of *American Heritage*, was there to give some fantastic evidence on the current boom in things historical, and at one panel session Architect Samuel Wilson Jr. gave an illustrated talk on achievements in the restoration of the Vieux Carré.

In the meetings and informal discussions it was clear that the National Trust is in more than one sense standing where brook and river meet. Perhaps its greatest organizational strength so far has come from members chiefly interested in specific historical properties

and the philanthropists who can make their preservation possible; but the Trust has moved steadily toward the broader goals of "a well-rounded program of scientific study, protection, restoration, maintenance and interpretation of sites, buildings and objects significant in American history and culture," and the expanded program for the future proposed in the report of the Committee on Planning would still further stress the educational side of the Trust's twofold mission of education and preservation. The Federal urban renewal and highway programs give the field of preservation entirely new dimensions and tempo, and the Trust is already being asked to consult on the problems they create. An important tool in this activity is the "Criteria for Evaluating Historic Sites and Build-

THE A.I.A. AND PRESERVATION

Activities of the American Institute of Architects in the preservation field are conducted by its Committee on Preservation of Historic Buildings, headed by Earl H. Reed, F.A.I.A., of Chicago, as chairman. At the RECORD's request, Mr. Reed has prepared the following statement describing the committee's work.

The National Preservation Program was authorized by the Institute in 1951 to meet the menace of destruction and mutilation faced everywhere by our historic buildings. The Committee on Preservation of Historic Buildings developed and administers it, in close cooperation with the National Park Service, the National Trust for Historic Preservation and the Society of Architectural Historians, with the object of fully recording and protecting our historic buildings through education of the public and profession in advance of menace.

Viollet-le-Duc well stated historic building values as "lasting memories of the faith, the patriotism and the social customs of our forefathers." But our committee carries forward to the present. While centering our attention on structures dating from 1855 to 1900, we also supplement and correct previous records of the Historic American Buildings Survey and add later significant structures after 1900 as identifiable — works by Sullivan, Saarinen and Wright

ings," established in 1948 and revised last year. The Criteria stress cultural as well as historical and give full recognition to architectural significance.

The National Trust was chartered by Congress in 1949 (two years after it was organized) as a private voluntary agency to supplement the work of the National Park Service in historical preservation. Supported entirely by (tax-exempt) contributions, it has grown to a membership of 2118 individuals and 234 organizations, among them the American Institute of Architects, whose collaboration the Trust values and seeks. Individual architect members number about sixty. The headquarters staff in Washington (at 2000 K Street N.W.) is headed — since last year — by President Richard Hubbard Howland, former head of the Department of Fine Arts at Johns Hopkins University. David E. Finley, former director of the National Gallery and chairman of the National Fine Arts Commission, has been chairman of the Board of Trustees from the beginning.

have received our attention.

The more than 100 Preservation Officers in the chapter areas conduct the National Inventory, identifying and characterizing historic buildings. They also assist in preserving them, encourage educational programs and publicity, furnish preservation information and prepare H.A.B.S. records when possible. Completed Inventory forms are deposited in the Library of Congress, with copies to NPS, the National Trust, the Octagon and to local safekeeping in libraries of historical societies: completed forms now total about 1200. Virginia, subsidized by the Old Dominion Foundation through the National Trust, leads with 461 forms, with New York second, largely due to the activity of the Municipal Art Society of New York City; Rhode Island, Connecticut, Michigan and Illinois follow in that order. Special projects are under way in Philadelphia and St. Louis. Great benefits to scholarship and preservation are expected through this continuous national listing.

Though concern for historic buildings is mounting, destruction continues alarmingly. We hope our efforts, with those of our colleagues in the National Park Service, the National Trust and the Society of Architectural Historians, will increase public appreciation — and thus preserve our national heritage for posterity.

(More news on page 181)

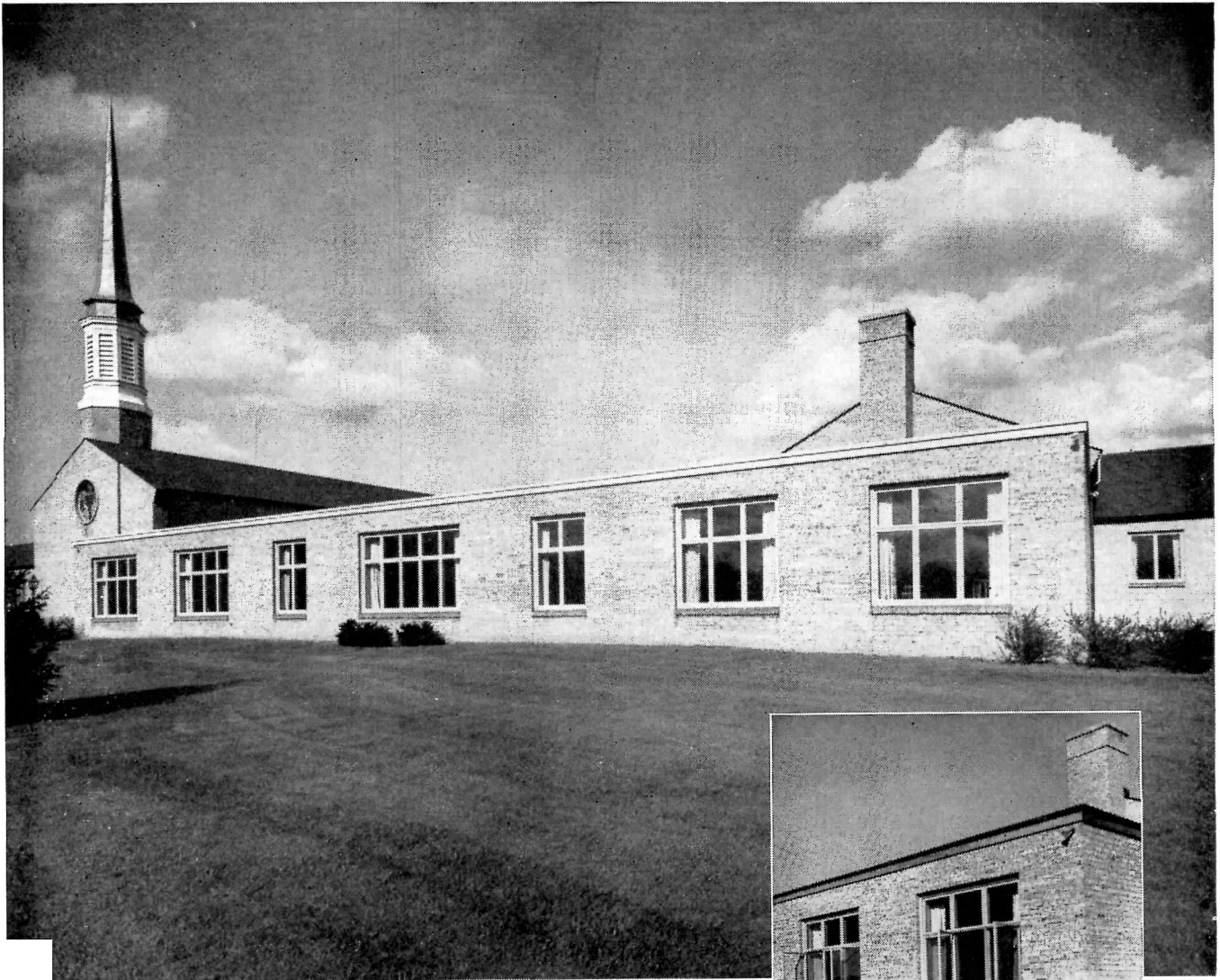

Artist Church, Rochester, New York. Architect: Martin, McGraw, and Wiard.

Four different combinations of PELLA 24" x 24" fixed and 48" x 24" ventilating casement units are used effectively here to accent the over-all design of this unadorned elevation.

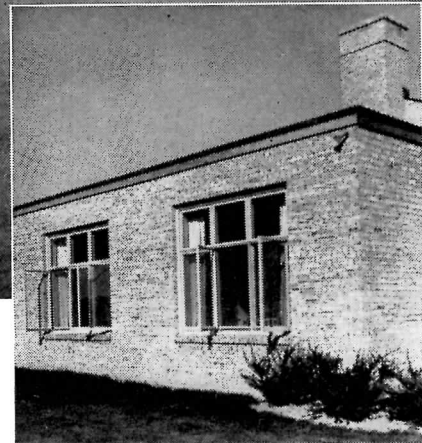

Wood Casement units up to...

68" HIGH, 24" WIDE AND SO HANDSOME

There is a good reason why PELLA offers the *only* wood casements with glass sizes as large as 24" wide x 68" high.

Butt plates of sash hinges are *riveted* to the inner rigid steel frame that reinforces the sturdy wood lining. Extra long hinge wings give extra bracing to sash.

PELLA WOOD CASEMENTS are equipped with ROLSCREENS... the inside screens that roll up and down like a window shade. Specify either PELLA Dual

Glazing Panels or insulating glass. Both eliminate "storm window nuisance" and protect against cold, heat and street noises.

See our catalog in Sweet's or fill in and mail coupon today.



WOOD CASEMENT WINDOWS

ROLSCREEN COMPANY, Pella, Iowa

Dept. 1-134

Please send helpful 20-page book, "Library of Window Ideas."

FULL NAME _____

ADDRESS _____

CITY _____

ZONE _____

STATE _____

ATTENTION MR. _____

TEL. NO. _____

NEW ZEALAND HOLDS FIRST ARCHITECTURAL "CONVENTION" AND EXHIBIT

The New Zealand Institute of Architects, which has been holding annual conferences attended by its own members for the last 50 years, this year held its first "convention." The term was used, as a departure from normal practice, to recognize a special effort "to follow overseas trends and widen the scope of the normal conference program to include as many public functions as possible." The aim was "to bring New Zealand's architects as a profession into closer contact with members of the com-

munity; to invite them to join in the convention to see and hear about modern trends in architecture, both at home and abroad." The convention, held in Auckland, had as its official guest and principal speaker Architect Harry Seidler of Australia; it had a series of symposiums on such subjects as "The Architect's Role in Building Projects"; "The Artist in an Architectural Age"; "Architecture of the Air Age"; "Soil Mechanics and Building Foundations"; and "Some Auckland Shapes and Spaces."

It also had a number of exhibitions, including the first in Auckland to be devoted solely to architecture and building and the largest ever held in New Zealand; focal point was the full-scale house designed by Mark Brown and Fairhead, Architects, and built in the Town Hall "to display to the public some of those materials, products and techniques . . . which are in use in New Zealand now or which we believe will become an integral part of New Zealand building in the near future."

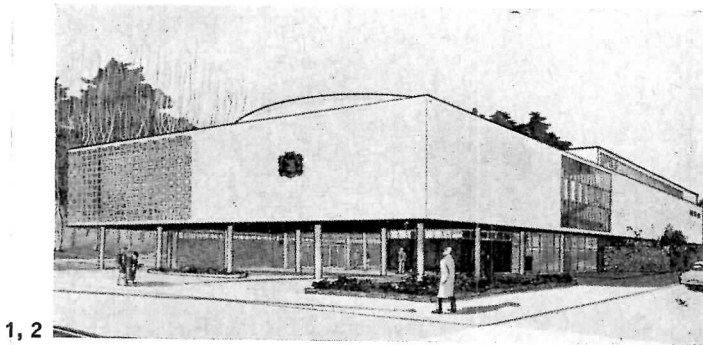

1, 2

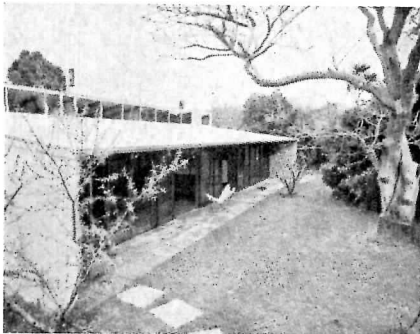

3, 4

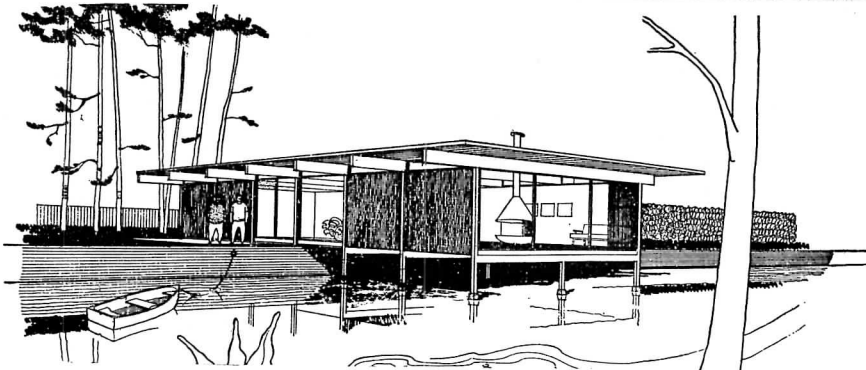
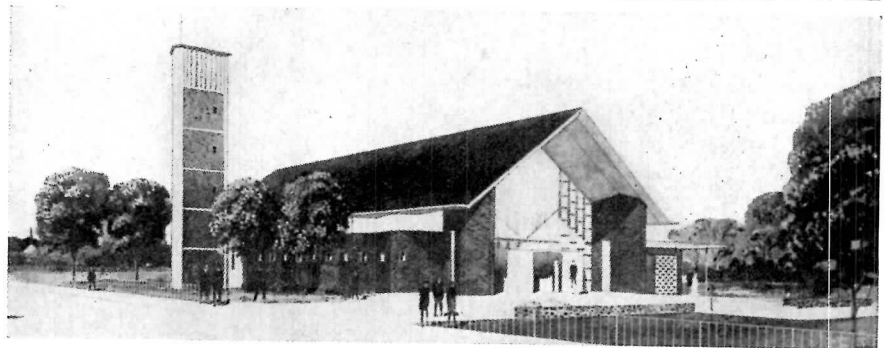

5

NEW ZEALAND ARCHITECTURE
 1. Wanganui War Memorial, prizewinning design by Greenough, Smith and Newman, architects. 2. Takapuna Grammar School Memorial Library; Massey, Beaton, Rix-Trott, Carter and Co., architects. 3. House at North Shore; Group Architects. 4. All Saints' Church; R. H. Toy, Architect. 5. Exhibition House; Mark Brown and Fairhead, architects. 6. Sports pavilion for Mt. Albert Grammar School; R. H. Toy, architect

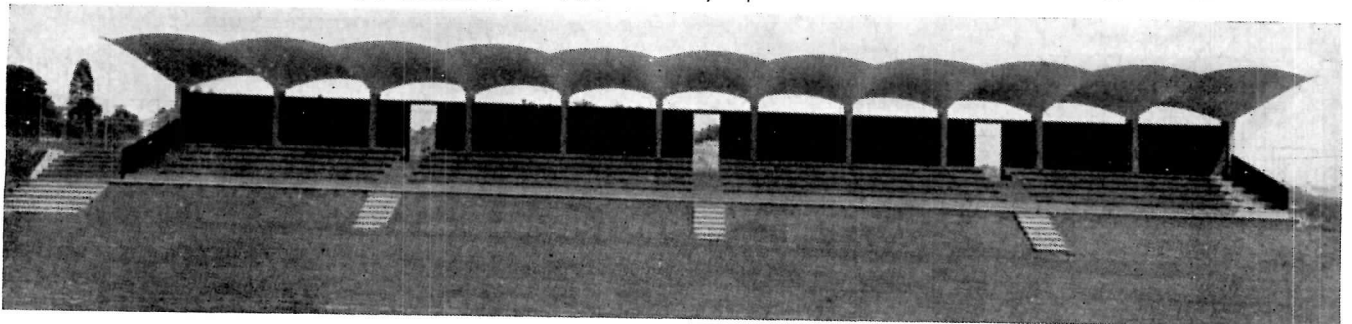

6

(More news on page 21)



Plate No. 620

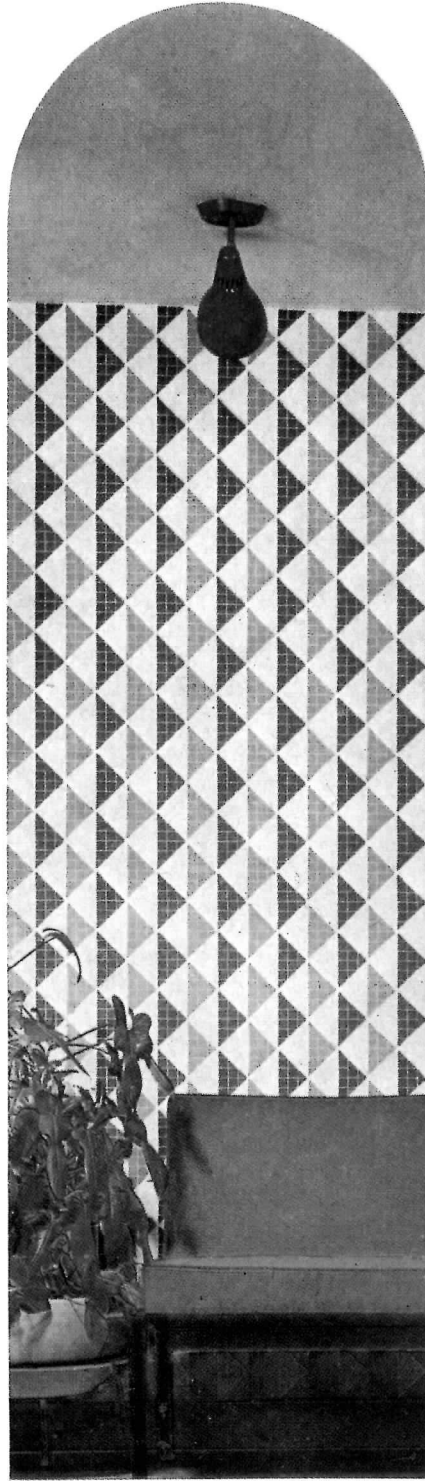

Plate No. 584

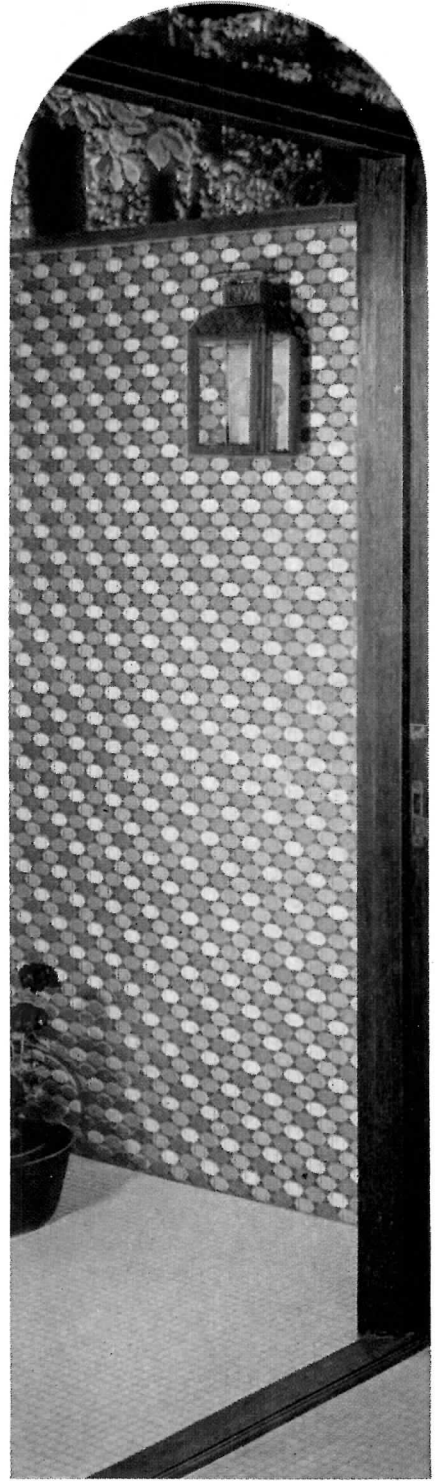

Plate No. 579

For free estimates on
Mosaic Tile, see the
yellow pages for your
Tile Contractor, Ceramic



MOSAIC[®]

BY MOSAIC



Brilliant new patterns, colors and shapes in ceramic mosaic floors and walls, indoors and out. Translated for the enrichment of our homes and public buildings by Kenneth M. Gale, our Director of Design, from his extensive research into the finest of old-world Byzantine mosaics. Wide variety of patterns offering great latitude in color, scale and decorative effect, all in everlasting, maintenance-free ceramic tile. Call for estimates from your ceramic tile contractor. For your file copy of the richly illustrated Mosaic Byzantine Pattern Book, Form No. 219, write Dept. 1038, The Mosaic Tile Company, Zanesville, Ohio.

A ROUNDUP OF NEW BUILDINGS AND CURRENT PROJECTS

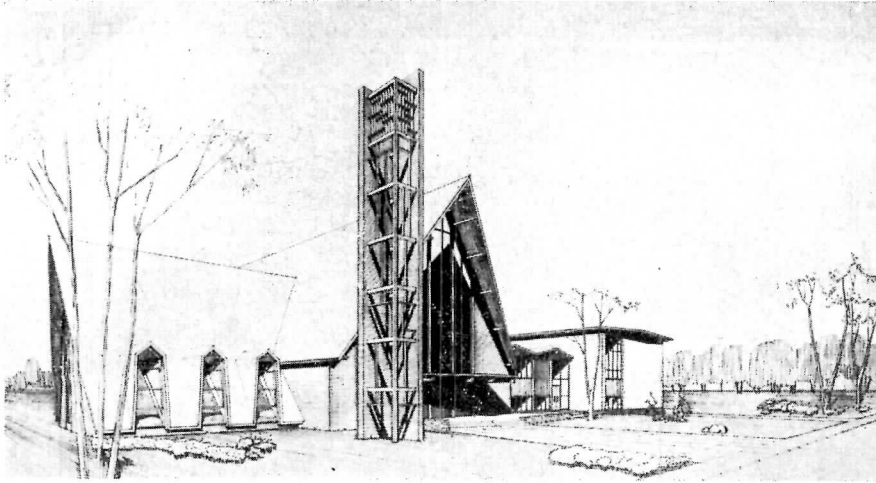

Below: Salvation Army Children's Village, London, Ont.; O. Roy Moore and Company, London, Architects. Photograph shows a typical cottage; overall view is shown in perspective



Above: United Church, Cooksville, Ont.; E. C. S. Cox, Architect. Project, to cost estimated \$325,000, includes church seating 520, chapel seating 40, free-standing bell tower, administration or office section and auditorium seating 400, to be used as part of Sunday School

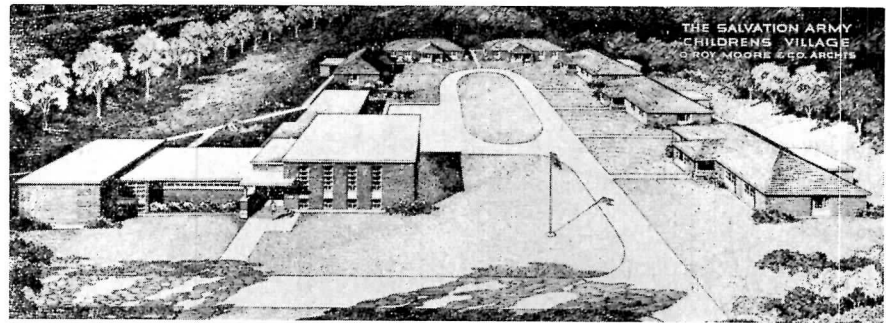

Service headquarters for B.C. Electric's natural gas distribution system, Burnaby; design by B. C. Electric Engineer Company



Imperial Oil Building, Toronto; Mathers & Haldenby, Architects. Offices are grouped around service core

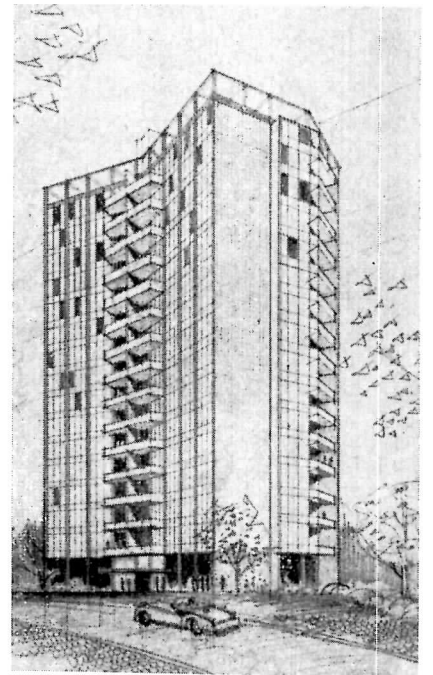

Above: Kilsilano Towers apartments for Vancouver, B. C.; Robert C. Bennett Associates of Vancouver, Architects, W. K. Noppe, Associate Architect, Sanderson and Company, Consulting Engineers. This 15-story apartment building, for prominent site near Vancouver's Burrard Street Bridge, will have 140 suites

Below: Residence of Mr. and Mrs. Gabriel Gilbert, Quebec City; André Gilbert, Architect. Street façade of stone and cedar is

designed for privacy; window walls at rear look out on wooded lot. Foundation is slab on ground with one basement area

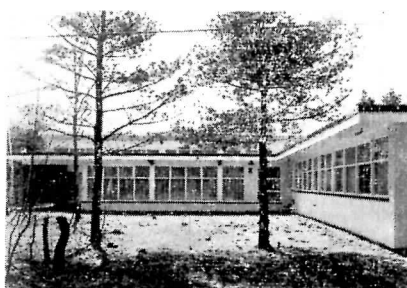
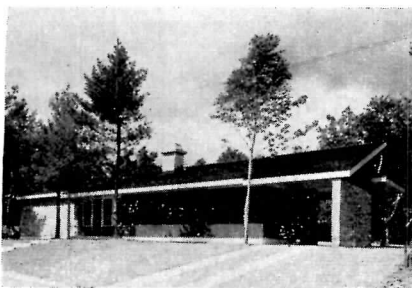

(Continued on page 40)

In the first five months following their introduction in May 1957, Color Glass Blocks by Pittsburgh Corning have been specified by more than 50 leading Architects. Projects include schools, churches and commercial buildings. This product, pioneered by PC, comes in a variety of ceramic face colors and is translucent.

*It is available on Architect's
Pittsburgh Corning*

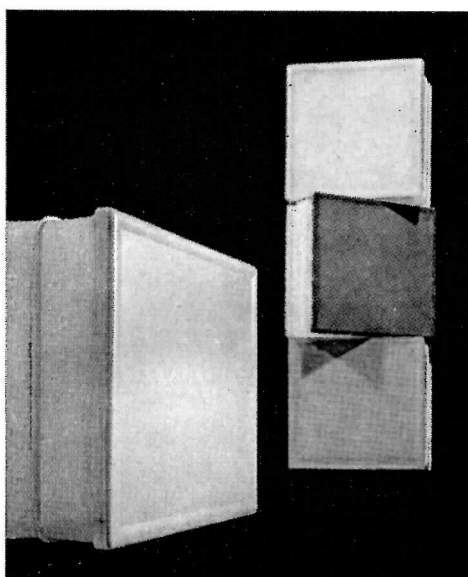

*specification only.
Corporation*



For complete information on this new design medium for Glass Block Curtain Walls, write Pittsburgh Corning Corporation, Dept. C-127, One Gateway Center, Pittsburgh 22, Pa. In Canada: 57 Bloor Street West, Toronto, Ontario

THE RECORD REPORTS

NEWS FROM CANADA

(Continued from page 36)

MORE THAN A RACE TRACK: TORONTO'S WOODBINE PARK

The 780-acre, \$13 million race track opened last year in Toronto's Woodbine Park has three tracks and can comfortably accommodate 40,000 spectators — 8751 of them in clubhouse and grandstand, 20,000 as standees and the bal-

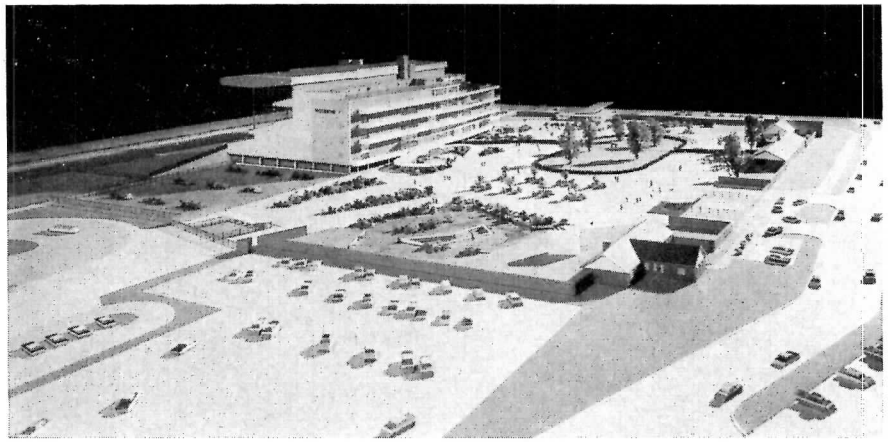

a water cooler that fits inside the wall...

this is one of the new

SUNROC

RECESSED PANEL COOLERS

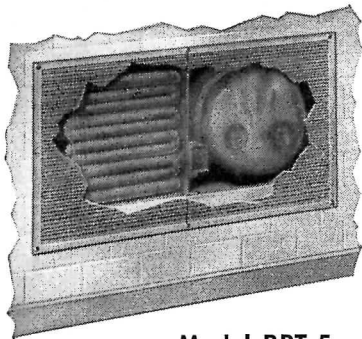

• • • **Model RPT-5 gph** • • •

This super-slim cooler is only 6 3/4" deep x 23 1/8" wide x 21 1/2" high. It fits in any extremely small area. The illustrated wall grille is available for access to cooler when installed inside the wall.

Models RP-16, 33, and 42 gph

Sunroc RP Coolers are available in a variety of models and sizes to meet every need for a remote or concealed water cooler.

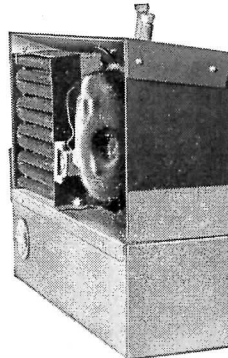

ideally used with

**SUNROC
DRINKING FOUNTAINS**



Sunroc RP Coolers can supply any type outlet. A wide range of Sunroc wall and deck-type fountains are available in vitreous china and stainless steel. Individual requirements are met by a variety of glass fillers and bubblers that offer a choice of fixtures.

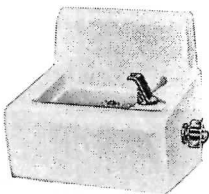

**FOR PROMPT
INFORMATION** ➔

SUNROC CORPORATION
Division M—Glen Riddle, Pa.

Check which and PLEASE PRINT

Send literature on RP Coolers Wall Fountains
 Deck Fountains

NAME.....TITLE.....

COMPANY.....

ADDRESS.....

CITY.....STATE.....

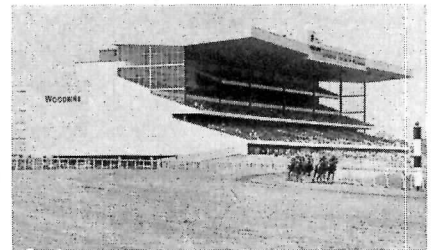

ance enjoying various other facilities on the grounds. Woodbine also has its own community center, including a 22-bed hospital, a bank, florist and barber shops, three cafeterias and two dining rooms. For off-duty jockeys, there are a baseball diamond and a football field. Architect was Earle C. Morgan of Toronto.

The tracks are a one-mile dirt track and a seven eighths-mile turf track plus another one-mile dirt track for training. The clubhouse seats 2528, the grandstand 6223; and free parking is provided for 35,000 cars — 30,000 "public" spaces and 5000 clubhouse spaces.

Stabling facilities accommodate 896 horses and provide double-deck bedrooms, with tile showers and bath, for 600 men.

Seating is arranged on four tiers so that "every seat appears to be over the finish line," and there are concessions, mutuel windows and rest rooms on every level within a few ft of every seat. There are escalators, elevators and ramps for access to all levels. The entire track can be cleared in 15 minutes.

Green and white is the predominant color scheme, and the park is elaborately landscaped — there is an outlook over the infield of shrubs, artificial lakes and waterfalls and elsewhere on the grounds there are a number of sunken gardens.

(Continued on page 44)

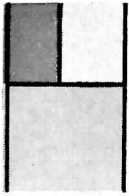

Colorful porcelain enamel curtain walls give office buildings durable beauty, assure low maintenance

Architects utilize unusual design freedom provided by porcelain enamel on Armco Enameling Iron to create distinctive single and multi-story curtain wall structures.

These four distinctive, colorful office buildings demonstrate how porcelain enamel curtain walls create the opportunity for individual architectural expression.

More Design Freedom

Porcelain enamel on Armco Enameling Iron gives you an unlimited choice of hues, enables you to make color a basic element of design. You can select the exact tone needed for effective contrast or harmonious blending.

Economical standard panels are available in almost

any size. Panels with patterned or textured surfaces also can be produced to meet specific requirements. You have all the advantages of a factory-produced building unit that broadens rather than restricts design possibilities.

Proved Durability

More than a quarter-century of satisfactory service in architecture is your assurance of the economical durability of porcelain enamel on Armco Enameling Iron. Weather has no visible effect on either color or surface. Buildings with porcelain enamel curtain walls retain their client-pleasing new look indefinitely.

Low Maintenance Costs

Curtain walls of porcelain enamel cost less to maintain because their hard, color-fast surface sheds dirt. Rain plus an occasional cleaning with soap and water keeps them looking like new. Porcelain enamel on Armco Enameling Iron also provides strength and rigidity.

In your plans for large or small buildings of any type, consider the durable beauty and economy you can offer clients by specifying curtain walls of porcelain enamel on Armco Enameling Iron.

Because of its purity and uniformity, porcelain enamellers use more of this special metal than any other base metal for architectural applications.

Let us send you more information on porcelain enamel curtain walls in modern architecture. Write us at the address below for a copy of "Architectural Design with Porcelain Enamel."

ARMCO STEEL
CORPORATION

2367 CURTIS STREET, MIDDLETOWN, OHIO • SHEFFIELD DIVISION • ARMCO DRAINAGE & METAL PRODUCTS, INC. • THE ARMCO INTERNATIONAL CORPORATION



THE RECORD REPORTS

NEWS FROM CANADA

(Continued from page 40)

CMHC AWARDS FELLOWSHIPS FOR CITY PLANNING STUDY

Fifteen fellowships for postgraduate study in community planning at Canadian universities have been awarded by the Central Mortgage and Housing Corporation. The fellowships are valued at \$1200 each.

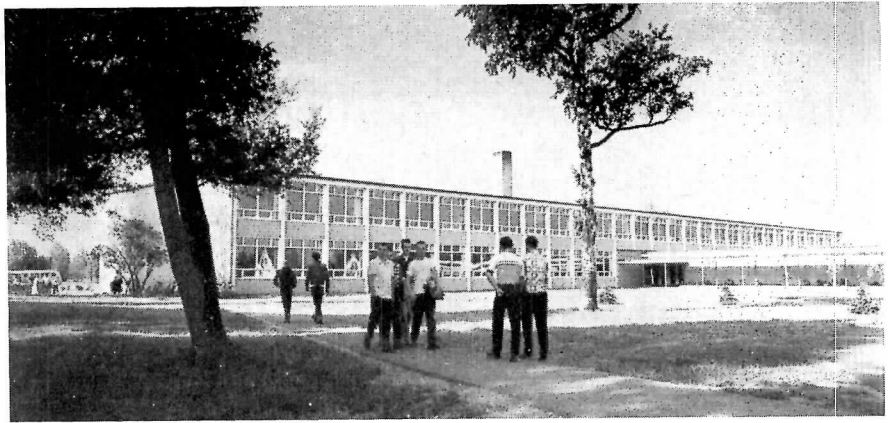

Collingwood District Collegiate Institute, Collingwood, Ont.; Shore and Moffat of Toronto, Architects

FOR YOUR DOORS OF DISTINCTION

CIPCO
CORPORATION
2200 COLE STREET
ST. LOUIS 6, MO.

Cipco has the flexible resources that can accurately interpret your special designs, combining functional construction with beauty and quality that provides the best guarantee for enduring Architectural Hardware.

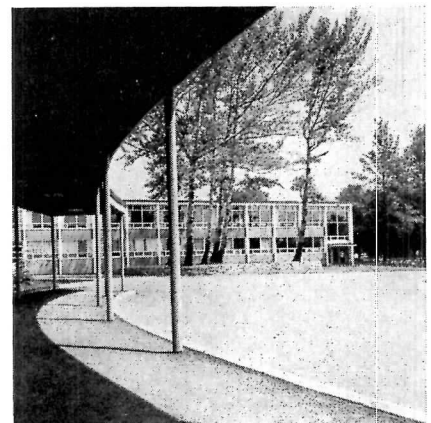

Award winners are: J. R. Anton and Q. H. Stanford, Toronto, University of Toronto; E. T. Clegg and R. A. Williams, Vancouver, T. W. Loney, Calgary, and R. S. McConnell, Edmonton, University of British Columbia; K. J. Jones, H. B. Goldman and Mrs. C. D. Walford, Montreal, McGill University; N. J. Metz and S. H. Osaka, Montreal, University of Manitoba.

Also Miss Jean Downing, Regina, and S. W. Pape, Vancouver, University of British Columbia; Miss Edith Wasserman, Toronto, University of Toronto; and Rev. J. E. Page, Winnipeg, University of Manitoba.

The committee of awards consisted of Prof. D. L. Thomson, dean of the Faculty of Graduate Studies and Research, McGill University, chairman; Prof. A. P. C. Adamson, president of the Town Planning Institute of Canada; Eric Thrift, director of the Metropolitan Planning Commission of Greater Winnipeg; and Alan Armstrong, representative of C.M.H.C.

QUERIES FLOOD TORONTO IN CIVIC SQUARE COMPETITION

Inquiries about the international competition for the design of Toronto's civic

(Continued on page 46)

NOTES FROM AN ARCHITECT'S SKETCH BOOK

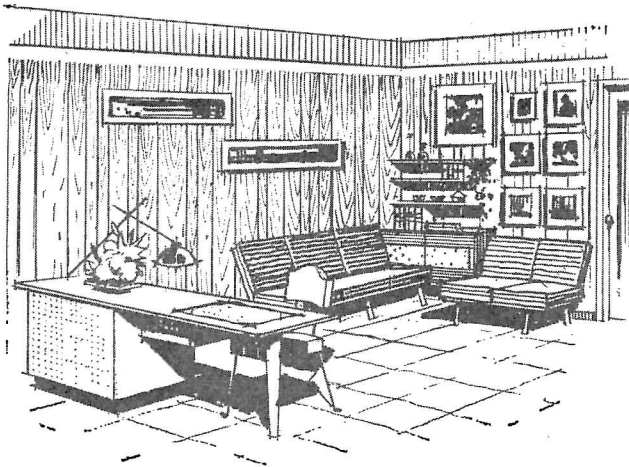

IN THE RECEPTION ROOM- NEW MASONITE SEADRIFT PANELS MAKE INTERESTING TEXTURAL CONTRASTS WITH ROOM FURNISHINGS AND ADD RICHNESS TO OTHERWISE DRAB DECOR.

IN THE BETTER RESTAURANTS

NEW MASONITE SEADRIFT PANELS COMBINE WITH ALL OTHER MATERIALS AND FURNISHINGS TO CREATE SMART DECORATIVE SCHEMES. ECONOMICAL FOR REMODELING.

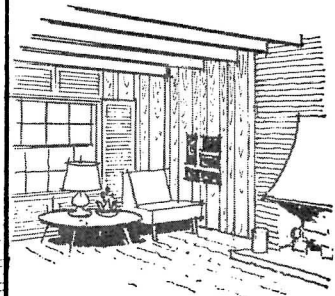
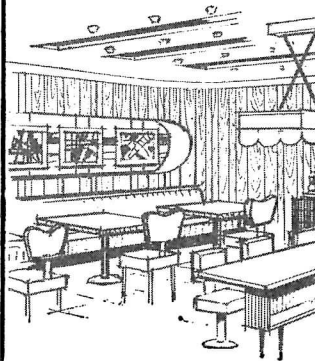

IN THE HOME

NEW MASONITE SEADRIFT PANELS COMBINE WITH WOOD, MASONRY AND FABRICS IN FAMILY ROOM, DEN, OR EVEN LIVING ROOM.

FOR DRAMATIC BACKGROUND EFFECTS—

MASONITE'S

NEW SEADRIFT PANELS

Seadrift, a tempered hardboard, is 1/4" thick in 4' widths, up to 16' long. Authentic wood-grain pattern deeply embossed and random-

groove pattern added. Butt joints provide a continuous pattern. Now distributed east of the Rockies, through lumber dealers.

©Masonite Corporation—manufacturer of quality panel products.



MASONITE CORPORATION
 Dept. AR-12, Box 777, Chicago 90, Ill.
 In Canada: Masonite Corporation, Gatineau, Quebec

Please send more information about Seadrift and other Masonite® panel products.

Name.....
 Firm.....
 Address.....
 City..... State.....
 Zone..... County.....

Low bay...

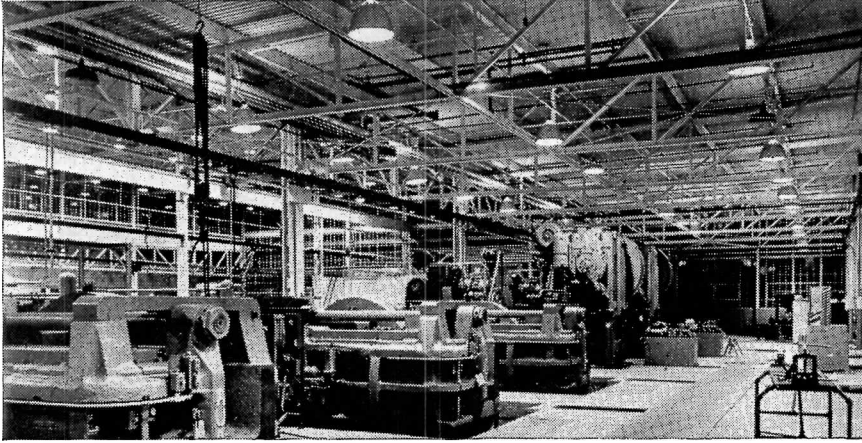

or high bay...

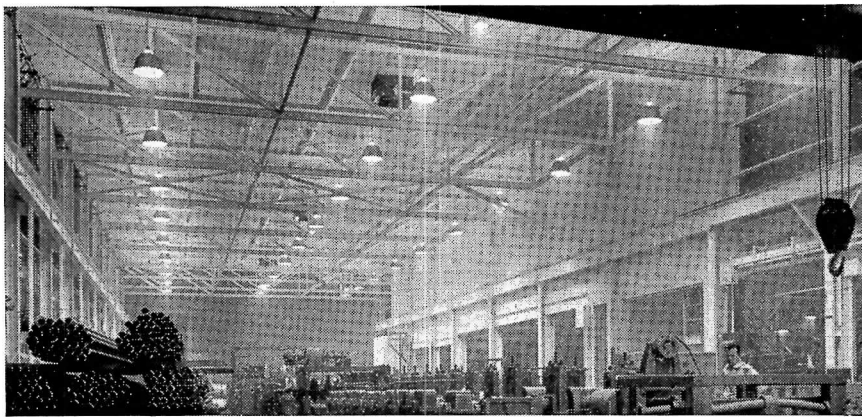

Improve lighting, reduce eye fatigue with Abolite uplight fixtures

Only a *small* amount of light (18%) is directed upward through the open top of Abolite uplight fixtures, but it makes a *big* difference in both high bay and low bay installations. Dark ceiling shadows are washed away—there's no sharp contrast of bright light against black background. Eye fatigue is reduced—workers are more efficient. Air circulation through the open top fixture sweeps the reflecting surfaces clean, keeps maintenance at a minimum.

There are three Abolite uplight units: 18" and 24" diam. Alzak fixtures for use with 400 and 1000 watt mercury lamps; 18" Alzak fixtures for 500 watt incandescent lamps. For full details, write *Abolite Lighting Division, The Jones Metal Products Co., West Lafayette, Ohio.*

INSTALLATION DATA

Top picture: 24" Abolite Alzak aluminum fixtures with H-400-watt RC1 color-improved mercury lamps. 18' mounting height, spaced 13' 4" by 16' 8". 60 foot-candles average initially.

Bottom picture: 24" Abolite Alzak aluminum fixtures with H-400-RC1 color-improved mercury lamps. 28' mounting height, spaced on 20' centers. 35 foot-candles average initially.

ABOLITE

Lighting

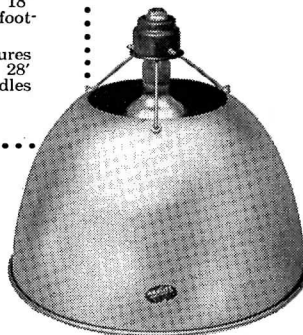

THE RECORD REPORTS

NEWS FROM CANADA

(Continued from page 44)

square (AR, Sept. 1957, page 44) are coming in from all parts of the world, even from behind the Iron Curtain, Professional Adviser Eric R. Arthur has announced. Copies of the "Conditions of Competition" may be obtained from Professor Arthur (address him % City Hall, Toronto, Canada).

Special secretarial facilities have been provided by the city to cope with the flood of mail from the United States, Great Britain, Sweden, Italy, Greece, Czechoslovakia and other countries.

Closing date for submission of drawings in the first stage of the competition is March 28, 1958. At the end of the first stage, eight competitors will be selected to compete in the second stage, at the end of which each will receive \$7500. The winner will be the architect for the building and will be paid a \$25,000 advance on his six per cent fee. The City of Toronto has not set a limit to cost of the project, but estimates have ranged up to \$18 million.

Jury for the competition has been announced as follows: Eero Saarinen, architect, Bloomfield Hills, Mich.; Sir William Holford, architect and planner, London; Ernesto Rogers, architect, Milan; C. E. Pratt, architect, Vancouver; and Prof. Gordon Stephenson, architect and town planner, Toronto.

The "Conditions of Competition," which were drawn up by Professor Arthur, received the official sanction of the Toronto City Council. The required scheme will provide a 660,000-sq-ft city hall designed for expansion and set in a square developed as a park.

Contracts Awarded: Comparative Figures*

(in \$ million)

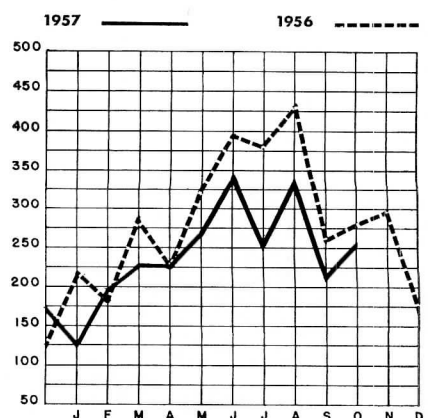

*Compiled by the Editor and staff of The Building Reporter, from information collected by Maclean Building Reports

(More news on page 48)

BES-STONE

The **SPLIT BLOCK** *with Character!*

*Beautiful
Permanent
Economical*

Adds Beauty and Dignity to this Quaint Irish Church . . . Yet Costs Considerably Less than Any Quarried Stone

Here is a fine example of ingenuity and fore-sight on the part of the architect, in designing a church to meet the needs of the local community.

The members of this Irish church wanted the beauty and permanence of building stone, but were faced with cost limitations. They finally selected BES-STONE — the split block with character because it has many of the qualities of fine quarried stone, yet costs considerably less.

While relatively new in Ireland, BES-STONE has for years been specified by American architects. Made of dense block composed of carefully selected aggregate, BES-STONE offers beauty, versatility in construction, freedom from costly upkeep and a distinctive charm that lasts for years.

BES-STONE Split Block is available in a variety of colors and patterns, for either veneer or solid masonry construction. Ask your local Vibrapac block plant for literature or write directly to Besser Company, Alpena, Michigan.

Presbyterian Church, Malahide, County Dublin, Ireland. Architect: W. I. Baird, M.R.I.A.I., Kaye Parry, Ross & Hendy. Contractor: S. McConnell & Company, Ltd. All block supplied by Concrete Products of Ireland, Ltd.

BESSER Company

Dept. 173 • Alpena, Michigan, U. S. A.

FIRST IN CONCRETE BLOCK MACHINES

BESSER



BES-STONE, the modern building material, made from Vibrapac Block produced on a Besser Vibrapac. Available in standard wall widths.

Religious Buildings for Today. Edited by John Knox Shear, A.I.A., Editor-in-Chief, ARCHITECTURAL RECORD. F. W. Dodge Corp. (N. Y.) 1957. 183 pp., illus., \$7.50

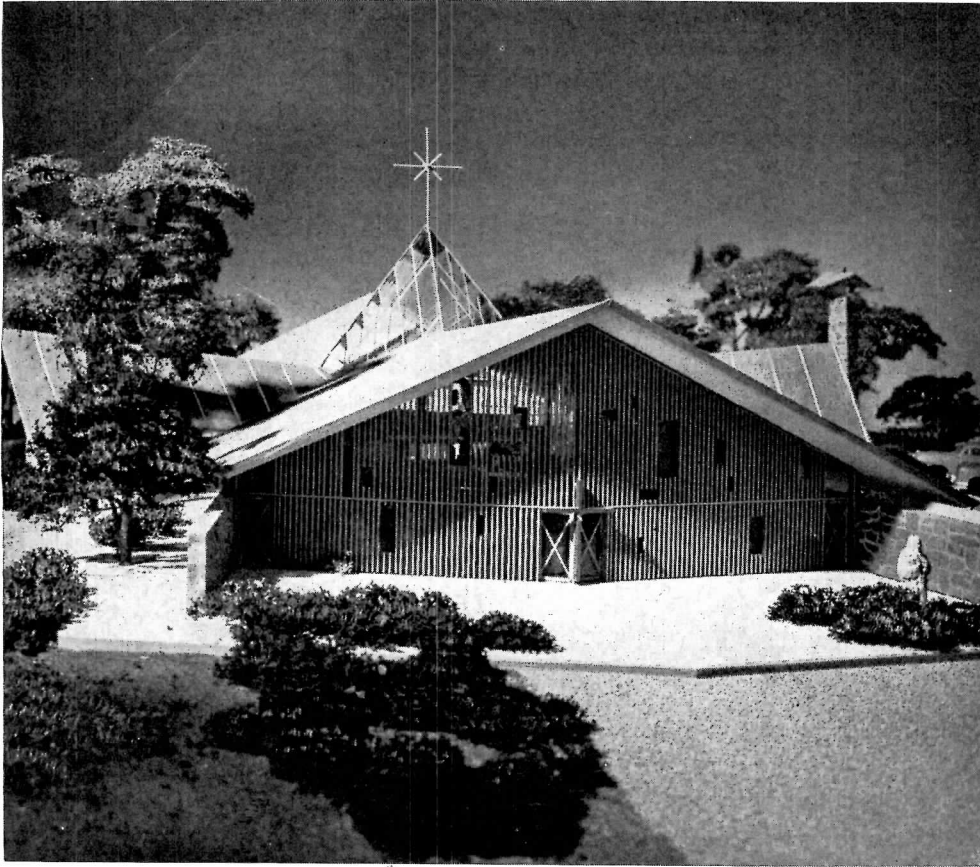

CREATIVE NEW PATTERNS IN CHURCH ARCHITECTURE

BY JOHN OLIVER NELSON, Yale University Divinity School

IF IN THESE TEN YEARS we are building or radically rebuilding 70,000 places of worship at a cost of six billion, every signpost pointing committees and clergy and public to creative new patterns is urgently needed. In compiling *Religious Buildings for Today* from recent issues of ARCHITECTURAL RECORD, Editor John Knox Shear — even though doubtless tantalized by the great number of items he had to omit — has provided a satisfyingly suggestive and educative contribution to the whole subject.

Notoriously, church architecture within past decades has lost the initiative in America which it has carried for many centuries. It succumbed to imitativeness, banality, or a too thorough merging with secular architecture. The trends documented in this volume are complete evidence that religious inspiration has again thrust forward the most distinctive, creatively functional structures of the time. Not slick copies of the past, not “faceless” duplications of the uniform rectilinear mode of today’s factories, schools, office buildings, hospitals, and the rest, church architecture is sending forth new sur-

(Continued on page 62)



Above, St. Francis of Assisi Church, Weston, Conn. Joseph Salerno, Architect. Left, St. Andrew's Church, Park Ridge, Ill. Charles Edward Stade & Associates, Architects; M. Dolan and H. Anderson, Associated Architects

Because

THEY PROVIDE Perfect Air Control

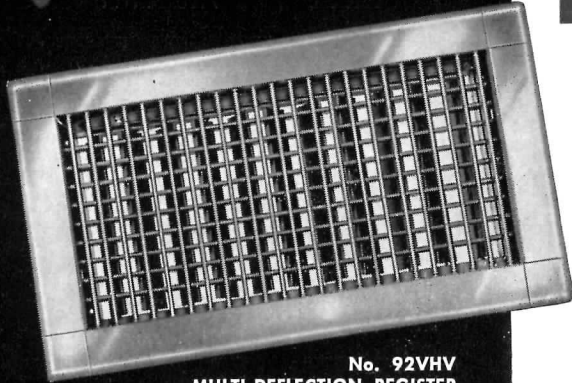

No. 92VHV
— MULTI-DEFLECTION REGISTER
Vertical face bars, horizontal secondary bars, vertical louvers. Also available without valve, No. 92VHO.

No. 92VOV —
SINGLE DEFLECTION REGISTER
with vertical face bars and louvers. Also available without valve, No. 92VOO.

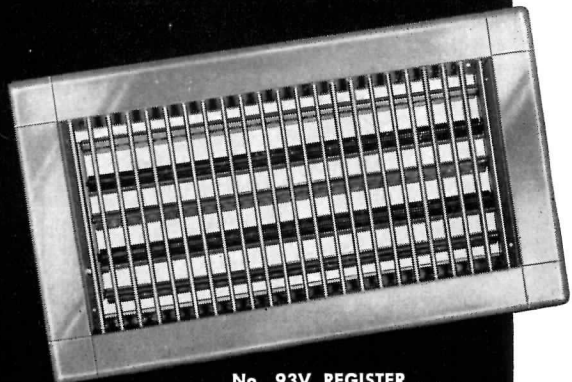
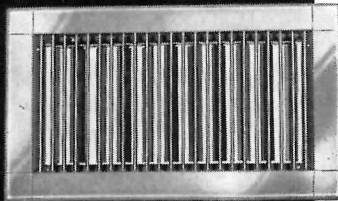

No. 93V REGISTER . . .
vertical front bars set
straight, horizontal louvers.

No. 94A GRILLE
. . . horizontal
face bars set at
22° angle for up
or down deflection.

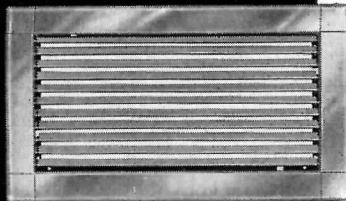

TRIPL-AIRE . . .

REGISTERS & GRILLES for COMMERCIAL INSTALLATIONS

. . . are already downright favorites with a large and rapidly growing number of architects, air conditioning engineers and installers. For with this line it's never necessary to compromise. It permits you to readily achieve the exact air distribution, direction and volume best suited to each and every situation. There are 26 standard sizes, up to 36" x 12", offering 260 possible horizontal and vertical deflection combinations. Intermediate sizes up to 36" x 36" may be had on order. Front adjustments control face bars and louvers, and opposed louvers permit absolute volume control with equal distribution over entire face. Top quality "Decorator Gray" enamel finish. Your nearby H&C Jobber has complete details. We will be glad to furnish his name and location on request.



FIXT-AIRE . . .

. . . return air registers and grilles designed to complement and harmonize with the TRIPL-AIRE line. Registers have a single bank of face bars in fixed vertical or horizontal position, and feature the same opposed louver construction for positive volume control found in TRIPL-AIRE units. Grilles are available with horizontal face bars set at 22° angle for up or down deflection where desired. One-piece sizes up to 36" x 30".

CONVENIENT CATALOG
GIVES COMPLETE DETAILS
AND ENGINEERING DATA . . .
Available from H&C Jobbers
or write direct.



HART & COOLEY

MANUFACTURING COMPANY
Dept. 1-AC, HOLLAND, MICHIGAN

Before you buy any boiler compare quoted prices with **REAL COSTS**

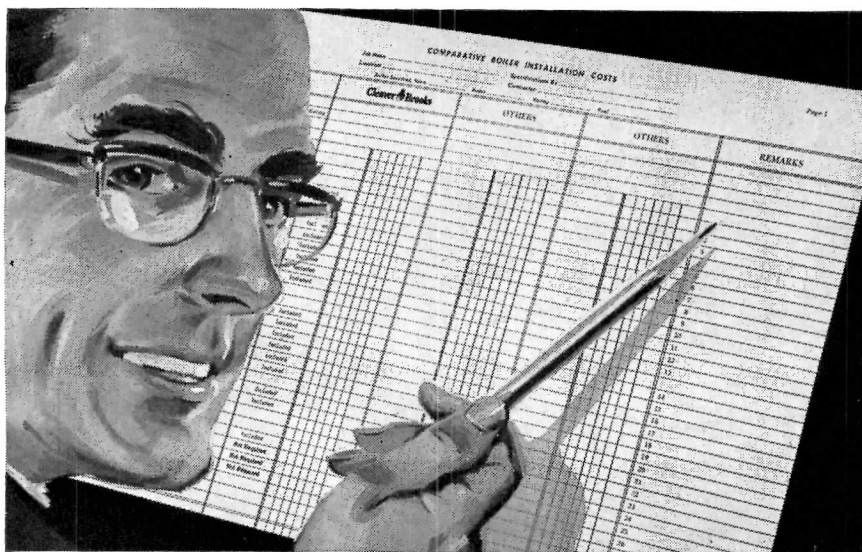

New Cleaver-Brooks cost analyzer clears "quotation" confusion — reveals ALL costs

Get *all* the costs... the *real* costs... down on paper before you recommend or specify a boiler to your clients. On many boiler installations "quoted prices" seldom agree with the total costs, as you may have learned. This is frequently the case with so-called "built-up" boilers assembled on the site.

Cleaver-Brooks' cost analysis enables you to compare all material costs (boiler, steam trim, burner, refractory, controls and other equipment) and installation labor costs. You'll know the "real costs" on the complete installation before you start.

Real eye-opener

The figures you'll see may be startling. In most cases the cost analysis proves a Cleaver-Brooks costs *less*. On-job time is dras-

tically reduced because Cleaver-Brooks packaged units are fully assembled, ready to install. Cleaver-Brooks boilers give you more in performance, too... each boiler is fully fire-tested at the factory under load, tuned to peak economy. Starting service and on-the-job operator training by authorized field engineers further decreases your over-all costs.

Contact your Cleaver-Brooks agent

Once you add up all the benefits of a Cleaver-Brooks "one-cost" package... the proved trouble-free economy of exclusive four-pass, forced-draft design, you'll find it pays over and over to analyze costs carefully before you buy. See your Cleaver-Brooks agent for details or write Cleaver-Brooks Company, 362 East Keefe Avenue, Milwaukee 12, Wisconsin, Dept. P.

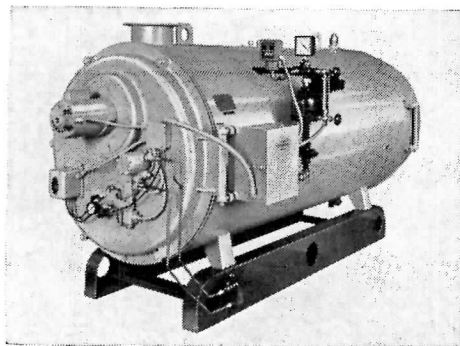

Choose from 19 sizes, 130 models, 15 to 600 hp. Oil, gas and combination oil/gas fired — steam or hot water for heating or processing.

Cleaver Brooks

ORIGINATORS OF SELF-CONTAINED BOILERS

REQUIRED READING

(Continued from page 58)

prising shoots and even a few indisputable blossoms. This book points to some of the most arresting and practical of these.

Unlike some other approaches to the field, the emphasis here is not on the outlandish and bizarre but on good architecture in various lands and many media which can betoken a new level, a new "water table" of general taste. Even though the text is in many instances over-concise, letting the excellent pictures give the story, it weaves a setting of interpretation which is theologically important for most architects, and technically important for most church people. Particularly are Marvin P. Halverson's contributions, pointing to a new Protestant realization of what architecture can mean, a revealing part of the text. It is evident that Roman Catholic, Orthodox, Jewish, and Protestant building has all been vitally affected by new practices and self-analyses — the apparent effort to balance contributions from all these traditions becoming one of the most successful aspects of the book. Again, there are designs for large congregations and small, modest-income groups and wealthy ones, the hard-headed worshiper who "wants something that looks like a church," and the aesthetically urbane whose desire may be just the opposite.

For whom is such a volume most specifically useful? Most architects may have seen these designs one by one as the RECORD first presented them; to have them here in one 182-page volume provides a suggestive reference work. Most building committees and clergy setting out earnestly to secure distinctive housing for their worship and program need to become familiar with the best contemporary design in churches and synagogues; this is definitely the book for them. For both designer and client, the apposite doctrinal synopses — a brief but serious attempt to show the deepest spiritual concern of the various traditions — will be rewarding. The book is a long forward step in recognizing the strides which newly awakened religious architecture has been making.

Technical References

ATOMIC ENERGY FACTS

This 214 page soft-bound volume is a handbook on nuclear operations in the United States devoted to the peaceful uses of atomic energy. *Superintendent of Documents, US Government Printing Office, Washington 25, D. C., \$2.00.*

(More reviews on page 324)

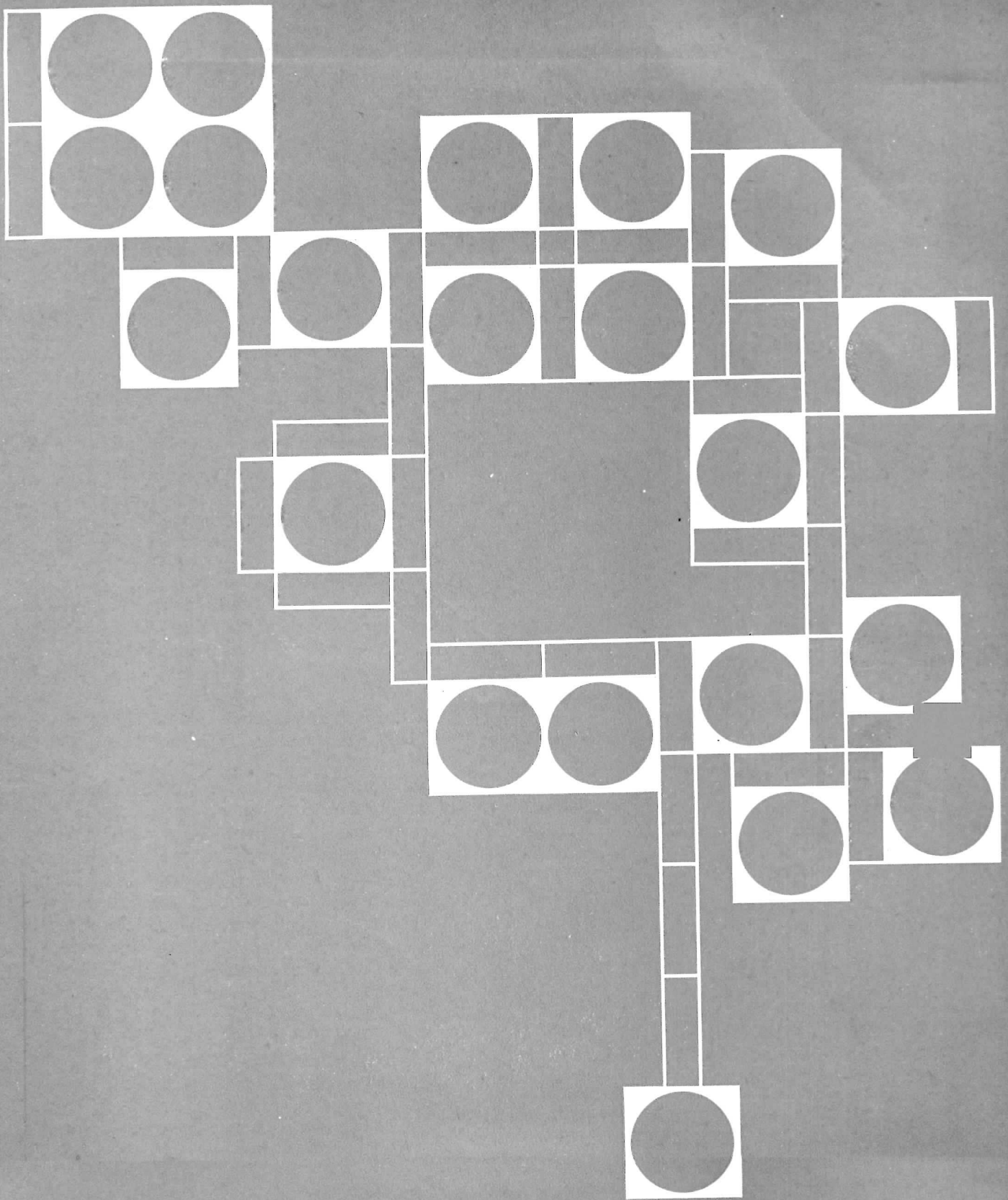

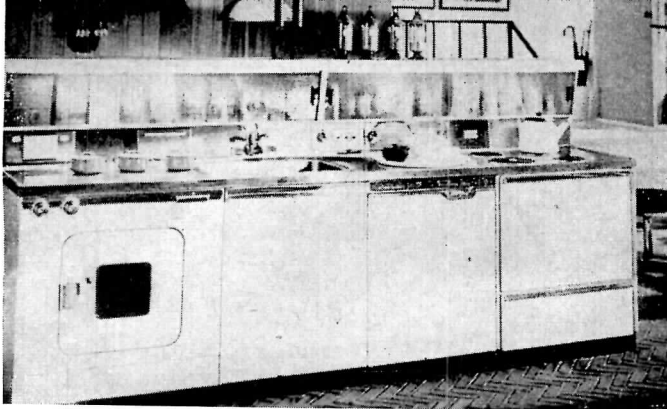

Above: kitchen center designed by General Electric as a result of consultation with the Nelson organization. Below: house for Otto L. Spaeth at Easthampton, L. I.

© Ezra Stoller

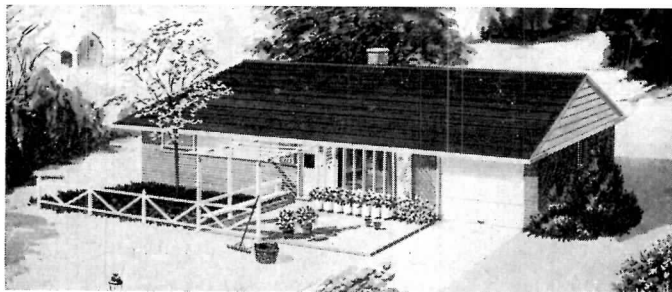

Above: prefab for the Pease Woodwork Co. designed from existing inventories of available materials and components for a market which is unknowing in design terms, nostalgic, emulative and concerned about resale values. Below: office interior for the Columbia Broadcasting System, Milwaukee, Wis.

Hedrich-Blessing

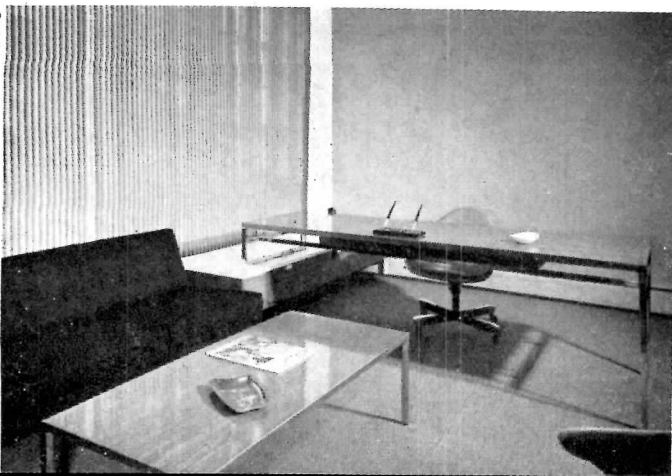

THE GEORGE NELSON OFFICE: A COMPREHENSIVE DESIGN ORGANIZATION

The George Nelson Company differs from most architectural or industrial design firms in the scope and variety of its projects, as well as in the manner in which these projects interrelate. This greatly diversified design operation manifests a unity imposed by architectural discipline. Two of the four principals are registered architects, the others are architecturally trained.

George Nelson, architect, design consultant, editor, and author, in association with senior staff members Irving Harper and John Pile, has established an office which has produced distinguished product, graphic and exhibition design. Architectural and interior design of the same high quality is done by the partnership of George Nelson and Gordon Chadwick.

The architecturally ordered versatility of the George Nelson office is of great value to its clients, any one of whom may benefit from some or much of the design done for other clients. There are many examples in the Nelson work of the intricate interrelations among the basic categories of product, graphic, architectural and interior design. A manufacturer producing furniture designed by the Nelson office uses an aluminum drawer pull the designers developed for a firm making aluminum extrusions. The owner of a custom built house by Nelson and Chadwick is one of the first to have a shelving system made from an extruded aluminum structural pole, connector, and bracket developed for the same firm. An exhibition in San Paolo, Brazil, and one in Williamsburg, Virginia, both completely designed by the Nelson graphics staff, demonstrate another adaptation of this pole and connector system. Clients who have commissioned from Nelson and Chadwick buildings or commercial and residential interiors benefit from other work of the architectural and product design staff as design consultants to the building industry. As a result of their work with manufacturers of glass, aluminum and other basic materials, as well as with the producers of such building components as windows, structural systems, furniture, partitions, lighting and air conditioning systems, and kitchen appliances, the designers are able to make actual use in their architectural commissions of the products they have helped develop.

The comprehensive design program of George Nelson has another important value to the client. It enables the design firm to provide an overall coordinated program of design where needed. A client may invite the firm to design its plant, products, showroom and exhibits, catalogs, displays and packaging. Thus a business can be given its own visual identity.

Right: model of factory complex for the Ansul Chemical Company. Curved glass roof encloses court making it useable all year. Below: James T. Kirkpatrick residence in Kalamazoo, Michigan

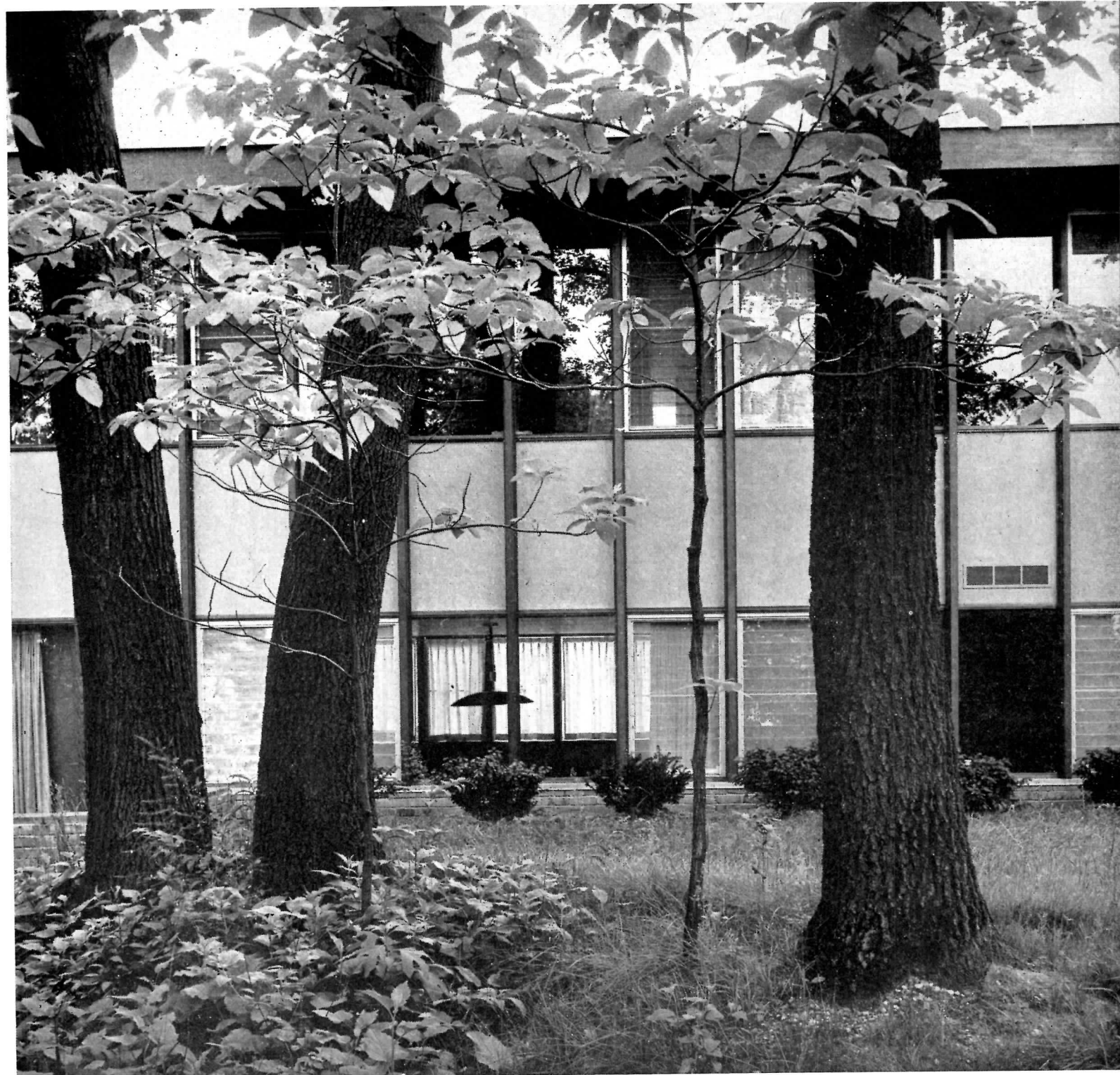
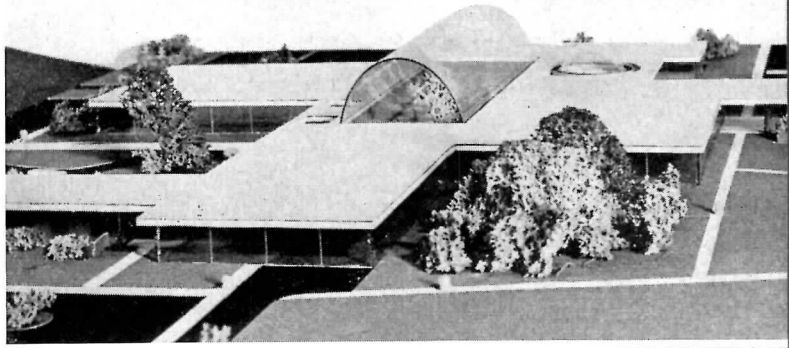

Norman Carver

The New York Times

The New York Times

INFORMATION AND SERVICE CENTER

RECIPES

GARDENING

REFERENCE SERVICES

WARRANTY AND HOME DELIVERY

ORDERS TAKEN HERE

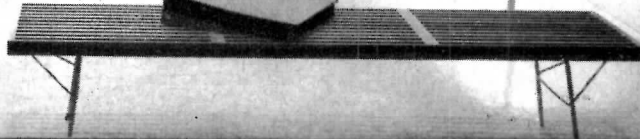

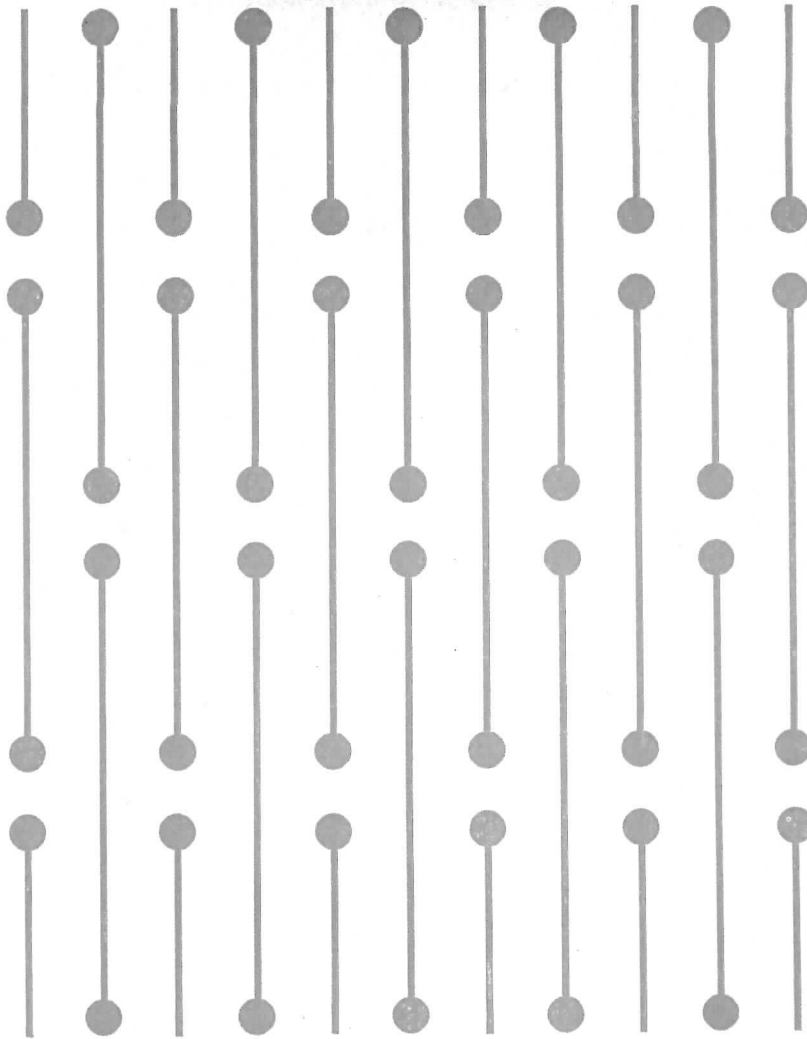

Left: information center for the New York Times. The façade, the light diffusing ceiling made of Venetian blind slats, and the graphic exhibits are all the work of the Nelson office. Most of the furniture shown is manufactured by the Herman Miller Company for which George Nelson is design consultant. Above: one of several different patterns designed to be printed on the plastic sheets which form the core of safety glass. These colored patterns modify light which is transmitted through them. This architectural application was developed for the Monsanto Chemical Company. Right: installation of the pattern at the University of Georgia. Like most of the Nelson interiors this was first studied as a 1-in. scale model of which this is a photograph

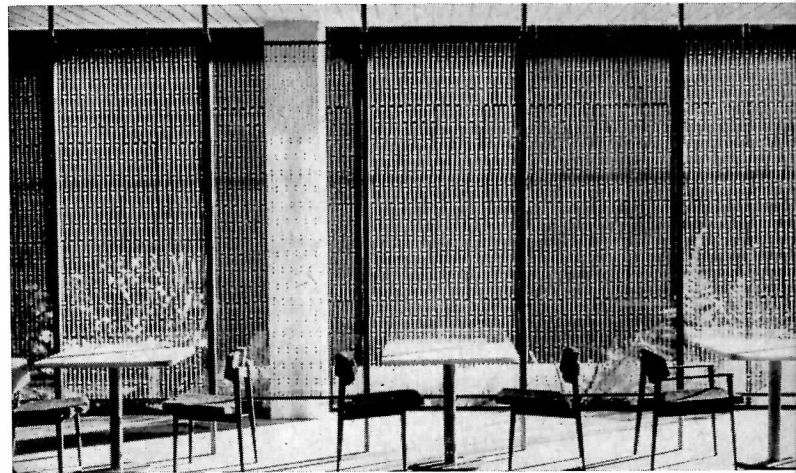

COLONIAL *Williamsburg*

Robert C. Laufman



2



3



4

Drawing by Ronald Beckman

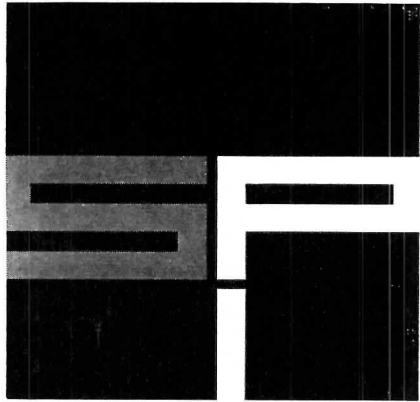

5

1. Don Ervin of the Nelson graphics staff developed a display alphabet based on the Bulmer type face which was cut in 1790. This alphabet is used in the Williamsburg Exhibition itself, and throughout the Williamsburg Restoration area for traffic, parking, identification and other signs. 2. Williamsburg Exhibition system based upon the round 'Omni-pole' designed for Aluminum Extrusions Inc. 3. Exhibition in San Paolo, Brazil, also constructed on the round 'Omnipole' system. 4. A shelf and bracket device designed for Structural Products Incorporated using a square post based on the same principle. All structural members shown in photographs are aluminum extrusions drawn in full scale on opposite page. 5. A symbol created for Structural Products Inc. to be used on letterheads, promotional material, labels and other ways to help establish corporate identity

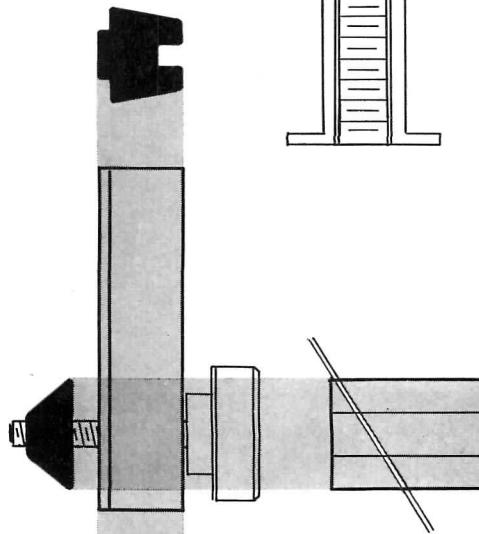
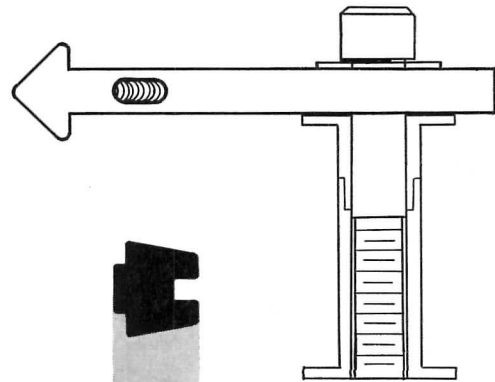
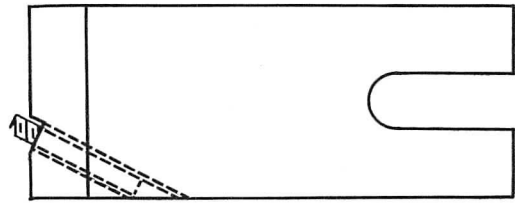
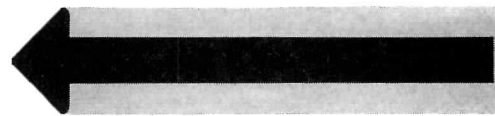
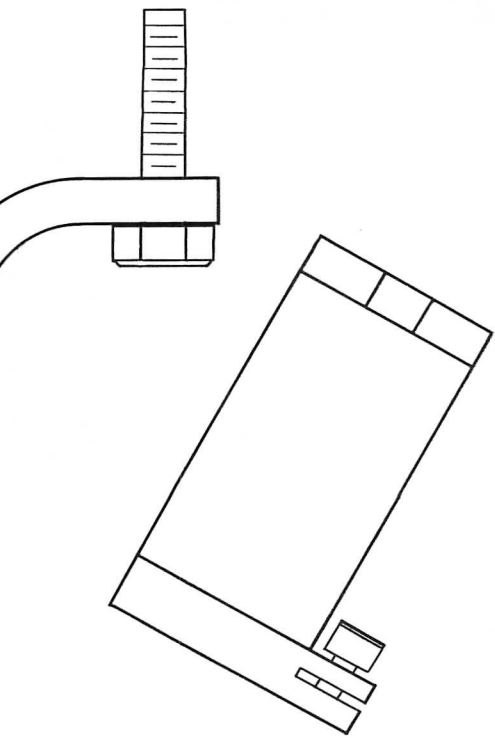
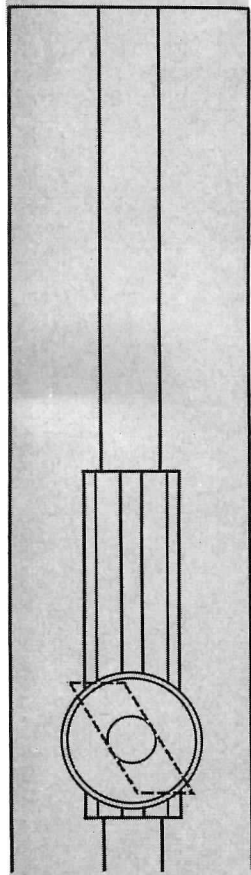
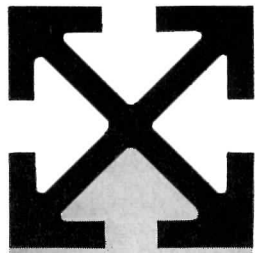
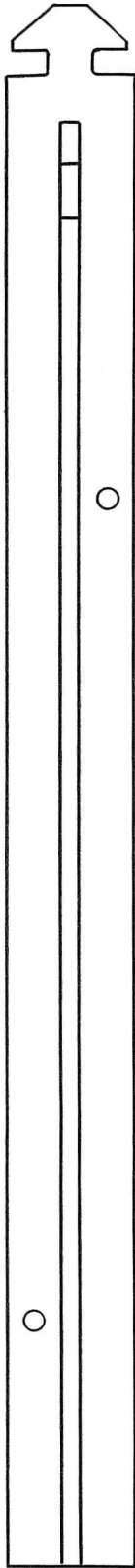
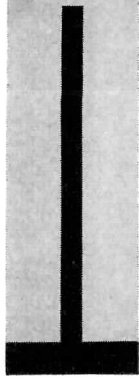
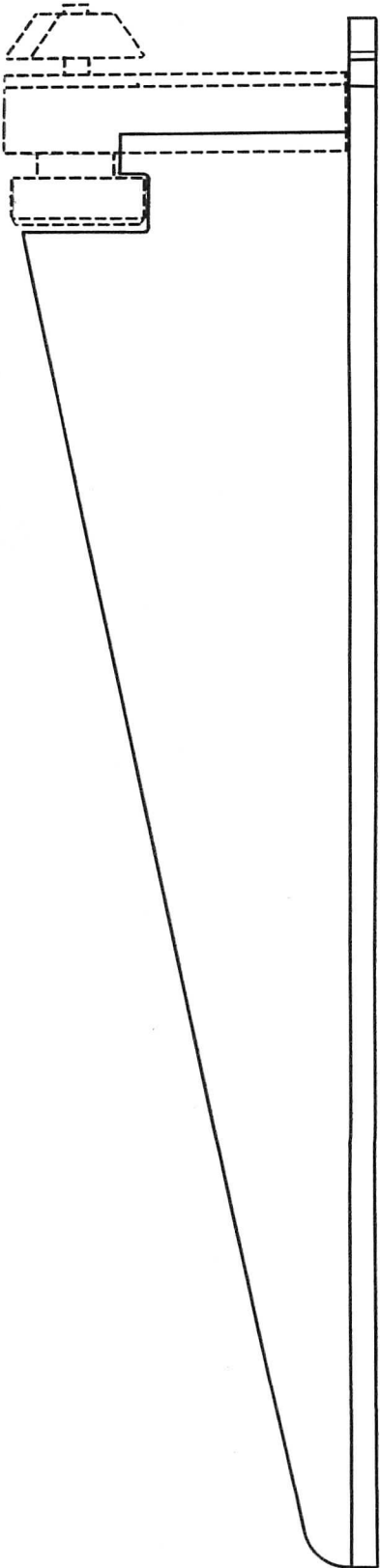
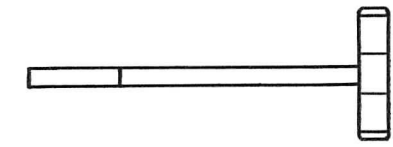

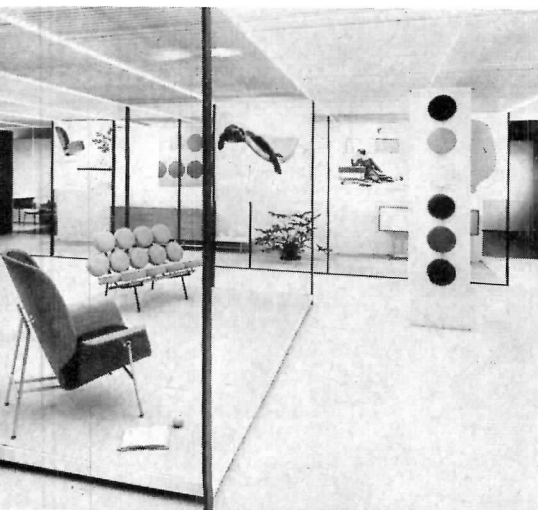

Lionel Freedman

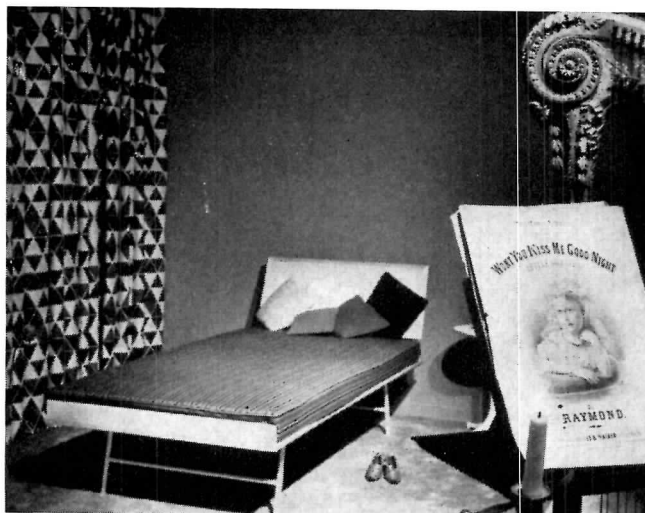
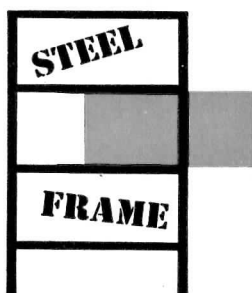

The work of the Nelson office for the Herman Miller Furniture Company represents a highly developed coordinated design program as can be seen by the inclusion on these pages of an ad, two trademarks, a factory site plan, a showroom, a museum installation, as well as examples of the furniture itself. The chair (upper left) which utilizes the latest industrial techniques is made of one piece of sheet metal cut and formed. In plan it makes a perfect triangle. The cabinet shown is of rosewood with porcelain pulls and aluminum cast legs. The George Nelson office has designed all Herman Miller showrooms, including the one in New York (above left). Steel frame (above center) is an identifying symbol for steel cabinets. In the exhibition at the Brooklyn Museum (above right) assembled by the Nelson staff, selections from the museum's collection of period furniture were combined with examples from the Herman Miller line to demonstrate how well designed modern furniture can be compatible with the best furniture of the past.

E

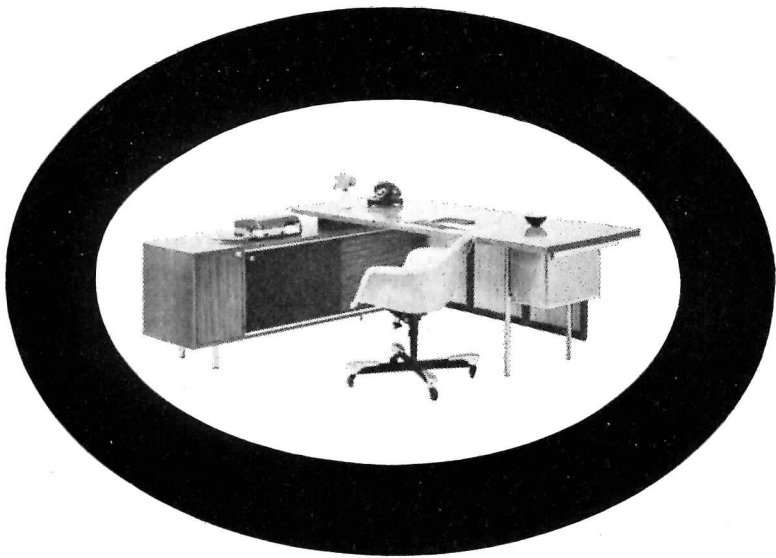

G

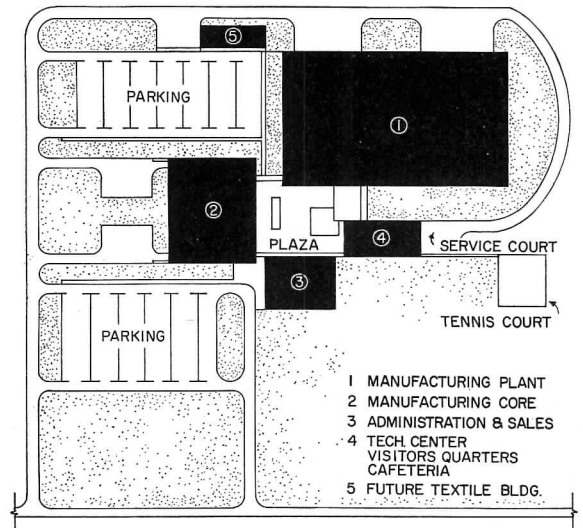
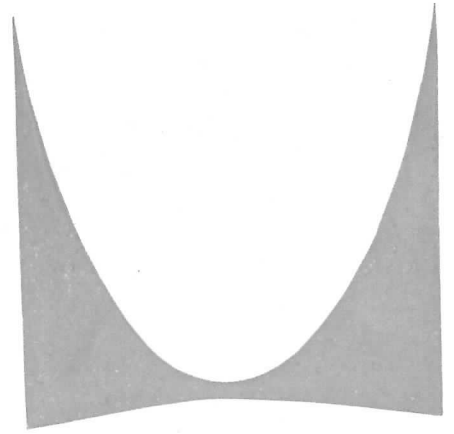

The letters in the ad (left) stand for "Executive Office Group", a line of furniture for industry based on a modular, interchangeable, flexible system. The Herman Miller symbol (upper right) has become widely familiar. Above: site plan for the expansion of the Herman Miller factory

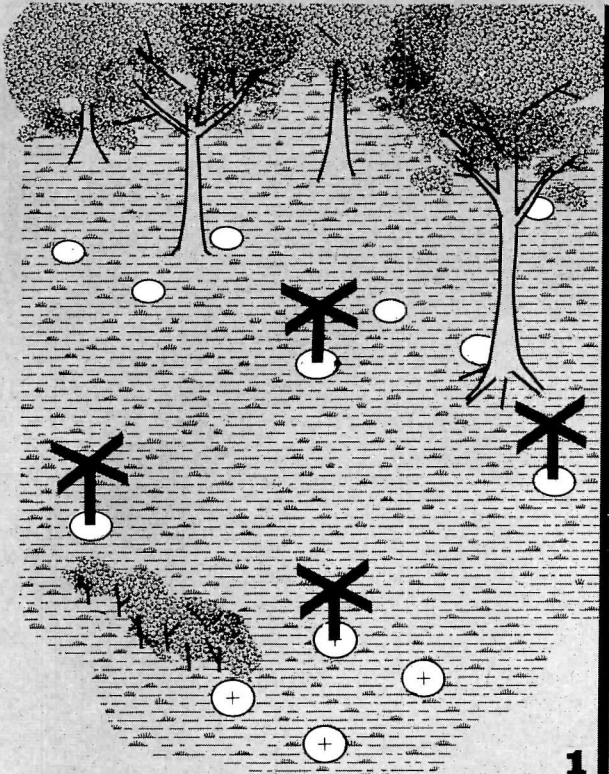

1 2

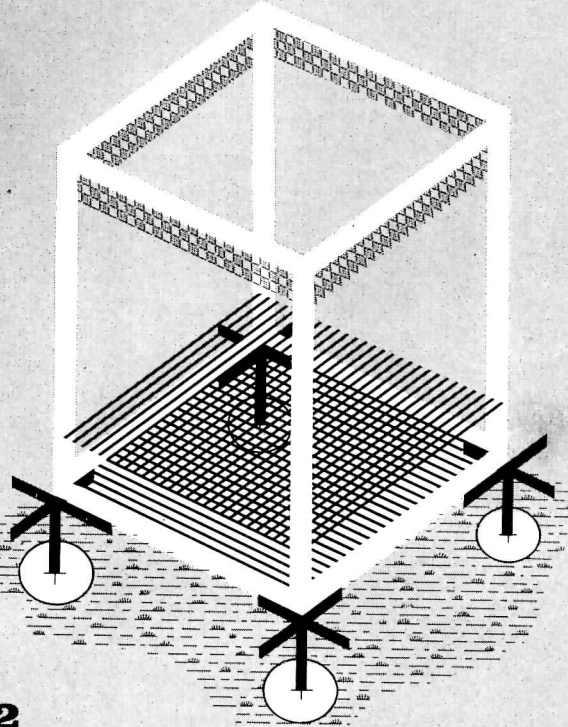

3 4

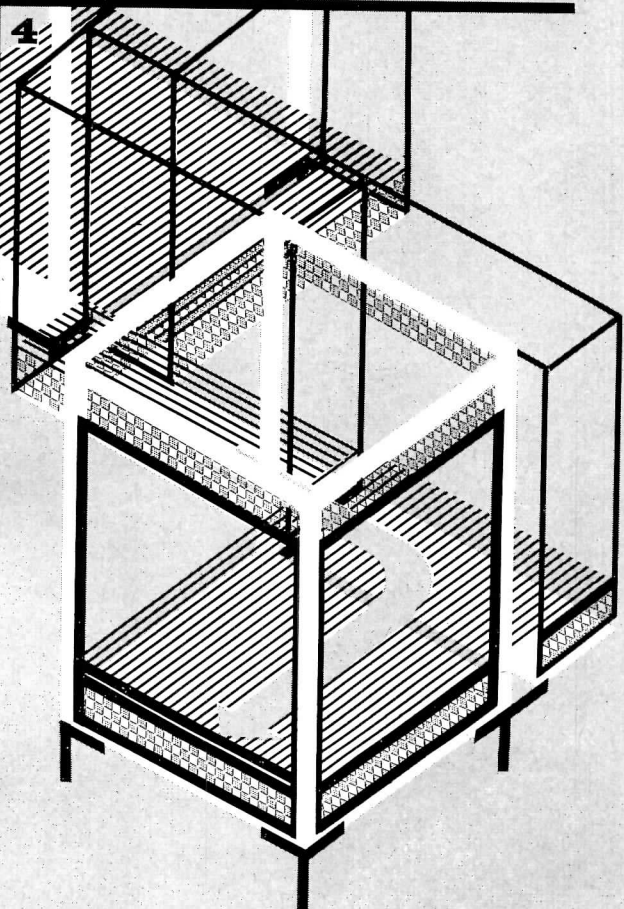
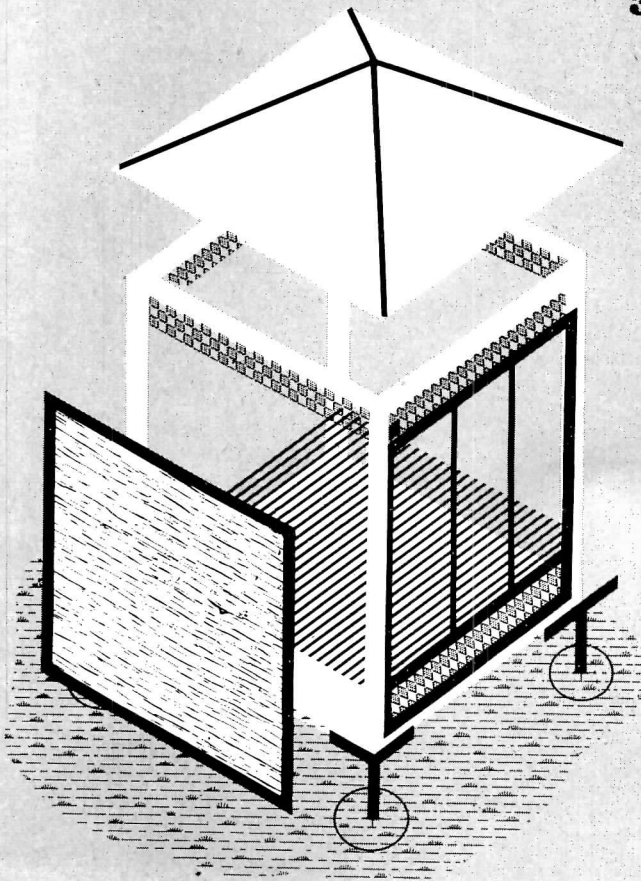

EXPERIMENTAL HOUSE BY NELSON AND CHADWICK

In recent years, one building type after another has turned to industry for its major components. Mobile forms of shelter such as trains, buses, trailers and planes exhibit the forms and structures typical of a high level technology, but the house has lagged behind. The George Nelson office has developed an experimental house designed as if it were an industrial product, a structure produced by a highly advanced large-scale manufacturer. In developing a solution no attention was paid to cost or market acceptance. The house is an experiment, not a salable product.

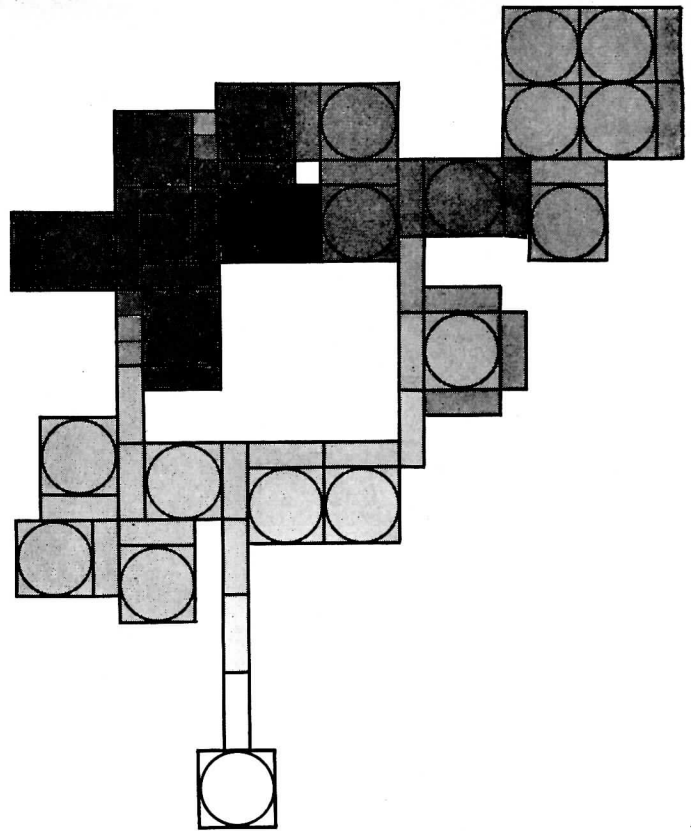

1. **FOUNDATIONS:** To reduce site labor to a minimum and eliminate the use of costly earth moving equipment, this proposal involves the use of a boring machine for adjustable metal foundations.
2. **STRUCTURE:** The structure is a conservative metal cage. The unit is a square, 12 by 12 ft in plan, a size which provides enough space for most furniture groupings. It can obviously be multiplied. A light truss forms the top member of the frame. Floors are used to brace the structure.
3. **WALLS, ROOFS:** Walls could be made of light weight material in large sizes. Roofs were considered as a symbol of the needs of people, emotional as well as physical. It is quite clear that top lighting is superior to windows or glass walls in many cases and that the possibilities of visual effects which can be obtained by its use have been fully explored. The dome is indicated in the model as an unbroken surface of translucent plastic. In actuality it would be a complex structure of both metal and plastic, containing thermal insulation, sound absorbing materials, possibly a part of the ventilating system, and devices for light and solar heat control.
4. **CORRIDORS, PACKAGES:** In order to provide flexibility for planning it became necessary to add a second major item of inventory. This is a cantilevered structure 4 by 12 ft in plan which hangs from the frame. It serves as a corridor but is equally usable as a room extender, bed-storage alcove and a housing for service packages. Mechanical and other services are visibly moving in the direction of package installations. Work has already been done by the Nelson office on storage and kitchen packages. Pullman bedrooms and bathrooms suggest other possible extensions of the same idea. Heating-Cooling packages would service the units individually or in groups. All services would come as assemblies to be plugged into the standard framework.

Above: plan of Experimental House. Tones from light to dark indicate the relative levels of each group of pavilions in relation to a downward slope. The dark rectangle is the highest point, the white square the lowest. The house adapts to different levels of terrain with ease. Opposite page: basic components of house

All drawings and photographs on this and following pages were made by Ronald Beckman of the Nelson office who helped develop the Experimental House

Once the basic units had been worked out the problem of their arrangement presented itself to the designers. A rectangular configuration created a noise problem, because the components of this house were expected to weigh less than today's builder house or prefab and would therefore transmit more sound. To avoid this it was decided to break up the house into a series of semi-isolated living areas using the space between the units as the primary method of controlling sound transmission.

The result of this decision was a plan showing the house as a series of pavilions. One of the virtues of the system is that the plan could expand and contract according to the needs and financial status of the family with very little disturbance to the portion of the house to remain.

The standardization of all parts and the ease with which they could be specified would result in a great cost saving which could be applied to furniture and landscape. The large number of combinations of materials and shapes and the many adjustments to contour and terrain possible afford the architect an opportunity to create interest and variety within a unified whole.

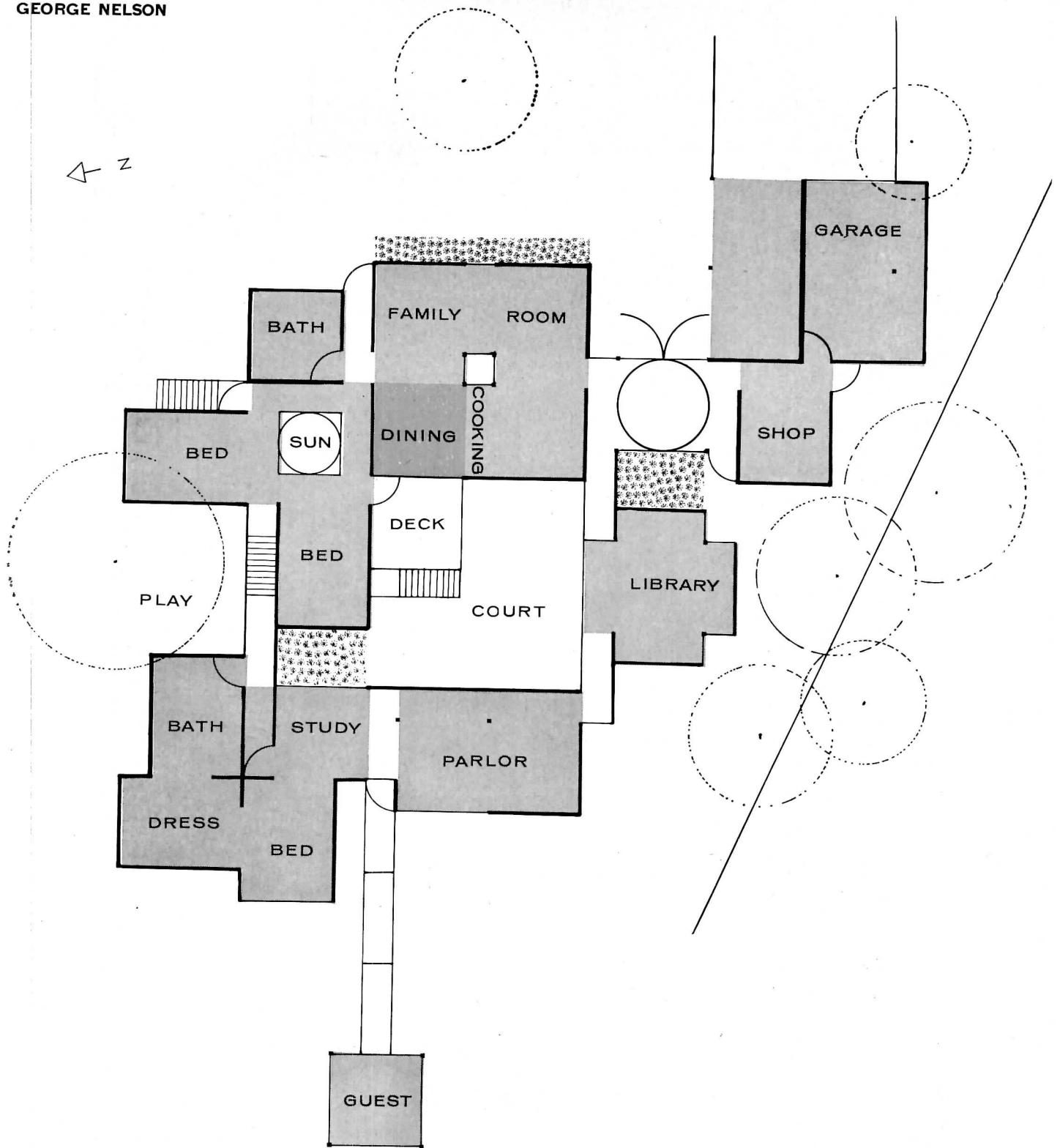

Above: plan of Experimental House shows an elaborate and generous development of the basic concept. Shaded areas show actual useable space created by configurations of 12 by 12 ft and 4 by 12 ft units. Right: a suggestion of the manner in which the components of the Experimental House would be presented in a manufacturer's catalog. The choice of color, materials, mechanical panels, packaged units, and types of wall suggests multiple possibilities of arrangement within the system

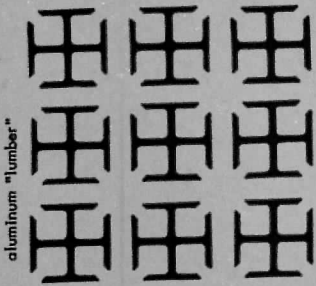

aluminum "lumber"

modular house

- 1) nested domes
- 2) stacked floors
- 3) standardized structural system
- 4) interchangeable walls and floors
- 5) packaged mechanical cores

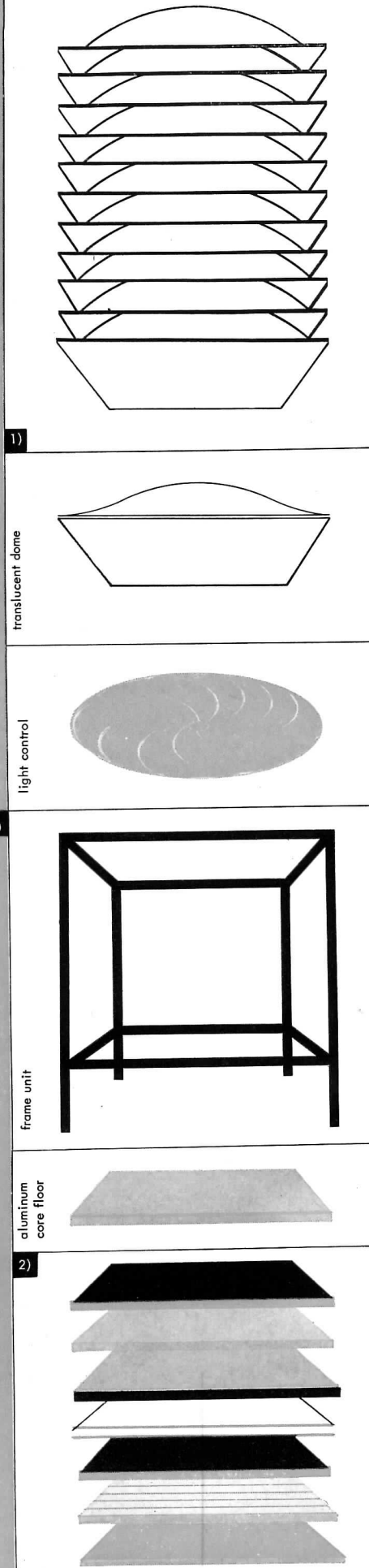

1)

translucent dome

light control

3)

frame unit

aluminum core curtain wall

4)

aluminum core floor

2)

5)

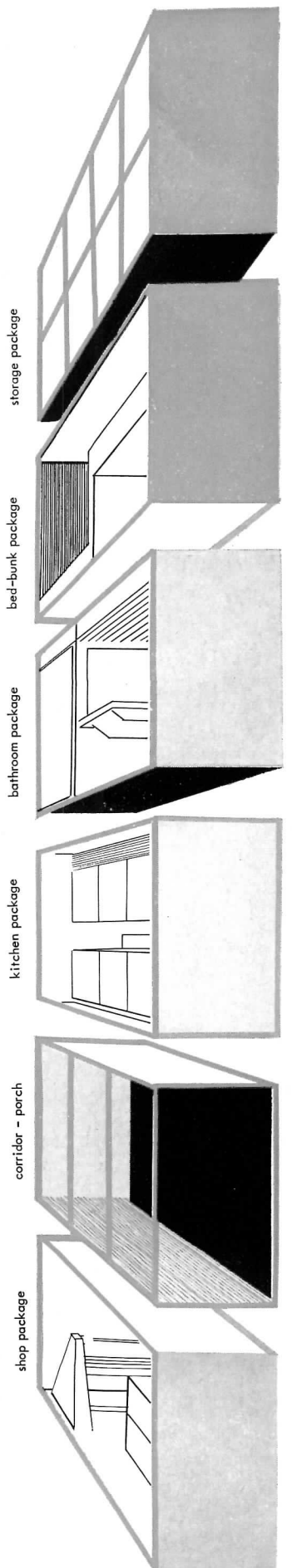

storage package

bed-bunk package

bathroom package

kitchen package

corridor - porch

shop package



1

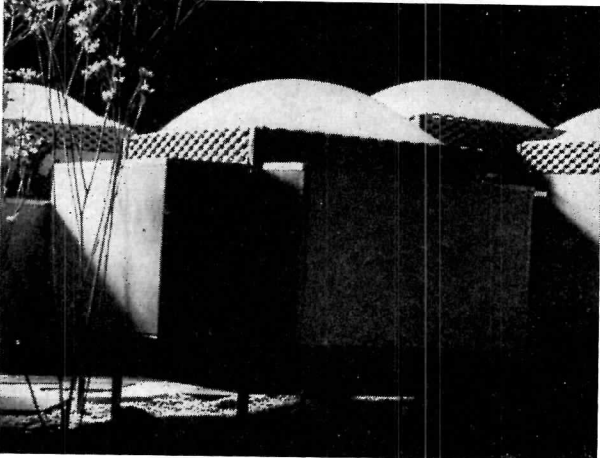

2

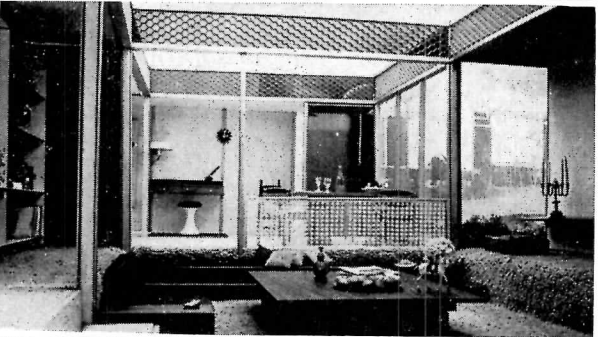

3

"My first exposure to George's house was extremely short, but interestingly enough, my impressions were unusually clear and strong. First—The concept is so simple that it can be grasped in a matter of seconds. Second—It is a module, but it is a true volume module at a scale which seems surprisingly natural. Third—One is immediately drawn into thinking of the space as an experience. An experience in which one wants to take part. It is hard to say what the connections are—remembered Alhambras, or playing house under grandmother's cutting table. Whatever it is, I suspect that it has little to do with conscious style and has a lot to do with human scale—and human need."

CHARLES EAMES

"George Nelson's aluminum house is the most exciting new thinking I have seen in the field of house design. It shows for the first time positively the advantages possible to residential building through the full use of technology and prefabrication. I think it wonderful because it points a way out of our present dilemma in housing. The delight it promises through the interest and surprise inherent in its plan should mean much to our residential future."

MINORU YAMASAKI



4

The Experimental House provides interior spaces of great variety. Simplicity and ease are inherent within the system. 1. Interior shows basic 12 by 12 ft component opening into surrounding 4 by 12 ft connecting elements. 2. The exterior of this grouping. The vertical dimension is also 12 ft. 3. Two 12 by 12 ft units joined to form a larger space enclosure. Note view of adjacent elements through glass corner. 4. The house, partly on stilts, partly on slabs not only lends itself to many plan combinations, but to a variety of elevations. Posts will be designed so that elements can be pinned to them at any vertical point

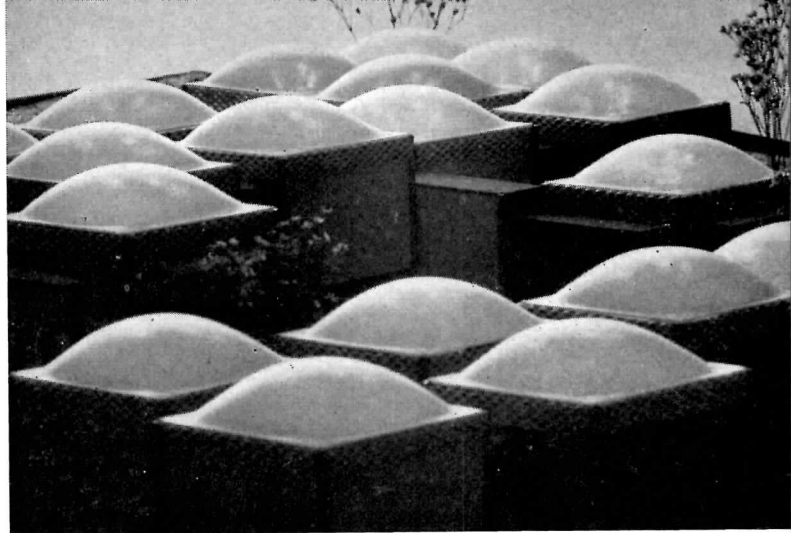

"Of all the prefabricated and experimental houses I have seen in recent years, this gives me the greatest thrill. Unfortunately, the test as ever will be on economic grounds, that is, on the ability to produce these units with all the services at a lower cost than a conventional house. There is no question though that from a creative and intellectual point of view, it is a most exciting concept. I hope some industry will finance its development."

PIETRO BELLUSCHI

"George Nelson has treated his Experimental House as an aspect of product design rather than architecture. By taking advantage of American methods of production, distribution and obsolescence, he is able to offer a product technically superior to its handcrafted competitors. The design also provides an unexpected luxury by way of its elegant pavilion-like plan."

ARTHUR DREXLER

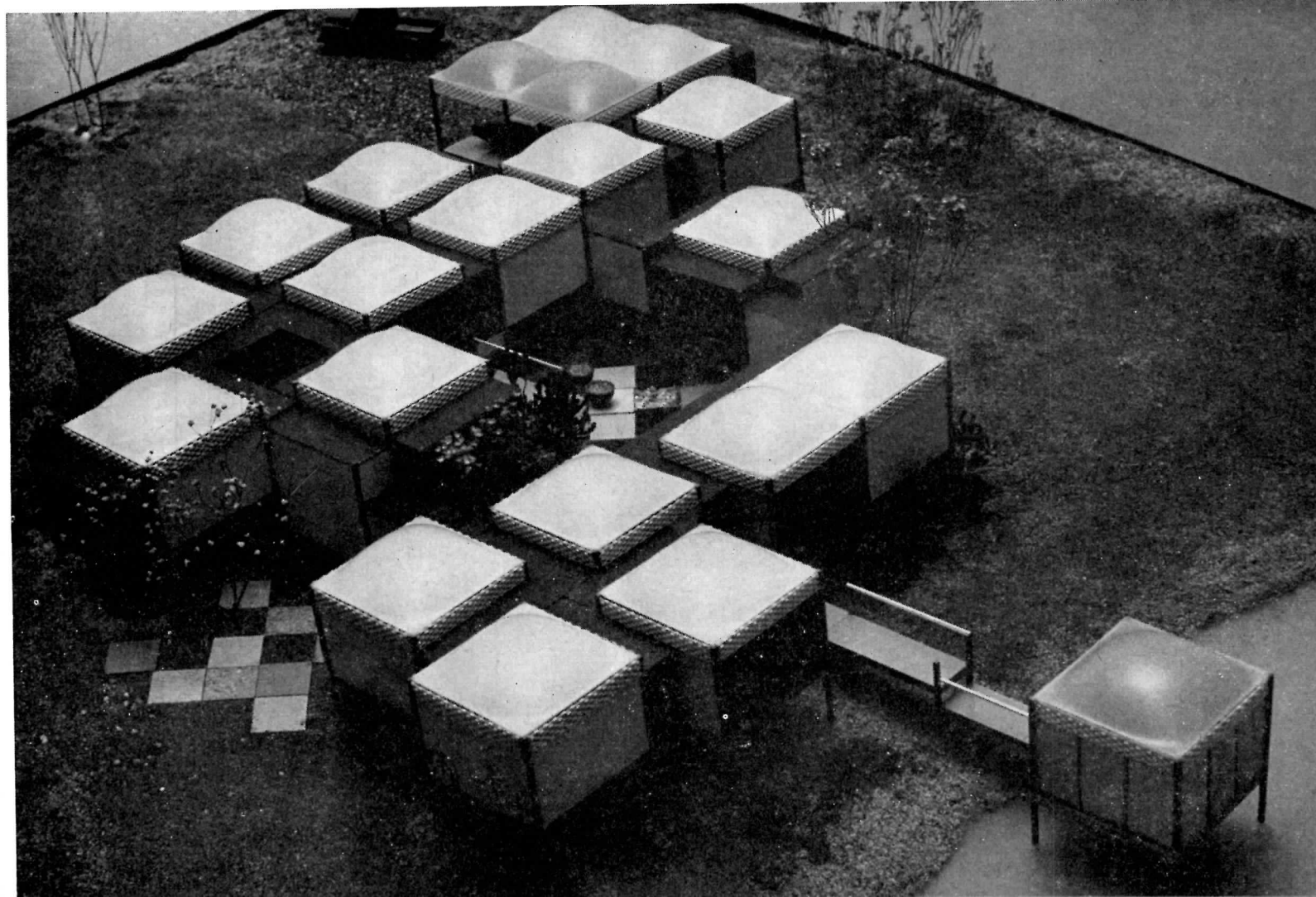

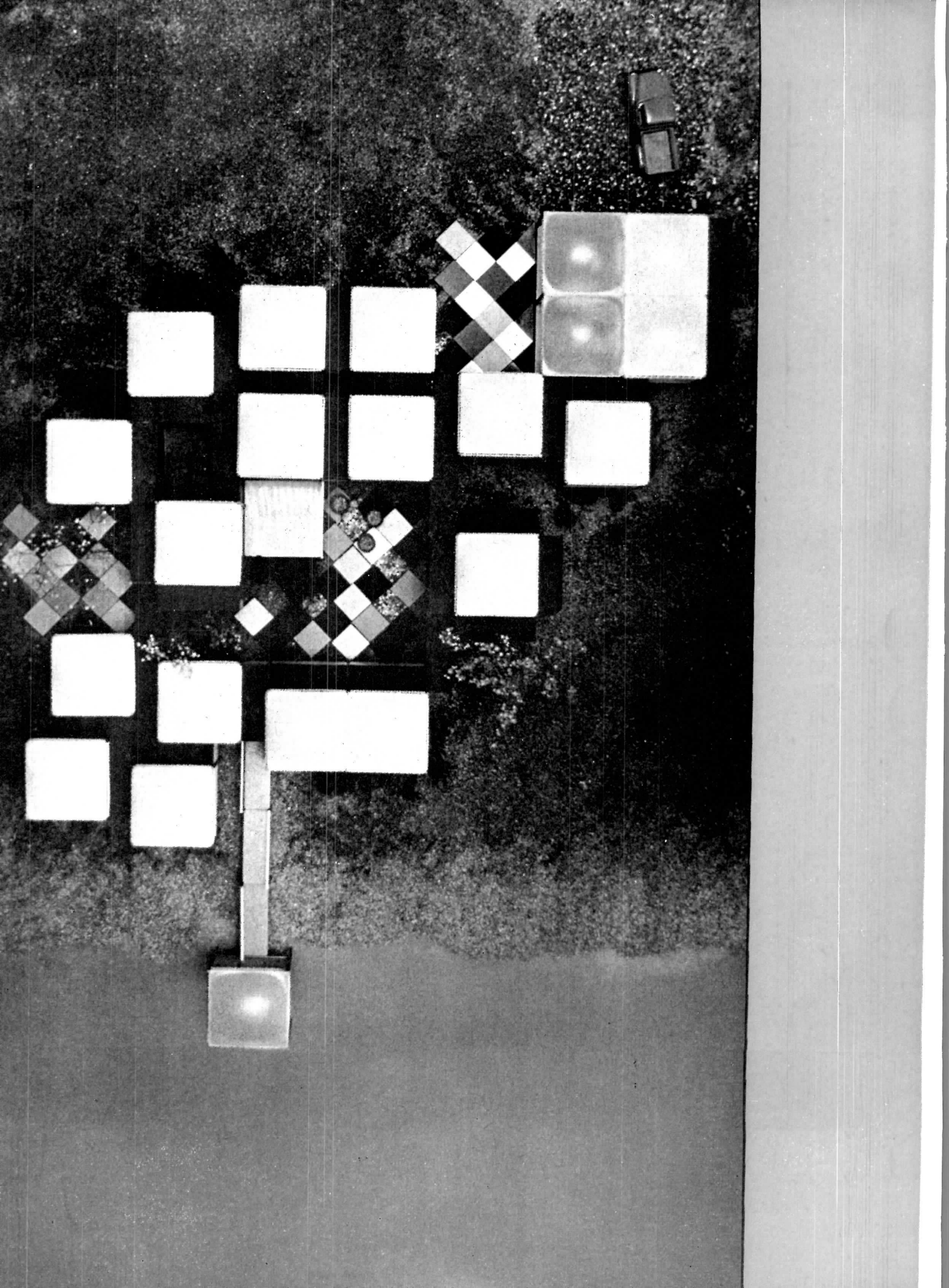

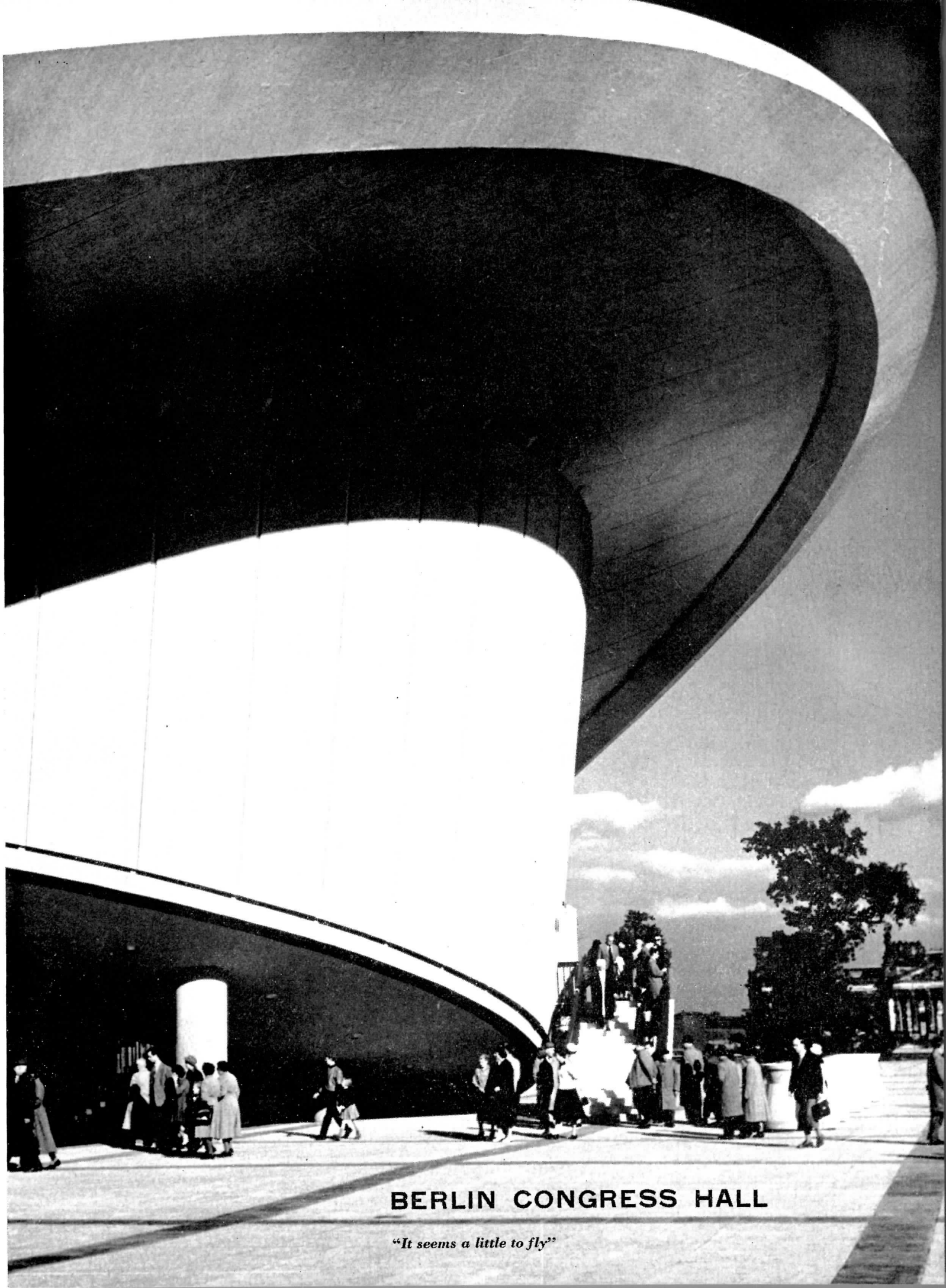

BERLIN CONGRESS HALL

"It seems a little to fly"

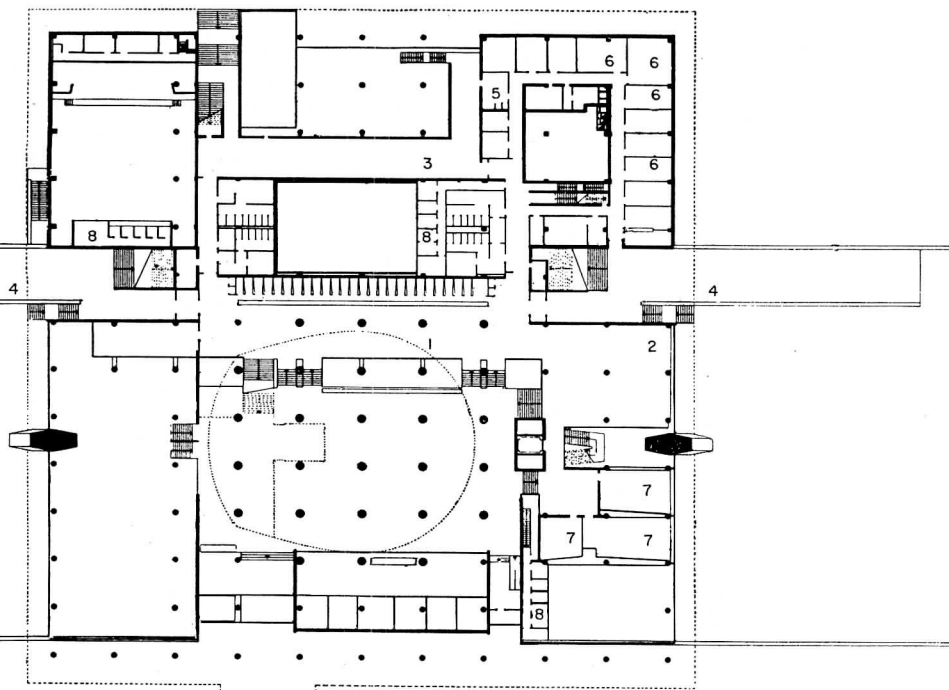

MEZZANINE

- 1. Foyer and Wardrobe
- 2. Lounge
- 3. Restaurant
- 4. Entrance Ramps
- 5. Serving Pantry
- 6. Permanent Administration
- 7. Conference Rooms
- 8. Translation Booths

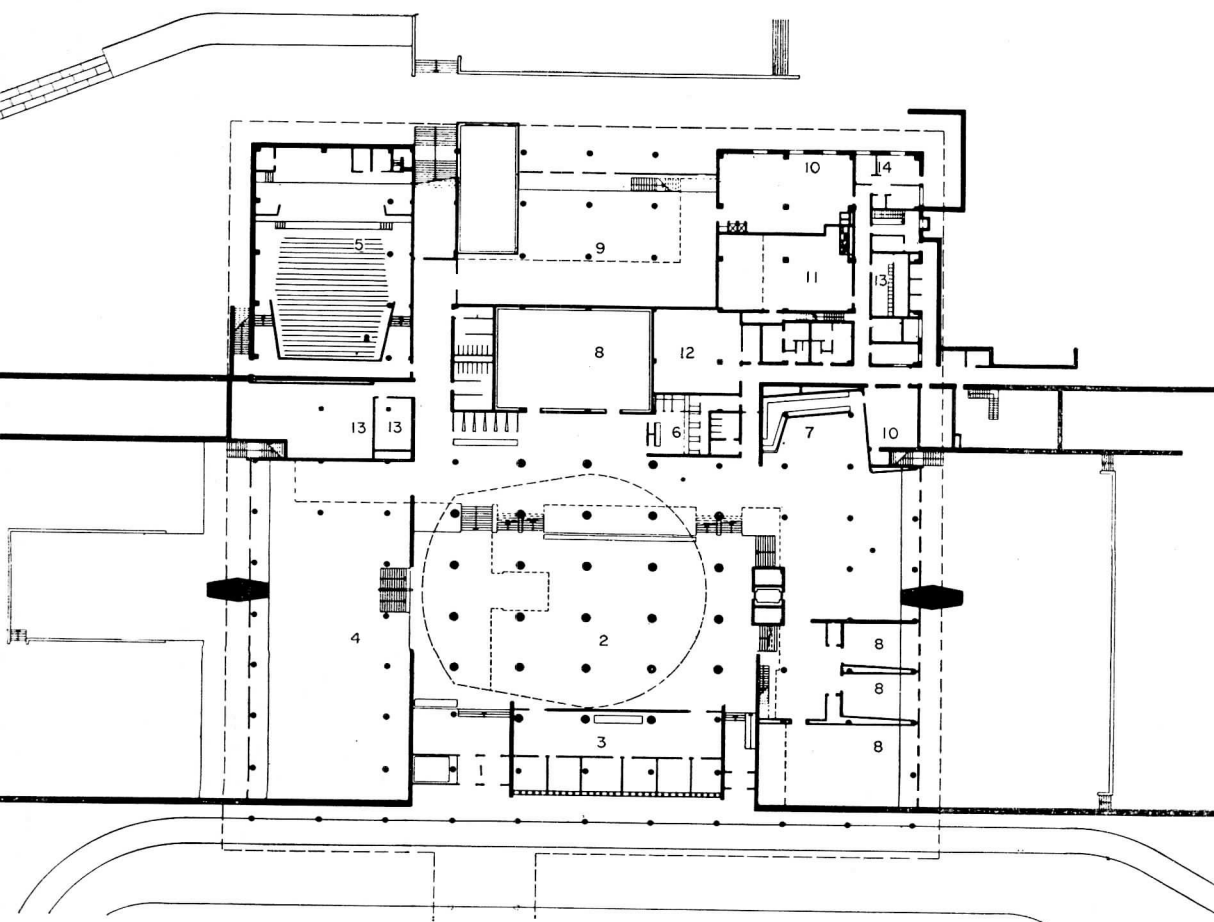

GROUND FLOOR

- 1. Entrance
- 2. Great Hall
- 3. Congress Administrative Facilities
- 4. Exhibition Hall
- 5. Theater
- 6. Telephone and Wire Facilities
- 7. Bar and Lounge
- 8. Conference Rooms
- 9. Restaurant
- 10. Kitchen
- 11. Boiler Room
- 12. Receiving Room
- 13. Services
- 14. Caretakers Apartment



Joachim Diedrichs (photo page 143, Wimmer)

BERLIN CONGRESS HALL

*Architects: Hugh Stubbins and Associates
Associates: John Myer and Jack Gensemer*

*Berlin Associates: Düttmann & Mocken
Structural Engineers: Severud-Elstad-Krueger
Acoustical Consultants: Bolt, Beranek & Newman*

American Institute of Architects advisory committee to select the architect was comprised of: Ralph Walker, chairman; Leon Chatelain, Jr.; Howard Eichenbaum; Moreland G. Smith. Mr. Walker is chairman of the Benjamin Franklin Foundation, set up to take charge; other members of the advisory committee serve the Foundation as directors.

IN ORDER TO SEE this design in its proper context, it may be necessary to make a conscious adjustment in visual habits. It is necessary to realize that in this instance the spectacular, inventive, structure-formed design was the means, not the goal, of the architect. The committee in charge of the project sought a symbol for freedom of thought and expression, something to proclaim to West Berlin, and especially to East Berlin, that Uncle Sam encourages innovative enterprise. So this is inventiveness addressed to an idea to be expressed, not a rationalization of a dominant structural theme. So, Dean Hudnut tells us (*ARCHITECTURAL RECORD* July '57), were the gothic cathedrals.

This building would be welcomed if the reverse were true. Surely we should find it good, perhaps great. We should be thankful for its daring, knowing that each

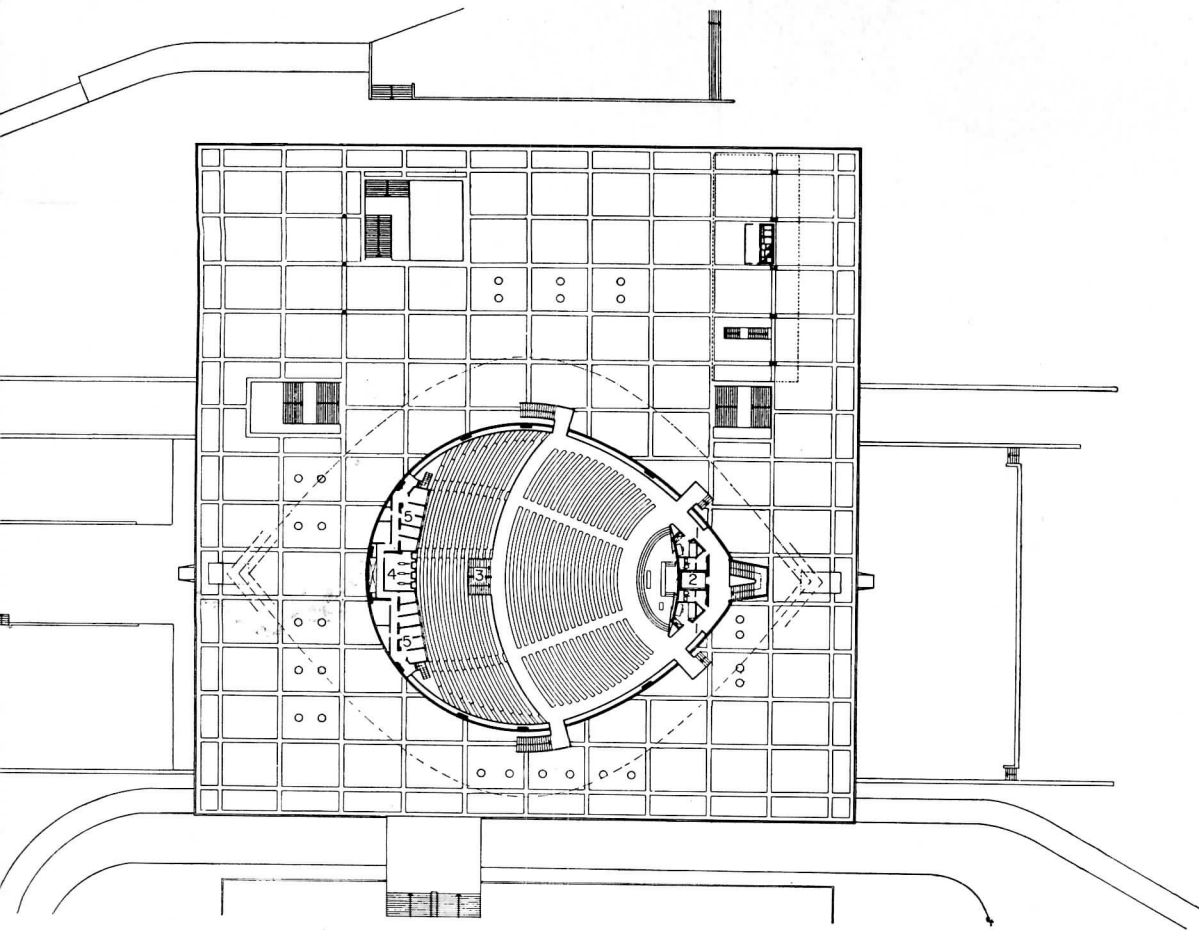

AUDITORIUM

- 1. Retiring Rooms
- 2. Elevator
- 3. Main Entrance
- 4. Projection Booths
- 5. Translators' T.V. and Radio Booths

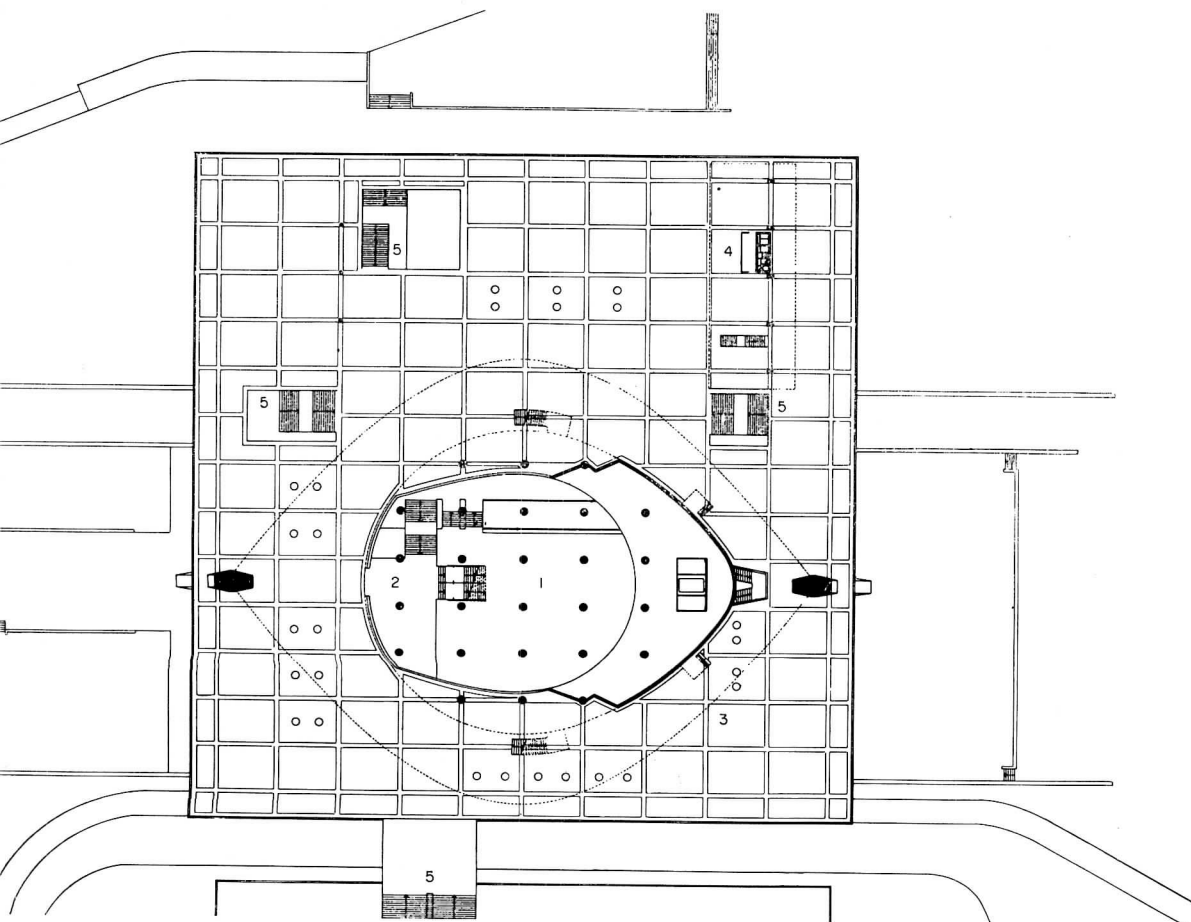

PLAZA

- 1. Upper Part of Great Hall
- 2. Foyer
- 3. Plaza
- 4. Cafe Bar
- 5. Stairways



Wimmer

BERLIN CONGRESS HALL

new idea, set before the world in actuality, adds something in acceptance of creative architecture. But the fact that its expression was consciously reached for does heighten the cogency of the design.

That this design was architecturally conceived is easily readable in any exterior photograph. The soaring quality of the concrete arches might not have been so aptly expressed. The outside walls might have been placed at the outer edge, with entirely different effect. It might then have looked like a stepped-on tin can. Or, horrors, the arches might have been concealed.

Clearly the motivation was architectural. Small wonder; for when did an architect ever get so clear a call to creative thinking? Indeed the praise being showered on this building, after its recent opening, might be taken as testimony for a unique system of

selecting an architect — asking the A.I.A. to name a committee to name an architect. Then Mrs. Eleanor Dulles, for the Department of State, the architect, and the selecting committee visited the site to discuss American participation in the Exposition; they agreed on a permanent building “for international congresses dealing with arts, science, letters, government and other matters of cultural interest to men of all nations.” A strong architectural orientation, both in procedure and in program.

The concept of the building which resulted is a rather important one in international relations. While the building clearly is to speak for America, it is to lend its voice toward fostering international cultural relations, not toward saber rattling. Says the brochure: “This international Conference Hall is representative of a

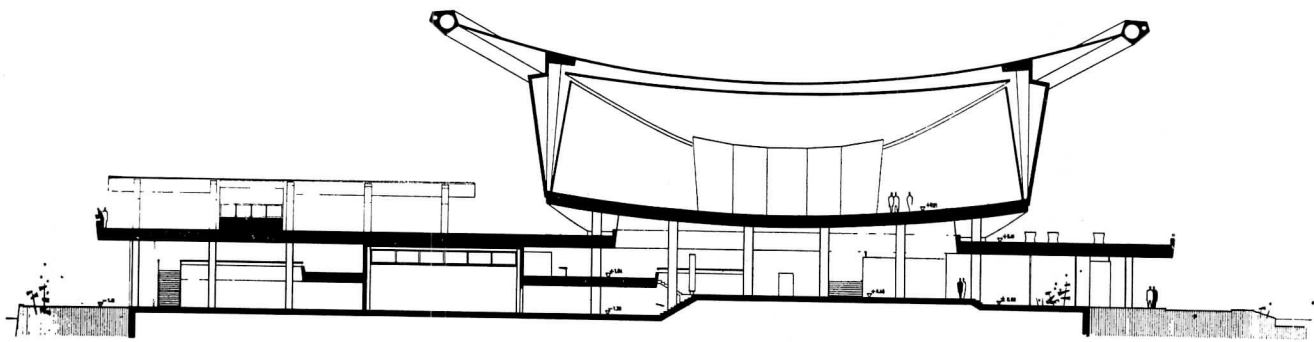
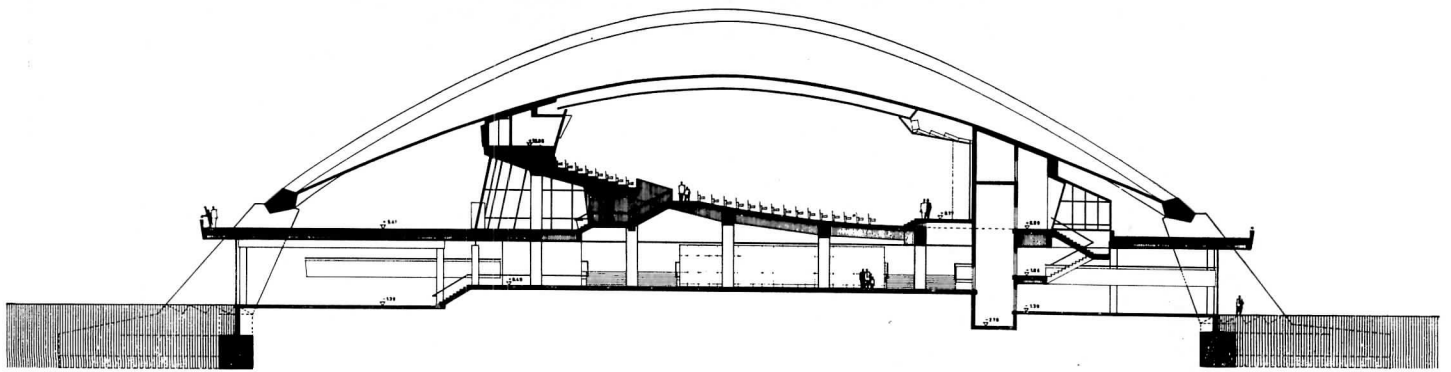

new building type. At present the United Nations General Assembly in New York, the UNESCO Building in Paris, and Conference Hall in Caracas are the only structures in the world with comparable facilities. It is the hope of all those concerned with the building of the Kongresshalle that it will serve to enrich the cultural life of Berlin by bringing to the City scholars of all nationalities, and that these people will, in turn, draw inspiration for themselves and their work from their experience here." What might have been just another temporary building for a Fair thus becomes a permanent influence toward international understanding.

If this is a fairly involved message for architecture to communicate, this design seems to have spoken effectively to those who have experienced it. A wide variety

of adjectives includes: beautiful, gay, dignified, jaunty, soaring, earthbound but floating, sweeping, inspiring, and so on. Clare Booth Luce, speaking at the dedication ceremonies as the U. S. official representative, said, "it seems a little to fly."

Mrs. Eleanor Dulles, who acted throughout as the client, told *ARCHITECTURAL RECORD*: "This is the most beautiful building constructed in the last 100 years. The perfect balance creates a soaring, floating sensation, but the two anchors on either end keep it earthbound, much like a rainbow. The building has dignity and quiet, but suggests great strength. . . ."

Working to this end, Stubbins has utilized to the full the freedom and power of the basic structural idea. When, after being entranced by plastic form and curves and visual beckonings, one begins to observe inquir-



Wimmer

BERLIN CONGRESS HALL

ingly, he might notice first of all the manipulation of the exterior walls. Notice (transverse section) that both exterior and interior walls are splayed. At the top the outside wall returns to its projected starting point, forming a recess under the arch. This pocket contains floodlights to emphasize the freedom of the roof from side supports and add to the illusion of gliding. At the bottom, the base of the wall rises and falls in a great sweeping arc, defining the form even more dramatically since this sweep occurs at eye level.

Looking more closely one would discern that everything about the siting of the building tends to increase the rising quality of the design. Firstly, the site itself joined in the suggestion for development of a soaring form; it was so very flat, so open; if the architect was not consciously visualizing it as an airfield he was

acutely conscious of a need to reach upward. For a building program that called for a low building the traditional verticals were unthinkable. So the architect disposed his exhibition spaces and others in low, wide plaza-like organizations, these making a platform from which the auditorium might take off. Also he sloped the site gently upward toward the platform so that the parklike surroundings seem to start the upward curves. The river, at one end, the pool at the other, are also useful in this heightening effort.

The scheme gains, rather than loses, when the scrutiny gets penetrating on the practical side, and it is nice to observe that the engineer is happy and the cost accountants content. Severud has here considerably extended the promising work with arch-supported hung roofs. This one is of concrete (the acoustical engineers



Kessler



Kessler

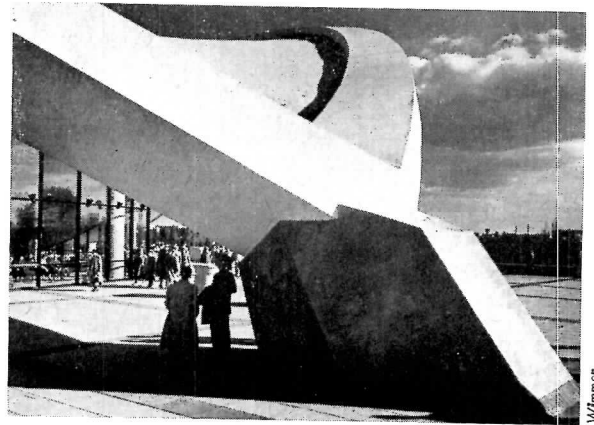

Wimmer

BERLIN CONGRESS HALL

wanted 2½ in. of solid concrete, unbroken by the openings of expansion joints, to insulate the auditorium against noise of jets overhead). The concrete roof is suspended in a catenary curve from the huge arches. Racking loads are taken in a huge concrete compression ring around the top of the auditorium walls, where the structure is held stable against overturning. The expansion problem here became quite complicated, but did not add substantially to cost. The catenary curve was inherently conducive to good acoustics. As to cost, Severud says it is quite inexpensive for a wide span building. This would seem to be, then, an innovative system which contributes a good deal of mental satisfaction to the sensual ones so consciously sought in the design. And if the building "seems a little to fly," well, it does seem to move forward.

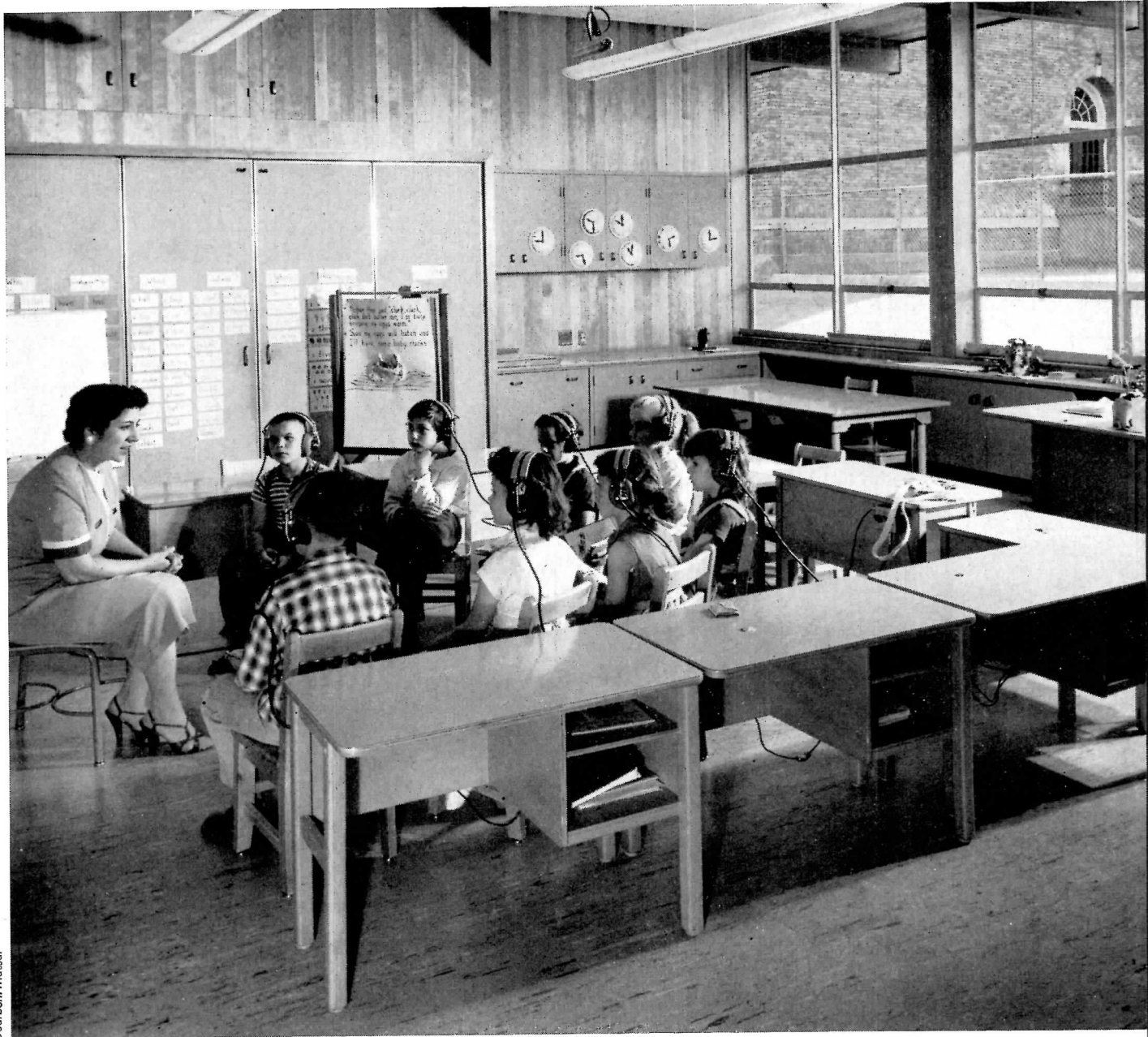

Dearborn-Massar

THREE SCHOOLS FOR DEAF CHILDREN

1. *Tucker-Maxon Oral School, Portland, Oregon*
Belluschi and Skidmore, Owings & Merrill, Architects
2. *Hosford School Addition, Portland, Oregon*
Belluschi and Skidmore, Owings & Merrill, Architects
3. *American School for the Deaf, West Hartford, Connecticut*
Louis J. Drakos, Architect

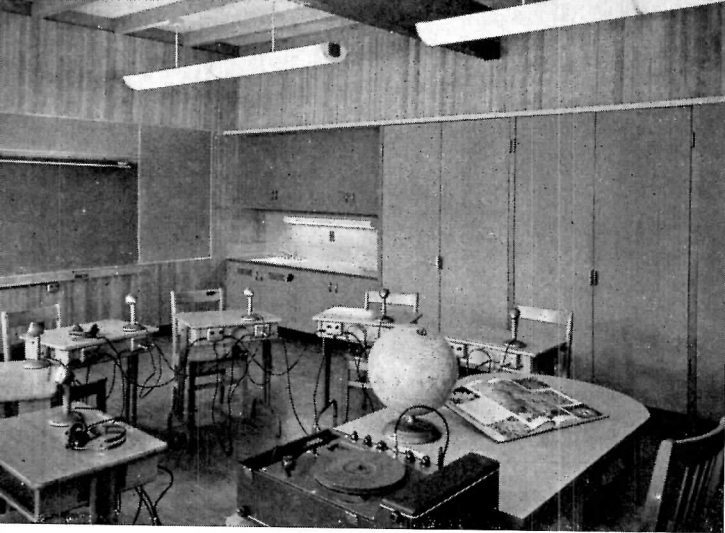

RESIDENTIAL QUALITY FOR SCHOOL FOR DEAF CHILDREN

Tucker-Maxon Oral School, Portland, Oregon; Architects: Belluschi and Skidmore, Owings & Merrill; Structural Engineers: Cooper & Rosé; Mechanical Engineers: J. Donald Kroeker & Associates; Electrical Engineers: Pettingell & Kelley

THE NEEDS of the child handicapped by hearing difficulty are so insistent as to demand a separate school, and they guide the architect in the design of the building for it. The business of ordinary communication, which comes so easily for the normal child, is very difficult for the one who can't hear; it must be the first task of the school. Beyond that, the child naturally has adjustment problems, needs a warm and friendly environment. Those two major factors guided the planning here. This is a private school, small, in a residential neighborhood. Classes are limited to six children. Residential scale and appearance were essential, not alone for the problem itself, but to overcome objections of nearby property owners. Landscaping was stressed in both budget and execution. Wood frame construction with laminated beams; exterior is of cedar with hemlock siding in corridors and classrooms. Heating system is primarily of the radiant floor type. Cost per sq ft, in 1953, was \$11.75.



A conscious effort was made to express the functions of beams, purlins, decking. Beams are stained a blue gray, the purlins light gray. Warm primary colors and the natural cedar and hemlock complete the color scheme. The residential quality, with emphasis on landscaping, has won over the neighbors who at first objected

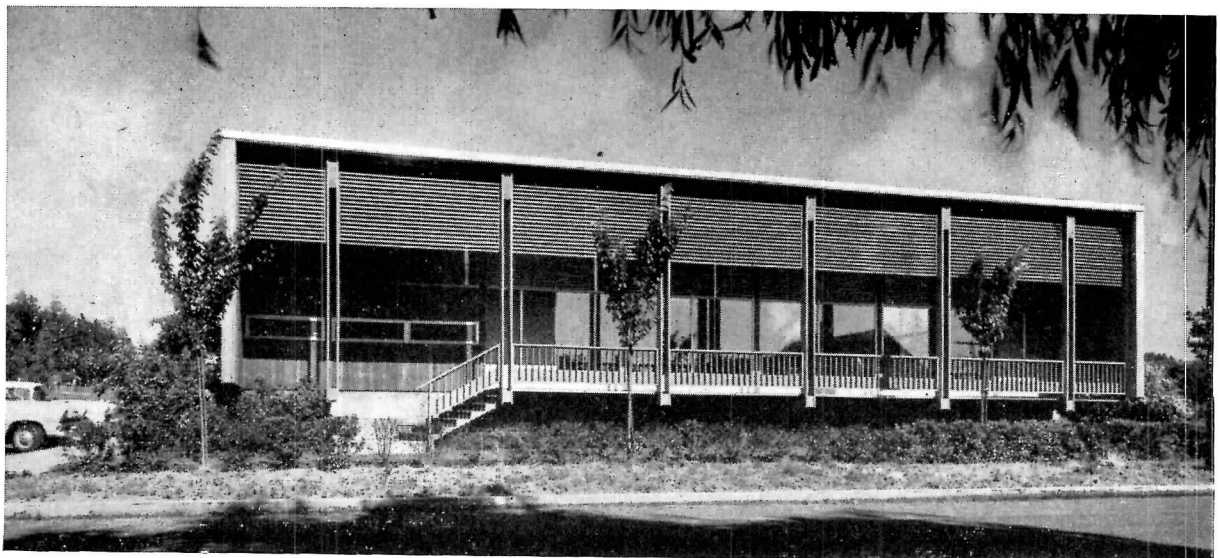

Dearborn-Massar

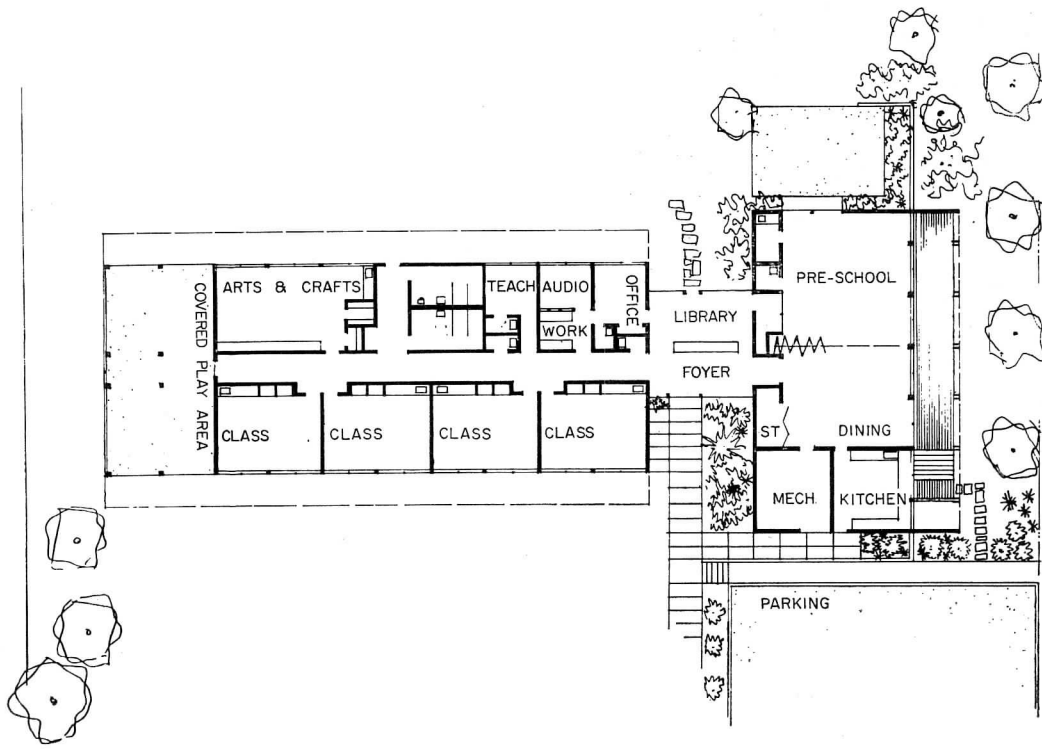



Relationship to the existing school building was something of a problem. Solution was to put the kitchen and "cafetorium" near the older building, on grade, so that this portion could be used by either group of children without disturbing the other. Classroom unit for deaf children extends out beyond existing grade to form covered play area

SCHOOL FOR THE DEAF AS A PUBLIC SCHOOL UNIT

Deaf Children Addition to Hosford School, Portland, Oregon; Architects: Belluschi and Skidmore, Owings, & Merrill; Structural Engineers: Cooper and Rosé & Associates; Mechanical Engineers: J. Donald Kroeker Associates; Electrical Engineers: Grant Kelley & Associates and George Pettingell

THIS SCHOOL is a unit of a regular public elementary school, the educational concept being one of separate training for the child handicapped by deafness but full opportunity to associate with normal school children in recreational activities. Classes are kept to smaller than standard size, ten to twelve; rooms are therefore smaller than regular classrooms. These rooms do require some special hearing aid equipment and grouped seating arrangements. Kitchen and dining facilities for the entire school were built as part of this project. The "cafetorium" is placed so that it can be used by the handicapped ones for their programs, or by pupils from the regular school, to which the deaf unit is connected by covered passage. The classroom wing extends from this point away from the existing building. The deaf unit has its own administration spaces; also special speech training room and audiometer test room, and so on. Cost is given at \$12.32 per square foot.

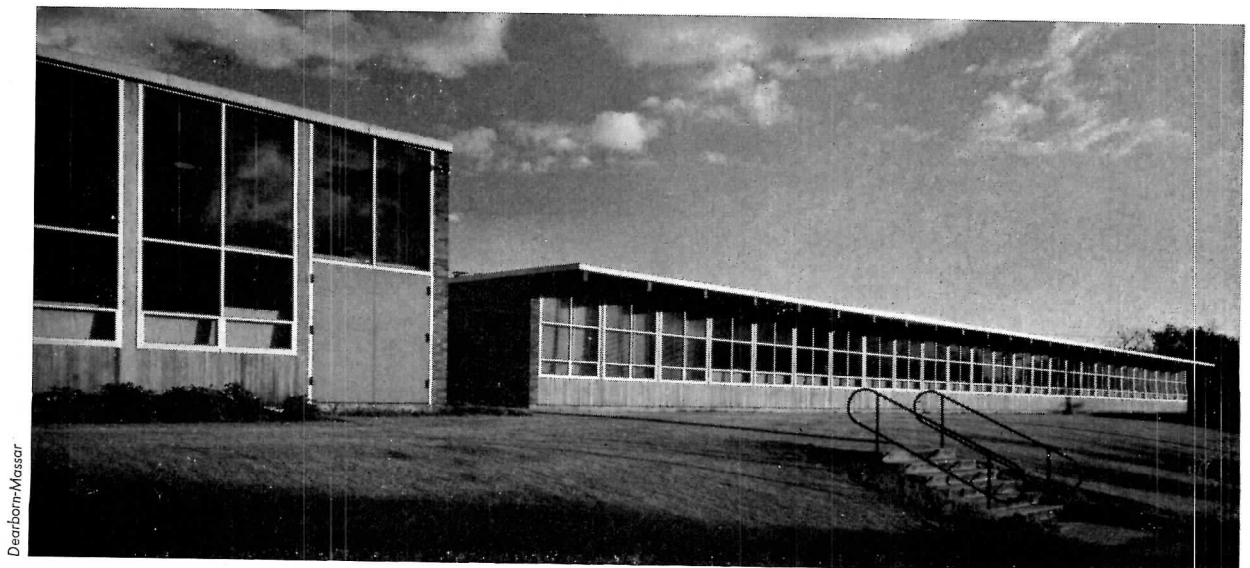

Dearborn-Messner

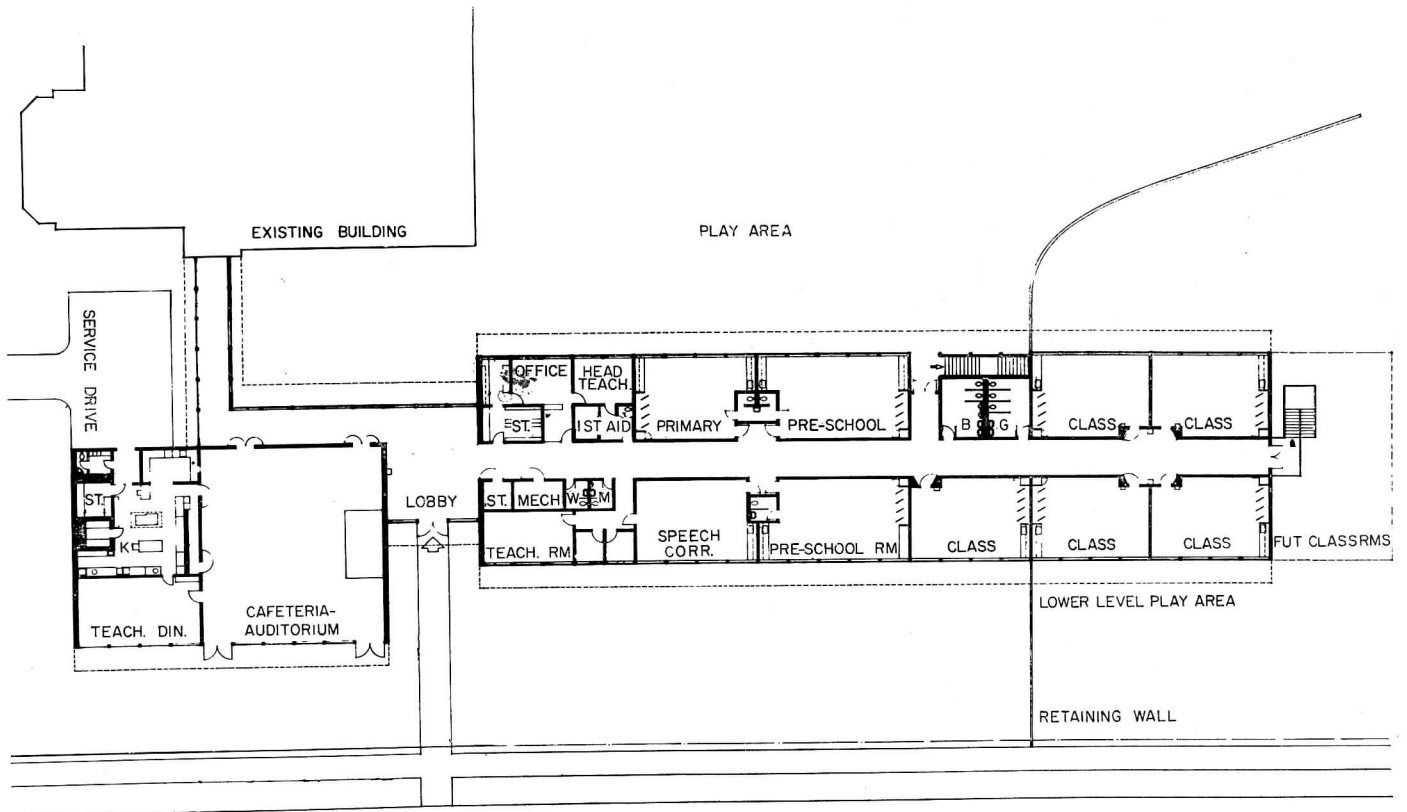

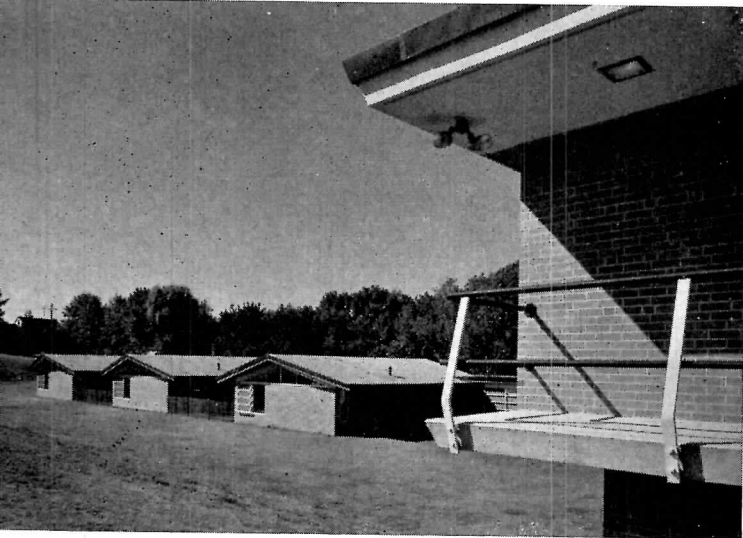

The large playroom is the scene of much of the training effort, since the three-year-old must not be pushed too hard. The regular classrooms are three separate units in a finger-plan scheme, as a wing extending out from the residential building. Costs of the reinforced concrete buildings was \$11 a square foot, or a total of \$300,000

PRE-SCHOOL UNIT FOR SCHOOL FOR THE DEAF

Nursery and Kindergarten Building, American School for the Deaf, West Hartford, Conn. Architect: Louis J. Drakos; Engineers: Marchant & Minges

AS AN INSTITUTION this is the school for the deaf which started a movement back in 1817. It has gradually grown, has moved to new locations a couple of times. Its superintendent, Dr. Edmund B. Boatner, has long felt the need for a building where the pre-school child could start the difficult effort to learn communication, and this new building is another pace-setter in that respect. It is a boarding school; indeed most of this project is residential quarters for children and staff, with a small group of classrooms (not on these plans). The children live in dormitory units, the staff in various apartments in the same building. There are accommodations for 51 boarding children, and a few day students may be taken care of as well. Children are taken as early as the age of three, so that training can be given as fast as the child maintains interest, in the effort to lessen the lag that the deaf child usually suffers.



Joseph W. Mollitor

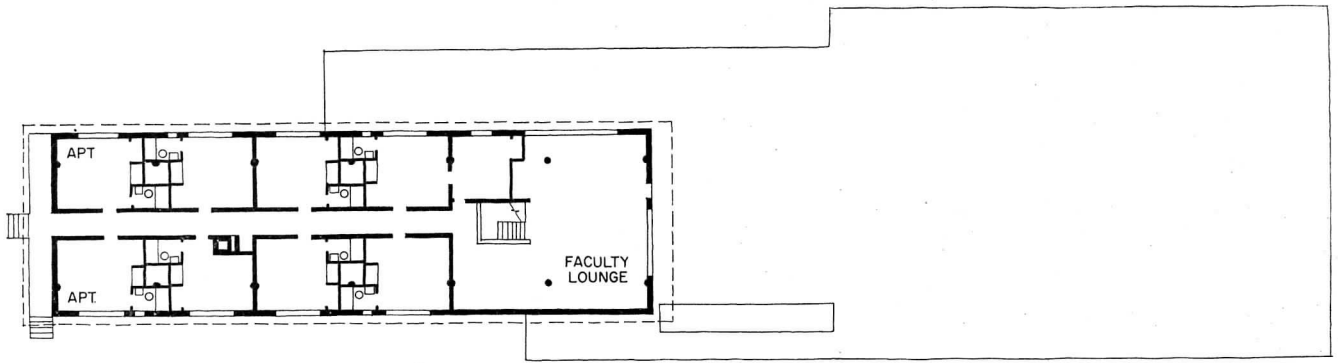

SECOND FLOOR PLAN

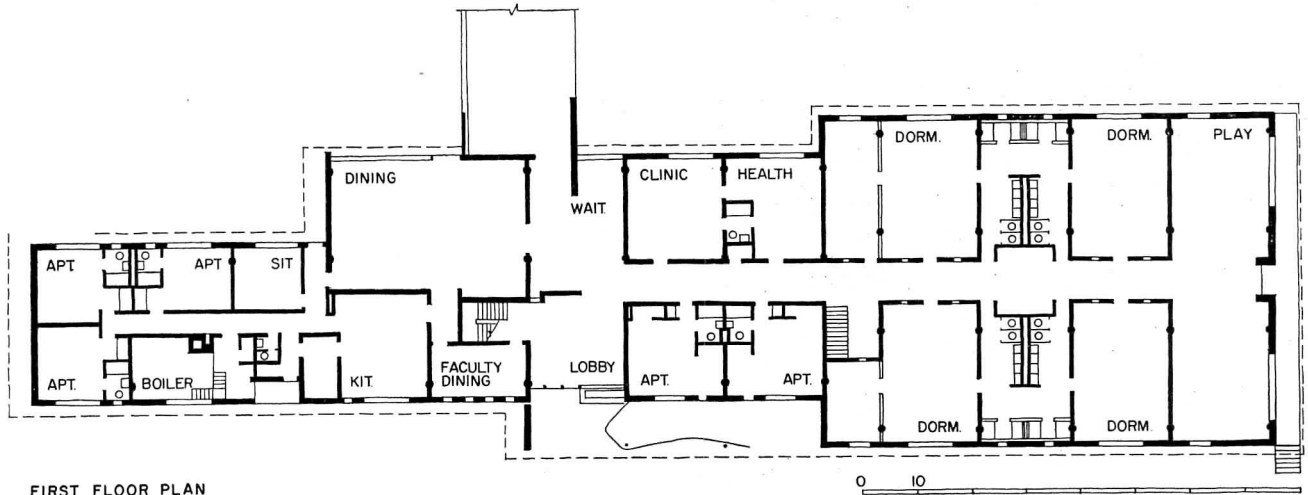

FIRST FLOOR PLAN





Joseph W. Malfor



**PRE-SCHOOL UNIT
FOR SCHOOL FOR THE DEAF**

Nearly all of the children "live in," in dormitory accommodations. Child-scale bathroom facilities adjoin the dormitory rooms. The bottom photograph shows one of the faculty apartments.



UNITED STATES EMBASSY OFFICE BUILDING

ATHENS



Photos by Walter Gropius

A R C H I T E C T S

THE ARCHITECTS COLLABORATIVE

Partners: Jean B. Fletcher, Norman Fletcher, Walter Gropius, John C. Harkness, Sarah P. Harkness, Robert S. McMillan, Louis A. McMillan, Benjamin Thompson. Associates: Chester Nagel, Richard Brooker, Herbert Gallagher, Witold von Hennenberg, H. Morse Payne, Jr. Consultant: Perikles Sakellarios, Athens

E N G I N E E R S

Mechanical and Electrical Design: General Engineering Associates. Structural Design: Paul Weidlinger; Mario Salvadori, Associate. Engineer in Charge of Design: Antranig M. Ouzoonian. Acoustical Engineering: Bolt, Beranek & Newman

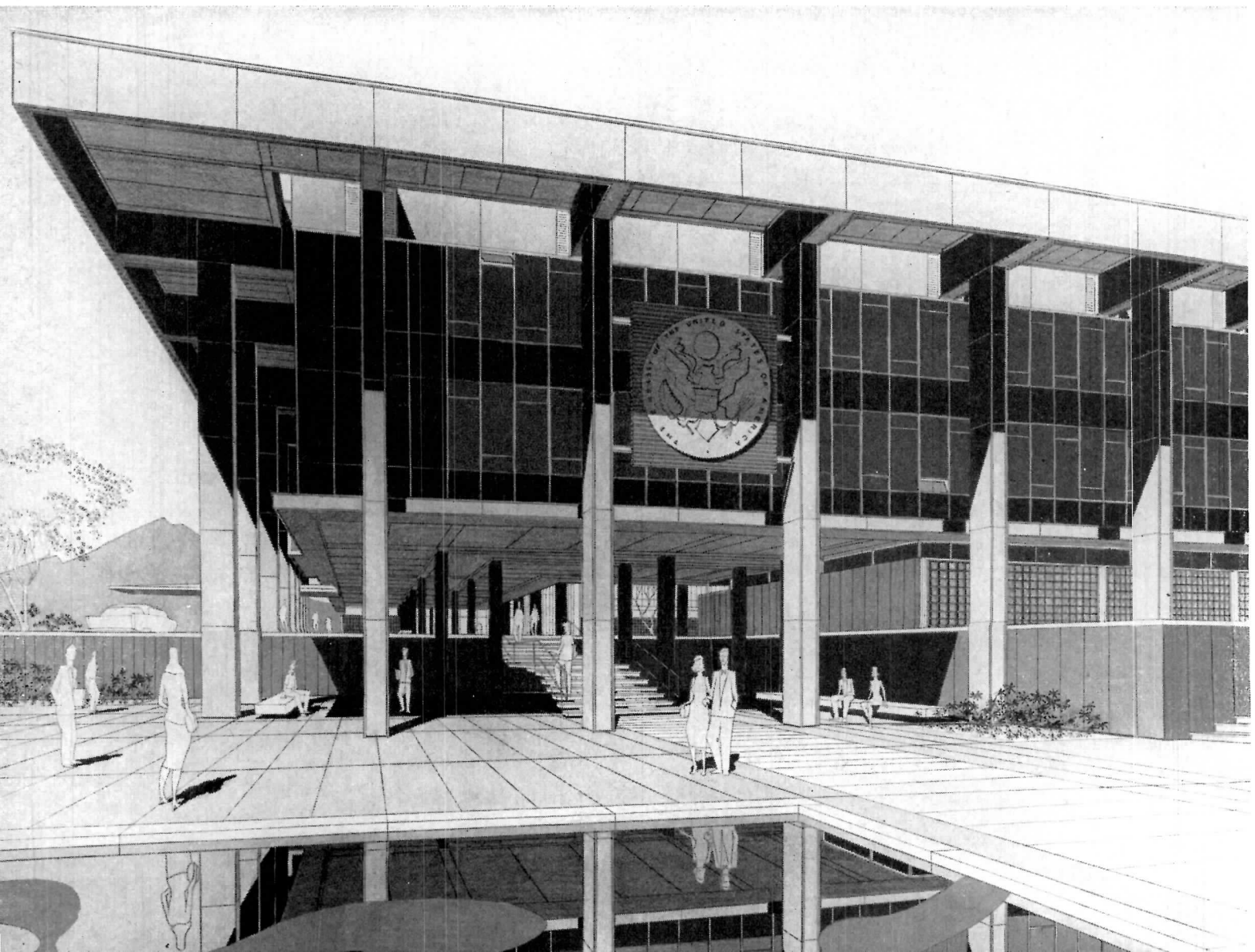

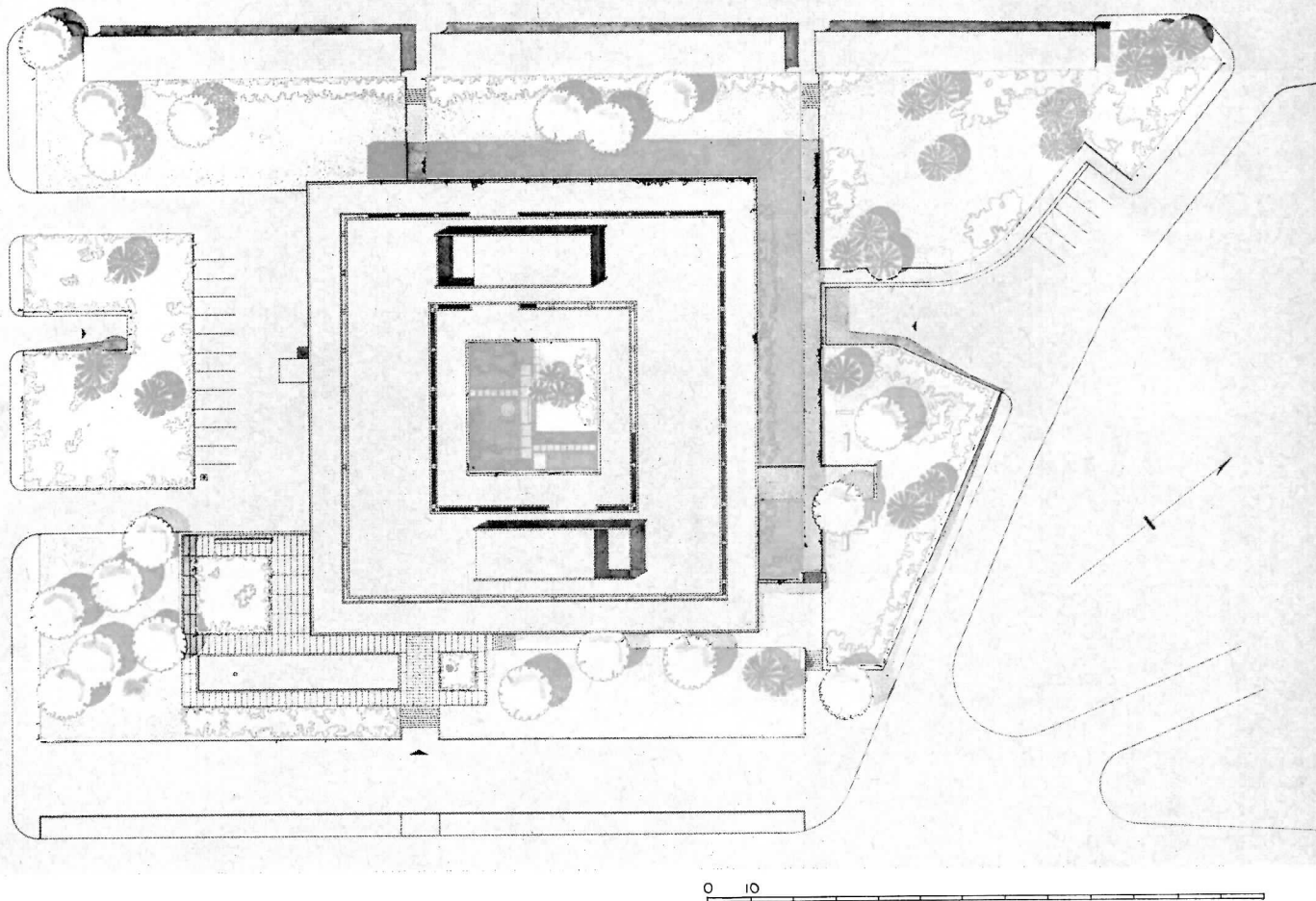

UNITED STATES EMBASSY OFFICE BUILDING, ATHENS

Architect Walter Gropius prefaces his remarks on the ideas motivating this design with the view that "architecture begins beyond the fulfillment of practical problems . . . and must manifest a psychological quality or attitude symbolizing its purpose."

He says, "our aim was . . . a building which should appear serene, peaceful and inviting, mirroring the . . . political attitude of the United States. Also, the design should abide by the classical 'spiritus loci' . . . but in contemporary . . . terms."

When complete, this design should meet those aims with consummate distinction.

The sloping site on Queen Sophie Avenue



UNITED STATES EMBASSY OFFICE BUILDING, ATHENS

The three-story structure — square in plan — opens inward to a spacious, landscaped patio — also square. Slender reinforced concrete columns, clad in honed white Pentellic marble, front on both the patio and the building's periphery. Each pair of columns supports a girder that carries the 20 ft roof overhangs which will serve to break down the intense sky-glare. The exterior walls for the offices will hang from the girders. At ground level, sun and burglar protection will be furnished by perforated, glazed tile screens, sky-blue in color.

In addition to the white marble that will sheathe and define structural elements, gray Marathon marble will be used in the basement; Santa Marina marble for the stairs, corridors and toilets. The plaza and lobby floors will be finished with terrazzo made of white marble-chip aggregate. The curtain walls will be composed of aluminum and gray glare-reducing glass. To ameliorate the excessive sun-heat, the roof construction will be double, with louvers for through air movement.

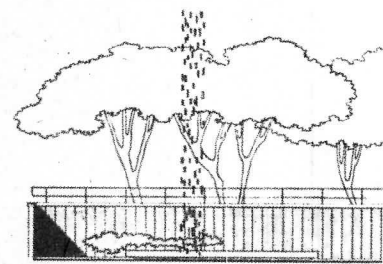

Detail of lower vents for double roof

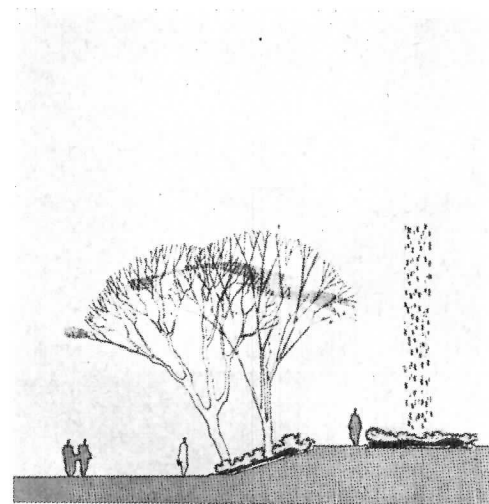
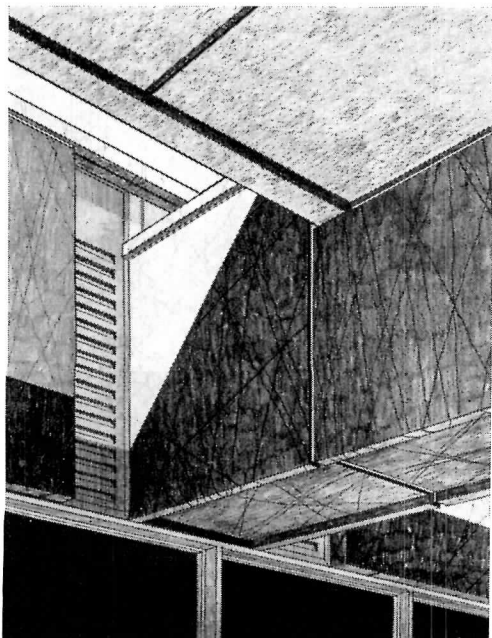

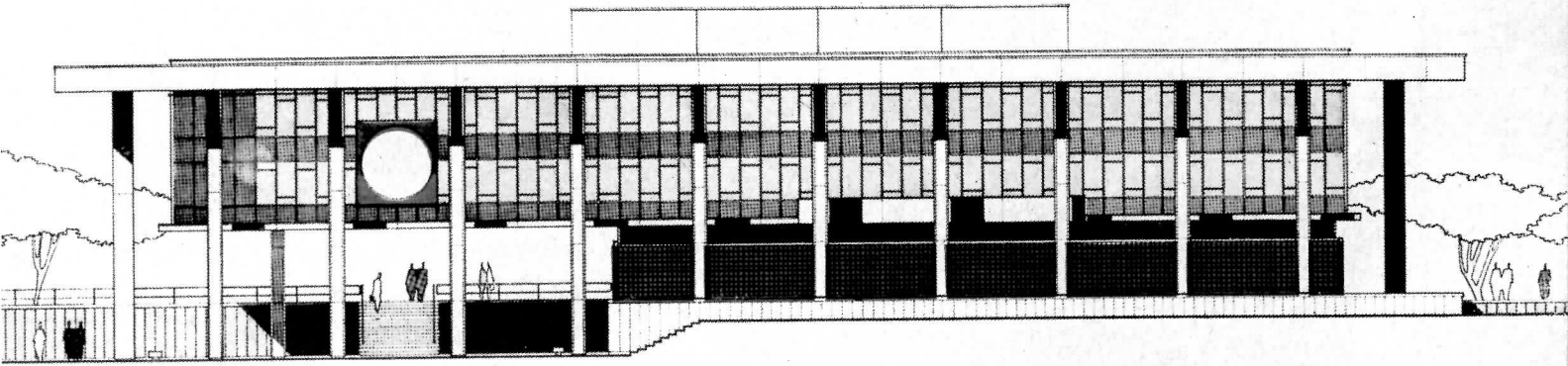

Elevation on Queen Sophie Avenue

Longitudinal cross section

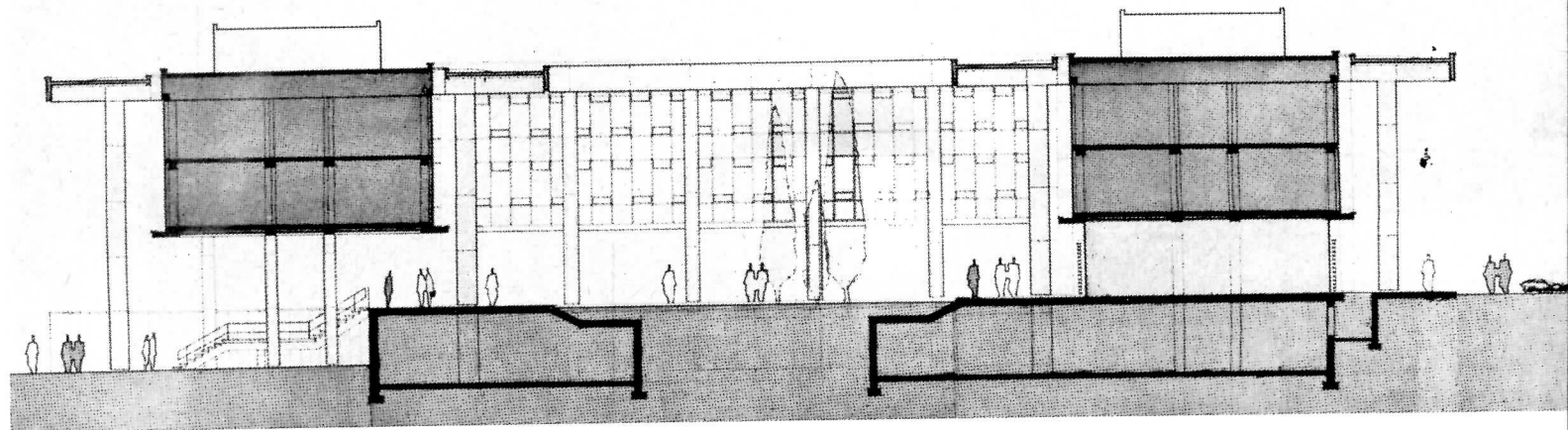

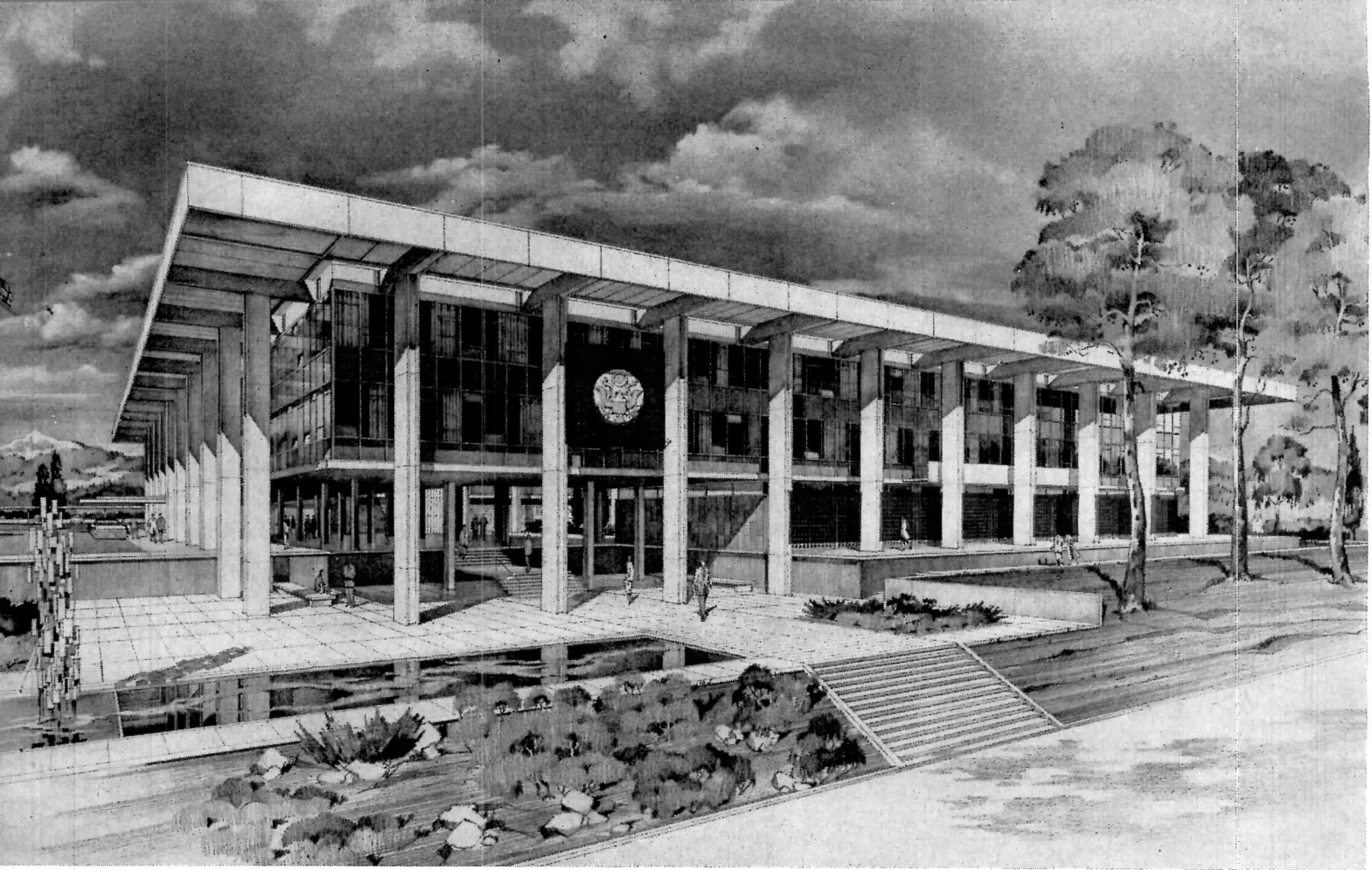

In the office layout, below, note roof overhang (shaded, top of plan) punctured by slots for hot air escape. For over-all flexibility, the 3 ft window module coordinates with corridor doors, ducts, lighting, partitioning, and the underfloor phone raceway (lower plan)

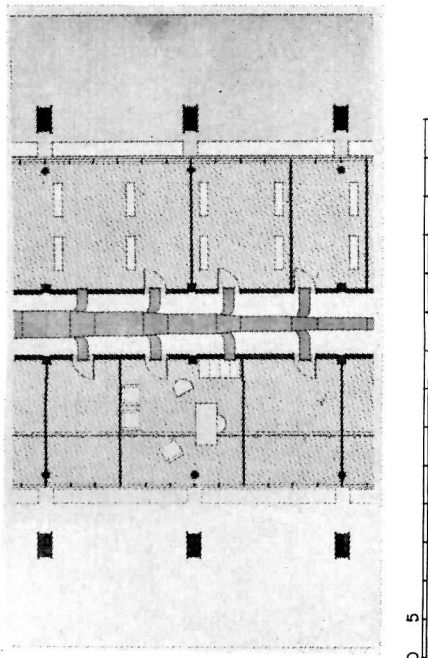

UNITED STATES EMBASSY OFFICE BUILDING, ATHENS

Plans at right: the second and third floors will be devoted to typical office areas, while the majority of the enclosed space at ground level will be turned over to consulate facilities, with the exception of the small area at upper left for embassy guards. One-third of the ground floor area will be unenclosed. In the basement, the large central space will park 30 cars, which will enter from the ramp at left. Service and deliveries will enter from the ramp at the right.

All mechanical and electrical services will rise through two vertical shafts adjacent to the stairways, to be distributed at each level through horizontal shafts above corridor ceilings.

A built-in apparatus for window washing will consist of ladders mounted on rollers which will run on horizontal tracks. The installation will allow a window washer to propel himself laterally along the various faces of the building.

2 & 3

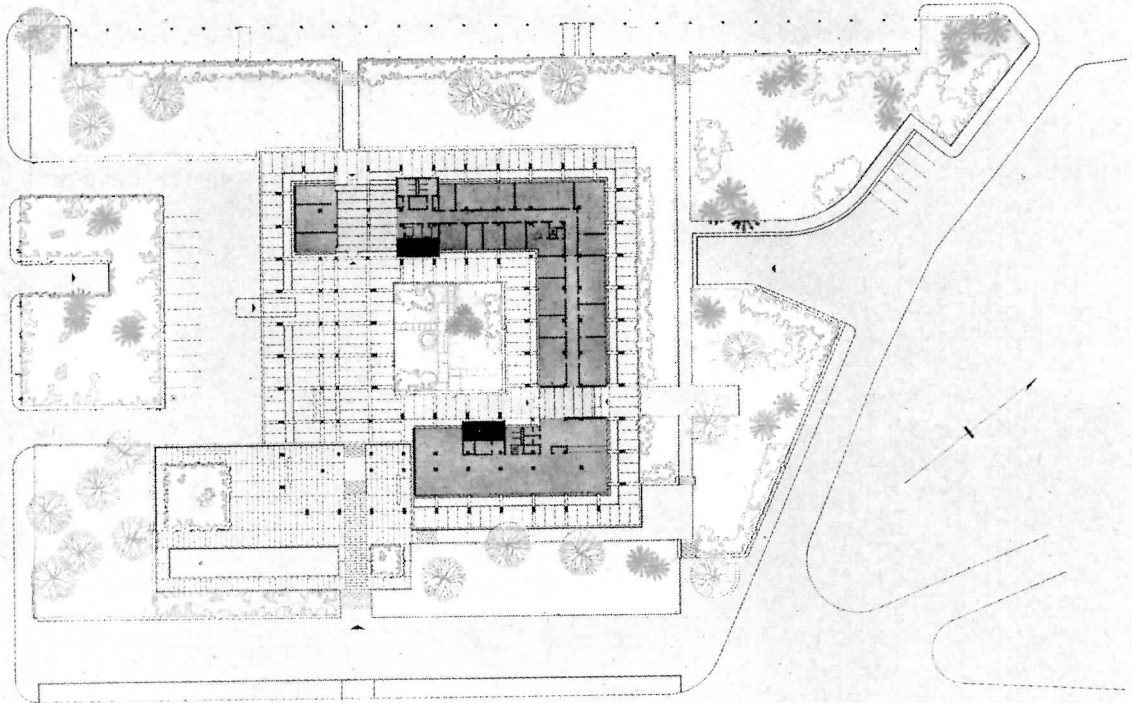
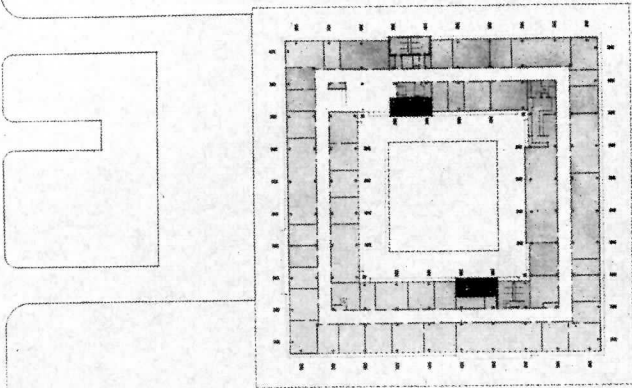

G

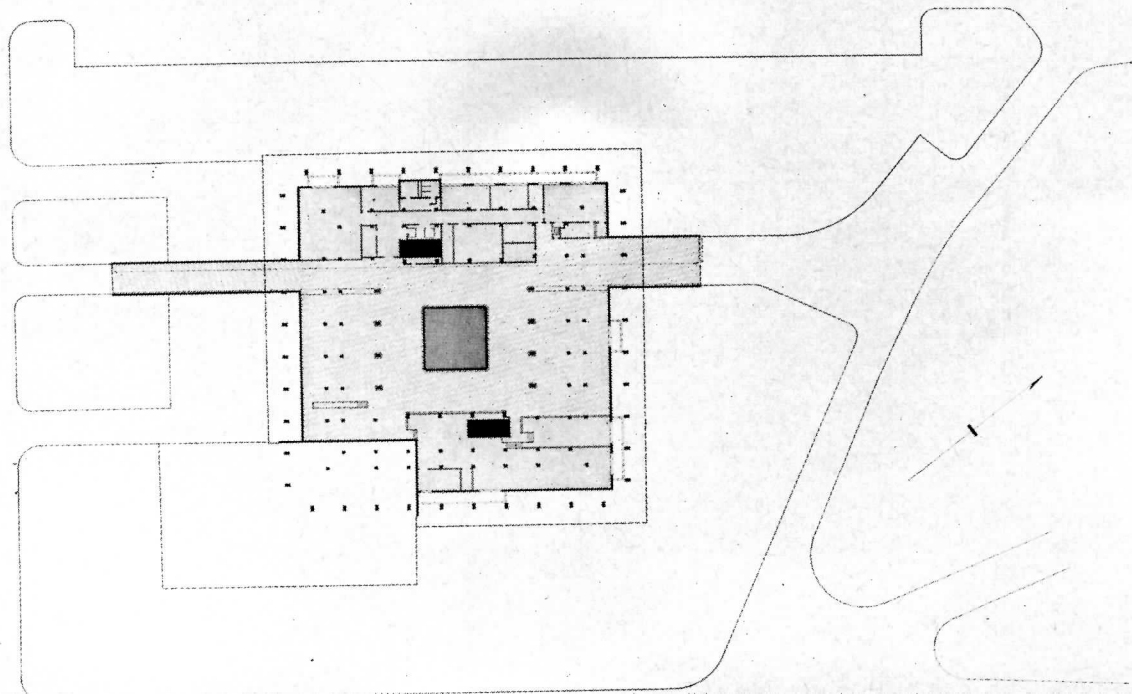

B

0 10

UNITED STATES EMBASSY OFFICE BUILDING, ATHENS

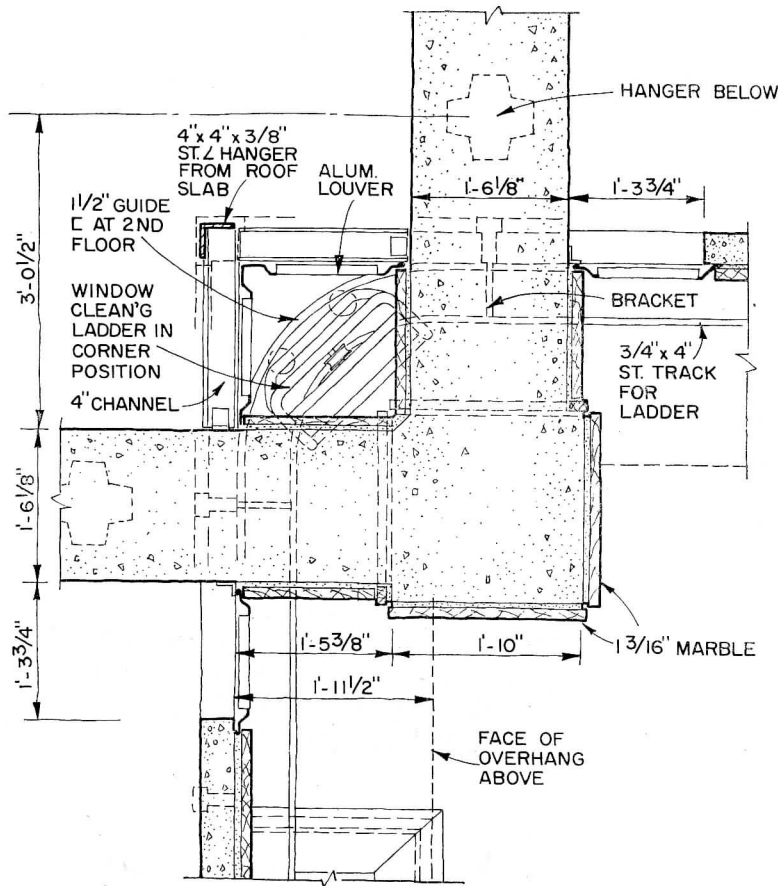

Plan detail shows corner of court at roof girder level

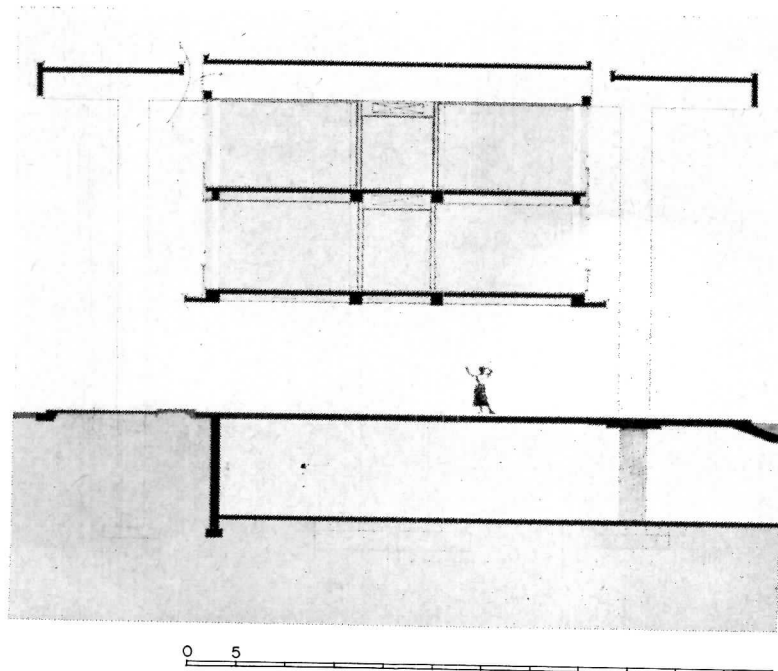

HIGH ACTIVITY IN PROSPECT FOR SCHOOLS, COLLEGES, HOSPITALS

By R. M. CUNNINGHAM, JR., *Editorial Director, The Modern Hospital Publishing Co.*

SCHOOL, COLLEGE AND HOSPITAL construction includes a little more than one-third of all non-residential construction in the United States. By the end of the year, we shall have spent \$4 billion in new construction of schools, colleges and hospitals in 1957, and the best sources of information in these fields estimate that new construction next year should exceed 1957 totals by a modest amount — probably four or five per cent.

PROSPECTS FOR SCHOOL BUILDING

Approximately \$2.8 billion of the total for 1957 will be spent in the construction of public elementary and secondary schools. Moreover, school construction must continue at this level, at very least, simply to keep pace with the growth in school populations. This year, there are 25,300,000 children enrolled in elementary schools, and 6,900,000 in secondary schools; next year, we shall add 750,000 children to the grade school population, and a half million to the high school population. These are not estimates; these children have been born and are surviving to school age, and it is our statutory responsibility to provide facilities for their elementary and secondary education. If school construction does nothing more than keep up with the birth rate, we must expand our school plant by 25 per cent to accommodate a school age population of 40 million children in 1965. At today's rate of new construction, we are falling behind the population increase.

Of course, there are differences of opinion among educational authorities, and even wider differences of opinion among other interested groups, including taxpayers, about the adequacy of our existing educational plant. The chief school planning officer of one Southern state wrote to *The Nation's Schools* recently, in reply to an inquiry about the school construction outlook for his state, indicating the state was planning to add 1,500,000 square feet of new school construction in 1958. Then he added: "If we had the money to replace antiquated buildings our need would be close to 2,500,000 square feet for 1958."

In spite of the widespread need for new and better school buildings, the charge has been made against public school authorities in recent months that we are

spending far too much money on schoolhouse construction, and that our new schools are "costly palaces" including luxurious, clublike accommodations that have no proper place in the educational process. Considerable national publicity has attended the controversy about so-called luxury public schools.

It would be foolish to deny that any extravagant schools have been built in recent years, or to suggest that all the elements of the modern school can be fully justified in every instance as essential to learning. Obviously, a few communities have been lavish in their provision of school facilities, and some features of some school buildings are dispensable — or, at least, less indispensable than other features.

It should be pointed out, however, that the clublike schools, if any, have been built in our wealthy suburbs. In most communities, in most states, schoolhouse construction is if anything too conservative, too restricted to the bare minimum of classroom and corridor space, and too lacking in all the other facilities that are accepted by most educators, and by most parents of school children, as desirable elements of the learning environment. The concept that education takes place only within the four walls of a classroom is as outmoded as the one-room school. This is not just the view of a few educators dwelling in ivory towers; obviously, it must be the prevailing view about education in our society, because, more than any other institution, the public school reflects what the community wants. Our schools today have athletic fields, and gymnasiums, and auditoriums, and music rooms, and lunchrooms, and domestic science rooms — not because educators have dreamed these facilities up as a method of tor-

turing the taxpayers, but because the great majority of us have wanted our children to have the learning experiences that take place in these environments.

Whether we are talking about an elaborate, glass-and-aluminum structure in Fairfield County or a simple, cinder-block box in western Kansas, however, the fact is that most communities are going to be hard put in the years ahead to finance the expansion needed to keep up with growing school populations. The *average* cost of new school construction today is over \$1000 per pupil for elementary schools, and over \$1500 per pupil for secondary schools. With an ever-growing number of children entering elementary schools, and an ever-growing fraction of these who finish elementary school going on to high school, and remaining in high school until graduation, many communities are going to have a hard time financing enough construction to keep their school children warm and dry all day, let alone giving them club rooms and swimming pools.

Most local school districts finance the greater part of new schoolhouse construction by means of school bond issues, and, while some bond issues have been defeated this year, most of the building that will be

done in 1958 will be financed by bond issues that have already been approved. Some school people think the public debate about our so-called lavish school palaces may result in defeat for school bond issues that need to be approved to finance construction planned for 1959 and later years, but it seems unlikely that this will happen in many cases, and, even if it does happen, public debate about school buildings and school programs is essentially a wholesome thing from which schools are bound to benefit in the long run, because it will result in more people having a better understanding of school problems.

Increasingly in recent years, school districts have been dependent to some extent on state aid in financing plant construction and expansion. More than half the states make direct grants for construction, according to various state-school district formulas; some state assistance to school districts is in the form of loans. Usually, funds for state aid to local school districts depend on current appropriations by the legislatures and thus vary from period to period, but a few states are now earmarking state funds to provide continuing aid for long-range school construction programs.

PROSPECTS FOR COLLEGE BUILDING

As in the case of school construction generally, the outlook for construction of buildings for higher education is favorable for many years to come, because the population of 18-to-21-year-olds will continue to increase for a number of years, and also because the percentage of the college age population actually enrolled in colleges is also increasing rapidly. In 1940, only 15 per cent of the college-age population was enrolled in colleges; today, 32 per cent of the college-age population is attending college, and the percentage is expected to continue steadily upward in the years ahead. College enrollment this year totaled approximately 3,500,000; authorities estimate that the total enrollment will increase by at least a quarter of a million students each year, and that we shall have more than 6,000,000 students enrolled in our colleges and universities by 1968.

These students not only have to be taught, but a large fraction of them have to be housed as well. For the last five years, the construction of college residential facilities has been approximately one-third of the total of college and university construction for all purposes, *including* football stadiums and athletic fieldhouses. College and university construction this year, it is estimated, will total approximately \$550 million, and, again, estimates for 1958 indicate a moderate increase, in line with the anticipated increase in college population.

Of current college and university construction, approximately 60 per cent is for public institutions and 40 per cent for private institutions. As we look ahead to the need for constant expansion of college facilities

to keep abreast of the growing population and the constantly increasing percentage of high school graduates wanting to go on to college, it seems inevitable that the expansion will be increasingly in public institutions rather than private institutions, for two reasons. First, it is generally easier — or *apparently* easier, at any rate — to raise money by presenting a budget to the legislature than by presenting an appeal to a group of prospective donors, and, second, there are still some private institutions, but not as many public institutions, that cling to the quaint, old-fashioned notion that some intellectual qualifications or standards should be required of candidates seeking admission to college, and that the colleges are not automatically obligated to add a seat in the classroom and a bed in the dormitory for every candidate who appears in the admissions office.

One other phenomenon that should be noted in a report on the future of college building is the emergence of the junior college — usually as a 13th and 14th grade under the public school system, planned to meet the needs of those who wish to continue beyond high school but are unable to go on to the residential college or university. More popular in some areas than others — and notably a development of our larger cities — the junior college is unquestionably here to stay, but it seems likely that it will emerge slowly rather than rapidly, simply because the public school systems are so largely preoccupied with planning and building for expanding elementary and secondary school populations.

PROSPECTS FOR HOSPITAL BUILDING

Of course, all these children who have been born and are growing to school and college age and have to be educated are also going to get sick from time to time, and so the medical facilities to meet their needs when they are sick and injured have to be provided, and the base line from which we estimate the need for hospital building in the future is the same as the base line for estimating educational needs — the growing population.

In the case of medical facilities, however, there are other factors besides population that have an important bearing on the need, a circumstance that is demonstrated by the fact that admissions to our hospitals have increased approximately 50 per cent in the last 15 years, a period during which our population has increased only 25 per cent.

For the last ten years, we have been adding to our hospital plant at the rate of approximately three-quarters of a billion dollars of new construction each year. It seems likely we will exceed that figure this year; estimates now indicate the 1957 total should reach \$850 to \$900 million of hospital construction, the largest of any of these years of intensive hospital building. Moreover, estimates for next year indicate hospital building will continue at these levels and may even show a modest increase in 1958.

With all this building, it seems reasonable to think that we may have reached the point where the need for hospital beds is largely supplied, or will soon be largely supplied, and thus the outlook for continued intensive building activity would be less favorable than it has been in the recent past.

Actually, this is a long way from being the case. There are some areas, to be sure, which are now well supplied with hospital beds and may be expected to curtail building expansion in the years just ahead. For the nation as a whole, however, the new hospital beds that have been furnished in the building program of the last ten years have barely kept pace with the demands of the growing population; there are still large areas with substantial bed deficits, and there are other areas in which large numbers of hospital beds still in use are in old, inefficient and unsafe structures. To meet these needs, hospital construction must be maintained at present levels for many years to come.

If we consider other factors than the population base, however, we may need to step up the rate of hospital expansion considerably beyond the present level. The utilization of hospital facilities is increasing more rapidly than the population, and while advances in medical science affecting the need for hospital facilities are of course unpredictable, there can be little question that the trend in developing medical technology over the years is always toward a greater and greater need for the staff and facilities available only in the hospital. You can't put a cobalt machine in a doctor's office.

Evidence of the trend of events in utilization of

hospital facilities is abundant. For example, the American Medical Association reported recently that the proportion of the medical care dollar spent for hospital services has doubled in the last 25 years — from 13.7 cents in 1929 to 28.5 cents in 1956. An even more significant figure, in terms of the interests of this particular group, is the difference in space requirements in the hospital today, compared with those of 20 years ago. When I first began to report hospital affairs, hospital architects, planners and consultants used to consider that the general hospital offering complete service should have 325 to 350 square feet per bed for all services. If a hospital had as much as 375 or 400 square feet per bed at that time it was regarded as extravagant. Today the United States Public Health Service standard for general hospitals calls for 550 to 650 square feet per bed, and many of the new hospitals have as much as 700 square feet per bed. The added space is used for all the facilities — such as postanesthetic and post-operative recovery rooms, and intensive care areas, and radioisotope laboratories, and high humidity treatment rooms, and inhalation laboratories, and cobalt machines, and blood banks, and many, many other services that didn't exist a few years ago, when the hospital got along nicely with 350 square feet per bed. It takes twice as much space today to provide hospital service for the same bed.

While surgery was the major part of hospital practice up until a few years ago and may still be considered the core of hospital practice, the fact is that the hospital has expanded far beyond the surgeon's horizons and is now the focal point for all the medical services of the community, including diagnostic services for outpatients as well as inpatients. In the general hospital today, as a matter of fact, from 20 to 30 per cent of all patients are not acutely ill and don't need to be in bed. This is a circumstance that foretells some changes in hospital design that are going to take place in the years ahead, and are already beginning to appear.

It is medically unnecessary and economically imprudent to keep a patient in bed all day on a unit designed to provide intensive nursing supervision, and give him three meals in bed, when he is in the hospital only for a diagnostic workup, needs only a minimum of nursing supervision, and is well able to walk to a cafeteria or dining room and get his own meals. So hospital planners are beginning to think about grouping hospital facilities according to the needs of patients, rather than by medical jurisdictions, and already some hospitals have been planned with special floors or units for ambulatory patients, and other floors or units for patients with ordinary nursing needs, and still other floors or units for patients with need for intensive nursing and medical supervision.

This kind of planning is going to be more and more evident as hospitals add to their facilities and undertake modernization programs in existing buildings. The

great expansion of hospital plant in the years ahead is going to come from additions to existing hospitals, rather than primarily in wholly new institutions, and the ingenuity of architects, consultants and builders is probably exercised as thoroughly by the task of adding new facilities to an old hospital building as it is in any other assignment in the whole construction industry.

As we look down the years, it seems likely that a lot of space in and around our existing hospitals is going to be needed for buildings and functions that our hospitals are just beginning to recognize as hospital functions — the provision of facilities and services for the aged, and also for the mentally ill, whose problems have generally been set aside for special institutions, and mostly for state supported institutions, up to this time.

While more than half of all the hospital beds in the United States are occupied by mental patients, nearly all these beds are either in huge state hospitals, where treatment is generally inadequate, or in small, private mental hospitals costing up to \$40 or \$50 a day, a figure few patients can afford. Only ten per cent of our general hospitals accept patients requiring psychiatric treatment, a circumstance that is about as illogical as it would be if we had hospitals caring for diseases and injuries of the soft tissues but not the bones. Physicians and hospital people, however, are beginning to recognize that the patient whose illness is mental or emotional in origin is as much their responsibility as one whose disease is organic, so we can expect to see the establishment of psychiatric buildings and psychiatric floors and psychiatric nursing units in general hospitals in increasing number. This is one of the directions that our hospital expansion is going to take in the years ahead.

Similarly, hospitals in their concern for the acutely ill and severely injured in past years have largely neglected the needs of the aged population. The aged constitute an ever-growing fraction of the whole population; there are now 1000 men and women reaching age 65 every day in the United States. Primarily, hospitals must be concerned with the needs of old people with chronic ailments requiring something more than home care but something less than the intensive nursing and medical supervision that is available in the general hospital.

While the Hill-Burton Act has provided substantial funds for such special hospital needs as these, and for regular hospital expansion, for the last ten years, and will continue to stimulate hospital construction, unquestionably, for some years to come, the fact is that the greater part of hospital construction funds right along has been coming from local, and not federal or state, resources, and the greater part of the local funds have come from private, and not tax, sources. Hospital fund-raising experience, for the most part,

has been favorable during the last year, and fund-raising efforts now in progress to finance expansion in 1958 and 1959 are also successful for the most part.

As in the case of private educational institutions, hospitals look more and more to corporate, as opposed to individual, contributions for a major share of their voluntary funds. It is encouraging to hospital people that business and industry generally recognize a responsibility for the provision of health facilities in their communities, and contribute substantially to such fund raising drives. The important part corporate contributions play in support of our medical institutions was recognized by President Eisenhower recently in his speech at a dinner honoring Alfred P. Sloan for his contributions to education and medicine. The President noted that Mr. Sloan was "among those pioneers who believed, far back, that the corporations of America derive from our colleges, our technical institutes, and our medical schools and hospitals a benefit which is ample to sustain — if not oblige — contributions toward their continued and effective service to the American people. . . . The American corporation is showing increasingly that it is a good citizen. Industry is accepting support of (education and medicine) as the normal responsibility of a successful business, because it senses a fundamental truth, too long veiled: That, by contributions to the strengthening of these resources, each giving corporation makes a sound investment in its own as well as in our nation's future."

Mortgage financing of capital expansion for hospitals is no longer a rarity, as it was until a few years ago. Hospitals have emerged in recent years as business institutions earning a large part of their own revenues, with an increasing share of earned income coming from hospitalization insurance agencies rather than individuals, and banks and insurance companies have recognized hospital building loans as good business. They have been more ready to make such loans than they were when hospitals were regarded as exclusively religious and charitable institutions whose incomes were uncertain and whose business methods were haphazard.

Like residential and industrial building, institutional construction in both the educational and medical fields is affected by the general economy, and estimates of anticipated school and hospital construction for the coming years might be substantially changed by the economic upheaval of war or depression. However, this is probably less true of institutional building in education and medicine than it is of most other programs in our economy. The basic importance of health and education in the survival and well being of our society is now generally recognized, and it is unlikely, even in times of distress, that we shall ever neglect to provide the facilities needed to maintain high standards of health for the entire population, and to give our children the kind of education we want them to have.

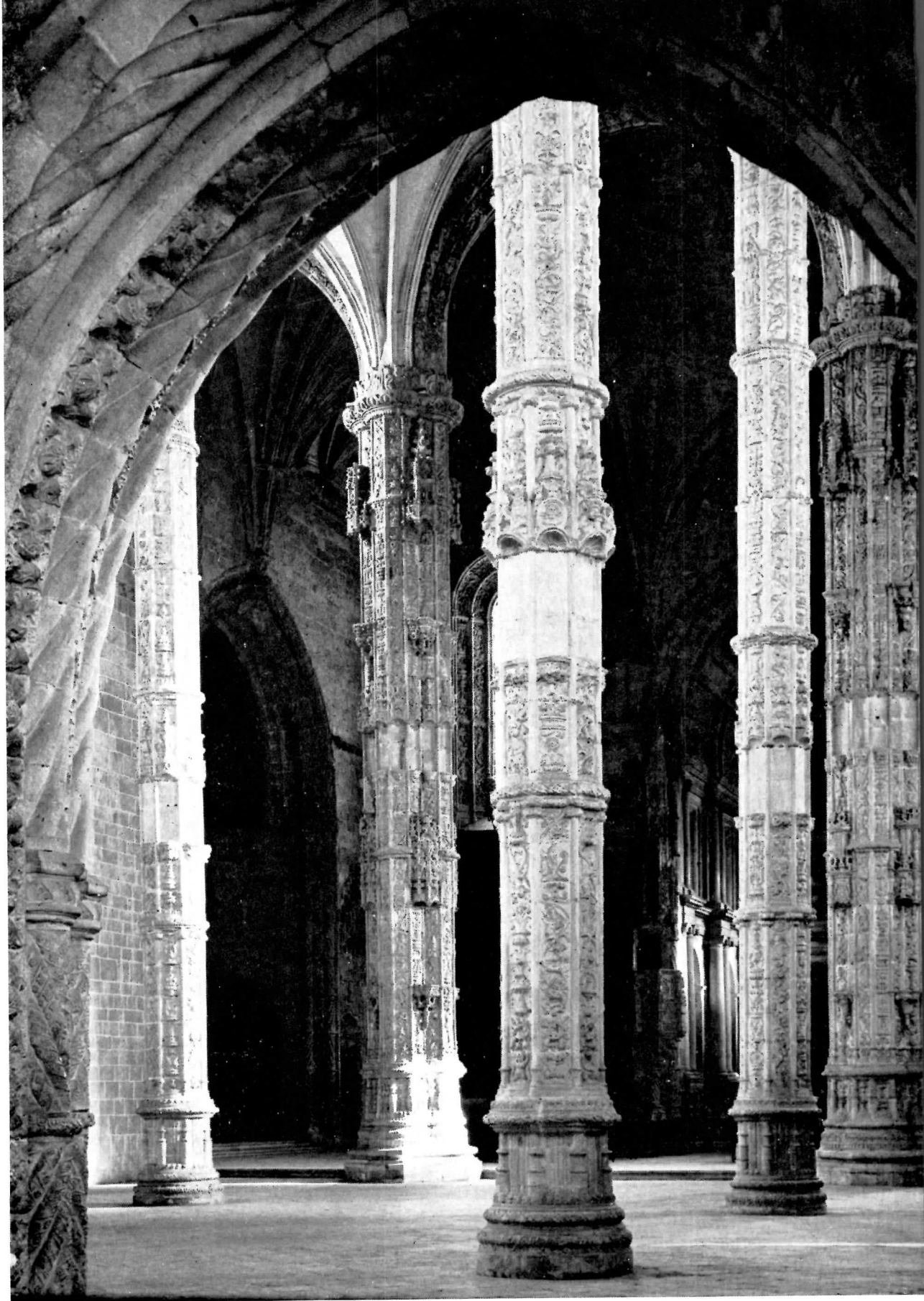

The Jeronimus Church, Lisbon (G. E. Kidder Smith photo)

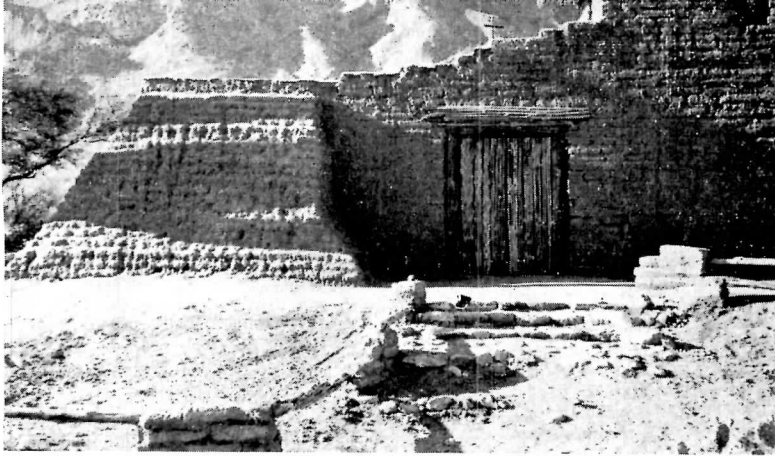

From the materials of the site

THE POWER OF POSITIVE SPACE

IF THE STRONGEST development of form occurs in those building types which express the dominant concerns of a society, and if those types, in turn, influence all other building form, then it is not surprising that church building in America has not been, on the whole, rewarding. Only infrequently have we organized spaces for worship as powerful as the richly simple Mission of Guadalupe recently completed in Arizona by Indian worshippers under the direction of the painter Ettore de Grazia. On the contrary we seem to have been concerned with achieving a kind of Gracious Living in God's House. We have filled self-conscious volumes with planter boxes and finicking decorative gestures; conducted planning exercises and structural experiments; but have not made many positive spaces in which men can find — in the quality of the space itself — “something there that was not put there.”



Meaningful elaboration of surface

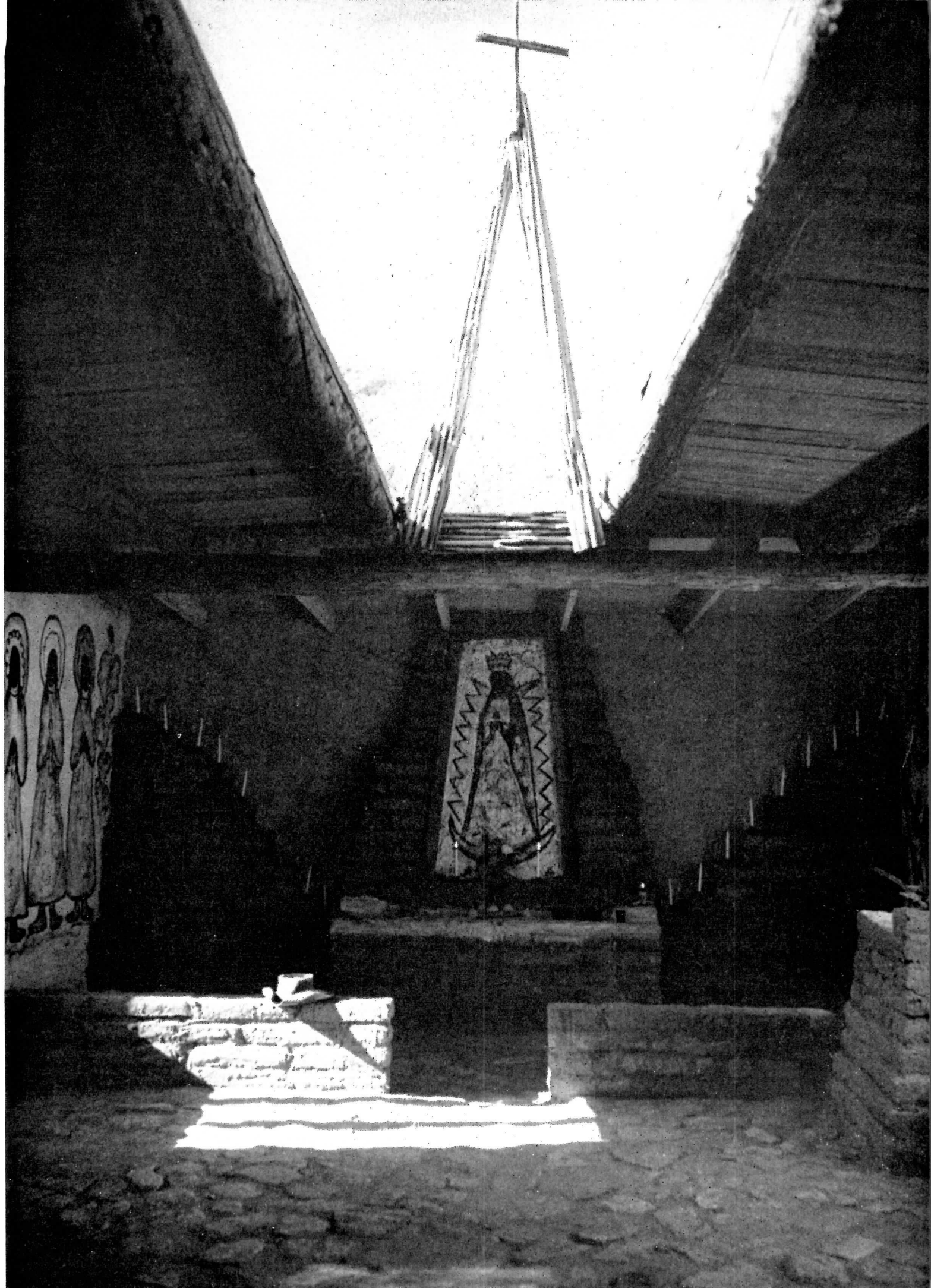

Granite altar in a moving space



The ingredients of a positive space are easier to identify than to successfully exploit: Shape responsive to purpose and to the means of its forming; Size related to man and to his aspirations as well; Surface which contains without dominating and elaborates without distracting; all brought together in Light to achieve a visual harmony whose unity escapes monotony through a variety which avoids chaos. Even more difficult to achieve is *character* which can come only through the ability of the whole to convey meaning. Just as with good men good spaces must stand for something. In this, where we have most often failed, we are beginning again to get instructive examples. Recent in a series of remarkable European works is the fisherman's chapel on the Riviera in which Jean Cocteau's frescoes and a few liturgical objects have rendered a powerful, palpable space.

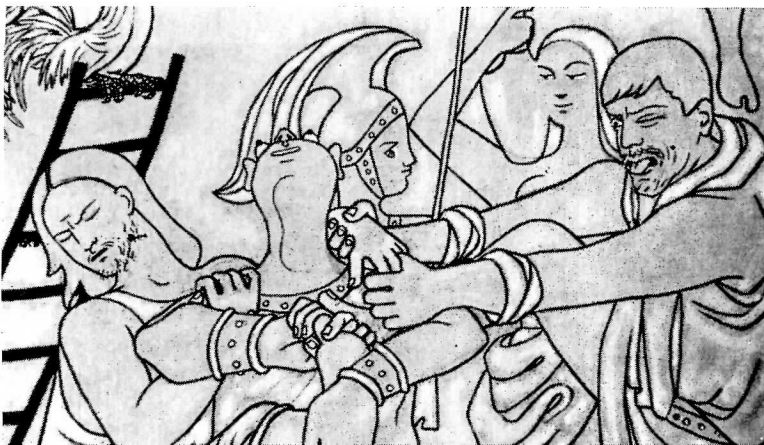

In simple lines a rich experience

The chapel at Villefranche-sur-Mer



Marc Riboud-Magnum Photos, Inc.



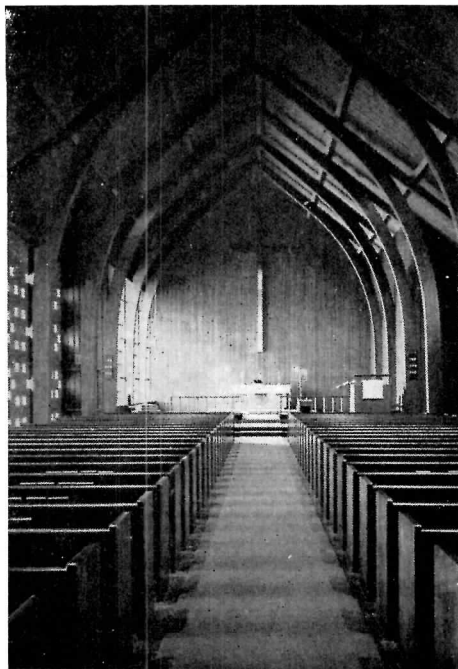

*St. Thomas More Chapel, Portland (left);
Zion Lutheran Church, Portland, Pietro Belluschi*

Left, Erven Jourdan, right, K. E. Richardson

In twentieth-century America outstanding examples are few and scattered, and the general level of work is commonplace. Perhaps only in the Pacific Northwest has there developed anything approaching a concentration of church building distinctly superior to the national average. There the work of Pietro Belluschi and Paul Thiry has set high standards for all who would design churches and an encouraging number of architects are endeavoring to meet those standards. In part the strength of the northwest prototypes derives from a simple directness which eschews the gimmick — structural or decorative. Their spaces are calm but intensely so. Shapes are simple but contoured and lighted so as to extend and enrich experience. Scale is man-and-God related. Surfaces are developed in a continuity possible only with a rigorously restricted palette.

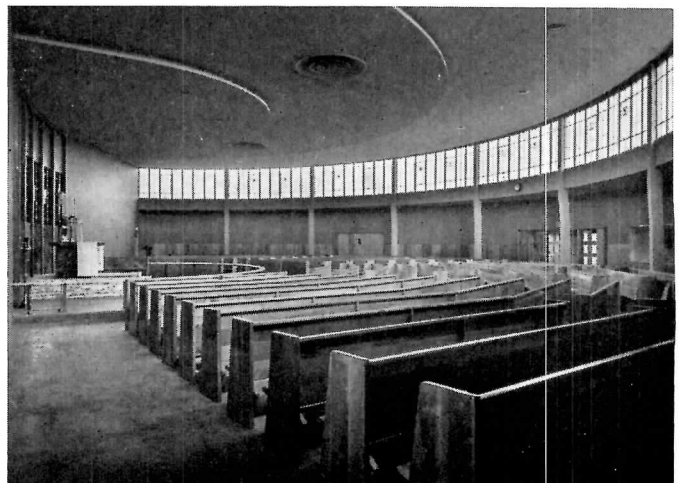

Church of Christ the King, Seattle, Paul Thiry





Simple materials plastically employed

ST. ELIZABETH'S EPISCOPAL CHURCH, BURIEN, WASH.

THE THREE LOW-COST churches presented here offer witness to the continuing high quality of church design in the far northwest and indicate something of the magnitude of the reach from architectural good looks to architectural personality and the further and harder reach from personality to character. If they do not ultimately accomplish their goals — the actual experience of their spaces must be prerequisite to that judgment — it can be observed that there is here evident that character-building concern for the unique qualities which inform these faiths.

In St. Elizabeth's Architects Durham, Anderson & Freed have found in the union of a simple source of natural light and the glue-laminated framing arches an appealing sculptural shape when read from either inside or out. On a budget of \$100,000 and with the necessity of seating 400 all materials are simple and directly used.

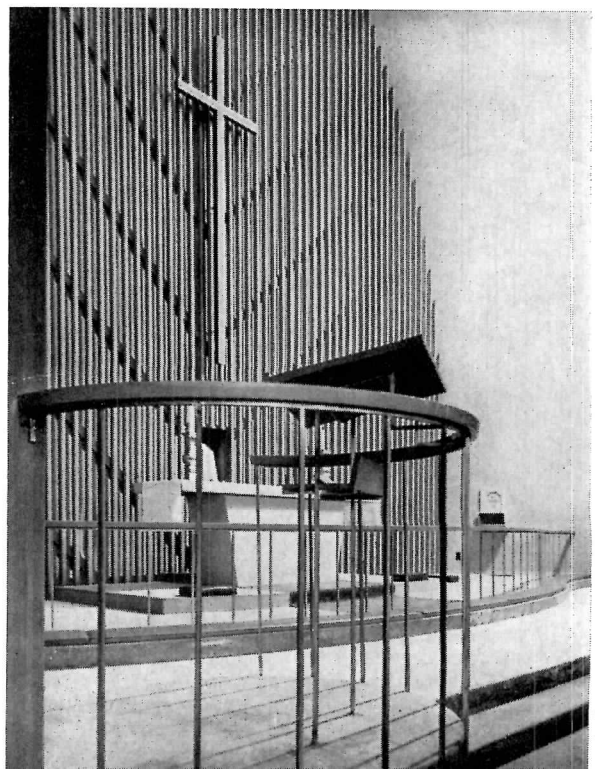

A space transformed through light

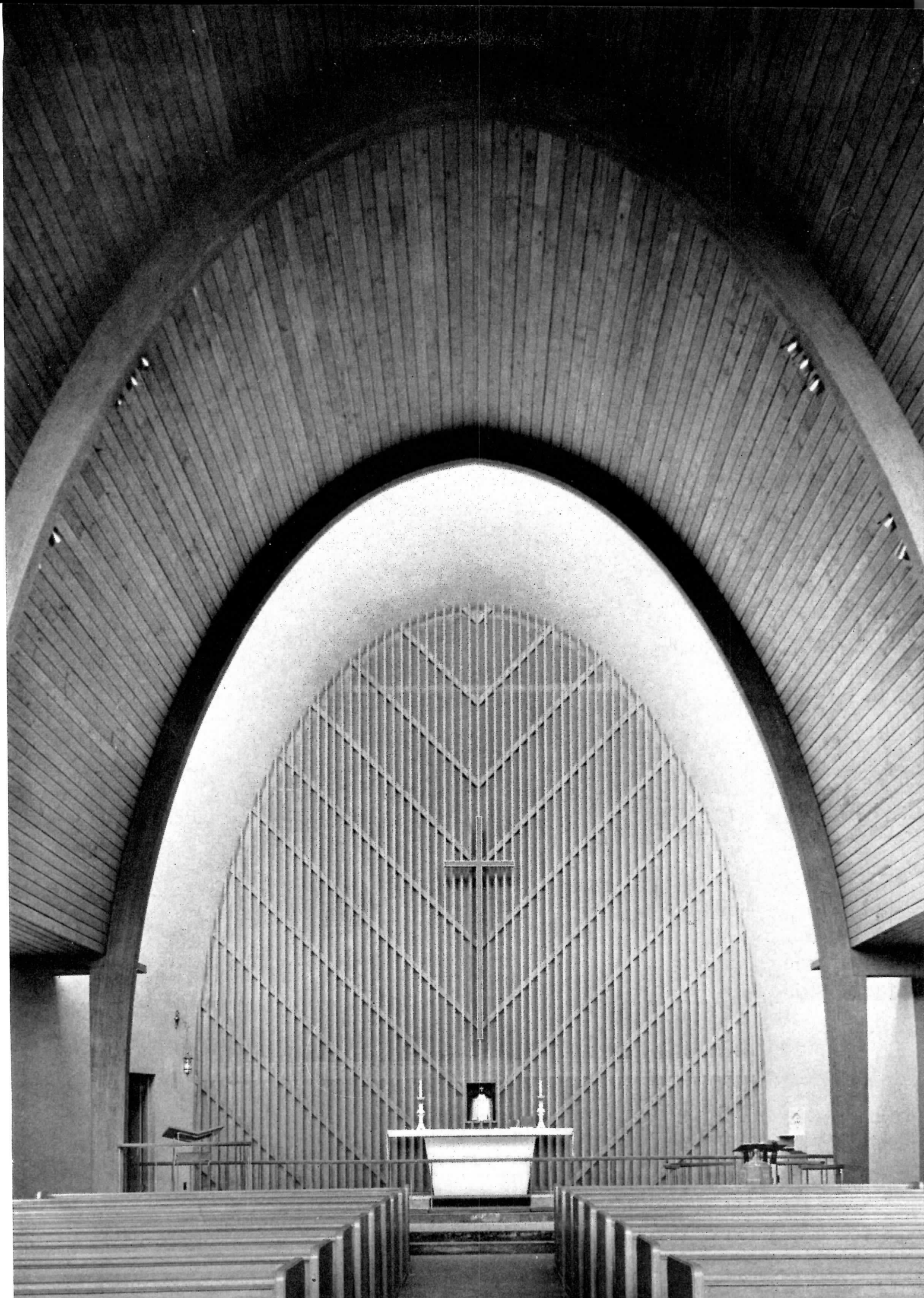

The restrained appointments of a unique liturgy

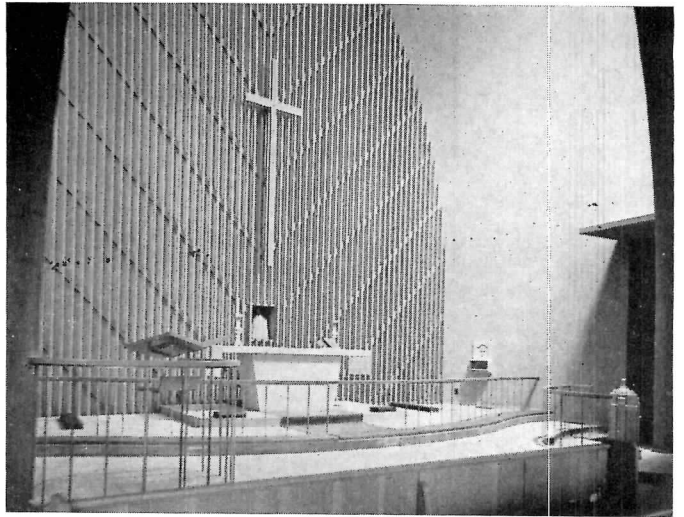

Arl Hupy

Hand-split shakes cover the three-inch plank roof. The curved brick wall retains the grade at the chancel end and is the only major masonry element. Elsewhere — on exterior and interior — stained wood is used. A grayed beige and a middle value grayed blue are the principal nave colors. Altar and baptistry rails and the pulpit are in light wrought iron. Heating is warm air. Engineers: Stevenson & Rubens, Structural; Stern & Towne, Mechanical; B. A. Travis, Electrical; Color Consultant: Gladwyn Morrison.

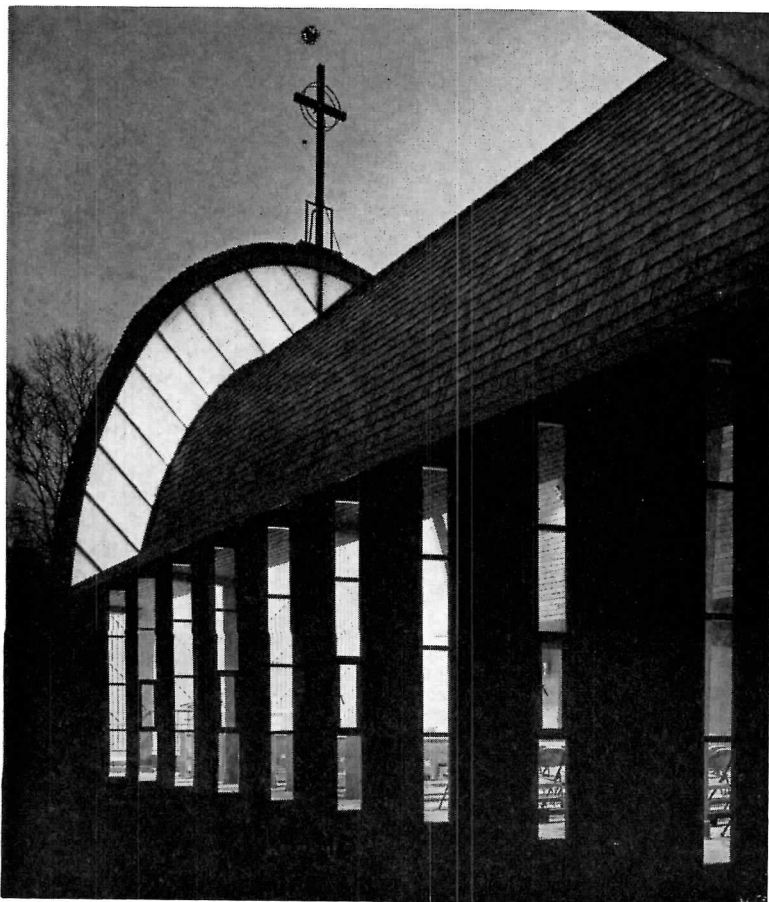

An architecture for night and day

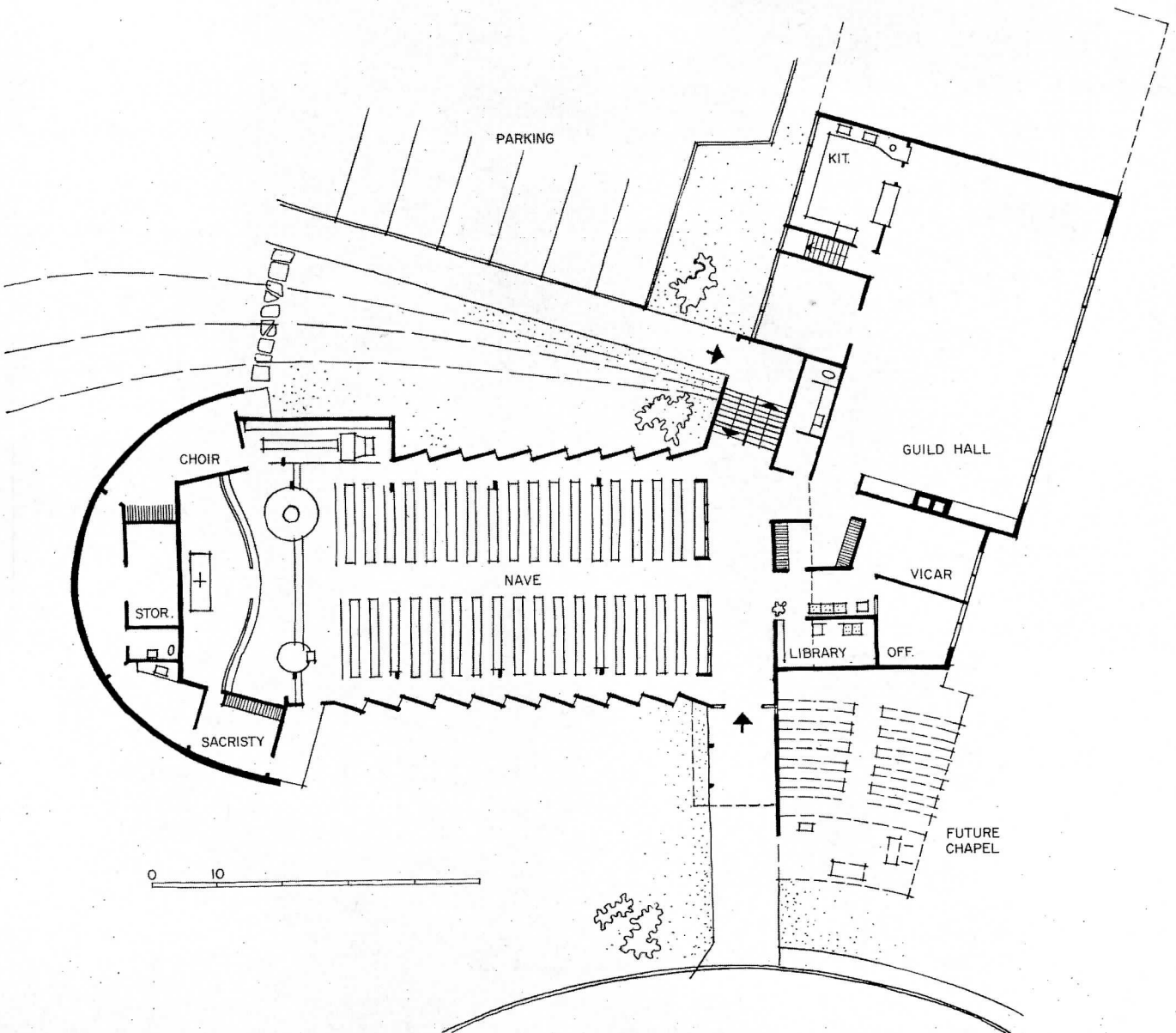
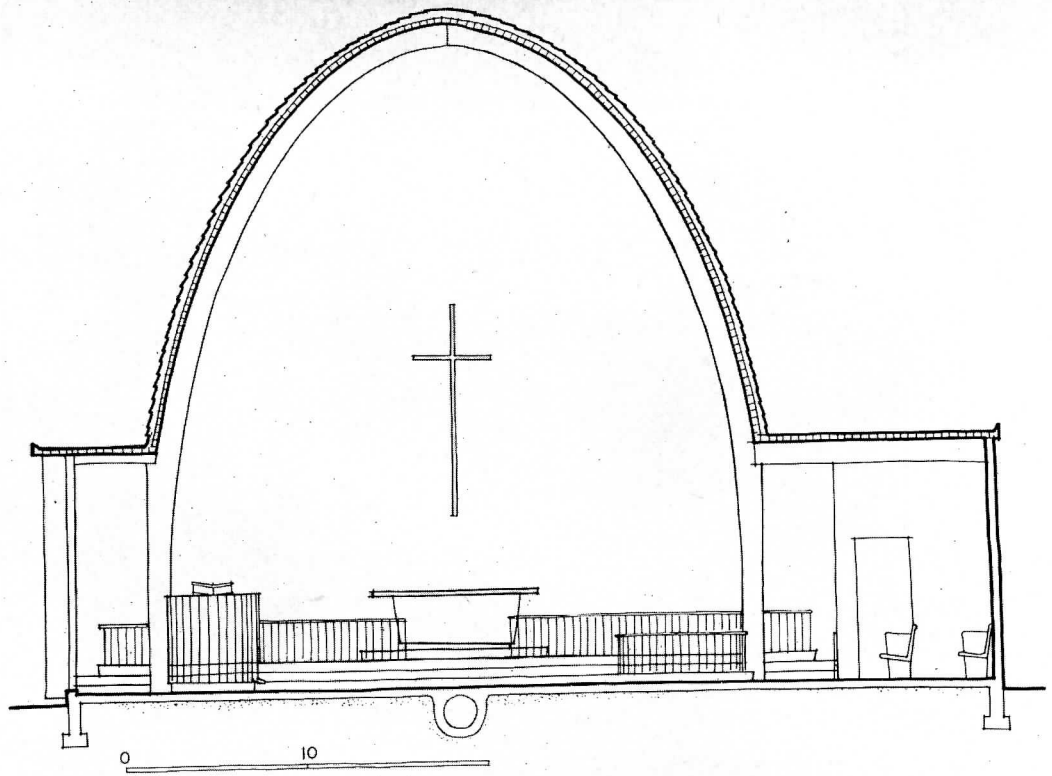

MAIN FLOOR PLAN



First stage in a larger program

HOPE LUTHERAN CHURCH, TACOMA, WASH.

IN THE NAVE of this church — which will eventually become the parish hall of a larger plant — Architect Robert Billsbrough Price has achieved a splendidly simple and beautifully refined space. Glue-laminated beams and columns frame a room to seat 400. Tile-finished concrete floors (carpeted in the chancel), natural birch slats (on the upper side walls), white acoustical tile ceiling, and low side-aisle walls painted chalk pink are composed in very low key with the plum-colored brick of the chancel end wall. Because the narthex must double as overflow nave space and as a multi-purpose fellowship area it can be completely opened or closed to the nave

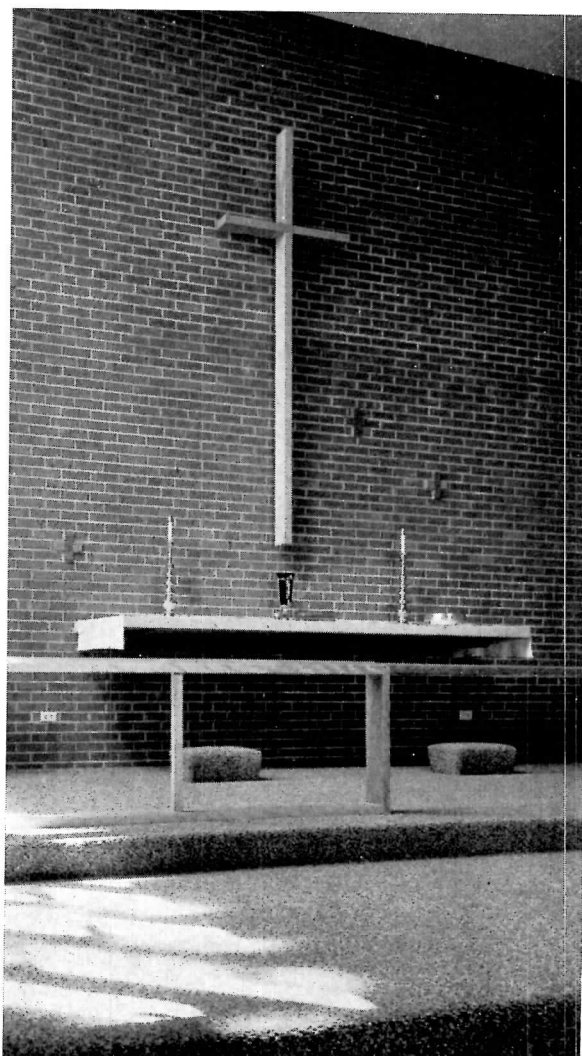

Refinement and restraint



A font of simple beauty

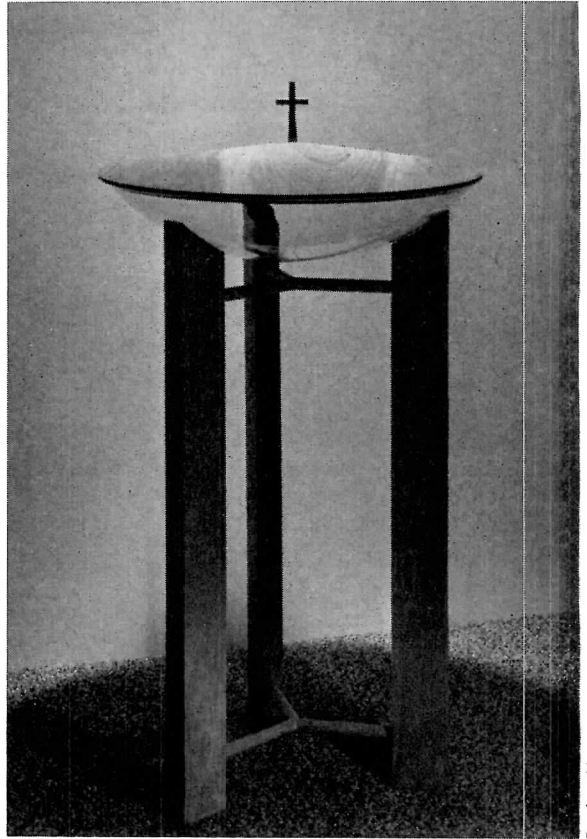

Deerborn-Messer

by means of wood folding partitions. The chancel is naturally lighted through an east window of French antique satined glass. Interior rooms around the nave are toplighted. Liturgical objects, rails and cross are extremely simple. Heating is warm air. Construction cost excluding fees was just under \$100,000. Electrical Engineer: Walter S. Gordon.

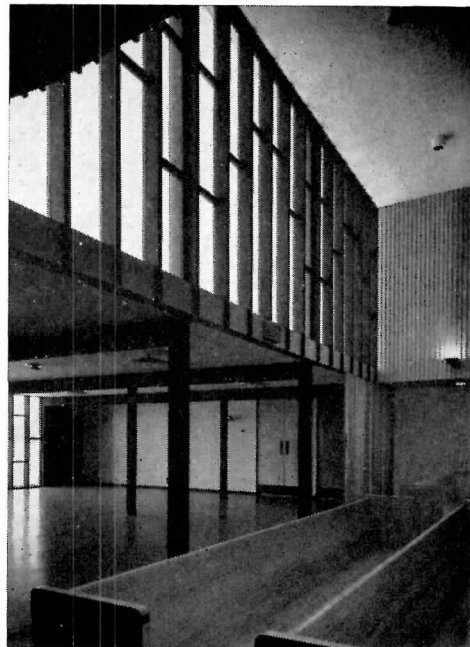

Expansion and contraction

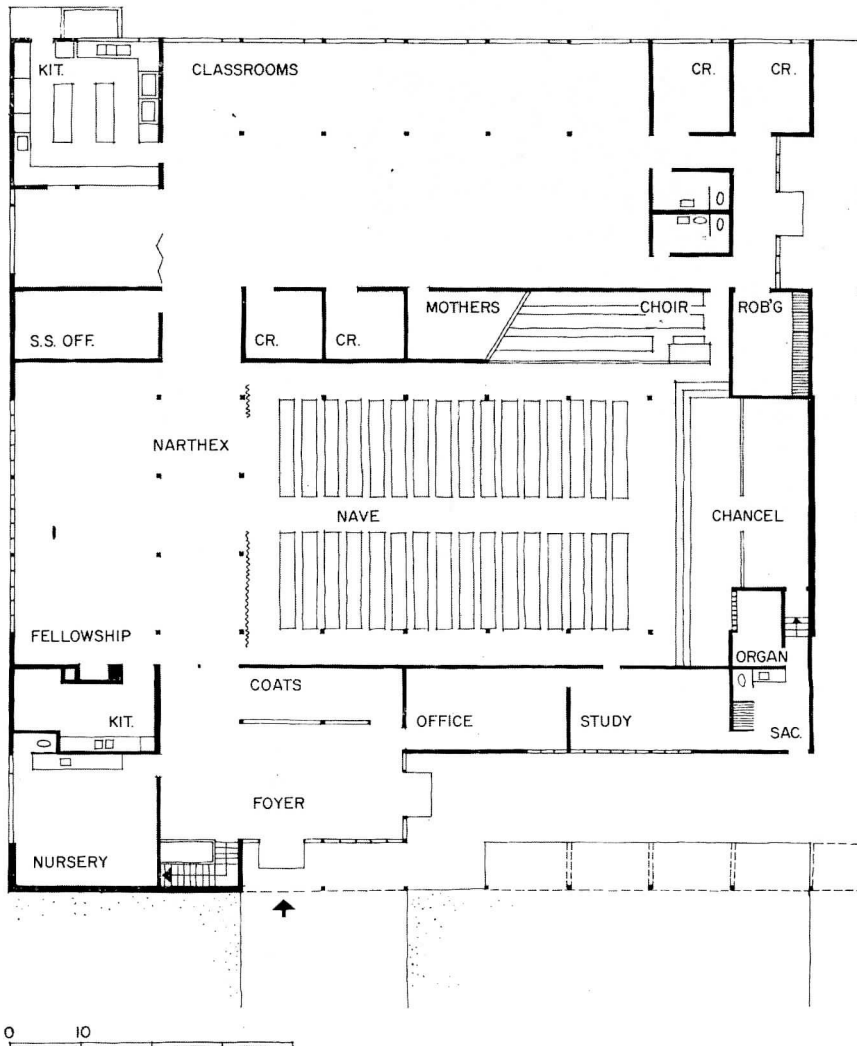
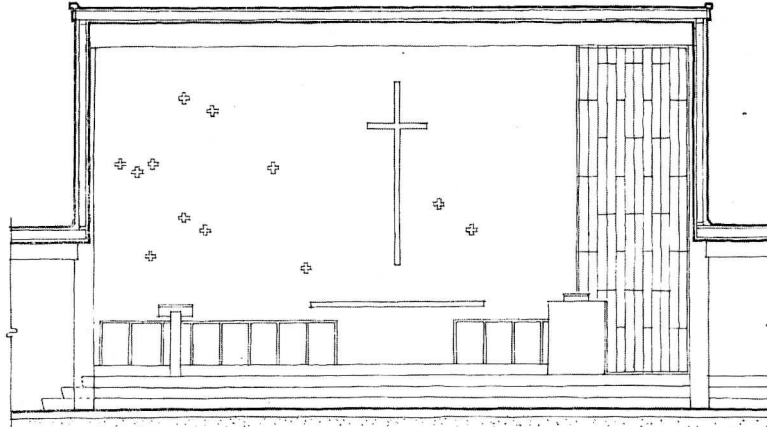



Soaring canopy for the west front

EAST SHORE UNITARIAN CHURCH, BELLEVUE, WASH.

UNDER THE UNIFYING canopy of an elemental roof form Architects Bassetti & Morse have created a space of simple dignity and strong character. On a high site among tall firs this building is peculiarly responsive to its worship purposes, its environment and its budget: \$60,000. The ridge roof, framed as a diamond in plan, lifts high and extends far over the entrance at the west and the low-transmission glass wall at the east. Glue-laminated beams and girders are carried on wood or steel

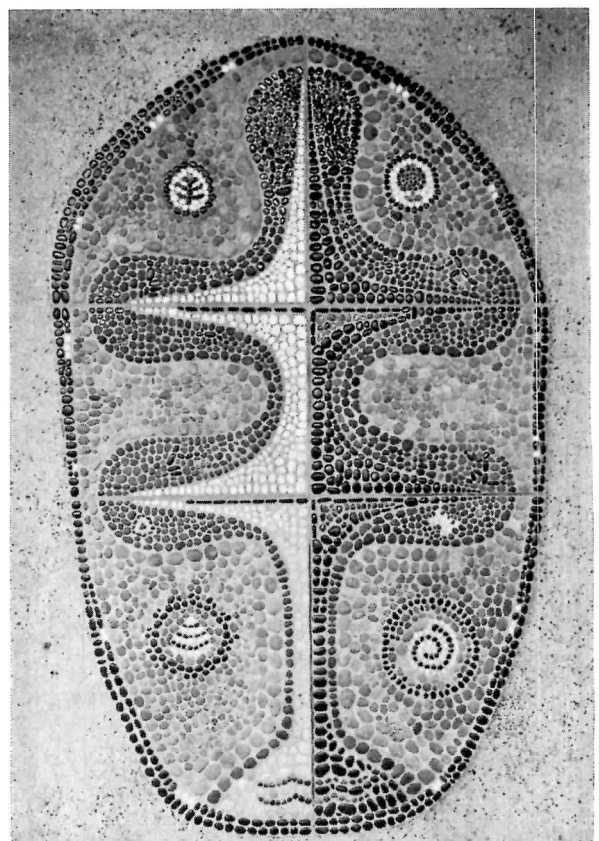

Polished pebbles in a sculptor's hands

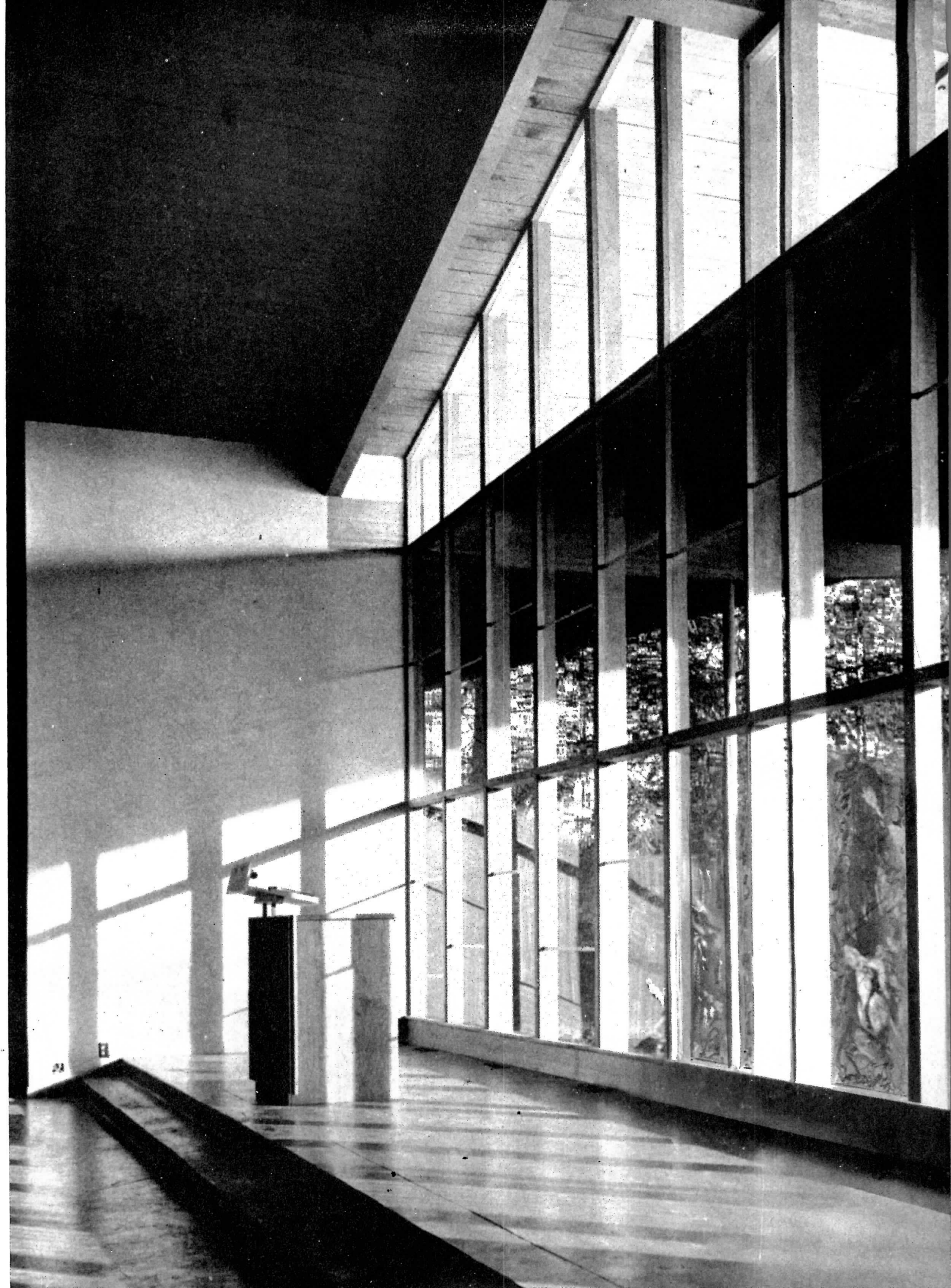



A simple, soaring shape

A quality of simple richness

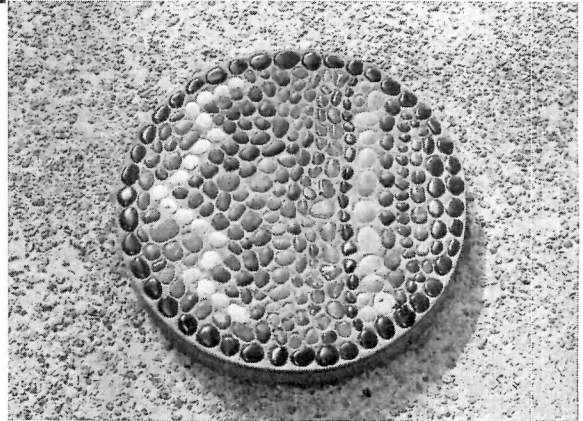

Art Hupy

posts. The built-up roof is topped with white marble chips. Tilt-up concrete wall panels are used on the west front and carry polished pebble mosaic decorations. Ceiling boards are stained warm gray and the assembly room side walls, presently painted a grayed pink, will eventually be covered with fabric in abstract design. Floor is concrete slab on grade. Assembly room will accommodate 300. Heating is warm air. Engineers: S. Ivarsson, Structural; Stern & Towne, Mechanical; B. A. Travis, Electrical; Sculptor: Jean Johanson.

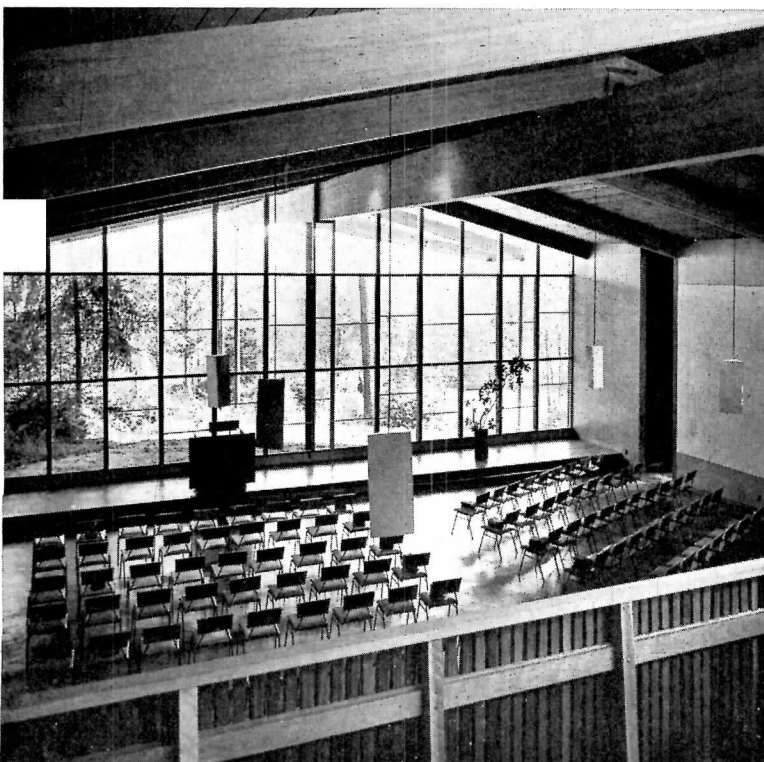

The directness of the faith

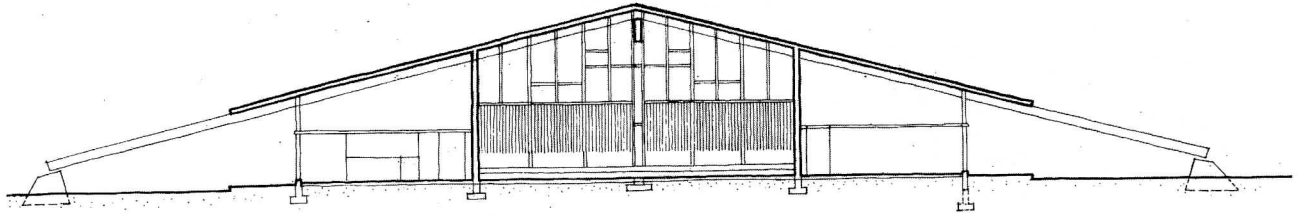

CROSS SECTION

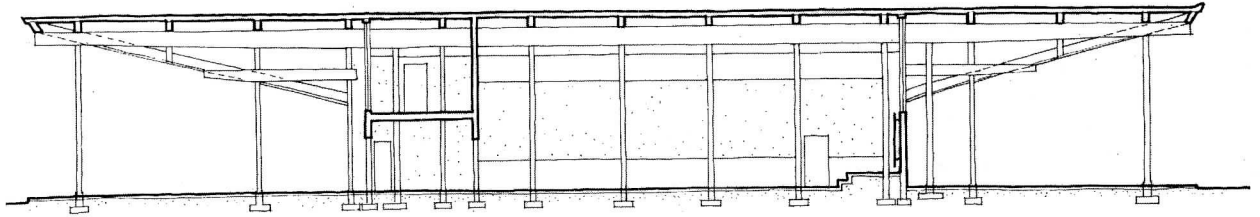

CROSS SECTION

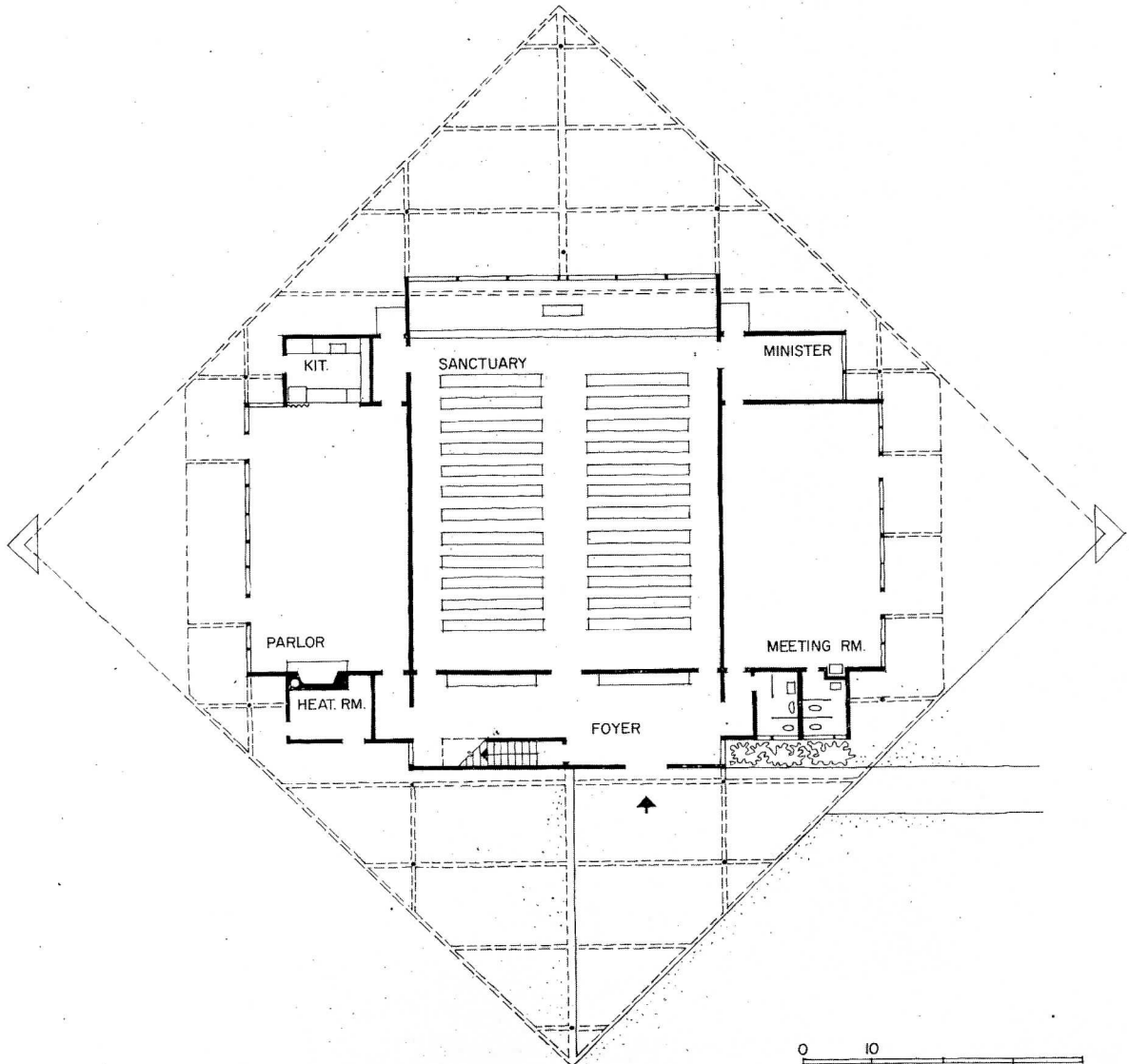
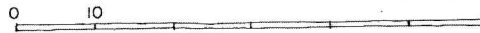

Room Shapes and Materials Determine Church Acoustics

By R. N. LANE, Boner and Lane, Consultants in Acoustics, Austin, Texas

Perhaps in no other building type except auditoriums (and churches are in a sense auditoriums) is the necessity so strong for considering room shapes, sizes and locations, and selection and location of finishing materials as they affect acoustic performance. Obviously consideration for acoustics must start at the inception of the design.

What Are Good Acoustics?

Quietness or peacefulness is probably the first and foremost requirement in the church sanctuary. Second, a uniform distribution of sound, both for speech and music, with adequate volume, should be provided in the auditorium. In addition, there should be no echoes or other discrete sources of sound which will be annoying to the listeners. Also, the reverberation time or acoustic response of the church should be chosen so that a successful compromise will be obtained between the best time for speech and the best time for music.

To exclude street and other exterior noises it may be necessary to provide the foyer of a church with self-closing doors and to have fixed windows, ventilation being provided mechanically. Such design will effectively exclude most outside traffic noise with the exception of low-flying airplanes. If the church is to be built near an airport, then special considerations will have to be taken.

Interior Noises

The first interior noise source to consider is the ventilating system. The mechanical engineer should design a system such that the noise from the compressors and blowers is not transmitted into the church sanctuary. An easy way to be sure of this is to locate the equipment in a room which is not directly under or beside the church auditorium, to provide some type of sound absorbing plenums

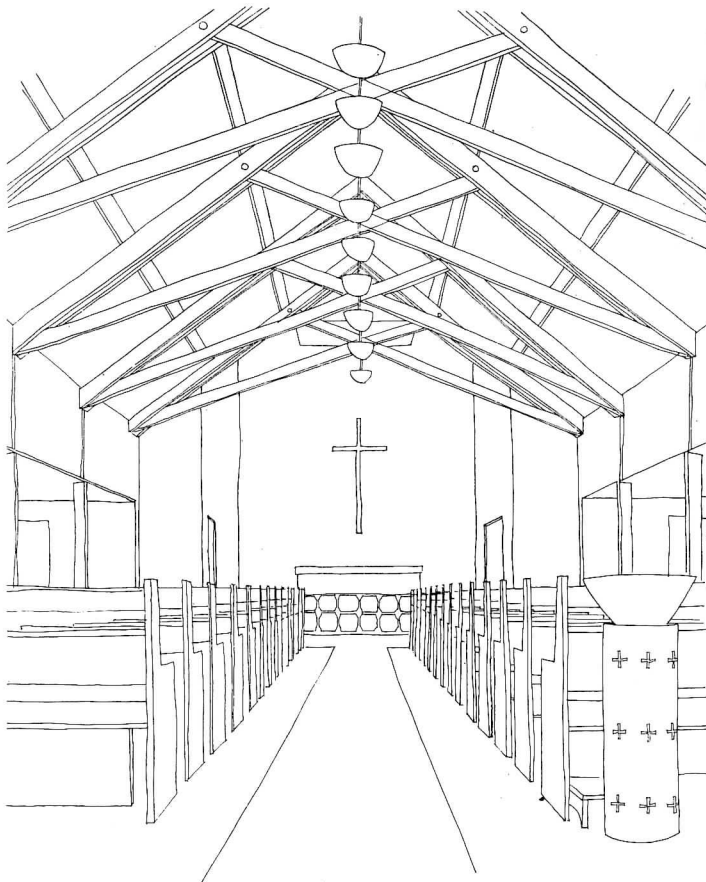
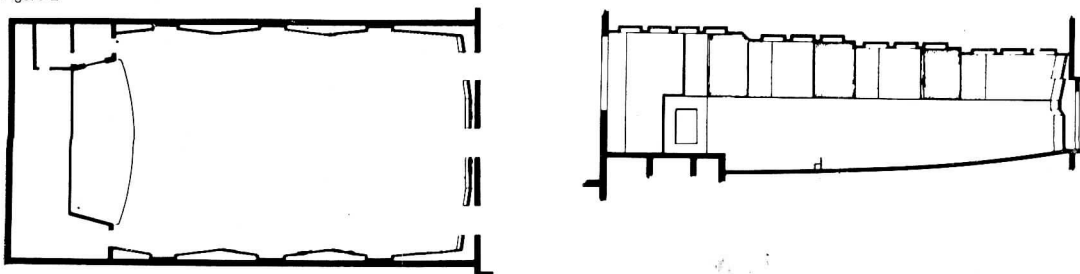

Figure 1

More uniform distribution of sound results when there are many irregularities in the room such as exposed trusses, beams, coffered ceilings, etc. When this is not possible, a similar effect can be achieved by alternating hard and sound absorbent materials. In the drawings below walls are splayed to prevent flutter echoes; ceiling is coffered

Figure 2



or lined ducts from the air handling units into the auditorium, and to specify that the noise ratings on the output grilles in the auditorium should not exceed 20 to 25 db.

All the equipment in the machinery room should be mounted on vibration isolators, and it would be very desirable to have the ceiling and walls of this room acoustically absorptive to reduce the noise in the room as much as possible. Also, if the machinery room is adjacent to any meeting or fellowship room, the walls and ceiling above should be of such construction as to provide 50 to 55 db transmission loss. Several structures providing a 50 db transmission loss are shown in Figure 6. In some instances when the machinery room is isolated from all other important rooms, any type of wall structure may be used.

Another source of noise in churches is the downstairs social and recreation room — often located in the basement below the main auditorium. This noise problem may be eliminated by the use of a floor and ceiling construction between the sanctuary and downstairs recreation room providing a transmission loss of 55 db or more. A common floor and ceiling structure which will do this is shown in Figure 7. This simple construction consists of concrete on cellular metal flooring with a plaster ceiling furred down from that. Now, to control the noise inside the downstairs social and educational room, an acoustic tile or other acoustic absorbent material should be cemented to the suspended plaster ceiling.

Often adjacent to the education or social room there is a kitchen which can prove to be a very distracting noise source. This problem can be solved in the planning stage with provision for a sound barrier between the kitchen and serving aisle in addition to a partition

between the serving aisle and social hall. This combination will function as a sound lock by providing double walls. In addition, sound absorbing material application is a must for the ceiling of the kitchen.

Sanctuary Design

First to be discussed is the reverberation response. While reverberation response is not the most important subject, it can be exactly controlled. (There is really no excuse for incorrect reverberation response in modern churches. Nevertheless, many churches are built each year with a reverberation response which is either far too long or too short.)

Figure 4 shows the presently recommended response time for large rooms, and it may be seen that the exact response is not critical within a few tenths of a second, but the response time does have to be maintained within the limits shown. For Protestant churches, because of the importance of speech, it is recommended that the design goal should be along the lines indicated for school auditoriums. Music also is an important part of the worship service, so the choice of reverberation time is a compromise with the emphasis shaded toward speech. Synagogues will be practically in the same range. Response for the Catholic church should be up near the top curve for best music performance. One thing that should be done to help musicians is to use hard reflective surfaces around and above the choir and pulpit. In this way the choir can sing in a live portion of the church and more easily blend their voices for the desired effect.

As is well known, the reverberation response of any space is controlled primarily by the amount and secondarily by the location of acoustically absorbent materials. These acoustically absorbent

materials include pew cushions, carpet, draperies, people, and special acoustically absorbent materials.

It should be apparent that the amount of acoustic tile to be used in a church is totally dependent on the rest of the finishes in the church and the determination of the total amount of tile required should be left until all other finishes are selected. The placement of the tile is also dependent on other factors, the most important of which is proper sound distribution throughout the seating areas.

The problem of achieving uniform sound distribution throughout the seating area is analogous but not identical to the problem of uniform light distribution. High frequency sound waves propagate in straight lines like light, but low and middle frequency sound waves propagate differently, bending around objects and starting new trains of waves in different directions from each irregularity or obstacle in their path. Because of this, the most uniform sound coverage results when many irregularities are introduced to the room surfaces such as deep windows, exposed columns, coffered ceilings, exposed trusses, etc. If it is not possible to provide wall and ceiling irregularities and still meet the esthetic and financial requirements of the building, it is possible to produce these irregularities by alternating acoustically absorbent patches on the surface with panels of hard surface materials. This discontinuity in material bends and disrupts the propagation of sound producing beneficial scattering of the sound wave trains.

The shape of the church building is also important in the distribution of sound waves, and some shapes are to be avoided if at all possible. First, don't design a round church, see Figure 3. Circular or elliptical floor plans always

Circular plans cause many sound distribution problems. First, reflections result in focusing effects. Sound creeps around walls as in a "whispering gallery." Echoes occur due to delayed sound. If a circular plan must be used, walls should be broken into convex shape

Figure 3

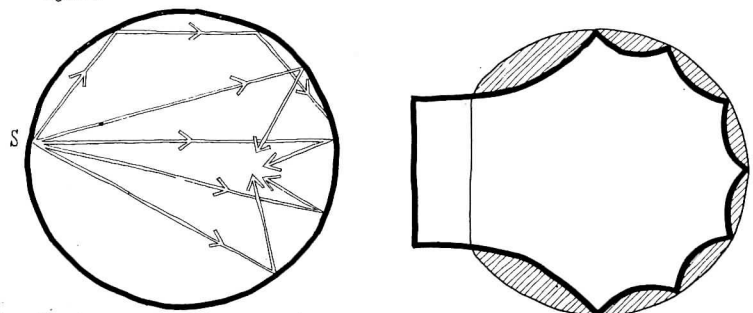

CHURCH ACOUSTICS

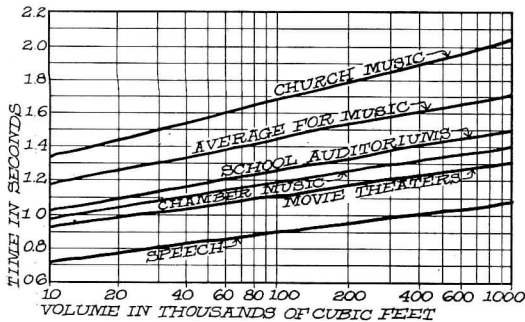

Figure 4

Reverberation times for churches should lie somewhere between the line for school auditoriums and the top line where music is the most important aspect of the service

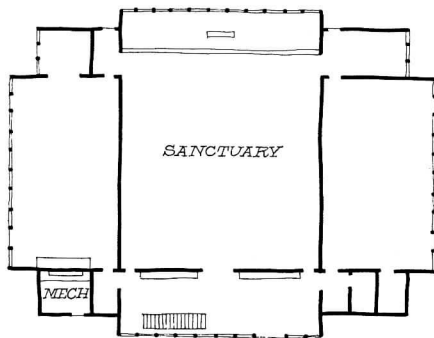

Figure 5

Mechanical rooms should be moved away from sanctuary if possible to reduce the need for sound isolation in the form of special walls. Ducts may need sound insulation

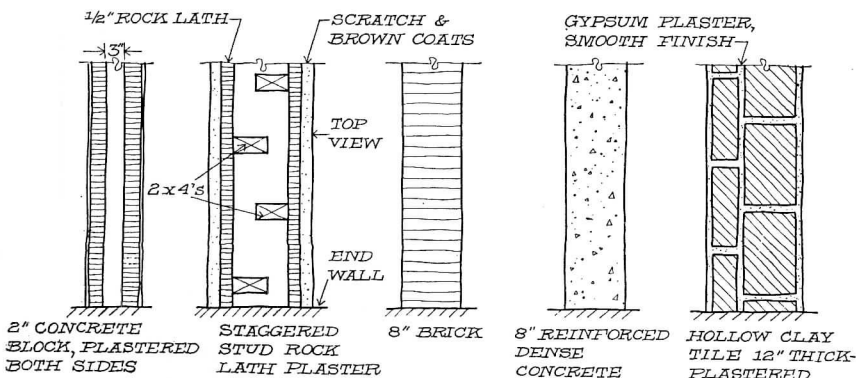

Figure 6

50 db Sound Reduction Walls

If a machinery room must be situated next to a meeting room or fellowship hall, then a sound isolating wall providing at least 50 db loss should be used. This can be achieved through air spaces, weight and discontinuity

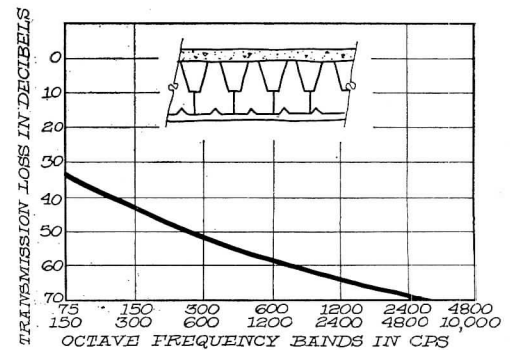

Figure 7

50-55 db Sound Reduction Floor

When the machinery room is below the sanctuary, the floor above should have a loss of 50-55 db. Characteristics of one are above

give rise to focusing effects, non-uniform distribution of sound, sound creeping effects and echoes. In the circular plan, sound originating at S and directed at nearby grazing incidence to the walls tends to creep along the side of the wall as in a whispering gallery. One can be sure that where sound foci exist, it means that other areas of the room are lacking in sound, and it is impossible to crown everyone into the sound foci. Focusing is also illustrated by the sound rays striking the rear wall and all being reflected to one spot.

If in spite of these difficulties it is decided to construct a round church, the acoustical conditions may be greatly improved by the addition of convex diffusing surfaces as shown in the plan on the right of Figure 3.

Domed ceilings produce similar bad effects, and particularly bad results occur when the radius of curvature of the dome has its center on the floor.

Another form of church guaranteed to lead to acoustic problems is the cathedral style church with long thin nave, or auditorium, and with extremely high ceiling. In this type of church the walls are usually parallel, and one obtains severe flutter echoes back and between each wall. The architecture or esthetics of the building usually prevent the use of any acoustically absorbing material on these side walls and therefore the reverberation response is always too long. Speech is usually barely understandable in these buildings but the choir and organist enjoy themselves.

Another type of building to be avoided is the very low ceiling, long church. This church is almost always too dead and the choir and congregation cannot get together for singing or speech responses.

The final important aspect of sound distribution is the suppression of echoes

of all types. An echo is a sound wave or pulse which has been reflected from some surface with sufficient magnitude and time delay to be perceived by the listener as a sound different from the one directly transmitted. For example, a person seated in the third pew from the front in a fairly large church may hear the direct sound and then one-tenth of a second later may hear this same sound reflected from an untreated rear wall or balcony face. Any room over one hundred feet in length with a long, flat reflective rear wall has a potential echo. These surfaces should either be splayed or tilted to prevent the formation of the echo or should be covered with acoustically absorbing material to prevent the reflection of any appreciable amount of energy. If none of the above treatments appear to be practical, the rear wall should be broken with doors, or other offsets. Concave rear walls and balcony fronts are to be entirely avoided because this type of surface focuses all the sound hitting it into an echo. On the other hand, convex surfaces are to be recommended when they are practical.

Flutter echoes are a sound wave train made up of the initial pulse followed by a series of pulses decaying in amplitude and following each other in rapid succession. If the pulses are evenly spaced in time, such a flutter echo is called a musical echo. This condition often occurs between opposite and parallel smooth hard sound reflecting surfaces. Flutter echoes may be prevented by splaying the walls, a minimum of one foot in 10, or by using irregular panels of absorbing material on the walls.

Multiple or succession of sound pulses are another serious echo problem. These echoes are generally caused in churches where a large number of concave surfaces are used over the chancel area combined with a domed auditorium.

High Frequency Lighting

BY R. D. BURNHAM

R. D. Burnham and Associates
Consulting Engineers, Lorain, Ohio

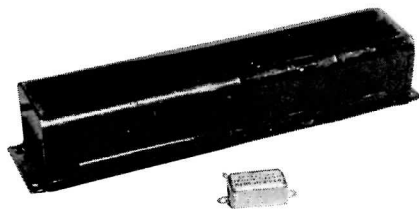

Figure 1

Conventional two-lamp brick type ballast looms huge beside small single lamp high frequency capacitor. Fixture weights can be cut by half at high frequency

Current-voltage traces are given for incandescent (top) and fluorescent (bottom) lamps. Incandescent lamp at 25 cycles is heating up and cooling off. At 60 cycles it stays at even brightness. Fluorescent lamp at 60 cycles deionizes; at 840 cycles it stays charged and efficiency increases

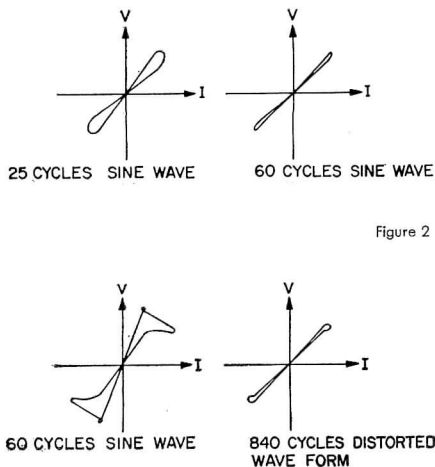

Figure 2

FLUORESCENT LAMPS CAN PRODUCE more light and last longer when operated at frequencies considerably above 60 cycles. About 40 test installations, coupled with recent new developments, indicate a better performing lighting system can be installed for an initial cost about the same as, or slightly less than conventional systems. Also the cost of operation can be reduced. A real advantage of high frequency is that fluorescent fixtures can be made smaller and weigh considerably less since ballasts are reduced to "peanut" size.

Some of the problems in this new method include the necessity of providing frequency converters, because power is distributed normally at 60 cycles. And since increased efficiency is achieved by operating lamps at higher brightnesses, fixtures with good brightness control are required, in some cases units of special design.

In any case, it seems likely that high frequency lighting will find widespread use in commercial and industrial areas, as well as in specialized applications such as radio and television studios, or mercury vapor and fluorescent street lighting.

History

Probably the first suggestion that gaseous tubes activated by high frequency energy could be used for general lighting occurred over 60 years ago. In May 1891, Nikola Tesla gave a historic lecture at Columbia University, "Experiments with Alternate Currents of Very High Frequency and Their Application to Methods of Artificial Illumination."

Tesla became one of the greatest electrical inventors of all times, making basic discoveries in radio, electrotherapeutics, high-frequency induction heating, and gaseous tube and fluorescent lighting. He also invented the polyphase induction motor and helped George Westinghouse design the first 60 cycle polyphase electrical generating stations.

The selection of 60 cycle current in 1890 was based largely on the fact that the motors operated well at this frequency and current of this frequency could be transformed and transmitted over long distances which was not possible with direct current. But by far the major electrical load at this time was lighting. Frequencies much below 60 cycles caused the light from the filament lamps to flicker.

The first commercial filament lamp

was put into use in 1881. These lamps for the most part were powered with Edison's low voltage direct current.

Why High Frequency?

In 1938 Tesla's fluorescent lamp came into commercial use. Unlike the filament lamp which acts to limit the current as it warms up, the fluorescent lamp rapidly decreases its resistance after starting and soon would destroy itself if some current limiting element were not used in conjunction with it. The current limiting element can be a resistance, capacitance or an inductance. At 60 cycles both the resistor and capacitor circuits result in a low overall efficiency in the transformation of electrical energy into light energy. For this reason, the inductance is chosen as the current limiting device and takes the form of the brick type fluorescent ballast associated with fluorescent lighting.

The fluorescent lamp, unlike the filament lamp, operates much better at frequencies considerably higher than 60 cycles. In Figure 2 the dynamic curve is shown for a filament lamp at 25 cycles and 60 cycles. At 25 cycles the loop opens indicating the filament is cooling off and reheating each cycle. Figure 2 also shows a curve for a fluorescent lamp at 60 cycles and 840 cycles. The open loop in the curve at 60 cycles indicates that the lamp cathodes are deionizing between cycles. At 840 cycles the ion cloud is maintained; this results in an increased lamp efficiency or more light for the same wattage. This comes from a reduction in the amount of unused power turned into heat at the lamp cathodes. For a 4-ft fluorescent lamp, this efficiency gain may be from three to 25 per cent depending on the frequency, wave shape and lamp circuit.

The ion cloud tends to be maintained over the complete cycle at higher frequencies and acts as a buffer for the cathode against the rapidly reversing electrical arc. This prolongs lamp life. How great an increase has not been determined accurately. Accelerated life tests indicate the increase may be between 10 and 20 per cent.

At higher frequencies it becomes practical to limit lamp current with a capacitor. At 60 cycles a capacitor in the line with a fluorescent lamp causes the current to peak due to the relatively slow charging and discharging of the capacitor. The peaked current wave limits the amount of power to the lamp and causes it to operate inefficiently. At higher frequencies the cycle reverses

more rapidly and the peaked current wave form vanishes. At frequencies above 300 cycles it becomes practical to use a capacitor. It is a much more favorable element to use as a ballast than an inductance. The power consumed is considerably less with the capacitor. It is smaller in size, lower in cost and develops little if any noise.

In the conventional fluorescent ballast the voltage applied to the lamp for starting is from two to six times the line voltage. In today's high frequency, a voltage of 400 or 600 volts is developed by the frequency conversion equipment and distributed to the lighting load. 400 volts will strike the arc for 4-ft lamps and 600 volts will start 8-ft lamps and lamps of shorter length. Because of the instant starting feature only instant starting lamps should be used such as the 8, 6 and 4 foot slimline lamps.

The 60 cycle ballast is usually designed to pass about 430 milliamperes through the lamps. The value of the current limiting capacitor for high frequency determines the lamp current. This offers a wide range of selection of lamp current ranging from 100 to 700 milliamperes for standard lamps. The light output of the lamp will vary accordingly. This selectivity makes it possible to group the lamps or luminaires in a desirable arrangement and then choose the proper value capacitor to give the desired illumination.

The latest tests indicate that the light output of 4-ft lamps may be increased up to 50 per cent and still operate as efficiently as the same lamps operated on the conventional 60 cycle system. To state this another way, two lamps on high frequency would give the same light and have the same wattage as three on 60 cycles, under these circuit conditions. This reflects a savings in the installed cost of lamps and lighting fixtures. Fewer units require maintenance.

The higher lamp brightness requires a well designed luminaire with good brightness control. Specially designed lighting equipment has been used in some cases. It is possible to design smaller and more efficient lighting fixtures since the larger section electrical channel required for the brick type ballast can be reduced if not eliminated completely in preference to the pigmy size capacitor which can be tucked into the socket assembly. Fixture weight is usually cut in half with the removal of

the 60 cycle brick type ballast even with present lighting equipment.

Typical Installations

One of the first high frequency installations was at the Plant Industry Station of the U. S. Department of Agriculture, Beltsville, Md. for plant growing under controlled levels of electrical lighting. At first in these experiments, 1600 foot-candles at 60 cycles were employed and such high illumination level required the large conventional ballasts to be mounted remotely. Then when high frequency was installed, small 3 oz capacitors were used in the fixtures of 8-ft T-8 lamps operating at a maximum of 550 ma producing 2400 foot-candles at the growing area below.

A special 5 kw harmonic frequency multiplier was used for frequency conversion. This multiplier was developed by the General Electric Company and has a 360 cycle square wave output. This static type unit has low maintenance and controls are provided which allows a variation in illumination from 1600 to 2400 foot-candles. The cost of this unit is comparatively high and its capacity fairly low so its use has been limited primarily to special constant load applications.

With larger electrical loads the motor generator has been selected. The first larger installation of this type was at the Union College Field House, Schenectady, N. Y. Frequency was changed by a 208/120 volt 3 phase motor and a 400 cycle 3 phase generator. 490 8-ft slimline lamps were operated from two 30 kw generators. A split phase lamp circuit was used in this system to maintain nearly unity power factor. Both a capacitor and a small inductance were used as shown in Figure 4. The savings in initial cost was reported to be 10 per cent less than the filament and mercury vapor lighting intended.

The first commercial installation of its type was installed in late 1955 in the new office building of the Wakefield Company. Like the Union College Field House the power for lighting was supplied by a 30 kva generator. The generator was a different type and developed a frequency of 840 cycles. The permanent magnet rotor of the generator is mounted directly to the shaft of the standard 440 volt three phase induction drive motor. The generator stator is mounted directly to the motor by means of a special bell end. The permanent magnet feature reduces maintenance

since there are no voltage regulators, exciters or brushes to require service. 400 volts were selected since the number 4-ft lamps were used. The lamp circuit was as shown in Figure 6. Capacitors are used in series with each lamp and power factor correction is achieved about every 25 lamps with an air core reactor across the line. Lamps were operated at currents of 430 and 600 ma, depending upon the illumination desired for the area. The 580 lamps have operated about 6800 hours during the last year and one-half. No lamps have as yet burned out. Overall efficiency was measured to be 13 per cent greater than the 60 cycle systems which have been used.

Since most of the auxiliary power loss of the lighting system is removed from the occupied area, the heat developed by the lighting system is reduced from 15 to 25 per cent. Thus the capacity of air conditioning can often be reduced.

The three story windowless Federal Reserve Bank Building in Houston, Texas is now being completed, using a similar system. The architects for this building are Goleman and Rolfe of Houston. Their engineer, Dana Price, was one of the first to recognize the advantages of high frequency lighting for larger buildings.

All of the general lighting is supplied from seven 30 kva, 840 cycle 600 volt permanent magnet generators located in the equipment room. Several thousand 8 ft slimline lamps at 600 ma are used; however, 4-ft and 6-ft slimline lamps are used as well as the 2-ft and 5-ft bi-pin fluorescent lamps. Even a few filament lamps are used on high frequency for exit signs and in storage areas.

Two engineering advances are used in this installation. One is in the design of the high frequency control center. The lighting power center is fully automatic, paralleling the required number of generators as the lighting load varies. Ordinarily this takes rather complex equipment. Georator Corporation, the builders of this equipment, have so designed and matched these generators that they can be connected directly to the bus and synchronization is automatic.

The lamp circuit was modified to a two lamp series circuit as shown in Figure 7. This circuit is similar in operation to the series sequence start circuit used in ballasts. One lamp starts and then the other. The two lamps then operate in series.

One of the major problems has been low power factor; a capacitor in series with each lamp has a leading power factor of about 25 per cent. Such a high reactive current makes it necessary to use about the same kva of inductive reactance as the kva of the lighting load in order to correct the power factor. The series circuit has a leading power factor of about 50 per cent, cutting the required power factor correction in half.

The series circuit uses only one capacitor "can" for two lamps and since the power factor correction is reduced the auxiliary losses are again cut in half. The capacitor and coil losses for such a circuit would be 4 watts as compared to about 28 watts for a two 8-ft lamp ballast. It is this difference which sometimes affects the capacity of the air conditioning.

New Developments

After the development of the series circuit about a year ago, it was believed that still further improvements could be made. Ideally the power factor correction coils and inductive ballasts should be eliminated altogether. The new circuit should be able to use any fluorescent lamp and particularly the 4-ft rapid start and the high output rapid start lamps. The improved system should have a three phase distribution rather than the three single phase system. This would cut the number of feeder wires in half, and finally, the distribution voltage should be less than 280 volts so standard single pole switches and circuit breakers could be used rather than the more costly 600 two-pole variety.

These requirements are now satisfied by a new single circuit design which can be applied to any of the fluorescent lamps.

The installation of this system is identical to a standard three phase 120/208 system. The only difference is that the lighting panels are fed from a frequency converter and the circuit within the lighting fixture is modified.

The key to the widespread use of high frequency lighting is an efficient inexpensive means of frequency conversion. A new type frequency-changer has been developed which is smaller, has a higher efficiency and lower maintenance than the presently used units. The construction is similar to that of a transformer and has no moving parts. Operation of this static multiplier relies on a rotating magnetic field while both the primary and secondary windings are stationary.



Installation at Dept. of Agriculture test station, Beltsville, Md. provides 2400 ft-candles 360 cycles. Frequency conversion supplied by magnetic multiplier, left

Figure 3

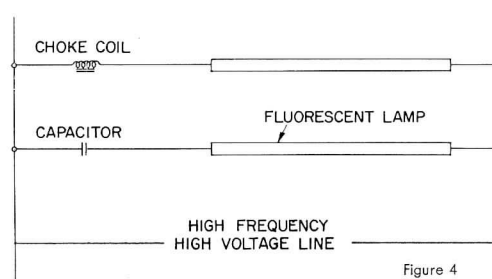

Figure 4

Split-phase ballasting for unity power factor

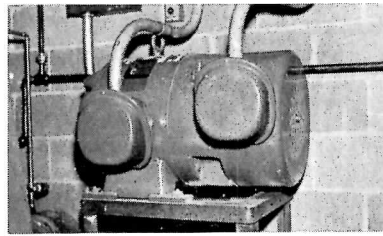

Figure 5

840 cycle permanent magnet generator, right, is driven by standard induction motor, left. 30 kva size, 18 by 30 in.

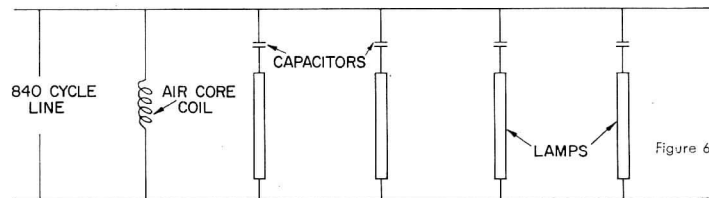

Figure 6

Capacitors in series with lamps. Reactors across line for power factor correction

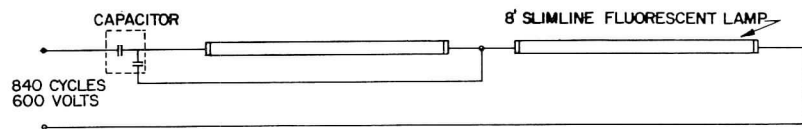
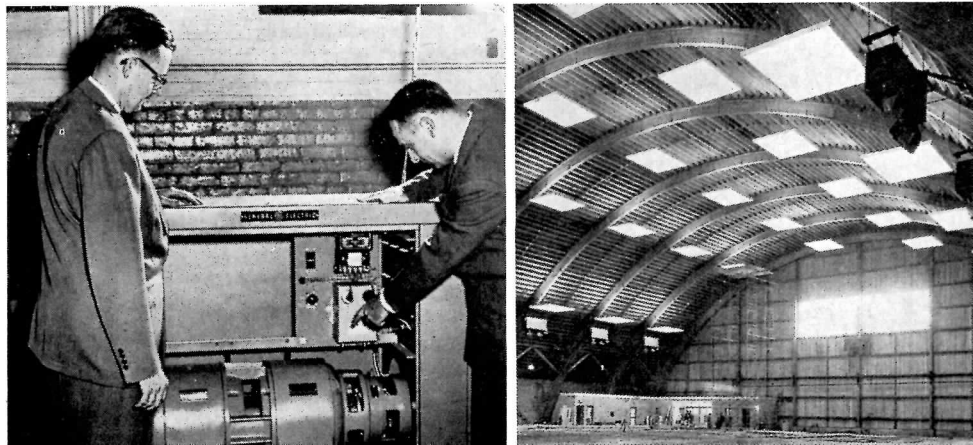

Figure 7

Series circuit reduces number of capacitors and power factor correction units

Union College Field House has two 30 kva, 400 cycle generators to operate 490, 8-ft slimline lamps, providing 45 ft-candles in service. Fixtures are 8 ft sq

Figure 8



BRICK HOUSE BUILT SANS BRICKLAYERS

PLANT-PREFABRICATED BRICK PANELS developed by the Structural Clay Products Research Foundation recently made a successful debut in an 1800 square foot ranch style home near the foundation's laboratories in Geneva, Illinois. Construction of the house marked the first full scale test of the "SCR building panel" — and a significant step forward in the structural clay products industry's efforts to adopt brick's time-honored qualities of strength, economy and weather-resistance to modern building techniques.

The 1200 square feet of load-bearing brick panels used for the Geneva house were erected in eight and one-half hours by a construction crew of five men, resulting in a total site erection cost of 30 cents per square foot of wall area, including mortaring.

The panels, each of which consists of 36 special norman-face bricks set in stack bond, were made at the SCPRF laboratory by placing the bricks, reinforced with steel bars and squared with drilled metal corner braces, in forms and bonding them with quick-drying mortar forced into the frame. The finished panels — each one foot (one brick) wide, eight feet (36 bricks) high and two and one-half inches thick — come from the frames complete with angle bolt attachments at top and bottom, and beveled edges along the sides.

They were delivered to the site on a flatbed truck from which they were raised by a small hand-cranked crane equipped with a vacuum device. Two men operated the hoist, a third guided the panels into position, and two others bolted them through a flange on the panel to horizontal steel angles attached to the sills at top and bottom of the walls. To hold the panels firmly in place, only a single bolt was required at each end.

When all the units had been placed, the roof trusses were immediately swung into position and the finishing work was begun. The interior vertical joints between panels were power mortared, after which the wall was furred and finished in the conventional way. The beveled joints on the exterior were similarly mortared as the house neared completion.

Robert B. Taylor, director of the Structural Clay Products Research Foundation, points out that the panels, while loadbearing, are also practical for non-loadbearing walls in curtain wall type construction. He has also indicated that the foundation is continuing its experimental work with the masonry panels, and that further applications of the "SCR building panel" in both single and multistory construction are being planned for 1958.

(More Roundup on page 208)



"SCR building panels," each made up of thirty-six norman-face brick set in stacked bond, are vacuum-lifted into place



A single bolt at top and bottom of each panel secures them to horizontal steel angles attached to the sills



The brickwork completed — by five men in eight and a half hours, roof trusses are installed and finishing work begun

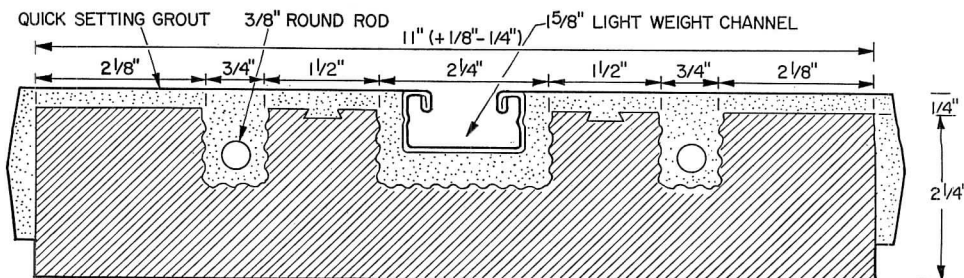

Section through panel shows placement of reinforcing, beveled edges. Mortar is forced into forms after brick has been placed

HOUSE ANCHORAGES: 5—Tabular Check for Wind Pressure

By ALBERT G. H. DIETZ

Tables Below Give Specific Values of Resistance to Sliding and Overturning for One- and Two-story Houses, and Correspond to Values in Graphs on Sheet 4

TABLE 4: One-story House, Wind Pressure (psf) Necessary for Sliding

Weight Per Unit Length of House (lb)	Roof Slope in Degrees						
	0	10	20	25	30	35	40
600	11.7	12.7	13.1	13.8	14.0	13.7	13.3
800	15.6	17.0	17.4	18.4	18.7	18.3	17.7
1000	19.5	21.2	21.8	23.0	23.4	22.8	22.1
1200	23.4	25.4	26.2	27.6	28.0	27.2	26.7
1400	27.4	29.7	30.5	32.2	32.7	31.8	31.0
1600	31.2	33.9	34.9	36.8	37.4	36.4	35.4
1800	35.1	38.2	39.2	41.4	42.0	40.8	39.8
2000	39.0	42.4	43.6	—	—	45.1	44.2
2250	44.0	—	—	—	—	—	—

TABLE 5: One-story House, Wind Pressure (psf) Necessary for Overturning

Weight Per Unit Length of House (lb)	Roof Slope in Degrees						
	0	10	20	25	30	35	40
600	9.5	9.8	10.1	11.7	13.7	13.7	13.7
800	12.7	13.1	13.5	15.7	18.2	18.5	18.5
1000	15.8	16.3	16.9	19.6	22.8	23.0	23.0
1200	19.0	19.6	20.2	23.5	27.3	27.7	27.7
1400	22.2	23.0	23.6	27.5	31.9	32.3	32.3
1600	25.4	26.2	27.0	31.4	36.4	36.9	36.9
1800	28.5	29.5	30.3	35.3	41.0	41.5	41.5
2000	31.8	32.8	33.7	39.2	—	—	—
2250	36.5	36.7	37.9	43.0	—	—	—

Typical Unit Weights of Building Materials

Asbestos shingles—siding	1.75 psf
Asbestos shingles—roofing	2.60 "
Asphalt shingles—roofing	2.10 "
Gypsum sheetrock— $\frac{3}{8}$ in.	1.50 "
Gypsum sheetrock— $\frac{1}{2}$ in.	2.00 "
Gypsum plaster— $\frac{3}{4}$ in.	4.00 "
Plywood— $\frac{1}{4}$ in.	0.80 "
Plywood— $\frac{3}{8}$ in.	0.95 "
Plywood— $\frac{1}{2}$ in.	1.10 "
Plywood— $\frac{3}{4}$ in.	1.50 "
Plywood— $\frac{5}{8}$ in.	1.80 "
Plywood— $\frac{3}{4}$ in.	2.20 "
Asphalt tile flooring	1.50 "
Insulation board—25/32 in.	1.20 "
Insulation—mineral wool	0.50 "
4 in. brick masonry veneer	50.00 "
Wood—Douglas Fir	
3.0 lb/bd ft	35 lb per cu ft
Shortleaf pine—3.0 lb/bd ft	36 "
Hemlock—2.5 lb/bd ft	29 "

TABLE 6: Two-story House, Wind Pressure (Psf) Necessary for Sliding

Weight Per Unit Length of House (lb)	Roof Slope in Degrees						
	0	10	20	25	30	35	40
1250	18.7	20.0	20.2	21.4	21.6	21.2	20.6
1500	22.5	24.0	24.5	25.6	25.9	25.4	24.8
1750	26.2	28.0	28.6	29.9	30.2	29.6	28.9
2000	30.0	32.0	32.6	34.2	34.5	33.8	33.0
2200	33.0	35.2	35.9	37.6	38.0	37.2	36.2
2400	36.0	38.4	39.2	41.0	41.5	40.6	39.6
2600	39.0	41.6	42.4	44.5	—	—	42.8
2800	42.0	—	—	—	—	—	—

TABLE 7: Two-story House, Wind Pressure (Psf) Necessary for Overturning

Weight Per Unit Length of House (lb)	Roof Slope in Degrees						
	0	10	20	25	30	35	40
1250	16.6	17.2	17.8	20.0	21.6	21.4	20.9
1500	19.8	20.6	21.4	24.0	26.0	25.6	25.0
1750	23.2	24.0	24.9	28.0	30.3	29.9	29.2
2000	26.5	27.5	28.6	32.0	34.6	34.2	33.4
2200	29.1	30.2	31.4	35.2	38.1	37.8	36.7
2400	31.8	33.0	34.2	38.4	41.5	41.0	40.0
2600	34.4	35.7	37.1	41.5	—	—	43.4
2800	37.0	38.5	39.9	—	—	—	—
3000	39.8	41.3	42.7	—	—	—	—

Block brings progress wherever it goes



*Split block used in the Liberty Bank Building, Honolulu, Hawaii. Vladimir Ossipoff, Architect.
Ask your local NCMA member for a copy of the new booklet "Split Block Architecture."*

National Concrete Masonry Association • 38 South Dearborn Street • Chicago

HOUSE ANCHORAGES: 4—Graphic Check for Wind Pressure

By ALBERT G. H. DIETZ*

A rapid approximate approach for wind design is set forth on this Sheet. The graphs are based on average ratios of widths to heights of houses, as usually found, and take into account the pitch of the roof, whether the house is one story (8 feet) or two stories (16 feet) high, the design wind pressure, and the weight of the house. The graphs are for overturn and sliding, the conditions which usually control. An example shown on the chart is for a 2-story house, 5/12 pitch, in a 20-pound per square foot wind pressure zone. The graph shows that a house weighing 1250 pounds per foot is stable against sliding, and a house weighing 1500 pounds per foot is stable against overturn.

The graphs are intended for rapid determination of obviously stable conditions. If the graphs indicate a borderline or unstable condition, the more exact analysis described on Sheets 1-3 should be employed.

* Professor of Building Engineering and Construction, Massachusetts Institute of Technology, Cambridge, Mass., and Chairman, BRAB Special Advisory Committee for the study, "The Anchorage of Exterior Frame Walls to Various Types of Foundations," conducted by the National Academy of Sciences-National Research Council at the request of the Federal Housing Administration, 1955-56.

The members of the committee were: Albert G. H. Dietz, Reuben W. Binder, A. T. Masters, Ernest T. H. Bouven, Clarence W. Farrier, Harry C. Plummer, Benjamin C. Taylor, Leonard G. Haeger, T. C. Combs, Henry Giese, R. H. Sherlock, E. George Stern, Richard Hudson, James P. Thompson, R. F. Luxford, Garrett L. Schuyler (Alternate), Clyde N. Dirlam (Alternate), Theodore Leba, Jr. (Consultant), Robert M. Dillon, Building Research Institute Staff Architect (Secretary).

The complete report can be obtained by writing to Publications Office, National Academy of Sciences, 2101 Constitution Avenue, Washington 25, D. C. Full title, description, and price of the publication are: "FHA-6. Anchorage of Exterior Frame Walls to Various Types of Foundations." 1956; 71 pp., paper; \$1.50. Pub. 445.

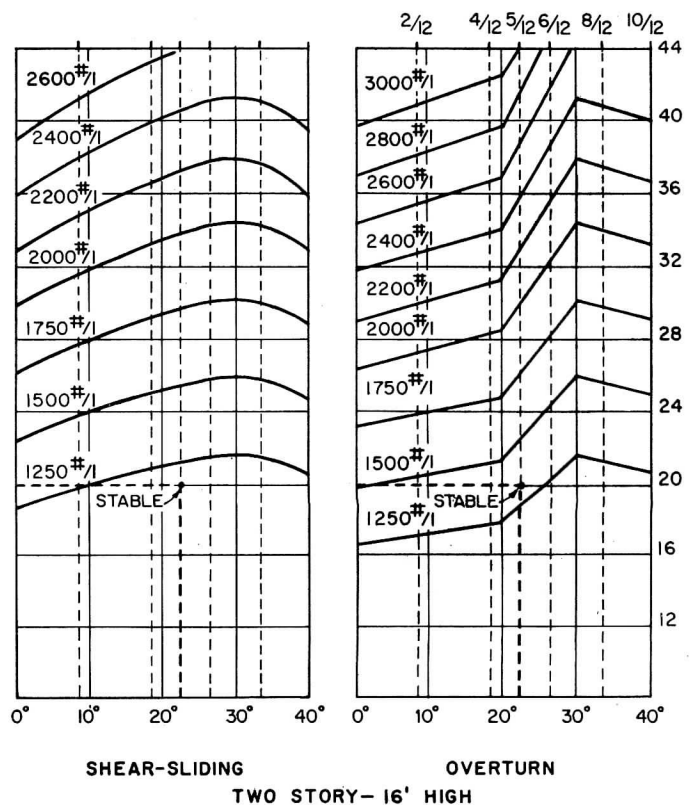
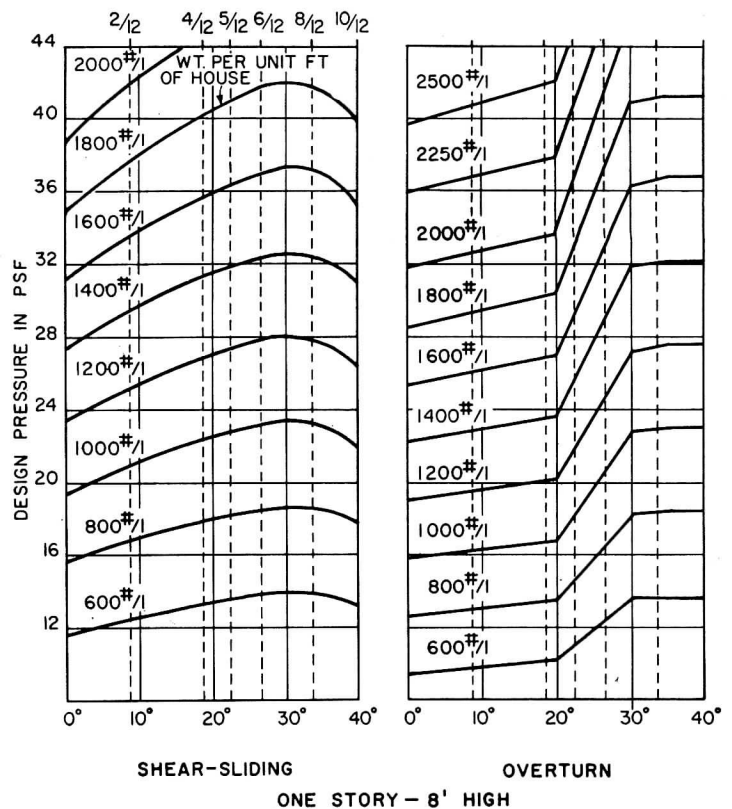



TO SERVE YOU BETTER . . .

THE LARGEST AND MOST MODERN SANITARY-WARE POTTERY IN THE WORLD

Now, giant additional modern facilities at Eljer's Ford City pottery assure you maximum quality and service on all your vitreous china bathroom fixture needs. Here, in one location, skilled workmen and skillfully engineered equipment produce vast quantities of vitreous china fixtures . . . all made to the traditionally high Eljer quality standards. Contact your Eljer Plumbing Contractor now to determine how Eljer can help solve your bathroom fixture problems in vitreous

china . . . and, from three other up-to-date plants, in cast iron, formed steel and brass fittings. Eljer Division of The Murray Corporation of America, Three Gateway Center, Pittsburgh 22, Pa.

ELJER

DIVISION OF THE MURRAY CORPORATION OF AMERICA

HOUSE ANCHORAGES: 6—Resistance to Earth Pressure

By ALBERT G. H. DIETZ

Earth Pressure

Foundation walls may collapse because of earth pressure if they are not restrained at the top, whereas they may be completely adequate if lateral top support is provided. Such lateral support may be provided by the superstructure, either by frictional resistance to movement of the top of the foundation, or by anchorage between the foundation and the superstructure.

A simplified approach to determine the need for anchorage is illustrated in Figure 4. The foundation wall is considered to be a simple beam supported laterally top and bottom. Earth pressure has a horizontal component assumed to act as shown. The computations for R_1 , the horizontal thrust at the top of the wall, are shown. The weight of the superstructure exerts a frictional horizontal force F which may be large enough to equal R_1 . Because loads here are long-time rather than short as in wind loading, the frictional coefficient is reduced to $1/3$ instead of being taken as $2/3$ as in wind.

Active horizontal earth pressures vary from an insignificant amount as in tamped backfills of cohesive soils to greater than hydrostatic as in heavily saturated soils. Such pressures may be difficult to determine. For average conditions a horizontal thrust P of 20 pounds per square foot is suggested. This should be raised to 40 pounds per square foot if hydrostatic conditions are suspected. Unusual condi-

tions call for special investigation.

Explanation of Fig. 4 follows:

- R_1 = reaction at top of foundation wall.
- R_2 = reaction at bottom of foundation wall.
- P = approximate horizontal resultant earth pressure per foot of wall applied at $d/3$ up from the top of the footing.
- d = depth of backfill
- h = height of foundation wall
- p = horizontal earth pressure in psf.

Taking moments about R_2 :

$$\frac{Pd}{3} - R_1h = 0 \text{ and } P = \frac{pd^2}{2}$$

$$\therefore R_1 = \frac{pd^3}{6h}$$

Coefficient of friction = $1/3$. The horizontal resisting force at top of wall, $F = 1/3w$ (w = superimposed weight per linear foot bearing on the wall);

$$\therefore F = R_1$$

$$\frac{1}{3}w = \frac{pd^3}{6h}$$

Solving for "w", "h", and "d" respectively:

$$w = \frac{pd^3}{2h}$$

$$h = \frac{pd^3}{2w}$$

$$d = \sqrt{\frac{2wh}{p}}$$

Table 8 gives some computed values of w,

or "unnecessary" weights of superstructure per foot of length of foundation wall, to provide lateral stability without anchorage, for earth pressures varying from 20 to 40 pounds per square foot. If the weight of superstructure is less than indicated, anchorage should be provided for the excess horizontal thrust R_1 above that resisted by friction. It can be computed in much the same manner as the horizontal thrust for wind, except that no increase in allowable stress against wood, for example, may be employed. Earth pressures are not short-time loads.

Earthquake

Although formulas for the calculation of seismic forces have been developed, the committee adopted the recommendations of its members from earthquake areas that in those areas anchorage for frame houses should consist of at least half-inch round anchor bolts, not more than six feet on centers, embedded not less than 7 inches in poured concrete or not less than 15 inches in concrete block or other masonry.

The committee concluded that it had insufficient data to make firm recommendations respecting allowable loads on various devices and recommended further research and analysis of existing data. Available data are tabulated in the full report for the information of interested users.

TABLE 8: Minimum Required Superimposed Weight

d (ft)	h (ft)	w (lb/ft)		
		p = 20 lb/ft ²	p = 30 lb/ft ²	p = 40 lb/ft ²
4	6	106.7	116.0	214.0
4	7	91.5	136.0	183.0
4	8	80.0	118.6	160.0
5	6	208.3	313.0	417.0
5	7	178.6	266.0	357.0
5	8	156.3	232.0	313.0
6	7	309.0	461.0	618.0
6	8	258.0	385.0	515.0
7	8	429.0	640.0	858.0
8	9	569.0	854.0	1140.0
8	10	512.0	765.0	1025.0

Fig. 4

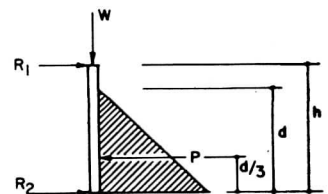

When only the finest is acceptable—

Erie ARCHITECTURAL PORCELAIN ENAMEL

The lifetime satisfaction expected from this Administration Building, recently completed for one of the nation's largest automotive corporations, exemplifies the confidence placed in The Erie Enameling Company by discriminating owners.

When your reputation as an architect or contractor hinges upon the quality of architectural porcelain enamel and the service of your supplier—specify Erie Porcelain Enamel.

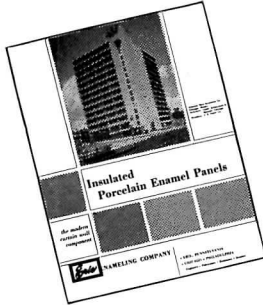

Write for free copy of this new 24-page manual on Insulated Porcelain Enamel Panels for Curtain Wall

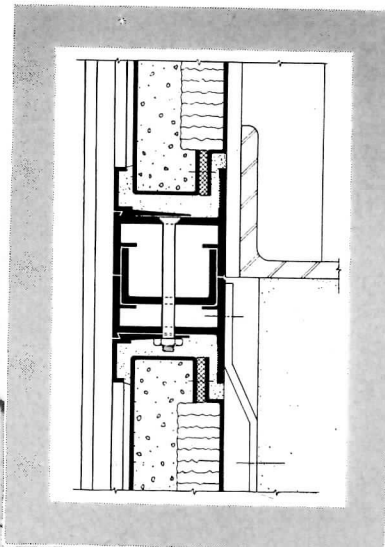

Details at left show a cross section illustrating the special modification of the Erie U-16 Panel used and the method of attachment.



Engineers • Fabricators • Enamellers • Erectors



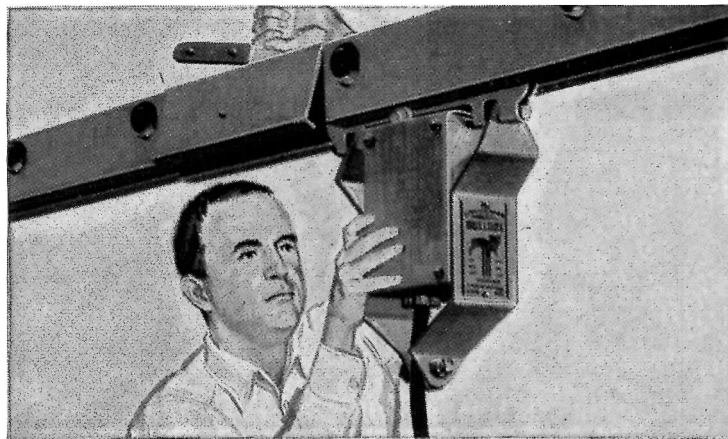
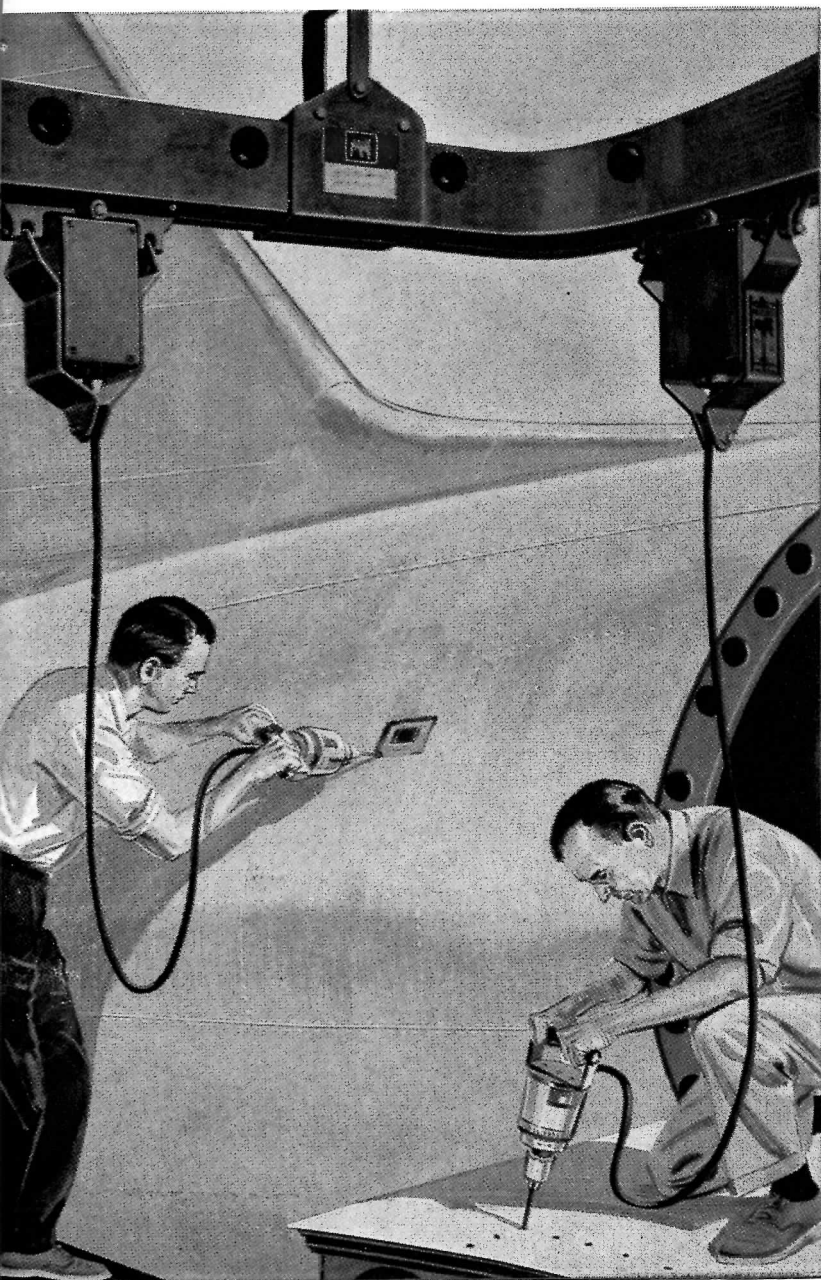

Smooth-rolling trolleys tap power from the duct . . . can be added, removed or relocated in minutes without any downtime or rewiring. Duct is rated at 100 and 225 amps. Special curved sections can be ordered to fit any production line.

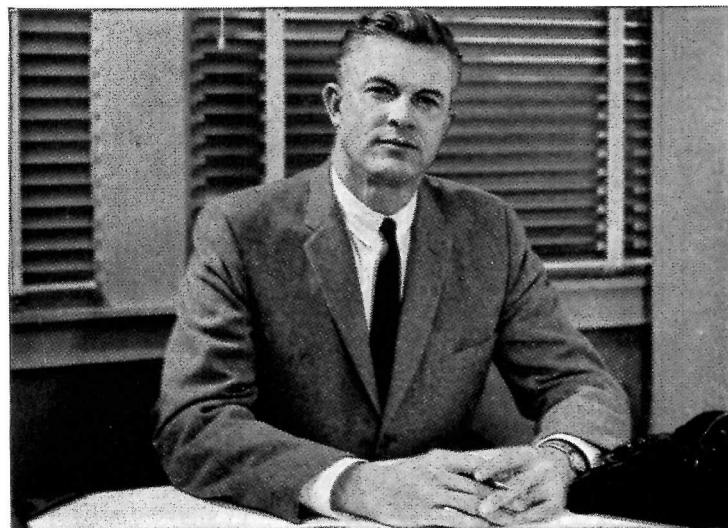

Your Bulldog field engineer will be pleased to give you all the details on Industrial Trol-E-Duct and other Bulldog products. Call him. You'll find his know-how very helpful in planning new systems or modernizing existing systems.

Roll power to the job . . . save production time and dollars!

Can your present electrical system actually contribute to higher production? Here's one that can—Bulldog Industrial Trol-E-Duct®! It brings *mobile* power to your assembly lines . . . gives you electrical flexibility that saves time, increases output. Looks to your future, too. When you want to add new production units, just insert a new trolley . . . and forget about rewiring and downtime.

Industrial Trol-E-Duct is but one of many Bulldog engineering advances that help solve your power problems. A complete Bulldog distribution system, from safety switch to Unit Substation, increases safety and efficiency, saves production time and dollars. Consult your Bulldog field engineer now about your electrical system.

© BEPCO

Bulldog Electric Products Company, Detroit 32, Michigan • A Division of I-T-E Circuit Breaker Company • Export Division: 13 East 40th St., New York 16, N.Y. In Canada: Bulldog Electric Products Co. (Canada), Limited, 80 Clayson Rd., Toronto 15, Ontario



IF IT'S NEW . . . IF IT'S DIFFERENT . . . IF IT'S BETTER . . . IT'S

BULLDOG

ELECTRIC PRODUCTS COMPANY

A DIVISION OF I-T-E CIRCUIT BREAKER COMPANY

(Continued from page 196)

STUDENT-BUILT LABORATORY TO TEST TRUSSED RAFTERS

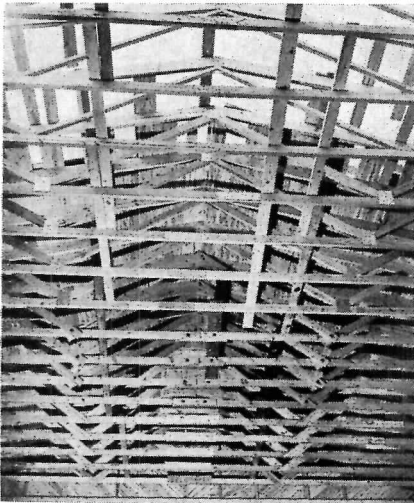

Students at Virginia Polytechnic Institute have recently completed an experimental laboratory building in which five types of lightweight trussed rafters of "W" design were used to span the thirty feet between the outside walls. The rafters are to be tested in use over a long period, the first tests being deflection measurements taken before, during and after their erection. According to the Institute, the data obtained to date has already yielded information not previously available.

Built mainly of 2 in. lumber, the twenty-one rafters used for the building are spaced 2 ft apart and are designed to carry a roof load of 35 psf. The five types include nail-glued trussed rafters with plywood gusset plates; split-ring connected trussed rafters; "H-Brace" connected trussed rafters with one-piece, 19-gauge steel plates bent to form an "H" between the jointed structural members; *Tim-Plate* connected trussed rafters with two 20-gauge galvanized steel plates inserted into two symmetrically spaced saw kerfs at each joint to connect the structural members; and the V.P.I.-designed nailed trussed rafters with lumber gusset and splice plates fastened to the structural members with hardened high carbon steel, helically threaded nails. All the trussed rafters were anchored to the plates and masonry walls — some toe-nailed to the plates with four 20d hardened steel, annularly threaded nails; others face-nailed with two 8 in. hardened steel, annularly or helically threaded spikes; and still others held down with sheet-steel angles, *Trip-L-Grips* or *Hurricane Braces*.

The building was erected under the

supervision of William L. Favrao, professor in charge of the building construction curriculum at Virginia Polytechnic Institute. Dr. E. George Stern, research professor of wood construction and head of the Institute's wood research laboratory, planned the roof construction and the long-time testing of the trussed rafters.

5½ Mile Span to Bridge Lake Maracaibo

A prestressed concrete bridge is being thrown across one end of Lake Maracaibo, Venezuela's fabulous "money lake," to the tune of 100 million dollars.

One of the longest bridges in the world, it will have a center span of 1300 ft, five secondary spans of 500 ft, and smaller spans of 60 ft or more for a total length of 5½ miles. Work on the huge project, which is due for completion in 1960, is being done by a Venezuelan company, Precomprimido, and its German associate, Julius Berger.

According to residents of Maracaibo, the bridge is expected to spark still further development of the lake and shoreline installations which already produce more than two-thirds of Venezuela's oil.

(More Roundup on page 212)

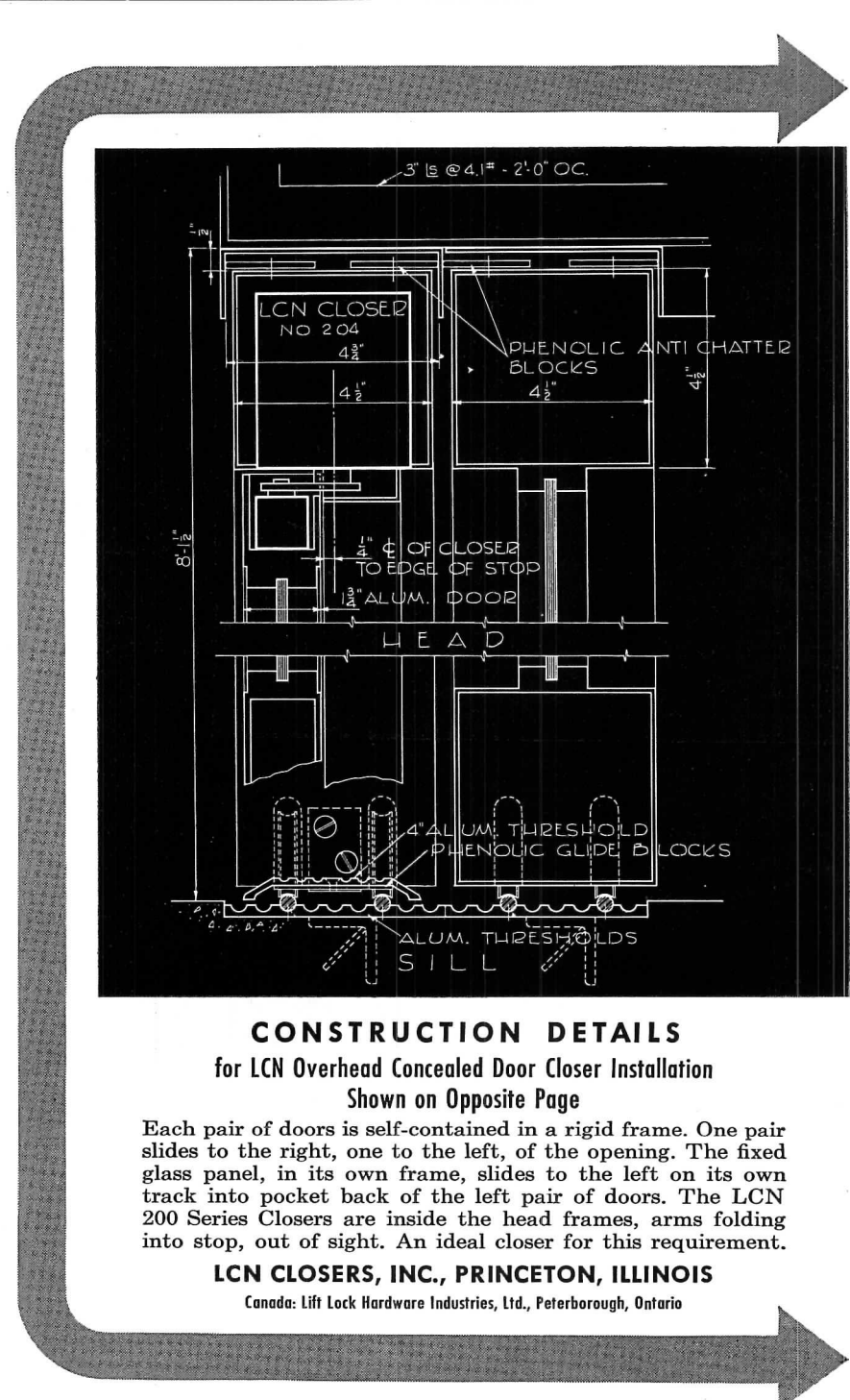

CONSTRUCTION DETAILS
for LCN Overhead Concealed Door Closer Installation
Shown on Opposite Page

Each pair of doors is self-contained in a rigid frame. One pair slides to the right, one to the left, of the opening. The fixed glass panel, in its own frame, slides to the left on its own track into pocket back of the left pair of doors. The LCN 200 Series Closers are inside the head frames, arms folding into stop, out of sight. An ideal closer for this requirement.

LCN CLOSERS, INC., PRINCETON, ILLINOIS

Canada: Lift Lock Hardware Industries, Ltd., Peterborough, Ontario

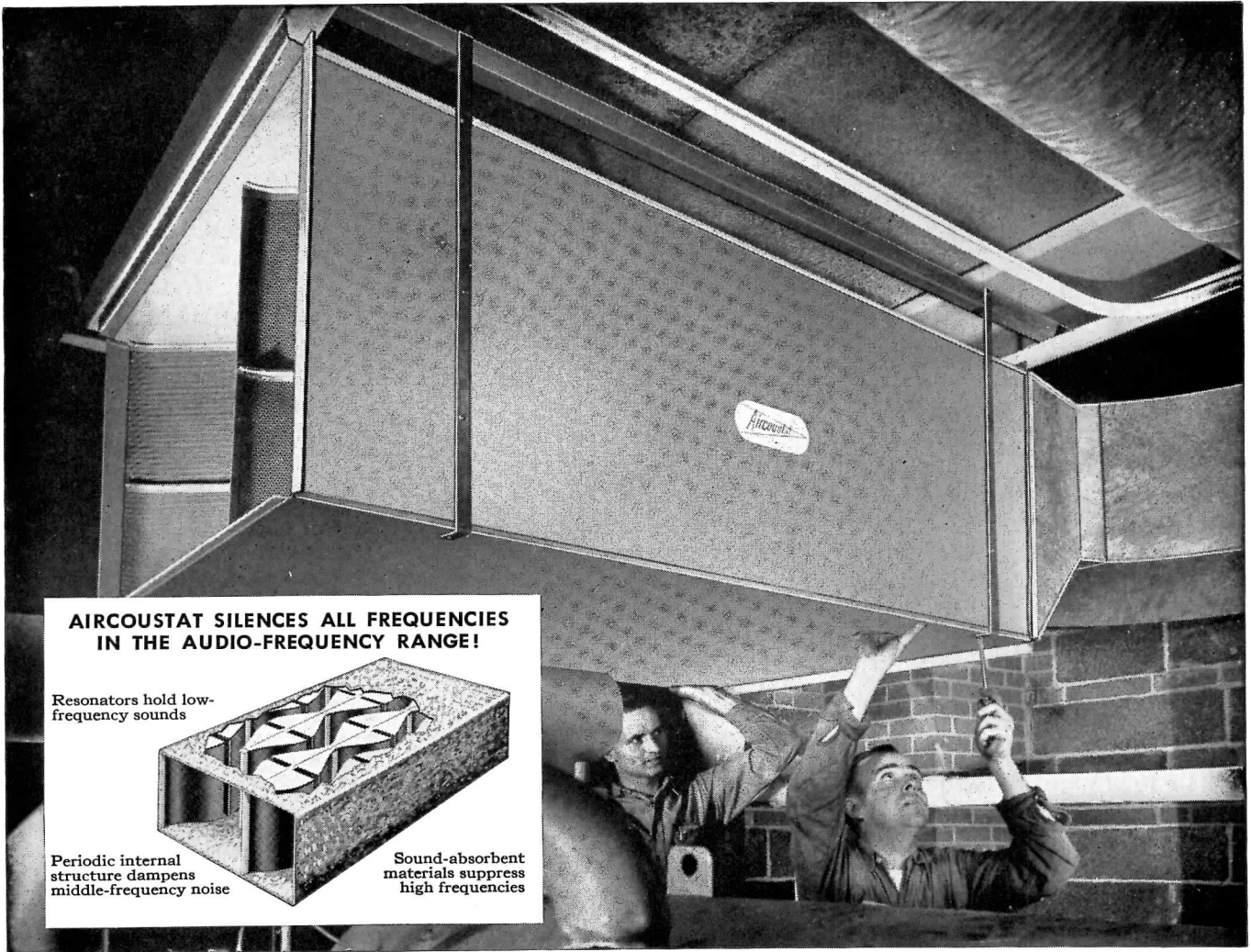

AIRCOUSTAT SILENCES ALL FREQUENCIES IN THE AUDIO-FREQUENCY RANGE!

Resonators hold low-frequency sounds

Periodic internal structure dampens middle-frequency noise

Sound-absorbent materials suppress high frequencies

AIRCOUSTAT* Sound Traps eliminate air conditioning noise at 50% less cost

Acoustical Performance Guaranteed. Easy to Install. Pre-Engineered — No Design or Layout Headaches.

Revolutionary AIRCOUSTAT Sound Traps require no special tools for installation . . . reduce your labor costs and lower your installation time. Units fit any size or shape of duct. If AIRCOUSTAT fits *geometrically*, it fits *acoustically*.

AIRCOUSTAT is the most efficient method of sound-deadening you can provide your customers. A 7-foot AIRCOUSTAT unit suppresses as much sound as 100 feet of ordinary duct lining. AIRCOUSTAT eliminates all frequencies in the entire

audio-frequency range, silences entire systems or selected outlets. Flow resistance and pressure drop are lower. 4 series cover applications ranging from general offices to recording studios.

Discover how AIRCOUSTAT Sound Traps can save you time and money . . . create greater customer satisfaction.

**Koppers Trade Mark*



**INDUSTRIAL
SOUND CONTROL**

Engineered Products Sold with Service

MAIL THIS COUPON TODAY

KOPPERS COMPANY, INC., Metal Products Div., Industrial Sound Control Dept., 6612 Scott St., Baltimore 3, Md.
Gentlemen: Please send me a free copy of your booklet on AIRCOUSTAT Sound Traps.

Name..... Title.....

Company.....

Address.....

City..... Zone..... State.....

TECHNICAL ROUNDUP

HYPERBOLIC PARABOLOID BAND SHELL COLLAPSES FOR STORAGE

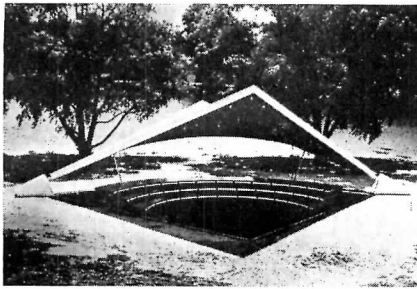

A demountable hyperbolic paraboloid — believed to be the first of its kind — has completed its first summer's service as a bandshell for a series of outdoor concerts at Fort George G. Meade, Maryland. Formed of two layers of $\frac{3}{4}$ in. pine framed by steel edge beams, the shell was designed in such a way that it can easily be sawed into separate panels, stowed away for the winter, and then reassembled in three days by simply bolting the panels back together.

The completed shell has a roof area of 2000 sq ft, painted white on the top-side, maple-stained beneath. From the fleche or central point, which is eleven feet off the ground, it curves upward to

a height of 23 ft at the front, 15 ft in the rear. The resulting curved plane perches butterfly fashion on two concrete buttresses 60 ft apart, maintained in its precarious position by tensile stiffeners at the rear of the shell.

Because the hyperbolic paraboloid form permits maximum use of a minimum of material, the shell is both lightweight (approximately 10 lb per sq ft) and inexpensive (\$2.50 to \$3.00 per sq ft.) Its primary purpose — to disperse sound — is also fulfilled by the hyperbolic paraboloid shape. Sound is projected from the shell in a conical

distribution pattern roughly 200 ft wide and 400 ft long, and the natural reflective qualities of the wood undersurface are further reinforced by baffles in the wings.

The shell was designed, and its construction supervised, by Pfc. Steven M. Jones, a young architect assigned to the Post Engineer's Office at Fort Meade. In discussing his choice of a hyperbolic paraboloid form for the bandshell, Jones points out that the resulting structure is lightweight, economical, easily constructed — and easily dismantled. His summary: "It happened to fit the problem."

U. S. Army Photo

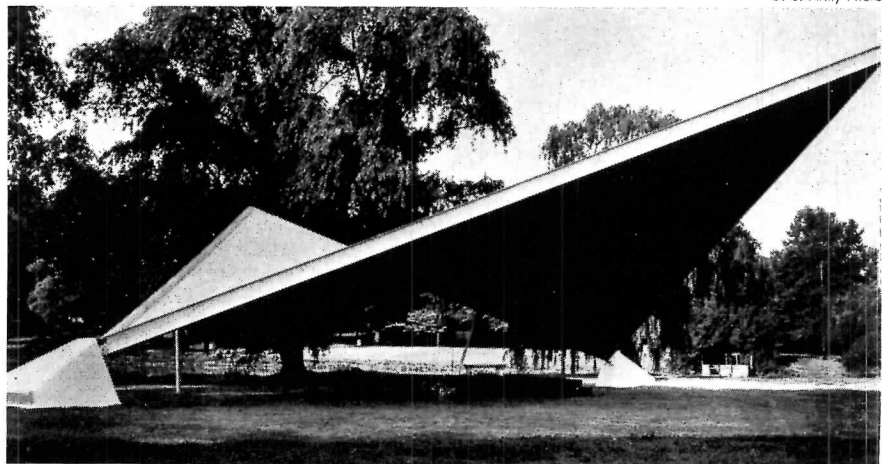

WHEN THE AIR SUPPLY IS VITALLY IMPORTANT

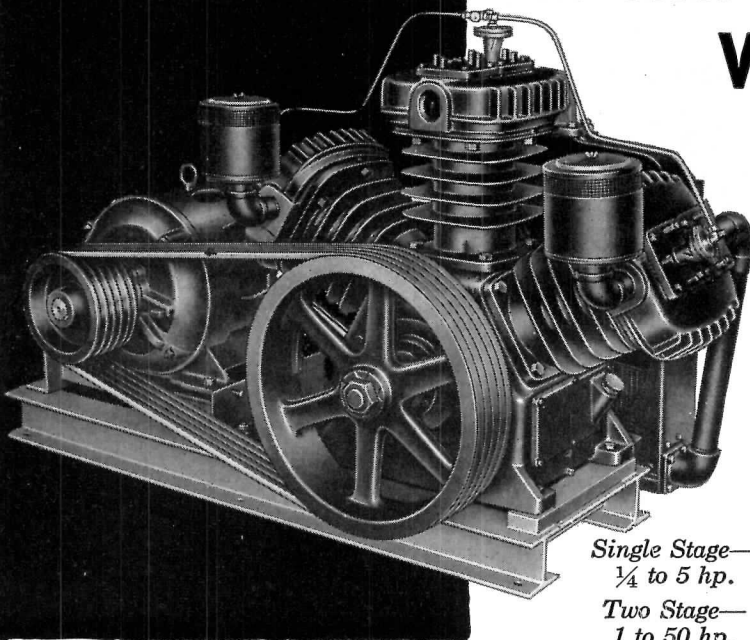

Specify
Curtis
and Relax!

Large fin area for quick and efficient air cooling—Timken Tapered Roller Main Bearing, adjustable for wear—Positive Centro-Ring pressure oiling system.

Available for prompt delivery

—With 103 years of engineering and manufacturing experience "built-in" you can be confident that there are no finer air compressors on the market than Curtis.

REMEMBER...YOU CAN COUNT ON

CURTIS MANUFACTURING CO.

OUR 103rd YEAR

PNEUMATIC DIVISION

1986 KIENLEN AVENUE • ST. LOUIS 20, MO.

Single Stage—
 $\frac{1}{4}$ to 5 hp.
Two Stage—
1 to 50 hp.



AIR CYLINDERS AND AIR HOISTS

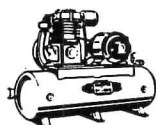

VERTICAL OR HORIZONTAL TANK MOUNTED COMPRESSOR $\frac{1}{4}$ THRU 15 HP.

CM-24

**ARTS FESTIVAL FEATURES
PLYWOOD VAULTED ROOFS**

Two displays at the San Francisco Arts Festival last September were sheltered by a pair of pavilions as interesting as the exhibits themselves. Designed by Evelyn and George Kosmak, in conjunction with the Berkeley Plywood Company, the twin pavilions were roofed with plywood vaults extending in opposite directions from adjacent sections of a common wall. Each was made up of an eleven foot vault with a clear span of 40 ft, plus an 8 ft cantilevered overhang at each end. The vaults, which were prefabricated in 8 ft sections, consist of two 4 by 12 ft panels of 1/2 in. fir plywood, joined with a plywood cleat and bent over a form. These panels were nailed and glued to beveled 3 by 4 in. flanges and steel tension rods were inserted to maintain the desired curvature. When the vaults were assembled at the site, the curved sections were connected by plywood cleats and screws, according to calculations made by structural engineers Mackintosh and Mackintosh of Los Angeles. The addition of a one foot overhang over the sides of the vaults, brought the total area covered by each pavilion to 728 sq ft.

The bandshell for the festival, also

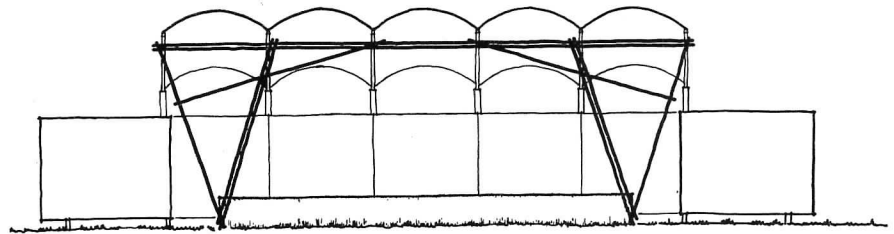
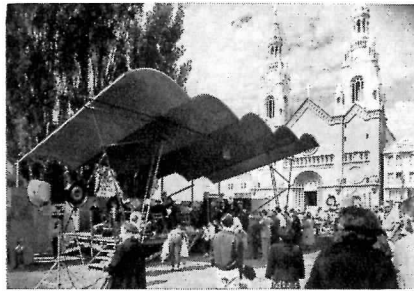

Bandstand Elevation

designed by the Kosmaks and fabricated by Berkeley, repeated the theme introduced by the pavilions. Five smaller vaults, each 24 ft long by 8 ft wide, were placed side by side to form a sheltering canopy for the 16 by 32 ft stage. As shown, the resulting scalloped roof was supported by light steel tube scaffolding. The vaults themselves each consist of six 4 by 9 ft sandwiches of light top and bottom plywood skins, glued to curved framing members. The

walls of the dressing rooms at the rear of the stage were also constructed of plywood panels, similar to conventional stressed skin panels, but with their plywood skins curved to a 64 in. radius.

Both the complete vaults and the smaller sections are currently being produced by Berkeley Plywood as standard components under the trade name *Plyvault*, and are expected to find wide application in the building industry.

IMPORTANT REASONS WHY

**Architects - Engineers -
Contractors and Owners**

prefer the **CURTIS 50 Ton
PACKAGED AIR CONDITIONER**

INSTALLATION EASIER: Line assembled at the factory—eliminates expensive field labor.

PERFORMANCE KNOWN: Curtis units are run-in at the factory and guaranteed to deliver their rated tonnage. Assures a **BALANCED SYSTEM**.

DELIVERY ON TIME: Curtis can meet your delivery requirements, a decided advantage over multiple supplier delivery promises!

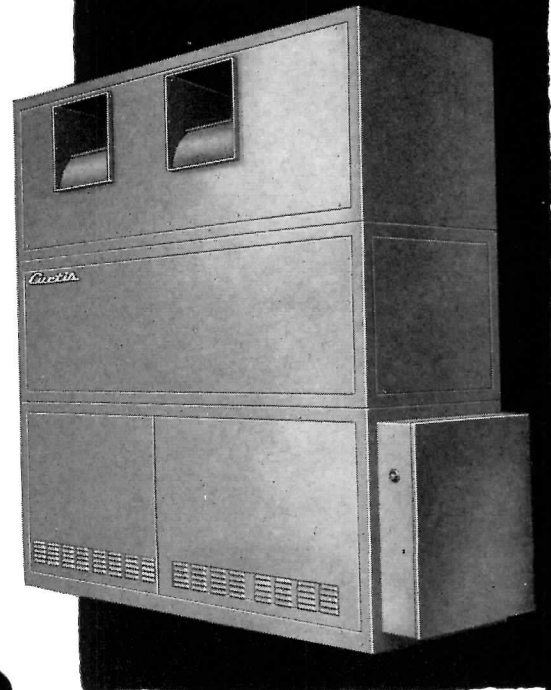

CAN COUNT ON
REMEMBER...
YOU

SEE OUR CATALOG
IN SWEET'S
ARCHITECTURAL
FILE
OR WRITE FOR COPY

Curtis

OUR 103rd YEAR

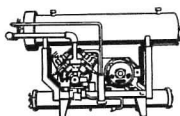

PACKAGED
LIQUID
CHILLER
UP TO
100 TONS



PACKAGED AIR
COOLED UNITS
UP TO 7 1/2
TONS

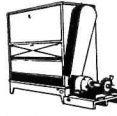

AIR HANDLING UNITS
COOLING TOWER
AND EVAPORATIVE
CONDENSER
TO MATCH

**MANUFACTURING CO.
REFRIGERATION DIVISION**

1986 Kienlen Ave., St. Louis 20, Mo.

CM-23

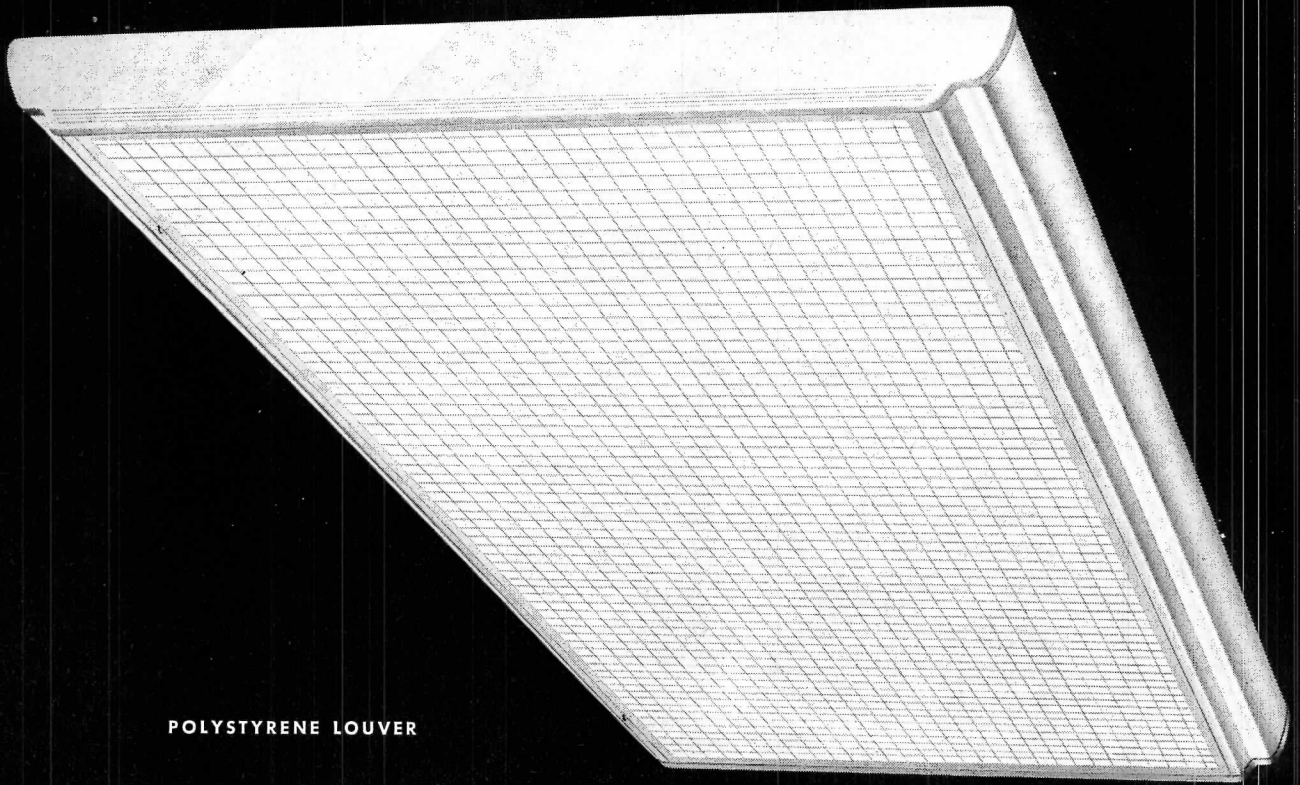

POLYSTYRENE LOUVER

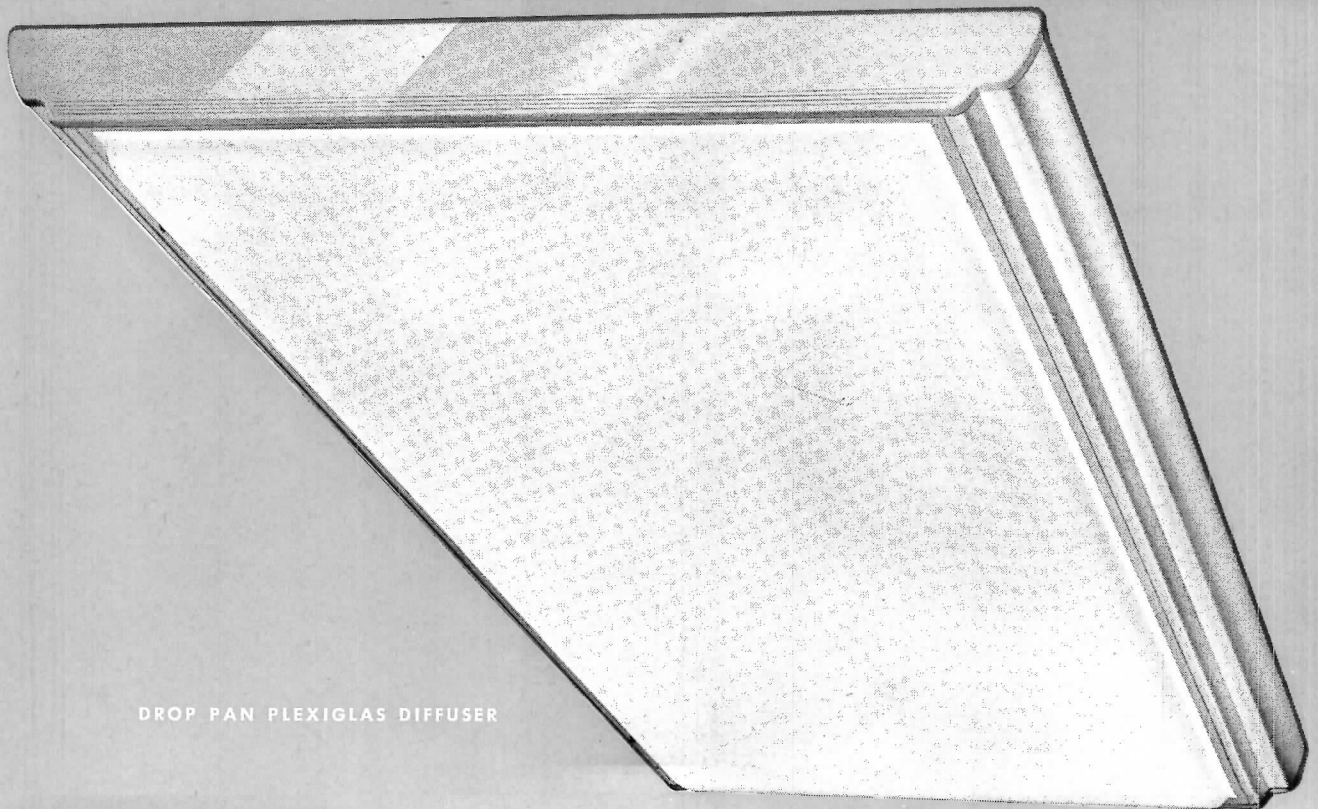

DROP PAN PLEXIGLAS DIFFUSER



GIBSON MANUFACTURING COMPANY

IN CANADA manufactured under franchise by ELECTROLIER MANUFACTURING CO., LTD., Montreal,
one of Canada's oldest and largest manufacturers of lighting fixtures.



Some insulations
feed a fire . . .

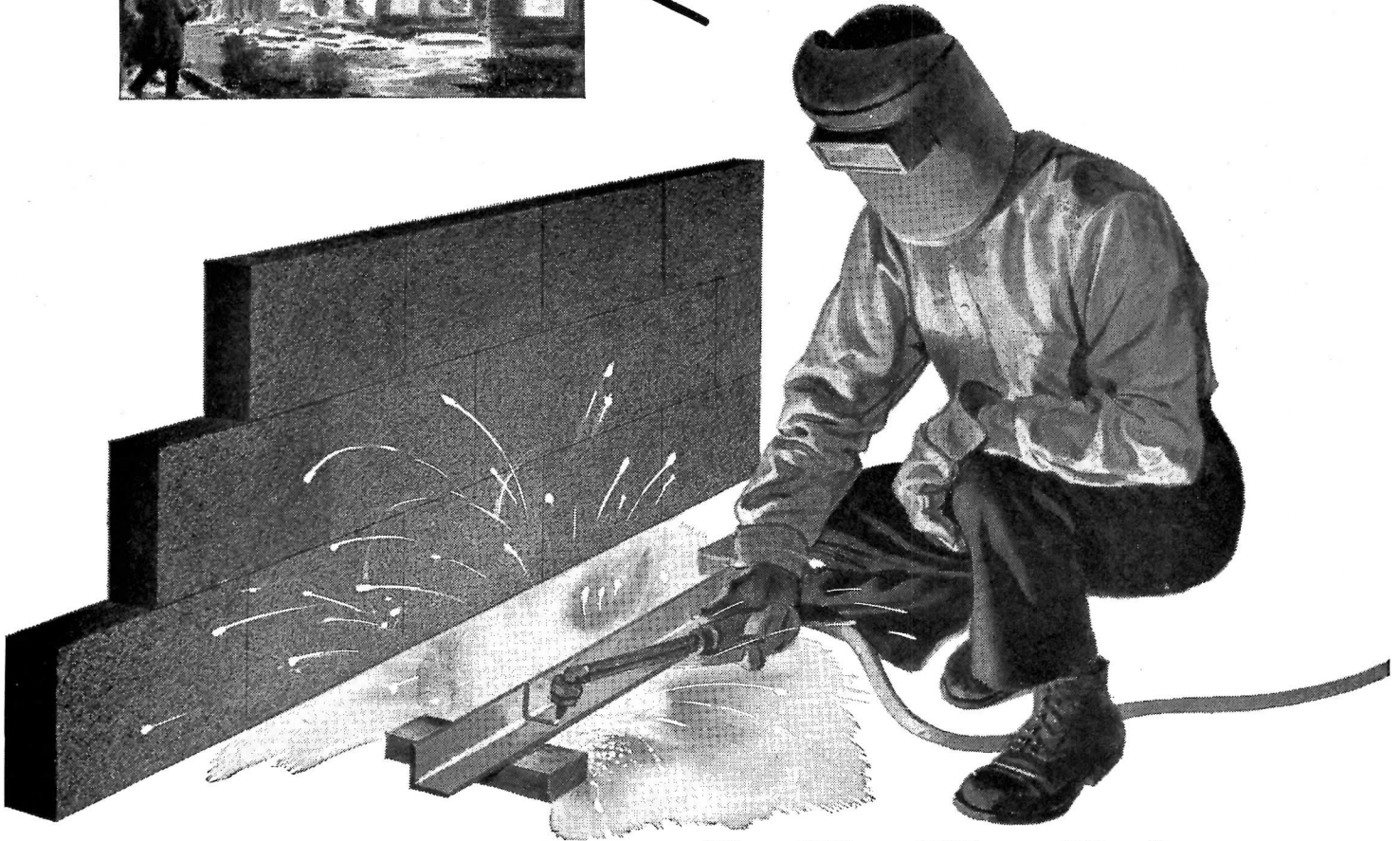

FOAMGLAS[®]

INSULATION

won't burn!

—and only inorganic FOAMGLAS insulation offers all these added benefits . . . waterproof and vapor-proof (closed glass cell structure) . . . dimensionally stable . . . high compressive strength . . . vermin-proof . . . easy, economical to handle and install. Write for detailed literature.

FOAMGLAS is listed by Underwriters' Laboratories, Inc. under Label Service.



Pittsburgh Corning Corporation

Dept. B-127 One Gateway Center, Pittsburgh 22, Pa.
In Canada: 57 Bloor Street West, Toronto, Ontario

(Continued from page 9)

a building expressing or accommodating worship by three faiths in a satisfactory way and not being the fully studied building it might have been, it uses a construction method which is strong and appropriate to achieve a very expressive chapel.

— John MacL. Johansen, Architect

Three generations of architects and engineers have struggled with the expressive range of new structures as technology has introduced these; in that long effort there have been some brilliant and many happy results. The Air Academy Chapel as presented in your September issue is not likely to be counted among these. I respect the architects' goals, admire their fortitude under attack. If only they had succeeded better I would willingly cheer more than their principles. Overlooking some unhappy but no doubt inconsequential details, the

interior spaces seem more pleasant than the exterior; no Congressman has yet done justice to that, and indeed the first published version seems preferable.

— Edgar Kaufmann Jr.,
Writer and Critic

The Chapel is in the tradition of the great churches of Europe. It has the recognizable elements which one associates with such religious buildings. The polyhedrons which form the structure, laced together and spaced to permit the penetration of light into the nave through the stained glass interstices, give the visual satisfaction of vital, dynamic forces brought under control and in balance. Rising from the bold, clearly expressed buttress-like foundations to the serrated silhouette at the ridge, they lift the spirit. The resulting form and color of the interior should receive a reverent response from the worshipper.

The materials, structure and method of fabrication are as much a product of our day as the Air Force itself. Together they form a distinguished concept of a religious center for the Air Academy.

— Roy F. Larson, Architect

At the time of the Congressional debate on the Air Force Academy two years ago, I made a public statement in support of the Air Force's plans designed by the firm of Skidmore, Owings & Merrill (see *Architectural Record*, August, 1955, page 18).

It is not necessary here to repeat it, except to reiterate that each creative age has its own architectural language, and that it is as absurd for us today to use the architectural style of some past age as it would be to conduct Congressional debates in Greek or Anglo-Saxon.

Insofar as present Congressional criticisms argue a return to the Classic, Gothic, Renaissance, or any other historic style, they may be rejected as wrong in principle.

We must use our own architectural language. It is true that language can be used with skill and feeling to create — say — a great and moving speech in the House; or it can be used in a monotonous, pedestrian fashion; or a downright awkward and ungrammatical way to make mediocre or poor speeches.

Similarly, our own modern or contemporary style in architecture can reveal a great range of creative talent. Not all of it will be good, and not all of it will please all tastes. It has always

(Continued on page 272)

SEND TODAY

TO: FARLEY & LOETSCHER MFG. CO., DUBUQUE, IOWA

GENTLEMEN: I am interested in learning more about Farlite Decorative High Pressure Plastic Laminates. Please note the items I have checked at the right.

Name _____

Title _____

Company _____

Address _____ Zone _____

City _____

State _____

Sheet Stock

Panel Stock

Complete Tops

Literature

Samples

Send your Salesman

Use this coupon
for complete details on



Visit Us At
BOOTH 578
NAHB BUILDERS SHOW
Hotel Sherman

HIGH PRESSURE
**PLASTIC
LAMINATES**

New, modern Farlite laminates in eye-catching patterns, solid colors, or wood grains can add functional beauty to homes, offices, schools, institutions! You can rely on Farlite . . . it's guaranteed to meet or exceed NEMA standards!

PLASTICS DIVISION
FARLEY & LOETSCHER MANUFACTURING CO.
DUBUQUE, IOWA

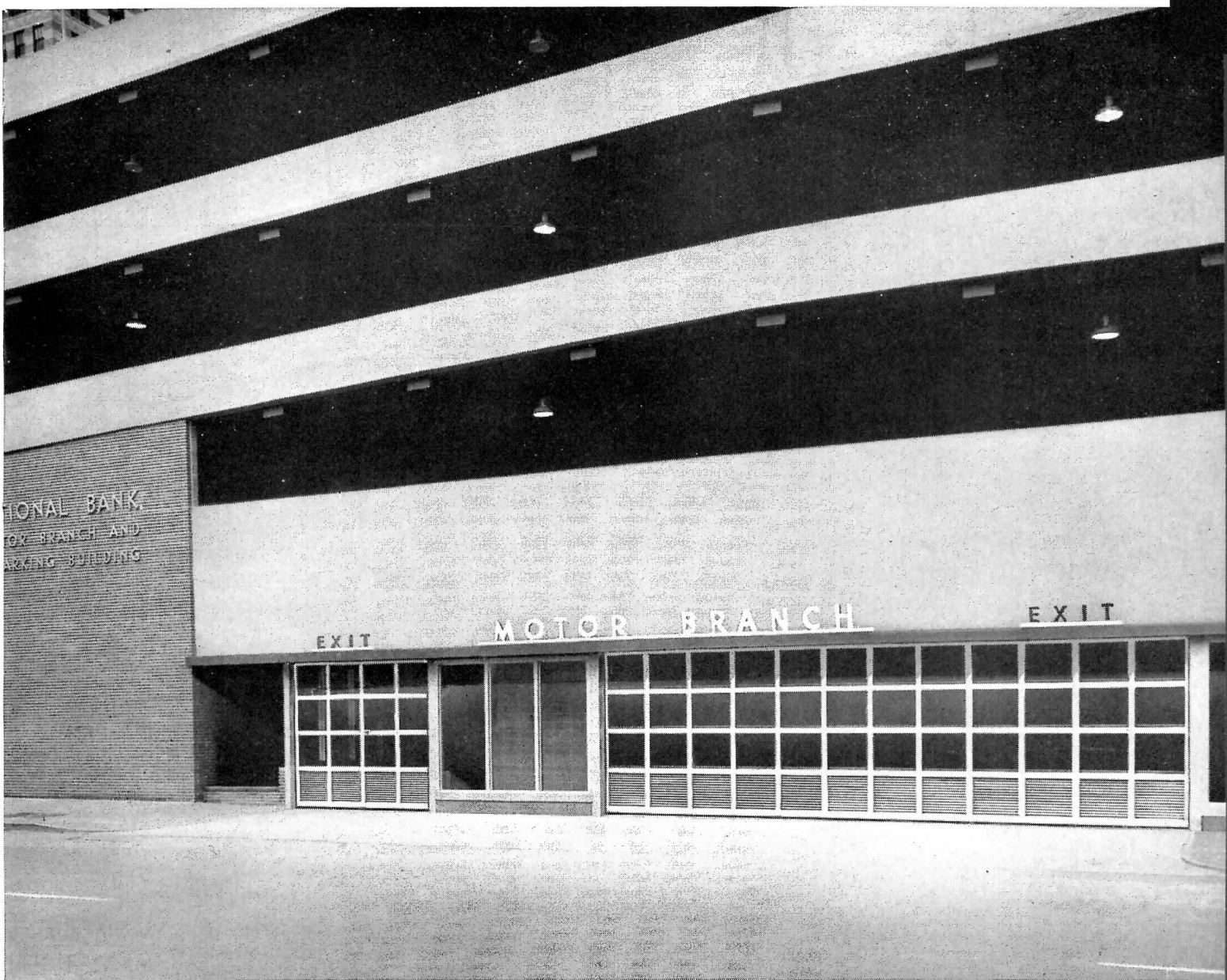

Merchants National Bank at Mobile, Alabama, provides drive-in facilities with the addition of a new Motor Branch and Parking Building. Two aluminum "OVERHEAD DOORS," with bottom sections lowered to permit escape of exhaust fumes, give an attractive "store front" appearance to the building. The larger door, 26'9" wide, is matched by a door of the same size and design on the entrance side of the building. ▲

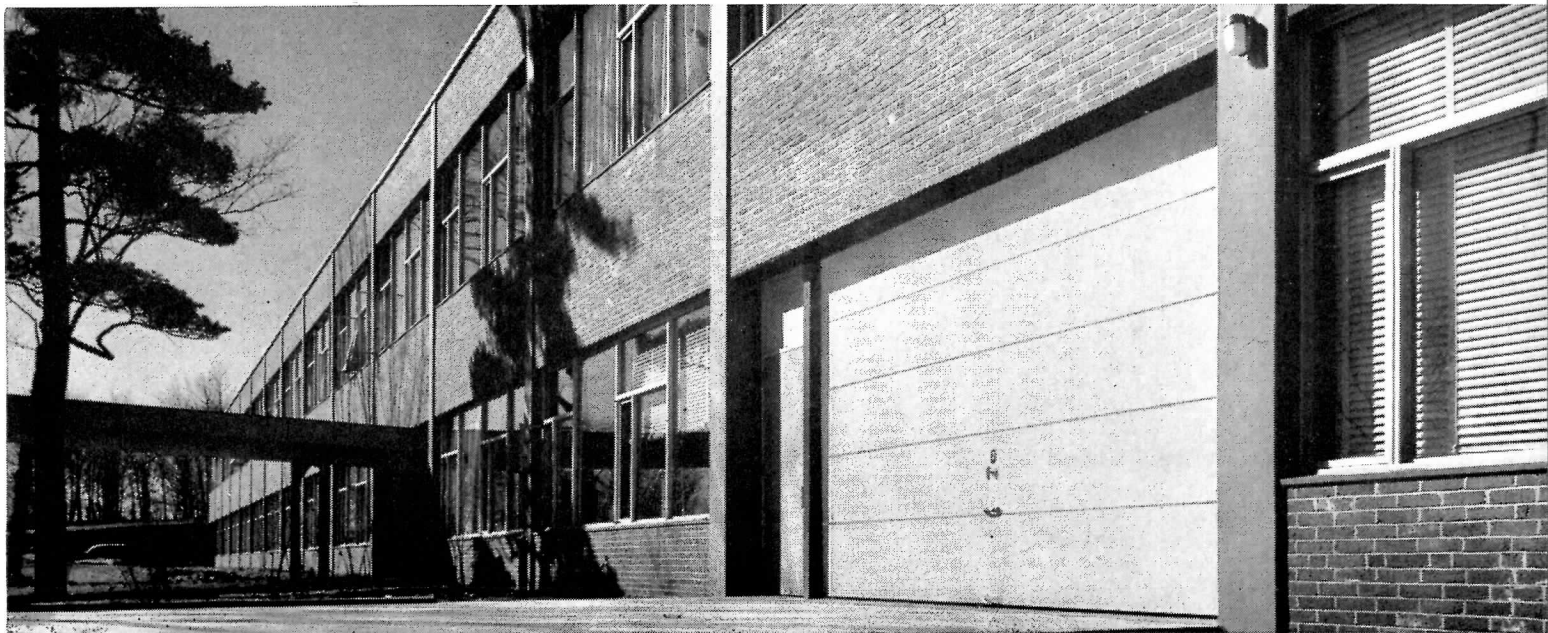

PERSPECTIVES

(Continued from page 266)

been so in the past. Witness all the controversy and turmoil, the bitter committee criticisms, that accompanied the building of the U. S. Capitol.

I do not myself find all aspects of the new chapel design pleasing. To me the uniform succession of sharp-pointed forms on the skyline lacks climax, and

it is too brittle and nervous. The building suggests a centipede in rapid motion. Neither does it harmonize with the mountain skyline as well as did the earlier design — which was also criticized.

On the other hand, the structural conception is brilliant, and I believe the interior space, color and diffusion of light would be of great charm and serenity.

The placing of the large Protestant chapel above, and the smaller Catholic and Jewish chapels in the basement is

open to question. Would it not be wiser to make all three chapels, architecturally, of an interfaith character so that portable ritual furniture would permit the use of any one in accordance with varied requirements of use and congregational size?

The main point is that you can't legislate beauty. Any more than you can legislate good oratory. The Air Force, after long search and consultant opinion, has selected what is almost universally recognized as one of America's leading architectural firms. They may not please all of us; they may not create a masterpiece for the centuries: but they've got a better chance of doing so than a collection of too many cooks stirring too much broth. Would Congress send a committee to the Mayo Clinic to tell it the best treatment for appendicitis?

— **Hugh Morrison, Chairman, Department of Art and Archaeology, Dartmouth College**

The proposed design for the Air Force Academy Chapel seems to me a brilliant solution to a difficult problem. As form, I find it splendid in its relationship to the other buildings and the site — particularly the mountains and trees. In structure I find it ingenious and valid. As a whole concept, it seems to have a special appropriateness for the Air Force.

— **Eliot Noyes, Architect**

The latest design, if imagined to be free of its surroundings, should be effective, possibly handsome, both in silhouette and in the alternation of light and shade on the angular faces. The height will be impressive probably from the exterior and certainly on the interior.

Taken in context with the other units of the Academy as they are now proposed, one may wonder at the effectiveness of the change from the grand sweep of rectangular planes — in glass and concrete — to small, sharply triangular divisions.

Do the two architectures come about in order to emphasize the difference between the religious use and military-academic use, or is the difference compelled by the difference in framing? Perhaps this is not important.

At any rate, none of it appears to have been the concern of those who debated the design in Congress. I gather that the worry there was that the chapel just didn't look the way the Congressmen thought a chapel should look. Time can be the only remedy for this, unless

(Continued on page 278)

MAXIMUM PROTECTION

... your most important consideration!

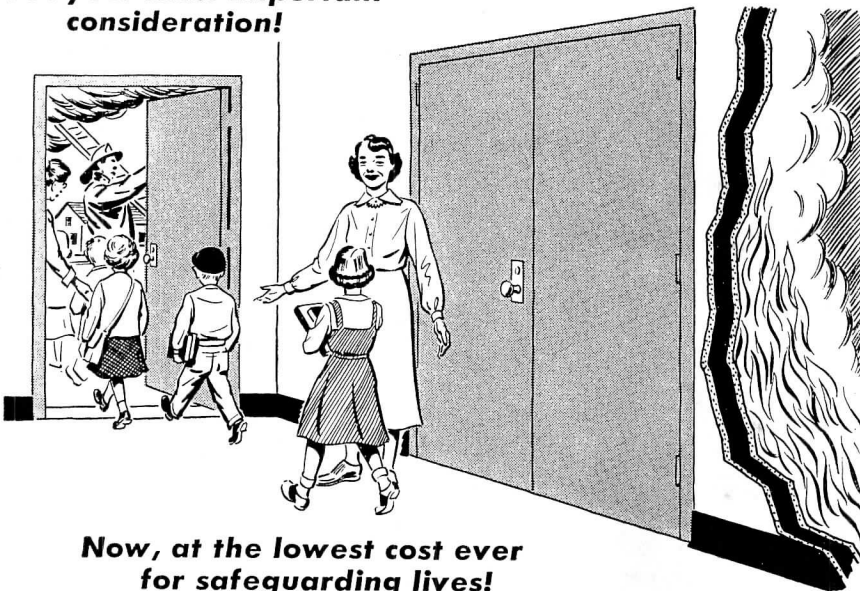

Now, at the lowest cost ever for safeguarding lives!

D-H PyroDor[®] 3 HOUR TEST UNDERWRITERS' CLASS "A" LABEL INTEGRAL DOOR & FRAME UNITS

- ★ Eliminates Complicated or Expensive 3-Point Locking Devices
- ★ First Class "A" Labeled Door with Single Point Lock
- ★ Solid Mineral Core Construction gives Lowest Heat Transmission
- ★ Guaranteed for the Life of the Building

Model "SA" — Available in Single Swing or Pairs

• NOW... top quality, true flush Class "A" doors, frames and hardware available at HALF THE COST of Class "A" Hollow Metal assemblies. Delivery from Distributors' stocks or Factory Warehouse. Contact your nearest D & H Distributor through the Yellow Pages of your phone book or write...

Request Bulletin SA-157

D AND H DUSING & HUNT, Inc.
Over 50 Years Manufacturing Fireproof Doors and Metal Trim
61 LAKE STREET LEROY, NEW YORK

Fire Alarm Systems Tailored to YOUR BUILDING...

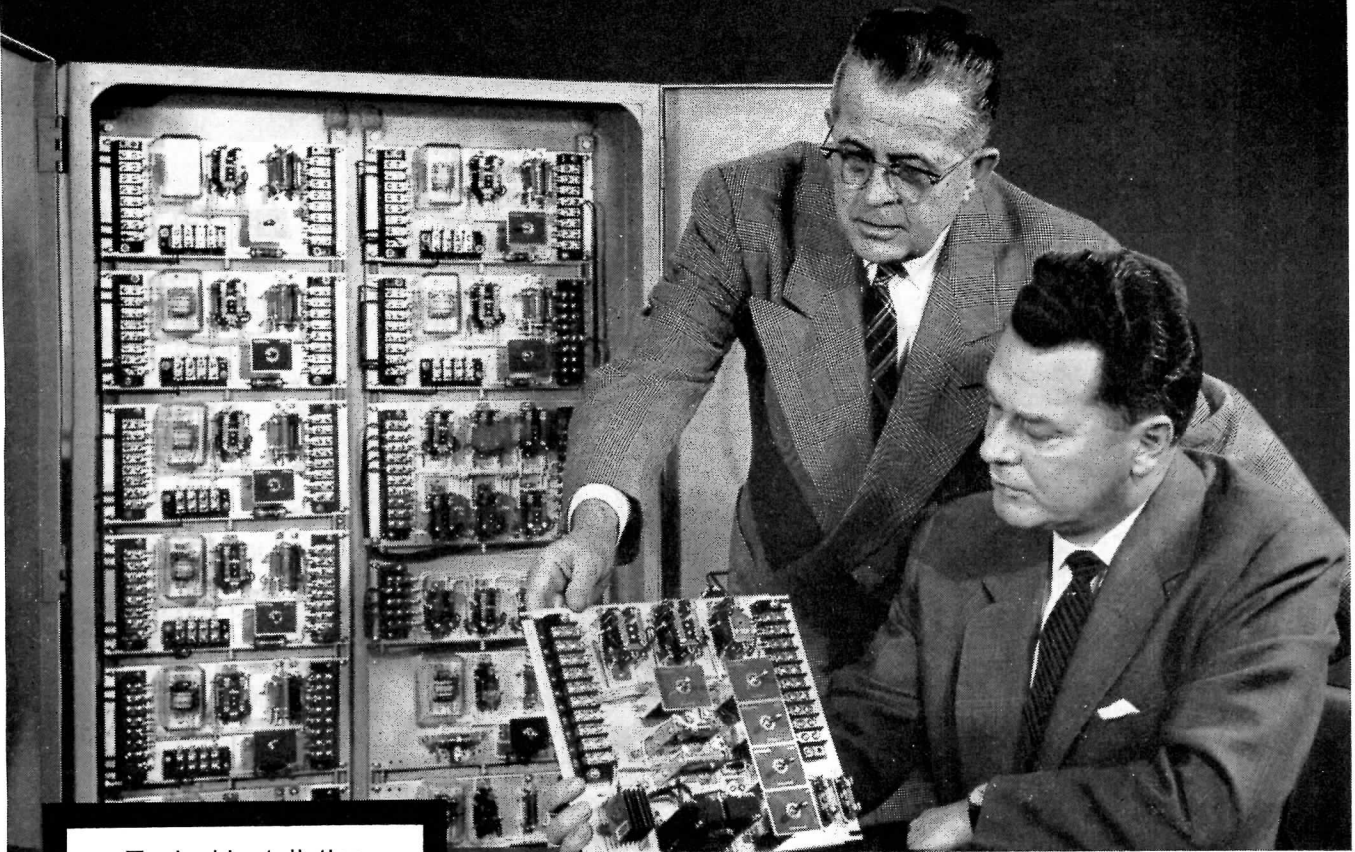

Typical installation
FLEXALARM Automatic
Fire Alarm System

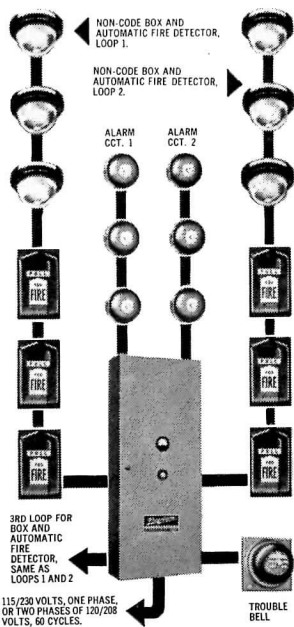

The Modern ALL-IN-ONE Fire Alarm System

GAMEWELL *Flexalarm*

Here, for the first time, is a completely pre-engineered fire alarm system . . . designed to give you new freedom and flexibility in specifications.

Complete Flexibility . . . Flexalarm is based entirely on the building-block concept. Unit-type panel assemblies and components permit a completely tailored system for all types of construction, fire codes and life hazards.

Easy to Specify, Economical to Buy . . . Building block design, plus pre-engineered systems greatly simplify specification for all types of buildings. Flexibility and ease of installation save money all down the line . . . and all from one source, one line of equipment.

Send for New Flexalarm Manual . . . Easy-to-use technical manual with functional descriptions, typical specifications and data on major components. Get your copy now for time and cost saving on your next project. And for specific technical assistance, ask to see a Gamewell Engineer.

GA7-18



In Canada: Northern Electric Co., Ltd., Belleville, Ont.
First When Seconds Count



THE GAMEWELL COMPANY, Dept. BB, Newton Upper Falls 64, Mass.

Send me the free Flexalarm Fire Alarm System Planning Guide, F249.

Name Title

Firm

Address

City Zone State

PERSPECTIVES

(Continued from page 272)

there is to be a finishing school in fine arts for confused Congressmen.

— Paul Schweikher, Head, Department of Architecture, Carnegie Institute of Technology

The employment of the distinguished architects for the above project was de-

ecided only after considerable deliberation.

Responsible clients accept the advice of responsible counsel. It is regrettable that such practice has not prevailed.

— Glenn Stanton, Architect, former president, American Institute of Architects

In rationalizing the Air Academy problem, I would hesitate to start out by denying a member of Congress his right to a personal opinion. He is answerable to his constituents and that means you,

and me, too. However, in this case, I believe we are in safe hands and undue anxiety is being expressed.

To go beyond this point, however, and satisfied to leave the design of the Chapel strictly to S.O.M., I believe there is an error in philosophical perspective in the programming for the building.

The thought of a Protestant church atop a Catholic church and a synagogue in the round would have made a Pilgrim Father or a rugged Calvinist or Huguenot turn pale. How these divergent religious viewpoints can be reconciled, hand-in-hand, is hard to explain. Protestantism, by its very nature, is in contradiction to Catholicism, and Judaism is in contradiction to both.

It is the style nowadays to stress the common meeting ground. But the common meeting ground too often deprives people of their intrinsic right to be different. The amalgamation of religions under one roof sponsored by a free and democratic government, in a government institution, if you will, does not bode well for individual liberties and freedom from intrusion, which have been sacrosanct in our country since the dawn of its history.

We must protect freedom of religion but just as surely we must protect ourselves against the new freedom which seems to be to intrude.

When everybody's freedom is nobody's freedom we have cause for real worry, and this, to my mind, surpasses by far any opinion we may have on separate entrances, or the appearance of a building.

— Paul Thiry, Architect

The Air Academy Chapel is an arresting piece of architectural design. It has been conceived with singular unity and carried to the paper stage illustrated in the September issue of ARCHITECTURAL RECORD with great professional skill.

But it leaves me spiritually cold. As an expression of peace and humility it is wanting. As an expression of stern righteousness and might, it fails. How to infuse these qualities in a building which would be architecturally compatible with the mathematical precision of the rest of the brilliant design may be possible but has not been achieved.

Perhaps there should not be a chapel building or buildings but just a hill with a wooden cross and other symbols of eternal unchanging faith and trees and earth and the sky.

— Edgar I. Williams, Architect

National Headquarters Building INTERNATIONAL UNION of OPERATING ENGINEERS

Washington, D. C.

ARCHITECT:
Holabird & Root & Burgee



6 Balanced Doors in the entrances to National Headquarters Bldg. INTERNATIONAL BROTHERHOOD of OPERATING ENGINEERS.



The Door that lets
TRAFFIC through QUICKLY

ELLISON BRONZE CO.
Jamestown, New York

representatives in 77 principal cities in the
United States, Canada and Puerto Rico

Ellison
the **BALANCED DOOR**



General Contractor: B. E. Fulghum • Water Coolers Furnished and Installed by Engle Electric Co.

...BY DESIGN

stainless-steel top and Dual Drink Control make drinking more inviting, so much easier. And there's no spurt or splash thanks to the automatic Stream Height Regulator. Just a few of many reasons why America's leading architects, builders and plumbing contractors put Westinghouse Water Coolers in their plans.

For more information, call your local Distributor listed in the Yellow Pages. Or write to Westinghouse Electric Corp., Springfield Works, Springfield 2, Mass.

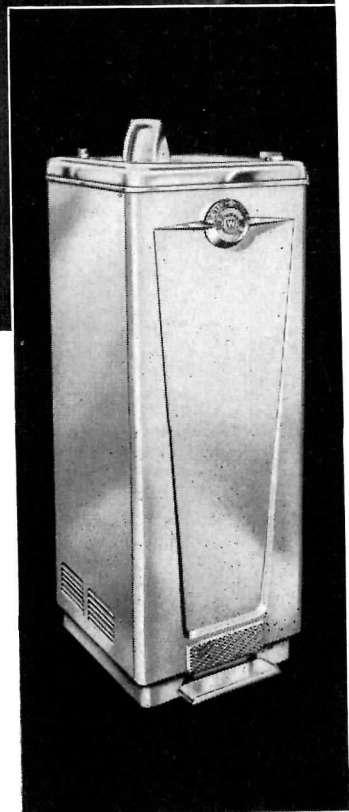

YOU CAN BE SURE...IF IT'S **Westinghouse**



ELECTRIC PLANT NEWS



Power outages can do no harm in this hospital

Onan Electric Plant supplies emergency power for lighting and all vital electrical equipment

An Onan Emergency Power System protects patients and personnel. Supplies current for lighting corridors, operating rooms, delivery rooms, stairways; provides power for heating system, ventilators, elevators, X-Ray machines, and other vital equipment.

Your hospital is assured of electric power at all times with Onan Emergency Electricity. *Operation is completely automatic.* When highline power is interrupted, the plant starts automatically; stops when power is restored.

Models for any size hospital—1,000 to 75,000 watts A.C.

Complete standby systems at lower cost

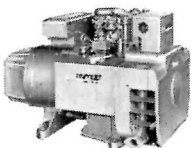

Onan Vacu-Flo cooling permits using air-cooled models in many installations at a considerable saving. Check Onan before you specify.

See our Catalog in Sweet's



Write for engineering data

D.W. ONAN & SONS INC.

2671 University Avenue S. E.
Minneapolis 14, Minnesota

REQUIRED READING

(Continued from page 62)

DESIGN OF STEEL

... *Structures, Including Applications in Aluminum*, by Gaylord and Gaylord is intended as a textbook for civil engineering courses, and deals with the design of structural members and their connections, with applications to steel bridges and building frames. Understanding of the basic philosophy of structural design is emphasized. *McGraw-Hill Book Company, Inc.* (N. Y.) 540 pp., illus., \$8.00

HARD METALS

A Handbook of Hard Metals, by W. Dawihl, explores the scientific principles of sintering and describes the technical production of hard metals. *Philosophical Library* (N. Y.), 162 pp., \$10.00.

EDUCATION FOR PLANNING

... *City, State, and Regional* by Harvey S. Perloff, is devoted to the question of what is an appropriate intellectual, practical, and philosophical basis for the education of city and regional planners. *The Johns Hopkins Press* (Baltimore), 1957, 189 pp., \$3.50.

ART OF SCHOOL BUILDING

Work Place for Learning. By Lawrence B. Perkins. Reinhold Publishing Corp. (N. Y.), 1957. 63 pp., illus. \$4.00.

Many photographs, a number of them in color, illustrate this interesting survey of a group of Perkins & Will's schools. Mr. Perkins explains that the book is limited to work of his own firm—though it meant omitting much good school design—because the treatment of the schools required showing examples whose exact purpose and intended effect were known intimately. The Libbey-Owens-Ford Glass Company, incidentally, commissioned the book, because of the company's interest in good school design; the author, however, was given complete freedom in putting it together.

Discussing the *art*, rather than the science, of school building, Mr. Perkins considers—and illustrates—approaches, corridors, offices, classrooms, lighting, the use of color, and other aspects of fashioning a "tool for the teacher" that is also an environment that will contribute as much as possible to "the full growth of each child's mental, physical, and spiritual potentials."

P. C. F.

NINE YEARS OF NEW DEVELOPMENTS IN ONE GREAT VOLUME!

ARCHITECTURAL ENGINEERING

by the Editors of *Architectural Record*

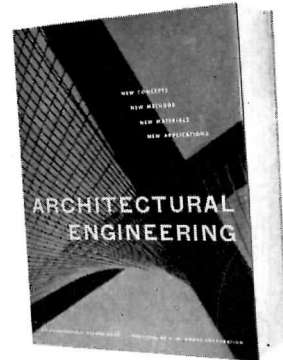

NEW CONCEPTS • NEW MATERIALS NEW METHODS • NEW APPLICATIONS

HERE for the first time in one place are nine years of new developments in architectural engineering, nine years of sweeping progress in building technology, nine years of exciting new concepts, time and labor-saving new methods, unique new materials and revolutionary new applications.

Architectural Engineering is divided into six important sections:

The Building Shell, Environmental Control, Utilities, Site Planning, Materials, and Special Problems. Each section contains dozens of articles by leading engineers and architects—a total of 97 detailed technical studies, illustrated with over 1,500 plans, photographs, and drawings. This giant book will be interesting reading for architects and engineers, and will be of continuing use as a daily reference.

PHYSICAL REASONS WHY YOU WILL LIKE THIS BOOK

495 pp, large 8¾ x 11¾" size.
Contains research and experience of leading architects and engineers.
Over 1,500 illustrations, plans, photographs.
8-page master index contains 1,200 topics, over 2,000 page references.
Clothbound—only \$11.50.

To fully appreciate this massive volume, you must actually see it—use it in your office for ten days. Order a copy now on our ten-day free trial. If *Architectural Engineering* does not meet your expectations, simply return it to us and owe nothing.

DODGE BOOKS, F. W. Dodge Corp.
119 W. 40 St., New York 18, N. Y.

Send me copies of *Architectural Engineering* @ \$11.50.

Payment enclosed. Bill me.

Name

Address

City Zone State