



# ARCHITECTURAL RECORD

2 February 1961

*Building Types Study: Hospitals*

*Planning the University of Baghdad*

*A New Skyscraper for Chicago by SOM*

*Full Contents on Pages 4 & 5*



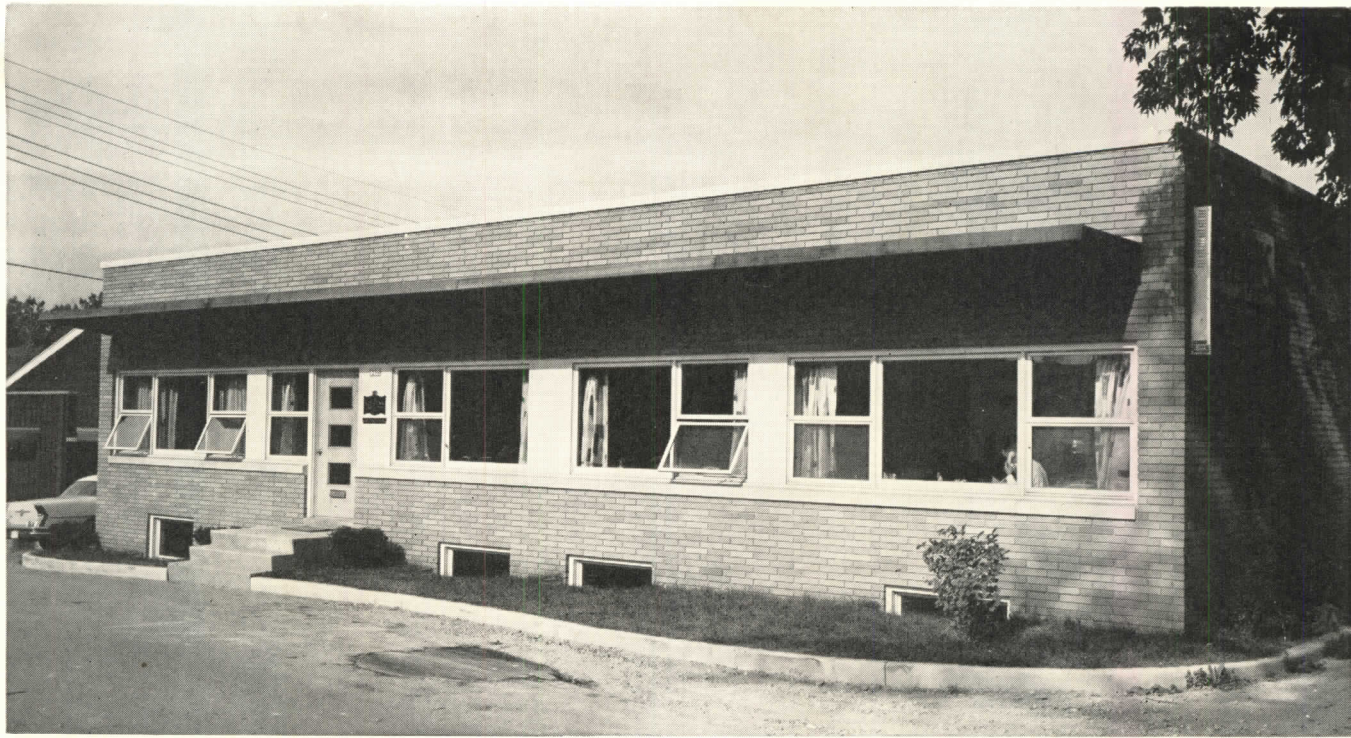

**INEXPENSIVE, VERSATILE**  
*Wood Windows* **FOR**  
**COMMERCIAL BUILDINGS**



**4-WAY**  
**Qualitybilt**  
**WINDOWS**®

Entrances / Doors / Frames / Sash / Blinds / Screens  
 Casements / Glider Windows / Combination Doors  
 Sliding Doors / Storm Sash / Mouldings / Sash Units  
 Interior Trim / Stairwork / Louvers / Cabinet Work  
 Kitchen Cabinet Units / Disappearing Stairs  
 "Farlite" Laminated Plastics

● These economical Qualitybilt wood windows are just the ticket for budget-minded businesses. Developed from a basic group of SINGLE SASH and TWO-SASH units, they can be used as Awning, Hopper, Casement, or Fixed units . . . providing hundreds of interesting and functional arrangements. Although economically priced, each unit is of highest quality throughout . . . carefully and completely weatherstripped, chemically treated for long service, and with a wide choice of hardware and glazing. We'll be happy to send you architectural details and other pertinent data. Ask for AIA File No. 16-L.



**FARLEY & LOETSCHER MFG. CO., DUBUQUE, IOWA**

ARCHITECTURAL RECORD (Vol. 129, No. 2 February 1961) is published monthly, except May 1961 when semi-monthly, by F. W. Dodge Corporation, 10 Ferry Street, Concord, N. H. Editorial and executive offices: 119 West 40th Street, New York 18, New York \$5.50 per year in U. S., U. S. Possessions and Canada: Second-class mail privileges authorized at Concord, N. H.





*Burner keeps the entire building comfortably warm, at unusually low cost.*

## managers heat with **LO-BLAST GAS** burners

able chimney drafts. You get greater combustion efficiency with all the convenience, economy and safety of modern *gas* heating.

Heat for less with *gas*! For information on Lo-BLAST Gas Burners—and their small counterpart, the Econo-

*Economite and Lo-BLAST Power Gas Burners operate silently, cost less to install, are well suited for down-draft boilers, and are available in capacities from 70,000 to 20,000,000 BTU.*

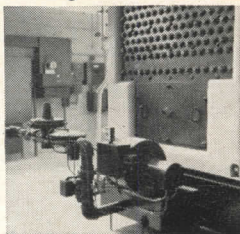

mite—contact your local Gas Company, or write to Mid-Continent Metal Products Company, 1960 North Clybourn Avenue, Chicago 14, Illinois.

*American Gas Association*

**FOR HEATING  GAS IS GOOD BUSINESS!**



# Architectural Engineering

- ESTIMATING RESIDENTIAL COOLING LOADS 170**  
A method for estimating heat gain greatly simplifies the more accurate sizing of cooling systems and eliminates disparities in "standard" methods now used
- ASBESTOS ROOF FOR LOW COST HOUSING 175**  
Asbestos-cement pipe is turned into structural channels in a U. N. study for low cost housing in Guatemala
- WIRE FABRIC HEATS, REINFORCES SLAB 176**  
A power company in North Dakota runs electricity through wire fabric floor slab reinforcement to provide space heating for a 6500-sq-ft service center-warehouse
- TIME-SAVER STANDARDS 177**  
*Sprinkler Systems for Fire Protection: 1, 2, 3*
- BUILDING COMPONENTS 183**  
*How Europeans Use Polystyrene Foams 183*  
by *Dr. Helmuth Osken*  
A German researcher discusses construction practices which take advantage of the unique properties of polystyrene
- PRODUCT REPORTS 185**
- OFFICE LITERATURE 186**

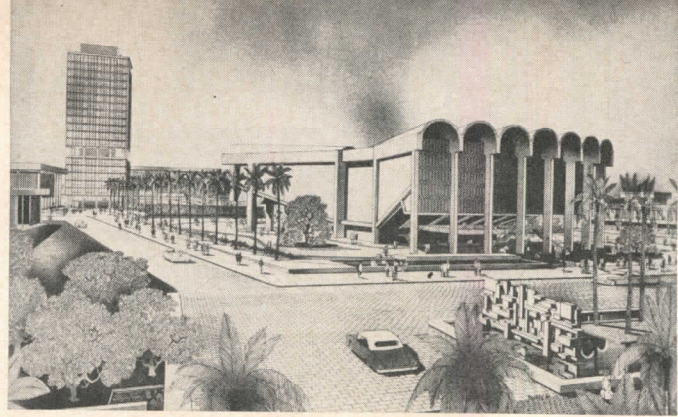

*Cover:*

The University of Baghdad, Iraq. The Architects Collaborative International Limited; Walter Gropius, Robert S. McMillan, Louis A. McMillen, Architects

*Advertising Index 312*

ARCHITECTURAL RECORD February 1961 Vol. 129, No. 2 © 1961 by F. W. Dodge Corporation, with all rights reserved. ARCHITECTURAL RECORD (combined with AMERICAN ARCHITECT and ARCHITECTURE) is published monthly, except May 1961 when semimonthly, by F. W. Dodge Corporation, 10 Ferry Street, Concord, New Hampshire. Editorial and Executive offices: 119 West 40th Street, New York 18, New York. Western Editorial office, 2877 Shasta Road, Berkeley 8, California

# ARCHITECTURAL

## Record Reports

- BEHIND THE RECORD 9**  
*A Memorial is a Memorial by Emerson Goble*
- CONSTRUCTION COST INDEX 10**
- PEDERSEN AND TILNEY WIN FDR MEMORIAL COMPETITION 12**  
Results of the most important architectural competition in many a year—the \$50,000 winner, the five other finalists, and the complete jury report—are here presented for professional scrutiny: a first look
- MEETINGS AND MISCELLANY 19**
- CURRENT TRENDS IN CONSTRUCTION 20**  
by *George Cline Smith*
- REQUIRED READING 54**
- CALENDAR 254**
- OFFICE NOTES 254**

*Architects and Buildings*

- ARCHITECTS COLLABORATIVE, THE. The University of Baghdad, Iraq .....107; Arthur R. Gould Memorial Hospital, Presque Isle, Me. ....155
- DUFRECHOU, L. F. West Jefferson General Hospital, Marrero, La. ....151
- KECK, GEORGE FRED-WILLIAM KECK. House, Kenilworth, Ill. ....133
- SKIDMORE, OWINGS & MERRILL. The Harris Trust and Savings Bank, Chicago .....123; Northwest Community Hospital, Arlington Heights, Ill. ....145

*Authors and Articles*

- HARRIS, W. S., AND E. J. BROWN. "A Simplified Procedure for Estimating Residential Cooling Loads" 170
- OSKEN, HELMUTH. "How Europeans Use Polystyrene Foams" .....183
- U. S. PUBLIC HEALTH SERVICE. "Planning the Laboratory for the General Hospital" .....160
- IMAGE OF THE ARCHITECT IN PRACTICE. Organization of Efficient Practice, 5: Hellmuth, Obata and Kassabaum, Inc., Architects .....137

PLEATED ASBESTOS ROOF FOR LOW COST HOUSING .....175



# Features

PLANNING THE UNIVERSITY OF BAGHDAD **107** *Walter Gropius and The Architects Collaborative International design an entire campus along the Tigris*

SOPHISTICATED CHICAGO SKYSCRAPER **123** *Highly refined stainless steel curtain wall and elegant interiors by SOM*

A LOT OF HOUSE FOR A LOW BUDGET **133** *William Kessler gets maximum space and privacy in his own house for \$30,000 including lot*

ORGANIZATION FOR EFFICIENT PRACTICE: 5 **137** *Quality controls, division of responsibility, businesslike administration are keys to architectural practice of Hellmuth, Obata and Kassabaum*

# RECORD

CONTENTS

February 1961

## Building Types Study 291: Hospitals

HOSPITAL WILL GROW WITH SUBURB **145** *SOM combines good detailing, extreme flexibility to produce suburban Northwest Community Hospital*

HOSPITAL FOR INDUSTRIAL COMMUNITY **151** *Few private rooms, large and convenient emergency facilities characterize West Jefferson General Hospital by L. F. Dufrechou*

NORTHERN CLIMATE INFLUENCES DESIGN **155** *Less fenestration than usual, compactness, more insulation help TAC Arthur R. Gould Memorial Hospital overcome severe Maine winters*

PLANNING THE LABORATORY FOR THE GENERAL HOSPITAL **160** *Public Health Service analysis of principles of lab planning complete with data and layouts of typical examples*



## Staff of Architectural Record

EDITOR  
Emerson Goble, A.I.A.

CONSULTING EDITOR  
John E. Burchard

SENIOR EDITORS  
James S. Hornbeck, A.I.A., *Features*  
William Dudley Hunt, Jr., A.I.A.  
Elisabeth Kendall Thompson, A.I.A., *West*

ASSOCIATE EDITORS  
Robert E. Fischer, *Engineering*  
Florence A. van Wyck, *Production*  
Jeanne M. Davern, *Assistant to the Editor*  
Herbert L. Smith, Jr., A.I.A., *Houses*  
Mildred F. Schmertz, *Design*  
Grace M. Anderson  
Margaret F. Farmer, *Engineering*

CONTRIBUTING EDITOR  
Ernest Mickel, *Washington*

ASSISTANT EDITORS  
Kathryn Gallant  
Anne Keffer

DESIGN  
Eugene H. Hawley, *Director*  
Alex H. Stillano, *Associate*

CONSULTANTS  
George Cline Smith, *Economics*  
Clyde Shute, *Statistical*  
Clifford G. Dunnells, Jr., *Field Research*  
Daniel J. Howe, Jr., *Public Relations*  
Edwin W. Magee, Jr., *Industry Relations*  
Sigman-Ward, *Drafting*

PUBLISHER  
Robert F. Marshall

EDITORIAL DIRECTOR  
Robert M. Cunningham, Jr.

PUBLISHING ADVISER  
H. Judd Payne

CIRCULATION MANAGER  
Marshall T. Ginn

## Officers of F. W. Dodge Corporation

HONORARY CHAIRMAN OF THE BOARD  
James McV. Breed

CHAIRMAN OF THE BOARD  
Paul Abbott

VICE CHAIRMAN OF THE BOARD  
Chauncey L. Williams

PRESIDENT  
Irving W. Hadsell

EXECUTIVE VICE PRESIDENTS  
Julius T. Little, Robert F. Marshall,  
T. Oliver Morgan, O. O. Paulsell

EXECUTIVE VICE PRESIDENT AND TREASURER  
Howard M. Thompson

VICE PRESIDENTS  
Robert M. Cunningham, Jr., William H.  
Hatch, Jr., H. Judd Payne, Richard H.  
Ray, George Cline Smith

REGIONAL VICE PRESIDENTS  
Miles W. Beatty, Carl S. Bennett, Robert  
G. Bingham, Clinton C. Bennett, Roy J.  
Hard, Alton W. Kitchens, Arthur D. Prior

ASSISTANT VICE PRESIDENT AND COMPTROLLER  
Edwin H. Freed

ASSISTANT VICE PRESIDENTS  
Walter F. DeSaix, Clifford G. Dunnells, Jr.,  
Gault Eastman, Clyde Shute

SECRETARY  
John S. Brittain

ASSISTANT SECRETARIES  
William C. Breed, Jr., George W. Morgan

ASSISTANT TREASURER  
Irving B. Satin

## Coming in the Record

### NEW DIRECTIONS: NEW WORK OF PAUL RUDOLPH

*It is not very often that a major shift becomes visible in the design approach of a highly talented and well established architect: and when this occurs it is major architectural news. Next month's portfolio on the current work of Paul Rudolph will reflect such a shift: architects will differ strongly in their reactions to it, but they will agree that it constitutes a significant and highly individual statement in the current architectural stream.*

### BUILDING TYPES STUDY: APARTMENTS

*Even in the worst of the housing dip, construction of multi-family housing continued strong, and it gives every indication of becoming an ever more important building type in architectural practice. How to arrive at better designs for urban (and suburban) living while solving the economic problems involved is the key theme of a study which leads off with an article by Architect Gyo Obata of Hellmuth, Obata and Kassabaum.*

OTHER F. W. DODGE SERVICES: Dodge Reports—Dodge Construction Statistics—Sweet's Catalog Services—Dodge Books—Dodge Mailing Service—The Modern Hospital—The Nation's Schools—College and University Business—Hospital Purchasing File—Chicago Construction News—Daily Pacific Builder (San Francisco)—The Daily Journal (Denver)—Real Estate Record & Builders Guide—Dow Building Cost Calculator.

Members of Audit Bureau of Circulations and Associated Business Publications. ARCHITECTURAL RECORD is indexed in Art Index, Industrial Arts Index and Engineering Index.

Every effort will be made to return material submitted for possible publication (if accompanied by stamped, addressed envelope), but the editors and the corporation will not be responsible for loss or damage.

Subscription prices: Published monthly except May 1961 when semimonthly. U. S., U. S. Possessions and Canada: \$5.50 per year; other Western Hemisphere countries, to those who by title are architects and engineers, \$9.00 per year. Single copy price except Mid-May 1961 issue \$2.00; Mid-May 1961 issue \$2.95. Beyond Western Hemisphere, to those who by title are architects and engineers, \$9.00 per year for 12 monthly issues not including Mid-May 1961 issue. Subscriptions from all others outside U.S., U.S. Possessions and Canada for 12 monthly issues, not including Mid-May issue, \$24.00 per year. Change of address: subscribers are requested to furnish both the old and new address, sending if possible stencil impression from magazine wrapper and to include city delivery zone number, where such is used, for the new address. Allow four weeks for change.



## A Memorial is a Memorial

If you haven't felt any of the shock waves following the Franklin Delano Roosevelt Memorial Competition, it's a safe bet that you soon will, depending on your figurative distance from Washington, D.C. This was, of course, one of the largest and most important architectural competitions since the famous Chicago Tribune Building competition back in the Twenties. (News of the final judging, with model photographs of the six finalists, is reported on pages 12-15.)

Any competition drawing 574 entries, most of them done by sizable teams not individuals, seems destined to produce considerable quantities of disagreement, but this one promises new records. Maybe the furor is inherent in the subject, or the peculiar challenge of a memorial in modern thinking, or maybe in the human and political involvements of this one.

This observer finds himself splashed by waves from several directions. About the only positive statement that seems appropriate right now is that I can't think when I have seen an issue quite so subject to snap judgments.

One of the interesting reflections is that, while this seems above all else an exercise in purely architectural design, it was concept or parti that pushed the winning design forward to the \$50,000. We asked the winner about it (in the person of William Pedersen of Pedersen and Tilney—see page 13 for full credits).

He told of the seemingly endless hours of brain-beating, involving the whole office in philosophical debates about definitions and purposes and people. A few of the important points, quickly, are:

One, it should not be a "useful" memorial. Yes, of course, there were all the table poundings about utility, so familiar in early assertions about contemporary architecture. But it should *not* be something for use in the usual sense. One reason dominated: they wanted a memorial for 24 hours a day, every day of the year, to all people within range, not just

in the normal hours of use of, say, a concert hall.

This same reasoning ruled out, for this group of brainstormers, any garden or plaza scheme, which supposedly would lie idle and largely unseen through many winter months.

Secondly, it should have height. Height, of course, for identity. To stand out in the Washington scene, to take its place with other memorials for visibility. A special consideration here was the great numbers of people, government workers or not, who pass it in automobiles day in and day out. A memorial for automobile age visibility.

Then, too, Pedersen spoke of the conviction that you couldn't create a sheltered dell in the center of a metropolitan area. Anything contemplative had to be scaled for the busloads of tourists; hence the disposition of the steles in the winning design.

Anything as contemplative as might suggest a temple was ruled out, he said, because the group did not consider a temple suitable to the times. Attempts at deification, even if considered appropriate, so seldom come off.

As for the quotations: they considered that Roosevelt found his power in words, in ringing phrases. These were likely to live in later times.

And so the sketches started. And an interesting problem arose—"centrality." With pylon patterns they were always asking what you did in the center. A statue? Well, yes, and again no. There was a statue in the scheme, almost to the end of the charette. But they didn't like it there very well; they felt a statue would be so restrictive in the realm of images—there are so many images in photographs and films, stamps, coins.

I was interested to reflect that we had earlier heard so much of this from a member of the jury group. Surely these thoughts about memorials will always be fragmented, as they are here, but it appears that in general they were communicated to the jury.

Emerson Goble



# Construction Cost Indexes

Presented by Clyde Shute, Director of Statistical Policy, Construction News Div., F. W. Dodge Corp., from data compiled by E. H. Boeckh & Assoc., Inc.

Labor and Materials: U.S. average 1926-1929=100

NEW YORK

ATLANTA

PERIOD	RESIDENTIAL		APTS., HOTELS, OFFICE BLDGS.	COMMERCIAL AND FACTORY BLDGS.		RESIDENTIAL		APTS., HOTELS, OFFICE BLDGS.	COMMERCIAL AND FACTORY BLDGS.	
	Brick	Frame	Brick and Concrete	Brick and Concrete	Brick and Steel	Brick	Frame	Brick and Concrete	Brick and Concrete	Brick and Steel
1930	127.0	126.7	124.1	128.0	123.6	82.1	80.9	84.5	86.1	83.6
1935	93.8	91.3	104.7	108.5	105.5	72.3	67.9	84.0	87.1	85.1
1939	123.5	122.4	130.7	133.4	130.1	86.3	83.1	95.1	97.4	94.7
1948	250.1	251.6	239.4	242.2	235.6	199.2	202.5	178.8	178.8	178.8
1949	243.7	240.8	242.8	246.6	240.0	189.3	189.9	180.6	180.8	177.5
1950	256.2	254.5	249.5	251.5	248.0	194.3	196.2	185.4	183.7	185.0
1951	273.2	271.3	263.7	274.9	271.8	212.8	214.6	204.2	202.8	205.0
1952	278.2	274.8	271.9	265.2	262.2	218.8	221.0	212.8	210.1	214.3
1953	281.3	277.2	281.0	286.0	282.0	223.0	224.6	221.3	221.8	223.0
1954	285.0	278.2	293.0	300.6	295.4	219.6	219.1	233.5	225.2	225.4
1955	293.1	286.0	300.0	308.3	302.4	225.3	225.1	229.0	231.5	231.8
1956	310.8	302.2	320.1	328.6	324.5	237.2	235.7	241.7	244.4	246.4
1957	318.5	308.3	333.1	345.2	339.8	241.2	239.0	248.7	252.1	254.7
1958	328.0	315.1	348.6	365.4	357.3	243.9	239.8	255.7	261.9	262.0
1959	342.7	329.0	367.7	386.8	374.1	252.2	247.7	266.1	272.7	273.1
Sept. 1960	354.3	339.4	380.6	399.2	381.1	261.4	254.9	277.2	285.6	279.5
Oct. 1960	353.6	338.5	380.5	399.1	380.9	260.0	253.1	276.9	285.4	279.1
Nov. 1960	354.0	338.9	381.0	399.5	381.3	259.8	252.9	276.6	285.2	278.9
			% increase over 1939					% increase over 1939		
Nov. 1960	186.6	176.9	191.5	199.5	193.1	201.0	204.3	190.8	192.8	194.5

ST. LOUIS

SAN FRANCISCO

PERIOD	RESIDENTIAL		APTS., HOTELS, OFFICE BLDGS.	COMMERCIAL AND FACTORY BLDGS.		RESIDENTIAL		APTS., HOTELS, OFFICE BLDGS.	COMMERCIAL AND FACTORY BLDGS.	
	Brick	Frame		Brick and Concrete	Brick and Steel	Brick	Frame		Brick and Concrete	Brick and Steel
1930	108.9	108.3	112.4	115.3	111.3	90.8	86.8	100.6	104.9	100.4
1935	95.1	90.1	104.1	108.3	105.4	89.5	84.5	96.4	103.7	99.7
1939	110.2	107.0	118.7	119.8	119.0	105.6	99.3	117.4	121.9	116.5
1948	227.9	231.2	207.7	210.0	208.1	218.9	216.6	208.3	214.7	211.1
1949	221.4	220.7	212.8	215.7	213.6	213.0	207.1	214.0	219.8	216.1
1950	232.8	230.7	221.9	225.3	222.8	227.0	223.1	222.4	224.5	222.6
1951	252.0	248.3	238.5	240.9	239.0	245.2	240.4	239.6	243.1	243.1
1952	259.1	253.2	249.7	255.0	249.6	250.2	245.0	245.6	248.7	249.6
1953	263.4	256.4	259.0	267.0	259.2	255.2	257.2	256.6	261.0	259.7
1954	266.6	260.2	263.7	273.3	266.2	257.4	249.2	264.1	272.5	267.2
1955	273.3	266.5	272.2	281.3	276.5	268.0	259.0	275.0	284.4	279.6
1956	288.7	280.3	287.9	299.2	293.3	279.0	270.0	288.9	298.6	295.8
1957	292.0	283.4	295.2	307.1	302.9	286.3	274.4	302.9	315.2	310.7
1958	297.0	278.9	304.9	318.4	313.8	289.8	274.9	311.5	326.7	320.8
1959	305.4	296.4	315.0	329.8	323.9	299.2	284.4	322.7	338.1	330.1
Sept. 1960	311.1	300.5	322.1	337.1	326.7	305.0	287.4	338.0	355.9	344.5
Oct. 1960	312.6	301.7	324.3	339.4	329.4	303.6	285.6	337.7	355.7	344.1
Nov. 1960	312.8	301.9	324.6	339.6	329.6	303.4	285.4	337.4	355.5	343.9
			% increase over 1939					% increase over 1939		
Nov. 1960	183.8	182.1	173.5	183.5	177.0	187.3	187.4	187.4	191.6	195.2

Cost comparisons, as percentage differences, for any particular type of construction, are possible between localities, or periods of time within the same city, by dividing the difference between the two index numbers by one of them; i.e.:

index for city A = 110

index for city B = 95

(both indexes must be for the same type of construction).

Then: costs in A are approximately 16 per cent higher than in B.

$$\frac{110-95}{95} = 0.158$$

Conversely: costs in B are approximately 14 per cent lower than in A.

$$\frac{110-95}{110} = 0.136$$

Cost comparisons cannot be made between different types of construction because the index numbers for each type relate to a different U. S. average for 1926-29.

Material prices and wage rates used in the current indexes make no allowance for payments in excess of published list prices, thus indexes reflect minimum costs and not necessarily actual costs.



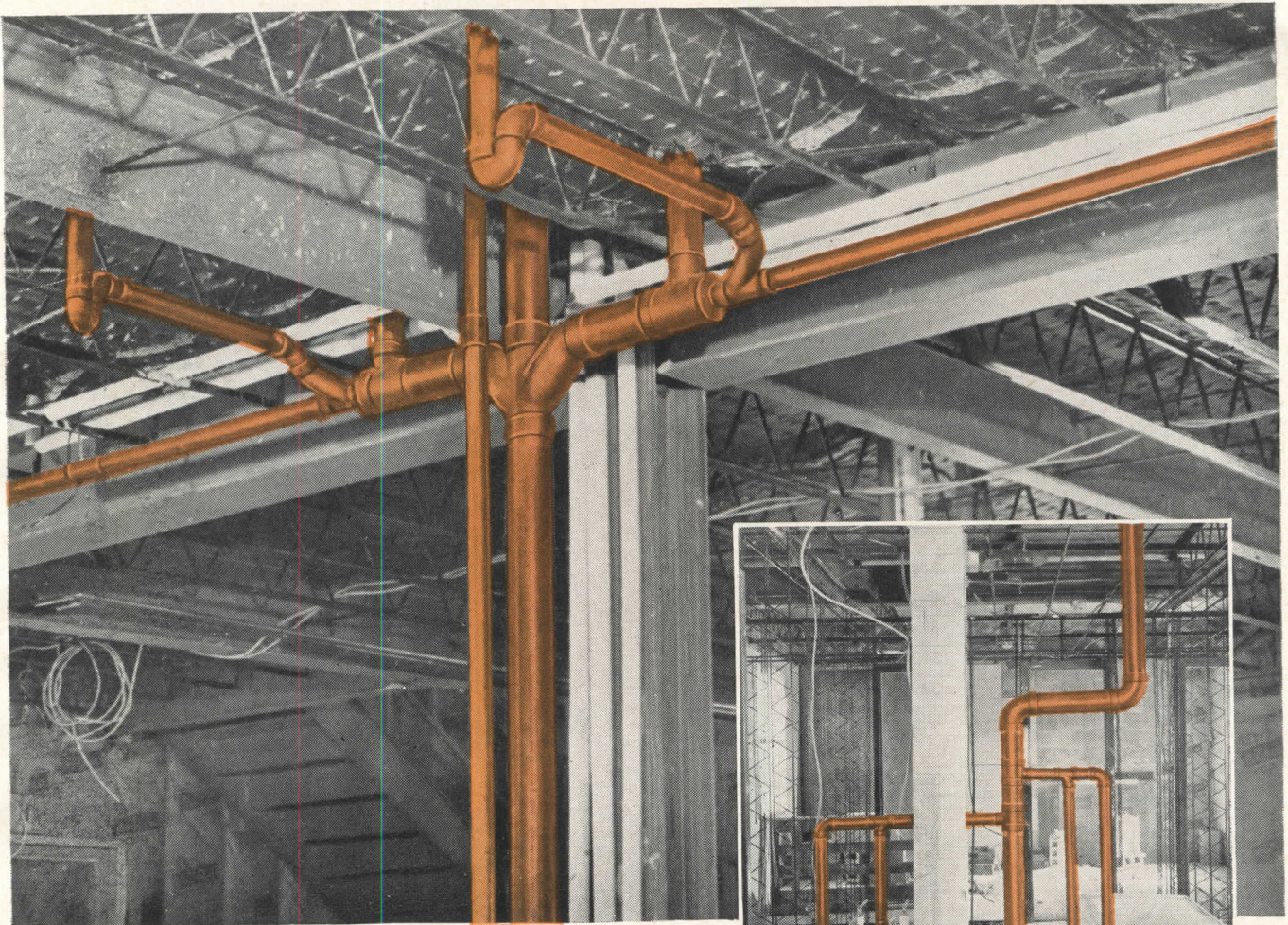

**Typical waste and soil line layout** for two complete bathrooms in the Novitiate Building of Brothers of the Holy Cross. Note compact, space-saving connections to the 4" soil stack. Light weight of copper tube makes overhead work easier, faster. Combination of copper tube and solder-joint fittings makes working in close quarters easy. *Right:* Trim copper tube vent lines on top floor for back-to-back bathrooms on this floor and floor below—eliminate wide plumbing walls, reduce construction costs, give greater usable floor area.

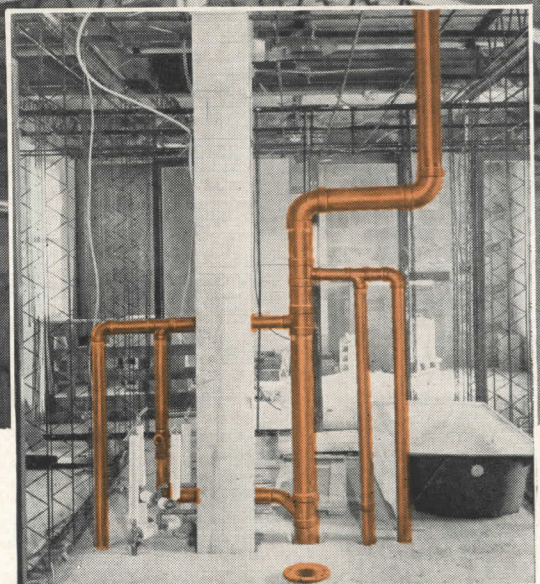

## In big jobs, too, Copper Tube drainage systems provide substantial installed-cost savings

"We prefer to use copper tubes because we have compared costs — material and installation — and come up with copper tube as the most economical of the specified materials *every time*," says David L. Farrell of Farrell Bros., plumbing contractor of Albany, N. Y. "The light weight of copper tube makes it easier to work with and reduces the hazards of handling heavy, bulky materials. Copper tubes can be accurately cut to desired lengths and much more quickly

installed. All of these advantages add up to substantial savings."

More and more local and regional building codes are being modernized to allow copper tube in sanitary drainage systems. Wherever permitted, in buildings large or small, copper can effect substantial savings as compared with conventional cumbersome materials. It is a worthwhile building cost-reduction factor.

For a new publication on All-Copper plumbing, write for Publication C-33. Address: Anaconda American Brass Company, Waterbury 20, Conn. In Canada: Anaconda American Brass Ltd., New Toronto, Ont.

5807AL

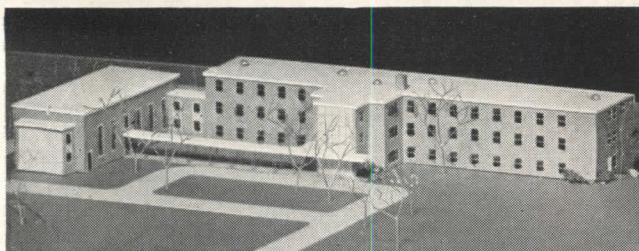

**Model of Chapel and Novitiate Building**, Brothers of the Holy Cross, Kinderhook, N. Y. Anaconda Type DWV copper drainage tube and Anaconda cast-brass drainage fittings were used on interior soil, waste, and vent lines. Architect: Toole and Angerame, Albany, N. Y. Plumbing and heating contractor: Farrell Bros., Albany, N. Y.

**ANACONDA** 

**COPPER TUBE AND FITTINGS**

**Anaconda American Brass Company**

*Available through Plumbing Wholesalers*





Louis Cheekman

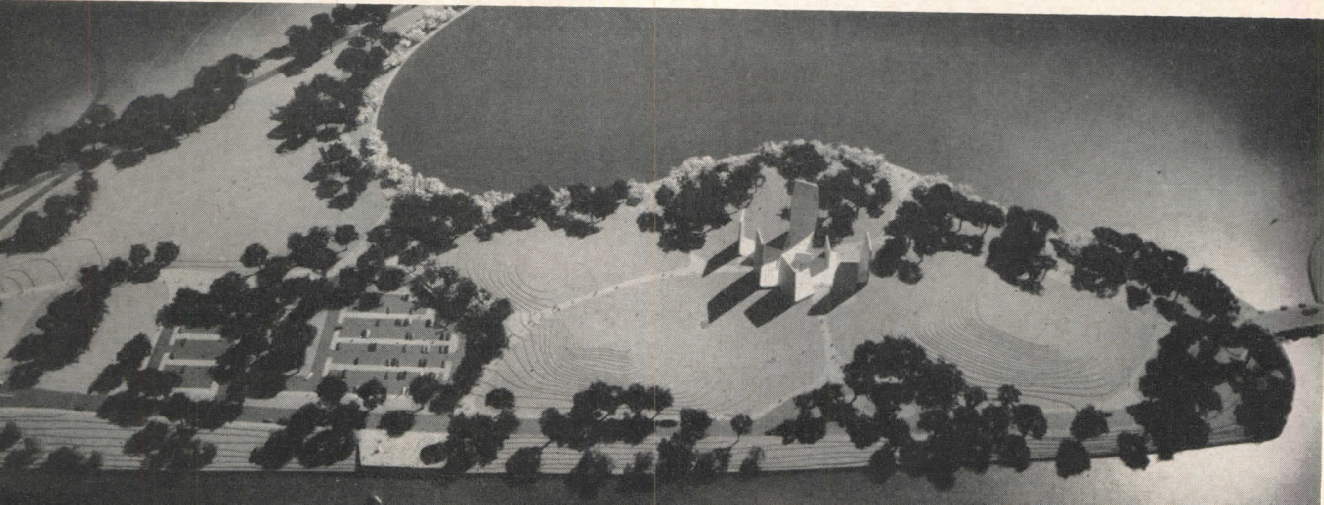



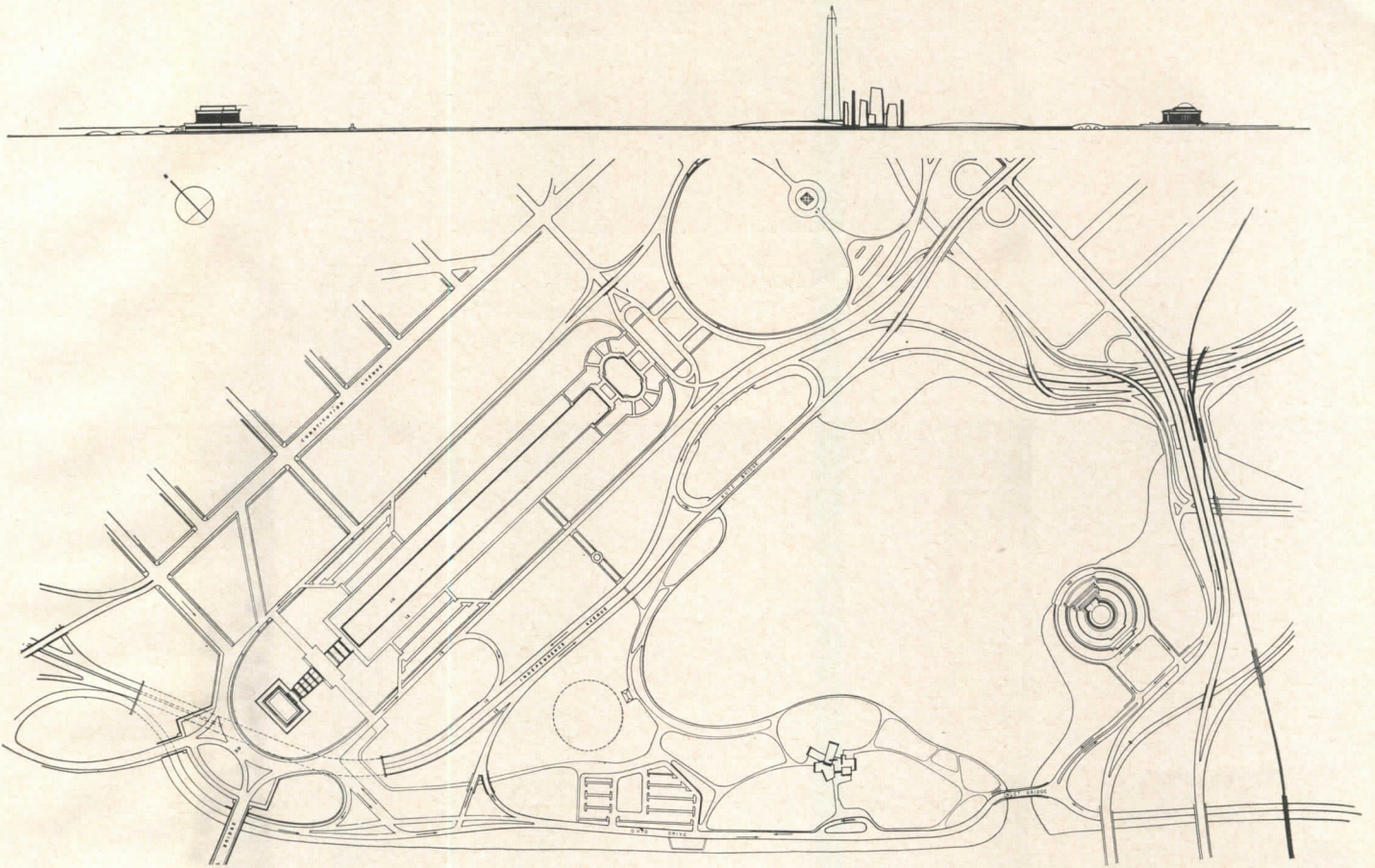

## Pedersen and Tilney Win FDR Memorial Competition

One of the largest, richest and most talked-about architectural competitions in history ended December 30 in Washington, D.C., with the selection from six finalists of the design shown on these pages as the winner of the Franklin Delano Roosevelt Memorial Competition. Designs of the other five finalists are shown on the following two pages.

Winners of the \$50,000 first award are the team of William F. Pedersen

and Bradford S. Tilney, architects; Norman Hoberman, sculptor; Joseph Wasserman and David Beer, associates; and Ammann and Whitney, structural engineers.

The winning design, praised by the professional jury for "giving a clear image of Mr. Roosevelt's greatness" and for "the way its open character incorporates the natural beauty of the landscape," focuses on eight monumental tablets—the highest 165

ft—inscribed with excerpts from President Roosevelt's speeches and writings. Structure is reinforced concrete using special white marble aggregate, white fines and white portland cement. The vertical elements are of cellular construction, walls of the cells being from eight to 12 in. thick, except for the center stele, which is poured monolithically. Size and height of the steles, the designers

*continued on page 14*

*Louis Checkman*

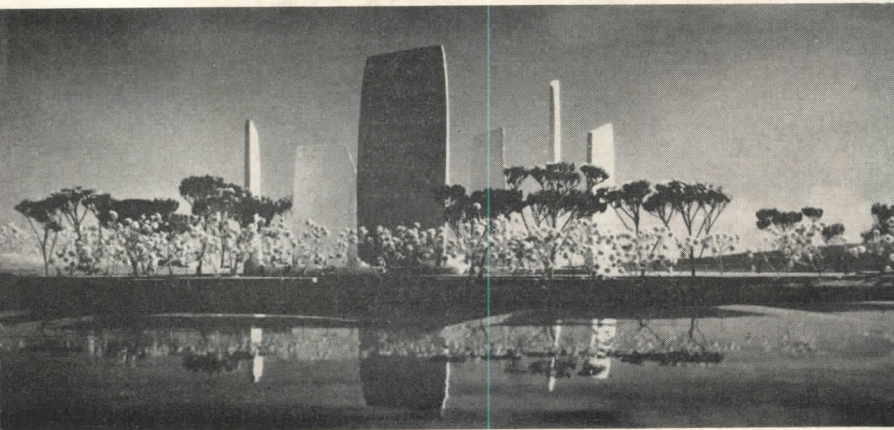

*James R. Dunlop, Inc.*

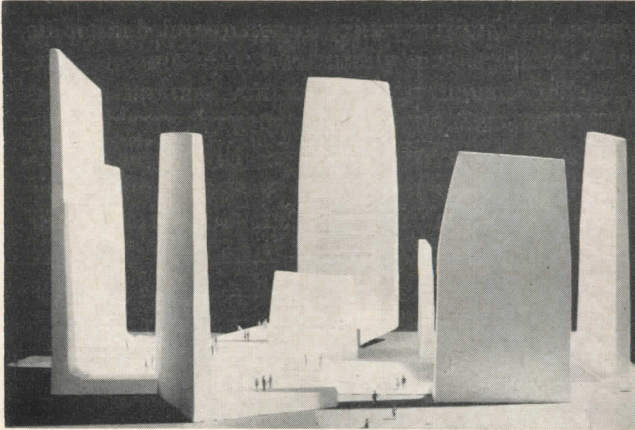



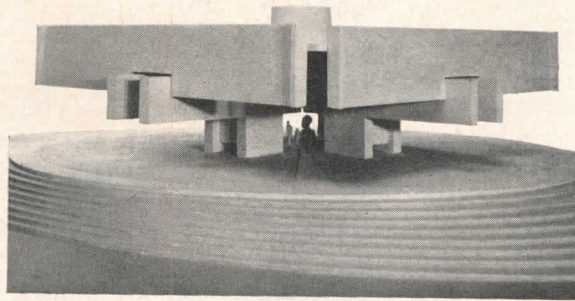

Architect Tasso Katselas of Pittsburgh and associates Troy West, Norman Erbrecht, Joel Kranich, Anthony DeChicchis, Alfred Belle, Richard Palmer, and Zoran Jovanovic, with Gensert, Williams and Associates, structural engineers: "Design attempt is to effect through a progression of space ultimate union of the essential spirit of Roosevelt with man"

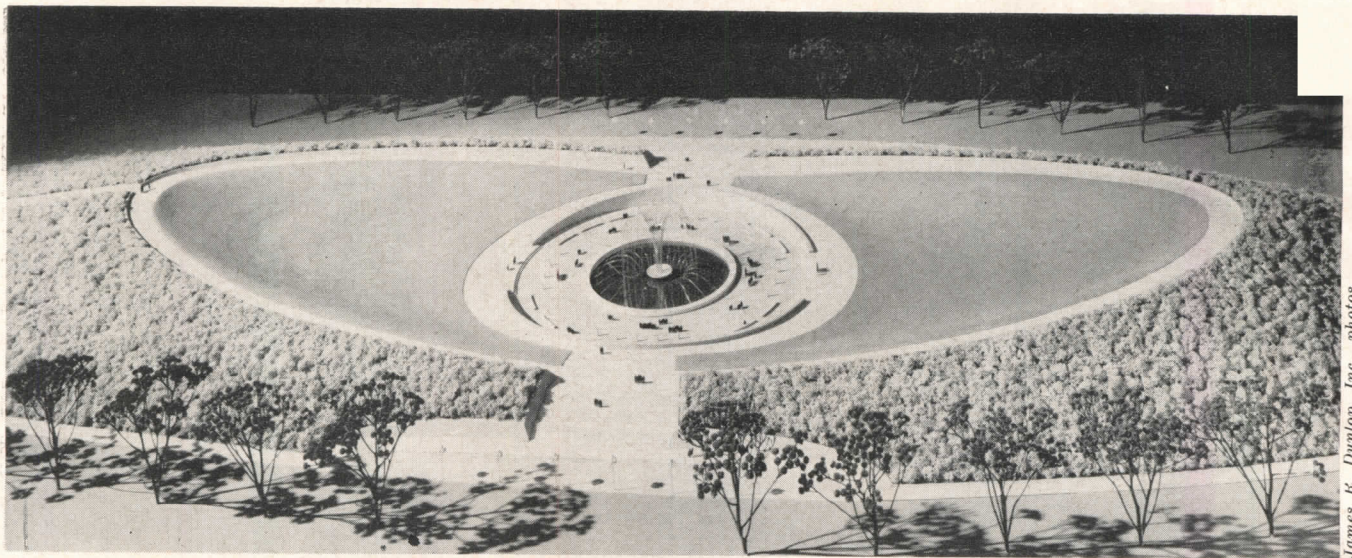

James K. Dunlop, Inc., photos

Sasaki, Walker & Associates (Landscape Architects and Planners, Watertown, Mass.) —Luders & Associates, (Architects and Planners, Irvington-on-Hudson, N.Y.); Svend Bruun (lighting) and T. Lewis Buser (structural), consultants: "This scheme attempts to consider the site as a whole, and to find its genesis in it. . . . The fountain itself is only a part of the memorial. It portrays the essence of FDR: his ability to receive inspiration from many sources, and to give generously in return. . . . This design attempts to work within the means of the expressive art of today, architecture of the environment"

## FDR MEMORIAL COMPETITION

explained, were determined by "our desire to have them relate in size and scale to the Jefferson and Lincoln Memorials. We wished them to be seen in the landscape above the trees, but did not want them to be so high as to compete with the one dominant vertical form in the landscape, the Washington Monument" [555 ft].

A jury headed by Dean Pietro Beluschi of the School of Architecture and Planning, Massachusetts Institute of Technology, selected the winner as it had, last September, selected the finalists from among 574 en-

tries from all parts of the country. Other members of the jury were: Thomas D. Church, landscape architect, San Francisco; Bartlett Hayes Jr., director of the Addison Gallery of American Art, Phillips Academy, Andover, Mass.; Joseph Hudnut, professor of architecture emeritus, Harvard University; and Paul Rudolph, chairman of the Department of Architecture at Yale. Professional adviser was Edmund M. Bacon, executive director of the Philadelphia City Planning Commission. Francis Biddle is chairman of the Franklin Delano Roose-

velt Memorial Commission.

The jury called the competition "an unqualified success" and felt it "served to discover new talent and to encourage architects to discover enduring monumental qualities in an age expressed in more commercial pursuits."

Total cost of the winning design is estimated at \$4,254,366. Funds for the memorial are still to be raised from both public and private sources, and the design must be approved by the Franklin D. Roosevelt Memorial Commission, the Fine Arts Commis-



Rolf Myller Group—Rolf Myller, New York, Architect, with consultants Lev Zetlin (structural), Robert S. Malkin (landscaping), Ian Grad Associates (mechanical), David Chapin (artist-painter) and Leslie Larson (lighting); Henry Szwarcze, job captain; Rolf Myller, sculptor; Luis Sanguino, alternate sculptor: This design proposes a monumental statue of Roosevelt at the center of the great interior space created by the structure

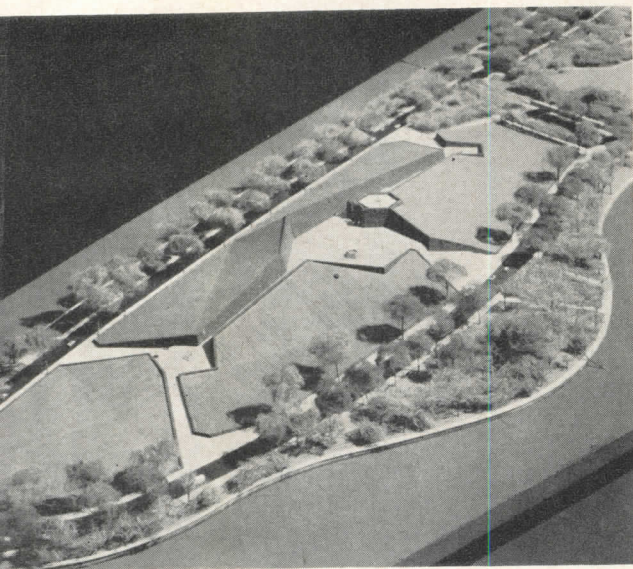
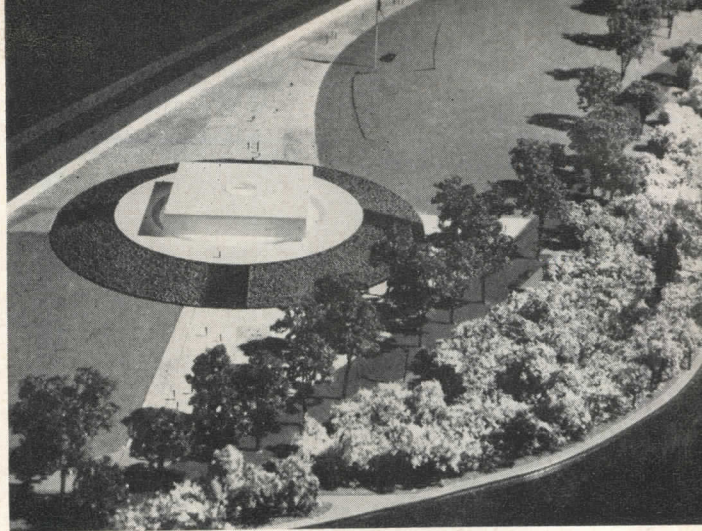

Wehrer-Borkin Group—Joseph J. Wehrer and Harold Borkin of Ann Arbor, Mich., architects; William Johnson, landscape architect, and Thomas McClure, sculptor, associates: "The memorial . . . is conceived on two levels: the institution of the Franklin Delano Roosevelt Award and the physical setting and permanent record of the award in West Potomac Park. The prize each year restates the essential quality of excellence in Roosevelt and brings to the attention of the world our constant concern with human achievement. The monument itself is a physical expression of this concern for high performance and attempts to directly communicate the sense of drama in high achievement." A podium is the central focus of a "Presentation Court" raised 18 ft above the level of the roadway

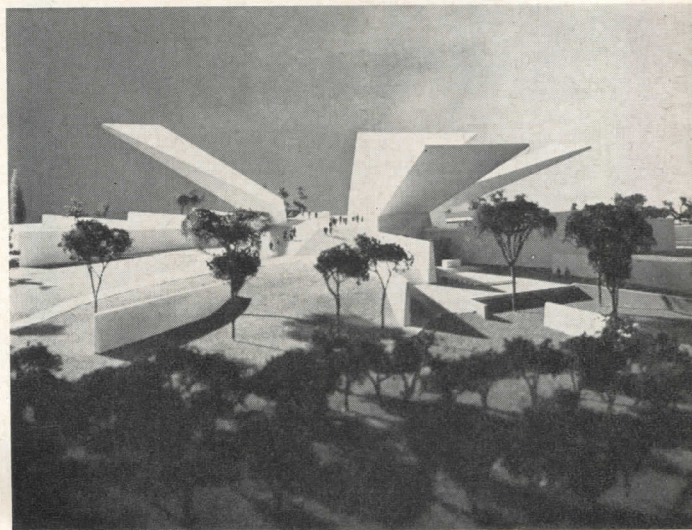

Abraham W. Geller Group—Abraham W. Geller, New York, architect, associated with Douglas Gordon, Diana Kirsch, Claude Samton and Peter Samton; Richard Haag, landscape architect associate; Salvadori and Weidlinger, structural engineer consultants; Joel Rubin, lighting engineer consultant; Bolt, Beranek and Newman, acoustical engineer consultants; and George A. Fuller Co, cost estimating consultants: Four cantilevered roof wings springing from concrete buttresses shelter four "courts" each dedicated to one of Roosevelt's Four Freedoms. A 15-ft bronze statue of Roosevelt on a 4-ft granite pedestal would face the Memorial

sion, the National Park Service and the Congress.

Site for the proposed memorial (see page 13) is a 66-acre portion of Washington's West Potomac Park between Independence Avenue and the Inlet Bridge. The competition program invited any kind of solution appropriate to the purpose of honoring Roosevelt, provided it was in harmony as to location, design and land use with the Washington Monument, the Jefferson Memorial and the Lincoln Memorial.

*continued on page 44*



Professional adviser Edmund Bacon (far right) and (from left) Jurors Hudnut, Church, Hayes, Belluschi and Rudolph



for  
approximately



By doubling the thermal efficiency of most masonry walls. Zonolite Masonry Fill Insulation saves money and increases comfort.

This new insulation often pays for itself while a building is in the planning stages. Because of its high efficiency, smaller, less costly heating and air conditioning units frequently can be used. Savings on this equipment pays the low cost of Zonolite water-repellent Masonry Fill Insulation.

The approximate installed costs per sq. ft. of insulating walls of different sizes are:

10¢ for 6" concrete block or 10" brick cavity walls

13¢ for 8" concrete block walls

21¢ for 12" concrete block walls

Savings in operating costs were demonstrated in a study of a standard U.S. Corps of Engineers Army Barracks Building, conducted for the Vermiculite Institute by J. N. Pease

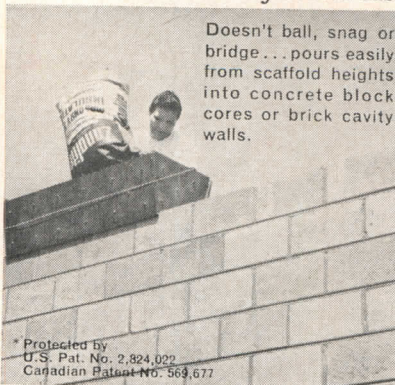

Doesn't ball, snag or bridge... pours easily from scaffold heights into concrete block cores or brick cavity walls.

\* Protected By  
U.S. Pat. No. 2,824,022  
Canadian Patent No. 569,677

& Co., architectural and engineering firm of Charlotte, N.C.

It showed that by insulating the walls of a two-story concrete block barracks, an \$800 saving could be realized in the cost of the heating plant, thus paying more than half of the cost of the Zonolite Masonry Fill Insulation.

If the building were air-conditioned, the total cost of the insulation would be recovered before the building was occupied.

This unique insulation offers other benefits as important as its economy:

**COMFORT:** Interior wall temperatures are brought closer to skin temperatures. Radiant heat exchange is reduced about 30%,



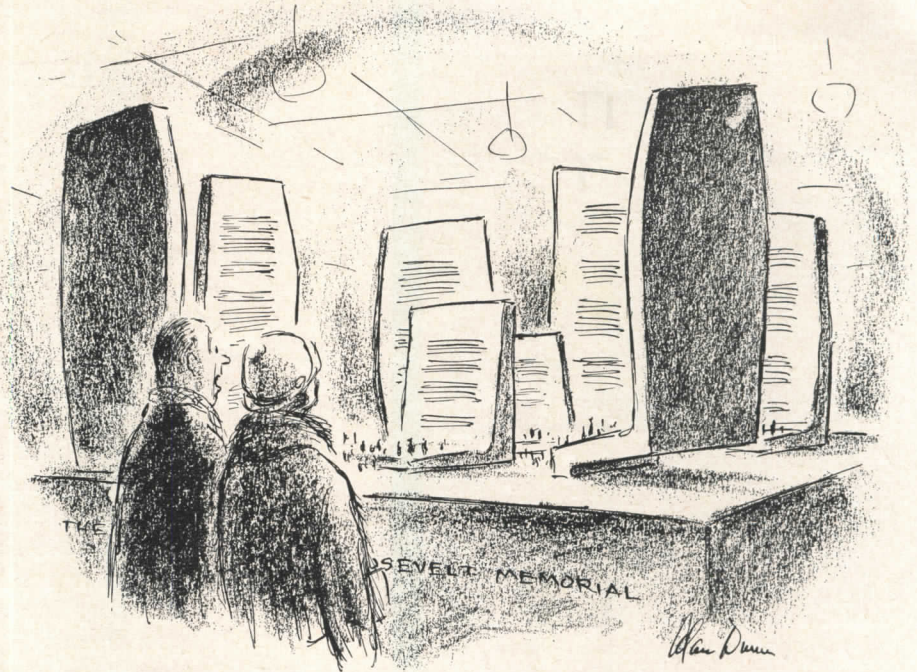

—Drawn for the Record by Alan Dunn  
 “Well, what do you know—the open plan!”

**Le Corbusier Named to Get 1961 A.I.A. Gold Medal**

The 1961 Gold Medal of the American Institute of Architects, highest honor in the gift of the profession, will be presented to Charles Edouard Jeanneret, Le Corbusier, who is expected to accept it in person at the annual dinner of the A.I.A. April 27 in Philadelphia. The award, which went last year to Ludwig Mies van der Rohe and the preceding year to Prof. Walter Gropius, is given “in recognition of most distinguished service to the profession of architecture or to the Institute.”

Other major awards to be presented at the Institute’s Philadelphia convention, announced last month following the annual meeting of the A.I.A. Board of Directors in Washington, are as follows: Fine Arts Medal, for “achievement in the fine arts related to architecture,” to sculptor Alexander Calder; Architectural Photography Medal, to Ezra Stoller; Industrial Arts Medal, for “design for and execution by the machine,” to Florence Knoll; Allied Professions Medal, for “achievement in the fine arts related to architecture,” to Annie Albers.

Honorary memberships, announced earlier, will be awarded at Philadelphia to six non-architects for “distinguished service either to the profession or to allied arts and sciences”—Mrs. Helen Duprey Bullock, historian, National Trust for Historic Preservation; Douglas Whitlock,

chairman of the board and general counsel, Structural Clay Products Institute; Walter D. Cocking, educational consultant, *Overview*; John T. Carr Lowe, attorney; Dr. George Bishop Tatum, School of Fine Arts, University of Pennsylvania; and Grady Clay, executive editor, *Landscape Architecture*, and real estate and building editor of the *Louisville Courier-Journal*.

Program details for the convention, to be held April 24-28 in Philadelphia, with headquarters at the Bellevue-Stratford Hotel, are nearly complete. Theme of the professional program will be “Redesigning Urban America” and the scheduled keynote speaker is John Kenneth Galbraith, Harvard economist and author of “The Affluent Society” and “The Liberal Hour.” Mr. Galbraith will discuss the economic imperative for urban revitalization.

In the second session of the professional program, Lewis Mumford, a leading American philosopher and critic, and Bruno Zevi, architectural historian of the University of Rome and editor of the Italian architectural journal *L’Architettura* will consider esthetic, cultural and sociological aspects of the city.

Edmund Bacon, executive director of the Philadelphia Planning Commission, will hold a comprehensive presentation “Redesigning Downtown Philadelphia” at the third and final session of the professional program. Joining him will be Willo von Moltke, Roy Larson, F.A.I.A., Oskar

Stonorov, F.A.I.A., Vincent Kling, F.A.I.A., Robert Geddes and I. M. Pei, all architects who have had a part in the development.

The Gold Medal will be presented at the annual dinner on Thursday night of convention week; other medals and awards will be presented at an awards luncheon (a function which has been returned to the convention program after a two-year lapse). Business sessions, which will have to consider a proposed dues increase and a revised plan for a new organization structure for the Institute among other matters, will be held each afternoon of the convention.

As in other years there will be a President’s Reception, the traditional ceremonial of investiture of new Fellows of the Institute and a selective exhibition of building products co-sponsored by the Institute and the Producers’ Council. A special feature of the program will be a concert by the Philadelphia Symphony.

Beryl Price is chairman of the Philadelphia A.I.A. host chapter committee, assisted by Paul C. Harbeson, Harry W. Peschel, Charles E. Peterson and Herbert H. Swinburne. Subcommittee chairmen are: Alfred Clauss, William W. Eshbach, Joseph T. Fraser Jr., John F. Harbeson, Hermann A. Hassinger, Vincent G. Kling, Roy F. Larson, Benjamin S. Linfoot, Michael P. Marcelli, Richard W. Mecaskey, George W. Qualls, Herbert H. Swinburne, Mrs. Arthur B. White, Arthur B. White, and Theo Ballou White.

continued on page 48



## NEW GLIMPSE OF GLORY?

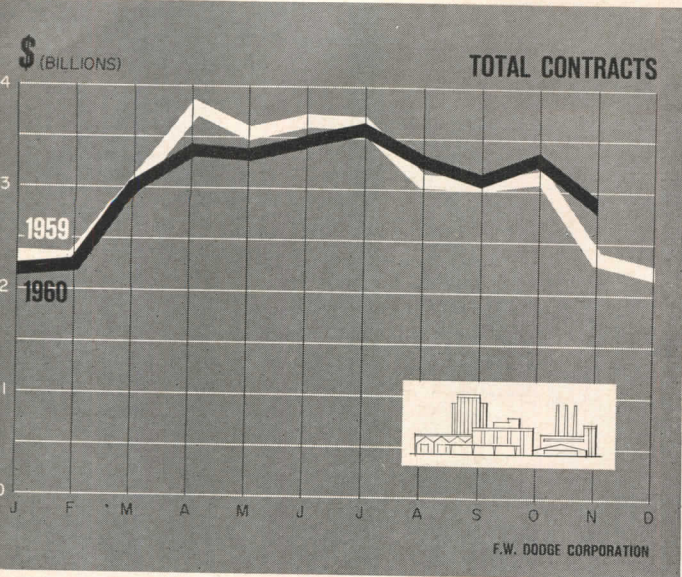

Total contracts include residential, nonresidential, heavy engineering contracts

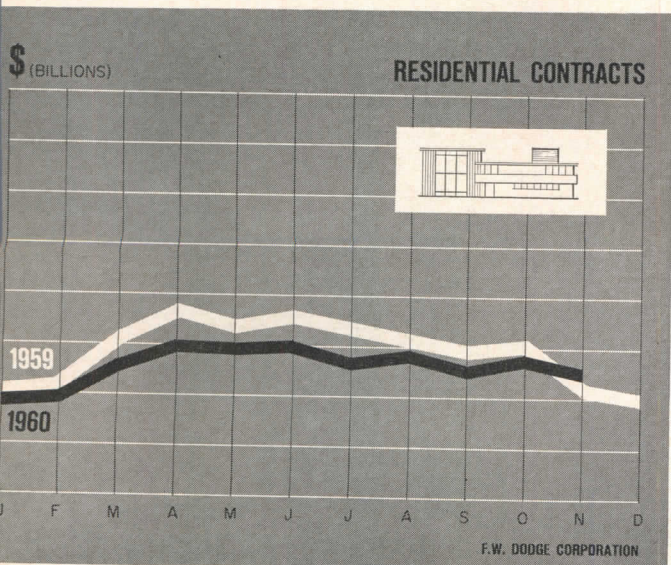
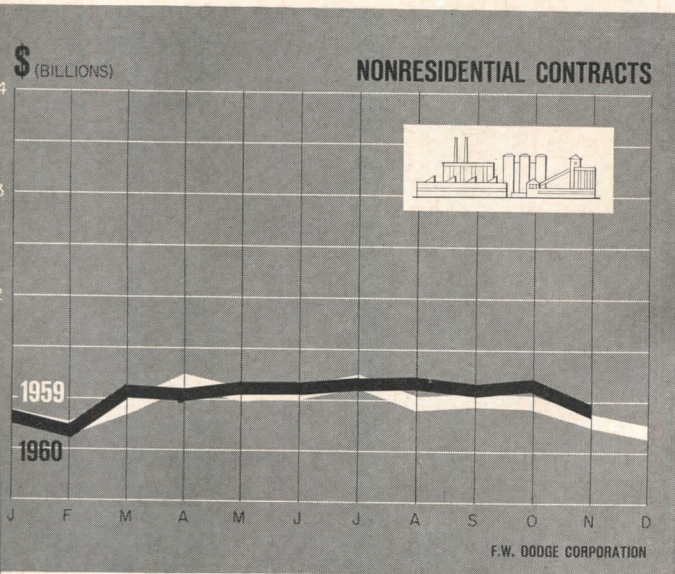

WHILE FINAL figures for the year are not available at this writing, it appears that construction wound up 1960 in a surprising burst of glory. Contracts in November, as reported by F. W. Dodge Corporation, set an all-time record for any November, and the seasonally adjusted index of total contracts stood at 280, a relatively high figure. Preliminary tabulations for December indicated a similarly good performance, and the year as a whole wound up very close to the record level of 1959. The large volume of contracts guarantees a high level of construction activity for months to come. Since, as we have often pointed out, construction is by far the largest fabricating industry in the nation, accounting for about 11 per cent of our total national output, this should go a long way toward moderating the current recessionary tendencies of business in general.

OUTSTANDING in the 1960 record is the performance of the heavy engineering category of construction. Streets, highways and bridges were primarily responsible for sharp gains in heavy engineering contracts. Among the major nonresidential building types, office buildings racked up a phenomenal record, with office building contracts at the end of eleven months exceeding any previous full year. The most interesting feature of this office building boom is that it tended to spread across the whole country in 1960, without the pronounced concentration of activity on Manhattan Island that has characterized earlier years. Nonetheless, the biggest new office projects of 1960 were still in Manhattan.

AMONG OTHER nonresidential building types, contracts for schools also made an excellent showing, far above 1959. Manufacturing buildings also did well in 1960, but with some tendency to slide off toward the end of the year. Jails and penitentiaries had quite a boom in 1960. Other types of nonresidential building, including hospitals, religious buildings, and stores, tended to decline moderately.

BUT HOUSING was the only really bad actor among the principal categories of construction, and even here, it was only the one- and two-family houses that declined. In dollar terms, the one- and two-family houses fell off about 16 per cent (in 11 months), and in terms of dwelling units, the drop was slightly greater. Apartments, on the other hand, had their best year ever, with contracts well above the \$2 billion mark for the first time. As a result, apartments accounted for more than 20 per cent of all the dwelling units put under contract, the highest proportion they have reached in the postwar period.

GEORGE CLINE SMITH  
Vice president and chief economist  
F. W. Dodge Corporation





**Easiest way to bend a ceiling (or wall) to your will** is to build with plaster on metal lath. Its plasticity transcends the rigid limitations imposed by less flexible wall and ceiling materials. You enjoy a free hand in design. And you avail yourself of the beauty of plaster construction — of its light weight, fast erection, and fire ratings up to four hours. The complete line of Milcor metal lath and accessories includes everything you need to specify. Refer to Sweet's, section 12a/In. Or write today for catalog 202.

*Milcor Metal Lath and Trim Products*

METAL LATH • CORNER BEADS • CASING BEADS • CHANNELS • STUDS • PARTITION SYSTEMS • ACCESS DOORS • WINDOW STOOLS • METAL BASES

**MILCOR**<sup>®</sup>

**Inland Steel Products Company** Member of the **INLAND** Steel Family

DEPT. G, 4033 W. BURNHAM ST., MILWAUKEE 1, WISCONSIN

BALTIMORE, BUFFALO, CHICAGO, CINCINNATI, CLEVELAND, DETROIT, KANSAS CITY, LOS ANGELES, MILWAUKEE, NEW ORLEANS, NEW YORK, ST. LOUIS

ML-49



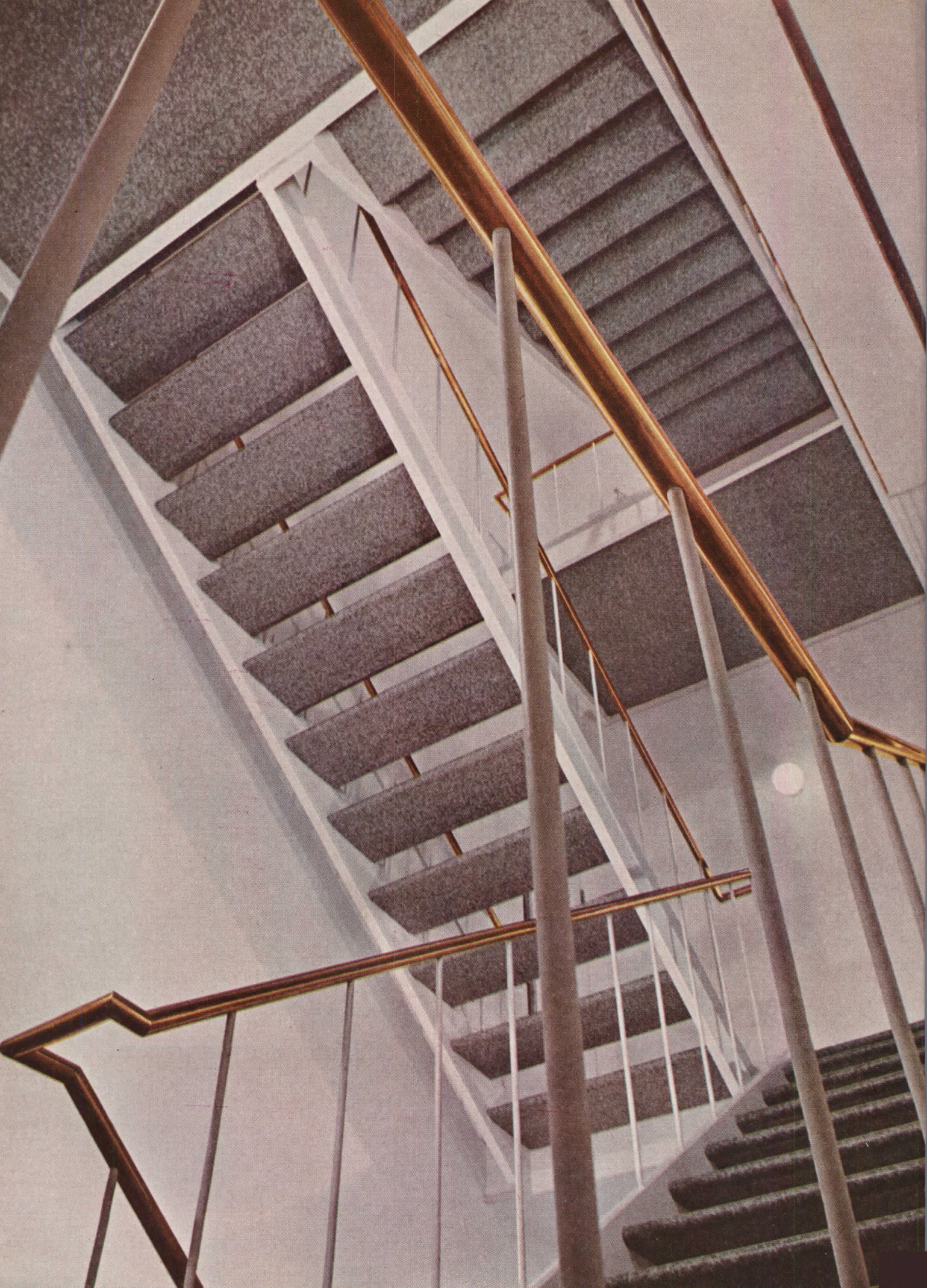



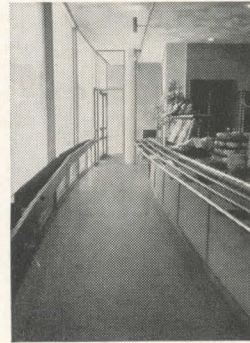

# A floor of Armstrong Tesser Corlon on and under a staircase at American Society for Metals

The picture at left shows a stairway in the new American Society for Metals building at Metals Park, Ohio—architect John Terence Kelly, A.I.A. Armstrong Tesser Corlon (Style 86532) is wrapped completely around the stair treads and is installed on the tops and undersides of the landings. This installation, which is as practical as it is dramatic, takes unusual advantage of the exceptional good looks, toughness, and flexibility of Tesser Corlon. Tesser's interesting random-chip design and functional versatility made it the logical choice for offices, hallways, cafeteria, and other areas throughout the building.

**TECHNICAL DATA ON TESSERA:** uses: heavy-duty commercial and de luxe residential interiors, above, on, or below grade; grease and alkali resistance: excellent; dimensions: .090" gauge in rolls 6 ft. wide and lengths up to 60 ft.; stylings: monochromatic and multicolor designs, 16 colors.

The Armstrong Architectural-Builder Consultant in your area can help you solve any flooring problems you encounter. He will make on-the-job recommendations and, if you desire, will get you the assistance of technical, design, and installation experts at Armstrong. Call him at your Armstrong District Office. Or write Armstrong, 1602 Rock Street, Lancaster, Pennsylvania.



ARMSTRONG FLOORS—APPROXIMATE PRICE PER SQUARE FT. INSTALLED OVER CONCRETE FOR A MINIMUM AREA OF 1000 SQ. FT.

20¢ - 25¢  
Asphalt Tile 1/8"  
Linoleum Tile .0625"

35¢ - 50¢  
Asphalt Tile 3/16"  
Greaseproof 1/8"  
C and D colors 1/8"  
Excelon (vinyl-asbestos)  
Tile 1/16" and 3/32"  
Linoleum (tile and sheet)  
.090"  
Vinyl Corlon (sheet) .065"

55¢ - 70¢  
Asphalt Tile  
Greaseproof 3/16"  
Excelon (vinyl-asbestos)  
Tile 1/8"  
Linoleum ("Battleship")  
.125"  
Vinyl Corlon (sheet)  
.070"

75¢ - 95¢  
Cork Tile 1/8"  
and 3/16"  
Linoleum,  
special plain  
colors, .125"  
Rubber Tile 1/8"  
Vinyl Corlon (sheet)  
.070" and .090"  
Linotile 1/8"  
Custom Corlon  
(vinyl) Tile 3/32"

\$1.00 and over  
Cork Tile 5/16"  
Vinyl Corlon (sheet)—  
Palatial Series .070"  
Custom Corlon  
(vinyl) Tile  
3/32" and 1/8"  
Custom Vinyl Cork  
Tile 1/8"



# HOW "CONCRETOR" CLIMBING-CRANES REVERSE RISING CONSTRUCTION COSTS

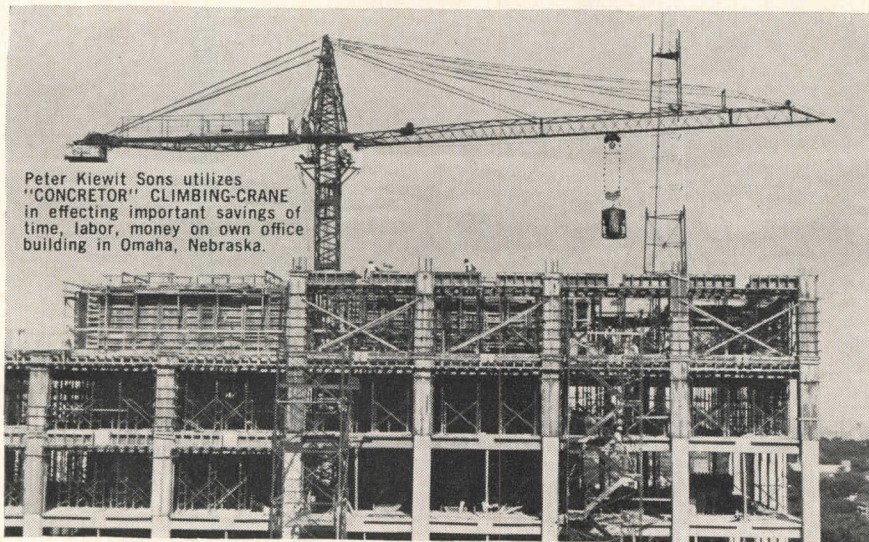

Peter Kiewit Sons utilizes "CONCRETOR" CLIMBING-CRANE in effecting important savings of time, labor, money on own office building in Omaha, Nebraska.

The "CONCRETOR" CLIMBING-CRANE goes up with the building while work is in progress... 2-3 floors at a time... the sky's the limit. Climbs by its own hoisting winch on floors or inside elevator shafts.

"CONCRETOR" CLIMBING-CRANES quickly and efficiently place loads "on a dime"... up to 100 foot radius due to the 360 degree swing of its 100 foot jib. They eliminate the need for street access and expensive rehandling of materials over unnecessary ramps and runways, thus substantially lowering operating costs... while also serving to keep community relations on a pleasant, friendly level.

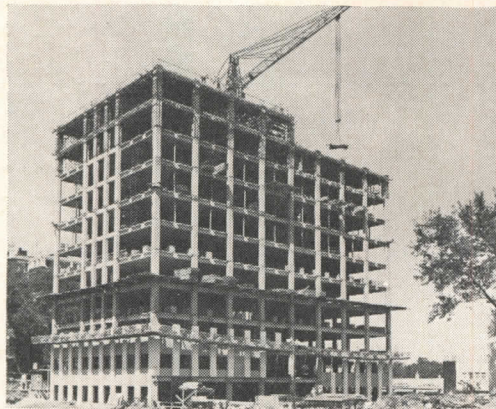

Scandinavian "CONCRETOR" CLIMBING-CRANES are recommended for all types of construction including industrial, apartment and office buildings, silos, water towers, bridges and viaducts. Perfect when slipped with "CONCRETOR" hydraulic slipform equipment



Crane is remote-controlled by one man from working deck with 3 1/2 lb. electronic panel. He is free to move to any part of the job, and to assist in loading and unloading.

**LOWER CAPITAL INVESTMENT!** "CONCRETOR" CLIMBING-CRANES cost about half of what you'd expect to pay for earth-bound cranes of similar capacity. Experience has shown that with ordinary use, the cost of a "CONCRETOR" CLIMBING-CRANE can be amortized over a period of about 2 years. CHOICE OF 4 MODELS — RENTAL/PURCHASE PLANS. Delivered anywhere in U. S. Factory-trained service engineers available.

Versatile combined climbing and traveling crane. Can be used on rails or in a fixed position.

## B. M. HEEDE, INC.

30-01 37th Ave., Long Island City 1, N. Y.

B. M. HEEDE CALIFORNIA, INC.,  
630 Sixth Street, San Francisco 3, Cal.

DISTRIBUTOR FRANCHISES AVAILABLE in a few selected territories. Write Dept. AR-2 for details.

### MAIL COUPON FOR LOW COST DETAILS AND FREE LITERATURE

B. M. Heede, Inc. 30-01 37 Ave., L. I. C. 1, N. Y.

Send me "CONCRETOR" CLIMBING-CRANE AR-2 literature and price list.

I am interested in  Buying  Rental-Purchase

Company.....

Address.....

Town..... Zone..... State.....

My Name..... Title.....

## FDR Competition

continued from page 15

The winning design, the other five finalists and the 22 Honorable Mentions are on exhibit at the Corcoran Gallery in Washington through February 19, and it is hoped it will circulate thereafter.

The full text of the jury report follows:

"In the opinion of the jury the competition was an unqualified success. The great number of worthwhile entries and the general interest of architects and designers are testimony of the admiration in which Franklin Delano Roosevelt is held by the American people.

"The competition proved to be a mirror of our present-day culture; and served to discover new talent and to encourage architects to discover enduring monumental qualities in an age engrossed in more commercial pursuits.

"The jury feels that the winning entry has met the basic requirement of the competition by giving a clear image of Mr. Roosevelt's greatness through carefully chosen excerpts from his writings over the period of his Presidency. His humanity, his charity and concern for all people emerge with great force.

"The monumental quality of the project comes from the simplicity with which this idea is transmitted. Although the basic form is so elemental as to be virtually the outgrowth of tradition, the vast concrete planes emphasize the intervening spaces as positive entities, thereby providing a total image which is firmly identified with the 20th Century.

"As one moves onto the various levels of the platform the views change and new spaces acquire significance. As a monument it satisfies the visitor's desire to apprehend the whole from many approaches and is visible, but without massiveness, from the distance. Among its many virtues is the way its open character incorporates the natural beauty of the landscape, including altering views of the Potomac River and the Tidal Basin, in which the bright shafts are reflected. Added to this the shifting play of light and shadow as the sun traverses the sky animates the structure and imparts a sense of living reality to enhance its spiritual meaning."





## LOOK TO THE FUTURE WITH ROYAL

**NEW CHALET room furniture is your client's best investment.** The furniture with the built-in future, Chalet is the latest of Royal's complete lines for hospitals and nursing homes. So durable, it's guaranteed for 10 years; so economical, it pays to buy now. Sturdy O-frame construction assures rigid durability and maintenance-free service.

Cases are sound-deadened and sealed against dust. Stainless steel drawer pulls are fully recessed. There are no screws to loosen or come out on pulls—or on backs and side panels. Exterior frame in Satin Chrome or Plastelle enamel, interchangeable tops, legs, panels and drawer fronts all assure you of carefree beauty that will last.

Chalet's Four-Drawer Dresser Desk makes the most of room space with good looks and strength to spare. Self-edge Royaloid top defies damage and wear. Write for full information. ROYAL METAL MANUFACTURING COMPANY, Dept. 8-B, One Park Avenue, New York 16, N. Y. In Canada—Galt, Ontario. SHOW-ROOMS: New York, Chicago, Los Angeles, San Francisco, Seattle; Galt, Ontario.

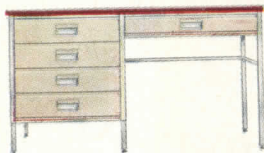

**Royal**<sup>®</sup>  
HOSPITAL FURNITURE



# Meetings and Miscellany

continued from page 19

## A.S.L.A. Officers Elected

New president of the American Society of Landscape Architects is John I. Rogers, F.A.S.L.A. Chief of Planning and Construction, Michigan State Department of Conservation in Lansing, Mr. Rogers succeeds Professor Norman T. Newton of Harvard next July at the Society's 62nd annual meeting in Boulder, Colo.

Other officers elected were: John

Ormsbee Simonds, Pittsburgh, vice president; Merel S. Sager, Washington, D. C., secretary; and George A. Yarwood, Simsbury, Conn., treas.

## Scholarship Opportunities

The 72nd winner of the ROTCH TRAVELLING SCHOLARSHIP, carrying this year a stipend of \$4500, will be selected in April. Applicants must be American citizens, under 31 years of

age on March 15, 1961, whose architectural background includes study or experience in Massachusetts. For details write William G. Perry, Rotch Travelling Scholarship, 955 Park Sq. Building, Boston 16 before March 1. Applications are due March 20.

Several fellowships and scholarships are open for graduate studies in Landscape Architecture at the UNIVERSITY OF PENNSYLVANIA. Write Ian L. McHarg, Chairman, Dept. of Landscape Architecture, Univ. of Pennsylvania, Philadelphia 4. Closing date for applications is March 1.

## San Francisco Announces New Design Competition

An architectural competition for design of the 22-acre multi-family section of San Francisco's Diamond Heights redevelopment area is being announced by the City's Redevelopment Agency. The competition is to be held in two stages. The hilly terrain of Red Rocky Hill, on whose crest and upper slope some 600 apartments will be built, offers unusual, if difficult, design opportunities. Professional adviser is William J. Watson of the firm of Rockrise and Watson, Architects, San Francisco. Entrants, who must be registered architects, can obtain the Architectural Program Statement, Diamond Heights, Red Rock Hill Competition by writing the San Francisco Redevelopment Agency, 525 Golden Gate Avenue, San Francisco 22.

## N.Y. Zoning Amendment Adopted

In December the New York City Board of Estimate unanimously adopted the Comprehensive Amendment of the Zoning Resolution. The first thorough revision of the city's zoning ordinance since its adoption in 1916, it will go into effect on Dec. 15, 1961.

The original resolution (see AR 4/59, p. 32) has undergone a few changes, among them liberalization of plaza and arcade bonuses and increase of ratio of floor area space to plaza and arcade space with smaller plazas and arcades qualifying for bonus provisions.

The zoning resolution has been followed and supported at every step by the New York Chapter of the American Institute of Architects.

more news on page 254

# Planning a laundry for a

**HOSPITAL?**

**HOTEL?**

**COMMERCIAL LAUNDRY?**

**MOTEL?**

**INDUSTRY?**

**SCHOOL?**

**INSTITUTION?**

## Then here's time-saving help

TROY offers you *complete laundry planning service* to help you design the most efficient laundry in the *least* floor space for your client. TROY will prepare floor plans and specifications to your instructions. Or send for complimentary 100-page data book containing machine dimensions, suggested floor plans and other helpful information printed on separate, loose-leaf pages. Just attach coupon below to your business letterhead.



**Troy**<sup>®</sup>

TROY LAUNDRY MACHINERY DIVISION OF  
American Machine and Metals, Inc.  
EAST MOLINE, ILLINOIS

### TROY LAUNDRY MACHINERY

Division of American Machine and Metals, Inc.  
Dept. AR-261, EAST MOLINE, ILLINOIS

- Please send me the name of the nearest TROY representative.  
 Please send me architect's data sheets.  
 Or both.

NAME & TITLE \_\_\_\_\_

FIRM \_\_\_\_\_

ADDRESS \_\_\_\_\_

CITY & ZONE \_\_\_\_\_

STATE \_\_\_\_\_



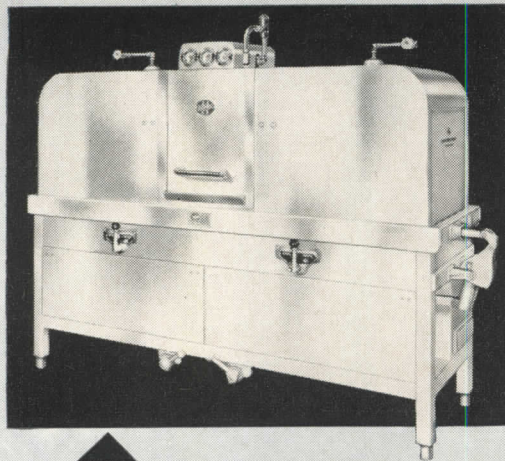

**Model XXM-4** Completely automatic, with dual-drive that speeds racks in and out—provides extra wash time without loss of speed or capacity. Automatic control of water and separation of power-wash and power-rinse streams mean cleaner dishes faster. Pumps designed with new-type packless seals and other advanced Hobart features contribute to all-around superior performance.

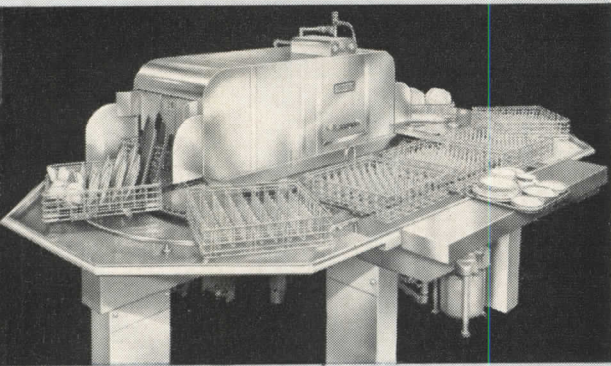

**Rack-O-Matic** Increased capacity to meet space and operational limitations. Dishes, in multi-purpose racks, travel the Hobart "sanitizing circle"—a completely automatic circuit through recirculating power water scrapper, jet-powered wash and rinse, and final sanitizing rinse action. One operator handles racks. Rack-O-Matic models take as little as 12' x 6'.

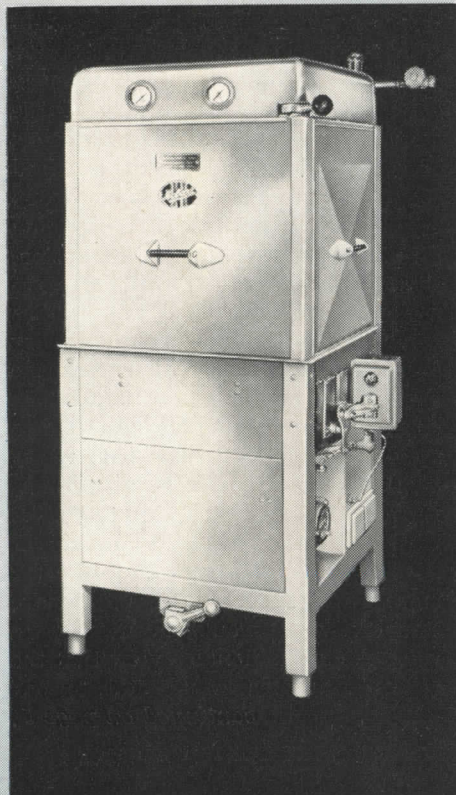

**AM Series** Will wash a stack of dishes six stories high every hour, in just four square feet. Tailor-fit them for straight-wall or corner operation. Exclusive high-speed Hobart revolving wash action and all-angle, above-and-below rinse. Electric-controlled (timed) wash and rinse, plus other optional features, reduce operator supervision.

**FT-13** Another Hobart first! The speed and efficiency of a big-capacity, flight-type dishwasher in a "compact" design. Model FT-13 power-scrapes, power-washes, power-rinses and final rinses... handles up to 900 persons per meal in just 13 feet. New exclusive "Delrin" acetal resin flight links standard... stainless steel links optional.



# It's the ULTIMATE COST that counts in a dishwasher!

The true cost (or rather savings) of a Hobart dishwasher won't be measured till long after the sale. That's when Hobart quality proves it's more than a surface thing... when the reputation for long-life, trouble-free performance comes to life and pays dividends in continuing low-cost operation. The low cost of Hobart quality—as we call it—let's you specify Hobart with full confidence.

**Complete line**—One of the more than 50 dishwasher models in Hobart's complete line is right for every type and size of operation. There are complete lines of other kitchen machines, too, you should know about. Send for literature and /or name of your nearest dealer. Write The Hobart Manufacturing Company, Dept. HAR, Troy, Ohio.

## NATIONWIDE SERVICE TO ARCHITECTS

Your nearby Hobart representative, a member of the largest field organization in the business, will gladly help you in creating efficient plans and in writing specifications for school, institutional and commercial kitchens.

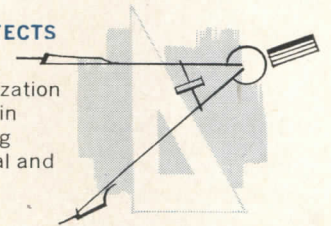

Nationwide Factory-Trained Sales and Service...over 200 offices

# Hobart machines



A Complete Line by the World's Oldest and Largest Manufacturer of Kitchen, Food, Bakery and Dishwashing Machines



# Required Reading

Top: door handle in form of pine needles  
Bottom: exteriors of Katsura Palace  
—from *Katsura*

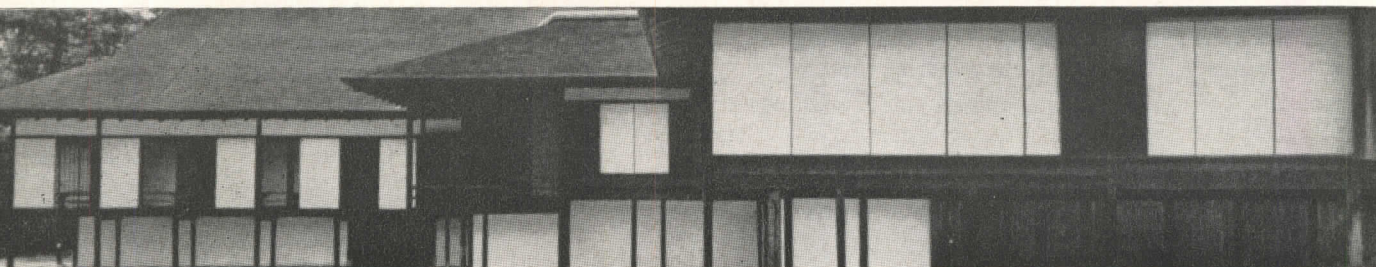
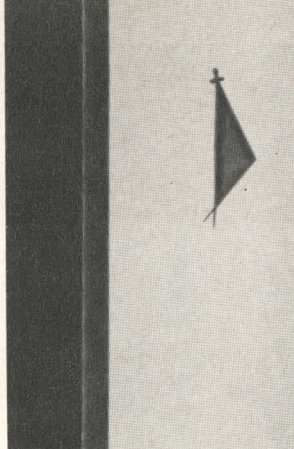

## A Japanese Palace

*KATSURA: Tradition and Creation in Japanese Architecture.* By Kenzo Tange and Yasuhiro Ishimoto; intro. by Walter Gropius; designed by Herbert Bayer. Yale University Press, New Haven, Conn. Approx. 150 pp., illus. \$15.

The Katsura Detached Palace and its integral gardens comprise one of the most justly famous combinations of architecture and landscape that are to be found anywhere in the world. Now and for the first time a thoroughly distinguished book offers a vicarious opportunity of substantial understanding for those who cannot visit Kyoto, and a magnificent souvenir for those who have been able to.

It is appropriate that it should be mainly a book of photographs. Mr. Ishimoto has provided more than 150 sensitively conceived and brilliantly executed views, almost all of which are, happily, at the good full size that the opulent 10-by-11 page permits. The photographs range widely from air views that reveal the whole complex to close-ups of textures such as those of the bamboo fencing of the Imperial gate, the grain of the flooring of the old Shoin, the stepping stones along the shore, the door handles in the Shoiken. In between are verandahs and hearths, whole buildings, rooms, corners. Each section is

carefully related to handsome and clearly designed plans, sections and line drawings of elevations, all to scale. The reproductions are first class, so that the presentation is both thoroughly instructive and completely beautiful. Many readers who live with these photographs will know the Katsura better than most tourists who have visited there.

To this is added a short, equally sensitive, equally brilliant essay by Kenzo Tange on the problems of Tradition and Creation in Japanese Architecture. These 20,000 words offer an authentic and illuminating understanding both of Japanese architectural history and of the major tension between Yayoi and Jomon which has characterized this history and probably is still at work; and in addition just what is specifically needed about Katsura itself to supplement the photographs in enriching our understanding.

Herbert Bayer has wisely separated this text from the ensuing Ishimoto photographs, but illuminates it with a few other pictures of relevant Japanese art and architecture. The design of the book measures up to Tange's writing and Ishimoto's photographs, so that the ensemble is thoroughly distinguished.

Only the essay by Gropius is a disappointment. One always is expectant about the words of this great teacher. His words here are undoubt-

edly from the heart of a man who was much moved by his belated visit to Japan, but regrettably they really add nothing to an understanding of Katsura, of Zen, of Japanese art and culture, of the state of contemporary architecture, or even of Gropius himself. This is a pity, but it is not enough to mar such an otherwise admirable book.

Contemporary architects need more books of this quality and fewer pictures of the latest enterprise on Park Avenue or in Milan. They could offer valuable hints to perceptive young men who will do whatever is good about the architecture of the next quarter century. The patriarchs of the modern movement admired chastity, and Katsura is a marvelous example of chastity, just gay and flirtatious enough with corruption. But an architectural bill of fare needs Marguery sauce as well as strained consommé. Contemporary architects are trying to enrich the menu, but brutalism, structuralism and neo-Victorianism do not seem to satisfy. I hope we may have other books as good as Katsura, perhaps from India, perhaps from Persia, perhaps from Spain. But they might even come from Japan, from Ise for more purity, from Kasuga for more complexity; I would even dare to voice the unfashionable view that the Nikko Mausolea could add to our

*continued on page 56*



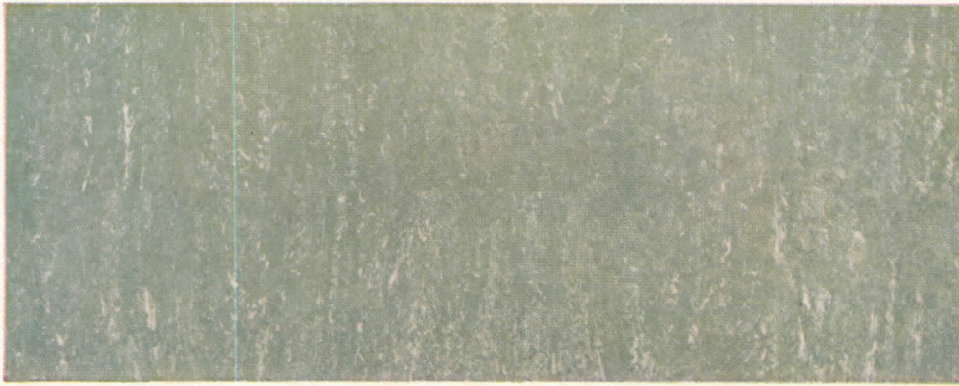

*Now, with new, lower prices...*

# Kentile Rubber Tile

## costs so little



Now you can specify Kentile® Rubber Floors for many more commercial and institutional installations. The cost? Close to Vinyl Asbestos and other floors . . . even less than Solid Vinyl Tile. Look at this comparison:

	<u>1/8" thick marbled</u>	<u>Approx. installed cost</u>
10,000 sq. ft. Rubber Tile .....	@ 47¢ sq. ft.	= \$4700
10,000 sq. ft. Vinyl Asbestos Tile.....	@ 41¢ sq. ft.	= \$4100
10,000 sq. ft. Solid Vinyl Tile.....	@ 61¢ sq. ft.	= \$6100

## Provides so many more advantages

- The most quiet and comfortable underfoot of all colored resilient tile. (Only cork tile exceeds rubber tile in these characteristics.)
- Can be used anywhere indoors . . . even over concrete in contact with the earth, on or below grade, with the use of special adhesive.
- Tight-fitting joints . . . that stay that way permanently.
- Easy to clean and maintain. After the first few months' use, Kentile Rubber

Floors are as economical to maintain as Vinyl Asbestos or Solid Vinyl floors.

- Excellent resistance to indentation. (See chart below.)

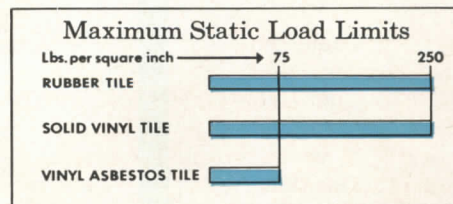

*Which tile for which installation?* Kentile Architectural Representatives offer expert advice to professionals. Since Kentile makes all leading types of resilient tile, counsel is unbiased. Call your nearest Kentile sales office.

# KENTILE FLOORS

58 Second Ave., Brooklyn 15, N.Y. • 350 Fifth Ave., New York 1, N.Y. • 55 Public Square, Cleveland 13, Ohio  
 3 Penn Center Plaza, Philadelphia 2, Penn. • 900 Peachtree St., N. E., Atlanta 9, Ga. • 106 West 14th St.,  
 Kansas City 5, Mo. • 4532 So. Kolin Ave., Chicago 32, Ill. • 2929 California St., Torrance, Calif.



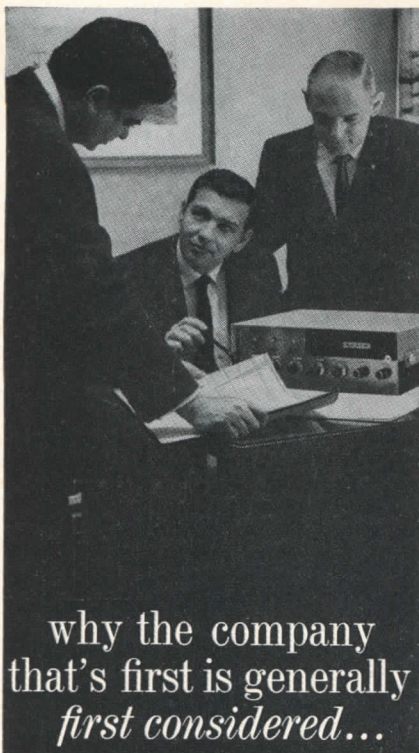

why the company  
that's first is generally  
*first considered...*

## BOGEN

### 1st in SOUND SYSTEMS for all INSTITUTIONS

- 1st in RELIABILITY

30 years of Engineering and Research devoted *exclusively* to sound development.

- 1st in CUSTOMER ACCEPTANCE & SALES

Over 1,000,000 systems in use today.

- 1st in APPLICATION

The world's broadest system and product line. A model for *any* application.

- 1st in QUALITY & STYLING

Industry's Standard of Comparison. Winner of the Milan Triennial Gold Medal.

That's why... Wherever Sound Decisions are made... **BOGEN** will be specified!



TIX Communophone Intercom



EC School Console



VP20 Transcription Player

## BOGEN-PRESTO

A DIVISION OF THE SIEGLER CORPORATION

Desk AR-2 — Paramus, N. J.



## Required Reading

*continued from page 54*

### A Japanese . . .

them "vulgar." To do such a thing well will need that men of quality care as much for it as Tange and Ishimoto cared for Katsura. Maybe such men do not exist. Meantime, we can be grateful for the present book and bestow it generously upon our cultivated friends.

—John E. Burchard

### Slides for Study

ARTS OF THE UNITED STATES. *A Pictorial Survey. Edited by William H. Pierson Jr. and Martha Davidson. McGraw-Hill Book Company, Inc., 330 W. 42nd St., New York 36. 452 pp., illus. \$9.95.*

In effect, this is not so much a pictorial survey as a catalog of a large color-slide collection assembled by the University of Georgia under a grant from the Carnegie Corporation of New York, and intended to be made available as teaching aids. New photographs were made specially for relatively inexpensive duplication.

Of a total 4156 slides—covering the fields of American architecture, decorative arts, costume, graphic arts, Indian art, painting, photography, sculpture, stage design and visual communication (posters, ads, cartoons, etc.)—1191 are concerned with architecture and city planning, from the 17th century to the present. In addition to the pictures, the book also contains introductory articles in the various categories—e.g., Hugh Morrison on "Architecture of the 17th and 18th Centuries," William H. Jordy on "Architecture of the Federal Period and the 19th Century," and Vincent Scully on "Architecture of the 20th Century." Equally knowledgeable authors have made contributions in the other fields.

The photographs and drawings reproduced here, because they are of necessity small and because they are half-tones made from color transparencies, are not really satisfactory as illustrations. But as reference the book will nonetheless be important, if not downright indispensable, to teachers, museum directors and other lecturers.

*more books on page 64*

other

## GLIDE-GRIDWALL architectural aluminum PRODUCTS

### glide SLIDING WINDOWS

Monumental stock and custom types. All sash operate and bypass for window cleaning from interior. Strength of section allows heights to 6'6". The leader in the field for weather-tight performance and beauty of sight lines.

### glide SLIDING DOORS

Monumental stock and custom types. Glazed with 3/8" to 1" thick glass. Double sill, flush with floor, leak-proof even in complex multiple track and wall pocket units. Stainless steel rollers and track. Transom units available as integral part of door framing. Screens may be used on interior or exterior as required.



### SLIDING DOORS

PANAVIEW stock door units employ the finest construction features of the GLIDE door series at competitive prices. Double weather-stripped, alumilited, and available in panels with single or 3/8" insulated glass.



### WINDOWS AND WINDOWALLS

The most economical window wall available. Infinite variety is achieved by mulling and stacking PANASEAL windows in any combination. Ideal for schools and commercial buildings. PANASEAL windows also available for residential use.



### ENTRANCES

Engineered for greater strength by integrating 1" narrow stiles with 1/2" plate glass, GRIDWALL offers the most appealing entrance door on the market. Cylinder lock, housed in push and pull plates of charcoal bronze finish, simultaneously throws a concealed bolt into threshold and head of door frame for maximum security. A complete line of mullion framing for flush glazing is available.

write for brochures and details  
GLIDE-GRIDWALL • 7463 Varna Avenue  
North Hollywood, California • TR. 7-3213



# Matico Polymerite™...A New Concept in Floor Tile

**\*GREASE RESISTANT... STAIN RESISTANT... FLAME  
RETARDANT... PRICED COMPETITIVELY WITH ASPHALT TILE!**

From an intensive program of research and development, Matico now proceeds to change all existing concepts of flooring with a tile that is years ahead of its time. Matico Polymerite Floor Tile has the characteristics of the finest floor tile—all at a remarkably low cost! Wears up to twice as long as asphalt tile too!

This astonishingly low-cost, easily-maintained tile resists grease and stain, and is flame-retardant. It has optimum flexibility, maximum uniformity, gauge control and appears in 32 vibrantly alive colors, every hue of which is under the most rigid technological control.

Now the sky is the limit on flooring specifications at astonishingly ground-level cost. Matico Polymerite Floor Tile finally opens the door to superlative flooring for every application. Be sure that you get the specifications on Matico's Polymerite Floor Tile right away. Your Matico representative can furnish them. Or, write today.



\*Matico Polymerite Tile conforms to Fed. Spec. SS-T-306b for Asphalt Tile and SS-T-307, Grease Resistant, Asphalt Tile; and the flame retardant qualities of Military Specification MIL-T-18830 (Ships).

**MATICO  
FLOOR TILE**  
A QUALITY PRODUCT OF

**RUBEROID®**

The RUBEROID Co., New York 36, N. Y.



# For Economy Minded School Boards who want LONG-LASTING CONSTRUCTION



## Typical areas requiring protection of OSMOSE Pressure Treated Wood

- 1 All weather-exposed siding, natural finished or painted.
- 2 All sleepers or nailing pieces under gymnasium floors, or where members are laid over concrete.
- 3 All roof and overhang areas.
- 4 All structural members where moisture can collect and where subject to extremes of temperature.
- 5 All sills within 18" of the ground or in contact with cement (24" in South).

For MORE Freedom of Design, look to OSMOSE Pressure Treated Wood.

## LASTS 3 to 5 TIMES LONGER Than Ordinary Lumber

With OSMOSE Pressure Treated Wood, you can take full advantage of the workability and beauty of wood...for only pennies more per board foot. The exclusive OSMOSE method gives positive protection against decay, termites and mold. OSMOSE treated wood lasts 3 to 5 times longer than ordinary lumber. It acts as a prime coat and holds paint better...with resultant savings usually enough to pay for the original treatment. Years of field experience prove it keeps maintenance to a minimum, is clean to handle, is non-corrosive, and results in satisfied customers. Conforms to all Federal and State specifications. More and more, OSMOSE is being specified by leading Architects. Industry sales records prove it. See our Catalog in Sweets.

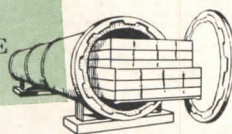

Pressure Treating Plants from Coast to Coast. Write for name of nearest Supplier.

**OSMOSE WOOD PRESERVING CO. OF AMERICA, INC.**  
983 Ellicott Street • Buffalo 9, New York

## Required Reading

continued from page 56

### Received and Noted

THE WORKS IN ARCHITECTURE OF ROBERT AND JAMES ADAM. *With a biographical tribute by John Swarbrick.* Quadrangle Books, 119 W. Lake St., Chicago 1, Ill. 106 pp., illus. \$12.50.

The works of Robert and James Adam were published serially in three volumes between 1773 and 1822. The beautiful plates were highly prized and the books are now virtually unobtainable. Now, however, all the plates have been rearranged and reproduced in a single volume, together with a short monograph on the two brothers and 44 pages of photographs. The engravings as reproduced lack some of the lively quality of the originals, and a number are rather dark; but the average individual is unlikely to own them any other way, and never in such a convenient form.

EGYPTIAN ART. *An Introduction.* By Boris de Rachelwitz. The Viking Press, Inc., 625 Madison Ave., New York 22. 256 pp., illus. \$6.95.

An introductory text, written by an Italian archaeologist, approaches Egyptian art not as a chronology of styles but from the viewpoint of the Egyptian "philosophical conceptions" of man and the universe in relation to their expression. The section on architecture is perhaps less convincing than those on the plastic arts, painting, and the minor arts of pottery faïence and metal work. Though the book depends more on text than on pictures, the illustrations are excellent.

ARCHITECTURAL FOLLIES IN AMERICA, or, *Hammer, Saw-Tooth & Nail.* By Clay Lancaster. Charles E. Tuttle Company, Rutland, Vt. 244 pp., illus. \$10.

The enjoyment of Mr. Lancaster's book will depend on the degree with which the reader shares his affection for the silly, the misplaced, the extravagant and the preposterous in architecture. The book is well written, well produced and, within the limits mentioned above, amusing.





# PLANNING THE UNIVERSITY OF BAGHDAD

ARCHITECTS: *The Architects Collaborative International Limited*  
*In charge: Walter Gropius, Robert S. McMillan, Louis A. McMillan*  
*Associates: Richard Brooker, H. Morse Payne Jr.*

STRUCTURAL AND MECHANICAL ENGINEERS: *Panero-Weidlinger-Salvadori, S.A.*

ARCHITECTURAL RECORD, FEBRUARY 1961





Total campus planned along Tigris River

Baghdad University began as an idea, unprogrammed. Before they developed the first campus master plan, Walter Gropius and his fellow architects at The Architects Collaborative International played the leading role in the precise formulation of the new university's teaching and administrative principles. The chance to plan such a complex organism from the very beginning doesn't often come to the architect, but in this instance the government of Iraq had the wisdom to give the opportunity to a firm uniquely prepared for it. For The Architects Collaborative International, Baghdad University is a problem whose scope demands the system of collaboration among equals which is part of the foundation upon which the firm is built. For Gropius, the firm's founder, Baghdad is an ideal project. To an architect and teacher long dedicated to the principle that members of the profession must play the broadest possible role in the pursuit of a better life for mankind, the total design of a university is a goal achieved.

The university of Baghdad is planned for flexible adaptation to change. The colleges which make up a university are continually changing in relation to one another in terms of their considered importance. Interest in certain areas of study may increase or decline. A university that is planning more new buildings for basic scientific research, will also be planning to alter an old structure which is providing too much space for a branch of the humanities presently considered irrelevant or esoteric, in favor of another academic discipline with an increasing number of adherents.

The architects and consultants recommended that Baghdad University should not be made up of individual colleges expressed as separate physical entities which would eventually suffer obsolescence through the need to expand or contract, or disappear. The new university will be comprised of three major disciplines, engineering, sciences and the humanities, located in the academic building group which embraces the central core (see building groups lying to east and west of main plaza above and on opposite page). Divided into three general instruction areas planned for flexible space utilization, rather than in distinct building groups, each division and the colleges within it are marked by functionally related permanent administrative spaces. Apart from the obvious advantages of economy through avoidance of duplication of facilities, the proximity and interchangeability of the three main divisions provides the students with opportunities for the cross fertilization of thinking among the various fields of specialization, to allow a breadth of intellectual development beyond the boundaries of the student's major field of study. To this end small student lounge rooms are dispersed through the academic area to bring students from different fields of study into daily informal contact.



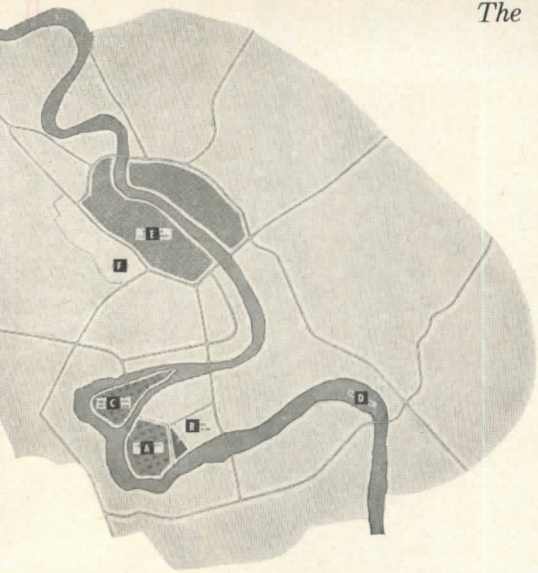







Vicinity Map:

- A. University Site
- B. Future Expansion
- C. University Zoo and Botanical Gardens
- D. Tigris River
- E. Baghdad City Center
- F. Airport

The master plan groups the library, student center, art gallery, museum, theater, auditorium, administration building, faculty club and faculty office tower to form an asymmetrical central plaza. The mosque is slightly to the north of the central area on the axis of view of the entrance drive into the university. The classrooms, laboratories and lecture halls form a ring around the central area buildings and with these buildings constitute the university proper. Expression of this unity of function is given by a circumventual road which encloses the total academic area and limits vehicular access to it only for entry to the administrative building or for service to the buildings. The facilities located outside this central-academic area are those which support the general life of the university in contrast to the specific educational function at the center. Men's dormitory areas are planned for the south and southeast areas of the campus, women's dormitory areas are in the north section. Faculty housing will be developed along the river front



-  GENERAL UNIVERSITY USE
-  ACADEMIC FACILITIES
-  STUDENT HOUSING
-  RECREATIONAL FACILITIES
-  SERVICE AREA
-  FACULTY HOUSING







Auditorium building, located to the north of the central area and connected to the main access road and to external parking

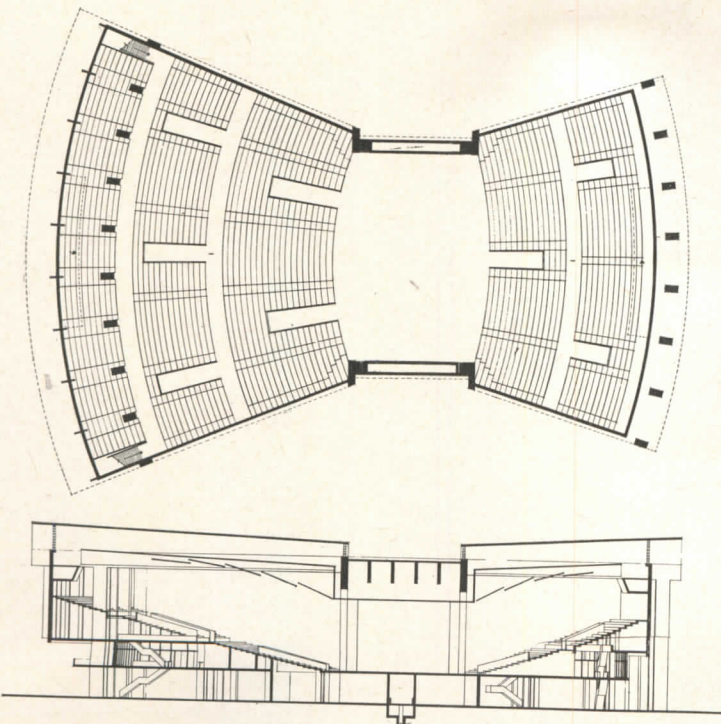

Auditorium plan and section. It has been designed to accommodate the large number of people required for special occasions, but it can also be divided into smaller auditoriums for lectures, music performances, etc. The two smaller auditoriums, seating 3,220 and 1,150, face each other across a central flat stage area which can be partitioned off in a number of different ways. When in use as a single large space, an additional 650 seats may be placed on the central stage providing a total seating capacity of 5,020

## Central Area

The University of Baghdad grows organically from the assymmetric central plaza at its core. Since the buildings which form the plaza, auditorium, faculty tower, library, administration building, student center, art gallery, museum, theater and faculty club, are of the type which will be used at most times by a large part of the campus population, the plaza will be a true gathering place and community center. Gropius has written: "Why does one core within a town or city attract us as pleasant when another may not? The intricate problem of scale lies at the bottom of this question. A good solution much depends on whether a harmonious relationship has been achieved between the height of the surrounding buildings and the dimensions of the plaza. The actual size of the plaza should barely accommodate the peak hour of activity. If it is too large it will look empty and may never provide the contagious atmosphere and liveliness so essential for its success. Gigantic, undivided open spaces leave most people intimidated rather than stimulated."\*

\* CIAM, *The Heart of the City*, Pellegrini & Cuddahy, New York, 1952



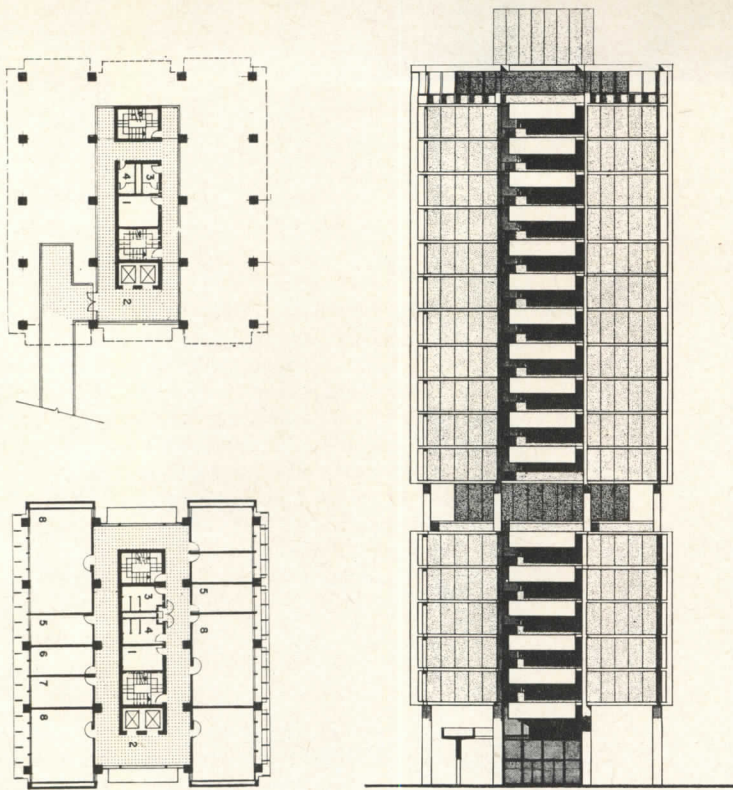

Faculty Tower. Floor plan at lobby, typical floor and elevation. The permanent headquarters for the dean of the faculty of humanities and his staff. Included are six chairmen of departments in the humanities and 272 other faculty members together with space for secretaries and conference rooms. The building is conveniently placed near the library to the south, and the faculty club and administration building to the east to permit easy access to one another by both the faculty and students, and the intent is to encourage a closer relationship between the students and faculty







Central plaza with auditorium just visible, closes vista from street in academic area

The drawing at the right shows the central plaza as it will appear from a terrace of the building which combines the student center, museum, theater and art gallery. The administration building is directly opposite the viewer to the left of the faculty tower, with the faculty club just discernible beyond. The administrative building houses most of the administrative personnel, including the president of the university and his assistants sequestered on the second floor, administrative personnel connected with operating the physical plant on the first floor, and the student business area situated on the ground floor, allowing easy access by the students, for this group handles all student activities



Opposite page bottom: library, principal floor plan and elevations. The library is one of the most important buildings in the university and therefore occupies an important position in the central area, directly across the plaza from the auditorium and adjoining the faculty tower. There are provisions for 1,000,000 volumes with about 900,000 in the central closed stacks, and space for another 100,000 in the various reading rooms. Space is provided for about 2,750 readers. The central library will house the complete university collection as presently planned except for the small libraries in various departments. In the future if expansion is needed, there are two specialized libraries planned of 80,000 volumes each, one for the sciences, and one for engineering. The complete building will be air conditioned and a relative humidity of approximately 50% will be maintained. Screens will prevent the direct sun from entering the reading rooms which not only cuts down the cooling load, but also protects the books in those rooms

Model photograph showing central area and surrounding academic buildings

Robert D. Harvey Studio

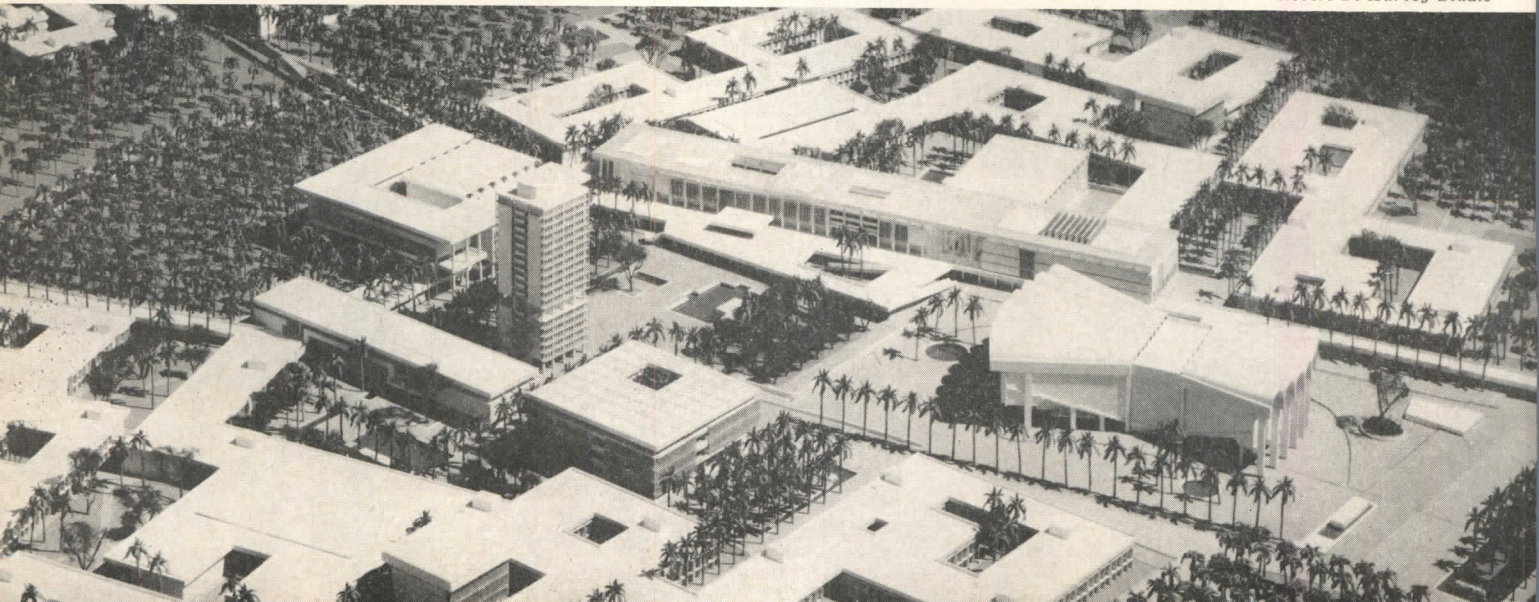



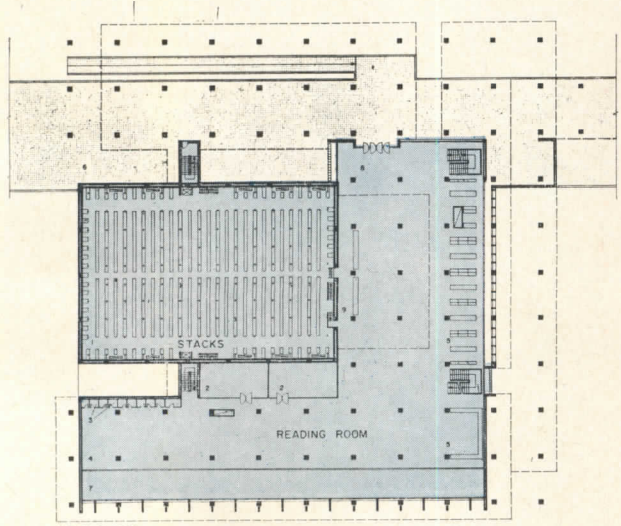

FIRST FLOOR

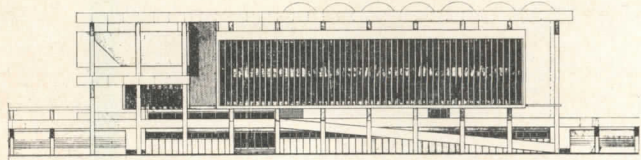
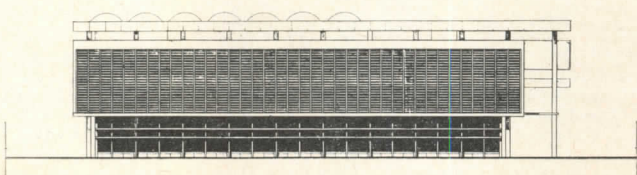
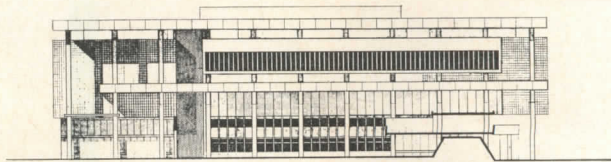
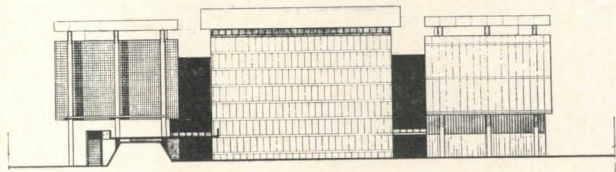



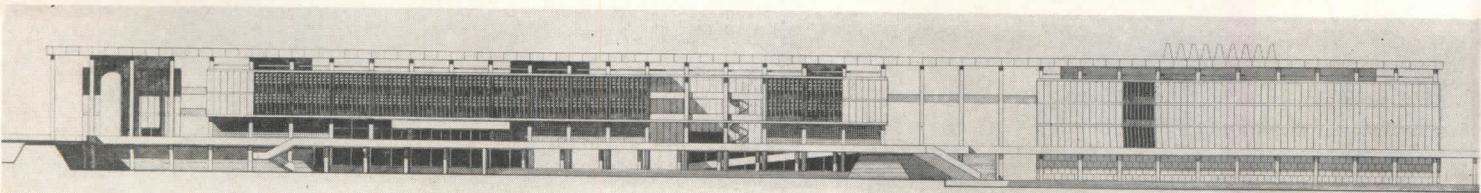
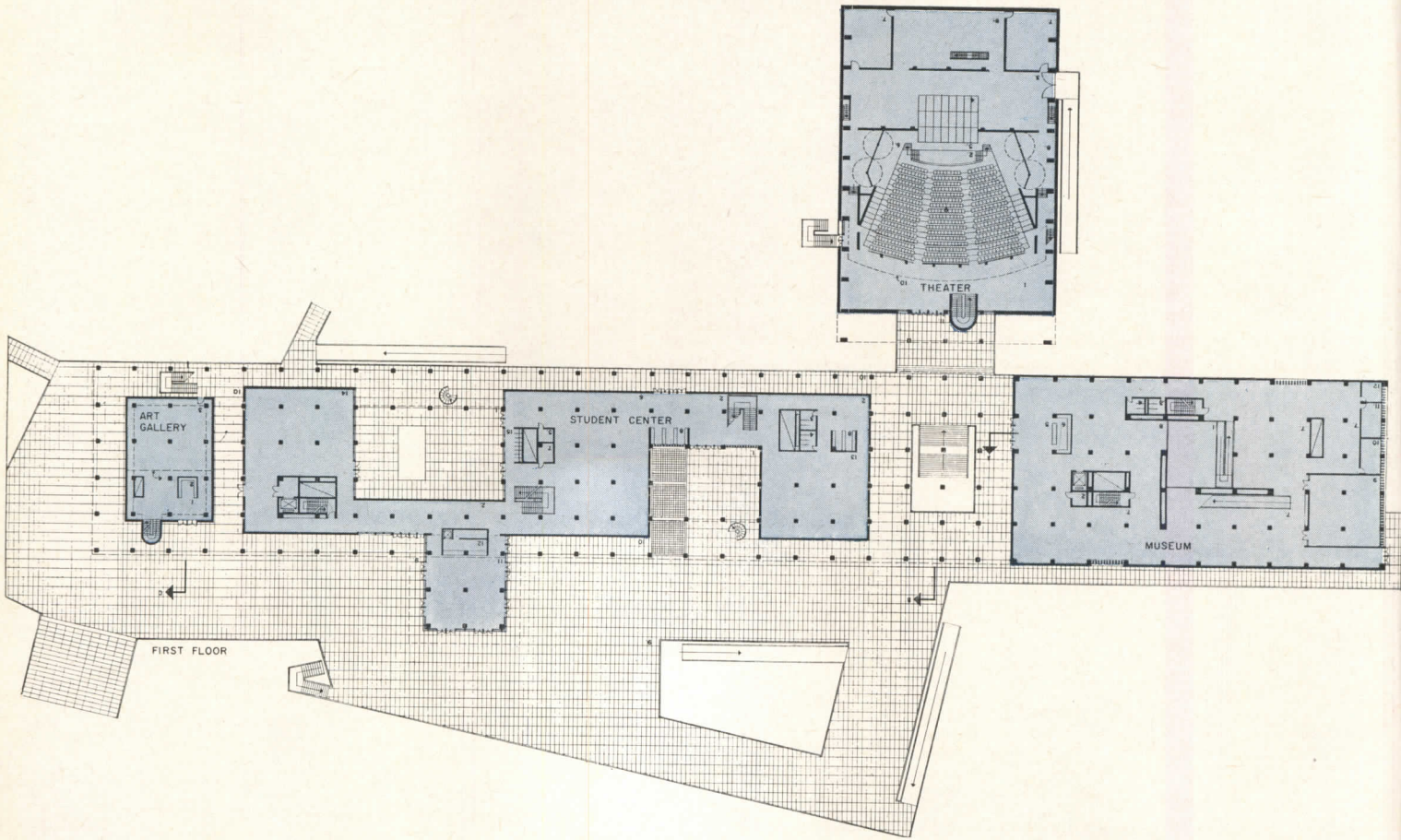
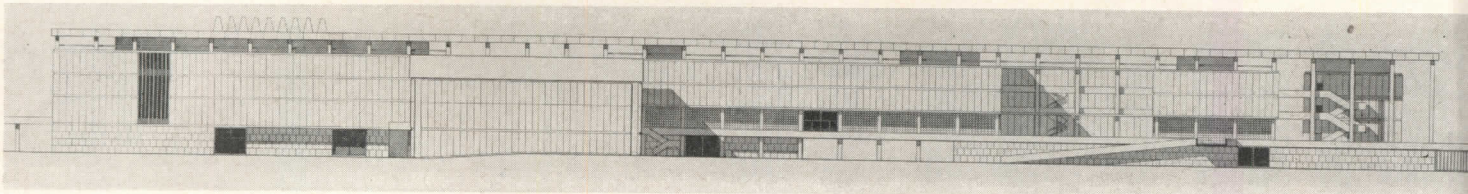



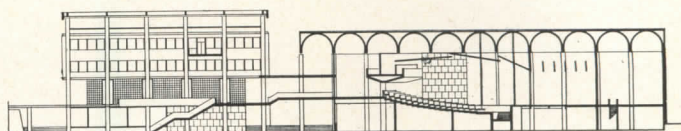
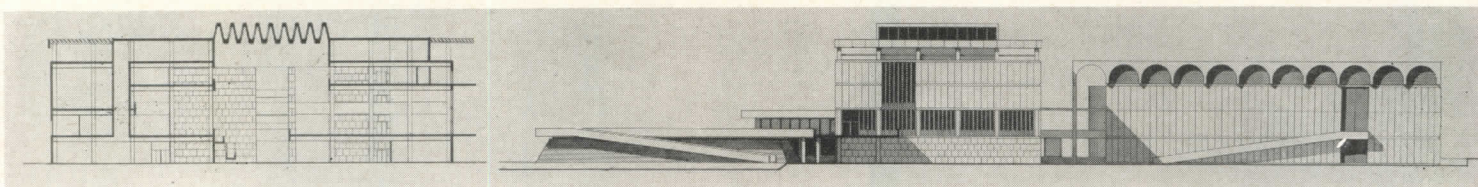

Student center, museum, theater and art gallery. The student center will be used as headquarters for student organizations. It will provide facilities for discussion and informal gatherings. Its position as one of the major elements of the central plaza is justified by its great importance in university life as the place where students meet other students from different parts of the country and the world for the free exchange of views. The museum will be devoted to natural history. The theater will be used for the teaching of drama and the associated arts. The art gallery is provided as a teaching facility for fine arts students and for the display and storage of works of art. It is centrally located at a main crossroads of the campus where students converge from dormitories, teaching spaces and the central area



Model photograph. Student center, museum, theater and art gallery enclose the plaza at upper right

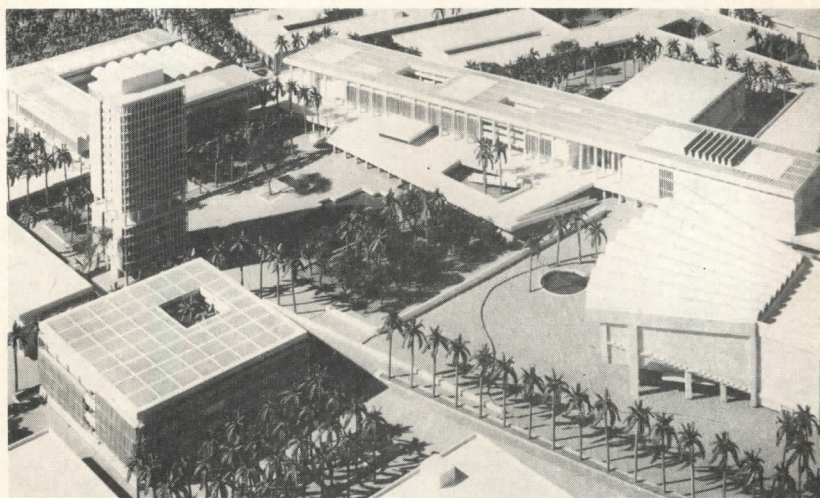

Robert D. Harvey Studio





Engineering library in academic area intended to supplement main library on central plaza. A science library will be similar

## Academic Area

The drawings above of enclosures within the academic compounds clearly reveal the degree of architectural enrichment made available by the system of sun screens and baffles on the façades. These interpenetrating surfaces, which help establish the architectural character of the university, are not the result of arbitrary caprice as interesting façades so often are these days. Members of The Architects Collaborative still base their aesthetic choices on thorough and detailed investigation of all that is pertinent. Throughout the Baghdad project, particular consideration was given to the peculiar climatic conditions, specifically to the excessive sun heat in Baghdad. The systems of horizontal cantilevers and vertical baffles were very carefully devised for each orientation of a façade. In every case windows are protected against direct sun rays and a substantial reduction in required air conditioning equipment was achieved. In the academic area most rooms face either north or south, and in some cases rooms face east. In other instances a single loaded corridor has been used on the western façade.

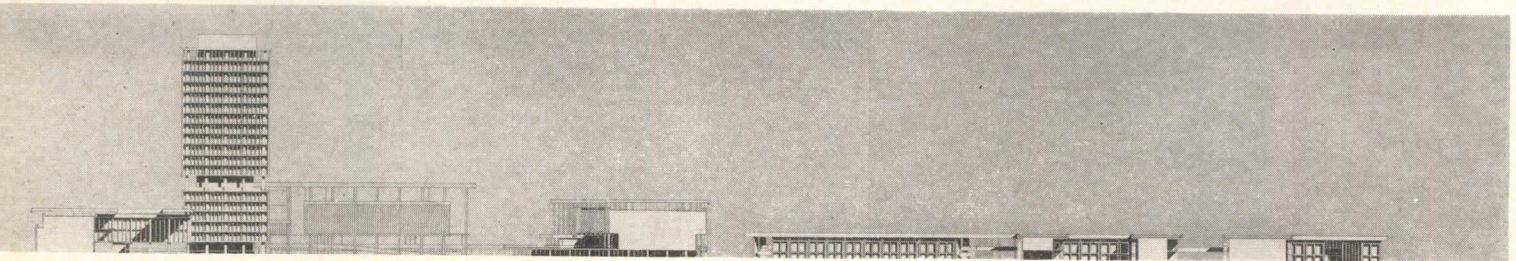





Sections showing scale of academic buildings in relation to those in central plaza

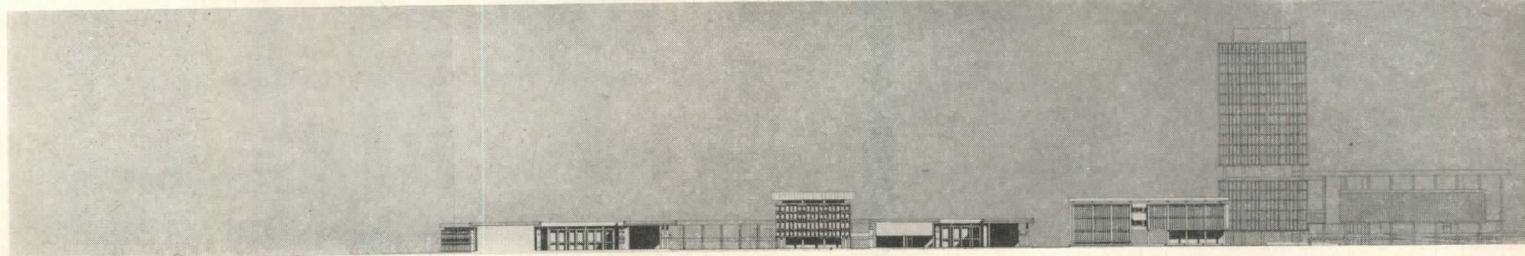



## Dormitories and Athletic Facilities

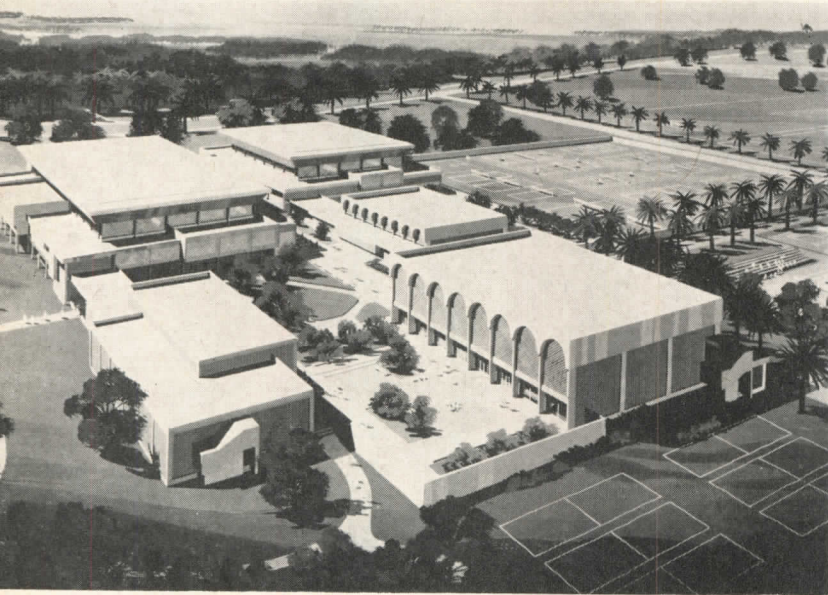

Athletic facilities include a gymnasium for men and one for women, both shown in building group at left. Several swimming pools are included in this scheme. A stadium, shown on plot plan has been included to accommodate the entire university community

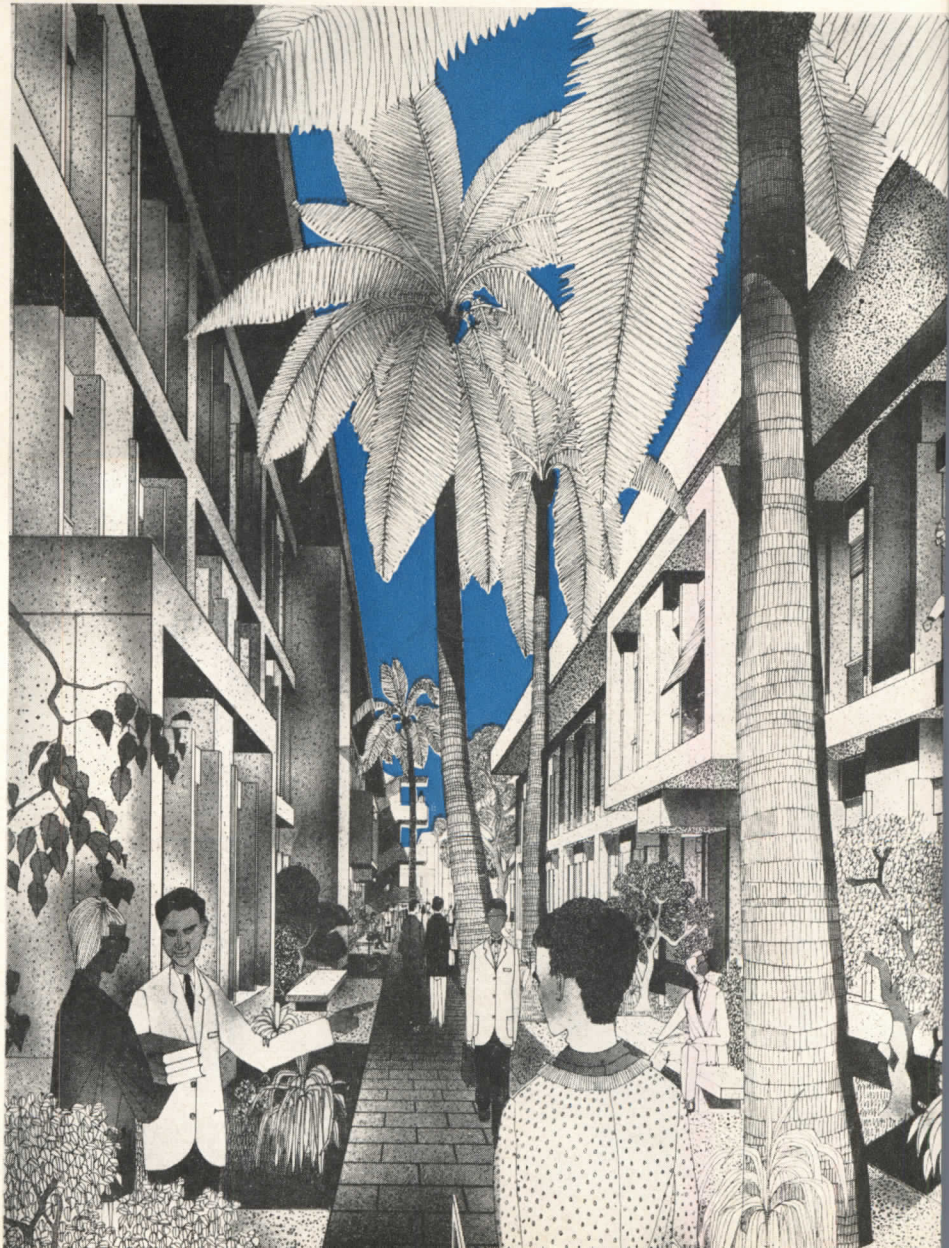



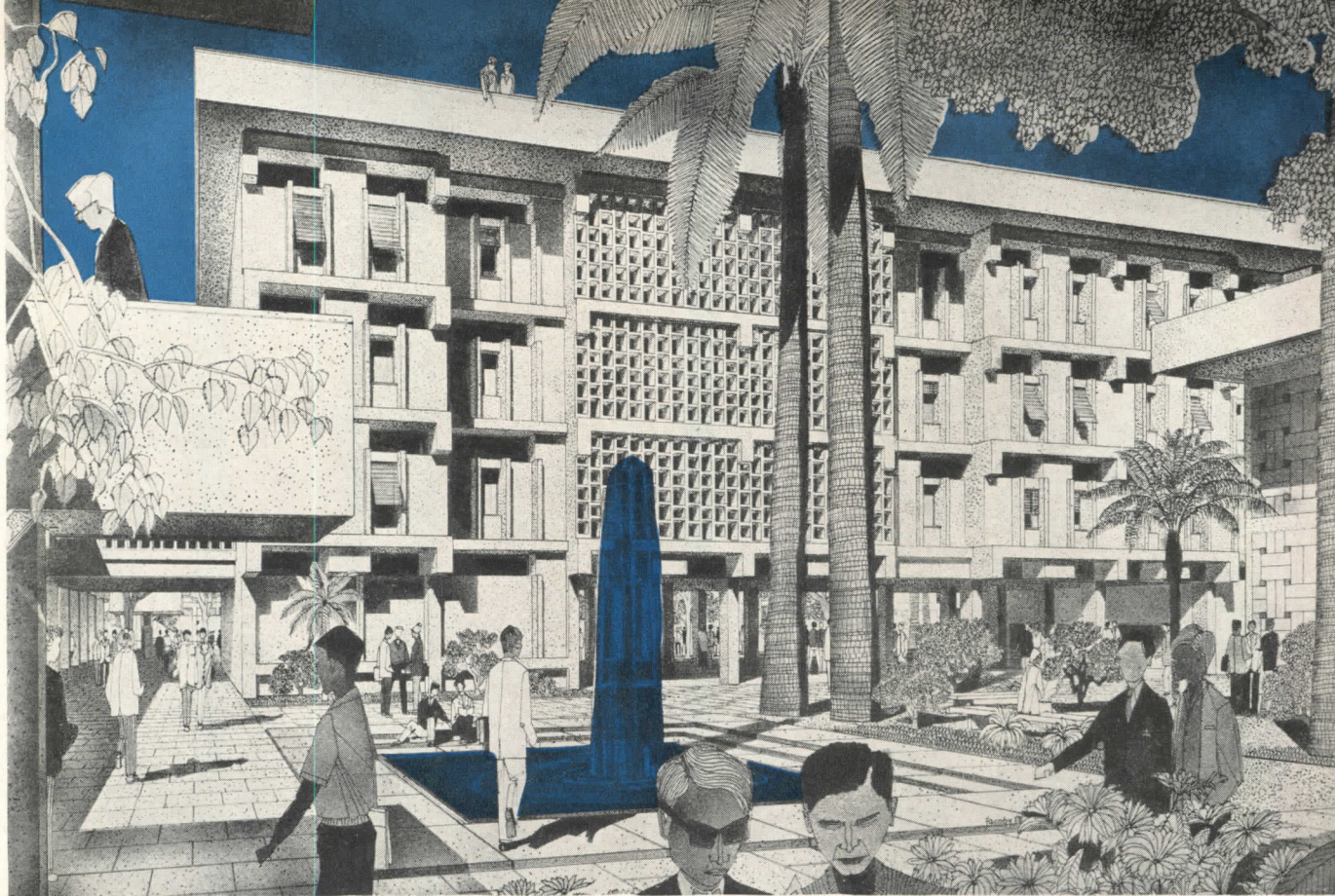

As in the whole project, the largest number of dormitory buildings have their rooms facing north and south. The remaining rooms face east, or are protected from the western sun. The windows have been kept to a minimum for good lighting and are equipped with exterior roller blinds for additional sun protection. If air conditioning proves too costly, it is hoped that the orientation and overall design of the dormitories will make them fairly comfortable. The close proximity of these buildings, their deep overhangs and projecting balconies shading narrow streets suggest the indigenous architecture of the Middle East



Each dormitory group is made up of two compounds, with a total number of 1,344-1,400 students in each pair. There is a dining hall for each double compound (note square structures in plot plan). Dormitories are of the double loaded corridor type, with a combination of two and four person rooms, allowing approximately 70 to 90 ft per room



# Housing

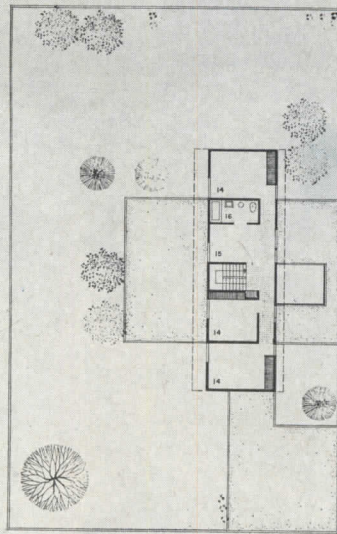
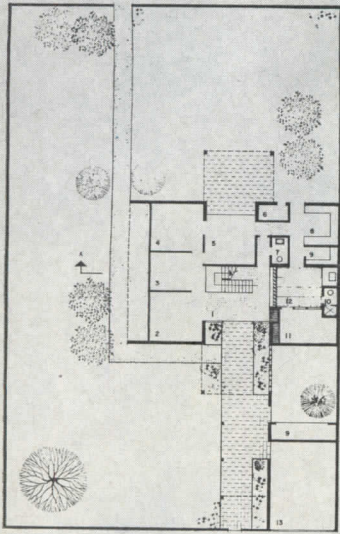

Typical single house, one of sixteen of the detached type with a court. They will have a library, entrance hall, reception room, living room, dining room, kitchen, pantry, toilet, storage and utility, servants room and carport on the ground floor; on the first floor three bedrooms, bathroom, access to the roof for sleeping, and covered porch. This type is planned for deans and heads of departments

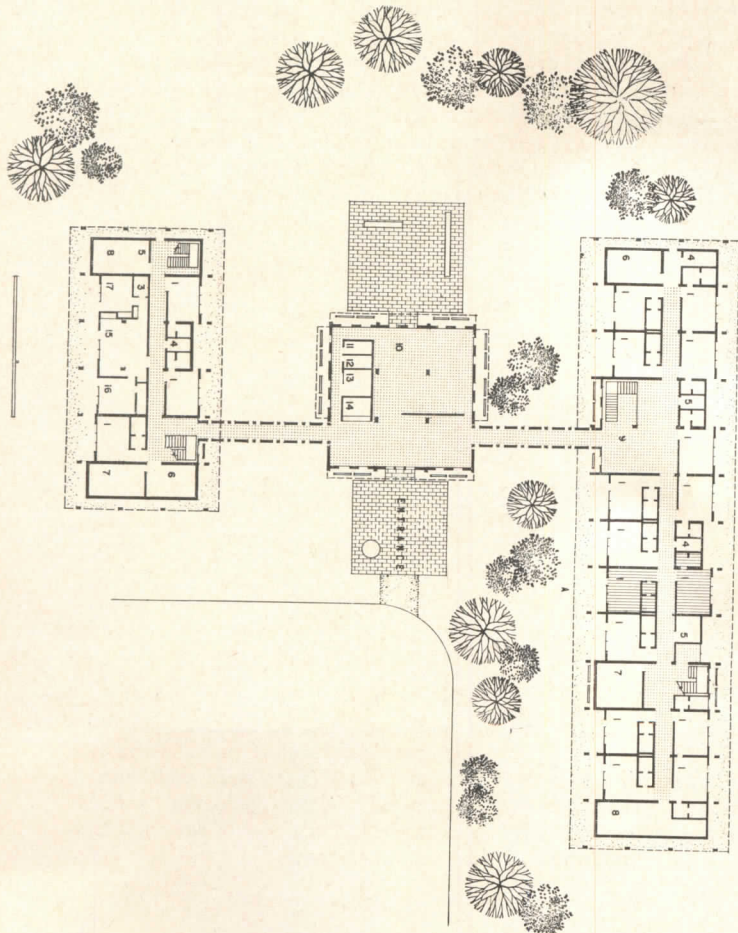
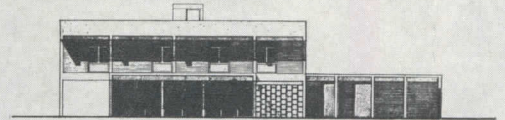
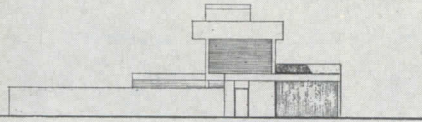

The guest house will contain 50 rooms with dressing rooms and bathrooms for guest lecturers and visiting professors. The rooms will have balconies. The lounge and two garden courts will be welcome amenities



# Mosque

The mosque is designed to be a quiet oasis near the central area of the campus which will be alive and teeming. It consists of four architectural elements: the paved court, enclosed by a wall with two groups of trees; the mosque which will be a single dome supported on three points surrounded by water and enclosing the prayer platform; the minaret, functional in the past, a symbol now; and the ablution areas contained in a small structure for men and women

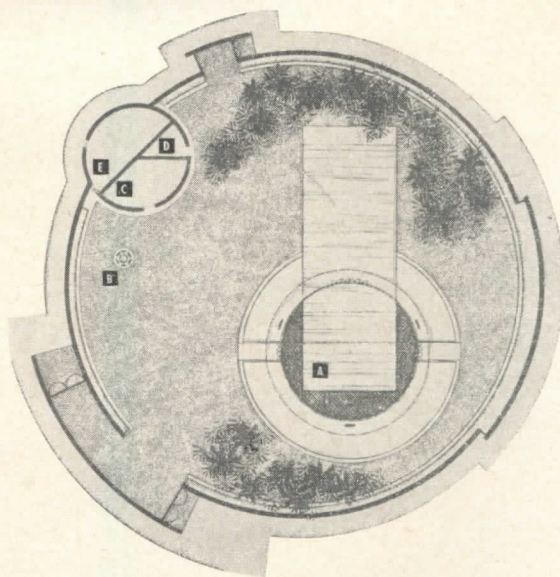

- A. Mosque
- B. Minaret
- C. Ablution—Men
- D. Ablution—Women
- E. Caretaker







Tahrir Women's College presently in Baghdad will be relocated on the university grounds. It is programmed to contain seventeen classrooms, laboratories and home economics laboratories, seminar rooms, faculty offices and a library for the use of 500 female students

Entrance gate

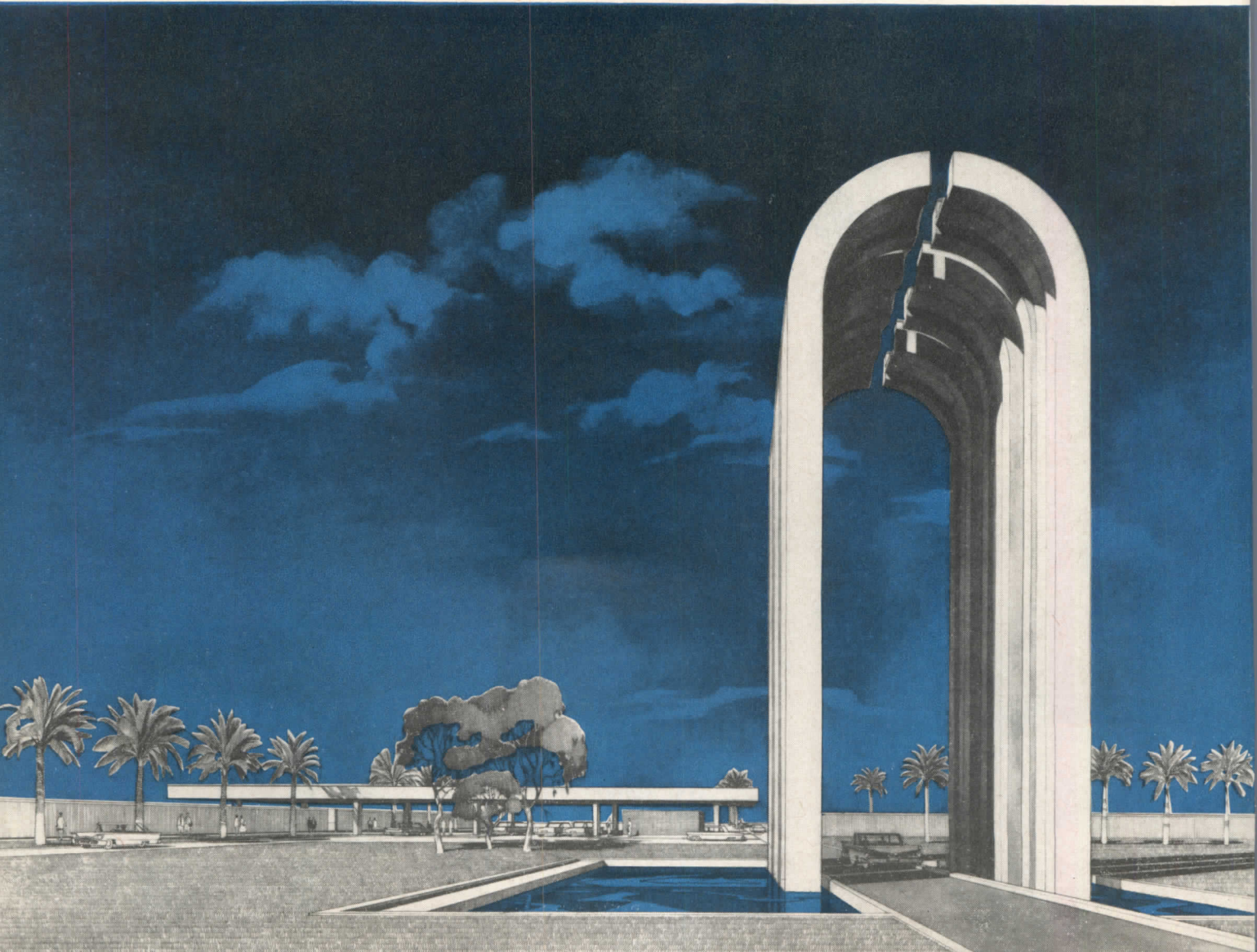





# SOPHISTICATED SKYSCRAPER

*The Harris Trust and Savings Bank, Chicago*

*Skidmore, Owings & Merrill, Architects-Engineers*

*Turner Construction Co., General Contractors*





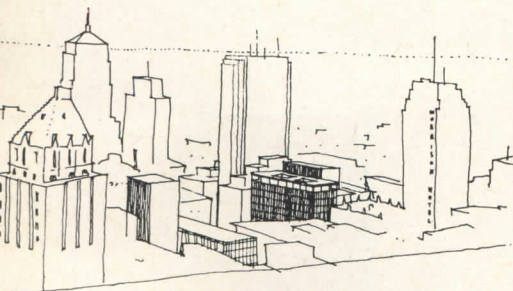
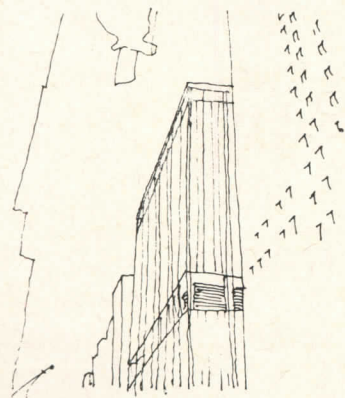
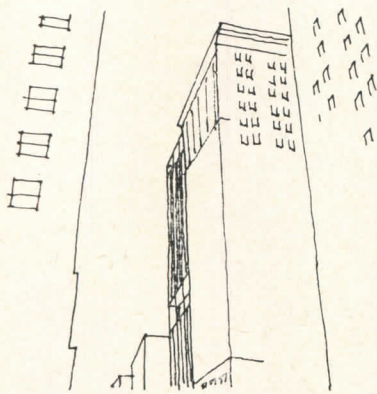
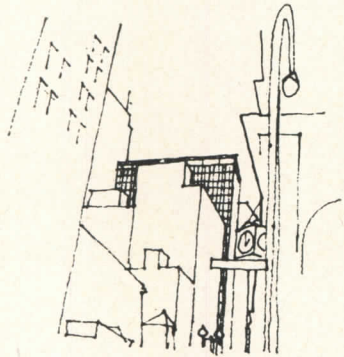
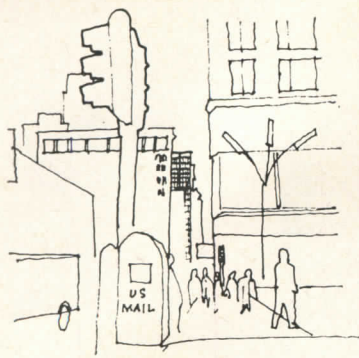

Several from a series of sketches by Paffard K. Clay to illustrate the relationship of the building to the Chicago cityscape



All photos by Hedrich-Blessing

Both inside and out, the Harris Trust building creates an impression of elegance and of architectural sophistication. Elegance stemming from good proportions, appropriate scale, refinement of detail, and a happy choice of materials and colors. Sophistication in the handling of the stainless steel and gray glass curtain wall, which was carefully detailed to eliminate the "oil-canning" effect so common in many earlier expressions of the metal and glass building. Refer to details and discussion, pages 128 and 129.

The project actually comprises three buildings: a new 23-story tower adjoining and connected to the completely remodeled, 50 year old, 20-story existing bank; plus a 3-story parking garage, now converted to banking facilities. SOM partner Walter A. Netsch, Jr. says, "This building reflects one of the great problems of our environment; how to add to an existing building and reflect the needs and character of the client and at the same time employ contemporary techniques. The curtain wall and proportions of the tower reflect the dignity of the bank; we were able—on a crowded site—to achieve a sense of environmental expansion by a ground level recess."

Under the over-all supervision of partners William E. Hartmann (executive) and Walter A. Netsch, Jr. (design), the SOM trio responsible for the work on Harris Trust consisted of: Paffard K. Clay, senior project architect and designer; John H. Schruben, project manager; and Edward G. Petrazio, contract drawings, approvals, and field coordination.



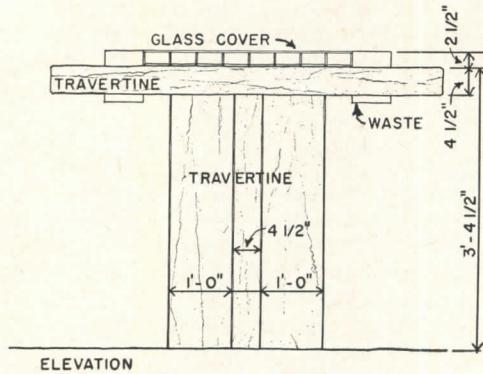
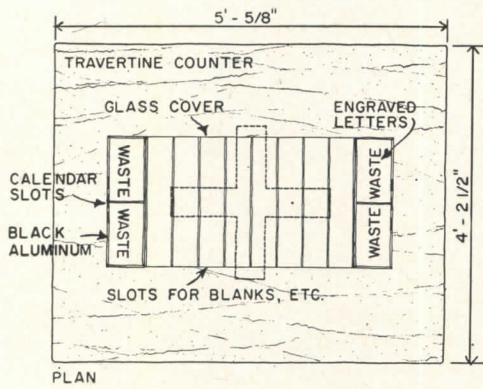

STAND-UP CHECK WRITING DESK

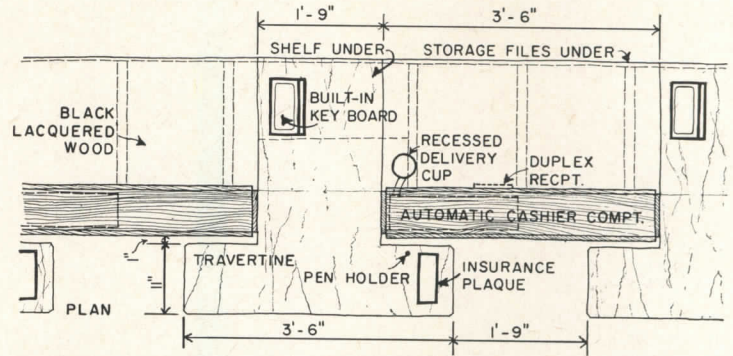
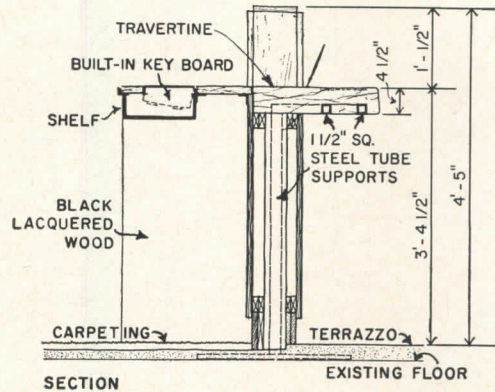

## Harris Trust and Savings Bank

All interiors for the bank were under the control of the architects, who designed special fixtures, installations, and furnishings; selected materials, colors, fabrics, etc. The photo below shows the ground floor of the new tower, which is devoted to the savings department. Above are SOM details for check desks and banking counters as used throughout the building







## Harris Trust and Savings Bank

### PLAN ANALYSIS

Vertically, the building is organized into two main elements: the bottom ten stories of bank, and the top ten stories of rental space. These two blocks are separated by two mechanical floors (11 and 12); and are topped by an executive penthouse. The sleek 23-story curtain wall is interrupted by recesses at the penthouse, mechanical floors, and ground floor levels. Regarding the 11th and 12th floor notch, Walter A. Netsch, Jr. says, "There are many different visual expressions for the mechanical floors at the center of the building; it can be ignored or expressed, played up or played down. In this case, we felt that the three setbacks differentiated the special areas of the building, offered a contrapuntal punctuation in its surface, and enhanced the post and beam character of its structure. In the tight, chaotic city environment, such recesses give vitality to a building."

Planwise and laterally, the scheme revolves around the idea of connecting the floors of the old and new buildings at every level, and creating at their juncture a composite core of elevators, toilets, and stairs to serve both. This concept led to complications in scheduling and construction, but the result—two beautifully free areas served at the greatest possible economy by the least possible service area—justified the temporary dislocations.

\* \* \* \* \*

Outside consultants who were called in on various aspects of the design: Bolt, Beranek & Newman, acoustics; Charles W. Lerch & Associates, vertical transportation; Walter C. Voss, curtain wall materials

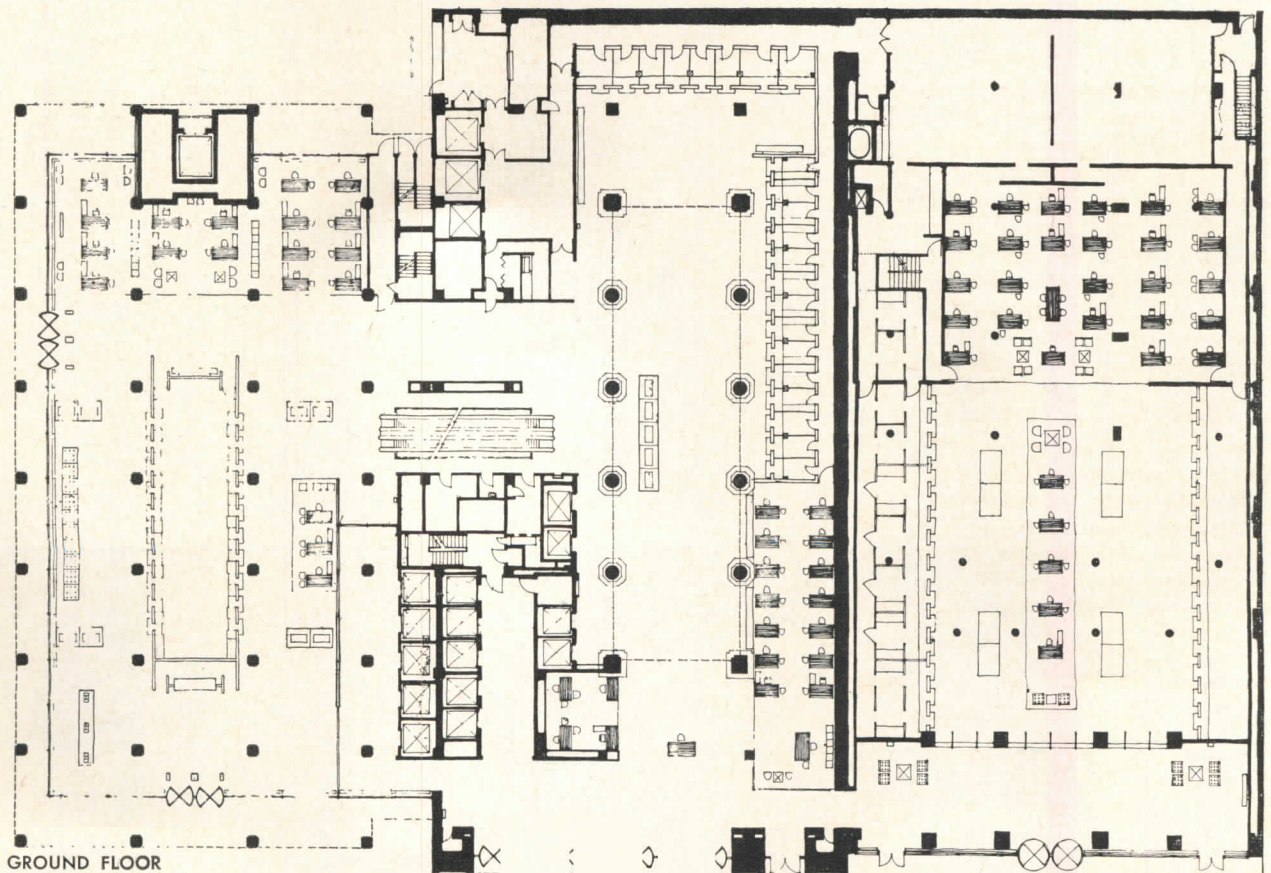



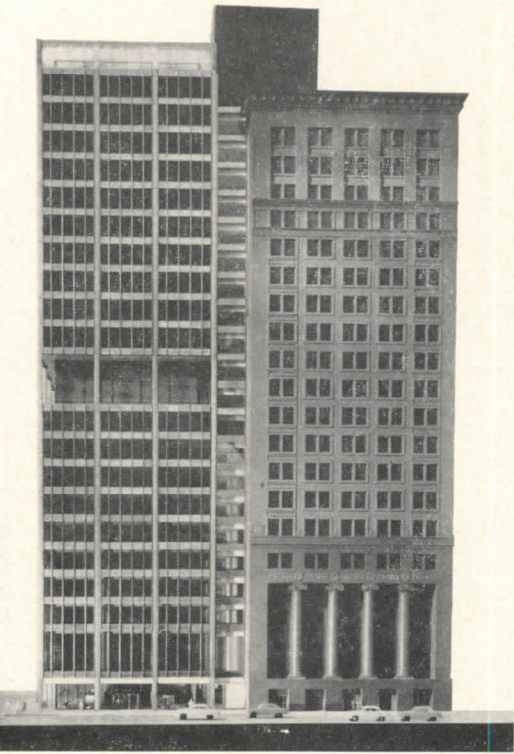

23

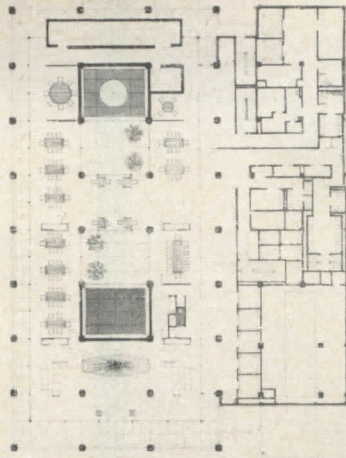

8

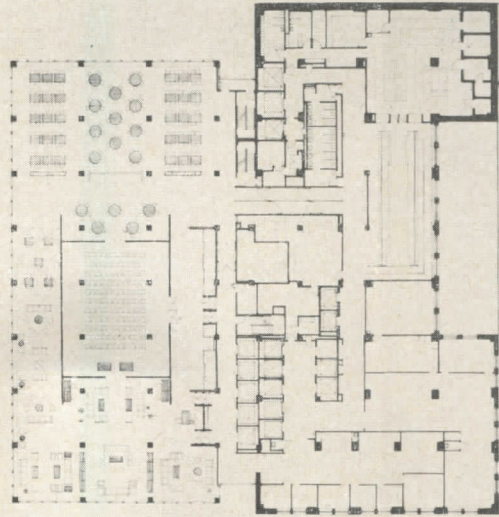

3

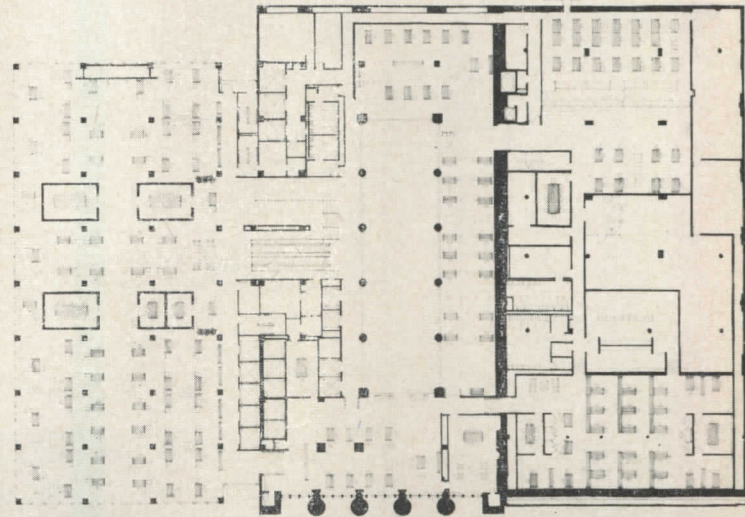

2

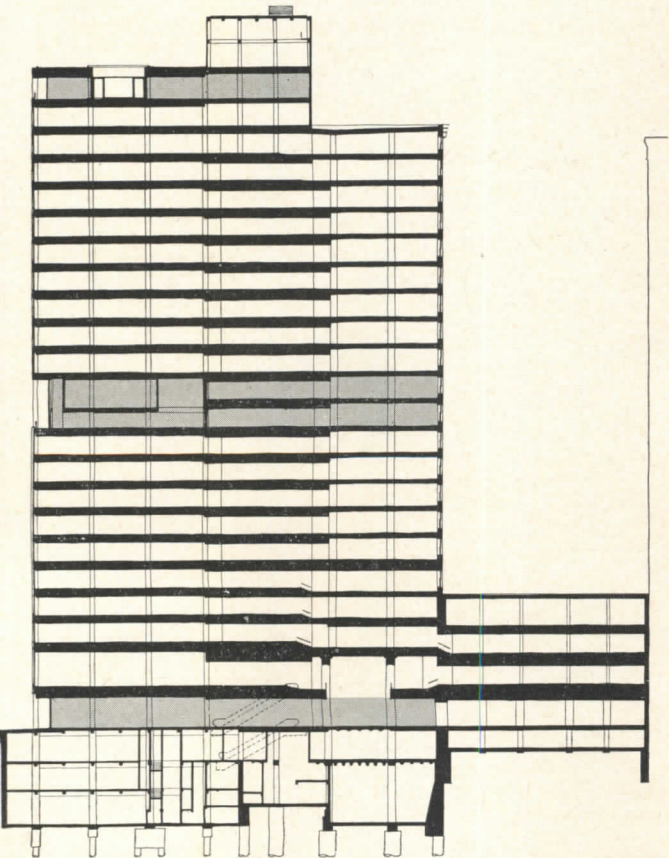
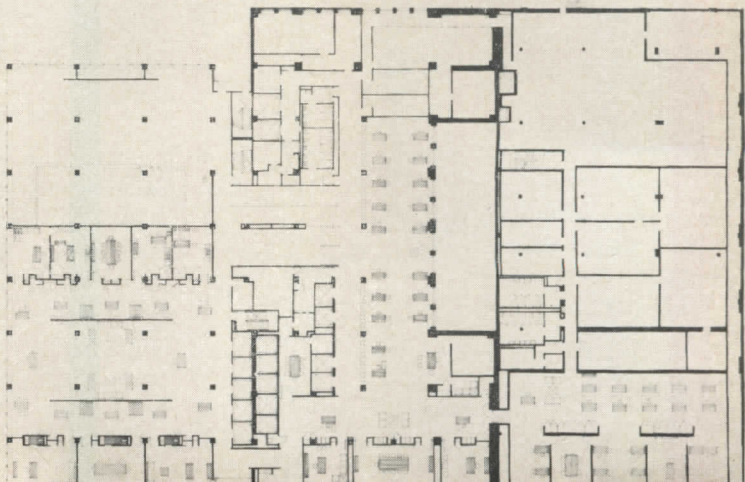



STAINLESS STEEL MULLION NO. 4 FINISH

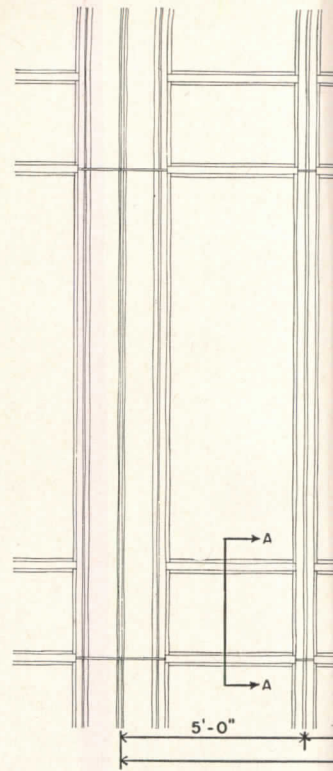
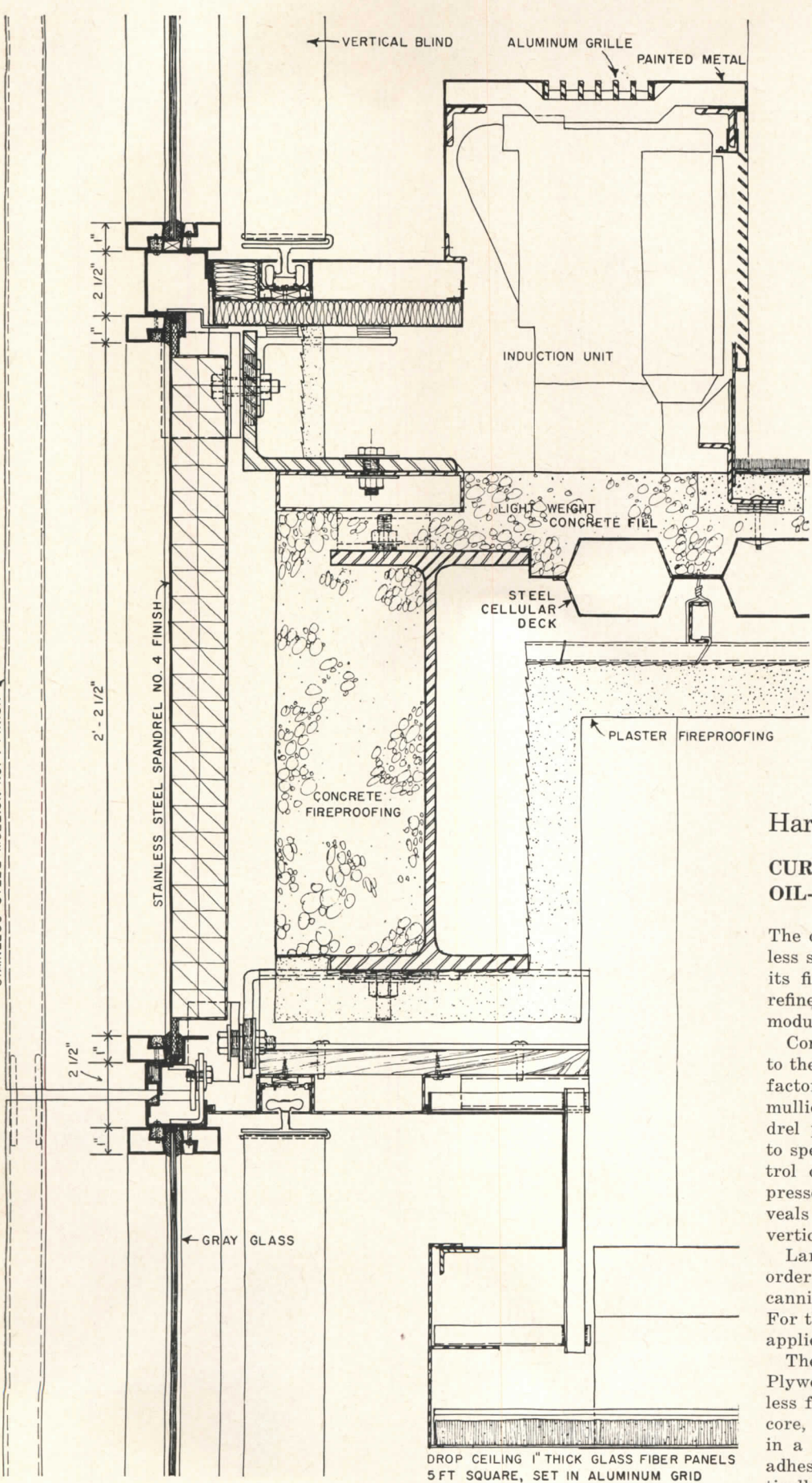

Harris Trust and Savings Bank  
**CURTAIN WALL ELIMINATES  
 OIL-CANNING**

The curtain wall—of #4 finish polished stainless steel and gray tinted glass—is notable for its fine proportions, ingenuity of detail, and refinement of scale appropriate to its 5 ft module.

Conceived as panel construction (as opposed to the more usual stick construction) the basic, factory assembled unit consisted of two half-mullions one story high, joined by head, spandrel panel, and sill. Such an installation led to speed in erection, lower costs, and close control over sealants. The resulting facade expresses the method of erection, with 1 in. reveals at head and mullion, plus continuous verticals.

Large flat areas of metal were avoided in order to cope with the sheet metal—or “oil canning”—characteristics of stainless steel. For the columns, narrow-faced, stiff pans were applied to precisely aligned outer corner pieces.

The spandrel panels (developed by U. S. Plywood Corp. technicians) consist of a stainless face, a 2 in. resin-impregnated honeycomb core, and a primed steel interior pan, bonded in a hot platen press with a modified epoxy adhesive. Since such a sandwich characteristically expands and contracts laterally, the panels have an unusually flat, smooth look

DROP CEILING 1" THICK GLASS FIBER PANELS 5 FT SQUARE, SET IN ALUMINUM GRID

DETAIL A-A VERTICAL SECTION THROUGH SPANDREL



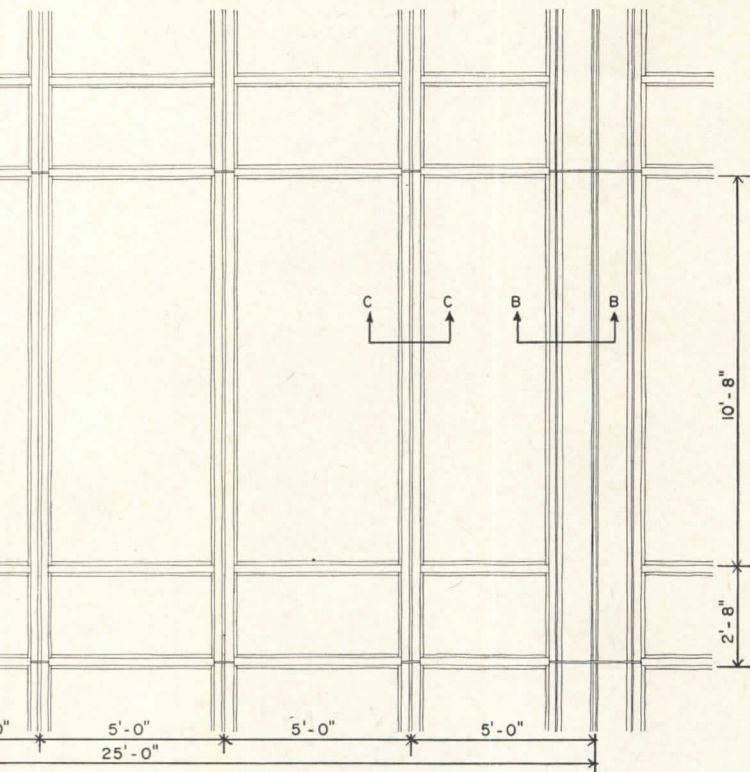

DETAIL OF NORTH & SOUTH ELEVATION

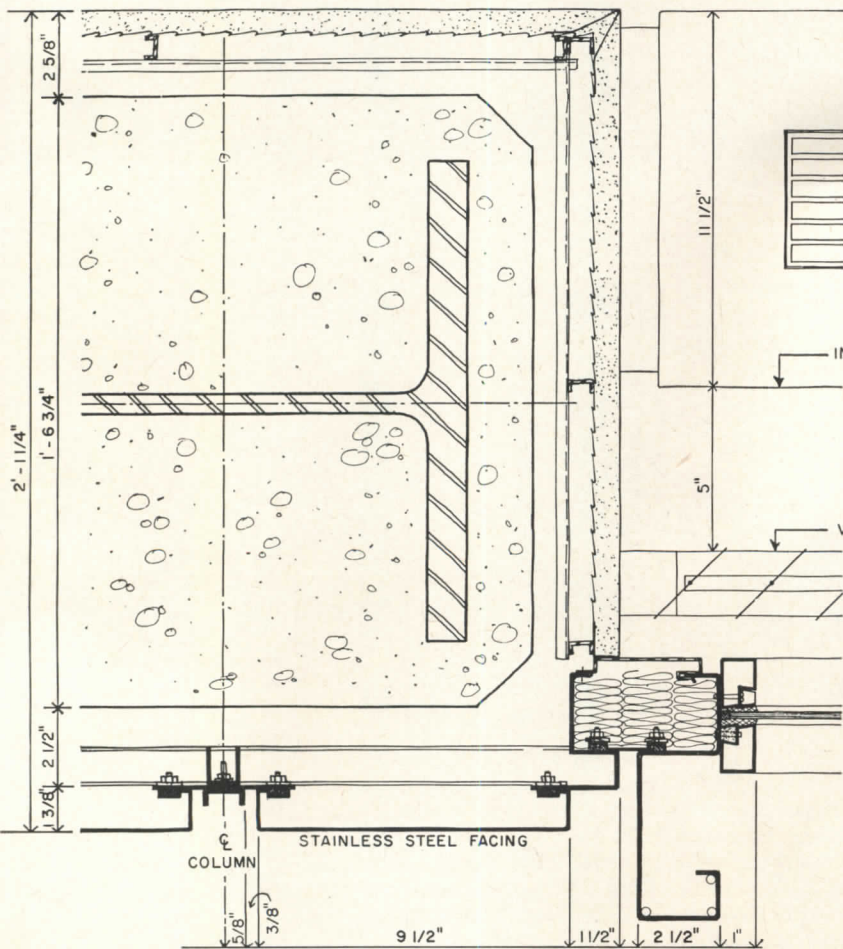
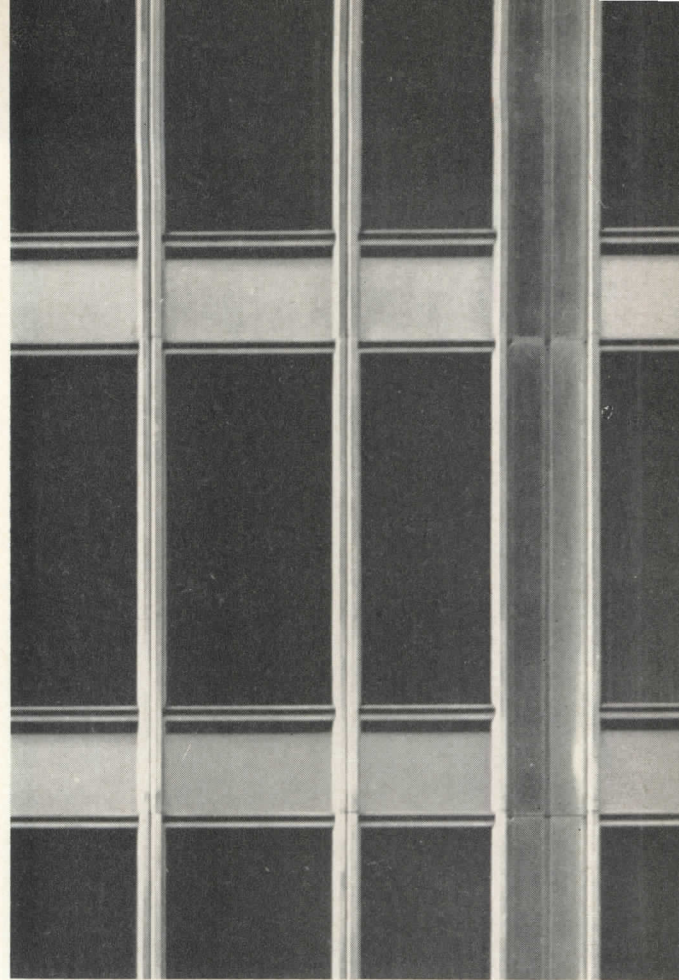

DETAIL B-B HORIZONTAL SECTION THROUGH COLUMN

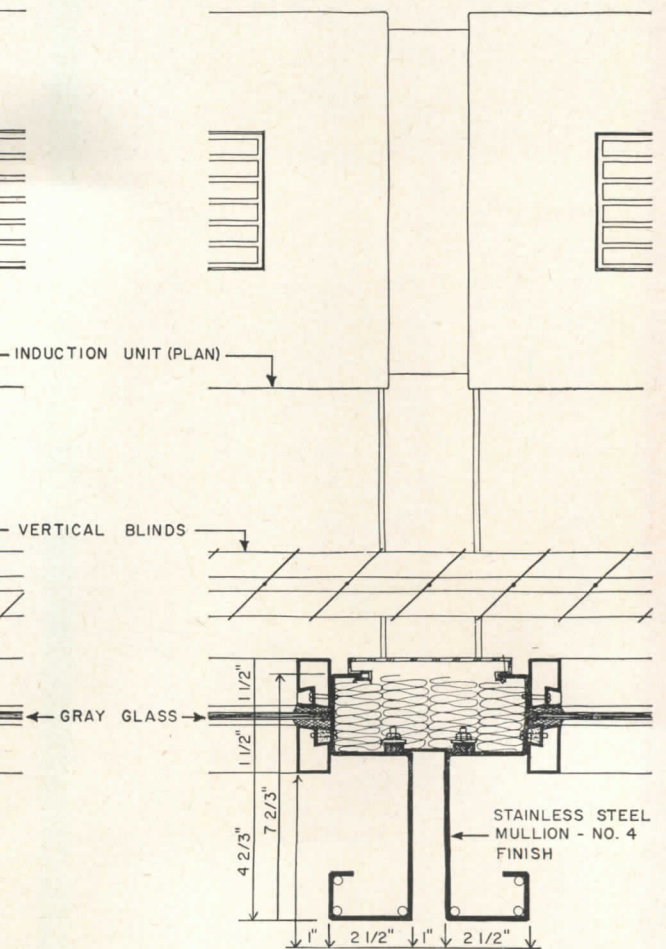

DETAIL C-C HORIZONTAL SECTION THROUGH MULLION



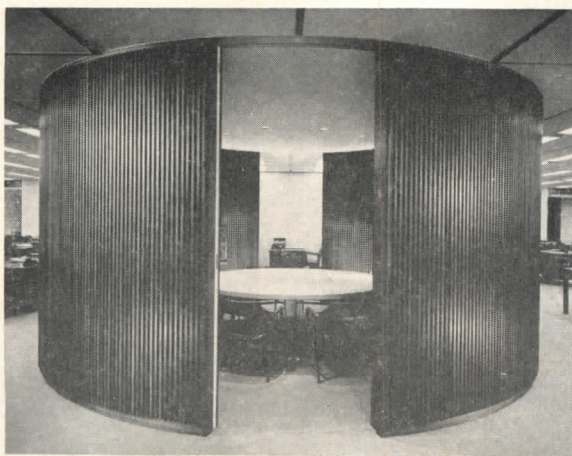

As one walks through the upper floors of the bank, he is impressed by the general air of spaciousness, muted color, and the quiet, yet interesting, use of fine materials; travertine, rosewood, walnut, stainless steel, black granite, verde antique, thick carpeting, etc. The total effect is dignified and elegant without being pretentious or stuffy. The spaciousness results from a minimum use of permanent partitions and dividers, which are of varied forms and materials, and which provide a changing series of spatial experiences from floor to floor, within the common modular and bay system.

Top photo: banking officers and their secretaries are on the 2nd floor. Bottom two: circular conference room, 4th floor



Harris Trust and Savings Bank  
**INTERIORS**

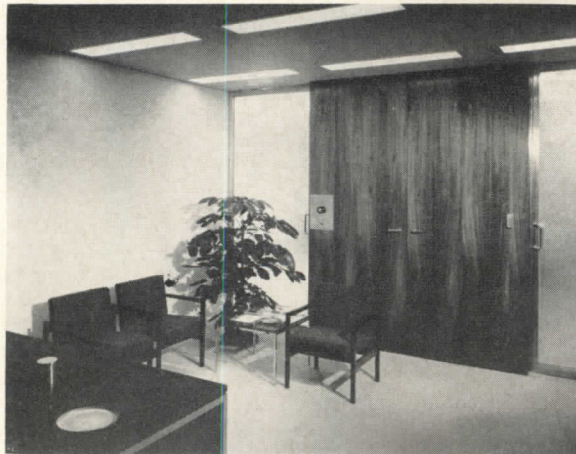
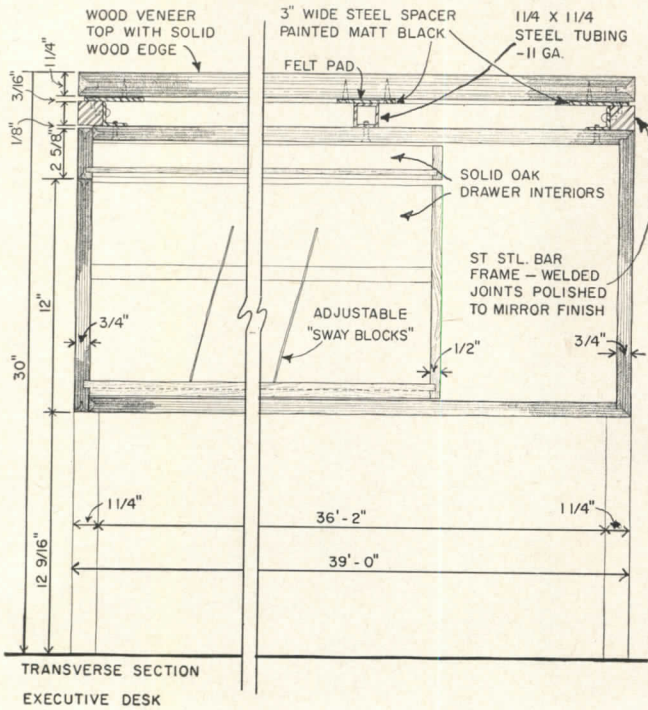

Executive offices and accompanying conference rooms are located on the 3rd floor, shown on this page. Top: executive reception area, which focuses on the old desk of Stanley G. Harris, chairman of the board. Center: the president's office. The drawing above shows a portion of the architect's detail of an executive desk—stainless steel, ebonized walnut, rosewood top. Bottom: two views of the combination wardrobe-cabinet unit in the office of the senior vice president.

At the time the bank was designed and the interiors worked out, Jane Johnson headed the interiors department at SOM, while William Merci was in large part responsible for the development of furnishings and their details; colors, fabric selection, etc.



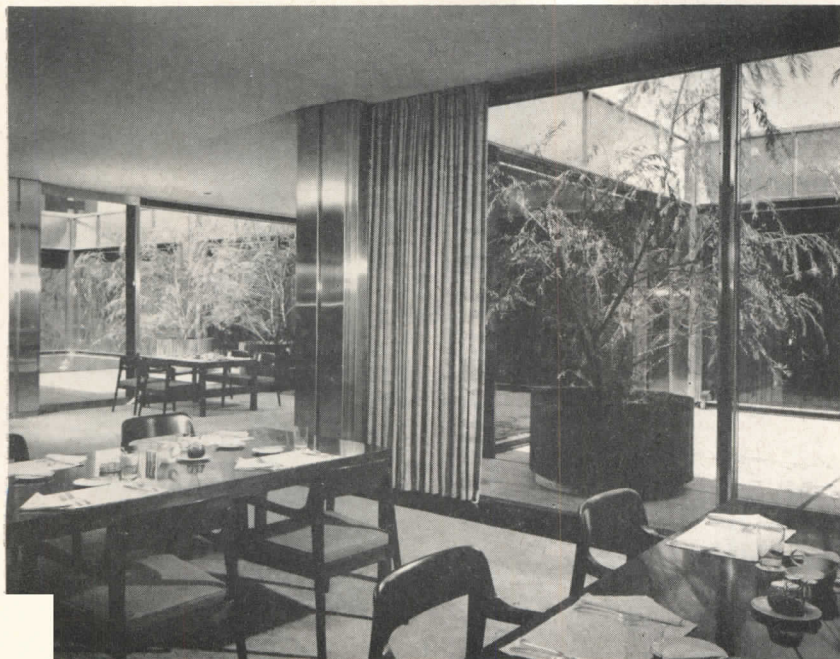

## Harris Trust and Savings Bank

### EXECUTIVE PENTHOUSE

The 23rd floor—shown on this page—is devoted to the board of directors room and to an executive and guest dining area. A kitchen on the eighth floor services both the employees' cafeteria at that level and the executive floor.

The board room centers on the architect-designed table of Burmese teak, which is supported on stainless steel legs. The 20 swivel chairs are upholstered in black leather and rest on stainless supports. The wall panels are of verde antique marble and walnut; the columns are clad in stainless steel.

The executive and guest dining areas are arranged about two attractively handled courtyard-gardens, open to the sky, which feature marble fountains and live willow trees



Bill Engdahl, Hedrich-Blessing



## AN ENCLOSED COURT HIGHLIGHTS

### A NEW KECK HOUSE

LOCATION: *Kenilworth, Illinois*

ARCHITECTS: *George Fred Keck-William Keck*

CONTRACTOR: *R. C. Wiebolt Co.*

LANDSCAPE ARCHITECT: *Atkinson & Fitzgerald*

INTERIOR DESIGNER: *Marianne Willisich*



Bill Engdahl, Hedrich-Blessing

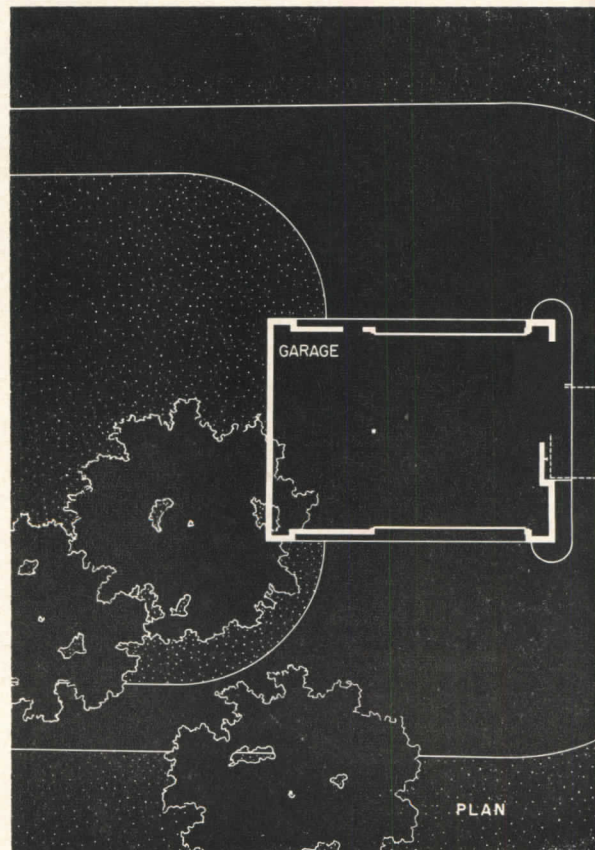
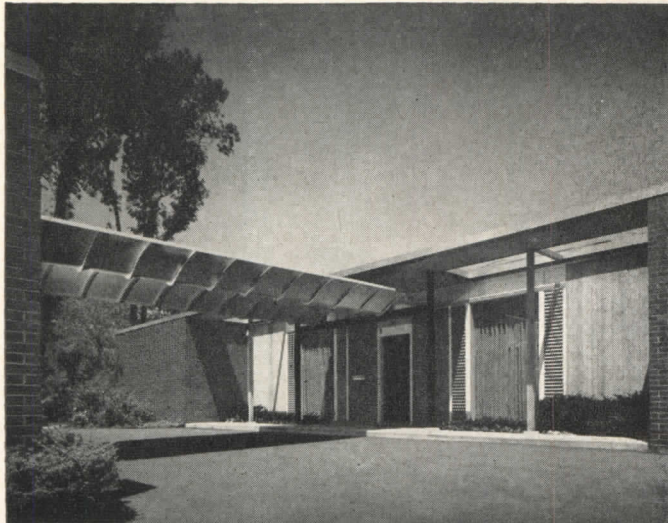
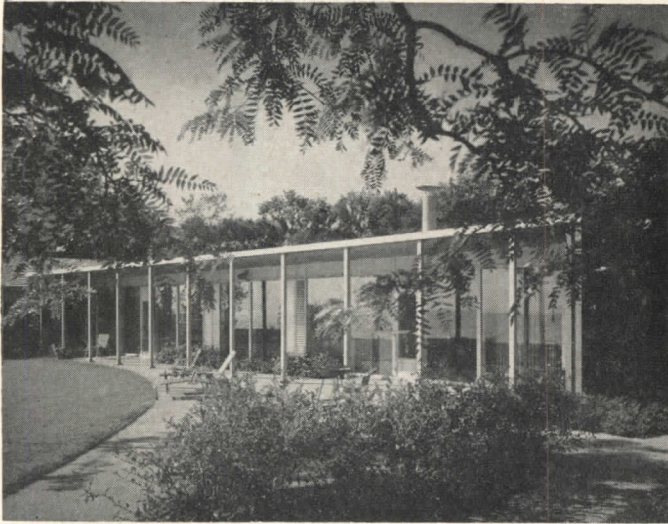



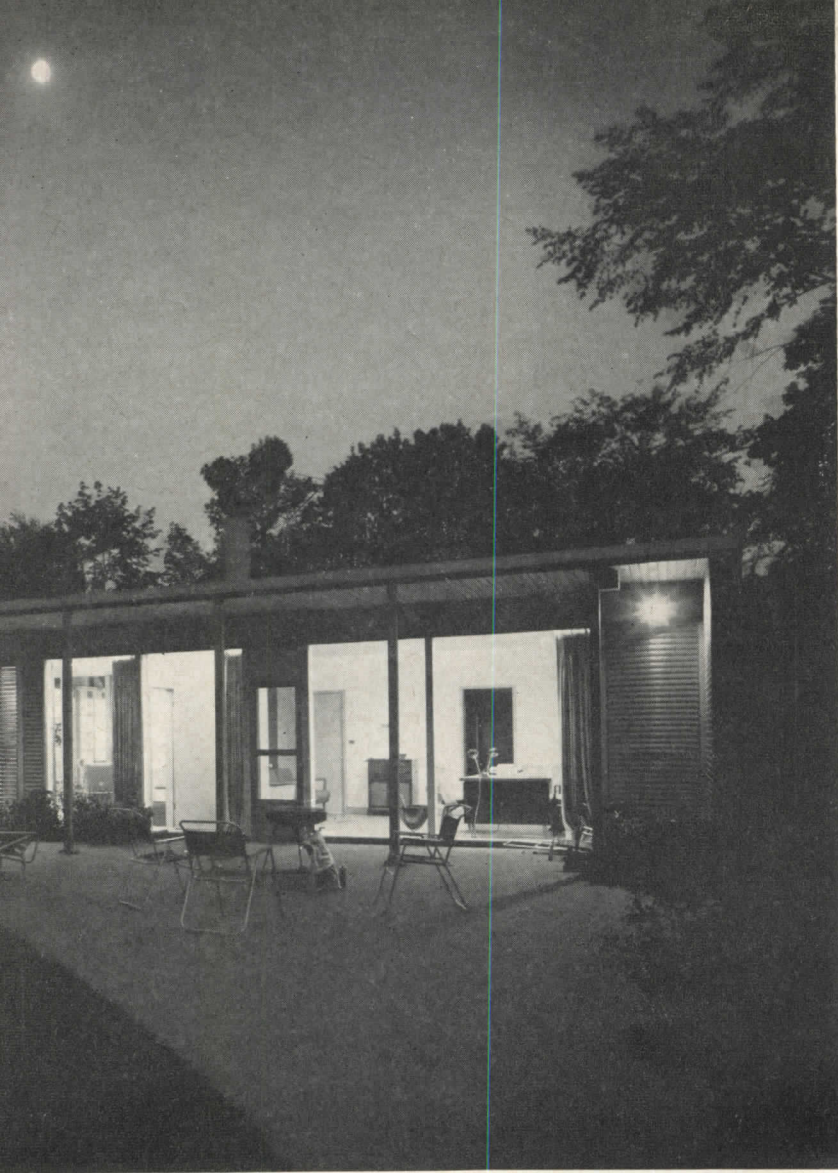

## A House in Kenilworth, Illinois

A sense of rather luxurious and relaxed formality pervades this sizeable new house by the Kecks. A number of their favorite design devices are incorporated in the scheme with great effect: a tidy, compact post and beam structure, fixed glass panels flanked by louver strips, a slender colonnade at the rear.

Two eye-catching innovations highlight the scheme, however. The plan focuses on a big, enclosed court which is flooded with light from a shallow clerestory and skylights. All rooms open directly on this court, giving wonderfully spacious connecting areas for entertaining. Shoji screens on two sides of the court can be closed to create hallways, and shield the dining area when desired. The court at all times serves as an extension of the living area.

The second eye-catcher is the contemporary version of the formal entrance drive: a detached garage with upward-acting doors on two sides so it can be driven through, connected to the entrance porch of the house by a porte cochere. In this case the latter is a bit of fanciful whimsy.

The structure of the house includes a concrete foundation, wood frame, brick and cedar exterior walls, wood and plaster interiors. The roof is built-up. Floors are variously vinyl tile, quarry tile or carpet. Windows are double glazed. Flashing is copper. Heating is by a hot water radiant system. The house also has an intercom and FM radio system. kitchen equipment is electric.

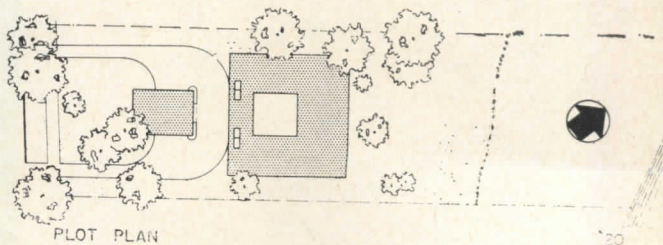
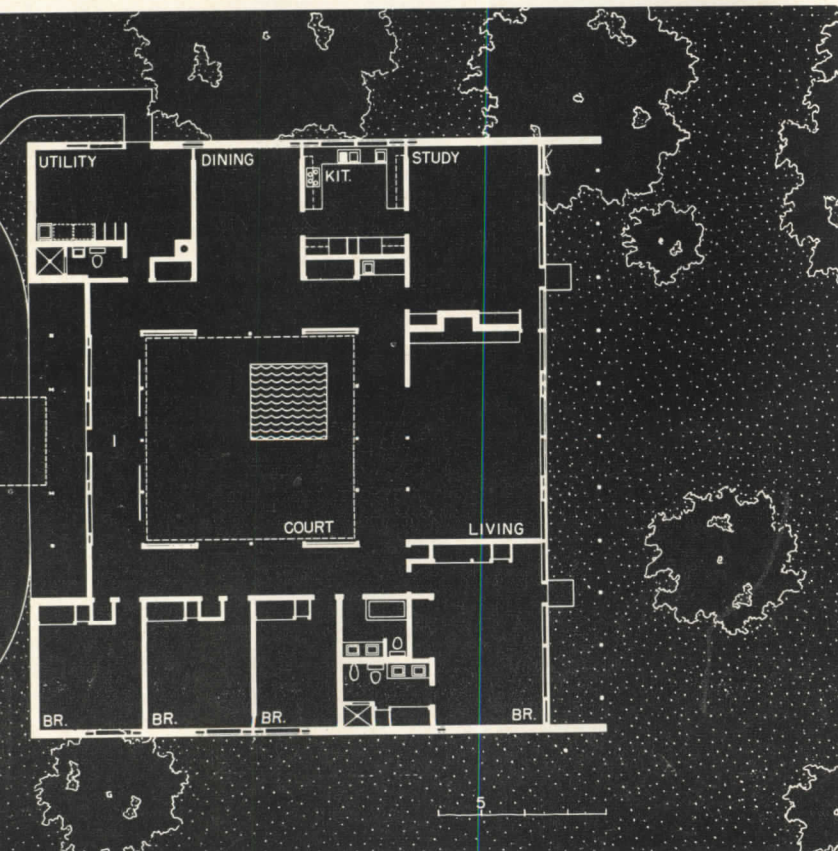



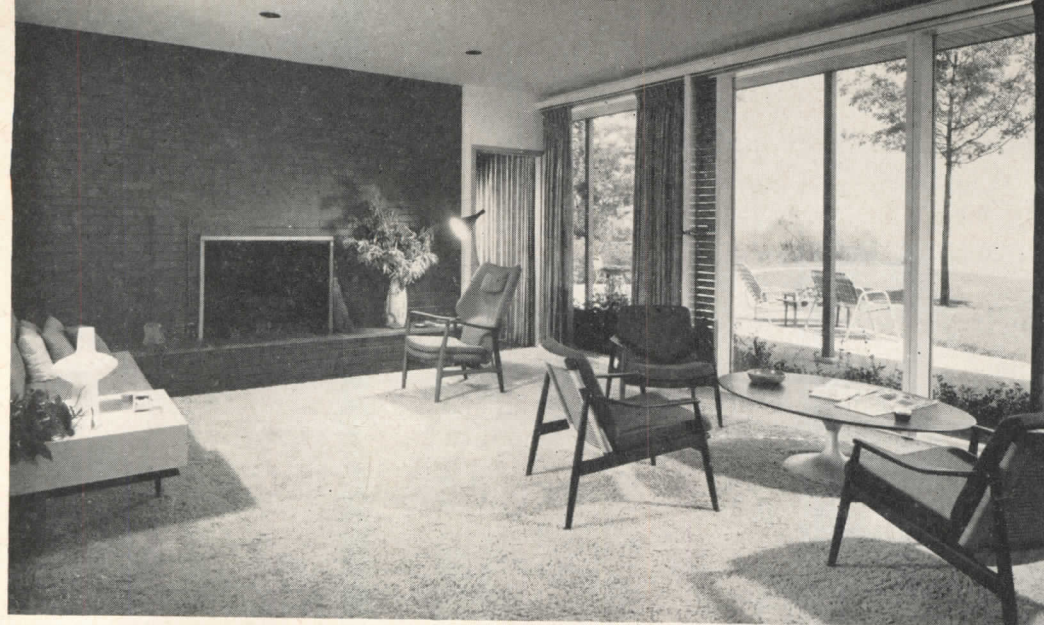

Bill Engdahl, Hedrick-Blessing

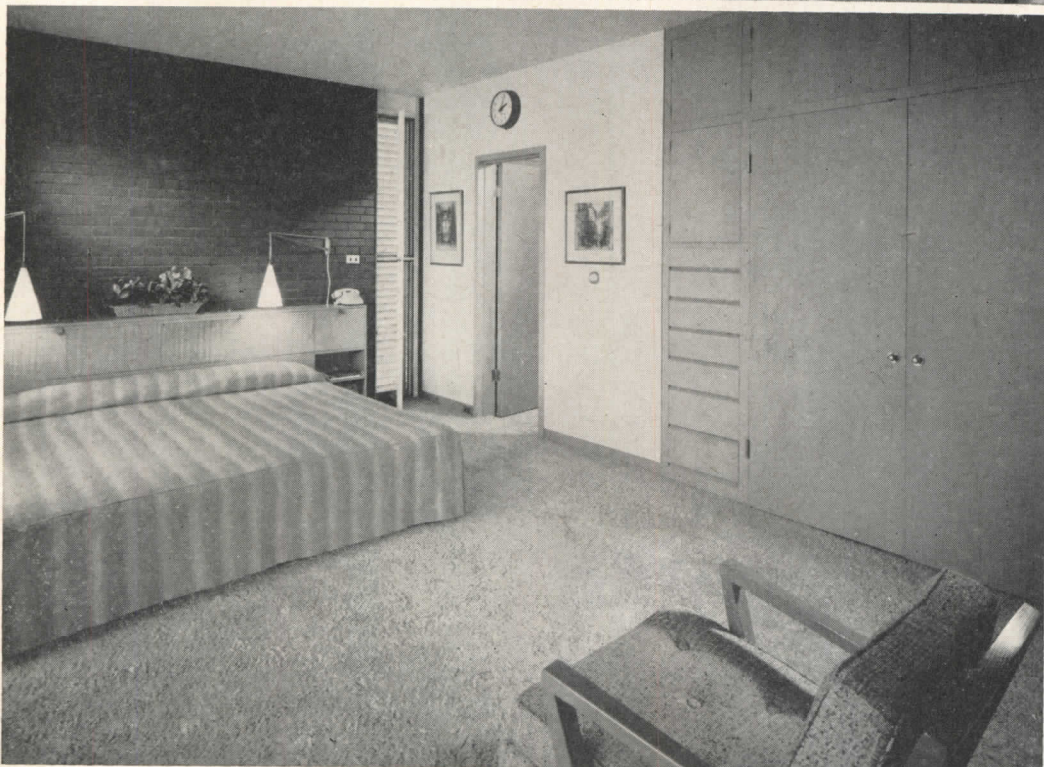

A House  
in Kenilworth, Illinois

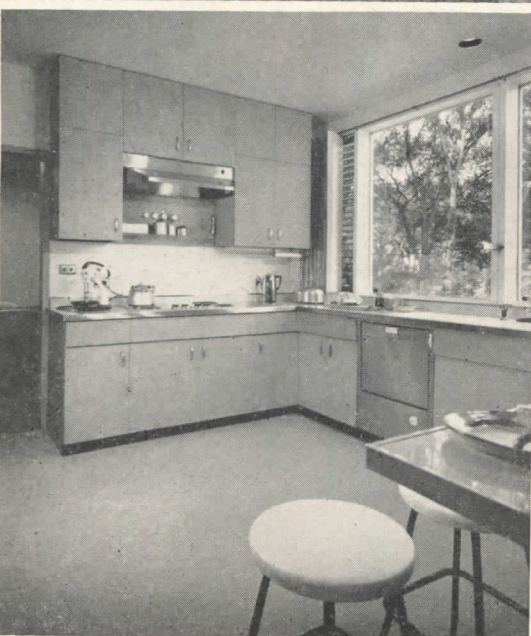

The living room is serene and comfortable, and is given clear definition from the court area double colonnade and by carpeting. On the opposite side, the living area overlooks the rear terrace and lawn.

The master bedroom (center) is lent an air of greater spaciousness by the profusion of built-in storage units, which minimize the need for extra furniture. The adjoining bath (bottom right) is semi-compartmented and has twin lavatories, shower and bidet, skylight and vent



# ORGANIZATION FOR EFFICIENT PRACTICE

## 5. Hellmuth, Obata and Kassabaum, Inc., Architects

In order to practice the type of whole architecture they feel is necessary in the world of today, Hellmuth, Obata & Kassabaum has instituted a flexible system of checks and controls. Not only does this system operate in the usual quantity areas of practice such as costs, time, and the like, but the firm believes they are enabled, because of the system, to practice a better quality of architecture through quality controls. The HOK systems and philosophies are discussed by the members of the firm in these pages

### Obata: HOK Philosophy of Design

The architect today is free as he has never before been free. No longer do the limitations of physical circumstance, of materials and techniques, provide him with a context of discipline within which he can achieve meaning. Today *any* space can be functional, *any* structure is possible. He is also free of national or regional characteristics—a Persian screen (in modern aluminum, to be sure, and gold anodized at that) is accepted as not out of place in Detroit. “The will of the epoch,” which Mies has said it is our ultimate task to express, is anybody’s guess, and we are all free to guess it as best we can.

Because of this unique freedom, because we can do anything we want to do, because we can meet all of the traditional demands upon architecture in an unlimited variety of ways, we face the problem of meaning in a new way. Meaning for architecture can no longer come from external esthetic theories like ‘functionalism,’ ‘structuralism,’ ‘Formalism,’ ‘mannerism’ or ‘brutalism.’ I suggest that meaning, and therefore discipline, must come from *within*. For me the only valid architecture today, the only architecture which can fulfill the demands made upon it as art and as building, and also escape the perils of falling into one ‘ism’ or another, and hence becoming trivial, is architecture which evolves outward, in a natural and organic process, from the program it sets out to fulfill.

In this approach, the greatest need is to understand the problem. In our work we seek always to penetrate to the essence of the client’s problem, and to understand it in all of its individuality. We try to let ourselves be en-

Mac Mizuki

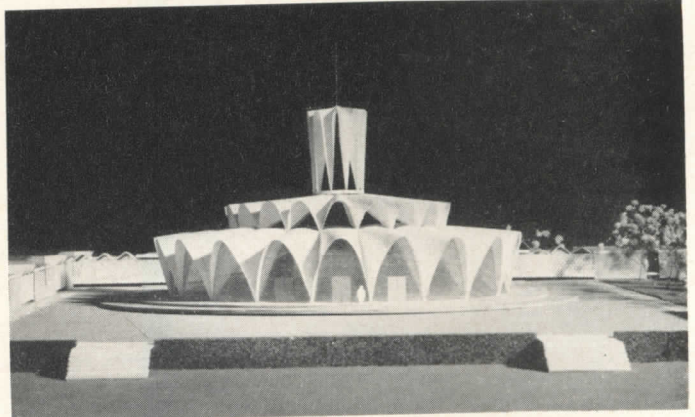

Priory of St. Louis and St. Mary, St. Louis, Mo.

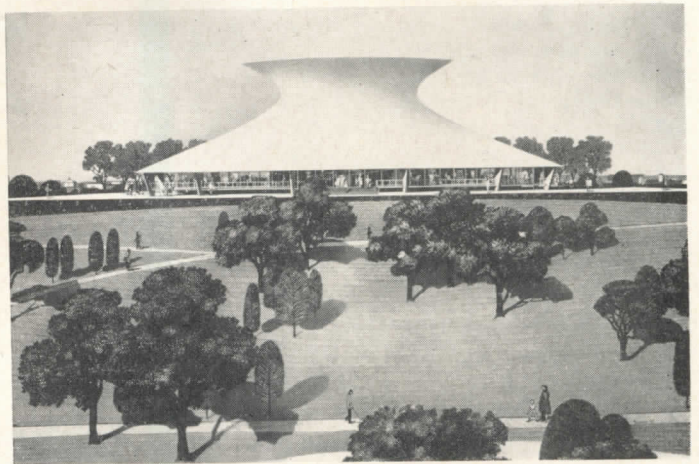

St. Louis Planetarium, St. Louis, Missouri

Mac Mizuki

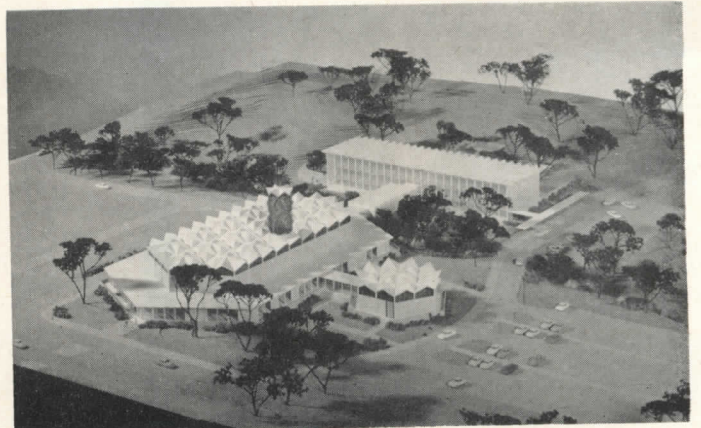

Temple Israel Synagogue and School, St. Louis County, Mo.



### No. 1 Basic Organization Chart

The basic organization of Hellmuth, Obata & Kassabaum, as shown in the chart, is divided into three main departments—management, design, and production. Each of these is directed by a firm principal who has the direct responsibility for his particular sphere of operations. There is considerable interplay between all of the departments, and each principal keeps himself involved in all of the work of the firm insofar as is practical

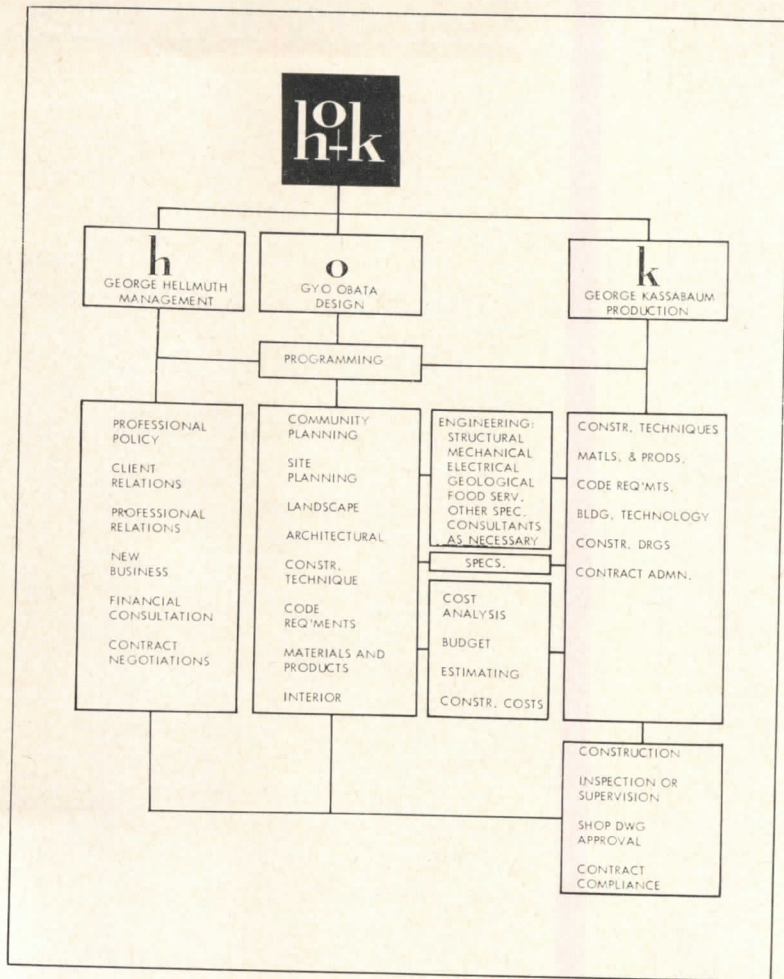

tirely grasped by, and in turn to grasp, the unique combination of needs, desires, aspirations and attitudes of this particular client and his particular program. When we can do this, then the project will, in a sense, design itself. I say in a sense, because I do not mean by "design itself" that anything mystical or beyond the rational control of the designer is going on, but rather that total understanding and absorption of the problem, when joined with rigorous study and broad experience, reveals to the designer the one right solution to that problem, the single design which for him is the design of that project.

This process proceeds by tough minded analysis, experimentation and research, all based on the principle of ex-

plotting the individual characteristics of each project to determine the expression of form and the arrangement of space and mass. Our Priory Church is circular because a monastic church with many monks participating in the service requires a central altar. The central altar is reflected in the tall lantern tower forming the upper tier of arches, while the lower tier of parabolic arches reflects the ring of small side chapels which are an important part of the church.

If the Priory Church design also expresses something of the grace and power of an ancient religion alive and relevant in the terms of the present, this too, follows from the approach to design which I have described. All of the

Art Fillmore

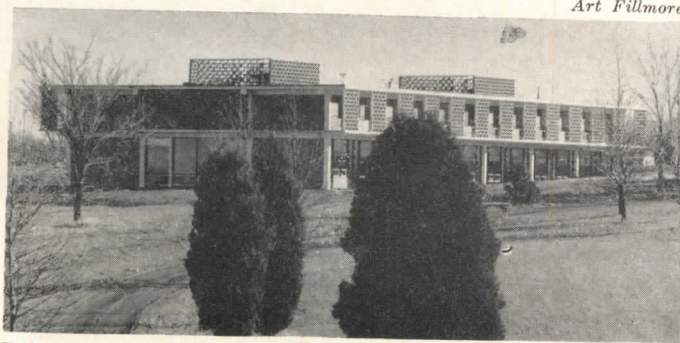

Priory of St. Mary and St. Louis, St. Louis, Mo.

Mac Mizuki

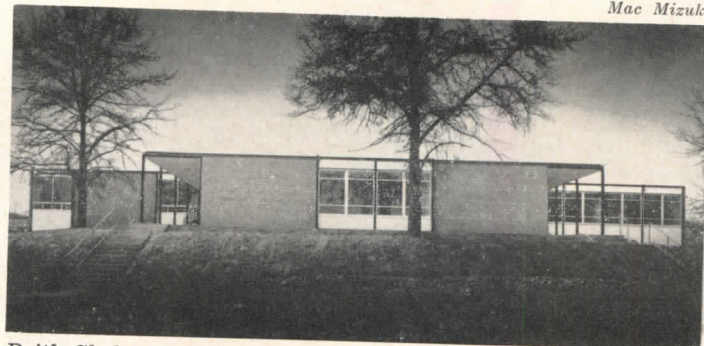

Brith Sholom Kneseth Israel Center, Richmond Heights, Mo.



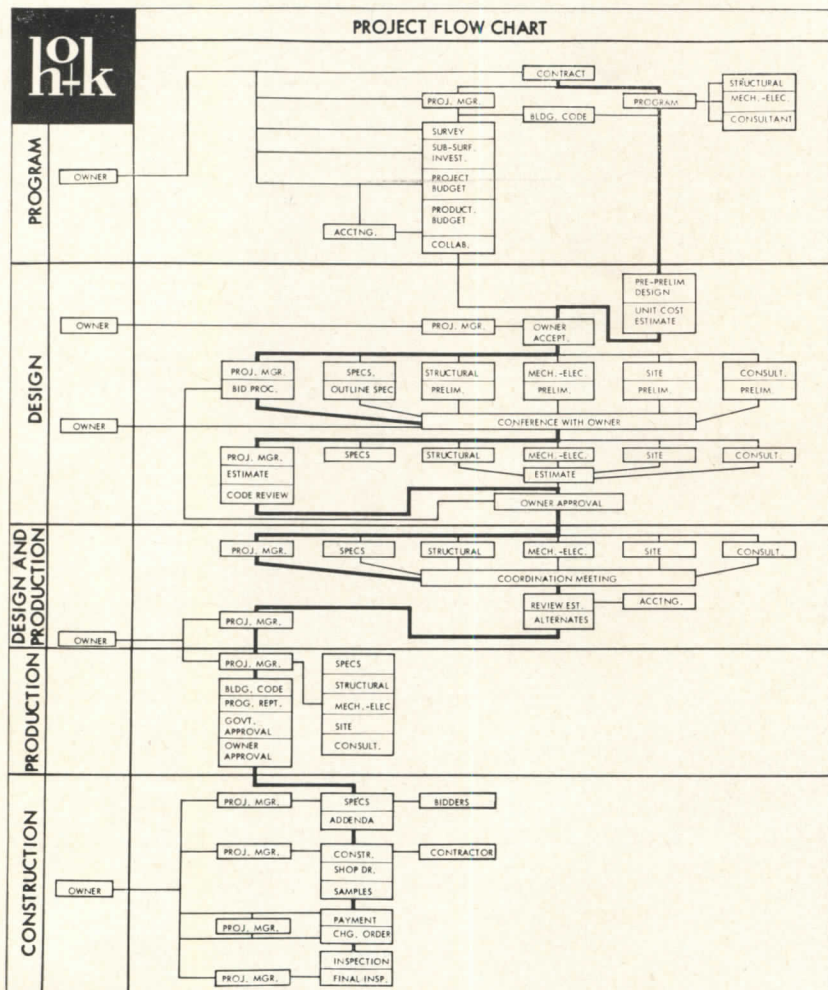

### No. 2 Project Flow Chart

This chart indicates the flow of projects through various stages. Another function is the definition of prime responsibility within the firm for different stages. Also shown are the principal points of client contact for consultations and approvals. To insure continuity in projects, most contacts with clients are made by the project managers in charge of individual commissions

projects shown here demonstrate the working of this approach—each is an attempt to express, in each detail as well as in the over-all conception of the design, both the functional requirements and the inner spirit of each building.

In doing this we have not consciously employed any 'style,' but have rather let the style of each project grow from the materials, the structure and the nature of the problem. Freed of the need for a constant search for new forms (for the sake of their newness) we can search for the right form. Freed also from the need for superficial ornamentation, we can exploit the essentials of each building to give it its own proper form and beauty.

This is, perhaps, the hardest kind of architecture to practice. It's easier to cram a program into a theory of design than it is to help a building be itself. And there is always the question, 'Is it right? Is this the one right expression of this project?' If we operate according to an external principle, then the principle will authenticate our work—at least for those who agree with the theory. But with us, there is no external authentication, and hence no absolute (even if only temporarily absolute) certainty. The result is to force us further and further into ourselves and into the heart of each problem, to seek there the only certainty we can know—the certainty of truth as we see it.

Gyo Obata

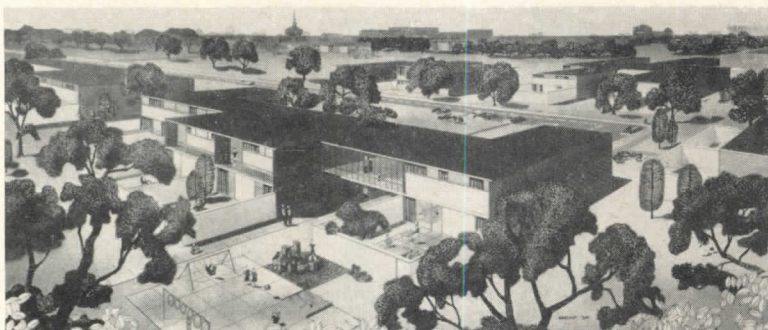

Burt Wencker Housing, St. Louis County, Mo.

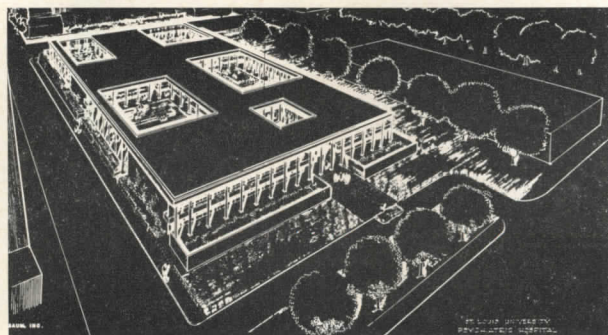

David P. Wohl Health Institute, St. Louis, Mo.



PROJECT BUDGET SHEET		HOK
PROJECT:		
a. Land Acquisition Cost	*	
b. Surveys	3,000.	
c. Soil Borings	2,500.	
d. Construction Cost	1,740,000.	
1. Buildings	1,680,000.	
2. Site	60,000.	
3. Off-site Utilities	-	IN CAFETERIA CONTRACT
e. Planning Fees 4.85 % of (d)	84,400.	
f. Consultants	-	IN PLANNING FEES
g. Reproduction of Bid Documents	1,100.	
h. Advertising	500.*	
i. Contingency 5 % of (d)	87,000.	
j. Interest During Construction	45,000.*	
k. Owner's Legal & Administrative Costs	1,500.*	
l. Owner's Supervision 1 % of (d)	17,400.*	
m. Equipment	2,000.	KITCHENETTES
n. Furnishings	144,000.	DRAPERIES, FURNITURE
o.		
p.		
TOTAL PROJECT COST		2,128,400.
* TO BE CONFIRMED OR ADDED BY OWNER		Approved by:
		(Owner) (Date)

No. 3 Project Budget Form

PROJECT CHECK LIST			HOK
PRELIMINARY	DATE	REMARK	
Contract signed	11-15-57		
Surveys ordered		} SURVEYS MADE PRIOR TO OUR CONTRACT	
Surveys received			
Test borings ordered	12-12-57		ADD'L DATA 5-58
Test boring data received	1-3-58		
Applicable Building Codes			BOCA + CLAYTON, MO.
Program received	11-22-57		
Preliminaries submitted to Owner	12-23-57		
Preliminary Estimate	12-23-57		
Preliminary approval of Bldg. Commissioner	12-19-57	VERBAL APPROVAL	
Owner's Approval on preliminaries rec'd.	1-8-58		
PRODUCTION			
Contracts with Collaborators	11-25-57		
Working Drawings Begun	3-3-58	HHFA APPROVAL REC'D.	
Completion Date	5-22-58		
Final Estimate	6-4-58		
Final Approval of Bldg. Commissioner and other Authorities	5-23-58		
Owner's Final Approval	5-23-58		
Drawings and Specs to Bidders	5-26-58		
CONSTRUCTION			
Work order issued	6-17-58		
Occupancy	9-9-59	PARTIAL OCCUPANCY	
Certificate of Completion	1-11-60		

No. 4 Project Check List

**Kassabaum: How Our Firm Works**

Modern times require systematic procedures. This switch from the individualized and rather unsystematic procedures for the practice of architecture in previous times may be attributed to several causes: (a) the expansion of the architect's role from design in a limited sense to everything from programming through construction supervision, (b) new techniques, (c) new materials, (d) more complex needs of more and different types of clients, (e) the modern emphasis on group decisions by clients, which in turn is bound to put greater trust in group decisions made by architects, particularly in materials selection, estimating and other technical areas. It is, in short, no longer fashionable to be vague, and when you have to

offer both the services of many people making up your architectural team, plus precision, you must have orderly procedures—system—or you wind up with chaos.

No doubt at this point the reader will ask, 'Yes, but how does your firm work?' One way to answer would be to discuss in detail the Project Flow Chart (page 139). Indeed this is the way a project is handled as it goes through our office. I believe that a better answer to the question (since the Project Flow Chart virtually explains itself) is simply: 'As smoothly and accurately as we can possibly make it in the light of current conditions.' I do not consciously intend to beg the question with an answer of this sort. The hard fact is that we at HOK do not practice architecture by formula, any more than our design

Alexandre Georges

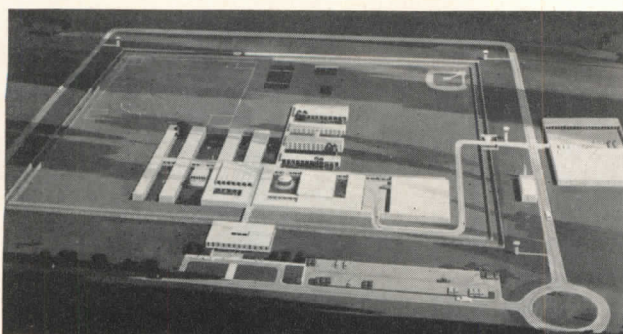

Federal Maximum Security Prison, Marion, Ill.

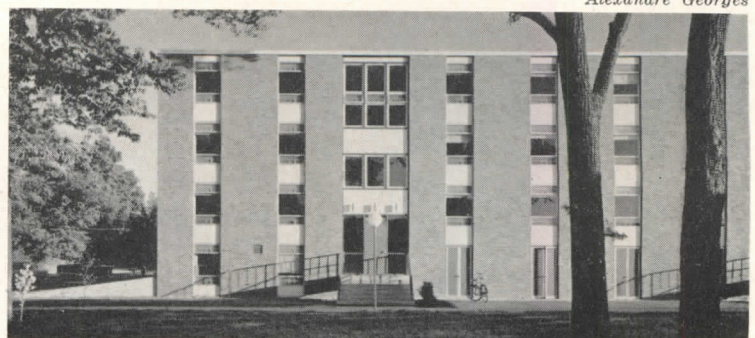

University of Missouri Men's Dormitories, Columbia, Mo.



No. 3 Project Budget Chart—prepared by the firm before starting preliminaries, to tie down financial considerations. HOK makes three estimates for each project, from sketches, intermediate drawings, and final documents, each based on accurate quantity surveys

No. 4 Project Check List—serves as a schedule and record of progress. Each project manager submits a revised form at the end of each month. In this way, controls are possible on individual job progress and the overall situation on all of the firm jobs

No. 5 Production Schedule—derived from project check lists and man-hour budgets. Projected ahead six months, schedule shows estimated progress of all jobs and man-hour requirements for efficiently handling the expected work load of the firm

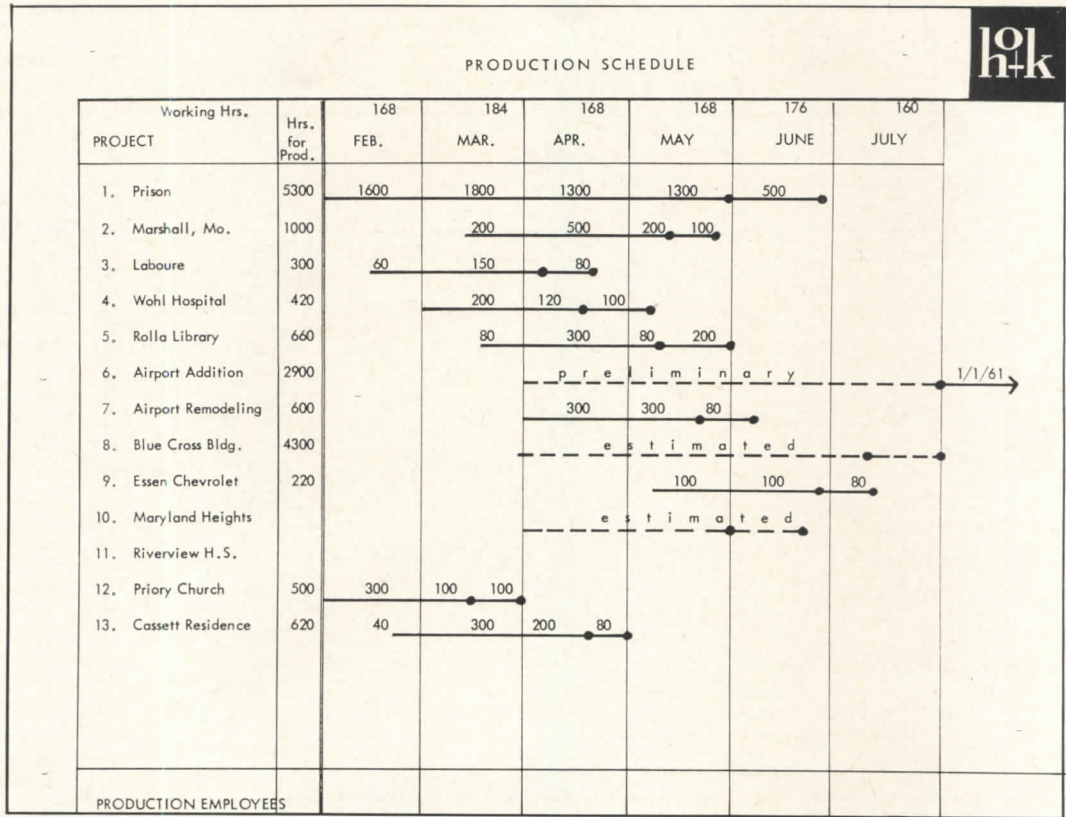

No. 5 Production Schedule

department produces design ideas for our architectural projects by formula.

What I am saying is that our charts, schedules and check lists exist for the sake of our operations, and the needs of our clients, not the other way around. In practice, starting with the client's needs and budget, this means that we do not stop with one estimate, and that based on unit cost. We make three estimates of our costs and sometimes more than three, always working closely with the owner to reach an understanding about other costs over which we have no control. These efforts result in what we hope are quite accurate Project Budgets similar to Chart No. 3 shown on page 140.

We do not have a fixed form for Planning and Pro-

cedures Studies (Chart No. 9 on page 144). We make one on almost every project that we consider, but the form (and most assuredly the content) can vary considerably from one project to another.

We frequently adjust our Man Hour Budgets (Chart No. 8 on page 143) as we go along, and particular problems may force periodic revision of our Production Schedules (Chart No. 5, above). Construction Schedules (such as the examples shown as Chart No. 6, page 142) would be most unusual indeed if the actual construction curves intersected the projected construction curves at every point. Even our Project Flow Chart itself has been recently revised to give a better representation of how work flows through the office.

© Ezra Stoller

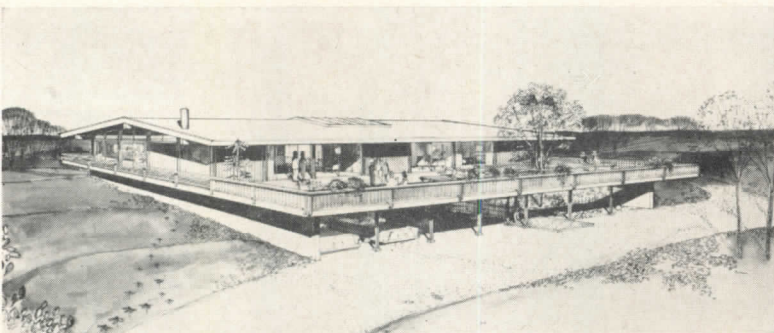

Wilson Residence, Ladue, Missouri

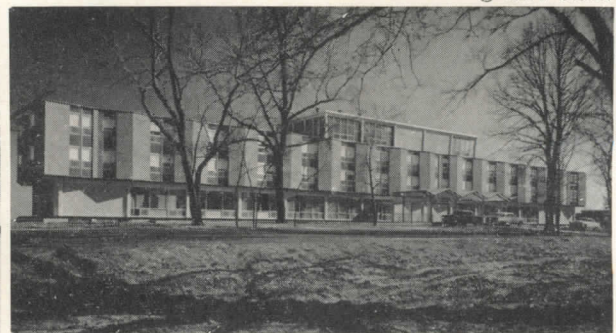

Good Samaritan Home for Aged, St. Louis, Mo.; Manske & Dieckmann, Associate Architects



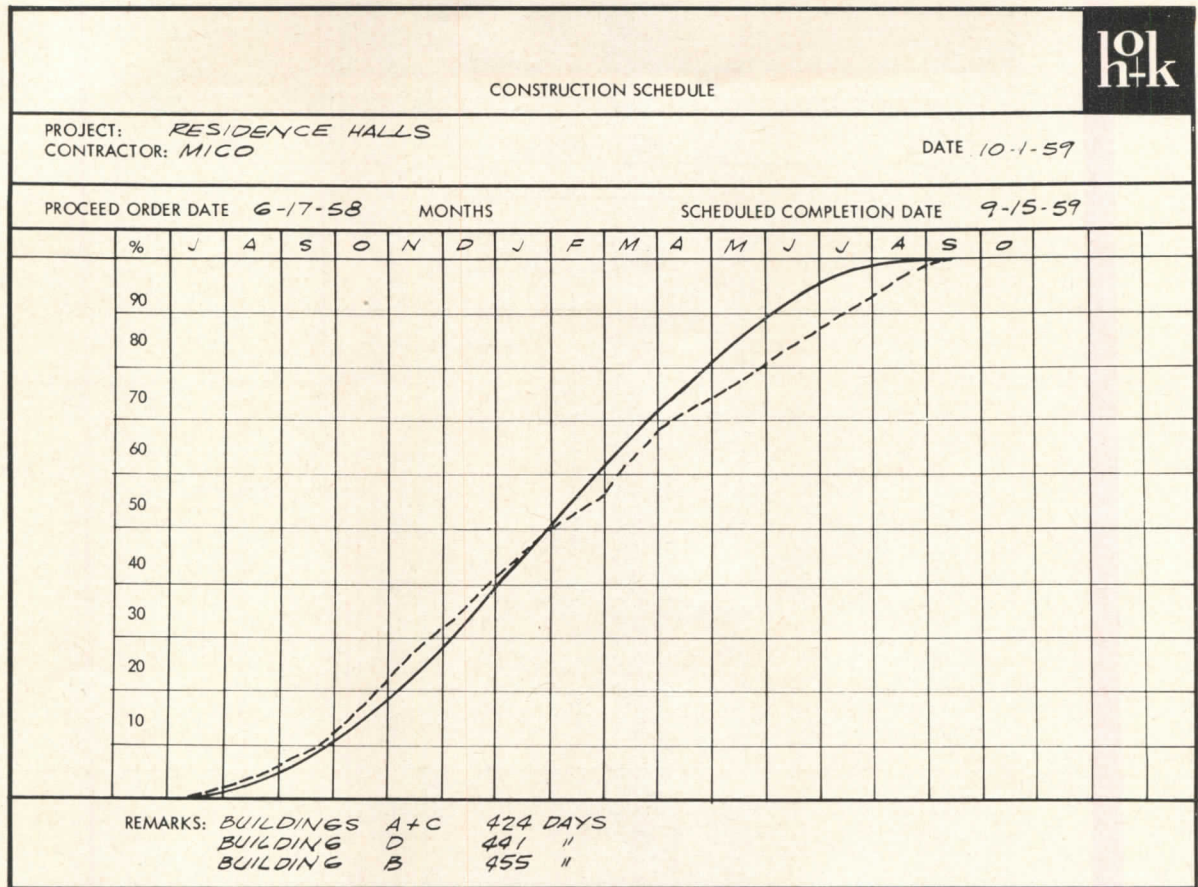

No. 6 Construction Schedule

Our intention in all of this is to serve our clients' total architectural needs, and the goal throughout all this seeming flexibility is to aim ever closer to the bullseye. We use the experience gained from one Planning and Procedures Study to make an even better one next time. We learn from the problems we may have had from one job to try to solve similar problems on the next job, in advance. We change our 'ideal' Construction Schedule curve every time we learn about factors which might alter it. Just as even these paragraphs represent some recent thinking on the question of how our firm operates, so do our procedures themselves represent plenty of hard thinking, before, during

and after our work on every project we do in our office.

We simply do not practice architecture at HOK in a rigid and inflexible way, so we are stopped, by our own method, from providing an unshifting picture of our operations. On the other hand, it may be of some help to know that we do alter our procedures to meet specific conditions, and also to learn, from our particular charts, schedules and check lists the procedures which up to this time, have proved quite valuable to us in maintaining the internal controls necessary for the successful practice of architecture in a busy office.

*George E. Kassabaum*

*Art Fillmore*

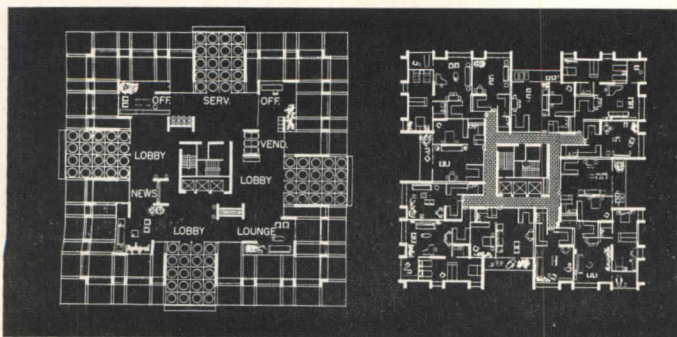

St. Louis Hills Towers Apartments, St. Louis, Mo.



Washington University Residence Halls, Clayton, Missouri



PROJECT COST INFORMATION SHEET						
PROJECT	RESIDENCE HALLS					
NO.	571032					
DATE BID	JUNE 13, 1958					
ENR BUILDING COST INDEX	560					
DESCRIPTION	4 BUILDINGS - 2 MENS AND 2 WOMENS 144 STUDENTS PER BLDG. - 576 TOTAL 203,36 FT <sup>2</sup> ENCLOSED AREA PER STUDENT					
AREA 117,140 ENCLOSED ( 98.1 % )						
TOTAL 119,461						
VOLUME 1,062,382						
	BID	% TOTAL	% GENERAL	\$/sq.ft.	\$/cu.ft.	\$/STUDENT
General	\$ 1,332,160.	77.17		11.37	1.25	2313.
Heating	170,840.	9.90	12.82	1.46	.16	296.
Plumbing	131,150.	7.60	9.84	1.12	.12	228.
Electrical	92,000.	5.33	6.91	.79	.09	160.
TOTAL	\$ 1,726,150. <sup>(1)</sup>	22.83%	29.57%	\$ 14.74	\$ 1.62	\$ 2997.
UNIT COSTS AT TIME OF BID				UNIT COSTS ADJUSTED TO: $\frac{5.60}{5.81}$		
\$ 14.74 sq. ft. (enclosed)				\$ 15.29 sq. ft. (enclosed)		
\$ 14.45 sq. ft. (total)				\$ 14.99 sq. ft. (total)		
\$ 1.62 cu. ft.				\$ 1.68 cu. ft.		
\$ 2997 /STUDENT				\$ 3109 /STUDENT		
REMARKS: (1) INCLUDES ADDITIVE ALTERNATES						

### No. 7 Project Cost Information Form

No. 6. Construction Schedule—prepared in advance of construction for each project, showing estimated time of construction as solid line; actual progress is plotted on form as broken line as the work progresses during construction. Helps architects in controlling time factors and in later analysis of deviations from estimates. Aids owner in determining when construction funds will be necessary and approximate amounts that will be needed

No. 7. Project Cost Information Form—master form, completed for each job after its final acceptance, contains complete data on major factors of construction costs for jobs

No. 8. Man Hour Budget Form—completed in advance for each project and amended as required as job progresses. This form, together with final actual production costs within firm helps the architects to control own costs in producing their jobs

MAN HOUR BUDGET			
Construction Costs	General Mech. & Elec.	1,390,000.	
	Kitchen	350,000.	
	Others	-	
	Total	1,740,000.	
Fee @ G %	4.85	104,400.	\$ 84,400.
Actual Fee	Difference		
	Less 1/5% No Supervision	20,000.	
	Reduction due to duplication		
Collaborator Fees	Mechanical 3.23 % of	338,000.	10,910.
	Structural 4.85 % of	1,740,000.	8,440.
	Kitchen - % of		
	Other - % of		
	Total Collaborator Fees		1,000.
			20,350.
Preliminary	a. 15% of Total Fee	104,400.	15,660.
	b. 25% of Reduction	20,000.	5,000.
	c. Less 90% of Prog. Cons.		
	d. Less 10% of Collab. Fees	20,350.	2,040.
			8,620.
	e. Less 5% Profit	8,620.	1,300.
	f. Less Direct Expenses		300.
	g. Less Estimating 40 hrs.		320.
			6,700.
			6,700/6.25* = 1072MH
Intermediate	a. 20% of Total Fee	104,400.	20,900.
	b. Less 27% of Reduction	20,000.	5,400.
	c. Less 3% of Prog. Cons.		
	d. Less 23% of Collab. Fees	20,350.	4,700.
			7,500.
	e. Less 5% Profit	10,800.	1,620.
	f. Less Direct Expenses		400.
	g. Less Estimating 80 hrs.		640.
			3,240.
			8,240/6.00* = 1370 MH
Working Drawings	a. 35% of Total Fee	\$ 104,400.	\$ 36,540.
	b. Less 48% of Reduction	20,000.	9,600.
	c. Less 7% of Prog. Cons.		
	d. Less 42% of Collab. Fees	20,350.	8,540.
			18,400.
	e. Less 5% Profit	18,400.	2,750.
	f. Less Direct Expenses		500.
	g. Less Estimating 80 hrs.		640.
			14,510.
	h. Less Specifications (min. 40 hrs. + 10%)	240 @ 6.25*	1,500.
			13,010.
			13,010/6.00* = 2168MH
Bidding Period and Constr. Contract Negotiation	d. 5% of Total Fee	104,400.	5,220.
	e. Less 5% Profit	5,220.	800.
	f. Less Expenses		200.
			4,220.
			4,220/6.25* = 672MH
Construction	a. 25% of Total Fee	104,400.	26,100.
	b. Amount Allowed for Supervision		
	c. Less No Supervision	20,350.	5,100.
	d. Less 25% Collab. Fees		21,000.
	e. Less 5% Profit	21,000.	3,150.
	f. Less Direct Expenses		400.
	g. Less Salary of Clerk of Works		9,000.
			8,450.
			8,450/6.25* = 1352MH
* LABOR + OVERHEAD MH - MAN HOURS			

### No. 8 Man Hour Budget Form

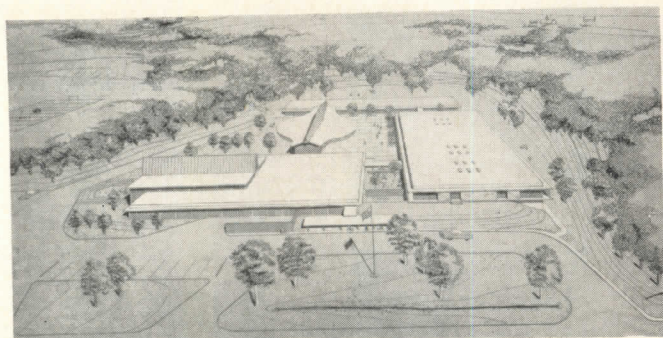

Leonard Steger Junior High School, Webster Groves, Mo. Caudill, Rowlett & Scott, Associate Architects

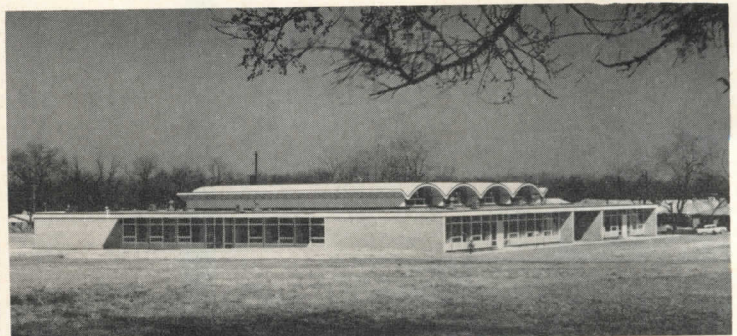

Warson Woods Elementary School, Webster Groves, Mo. Ezra Stoller



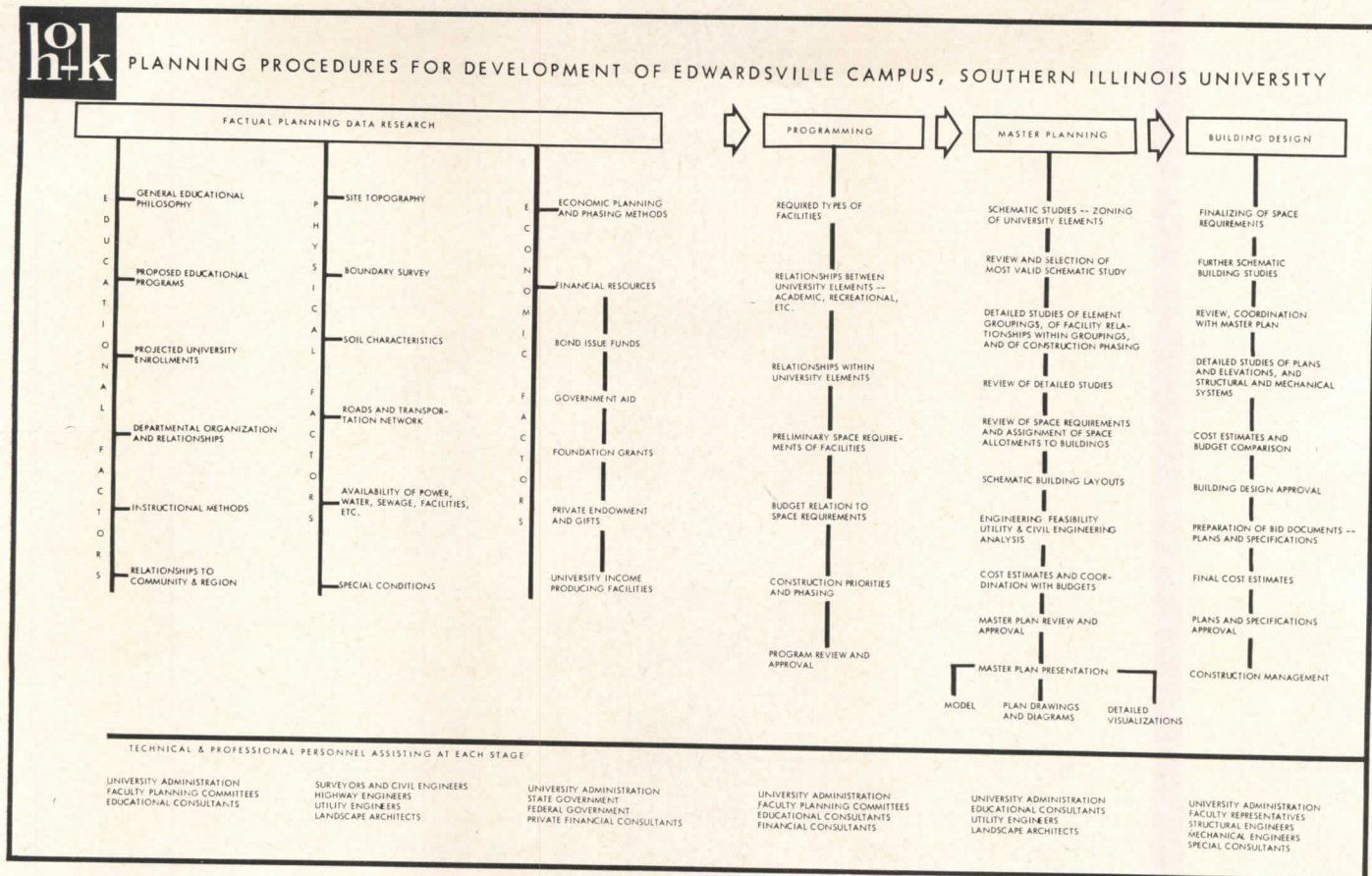

### No. 9 Planning Procedure Chart

HOK prepares this type of chart for each project of any complexity, as an aid in controlling its work and explaining it to clients. As George Hellmuth put it, in *ARCHITECTURAL RECORD*, February, 1960, p. 175, "The purpose of all this is to perfect a thoroughly hardheaded, cost conscious business operation in order to make available the creative abilities of outstanding architects to clients."

### Hellmuth: Practice of Architecture

Sixteen years ago I wrote down what I believed then to be some sound principles for building a broad practice. Reviewing the list recently only served to confirm what I had felt about them all along. Here are some of the points:

Specific clients whose interests are national and international have a tendency to have one firm do their work wherever it may be.

After a firm has completed several projects of one type, or for other reasons, it is considered expert. It can successfully compete for that type of business wherever that business may be located.

By effective local associations, other 'trade territories' can be added.

A helpful interest taken in architectural and engineering problems of (the right) people frequently leads to contracts, if not with those people then with others in allied or closely related fields.

An outstanding national reputation would, of course, be most productive, followed up by well directed personal calls by members of the firm.

All past clients of the firm should be continuously cultivated.

Unless past clients as well as new prospects see ample evidence of continuing vitality and a progressive tendency, there is always the possibility they will go elsewhere.

Ability to build an effective staff quickly—to man a

large project which suddenly goes ahead—is second only in importance to getting the contract.

These points have been valuable both to our firm and to me personally and they are, I believe, just as valid today as they were back in 1944. The trouble with them, of course, is that architecture is not practiced by formula. Assembling top talent, exercising crisp operational control, following a policy of "consultation unlimited," being ready to expand, showing continuing vitality, these things are not the whole story.

Architecture is not just putting up buildings. It is, in reality, a major part of a broad spectrum. Properly, it should start with programming, not just for one building or group of buildings but for local, state and even national plans. Properly, architects should function down through completion of construction, not in contracting, of course, but through the giving of helpful, indeed invaluable, construction supervision.

Many architects presently limit themselves to a narrow band on the spectrum. We at HOK propose to widen our area on that spectrum, for we believe the added strength resulting from such broader participation is central to the solution of architecture's major problem in the days ahead: to secure a place at the council tables where community, state and national planning policy decisions are to be made in the future.

George F. Hellmuth.



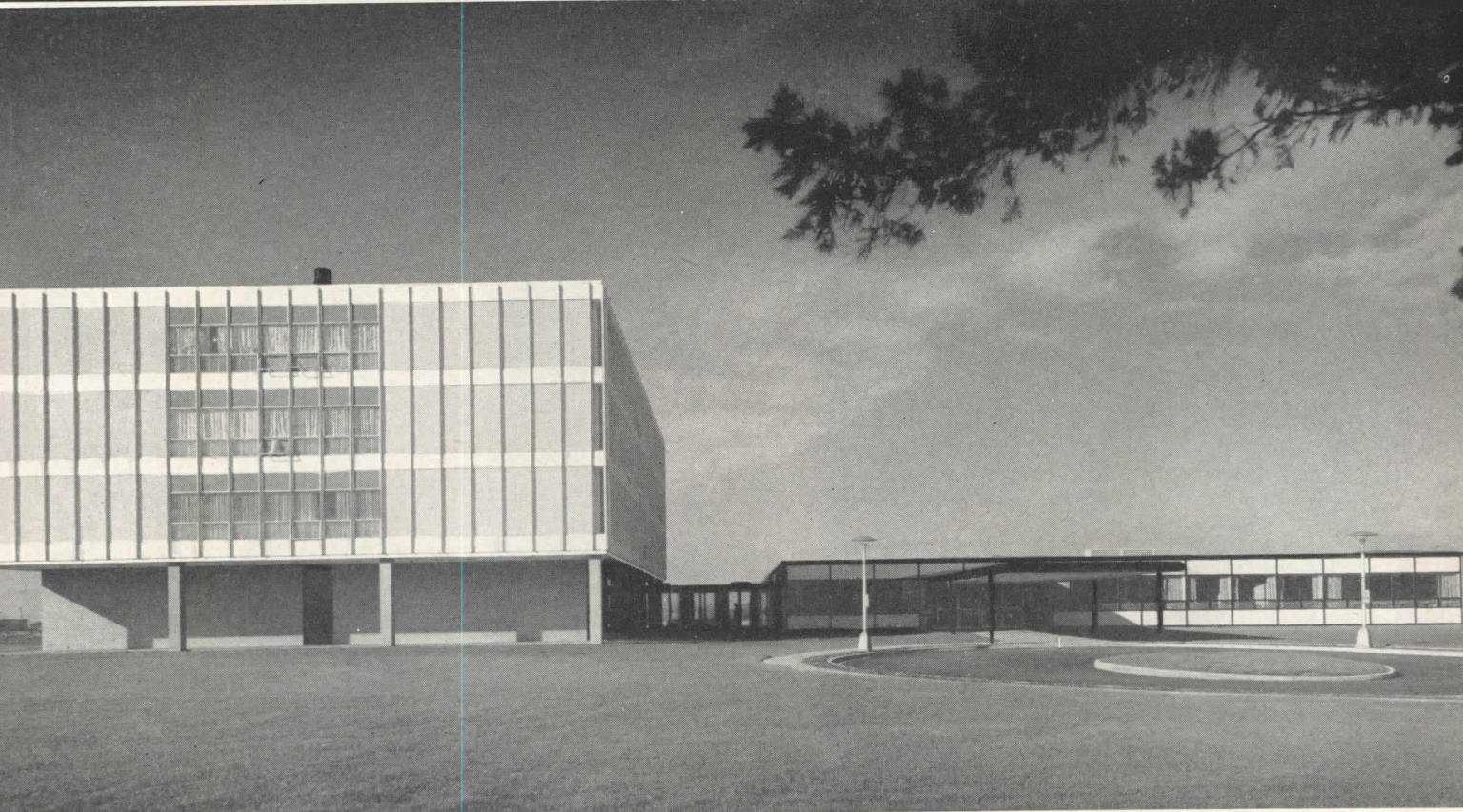

Bill Engdahl, Hedrich-Blessing photos

## HOSPITAL WILL GROW WITH SUBURB

### *Northwest Community Hospital*

LOCATION:  
*Arlington Heights, Ill.*

ARCHITECTS-ENGINEERS:  
*Skidmore, Owings & Merrill*

CONTRACTOR:  
*B. W. Handler Construction Co.*

Located in a rapidly expanding suburban community northwest of Chicago, this hospital was designed to keep pace with the suburban growth. It is expected that the present 100 beds must be supplemented by an additional 200 in the next few years. Accordingly, the board of trustees and architects decided to purchase 15 acres for the prime hospital site and an additional 12 acres for future related hospital facilities. According to long-range designs made by the architects, this site will be more than adequate for the projected 300 beds and 350 auto parking spaces.

The present plant consists of a four story and basement nursing unit connected by covered walkways with a one story ancillary facility unit. Eventually, both of these units will have additions, and a similar complex will be built alongside.

The hospital was designed for efficiency, cleanliness, and all of the other criteria usually associated with medical buildings, and with a further goal in mind—that of providing the best possible atmosphere for healing through the means of fine detailing.

The nursing unit has a reinforced concrete frame, while the ancillary unit structure is steel frame with a bar joist and metal deck roof structure. Exterior walls are face brick and aluminum framed curtain walls with insulated porcelain enamel panels. The curtain wall is glazed with ¼ in. plate, while the steel windows of the ancillary unit have grey tinted glass. Interior partitions are solid plaster on metal studs, except for special areas such as operating rooms which have glazed structural tile and toilet rooms which are finished with ceramic tile.



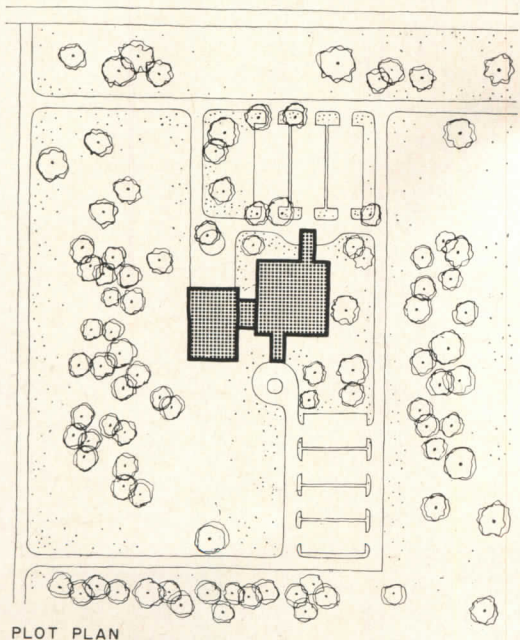
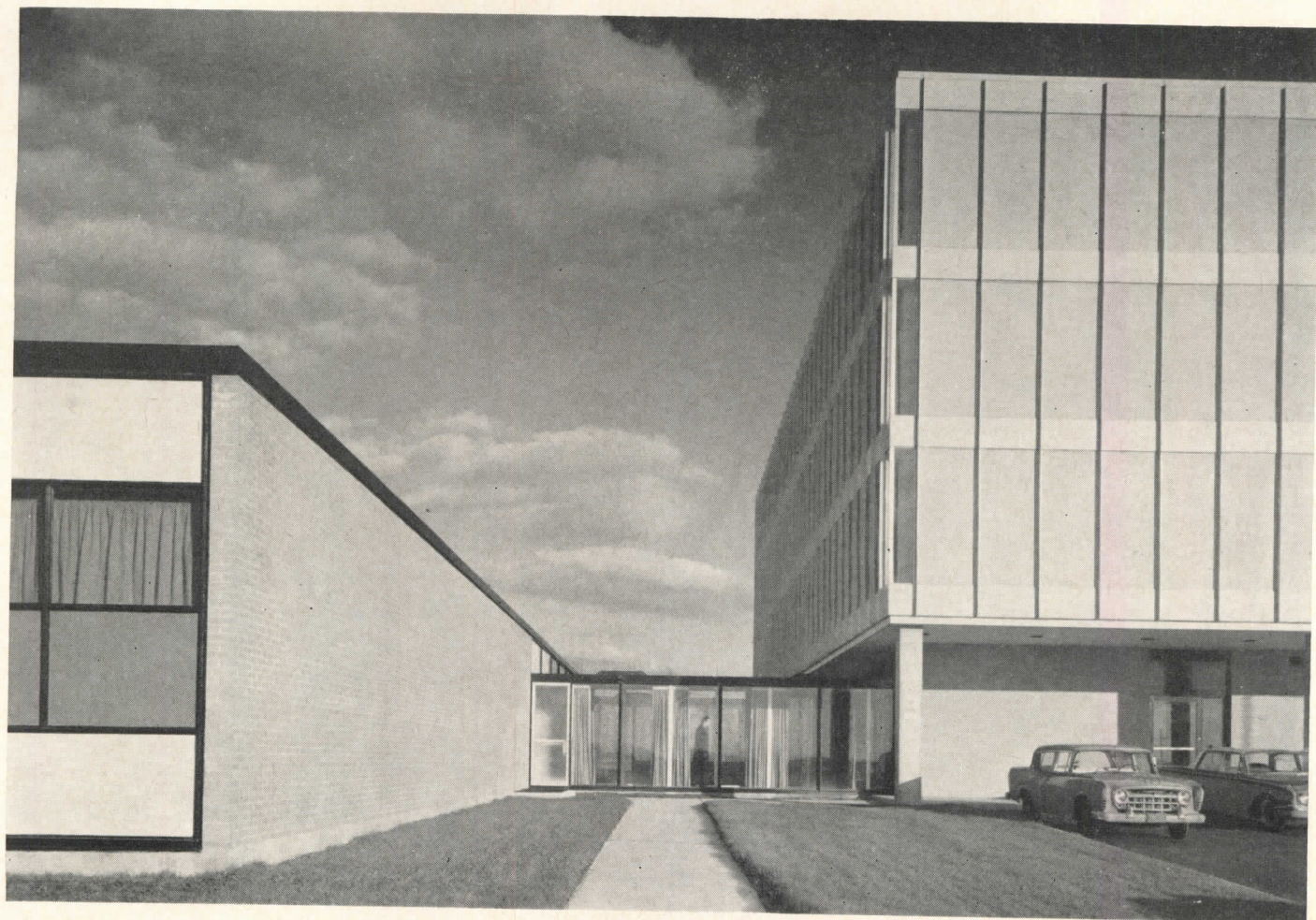

PLOT PLAN

The present structure, as shown in site plan, was designed for expansion in stages to 300 beds. This will be accomplished by adding on to the present nursing and ancillary units in the ensuing expansion stages, and eventually building another complex similar to the existing, but with its plan reversed, attached to the present building. When this stage has been completed, the hospital will have facilities for a total of 300 beds

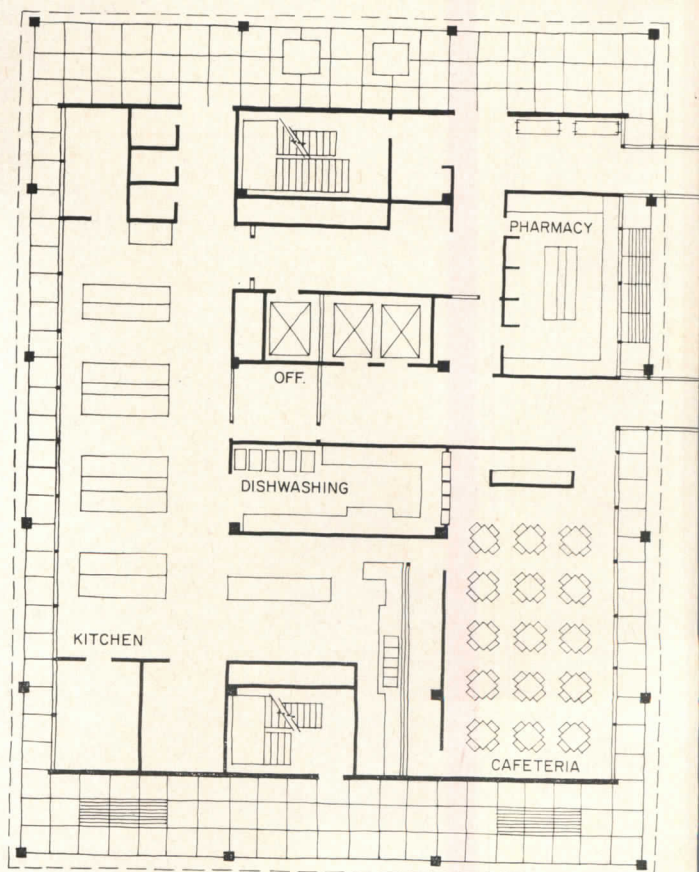

GROUND FLOOR - NURSING WING



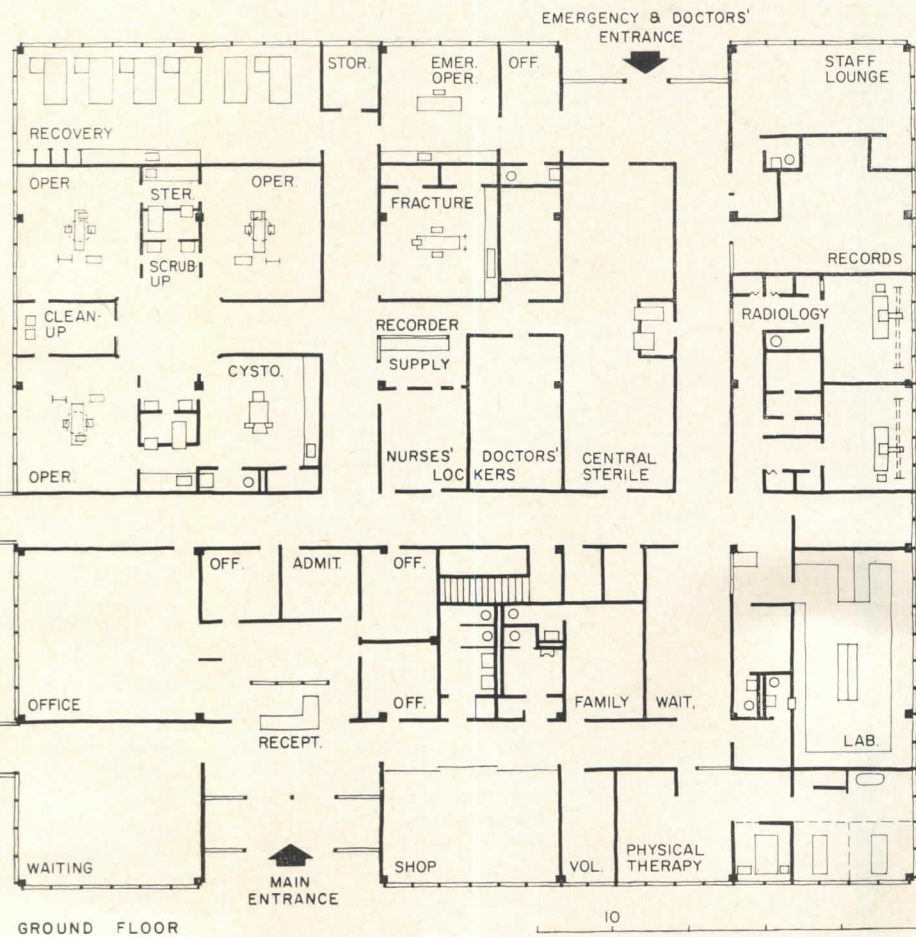
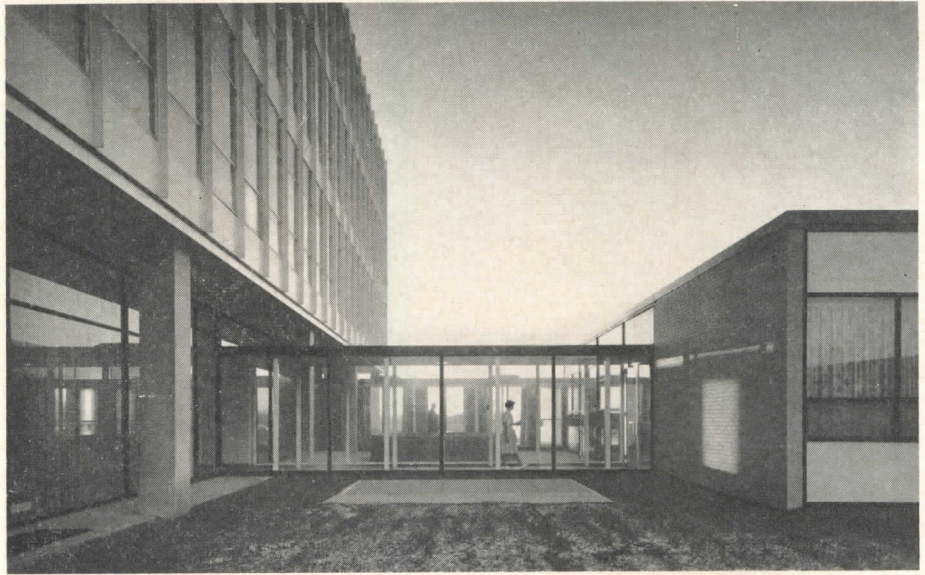

## Northwest Community

The two major units of this hospital are a four story nursing building connected by two covered walkways with a single story unit containing ancillary facilities. The first floor of the nursing unit building contains the dining area and its related service areas—kitchen, bakery, and storage. In addition, the pharmacy is located here. Separate direct entrances to this building are provided for employes and service. A covered walkway is provided for visitor and patient entry to the ancillary building, a second walk for service entry. The emergency entrance is located at the rear of the one story element. A full basement contains mechanical equipment, central storage and housekeeping facilities, and the autopsy room



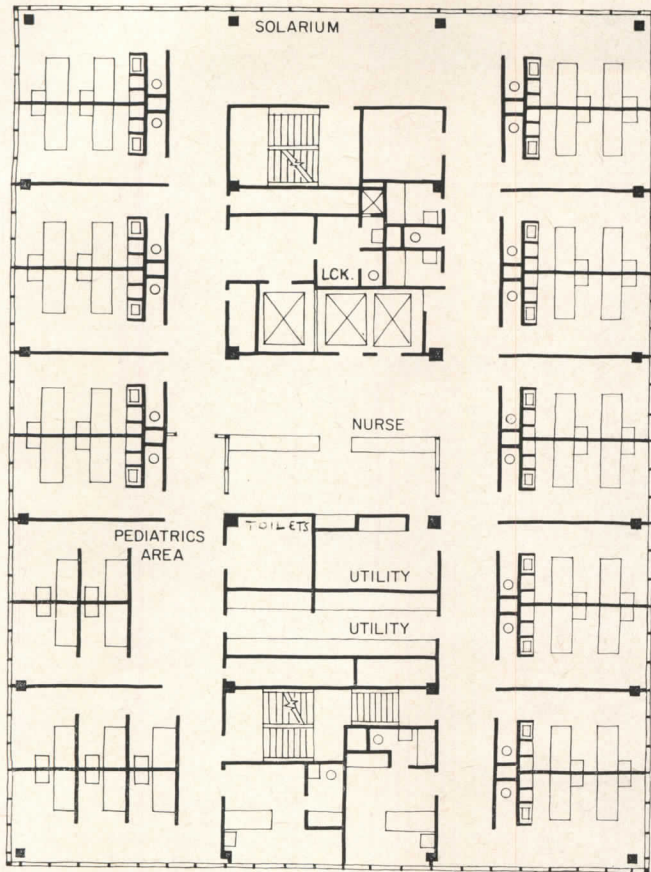

THIRD FLOOR

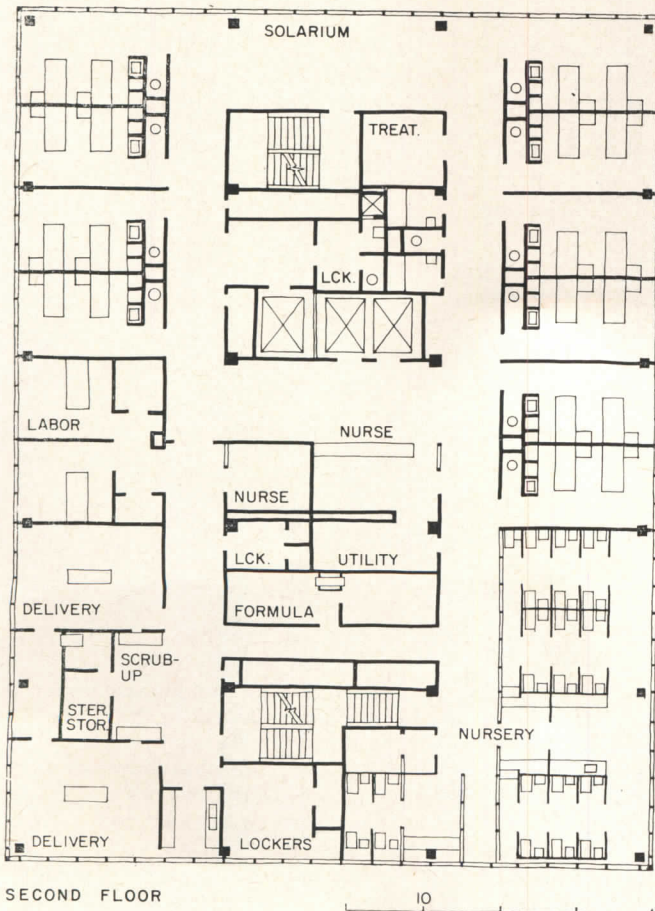

SECOND FLOOR



### Northwest Community

Above: The hospital main entrance, located in the medical-surgical wing. On the right, in this view, is the reception desk; the main waiting room is shown in the background. The second floor (plan at lower left) contains the maternity nursing unit. The third floor (left, top) is similar to the fourth floor nursing unit, except that a portion of the third is used for pediatrics. All three nursing floors are planned around the central service core, which contains elevators, public lobbies, service lobbies, nurses stations and work areas, lockers, toilets, treatment rooms, and stairs. Hot water heating is provided in this entire unit. The central cores are air-conditioned and provisions have been made for future conditioning of patient bedrooms utilizing the duct spaces located between the patient bathrooms



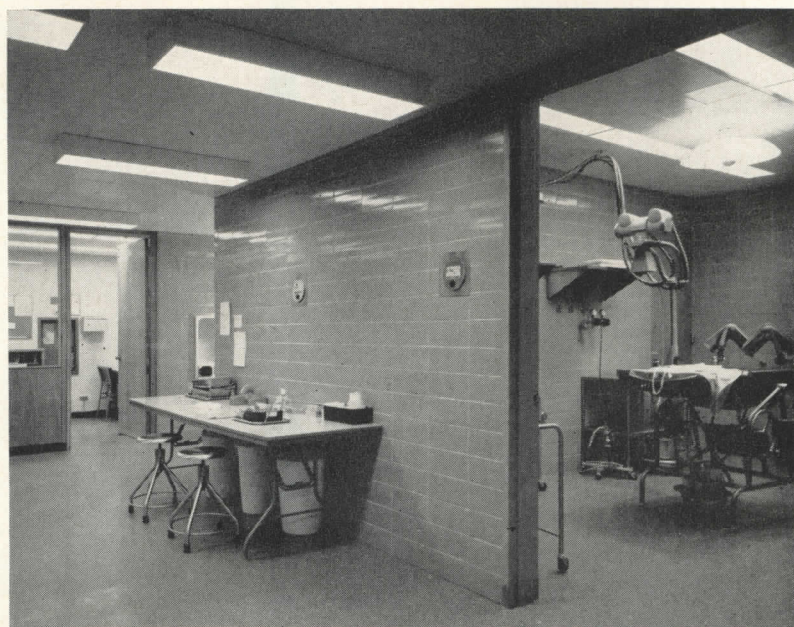

Above: view of the main dining area, which is located on the first floor of the nursing unit. Dining is operated cafeteria style; the serving line is located on the opposite side of the room from the windows shown. Entry to the room is from the nursing unit lobby shown in the background. The surgical suite (right, top and middle) are located in the ancillary building, on the ground floor. The three operating rooms and the cystoscopy room are located around a common central area, as shown. Closely related to this suite are the emergency operating and fracture rooms, recovery room, and central supply. Surgical suite walls are glazed structural tile; floors are conductive vinyl; ceilings are metal pan acoustical tile. Right, below: a view of a typical utility area of a nursing station. Hospital consultants for the owners was Ross Garret & Associates. Skidmore, Owings & Merrill personnel responsible for planning were: James W. Hammond, Partner-in-Charge, Wilbur A. Mullin, Project Manager, Thomas Houha, Project Architect, Fred Wilbur, Technical Coordinator

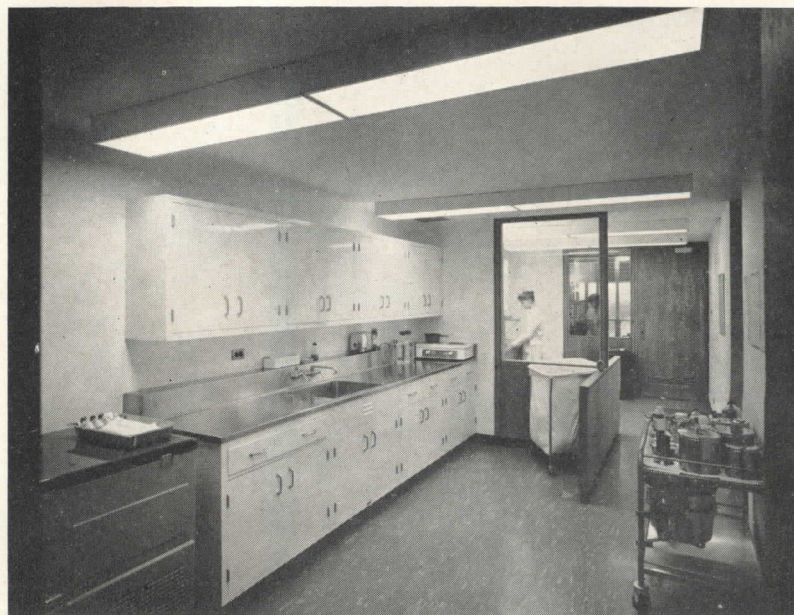



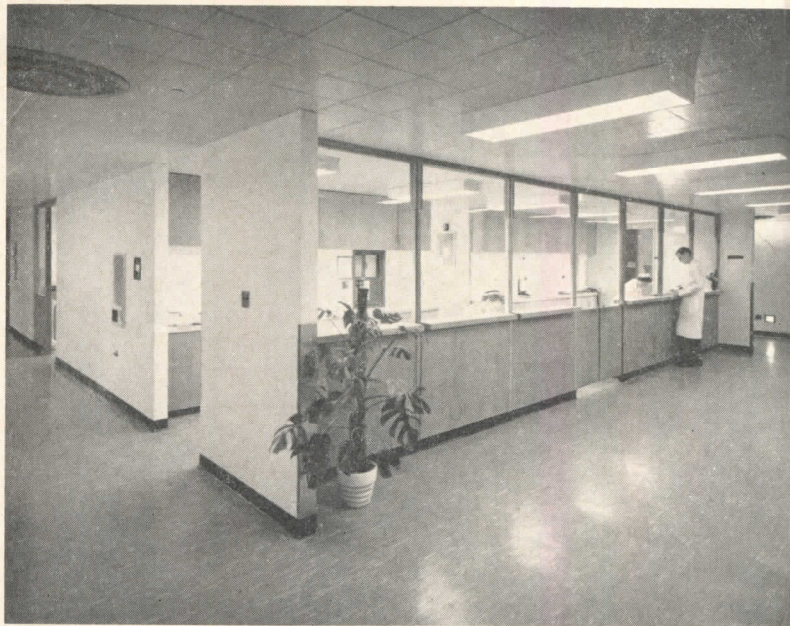

### Northwest Community

Nurses stations, similar to that shown right, top, are located on each nursing floor, in the central service cores. The placement of the stations make it possible for nurses to care for patients with a minimum of lost time in travel to and from the bedrooms. Wall finishes in these areas are plaster or wood panels. Floors are asphalt tile. Plastic wall coverings are used on walls of halls and special work areas. Most of the patient rooms (as shown) are double bedrooms. Each has a closet-storage-lavatory unit within the room and a separate toilet. Windows are continuous as shown, and are glazed with  $\frac{1}{4}$  in. plate. Hot water heating units are raised from floors, for ease of cleaning and to provide a sense of security for patients who might otherwise react unfavorably to the large glass areas

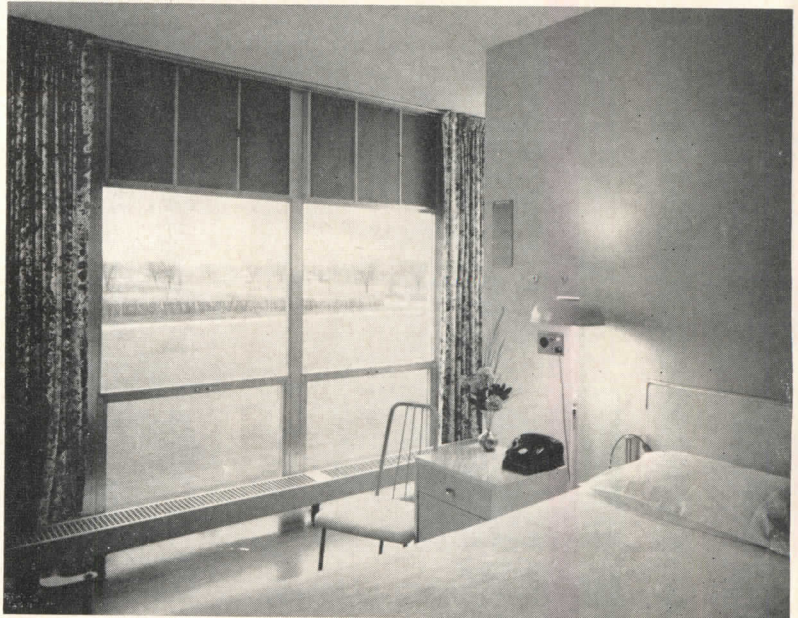
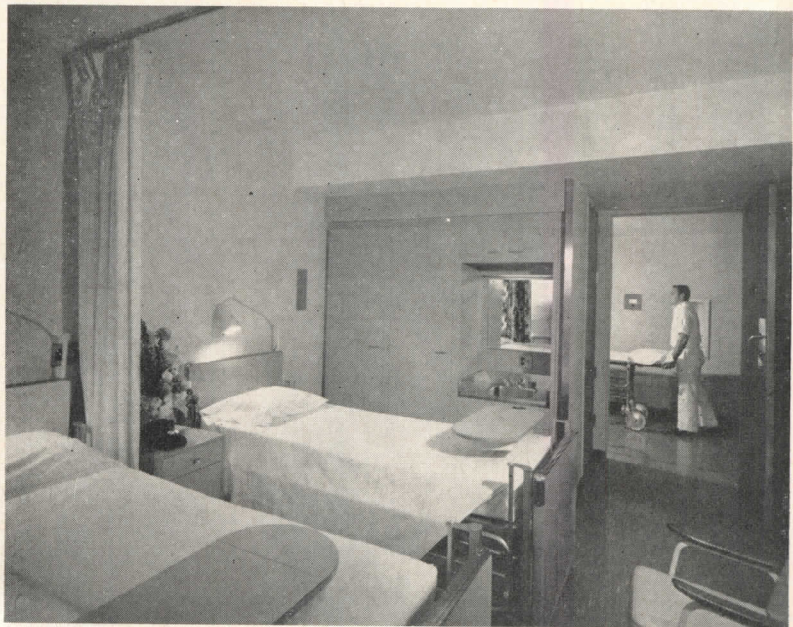



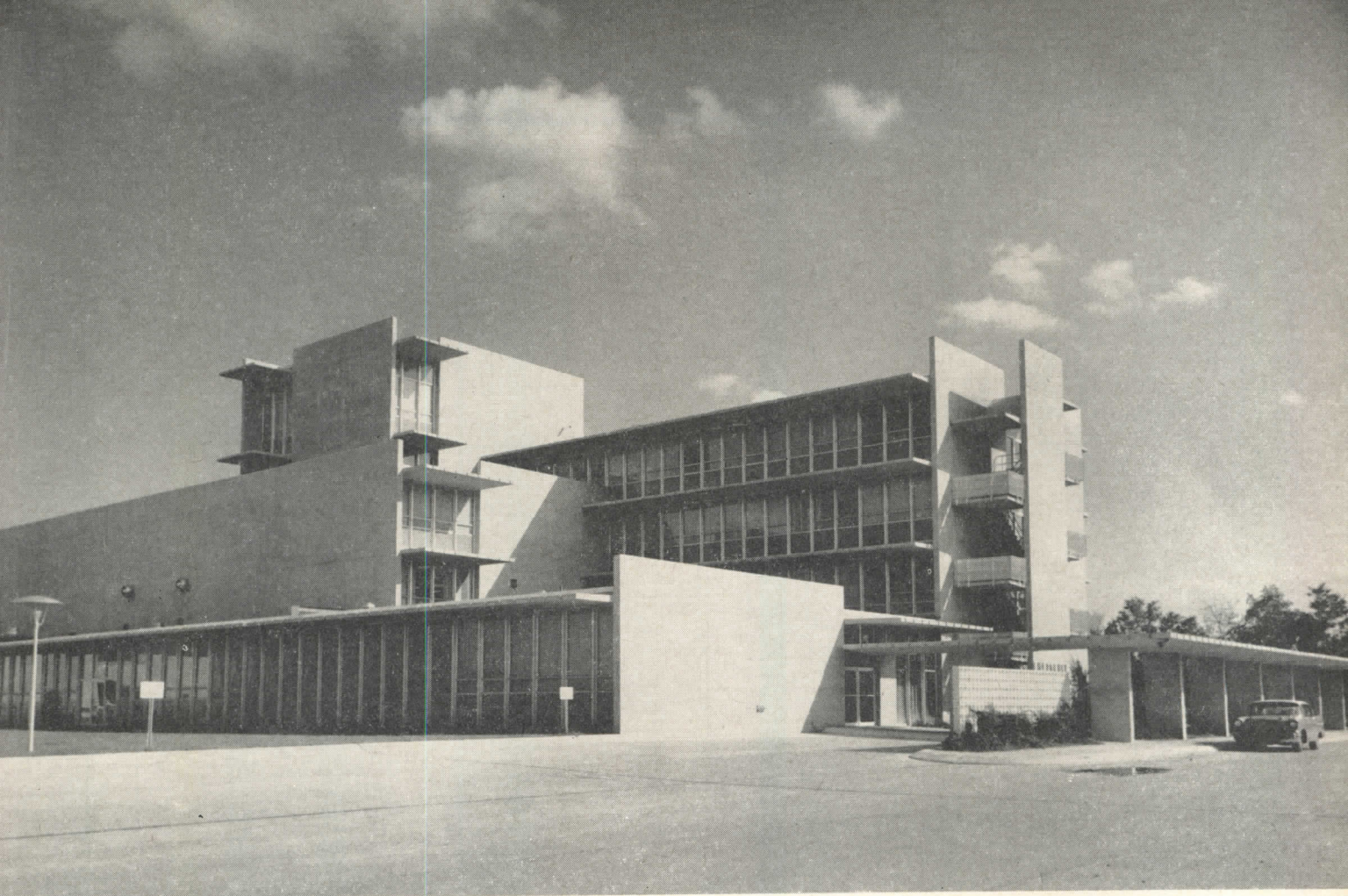

Darrell De Moss photos

## HOSPITAL FOR INDUSTRIAL COMMUNITY

### *West Jefferson General Hospital*

LOCATION:

*Marrero, Louisiana*

ARCHITECT:

*L. F. Dufrechou*

HOSPITAL CONSULTANTS:

*Bankston Assoc.*

STRUCTURAL ENGINEER:

*Walter E. Blessey*

MECHANICAL AND ELECTRICAL ENGINEERS:

*Guillot, Sullivan & Vogt*

CONTRACTOR:

*Keller Construction Co.*

West Jefferson General Hospital is located in the geographical center of population of the heavily industrial west bank of the Mississippi across from New Orleans. To a large extent, the industrial character of the surroundings determined the planning of the hospital. The emergency facilities are unusually large, and are located for convenience and efficiency on the ground floor. They are provided with an entrance removed from those used by other patients, visitors, and staff. The normal capacity of the hospital is 160 beds, with 178 maximum. Of these, only 18 private bedrooms are provided, while the remainder consists of 59 semi-private rooms and 6 four-bed rooms.

Circulation in the hospital was studied by the architects in some detail, in order to develop a plan in which traffic loads would be kept to a minimum and there would be little cross-traffic of visitors, patients, and staff. Building costs were lower than most hospitals of this size and complexity, totaling \$2.735 million with groups I, II, and III equipment, site work and landscaping, and all professional fees. This works out to a cost of approximately \$17,000 per bed.

The basic structure of the building is concrete frame, utilizing lightweight concrete columns, and precast lightweight ribbed floor joists. Exterior walls are aluminum-framed curtain walls with porcelain enamel panels and projected sash. Terrazzo flooring is used on the ground floor, vinyl tile elsewhere. Ceilings are acoustical tile. The building is completely air-conditioned and rooms are provided with individual controls.



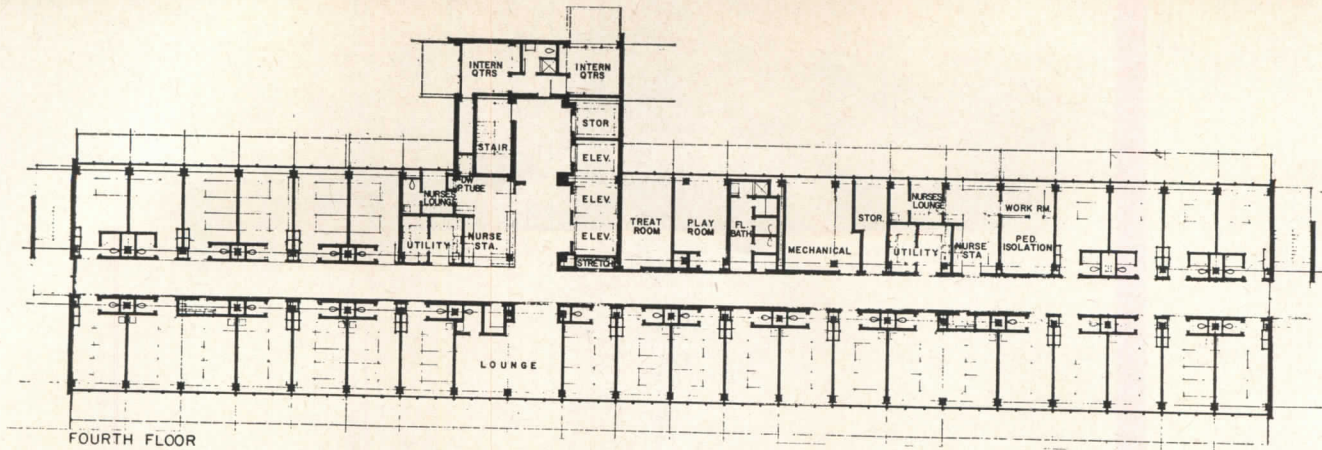

FOURTH FLOOR

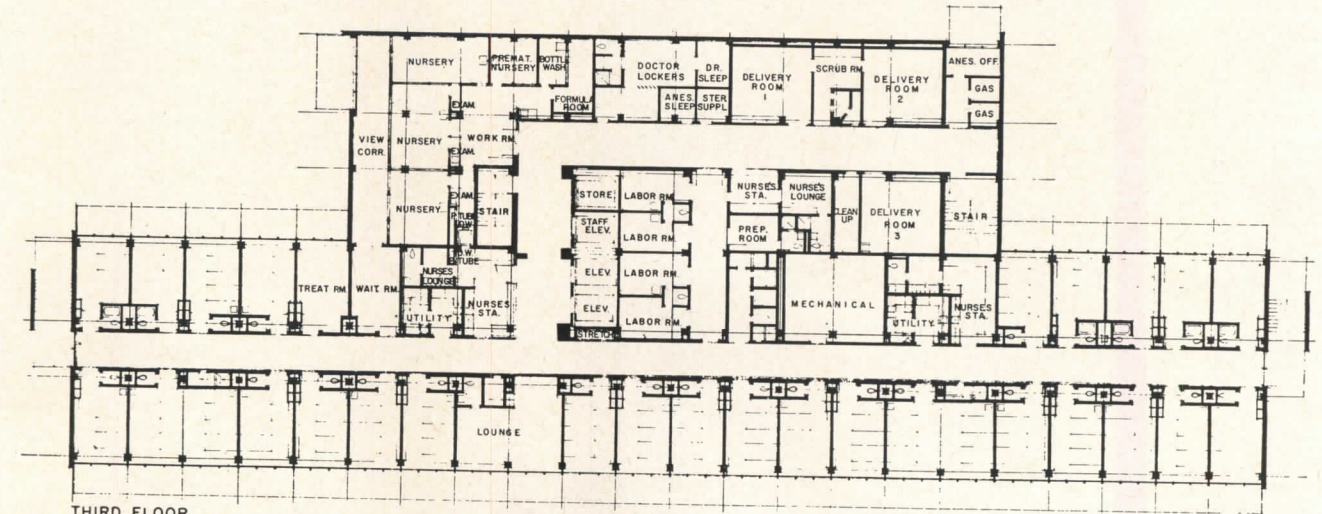

THIRD FLOOR

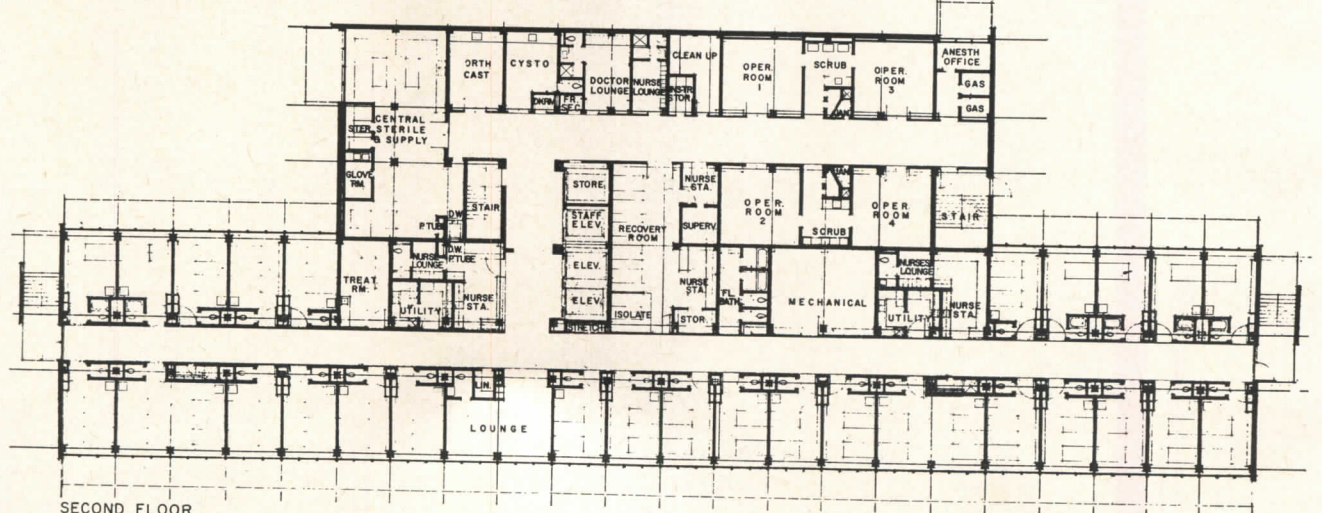

SECOND FLOOR

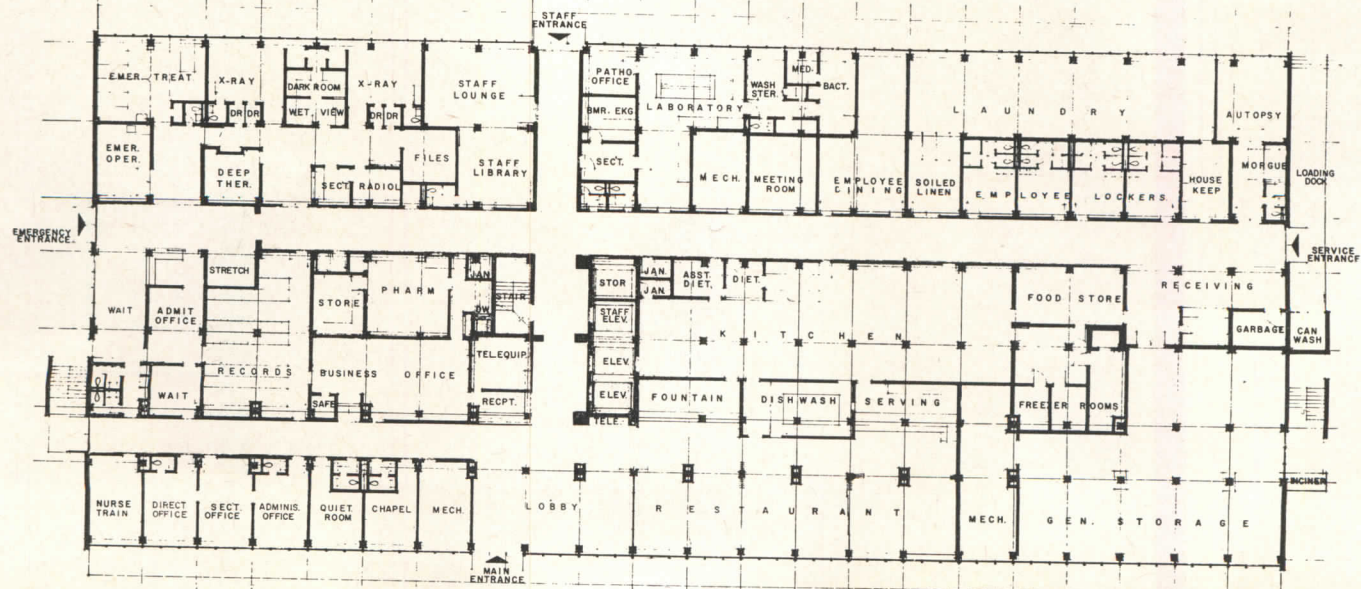



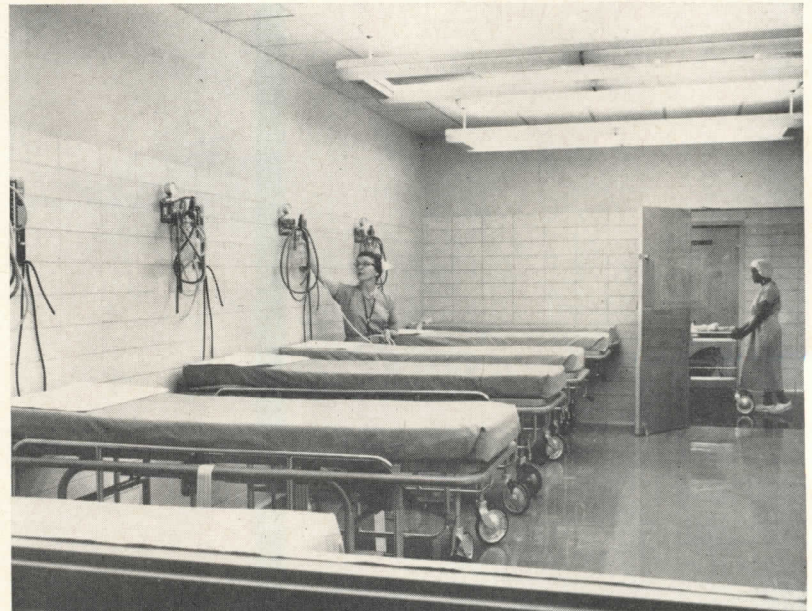
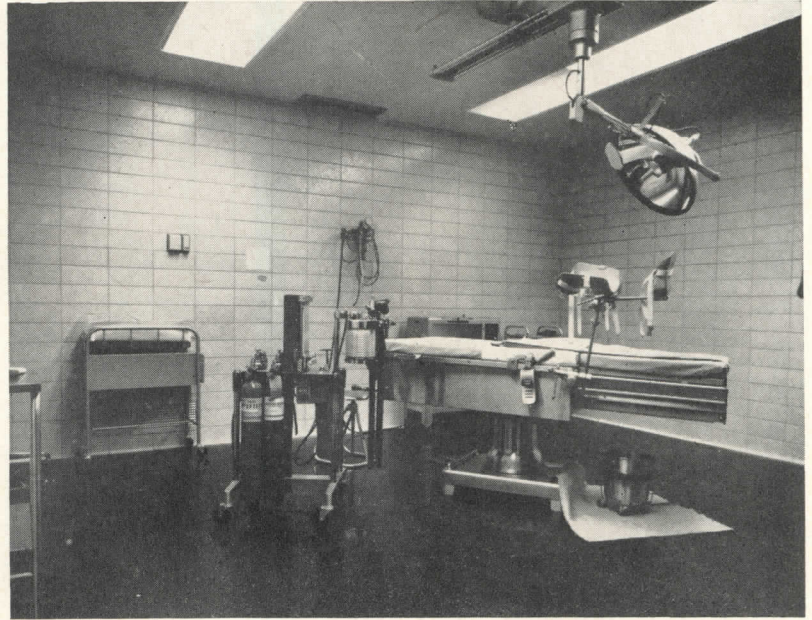
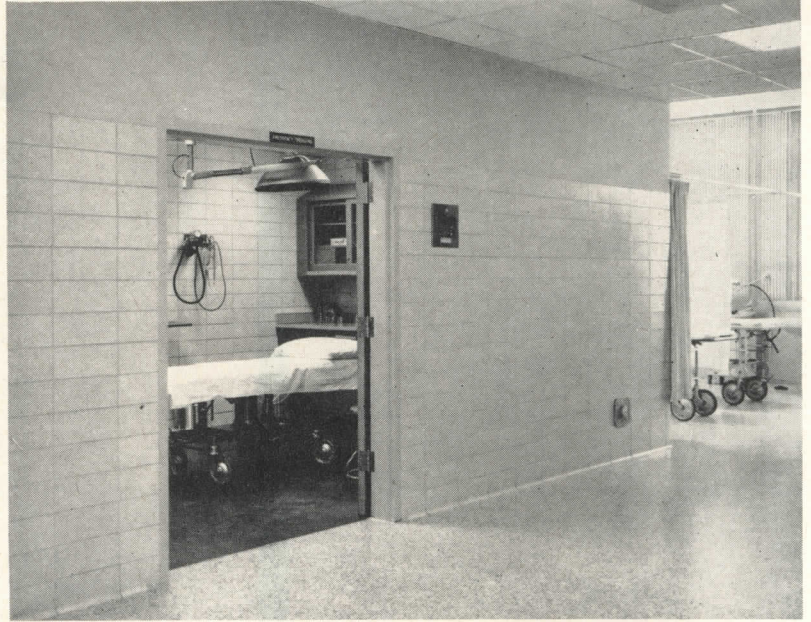
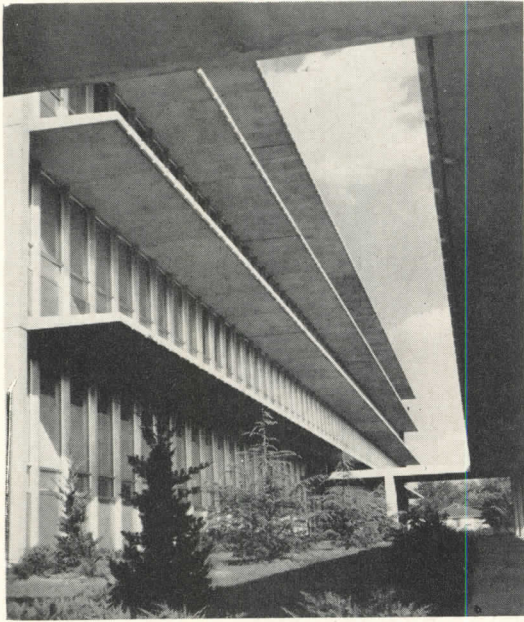

## West Jefferson

The hospital is organized basically as a four story building with emergency, administration, and service facilities located on the ground floor, surgeries and the surgical nursing unit on the second, maternity on the third, the medical nursing unit on the fourth floor. Departments such as radiology, laboratories, and the like which require access to vertical transportation are centrally located on the various floors, in close proximity to the elevators, dumbwaiters, and pneumatic tubes. Above: view of the exterior showing the arrangement of horizontal sun shields. Right, top and middle: views of the operating suite. Right, bottom: recovery room. Walls in these areas are glazed structural tile; floors are conductive vinyl tile in the operating rooms. The engineers and consultants were brought into the project immediately after the naming of the architects. Close cooperation was achieved between all of these professionals from the beginning of preliminaries. The low costs achieved, are due—in large part, the architects believe—to this early and close collaboration



### West Jefferson

Right, top: the hospital laboratory is located on the ground floor, near the center of the building. It is closely related to the lobby, staff entrance, and the elevators. Right, middle: view of a typical semi-private room. The majority of the beds in the hospital (118 out of the 160 total) are in such semi-private rooms. Right, bottom: a typical four bed room. In the hospital, six rooms are provided with facilities for four beds. The remaining rooms (18) are private bedrooms. All patient rooms are air conditioned, with individual controls, and have piped oxygen, audio-visual call system, telephones, and outlets to the central television antenna system. Finishes are vinyl floors, plastered walls, and acoustical ceilings. Below: View of a typical nurses' station. Hospital was planned for eventual expansion to a total of 210 beds, from the original 160 bed size, and ample land was purchased to make this possible

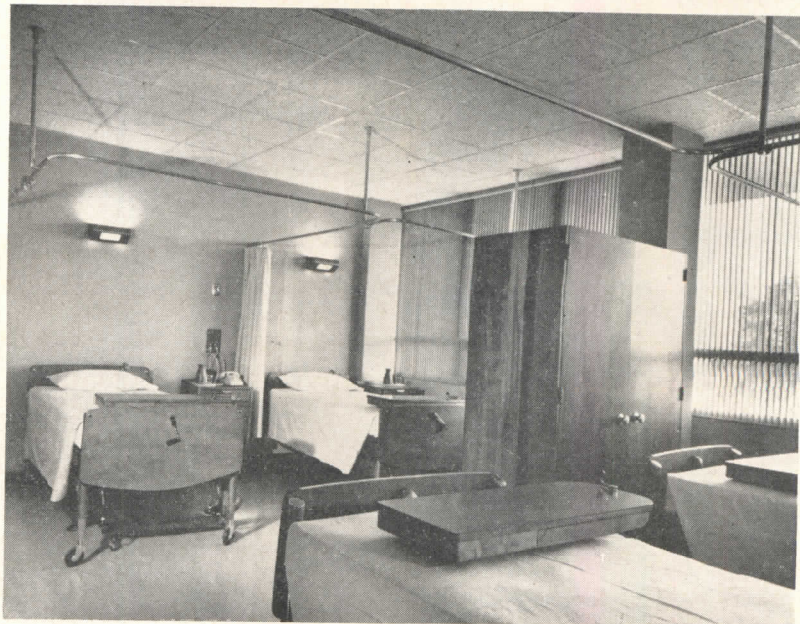
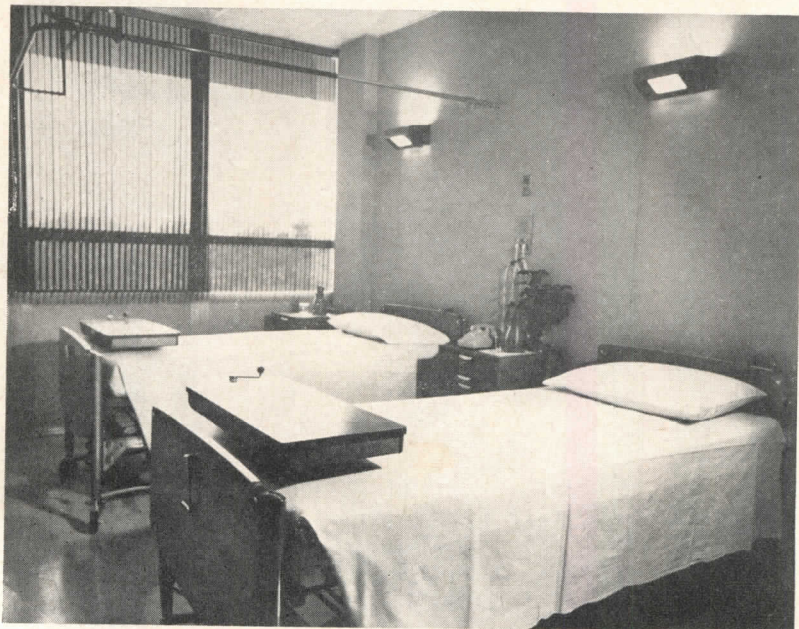
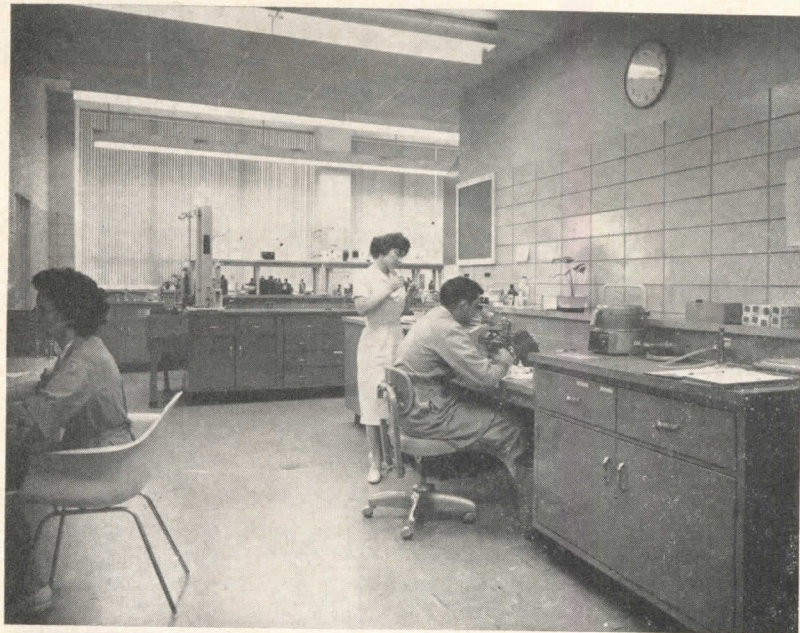





Joseph Molitor photos

## NORTHERN CLIMATE INFLUENCES DESIGN

*Arthur R. Gould Memorial Hospital*

LOCATION:

*Presque Isle, Maine*

ARCHITECTS:

*The Architects Collaborative*

*Jean B. Fletcher, Partner-in-Charge*

MEDICAL CONSULTANT:

*Thomas Chalmers, M.D.*

STRUCTURAL ENGINEERS:

*Morgenroth & Assoc.*

MECHANICAL ENGINEERS:

*R. D. Kimball Co.*

CONTRACTOR:

*Consolidated Constructors, Inc.*

Located in the northernmost part of Maine, this 80 bed general hospital will serve a population of 28,000 people. In the next ten years, it is expected that the expanding population will require another 20 beds. The major problems faced by the architects were those caused by the location (on the same latitude as Quebec City), the sloping site, and the requirements for expansion.

This new structure replaces older and smaller facilities which had become inadequate and inefficient with the growth of the country. When it became apparent more than five years ago that a new hospital was needed, the Board of Trustees engaged Neergard, Agnew, Craig, and Peckham, hospital consultants, to make a study and recommend a program. From their studies, it was determined that an entirely new hospital would be necessary. The architects prepared designs and construction began in April 1958. The building was completed early in 1960, at a total cost of approximately \$15 million including fees and groups I, II, and III equipment. All medical and surgical facilities have been provided for the projected eventual size of 100 beds.

The building structure is steel frame with open-web steel joist floors and roof and reinforced concrete slabs. The open-web joist system allowed for economical placement of piping, ducts and wiring. Exterior walls are brick; interior walls are plastered. Because of the severity of the sustained sub-zero temperatures during the long winters, all walls were insulated with 1½ in. of glass fiber. Double glazing was provided throughout the building.



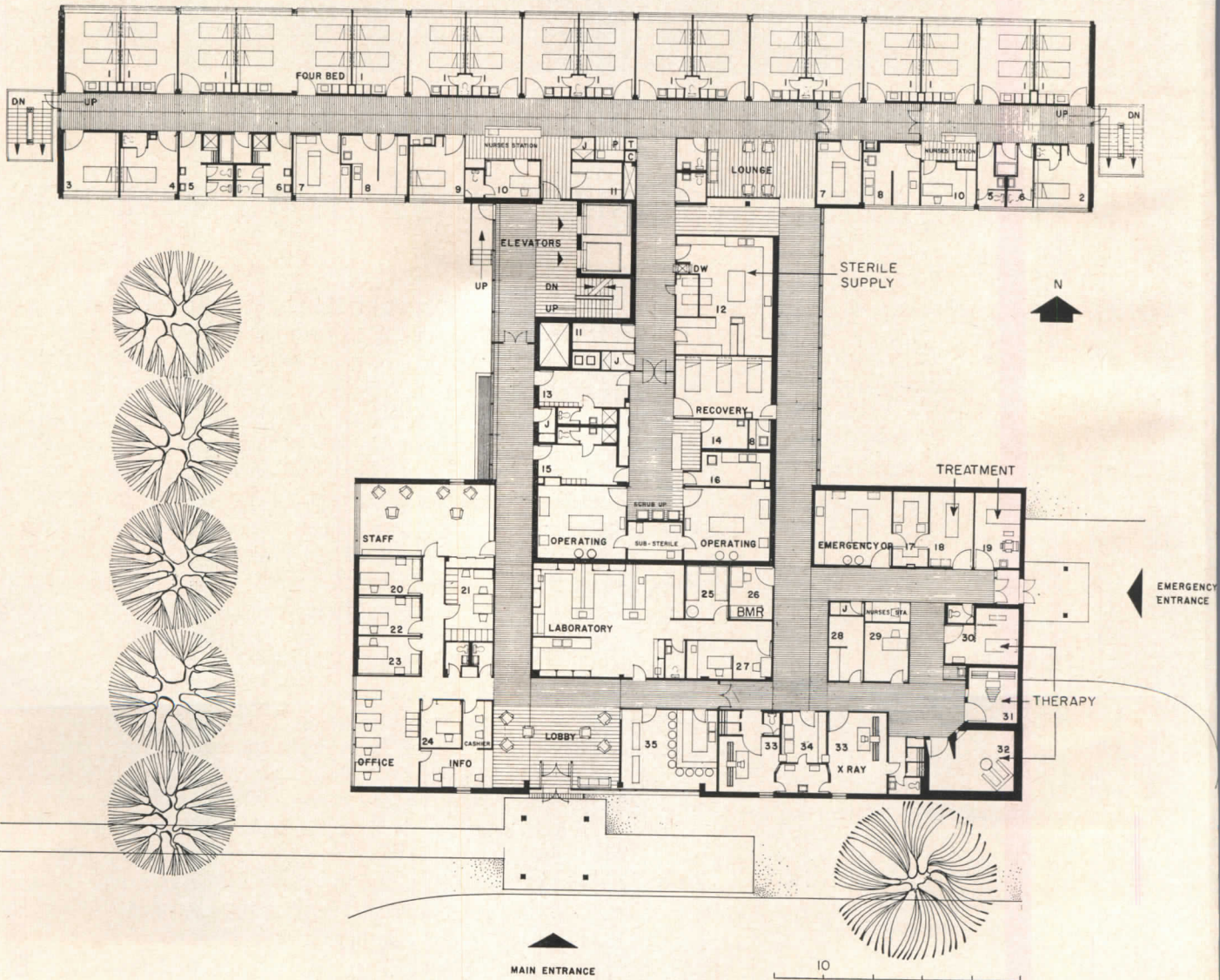
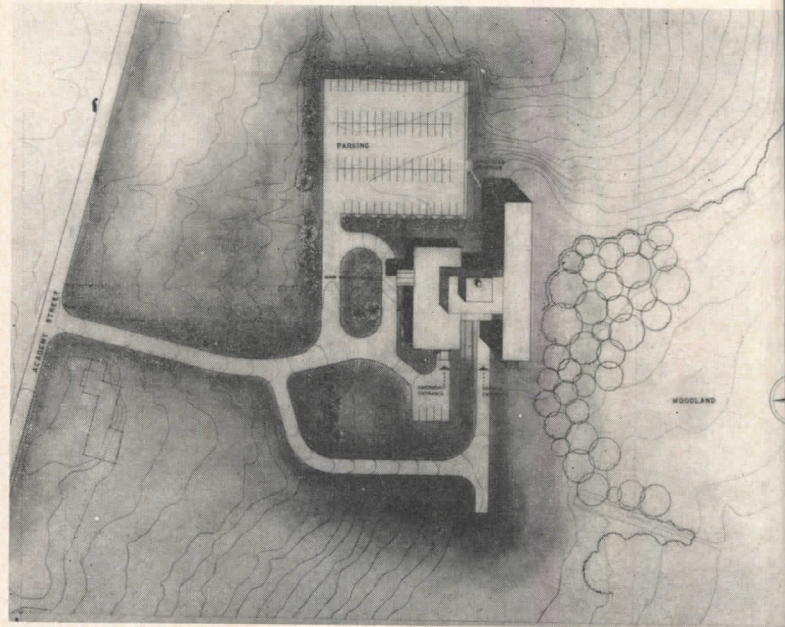
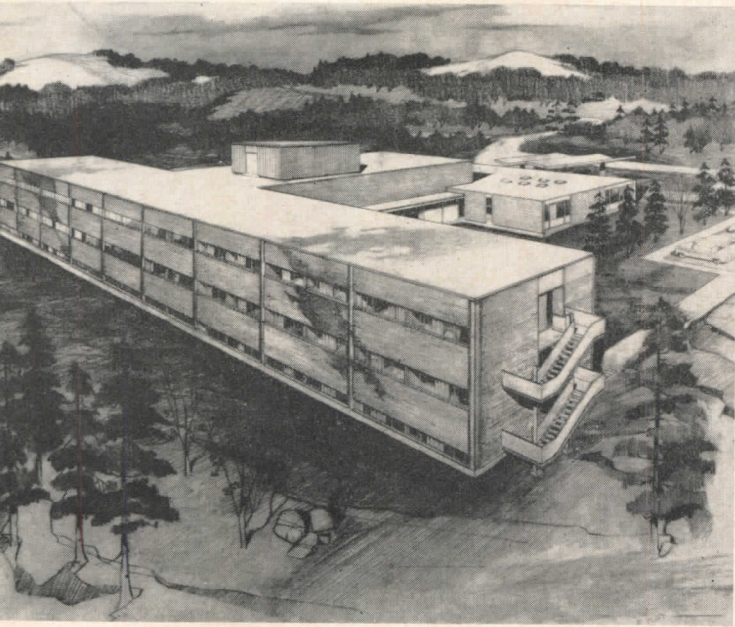



# Presque Isle

The sloping site was turned to advantage by the architects, to achieve a separation of grade between the service entrance and those used by patients and staff. The nursing unit, located on the low, south side of the site is two stories high and has a basement. Different kinds of circulation are entirely zoned away from each other, by the provision of separate entrances for patients, emergency, and service and by the elimination of cross-traffic of patients, visitors, and others. Patients go to various treatment areas such as x-ray, laboratories, EKG, XMR, and the like through corridors separate from those used by visitors. The emergency entrance, at the side of the building, connects directly with the emergency facilities. These are contained in an area, related to but separate from, the main lobby and removed from the neighboring operating suites. Central sterile supply is adjacent to the operating area. A dumbwaiter connects supply with the delivery suite above. Zoned forced hot water heating is provided throughout the hospital; surgical and obstetrical suites, laboratories, and x-ray are air conditioned.

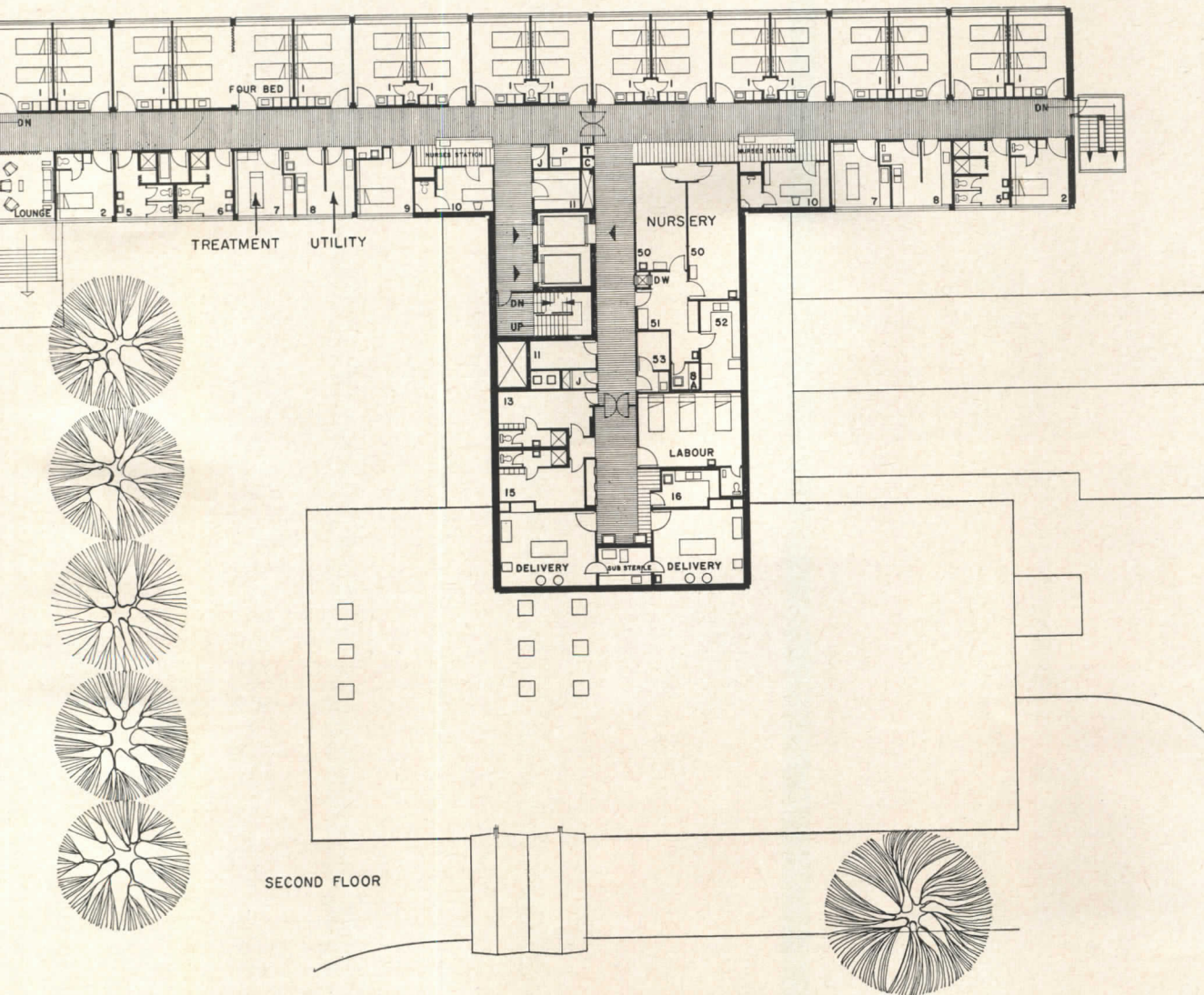
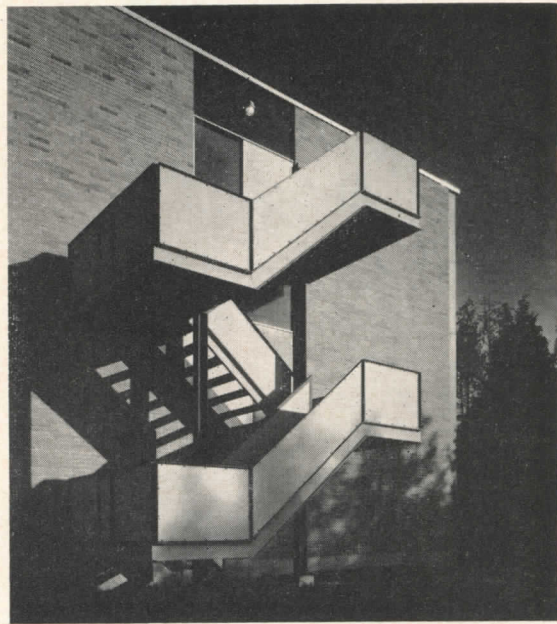





### Presque Isle

At the left, top, is shown the free-standing canopy at the front entrance. The main lobby is directly related to this entrance. Visitor circulation is directed down a hall, not used by patients, to the elevator lobby shown left, bottom. Mechanical rooms, cafeteria and kitchen, employe locker rooms, storage, and autopsy are located in the basement. Typical operating and delivery rooms are shown across-page at the top. These and other interior rooms have a mechanical ventilating system and air-conditioning. Floors are conductive vinyl tile. At the center are shown the surgical suite scrub room located between the operating rooms and the central sterile supply. A similar scrub room is provided between the delivery rooms. At the bottom of the page, on the left, is shown a typical double bedroom. Nearly all of the patient bedrooms are located on the south side of the nursing wing. The staff meeting room and lounge is shown at bottom, right. Flooring in the nursing units and related areas are vinyl asbestos tile. Walls and ceilings are, for the most part, plastered. In corridors and rooms which receive heavy usage, vinyl wall coverings are used. The kitchen has quarry tile floor and ceramic tile walls



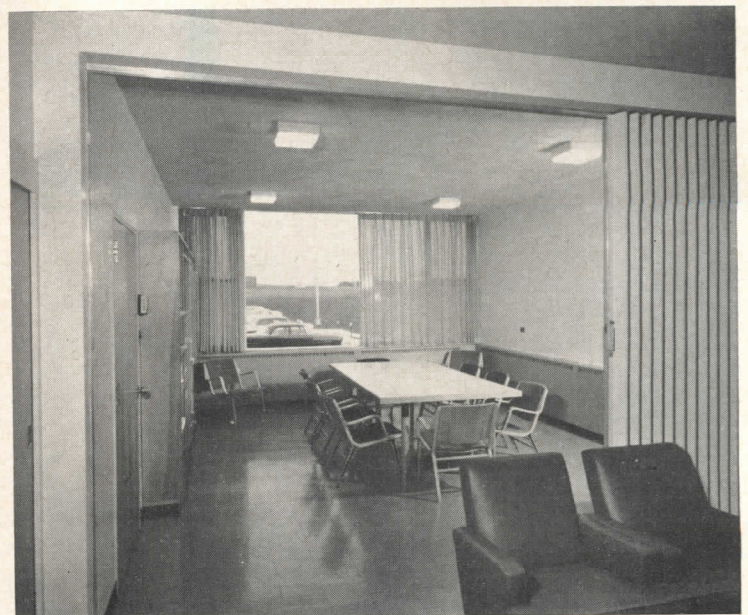
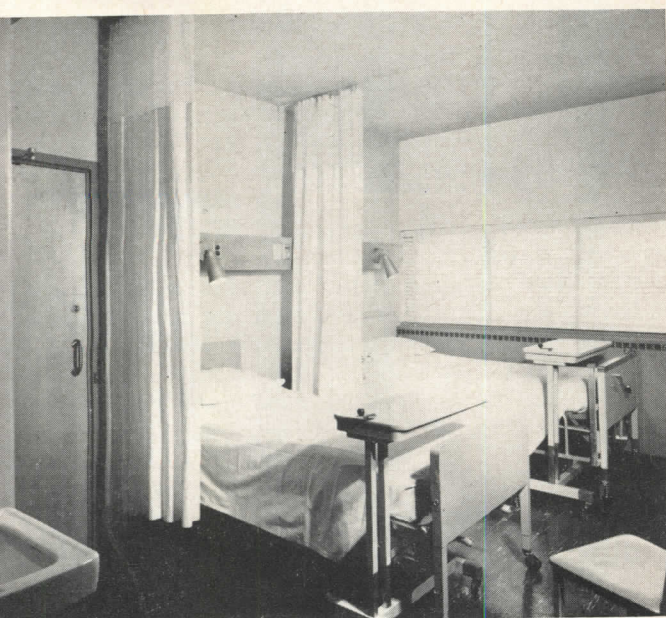
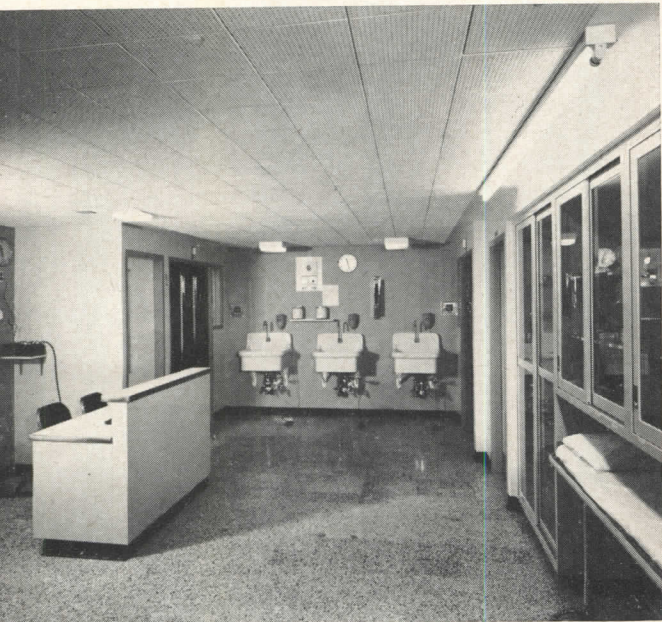
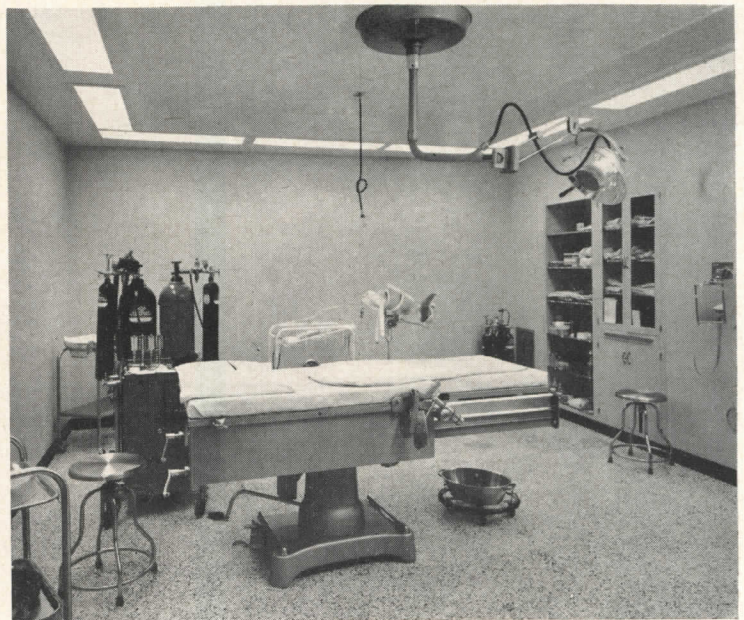
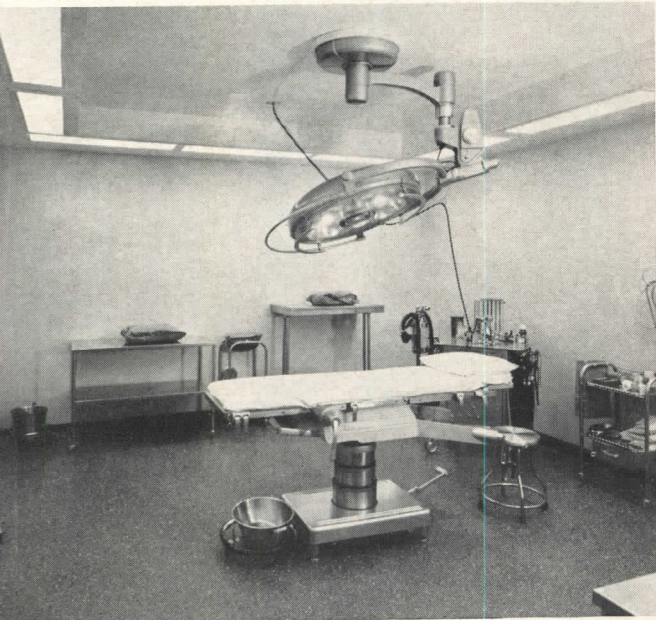



# PLANNING THE LABORATORY FOR THE GENERAL HOSPITAL

*Architectural and Engineering Branch, Division of Hospital and Medical Facilities\*  
U. S. Public Health Service, Department of Health, Education, and Welfare  
in collaboration with College of American Pathologists†*

Well-designed laboratories attract pathologists. Good pathologists breed good medicine. Competent doctors are drawn to communities where advanced laboratory medicine flourishes. Qualified, registered technologists seek employment in this environment.

No matter what the size of the hospital, pathology as a diagnostic tool is as vital in the care of patients as the other major branches of medicine. In addition to performing tests, laboratories promote continuing educational activities within hospitals. From the laboratory flows the teaching material for clinical pathological conferences, staff meetings, reviews of cases, critical evaluation of diagnoses, and assessment of therapy. The laboratory is the basis for the Tissue Committee, The Medical Audit Committee, The Hospital Infection Committee, and numerous other committees.

No hospital should be without the services of well-trained pathologists, working in well-equipped laboratories and assisted by registered technologists. This is just as important in small rural hospitals as it is for large urban institutions and university hospitals. It must be remembered that of 5419 short-term general hospitals in the United States, 4516 hospitals (about 83 per cent) have less than 200 beds. A critical tissue diagnosis, an exact biochemical measurement or bacteriological procedure is as important to a patient in a small suburban hospital as it is for one in a large medical center: he should not be deprived of these diagnostic possibilities.

The striking pathology "explosion" of the past few years is evidence that the study of disease by laboratory methods substantially improves the service of the hospital to the patient. The volume of laboratory studies may be expected to continue to increase.

While these truisms are generally accepted by most physicians, they should also be fundamental in the think-

ing of all architects and hospital administrators who are responsible for the design, construction, and management of hospitals. The cost of building and equipping adequate hospital laboratory facilities can and must be met because they are as vital to the function of the hospital as the operating rooms or the kitchens. A hospital laboratory serves not only the hospitalized patient but also, in the absence of a private pathologist-directed laboratory, contributes to the community through its service to the ambulant patient.

The determination of adequate size for this inevitable expansion must be based on good records, statistical analyses, and sound fiscal planning. Experience has shown that as hospitals of 100 beds or less are more fully utilized, a greater need for better laboratory services becomes evident, and as a result, these hospitals usually expand within a few years.

The principle of cooperative effort among several small hospitals in procuring the services of an experienced pathologist has been accepted and has proved its value. Frozen tissue examinations, consultations, and teaching activities are made available on regular schedules. Pooling of physical and technical resources by several hospitals permits the establishment of centralized laboratory facilities which can furnish more complex diagnostic procedures to each participating hospital than would be possible with the limited resources of each hospital. A fine example of this concept has been created at the North Central Associated Laboratories in Elyria, Ohio.

The introduction of automation devices, although costly at present, suggests that an increased number of tests can be prepared without a proportionate increase in space. This has opened an entirely new vista for medical diagnosis, as well as economical growth and development, particularly for small hospitals that are unable to maintain complete diagnostic services and must share facilities.

In small hospitals of 25 beds or less, collecting stations may be established for specimens, which are sent to a neighboring central pathologist-directed laboratory. Specimens can be easily delivered by using the local and interurban transportation systems. The development of communication systems utilizing short wave radio, private telephone lines and teletype circuits permits imme-

\* Material developed by Staff of Architectural and Engineering Branch: A. F. Hoenack, Chief; W. R. Taylor, Chief, Architectural Section; W. W. McMaster, Jr., Hospital Architect; R. P. Gaulin, Chief, Mechanical Section; J. J. Pargoe, Electrical Engineer; D. F. Burgoon, Laboratory Consultant, Assistant Chief of the Hospital Equipment Planning Branch.

† Arthur E. Rappoport, M.D., Consultant and Chairman, Committee on Lab. Planning and Design, College of American Pathologists.



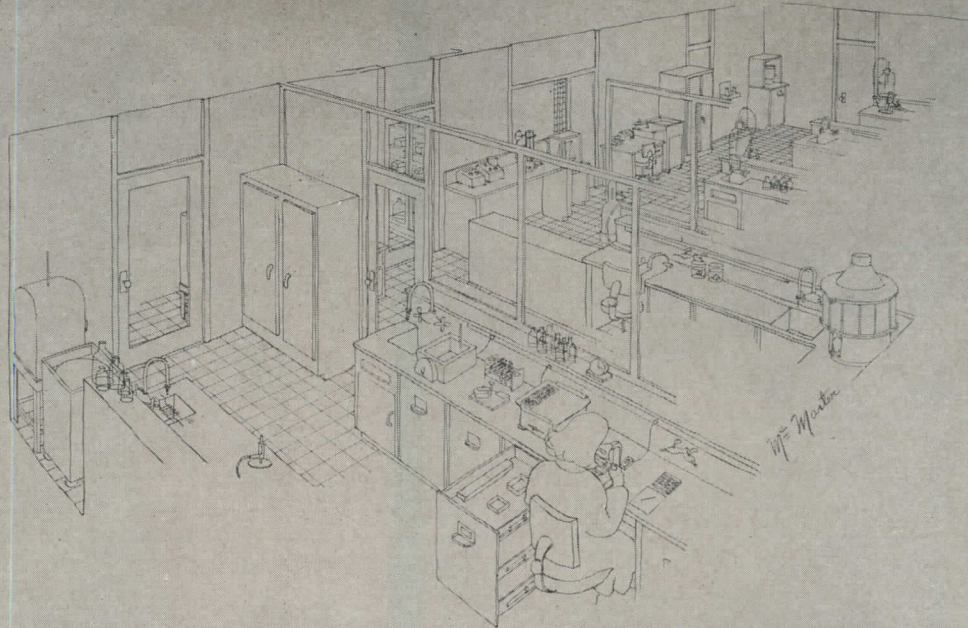

diate and rapid transmission of the reports from the central laboratory to the member hospitals.

Even a small 100-bed hospital can justify and interest a competent, energetic pathologist. Experience has shown that as soon as a pathologist assumes responsibility of directing a laboratory, a distinct upgrading of the quality of medical care ensues, the volume of laboratory studies increases, consultation among the staff is stimulated, and the patient's welfare is improved.

The laboratory must be designed according to progressive architectural and medical principles which insure economical use of space, efficient utilization of trained personnel, and adoption of sound systems of management.

The hospital architect should be chosen with care from among those who have the necessary experience and background. The hospital administrator should be assured that the laboratory will be solvent financially so that he will not be impelled to "pinch pennies" in the design and construction of this department. The services of a qualified pathologist, experienced in the organization, personnel requirements, and the physical requirements of hospital laboratories, should be procured to write the laboratory program and consult with the architect in the design of the facilities to assure meeting the needs of the hospital and the community. This team—the pathologist, administrator, and architect—working together can de-

### TOWARD BETTER PLANNING

With the increasing demand for laboratory services, the hospital often finds itself with a crowded laboratory department which is hampered in its operations because of limited space. Perhaps the reason this situation prevails is that insufficient emphasis has been placed on the design and physical requirements for the laboratory.

The first essential in planning a laboratory department is a better understanding of the laboratory requirements by pathologists, architects, hospital officials and trustees, and hospital professional staffs.

Pathologists should become acquainted with the needs for physical space and equipment so that they can accurately describe and support these requirements with the

sign a laboratory for the present and include the potential for future expansion.

The *Manual for Laboratory Planning and Design* by the author of this article and published by the College of American Pathologists discusses many of the problems of laboratory design.

The College of American Pathologists recognizes the experience and guidance of the Public Health Service in aiding communities to develop their hospital programs. It welcomes the present study as an authoritative effort in the educational drive to impress upon responsible hospital lay people and staff members the need to plan with vision and to recognize that the science of laboratory medicine will continue to flourish and enrich the lives and health of all of our citizens.

The material prepared by the Division of the Hospital and Medical Facilities of the U. S. Public Health Service presents a modern approach to the problem of laboratory design, based on widespread experience in the construction of many hospital laboratories of diverse types in various communities. The aforementioned publication of the College of American Pathologists and the Public Health Service guide will help to ensure that laboratories of the future will fill the needs of the physicians and citizens of our nation.

ARTHUR E. RAPPOPORT, M.D.

basic data needed for planning a hospital laboratory.

The architect, too, should become acquainted with the functions, equipment, space, and personnel required in the various units of the laboratory so that he can more efficiently lay out the design, develop the plans, and complete the specifications.

The hospital administrator and the trustees should be informed of the financial and clinical advantages of having adequate physical space and equipment to maintain a laboratory service. The speed and accuracy in determining a diagnosis, as well as the necessity to expedite a large volume of tests, depend on well-planned, ample laboratory facilities.



The related professional staffs should also be made aware of the importance of having a smoothly functioning laboratory.

### TEAM APPROACH AND THE PROGRAM

The laboratory design should be the responsibility of a team comprised of the pathologist, the administrator or owner, and the architect. Each will have his sphere of responsibility: the pathologist to determine the requirements of space and equipment and to develop the program; the administrator or owner to review and approve them; and the architect, working with the pathologist, to incorporate these requirements within the structure.

Planning laboratory facilities—as in planning most areas—depends on the clarity of the proposed program. The program, as it relates to architectural planning and construction, is the written description of all requirements to be incorporated in the design of an area. In developing the laboratory program, the pathologist should realize that the architect may know little about the requirements for a specific laboratory. Therefore, the program should explain as fully as possible the services to be provided, the functions and procedures, the personnel required, working relationships, equipment required, and some concept of the space needed.

### CONSIDERATIONS FOR DEVELOPING THE PROGRAM

The following checklist may be helpful in determining laboratory requirements:

1. Determine which services are to be provided
2. Determine space requirements to accommodate equipment and personnel in the following areas:
  - a. Administrative
  - b. Technical
  - c. Auxiliary (includes washing, sterilizing, storage and locker facilities)
3. Divide the technical area into functions or units, such as: Hematology; Biochemistry; Parasitology; Blood Bank; Bacteriology; Histology; Urinalysis; Serology
4. Determine where the procedures are to be performed:
  - a. Those to be combined in the same work area
  - b. Those to be done in completely separate work areas
5. Estimate the volume of work in each area or unit, allowing for future increase in workload
6. Indicate the number of personnel requiring a work station in each unit
7. Describe the major equipment in each unit:
  - a. If possible, indicate the linear feet of bench space required and how the space may be arranged. In many instances this can be determined only by an architectural study
  - b. List the equipment that requires utility lines and indicate the location
  - c. List equipment, such as refrigerators, centrifuges, hoods, desks, that may be jointly used by technologists from different work stations
8. Indicate the desirable functional arrangements. (For example, the bacteriology unit may be located at the extreme end of the laboratory, to reduce the contamination hazard, and the washing area should be next to the bacteriology unit; hematology may be next to the waiting room, adjoining the examination and specimen area)

9. Indicate which work units may be expected to expand. (It may be possible to locate these areas at one end of the department to facilitate efficient, coordinated expansion)

10. In the technical area, a standard module for the work areas is suggested (for instance, a module of 10 by 20 ft as is used in these plans). This module can be worked out in collaboration with the architect. By using a standard module, the architect can accommodate more easily the laboratory within the fenestration and structural patterns of the building. A standard module will also facilitate future rearrangement of the department

11. List the utilities to be provided and any special requirements for instruments such as electronic counters. Separate electrical circuits for some electronic instruments are necessary in order to avoid fluctuating voltage, which affects the accuracy of these instruments

12. List environmental requirements, such as light, ventilation, color, and isolation of equipment that may be noisy or may produce heat when used

### PRELIMINARY PLANNING

Locate the department as favorably as possible for the laboratory staff and the ambulant inpatients and outpatients. A space on the first floor near an elevator is preferable. However, as first floor space is in great demand and it is not possible to place all departments in this preferred location, some compromise may be necessary. Also, another determinant in locating the laboratory is the consideration for future expansion.

In determining the overall size of the laboratory, the first concern is the individual technical units. It is only after the size of these units has been established and an architectural layout has been developed to fit the program that the sum of the areas can accurately reflect the size of the laboratory department.

The square-foot-per-bed ratio is no longer considered a desirable guide in determining the size of a hospital department because of the wide variation of such factors as type and size of hospital, pattern of usage, growth of the community, and medical practice. Plans for the laboratory area should be based on work volumes within specific ranges, such as 40,000-75,000 tests, or 75,000-120,000 tests. The key to this method is to estimate the work volume and its breakdown into work units for hospitals of different sizes. This points up the necessity for maintaining accurate records, which, aside from their clinical and fiscal use, provide data for planning a laboratory service.

The following is an outline of the procedure which may be used in estimating needed laboratory space, based on the number of tests performed, personnel, and equipment.

1. Break down the total volume of work into units, such as hematology, urinalysis, chemistry, as previously noted.
2. Determine the number of technologists required in each department. The data shown in Table I may be used as a basis for this determination.
3. Determine the necessary equipment and space for the number of technologists required.

For the purpose of developing guide material, the Architectural and Engineering Branch of the Division of Hospital and Medical Facilities collected data from 360 hospitals in addition to the data compiled by the Committee on Laboratory Planning of the College of American Pathologists. Tables II, III, IV, and V present these data.



Many laboratories show annual workload increases of about 10 per cent, thus doubling the work volume in approximately nine years. This annual increase should be considered during the planning stage of the laboratory. However, improved techniques and automation suggest that it may be possible for a greater volume of work to be done in the same work area size.

### LABORATORY GUIDE PLAN

Plan A—is a suggested plan for a hospital laboratory service with an estimated workload of 70,000 to 120,000 laboratory tests annually. For planning purposes, this laboratory is designed to serve a general hospital of 150 to 200 beds. Designing for a range of 69,000 to 163,000 tests (shown in Table II) was not considered practical, since a laboratory plan for 14 technologists (shown as 13.3 in Table IV) would be excessive for a staff of only 6 technologists (shown as 5.9 in Table IV) for the median workload range. By adjusting the work volume of the data shown in Table IV to two thirds of the high annual volume for each laboratory unit, the technical staff required would be 6 to 10 technologists, based on the tests performed annually per technologist, as shown in Table I. The nontechnical staff would include one or more laboratory helpers in the glasswashing and sterilizing unit and a clerk-typist and secretary in the administrative unit.

The laboratory services of a general hospital having this work volume would require work areas for six main technical units: hematology, blood bank, urinalysis, biochemistry, histology, and serology-bacteriology.

The block plan has been utilized here, as it provides a good functional relationship for all units. The pathologist's office in the center provides for easy supervision of the work stations; the hematology unit is near the waiting room; the bacteriology unit is at the end of the laboratory, yet near the washing and sterilizing areas; and the histology unit is near the pathologist's office.

Other schemes similar to that shown in Plan C or a typical wing arrangement with a corridor down the center would also be satisfactory.

In the technical area of Plan A, the open plan arrangement (except for the histology and serology-bacteriology units) has several advantages over the "separate room for each unit" scheme for hospitals of this size. These advantages include: easier supervision; common use of such equipment as desks, refrigerators, and centrifuges; flexible use of personnel; and more available space since many doors and partitions are eliminated. If desired, partitions could be erected between each unit, as indicated on the plan for the histology and serology-bacteriology units.

### Laboratory Module for Technical Area

Maximum flexibility is desirable in the technical work areas of the laboratory department. In the plans, this has been achieved by using a module of approximately 10 by 20 ft, with a similar arrangement for each module. Each one consists of two standard laboratory workbenches 12 ft long, 30 in. deep, with a working surface or counter of about 23 in., and a reagent shelf. Knee-spaces are indicated where needed for personnel who perform tests from a sitting position. Drawers, cabinets, and shelves are provided below the work counter for daily equipment and supplies. This arrangement provides a 5-ft aisle between workbenches, which is considered optimum for movement within the working area. Equipment such as centrifuges,

**TABLE I**  
TESTS PERFORMED ANNUALLY PER MEDICAL TECHNOLOGIST\*

Laboratory Unit	Tests
Hematology	13,400
Urinalysis	30,720
Serology	11,520
Biochemistry	9,600
Bacteriology	7,680
Histology	3,840
Parasitology	9,600

\* These figures were derived from data developed by Seward E. Owen and Edmund P. Finch, presented in two articles published in *Modern Hospital*, June and October, 1957. Titles of the articles are: "How to Calculate the Laboratory Work Load" and "How to Measure Laboratory Productivity"

**TABLE II**  
TESTS PERFORMED ANNUALLY IN GENERAL HOSPITALS

Hospital Bed Size	Number of Tests		
	Low	High	Median
50- 99	12,000	25,000	19,000
100-149	24,000	75,000	39,000
150-200	55,000	163,000	69,000

**TABLE III**  
UTILIZATION INDEX OF LABORATORY SERVICES  
IN GENERAL HOSPITALS

Hospital Bed Size	Tests per Patient Day		
	Low	High	Median
100-149	1.05	2.02	1.29
150-200	1.08	2.67	1.32

**TABLE IV**  
TESTS PERFORMED ANNUALLY IN EACH LABORATORY UNIT

Unit	General Hospitals—150-200 Beds			Technologists Required	
	Low	High	Median	Median	High
	Urinalysis	6,200	20,100	11,300	0.4
Hematology	29,800	81,200	35,800	2.5	5.6
Serology	3,600	13,500	6,800	0.6	1.1
Biochemistry	2,300	19,600	6,600	0.7	2.0
Parasitology*	—	—	—	—	—
Bacteriology	400	4,700	1,800	0.2	0.6
Histology	700	5,100	1,800	0.5	1.3
Basal Metabolism	30	700	400	—	—
Electrocardiograms	800	4,200	1,300	—	—
Blood Bank Tests	130	23,200	4,500	1.0	2.0
Transfusions	800	2,000	1,000	—	—
Other	500	9,600	1,700	—	—
			TOTALS	5.9	13.3

\* Included with urinalysis

**TABLE V**  
TESTS PERFORMED ANNUALLY IN EACH LABORATORY UNIT

Unit	General Hospitals—100-149 Beds			Technologists Required	
	Low	High	Median	Median	High
	Urinalysis	3,000	9,000	4,800	0.2
Hematology	9,000	37,000	20,200	1.4	2.5
Serology	220	5,600	3,500	0.3	0.4
Biochemistry	1,300	5,300	2,800	0.3	0.6
Bacteriology	85	3,800	700	0.09	0.5
Histology	700	3,100	1,500	0.4	0.8
Parasitology	200	250	200	0.02	0.02
Basal Metabolism	20	300	60	—	—
Electrocardiograms	500	3,300	650	0.5	1.0
Blood Bank Tests	20	9,200	2,800	—	—
Transfusions	400	1,300	700	—	—
Other	80	7,300	400	—	—
			TOTALS	3.21	6.12



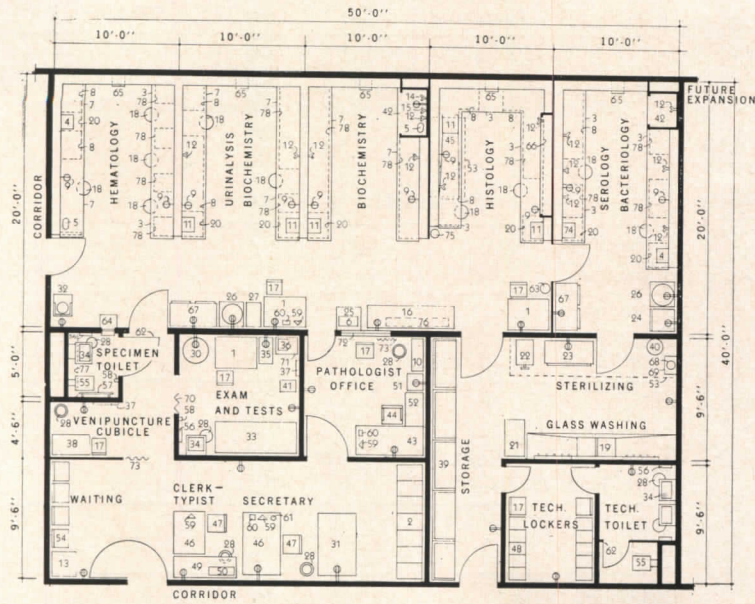

Plan A (70,000-120,000 Tests Annually)  
for Average Size of 150-200 Beds

LEGEND

1. Desk, 30 by 40 in., single pedestal
2. Filing cabinet, letter size
3. Counter, 30-in. high
4. Staining sink
5. Cup sink
6. Analytical balance
7. Counter, 36-in. high
8. Cabinets with adjustable shelves, below counter
9. Electric strip outlets, continuous
10. Bookcase
11. Utility sink
12. Gas outlet
13. Table for magazines
14. Suction outlet
15. Compressed air outlet
16. Table for instruments
17. Straight chair
18. Stool
19. Two-compartment sink 8-in. deep; drainboards-noncorrosive metal; peg boards above drainboards
20. Cabinet with trash receptacle on inside of door
21. Utility cart
22. Laboratory pressure sterilizer
23. Hot air oven
24. Incubator
25. Shelf or table for analytical balance
26. Centrifuge
27. Table for Harvard trip balance
28. Waste paper receptacle
29. Refrigerator, 8 cu. ft.
30. Refrigerator, blood bank
31. Worktable
32. Micro-hematocrit centrifuge
33. Examination table
34. Lavatory
35. Basal metabolism apparatus
36. Electrocardiograph
37. Hook strip
38. Table, 24 by 36 in.
39. Storage cabinets
40. Water still, 2-5 gals. per hr.
41. Adult scale
42. Fume hood
43. Double-pedestal office desk
44. Office chair, swivel, with arms
45. Noncorrosive metal work surface; pitch to sink
46. Typewriter desk
47. Posture chair
48. Technicians' lockers
49. Specimen receiving table
50. Request file with pigeon holes
51. Slide file cabinet
52. Microscope table
53. Exhaust hood
54. Easy chair
55. Wall-hung water closet
56. Paper towel dispenser
57. Grab bar, continuous
58. Emergency call station (push button) connected to buzzer at secretary's desk
59. Telephone outlet
60. Intercommunication system outlet
61. Buzzer at receptionist's desk from emergency calling stations
62. Hook on toilet-side of door
63. Fire extinguisher
64. Pass-through between toilet and laboratory
65. Exhaust air grills near floor
66. Wall cabinet
67. Refrigerator, 11 cu. ft.
68. Pipette washer
69. Shelf, for pipette washer, 10 in. above floor
70. Folding door
71. Table for electrocardiograph
72. Window
73. Curtain
74. Sink with electric waste disposal
75. Carbon dioxide cylinder
76. Gas cylinders under table
77. Shelf for urine bottles
78. Drawers with adjustable shelves, below counter
79. Sink with electric waste disposal

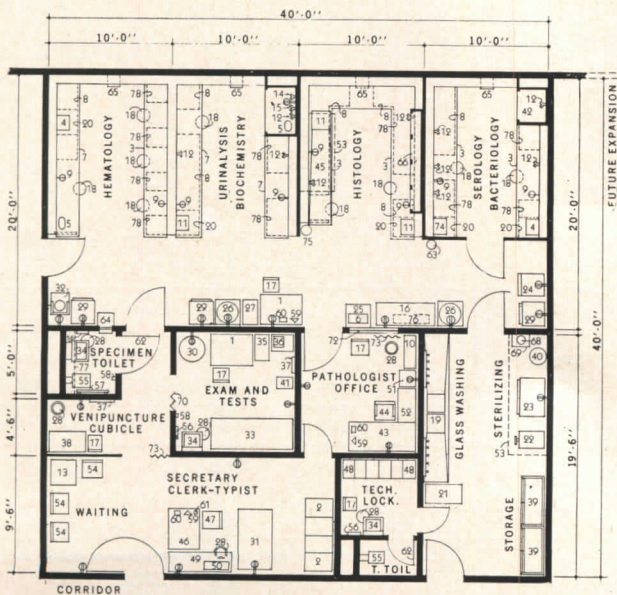

Plan B (40,000-75,000 Tests Annually)  
for Average Size of 100-150 Beds



refrigerators, and desks, which may be used jointly by the personnel, is located opposite the units along the interior of the technical work area.

### Technical Areas

*Hematology-blood bank unit*, a standard module is assigned to the hematology-blood bank unit. One half of this module is provided with a workbench for procedures such as hemoglobin tests, sedimentation rates, staining, and washing of pipettes (in Plan A, counter No. 7 on left side of unit). Kneespace and storage cabinets are provided below the counter. In the other half of the module, a workbench 30 in. high, with three kneespaces, is provided for technologists who are seated during tests, such as those involving microscopic procedures.

The micro-hematocrit centrifuge, because of its noise and vibration when in use, is placed in the general technical area along the interior wall directly opposite the hematology unit. The other equipment needed by this work unit, such as a refrigerator, centrifuge, and recording desk, is located conveniently opposite the unit, where it is shared with the urinalysis and the chemistry units.

It is assumed that the laboratory will obtain blood for transfusions from other sources, and, therefore, needs only facilities for blood storage. A blood bank refrigerator is provided for this purpose in the examination and test room. Compatibility tests on the blood are done in the hematology unit. A hospital which operates a self-contained blood bank, that is, collects and does complete processing of all blood, should provide a separate bleeding room, processing laboratory, donors' recovery room, and an office available for preliminary physical examinations.

*Urinalysis unit*, the urinalysis unit is assigned one half of a standard module, consisting of a workbench, 12 linear ft, 30 in. high, and serves as the work area for the microscopic and chemical examinations. Five linear ft of the workbench and a kneespace are provided for personnel performing the microscopic examinations; the remainder of the workbench is used for the chemical examinations. A sink located at one end of the workbench provides a continuous working surface for the technologists.

*Biochemistry unit*, the biochemistry unit requires an area that occupies one and a half standard laboratory modules. The half module is shared with the urinalysis unit and is used for the necessary preliminary procedures that are done prior to the actual chemical analyses. A kneespace is provided in this workbench for personnel who perform titrations and other procedures while seated. The adjoining module provides workbench area where a variety of chemical procedures may be performed and includes a fume hood for removal of vapors and gases.

The workbenches for the chemical procedures are about 36 in. high, with drawers and cabinets below. The reagent shelves are used to hold the chemicals needed during the procedures. Two utility sinks are provided, one in each chemistry work area. Apparatus used in this unit is cleaned by the personnel in the unit; tests tubes, pipettes, and flasks are sent to the central glasswashing area nearby.

An instrument table 36 in. high is located along the interior wall opposite this unit where chemical apparatus, such as colorimeter, flame photometer, spectrophotometer, and carbon dioxide gas apparatus are placed. Adjacent to the instrument table is an analytical balance on a vi-

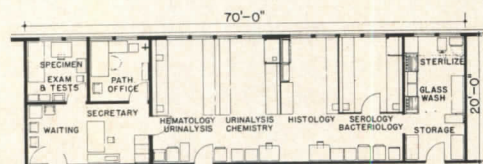

Plan C Alternate Plan  
(40,000-75,000 Tests Annually)

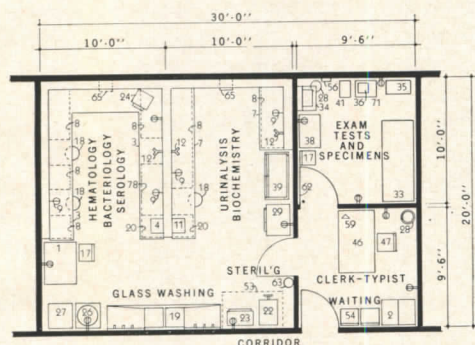

Plan D (20,000-30,000 Tests Annually)  
for Less Than 100 Beds

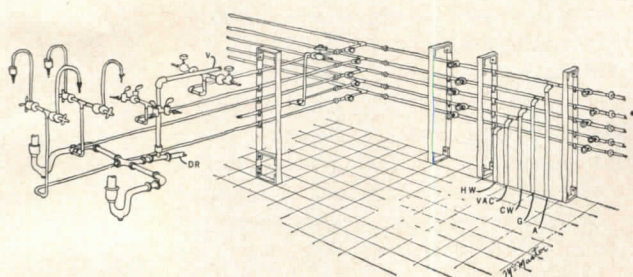

Figure 1. Laboratory Piping Diagram

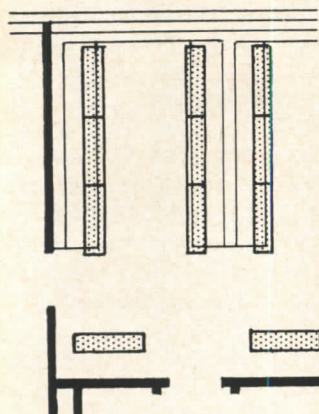

Figure 2.  
Typical Work Area Lighting



bration-free table or other type of support. By placing this apparatus away from the busy preparation and test procedure work areas, personnel can use the apparatus without interference from other procedures. It also lessens the possibility of damage to the equipment by the accidental spillage or splattering of chemical reagents.

A centrifuge, refrigerator, and desk are provided along the interior wall opposite the unit for the use of the personnel in this unit. The desk and refrigerator are shared with the urinalysis and the hematology units.

*Histology unit*, the histology unit is assigned a standard module, separated from the other units by a partition to prevent odors from spreading to other areas. It is located near the pathologist's office since the medical technologist here works under his direction and supervision.

Along one half of the module, an area is utilized by the pathologist to examine surgical and autopsy specimens and to select the tissues for slide sections to be prepared by the technologist. An exhaust hood is provided over this section, as shown in the plan (No. 53) to draw off disagreeable odors from specimens and solutions. The remainder of the module is used for the processing and staining of tissues. Three kneespaces are provided at each of the specialized work areas. The workbench is 30 in. high with a 22- or 23-in. deep working area, cabinets and drawers below the counter, and a reagent shelf. Wall-hung cabinets are provided for additional storage. A utility sink is provided at the end of the workbench.

*Serology-bacteriology unit*, the serology and bacteriology work is combined in one standard laboratory module, where a half module is assigned to each unit. Culture media for use in bacteriology are prepared in the bacteriology work area and sent to the sterilizing unit for sterilization. Parasitology may be performed in either the bacteriology or the urinalysis unit.

The workbenches are 30 in. high with a 22- or 23-in. deep working area, and are provided with reagent shelves. A kneespace is provided in each workbench since most of the procedures are done in a sitting position. A utility sink is provided for the personnel in both units, but the bacteriology unit also requires a sink for the staining of slides. A fume hood is provided to prevent the spread of possible infection to personnel when preparing specimens from suspect cases of tuberculosis, fungus, or virus diseases. The stool cultures also may be prepared here to reduce the spread of odors to other work areas.

A centrifuge, refrigerator, and incubator are provided along the interior wall within the unit. A desk is also conveniently located for the use of the personnel.

This module is partitioned and separated from the other units by a door to reduce contamination of air and the hazard of infection to personnel in the other lab areas.

#### Administrative Area

The administrative area is separated from the technical work areas so that the nonlaboratory personnel need not enter the technical areas. This is the central control and collection point for receiving specimens and is the reception area for the patients and the hospital staff who come to the laboratory.

*Waiting room*, a waiting area, with conventional waiting room furnishings, is provided for the ambulant patients. In this area, a desk is provided for a clerk-typist. An intercommunication system between the technical areas of the laboratory and the clerk-typist is recommended.

This enables her to quickly notify the technical personnel when a patient arrives and also to transfer phone calls for information concerning a laboratory report.

The pathologist's secretary is also located in this area, near the pathologist's office. She takes dictation and handles all the pathologist's correspondence, surgical pathological reports, and autopsy protocols.

*Venipuncture cubicle*, a venipuncture cubicle is provided where blood specimens are taken from the ambulant patients sent to the laboratory.

*Specimen toilet*, a specimen toilet is provided in this area for the collection of urine and stool specimens; a pass window opens directly into the technical area near the urinalysis unit.

*Basal metabolism-electrocardiography room*, a room is also located here for basal metabolism tests and electrocardiograms, and when necessary, to obtain blood from donors. A desk is provided in this room to permit handling of paper work. A lavatory is also provided.

*Pathologist's office*, the pathologist's office is located so that he may have easy access to the technical areas of the laboratory, particularly the histology unit. This office is separated by a glass partition which permits the pathologist to observe the technical work areas. A draw curtain may be used when he desires privacy. Those who wish to consult the pathologist have access to his office through an entrance from the administrative area.

A table or working surface suitable for a microscope is provided for the pathologist so that he may examine the tissue slides undisturbed. Other essential office furniture includes a bookcase, chair, and files for slides.

#### Auxiliary Service Areas

The auxiliary service units are located adjacent to the administrative area and are easily accessible to the technical areas.

*Glasswashing and sterilizing unit*, the glasswashing and sterilizing unit is close to the serology-bacteriology and the biochemistry units which will utilize such services more often than the other units. A separate door leads directly into the serology-bacteriology unit so that contaminated glassware need not be transported through other work areas.

Within this unit are located a water still, pressure sterilizer, sterilizing oven, and pipette washer. Storage cabinets are also provided for stock items of glassware, chemicals, and reagents. A hood over the sterilizers and water still is used to exhaust the heat generated by the equipment. Utility carts used to transport dirty glassware from the various laboratory units to this area are parked in this unit.

*Locker and toilet facilities*, separate locker and toilet facilities are provided within the laboratory department for the medical technologists. This convenience reduces the time personnel must be away from the work areas. Since most medical technologists are females, lockers have been provided for them in the department. However, where male technologists are employed, lockers should also be provided for them, either in the laboratory or in another location.

*Optional services*, clinical photography, medical illustration, and research facilities are not included in the plan because of their specialized requirements. If these services are to be part of the laboratory department, revision and expansion of the plan will be necessary.



Right: view of laboratory shown in Plan A (70,000-120,000 tests annually). This area is divided into five units, each 10 ft. wide. On the extreme left is the Hematology-Blood Bank Unit; next to it is the Urinalysis-Biochemistry Unit; in the center is the Biochemistry Unit, followed by the Histology Unit. In the background, behind the glass partition is the Serology-Bacteriology Unit

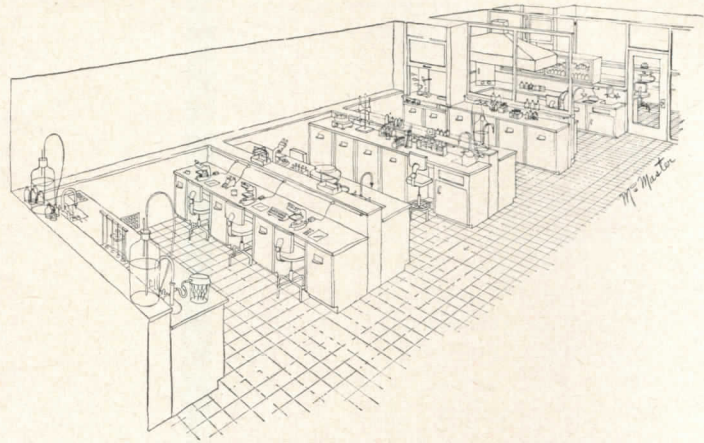

## GUIDE PLANS FOR SMALLER HOSPITAL LABORATORIES

Plan B—a suggested guide for a general hospital laboratory service having an anticipated annual workload of 40,000 to 75,000 tests. The estimated technical staff required to handle this workload is 4 to 7 medical technologists, based on the annual workload per technologist (Tables I and V). The nontechnical staff would include one or more laboratory helpers in the glasswashing and sterilizing unit and a secretary to handle the administrative work.

Many hospitals having laboratory services within this workload range employ a pathologist on a part-time basis. However, as more pathologists become available and the steady growth of laboratory services continues, more hospitals will employ pathologists on a full-time basis. This plan, therefore, provides for a laboratory department having a full-time pathologist. It is assumed that a histology unit will be needed, since it is common practice for pathologists in hospitals so equipped to do the pathology for smaller hospitals in the area. Hence, the histology unit workload will be greater than if the pathologist were processing the work of only one hospital.

A laboratory service performing a yearly volume of 40,000 to 75,000 tests requires the same types of technical units as one that handles 70,000 to 120,000 laboratory tests. The space requirements for the technical work areas of the units are reduced, however, because the workload is less and fewer technologists are needed.

*Technical, administrative, auxiliary areas*, the plan provides four laboratory modules where the technical procedures performed includes hematology, urinalysis, biochemistry, histology, and serology-bacteriology. Only the biochemistry unit is reduced in area because of less work and simpler procedures. The decreased work volume in the other units does not warrant further reduction of their work areas.

The principle of having equipment such as centrifuges, refrigerators, and recording desks close to the working unit which is to use them was followed as in Plan A.

Because of the decreased workload, the working area and the space for clerical personnel also is reduced.

The glasswashing, sterilizing, storage space, and technicians' locker facilities also are reduced.

Plan C—presents a design which might be used for a laboratory service in a small hospital. It allots the same

areas for the technical, administrative, and auxiliary service units that Plan B provides, but the total square footage is less. However, more difficulty is encountered in providing as efficient a relationship between the administrative and auxiliary services and the technical laboratory units as in the plans for larger departments.

Plan D—a suggested plan for a general hospital laboratory service handling an annual workload of from 20,000 to 30,000 tests. The estimated technical staff required to handle this workload is 2 to 3 medical technologists, based on the workload per technologist and the annual volume of tests (Tables I and II). The nontechnical staff would include one laboratory helper and a clerk-typist.

The requirements for an efficient and functional laboratory design are often overlooked in a small hospital because of the relatively small work volume in each category and the simplicity of the tests performed. The utilization of the standard laboratory module previously described permits even the small laboratory to be divided into technical, administrative, and auxiliary service work areas where the technologists may work in an area designed for the specific task.

Because of the decreased workload in a laboratory of this size, it is feasible to combine the hematology, bacteriology, and serology units by providing half a module for hematology and the other half for bacteriology and serology. A second module is provided for urinalysis and biochemistry, storage space, and refrigerator. No histology unit is indicated as it is customary for a laboratory service of this size to send pathological specimens to a pathologist in a nearby hospital. Specimens requiring complex bacteriological and chemical procedures would also be sent to an outside laboratory for study. Only the more common and simple laboratory procedures would be done in these units.

A glasswashing and sterilizing area is provided directly opposite but apart from the technical work areas.

The administrative area provides a small waiting room where a clerk-typist receives patients and laboratory requests and specimens. In this area, a room is also provided for performing basal metabolism tests and electrocardiograms. This room also can be used for obtaining blood specimens from ambulant patients. No separate toilet facilities are provided for obtaining other laboratory specimens because such facilities in this size hospital often are located a short distance from the laboratory. Be-



cause of the small number of personnel in this laboratory service, no separate locker facilities are provided since the hospital would probably have a central locker and restroom.

### UTILITY SERVICES

The utility service systems required in the operation of the laboratory include water, waste, gas, vacuum and compressed air. Because of the importance of these systems, the need for continuity of service, and the probability of future expansion, careful study is necessary in designing them for safety and efficiency.

Piping systems should not be exposed because they create housekeeping problems as dirt collectors and may be hazardous; many are noisy and unsightly. They should be located where they will be easily accessible for service and repairs with a minimum of disruption of normal laboratory services. A sufficient number of valves, traps, and cleanout openings should be installed and should be located so as to permit maximum use of the facilities during repairs.

Laboratory benches are usually placed at right angles to and adjoining outside walls to effectively utilize space. This location of the benches simplifies, to some extent, the arrangement of the piping systems by installing vertical lines in the outside wall and mounting the horizontal piping on this wall. (See figure 1.) This arrangement is particularly advantageous for the waste vent stacks which must be carried vertically to the roof. Removable panels between the bench islands on the outside wall provide easy access to the main piping systems and sectionalizing valves. Branch lines may be carried from the horizontal wall piping through the center of the island to serve the benches on both sides.

For safety purposes and to facilitate repairs, each individual piping system should be plainly identified by color, coding, or labeling. All waste piping should be of a noncorrosive material and should be discharged to a dilution pit or should be carried to a point in the piping system where the discharge will be diluted by waste from other areas.

Laboratory sinks should be made of noncorrosive material and should be designed for laboratory service. A waste grinder under the sink in the serology unit is highly desirable for disposal of clotted blood which may otherwise clog the drain.

*Air conditioning and ventilation*, air conditioning with a well-defined pattern of air movement is necessary to provide an acceptable environment in the laboratory. Chemical fumes, vapors, heat from equipment, plus the undesirability of open windows, all contribute to this need.

The ventilation requirements for each work unit should be carefully studied and definite air-flow patterns should be provided by proper location of supply and exhaust grilles and by regulating the quantities of air handled by each. Ceiling supply air grilles of a non-aspirating type with low wall exhaust grilles, located so that air moves into the working areas and down to the floor for exhaust, are desirable. Fume hoods usually have integral exhaust systems and provision must be made in the ventilation system or by other means to supplement the air discharged through them. The exhaust ducts from fume hoods and the fans serving them should be made of noncorrosive materials and the discharge from them should be carried above the roof. A slightly negative pressure

relative to other hospital areas should be maintained in the laboratories because of the contaminants and odors which originate in and are common to laboratories.

The exhaust air from the hoods in the biochemistry, histology, glass-washing-sterilizing, and serology-bacteriology units, including the air from the exhaust grilles in the histology and seriology-bacteriology units, should be discharged to the outside with no recirculation.

To reduce the spread of odors in the histology unit, approximately 50 per cent of the exhaust from this unit should be removed at the fume hood over the work area, with the remainder being removed at the exhaust grille near the floor.

The serology-bacteriology unit should be slightly pressurized by supplying more air to it than is exhausted from it. This reduces the possibility of infiltration of aerosols from other areas which might contaminate the specimens being processed.

The administrative areas will require no special air conditioning design, although it is desirable that they be pressurized relative to the laboratory areas to eliminate laboratory odors.

Temperatures and humidities for all areas should be within the normal comfort units.

The air conditioning system should be designed to permit its extension to serve future expansion or rearrangement of the laboratory.

### ELECTRICAL INSTALLATIONS

Voltage supplied to the laboratory outlets must correspond to the specific stationary or portable laboratory equipment to be used. In the planning stage, after the major stationary equipment and areas have been determined, outlets for electric power can be arranged as to location and current characteristics required. Because of the variations in types of equipment, flexibility of the current characteristics and location of the electric power outlets are of primary importance throughout the laboratory. For example, portable and specially built apparatus may require 115 volts or 230 volts, depending upon the equipment model.

### LIGHTING

Illuminating intensities at the laboratory workbenches should be a minimum of 50 footcandles, preferably produced by fluorescent lamps because they provide diffuse light sources with minimum glare. For close detail work, an illumination level of 100 footcandles is preferable. Figure 2 illustrates a typical lighting arrangement for each work area. In offices and areas where clerical work is performed, a minimum of 50 footcandles should be provided.

### ROOM FINISHES

In the washing and sterilizing unit the floor finish should be waterproof, free of cracks, easy to clean, nonslip and resistant to wear from heavy traffic. A material such as quarry tile is satisfactory. Wall surfaces should be smooth, easy to clean, free of cracks, and have a waterproof finish. Glazed or similar finishes have been used satisfactorily.

In the technical areas there are no special requirements for finishes. Floor tiles such as asphalt, vinyl, and rubber have been used successfully. Tiles are preferable to sheet materials, since they are relatively easy to replace.



# Architectural Engineering

## A Science for Fire Endurance?

Whenever a new material or construction is introduced, one of the vital questions is: How well does it resist fire? Establishing fire resistance is an expensive and slow process, since, at present, full-size specimens must be tested. Thus increasing attention is being given to the development of a science for fire endurance, comparable to the existing science of structural analysis. The basic needs for such a science are outlined in a paper by Hubert Woods, Director of Research for the Portland Cement Association Research and Development Laboratory, which describes fire research on prestressed concrete at this facility. (See *Journal of the Structural Division*, American Society of Civil Engineers, November, 1960.) These needs are: (1) acceptably reliable analytical solutions, and (2) reliable small-scale methods for fire testing to confirm predictions and substitute, at least partly, for full-scale testing.

## Prestressed Concrete Stands Up To a Fire

Serious fires, though unfortunate, many times uncover new knowledge regarding structural behavior of new systems of building construction. Such an example has been reported by consulting engineers Schupack and Zollman of Newtown Square, Pa., who recently investigated and prescribed renovation steps for an all precast, prestressed store, 200 by 750 ft, near Philadelphia which was subjected to a raging five-hour fire. (The building had neither fire walls nor a sprinkler system.) After thorough inspection of the structure the engineers concluded that its condition was a "remarkable tribute to prestressed concrete as a construction material." Framing consisted of 600 prestressed roof panels (called monowing double T's), 86 prestressed inverted T-girders, 130 precast, non-prestressed columns and 64 precast, non-prestressed spandrels and struts. Collapse of roof panels occurred in only 10 out of 100 bays (30 by 50 ft, containing six roof panels each) in areas where the fire was most severe, probably involving explosions in eight of the 10 bays. Inspection, testing, and restoration as described in the December 1960 issue of *Civil Engineering*, took only a little over two months.

## Heels Hammer Floors

While building materials always have to meet the adversities of weather and wear, seldom do they have to cope with vogue in women's fashion. But such is the case with the steel stiletto heel, which seems to be causing no end of trouble for flooring. These heels were described before on this page as "wreaking more damage than a bull elephant or a wild rhinoceros." Apparently the situation is serious enough that the new U. S. Commercial Standard for Douglas Fir Plywood (CS-45-60) calls for a change in the requirements for floor underlayment. The grade of plywood veneer used next to the face ply must not have large knot holes or voids which might allow the floor to be punctured by hammering heels.

## Who Wants A Multi-Widget?

The next ten years will probably see no revolution toward total utility cores—i.e., complete kitchens, bathrooms, laundries, etc.—according to John C. Martin, Assistant Chief Engineer of Frigidaire, because "the combining of existing components into larger packages at the factory appears neither practical nor desirable." It is doubtful whether there is any real cost advantage in factory production of super PMCs (Prefabricated Mechanical Components) versus site fabrication of conventional PMCs now on the market, he remarked at a talk given at the Building Research Institute Fall Conferences in Washington. In addition, today's components offer almost maximum individuality of design. Martin proposed four questions to test the marketability of any "multi-widget" assembly: 1) Is there a need and/or desire for this product right now? 2) Does it require special wiring, equipment or construction? 3) Is it reliable and simple to service? 4) Does it depend on another industry's developments?

## This Month's AE Section

*ESTIMATING RESIDENTIAL COOLING LOADS*, p. 170. *PLEATED ROOF FOR LOW COST HOUSING*, p. 175. *WIRE FABRIC HEATS, REINFORCES SLAB*, p. 176. *TIME-SAVER STANDARDS*, Sprinkler Systems, p. 177. *BUILDING COMPONENTS: Plastic Foams*, p. 183. *Product Reports*, p. 185. *Literature*, p. 186.



# A Simplified Procedure for ESTIMATING RESIDENTIAL COOLING LOADS

by W. S. Harris\* and E. J. Brown\*\*

*Can the estimated design cooling load for a single house range from 33,000 to 60,000 Btuh, depending solely on the calculating method used?*

*It can. And it did in a case cited by the Federal Housing Administration as being typical of the disparity in the results produced by the various company- and industry-propounded heat gain calculation methods now in use.*

*Because this disparity in calculated loads causes a corresponding disparity in "competitive" bids on central cooling systems, a special "Industry Heat Gain Joint Study Group" was formed in September 1959 to develop a unified calculation procedure for adoption by the entire air conditioning industry. The result, as outlined here, is a proposed method for estimating heat gain which, when adopted, will greatly simplify more accurate design of residential cooling systems.*

As the demand for residential air conditioning has increased, each of the major trade groups interested in this growing market has developed its own approach to the problem of calculating design loads. Since the basic assumptions regarding design conditions are not the same for each of these calculation procedures, the design loads determined often disagree also, with resulting confusion both to the prospective buyer of cooling equipment and to those engaged in financing the construction of air conditioned homes.

To correct this situation, the Federal Housing Administration recently requested that an effort be made to bring about greater agreement in the methods of calculating residential cooling loads. The Air Conditioning and Refrigeration Institute, the Institute of Boiler and Radiator Manufacturers and The National Warm Air Heating and Air Conditioning Association accordingly appointed a joint committee to study cooling load estimation methods with the aim of developing an acceptable common procedure.

Two of these trade associations, The National Warm Air Heating and Air Conditioning Association and the Institute of Boiler and Radiator Manufacturers, have for many

years sponsored residential heating and cooling research under cooperative agreements with the University of Illinois Engineering Experiment Station, the Association having built four Research Residences and the Institute two Research Homes.

The analysis of cooling loads presented here is based on data collected through investigations conducted in W. A. Research Residences Numbers 2, 3 and 4, and in the IBR Research Home and Hydronic Research House, the measured cooling load information on the five presenting a sound basis for comparison of cooling load estimation procedures.

The IBR Research Homes<sup>1,2\*</sup> and W. A. Research Residence No. 2<sup>3,4</sup> were fully insulated and tightly constructed; W. A. Residence No. 3<sup>5</sup> was the opposite, with a minimum of insulation. The new IBR Hydronic Research House (Figure 3) and W. A. Research Residence No. 4 (Figure 1) incorporate features of all three of the other houses, with some wall sections well insulated and others completely uninsulated.

## The Design Conditions

Since all cooling load calculation procedures are basically for sensible loads, with allowances added for latent and internal loads, the studies discussed here dealt with the sensible loads only.

*Inside conditions.* The inside de-

sign dry bulb temperature was assumed to be 75F, a commonly accepted comfort condition. It was further assumed that equipment selected on the basis of the calculated design loads should be adequate to maintain indoor design temperatures within normal thermostatic control tolerances during a design day and at the same time operate more or less continuously during daylight hours.

*Outside conditions.* It was concluded that the effect of daily temperature range on total load was small enough to be neglected, and that the tabulated data could be simplified by using a daily outdoor temperature range of 20F regardless of the outside design dry bulb temperature.

*Maximum Load Period.* Figure 2 shows the outdoor dry bulb temperature and the heat flow rates through three walls and one ceiling of W. A. Residence No. 4 on a near-design day for the period from 6:00 AM to 12 midnight CST. The curves show the effects of wall construction and orientation on the heat flow. The heat flow rate through the uninsulated lower level concrete block east wall increased rapidly after 7:00 AM because of the direct exposure to the morning sun, decreasing after the peak heat flow rate of 10.5 Btuh per sq ft was reached at 12:00 noon. Maximum heat flow through the upper level east frame wall was recorded at 9:00 AM since shading provided by the roof overhang caused a decrease after that time. The heat flow through the west frame wall on the middle level reached a peak at 6:30 PM; that through the ceiling between 2:00 and 3:00 PM.

Figure 4 represents the measured hourly transmitted sensible cooling load (not including internal load) for each level of the IBR Hydronic Research House and for the house as a whole. The maximum hourly sensible heat gain for the house, about 20,000 Btuh, occurred at about 4:00 PM. The maximum sensible loads and times of occurrence by

\*Professor of Mechanical Engineering, University of Illinois

\*\*Research Associate in Mechanical Engineering, University of Illinois

\*See References page 244



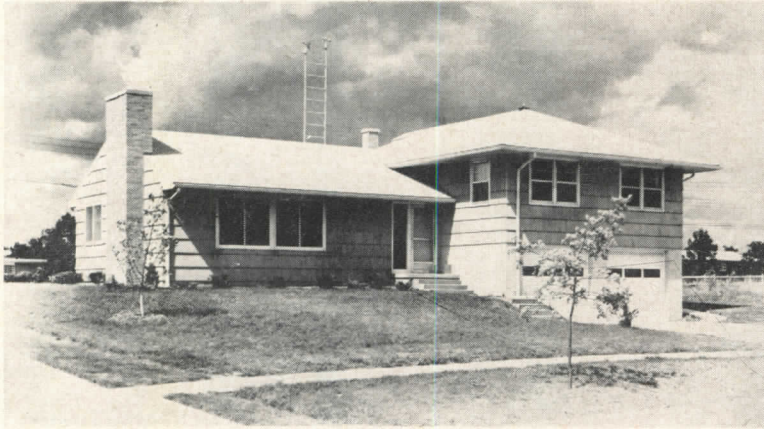

Figure 1. Warm Air Research Residence No. 4, is three-level house with concrete block walls on lower level, stud walls on upper levels

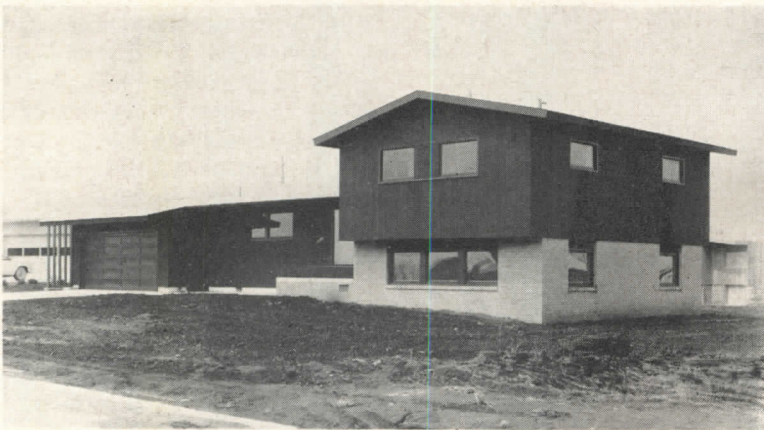

Figure 3. IBR Hydronic Research House is tri-level masonry and frame with cathedral ceilings in second and third level rooms

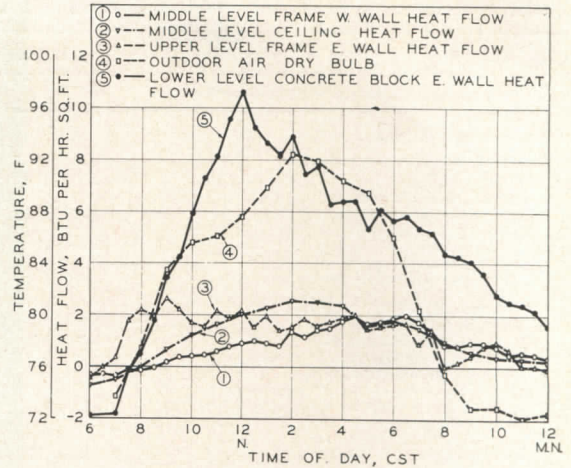

Figure 2. HEAT FLOW AND TEMPERATURE STUDY WARM AIR RESIDENCE NO. 4

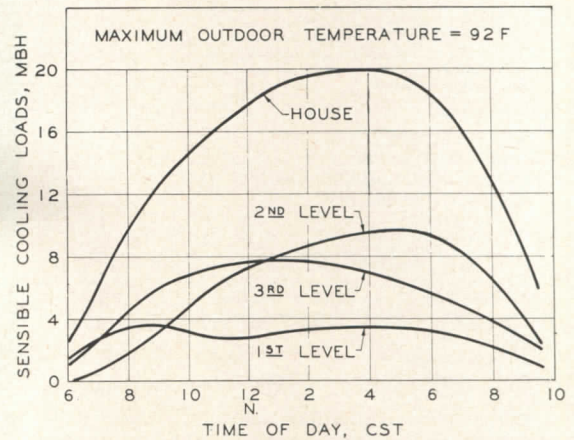

Figure 4. MEASURED SENSIBLE COOLING LOADS IBR HYDRONIC RESEARCH HOUSE

levels were 3,600 Btuh at 9:00 AM for the first level, 9,700 Btuh at 5:00 PM for the second level, and 7,800 Btuh at 1:00 PM for the third.

As is true for any house, the peak heat flow rates through the various elements of the house did not occur simultaneously. Since heat flow rates are affected by construction and orientation, the maximum cooling load is not reached at the same time of day in all rooms or even on all levels of a house.

Figure 4 also indicates that for a period of about 8 hours the measured load was equal to or greater than 80 per cent of the maximum. Thus if a cooling system were designed to satisfy a maximum load equal to the average calculated load for the highest eight-hour period of the design day, it would operate more or less continuously and at the same time have capacity enough to insure little, if any, overrun of house temperature.

Once it was decided that the factors through walls should be based

on average heat flow rates over an eight-hour period, the problem of selecting the period to be used and the method of averaging still remained. Since the period of maximum equivalent temperature difference (maximum heat transfer) is dependent on the mass of the wall (See Table 10, page 192, 1960 ASHRAE Guide), it is apparent that different eight-hour periods will have to be used for different wall constructions if maximum factors are desired.

However, for design purposes, one is interested not in the maximum heat transfer rates, but in the average heat transfer rate through each wall or ceiling construction at the time of maximum load on the house.

Observations in both IBR Research Houses and in the three Warm Air Residences indicated that the maximum loads occurred before 6:00 PM standard time, and the highest 8-hour period occurred between 10:00 AM and 8:00 PM regardless of the wall construction or

amount of insulation used.

On the assumption that in a typical residence the peak load will always occur before 7:00 PM, the eight-hour period starting at 11:00 AM and ending at 7:00 PM was used to determine the average heat transmission factors to be used for wall constructions.

### Calculating Sensible Heat Gain

The sensible heat gain through a wall is defined by the equation

$$H = A \times U \times ETD$$

where

H = Sensible heat gain through wall in Btuh

A = Wall area in sq ft

U = The coefficient of heat transfer in Btuh per (sq ft) (deg F)

ETD = Equivalent temperature difference, a value used in place of outdoor-indoor temperature difference when estimating heat gains through walls. Equivalent temperature



**TABLE 1: PROPOSED HEAT GAIN FACTORS, BTUH PER SQ FT**

Maximum Outdoor Temperature, F	FACTOR			ETD			U
	90	95	100	90	95	100	
<b>Walls and Doors</b>							
1. Frame and Veneer on Frame							
a) No insulation	4.8	6.1	7.4	18.6	23.6	28.6	.26
b) Less than 1" insulation, or one reflective air space	3.5	4.5	5.4	18.6	23.6	28.6	.19
c) 1" to 2" insulation, or two reflective air spaces	2.4	3.1	3.7	18.6	23.6	28.6	.13
d) More than 2" insulation, or three reflective air spaces	1.5	1.9	2.3	18.6	23.6	28.6	.08
2. Masonry, 8" Block or Brick							
a) Plastered or plain	5.4	7.8	10.2	11.3	16.3	21.3	.48
b) Furred, no insulation	3.4	4.9	6.4	11.3	16.3	21.3	.30
c) Furred, with less than 1" insulation, or one reflective air space	2.3	3.3	4.3	11.3	16.3	21.3	.20
d) Furred, with 1" to 2" insulation, or two reflective air spaces	1.5	2.3	3.0	11.3	16.3	21.3	.14
e) Furred, with more than 2" insulation, or three reflective air spaces	1.0	1.5	1.9	11.3	16.3	21.3	.09
3. Partitions							
a) Frame, finished one side only, no insulation	6.0	9.0	12.0	10.0	15.0	20.0	.60
b) Frame, finished both sides, no insulation	3.4	5.1	6.8	10.0	15.0	20.0	.34
c) Frame, finished both sides, more than 1" insulation or two reflective air spaces	1.4	2.1	2.8	10.0	15.0	20.0	.14
d) Masonry, plastered one side, no insulation	1.2	3.0	4.7	3.5	8.5	13.5	.35
4. Wood Doors †	9.3	11.8	14.3	18.6	23.6	28.6	.50
<b>Ceilings and Roofs</b>							
1. Ceilings under naturally vented attic or vented flat roof							
a) Uninsulated	9.0	10.2	11.3	39.0	44.0	49.0	.23
b) Less than 2" insulation or one reflective air space	3.9	4.4	4.9	39.0	44.0	49.0	.10
c) 2" to 4" insulation or two reflective air spaces	2.3	2.6	2.9	39.0	44.0	49.0	.06
d) More than 4" insulation or three or more reflective air spaces	1.6	1.8	2.0	39.0	44.0	49.0	.04
2. Built-up roof, no ceiling							
a) Uninsulated	15.6	17.6	19.6	39.0	44.0	49.0	.40
b) 2" insulation	7.8	8.8	9.8	39.0	44.0	49.0	.20
c) 3" insulation	5.5	6.2	6.9	39.0	44.0	49.0	.14
3. Ceilings under unconditioned rooms	1.9	2.9	3.8	10.0	15.0	20.0	.19
<b>Floors</b>							
1. Over unconditioned rooms							
	2.4	3.6	4.8	10.0	15.0	20.0	.24
2. Over basement, enclosed crawl space, or slab on ground							
	0	0	0	0	0	0	0
3. Over open crawl space							
	3.4	5.1	6.8	10.0	15.0	20.0	.34
<b>Infiltration, Btuh per sq ft, gross exposed wall</b>							
	0.97	1.30	1.62	½ air change			

† Treat glass doors same as windows  
 \* Thermal conductivity of roof-ceiling combination, from guide. (Multiply by ETD for heat gain factor)  
 \*\* Thermal conductivity of ceiling only, calculated.

**TABLE 1-A: GLASS FACTORS, BTUH PER SQ FT, 30 and 40 deg N. Latitude**

Maximum outdoor temperature, F	SINGLE GLASS			DOUBLE GLASS		
	90	95	100	90	95	100
No inside shades						
N. (or shaded) <sup>a</sup>	26	31	36	19	21	24
N.E. and N.W.	58	63	68	43	45	48
E. and W.	84	89	94	61	64	66
S.E. and S.W.	73	78	83	72	75	77
S.	43	48	53	34	37	39
Shades half drawn (0.81) <sup>b</sup>						
N. (or shaded)	23	27	31	16	18	20
N.E. and N.W.	49	53	57	36	37	40
E. and W.	70	74	78	50	53	54
S.E. and S.W.	61	65	69	59	62	63
S.	37	41	45	29	31	33
Inside venetian blinds or drapes (.65) <sup>b</sup>						
N. (or shaded)	20	23	26	14	16	18
N.E. and N.W.	41	44	47	30	31	34
E. and W.	58	61	64	42	44	45
S.E. and S.W.	50	54	57	49	51	52
S.	31	34	37	24	26	27
Awnings or outside shade screens (0.35) <sup>b</sup>						
N. (or shaded)	14	16	18	10	10	11
N.E. and N.W.	26	28	30	18	19	20
E. and W.	35	37	39	24	25	26
S.E. and S.W.	32	33	35	28	29	30
S.	20	23	25	15	16	17

<sup>a</sup> Permanent shading such as roof overhang, adjacent buildings, etc.  
<sup>b</sup> Multiplying factors for Medium "Color Shading Devices" selected from 1960 ASHRAE Guide

difference is adjusted to compensate for solar radiation effects.

(Generally accepted values of equivalent temperature differences are given in ASHRAE Guide.)

Having previously decided that the wall constructions listed in Table 1 would be adequate for residential heat load calculations, the average equivalent temperature difference to use for each was determined in the following manner.

*Frame and veneer walls.* Using Table 10, page 192, 1960 ASHRAE Guide, all tabulated values of equivalent temperature differences for dark walls in the sections headed "frame" and "4 in. brick or stone veneer and frame" between 11:00 AM and 7:00 PM and without regard to orientation were averaged together, and corrected as directed in footnotes to the table to outdoor-indoor temperature differences of 15, 20, and 25F (outdoor temperatures of 90, 95, and 100F and an indoor temperature of 75F). Dark wall equivalent temperature differences were used since the designer does not always know the wall color and dark wall values result in safe heat gain factors.

*Masonry walls, 8-inch block or brick.* The same procedure described above was followed except that the tabulated values were taken from the sections of Table 10 headed "8-in. hollow tile or 8-in. cinder block," "8-in. brick or 12-in. hollow tile or 12-in. cinder block," and "8-in. concrete or stone or 6-in. or 8-in. concrete block."

*Partitions.* Again the same procedure was used but since partitions are always shaded, they were treated as north-facing walls.

Equivalent temperature differences as computed by the above methods are given in Table 1, along with the assumed coefficient of heat transfer, and the resulting heat gain factor for each wall construction considered. The heat gain factor is the product of the coefficient of heat transfer for each wall and the appropriate equivalent temperature difference.

*Ceilings.* The measured instantaneous heat transmission rates for the ceilings of four residences located in Urbana, Illinois were obtained for all hours of the day over a range of summer conditions. Using the measured ceiling heat transmis-



**TABLE 2: COMPARISON OF CALCULATED AND MEASURED SENSIBLE COOLING LOADS**  
(Indoor Air Temperature of 80 F Used with Manual 11 and ARI-230, 75 F Used in all other cases)

House	Method of Obtaining Load	1st level	2nd level	3rd level	House	Glass	Walls	Ceilings	Fir.	Infil.
W. A. Residence No. 2 (Outdoor Temp. 95 F)	Manual II	12,747			12,747	5,311	1,790	4,040	00	1,606
	Guide C-30	11,930			11,930	5,105	676	2,020	00	4,129
	Proposed	14,885			14,885	8,901	1,869	2,625	00	1,490
	Measured Max.				15,080					
W. A. Residence No. 3 (Outdoor Temp. 95 F)	Manual II	14,751			14,751	5,306	4,340	3,072	00	2,033
	Guide C-30	10,472			10,472	3,135	2,655	1,536	00	3,100
	Proposed	12,387			12,387	4,208	4,935	1,994	00	1,160
	Measured Max.				11,890					
W. A. Residence No. 4 (Outdoor Temp. 90 F)	ARI 230-57				25,059	8,801	6,158	5,652	438	4,010
	Manual II	4,453	8,039	9,024	21,516	8,500	3,675	2,843	341	6,157
	Guide C-30	10,000	5,313	7,819	23,132	6,389	3,481	3,041	119	10,102
	Proposed	6,159	7,722	9,389	23,270	11,657	6,284	3,249	170	1,910
	Measured Max.	4,220	10,900	8,160	23,240					
I-B-R Research Home (Outdoor Temp. 100 F)	Manual II	8,705	8,615		17,320	7,810	3,105	2,800	00	3,605
	Guide C-30	6,850	7,475		14,325	7,150	1,755	1,600	00	3,800
	Proposed	7,950	8,880		16,830	8,950	3,600	1,840	00	2,440
	Measured Max.	5,098	5,979		11,077					
I-B-R Hydronic Research House (Outdoor Temp. 90 F)	ARI-230-57				41,845	25,140	5,875	5,150	3,225	2,455
	Manual II	5,710	18,425	8,325	32,460	22,420	3,630	2,885	2,075	1,450
	Guide C-30	4,725	9,600	5,650	19,975	10,825	2,875	2,200	1,025	3,050
	Proposed	4,120	7,120	6,600	17,840	9,710	3,920	2,710	00	1,500
	Measured Max.	3,350	9,350	7,150	19,850					

sion rates for the same 8-hour averaging period as was used for walls, and determining sol-air temperatures by use of the method of analysis described on page 131 of the 1960 ASHRAE Guide, resulted in average sol-air temperatures of 114F, 119F and 124F at outdoor temperatures of 90, 95 and 100F respectively.

The sensible heat gain through ceilings is given by the equation:

$$H = U_o A (t_s - t_i)$$

where H = sensible heat gain through the ceiling in Btuh

$U_o$  = The combination ceiling-roof heat transmission coefficient in Btuh per (sq ft) (deg F)

A = Ceiling area in sq ft

$t_s$  = Sol-air temperature in deg F

$t_i$  = Indoor temperature in deg F

The 1960 ASHRAE Guide (page 131) also presents a method whereby the combined ceiling-attic coefficient  $U_o$  can be determined from the ceiling value,  $U_c$ . For example, a ceiling value of 0.13 Btuh per (sq ft) (F deg) combined with an attic ventilated at the rate of 0.1 air changes per hour (natural ventilation) results in a combined coefficient,  $U_o = 0.10$ .

In the equation for ceiling sensible heat gain, the  $U_o$  and temperature difference terms may be combined to

result in the equation:

$$H = KA$$

where  $K = U_o(t_s - t_i)$ .

If  $U = 0.10$  and  $t_s - t_i = 39$ , the factor  $K = 3.9$  Btuh per sq ft. All factors for ceilings in Table 1 were determined in this manner.

*Infiltration.* At best the assumed design infiltration rates are approximations. It is reasonable and convenient to relate infiltration to gross wall area. Direct measurement of the infiltration rate in two experimental houses<sup>4</sup> indicated an infiltration rate, under summer conditions, of 0.5 air changes per hr, or 3.6 cfh per sq ft of gross wall area. The sensible heat gain due to infiltration is represented by the equation:

$$H_a = VdC_p (t_o - t_i) A$$

where  $H_a$  = Sensible heat gain due to infiltration in Btuh

V = Infiltration in cfh per sq ft of gross wall area

d = Density of air in lb per cu ft

$C_p$  = Specific heat of air in Btu per (lb) (deg F)

$t_o$  = Outdoor air dry bulb temperature in deg F

$t_i$  = Indoor air dry bulb temperature in deg F

A = Gross wall area in sq ft

This may be simplified to  $H_a = K \times A$  where K is all terms on the right hand side of the equation except A. Thus if  $t_i$  is 75F, K becomes 0.97

when  $t_o = 90F$ , 1.30 when  $t_o = 95F$ , and 1.62 when  $t_o = 100F$ . These are the factors appearing in Table 1 under infiltration.

*Glass.* Having selected the period from 11:00 AM to 7:00 PM as the averaging period to establish heat gain factors for walls and ceilings, it seemed logical to use the same period of time for the glass. Accordingly, factors for this period were established from the ASHRAE data for glass, and the calculated sensible heat gains determined for the research houses for a day having a maximum outdoor temperature of 90F. Comparing these calculated heat gains with those determined by test indicated, however, that this procedure resulted in calculated heat gains which were too high, especially in rooms with western exposures. This suggested a longer averaging period which would include more of the morning hours, thus distributing the total glass load more evenly.

Using an averaging period from 5:30 AM to 6:30 PM and omitting data for 50 deg north latitude, since this latitude is north of most areas where cooling is required, resulted in calculated loads which agreed well with test results.

The instantaneous sensible heat gain through glass is expressed by the equation:

$$H = H_i + H_{r,c}$$

where H = total instantaneous solar



heat gain in Btuh per sq ft

$H_t$  = transmitted solar heat gain in Btuh per sq ft

$H_{r,c}$  = solar heat gain by radiation and convection in Btuh per sq ft.

Values of  $H_t$  and  $H_{r,c}$  as given in Tables 12 and 13, page 196 of the 1960 ASHRAE Guide were averaged for the 13 hr period (5:30 AM to 6:30 PM) decided upon.

Values of  $H_t$  are not affected by indoor temperature, but  $H_{r,c}$  is dependent on indoor temperature and the required corrections were applied to the  $H_{r,c}$  averages. For a north window with an outdoor temperature of 90F and an indoor temperature of 75F, the average values are:  $H_t = 18$ ,  $H_{r,c} = 8$ , and  $H = 18 + 8 = 26$  Btuh per sq ft. Table 1a lists factors for unshaded and shaded single and double glass which were determined by this method.

#### Calculated vs. Measured Loads

Table 2 is a comparison of the calculated and measured sensible cooling loads of the five test houses. The cooling loads for all houses were calculated by Warm Air Manual 11<sup>5</sup>, by IBR Guide C-30<sup>6</sup>, and by the method proposed in this article. In addition, the loads for W. A. Residence No. 4 and the IBR Hydronic Research House were calculated by the ARI Standard 230<sup>7</sup> method. The indoor and outdoor temperatures used in determining all loads are noted on the table.

In W. A. Residence No. 4, the calculated loads are compared with the maximum measured load, which occurred between 5:00 and 6:00 PM on a day when the maximum outdoor dry bulb temperature was 92F. The calculation procedures are compared level-by-level, and in addition the heat gains due to each component of the complete sensible load are compared.

By the Manual 11 method, the calculated load was equal to 92 per cent of the measured load. However, the load estimation was based on an 80F indoor temperature rather than the actual indoor temperature which was nearer 75F. An estimation based on Manual No. 11 and a 75F indoor temperature would result in a load in excess of the measured load.

The ARI method resulted in a calculated load equal to 108 per cent of the measured load. This method is also

based on an 80F indoor temperature and with 75F would result in a much greater estimated load.

The load estimated by the Guide C-30 method was nearly equal to the measured load because the infiltration factors for the lower level concrete block walls were unusually high. This is shown by the comparison of the infiltration components as determined by the three methods and also by comparison of the lower level loads. Without the high infiltration allowance, the Guide C-30 method would result in a calculated load less than that determined by the other procedures and also less than the measured load.

The load estimated by the proposed method, which is based on a 75F indoor temperature and distributes the direct solar heat gains among all of the rooms, was equal to 101 per cent of the measured load.

The W. A. Residence No. 2 loads as calculated by both Manual 11 and Guide C-30 were less than the measured load, while the proposed method resulted in a load equal to 99 per cent of the maximum measured load. Again, if the Manual 11 method had been applied with a 75F indoor temperature, the resulting load would have been higher. The Guide C-30 method, without the high infiltration allowance, would have resulted in a calculated load of only 62 per cent of the measured maximum.

In the case of W. A. Residence No. 3, the Manual 11, Guide C-30 and proposed methods resulted in loads equal to 124, 88 and 104 per cent of the measured load, respectively. The proposed method resulted in a better approximation of the actual load than either of the other methods.

For the IBR Hydronic Research House, the use of either Manual 11 or ARI Standard 230 resulted in calculated sensible heat gains well in excess of the measured maximum value. Examination of Table 2 indicates that most of the excess was in the gains attributed to glass since better than 50 per cent of the glass area faced the northwest and both manuals used high radiation factors for this orientation.

The calculated sensible heat gain obtained by use of the proposed factors was about 10 per cent less than the measured sensible heat gain. In this particular instance, the calculated heat gain obtained by the use

of Guide C-30 was in best agreement with the measured value. However, the floor gains and the infiltration gains as computed by Guide C-30 were both high, and if these were reduced to correspond with normal gains to be expected from these sources, the calculated load obtained by Guide C-30 would be in close agreement with that obtained by the use of the proposed factors.

For the first level, the calculated heat gain obtained by the use of the proposed factors was high compared to the measured heat gain. The same condition was observed in W. A. Residence No. 4. In each instance the floor consisted of a concrete slab on the ground and it is believed there was a negative heat gain (heat loss) through the concrete floors. In all methods of calculating the heat gains, the heat loss through a concrete floor on the ground is assumed to be zero.

Measured floor surface temperatures in the den and recreation room, which are on the first level of the IBR Research House, were from 0.5F to 1.7F lower than the air temperature 3 in. above the floor. Using the average difference of 1.1F and a film coefficient of 1.08, it would appear that the heat flow from the rooms to the ground was approximately 1.2 Btuh per sq ft of floor area or about 590 Btuh for the entire first level. Subtracting 590 Btuh from the calculated value of 4120 for the first level gives 3530 Btuh, which is in good agreement with the measured load on that level.

Applying the proposed factors to the IBR Research Home, which was very well shaded by trees and nearby buildings, resulted in calculated sensible heat gains in excess of those computed by either Manual 11 or Guide C-30, while the measured sensible heat gain was less than any of the calculated values. Correcting the calculated glass gains for the natural shading reduced the sensible heat gain obtained when using the proposed factors from 16,830 to 14,170 Btuh, as compared to a measured heat gain of 11,077 Btuh. There is no doubt but that the shading also reduced the heat gain through the roof and the walls; furthermore, the windows had shades half drawn as well as draperies. The glass factors used assumed the use of draperies but did not consider the combined

*continued on page 244*



# Pleated Asbestos Roof for Low Cost Housing

Architect Alvaro Ortega of the UN Technical Assistance Board specializes in developing building techniques that use local materials, labor and manufacturing facilities. In the project shown here, locally-made asbestos-cement pipe is turned into structural channels for low cost housing in Guatemala City

In the investigation carried out by UN expert Ortega in collaboration with the Asbestos-Cement Industry of Guatemala, 12-in. diameter, high pressure asbestos-cement pipe made on the machinery at left is cut in halves which, while still fresh, are pressed into a galvanized metal form (right)

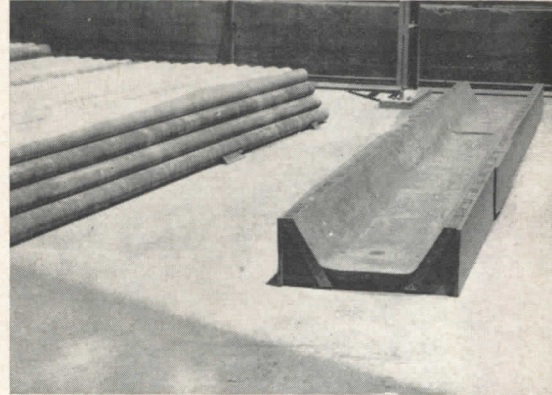
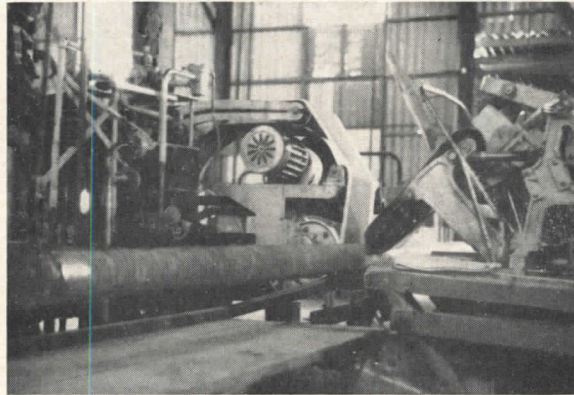

Resulting channels are 21 ft long, 8 in. deep, 15 in. wide at the bottom and 26 in. wide at the top. In the  $\frac{1}{2}$  in. (8 mm.) thickness selected for production, they weigh slightly less than 15 lb (67 kg), and can easily be handled by two men. They are set in place without cranes—or even stepladders—by resting one end on a wall and lifting the other end onto the wall opposite

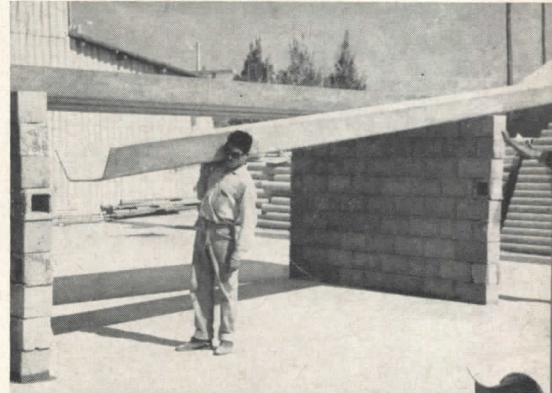
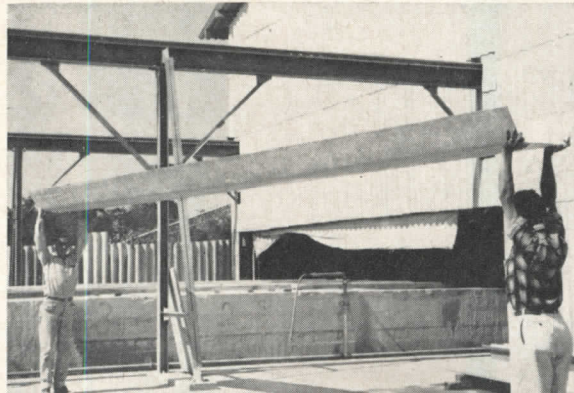

Rigid enough to span 20 ft (5 meters) without intermediate support, the channels can also be cantilevered for added protection from sun and rain. (Those shown at left cantilever about 4 ft, those at right about 12 ft). Because the material is produced under high pressure and formed in metal molds, the channels have a dense, smooth surface that needs no interior finish or exterior waterproofing

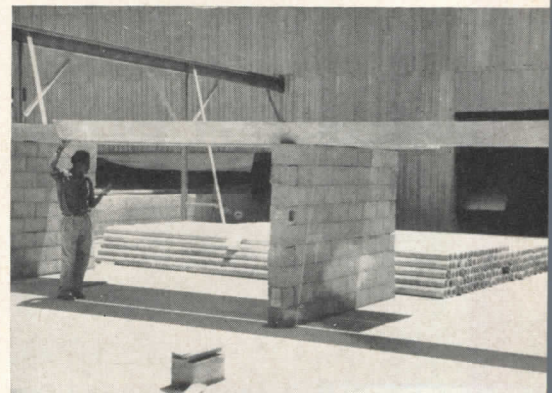
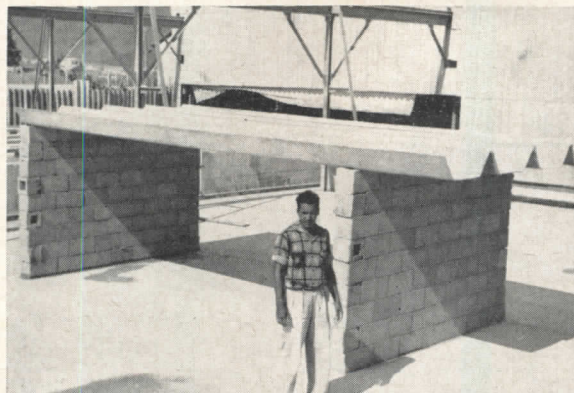

The final stage of the exploratory project was the load testing of the channels.

Under a uniform load imposed by filling the channel trough with water (left), a  $\frac{1}{2}$ -in. thick test member deflected about 0.8 in. at center-span. Under a concentrated load of 500 lb (right), it deflected about 0.6 in.





# Wire Fabric Heats, Reinforces Slab

A power company in North Dakota will use electric radiant heating in the slab of a 6500-sq ft service center-warehouse. Welded wire fabric performs double duty by heating the slab as well as reinforcing it. Trick was to electrically insulate sections of fabric without impairing the reinforcing function

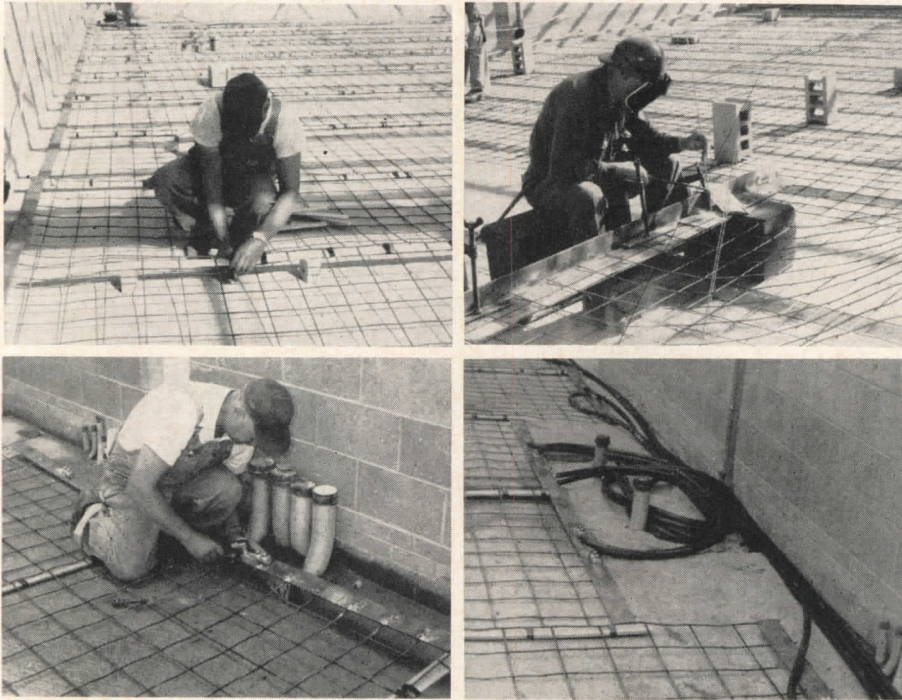

Looking like the elements of an immense toaster, welded wire reinforcing fabric serves also as a heating element in the concrete floor slab. In the top left photo are shown strips of asbestos cement which separate grids of fabric to zone the system. In the top right photo copper bus bars through which voltage is applied are being welded to the fabric. Bars 9 ft 10 in. long are used on one end and 5 ft long on the other end (see plan) to make the current flow in a sinuous pattern. Lower photos show lugs being fastened to the bars and the supply cables

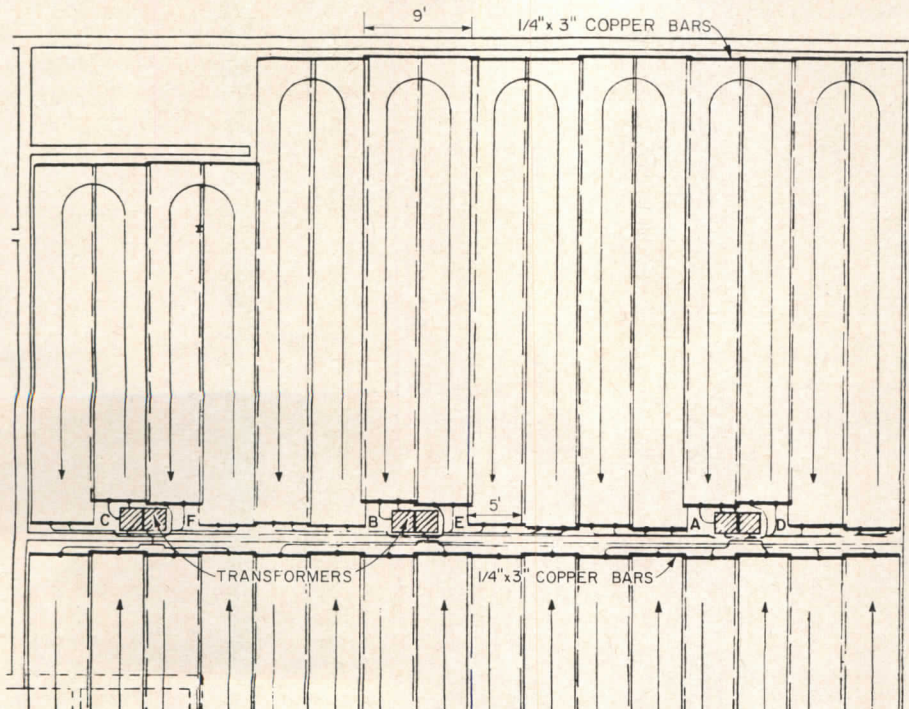

Reinforcing wire fabric also serves as an electric heating element in the concrete floor slab of a 6500 square foot service center and warehouse built by Norther States Power Company outside Minot, North Dakota.

The floor grid will be energized primarily at night to store heat in the floor and underlying area thereby eliminating an increase in the daytime demand factor. Baseboard type resistance heating is provided to supplement the 'stored heat' during late afternoon hours.

Three different types of welded wire fabric were used—66-44, 66-66, and 66-88. (The first pair of figures in each case refers to the 6 inch spacing of the wires; the second pair of figures designates the gauges of the wires.)

In the major warehouse area, the heavier 66-44 was used in order to carry a heavy flow of current and provide the desired floor temperature. In the office area, 66-66 was used because lower current flow and floor temperature were planned, the baseboard units helping to heat this space. The lightest fabric 66-88, was placed in a section of the warehouse where less current will be required to maintain the desired floor temperature.

The major problem in using the wire fabric as both reinforcement and electrical conductor was accomplishing both functions without impairing either one. To be effective as reinforcement welded wire fabric must be overlapped to assure continuity. But, in order to maintain a proper flow of current, the overlapping lengths of fabric had to be separated.

This was done by placing between the lengths of fabric a 2 in. wide, 1/2 in. thick strip of cement asbestos lumber tied securely in place every 12 in. by electrical tape and wrapped about the "sandwich" formed by the insulation and the overlapping wires.

In order to apply the electric potential to the lengths of wire fabric, 1/4 by 3 in. copper bars were welded across the full width of each length.

*continued on page 232*



## SPRINKLER SYSTEMS FOR FIRE PROTECTION: I

by Howard P. Vermilya, A.I.A.

The design of sprinkler systems requires the services of an engineer with a specialized knowledge of such systems for several reasons. First, a system must be developed which will meet the requirements of local authorities and the insurance companies. Second, there is the tricky problem of integrating the sprinkler system with the structure, the mechanical and electrical services and the lighting equipment. While a complete design procedure is much beyond the scope of this article, it does give an orientation to the major features and design criteria of sprinkler systems so that their needs can be anticipated in the early planning of a building.

Sprinklers are recommended for all occupancies having combustible contents or flammable liquids. In non-combustible buildings the installations may be limited to specific areas, but in structures with combustible floors or roofs, it is advisable that sprinklers be provided throughout. Sprinklers are recommended also for all concealed spaces involving combustible construction which are not otherwise protected from fire.

A sprinkler system consists of (1) an adequate water supply, (2) a distribution system consisting of pumps, gages, valves, main, riser, feed and branch line piping, (3) sprinkler heads automatically activated by heat and (4) an alarm system. All equipment used must be listed as "approved." Both the Engineering Division of the Associated Factory Mutual Fire Insurance Companies and the Underwriters Laboratories, Inc. maintain testing facilities for the listing of "approved" equipment.

The building authorities and the insurance companies will require complete working drawings of the system for their approval. Sprinkler drawings should show the building construction, equipment, lighting, and storage facilities. The submission of preliminary sketches of proposed systems also is usually required. The system must be thoroughly tested and inspected before acceptance.

In multi-story buildings of

fire-resistant construction, it is advisable, where possible, to locate the storage areas in the lower stories, preferably the basement, to facilitate the sprinkler installation and cost.

### WATER SUPPLY

*Small Properties* (good construction):

Single source of water with adequate volume and pressure is required. Public water works connections to two streets is preferable.

*Large or Valuable Properties:* Two independent sources are required—primary, which is instantly available, and secondary, which may or may not be automatic.

Primary supply should generally exceed 500 gal/min at a pressure of 15 psi at highest main roof level where cross mains connect to risers or feed mains. Additional volume and pressure are often required depending upon the hazard of occupancy or construction.

### Sources

*Public Water*—one or more connections to reliable public water system of good pressure and capacity are preferable as a primary source.

*Elevated Gravity Tanks*—Acceptable as a primary source when public water is not available. Capacity is dependent upon height, construction and occupancy of building or buildings and the need to supply hose connections in addition to sprinklers. Tanks may supply secondary source for small property with a limited public supply.

*Fire Pumps*—A well located fire pump with ample suction supply, capable of maintaining high pressures over long periods is a most satisfactory secondary supply. (Suction supply may consist of tanks, reservoirs or public water mains of low pressure.)

*Pressure Tanks*—Ordinarily located on or above roof; sometimes an adequate single source.

*Fire Department Pumper Connections*—An auxiliary supply which utilizes a low pressure source for sprinklers and standpipes.

### YARD SYSTEM

This is the portion of the sprinkler system which distributes water from the water supply source to the automatic sprinkler risers. For larger fire protection systems it also distributes water to standpipes and hose connections. All piping is underground (protected from freezing) and outside the building area. Valves are accessible in pits and by use of indicator posts. Manufacturing or domestic water service connections should be separated from fire service systems.

### TYPES OF SYSTEMS

1. *Wet Pipe Automatic Systems.* Piping contains water under pressure for immediate release when valve of sprinkler head is activated. Most general type, used in heated areas or areas not subject to freezing.

2. *Dry Pipe Automatic Systems.* Piping contains air under pressure which, when released by activated sprinkler head, permits water to enter pipes automatically by action of dry pipe valve and flow through sprinklers. Generally used when not feasible to heat area which is subject to freezing weather. Small dry pipe systems may be used in conjunction with wet pipe systems for special areas.

3. *Deluge Systems.* A system of open sprinklers, or a combination of open and closed sprinklers controlled by a quick opening mechanical or hydraulic valve (deluge valve), the latter operating either by automatic heat-responsive devices, or by manual control or otherwise. A deluge system is designed to wet down an entire area in which fire may originate. It is designed for special hazards involving possible flash fires and for structures with high ceilings where heat may be dissipated in early stages of fire before it reaches ceiling. Water demands of deluge systems are usually great.

4. *Pre-Action Systems.* A normally closed, automatic dry sprinkler system in which water is admitted by deluge or hy-





**SPRINKLER SYSTEMS FOR FIRE PROTECTION: 2**

by Howard P. Vermilya, A.I.A.

(To be concluded in March issue)

draulic valve operated by a heat-responsive device before sprinklers operate. Designed to protect properties where there is danger of serious water damage.

5. *Limited Water Supply Pressure Tank System.* Uses water in tank usually located in basement, under air pressure of 100-110 psi, for light-hazard occupancies involving small areas where not more than 5 to 10 sprinklers will operate in any one fire. Designed for conditions where adequate water supply is not available for occupancies such as schools, small hotels, country clubs etc.

6. *"Junior Systems."* A wet pipe system with small orifice sprinkler heads, usually 3/8 in., which uses copper tubing and is connected to the service water supply where there is sufficient pressure and volume. Designed for basements of dwellings and similar occupancies where not more than 3 or 4 sprinklers are liable to operate.

7. *Special Systems.* Sprinkler systems employing limited water supplies, reduced pipe sizes and other departures from the requirements for standard systems are not classified by the National Board of Fire Underwriters as standard sprinkler systems. Systems of this type may include those pressurized with air or nitrogen. The authority having

jurisdiction may recognize the degree of protection afforded by special types of sprinkler systems.

Sprinkler installations are also classified by hazard of occupancy:

- a. "Light-hazard"—residential, business, school, institutional.
- b. "Ordinary-hazard"—storage, industrial, theatres, restaurants.
- c. "Extra-hazard"—storage and processing of cotton and flammable liquids, dusty areas of woodworking plants.

**PIPE SIZES**

The number of sprinklers on any one floor undivided by a fire wall and supplied through given sizes of pipe should not exceed that given in Table 1 below, for ordinary hazard occupancy.

Where the piping arrangement provides long risers or feed mains an increase in pipe sizes may be needed to offset friction losses.

*Risers*

Each system riser should be of sufficient size to supply all sprinklers on the riser of any one floor of one fire section as determined by the schedule of pipe sizes. There should be one or more risers in each building and in each section of building divided by fire walls. Where conditions warrant, the sprinklers in ad-

joining buildings or sections cut off by fire walls may be fed from a system riser in another section or building.

*Riser Location*

"Center-central" or "side-central" feed to sprinklers is recommended. (See Fig. 1.)

*Cross Main and Branch Line Sizes*

Branch lines should ordinarily be limited to 8 sprinklers. Not more than 14 branch lines should be allowed on either side of cross main, riser or feed main.

*Hangers*

Only "approved" pipe hangers installed according to the standards are acceptable.

**SPRINKLERS**

*Automatic Sprinkler Heads*

Only "approved" and tested makes and types are acceptable. A 1/2 in. discharge orifice is standard for all systems other than the "Junior." Automatic sprinklers are designed to discharge water in spray form upon release of valve held on its seat by a mechanism employing some heat-responsive element. Older type deflectors discharged the spray in all directions, wetting the ceiling. The standard spray type deflector directs the spray downward. Side wall sprinkler head deflector directs the water in one direction.

**TABLE 1:—Pipe Size vs. No. of Sprinklers**

(a) When both the distance between sprinklers on branch lines and the distance between branch lines is 12 ft or less.

(b) When either the distance between sprinklers on branch lines or the distance between branch lines exceeds 12 ft.

Size Pipe, In.	Max. No. Spkls	Size Pipe, In.	Max. No. Spkls	Size Pipe, In.	Max. No. Spkls	Size Pipe, In.	Max. No. Spkls
1	2	3	40	1	2	3	30
1 1/4	3	3 1/2	65	1 1/4	3	3 1/2	60
1 1/2	5	4	100	1 1/2	5	4	100
2	10	5	160	2	10	5	160
2 1/2	20	6	275	2 1/2	15	6	275
		8	400			8	400

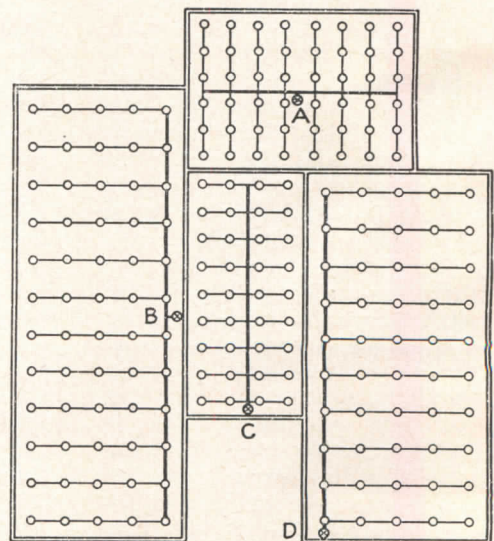

**A—Center Central Feed B—Side Central Feed C—Central End Feed D—Side End Feed**

**Figure 1: Location of Cross Mains and Risers**



# How Europeans Use POLYSTYRENE FOAMS

by Dr. Helmuth Osken\*

*Because of their expanded structure and closed cells, polystyrene foams combine light weight with excellent heat, sound and moisture insulating properties. The following survey discusses the various factors affecting these properties, and describes how polystyrene foams are used in European construction*

## Physical Properties and Processing

Polystyrene foam, which belongs to the class of tough foams, has very low density because of its cellular structure. (The weight of a square yard, one-half inch thick, is only 6 ounces at a density of 1 lb per cu. ft.) In spite of this, the compressive strength is relatively high, as are the flexural strength and shear strengths. Water absorption, vapor conductivity and thermal conductivity are low.

The foam is not attacked by acids (except concentrated nitric acid), alkalis, or alcohol, but it is unstable against gasoline, benzene, or chlorinated hydrocarbons. It can be cut, sawed, bored, milled, and otherwise worked with ordinary tools and machines, while mortising, rabbeting, and other cutting jobs can be performed with electrically heated wire.

Foam sheets can be fastened with broad headed nails, or because of their light weight, attached by gluing. Adhesives containing hydrocarbons or benzene have proved unsatisfactory because of solvent attack, but alcohol solutions are not harmful. Many aqueous dispersion adhesives can also be used although a sufficient evaporation time must be allowed. To resist attack by water, water vapor and heat, an adhesive must be used in which the glue line is undamaged by exposure for twenty-four hours under water, one week in a moist cabinet at 90-95 per cent relative humidity at ordinary temperature, as well as twenty-four hours in an oven at 185 F.

Although gluing is principally employed on flat surfaces, it can also be used with a rough or irregular substrate such as masonry. Usually,

however, the foam sheets are attached to such surfaces with mortar. Since the surface of the foam is not rough enough for a firm attachment to mortar, a preliminary surface treatment with bitumen emulsion and sand is required.

## Thermal Insulation: Walls

Since polystyrene foam sheet 0.4 in. thick is equivalent in insulating value to a masonry wall one brick thick, the insulating value of a 4.5-in. brick wall with 0.4 in. of polystyrene foam is the same as that of a brick wall 15 in. thick.

When a large temperature difference arises between the two surfaces of such a thin insulating layer, with humid air on the warmer side, water vapor can diffuse through the insulation toward the cooler surface and condense there, moistening the insulating layer and consequently reducing the insulating value. However, in the case of polystyrene foam with a water vapor diffusion factor of 40, a density of 1 lb per cu. ft., and a water absorption of 1.5 volume per cent, there is only a relatively small increase in the thermal conductivity.

Where external walls can be damaged by inside moisture, an insulating layer of polystyrene foam retards excessive entry of moisture into the wall, thus maintaining the thermal insulating value of the wall and increasing the thermal protection of the wall combination. (Figures 1 and 2 show examples of foam insulation applied to walls.)

In air-conditioned spaces with high humidity, a layer of plaster is recommended as a buffer for the

\* Physical Laboratory, Correcta-Werke G.m.b.H., Bad Wildungen, Germany. Translated by Dr. W. J. Gort, Research Department, Koppers Company.

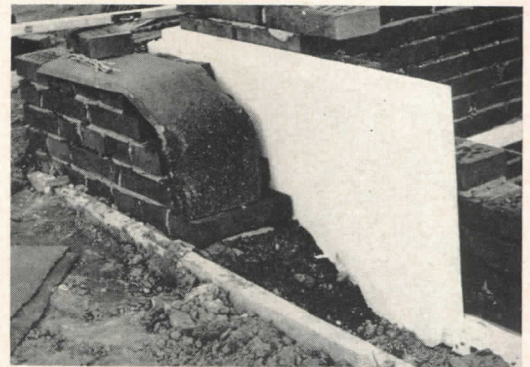

Figure 1. Insulating an exterior masonry wall with sheets of polystyrene foam reduces thermal conductivity and prevents moisture damage

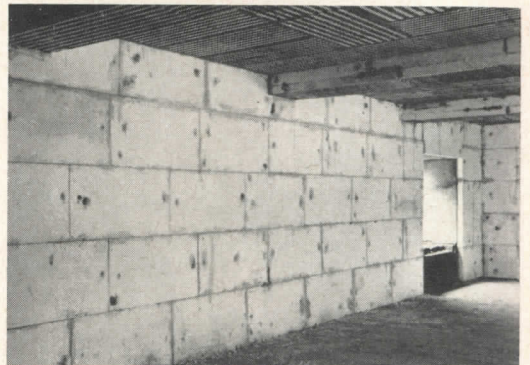

Figure 2. To insulate a double brick wall, the insulating foam layer is placed against one masonry wall before laying up the second

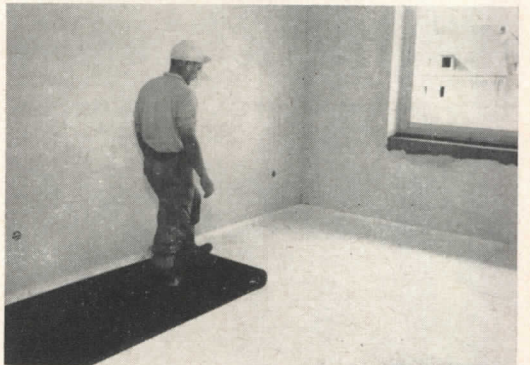

Figure 3. Used as an insulating layer beneath a "floating" mastic floor, foamed polystyrene combines both thermal and sound insulation

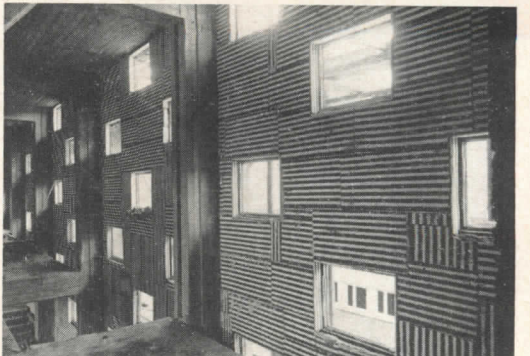

Figure 4. Polystyrene foam on the walls of a swimming pool hall supports the plaster and provides thermal and condensation insulation



foam, and adhesives with a high water vapor diffusion factor should be avoided.

### Thermal Insulation: Floors

The most popular kind of floor construction in Europe today is floating mastic, often with a polystyrene foam barrier layer which combines both thermal and sound insulation. The effective thickness of the insulating layer for sound deadening is about the same as that required for thermal insulation—at least 0.33 in. since the insulation is loaded and more or less compressed.

In this type of construction, polystyrene foam sheets are laid edge to edge on the rough concrete subfloor and covered with building paper to avoid penetration of the mastic into the joints (Fig. 3). Mastics made from cement, gypsum or sorrel cement are suitable but asphalt mastics should not be used because of their high pouring temperature and high heat capacity. Under normal conditions of service, the mastic layer should be 1¼-1½ inches thick.

For insulation around the walls, 2¼ in. strips of polystyrene foam in the same thickness as that used under the floor can be placed vertically, again using building paper over the joints. Thus the mastic floor “floats” completely isolated from the building structure. The direct placement of floor coverings on polystyrene foam has been proved unsatisfactory because the foam layer can be damaged by local over-loading.

### Thermal Insulation: Roofs

The relatively high thermal stability of polystyrene foam has encouraged its use as roof insulation. Temperature measurements on tar paper roofs insulated with polystyrene foam have given temperatures as high as 149 F on the surface of the top layer of roofing paper and 153 F between the layers of roofing paper above a 0.6-in. sheet of polystyrene foam, but even this approximation to the heat distortion temperature of the foam (185 F) does not mean that it will begin to shrink. Conclusive tests have shown that only at a temperature above 212 F is there shrinkage and collapse.

On flat roofs, the concrete is first swabbed with an asphalt emulsion. After that has dried, a hot asphalt layer is applied, and the polystyrene foam sheets are laid on top of the

tacky surface (Fig. 5). When a suitable number have been laid, the first layer of roofing paper is coated with hot asphalt and laid on top of the foam polystyrene as shown in Figure 6, after which the roof is built up in the usual way.

Sloping roofs are insulated in the same manner (Fig. 7), but this practice is not followed in the case of wood roofs since there is always the danger that the insulation might be broken because of the flexibility of the joists or rafters. Instead, the insulation is applied from the underside and supported by a lattice work. The edges must fit tightly and are preferably glued together.

### Condensation Insulation

To prevent condensation on floors, ceilings, and walls of rooms where there is continuously high relative humidity, it is necessary to avoid temperatures below the dew point and to choose an insulation that transmits as little water vapor as possible.

The first requirement is met by making the foam layer thicker with increasing relative humidity. The necessary insulation thickness is also influenced by the difference between the exterior and interior temperatures, greater temperature differences requiring the selection of thicker insulation. However, the effect of the temperature difference is considerably smaller than that of the humidity, which above 90 per cent requires very thick insulation.

The second requirement, resistance to transmission of water vapor, is also met by polystyrene foam, which has a water vapor conductivity value so low that it can be designated as a vapor barrier.

For walls where small amounts of diffused moisture can evaporate on the outer side, such a vapor barrier is sufficient. In the case of roofs, however, where the insulation is covered on the upper side with roofing paper, the polystyrene foam insulation must be protected with a bitumen layer sufficient to limit the diffusion to the lowest possible value. Otherwise bubbles and blisters may develop underneath the roof covering. Fig. 4 shows the thermal and condensation insulation of a swimming pool hall with 3.5 in. thick polystyrene foam sheets which have been provided with sanded asphalt supports for the plaster finish.



Figure 5. On flat roofs, insulating polystyrene foam sheets are laid on top of a layer of hot asphalt applied over a dry asphalt emulsion



Figure 6. The roof is built up in the usual way after the polystyrene foam has been covered with a layer of asphalt-coated paper

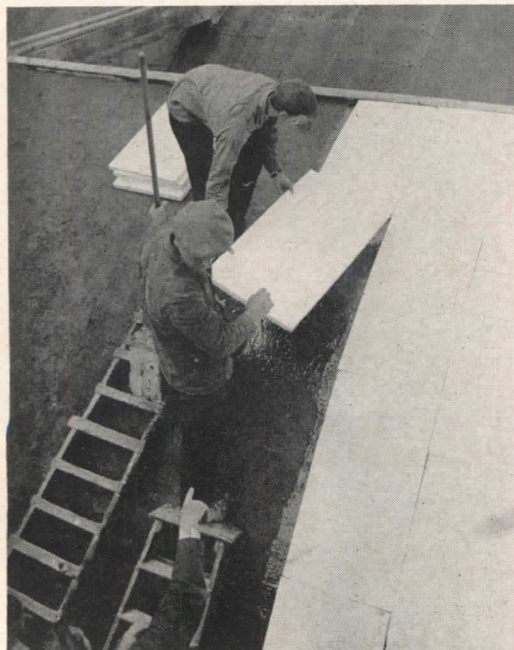

Figure 7. Polystyrene is used similarly on sloping roofs, but if the roof is wood, it is applied from beneath and supported on a lattice



## New Cement for Crack-Resistant "Floating Floors"

*Synthanite*, a synthetic anhydrite cement produced as a byproduct of hydrofluoric acid manufacture, is expected to find increasing use in making crack-resistant concrete floor toppings. Because of its high strength and negligible shrinkage (about  $\frac{1}{20}$  that of ordinary concrete), *Synthanite* concrete does not depend on bonding to the structural subfloor, but lends itself to use in "floating" floor systems which offer a number of design advantages.

For floors with normal live loads, a one-inch thickness of 2500 psi *Synthanite*-sand-gravel concrete installed without reinforcement over a mem-

brane separator, and separated from walls and columns by  $\frac{1}{2}$ -in. expansion joints, has been proved adequate.

Such a floor system practically eliminates damage to the finish floor caused by movement of the subfloor, and it provides enough stability and strength to permit lightweight concrete fills, which often cause problems due to bond failure, to be used to imbed electrical conduit and other services in the floors. This of course reduces dead loads, as does the thinness of the topping itself. (A one-inch topping of *Synthanite* concrete weighs 12 lbs per sq ft: a floating floor topping of ordinary concrete

would require a thickness of 2 to 3 inches with reinforcement, and weigh 25 to 38 lbs per sq ft.)

The topping's rapid hardening and drying properties offer another advantage. Depending on atmospheric conditions, it can take construction traffic in three days, and a floor covering can be laid in six to ten days after installation. Its floating feature also makes the topping highly useful for renovating old concrete and wood floors, in most cases eliminating the cost of preparing the old floor for a new surface. *American Synthanite Corp.*, 99 Park Ave., New York 16, N. Y.

## Plastic Sheet Flashing Seals

### Joints of Exposed Steel Frame

To give a new high school in Flint, Michigan, an industrial character compatible with the character of the community, architects Eberle M. Smith Associates, Inc., relied heavily on candid exposure of the building's structural steel framework. To solve the flashing problems created by joining dissimilar materials exposed to Michigan's 100-degree summer-winter temperature variation, with its resulting high differentials in expansion and contraction, they relied heavily on Dow's *Saraloy* 400, an elastic sheet flashing based on a copolymer of vinylidene chloride.

The major areas of concern were five huge steel bents that support, and protrude above, the roof of the gym, and the folded plates that roof several other areas (see photo below). In the case of the bents, the *Saraloy* flashing was used to join the girders to the composition roof (above right) and the columns to the sloping aluminum walls of a clerestory. It was easily applied by bond-

ing the *Saraloy* to the adjoining materials and to a fiberboard cant strip used to lessen the abruptness of the 90-degree corners. The flashing was mopped into the composition roof with hot bitumen, and bonded to the steel and aluminum with a special adhesive. A complete bond was assured by heat-softening the material and pressing it snugly against the contours of the joints.

In the valleys of the folded plates (below right), where the principal problem was to prevent leakage under heavy loads of accumulated snow, *Saraloy* was used in its full 36-in. width. The material was run down one side of the valleys, across the bottom, and up the other side so that each 36-in. strip was 4 ft long. Adjacent strips were overlapped, and bonded to one another with methyl ethyl ketone and to the aluminum underneath with Dow No. 400 adhesive. *Dow Chemical Co.*, Midland, Mich.

more products on page 196

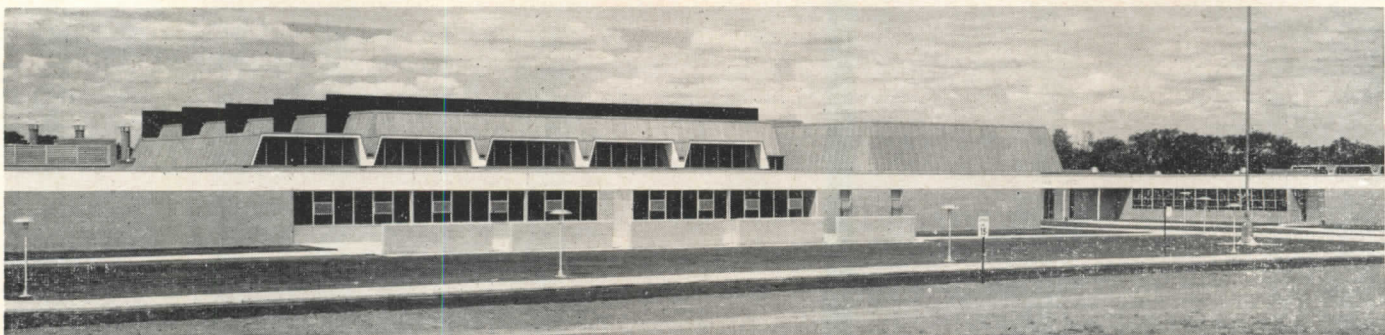
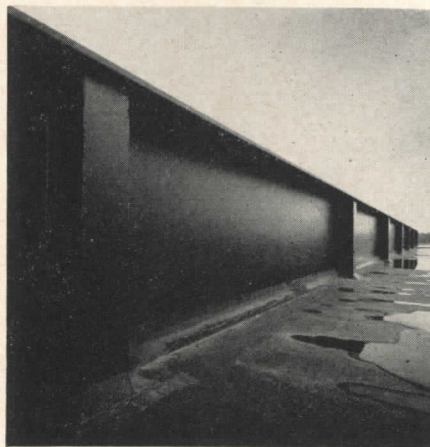



**Airtherm Decking**

(A.I.A. 12-C) Gives selection data, load-span tables, erection and welding data, details, and general specifications on several types of metal deck product. Bulletin 211, 16 pp. *Airtherm Mfg. Co., P. O. Box 7039, St. Louis 77, Mo.\**

**Efficiency Waterstops**

(A.I.A. 4-E-11) Describes and details applications of rubber, neoprene and vinyl waterstops for sealing construction joints and expansion joints in concrete. Bulletin W-61, 4 pp. *Williams Equipment and Supply Co., Inc., 486 W. Eight Mile Rd., Hazel Park, Mich.\**

**The Story of Panelray Lighting**

Discusses present and future design possibilities of *Panelray* electroluminescent lamps, with technical data on performance and physical characteristics. 16 pp. *Electron Tube Div., Radio Corp. of America, Harrison, N. J.\**

**Gallery of Lighting Inspirations**

Illustrates and describes (finish, width, body height and general data) *Great Masters* collection of lighting fixtures. 20 pp. *Gill Glass and Fixture Co., Inc., Philadelphia 34, Pa.*

**Ornamental Metal Work**

Design and selection guide includes drawings of suggested designs and typical applications as well as information on materials, production, relative cost and quality. Bulletin 071, 20 pp. *Julius Blum & Co., Inc., Carlstadt, N. J.\**

**Fresh Air Electric Heating**

Presents the various types of electric heating, with emphasis on the advantages of ducted systems and detailed information on their design and control. Floor plans with recommended duct layouts are also included. 40 pp. *Lennox Industries, Inc., Marshalltown, Iowa*

**Drawing for Good Reproduction**

Discusses and illustrates drafting techniques to improve the reproducibility of technical drawings, with sections on preparation and care of drawings, and reproduction processes and materials. Second Edition. 32 pp., \$1. *National Assn. of Blueprint and Dye Coaters, 1925 K St., N. W., Washington 6, D. C.*

**Testing Partitions**

A 12-page report explains how to calculate the effectiveness of a partition or sound barrier. In addition to showing the sound transmission characteristics of a number of wall constructions, the report includes calculation methods applicable to most simple partitions. *Lead Industries Assn., 292 Madison Ave., New York 17, N.Y.\**

**Colorweld 60**

(A.I.A. 12-C) Describes a pre-colored aluminum sheet used for commercial-industrial building products and how and where it may best be used. *Reynolds Metals Co., Department PRD-39, Box 2346, Richmond 18, Va.\**

**Plastics for Lighting**

(A.I.A. 31-F-2) Covers plastic as a lighting medium in regard to light transmission, color stability, outdoor exposure, resistance to cleansing agents, abrasion resistance, and surface resistivity. *Holophane Co., Inc., 342 Madison Ave., New York 17, N.Y.*

**Fir Plywood Standard**

*U.S. Commercial Standard C.S. 45-60* contains the registered DFPA grade-trademarks for fir plywood used to identify plywood manufactured in conformance with the requirements of the Standard. *Douglas Fir Plywood Assn., 1119 A St., Tacoma 2, Wash.\**

**American Standard Specification**

*... for Polysulfide-Base Sealing Compounds for the Building Trade* covers application of polysulfide base sealants to concrete, aluminum, stainless steel and glass surfaces, and gives minimum performance of these sealants on other structural materials. *Thiokol Chemical Corp., Trenton 7, N.J.\**

**Fluorescent Fixtures**

Describes commercial and industrial lighting fixtures, recessed shallow troffers and air-handling troffers, plus translighted ceilings featuring plastic panel and louvered shieldings. Catalog V-602A. *Sylvania Electric Products, Inc., Fluorescent Lighting Fixtures, 48th St., Wheeling, W. Va.\**

*\*Additional product information in Sweet's Architectural File*

*more literature on page 222*

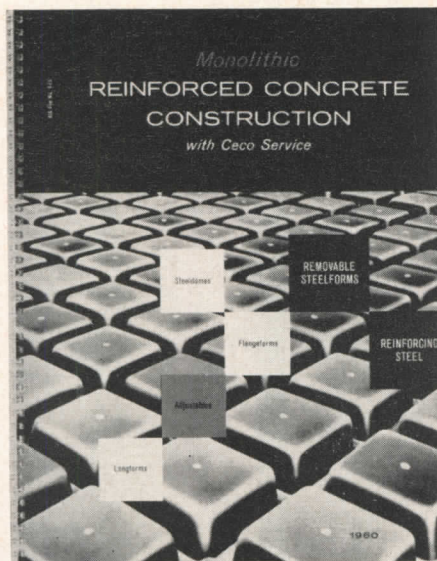

**REINFORCED CONCRETE CONSTRUCTION** (A.I.A. 4-E-6), a new manual on monolithic light weight concrete joist construction, contains isometric details, cross section drawings and tabulated data on Ceco steeldomes, flange forms, adjustable forms and long forms. It also describes such related items as anchorage devices, underfloor electrification, ceiling construction, reinforcing bars, spirals, welded wire fabric and accessories. Manual 4002-C, 68 pp. *Ceco Steel Products Corp., Dept. A, 5601 West 26th St., Chicago 50, Ill.*



The best ideas are more exciting  
in **concrete**



Henry Ford Hospital 870-car parking structure, Detroit, Michigan. Architect: Albert Kahn, Associated Architects and Engineers, Inc., Detroit, Michigan

## Louvers give a new beauty twist to concrete curtain walls!



True hyperbolic paraboloids, 7'-4½" concrete panels have 90° twist, are 24" wide at top and base, 18" at waist.

Precast concrete curtain walls have given Henry Ford Hospital an off-the-street parking structure that blends attractively into a residential area. 1,716 hyperbolic paraboloid panels, precast from white cement, white quartz and sand aggregates, form the unique walls. An intriguing visual effect is obtained from these louvers which seem to change shape and position, depending on lighting and angle of view.

Practicality is everywhere. In the light, open feeling of the interior . . . in the enduring solidity of the concrete frame and floors. The versatility of concrete is today winning new appreciation as architects express fresh concepts in design.

**PORTLAND CEMENT ASSOCIATION**

*A national organization to improve and extend the uses of concrete*



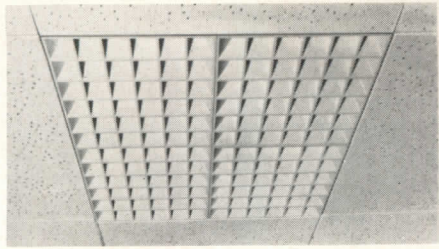

**Versatile Modular Diffuser**

The new Model "M" modular plastic diffuser makes it possible to provide an unobtrusive, efficient air handling system that can easily be altered when relocation of partitions or fixtures demands a different air distribution pattern. This flexibility is achieved by three basic 6-in. square modules—one-way throw, two-way throw and corner throw—that can be combined to create one-, two-, three-, or four-way diffusers in a wide variety of shapes and sizes. Each module snaps into a metal frame independent of adjoining modules so that it can easily be rotated or replaced to project conditioned air in a different direction. Small-scale in texture, and made of a durable white, flame retardant plastic, the Model "M" is compatible with standard ceiling materials and lighting fixtures, and can be arranged to fit any ceiling tile pattern or suspension system without exposed frames. *Carnes Corp., Verona, Wis.*

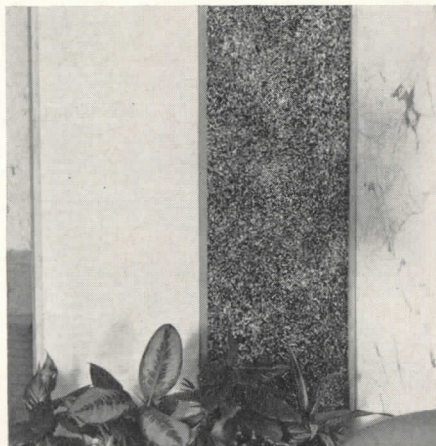

**Decorative Sandwich Panel**

*Coden-Wall* is a strong, light weight sandwich panel with an expanded polystyrene core that provides moisture resistance as well as sound and thermal insulation. Since virtually any facing material can be laminated to this core, panel size is limited only by the size of the facing material chosen. Maximum size is 4 by 10 ft in 1, 2 or 3-in. thicknesses.

The lightweight panels can be cut on the job or precut for use as doors, room dividers, partitions, paneling or any other non-loadbearing application. *Coden Industries, 634 Wager St., Columbus 6, Ohio.*

**Ceramic-Tiled Curtain Wall Panels**

Curtain wall panels faced with ceramic tiles are now available in four basic types. The core of the panels is a sandwich composed of asbestos-cement board bonded to an insulating board with waterproof epoxy

adhesive. The tiles are set with weatherproof flexible grout, making the panels suitable for exterior use. Asbestos-cement board is standard on the interior surface but other finishes such as ceramic tile, porcelain enamel, aluminum or vinyl plastics are also available. The panels come in sizes up to 16 sq ft, but specially reinforced panels can be made larger. *Maul Macotta Corp., 1640 E. Hancock Ave., Detroit 7, Mich.*

more products on page 200

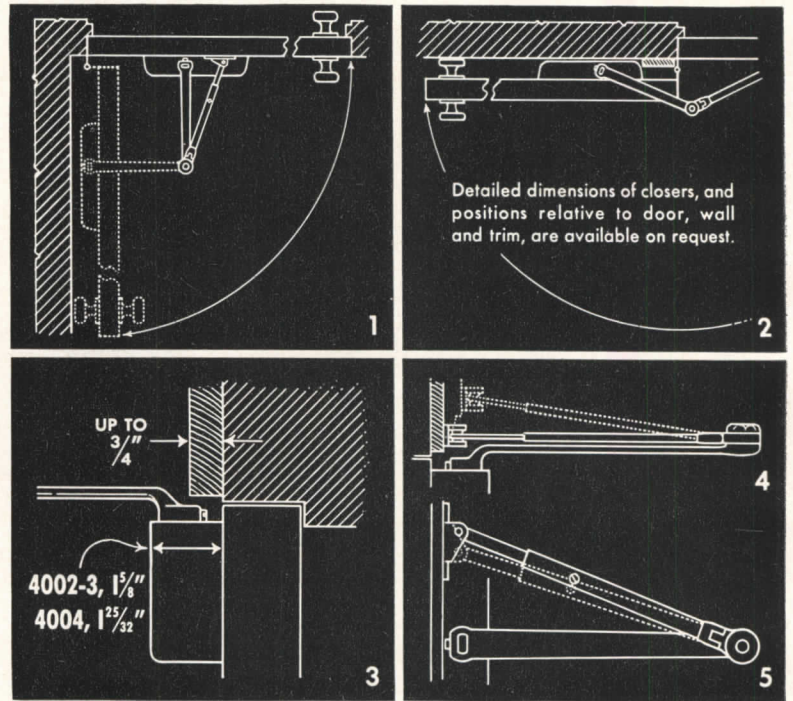

**APPLICATION DETAILS**

for the Modern LCN "Smoother" Exposed Door Closer  
Shown on Opposite Page

As Demonstrated in Drawings Above:

1. The LCN "Smoother" takes less space than most doorknobs between door and wall.
2. Degree of door opening possible depends mostly on type of trim and size of butt used.
3. Arm of LCN "Smoother" is curved to avoid conflict with almost any conventional trim.
4. Joints in arm and shoe make it easy to vary the height of shoe as needed for beveled trim.
5. Power of closer is increased or decreased by simply reversing position of shoe.

Complete Catalog on Request—No Obligation  
or See Sweet's 1961, Sec. 18e/Lc

**LCN CLOSERS, INC., PRINCETON, ILLINOIS**

Canada: LCN Closers of Canada, Ltd., P.O. Box 100, Port Credit, Ontario



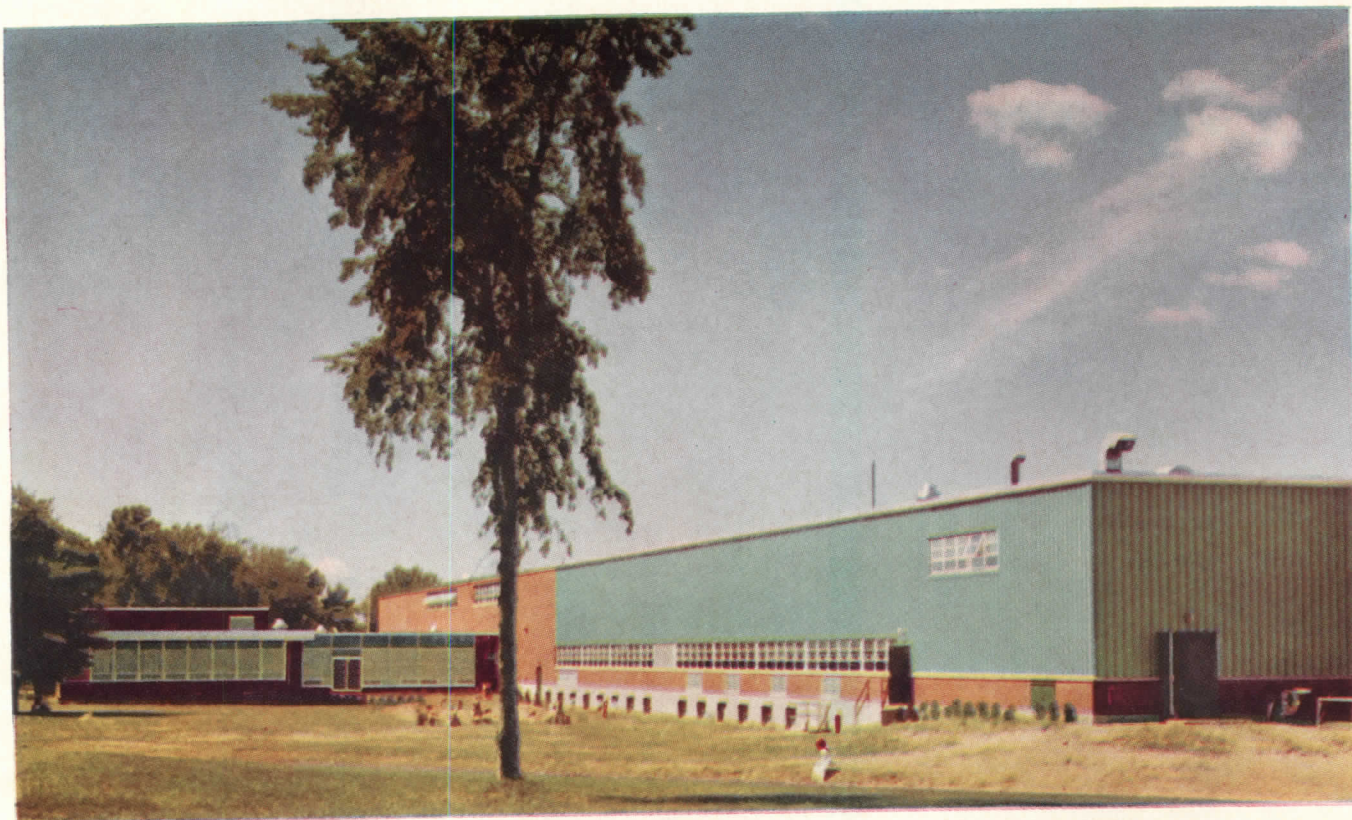

In this industrial building, EGSCO Metal Wall Panels in COLORGARD blend in with masonry and glass building components. The finished appearance of the building is well-suited to the suburban area in which it is located.

## A jewel in any setting . . . **COLORGARD WALL PANELS BY EGSCO®**

Industrial buildings can be attractive as well as functional when they are constructed with EGSCO Metal Wall Panels in COLORGARD. Sparkling colors in durable baked-on epoxy enamel combined with pleasing configurations permit the architect a wide range of design possibilities. In addition to being used for entire curtain walls, EGSCO Metal Wall Panels are easily adapted, architecturally and structurally, to other wall components of masonry, metal or glass.

EGSCO Wall Panels are available in aluminum, aluminized or galvanized steel or stainless steel depending on the application. They can be insulated or uninsulated . . . prefabricated or field-assembled. EGSCO Wall Panels provide strength with light weight and high insulating value.

Invisible fastenings and wall seams further add to

the appearance of the finished building. Wall heights to 40 feet or more are possible without horizontal lap joints.

But the greatest beauty of EGSCO Metal Wall Panels is in their economy. Lower material cost and construction man-hours (the unique assembly design permits fast erection) provide savings all along the line. The result is a truly economical wall . . . structurally sound, durable and architecturally aesthetic . . . an imposing corporate image.

Consult Sweet's Architectural or Industrial Construction File for complete description and specifications on EGSCO Metal Wall Panels in COLORGARD, and other EGSCO metal building products.

Or consult the EGSCO sales engineering office nearest you.

**ELWIN G. SMITH & CO., INC.**  
 WILLIAMS ST. PITTSBURGH 2, PA.  
 Manufacturers of  **EGSCO® Metal Wall Products**

BOSTON • CHICAGO • CINCINNATI • CLEVELAND • DETROIT • TOLEDO • NEW YORK • PHILADELPHIA • PITTSBURGH



*Weight?  
Measurements?  
Age?*

**STA-CRETE 15 —**

8 pounds = 1 gallon  
400 square feet = 1 gallon

**AGE — UNLIMITED**

**STA-CRETE 15 —**

**UNADULTERATED**

No Solvents — No Fillers

**STA-CRETE 15 —**

**AN EPOXY**

- that Bonds Concrete
- Waterproofs
- Resurfaces
- Decorates



STA-CRETE Inc.,  
115 New Montgomery,  
San Francisco 5, California

Name \_\_\_\_\_  
Address \_\_\_\_\_  
City \_\_\_\_\_  
State \_\_\_\_\_  
Position \_\_\_\_\_  
Company \_\_\_\_\_  
Phone \_\_\_\_\_  
P.S.

*You're an Estimator \* \*  
By accurately calculating the age,  
weight and measurements of our gal —  
a Sta 'N Play kit is yours.*

*Product Reports*



**Pint-Size Prefab Bathroom**

The *Bath-O-Lett* combines a full size shower, full size vitreous china toilet, retracting Pullman style stainless steel wash basin, medicine cabinet and storage cabinets in one unit occupying a floor area no larger than a stall shower and costing less than \$400. Expected to find use in many buildings where complete bathroom facilities are desired and space is at a premium, the unit can be installed in a matter of hours by a plumber who supplies the necessary water and waste line connections to conform with local codes. Optional accessories include exhaust fan, light fixture, heater and choice of doors. *Consumers' Products Div., Morse Boulger, Inc., 80 Fifth Ave., New York 11, N. Y.*

**Leather Floor Tiles**

A solid leather floor covering in the form of 9-in. square tiles made of fine cowhide combines the warmth of natural leather with the toughness and durability required in flooring. According to the manufacturer, laboratory tests and test installations in homes and executive offices indicate that the tiles should last indefinitely with normal care. The deep wax finish applied at the factory resists stains and can be maintained by ordinary cleaning and re-waxing. Because they are resilient, the tiles are comfortable and quiet underfoot, and recover quickly from denting by heavy furniture. They are laid in the same way as other tiling, using a special mastic. They cost more than high quality vinyl flooring, but are competitive with fine carpeting. *Leather Tile Industries, 441 Pine St., Hanover, Pa.*

*more products on page 204*

**DORMITORY  
BUILT-IN  
FURNITURE**

*Is the Specialized Field of*

**SLIGH *Lowry***  
**CONTRACT FURNITURE COMPANY**

**PRE-BUILT • PRE-FINISHED  
STUDENT ROOM FURNITURE**

manufactured by a nationally known manufacturer of Institutional Furniture cannot be equalled by (1) ordinary mill-work, (2) ordinary household furniture in point of:

**CONSTRUCTION  
DURABILITY  
FINISH  
INSTALLATION  
AND FREQUENTLY IN  
ACTUAL COST!**

**Let Us Tell You Why!**

Our experienced assistance in room layout suggestions, designing and specifying is yours to draw upon . . . no obligation in letting us consult with you. If you have any dormitory plans in work, let us bid before you buy.



*You may have a copy of this comprehensive Manual without charge by requesting same on your letterhead. You'll find it most valuable — SEND FOR IT!*

**SLIGH *Lowry***  
**CONTRACT FURNITURE COMPANY**  
HOLLAND, MICHIGAN





*Office designed with an EXECUTIVE in mind...*



his furniture, of course, by **All-Steel**

ALL-STEEL EQUIPMENT INC.  
Aurora, Illinois

4000 Line by All-Steel combines beauty with functional design. Here is furniture as flexible as your imagination to create distinguished offices for every type of business. See your ASE dealer or write for brochure.





# Every Architect is a SPACE MAN



Over 70 years ago, Nietzsche called architecture "a visible manifestation of man's triumph over gravity." Today, as our missiles zoom skyward from Cape Canaveral, the German philosopher's words conjure up plausible pictures of geodesic buildings on the moon.

But it'll be some time before you're asked to come up with a lunar supermarket. Until then, you'll have the same old terrestrial space problems you've been wrestling with in the past.

Folddoor has a habit of helping architects solve problems involved with separating space . . . and sound. In this respect, the SOUNDGUARD Folddoor is especially beneficial. A Multi-X "narrow profile" partition, SOUNDGUARD has a rugged steel frame covered with wear-resistant vinyl fabric. Holcomb &

Hoke's Peacock, Titan and Americana fabrics offer the most discriminating architect an almost unlimited choice of decorative textures and colors.

SOUNDGUARD features a complete insulation system designed to block out passage of sound, not only through the partition but also around the complete perimeter. This is accomplished by double sweep strips at top and bottom of partition, and at jambs. Independent laboratory tests show that SOUNDGUARD offers greater sound reduction than any other single folding partition with standard weight fabric.

To conquer space, and shut out noise, specify Folddoor's SOUNDGUARD. Sweet's Architectural File 16e/HO.

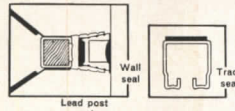

**CONSTRUCTIVE THOUGHT:** A space helmet (without radio telephone, optional extra) will provide that much needed quiet when you're trying to concentrate. Better yet, use SOUNDGUARD Folddoors . . . and in your own office, too.



A beautiful new idea for interior space dividers . . . polystyrene grillework (¾" thick) available in

various size panels for use as see-through walls, floating screens or wall decorations. For exterior application, Acrylic-Styrene grilles are available. Standard color is a natural white with factory painted colors optional. Panels are available in aluminum framing or can be custom framed by others. Sweet's Architectural File 6e/HO.

**HOLCOMB & HOKE**

**FOLDDOOR**  
FOLDING PARTITIONS AND DOORS

**HOLCOMB & HOKE MFG. CO., INC.**  
1545 Van Buren Street  
Indianapolis 7, Indiana  
Dept. B-32

Please send complete information on:

FOLDDOOR Soundguard     FILIGRILLE grillework     Have job in planning, please call

NAME \_\_\_\_\_

FIRM \_\_\_\_\_

ADDRESS \_\_\_\_\_

CITY \_\_\_\_\_ STATE \_\_\_\_\_

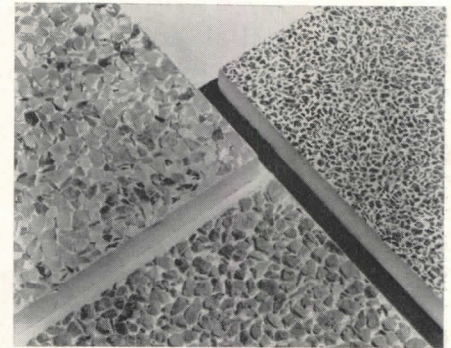

**Exposed Special Aggregate Concrete Gemset**, an exposed special aggregate concrete for precast architectural panels and other shapes, is produced under rigid controls to provide such advantages as precise regulation of aggregate size, color and texture; exact conformation to specified shape and dimension; absolute trueness of surface; and accurate, uniform curing. Available in various sizes and thicknesses, it can be cast as column covers or mullions, window surrounds, copings and specialty shapes as well as custom wall or spandrel panels. Aggregates are imbedded a full ¾ in. in units reinforced with galvanized steel wire or bars as required. The aggregates themselves come in a wide variety of types, mixtures, sizes and colors. *Indiana Limestone Co., Inc., Bedford, Ind.*

### Custom-Made Acoustics

A new electronic device, the Westrex 1400 Distributed Reverberation System, is said to improve acoustics in churches and auditoriums in which the natural reverberation time has been established primarily for voice sounds and is thus too short for satisfactory reproduction of music. Essentially a tape-and-speaker system, the device creates a complex train of repetition for each sound by recording them on magnetic tape and passing the tape over a succession of reproducing heads connected to loudspeakers which are distributed from front to back on both sides of the hall. Frequency of repetition, which is determined by tape speed and head spacing, can be adjusted to the requirements of a particular hall, as can the loudness of each successive repetition. The system duplicates another characteristic of natu-

*continued on page 214*



# Silence!

Mercury Switches operate as silently as a thermometer: last for years and years

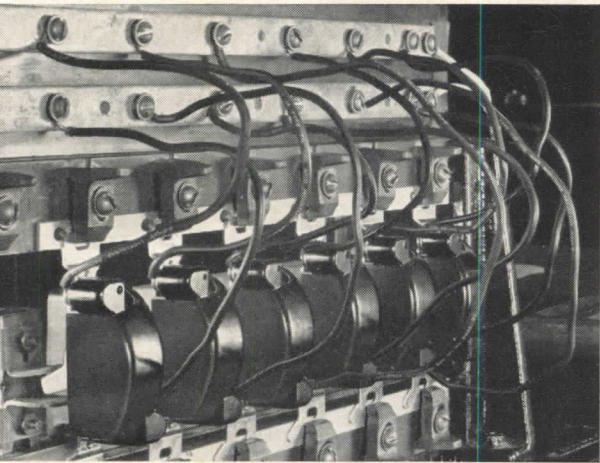

**LAST YEARS LONGER THAN SNAP-TYPE OR "QUIET"-TYPE SWITCHES** G-E Silent Mercury Switches have been turned ON—OFF, ON—OFF more than 1,000,000 times without failure! Lab tests indicate their average life is 500,000 cycles — some 4 times the required life of ordinary switches.



No groping! You can find these switches in the dark.

For bathrooms, basements, storerooms, halls and other often-dark spots, G-E Silent Mercury Switches are available with lighted handles. Built-in lamps "locate" these switches; also show when circuits are OFF.

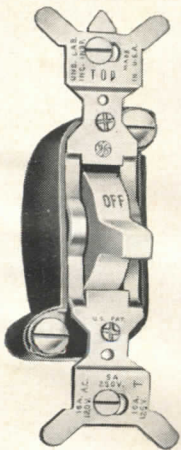

Regular (non-lighted) switches available with brown or ivory handles—single-pole, double pole, 3-way or 4-way. Lighted-handle switches available with ivory handle—single pole or 3-way. Listed by Underwriters' Laboratories, Inc., meet Federal and REA specifications.

**TOP QUALITY—REASONABLE IN COST** These silent General Electric switches are Specification Grade: can be used to 10A-125V T- and 15A-120V AC- ratings for tungsten filament and fluorescent lamp loads. They cost little or no more than other high-quality switches, usually cost less per year of service.

**SWITCH TO SILENCE!** Specify G-E Silent Mercury Switches for homes, motels, stores, offices, industry—anywhere complete silence, long life, or luxury-smooth action in a switch will be appreciated.

General Electric Company, Wiring Device Dept., Providence 7, Rhode Island.



*Progress Is Our Most Important Product*

**GENERAL  ELECTRIC**



## Product Reports

SEARS ROEBUCK & COMPANY, Saugus, Mass.

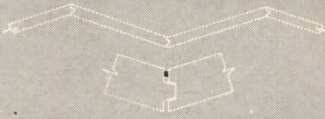

• FOR SEALING PANELS

BLUE CROSS BUILDING, Boston, Mass.

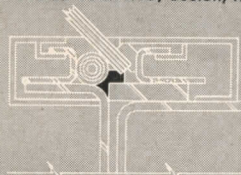

• FOR SEALING VISION GLASS

# PROVEN TREMCO 1-PART 100% LIQUID POLYMER SEALANT

THE EQUITABLE  
LIFE ASSURANCE SOCIETY  
New York City



• FOR SEALING REMOVABLE STOPS

• FOR CHANNEL GLAZING

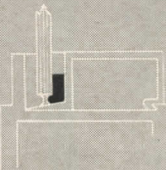

LIBERTY MUTUAL INSURANCE COMPANY  
Boston, Mass.

• FOR CAULKING



WHITE PLAINS HIGH SCHOOL  
White Plains, New York

## TREMCO MONO-LASTO-MERIC®, 1-PART 100% LIQUID POLYMER, ACRYLIC BASE SEALANT . . . .

factory mixed, ready for use in cartridge or bulk, assures absolute weathertightness for controlled joints, expansion joints and conventional caulking joints. It has a basic superiority over conventional sealants which require the use of ingredients that will migrate or oxidize in time, thus lowering sealant life and efficiency. Mono-Lasto-Meric is formulated with Tremco developed and Tremco manufactured pure 100% liquid polymer. The desired requirements of exceptional adhesion and enduring elasticity are *inherent* and *permanent* parts of the basic polymer. Absolutely non-staining on masonry surfaces.

For your next bonding, sealing or caulking assignment consider Mono-Lasto-Meric. A product data sheet designed for specifying authorities is available from your Tremco Representative or write: The Tremco Manufacturing Company, Cleveland 4, Ohio, or The Tremco Manufacturing Company (Canada) Limited, Toronto 17, Ontario.

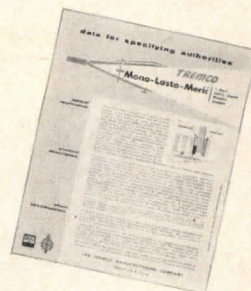

# TREMCO

PRODUCTS AND TECHNICAL SERVICES FOR  
BUILDING MAINTENANCE & CONSTRUCTION

"When you specify a Tremco Product  
... you specify a Tremco Service!"

SEE OUR CATALOG IN SWEET'S

ral reverberation by automatically boosting low frequencies and attenuating high frequencies so that the lower frequencies reverberate for a longer period. According to the manufacturer, the user may also vary the reverberation pattern set up by the system to suit the program material being presented: long reverberation time for organ music, for example, and short for speaking.

The system includes three groups of equipment—the tape transport, including erase, record and reproduce heads; the distributed reverberation assembly, including recording and reproducing circuits; and an amplifier cabinet containing 60W amplifiers for each speaker. Microphones and speakers are optional to allow the user to utilize present equipment. *Westrex Corporation, Division of Litton Industries, 336 N. Foothill Rd., Beverly Hills, Calif.*

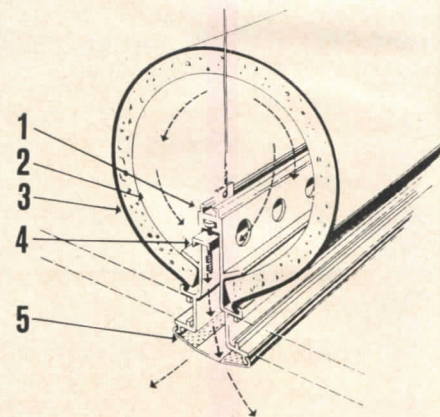

### Ceiling Air Distribution System

The *Acousti-Flo* system, a new low-velocity method of introducing conditioned air, combines a perforated aluminum bar diffuser (1, 5 above) with a *Fiberglas* supply tube (2) self-insulated by an aluminum jacket and vapor barrier (3). The result is a low cost, attractive ceiling installation that provides uniform wall-to-wall diffusion controlled by adjusting continuous dampers (4). Since the system also functions as a support for a variety of ceilings, it makes possible a complete ceiling package which provides air distribution, noise control, thermal efficiency and lighting. *Owens-Corning Fiberglas Corp., 717 Fifth Ave., New York, N. Y.*



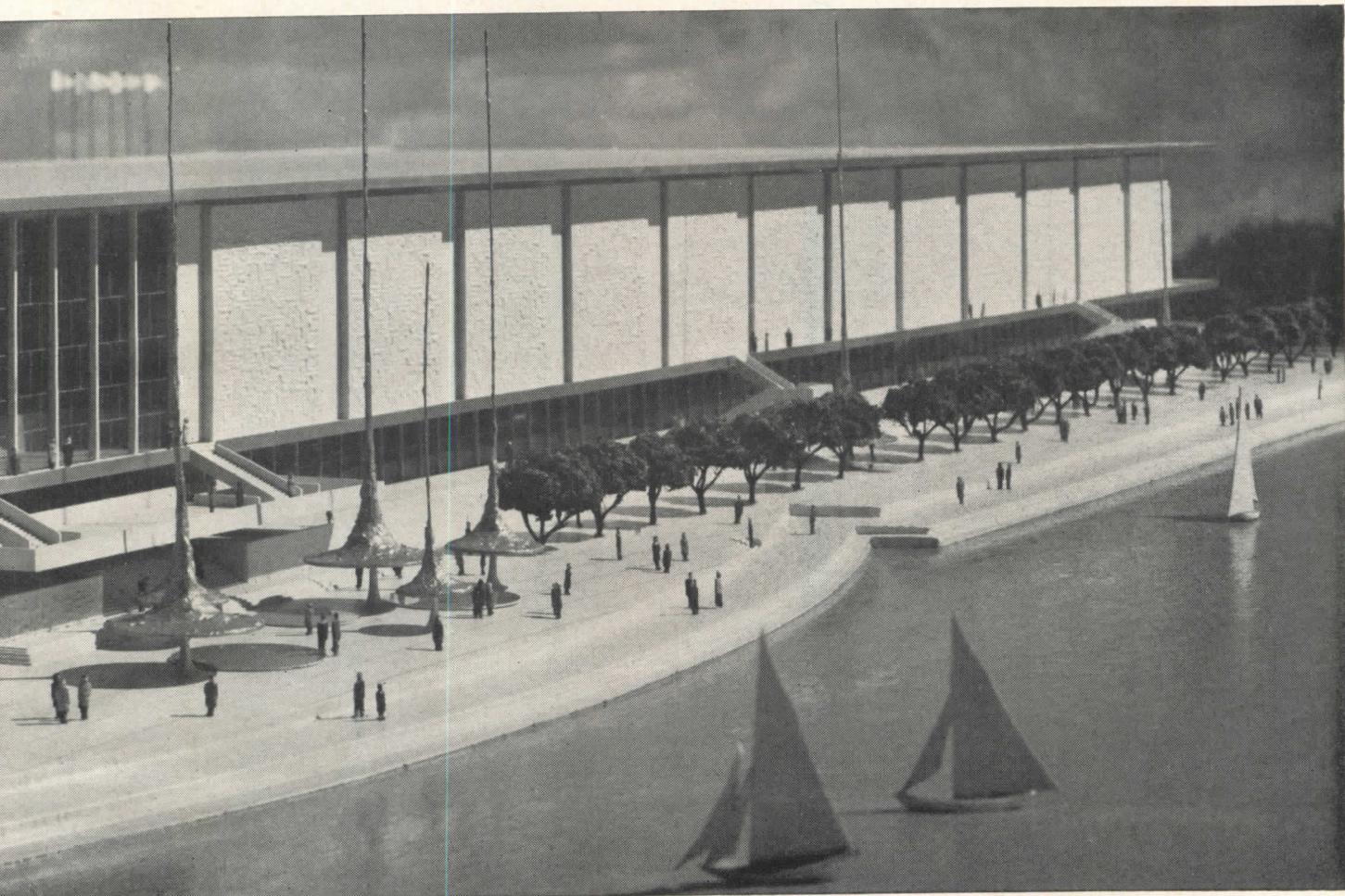

## in Chicago's McCormick Place Lakefront Exposition Center—

nal or transverse intervals of 2" to 16".

For more information on the advantages and applications of USS American Welded Wire Fabric, get in touch with our nearest Sales Office or write American Steel & Wire, Dept. 1109, 614 Superior Ave., N. W., Cleveland 13, Ohio.

*USS and American are registered trademarks*

**Credits:** Chicago's McCormick Place Lakefront Exposition Center—23rd Street and the Lakefront. *Chief Architect:* Alfred Shaw, *Consultants:* Carl A. Metz, John Dolio, Edward D. Stone, John Root, Victor Hofer. *General Contractor:* Gust K. Newberg Construction Co. *Welded Wire Fabric Distribu-*

The cast-in-place pan-type reinforced concrete floor is designed for a live load of 400 psi.

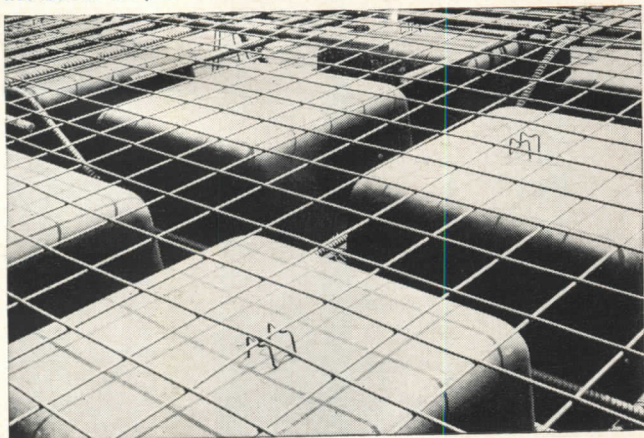

*tor:* Joseph T. Ryerson & Son, Inc. *Posttensioning Wire Tendons:* Joseph T. Ryerson & Son, Inc. *Precast Wall Panels:* American-Marietta Co., Concrete Products Division.



**American Steel & Wire  
Division of  
United States Steel**

Columbia-Geneva Steel Division, San Francisco, Pacific Coast Distributors  
Tennessee Coal & Iron Division, Fairfield, Ala., Southern Distributors  
United States Steel Export Company, Distributors Abroad

Large sheets of USS American Welded Wire Fabric, style 6 x 6—2/2 used to reinforce the 4½" thick concrete slabs are handled by two men.

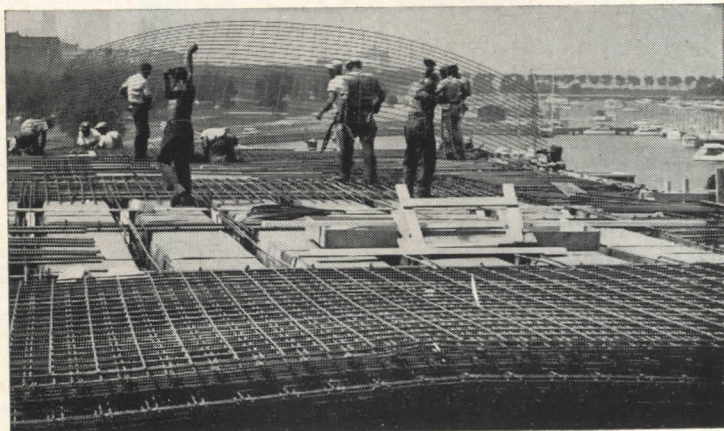



**Drive-Up Windows for Banks**

Illustrates and describes bank drive-up equipment from the depository drawer to the stainless steel exterior and teller's *Swing-Way* seat. *Herring-Hall-Marvin Safe Co., Hamilton, Ohio\**

**Built-Up Roofing**

. . . *Specifications Manual for Architects and Engineers* (A.I.A. 12-B) gives complete specifications for constructing a built-up watertight

roof including information on conditioning of the surface, step-by-step application of the roofing materials, preparation of materials and bonding conditions. 28 pp. No. TA-49-61. *Koppers Co., Inc., Pittsburgh 19, Pa.\**

**Electrical Fittings Data Manual**

(A.I.A. 31-C-62) Describes and illustrates *Q-Electrical* wiring systems for cellular-steel flooring and cellular-strip systems. Specific informa-

tion includes roughing-in materials, finish materials, layout design and installation data as well as specifications and dimensional drawings of *Q-Electrical* fittings. 56 pp. No. Q-63. *H. H. Robertson Co., Pittsburgh, Pa.\**

**Insulite Roof Insulation Manual**

(A.I.A. 37-A) Includes a product description, specifications and other technical data, and illustrates installations of *Insulite* roof insulation. A special section covers *Insulite* tapered edge strips and cant strips. 24 pp. *Insulite, 500 Investors Bldg., Minneapolis 2, Minn.\**

**The Electronic Handbook**

Explains in detail the theory of electric and electronic control, makes comparisons between electronic and pneumatic controls and is illustrated with photographs and diagrams. All information is directed primarily to heating, ventilating and air conditioning applications. *Barber-Colman Co., 1300 Rock St., Rockford, Ill.\**

**Office Furniture**

Describes and illustrates a line of contemporary furniture designed for use in public areas, executive offices, institutional and commercial installations. *Edgewood Furniture Co., Inc., 334 East 75th St., New York 21, N.Y.\**

**Hydro-T-Metal**

(A.I.A. 12-C, 12-H, 12-L, 12-P) Illustrates and describes in detail the properties of *T-Metal* alloy and the advantages of its use in the building field. *Hydro-Metals, Inc., 405 Lexington Ave., New York 17, N.Y.\**

**Light Steel Framing**

(A.I.A. 13-G) Shows through photographs and descriptive details the use of steel framing in the home and light industrial construction field. *Bethlehem Steel Co., Inc., Bethlehem, Pa.\**

**Air-Handling Troffers**

Provides application information, air-handling and photometric data for complete air-handling troffer line. Catalog V-260. *Sylvania Electric Products, Inc., Fluorescent Lighting Fixtures, 48th St., Wheeling, W. Va.\**

\* Additional product information in *Sweet's Architectural File*  
more literature on page 226

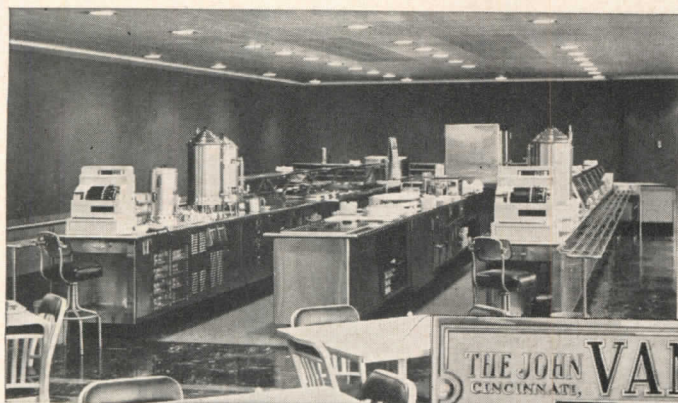

Double Lane Cafeteria

Cincinnati Gas & Electric Company

Mrs. Julia Krimme Manager



Carl Wessling: Coordinator of Employees' Activities  
Architects: Harry Hake & Harry Hake Jr.

# Van has served CG&E for almost 50 years

★ Food service operators and their architects always have had a healthy respect for Van's ability in kitchen engineering and food equipment craftsmanship. It is based on long satisfaction such as CG&E's.

★ Van equipped its first kitchen from which a few employees were served before World War I. When the magnificent new CG&E building was erected in the late twenties, Van fabricated equipment of Monel. When the Annex building was erected in the fifties, again Van furnished much of the equipment for the new all stainless kitchen and cafeteria.

★ Van's counsel to CG&E and its architects was invited and relied on. Straight line flow from one end of the kitchen to the far end of the cafeteria expedites service of 555 daily luncheons plus occasional club parties and private dining room meals.

★ Call Van engineers in early for help on food service equipment.

## The John Van Range Co.

EQUIPMENT FOR THE PREPARATION AND SERVING OF FOOD

Branches in Principal Cities

429 CULVERT STREET

CINCINNATI 2, OHIO





**Modine**<sup>®</sup>  
MANUFACTURING COMPANY

**MODINE MANUFACTURING COMPANY**

1510 DeKoven Ave., Racine, Wisconsin

I would like complete PERMA-LAP details. Please send  
Convactor Bulletin 259 and Cabinet Unit Catalog 557.

NAME.....

FIRM.....

ADDRESS.....

.....



R-1413



# BEAUTY WITH MUSCLES OF STEEL!

When you think of steel, you think of strength. Strength to stand the test of time and stress. But in the hands of today's designers steel can also be a thing of beauty. And the beauty of steel is that it endures. Plan with steel . . . then for skill, versatility, and economy . . . specify Ingalls for the fabrication and erection. The Ingalls Iron Works Company / Birmingham, Alabama



**INGALLS**



## Office Literature

**Revolving Doors, Swing Doors,**  
. . . *Balanced Doors* describes a complete series of doors for packaged entrances, and gives details for installation and planning, and specifications. Catalog 610, 20 pp. *Revolving Door Div., International Steel Co., 1460 Edgar St., Evansville, Ind.\**

### Rolling Doors

A 27-page catalog gives standard specifications and drawings for rolling steel doors, rolling grilles, mid-gut slat closures, and overhead doors. *The Wilson Corp., P.O. Box 599, Norfolk, Va.\**

### Doors 1961

(A.I.A. 19-E-1) Illustrates and describes flush, bifold and stile and rail doors with photographs and drawings. Also included are charts giving complete technical information and specifications. 8 pp. *Simpson Timber Co., 2039 Washington Bldg., Seattle 1, Wash.\**

### Shower Stalls and Receptors

A six-page catalog gives description and specifications of Cutler's shower cabinet models, and charts and drawings showing sizes and dimensions. Also available is a four-page catalog on receptors with specification and reference tables as well as installation instructions. *Cutler Metal Products Co., Camden 3, N. J.\**

### Glass Blocks and Modules

*PC Glass Blocks and Sculptured Glass Modules* (A.I.A. 10-F) contains information on light transmission, insulation value, physical performance and proper selection. 20 pp. *Pittsburgh Corning Corp., One Gateway Center, Pittsburgh 22, Pa.\**

### Aluminum Traverse Track

Gives technical information and specifications on cut-to-measure traverse equipment for all types of drapery installations. *Kirsch Co., Sturgis, Mich.\**

### Literature Requested

William Henry Johnson, Architect,  
807 Brooklyn Ave., Kansas City, Mo.

Professor G. M. Mandalia, Head,  
Architecture Dept., University of  
Roorkee, Roorkee, India

\* Additional product information in  
*Sweet's Architectural File*





# “Extensive testing proved that we should specify prismatic shields cast from Du Pont MONOCITE\* by The Polycast Corporation”

Says Gunnar Anderson, Manager of Newark's beautiful new Mutual Benefit Life Insurance Building: "Achieving the finest and most efficient lighting system possible was so important to the architects, design engineers and electrical contractors that a special 'mock-up' room was created. All types, shapes and makes of lighting designs were installed and carefully analyzed. The unanimous selection was to use acrylic prismatic shields\*\* made from Du Pont MONOCITE and cast by The Polycast Corp. of Stamford, Conn.

"We've had absolutely no problems with any of the more than 3,500 fixtures made from cast acrylic sheet since they were installed in 1957. And we don't anticipate any for a long, long time. These fixtures provide us with virtually glare-proof lighting—soft illumination that gives maximum efficiency to eliminate eyestrain. Also, our maintenance problem is at a minimum with acrylic shields made from MONOCITE. When the fixtures need cleaning, lukewarm water and mild soap keep them spotless and free from yellowing or streaking. I'd say that this lighting system with acrylic shields has contributed greatly to the beauty of the building."

It will pay you to find out how Du Pont's customers are using Du Pont MONOCITE to produce lighting-fixture shields that will give you outstanding service with a minimum of maintenance. For further information write to: E. I. du Pont de Nemours & Co. (Inc.), Dept. AR-2, Room 2507M, Nemours Building, Wilmington 98, Delaware.

\*Trademark for Du Pont's methacrylate monomer.

\*\*Polycast acrylic R-14 diamond-pattern shields.



The Mutual Benefit Life Insurance Building, Newark, N. J., is one of the city's most modern landmarks. (Architects, Eggers & Higgins, New York City; Design Engineers, Syska & Hennessy, New York City; Fixture Manufacturer, Gruber Lighting Inc., Brooklyn, N. Y.; Installation, The Beach Electrical Company, East Orange, N. J.)

POLYCHEMICALS DEPARTMENT



BETTER THINGS FOR BETTER LIVING...THROUGH CHEMISTRY



WIRE FABRIC

Heats, Reinforces Slab

continued from page 176

At the ends nearest the transformers, these bars were 5 ft long; at the far side, they were 9 ft-10 in. long, bridging two strips of fabric and conducting the current from one length to the adjacent strip. Thus, the current, lead by cable from the transformers to the end of one length of fabric, followed a U-shaped path, down one length, back the other, and back to the transformer.

To facilitate placement of the wire fabric, welding of the copper buss bars, and the insulating and tying of the overlapping lengths, the floor slab was constructed in two stages. The first stage was a two inch thickness of unreinforced concrete placed over a polyethylene vapor barrier on 6 in. of well compacted gravel.

After this set, the electrical contractor placed the fabric, attached the buss bars and cables, and tied the insulation. Electric tests were made to be sure of proper current flow through the grid and then remaining four inches of concrete slab were placed.

Six dry-type transformers power the radiant networks. Two hundred and eight volts applied to the transformers is stepped down to 20 volts for the wire fabric. Current flow in the fabric is in the 500-600 ampere range, with 45 to 55 amperes in each of the 11 longitudinal wires in each strip of fabric.

Despite the low 20v potential involved, engineers have taken care to confine the current to the fabric network by specifying insulation of any obstructions in the slab, or, alternately, removal or detour of any wire that closely approaches drains, conduits, plumbing, etc.

The wire fabric system is designed to emit 20 watts per square foot in the warehouse area, giving floor surface temperature of 80F and 15 watts per sq ft in the office-shop area, with a slightly lower floor temperature (because of the auxiliary baseboard heating).

Temperatures will be controlled by a system of thermostats, four em-

continued on page 240

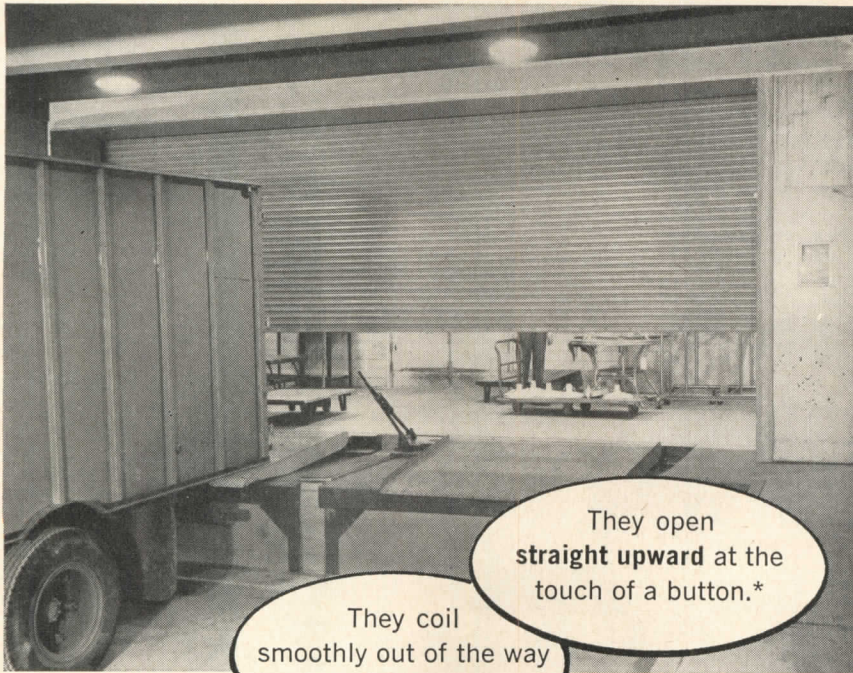

They open straight upward at the touch of a button.\*

They coil smoothly out of the way above the opening.

They clear the doorway quickly — from jamb to jamb and from floor to lintel.

They stay out of reach of damage by wind or vehicles.

All floor and wall areas around the doorway are always fully usable.

Ceiling space also remains clear, for unimpeded use of overhead cranes, hoists, conveyors, ductwork, lighting, or other overhead equipment.

The tough, flexible all-metal curtain assures long service, low maintenance costs, extra protection against fire, wind, intrusion, vandalism.

Kinnear Rolling Doors are built in any size. Write for information, or for recommendations on your door needs.

# Kinnear Steel Rolling Doors

boost door efficiency

Heavy galvanizing (1.25 ounces of pure zinc per square foot of metal, ASTM Standards) adds resistance to weather, wear, and corrosion.

\*—when equipped with Kinnear Motor Operators. Also available with manual lift, crank, or chain control. Kinnear's torsion-spring counter-balance assures smooth, easy door operation under all conditions.

The KINNEAR Mfg. Co.

FACTORIES:

1860-80 Fields Ave., Columbus, Ohio  
1742 Yosemite Ave., San Francisco 24, Calif.  
Offices and Agents in All Principal Cities

**KINNEAR**  
ROLLING DOORS  
Saving Ways in Doorways



Architects and Engineers: Tippetts-Abbett-McCarthy-Stratton, New York.

# SARALOY<sup>®</sup> 400

frees design from conventional flashing limitations,  
cuts flashing labor costs 25% for new air terminal

45,000 square feet of Saraloy 400 roof flashing provide hundreds of *permanent* moisture seals for this ultra-modern air terminal. Among the many critical flashing problems solved by Saraloy 400 were: sealing 875 acute and obtuse angles created by almost inaccessible junctures of structural steel beams and purlins; flashing steel-to-concrete joints and lining scupper holes.

The design of the terminal's elliptical cantilevered roof produced 144 different odd shapes and angles where beams, purlins and equipment housing shells meet. Flashing with conventional materials would require that each seal be specially cut and custom-fitted, often to match curved contours. The labor costs for installing metal flashing would have been prohibitive. Because Saraloy 400 could be quickly and easily cut and formed on the job, labor costs were about 25% less than the cost of installing conventional flashing materials. And each seal is permanent.

Saraloy 400 is Dow's brand of flexible roof flashing. It can be bonded to almost any construction material, such as concrete, wood, metal, ceramic, and it can be painted. It provides a permanent watertight seal which won't check, peel or crack . . . and which moves with building contraction and expansion. For more information write to THE DOW CHEMICAL COMPANY, Midland, Michigan, Plastics Sales Dept. 1501N2.



Saraloy accomplishes difficult flashing  
of bolted girder-purlin intersection

## OTHER DOW BUILDING PRODUCTS

**STYROFOAM\***—Long-lasting insulation for cavity walls; effective insulating base for plaster and wallboard. Rigid, low "K" factor, highly resistant to water and water vapor.

**SCORBORD\*** (pat. applied for)—Superior rigid insulation for foundation perimeters, slab floors. Exclusive pre-scoring speeds installation.

**ROOFMATE\***—Lightweight, rigid insulation for built-up roofs serves as its own moisture barrier. Reduces blistering, resultant leaks. 2' x 4' boards speed installation. \*TRADEMARK

THE DOW CHEMICAL COMPANY



Midland, Michigan



# GRIFFIN

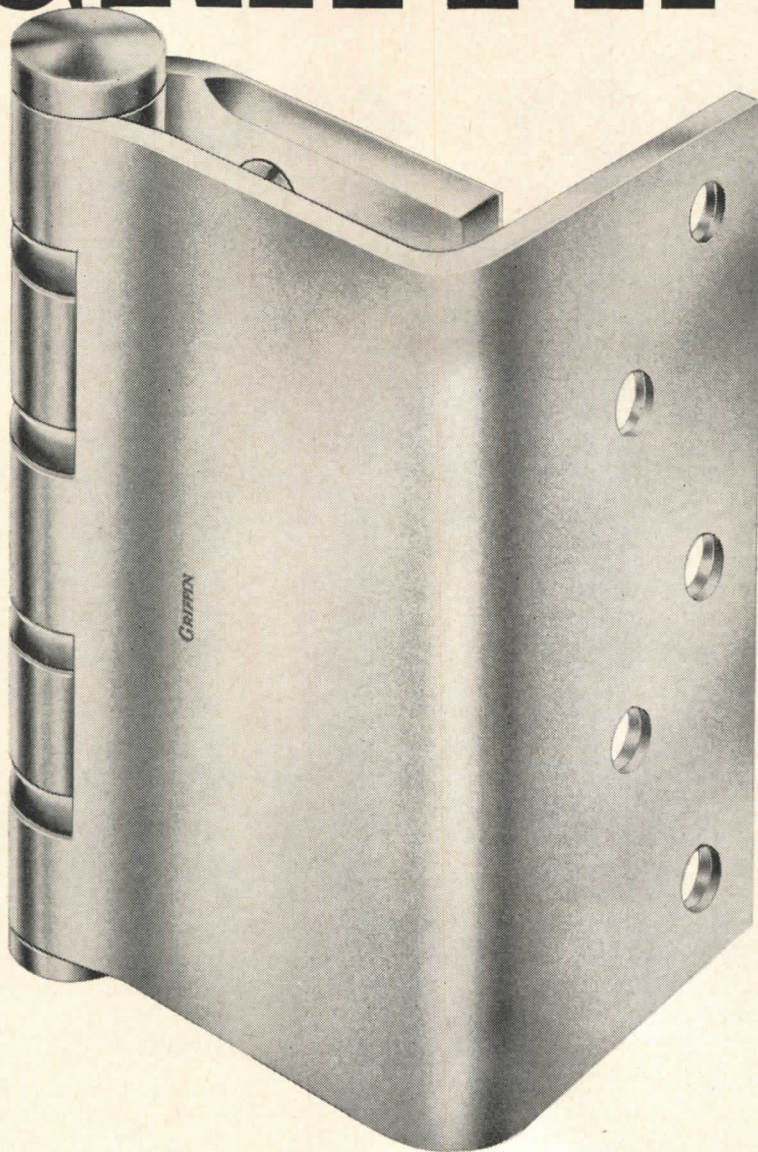

## HINGES for HEAVY DOORS or HIGH FREQUENCY USE

"Swing Clear" extra heavy, four ball bearing, half mortise template hinges for heavy doors or high frequency use where full opening is desired when door is opened 90°. Made of wrought steel, highly polished

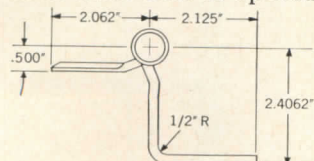

and heavily plated or bonderized and primed for painting with inner edges of leaves beveled. Also available with hospital type rounded barrel ends. All Hinges Conform to Federal Specifications.

**GRIFFIN MANUFACTURING COMPANY · ERIE, PA.**

*Architectural Engineering*

### WIRE FABRIC

#### Heats, Reinforces Slab

*continued from page 232*

bedded in the floor slab itself, and others measuring the air temperature, both inside and outside. These stats will control the heating system, "predict" coming temperature changes and demands, and switch the transformers on and off.

Engineers estimate that heating the new service facility will require about 300,000 kilowatt hours annually, or, at a rate of 1.5 cents per kwh, represent a heating bill of about \$4500.00.

The Minot installation is not the only "double" use of welded wire fabric. First experimentation in electrically heating slabs using material other than especially manufactured wire, was done by Commonwealth Edison Company in Chicago, starting in 1945. Three installations were made between 1945 and 1957 in which the resistance material was expanded metal or diamond mesh. In 1957 the use of wire fabric was suggested because of the ease of unrolling and placing fabric, and because of the economy inherent in the "double" use of reinforcing fabric.

In 1957, Commonwealth Edison erected a service facility at DeKalb in which the resistance material was welded wire fabric. Because of the generally favorable results from this "in-service" test, engineers of the Chicago utility firm next decided to test wire fabric in the laboratory to determine the relationships of current flow, resistances, and wire sizes.

Results of the Commonwealth Edison tests and experience were furnished by the Northern States Power Company engineers. Active in the project were sales engineer France Anderson, division manager W. R. Williams and general superintendent Loren E. Linder. Engineer Harold Teachout of the NSP Minneapolis headquarters office was technical adviser in charge of design.

Architect for the new facility was James V. DeLoi of Minot; and the designer of preliminary plans for the dual purpose welded wire fabric heating system was Kenneth O. Tompt, electrical consulting engineer of Fargo, North Dakota.





## 67 mighty good reasons for investing in an automatic, steel pipe fire protection system

The 67 people in this photograph may not think about it, but they can shop with the assurance that a raging fire will not suddenly engulf the store. That's because in most of the nation's 11,494 department stores, even as in the one above, automatic *steel pipe* fire protection systems safeguard lives and property. In fact, wherever there is progressive management—be it in business or industry—there you will find fire prevention systems protecting the public, employees, property, goods.

A *steel pipe* fire protection system is a worthwhile investment. It offers security and pays for itself in a few years through lower insurance rates on buildings, equipment and inventory.

In fire protection systems, as in heating, plumbing, refrigeration and air-conditioning systems—*steel pipe* is first choice. Its high strength, ease of forming and joining and durability make it the optimum tubular product for conveying air, water, liquids and gases. With all these advantages, plus low cost—no wonder more tons of *steel pipe* are produced for more uses than any other tubular product in the nation.

### STEEL PIPE IS FIRST CHOICE

- Low cost with durability
- Strength unexcelled for safety
- Formable—bends readily
- Weldable—easily, strongly
- Threads smoothly, cleanly
- Sound joints, welded or couped
- Grades, finishes for all purposes
- Available everywhere from stock

Insist on



Steel Pipe

C-10

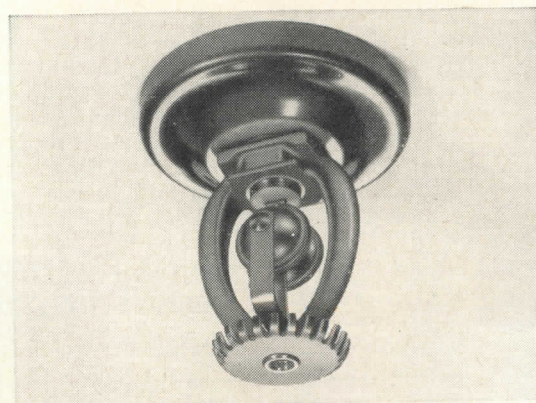

One certain way to stop fire before it does material damage, whenever and wherever it strikes, day or night, is through a steel pipe automatic fire protection system. Sprinkler pipes may be exposed or concealed; sprinkler heads are available for flush sidewall, upright or pendent mounting.

### COMMITTEE OF STEEL PIPE PRODUCERS

150 East Forty-Second Street, New York 17, N. Y.





Residential Cooling Loads

continued from page 174

effect of shades and draperies. In all probability these additional shade effects on glass, walls, and roof caused the difference between the measured and calculated loads.

On the whole, the proposed cooling load estimation method has resulted in an estimated load that closely approximates the measured maximum load in each of the five research houses. Such agreement has not been achieved through the application of any of the existing methods. That is, loads for the same houses estimated by existing methods have been in good agreement in *some* but not *all* cases. Since the five houses represent a wide variety of constructions, it is believed that the proposed method is applicable to any house of contemporary design.

References

- (1) "Cooling Studies in a Research Home", W. S. Harris and P. J. Waibler. (ASHVE Transactions, Vol. 60, 1954, p. 487.)
- (2) "Performance of a Hot Water Heating System in the Research Home", A. P. Kratz, M. K. Fahnestock, W. S. Harris and R. J. Martin. (ASHVE Journal Section, Heating Piping and Air Conditioning, December, 1941.)
- (3) "Cooling a Small Residence with a Two-Horsepower Mechanical Condensing Unit", H. T. Gilkey, D. R. Bahnfleth and R. W. Roose. (ASHVE Transactions, Vol. 59, 1953, p. 473.)
- (4) "Effects of Weather Conditions on Cooling Unit Operation in a Residence", H. T. Gilkey, W. F. Stoecker and S. Konzo. (ASHAE Transactions, Vol. 61, 1955, p. 255.)
- (5) "Cooling a Small Residence Using a Perimeter-Loop Duct System", D. R. Bahnfleth, C. F. Chen and H. T. Gilkey. (ASHVE Transactions, Vol. 60, 1954, p. 271.)
- (6) "Measurement of Infiltration in Two Residences", D. R. Bahnfleth, T. D. Moseley and W. S. Harris. (ASHAE Transactions, Vol. 63, 1957. Part I, p. 439, Part II, p. 453.)
- (7) *Manual No. 11*, "Design and Installation of Summer Air Conditioning for New and Existing Residences", 4th ed. (National Warm Air Heating and Air Conditioning Association, Cleveland, 1959.)
- (8) *Guide C-30*, "IBR Cooling Load Calculation Guide", 1st ed. (The Institute of Boiler and Radiator Manufacturers, New York, 1956.)
- (9) *Year-Round Residential Air-Conditioning*, "Standard 230-57," (Air-Conditioning and Refrigeration Institute, Washington, D. C., 1957.)



AUDIO-VISUAL NURSES' CALL EQUIPMENT



provides closer patient-nurse contact...speeds efficiency and service

DuKane Audio-Visual Automatic Nurse's Call System offers exclusive features of simplicity of installation, minimum maintenance and flexibility. The day you install a DUKANE Audio-Visual Nurse's Call System you automatically boost staff efficiency and actually increase the functional potential of your nursing staff. Needless trips are eliminated with two-way, nurse-patient communication. Both audible and visual registration of all incoming calls are indicated on the Master Station annunciator panels and outside corridor lights. Answering stations such as pantry, etc., eliminate needless steps for your nursing staff in answering simple patient needs. DUKANE has an Audio-Visual Nurse's Call System to meet every hospital requirement regardless of size. All patient and nurse controls provide easy fingertip control. Improved service, speed and efficiency builds hospital staff morale and boosts patient security and facilitates recovery. Find out full details today.

DUKANE OFFERS A COMPLETE LINE OF AUDIO-VISUAL NURSE'S CALL EQUIPMENT TO MEET EVERY SIZE HOSPITAL NEED.

Your Authorized Factory-Trained Dukane Engineering Distributor is as near as your phone.

**DUKANE CORPORATION**, Dept. AR 21, St. Charles, Illinois

Please send information on Dukane Audio-Visual nurse's call equipment.

NAME \_\_\_\_\_

TITLE \_\_\_\_\_

FIRM \_\_\_\_\_

ADDRESS \_\_\_\_\_

CITY \_\_\_\_\_ STATE \_\_\_\_\_



PELLA PRODUCTS

THE FOCAL POINT OF QUALITY



ARCHITECT: HOWARD W. TUTTLE



## wood casement windows

*impress quality-conscious clients*

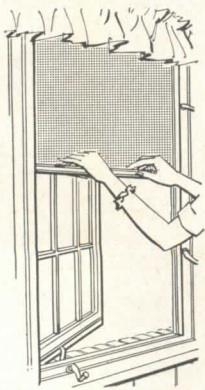

### ROLSCREEN®

Talk about "instant this" and "instant that," PELLA Casements are equipped with "instant screens." ROLSCREENS roll down in spring—roll up and out of sight in winter!

Homeowners often tell us they thought all windows were just about alike until their architects told them about PELLA WOOD CASEMENTS. They are always impressed with the good sense and convenience of the exclusive inside ROLSCREEN® that rolls up and down with the seasons and those self-storing inside storm panels for easier year 'round living. Best of all, the ROLSCREEN feature that makes Pella Casements "new" to most people has been user-tested by the millions. There are 18 standard ventilating sizes up to the large 24" x 68" glass size and 60 fixed sizes. Removable muntins in regular, diamond and horizontal styles offer additional design flexibility. Full specifications in SWEET'S or consult the classified telephone directory for the name of the nearest U.S. or Canadian distributor. ROLSCREEN CO., PELLA, IOWA.

PELLA ALSO MAKES QUALITY WOOD MULTI-PURPOSE WINDOWS, WOOD FOLDING DOORS AND PARTITIONS, ROLSCREENS AND WOOD SLIDING GLASS DOORS



On the Calendar

February

- 9-11 Fifth annual Home Improvement Show, sponsored by the Home Improvement Products Association—The Coliseum, New York
- 13-16 Semi-annual meeting, American Society of Heating, Refrigerating and Air-Conditioning Engineers—Chicago

20-23 57th annual convention, American Concrete Institute—Chase-Park Plaza Hotels, St. Louis

March

- 5-8 Third National Lighting Exposition and World Lighting Forum, sponsored by Lighting, Lamps and Electrical Manufacturers Salesmen's Association, Inc.—The Coliseum, New York

April

- 5-7 47th annual convention, Michigan Society of Architects—Sheraton-Cadillac Hotel, Detroit
- 9-15 23rd annual convention, National Association of Architectural Metal Manufacturers—Plaza Hotel, New York
- 10-15 National convention (first of three in 1961), American Society of Civil Engineers—Phoenix, Ariz.
- 18-20 Fifth Annual Industrial Mutual Aid and Disaster Control Seminar, sponsored by the National Institute for Disaster Mobilization and the Channel Industries Mutual Aid—Shamrock-Hilton Hotel, Houston, Tex.
- 20-22 76th annual convention, Illinois Society of Professional Engineers—Peoria, Ill.
- 30ff Annual meeting, Air-Conditioning and Refrigeration Institute; through May 30—the Homestead, Hot Springs, Va.

Because no one type is best for all loading dock situations...

**RITE-HITE**

OFFERS BOTH

**MANUALLY OPERATED**

mechanical ramps

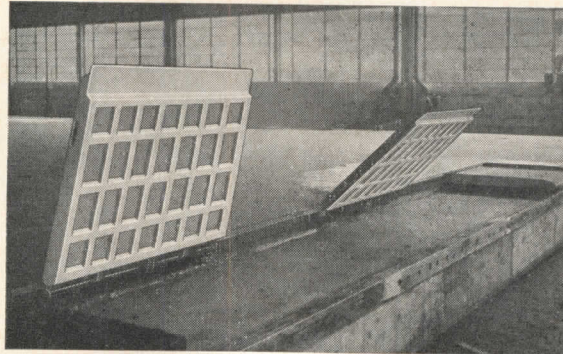

**TRUCK OPERATED**

mechanical ramps

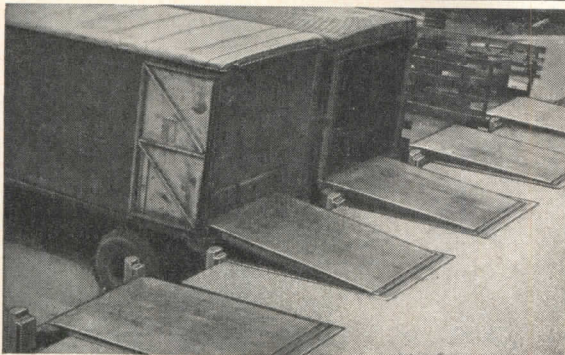

Smooth Precision Counterbalancing

- ... pioneered by Rite-Hite
- ... no complicated controls
- ... no piping, pumps, gears, wiring valves, motors
- ... just maintenance-free ruggedness throughout

For descriptive literature and installation details, write Dept. A-261



You get a choice of five manual ramps, 20,000 pounds capacity. Platform swings to nearly vertical position—trailer doors can be opened after trailer is parked at dock—overhead doors can be closed in front of platform. Only three moving parts. No levers project. Side-to-side platform adjustment.

You get a choice of three truck ramps, 20,000 pounds capacity. No operating cost, no electrical, hydraulic or pneumatic system to maintain. Year-around dependability. Platform floats with truck bed—from 9" below to 17" above dock surface—automatically levels and locks.

**LOOMIS MACHINE COMPANY**  
133 FOURTH STREET, CLARE, MICHIGAN

Office Notes

Offices Opened

Urban Engineers, Inc., civil and structural engineering consultants, have opened a new office at 1619 Chestnut St., Philadelphia 3, Pa.

New Manhattan offices have been opened by Samuel Paul & Seymour Jarmul, architects, at 59 East Fifty-fourth St., New York 22.

After 16½ years as design and construction department manager for the Omaha division of Safeway Stores, Inc., architect R. F. Henning resumes private practice, with offices at 4202 Emmet St., Omaha 11, Neb.

New Firms, Firm Changes

Carl F. Burmeister Jr. and Thomas B. Bealle Jr. announce the formation of a partnership for the general practice of architecture under the firm name of Burmeister and Bealle-Architects at 1914½ Grant St., Mobile, Ala.

Harry B. Mahler has been named an associate of the Newark architectural and engineering firm of Frank

*continued on page 262*



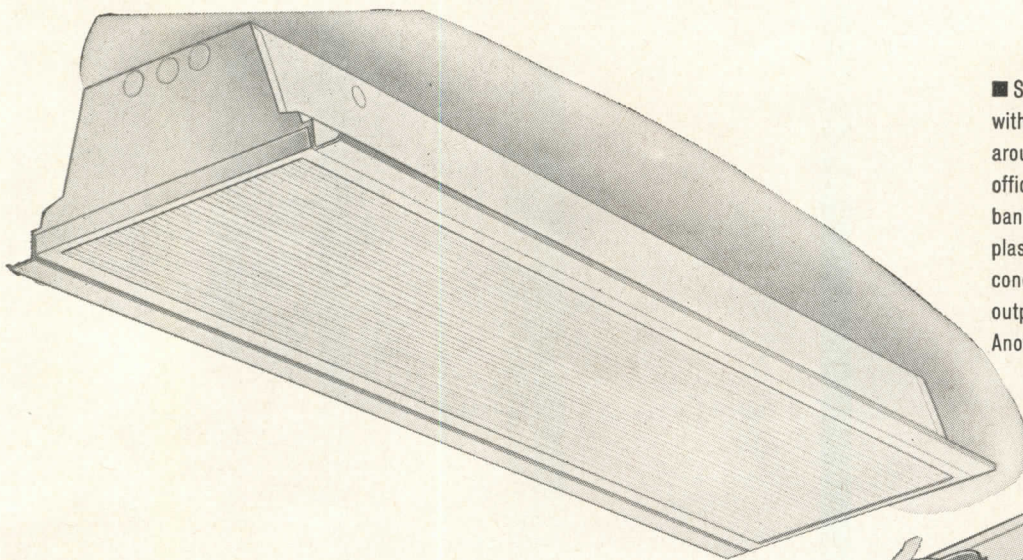

■ Shallow Troffer "Simplicity" unit— with flowing contours that will be around for years to come—ideal for offices, hospitals, schools, stores, and banks. Available with the new CALux plastic lens . . . providing maximum concealment of lamp . . . high output and attractive appearance. Another first from Curtis-AllBrite.

■ The new ALZAK 88 Industrial Series — bringing a new dimension to industrial lighting — a forward concept in harmony with today's plant designs.

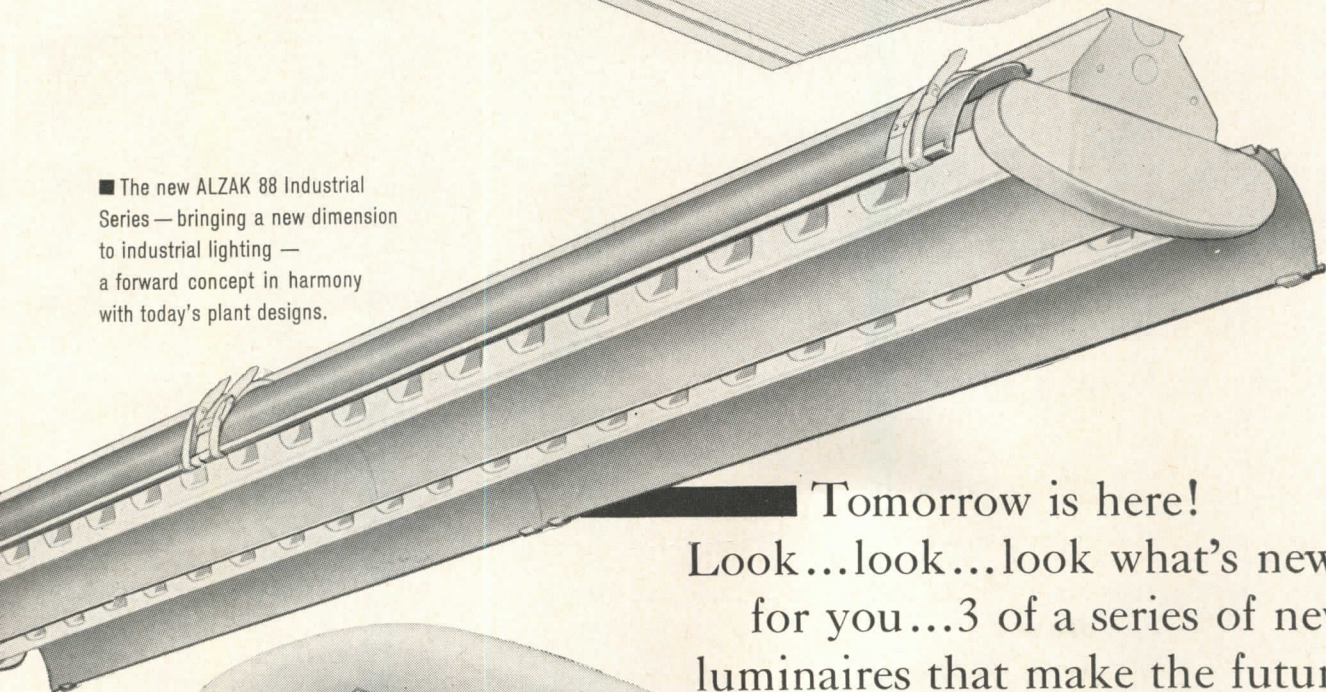

■ Tomorrow is here!  
Look...look...look what's new  
for you...3 of a series of new  
luminaires that make the future  
a realization today!

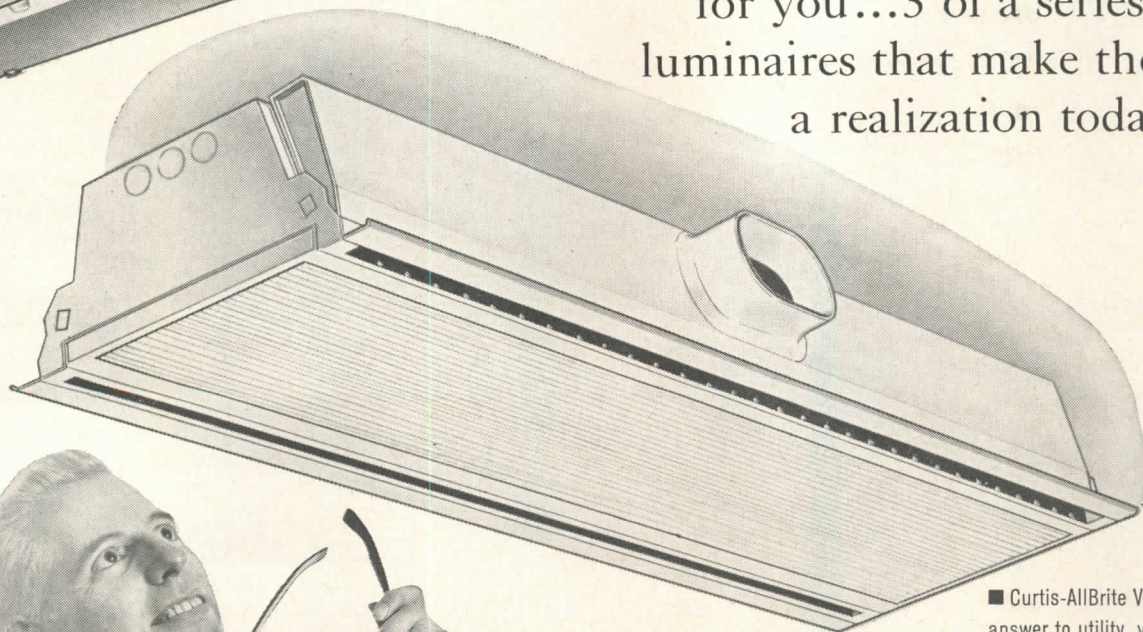

■ Curtis-AllBrite Vento-Lux — the answer to utility, yet brimming with beauty. Here you get illumination, and air distribution from a combination unit . . . available with the new CALux lens. Ideal for offices, stores, banks, hospitals and schools.





## The Record Reports

continued from page 254

Grad & Sons, 11 Commerce St., Newark 2, N.J.

A new partner in the Honolulu office of Bassetti & Morse, Architects, is John Tatom. The Honolulu firm name is now Bassetti, Morse & Tatom, Architects.

John J. Andrews, senior electrical engineer of Smith, Hinchman and Grylls Associates, Inc., Detroit architectural and engineering firm, has been named an associate.

Warren W. Cunningham has joined with Robert L. Geddes, Melvin Brecher, George W. Qualls to form the partnership of Geddes Brecher Qualls Cunningham: Architects, in Philadelphia.

Three new partners have been named in the Seattle architectural firm of Naramore, Bain, Brady & Johanson. They are A. Ernest Hennesy, Eric C. Rising and William M. Svensson. In addition, nine new senior associates have been named: William J. Bain Jr., James W. Evans, Robert A. Floren, Robert A. Hanson, Dean E. Hardy, Melvin J. Larson, William R. Pickens, Robert J. Pope and W. Redmond Stout. Seven new associates include Robert D. Bell, Bert J. Bruce, John D. Finnegan, Franklin J. Gribble, Gunnar R. Lie, Robert E. Messer and Vincent L. Oredson.

The firm of Turano-Gardner having been dissolved, Emanuel N. Turano announces the continuance of his practice of architecture in partnership with Leonard Feldman. The firm name is E. N. Turano—A.I.A.—Architects—Planners; the address, 16 E. 52nd St., New York 22, N.Y.

Peter Tarapata and Charles MacMahon Jr. of Tarapata-MacMahon, architects, Bloomfield Hills, Mich., announce the expansion and incorporation of their firm into Tarapata-MacMahon Associates, Inc. William J. Hayes, P.E. has been elected vice president and director. Others named to new responsibilities are: William J. Adams, production manager; Samuel M. Deyo, chief of specifications; Carl Luckenbach, design assistant.

New Addresses \_\_\_\_\_

Heinzel—Goettman, Architect and Engineer Associates, 41 Dolson Ave., Middletown, N.Y.

more news on page 270

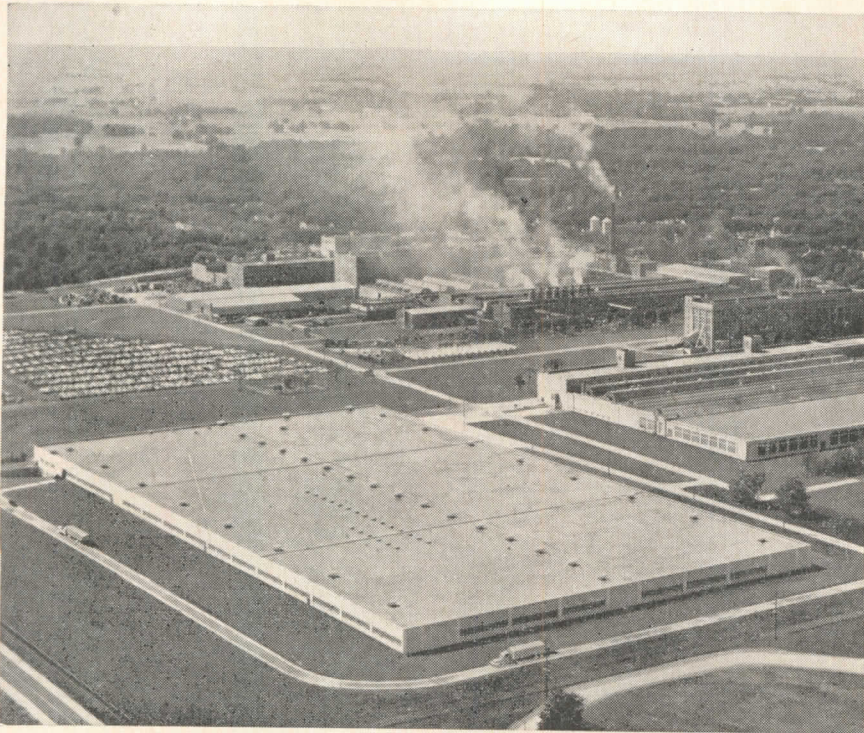

## New Kohler Engine and Electric Plant Building

*Capacity to meet growing sales*

Our customers' requirements will be met better than ever by the 12 acre new factory devoted entirely to the manufacture of engines and electric plants at Kohler, Wisconsin.

The building provides nearly three times the space formerly available, and allows for further expansion. Straight-line, one-floor production and newest equipment mean increased production, prompt deliveries.

Kohler engines, manufactured since 1920, are being increasingly specified for equipment used in agriculture, construction, industry and recreation. Kohler electric plants, known the world over for reliability, provide efficient electric power for a wide variety of sole supply, portable, automatic stand-by and marine uses.

Highest standards of service are assured by a nation-wide distributor and dealer organization.

The new factory is part of a continuing plan of expansion and diversification by Kohler Co.

Write for illustrated printed matter K-7

KOHLER Co. Established 1873  
KOHLER, WIS.

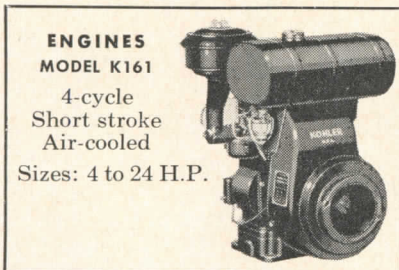

### ENGINES MODEL K161

4-cycle  
Short stroke  
Air-cooled  
Sizes: 4 to 24 H.P.

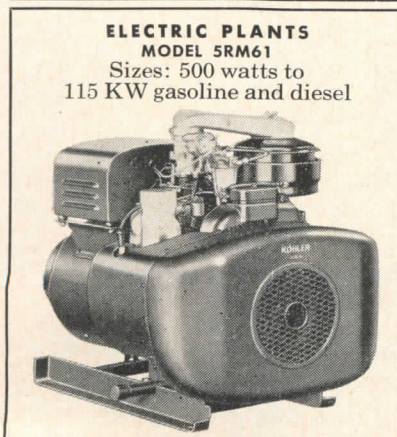

### ELECTRIC PLANTS MODEL 5RM61

Sizes: 500 watts to  
115 KW gasoline and diesel

## KOHLER OF KOHLER

ENAMELED IRON AND VITREOUS CHINA PLUMBING FIXTURES • ALL-BRASS FITTINGS  
ELECTRIC PLANTS • AIR-COOLED ENGINES • PRECISION CONTROLS



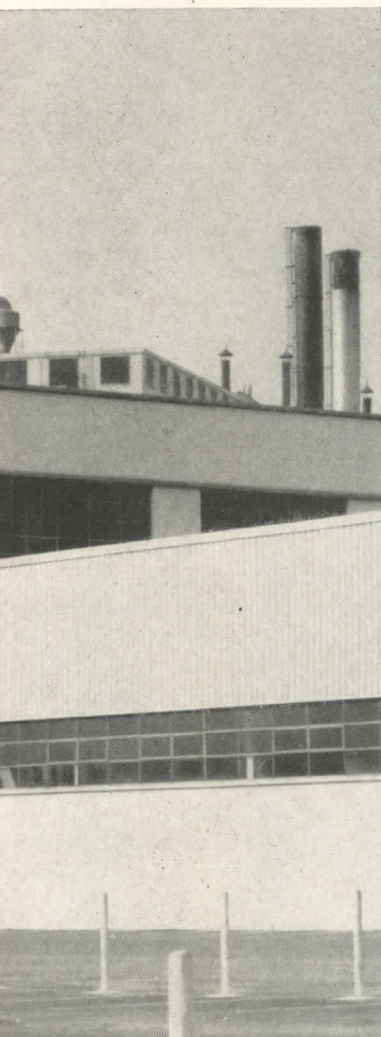

## with Gold Bond Fire-Shield Plaster!

This new \$5,000,000 addition to the Schlitz Brewery in Milwaukee got 3-hour fire protection for its steel beams in a new and better way. Gold Bond Fire-Shield Plaster was sprayed directly to the beams to a 2" thickness in just two days. No furring or caging was needed. This amazing new plaster is easy and economical to use because it sticks immediately to clean steel and dries (without fissuring) with a bond stronger than the material itself! Fire-Shield® Plaster also gives cellular steel decks a 4-hour fire rating when sprayed just 5/8" thick after the flutes are filled. It gives corrugated decks the same rating when sprayed 3/4" thick. Satisfy your own curiosity about this new kind of fire protection. Call your Gold Bond® Representative for a full explanation, or write direct to Dept. AR-21 for free samples and technical literature.

NATIONAL GYPSUM COMPANY, BUFFALO 13, NEW YORK



a step ahead of tomorrow



HAWS Model 7X

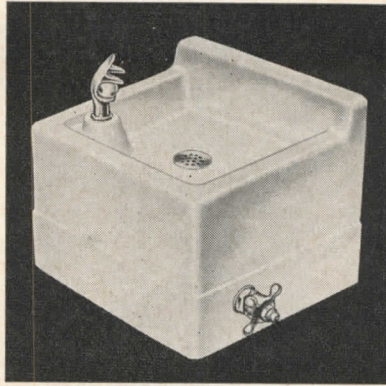

# RUGGED

Look at the *back* of this rugged HAWS fountain! The sturdy cast iron body is gripped in a thick shell of smooth porcelain enamel—impervious to weather extremes, corrosion, *even acids!* That's why HAWS Model 7X is the ideal specification for outdoor areas, industrial and chemical plants throughout the world! And good looking, too! This popular model matches anything on the market for sheer streamlined beauty. Get ruggedness with style. Specify HAWS!

## WRITE FOR DETAILED SPECS

*or request your free copy of the comprehensive Haws catalog. Also refer to your Sweet's File.*

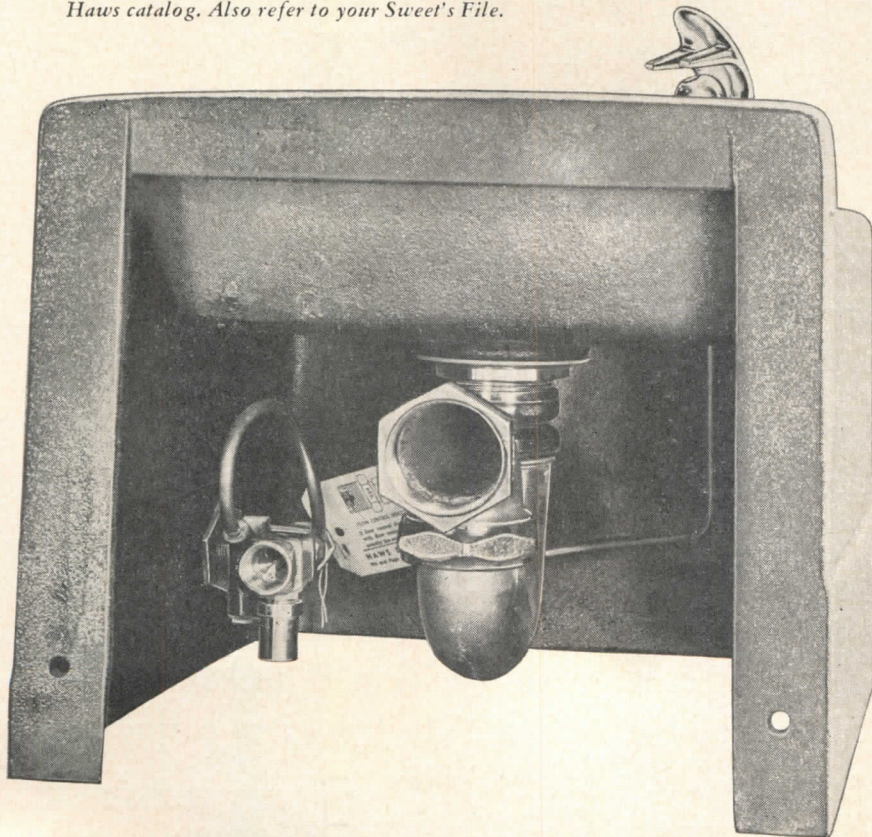

Since 1909



## DRINKING FOUNTAINS

products of  
**HAWS DRINKING FAUCET COMPANY**  
1441 Fourth Street, Berkeley 10, California

Export Dept.: 19 Columbus Ave., San Francisco 11, California

## The Record Reports

*continued from page 270*

ment of application of standards. Mr. James Harold Foote, Commonwealth Assoc., Inc., Jackson, Mich., received the Howard Coonley Medal for service in advancing national economy through voluntary standards.

### Lawrence M. Orton Receives City Planning Medal of Honor

The Medal of Honor for City Planning, given only three times since its establishment in 1939, has been awarded to Lawrence M. Orton, charter member of the New York City Planning Commission.

The medal is jointly sponsored by the Metropolitan Section of the American Society of Civil Engineers, the New York Chapter of the American Society of Landscape Architects, and the Brooklyn and New York City Chapters of the American Institute of Architects.

E. James Gambaro, F.A.I.A. and Chairman of the Joint Award Committee, said the award is given "to those planners with vision, a capacity for service, men with broad horizons of interest and a proven ability to solve problems endless in their complexity."

### Two Win 1960 Steedman Fellowship

Steedman Fellows for 1960 are Joanne Sheila M. Murphy and William L. Jordan. Both winners of the competition, established in the memory of James Harrison Steedman, an 1889 graduate of Washington University in St. Louis, are graduates of the Washington university School of Architecture, and both are presently employed in the St. Louis offices of Hellmuth, Obata & Kassabaum, architects.

Each Steedman Fellowship entitles the recipient to \$3000 for a year's study of architecture in foreign countries. Usually only one award is made each year. Miss Murphy is the first woman ever to be named a Steedman Fellow. Jordan has also been granted the Harbeson, Hough, Livingston, Larson Fellowship by the University of Pennsylvania for study in civic design.

*more news on page 282*



NEW PERSPECTIVES IN INTERIOR DESIGN

# MOVABLE VAUGHAN WALLS\* OFFER ONE-HOUR FIRE PROTECTION, 37-DB RATING

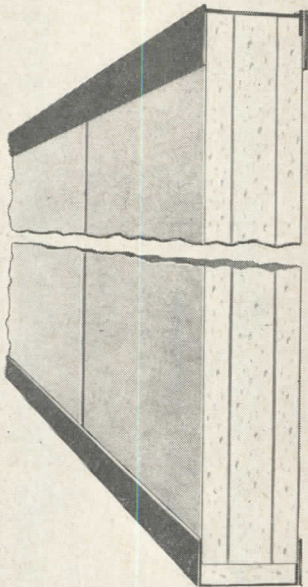

*Now a gypsum movable wall that performs like a permanent wall – opens new perspectives in design with new freedom and flexibility in planning, plus significant savings in maintenance cost and fire insurance rates. It's the Movable VAUGHAN WALL, the first movable partition to meet standard code requirements with a full one-hour fire rating, a high 37-decibel sound transmission loss. Like a permanent wall, it is job-laminated to provide exceptional flexibility. Also, like a permanent wall, it can be decorated with paint, vinyl, and veneers – economically redecorated. Yet it can be quickly moved to meet changing office needs with nearly 100% salvage. Learn more about Movable VAUGHAN WALLS from your U.S.G. representative, or write Dept. 122, 300 West Adams Street, Chicago 6, Illinois.*

VAUGHAN WALLS are modular gypsum panels, job-laminated to a thickness of 2¼" and held in place by metal floor and ceiling runners. With only three basic components, they offer the ultimate in simplicity.

NEW PERSPECTIVES WITH GYPSUM DRYWALL SYSTEMS

**UNITED  
STATES  
GYPSUM**

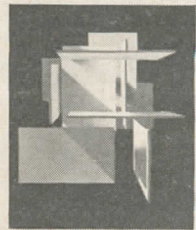

*the greatest name in building*

\* TRADEMARK OF VAUGHAN INTERIOR WALLS, INC.



New York City To Begin Major 8-Year Urban Renewal Project

March or April is the target date at which New York City aims for the initiation of a sweeping \$169,700,000 attack on blight and decay in the upper west side of Manhattan.

The 20-block urban renewal project, to be completed in eight years, according to Mayor Wagner, "is the fruit of two years' hard work . . . by the Urban Renewal Board headed by Planning Commission Chair-

man James Felt and by the new Housing and Redevelopment Board. It is our most ambitious undertaking in urban renewal to date . . . a part of a coordinated plan for the renewal of the entire west side."

J. Clarence Davies Jr., Chairman of the Board, said the plan calls for the first combined use of spot redevelopment, rehabilitation and neighborhood conservation in a single

project area in New York City. "The purpose . . . is to retain desirable neighborhood characteristics, including most of its sound structures, while eliminating existing blight and overcrowding, providing in their place new construction, open spaces and community facilities designed to restore long-term stability."

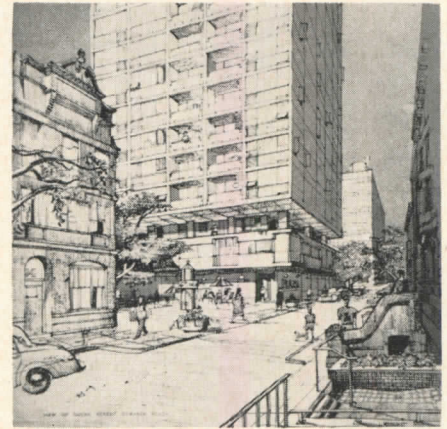

New construction, rehabilitated brownstones and plaza space are shown

The plan calls for clearance, redevelopment of 34 acres, providing for 7800 new dwelling units, commercial facilities and open spaces.

Rehabilitation is planned for some 465 brownstones to provide some 3100 dwelling units in areas totaling 21 acres. Conservation of existing sound apartment buildings, public, private schools, churches and other community uses will affect some 3600 units and some 19 acres.

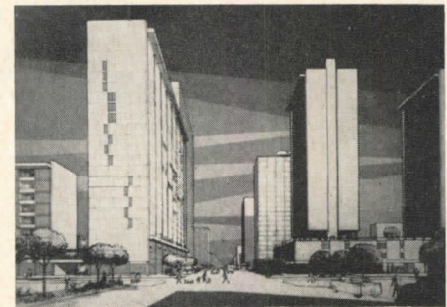

Future Columbus face-lifting includes widening of the street and landscaping

Traffic and pedestrian circulation will be improved through varied design treatment, building setbacks and landscaping.

The plan was developed by Brown & Guenther—Candeub & Fleissig, planning consultants.

At present under Federal review, the plan's final version will be submitted to the City Planning Commission and Board of Estimate for public hearings and approval.

more news on page 286

"Sedgwick concentrates responsibility by installing Sedgwick Dumb Waiters equipped with Sedgwick Dumb Waiter Doors."

"An investment in Sedgwick Dumb Waiters minimizes yearly costs of repair and replacement."

"Specifying Sedgwick assures maximum safety and performance."

"Wide range of Sedgwick Dumb Waiters, engineered to meet various service needs, permits selection of standard equipment to meet specific duty requirements."

**SPECIFY**  
**Sedgwick**  
**DUMB WAITERS**  
 for quality buildings of every class

see standard specifications and layouts in  
**SWEETS 24a/8e**

**Sedgwick MACHINE WORKS**  
 142 WEST 15TH ST., NEW YORK 11

Please send general information  
 Please send specific recommendation

on: \_\_\_\_\_  
 \_\_\_\_\_  
 NAME \_\_\_\_\_  
 ADDRESS \_\_\_\_\_  
 CITY \_\_\_\_\_ STATE \_\_\_\_\_

**Other Sedgwick Products**  
**FREIGHT WAITERS**  
**SIDEWALK ELEVATORS**  
**RESIDENCE ELEVATORS**  
**"STAIR-TRAVELORS"**



# Concordia Tiles by Ludowici

Designed by EERO SAARINEN  
and ASSOCIATES

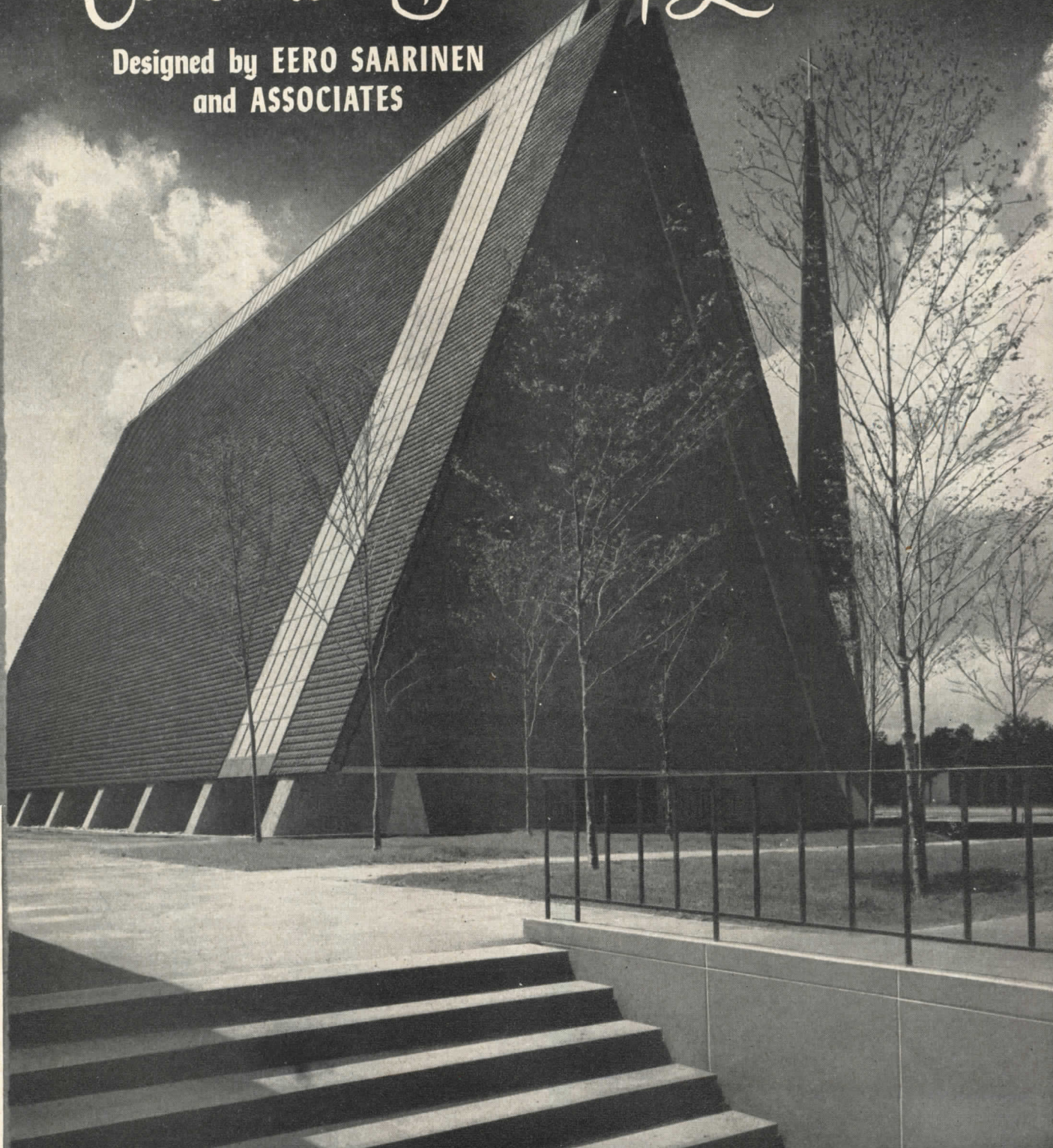

ST  
NOR  
WARD  
A.I.A.  
NUAL  
NOR  
WARDS  
OGRAM

Ludowici-Celadon Company was selected to produce the ceramic roofing tiles, designed by Eero Saarinen & Associates, which were so important in the full development of the architectural character of Concordia Senior College.

For over 65 years we have been assisting archi-

tects and engineers in producing roofing tiles for their specially designed work.

In addition, we offer standard patterns in a wide range of colors of roofing tile in both the Interlocking and Flat Shingle types for contemporary and traditional designs.

*Branch Offices and Sales Representatives available in all Metropolitan Areas*

Other Products—**QUARRY TILES** and **NAILON\*** Facing Brick

**LUDOWICI-CELADON COMPANY** • 75 East Wacker Drive • Chicago 1, Ill.



Architect-Designed Houses Win Awards for Builders

Parents' Magazine, in its 11th Annual Builder's Competition has singled out two National Merit Award winners built and sold in the United States during 1959-1960.

Selected from a group of 12 entries, two from each of six geographic regions, the two winners represent the contest's two price classifications: 1) houses sold for not more than \$15,999 and 2) houses

sold in a price range of \$16,000 to \$25,000, prices excluding land cost.

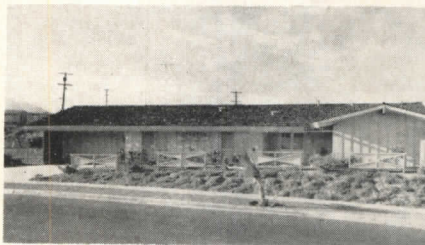

In the second category, the award went to Severin Construction Company. Owned by Dr. David M. Stenzil, La Mesa, Calif., the house was designed by Edward H. Fickett, A.I.A. (Shown left)

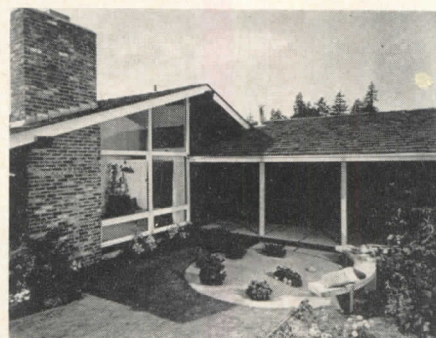

In the first price category, builder Wedgwood Homes, Inc. was cited. Owner is Alexander Kosloff, Portland, Ore. Architect was James C. Gardiner, A.I.A. (House shown above)

The competition's purpose is "to bring to the attention of the home buying public the continuously developing work of the nation's leading builders by finding and selecting the best homes for families with children."

The Jury consisted of Martin L. Bartling Jr., home builder, president, National Association of Home Builders; Richard Bennet, F.A.I.A., of Loebel, Schlossman & Bennett; Ralph J. Johnson, director, N.A.H.B. Research Institute; William H. Scheick, A.I.A., vice president, Research and Development, Timber Engineering Company; and Mrs. Maxine Livingston, Family Home editor, Parents' Magazine.

Award winners were selected on the basis of: the plan's excellence in terms of arrangement, use of space, storage, and provisions for equipment (present or future) to produce the greatest livability for a family with two or more children, excellence of architectural design, placement of house on the lot, usefulness of site as planned for outdoor family activities, and intelligent use of manufacturers' materials and products for durability, convenience, simplicity of maintenance and attractive architectural design.

Checks for \$500 were presented by Parents' Magazine on behalf of the winners to a nonsectarian child welfare organization or institution chosen by the builders.

more news on page 290



**FITS** any plan...

**MEETS ANY STORAGE REQUIREMENT**

Here's the economical answer to shelving problems. It's Erecta-Shelf, the versatile steel rod shelving. Erecta-Shelf assembles quickly (a cost factor) and easily to meet almost any height, width or depth requirement. Shelves and uprights are machined to notch rigidly together, without screws or bolts. Erecta-Shelf has been load tested to support as much as 1,000 pounds per shelf! Units fasten back to back, end to end or at right angles to fit any plan... meet any storage requirement.

Erecta-Shelf is truly the shelving of a thousand uses!

Write for free copy of illustrated folder today.

Available chrome plated or stainless steel



The Seal of Sanitation Quality!

**ERECTA SHELF®**

A quality product of METROPOLITAN WIRE GOODS CORP.  
N. Washington St. and George Ave. • Wilkes-Barre, Pa.



Impact and fire resistance are twin features of this Polished Misco Wire Glass installation in Tennessee School for the Deaf, Knoxville, Tenn. Architect—Painter, Weeks & McCarty, Knoxville, Tenn.

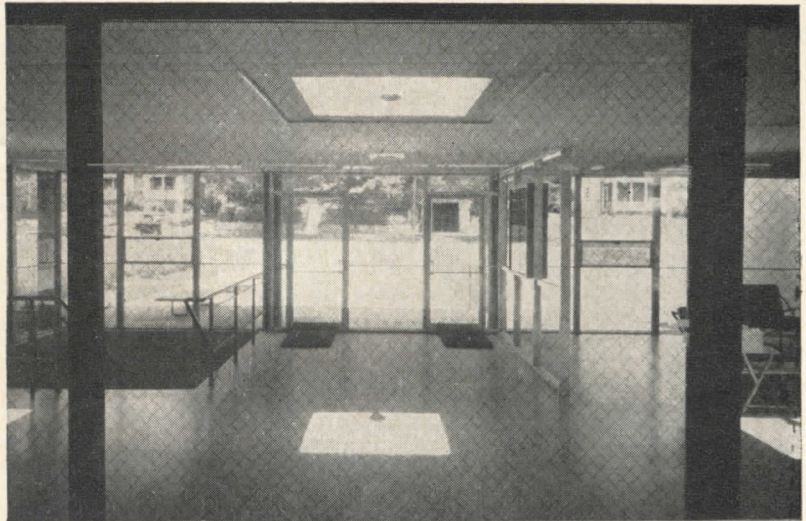

## MISSISSIPPI GLASS . . .

LEADS THE WAY IN

*Daylighting*

WITH SAFETY

Combining beauty, utility, and economy, Mississippi leads the way by making available an extensive selection of translucent glass patterns that do wonderful things with daylight. In addition, rugged Mississippi Wire Glass, whether for obscurity or clear vision, affords effective but inconspicuous fire protection while enhancing the appearance of any school . . . when installed in partitions, skylights, stairwells, windows, doors, or wherever else fire and breakage protection is required. The versatility of Mississippi glass provides architects and engineers with a practical solution to virtually every daylighting problem, including safety with decoration, with heat absorption and with light diffusion and direction.

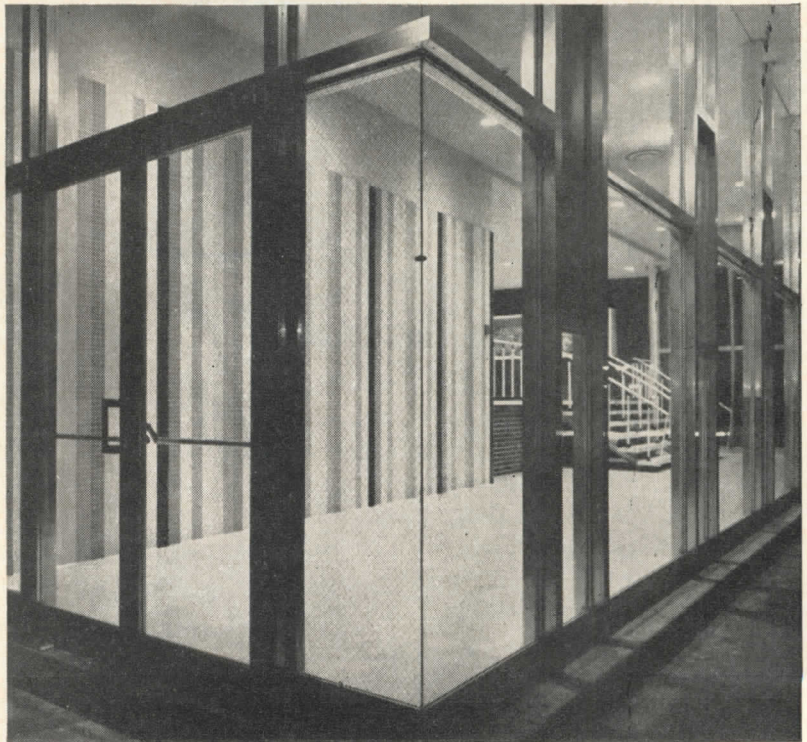

For details, see your nearby distributor of quality glass or write for latest catalog. Address Dept. 7.

Polished Misco Wire Glass glazed in main entrance of Hellertown High School, Hellertown, Pa. Architect—Heyl, Bond & Miller, Allentown, Pa. Contractor—Gottlieb-Schneider, Bethlehem, Pa. Glazing Contractor—Penn Allen Glass Company, Allentown, Pa.



**MISSISSIPPI  
GLASS COMPANY**

88 Angelica St. • St. Louis 7, Missouri

NEW YORK • CHICAGO • FULLERTON, CALIFORNIA



WORLD'S LARGEST MANUFACTURER OF ROLLED, FIGURED AND WIRED GLASS



**N.A.H.R.O. Gets Ford Grant For Urban Renewal Study**

A \$25,000 Ford Foundation grant has been awarded the National Association of Housing and Redevelopment Officials for the purpose of studying urban living and what is needed to strengthen the national urban renewal program. Selected to undertake the study is Dr. Constantinos A. Doxiadis, architect-engi-

neer-planner of Athens, Greece.

Mr. Doxiadis is trying to evolve a new "science of human settlements," which he calls *ekistics*. The principles of ekistics involve economic, sociological, geographic and technological influences on urban conditions.

The aim of the study is the formulation of principles and criteria for measuring performance that can serve American cities as long-term guides for renewal.

In announcing the Ford grant, N.A.H.R.O. President Charles L. Farris, executive director of the St. Louis and Land Clearance for Redevelopment Authorities, said, "Urban renewal . . . has arrived at a point where evaluation of goals and efforts are of great importance to the individual cities and their future. . . . To get the whole picture and set guidelines for the future, a complex of social, technical, and political factors affecting obsolescence of our cities must be appraised. This N.A.H.R.O. proposes to do with the aid of Dr. Doxiadis, who has made study and work with human environment his career."

**Stained Glass Association Holds Annual Meeting**

More than 125 persons attended the 51st annual conference of the Stained Glass Association of America, held in Cleveland.

One of the highlights of the meeting was a speech on "Symbolism" by Philadelphia architect Harold E. Wagoner. Participating in discussion panels on the subjects "What Makes for Good Stained Glass Design" and "Technical Aspects of Stained Glass with Emphasis on Faceted Glass" were Mr. Wagoner and Cleveland architect Anthony Cerisi, along with stained glass designers Orin Skinner, Henry Lee Willet, Robert Frei, Stephen Bridges, Bernard Gruenke, and Helen Hunt.

The following officers were elected: president, George D. Spiers of Payne-Spiers Studios, Patterson, N. J.; first vice president, Harold W. Cummings, Cummings Studios, San Francisco; and second vice president, Wilbur H. Burnham Jr., Burnham Studios, Boston.

A feature of the conference was the Apprentice Competition, which was open to all stained glass apprentices in the United States who had not completed their training before June 30, 1960. Seventeen apprentices submitted panels representing a wide variety of styles and techniques.

The judging committee included: Harold W. Cummings, S.G.A.A., San Francisco; Joseph McCullough, dean, Cleveland Institute of Art; Paul B. Metzler, art critic; John Riordan, S.G.A.A., Cincinnati; and

*continued on page 294*

**wherever appearance counts... the "slimline"**



**Autocall<sup>®</sup>**  
Type FA Fire Alarm Station  
is your logical choice

A local fire alarm station is an essential part of any fire alarm system. To perform its important function it must be quickly seen, readily recognized and easily operated. However, it need not project into hallways, office areas or lobbies, and with an Autocall FA Station it becomes an unobtrusive element in any architectural setting.

Autocall has taken the mechanism out of the hall and put it in the wall where it belongs. As a result, the new FA Station extends only 3/4" beyond the wall surface for the slimmest, newest profile of all fire alarm boxes, and its functional design makes it more compatible with its surroundings without losing its important identity.

**Autocall<sup>®</sup>**  
SAFEGUARDS MILLIONS

THE AUTOCALL COMPANY • SHELBY 1, OHIO • SALES OFFICES IN PRINCIPAL CITIES

**MAKE THIS PROFILE COMPARISON!**

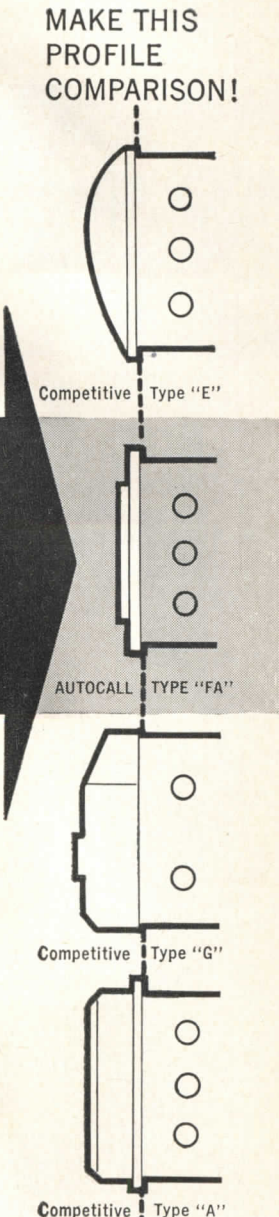

Competitive Type "E"

AUTOCALL TYPE "FA"

Competitive Type "G"

Competitive Type "A"

A coded station for use with fire alarm systems. Entire operating mechanism is sealed under glass.

For complete specifications, write:



Sound Solution to a Sound Problem:

# ALTEC SOUND SYSTEM

Specified for Civic Center,  
Lansing, Michigan

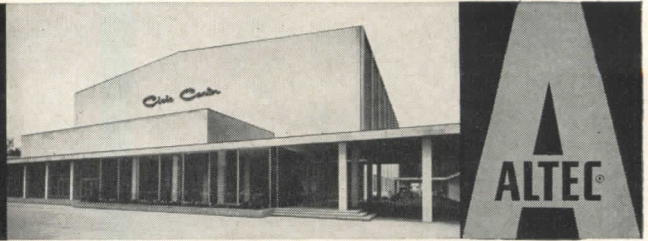

ALTEC Sound Contractor to the Civic Center: Tape Recording Industries, Lansing, Michigan

**CASE HISTORY FILE 60-86:** The Civic Center and its 6,000 seat auditorium is used for civic and social events as varied as boxing, stage shows, lectures, musicals, square dances, trade exhibits.

**SOUND PROBLEM:** The system selected had to have highest flexibility to serve the varied needs of this multi-purpose institution.

**SOUND SOLUTION BY ALTEC:** An all-ALTEC Sound System was installed. It provides highest fidelity for musicals, crisp reinforcement for speech, and a remarkable clarity that overcomes the high ambient noise levels of sporting events. And, ALTEC exceeded all competitive specifications while meeting competitive price!

**LET ALTEC HELP SOLVE YOUR SOUND PROBLEM:** Over several decades, ALTEC has specialized in quality sound equipment. ALTEC Engineered Sound Products—over 100 individual audio components—are known throughout the world for quality, dependability, ease of installation and operation.

Find out about the solution ALTEC offers your sound project, large or small, present or pending. Merely call the nearest ALTEC Sound Contractor (listed under "Public Address" in your Yellow Pages) or write Dept. AR-2. No obligation, of course.

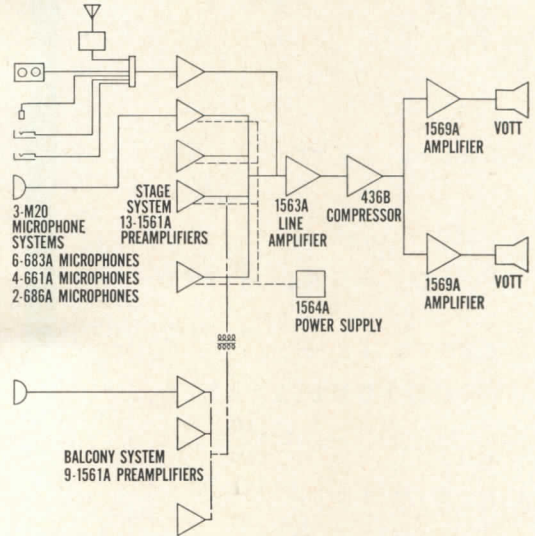

©1961 Altec Lansing Corporation



**ALTEC LANSING CORPORATION** A Subsidiary of Ling-Temco Electronics, Inc.  
1515 South Manchester Avenue, Anaheim, California • 161 Sixth Avenue, New York 13, New York

hpi means quality



## HARDWOOD PLYWOOD PANELING

The hpi seal guarantees that the plywood you specify has met the rigid testing and inspection of the Hardwood Plywood Institute—30% more exacting than Commercial Standard.



For more information  
about hardwood plywood  
or the Institute, write:

**HARDWOOD PLYWOOD INSTITUTE**

2310 South Walter Reed Drive, Arlington 6, Virginia

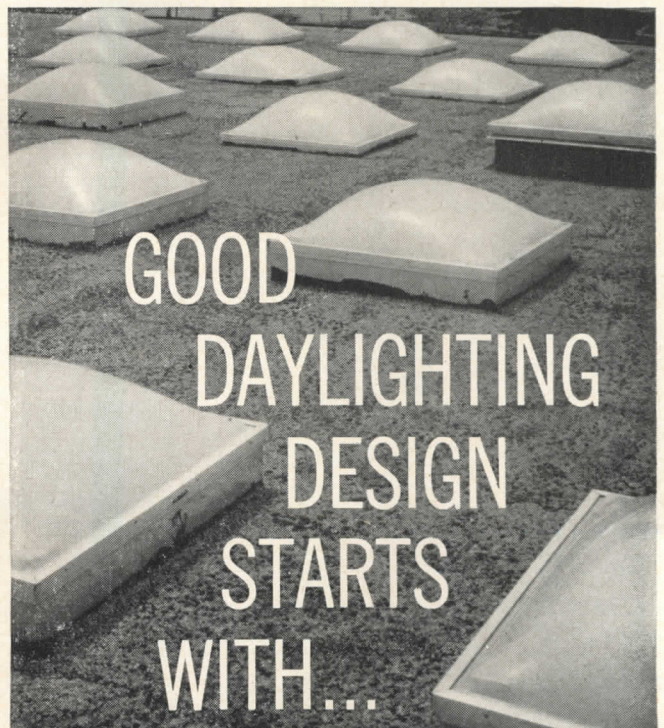

GOOD  
DAYLIGHTING  
DESIGN  
STARTS  
WITH...



**WASCO  
SKYDOMES**

WASCO PRODUCTS, INC., 5 BAY STATE ROAD, CAMBRIDGE 38, MASS.



*Weight?  
Measurements?  
Age?*

**STA-CRETE 15 —**

8 pounds=1 gallon  
400 square feet=1 gallon

**AGE—UNLIMITED**

**STA-CRETE 15 —**

**UNADULTERATED**

No Solvents — No Fillers

**STA-CRETE 15 —**

**AN EPOXY**

- that Bonds Concrete
- Waterproofs
- Resurfaces
- Decorates



STA-CRETE Inc.,  
115 New Montgomery,  
San Francisco 5, California

Name \_\_\_\_\_  
Address \_\_\_\_\_  
City \_\_\_\_\_  
State \_\_\_\_\_  
Position \_\_\_\_\_  
Company \_\_\_\_\_  
Phone \_\_\_\_\_  
P.S.

*You're an Estimator \* \*  
By accurately calculating the age,  
weight and measurements of our gal—  
a Sta 'N Play kit is yours.*

*The Record Reports*

**Study of Building Code Law**  
Published by N.A.H.B.—A.I.A.

The National Association of Home Builders now has approved, published and circulated in cooperation with the American Institute of Architects a comprehensive study of building codes. The title: "Survey of the Law of Building Codes."

The purpose of this first survey of its kind was to provide home contractors, architects, municipal officials and others interested with an understanding of the legal aspects of building codes and court decisions made in their enforcement. The document has been written for the legal layman, providing a general guide to the law of building codes in most common problem areas. Some of the subjects covered in the new study:

Police power of the state and its delegation; incorporation by reference; procedure for enforcement; limitation on discretion of administrative officials; procedures for administrative and judicial appeal from actions of administering officials; liability of municipalities and administering officials for malfeasance, misfeasance and nonfeasance in administration;

Rights, duties and liabilities of persons affected by building code regulations; validity of building code requirements in general under the test of reasonableness; validity of building code requirements as to materials, methods of construction, etc., under the test of reasonableness; building permit processes, validity of permit fees and revocation of permits; validity of inspection provisions; vagueness as a ground for invalidating building code provisions;

Affect on validity of building code as a whole of invalidating a part; applicability of municipal building codes to buildings erected by federal or state governments, or by other local governmental units; applicability of municipal building codes to buildings erected prior to code enactment; statutes of limitation as applied to building code violations, and applicability of building code regulations to mobile homes.

Author of the report is Charles S. Rhyne, a past president of the American Bar Association, and legal counsel for the National Institute of Municipal Law Officials.

**SOLVES**

**ALL**

**YOUR  
DOCK TO TRUCK  
LOADING PROBLEMS**

**DOCKBRIDGE EXTENDO-LIP**

**MOVES OUT 1 to 13 inches**

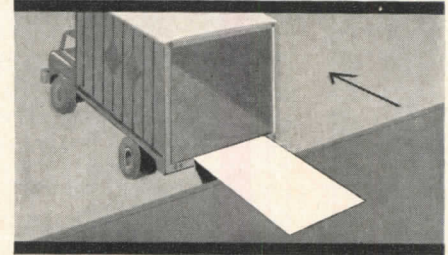

**MOVES UP 1 to 16 inches**

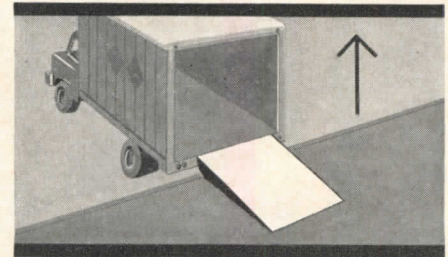

**MOVES DOWN 1 to 10 inches**

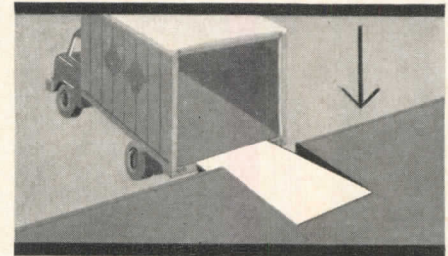

**CROSS-TRAFFIC, TOO!**

Dockbridge Extendo-Lip makes it easy to load and unload pallets at extreme edge of truck, even when truck is a foot away. Only 1 inch of lip need be on truck for full support. Self-contained packed unit, ready to install in prepared pit under 2 feet in depth, means fast low-cost installation in existing docks or new construction.

WRITE NOW FOR DETAILS



**AMERICAN DOCKBRIDGE, INC.**

**"BRIDGING THE GAP TO PROGRESS"**

241 W. Oklahoma Ave.  
Milwaukee 7, Wisconsin