

2 HAMMARSKJOLD PLAZA BY RAYMOND & RADO AND PARTNERS

A CREATIVE ARCHITECT TALKS ABOUT DEVELOPMENT HOUSING

TULANE MEDICAL CENTER: MASTER PLAN AND PHASE-ONE DESIGN BY CRS

BUILDING TYPES STUDY: PRESENT AND FUTURE TRENDS IN LIBRARY DESIGN

SYSTEMS APPROACH: WHAT IS IT REALLY ACCOMPLISHING?

FULL CONTENTS ON PAGES 4 AND 5



ARCHITECTURAL RECORD

APRIL 1973 **4** A MCGRAW-HILL PUBLICATION THREE DOLLARS PER COPY



The
first
step
takes
you
into
the
idea.

The floor is Imperial® Modern Excelon®. . .
in a spacious air terminal,
where passengers move into the 747
from a lounge built over the wing.

Here, design begins with room for movement.
The efficient, yet relaxed movement
of thousands of people a day.
And the design flows from a unified base
of color and style and serviceability: the floor.

Imperial Modern Excelon
helps coordinate design components,
helps coordinate exterior with interior
for a sense of "total architecture."
It's just one of the many Armstrong floors
available to help you bring
a design, a concept, an idea to life.

For assistance, or the
flooring information you may need,
please write us.
Armstrong, Lancaster, Pennsylvania 17604.

 **Armstrong**

For more data, circle 1 on inquiry card

A jewel box lights up the Tacoma night.

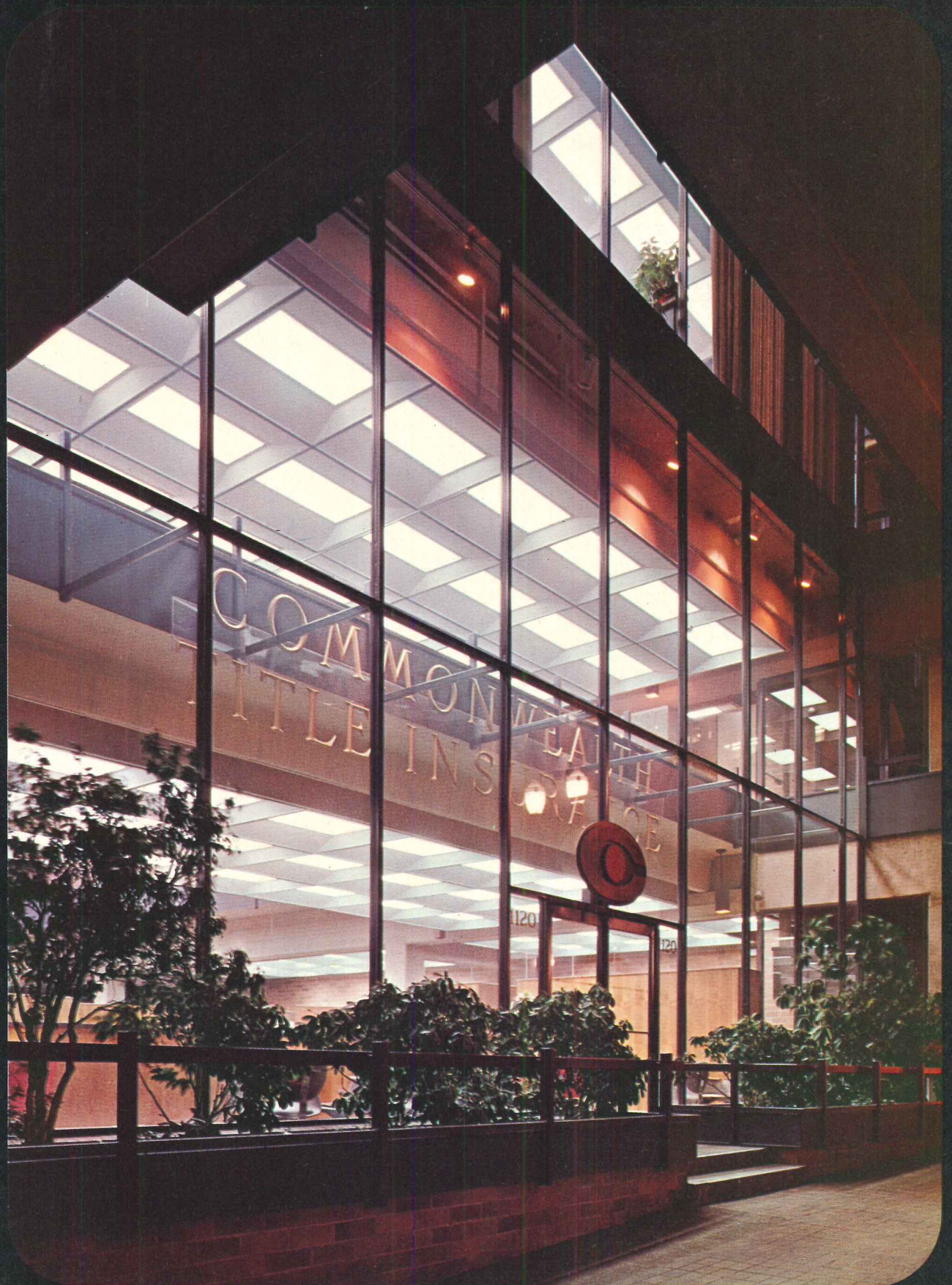

And architect
Robert Evans
uses the Armstrong
C-60/60 Luminaire
Ceiling System to
achieve the effect.

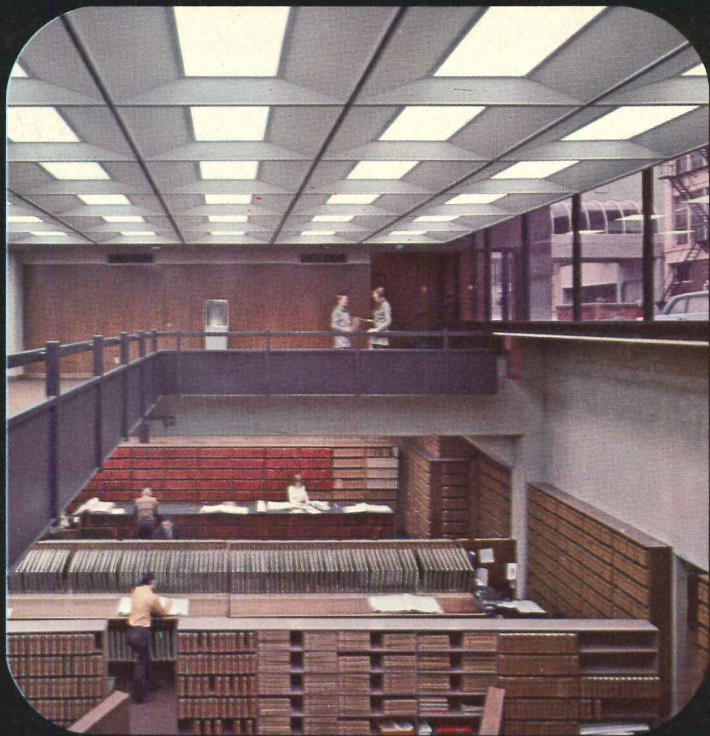

You look up from the street at the high ceiling of the new headquarters for the Commonwealth Title Insurance Company in Tacoma, and it glows at you.

And when you're working inside, going over figures in fine print, the 2' x 4' lighting fixtures light up the pages, with a maintained level of 125 footcandles for close work without eye strain.

But the Armstrong Luminaire Ceiling System provides more than light. As its name suggests, it also provides air. And it does it artfully — you don't see any ugly grilles or hardware in the coffered ceiling, since the air is diffused through Supply-Air Linear Diffusers in the grid.

Aesthetics and practicality. They are two good reasons why Robert Evans chose the Armstrong C-60/60 Luminaire Ceiling System for the first multistory building to go up in downtown Tacoma in six years.

For more information about Armstrong Luminaire and other Ceiling Systems That Work, write today to Armstrong, 4204 Rock Street, Lancaster, Pa. 17604, or call your Armstrong representative. In Canada, write Armstrong Cork Canada, P.O. Box 919, Montreal 101, Quebec.

Commonwealth Title Insurance Company
Building, Tacoma, Washington
Architect: Robert W. Evans, Tacoma
Associated Architect: Robert H. Eyre, Seattle
General Contractor: KAM Construction, Inc.,
Tacoma
Mechanical/Electrical Engineers: Arnold N.
Bogue & Associates, Tacoma
Ceiling Systems Contractor: Tacoma Asbestos
Company, Tacoma

FROM THE  INDOOR WORLD® OF

Armstrong

For more data, circle 2 on inquiry card



Cover: Hammarckjold Plaza office building and sculpture gardens, New York, New York. Architects: Raymond & Rado & Partners. Sculptor: Alexander Liberman

EDITOR

WALTER F. WAGNER, JR., AIA

MANAGING EDITOR

HERBERT L. SMITH, JR., AIA

SENIOR EDITORS

ROBERT E. FISCHER
WILLIAM B. FOXHALL
MILDRED F. SCHMERTZ, AIA
ELISABETH KENDALL THOMPSON, FAIA

WASHINGTON EDITOR

ERNEST MICKEL, Hon. AIA

ASSOCIATE EDITORS

BARCLAY F. GORDON
CHARLES E. HAMLIN
JAMES D. MORGAN, AIA

ASSISTANT EDITORS

GERALD ALLEN
ANNETTE K. NETBURN

DESIGN

ALEX H. STILLANO, Director
ALBERTO BUCCHIANERI, Associate
ANNA-MARIA EGGER, Assistant
MURIEL CUTTRELL, Illustration
J. DYCK FLEDDERUS, Illustration
JAN WHITE, Consultant

EDITORIAL CONSULTANTS

EDWARD LARRABEE BARNES, FAIA
ROBERT F. HASTINGS, FAIA
PAUL RUDOLPH, FAIA

INDUSTRY CONSULTANT

GEORGE A. CHRISTIE, JR., Economics

McGRAW-HILL WORLD NEWS

WALTER A. STANBURY, Director
20 domestic and
international news bureaus

PUBLISHER

BLAKE HUGHES

SALES MANAGER

LOUIS F. KUTSCHER

CIRCULATION MANAGER

HUGH S. DONLAN

THE RECORD REPORTS

9 Editorial

San Francisco as an urban caution, or how many pyramids can one city take?

33 News in brief

Short items of major national interest as well as award-winners and announcements.

36 News reports

AIA convention program detailed, honors announced. Women in architecture find discrepancies in status and pay. U. S. Army unveils new concept in barracks. Senate approves road funds for mass transit. Johns-Manville announces design competition. Manufactured housing producers in New York claim state hampers the industry.

41 Buildings in the news

The Mayor's Merchant's Assistance Program, Detroit. United Missouri Bank Towers, Kansas City, Childrens' playground, Nassau County, New York. Pine Grove Junior High School, Baltimore. Architecture buildings at: University of Southwestern Louisiana, University of Michigan, Ball State University. Design Center Studios, Denver. Downtown Manhattan High School, New York City (below).

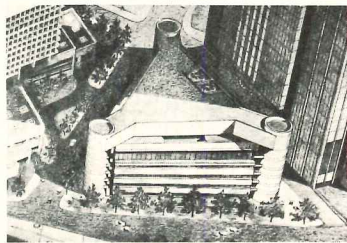

70 Required reading

ARCHITECTURAL BUSINESS

55 Whatever happened to Standard Form 251?

The progressive modification, bureau by bureau, of the standard U.S. Government form for A/E prequalification has opened up opportunities for individual amplification, but it has also introduced problems of special cases overlaid on an original intent to standardize. Gerre Jones, whose January article on Form 251 got unusual response, takes up the variations and their impact on the professions.

59 F. W. Dodge Construction outlook 1973: first update

George Christie takes another look at projected construction activity to sharpen focus on the effects of the shifting economic scene upon various categories of construction.

64 Indexes and indicators

GSA defines a professional role for value engineering.



ARCHITECTURAL RECORD (Combined with AMERICAN ARCHITECT, ARCHITECTURE and WESTERN ARCHITECT AND ENGINEER) April 1973, Vol. 153, No. 4. Title ® reg. in U.S. Patent Office © copyright 1973 by McGraw-Hill, Inc. All rights reserved. Copyright not claimed on four-color illustrations on front cover and on pages 105, 107 and 112. Indexed in Reader's Guide to Periodical Literature, Art Index, Applied Science and Technology Index, Engineering Index, and The Architectural Index. Published monthly except May and October when semi-monthly, by McGraw-Hill, Inc. Quotations on reprints of articles available. Every possible effort will be made to return material submitted for possible publication (if accompanied by stamped, addressed envelope), but the editors and the corporation will not be responsible for loss or damage. EXECUTIVE, EDITORIAL, CIRCULATION AND ADVERTISING OF-

FICES: 1221 Avenue of the Americas, New York, N.Y. 10020. Other Editorial Offices: 425 Battery Street, San Francisco, Cal. 94111; 1249 National Press Building, Washington, D.C. 20004. PUBLICATION OFFICE: 1221 Avenue of the Americas, New York, New York 10020. Second class postage paid at New York, New York 10001 and at additional mailing offices. OFFICERS OF McGRAW-HILL PUBLICATIONS COMPANY: John R. Emery, president; J. Elton Tuohig, senior vice-president—services: David J. McGrath, group vice president; vice presidents: Ralph Blackburn, circulation; John R. Callahan, editorial; John B. Hoglund, controller; David G. Jensen, manufacturing; Jerome D. Luntz, planning & development; Joseph C. Page, marketing; Robert M. Wilhelmy, finance. CORPORATION OFFICES: Shelton Fisher, president; Wallace F.

FEATURES

105 New delights for Hammar skjold Plaza

New York's ceremonial approach to the United Nations has two quietly elegant new buildings which abound with urban amenities and pleasures.

111 How to work with developers—and actually enjoy it (a case history)

Louis Sauer Associates has produced a wide variety of housing types in recent years, working with developers in most cases. His observations on the topic make interesting—and sometimes unsettling—reading.

137 Modular Theater for California Institute of the Arts, Valencia, California

Theater consultant Jules Fisher has designed a practical and economical teaching theater based on four integrated systems: adjustable modular floor, walls, lighting and hoists.

141 Master plan for total service at Tulane University Medical Center

CRS has mastered the complex forces of a dynamic client, the programming input of sophisticated consultants, and the politico-medical forces inherent in a multi-institutional urban enclave in a master plan and first-phase building design that has examples for everyone.

145 The Becker house

For a site in eastern Long Island, an area that was once duck farms and potato fields, architect Norman Jaffe has designed a strongly muscled residence that dominates its site and raises important questions both structural and esthetic.

BUILDING TYPES STUDY 446

119 Present and future trends in the design of public and college libraries

Three small public libraries and two major university facilities represent some of the best work currently being done in this field. They are followed by a discussion of predictable, yet dramatic, technological developments which will soon require from architects a radically different design approach.

120 Sherborn Library, Sherborn, Massachusetts
by James A. S. Walker

122 Farmington Public Library, Farmington, Michigan
by Tarapata MacMahon Paulsen Corporation

124 Greenburgh Public Library, Greenburgh, New York
by Max O. Urbahn Associates, Inc.

126 The Joseph Regenstein Library, The University of Chicago, Chicago, Illinois
by Skidmore, Owings & Merrill



Ezra Stoller © ESTO

130 Brown Sciences Library, Brown University, Providence, Rhode Island
by Warner Burns Toan Lunde

134 Communications technology and its implications for library design
A look to the future, by senior editor Mildred F. Schmertz

ARCHITECTURAL ENGINEERING

149 Student housing built by three methods in New Jersey program

High-rise precast construction, factory-built modules, and on-site construction were the responses from developers and manufacturers to invitations to bid on high- and low-rise housing for five campuses. Architects Ewing, Cole, Erdman & Eubank administered the program—developing a series of performance specifications to serve as the bidding documents.



Robert E. Fischer

- 157 Product Reports
- 190 Office Literature
- 215 Personal Business
- 233 A/E Update
- 238 Record Impressions
- 240 Classified Advertising
- 242 Advertising Index
- 245 Reader Service Inquiry Card

Traendly, group president—McGraw-Hill Publications Company and McGraw-Hill Information Systems Company; John J. Cooke, senior vice president and secretary; Ralph S. Webb, treasurer.
SUBSCRIPTIONS: Subscriptions solicited only from architects and engineers. Position, firm connection, and type of firm must be indicated on subscription orders; CHANGE OF ADDRESS or subscription service letters should be forwarded to Fulfillment Manager, ARCHITECTURAL RECORD, P.O. Box 430, Hightstown, N.J. 08520. Provide old and new addresses, zip code or postal zone number. If possible, attach issue address label. Annual subscription prices: U.S., U.S. possessions and Canada: \$9.50 for architects, engineers and other individuals in the fields served, all others \$20.00. Other countries: \$22.00 to architects, engineers; others \$30.00. Single copies \$3.00. GUARANTEE: Publisher agrees to refund that part of subscription price

applying to unfiled part of subscription if service is unsatisfactory. ASSOCIATED SERVICES/McGraw-Hill Information Systems Co.: Sweet's Catalog Files (Architectural, Light Construction, Interior Design, Industrial Construction, Plant Engineering, Canadian Construction), Dodge Building Cost Services, Dodge Reports and Bulletins, Dodge/SCAN Microfilm Systems, Dodge Management Control Service, Dodge Construction Statistics, Dodge regional construction newspapers (Chicago, Denver, Los Angeles, San Francisco). THIS ISSUE is published in national and separate editions. Additional pages of separate edition numbered or allowed for as follows: Western Section 32-1 through 32-4. POSTMASTER: Please send form 3579 to Fulfillment Manager, ARCHITECTURAL RECORD, P.O. Box 430, Hightstown, N.J. 08520.







Reveal[®] Wall System[™]

is a flexible, interchangeable system of components designed by John Nance

Wall elements may be easily regrouped at any time to fit new requirements.

The baseboard raceway carries separate channels for electrical and telephone wiring and provides access at any point on either side.

At each wall panel juncture there is a hook-in standard. Brackets may be inserted at any height to support desk tops, shelves and storage components.

Interior designer, Ann Hartman
Washington, D.C.

JG JG Furniture Company Inc.
Quakertown, Pa. 18951
Telephone 215 536-7343

For more data, circle 3 on inquiry card



The fake McCoy.

Koroseal® wall coverings capture the look of nature and help you create almost any feeling in any room with any room setting.

Choose the look of weathered barn siding with *Planks* and have the versatility of colors like Shiloh, Tombstone Gap, Bonanza, Cheyenne, Desert Sand, Pine Bluff, Dry Gulch and Dodge City.

Or choose the look of split cork, burlap, bamboo, stone, straw, leather, marble. 40 patterns and over 500 colors

in all to let you have more freedom than even Mother Nature will allow.

Specify Koroseal with Tedlar® and you'll get an extra plus: it'll never stain. Even grease, lipstick and ballpoint ink will wipe right off. And all Koroseal wall coverings are fire rated.

So consider Koroseal for your next job.

It looks so real it's a natural for anything you've got in mind.

No foolin'.

See our insert in Sweet's Architectural and Interior Design catalogs for the name of your nearest Koroseal distributor. He has a Koroseal Color Coordinator waiting for you.

B.F. Goodrich General Products Co., Akron, Ohio 44318.



San Francisco as an urban caution, or how many pyramids can one city take?

The editorial this month has been written by Betty Thompson, RECORD senior editor, long-time Bay Area resident, and surely one of the people most in love with San Francisco. With the AIA convention convening in that lovely city next month, I thought it important to let someone who knows the city well talk about it—especially the changes, which to many are shocking. To help you think about those changes, here are Betty's thoughts.—Walter F. Wagner, Jr.

Like many other cities, San Francisco—where AIA will hold its annual convention next month—has had a building boom, but San Francisco shows the effects of its boom in ways quite different from other cities. The city's location on a peninsula, for one thing, with the bay on one side and the ocean on the other, and its hilly terrain, make it the most visible of cities, and the most vulnerable. In the 13 years since AIA last met in San Francisco, much has been done to change the aspect of the city. The topography survives and, thanks to it, the city's sense of place.

Seen from the two bridges that connect it with the north and the east, however, the new skyline is overwhelming, especially to those who remember the old. The line of low hills on which the downtown is built used to be clearly discernible in the undulation of the old skyline. Now the sheer number of buildings, each trying for optimum return and for an assertive identity, concentrated in a relatively small area, has altered this, making all buildings seem to rise from the same flat plain.

But to comprehend the dimensions of change in The City—its name to all Bay Area residents—you must walk among the new buildings and discern for yourself what other changes have occurred and determine what has been good, and what bad—and most of all, what part architecture has played in achieving either.

Some of San Francisco's landmarks are undeniably good, and tell their urban tale well:

- Ghiradelli Square and its neighbor, The Cannery, and the adjacent Victorian Park with the cable car turnaround;
- A remodeled brewery warehouse, One Jackson Square on Battery Street, across from the Golden Gateway apartment buildings;

- Golden Gateway itself, and its park, which honest appraisal must admit to being the country's most successful redevelopment project in terms of urban design;

- The Alcoa Building and its sculpture gardens and fountain plaza;

- Jackson Square, the City's first designated historic district, a surprising survival of small-scale buildings in the midst of a great deal of new high-rise construction;

- The low-income housing in the Western Addition redevelopment area, scaled for people and designed with their needs in mind (and how rare that is!);

- St. Mary's Cathedral, whose superb interior is a masterpiece of contemporary design, successfully integrating architecture and structure.

There would be little argument over these as definitive contributions to the fabric of the city and its quality of delight which has always been high. But San Francisco would not be itself if it did not suggest some controversy. It always has done this, and it no doubt always will. Height and size have been the most recent elements of controversy—they led only a year or so ago to an election measure which would have severely limited height throughout the city had it passed—but this observer submits that it is scale that bids fair to be the most serious issue now confronting The City.

Four new buildings and five older ones, all located in one section of the city, make up the textbook, but your feet must provide the mobile classroom:

- Transamerica's 50-story, 853-foot-high "Pyramid" and its neighbor, the Chinese Cultural Center (and Holiday Inn), and its pedestrian bridge to Portsmouth Square and Chinatown, inject an entirely new scale at street level. The first does it with huge trusses, the second

with a sloping base. It is not a matter of form; though the pyramid makes that an issue as well, and one that will have to be considered in relation to future development. One pyramid may be assimilable; but what if there are others? At street level, and on the street, however, it is the scale of the human experience in man-created space that is now different from what it used to be.

- Security Pacific Building (One Embarcadero Center), the 45-story first building in the four-building Embarcadero Center complex, is a new approach to handling the base of a tall building—a response to earlier criticism, deserved or not, of the use of the Alcoa and Golden Gateway bases for parking. Security Pacific's base is made up of three levels of shops, entered from a low, open-sided and, for the most part covered concourse, announced on the street elevations by projecting panels and "people scoops." Above its base, the office tower is a series of flat slabs that add up to a commendably thin building (east-to-west view), and has been locally nicknamed "Rockefeller Center West."

- That the new scale is not a matter of size and bulk is clear from the biggest of all the new buildings, the Bank of America World Headquarters, for at street level this 52-story, 772-foot building which looms so large on the skyline has scale which is simultaneously monumental and clearly related to human beings, and its grace and elegance of detail further enhance its human scale.

Contrast these new buildings with some of the older ones—Crown Zellerbach, John Hancock and Bank of California, and with the scale and openness of Golden Gateway and Alcoa plazas, and it is clear that an important change is taking place. How much further it will go is impossible to predict, but it is something for all who design in the fabric of cities to see and to ponder.

Future shocks have emanated from the West before, and this might just be another. If you have any doubt of this possibility, raise your eyes to the topmost hills of San Francisco's horizon and drink in the scale of the 980-foot television tower on Mount Sutro. It took everyone by surprise, but there it is, a daily lesson in urban esthetics.

—Elisabeth K. Thompson



"Good god—it seeds itself!"

Alan Dunn (see above) wins the AIA's Architecture Critic's Citation

The "cartoon" above is the latest in a series that began in the June 1937 issue of the RECORD. As Herb Smith wrote for the inside cover of Mr. Dunn's newest book, "Architecture Observed," one of the best times we have each month around the editorial office is the arrival of Alan Dunn's ideas, sketches or roughs, "from among which a few are, with delightful difficulty, selected for publication." The news from AIA that Mr. Dunn has been named to receive the 1973 Architecture Critic's Citation for his book of 140 cartoons, harvested from those we have been privileged to publish for some 36 years, is wonderful news. I put the word "cartoon" in quotes at the head of this article, for all of us around here think second of Mr. Dunn as a "cartoonist"—and think first of him a serious, knowledgeable, and effective architectural critic who happens to use humor and a rare skill as an artist as his means of communication.

Mr. Dunn, congratulations on this new honor. We couldn't love you any more than we have for years . . . but we're very happy to see you get this new and prestigious recognition.

A new book about the new exams: how to pass, how to think about it

As everyone knows by now, the National Council of Architectural Registration Boards has been working for six years to modernize the examination process that stands between an architectural graduate and his license. That process has not proceeded without controversy—for while the new registration procedure has overwhelming support within NCARB, it is viewed by some with deep concern. Nonetheless, the first professional examination under the new format will be given in December.

There's a book about to be published that should be of real interest to candidates for the exam and to practitioners, whether they're for or agin' or somewhere between. The book is being jointly published by NCARB and ARCHITECTURAL RECORD. I see no point in trying to improve on the description of the book

presented in the last NCARB Newsletter, and herewith quote freely from it:

" . . . the book has been designed to serve a two-fold purpose. A primary objective will be to help prepare candidates for the Mark I version of the new Professional Exam, as well as to acquaint them with the philosophy and specific aims behind the six-year effort to modernize the examination process.

"A second purpose is directed toward the entire profession; NCARB believes that architects in practice both in the U.S. and abroad will benefit from this first Handbook in what is expected to be a series offered annually during the next few years. Each volume will review the substance of the exam for the previous year, together with what NCARB hopes will be a growing body of information elicited from exam candidates and from the profession in general concerning all three steps in the practitioner's career—education, training, and professional practice"

Well, enough. We thought it a critically important book and are proud to be part of it. If I've talked you into wanting a copy, details for ordering are on page 212.

About Federal design: We can't improve if we don't even try . . .

As you read this, the First Federal Design Assembly will have been held—an effort by professionals to convince Federal agency heads that good design is important—and show them what it is. Further, Miss Nancy Hanks has established—through the National Endowment for the Arts, of which she is the able chairman—a task force to reexamine and (presumably) reinstate in some form "The Guiding Principles for Federal Architecture," that much-admired directive given by President Kennedy to Karel Yasko of GSA, used by him as an effective tool, but since discarded.

There's been a lot of pessimism about these efforts. As Miss Hanks said in a speech following a press conference on Federal design: "The reporters, many of whom I know well and all of whom I respect, got a collective glassy eye of skepticism. They simply did not believe that we can improve Federal design. As one of the

staff members of the Endowment noted wryly, 'We have six people running around Washington beating drums and trying to make the Federal bureaucracy think it is surrounded.'"

Well, there is skepticism, And it is well founded. As Ada Louise Huxtable said in *The New York Times*: "One has the feeling that there will be a lot of eloquent talk and examples at the top . . . and business as usual at the bottom."

"The reason" she points out accurately, "is inescapable. Basically, Federal building is parceled out as patronage and pork barrel The Federal Design Assembly is not going to do much to change or challenge the habits of Congressmen or the way architects are selected and construction contracts made. . . ." She concludes: "Politics and good design do not make bedfellows of any sort at all, and eventually politics wins, hands down. There will be good talk in Washington. And bad design, forever."

As much as I respect the quality of Mrs. Huxtable's thinking and writing, I can't agree with her conclusion (unless of course—old journalistic ploy!—she's trying to stir up the bad guys so they'll act like good guys just to show her). I've been honored to be made a member of the "Guiding Principles" Task Force, and so can report (though it would be premature to say much more about that group's processes at this very early stage) that there was no one at the meeting, including the representatives of our government, who didn't understand very clearly the devastating role that "politics" has played in architect selection. I can promise everyone that that problem will receive deep and sophisticated discussion. Whether it can be licked, of course, still remains to be seen—but if it isn't, it won't be for lack of trying.

I may be a patsy, but I tend to agree with Miss Hanks that most agencies want to do a better job of design but just don't know how. The task force members combine enough experience, I think, to be aware of most of the road blocks. There's a feeling of optimism in the air. There's a small light suggesting that some people in Washington do care. Let's keep trying!

—Walter F. Wagner, Jr.

The beautiful new lavatory that works beautifully!

Duramel. The material we spent seven years developing.
Now available in our new 19" Contura™ Lavatory.

This beauty travels light, arrives on the job chip free and ready for quick installation. Comes in any of 12 American-Standard colors, including white. All fade-resistant and scorch-proof.

Once installed, the happy owner can look forward to years of rust-free, stain-resistant service.

Want to solve all your bathroom problems? Ask us. We've been coming up with the answers for over 100 years.

For any further information, please write to American-Standard, Plumbing/Heating, P.O. Box 2003, New Brunswick, New Jersey 08903.

Made from Duramel™ The high performance material.

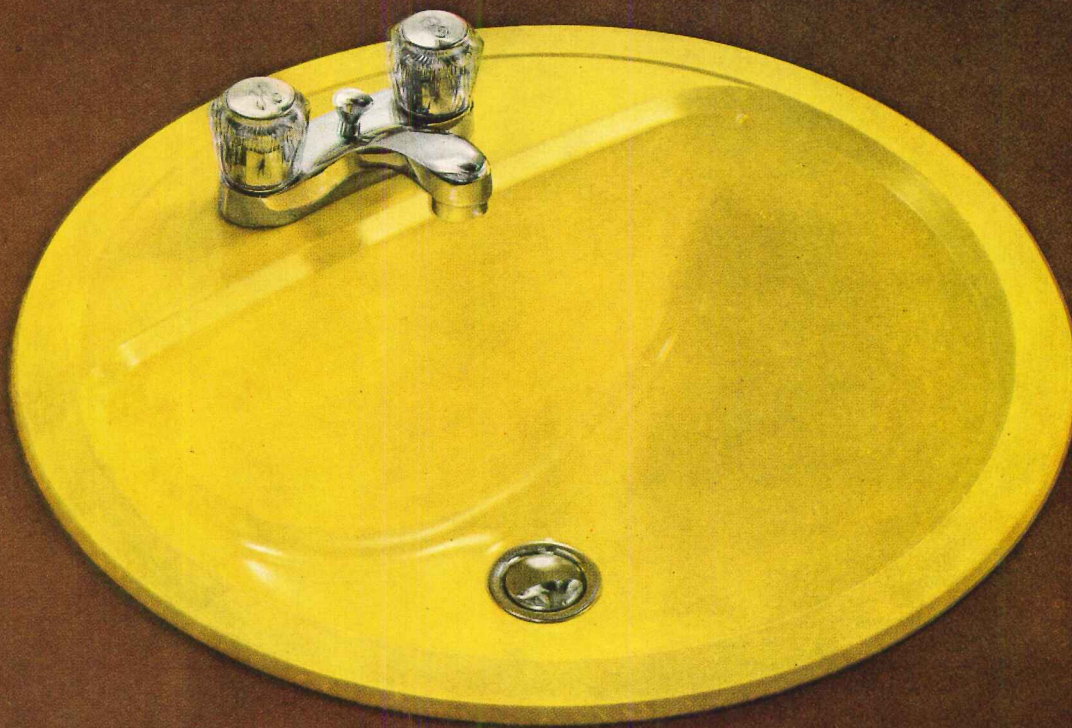

The Contura™ self-rimming lavatory

12 new decorator colors



For beautiful fixtures that work beautifully.

For more data, circle 5 on inquiry card

GRANGE HALL
136
1898

— THE HOME OF —
WETHERSFIELD GRANGE
NO. 114
MEETINGS... 2ND & 4TH TUESDAYS
AT 8 P. M.





Built 75 years ago at a total cost of \$5,000, Wethersfield, Connecticut's Grange Hall is still a focal point of community action in this historic Connecticut River town. And the mortise lock is the same Sargent hardware specified in the building's original plans.

**Consider the doors
equipped with
Sargent hardware.**

**Still proud doors.
Still proud hardware.**



 **SARGENT®**
Designers of fine doorware since 1864.

Sargent & Company • New Haven, Connecticut 06509 •
In Canada, Sargent & Company (Canada) Ltd.

For more data, circle 6 on inquiry card

The Celotex line.

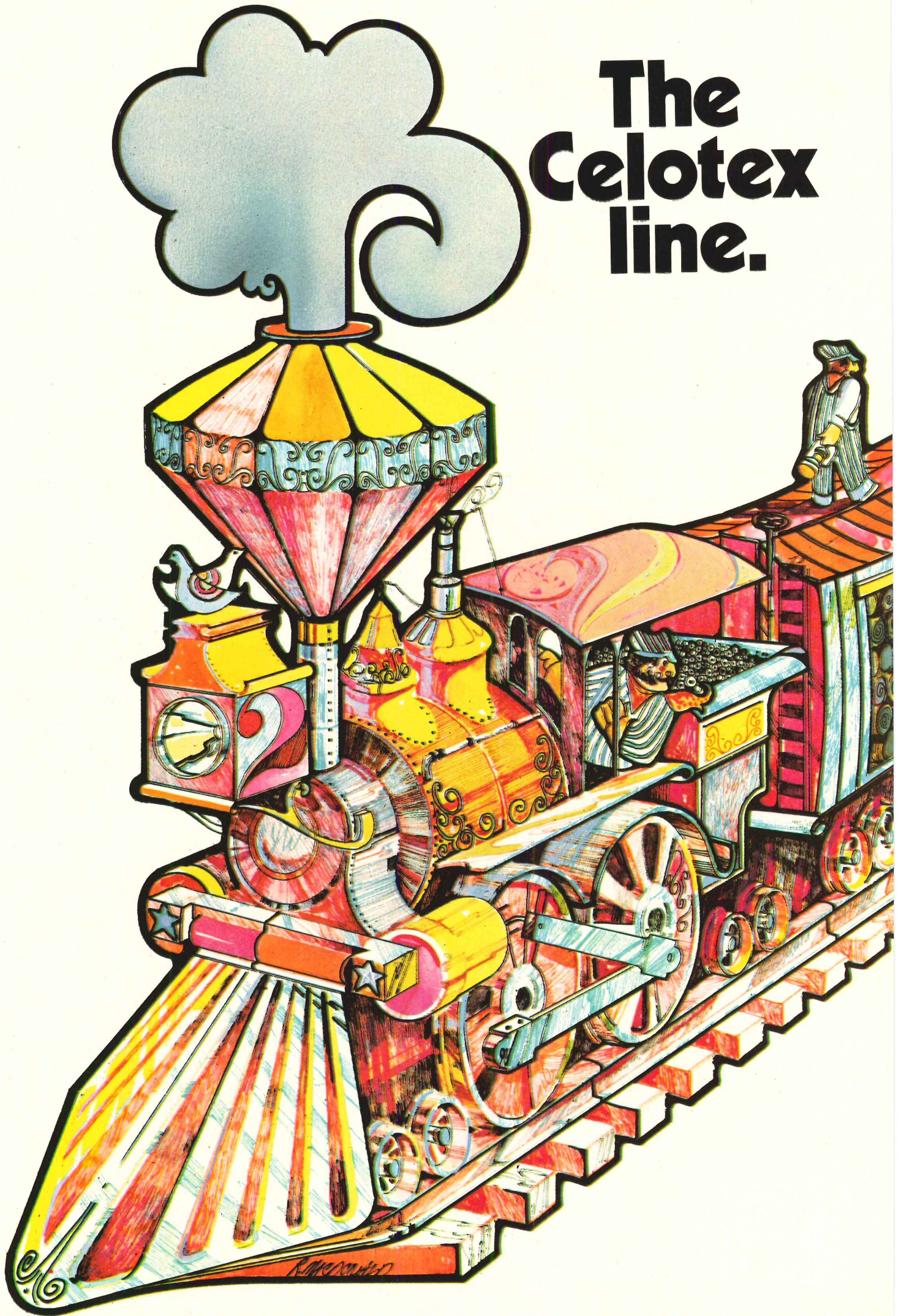

It's an almost never-ending line. Constantly moving. Constantly growing. No wonder. With over 4500 different building products more people are using more building products, from the Celotex line. The one company which can supply most all your needs. And see that you're put on the right track.

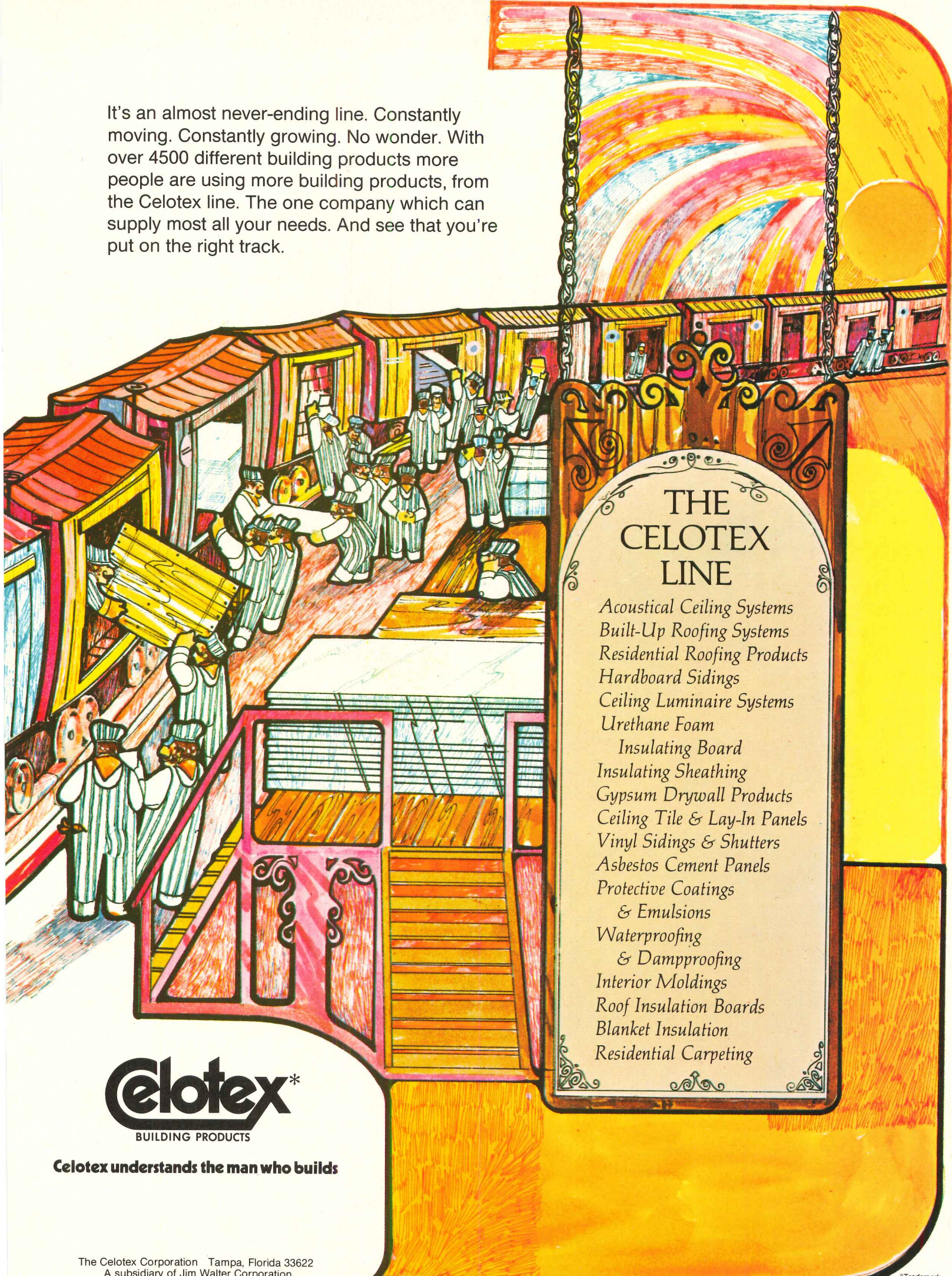

THE CELOTEX LINE

Acoustical Ceiling Systems
Built-Up Roofing Systems
Residential Roofing Products
Hardboard Sidings
Ceiling Luminaire Systems
Urethane Foam
Insulating Board
Insulating Sheathing
Gypsum Drywall Products
Ceiling Tile & Lay-In Panels
Vinyl Sidings & Shutters
Asbestos Cement Panels
Protective Coatings
& Emulsions
Waterproofing
& Dampproofing
Interior Moldings
Roof Insulation Boards
Blanket Insulation
Residential Carpeting

Celotex*
BUILDING PRODUCTS

Celotex understands the man who builds

The Celotex Corporation Tampa, Florida 33622
A subsidiary of Jim Walter Corporation

*Trademark

For more data, circle 7 on inquiry card



Andersen Perma-Shield®... because people have more important things to take care of than windows.

Building: Children's Home of Pittsburgh.
Architect: Franklin, Douden & Associates, Pittsburgh, Pa.
Builder: Navarro Corporation, Pittsburgh, Pa.

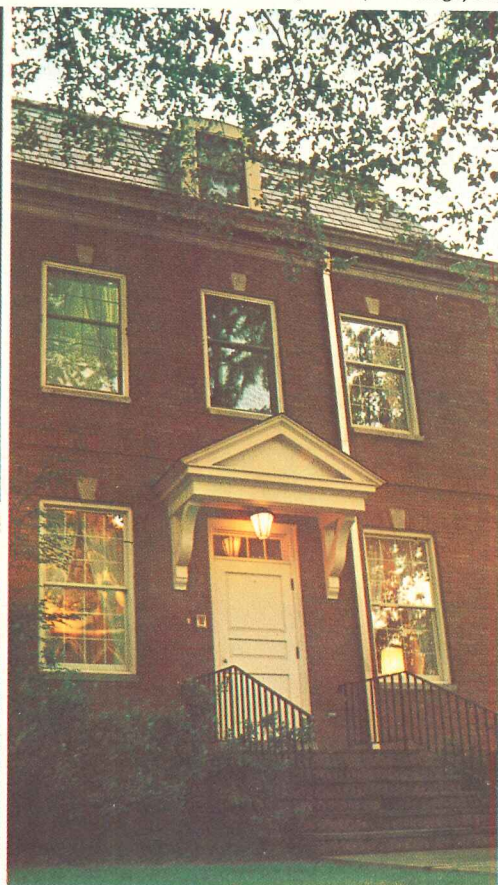
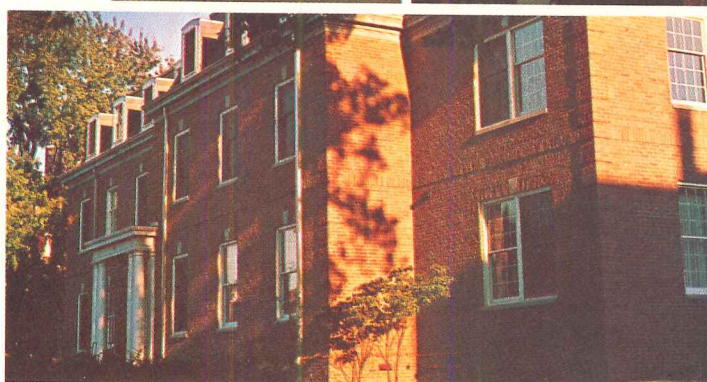

The Children's Home of Pittsburgh staff has more important things to take care of than windows.

That's why the architect specified Andersen Perma-Shield® Narroline® double-hung windows in his design of the adoption agency's new building.

He liked the way Perma-Shield Narroline windows provided traditional beauty without the traditional bother... at a traditionally reasonable price.

All window surfaces exposed to weather (except the sash) are enclosed in a sheath of tough, durable, attractive vinyl that won't rust, pit or corrode.

Unlike ordinary wood windows, Perma-Shield can be easily hosed clean with water. In fact, a "rain wash" will rinse away most common dirt.

Narroline's wood sash is protected by a special patented 4-step factory finishing process that won't chip, crack or peel, or require painting for at least 10 years.

Heating and cooling costs are reduced substantially, too... thanks to Andersen's close-fitting tolerances and double pane insulating glass.

Staff and babies are draft-free and comfortable year-round.

If your people have more important things to take care of than windows, specify Andersen Perma-Shield Narroline double-hung windows. Or any one of the Perma-Shield family.

For further details, see your Andersen dealer or distributor. He's in the Yellow Pages under "Windows, Wood." Or check your Sweet's File (Sections 8.16An. and 8.6/An.) or write us direct.

Andersen Windowalls®
ANDERSEN CORPORATION BAYPORT, MINNESOTA 55003



New information on plywood building systems and design.

For free books, use Reader Service Card.

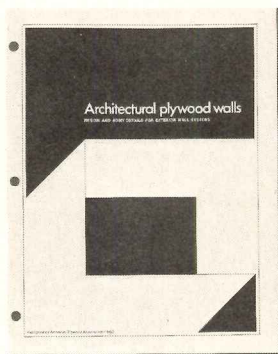

Architectural Plywood Details. New book showing 10 unique ways to handle plywood exteriors. Innovative treatment of walls, joints, corners, windows, doors and sills. All using conventional materials. Rendering and details of each concept, plus a listing of 38 joint details. A designer's book.

Circle Reader Service No. 10

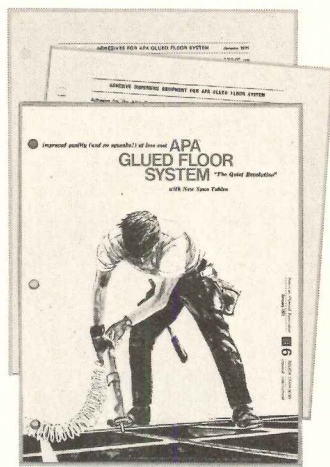

APA® Glued Floor System Package. New information on the no-squeak, no nail pop, no callback floor. Six new span tables. Application sequence. Cost comparison examples. Materials recommendations. Lists of glue manufacturers and equipment suppliers.

Circle Reader Service No. 12

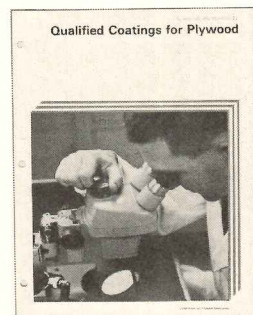

Plywood Coatings Package. All about plywood coatings: durability — weathertight coatings; uses — exteriors, interiors, roofs, decks; appearances — textured, colorfast surfaces; application — chemically coated and overlaid plywoods; and testing.

Circle Reader Service No. 14

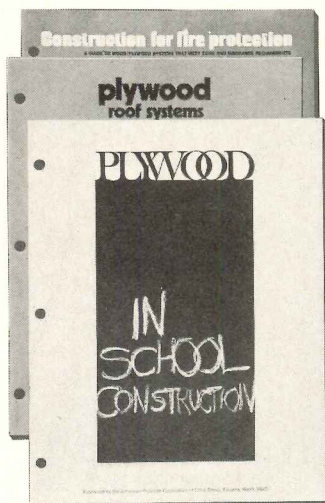

New Plywood Package: Schools, Roof Systems and Fire Protection. Includes a 22-page booklet on permanent, temporary and relocatable school buildings. A booklet on 7 proven plywood systems. And *Construction for Fire Protection*, a 32-page guide on wood/plywood systems that meet code and insurance requirements.

Circle Reader Service No. 11

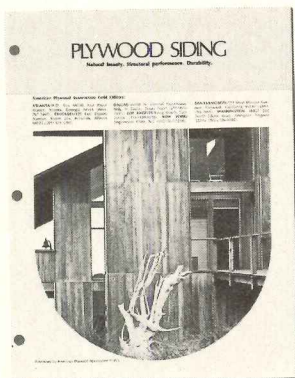

Plywood Siding. New full-color 16-page book on mostly multifamily and commercial siding examples. A few new ideas. Like diagonal application of Texture 1-11. Also color closeups of different plywood textures. Other information: Double-Wall, Single-Wall, Soffit, Shear Wall, and a good section on finishing.

Circle Reader Service No. 13

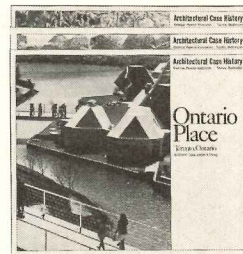

New Architectural Case Histories. Eight 4-Page Case Histories on Recent Plywood Design Innovations. 1. Ontario Place. 2. Bahia: A Waterfront Community. 3. Resort in a Park. 4. Boston Field House. 5. Modular Dorms; 6. Corte Madera Library; 7. Fiasco Restaurant; 8. Reedland Woods School.

Circle Reader Service No. 15

For free booklets, use Reader Service Card. For more information about plywood and other plywood publications, check your Sweet's Architectural File or write American Plywood Association, Dept. AR-043, 1119 "A" Street, Tacoma, WA 98401. Or get in touch with one of the American Plywood Association field service representatives. Offices: Tacoma, Atlanta, Chicago, Dallas, Los Angeles, San Francisco, Washington, D.C.

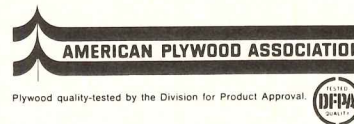

One of a series presented by members of the American Wood Council.

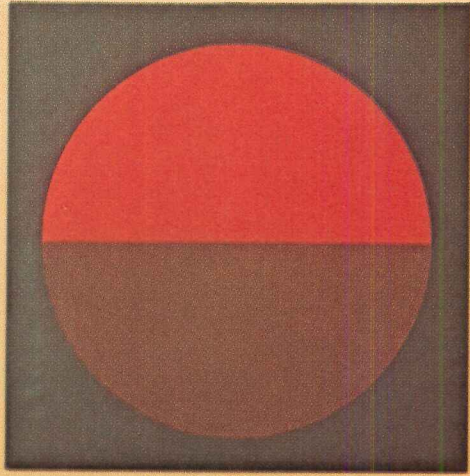

discover Cramer...

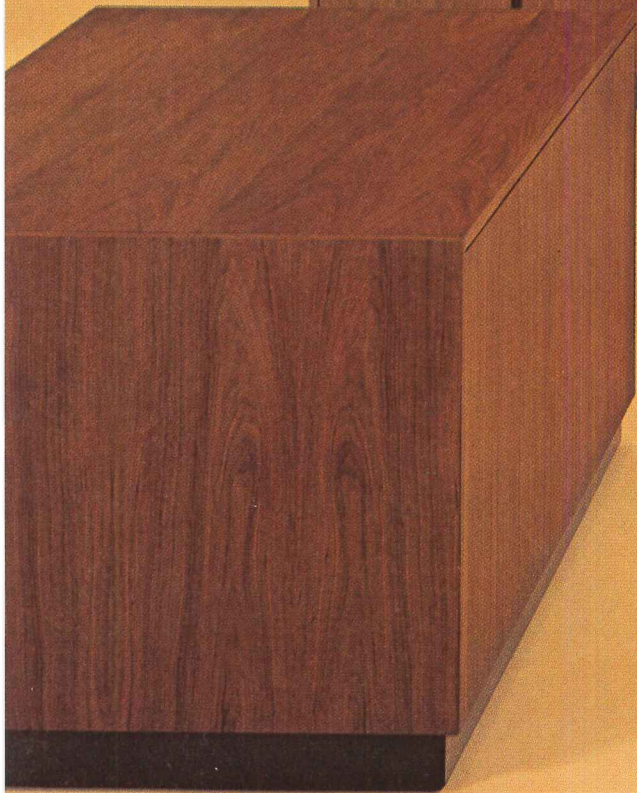
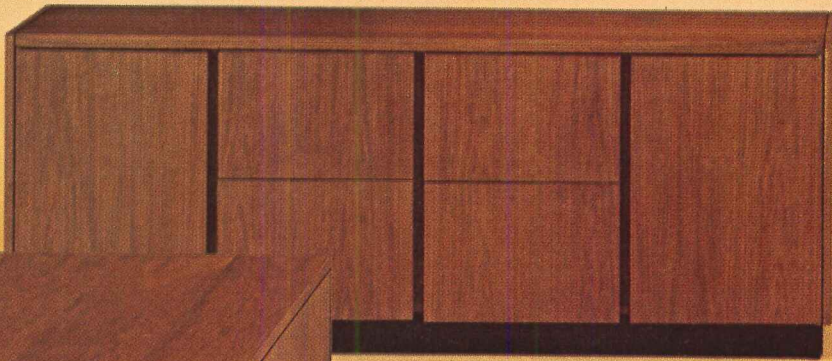

and you discover a choice

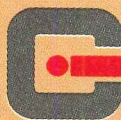

CRAMER INDUSTRIES INC.

625 Adams Street, Kansas City, Kansas 66105 Ph. (913) 621-6700

Showrooms in Chicago, Dallas, Kansas City, Los Angeles

Westwood Illustrated. Discover Cramer's full lines of wood, metal, fiberglass office furniture. Write for information.

For more data, circle 9 on inquiry card

Theme Tower.
Sculptor: Aristides Demetrios, San Francisco.
Owner: Cabot, Cabot & Forbes, South San Francisco.

Sculptor: Masao Kinoshita (of Sasaki, Dawson,
DeMay Associates), Watertown, Massachusetts.
Owner: Governmental Civic Center, State of New
York, Broome County, and City of Binghamton.

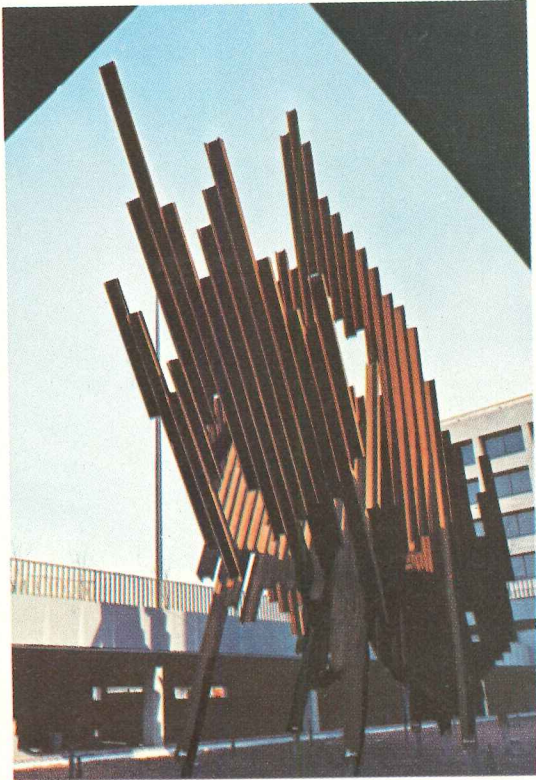

Interior, pre-weathered sculpture.
Sculptor: William Leizman, Baltimore.
Owner: City of Baltimore, Department of
Education, Rognell Heights Elementary School.



Sculptures in Weathering Steel

Sculptor: Michael Bigger, Providence.
Owner: Biological Society of Cincinnati.

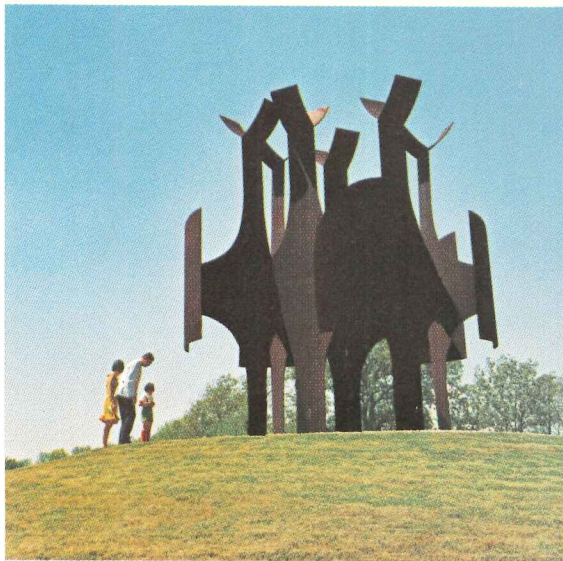

Architects have long been aware of the aesthetic values of Bethlehem's Mayari R Weathering Steel. The rich, earthy beauty of this material exposed, weathered, and textured can be seen in hundreds of unpainted applications for buildings, bridges, and other structures.

Architecture and art often go hand in hand, so it is not surprising that artists have found Weathering Steel ideal as a medium for sculpture.

With the passage of time, the color of Weathering Steel's oxide coating changes from a "rusty" red-orange to a dark, rich purple-brown. The moderately rough texture becomes more emphasized as the coating thickens and minimizes further oxidation. Over years of atmospheric exposure, the steel weathers into a distinctive and attractive texture and tone.

Weathering Steel can be ideal for sculpture.

But you don't have to be an artist to use it creatively in a building or a bridge. Why not express your own design in Weathering Steel?

Before you try Mayari R, ask for our Booklet 2781 which contains information on the consideration of staining, fabricating, and product and quantity availability in the use of Weathering Steel. Bethlehem Steel Corporation, Bethlehem, PA 18016.



Sculptor: Larry Griffis, Jr., Buffalo.
Owner: Ashford Hollow Foundation, Buffalo.

Bethlehem 

SkyCab GUARANTEES YOUR PACKAGE DOOR-TO-DOOR: New York-Chicago, 6 HRS; Chicago-Los Angeles, 8 HRS; Los Angeles-New York, 10 HRS...

Ship ad materials, films, blueprints, engravings, samples—practically anything, anywhere today!

SkyCab is ready to deliver your package to and from anyone, anywhere in over 18,000 U.S. cities and towns today.

Each SkyCab trip is a special express just for you—there's no faster way to get a package from one place to another, unless you take it yourself (even then, SkyCab might

win). One call to our toll-free number does it all.

SkyCab is a unique marriage of a nationwide fleet of high-speed taxis with the fully-computerized facilities of one of the world's largest air freight systems.

Call now—SkyCab is ready.



Your package flies as *passenger* baggage, not cargo. It's picked up within 30 minutes of flight arrival by another SkyCab agent who takes it directly and immediately to its destination. Instant proof of delivery available.

2

1 One toll-free call brings your SkyCab agent to your door. He'll take your package directly to a flight already assigned by SkyCab's computerized control.

3

Delivery to your addressee's hands within specified time limits is **guaranteed**, or you get half your money back. (Maximum package limits: 90 inches aggregate dimensions and 50 pounds.)

ONE CALL DOES IT ALL. 800-257-7888

In New Jersey, call 800-322-8600. In Alaska and Hawaii, call collect 609-424-5353.

SkyCab is a service of Shulman Air Freight

© Copyright 1973

For more data, circle 16 on inquiry card

Goodyear's Speedramp System can help you get self-service shopping off the ground floor.



The future of self-service shopping is looking up. And down.

To other levels of your store or shopping center.

Speedramp® passenger conveyor systems from Goodyear are changing a lot of concepts about self-service.

The Speedramp unit offers a continuous surface that easily accepts shopping carts as well as shoppers. Carts with grooved wheels (our special Cart-Lock feature) are secured to the ramp in transit, then released automatically.

And there you have it. Self-service shopping off the ground floor and up and down to other levels in your store or center.

Find out more today about economical, versatile Speedramp systems and the exclusive Cart-Lock feature. Just write to Goodyear, Transport Systems, Box 52, Akron, Ohio 44309.

GOODYEAR
TRANSPORT SYSTEMS

For more data, circle 17 on inquiry card

Percepta™ Convertible Coffers.

Designed for visual comfort.

And styled for visual appeal.



For design flexibility, the PERCEPTA Convertible Coffer can be installed with ceiling tile side panels (above), or matte white or black panels (below).

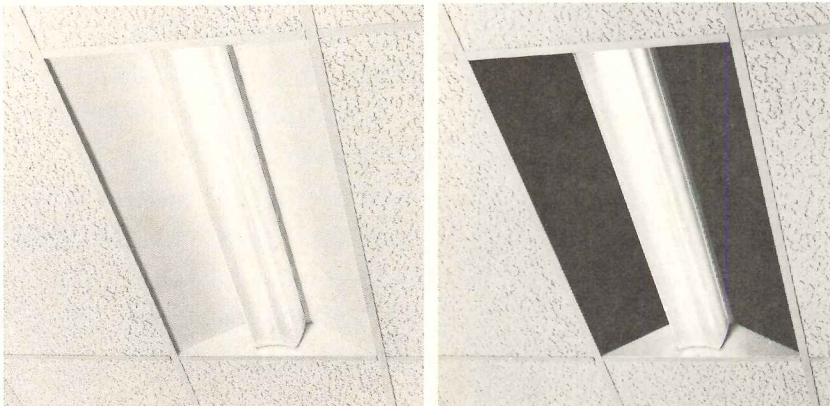

The introduction of PERCEPTA by Holophane brought an important new advance to lighting. A luminaire that eliminates veiling reflections (reflected glare). And thereby improves task seeability in places where eyes work the hardest. Schools. Offices. Libraries. Computer centers.

And with PERCEPTA, fewer lamps are needed to produce the required "effective" footcandles (E.S.I.). So your electric power and air conditioning requirements are substantially reduced, decreasing your operating costs and conserving energy resources.

Until now, PERCEPTA has been available only for surface-mounted applications.

But now you can have all the PERCEPTA benefits in a recessed unit as beautiful as it is effective.

You can even use it as a design element!

Install it in suspended ceilings with optional matte white or black metal side panels. Or paint the panels any color you wish. Or use ceiling tile instead. No matter which you choose, the glare-free light distribution is unaffected.

You can also choose between 430 and 800 ma luminaires to meet your specific lighting needs. Both are available in recessed or surface-mounted PERCEPTA units.

Highest visual comfort. Unusual flexibility. Lower power consumption. PERCEPTA Convertible Coffer offers all three.

Your local Holophane sales engineer has all the details on PERCEPTA and our other indoor and outdoor lighting products. Call him. Or write Dept. AR-4, Holophane Co., Inc., Montvale, N.J. 07645.

CONVENTIONAL LIGHTING

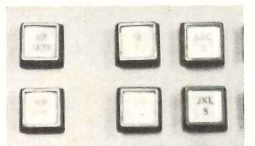
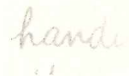

PERCEPTA LIGHTING

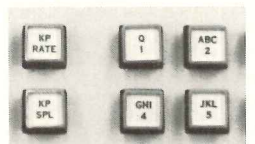

Unretouched photos of typical reading tasks: handwriting and keyboard. Conventional luminaires reflect light into viewer's eyes, producing veiling reflections. The unique PERCEPTA prismatic design virtually eliminates veiling reflections.

Holophane®
A Johns-Manville Company

For more data, circle 18 on inquiry card

DON'T PLAY WITH FIRE.

CCC's New Naturalweave spongebonded carpet has a Class "A" Flamespread rating.

If you're looking at carpet for an office building and it doesn't have a Class "A" flamespread rating—25 or less in the Steiner Tunnel Test—you may be playing with fire. The danger of fire always exists, that's why fire safety standards are becoming more and more stringent. At CCC, we know all about fire safety. We've become experts, because we've installed millions of yards of carpet in offices, hospitals, schools and stores.

Since fire safety is a major concern to us, we've just introduced a fire-retardant, spongebonded carpet with a Class "A" flamespread rating. We call it NATURALWEAVE FLAMEGARD and it meets *all* governmental flamespread standards.

NATURALWEAVE FLAMEGARD is an addition to our heavy duty Densylon Carpet series. It has a five-year wear guarantee and is made of tightly-twisted, densely-packed ANSO nylon bonded to B. F. GOODRICH fire-retardant sponge rubber cushioning. This built-in cushion extends the carpet's wear-life by one-third compared to carpet without padding. It's

guaranteed not to lose resiliency, enhances the carpet's appearance retention, reduces leg fatigue and increases floor safety. Among its other benefits, NATURALWEAVE contains a static control system, is easy to clean and keep clean, and helps cut maintenance costs.

But you get more than just superior carpet from CCC. We're the largest manufacturer of commercial and institutional carpet systems in the country. With CCC, you get SINGLE SOURCE RESPONSIBILITY for every aspect of your carpet projects anywhere in the country, starting with product selection and guaranteed installation through a comprehensive maintenance program that gives you maximum carpet wear-life at minimum life cycle cost. We even know how to effectively integrate carpet with subfloor access systems and can show you how it's done with trench headerducts and handhole covers.

For more information, just fill out the coupon below. CCC's NATURALWEAVE FLAMEGARD...THE SPONGEBONDED CARPET WITH A CLASS "A" RATING.

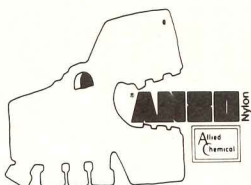
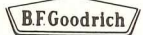

**Not just carpet,
but complete
carpet systems.**

Chicago:
Merchandise Mart (312) 321-0803
Los Angeles:
8899 Beverly Blvd. (213) 274-8171

For more data, circle 19 on inquiry card

About 4,000 gallons worth! To seal the joints of pre-cast masonry sections and thousands of glass walls and windows in the new Transamerica Pyramid soaring 48 stories above the streets of San Francisco.

These LP polysulfide base sealants will provide lasting protection against sun, wind and rain. Assure unbroken adhesion and flexibility despite temperature extremes and structural movement. We're sure of it because they bear the famous Thiokol Seal of Security.

To merit the Seal, sealants must meet

LP[®] polysulfide base sealants used all the way up.

exacting standards. And always be subject to laboratory testing to see that they maintain those standards. No approved sealant has ever failed on the job.

LP polysulfide polymers are just a few of the many products made by our Chemical Division. For aircraft, automobiles, buses, trucks and trains. For joint and window sealants, insulating glass. For gaskets, seals, printing rollers, hose and industrial tires.

Would you like more information? Write Thiokol Chemical Corporation, Chemical Division, Trenton, N.J. 08607.

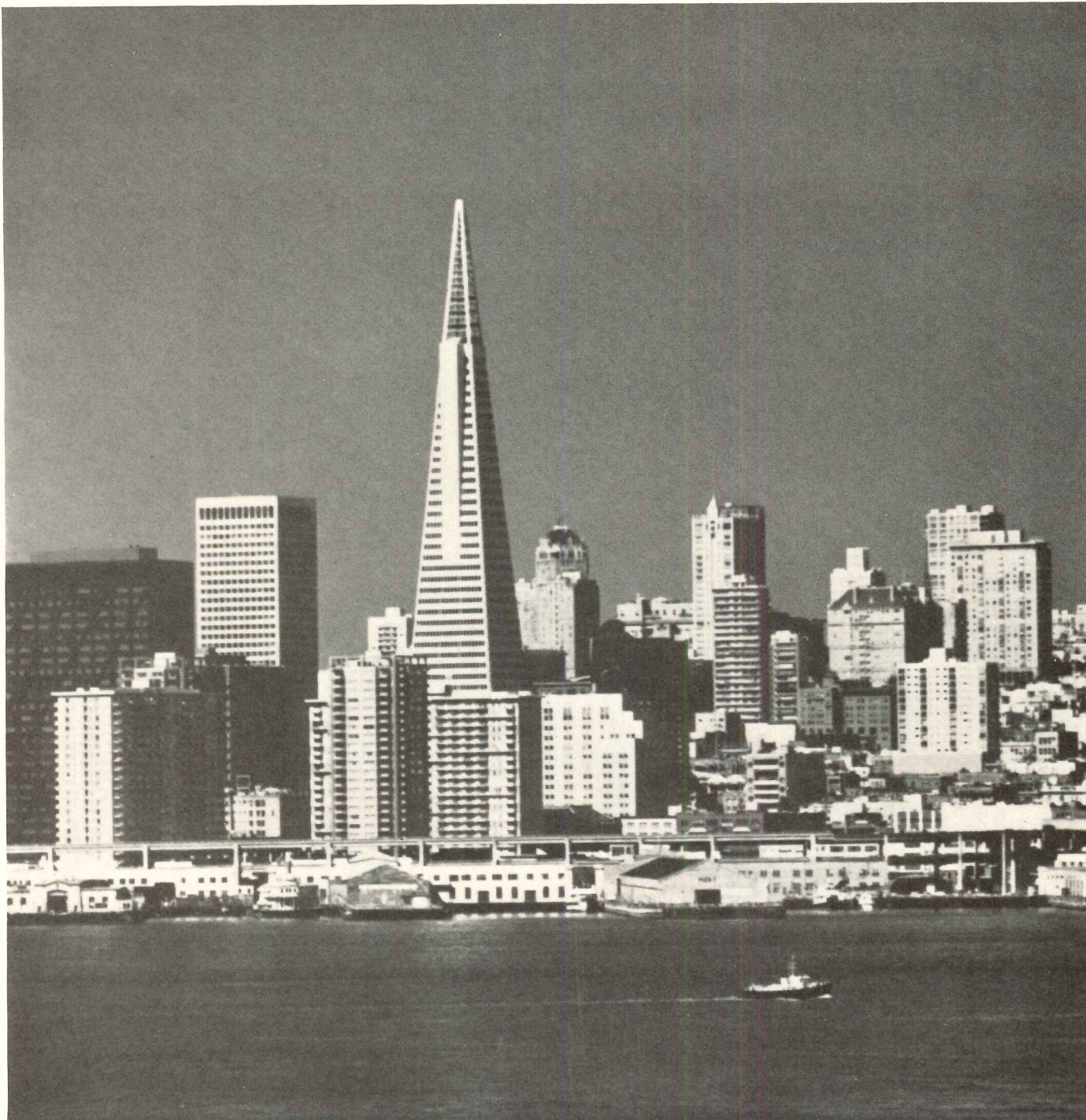

Thiokol

*Specialty Polymers • Off-The-Road Vehicles • Synthetic Fibers • Sprayers • Propulsion • Human Development
Friction Materials and Laminates • Pyrotechnics • Closures • Rubber and Rubber Chemicals • Medical Electronics Equipment*

For more data, circle 20 on inquiry card

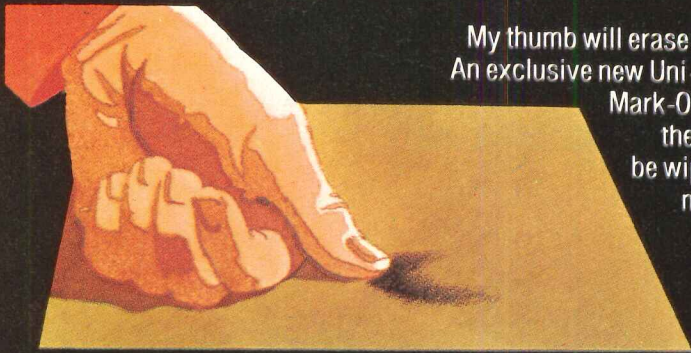

My thumb will erase this black heel mark. An exclusive new Uni-Turf® coating called Mark-Off keeps grime above the surface where it can be wiped away. That's low maintenance. It's part of every Uni-Turf installation. And only Uni-Turf.

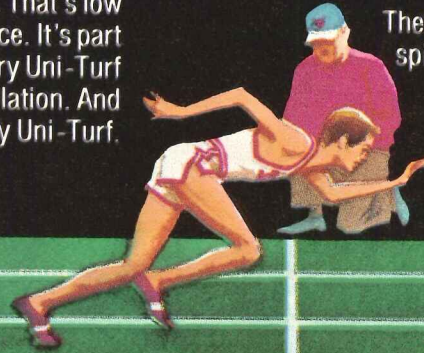

The track team is wearing spikes. It's okay though, because Uni-Turf is made of durable vinyl plastic to take that kind of punishment.

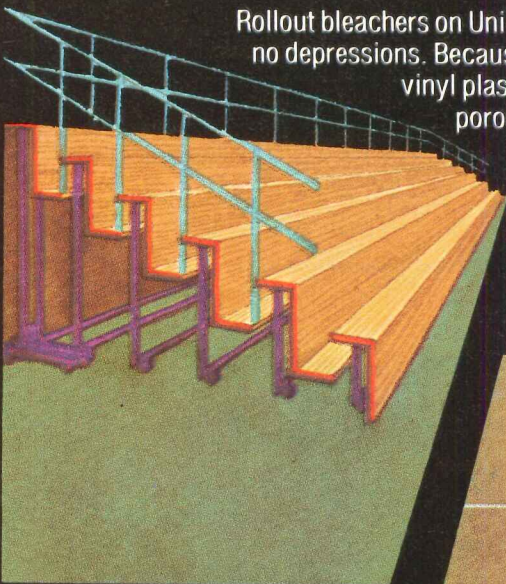

Rollout bleachers on Uni-Turf . . . no wheel marks, no depressions. Because it's an extremely dense vinyl plastic material. And it's non-porous . . . no stains, no warp.

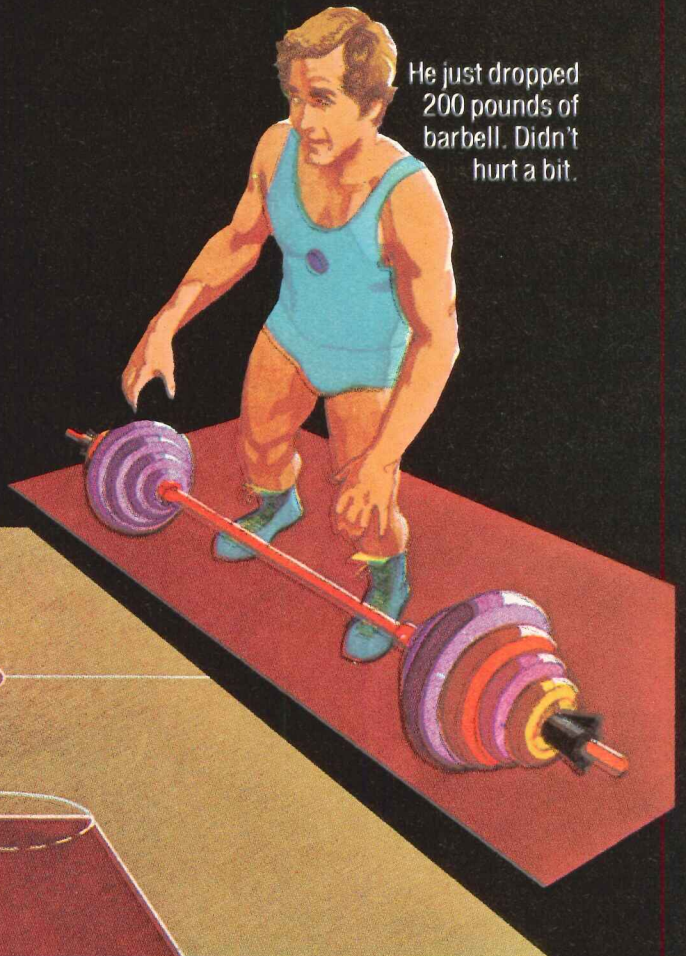

He just dropped 200 pounds of barbell. Didn't hurt a bit.

We make Uni-Turf in two different textures and five colors. So you can make the play any way you want . . . design-wise.

Nobody leaves his mark on Uni-Turf®

Tell me about Uni-Turf for use in —

- Field Houses Tracks Have representative call
 Gyms Tennis Other _____

NAME _____ TITLE _____

COMPANY/INSTITUTION _____

ADDRESS _____

CITY _____ STATE _____ ZIP _____

UNI-TURF®
 Sports Surfaces Department
 American Biltrite Rubber Co., Inc.
 P. O. Box 1071 Boston, Mass. 02103

The Wilson Art Look in laminated plastics.

Your ideas and our ideas look great, together!

In a retail sales environment, the emphasis is on smart, appealing good looks, long-lasting durability that needs little or no maintenance, and a tasteful blending of pattern, color and function to set the mood for sales.

When these are the performance requirements, the Wilson Art Look in laminated plastics helps you control design integrity.

Because the Wilson Art Look is the look of coordinated design — from walls to doors, from furniture to fixtures!

WILSON WALL PANELING SYSTEMS

Four distinctive systems to choose from, including a hidden aluminum molding V-Groove system (#310, featured here), a standard V-Groove system, a reveal system and a Class 1A fire hazard classification system utilizing acrylic-coated aluminum moldings. All panels are surfaced with Wilson Art laminated plastics — over 150 woodgrains and solids to choose from.

DOR-SURF® DOOR FACING

Doors surfaced with 1/8" thick Dor-Surf (Wilson Art laminated plastic door facing) are exceptionally im-

pact and abrasion resistant, and totally coordinated with other Wilson Art surfaces.

WILSON ART LAMINATED PLASTIC

Furniture and fixtures surfaced with Wilson Art laminated plastic complete the coordinate look. Choose from a wide variety of woodgrains, solids and patterns and an outstanding selection of finishes, including true dimensionals that look as great as they feel!

Simplify. Specify the Wilson Art Look — where your ideas and our ideas do look great, together!

For additional information, contact the Wilson Art Architectural Design Representative nearest you today:

- Atlanta 404-377-0731
- Chicago 312-437-1500
- Los Angeles 213-723-8961
- Miami 305-822-5140
- New Jersey 609-662-4747
- New York 212-933-1035
- San Francisco 415-782-6055
- Seattle 206-228-1300
- Temple, Texas 817-778-2711

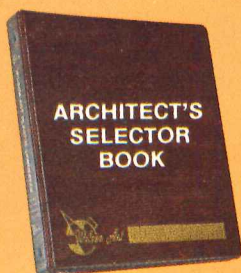
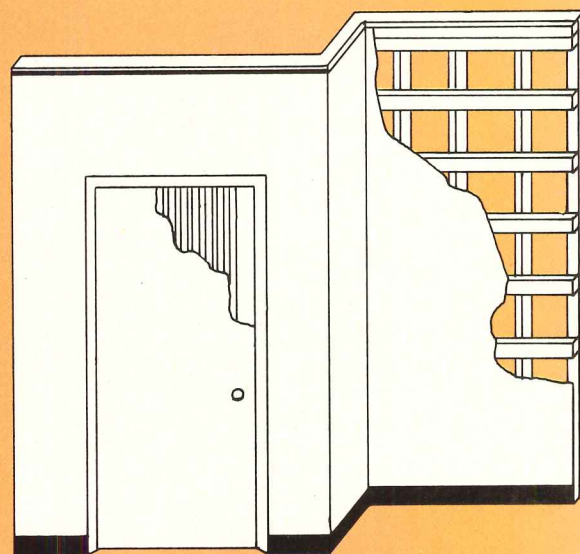
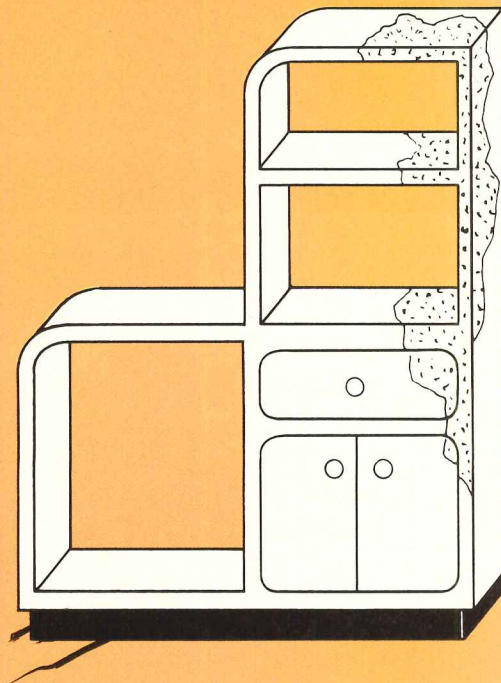

WRITE FOR THESE DESIGN AIDS:

WILSON ART Architectural Laminate Selector Books featuring Chips of Wilson Art woodgrains, solids and patterns. Contact your Wilson Art Architectural representative for your copy or write for prompt delivery.

Spec Data Sheets for: Wilson Art laminated plastics, Wilson Wall Paneling systems and Dor Surf door-facing material featuring 1/8" Wilson Art laminated plastic.



For more data, circle 22 on inquiry card

When the chips are down, you can depend on Wilson Art!



RALPH WILSON PLASTICS COMPANY ARCHITECTURAL PRODUCTS DIVISION TEMPLE, TEXAS DART INDUSTRIES INC.

Boutique

WILSONWALL PANELING SYSTEM 310

DOR-SURF
DOOR
FACING
MATERIAL

WILSON ART
LAMINATED PLASTIC

When the chips are down, you can depend on Wilson Art!



RALPH WILSON PLASTICS COMPANY ARCHITECTURAL PRODUCTS DIVISION TEMPLE, TEXAS
DART INDUSTRIES INC.

Don't overdraw. Use these Kodak shortcuts:

The snappy restoration shortcut.

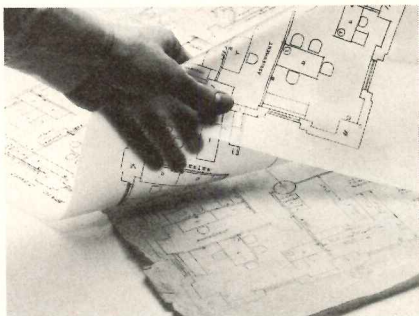

Why waste time retracing your old, battered drawings? Restore them by making sharp, clean photographic reproductions on Kodagraph film. Weak lines come back strong and clear. Stains virtually disappear. And instead of gray lines on yellow, you'll have snappy, contrasty, black-on-white prints.

The drop-of-water shortcut.

Why retrace the whole design for a few revisions? Just

order a second original on Kodagraph wash-off film. Then use a drop of water and erase unwanted details.

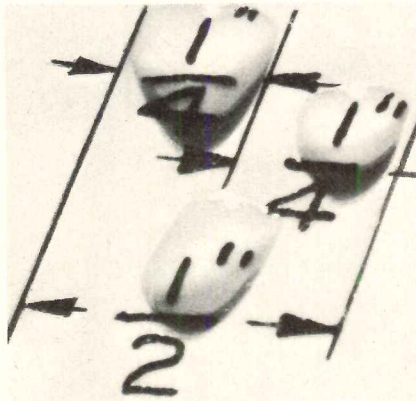

Draw your design revisions on the film and you're done.

The multiplication shortcut.

Why draw the same detail over and over? Kodagraph film will do the job for you. That way you draw the detail just once. Make as many photoreproductions as you need. Cut them out, paste them down, and make a

Kodagraph film print of the paste-up.

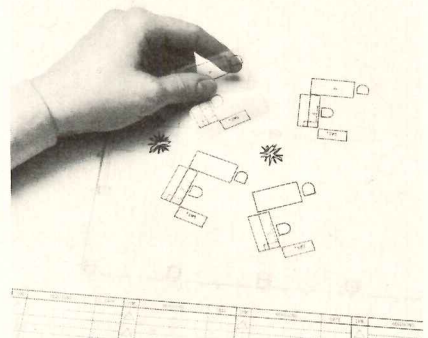

Now you have a superb second original for subsequent printmaking.

Get the facts from Kodak.

Drop us a line for more facts on how you can reduce drafting time and save money too, with Kodagraph films and papers. Eastman Kodak Company, Business Systems Markets Division, Dept. DP842, Rochester, N.Y. 14650.

Kodak products for drawing reproduction.



For more data, circle 23 on inquiry card



**THE
QUIET
WALL.**

THE BEAUTY SIDE...

THE QUIET WALL. THE WORKING SIDE.

Vicracoustic® wall panels* install quickly and easily That's the way we designed them. We set out to make a better wall panel system and we wanted to make it simple to handle.

Vicracoustic wall panels combine the beauty and durability of Vicrtex® with the sound absorbency of glass fiber. A Vicracoustic wall panel system is both beautiful and functional. The inner core of the panel does the work — the outer Vicrtex vinyl covering adds the decorative touch.

Choose from more than 85 Vicrtex patterns and over 1,500 different colors. This broad selection, and wide range of panel sizes, gives our system great versatility. And once you've installed them, they're easy to take care of.

But what about installation?

We have four different type panels — A, B, C and D. There are many different installation methods to satisfy most installation requirements. These include: steel hat channel, batten strip, aluminum extrusion, aluminum extrusion or steel with shelf support bracket, meitered "U" molding for office landscape screens, butted panels and panels with reveal. To name a few.

Since they've been on the market, Vicracoustic wall panels have been installed in such places as data processing areas, auditoriums, sound recording studios and executive offices. They really do the job.

If you're ready for the works, just fill out the coupon.

*Patent applied for.

LE CARPENTER
AND COMPANY



A DAYCO COMPANY

964 Third Avenue, New York, N.Y. 10022 (212) 355-3080

Sir: I want the works.

- I'd like to know more about Vicracoustic wall panels.
 I'd like more installation information.
 I'm involved in the following wall application:

Name _____

Title _____

Company _____

Address _____

City _____ State _____ Zip _____

- I'd like to have a salesman call.

AR

Distributed by Vicrtex Sales Division — Atlanta, Chicago, Los Angeles, New York.

For more data, circle 24 on inquiry card

News in brief

- HUD Secretary James T. Lynn claims subsidized housing starts this year will be bigger than in 1972**, and that Congress will, within a few months, have his department's new proposals on the Federal role in housing. Speaking before the Conference of the National League of Cities/Conference of Mayors, Secretary Lynn promised a target date—less than 12 months—for sending his proposals to Congress.
- Alan Dunn, noted cartoonist and critic (Perspectives, page 10), has been awarded the AIA Architecture Critics' Citation.** Other award-winners, to be honored in San Francisco at the AIA convention, listed on page 36.
- Women architects are seeking a wider role in the profession and an end to salary and rank discrimination.** Recent findings of a survey conducted by the Alliance of Women in Architecture show discrepancies in salary and status; details on page 36.
- The Senate has voted to permit use of the Highway Trust Fund for mass transit.** Informed sources say it is too early to estimate the final outcome, with House approval still to be decided.
- Presidents of five energy associations called the U. S. energy situation potentially a major national crisis.** In a joint statement, the presidents of the American Gas Association, American Petroleum Institute, Atomic Industrial Forum, Edison Electric Institute and National Coal Association emphasized that the development of badly needed energy resources has been discouraged by, among other things, lack of coherent national energy policies. Hearings are being held on two Senate bills that would establish a national energy policy.
- Merrill, Lynch, Pierce, Fenner and Smith Inc. has submitted the low bid for \$126 million in participation certificates to finance construction of three new Social Security Administration payment centers**, according to the General Services Administration. The certificates are issued under a public buildings trust and will evidence interests in an unconditional obligation of the U. S. Government.
- A \$29.6 million building system contract to design, fabricate and install 1.9 million sq ft of interior space for three Social Security payment centers has been awarded to the joint venture of Owens Corning Fiberglas of Toledo and Wolff and Munier Inc., of New York.** The innovative system is designed to conserve energy and includes everything from insulating materials to acoustical control and luminaire subsystems. The three buildings will be erected in San Francisco, Chicago and Philadelphia at a total cost of \$110 million.
- The U. S. Navy is seeking architects, engineers for a number of contracts in master planning, environmental impact studies and facilities designs for shore installations near Bangor, Washington.** Interested firms should submit Form 251 (RECORD, January 1973, page 55 and this month page 55) immediately to: OICC TRIDENT, Room 2B15, Yards and Docks Building, Washington, D. C. 20390. Telephone (202) 697-9129.
- A report on industrialized housing will be aired on the ABC television network, April 28 from 10-11 pm, EST.** Featured will be former HUD Secretary George Romney, and newly-appointed Secretary James T. Lynn, along with union, building code and AIA representatives, who will assess housing and the significance of industrialized housing in meeting our national goals.
- Meeting the housing needs of people at all economic levels will be discussed at the Fifteenth Annual Pacific Coast Builders Conference, June 13-15, San Francisco.** Land-use, design, construction techniques and environmental impact studies are on the program.
- Registered architects are invited to submit any new or remodeled structures developed and financed by a religious group for an exhibit to be presented at the National Interfaith Conference, Minneapolis, June 4-6.** Entry information can be obtained from: 1973 Minneapolis Conference, Guild for Religious Architecture, 1777 Church Street, N.W., Washington, D. C. 20036.
- May 9, 1973 is the deadline for submitting entries for the Birch Burdette Long Memorial Award for Architectural Drawings, sponsored by the Architectural League of New York.** A professional jury will consider any medium which clearly illustrates the appearance and communicates the spirit of a proposed building. Applications are available from The League, 41 East 65th Street, New York, N.Y. 10021.
- The F. W. Dodge Division of McGraw-Hill lists the 10 most active housing construction areas in 1972 as:** Chicago, New York, Washington, Los Angeles-Long Beach, Houston, Denver, Miami, Phoenix, San Francisco and San Diego.
- GSA's new guidelines on value engineering and the systems approach will be discussed by Larry F. Roush at the Mechanical and Electrical Systems Seminar, May 8-9 in Chicago.** Mr. Roush is Acting Commissioner of the Public Buildings Service, GSA. Sponsored by the Chicago Committee on High-rise Buildings, the conference will also focus on new advances in mechanical, electrical, water, waste and sprinkler systems. Registration fee is \$70 and reservations should be made prior to April 23. Contact the Committee at: 10 South Wabash Avenue, Chicago, Ill. 60603.

"3443 tons of GE cooling help the hold tolerances that would

Joseph H. Gauss, Vice President and General Manager,



In Greenville, South Carolina, there's a factory that makes gas turbines large enough to generate electricity for a city of 60,000 people.

There, rotor assemblies weighing as much as 26 tons are machined to a tolerance



of $\pm .0005$ (that's about one quarter of the thickness of the piece

of paper in this book.)

The plant makes these rotor assemblies, and the rest of the turbine, in three shifts a day, five days a week, throughout the year.

And even though Greenville has an average summer temperature of 79° with a normal daily high of 89° , the plant has never had to shut down because of heat.

Nor has hot weather ever ruined a 26 ton rotor assembly.

General Electric central air conditioning helps to maintain quality control and to make this plant a clean, comfortable place to work.

John Funke, manager of Greenville plant facilities has his own private morale booster: the General Electric

world's largest Gas Turbine factory make a watchmaker jealous."

Air Conditioning Products Division.

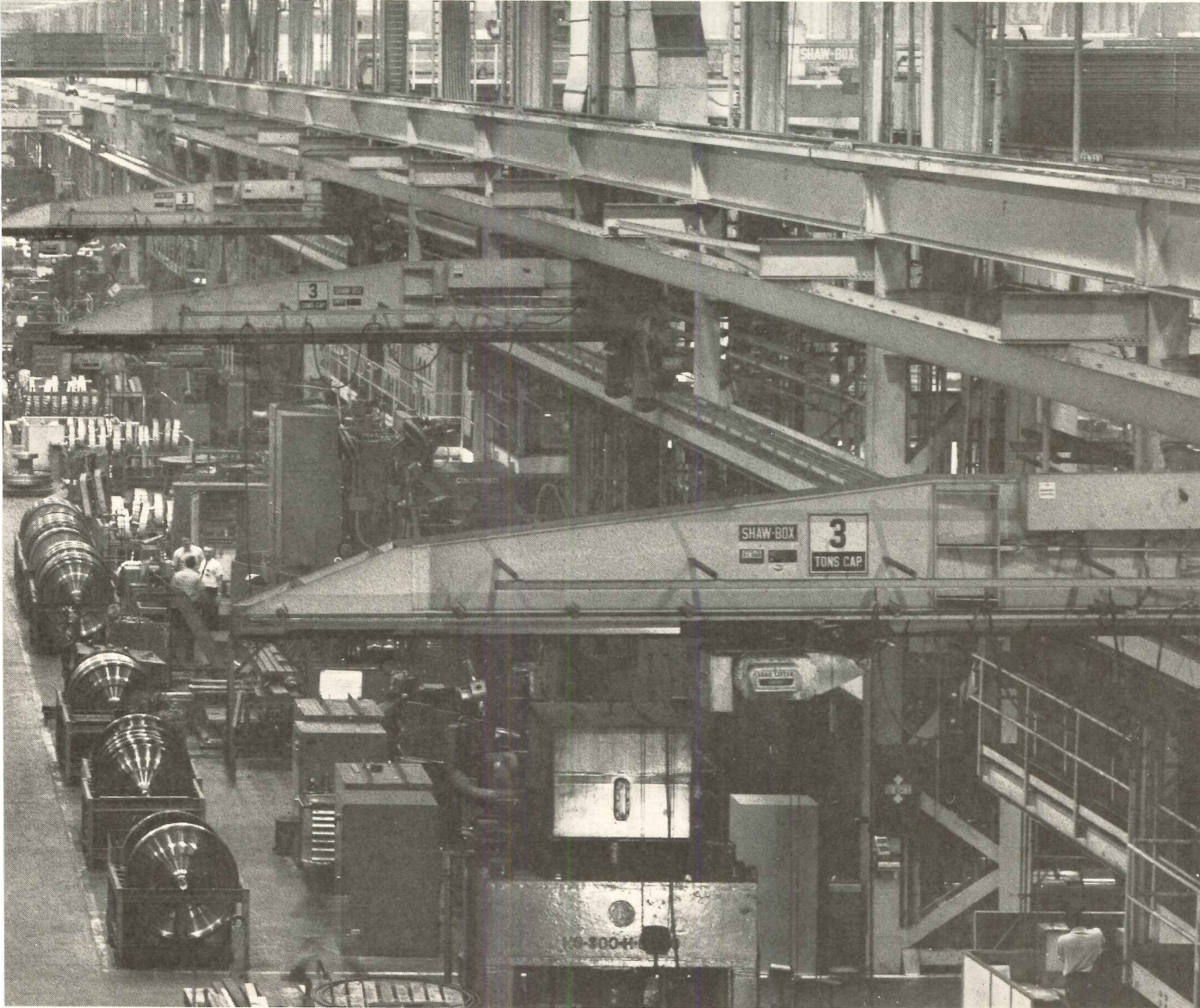

Service Contract that was bought with the installation.

The contract lets John budget his maintenance costs (resulting from normal usage) to the penny. With the contract, John knows that one predictable check will take care of anything that will have to be repaired or replaced for the life of

the contract.

John is very pleased with the installation.

Manufacturing men are discovering that the air in their factories is a very important part of their business. If one of your clients is a manufacturer, it can be a very nice piece of business for you.

Call the General

Electric central air conditioning dealer in your area for your Best Buy. He's listed in the Yellow Pages under Air Conditioning Equipment and Systems.

"We're going to be in this business a long time!"

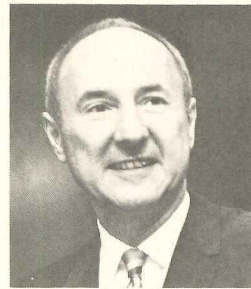

Joseph H. Gauss

GENERAL  ELECTRIC

For more data, circle 28 on inquiry card



George Dippel

1 HOST CHAPTERS, AIA FIRM UP SAN FRANCISCO CONVENTION

Louis De Moll, AIA convention chairman, Darryl Roberson, host chapter chairman, and program steering committee members (among whom is RECORD senior editor E. K. Thompson) from the East Bay, Santa Clara Valley and Northern California chapters, have announced a number of the professional and social events awaiting architects May 7-10.

During the convention, seminars on current professional practice, national growth and housing policies, and urban planning (illustrated with San Francisco's notable solutions), architect-government relations, education and specialized building types will be complemented with speakers of international prominence among whom are: Dr. Glenn T. Seaborg, University of California, Berkeley; Bernard Weissbourd, president of Metropolitan Structures, Chicago; and Representative Jerome R. Waldie, U.S. Congressman from California.

Of special interest among the seminar/field trips is "Preserving an Irreplaceable Natural Resource," a panel discussion during a cruise on San Francisco Bay. This event is sponsored by the host chapters and will feature on the panel William Evers, chairman of the Bay Area Conservation & Development Commission and Melvin Lane, chairman, Coastal Conservation Commission, and first chairman, B.C.D.C.

Restoration and renewal, illustrated by The Cannery (photo shown), Ice House and Show Place will feature talks by the participating architects and developers. Trips on the BART rapid transit system will be enhanced by, among others, Tallie Maule, consulting architect to BART and Joseph Bort, chairman, Metropolitan Transit Commission.

Social events include parties at Mario Ciampi's University of California Art Museum, and Kevin Roche and John Dinkeloo's Oakland Museum, where a special exhibit is being installed for the convention. San Franciscans themselves will conduct tours of areas and famous homes seldom seen by tourists, all selected for their special architectural interest, and ranging from Victorian to contemporary examples.



2 WOMEN ARCHITECTS SEEK WIDER ROLE IN PROFESSION, END TO DISCRIMINATION

Women architects, with increasing success, are asserting themselves in ways that range from highly organized professional groups for women, to all-women firms.

The movement is fueled not as much by the general feminist stance as by facts that confirm lower salary structures for women architects and lesser professional status within firms. For instance, a recent survey conducted by the Alliance of Women in Architecture in New York City, revealed that the mean yearly income of male architects is \$15,800 while that of women is \$13,200. This gap is in spite of the fact that professional qualifications match. Another finding is that the women reported a wide variety of experience, from designing houses to aviation facilities, but on the whole, hold positions of less responsibility than their male colleagues. Also, more women than men are self-employed (15 per cent compared with 2.5). According to the 1970 census, women represent 3.5 per cent of the 56,214 practicing professionals; the AIA includes 300 women and 24,000 men.

Gathering strength are the women's organizations that seek to give women a greater sense of their worth, such as the Alliance of Women in Architecture (coordinating committee shown left to right: L. Lucey, M. Lobell, J. Cone, A. Halpin, P. Birkby, J. Edelman, M. Lawrence, S. Grau and S. Brezavar). They provide such services as an *Underground Guide to New York Architects' Offices*, to help women—and men—find jobs. AWA and other similar groups are also mounting a vigorous campaign against sexist advertising by construction materials manufacturers.

The gains made by women include greater participation in policy-making within the professions, exemplified by Judith Edelman, a Manhattan architect who in 1971 became the first woman to join the executive committee of the New York Chapter, AIA. Also, New York architect Laurie Maurer is the first woman to sit on the seven-member State Board for Architecture.

Women are gaining in education.

With James Stewart Polshek, dean of Architecture at Columbia University, four women—double last year's number—teach architecture and a woman is assistant dean.

Engineering wants women too; at least at Stanford Engineering School, where Dean William M. Kays has embarked on a recruitment program for women. Dean Kays attributes lack of interest in the profession among women to "cultural conditioning." Stanford has about 50 women among its 635 engineering undergraduates.

The impact of women in architecture may be felt at the AIA convention this year, due to a resolution submitted by the New York Chapter; the Boston Society of Architects; and the New Jersey region. The resolution calls for AIA action to integrate women as full participants into all aspects of the profession with specific programs.

ARCHITECTS, ENGINEERS DISCUSS CURRENT LEGISLATION

The sixth annual Public Affairs Conference co-sponsored by the American Institute of Architects and the Consulting Engineers Council of the U.S. drew more than 350 registrants to Washington, D.C. last month for an in-depth study of pending national legislation. The delegates met in seminars on March 19 to hear members of Congress and other experts outline details and chances for enactment of new bills dealing with land-use policy, safety and health standards, procurement related to A/E's, energy, transportation, pensions and other current matters.

On March 20 delegates visited Congressional offices on Capitol Hill for personal visits with their Senators and Congressmen.

Luncheon speaker Arthur F. Sampson, acting administrator of the GSA told the assembly just what it wanted to hear when he reviewed findings of the Commission on Government Procurement which went to Congress recently. Two of the 149 recommendations vitally concern A/E's: that calling for a new Office of Federal Procurement Policy and another urging a statutory base for continuing and modernizing the government's use of the private sector.

Less favorable for the designers

present were the remarks of Capitol Hill committee staffers who briefed delegates at the National Growth Policy and land-use seminar. They told of developing committee jurisdictional disputes which threaten progress and passage of strong legislation.

3 AIA TO PRESENT AWARDS IN ARCHITECTURE AND RELATED FIELDS AT CONVENTION

Awards, medals, and citations will be presented by The American Institute of Architects at the Institute's 105th annual convention, May 7-10, in San Francisco. These honors, limited to one presentation a year in each category, are among the highest granted by the Institute.

The recipients represent a wide range of practitioners, artists, designers, craftsmen, and organizations involved in architecture and fields closely related to it.

For its award to a firm in which the continuing collaboration among members of the firm has been the principal force in consistently producing distinguished architecture, the AIA selected the Boston firm of Shepley Bulfinch Richardson and Abbott, soon to observe its centennial year. Other awards and their recipients are:

Fine Arts Medal, sculptor Harry Bertoia, Bally, Pa.; Allied Professions Medal, landscape architect and planner Hideo Sasaki, Watertown, Mass.; Craftsmanship Medal, textile design and weaver Helena Hernmarck, London; Industrial Arts Medal, designers Lella and Massimo Vignelli (pictured with furniture design), New York City.

Architectural Photography Medal, Robert C. Lautman, Washington, D.C.; Collaborative Achievement in Architecture Award, Bay Area Rapid Transit District, San Francisco; Citation of an Organization, San Francisco Planning Commission; Architecture Critics' Medal, Robin Boyd (posthumously), architect and author, Melbourne, Australia.

Architecture Critics' Citation, Alan Dunn, (Perspectives, page 10), New York; The Whitney M. Young Jr. Citation, Architects' Workshop of Philadelphia; and AIA Medal for Research, Harold B. Gores, Hon. AIA.



4

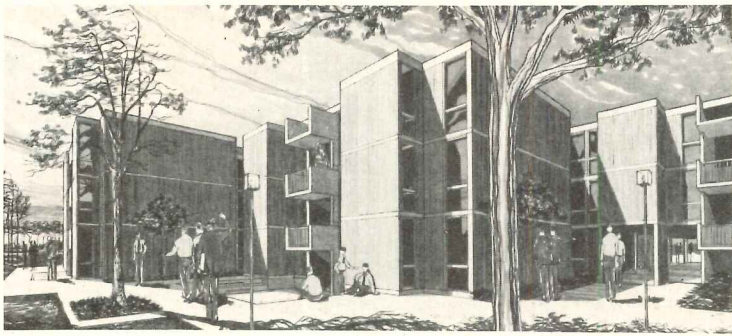

4

ARMY REVEALS NEW CONCEPT FOR BACHELOR HOUSING

A glimpse of how the bachelor soldier will fare in the all-volunteer army was revealed at a preview-showing last month of details of the new U.S. Army Enlisted Men's Barracks complex, scheduled for construction this year at Fort Carson, Colorado.

Design for the Fort Carson project was executed by Benham-Blair & Affiliates, Inc., Oklahoma City-based architectural and engineering firm, which received the assignment as the result of a competition sponsored by the Office of the Chief of Engineers. Given the responsibility for developing new bachelor enlisted men's and women's housing suitable for the modern volunteer army, the Corps asked each of its four regional districts to select an outstanding architectural/engineering firm in its particular area.

Designs of two of the firms were chosen as best meeting the Army's requirements. These were the ones submitted by Benham-Blair & Affiliates, Inc. for the Army's Omaha District, Corps of Engineers, and by Lyles, Bisset, Carlisle and Wolff, headquartered in Columbia, S.C. (design shown).

The townhouse-type barracks, one of several to be built on Army installations throughout the country, is also one of the initial projects in the Army Corps of Engineers' new regional barracks program. First public announcement of the program, which comprises a significant departure from traditional Army housing, came last month when Secretary of the Army Robert F. Froehlke revealed construction contract awards.

MANUFACTURED HOUSING PRODUCERS CLAIM BIAS

Discriminatory regulation and excessive fees attached to a new law to control the quality of factory-produced housing sold in New York State is threatening to close down plants in at least five states, according to Robert Majewski, co-chairman of the building codes committee of the Northeast Chapter of the National Association of Building Manufacturers. Majewski is acting as spokesman for NABM in New York, Pennsylvania and New England.

The uniform standards code for factory-manufactured homes was signed by Governor Rockefeller last June and became effective in February. Its intent is to standardize, throughout the state, building code requirements for factory-produced housing.

At an average cost of \$20,000 each, about 20 modular manufacturers submitted forms, architectural drawings, specifications, engineering calculations, quality control manuals and certificates by licensed New York State architects and engineers to the Housing and Building Codes Bureau during the last few months.

When the February deadline arrived—making it a felony punishable by a minimum fine of \$1,000 to sell a manufactured house without approval of the State Housing and Building Codes Bureau—not one application had been approved according to Majewski. As a result, a \$100 million housing industry has been shut down in New York State.

Replying to the charges, New York State Housing Commissioner Charles J. Urstadt said that six approvals had been granted and that the original effective date of the standards legislation had been postponed twice at the request of the housing manufacturers.

STUDENTS TAKING MORE RESPONSIBILITY FOR COLLEGE HOUSING

Students at the University of Michigan own and operate 25 houses worth \$2.5 million, saving them \$400 per year as compared with conventional dormitory rentals. And . . . A decrepit old dormitory at Cornell University was transformed into one of the most popular residence halls on campus with only \$7000 for building materials, paint supplied by the University, and some student ingenuity. This dormitory now has a waiting list for its 200 beds.

These and other working solutions to the problem of providing housing for college students are detailed in Educational Facilities Laboratories' (EFL) new study, *Student Housing*. The study documents new and economical ways to provide better housing at a time when college enrollments are swelling.

In the opening chapter, *Student Housing* cites a survey conducted by

5

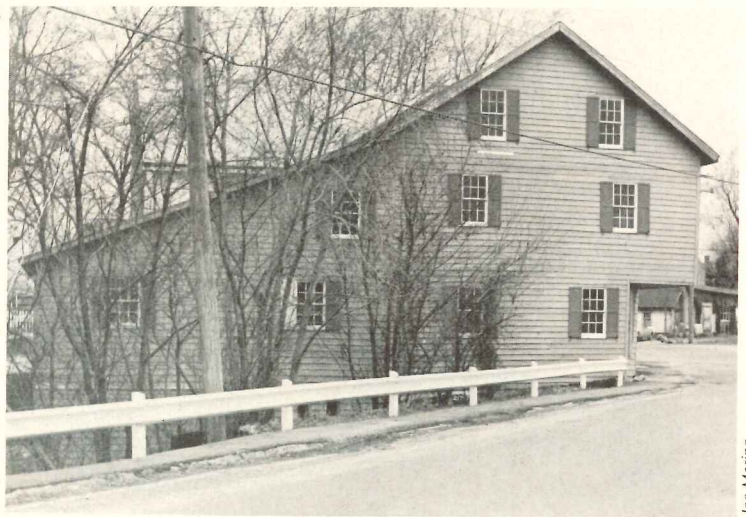

Joe Marino

architecture students at Pennsylvania State University that canvassed the college and university housing situation on a national basis. A consistent litany of unmet needs emerged, generally associated with the institutional character and restrictions on life styles. Two-thirds of students interviewed expressed a desire to return to campus living if they would be offered a variety of living options: coeducational dorms, apartments, suites, special interest dorms, snack bars, amenities such as private telephones, kitchenettes, carpeting, "rap" rooms, freedom to paint or decorate rooms, and public spaces.

A surprising variety of solutions have been found in sophisticated forms. One has been sponsorship by the college of cooperatives, owned or leased by the students. As an indication of potential student responsibility and involvement in their own affairs some of these are being managed successfully by students who live in the cooperatives. This is non-profit housing, which makes it possible to provide lodging and food at lowered costs. At the University of Michigan, where Inter-Cooperative Council owns and operates 25 houses worth \$2.5 million, savings amount to \$400 per year per student—and this for housing they like.

In addition to these approaches to student housing, the report notes phenomena surrounding these activities: the potential of student mobile home villages, systems components designed specifically for students' needs, the responsibility of the university to the community around it. Cited is the case of MIT, which assigned parcels of land it owned in Cambridge to housing for the elderly.

ARCHITECTS AGREE: CONSTRUCTION MANAGEMENT, PERFORMANCE BIDDING ARE OK

Architects attending a recent Producers' Council construction marketing seminar in Chicago joined other construction interests in agreeing that construction management, value engineering and performance bidding are good ideas. Several architects suggested that they themselves would make the best construction managers.

O. Reuben Johnson, of the firm of Buetow and Associates in St. Paul,

Minn., said "if you want to understand the problems of an owner, you have to become one. Some 60 per cent of the construction dollar is now apart from the activities of architects in the traditional sense. If you want to build your net worth rapidly, you have to be in on the development." Mr. Johnson said he saw definite advantages for architect-construction managers, developers on jobs of \$500,000 and up.

Randolph W. Shotwell, of Washington, D.C. said that anyone interested in construction management should look closely at the \$3.5 billion health care facilities market that is expected to grow 26 per cent by 1980. Mr. Shotwell said that if A/E firms get in early and approach owners with a consortium package that is life-cycle costed, they could have greater market success.

Walter A. Meisen, GSA assistant commissioner expressed faith in performance bidding as superior to prescriptive sub-system bidding, and said it would work for the private sector as well. Joseph A. Rorick, of IBM's real estate and construction division, agreed and said that IBM has done some performance bidding.

5 ZION & BREEN TRANSPLANTING FIRM FROM CITY TO COUNTRY

According to a recent announcement received here, "behind every corporate move from the city, latent, hushed and often unmentioned, lies the fact that some executive of the firm has a country home nearby."

Not so hushed in the case of landscape architects Zion & Breen Associates; their reasons for leaving Manhattan are loud and clear: "It is common knowledge that a principal (Bob Zion) owns a nearby farm and is determined to realize his dream of commuting to work on horseback instead of by taxi."

Complete with stable and pastures, the new offices are in a restored New Jersey landmark, Salter's Mill (shown) built in 1695 and once worked by Abraham Lincoln's great-great-grandfather.

The firm will maintain its New York office, but most work will be done at the mill, an hour and a half away.

Owner: T. C. & M. Co., Southfield, Michigan.
Architects: Jickling & Lyman, Architects Inc., Birmingham, Michigan.
Structural Engineers: McWilliam & Keckonen, Inc., Birmingham, Michigan.
General Contractors:
The Taubman Company, Inc.,
Southfield, Michigan.
Fabricator:
Congress Steel
Products Co.,
Melvindale,
Michigan.
Erector: Argo Steel
Construction Co.,
Detroit, Michigan.

Steel in

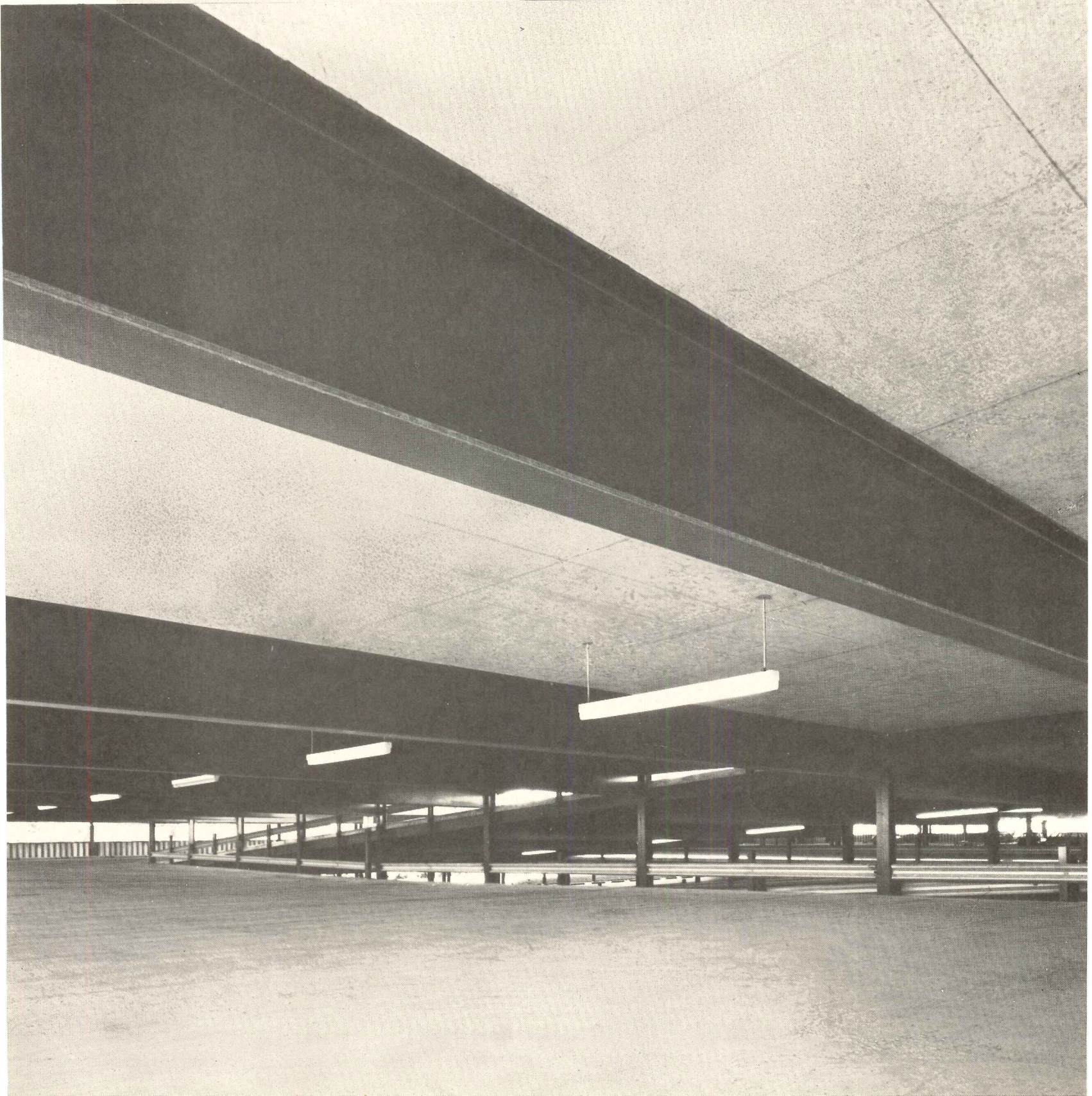

goes to great lengths this parking deck.

(More space for less cost)

More and more open-deck parking structures are being conceived and constructed in steel. The Executive Plaza Parking Deck in Detroit is a case in point.

Steel frame won out over competition—pre-cast concrete and poured-in-place concrete. Mainly because the long-span concept, which is most economical in steel, results in a minimum of interior columns. This allows much more open space, making self-parking easier and attendant-parking more efficient.

The three-tier building has 128,750 sq. ft. of supported parking area. While meeting the City of Detroit's requirements of a 75 psf live load, the building's structural weight is low. For the most part, the structural steel is USS EX-TEN 50 (ASTM A572 Grade 50) high-strength low-alloy steel. Certain lighter members are A 36. Naturally, the lighter the structure, the lighter the foundations. More savings!

The entire structure was finished in five and a half months at a total cost of \$910,000.

Not only did steel frame construction lower the total cost by lessening the time it took to build, but it also permitted the owner to begin realizing a rental income much sooner.

With all these factors considered, steel frame turned out to be the most economical system.

Here is another example of how an income-producing facility like an open-deck parking structure can be erected fast in steel and meet with great satisfaction—from a functional, economic and aesthetic point of view.

Minimal fire danger! Results of a recent extensive survey indicate that losses resulting from fires in this kind of structure are minimal. Realizing this, the City of Detroit permitted a deviation from their existing Building Code. With no fire protection necessary, costs were cut considerably. It is interesting to know that elimination of fire protection can mean a saving of as much as \$1 per square foot in steel parking decks.

Let us help you program your next garage in steel. For a more complete story on this structure, get a copy of our USS

STRUCTURAL REPORT (ADUSS 27-5779-01). Also, you might be interested in our Technical Report on Steel Frame Parking Structures (ADUSS 27-5227-02). For copies of these reports or to find out the many ways in which we can help you program your next garage, call our nearest sales office and ask for a USS Construction Marketing Representative. Or write to U.S. Steel, Box 86, Pittsburgh, Pa. 15230.

Construction Details

Description: A rectangular, three-level structure with interior, two-way straight ramps—open on all four sides. A parking capacity of 745 cars. All floor decks designed with a drainage slope. The slope is downward from the outer edge of the deck toward the building center—a total drop of 18 inches.

Building Description:

Dimensions: 311' -2½" x 252' -0"

Height: 2 tiers (above the on-grade parking level)

Floor to Floor Heights: 10' -6"

Capacity: 745 cars.

Gross Areas:

Ground level (including unenclosed space):	98,300 sq. ft.
Second level:	78,400 sq. ft.
Roof level:	78,400 sq. ft.
TOTAL	255,100 sq. ft.

Occupancy Type: Open-deck parking garage.

Applicable Code: City of Detroit Building Code

Design Loads: 75 psf live loads

82 psf dead loads

20 psf wind load

Structural Steel:

Total weight: 530 tons.

6.75 pounds of steel per square foot of supported structure.

All A572 Grade 50 except details.

All beams and girders are composite designed non-shored construction.

All bolts ASTM A325 High Strength.

Bracing: Semi-rigid moment connections in selected bays.

Floor Slab: 6" thick two-way post tensioned 4,000 psi stone concrete with supplemental reinforcing over 62 ft. girders.

Exterior Walls: Extruded anodized aluminum. Painted concrete block.

Foundations: Spread footings.

Elevators: 1 Hydraulic type 1,500 lb. passenger elevator.

USS and EX-TEN are registered trademarks.

 **United States Steel**

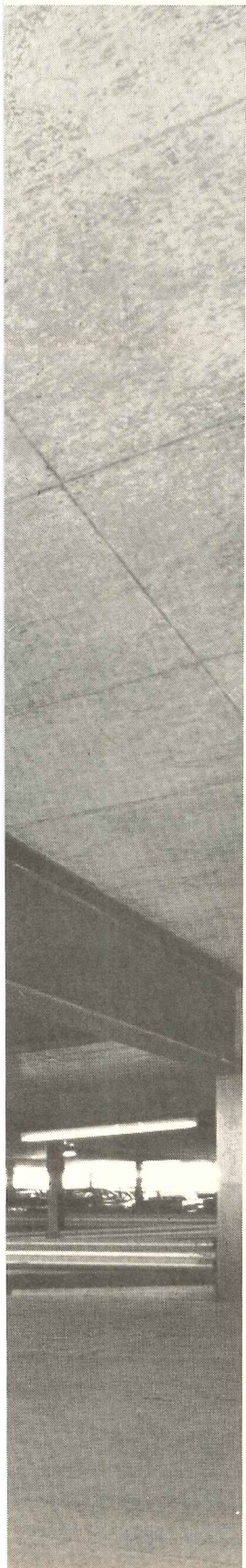

Dover® Stage Lifts. Rising star in the theater.

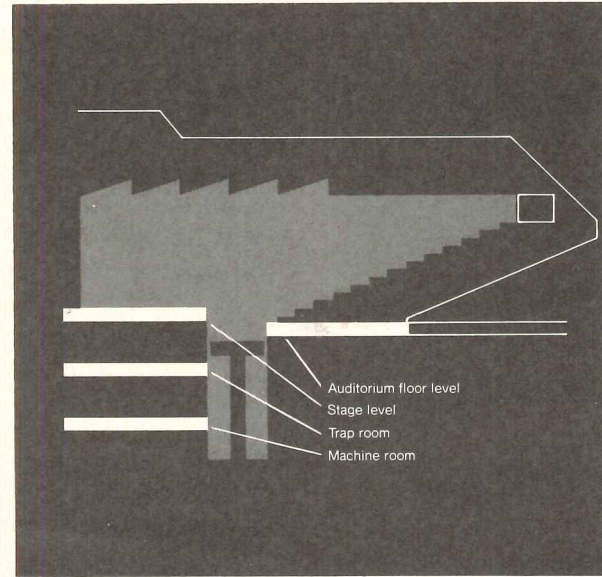
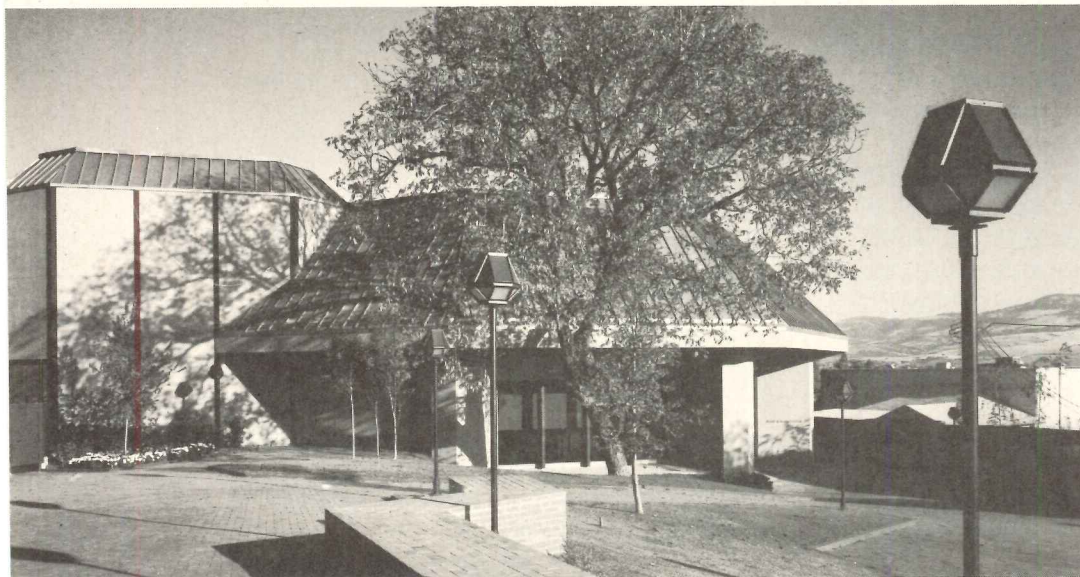
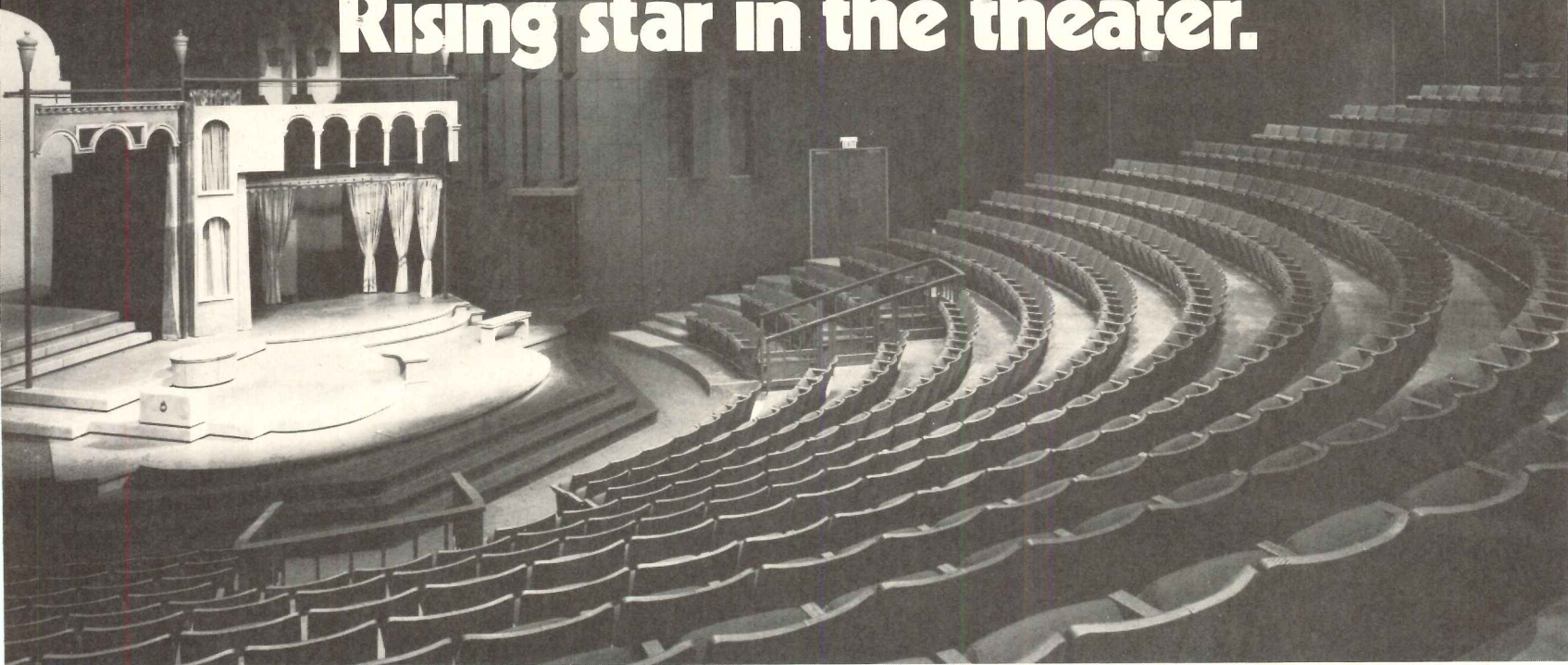

A good actor must adapt himself to a wide variety of roles and styles of interpretation. So must a good stage.

The designers of the Oregon Shakespearean Festival's Angus Bowmer Theater, Ashland, Oregon, recognized this and utilized a Dover Stage Lift as the heart of their new 600-seat playhouse.

This 28' x 8'6" lift is truly a versatile performer. It travels 21' and serves four levels: machine room, trap room, auditorium floor, and stage. In various positions it becomes part of the stage, part of the auditorium, and an easy way to move heavy, awkward scenery between floors.

Dover Lifts can be found in the Metropolitan Opera House and the Juilliard School, New York; in Harvard's Loeb Drama Center, the Santa Fe Opera House, and the Stardust Hotel, Las Vegas.

The same Dover skill that designed and built these lifts can be applied to your stage lift project, regardless of size or special requirements.

For more information, see our catalog in Sweet's Files, or write Dover Corporation, Elevator Division, Dept. A-4, P. O. Box 2177, Memphis, Tenn. 38101. In Canada: Dover/Turnbull.

OREGON SHAKESPEAREAN FESTIVAL ASSOCIATION, Ashland, Ore.
Architects: Kirk, Wallace, McKinley, A.I.A. & Associates, Seattle, Wash.
Theater Consultants: Landry, Hunt & Bogan, Palo Alto, Calif.
General Contractor: Robert D. Morrow, Inc., Salem, Ore.
Stage Lift installed by Dover Elevator Co., Oakland, Calif.

DOVER
Stage Lifts

For more data, circle 30 on inquiry card



The Mayor's Merchant's Assistance Program in Detroit is a commercial renovation program conceived and directed by four under-30 city-employed architects who are beginning to revive decaying neighborhood shopping areas (top left) with imaginative design and skillful coordination of private and city investment. Less than a year old, the program now has merchants pleading with the city for services of the design group lead by Alex Pollock. The group provides free design services to an area, obtains necessary approvals and aid from affected city departments, breaks down the

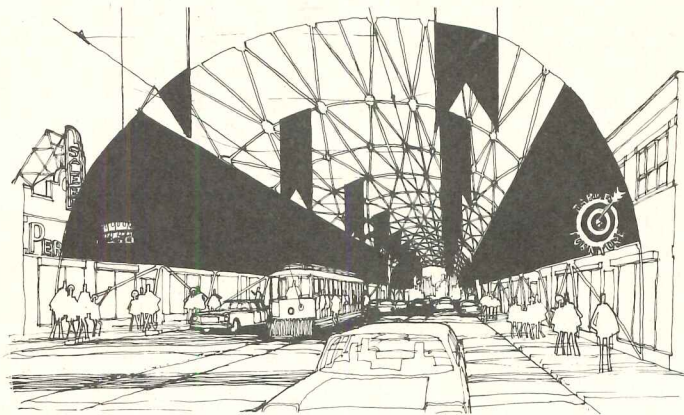
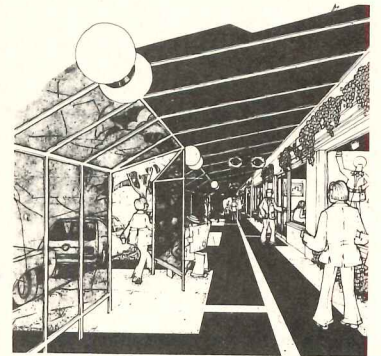

costs to be shared by the affected merchants, and selects the contractor for the work. The design (shown center) is expected to be underway by summer in the area shown top, left. Typically, the improvements consist of unifying facades with arcades, graphics, plantings, lighting, kiosks, etc. The 428-ft mall would cost the 11 shops \$100,000 as shown, but the design is presently being revised as a totally climate-controlled space. Another project, a gallery spanning a street, (left) will eventually include an old trolley line down the mall from peripheral parking.

Pine Grove Junior High School, Baltimore County, Md., is a modified open plan designed with three axially-located common-use areas. Surrounding these are instructional spaces based on a 56- by 28-ft bay divided with demountable partitions. The architects, Rogers and Vaeth, Inc., claim the modular concept was important in receiving a below-budget bid of \$4.5 million. Generally on one level, the school features varied ceiling heights and materials, plus varied lighting intensity to define circulation and relieve visual monotony. The two-story central commons area is ringed by administrative offices at mezzanine level. Completion date is for September, 1974.

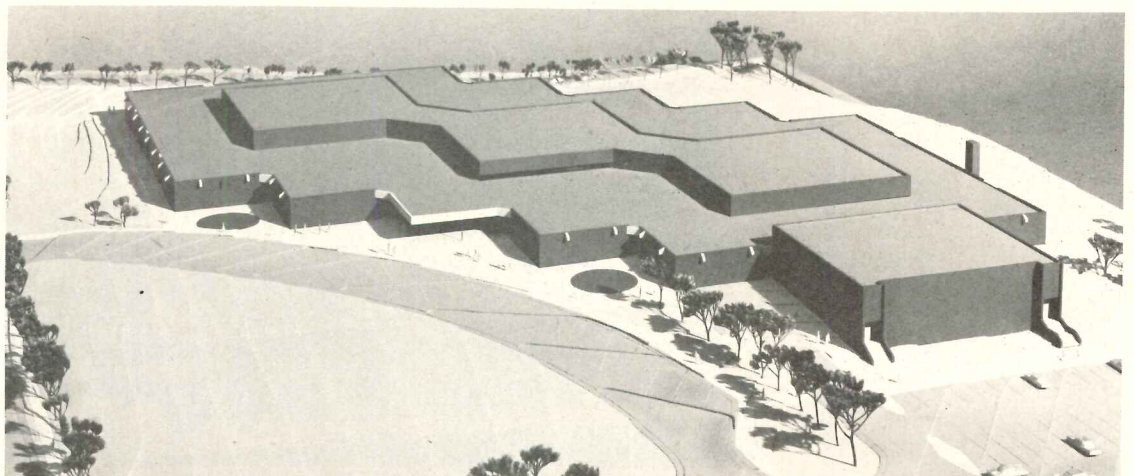

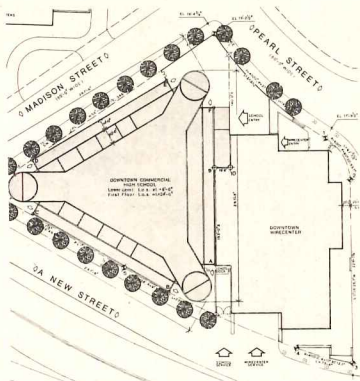

Downtown Manhattan High School, a \$22-million triangular structure for 2500 students, will be one of the first totally climate controlled schools in New York City. The central zone houses special-function spaces including the auditorium, cafeteria, kitchen, library and gymnasium. Circular towers at the apex of the angles contain stairs and mechanical systems. Classrooms and administrative offices are placed along the facades for natural light. A continuous triangular gallery on each floor provides for horizontal circulation; expression of interior structural columns gives visual relief to these 220-ft long spaces. The most frequently-used classrooms are located at ground level, with close access to a 3000-sq ft plaza, thus reducing traffic on the main entrance and stairwells. Gruzen & Partners designed the school for the New York City Educational Construction Fund and the New York City Board of Education.

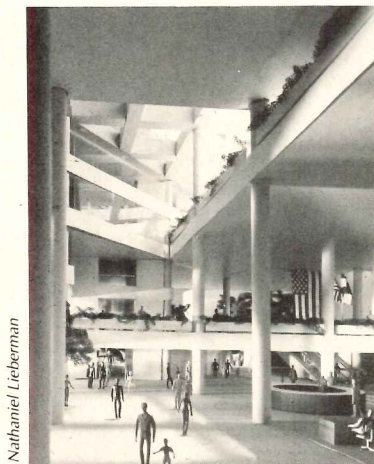
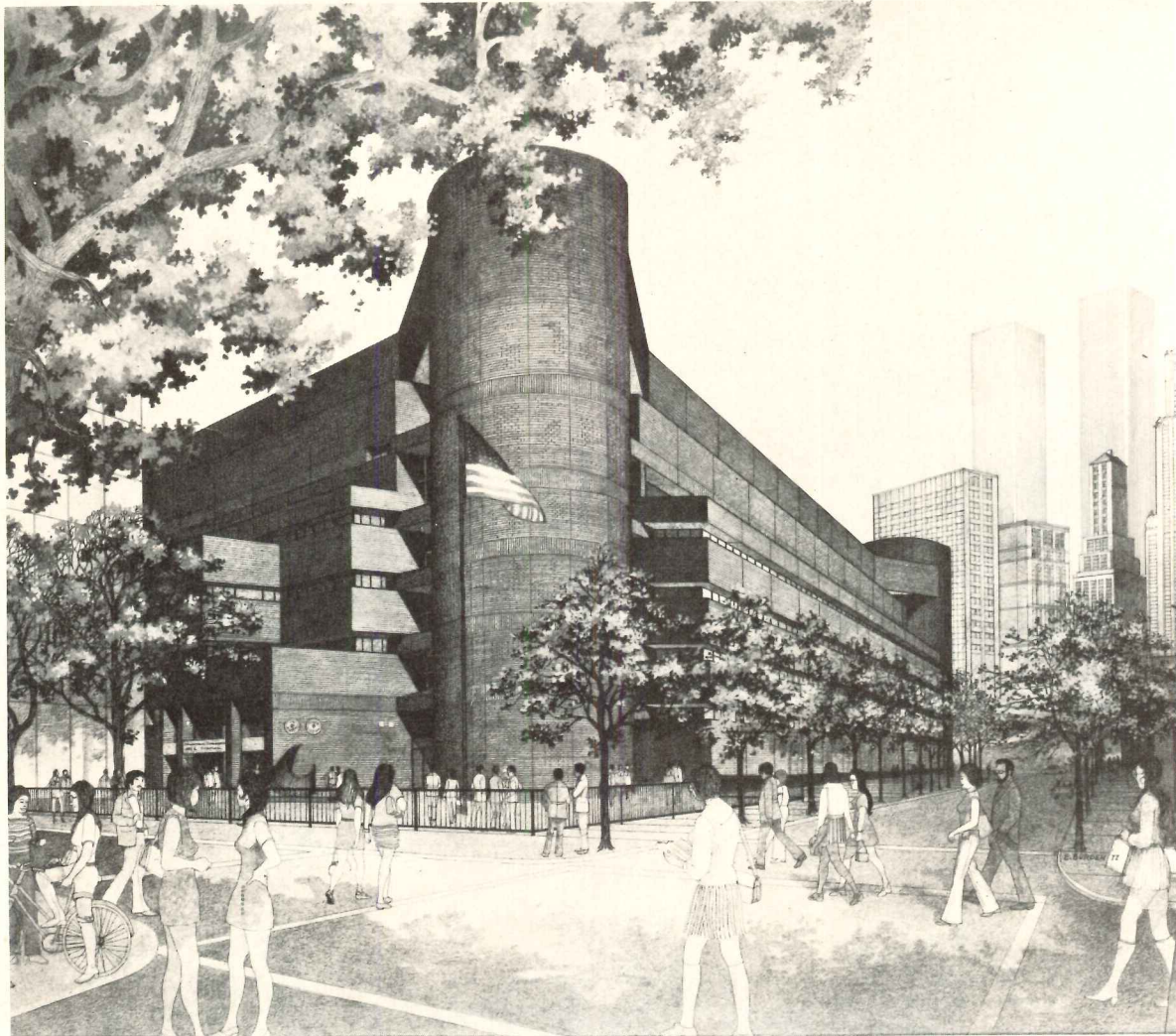

Nathaniel Lieberman

United Missouri Bank Towers, Kansas City, Mo., is the design of I.M. Pei & Partners. The design concept, contingent on implementation of a proposed public park (right, foreground), consists of two 10-story towers connected by a diagonally-placed four-story Galleria (interior above) containing banking spaces and shops. Moving stairs in the skylit Galleria will take pedestrians from one street level to another, due to placement of the structure on a sloping site. A sidewalk cafe is planned in the new park which will extend through the block. Underground parking for 350 automobiles will be provided. The building will be sheathed in mirror glass set in a highly polished grid system. As yet, no date has been set to begin construction.





North Woodmere Park, Nassau County, N.Y., is a 160-acre park just outside New York City. Shown are portions of its two-acre children's playground that makes imaginative use of ready-made equipment combined with structures designed by Vollmer Associates. The playground is divided into five thematically-designed areas, including "Maze," shown right, a three-dimensional puzzle of redwood. "Pyramid" is reached through a purple tunnel, above, one example of the way in which brilliant colors are used throughout. This area consists of four gently sloping walls into which are set pits of various shapes to ground level, accessible by tunnels, ladders and stairs. Another section of the playground is reminiscent of a fort, with multiple levels, sloped timber walls, wooden cannon and look-out posts. In the "Playland" area, the Vollmer group designed a brick serpentine wall with a flat top and sides sloping down to sand.

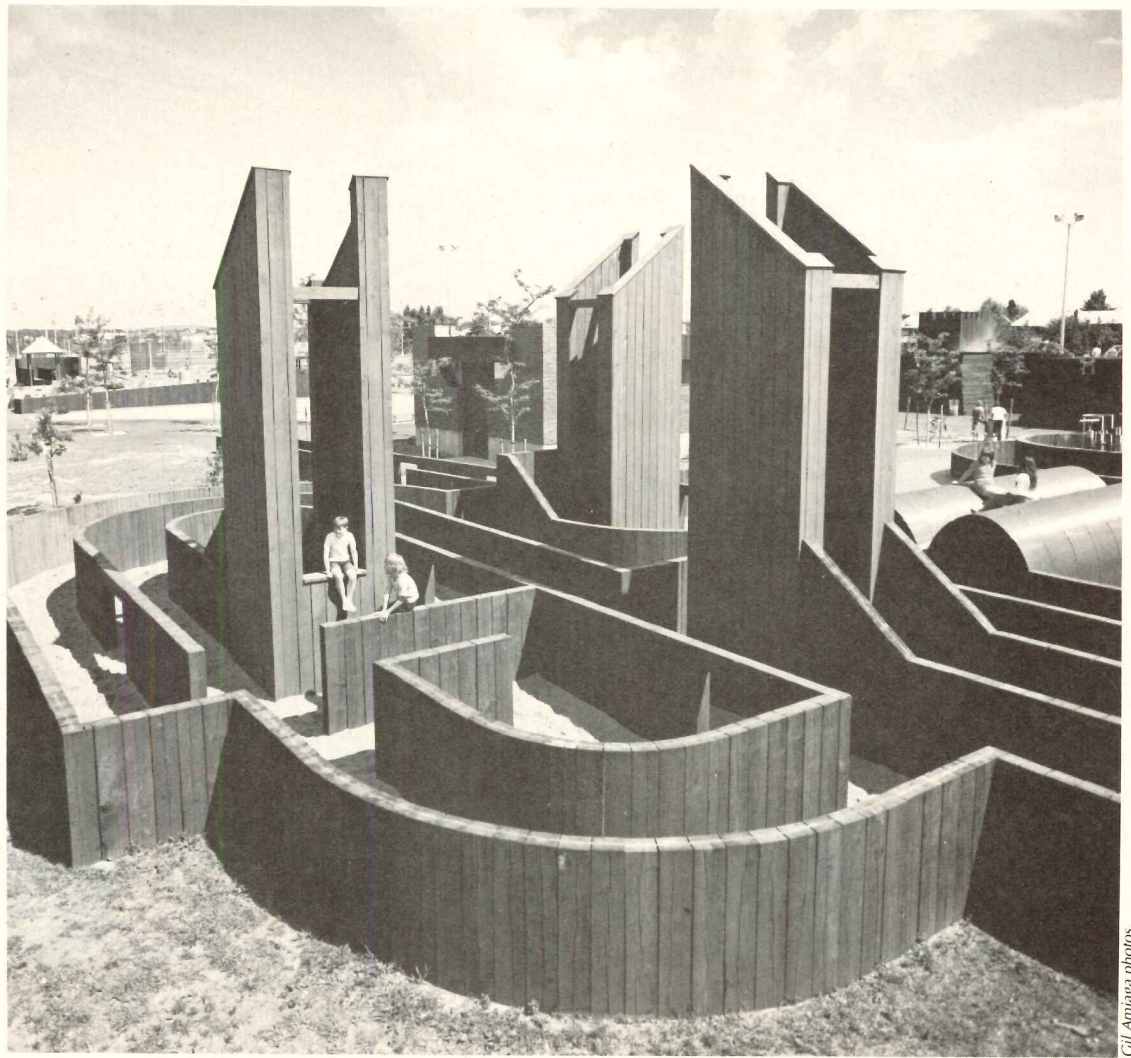

Gil Amigga photos

Buildings for schools of architecture are under construction on the campuses of The University of Southwestern Louisiana (right), Lafayette, and The University of Michigan (below left), Ann Arbor; the building shown lower right was recently dedicated at Ball State University, Muncie, Indiana, and is the design of Melvin D. Birkey who won a statewide competition for the \$2.2 million structure. The Southwestern Louisiana building by Barras, Breaux and Champeaux was also a winner in competition. It will house facilities for applied arts, architecture and fine arts, in four quadrants around a central court. The \$8.5 million building for The University of Michigan was designed by Swanson Associates.

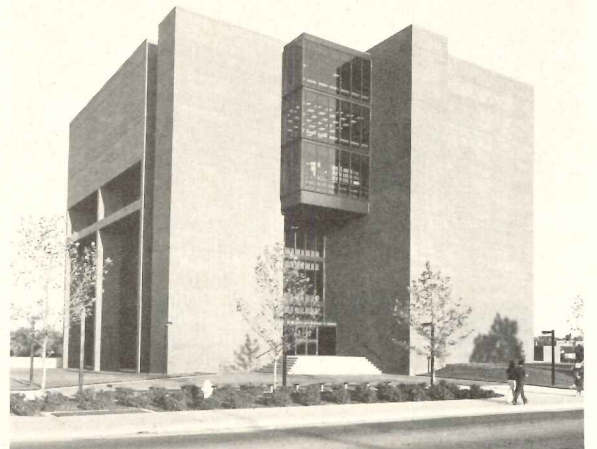
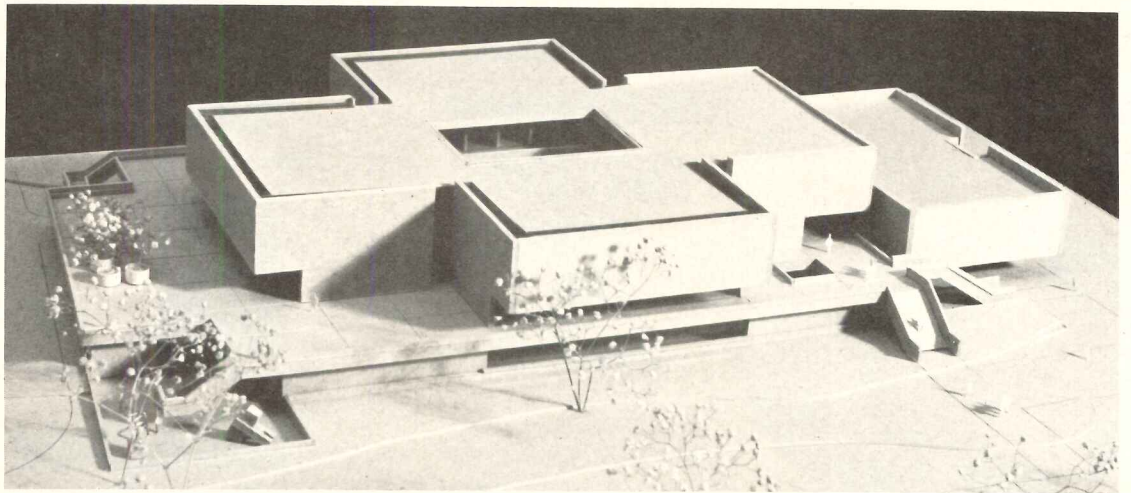

NEW

Kewaunee "Flexible Systems" Laboratory Furniture Catalog is Now Available!!

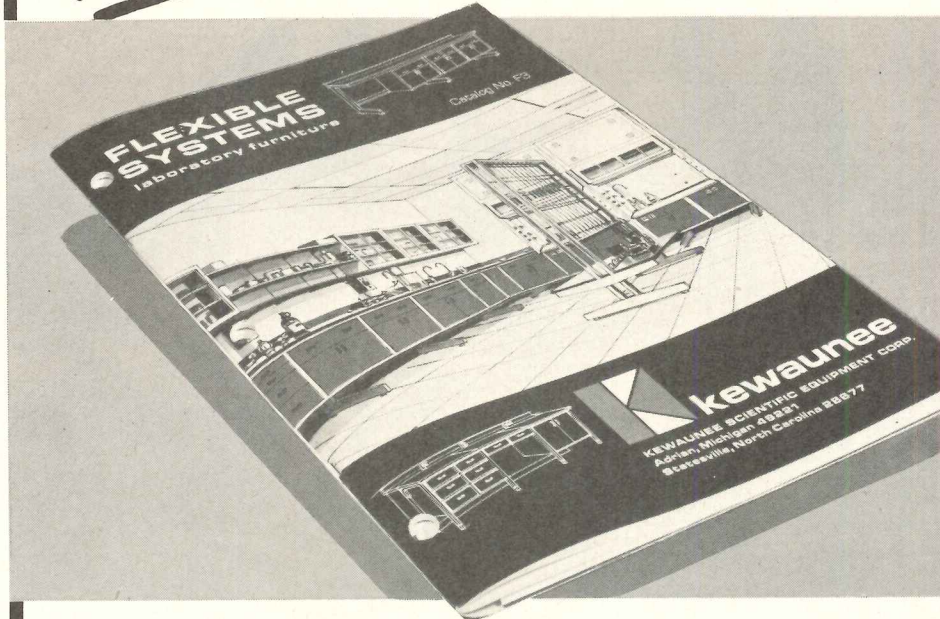

Need information on flexible and interchangeable laboratory furniture? If so, you will want a copy of this new 56 page catalog that illustrates and describes three types of support systems for off-the-floor, cantilevered or suspended casework laboratory furniture assemblies. All casework (both wood and metal) can be removed and interchanged with a minimal or no use of tools, and the support structures can also be taken apart and re-assembled into a different length and/or type of assembly.

Write or call for your **FREE** copy of this new Catalog.

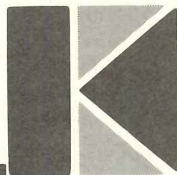

kewaunee
KEWAUNEE SCIENTIFIC EQUIPMENT CORP.
METAL FURNITURE DIVISION
5064 S. CENTER ST., ADRIAN, MICH. 49221
Phone: (313) 263-5731

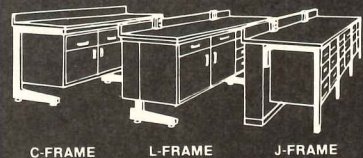

C-FRAME

L-FRAME

J-FRAME

For more data, circle 95 on inquiry card



YOU NOTICE NEENAH CASTINGS AROUND THE WORLD

Architects, designers and planners know Neenah castings are found in Pakistan, Kuwait, Turkey, South Africa, Argentina, Bahamas . . . and from Paris to Pittsburgh.

They know Neenah makes the finest quality castings: from gray iron manhole covers . . . to ductile iron airport drainage grates . . . to decorative tree grates . . . and a complete line of building castings. But did you know Neenah has thousands of design variations to choose from? 60,000 castings on hand (over 10,000 tons)? Over 100 years of experience? Three modern plants?

Write or call for the most complete construction castings catalog, Neenah's Catalog "R", 5th edition.



NEENAH
FOUNDRY COMPANY

NEENAH, WI 54956 Phone: 414-725-3041
Jobbers in most principal cities

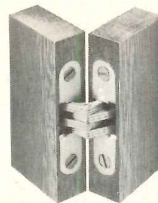

NOW YOU SEE IT



NOW YOU DON'T



Tamper-proof hinges that hide

Soss Invisible Hinges can't be seen or tampered with when a door is closed. Hinge bodies are mortised into the door and jamb to discourage any intruder. Specify Soss invisibility for beauty and security. Our new catalog includes application and installation ideas on all 20 models. Look for it in Sweet's, or write to Soss Mfg. Co., Div. of SOS Consolidated Inc., P. O. Box 8200, Detroit, Mich. 48213.



the SOSS
Invisibles

For more data, circle 97 on inquiry card

◆ For more data, circle 96 on inquiry card

toppers

PERMALITE® Pk and PERMALITE® RIGID URETHANE

Grefco roofing boards; unequalled for quality and economy—

Permalite® Pk: The unique composite of famous, non-combustible ¾" Permalite board, required thickness of self-extinguishing urethane and high strength water repellent laminate. Provides superior insulation at minimum thickness... sharply reduces shipping, installation and operating costs.

Permalite® Rigid Urethane: The extremely lightweight board that set the industry standard for thermal efficiency. Particularly stable and resistant to damage... ideal low temperature insulation and for masonry applications.

Get the facts.

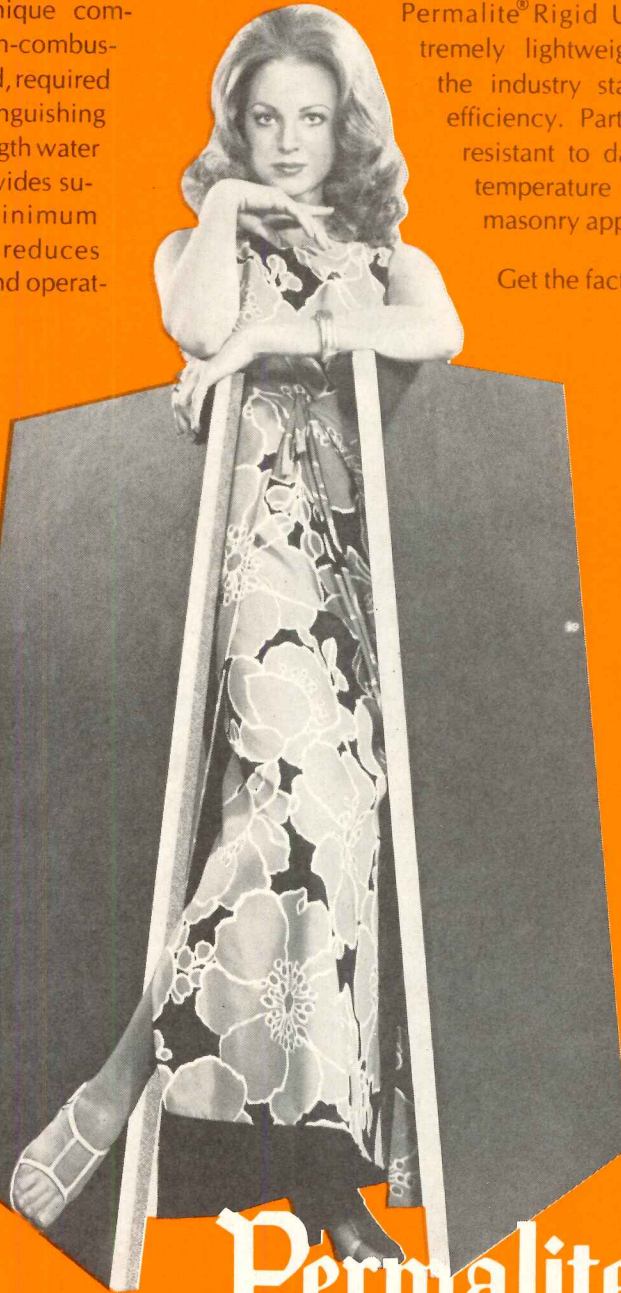

Grefco, Inc.
Building Products Division
2111 Enco Drive
Oak Brook, Illinois 60521

A Subsidiary of General Refractories Company

Permalite
RIGID ROOF INSULATION

*Note: Permalite Pk 1.6" has "C" value of .12, an "R" value of 8.33 and is equivalent to as much as 3" of competitive material. Listed by FM for Class 1 Steel Deck Construction (fire and wind uplift); UL Metal Deck Assemblies Construction Nos. 1 and 2.



HOUSE OF TEAK

The most comprehensive inventory in America

From around the world, bold inventories of kiln dried hardwood lumber and veneer—ranging from domestic Ash to exotic Zebrawood.

CHESTER B. STEM, INCORPORATED
GRANT LINE ROAD, NEW ALBANY, INDIANA

For more data, circle 33 on inquiry card



involved in a school project?

consider these better ideas when you plan
communications



for the **NEW** school project

Rauland **TELECENTER**

TOTAL ADMINISTRATIVE CONTROL

TELECENTER is a superior internal communications system which instantly links school staff and teachers with chief administrators. Features exclusive Digital Readout to identify incoming callers sequentially; multi-link capability; push-button dialing; zone or all-call announcements, and other advances—truly the *better idea* in school communications.

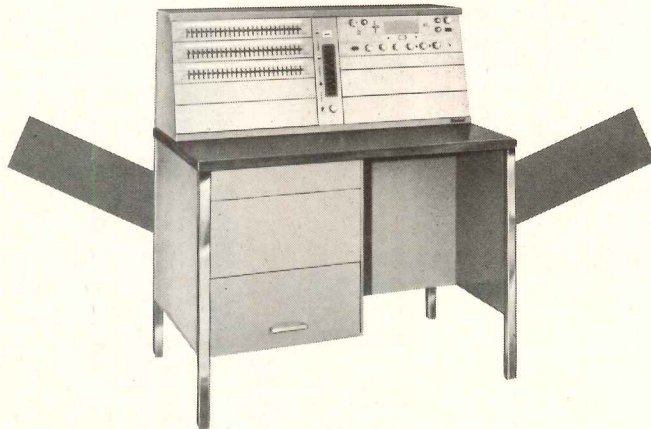

for replacement in **MODERNIZING** projects

Rauland **Administrative Control Centers**

LOW-COST AND MAINTENANCE-FREE

Features: Latest solid-state reliability; two-way voice communication; emergency all-call; program distribution facilities; handsome new console styling. Priced right for modernization programs; compatible with existing speakers and wiring. (Available for up to 250 classrooms.)

ASK FOR full details. A Rauland Communications Specialist in your area will be glad to provide detailed information and engineering data.

RAULAND-BORG CORPORATION

3535 W. Addison St., Dept. R, Chicago, Ill. 60618

New... the look of "Tomorrow"
... from Artistic Brass.

Here is the ultimate in contemporary decorative bathroom fittings — so modern that it had to be called the "Tomorrow Line." See complete full color literature with specifying data in Section 15.16 ART, 1973 Sweet's Architectural File.

Write for full color brochures on all of our 90 lines of exquisitely designed lavatory, tub, and shower sets plus accessories. Dealer lists included.

ab artistic brass
A Division of Norris Industries

3136-48 E. 11th St., DEPT. AR, LOS ANGELES, CA 90023 • TEL.: (213) 268-3473

For more data, circle 34 on inquiry card

For more data, circle 35 on inquiry card

"FreeSpace" for Your Clients



Put all your files in one fourth the area

With Lundia FULLSPACE[®] Mobile Filing and Storage Systems

Now you can "free" valuable floor space. It's a matter of record. In business firms nationwide, Lundia FULLSPACE systems are saving space, retrieval time and money. FULLSPACE occupies about one quarter the floor space of drawer files of equal capacity. Suppose your drawer files and aisles occupy 400 sq. ft. FULLSPACE of equal capacity saves space for other purposes by requiring only 100 sq. ft., or you can put four times the filing and storage in existing space.

Swedish-designed Lundia FULLSPACE mobile wood shelving has no equal... for efficient management of general files, records, computer tapes, printout forms, ledgers, books, stationery, supplies of all kinds, and even parts inventory.

When you select FULLSPACE for centralizing records-keeping and storage, you really have something working for you. Ask how FULLSPACE can pay for itself. Have a Lundia representative survey your requirements, present a free layout, and provide a cost estimate. Your installation date will be met. That's in the record, too.

**CALL FRANK BROWN COLLECT
217-423-3451**

OR WRITE TODAY FOR COMPLETE DETAILS

LUNDIA
The World's Record Holders

LUNDIA, MYERS INDUSTRIES, INC. DECATUR, ILLINOIS 62525
For more data, circle 36 on inquiry card

Are You a *Tough-Minded Architect?*

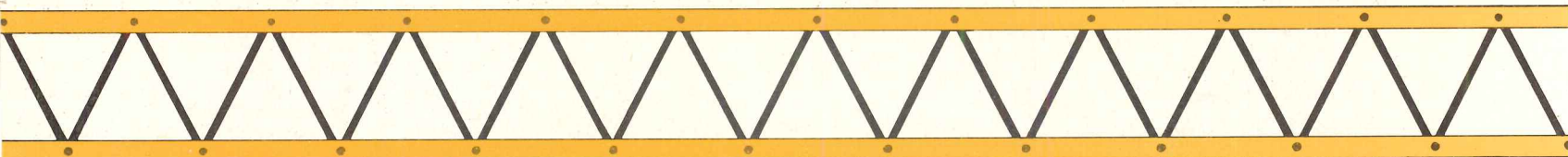

- . . . the kind of man who specifies specifically, who insists on quality and who will not allow "almost equal" substitutions?

- You're our kind of man.

- And we manufacture the kind of structural components you prefer . . . top quality in every way.

- To begin with we are the world's largest consumer of machine stress rated lumber, known to be the most effective grading method available. We have also developed MICRO=LAM lumber which is the most reliable and consistent wood structural product in use today.

- Our quality control program is supervised by professional engineers and our manufacturing

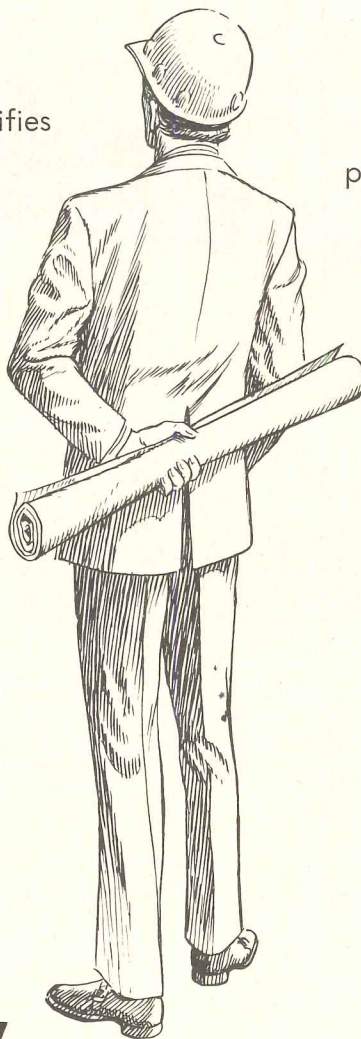

precision is such that TRUS JOIST products are manufactured to closer tolerances than any other structural product be it wood, steel or concrete. We also absolutely guarantee that every TRUS JOIST product will support the load for which it is designed.

- If you have any questions or need information you deal directly with our engineer in your area, not with an association go-between or some distant home office.

- It all adds up to product integrity, the kind of integrity we think you appreciate if you're a tough-minded architect.

- That's because when it comes to quality we're pretty tough-minded too.

Trus Joist[®]

Creative engineering in structural wood.
9777 CHINDEN BOULEVARD BOISE, IDAHO 83702

Fourteen plants and eighty sales offices throughout the United States and Western Canada.

For more data, circle 37 on inquiry card

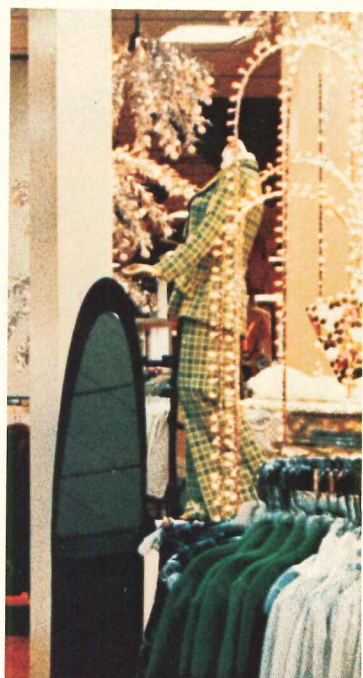

Art Metal has more light in store for Brandeis

Art Metal's 2x2 square Mercury Vapor luminaires add a new depth of dimension to the Brandeis Department Stores. Fewer fixtures are required, reducing ceiling clutter and giving a spacious look to the area. The system helped the architect and engineer to produce a ready-for-occupancy structure in four months.

The Art Metal 2x2 is the image of prestige, yet HID is the most economical lighting system now available. And it enhances sales with vertical lighting that illuminates merchandise brightly . . . right down to the lower shelves! Brings out the true hues and enticing luster of all hard and soft goods for added customer eye appeal.

Floating frame design creates an elegant atmosphere for the discriminating Brandeis customers. The new 2x2 HID recessed square luminaire is available in 250 and 400 Watt Mercury Vapor, or 400 Watt Metal Halide.

ART METAL LIGHTING
LIGHTING FIXTURE DIVISION
P. O. Box 195, Vermilion, Ohio 44089
In Canada: P.O. Box 3231, London, Ontario

Installation: Brandeis Westroads, Omaha, Nebraska • Architect: Leo A. Daly Co., Omaha, Nebraska

For more data, circle 38 on inquiry card

ARCHITECTURAL RECORD April 1973 49

GAF MAKES FLOORINGS FOR ALL KINDS OF FEET.

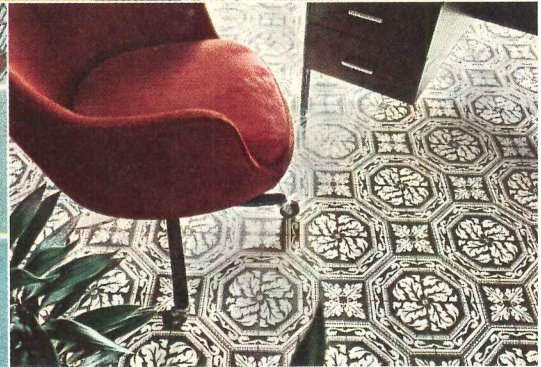

A floor covering should be chosen not only to withstand the number of feet that will go over it, but for the particular type of feet as well.

That's why, when it comes to resilient floorings, GAF makes over 300 types, patterns, and colors—to try to have exactly the one you'll need.

For instance, for a medium traffic area you might choose new Fashioncraft™ floor tile. This 3/32" grade comes in a striking assortment of high-fashion designs, making it a worthy candidate for residential areas, too. Or ask us about the GAF Thru-Chip® lines which offer no-wax maintenance in heavy traffic areas.

But perhaps you'll decide sheet goods can do the job better.

In that case, GAF offers sheet vinyl that comes up to 12' wide, is cushioned for softness and quiet, and needs no waxing or scrubbing.

Whether you're catering to high heels, office furniture legs, or shopping cart wheels, consider GAF. After all, we've got over 300 different ways to help.

All are fire resistant and meet Federal specifications where applicable.

For more information, contact Mr. Roy Gilb, GAF Architectural Flooring Division, Dept. L-43 P.O. Box 1121, Radio City Station, N.Y., N.Y. 10019.



For more data, circle 39 on inquiry card

All 3 of these structural columns do the same job.

Which one would you specify?

PIPE

\$3.52
▲ per foot

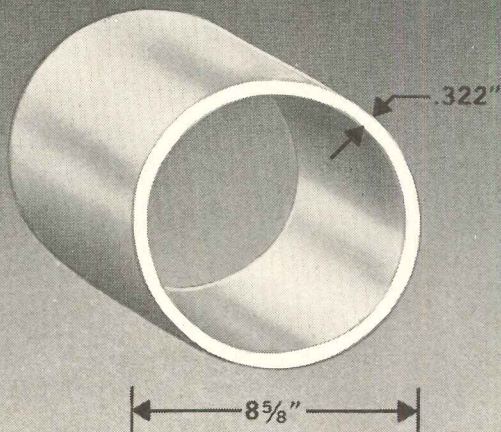

29 lb/ft

WIDE FLANGE BEAM

\$3.03
▲ per foot

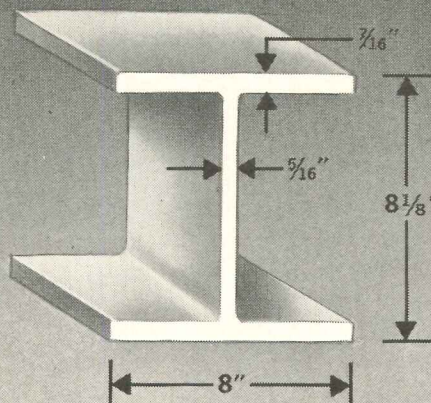

35 lb/ft

WELDED SQUARE TUBE

\$2.57
▲ per foot

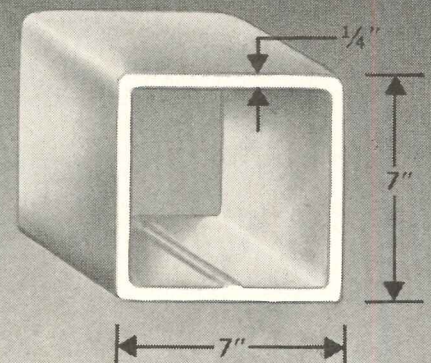

22 lb/ft

compare these price/weight advantages of square tubing over wide flange and pipe sections! Ask us for further facts and figures!

MINIMUM YIELD STRENGTH

PIPE _____ 36,000 psi

WIDE FLANGE BEAM _____ 36,000 psi

WELDED SQUARE TUBE _____ **46,000 psi**
or **50,000 psi**

ask for
our new
brochure



WELDED TUBE COMPANY OF AMERICA

SHUNK & VANDALIA STREETS
PHILADELPHIA, PENNA. 19148 • (215) 336-2000. TWX: 710-670-0488
1855 EAST 122nd STREET
CHICAGO, ILLINOIS 60633 • (312) 646-4500. TWX: 910-221-1347

For more data, circle 40 on inquiry card

Light is to be impressive by.
Light is to be friendly by.
Light is your personality
after dark.

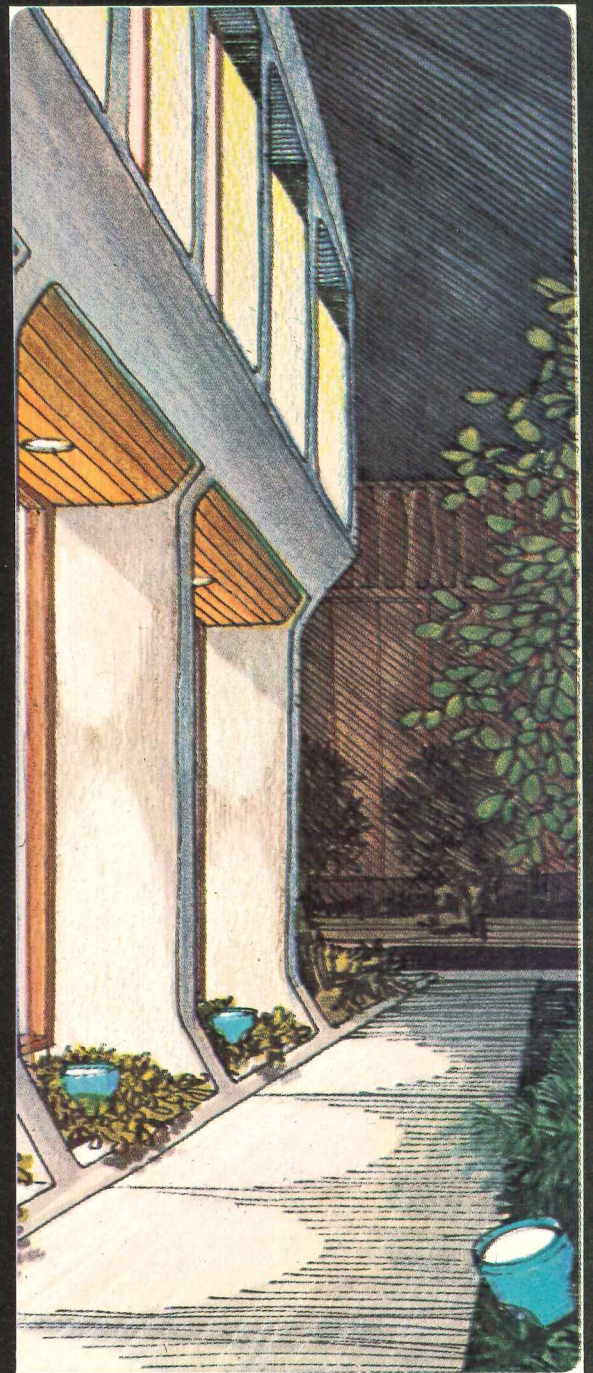
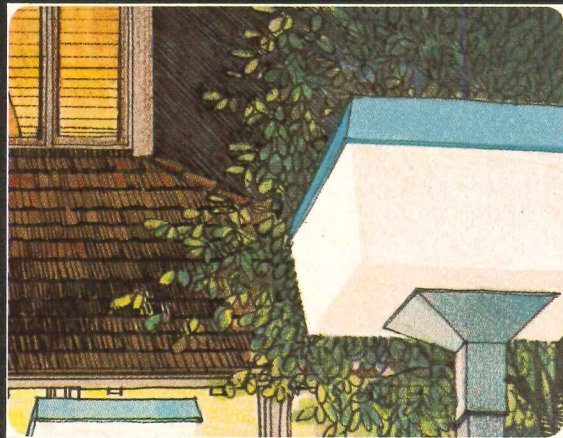
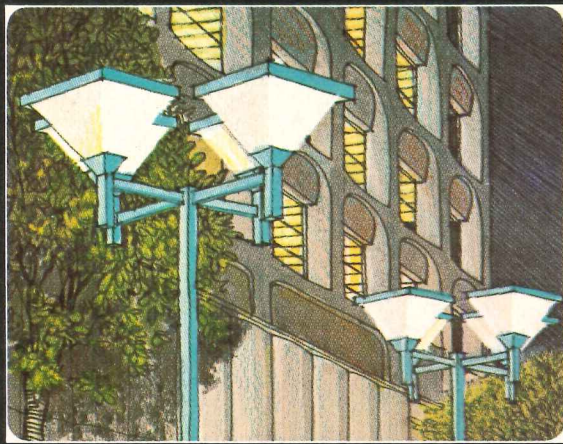

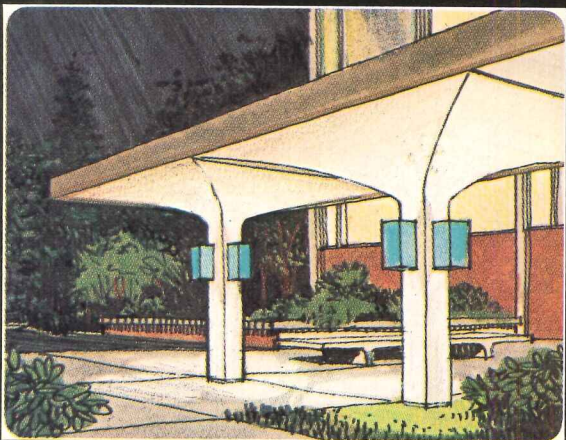
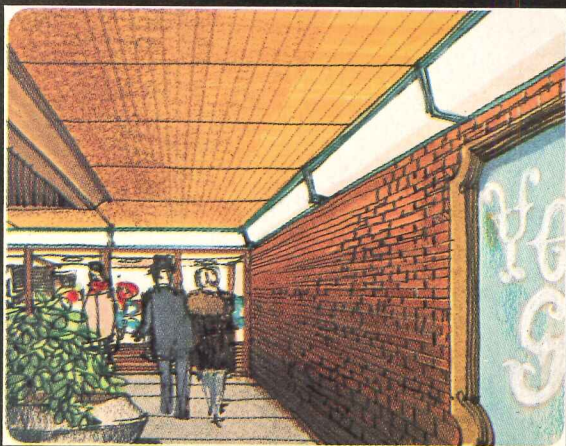
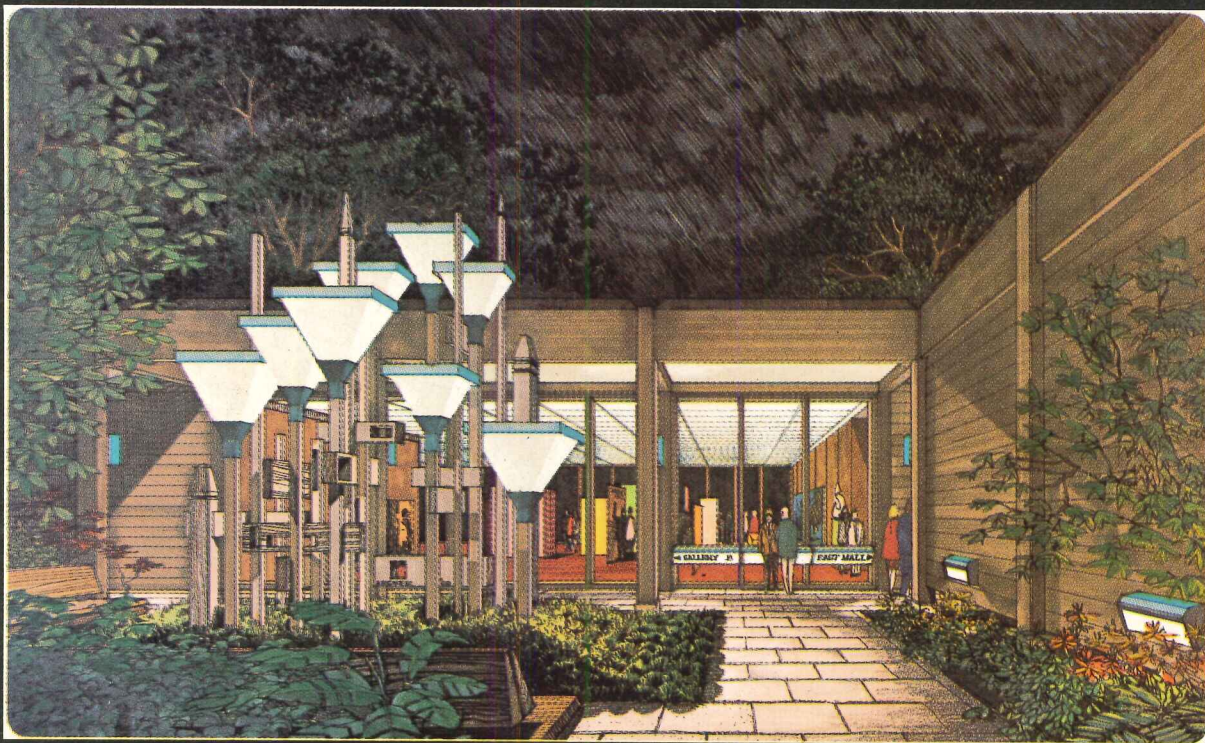

What you see and think of a building at night comes down to one thing. The light. It speaks for the architect. It speaks for the owner. We think light can speak eloquently.

You see a sample here. How our light fixtures coordinate to enhance the architecture. Post tops. Wall mounts. Up downs. Pencil beams. You name it, whether to spot a spire or flood an acre.

We can start with where you want to light. Or you can start with our Idea Book that covers the full spectrum. Check the reader service card. Call us. Or call your nearby Crouse-Hinds agent or distributor. We're ready to do the analyzing, costing and comparing, with an assist from our home office computer.

We'd like to hear from you. In the meantime, you can find us in Sweet's Section 16.8.

Lighting Products Division,
Crouse-Hinds Company,
Syracuse, N.Y. 13201

CROUSE-HINDS

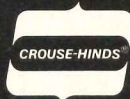

For more data, circle 41 on inquiry card

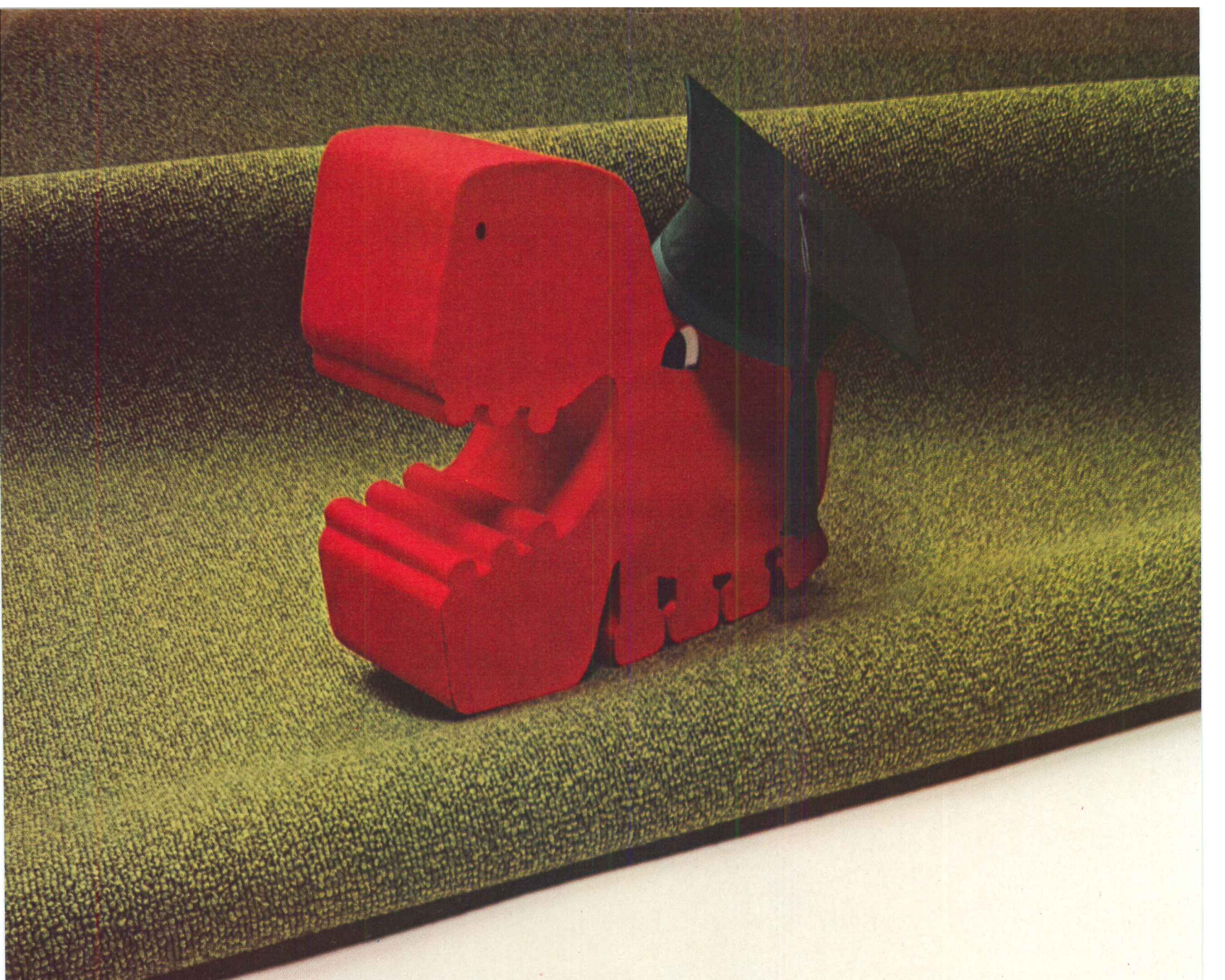

Anso[®] Nylon's five year carpet guarantee. It passes the school test with flying colors.

First one building. Then the second. Now the third building of this Educational Park for the Elkhart Community School System has Whipcord II carpet by Mohawk. It comes to more than 25,000 yards, all told.

Proof enough that this school community gives straight A's to ANSO nylon. And to Guaranteth—the guarantee with teeth. Allied Chemical's assurance that the carpet will not wear more than 10% in five years, or we'll replace it, installation included.

Allied can make this promise because we test every

carpet made of ANSO nylon—the second-generation soil-hiding nylon—ten different ways to be sure it will stand up.

So look for the label with the fierce little animal who symbolizes our Guaranteth. And get the carpet with the five year wear guarantee.

For your free copy of our Contract Carpet Manual, write to: Allied Chemical Corporation, Fibers Division, Contact Dept. AR, One [®] Times Sq., N.Y. 10036. Phone: (212) 736-7000.



Elkhart Memorial High School—Architect; Everett I. Brown Company, Indianapolis, Indiana.



For more data, circle 42 on inquiry card

Whatever happened to Standard Form 251?

Response to the January article on how design firms should approach government agencies was enormous. Biggest source of interest: how to cope with the Government Standard Form 251. Readers were invited to request a special guideline form used by the Corps of Engineers. That special form, it turns out, is used by only one of the COE districts and is being made available actually through the source of the article, the b.i.d.s. Jobletter. Gerre L.

Jones of Building Industry Development Services, publishers of the Jobletter, was invited to look into the several variations that seem to be developing around what was intended to be a standard form for simplification of the professional selection process for all Federal government agencies. The following is his report. It is suggested that any further inquiries be addressed to Mr. Jones at 1914 Sunderland Place, N.W., Washington, D.C. 20036

A contributing factor to the increased interest in Standard Form 251 undoubtedly is the greater significance it has taken on as a tool for governmental selection committees under the provisions of P.L. 92-582; the so-called "Brooks Bill."

Standard Form 251 was designed by the General Services Administration in 1960-61 and first published in June 1961. The original concept was to produce a questionnaire for Federal Government use which would elicit the significant information about design firms—work load, staff, experience, related work, branch office locations, etc.—in a standard format. Considerations such as easy and frequent updating and a size to fit standard filing cabinets also entered into the Standard Form design.

As the years passed, some Federal agencies accumulated great quantities of the Form 251. The Office of Construction of the Veterans Administration, for example, currently has more than 2000 of the forms on file. GSA has three or four times that number.

Eventually, the number of 251 forms to be dealt with threatened to engulf the storage facilities in some agencies. At about the same time, Federal agencies and departments began to obtain access to computer facilities—either their own or on a time-shared basis. Several years ago the Baltimore District office of the Corps of Engineers began distributing a supplementary sheet to Form 251 to its list of consultants. This turned out to be the thin edge of the wedge, as a general move got underway in the

larger government offices to computerize basic information about architects, engineers, planners and construction managers.

The Baltimore Corps office gradually organized its computer storage of 251 and the project was extended into other areas of the Corps' North Atlantic Region. The present supplement is NAD Form 778—April 72, Government Printing Office number 950-280. Consisting of 240 blanks, of which 199 are presently utilized, the supplement brings a whole new meaning to Block 13 of the original Form 251. An instruction sheet for completing the supplement accompanies NAD Form 778.

Few in the design professions could quarrel with the basic idea behind the Baltimore Corps' NAD Form 778. Almost everyone believes in progress and the Corps appeared to be moving toward a standardized supplement to Standard Form 251.

But healing balms, as is generally known, are sometimes plagued by bugs. The fly in this particular ointment appears to have been that no other Federal agency was aware of what the Baltimore Corps office was up to. Nor, for that matter, were the other Corps district and regional offices brought into the picture to a degree which would guarantee standardization.

In late 1972, computer supplements to Form 251 began to proliferate. The Sacramento, California District Engineers' office had its version, called simply "Page 2a," and designed to supplement Block 13 in Form 251. In Huntington, West Virginia, the Corps of Engineers generally adopted the format used by the Baltimore Corps office, but called their supplement "ORH Form 2451, 1 Nov 72."

The Veterans Administration has begun distribution of VA Form 08-6293, November 1972, "Supplement to SF 251, U.S. Government Architect-Engineer Questionnaire." The VA's supplement, as might be expected, asks for information on hospital and research projects.

Unlike the Corps of Engineers, the VA plans to store in its computers all of the data from a firm's 251, plus the information summarized in the new Form 08-6293. Like the

STANDARD FORM 251, JUNE 1961 GENERAL SERVICES ADMINISTRATION FED. PROC. REG. 141 CFR 1-116-003	U. S. GOVERNMENT ARCHITECT-ENGINEER QUESTIONNAIRE				See explanatory notes on page 9.		DATE (Month, day, and year)								
1. FIRM NAME		2. ESTABLISHED A. YEAR B. STATE		3. TYPE OF ORGANIZATION (Check one) <input type="checkbox"/> INDIVIDUAL <input type="checkbox"/> CORPORATION <input type="checkbox"/> OTHER (Explain in item 22) <input type="checkbox"/> PARTNERSHIP <input type="checkbox"/> JOINT VENTURE											
4. FORMER FIRM NAME(S), IF ANY, AND YEAR(S) ESTABLISHED				5. HOME OFFICE BUSINESS ADDRESS AND TELEPHONE NO.											
6. PRESENT BRANCH OFFICE(S)		A. ADDRESS		B. TELEPHONE NO.		C. NAME OF PERSON IN CHARGE									
7. PRINCIPALS OF FIRM		A. NAMES		B. ASSOCIATE MEMBERS OF FIRM		C. NAMES									
9. KEY PERSONNEL OF FIRM (Names)															
A. ARCHITECTS			D. STRUCTURAL ENGINEERS			G. ELECTRICAL ENGINEERS (Indicate Specialty)									
B. LANDSCAPE ARCHITECTS			E. SANITARY ENGINEERS (Indicate Specialty)			H. PLANNERS (Indicate Specialty as Site, City, Town, Community, etc.)									
C. CIVIL ENGINEERS			F. MECHANICAL ENGINEERS (Indicate Specialty)			I. OTHER KEY PERSONNEL (Indicate Specialty)									
10. NUMBER OF PERSONNEL IN YOUR PRESENT ORGANIZATION															
LOCATED AT		a. PRINCIPALS & KEY PERSONNEL*			b. OTHER PERSONNEL					TOTALS					
		ARCH. (1)	ENG. (2)	OTHER (3)	ARCH. (4)	ENGINEERS (5) MECH. (6) ELEC. (7) CIVIL (8) OTHER (9)			DRAFTSMEN (10)	SPEC. WRITERS (11)	ESTIMATORS (12)	INSPECTORS (13)	SURVEYORS (14)	BALANCE (15)	(15)
A. HOME OFFICE															
B. BRANCH OFFICES															
C. TOTALS															
11. NUMBER OF PERSONNEL IN YOUR ORGANIZATION DURING LAST 5 YEARS											A. MAXIMUM NO.	B. YEAR	C. NORMAL STRENGTH		

* (Total of items 7 and 9)

First of nine pages in the basic Standard Form 251

This cost-cutting
tool can save you
20% on your
next building's
walls.



It's the mason's trowel.
And in the hand of a skilled craftsman,
masonry can end up costing less than
metal, glass or precast concrete.

Less initially. And less in the long
run, too, since masonry needs less
maintenance.

What's more, because masonry
buildings aren't as expensive, you can
save on finance charges. And on real
estate taxes.

But wait. Let us prove it.

With a free comparative cost study,
"Walls to Save Dollars." Mail us the
coupon. We'll send the study.

It's chock full of information that can
save you a bundle next time you build.

Which makes the study a cost-cutting
tool, too.

**INTERNATIONAL
MASONRY INSTITUTE**

823 Fifteenth St., N.W., Washington, D.C. 20005
(202) 783-3908



I want to cut costs. Send me the tool, "Walls to Save Dollars." Mail to International Masonry Institute, Suite 1001, 823 15th Street, N. W., Washington D. C. 20005

Name

Title

Company

Address

City

State

Zip

Nature of business

AR

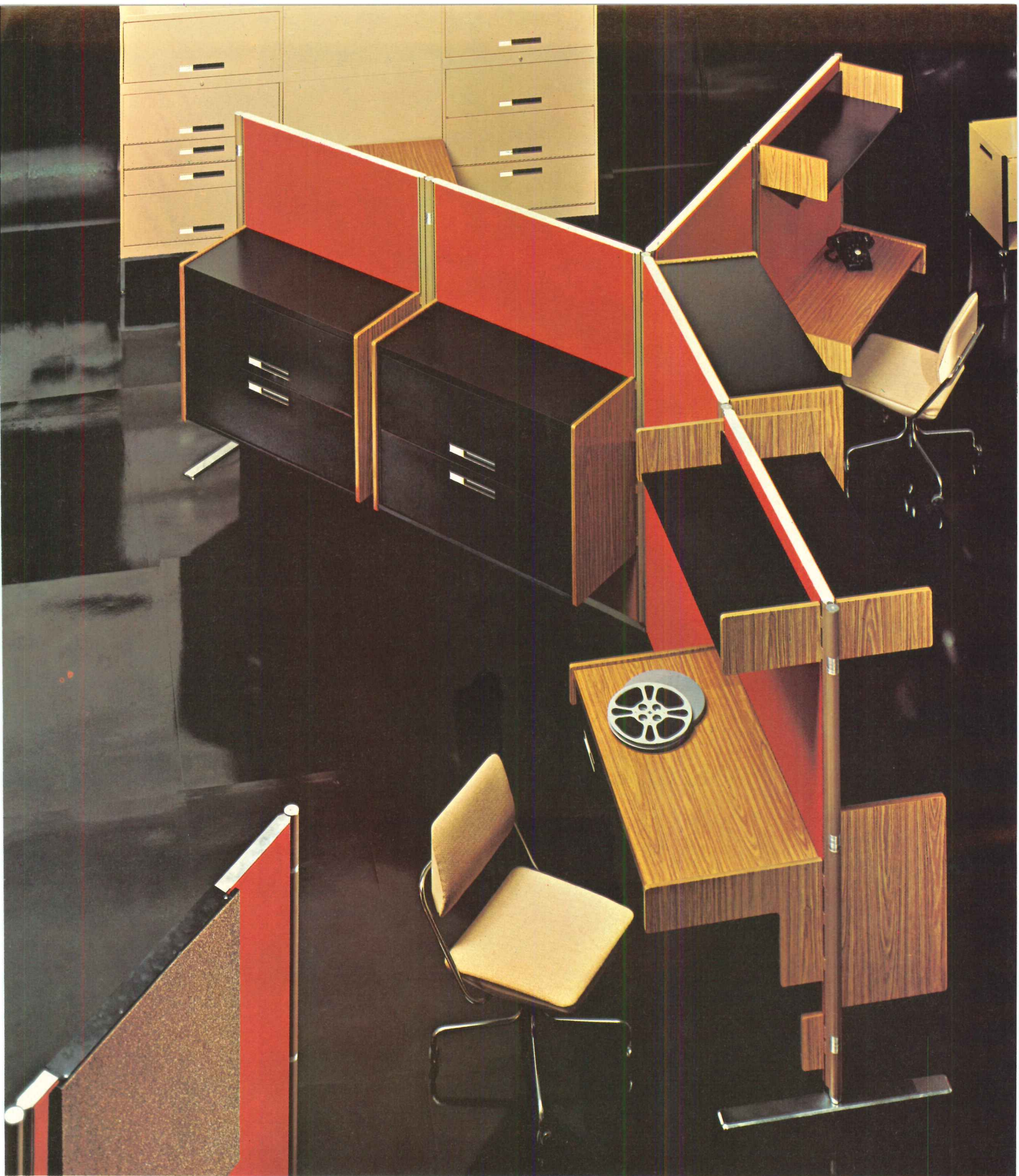

Space geography. Two durable open-office systems with one design identity provide total planning freedom... solve work-flow problems... allow for continuity of growth with the efficiency and convenience of one source:



INTERROYAL CORPORATION, ONE PARK AVENUE, NEW YORK, NEW YORK 10016 • (212) 686-3500

CURRENT TRENDS IN CONSTRUCTION

George A. Christie
Vice President and Chief Economist
McGraw-Hill Information Systems Company

Construction Outlook 1973: First Update

Now that economic recovery has finally reached the point of making it on its own, it's time to begin adjusting to some major shifts in economic policy. Among other things, this means that construction, usually the beneficiary of expansive fiscal and monetary conditions such as those we've seen these past two years, will also be among the first to feel the cutting edge of austerity.

In his new budget, the President has set a goal of cutting last year's deficit in half without adding any new taxes. That leaves room for only \$15 billion of extra spending—the smallest rise since Mr. Nixon took charge of things.

Within these constraints, the new Federal budget becomes mainly an exercise in deciding which programs are to bear the brunt of "fiscal conservatism." The President gave us most of the answer in his Second Inaugural Address with his doctrine of "... what can I do for myself" (i.e., accept revenue sharing in exchange for 100 or more community aid programs which are to be eliminated or cut back). And until the new budget takes effect at mid-year, he is relying upon the freeze of housing subsidies and the impounding of some \$8 to \$12 billion of funds for sewer and water facilities, college and hospital construction, highways, and other work to keep spending in check against runaway inflation.

Government's influence over credit markets—its other major means of shaping economic activity—is also bound to become more restrictive as the year goes on. The relaxation of price controls in Phase III will require the substitution of tighter money to contain inflationary pressures which may develop as we get closer to full employment.

While demands for construction in the public sector will be under considerable restraint through 1973, prospects will be improving steadily in the previously dormant private sector. The economy's strong fourth quarter surge in 1972 was evidence that recovery is finally in full swing, capable of taking off from here with the kind of self-generating momentum that business booms are made of. The "standard" forecast—a 10 per cent gain in GNP (six per cent real; four per cent price)—is an entirely reasonable expectation for 1973. One important development: the gap between output and capacity is narrowing rapidly. In order to sustain growth beyond 1973, we'll need—and we'll be getting—a healthy increase in business capital spending this year.

Most of the refinements of the F. W. Dodge Construction Outlook for 1973 in this First Up-

date are adjustments for level rather than for direction. Last year's final quarter came on so strongly that 1973 is off and running at a better rate than we previously expected. But otherwise, the several parts of the construction market are still heading along the same trajectories that we described in last October's forecast, published in RECORD, November 1972.

Stores and manufacturing lead in activity growth potential

Industrial and commercial building and electric power facilities will be up sharply, institutional building and public works construction will hold more or less steady, and housing will recede—although not by very much. As before, it all adds up to a total for 1973 that is not greatly different from last year's contract value.

■ **Business-related construction** will be doing what it always does in a period of vigorous economic expansion: expanding vigorously. As a category, it will increase by nearly

15 per cent in contract value (despite the fact that the office building market is moderately overbuilt and may decline slightly). Stores and warehouses are expected to add further growth to last year's gain of better than 30 per cent. For industrial building, 1973's economic conditions will nurture the recovery that was just beginning to take hold during the final half of 1972. And construction of power plants, off sharply last year for reasons that had more to do with ecology than the economy, will be back in stride soon.

■ **Institutional building potential** will be limited to about five per cent in 1973. Educational building needs are subsiding in response to the changing patterns of enrollments. And now that the government's new philosophy of budgeting emphasizes self-reliance, hospitals and other community health care facilities will have to depend more on loan guarantees and less on Federal matching grants for construction.

■ **Public works construction** is likely to be even more constrained in 1973. This is the area most directly affected by impounded funds (or, as the Administration prefers to call them, "budgetary reserves")—money appropriated by Congress which the President refuses to spend in order to hold to his budget ceiling for the current fiscal year. For highway construction this could mean no gain at all in 1973; for sewer and water projects it suggests a smaller gain this year than might otherwise have been expected.

■ **The housing boom** is in no danger of immediate collapse. The extraordinary liquidity of the savings institutions alone could support the current rate of homebuilding through mid-1973, provided demand holds up that long. Yet, the conditions that will bring about decline are accumulating: rental vacancies are rising, and the time it takes to fill new apartment projects is increasing; Phase III's relaxation of price controls implies tighter money; subsidized housing will inevitably grind to a halt later this year when pre-freeze approvals run out. So while the probability of another two-million-plus housing unit year remains very good (we're now estimating 1,200,000 one- and two-family homes and 900,000 apartment units for 1973), the second half decline could be quite steep, putting the opening and closing quarters of this year into sharp contrast.

How well the housing market holds up in the third and fourth quarters will be what determines whether total construction value in 1973 turns out higher or lower than last year's total.

National estimates 1973

construction contract value (millions of dollars)	1972	1973 forecast	% change
nonresidential buildings			
office buildings	\$ 5,314	\$ 5,100	- 4
stores and other commercial	6,143	6,900	+12
manufacturing	3,012	4,000	+33
educational	4,782	4,800	—
hospital & health	3,528	3,800	+ 8
other nonresidential buildings	4,339	4,700	+ 8
TOTAL	\$27,118	\$29,300	+ 8
residential buildings			
one- and two-family homes	\$28,109	\$27,000	- 4
apartments	15,131	13,800	- 9
nonhousekeeping	2,126	1,900	-11
TOTAL	\$45,366	\$42,700	- 6
TOTAL BUILDINGS	\$72,484	\$72,000	- 1
nonbuilding construction			
highways & bridges	\$ 7,799	\$ 7,800	—
utilities	3,543	4,500	+27
sewer & water supply	4,263	4,500	+ 6
other nonbuilding construction	3,124	3,300	+ 6
TOTAL	\$18,729	\$20,100	+ 7
TOTAL CONSTRUCTION	\$91,213	\$92,100	+ 1
Dodge Index (1967=100)	165	167	

This year, the need for designs that save energy is even more urgent.

Owens-Corning announces its 1973 Energy Conservation Awards Program for architects and engineers.

Show our Awards Jury a building design that doesn't waste energy—and you could win one of the Energy Conservation Awards Owens-Corning will present this year.

The Awards Jury will be looking for three things: Creativity. Originality. And most important—designs that save energy.

Too many buildings waste fuel and contribute to environmental pollution.

By continuing the Energy Conservation Awards Program we initiated in 1972, Owens-Corning hopes to stimulate even more new ways to conserve energy. And it will let us honor the architects and engineers who do the best job of designing buildings and mechanical systems that conserve fuel.

Who can enter. Any registered architect or professional engineer practicing in the U.S. is eligible. As an individual. Or in a team. But to qualify, your entry must be a commissioned building project—in the design process, under construction, or a completed structure.

Although Fiberglas* products are an excellent way to conserve energy, their use is not a requirement.

Four entry categories. A winner will be selected in each of these categories:

Institutional—schools and hospitals, for example.

Commercial—office buildings, shopping centers, retail stores, and similar structures.

Industrial—including manufacturing plants, research centers, warehouses.

*T.M. Reg. O.-C.F.



The Owens-Corning 1973 Energy Conservation Award. "Triangles," a Steuben crystal sculpture that captures and refracts light from multiple triangular planes.

Governmental—post offices, administrative buildings, and military structures to name a few.

The Awards. Winning architects and/or engineers will receive the Steuben Crystal sculpture "Triangles." Owners or clients associated with winning entries will receive other Steuben Crystal awards.

The Awards Jury for 1973. Seven outstanding professionals in architecture and engineering will serve as the Awards Jury to select the winners.

Walter A. Meisen, Public Buildings Service, General Service Administration, Washington, D.C.; James E. Wheeler,

Wheeler and Stefo-
niak, Inc.,
Dallas;
Ronald E.
Aspgren,
Montgomery
Ward, Chicago;
Robert B. Hollister,
Turner Construction
Co., Cincinnati; Profes-
sor Gifford Albright, Dept.
of Architectural Engineering,
Pennsylvania State University;
Jack Vincent, Energy and Process
Systems Division, VTN Consolidated
Inc., Irvine, Calif.; Frank M. Leberman,
Synergo Co., Philadelphia.

Send for entry details now. Completed entries must be submitted by August 31, 1973. Winners will be selected in September and notified in early October.

For a brochure giving complete details, contact your local Owens-Corning representative. Or write H. D. Meeks, Owens-Corning Fiberglas Corporation, Fiberglas Tower, Toledo, Ohio 43659.

Owens-Corning is Fiberglas



For more data, circle 45 on inquiry card

One-Controllables

Kohler celebrates its 100th birthday with Centura — a new line of single control faucets for tub, basin and sink.

Centura. Kohler's One-Controllables—single-control convenience, sparkling chrome beauty, quality by Kohler's Bold Craftsmen.

Pictured: (A) Centura push-pull lavatory faucet; (B) Centura single-lever sink faucet; (C) Centura push-pull bath and shower control.

All have self-contained, non-metallic, non-corroding cartridges with only one moving part that is permanently lubricated and completely isolated from water. Cartridge offers full 180-degree turn and easy lift for temperature and volume adjustment. Temperature does not return to inconvenient neutral setting when shut off.

For more great kitchen and bath ideas, write Box FR, Kohler Co., Kohler, Wis. 53044.

KOHLER
100
BOLD CRAFTSMEN
SINCE 1873

For more data, circle 46 on inquiry card



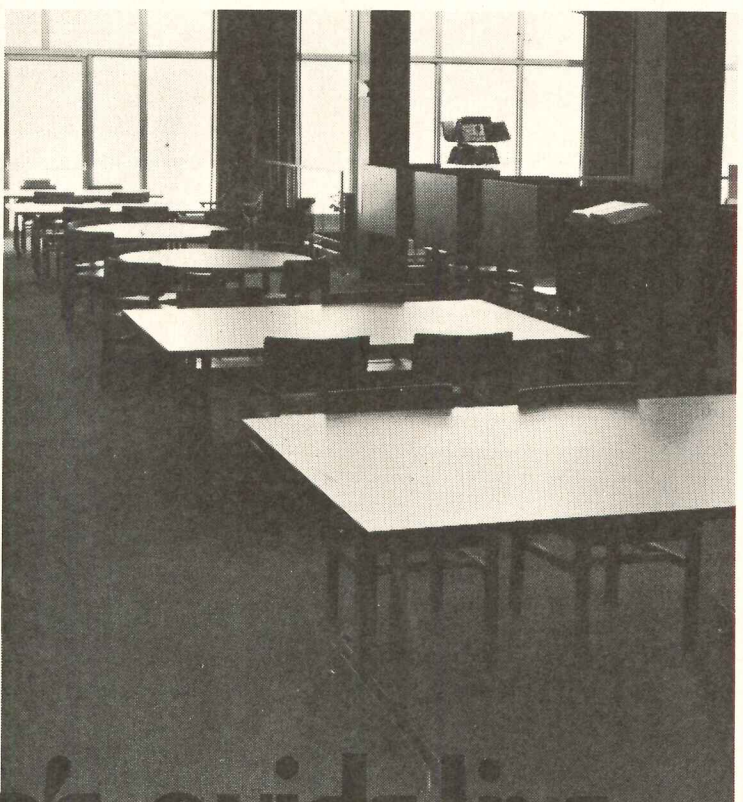
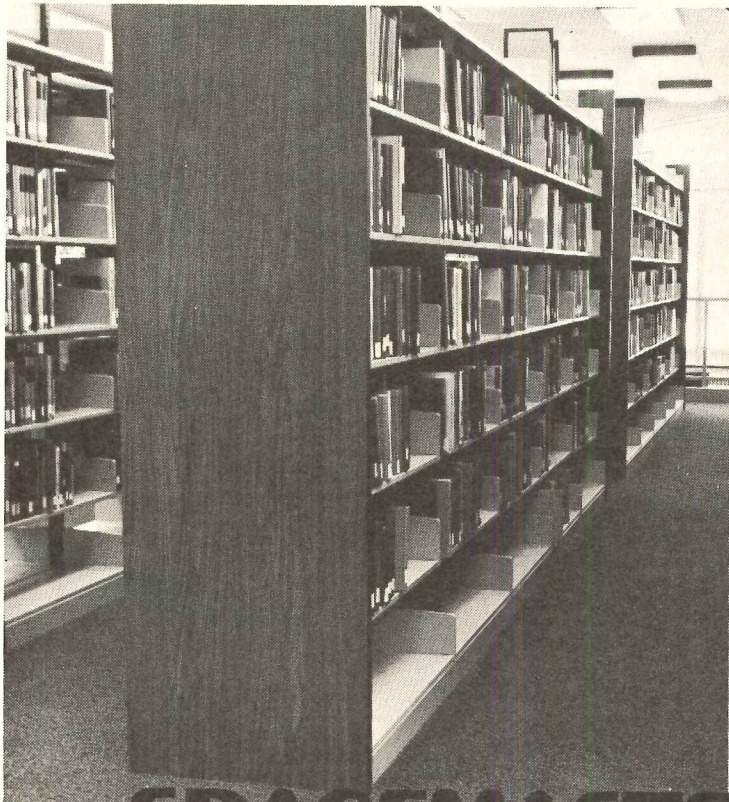
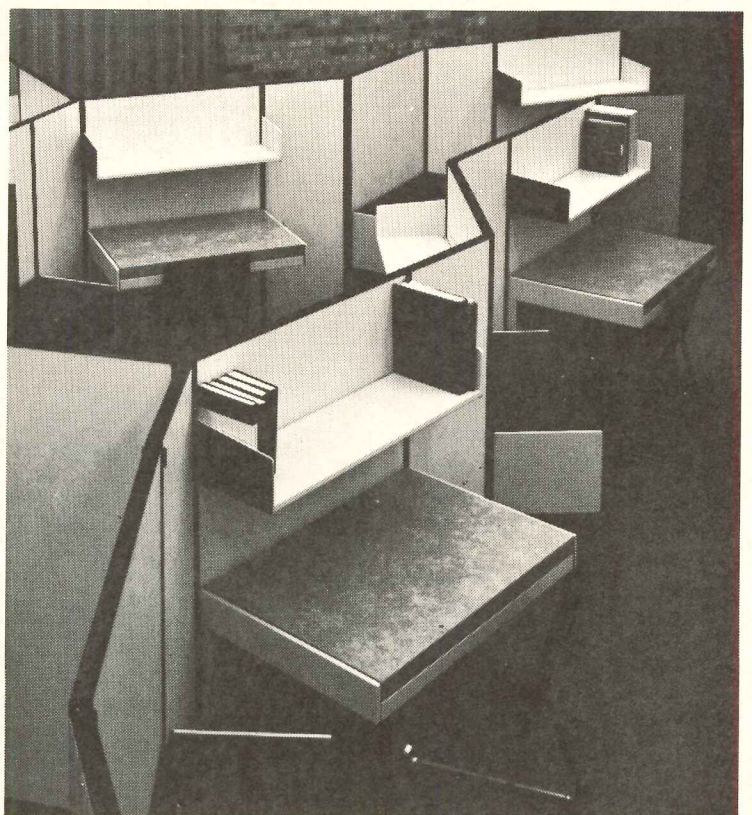

SPACEMASTER'S GUIDE LINE

Choose Spacemaster's T-Base furniture and you establish the guide to continuously unified and perfectly functional furnishings for your library. T-Base Book Stacks, Study Carrels, Tables, and Landscape Partitions all look good together and work well together.

Design integrity! Quality too, with Spacemaster's T-Base furnishings endorsed by use in leading libraries across the country.

Your local Spacemaster representative will assist you in designing, pricing and installing Spacemaster's equipment. It's your guide line!

Gentlemen, please send your latest catalog. 4AR

Name _____

Position _____ Institution _____

Address _____

City _____ State _____ Zip _____



Educational Products Division
REFLECTOR HARDWARE CORP.
 A SPACEMASTER CORPORATION COMPANY
 1400 North 25th Avenue, Melrose Park, Illinois 60160

GSA ENTERS VALUE ENGINEERING PHASE

The U.S. General Services Administration has implemented the final phase of its Value Engineering program by adding architect-engineer and construction manager services to the cost effectiveness effort.

Larry F. Roush, Acting Commissioner of GSA's Public Building Service, made the announcement at a seminar held by the Consulting Engineers Council and the American Institute of Architects on "Value Engineering and the A-E Community." "The basis of the architect-engineer and construction manager program," Roush said, "is the assumption that a cost effectiveness program would be most advantageous when applied to the design phase."

GSA utilizes Value Engineering as a prime method to reduce life-cycle costs of a building or contract through consideration of functions and configurations of materials.

GSA was the first Federal agency to introduce VE requirements in professional services contracts. The program was begun under Acting Administrator of General Services, Arthur F. Sampson, while serving as PBS Commissioner. Participation previously was limited to PBS personnel and construction contractors.

"Commencing today," Roush said on March 1, this will change. We will place a "level of effort" VE clause in most of our professional services contracts for architect-engineers and construction managers." The degrees of service will generally fall into one of four categories: basic, moderate, extensive and special.

Metropolitan area	April 1973 Cost differential	1941 average for each city=100.00 (except as noted)				% change last 12 months
		Current Indexes				
		non-res.	residential	masonry	steel	
U.S. Average	8.2	411.2	386.0	402.3	392.3	+ 9.20
Atlanta	7.6	523.1	493.2	508.5	496.9	+ 9.29
Baltimore	8.0	449.8	422.8	438.9	425.3	+13.84
Birmingham	7.2	376.9	350.5	364.3	359.9	+ 9.19
Boston	8.9	419.8	396.6	415.1	403.3	+ 9.73
Buffalo	9.0	459.5	431.4	452.3	438.4	+ 9.56
Chicago	8.2	472.3	449.0	456.3	449.2	+10.05
Cincinnati	8.4	436.4	410.6	425.8	414.8	+ 7.63
Cleveland	8.8	443.3	417.0	433.4	422.7	+ 5.18
Columbus, Ohio	8.0	430.5	404.2	417.6	409.8	+ 7.42
Dallas	7.5	411.4	398.3	401.9	394.1	+11.62
Denver	7.8	434.7	408.9	428.4	414.4	+ 7.83
Detroit	9.4	469.0	446.7	471.2	452.6	+11.15
Houston	7.2	381.3	358.0	371.4	363.8	+ 6.28
Indianapolis	7.6	374.5	351.7	365.5	357.4	+ 5.67
Kansas City	8.1	393.1	371.4	383.8	374.0	+11.18
Los Angeles	8.1	463.7	423.8	448.2	440.0	+11.16
Louisville	7.4	406.7	381.9	396.1	386.9	+ 8.68
Memphis	7.3	382.4	359.0	369.1	363.4	+ 6.68
Miami	7.7	424.4	404.3	411.8	403.5	+ 7.02
Milwaukee	8.1	455.5	427.7	447.3	433.3	+ 6.17
Minneapolis	8.6	435.8	409.9	428.8	418.0	+ 7.19
Newark	8.6	403.8	379.1	397.2	388.8	+ 7.80
New Orleans	7.1	387.4	365.7	380.3	371.8	+ 8.89
New York	10.0	464.4	431.7	452.6	440.9	+11.56
Philadelphia	9.1	464.8	442.8	460.4	447.5	+16.51
Phoenix (1947 = 100)	7.8	236.7	222.2	228.4	224.7	+10.52
Pittsburgh	8.8	411.2	386.8	405.6	393.5	+11.47
St. Louis	8.6	433.8	409.4	426.2	416.1	+10.97
San Antonio (1960 = 100)	7.0	149.9	140.8	145.4	142.1	+ 3.58
San Diego (1960 = 100)	8.0	164.6	154.6	160.9	157.3	+10.12
San Francisco	9.4	620.3	567.0	613.6	595.1	+13.28
Seattle	8.2	398.9	356.9	394.4	379.0	+ 7.00
Washington, D.C.	7.7	388.3	364.6	376.7	367.8	+ 9.41

Cost differentials compare current local costs, not indexes.

HISTORICAL BUILDING COST INDEXES—AVERAGE OF ALL NON-RESIDENTIAL BUILDING TYPES, 21 CITIES

1941 average for each city = 100.00

Metropolitan area	1963	1964	1965	1966	1967	1968	1969	1970	1971	1972 (Quarterly)				1973 (Quarterly)				
										1st	2nd	3rd	4th	1st	2nd	3rd	4th	
Atlanta	306.7	313.7	321.5	329.8	335.7	353.1	384.0	422.4	459.2	472.5	473.7	496.1	497.7	516.4				
Baltimore	275.5	280.6	285.7	280.9	295.8	308.7	322.8	348.8	381.7	388.1	389.3	418.8	420.4	441.8				
Birmingham	256.3	260.9	265.9	270.7	274.7	284.3	303.4	309.3	331.6	340.4	341.6	356.7	358.3	371.7				
Boston	244.1	252.1	257.8	262.0	265.7	277.1	295.0	328.6	362.0	377.3	378.5	392.8	394.4	414.0				
Chicago	301.0	306.6	311.7	320.4	328.4	339.5	356.1	386.1	418.8	422.8	424.0	442.7	444.3	465.3				
Cincinnati	263.9	269.5	274.0	278.3	288.2	302.6	325.8	348.5	386.1	399.9	401.1	400.1	410.7	430.4				
Cleveland	275.8	283.0	292.3	300.7	303.7	331.5	358.3	380.1	415.6	415.2	416.4	427.7	429.3	436.7				
Dallas	253.0	256.4	260.8	266.9	270.4	281.7	308.6	327.1	357.9	364.9	366.1	385.0	386.6	407.3				
Denver	282.5	287.3	294.0	297.5	305.1	312.5	339.0	368.1	392.9	398.3	399.5	413.8	415.4	429.5				
Detroit	272.2	277.7	284.7	296.9	301.2	316.4	352.9	377.4	409.7	416.9	418.1	431.5	433.1	463.4				
Kansas City	247.8	250.5	256.4	261.0	264.3	278.0	295.5	315.3	344.7	348.7	349.9	365.4	367.0	387.7				
Los Angeles	282.5	288.2	297.1	302.7	310.1	320.1	344.1	361.9	400.9	407.8	409.0	422.9	424.5	453.3				
Miami	269.3	274.4	277.5	284.0	286.1	305.3	392.3	353.2	384.7	391.5	392.7	404.8	406.4	419.0				
Minneapolis	275.3	282.4	285.0	289.4	300.2	309.4	331.2	361.1	417.1	401.7	402.9	411.3	412.9	430.6				
New Orleans	284.3	240.9	256.3	259.8	267.6	274.2	297.5	318.9	341.8	350.9	352.1	368.1	369.7	382.1				
New York	282.3	289.4	297.1	304.0	313.6	321.4	344.5	366.0	395.6	406.5	407.7	421.5	423.1	453.5				
Philadelphia	271.2	275.2	280.8	286.6	293.7	301.7	321.0	346.5	374.9	394.2	395.4	417.9	419.5	459.3				
Pittsburgh	258.2	263.8	267.0	271.1	275.0	293.8	311.0	327.2	362.1	364.5	365.7	378.7	380.3	406.3				
St. Louis	263.4	272.1	280.9	288.3	293.2	304.4	324.7	344.4	375.5	385.5	386.7	400.9	402.5	427.8				
San Francisco	352.4	365.4	368.6	386.0	390.8	402.9	441.1	465.1	512.3	535.3	536.5	559.4	561.0	606.4				
Seattle	260.6	266.6	268.9	275.0	283.5	292.2	317.8	341.8	358.4	363.0	364.5	369.9	371.5	388.4				

Costs in a given city for a certain period may be compared with costs in another period by dividing one index into the other; if the index for a city for one period (200.0) divided by the index for a second period (150.0) equals 133%, the costs in the one period are 33% higher than the costs in the other. Also, second period costs are 75% of those in the first period (150.0 ÷ 200.0 = 75%) or they are 25% lower in the second period.

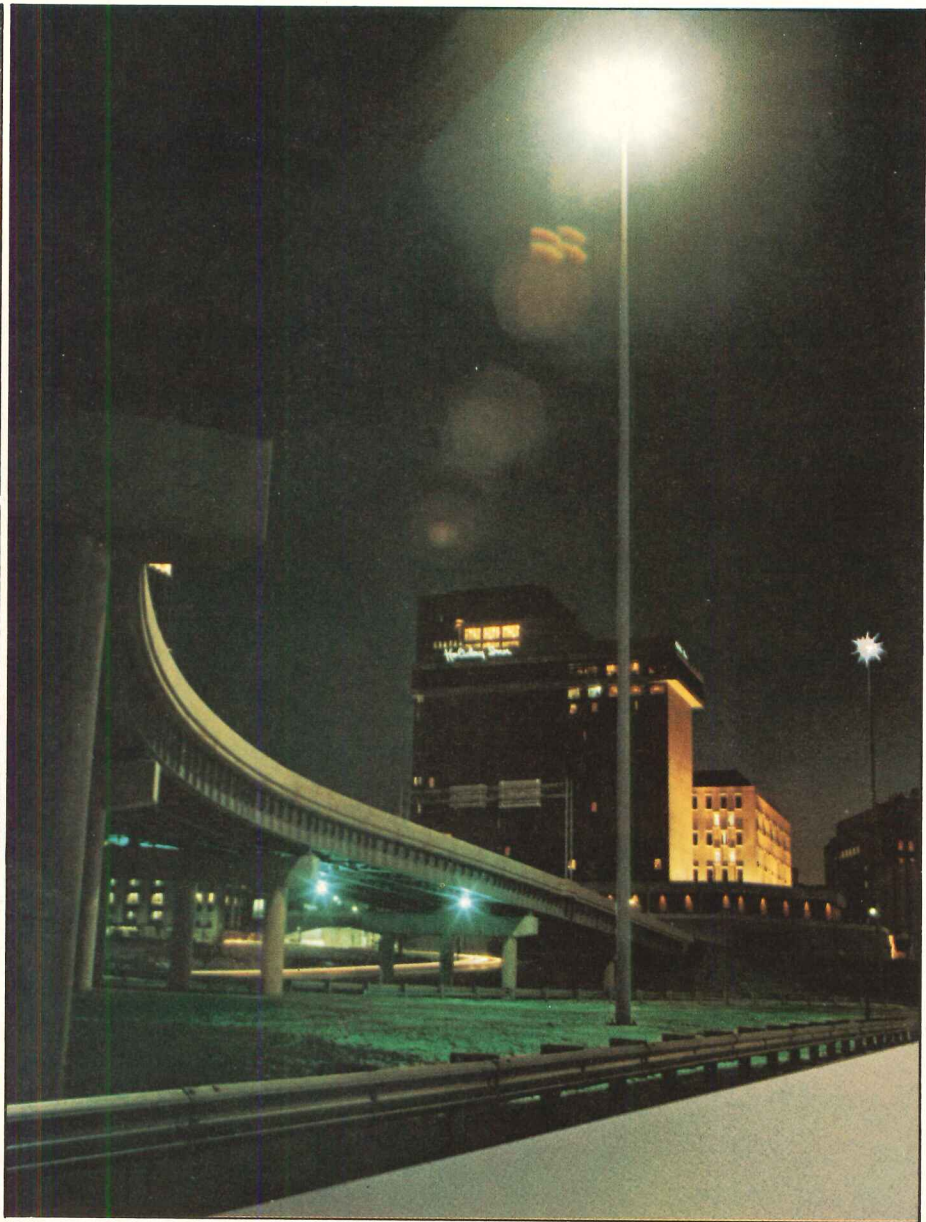
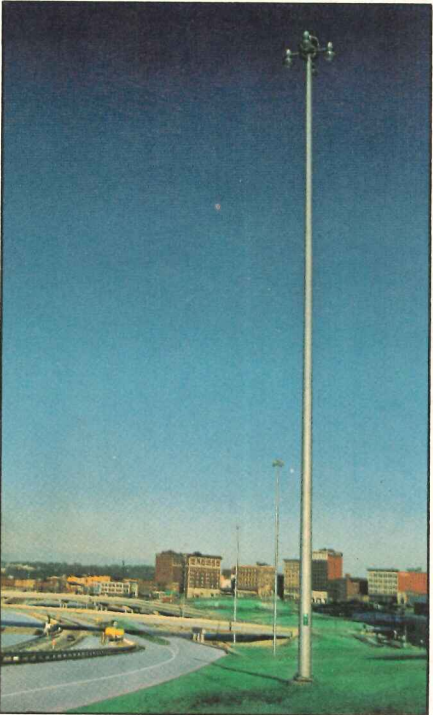
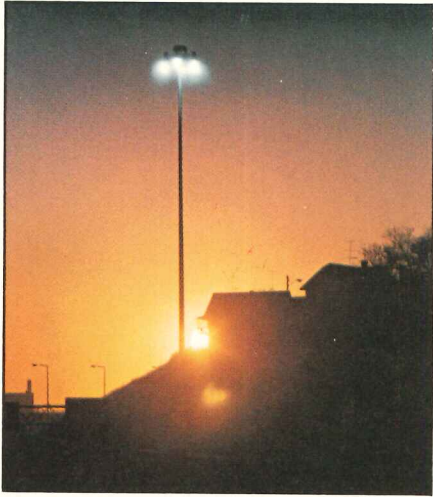

Monotube[®] High-Mast Light Poles

...have the
versatility to
meet exacting
specifications.

For example, Monotube High-Mast Light Poles can be designed for applications requiring heights of 200 feet or more. If desired, we will factory assemble and ship in one piece.

Different steels and finishes are other Monotube pluses—weathering, carbon, galvanized, epoxy, finished or prime painted are yours for the asking.

This versatility and the know-how of the industry's most experienced pole manufacturer are the benefits you get from specifying and using Monotube High-Mast Light Poles.

We've got what it takes!

Union METAL
MANUFACTURING COMPANY

Write or call: The Union Metal Manufacturing Company, Canton, Ohio 44711 • Phone (216) 454-6111

For more data, circle 48 on inquiry card

the 'M' chair

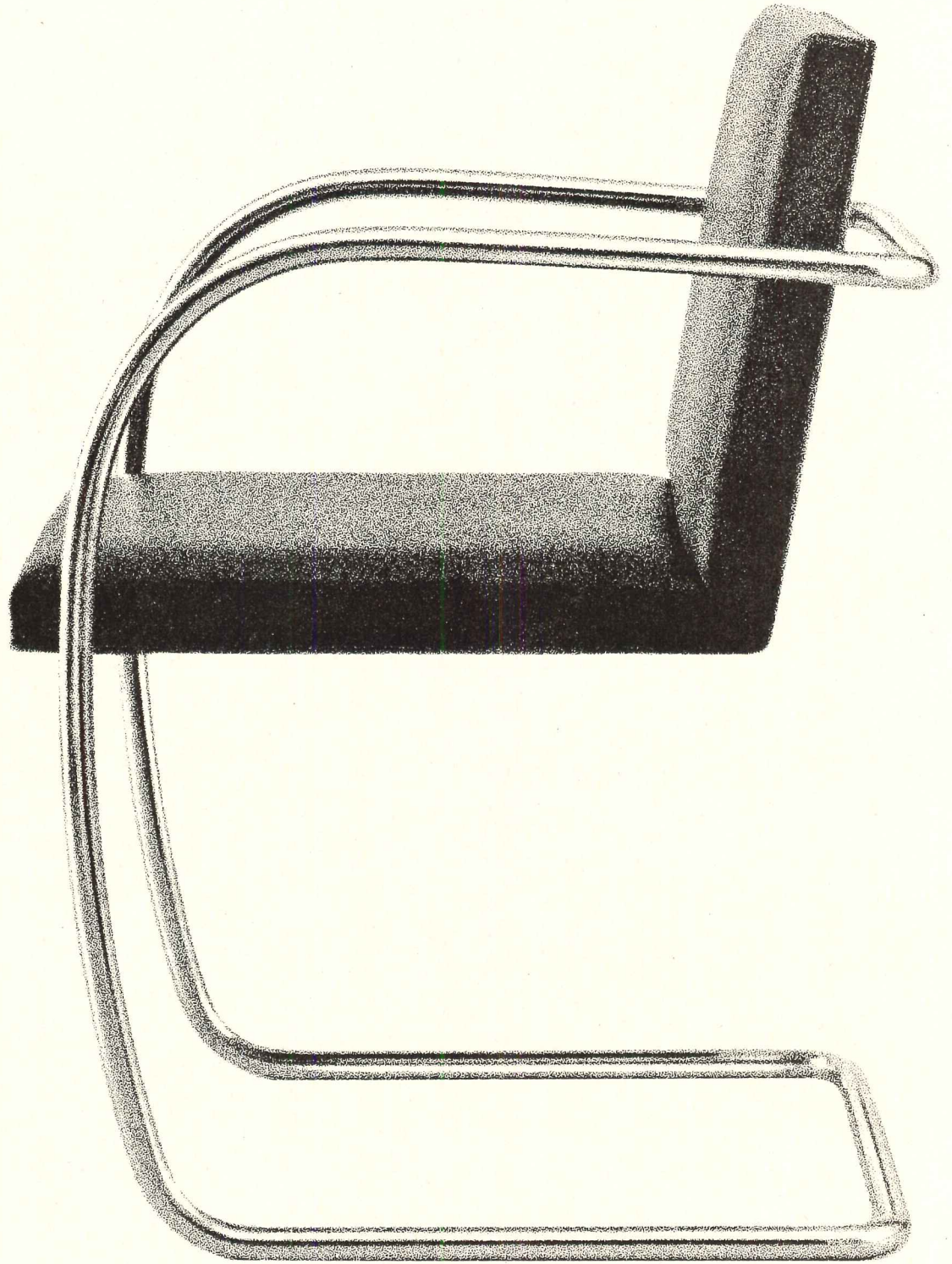

Scope Furniture Inc.

407 West 13th Street
New York, New York 10014
Tel. 212 243-0488

For more data, circle 49 on inquiry card



Efficient building idea: Recent report tells how to solve the acoustical problems of open offices.



Good news for architects who like the design freedom of open offices—but don't like the acoustics.

Tests by an independent acoustical testing agency show you can get excellent open office acoustics by using these three things (with the help of an acoustical consultant):

1) An acoustically non-reflective ceiling—so the sound won't bounce off to other areas.

2) Sound-controlling screens—to stop sound from going directly

from one area to another.

3) A masking sound system—so personal conversations can be held in a normal voice without being overheard.

Of all the ceilings tested for Owens-Corning Fiberglas—including expensive coffered and baffled systems—the best was Owens-Corning's Nubby II Fiberglas* Ceiling Board in a standard grid suspension system.

If you'd like the whole story,

send for our free design guide, "Achieving Acoustical Privacy in the Open Office."

Write to Mr. P. F. Meeks
Owens-Corning Fiberglas Corp.,
Fiberglas Tower, Toledo,
Ohio 43659.

Energy Conservation Award.

Owens-Corning is offering awards to stimulate new designs and ideas for conserving energy. See our advertisement in this magazine for details.

*T.M. Reg. O.-C.F.

Owens-Corning is Fiberglas

OWENS/CORNING
FIBERGLAS
TRADEMARK ®

For more data, circle 50 on inquiry card

PPG's Solarban® 575 Twindow® insulating glass.

A look at a smart money building: comfortable environment; comfortable economics.

S. S. Kresge Company executives, who know a lot about successful retailing, also know a lot about successful building.

When they commissioned the design of their new International Headquarters Building, they asked the architect to provide an economically reasonable, but comfortable, working environment for an executive and administrative staff of more than 2,500 persons.

And like most smart money people, Kresge, anticipating growth, asked for a complex that could be easily expanded in the future.

The architect's solution was an assembly of building modules, each two to four stories high, with 10,000 square feet on each floor. Connecting modules provide large, contiguous open spaces for the clerical staff. And

each module has its own mechanical services in an adjacent tower. This modular concept allows for future building additions without disruption of existing work areas.

The architect chose his exterior building materials for economics as well as esthetics. The exterior is colored in warm bronze and brown—specially glazed brick, no-maintenance weathering steel, and 77,000 square feet of high-performance *Solarban 575 Twindow* insulating glass from PPG. (The *Solarban 575* unit, with a *Solarbronze*® coverplate, takes on a muted bronze tone that complements the coloring of the other exterior materials.)

The *Solarban Twindow* units also contribute to the comfortable working environment. Their insulating construction reduces heat loss during the



winter. The exclusive *Solarban* coating reduces the sun's harsh glare for visual comfort and significantly reduces solar heat gain during the summer.

And these performance characteristics provide another economic bonus: day-to-day savings in the operating costs of the heating and air conditioning equipment.

Look into the advantages of *Solarban 575 Twindow* insulating glass—or the others in our family of Environmental Glass—for your next building. Early in the design stages.

Write to PPG Industries, Inc.,
One Gateway Center, Pittsburgh,
Pa. 15222.

PPG: a Concern for the Future



INDUSTRIES

For more data, circle 51 on inquiry card

Owner: S. S. Kresge Company, Troy,
Michigan
Architects and Engineers: Smith, Hinchman &
Grylls Associates, Inc., Detroit, Michigan



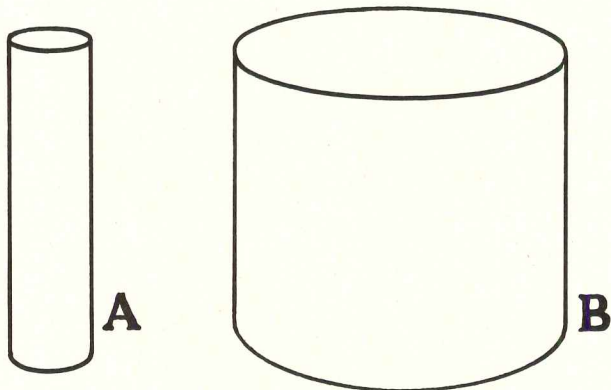

Quiz: Will the skinny tank (A) hold more cool water than the fat Oasis storage tank (B)? Obviously not. The large tank in an Oasis water cooler means it will serve more cool water to more people. With less wear and tear on the compressor. In fact, the compressor lasts so long, we back it up—and the entire cooler—with a full five-year warranty. Get Oasis. The coolers built to last. See them in Sweet's, in the Mechanical Products Catalog or write us.

OASIS[®]

The word for water coolers.

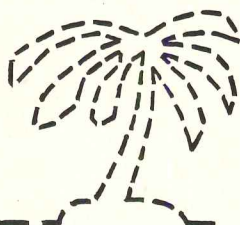

Ebco Manufacturing Co.
Dept. AR-1
265 N. Hamilton Rd.
Columbus, Ohio 43213

I want to know more. Please send me your full-line catalog.
Plus a copy of your five-year warranty.

NAME _____ TITLE _____

FIRM _____

ADDRESS _____

CITY _____ STATE _____ ZIP _____

For more data, circle 52 on inquiry card

REQUIRED READING

MEXICAN LANDSCAPE ARCHITECTURE: From the Street and From Within, by Rosina Greene Kirby. Mrs. Kirby's book should be of interest to anyone willing to shell out the necessary \$27.50. She rightly points out that "in the treatment of outdoor space for human use, Mexico has—throughout her history—exhibited an extraordinary feeling and sensitivity rarely found elsewhere." This history and tradition, too, are beyond the ken of most American architects. It would be well if this were not so, since a good many of the essential features of Mexican landscape architecture have as much to do with architecture as with plants. That is, most of the special outdoor spaces in Mexico are created by the careful arrangement of buildings, or at least of walls—be they monolithic temples at Monte Albán, standing free in a vast landscape, or the public plazas in Mexican cities and towns, or the secluded patios and *atrios* in Mexican houses.

The text of the book is compact and sensible, but it is the photographs which carry most of the message. They are good-looking, and range from precolonial to modern examples, including many of the extraordinary creations of Luis Barragán, the most famous contemporary Mexican landscape architect.

Mrs. Kirby argues strongly that Mexican landscape architecture is essentially Mexican rather than a provincial version of Spanish models. She may have a point, but in any case her book gives designers north of the border valuable exposure to a tradition that is not their own, even as they are taking a new interest in their own tradition and its practitioners—like Frederick Law Olmstead—in a search for ways to make the built environment outdoors pleasantly habitable.

University of Arizona Press, Tucson, 1972, 167 pages, illus., \$27.50.

THE PENGUIN DICTIONARY OF ARCHITECTURE, Second Edition, by John Fleming, Hugh Honour and Nikolaus Pevsner. This enlarged edition of its predecessor will probably find itself in the hands of scholars and amateurs more than in those of architects. But it is concise, comprehensive and therefore useful to professionals. It offers biographical sketches and technical definitions that run the gamut from the familiar—"Ictinus," "prestressed concrete"—to the obscure—"Hugh May," "aedicule" ("a shrine framed by two columns supporting an entablature and pediment, set in a temple and containing a statue"). If the nascent enthusiasm for historic preservation in this country ever grows to the stature it deserves, then this book will give architects invaluable first-aid as they trip over the subtle distinctions between "cyma recta" and "cyma reversa." In any case, like all good dictionaries, this one is fun to read. Unfortunately there is no guide to pronunciation, and so most of us are likely to continue to mispronounce "pilaster."

Penguin Books, Baltimore, 1973, paperback, 315 pages, illus., \$2.10.

For more data, circle 53 on inquiry card

all in the family



1000 watt
large area
light

400 watt
street
light

175 watt
walkway
light

kim lighting, inc.

City of Industry, California

Street and Area Lighting
Environmental Lighting
Landscape Lighting
Swimming Pool Lighting
Fountain Lighting
Custom Architectural Fountains
Pre Engineered Fountains
Fountain Components

A DIVISION OF
LCA
CORPORATION



terr a z z o

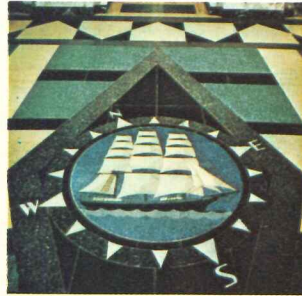

dream.

Anything you can dream up on your drawing board, you can do in terrazzo. Anything. Intricate geometrics. Abstracts. All-over patterns. Colors. Textures. □ Floors, to be sure. Also walls, stairs, decorative structures or centerpieces. In marble, quartz, granite or a myriad of unusual aggregates. Even in textured mosaics. And new blends of marble chips. □ The ancient art of terrazzo has been changing. It's really a new technology with new versatility. New methods. New materials. Many of its applications today are truly innovative. If you've had the opportunity to talk with a terrazzo contractor recently, you have an idea of what we mean. □ You'll also get an idea from "A Walk on the Wild Side." That's the appropriate title of our colorful new brochure describing the infinite possibilities terrazzo offers. Circle the number for your copy. For technical assistance, or a copy of new Terrazzo Design Data, containing 125 true-color terrazzo reproductions, contact Derrick Hardy, Executive Secretary, Terrazzo, 716 Church Street, Alexandria, Virginia 22314. (703) 836-6765.

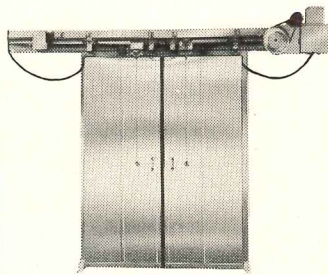

NEW! Jamiglide™ Power Doors

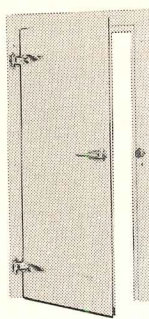

Jamolite® Plastic Doors

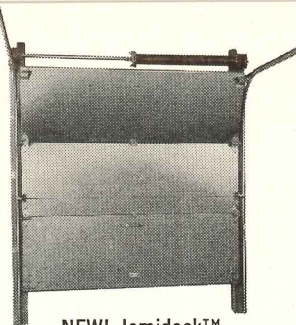

NEW! Jamidock™ Overhead Cooler Doors

You get more from Jamison

(THE COLD STORAGE DOOR PEOPLE)

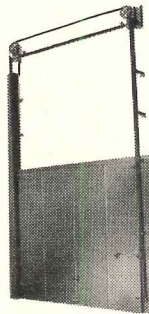

NEW! Jamidock™ Vertical Sliding Cooler Doors

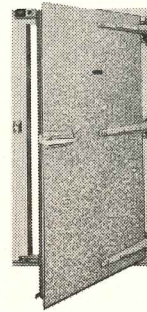

Plyfoam® General Purpose Doors

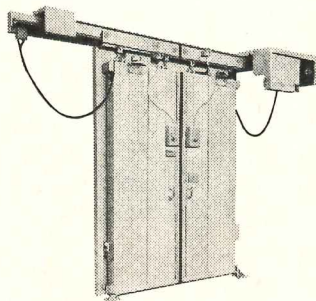

Electroglide® Power Doors

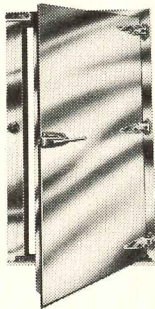

Food Service Personnel Doors

More doors

designed and built by Jamison to meet your needs precisely!

■ Our newly-expanded line now makes it possible for you to get traditional Jamison quality and service in **every** price range. Jamison exercises complete control over design, materials, and every step in manufacture to assure finest quality and maximum performance. And you also benefit by getting more technical assistance, from more door specialists, than you can get anywhere else.

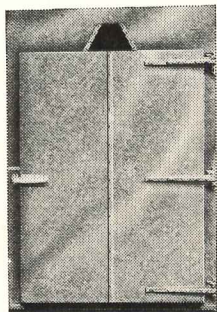

Plyfoam® Meat Rail Doors

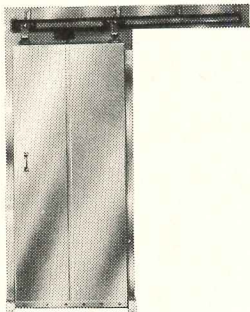

NEW! Jamiglide™ Manual Doors

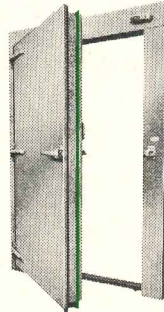

Plyfoam® Blast Freezer Doors

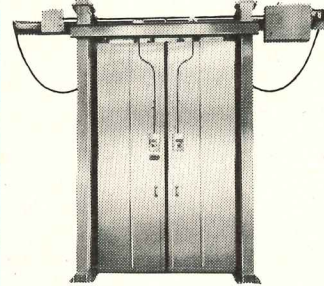

NEW! JamiSStand® Self Supporting Doors



Banana Room All Steel Doors

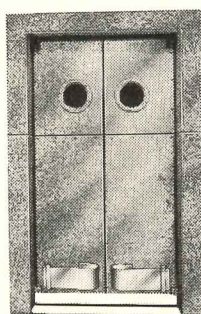

Auto Close Double-Acting Doors

Write or call for full details on the complete Jamison line, which now includes the widest price range in the industry.

the one to see in '73... **JAMISON**
COLD STORAGE DOORS BY
JAMISON DOOR CO • HAGERSTOWN, MD 21740

For more data, circle 55 on inquiry card



a) Grandstand, Indiana State Fairgrounds, Indianapolis, Ind. b) Kimberly-Clark Warehouse, Fullerton, Calif. c) Berths 80 & 82, Elizabeth-Port Authority Marine Terminal, in Elizabeth, N.J. d) Indoor pool, Kensington Club, Inc., South Bend, Ind. e) Delta Air Lines Hangar, Atlanta, Ga.

This is Alcoa Snug Rib roofing.
It's flat, tight and handsome.

Alcoa® Snug Rib roofing gives you all the advantages and savings of low-pitch construction plus excellent leak resistance. Since slopes as low as ¼ in. in 12 in. are possible, there's less dead space to heat or air condition. The patented Snug Seam® joint holds panel edges securely in place to create a weathertight seal, and there are no through fasteners to penetrate the weathering membrane. Since Snug Rib roofing is a "floating" system, it moves under thermal cycling, so locked-up thermal stresses are eliminated. Installa-

tion is fast and easy, and savings continue over the life of the building because aluminum requires so little maintenance. On most buildings end laps can be eliminated because lengths are limited only by shipping conditions. Handsome Alcoa Snug Rib roofing is ideal for swim clubs, industrial and port buildings, warehouses, grandstands and aircraft hangars. For more information on economical Snug Rib roofing, write Aluminum Company of America, 1130-D Alcoa Building, Pittsburgh, Pa. 15219.



Change for the better with Alcoa Aluminum



For more data, circle 56 on inquiry card



We helped turn the



Tennis has been moving indoors out of the cold, the wet, the wind, the sun and the night.

But there's still a stumbling block—the lighting. Light shining down on the players gets in their eyes and makes it hard to see the ball.

The Square Lake Racquet Club in Bloomfield Hills, Michigan, solved this problem with uplighting instead

of downlighting.

They use 142 Sylvania Metalarc lamps in an indirect lighting system, giving them uniform, glare-free illumination all over their courts.

Thousand-watt Metalarc high-intensity lamps emit a light nearly five times stronger than incandescent lamps of the same wattage. Which means it takes fewer lamps



lighting business upside-down.

and less electricity to light up a court.

The lamps have an average rated life of 10,000 hours. They last about ten times longer than 1000-watt incandescents.

And they're color-balanced to produce a natural effect. It's like bringing the outdoors indoors.

The lamps have been used for

years for direct lighting of stores, factories, ball parks, car lots and parking lots.

Now more and more tennis courts are using Metalarc lamps in fixtures pointed up to the ceiling.

Whole new illumination systems have been developed to take advantage of the Metalarc's good points.

So thanks to a lamp with a lot on the ball, things are looking up in the lighting business.

For details, call your GTE Sylvania representative or local distributor (in the Yellow Pages under Lighting) —or write to Sylvania Lighting Center, Danvers, Mass. 01923.

GTE SYLVANIA

Ozite carp



CRUSH RESISTANCE

Ozite carpeted the Baltimore Zoo with its new Colony Point carpet of HERCULON* olefin fiber. First came the elephant test. Result . . . not even 7,000 pounds of pachyderm could make a lasting impression on Colony Point's tightly packed pile of HERCULON. So bring on the heavy furniture!

*Hercules registered trademark



SNAG RESISTANCE

We even threw Colony Point carpet to the lions. But it took it all in stride, without a snag. Because of Colony Point's revolutionary new no-snag construction, even the king of beasts couldn't unravel its textured beauty. So why worry about little kids?

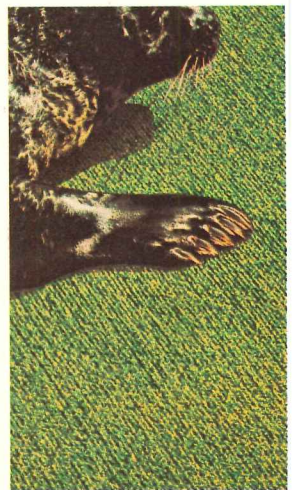

Ozite® "Colony Point" made with pile of HERCULON.® A

ets a zoo.



MOISTURE RESISTANCE

We let a group of happy, fish-loving seals throw a picnic on new Colony Point carpet of HERCULON. But it was easy come . . . easy go. HERCULON resists moisture, so all kinds of messy stains clean up fast.



BEAUTY

The resident peacock was justly proud of his wide range of colors. Until Colony Point's dazzling array of carpets and carpet tiles put him to shame. That may be a mean way to treat a peacock . . . but what a beautiful way to treat your installations . . . indoors and out.

Ozite's new textured Colony Point carpet held up beautifully at the Baltimore City Zoo. Isn't that the kind of carpet you want when specifying for schools, hospitals, office buildings and other installations that demand extraordinary toughness and good looks?

**Contact Ozite for samples and details.
Ozite Corporation
Libertyville, Illinois 60048**

whole new way of looking at indoor/outdoor carpet.

Walls of the perfect



Durasan: environment.

Bright. Cheerful. Practical.

Durasan . . . the vinyl-surfaced gypsum wallboard has style and beauty . . . yet is practical all the way. Practical because you save when you specify. Your client saves in future maintenance.

First, you save on installation. Because these 4'-wide, ceiling height panels can be nailed to studs, laminated to existing surfaces, or inserted in Gold Bond Contempo-Wall® demountable partitions. So you can install Durasan in new construction. Use Durasan for remodeling. Or consider Durasan for 'landscaping partitions' or movable wall designs.

Second, you save on finishing. Once Durasan is up, it's finished. Each gypsum panel is surfaced with one of many textures, patterns, or colors of vinyl film . . . factory laminated to insure good bond.

Finally, Durasan offers some savings any client will appreciate. Its tough vinyl surface is stain resistant, easy to wipe clean. And it stays clean and new looking for years. The Durasan colors and textures won't "date" a building either.

Durasan is just one of many constructive ideas for a better environment. Talk to your Gold Bond man. Or write National Gypsum Company, Gold Bond Building Products Division, Dept. AR-43G, Buffalo, N. Y. 14225.

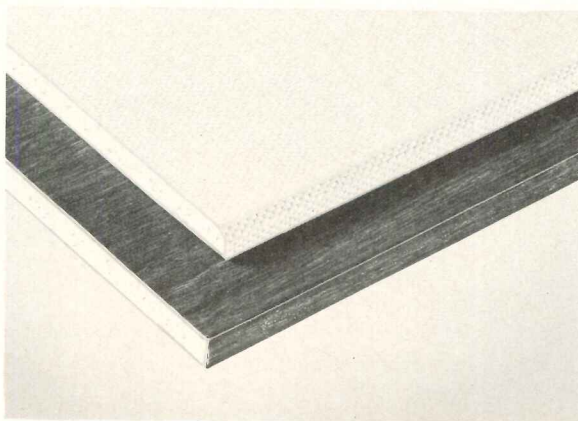

Durasan panels save money. With its bonded vinyl surface, a Durasan wall costs less installed than building a wall and then applying a comparable vinyl wall covering.



This is how fast Durasan goes up. Without interrupting normal work, workers can install Durasan panels. And if Durasan makes remodeling that easy, think how easy it makes new construction.



For more data, circle 59 on inquiry card

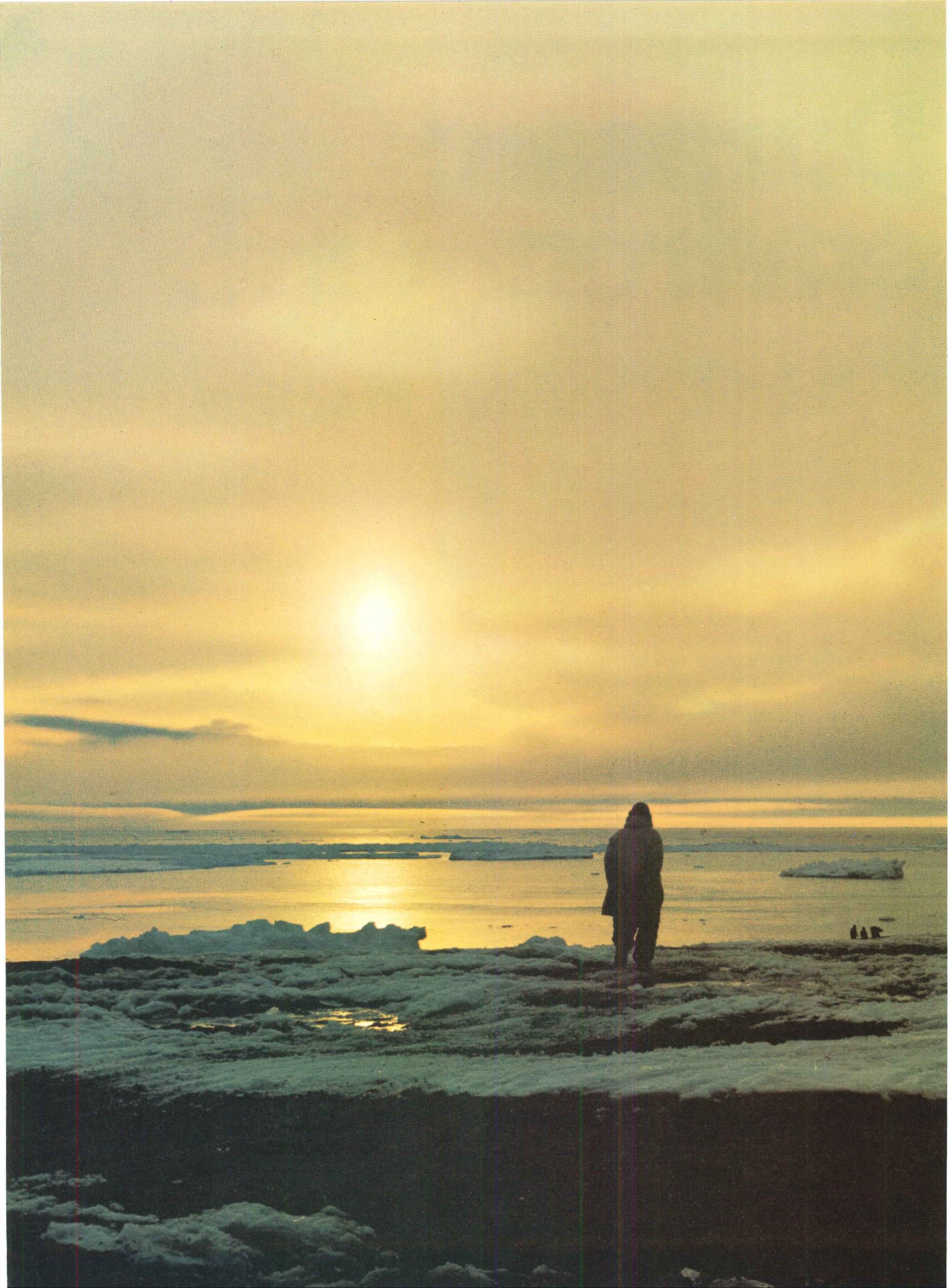

We replaced the sun in St. Mary's.

Around October, heat and light become precious in St. Mary's, Alaska. Winter comes early. It stretches down from the Arctic Circle like a giant sheet, blotting out the sun and smothering the warmth.

The people of St. Mary's must be ready. And, they are.

Two days after Christmas of 1969, the Mayor of St. Mary's flicked the switch of their new generating plant. The generators whirled and brought a new life to these Arctic people. And the power behind this new life was supplied by a 16V-71N Detroit Diesel engine . . . an engine which has performed flawlessly ever since.

Electricity came to St. Mary's, as it has to other Alaskan villages, through the cooperation and skill of a Detroit Diesel Allison distributor. This distributor was provided specs by the Alaska Village Electric Co-op. He then custom built the com-

plete generating plant, including a second peaking and service generator powered by a Detroit Diesel 6-71.

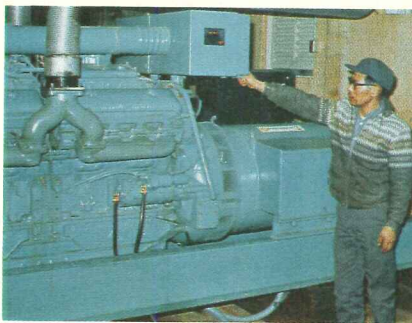

Why were Detroit Diesels chosen for the job? Three reasons: 1. They are reliable, proven in countless hours of the toughest kind of work. 2. They are basically simple engines, easy to maintain. 3. And most important, the Detroit Diesel Allison distributor had the know-how to handle the entire job, from start to finish.

The installation of this new power plant has meant everything to the people of St. Mary's. A new fish processing plant has opened on the waterfront. The nearby

airport uses it for vital navigational aids. And the generators will soon be used to power St. Mary's new 50-bed hospital.

Needless to say, these people depend entirely on this power source. And if part of your job is finding and specifying dependable power, then you should find out more about Detroit Diesel Powered Electric Sets. Just check with your nearest Detroit Diesel Allison distributor. He'll work with you in every possible way, actually custom building the exact electric set for your job. Any job, whether it's prime power for an entire town, or standby for emergency use.

To find out more about Detroit Diesel power, clip this coupon and we'll send you the latest catalog on Detroit Diesel Powered Electric Sets. Write:



Detroit Diesel Allison

Division of General Motors,
P.O. Box 81, Birmingham, Mich. 48012

NAME _____

COMPANY _____

ADDRESS _____

ZIP _____

GD01-AR-04-AC

Detroit Diesel Powered Electric Sets
Now you're talking power.

For more data, circle 60 on inquiry card

Announcing New Trane Rooftop Multizone Units

**Advanced control concept
reduces energy requirements**

TRANE announces a new line of curb-mounted rooftop multizone units in the 17 to 34 ton range. The units offer many advantages in terms of reliability and ease of installation, operation and maintenance, but their most significant feature is an advanced solid state control system designed to conserve energy. This control system provides operating cost savings over most existing rooftop multizone control systems.

The TRANE Energy Control System

determines which zone requires most heating and which zone requires most cooling.

These two zones serve as the controlling zones. The hottest zone always has its cold deck damper fully open and its hot deck damper fully closed. The coldest zone always has its hot deck damper fully open and its cold deck damper fully closed.

All other zones, through dual sensing of the zone and unit duct sen-

sors, receive a proper proportion of mixed air from the hot and cold decks to precisely meet their requirements.

In the hottest and coldest zones, either the hot or cold deck dampers are fully closed, so no energy is wasted in air mixing. And dual sensing maintains the heating and cooling functions at their most economical level.

This system eliminates the need to overheat or overcool zones to get a control response. This conserves energy and reduces operating costs. More even zone temperatures are obtained with less cycling of the mechanical equipment. This provides greater comfort with less equipment wear.

Institutional quality and reliability.

The TRANE Rooftop Multizone unit contains the same rugged efficient components as used in institutional quality, field assembled, engineered systems. Among them are the

TRANE Model M compressor, TRANE coils and TRANE stainless steel tubular heat exchanger. All components are factory assembled and tested as a complete system and enclosed in a weathertight but accessible cabinet. As a result, the units provide a degree of reliability comparable to field assembled, engineered systems.

Quick to install.

TRANE Rooftop Multizone units are factory assembled and receive a complete run-test before shipment. They arrive at the job-site ready for final positioning on a full roof curb.



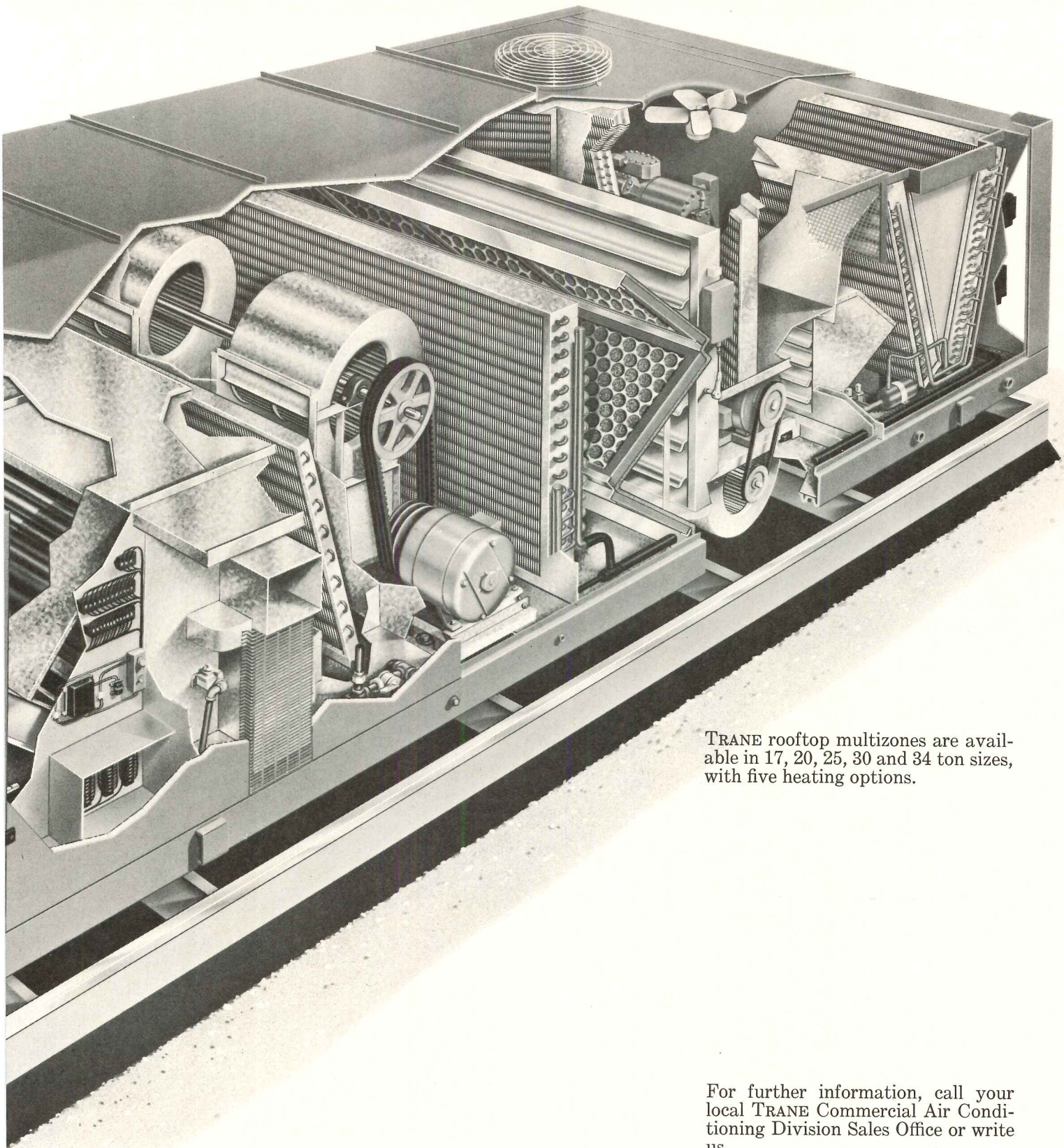

TRANE rooftop multizones are available in 17, 20, 25, 30 and 34 ton sizes, with five heating options.

**Automatic operation,
simplified maintenance.**

A remote control panel, with or without night setback, makes operation automatic. Maintenance is simplified by hinged panels with hold-open hooks providing access to all major components. An optional maintenance controller allows one man at the unit to completely check out all phases of operation.

**Local service backup,
nationwide.**

TRANE provides local service backup through over 80 TRANE Service Agencies throughout the nation.

Rooftop multizone units are the latest addition to the broad line of TRANE equipment designed for outdoor applications—air cooled reciprocating water chillers, Penthouse Climate Changers, single zone rooftop heating and cooling units and direct fired Torrivents.

For further information, call your local TRANE Commercial Air Conditioning Division Sales Office or write us.

The TRANE Company, Commercial Air Conditioning Division, La Crosse, Wisconsin 54601



For more data, circle 29 on inquiry card

Great ideas in inner space:

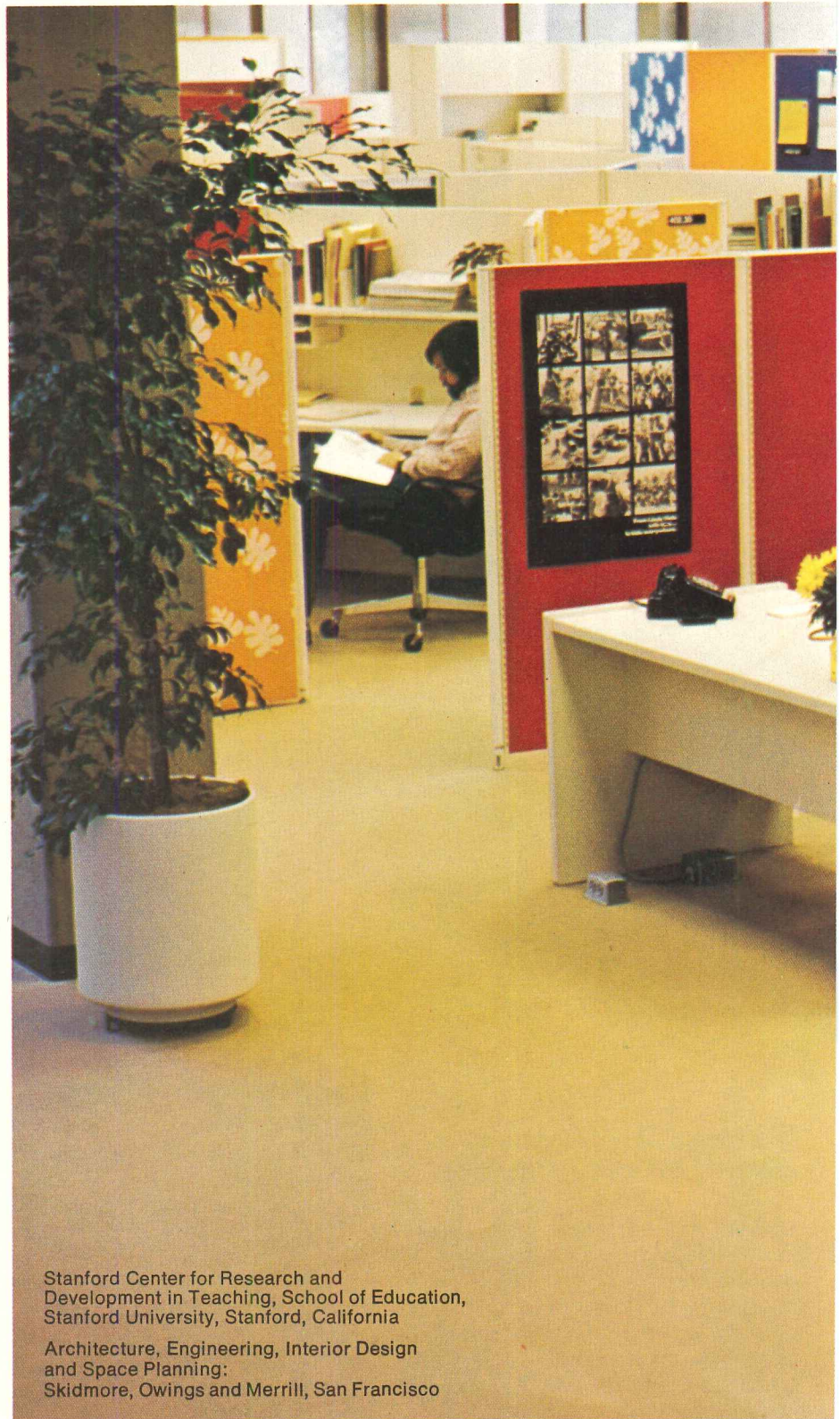
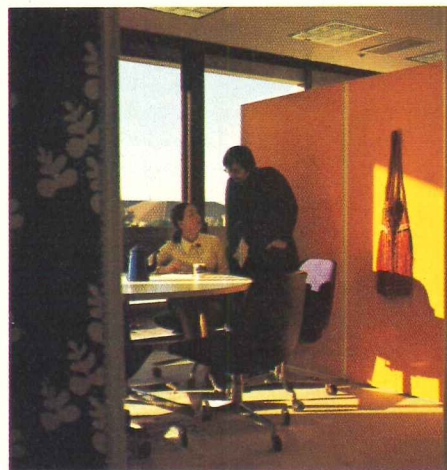

Stanford Center for Research and Development in Teaching, School of Education, Stanford University, Stanford, California
Architecture, Engineering, Interior Design and Space Planning: Skidmore, Owings and Merrill, San Francisco

Westinghouse ASD Group enriches new R & D environment at Stanford.



"At first, there was general skepticism here about the whole idea of open office planning," reports Dr. Robert N. Bush, Director of Stanford University's new Center for Research and Development in Teaching.

"Many of our people felt this sort of system might work for business and industry, but not in academic life.

"Now, after a few months' experience with it, some of our strongest critics tell us they like the way the open environment improves the communications and workflow of contiguous groups. It is a pleasant place to work.

"What I like especially about the system is its capacity for modification as program needs change.

"The ASD people have worked with us more as partners than suppliers," says Dr. Bush. Westinghouse problem-solving resources are helping make Stanford's first open planning experience a good one.

Inviting open offices at Stanford have encouraged freer interaction among the researchers, reduced the number of time-consuming meetings.

If you are considering a change at your office—either new construction or renovation—look into flexible, functional Westinghouse ASD Group. Showrooms in New York, Chicago, Los Angeles, and Grand Rapids.

Westinghouse
Architectural Systems Department,
4300 36th Street, S.E.,
Grand Rapids, Michigan 49508.
Telephone 616 949-1050.

HPA-5-72

Westinghouse ASD Group



For more data, circle 61 on inquiry card

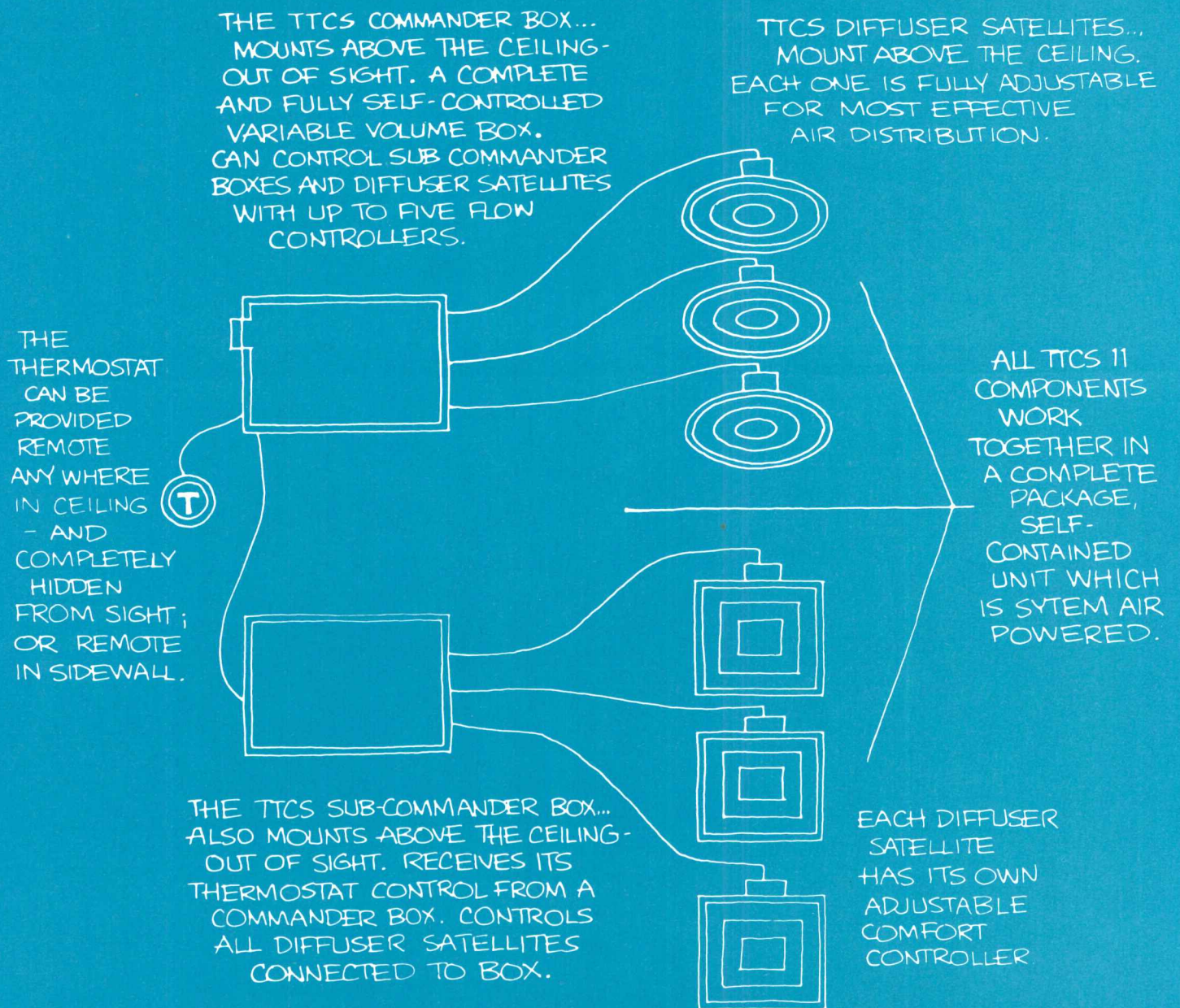

TTCS II... the new Titus "take command" total comfort system

The most sophisticated variable air volume system available. ■ Titus TTCS II truly "takes command" — as no other environmental system can — of the full range of elements necessary to produce today's finest, most efficient, big performance comfort system.

- TTCS II is easy to install, balance and maintain.
- It "takes command" of economy and energy. Because it is system-powered — is single duct — and saves space.
- TTCS II "takes command" of aesthetics. Because everything

You have complete freedom of architectural ceiling design — you make no compromises in air diffusion efficiency — when you specify the Titus TTCS II Comfort System.

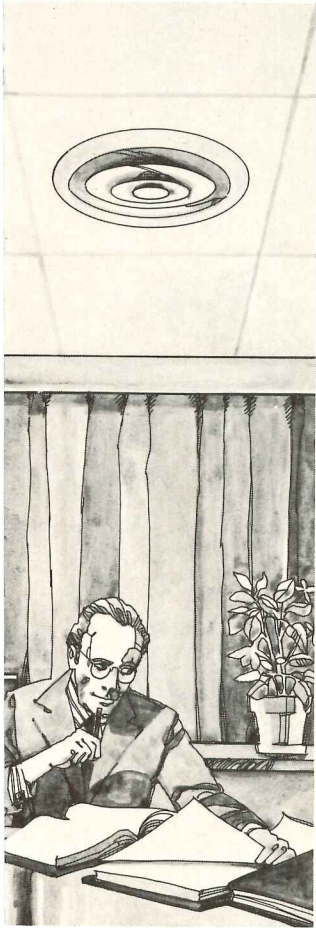

That's because you can use any of the full line of Titus Air-Diffusion-Council-certified ceiling diffusers with TTCS II — to exactly fit your requirements.



Specify any of the many types of Titus square and rectangular diffusers — including perforateds. And nobody but nobody has such a complete selection



of linear-type ceiling diffusers to choose from as Titus! After all, who should know more about air distribution than Titus?

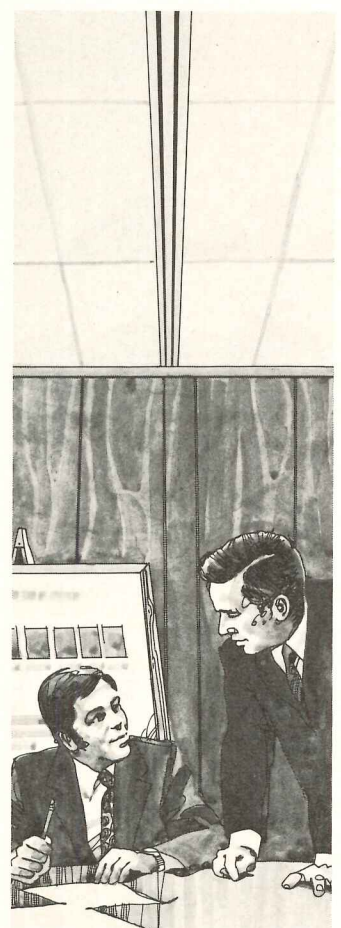

mounts out of sight — even the thermostat if desired. Only the air diffusers show — and any type Titus Diffuser can be used to fit any decor.

■ The Titus TTCS II “takes command” to produce the most *personalized* comfort control for room occupants. Adjustable area comfort controllers make it possible to provide just the right amount of air, automatically — correctly diffused — for maximum comfort in each room.

■ Mail coupon for complete information.

- Rush catalog with details on the new TTCS II Titus Total Comfort System.
- Have Representative call.

Name _____

Title _____

Company _____

Address _____

TITUS[®]

TITUS MANUFACTURING CORPORATION
Executive Sales Offices
12820 Hillcrest Road, Suite 209
DALLAS, TEXAS 75230

For more data, circle 62 on inquiry card

Introducing the montgomery[®] SPM-t[™] 2500

...standard pre-manufactured traction elevators for medium-rise buildings

Montgomery's new SPM-T2500 traction elevator package will save you *time* and *money* on your medium rise building project. Standard pre-manufacturing by Montgomery means lower cost to the owner, faster delivery and installation while maintaining "custom" quality. The Montgomery SPM-T2500 is rated at 2500 pound capacity with a choice of 200 or 350 fpm speeds. Montgomery's SPM-T2500 is designed for single or multi-car applications.

If you want to know more about this new Montgomery quality engineered traction elevator package, contact our general office or look in the Yellow Pages for the location of one of our 170 offices. You'll find we're not very far from anywhere in North America.

montgomery[®]
ELEVATORS/ESCALATORS
POWER WALKS & RAMPS

Montgomery Elevator Company, Moline, Illinois 61265
Montgomery Elevator Co. Limited, Toronto, Ontario M9B3S5
Offices in Principal cities of North America

montgomery moves people.



For more data, circle 63 on inquiry card

Timely Turn

Courtesy Lock Museum of America, Inc.

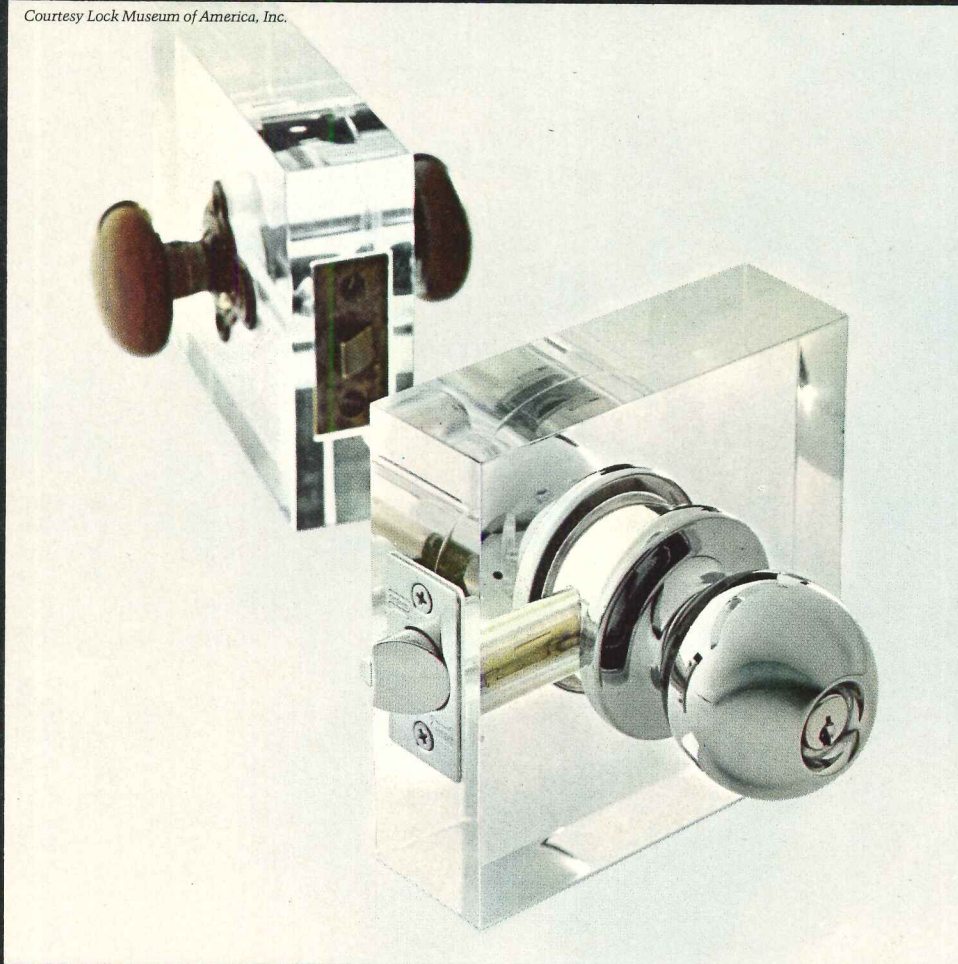

*Rondure design Ruswin Stilepacer™ lockset.
Refreshingly crisp and clean.*

*Whisper soft in its
velvet smooth response. A pace setter.
Progressive design in the Ruswin tradition.
Ruswin, Division of Emhart Corporation,
Berlin, Connecticut 06037.*

*In Canada — Ruswin, Division of
International Hardware.*



The Collector's Series by Ruswin

“I found nothing to equal the lively



freshness of carpet of Antron.[®]”

*Marcelle Courtright, Interior Designer
Beverly Wilshire Hotel, Beverly Hills, California.*

“When your objective is to create interiors of extraordinary luxury, you select carpets with extraordinary care.”

As Interior Designer for the new Beverly wing of the Beverly Wilshire Hotel, Marcelle Courtright traced the history of California to find themes for the 300 guest rooms and suites. Each became a different challenge—from Felipe II Spanish and Mexican Colonial to Avant-Garde Modern—and she literally shopped the world for museum quality furnishings and accessories. Then to weave a unifying element through the individuality and elegance, she turned to carpet with pile of Antron* staple nylon.

“I wanted richness. Life. Depth. Texture. And colors like spring everywhere. I must have looked at and evaluated 200 carpet samples before I selected carpet of ‘Antron’. The style I chose was a two-tone plush of exceptional beauty. We tested it in one guest room and found it performed beautifully. We know now that with carpet of ‘Antron’, the look of freshness will last.”

“Antron” staple fibers are a unique blend of size, crimp, and lusters which give the carpet its luxurious aesthetic properties. In addition, the fibers reflect, diffuse, and refract light to minimize the appearance of soil while retaining color clarity and luster.

Because it’s nylon, “Antron” has outstanding crush resistance and durability. (See stair-edge test comparison.)

For commercial installations where you want rich, warm aesthetics plus long-term appearance retention, specify carpet of “Antron” nylon.

For additional information and for a list of mill resources, write: Du Pont, Contract Specialists, Room 111/AR, Centre Road Building, Wilmington, Del. 19898.

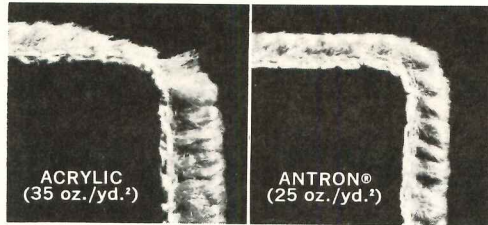

Abrasion test on simulated stair-edges shows pile wear in level-loop carpets after equal exposure.



For more data, circle 65 on inquiry card

*Du Pont registered trademark. Du Pont makes fibers, not carpets.

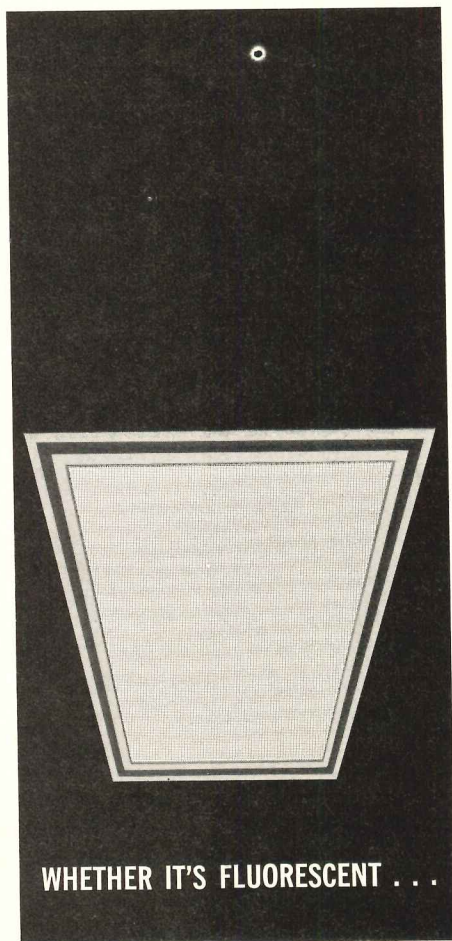

WHETHER IT'S FLUORESCENT . . .



. . . H. I. D. . . .

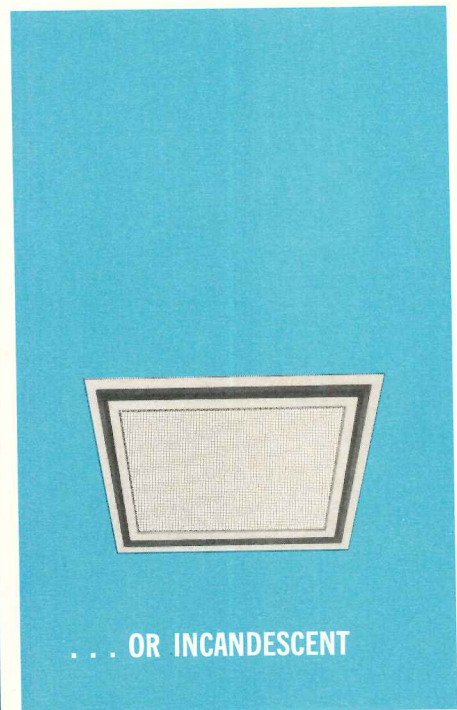

. . . OR INCANDESCENT

GUTH LIGHTING'S NEW

LOOK-ALIKE "MODULAR FAMILY"

From now on, your ceiling design efforts won't be frustrated by having to let light source and hardware requirements call the shots.

Because GUTH's new Modular Family lets you decide the size and shape of lighting fixtures based on uniformity and style considerations. Then, whether illumination requirements dictate incandescent, fluorescent, H.I.D., or combinations, the compatible members of the look-alike Modular Family can be mixed or matched to suit.

The Modular Family offers a full range of square and rectangular sizes and enclosures with your choice of flush or regressed "picture frame" doors, plus many other features and options.

The Modular Family. Another example of innovative design from Guth.

Now Guth Quality...In Tomorrow's Mode...At Today's Prices

For more information and specifications,
write or call (314) 533-3200

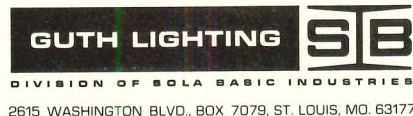

SOLA BASIC DIVISIONS: ANCHOR ELECTRIC • BISHOP ELECTRIC • DIELECTRIC COMMUNICATIONS • DOWZER ELECTRIC • GUTH LIGHTING • G-V CONTROLS
HEVI-DUTY ELECTRIC • LINDBERG • NELSON ELECTRIC • SIERRA ELECTRIC • SOLA ELECTRIC • TEMPRESS • WARREN COMMUNICATIONS

For more data, circle 66 on inquiry card

RENAISSANCE™

The new, antique look in paneling.

Introducing Renaissance™ hardwood plywood wall paneling from Georgia-Pacific. It comes in six warm shades of real hardwood face veneer, each flecked and shadowed. With a finish that looks handrubbed. Renaissance paneling. A new old-fashioned look, at old-fashioned prices.

Renaissance comes in 4' x 8' x 1/4" panels. And it's available with a Class III flame spread rating. For more information, just contact your G-P representative.

Georgia-Pacific

Portland, Oregon 97204



This busway lets you plug in afterthoughts

I-LINE® busway from Square D allows for afterthoughts, future requirements, unforeseen circumstances and second guesses. As future needs dictate, you can add branch runs using 1600 ampere bolt-on tees at the handiest plug-in openings (they're spaced every two feet) and run your power from there. And you can do this without separating the busway at the joint and disrupting your entire electrical system. The tee bolts directly onto the bus bars at each plug-in opening.

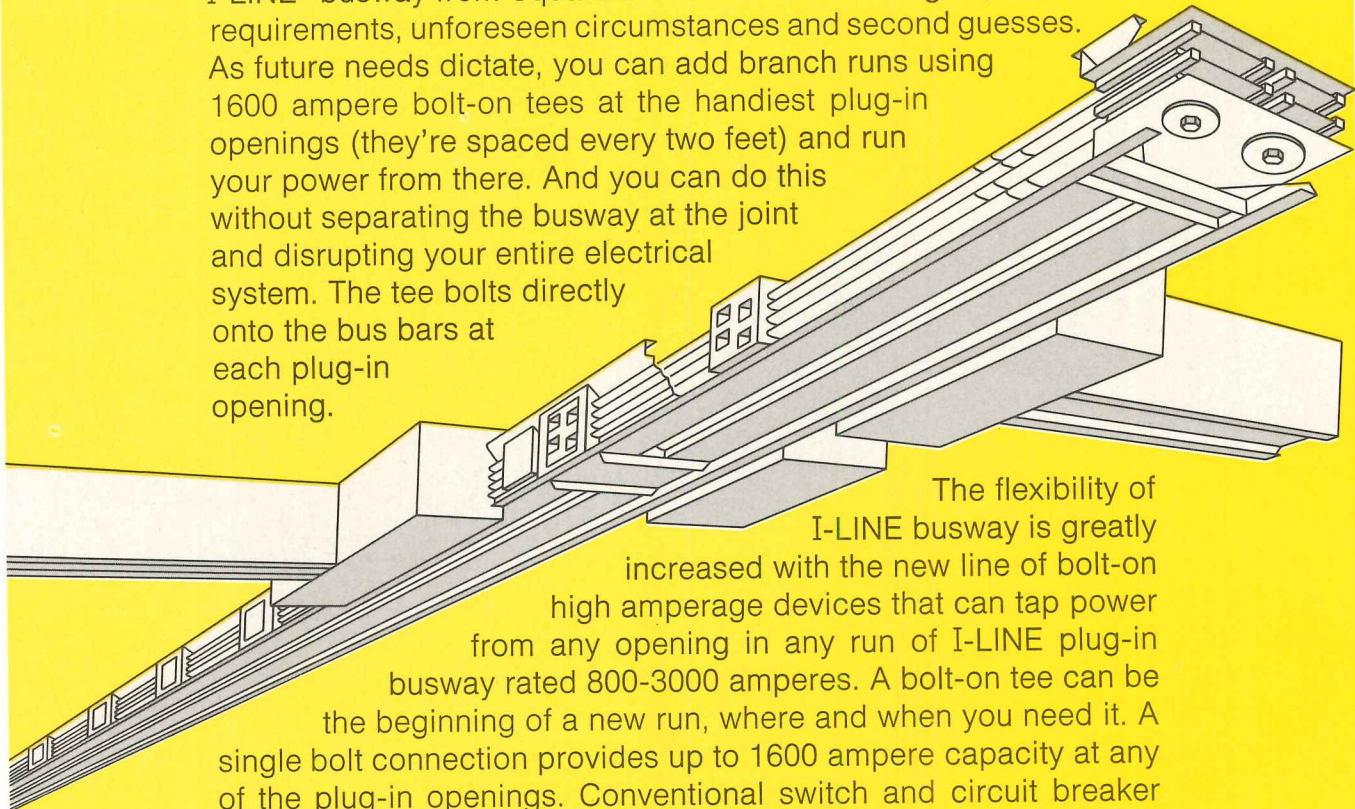

The flexibility of I-LINE busway is greatly increased with the new line of bolt-on high amperage devices that can tap power from any opening in any run of I-LINE plug-in busway rated 800-3000 amperes. A bolt-on tee can be the beginning of a new run, where and when you need it. A single bolt connection provides up to 1600 ampere capacity at any of the plug-in openings. Conventional switch and circuit breaker units (through 1600 amperes) are also available using this high current bolt-on construction.

For engineering data on crisis-proof I-LINE plug-in busway and high-ampere bolt-on devices, contact your nearby Square D field office. Or write, Square D Company, Dept. SA, 5735 College Corner Road, Oxford, Ohio 45056.



SQUARE D COMPANY

Wherever Electricity is Distributed and Controlled

For more data, circle 68 on inquiry card

Weyerhaeuser® Panel 15 makes beautiful “afters” happen.



State Bank of Fall Creek, Wisconsin, **BEFORE** and **AFTER** Weyerhaeuser Prefinished Siding/Panel 15.
Architect: Norman Sessing, A.I.A., of Neujahr, Drake and Sessing, St. Paul, Minnesota.



Section of downtown Atchison, Kansas, **BEFORE** and **AFTER** Weyerhaeuser Prefinished Siding/Panel 15.

And exciting “originals.”



Drive-in restaurant concept, W. C. Murchow Associates, Denver, Colorado.



Swope Park Puppet Theater, Kansas City, Missouri, Morton Rolsky, Architect.



Whistle Stop Restaurant, Phoenix, Arizona, Clarke Modular, Inc., Glendale, Colorado.

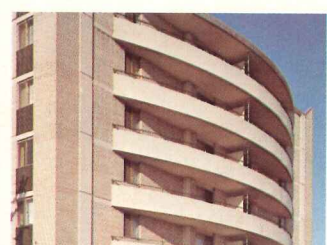

LaRonde Apartments, Arthur M. Hemlock, Hemlock Associates, Cleveland, Ohio.

From re-creation of nostalgic significance to innovative design concepts, the uses for Weyerhaeuser Prefinished Siding/Panel 15 are virtually limitless.

The 10-mil, pebble-textured aluminum face of Panel 15 is available in 19 stock and special order colors, plus custom colors.

Durable acrylic finished aluminum bonded to rugged Structural I exterior-type Douglas fir plywood means exceptionally low maintenance plus structural strength permitting application to any conventional support system.

Regular panels finished one side for sidings and backed with reflective foil insulation. Double-faced panels for balconies or dividers where both faces are exposed.

All Weyerhaeuser Panel 15 guaranteed in writing not to need refinishing for fifteen years. Approved by all building codes and FHA, qualifies for Class II Fire Hazard rating.

For more detailed information on Panel 15's unique qualities, uses and accessories write to Weyerhaeuser Company, Box B, Tacoma, Washington 98401.



The new generation of Norton® Automatic Door Operators

4 new benefits in a field-proven product

Quiet

We've incorporated a new hydraulic pump that drastically reduces the discernible noise level. It completely eliminates the whirr and whine, making it ideal for installations like hospitals and restaurants. Finally . . . an unobtrusive noise level.

Fewer Moving Parts...

have always been a Norton benefit. But now we've reduced the number of parts even further. So you have less to maintain, fewer places to have problems—for even greater dependability.

Improved Door Control

In selecting a new hydraulic pump we were able to increase the torque for smoother, more effective opening. And we've improved our circuitry for finer, more adaptable control.

System Responsibility

for specifications, sales, installation and maintenance for an automatic door system, all from a single source. The way it's always been, but we've improved the entire setup. We appointed Prime Dealers to offer more, even better service. And we've continued to train our Nationwide Norton Service Organization to provide you the maintenance and service you need . . . when you need it.

Same Dependability

We've simply made improvements on the Norton Automatic Operator that's proven itself in so many installations.

For more information ask your Norton Dealer, your Norton Representative or contact Eaton Corporation, Lock and Hardware Division, Norton Marketing Department, Box 25288, Charlotte, N.C. 28212.

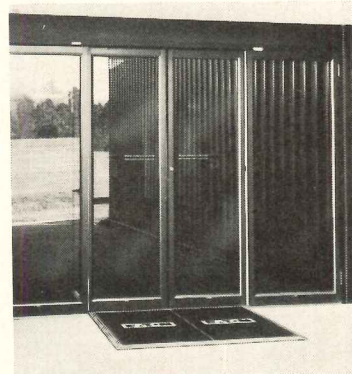

Norton Automatic Operator Systems

Series 2000, Transom Mounted for new and existing construction. Series 4000, Completely Concealed in almost any door manufacturer's header (4" x 5" minimum).

Series 5000 & 9000 for sliding doors; as an operator (5000); or as complete entrance package (9000). All control methods and schemes.

EAT•N Security Products
& Systems

For more data, circle 69 on inquiry card

Bally belongs.

**When a project calls for
a Refrigerated Building
Bally has experience that
will be most helpful.**

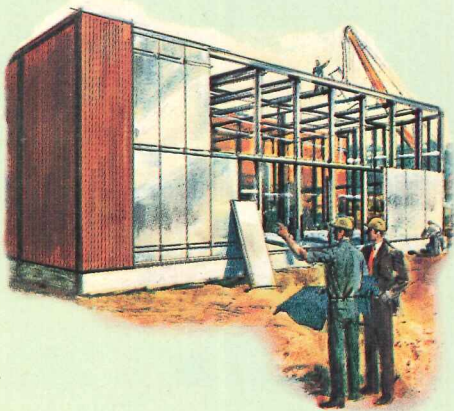

Unusual and complex requirements specifically associated with refrigerated buildings are part of our everyday business. They may involve the design of a low temperature foundation slab . . . computing the refrigeration load requirements . . . determining the best use of power and manually operated doors . . . design and placement of conveyors or the need of vestibules and partitions. Whatever the question, our three decades of experience qualifies us to provide the answers. Bally Buildings are prefabricated modular systems that can be assembled in any length and width up to 36' high from standard urethane insulated panels, UL and Factory Mutual approved. Refrigeration systems are available for every storage or processing need and for temperatures as low as minus 40°F. Bally's architectural metal facade in a choice of six colors can be installed on



© 1972 ALL RIGHTS RESERVED.

any portion of the exterior where colorfully styled appearance is important. Write for literature and wall sample. **Bally Case and Cooler, Inc., Bally, Pennsylvania 19503.**

ADDRESS ALL CORRESPONDENCE TO DEPT. AR-4

For more data, circle 70 on inquiry card

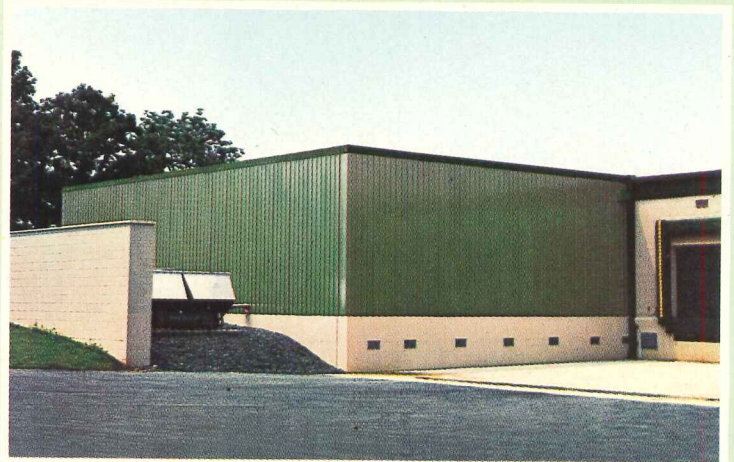

"THE PROBLEM WAS OF A MAGNIFICENT VIEW THE ANSWER:



A. Page Atkins, LOF
G. L. Loggins, Jr.,
Regional Mgr., Aetna Insurance Co.

Owners: Aetna Insurance Company, Inc., of Hartford. Architect: Saxelbye, Powell, Roberts & Ponder, Jacksonville, Florida. General Contractor: Batson-Cook Co., Jacksonville, Florida. Glazing Contractor: Florida Glass & Mirror, Jacksonville, Florida.

TO MAKE THE MOST AND SUBDUE A BOILING SUN. LOF GLASS."

A. PAGE ATKINS, LOF DISTRICT REP.,
ARCHITECTURAL CONSTRUCTION, ATLANTA, GEORGIA

Compatibility with the residential character of the area was fundamental in the planning of the new regional home office building for Aetna Insurance Company in the suburbs of Jacksonville, Florida.

The owners wanted a building of quiet dignity. Like the site itself, overlooking the Arlington River, richly endowed with huge oaks and magnolia trees. The magnificent views afforded to the occupants on all sides of the proposed building gave rise to the design concept of controlled vistas for the spaces within rather than a continuous undefined viewing plane. Vital to the design was LOF $\frac{1}{4}$ " thick monolithic reflective glass with a golden Vari-Tran[®] coating. Characteristically, monolithic Vari-Tran provided more than the desired controlled vistas. Vari-Tran coatings control sun glare and significantly reduce solar heat gain resulting in reduced initial air-conditioning costs and building operating costs.

A range of colors in both bright and subdued exterior reflections are now available in $\frac{1}{4}$ " thick reflective glass.

All over the country LOF architectural representatives are helping architects create in glass and building owners conserve on operating costs. For the entire story send for our brochure, "Reach for a Rainbow." Libbey-Owens-Ford Company, Dept. R-473, Toledo, Ohio 43695.



LOF

For more data, circle 71 on inquiry card



Introducing a beautiful side of

We don't have to tell you about GAF's existing roofing, flooring and siding products. Judging from the way you've accepted them, we know they've done a good job.

That's why we think you'll be pleased to hear that GAF is now in the vinyl siding business.

The name of our vinyl siding is Vanguard™. And that means leader.

Unlike non-vinyl sidings, Vanguard keeps its good looks all by itself.

That's because the colors, (there are 4 of them) go clear through the vinyl. So Vanguard won't show scratches, and never needs painting or finishing.

And since it's weather resistant, it won't rot or corrode either. Which means it'll last as long as the house you put it on.



GAF you've never seen before.

What's more, Vanguard's lightweight panels are much quicker and easier to install than most other types of siding. They can be cut and worked with ordinary tools. Special nailing flanges and preformed nailing slots help you put it up quickly and neatly. And, of course, there's no on-site painting or finishing for you either.

Finally this great new siding comes

with GAF's 20 year warranty against manufacturing defects.

Vanguard Vinyl from GAF. We think you'll be glad to have us on your side.

For further details, call your GAF Building Products distributor or write: GAF Corporation, Building Products Division, Dept. AR-43,140 West 51 St., New York, New York. 10020



Rock collection.

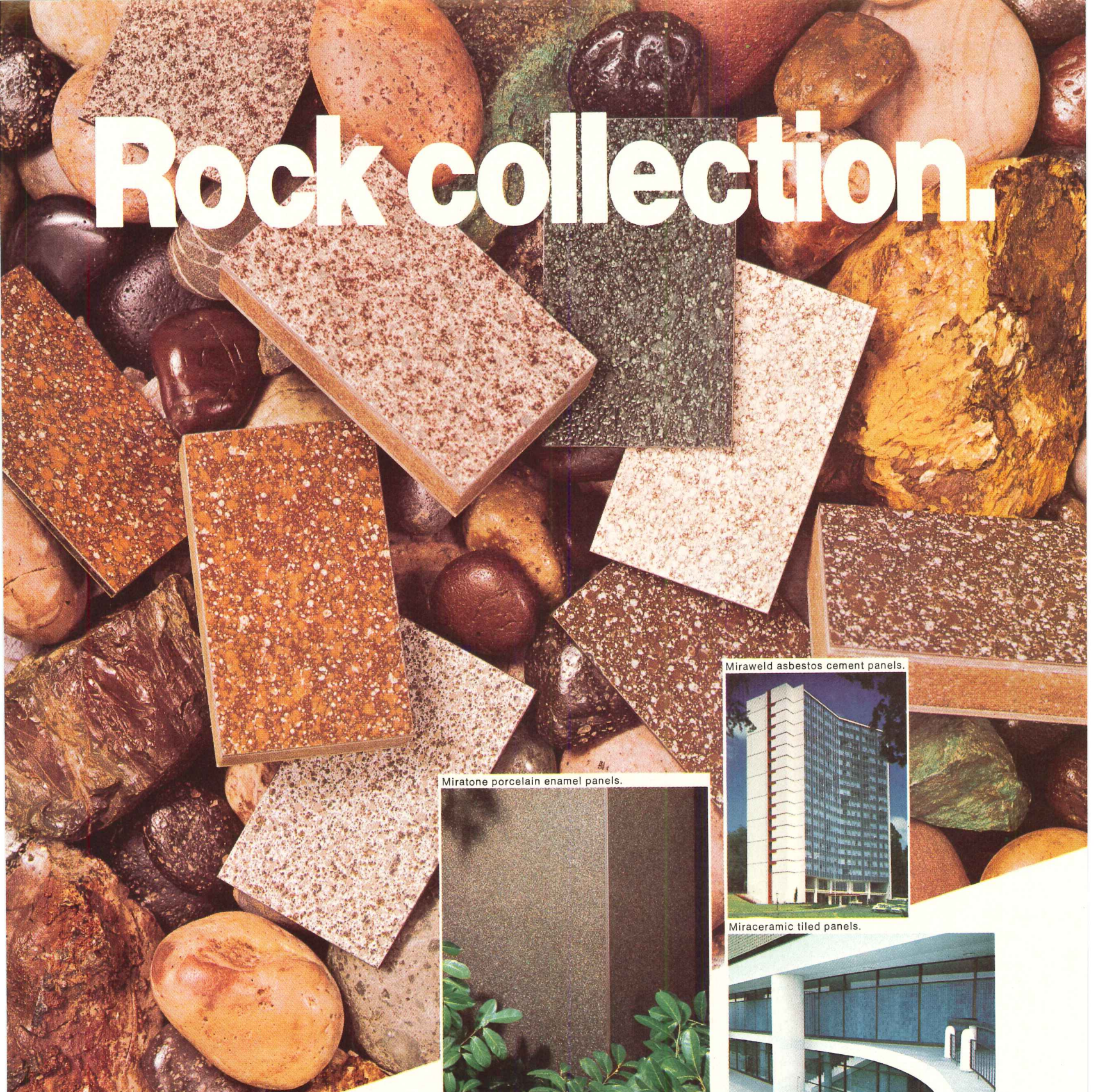

See the newest in today's largest line of building panels—Miratone porcelain enamel

New Miratone™ porcelain enamel panels have the richness of quarry stone.

They're the newest effect from Kaiser Mirawal—exciting additions to a building panel collection of more than 192 combi-

nations of standard colors, types and facings. The new four-color mottled textures are from an exclusive Kaiser Mirawal process. Unlike conventional stipples, Miratone porcelain has a deep, rich, crystalline warmth.

Fired to cold-rolled steel, this surface is stain and weather resistant—a beautifully natural-looking exterior or interior, modest or monumental.

Miratone is only one facing in the big Mirawal® line. You can also choose from more than a hundred other colors in porcelain enamel, plus these other facings:

Miraweld asbestos cement panels.



Miraceramic tiled panels.



Kalcolor® anodized aluminum; Miralume® painted aluminum; Miraweld® color-fused asbestos cement; Miraceramic™ tile on asbestos cement; and Miraroc™ natural stone aggregate panels. Just write for an information packet, with a note of your current need, to: Kaiser Mirawal, P.O. Box 38, Dept. A264, Port Carbon, PA 17965.

**KAISER
MIRAWAL**

NEW DELIGHTS FOR HAMMARSKJOLD PLAZA



If anyone really needs assurance that individual buildings are still relevant to the over-all urban fabric, here are two elegant new structures to ponder. The block of New York City's East 47th Street that forms the U.N.'s ceremonial approach was, early on, appropriately widened, boulevarded and tree-lined. But it has remained a fairly vacuous space, edged by a desultory cobblestone park dedicated to Dag Hammarskjold. Now, two small, gem-like buildings—each on its own—make big contributions to the public activities, amenities and pleasures the street should have: an office tower and sculpture garden (above) by Raymond & Rado and Partners, and Japan House (below) by Junzo Yoshimura and Gruzen & Partners.

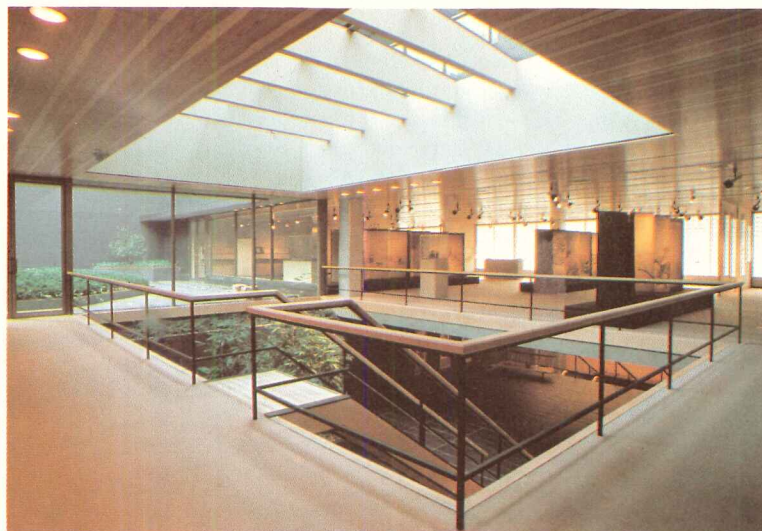

Christian Steiner

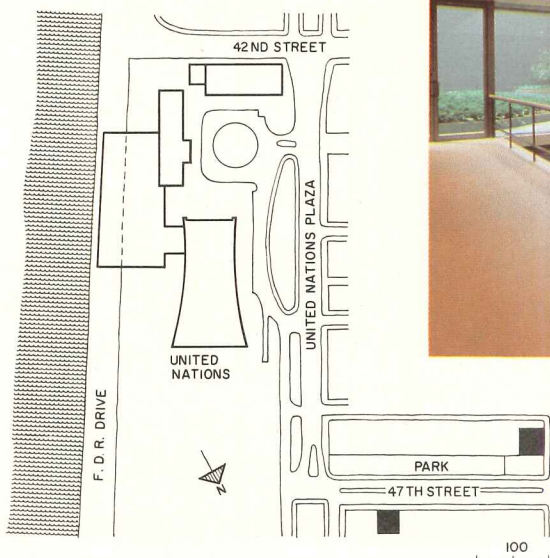

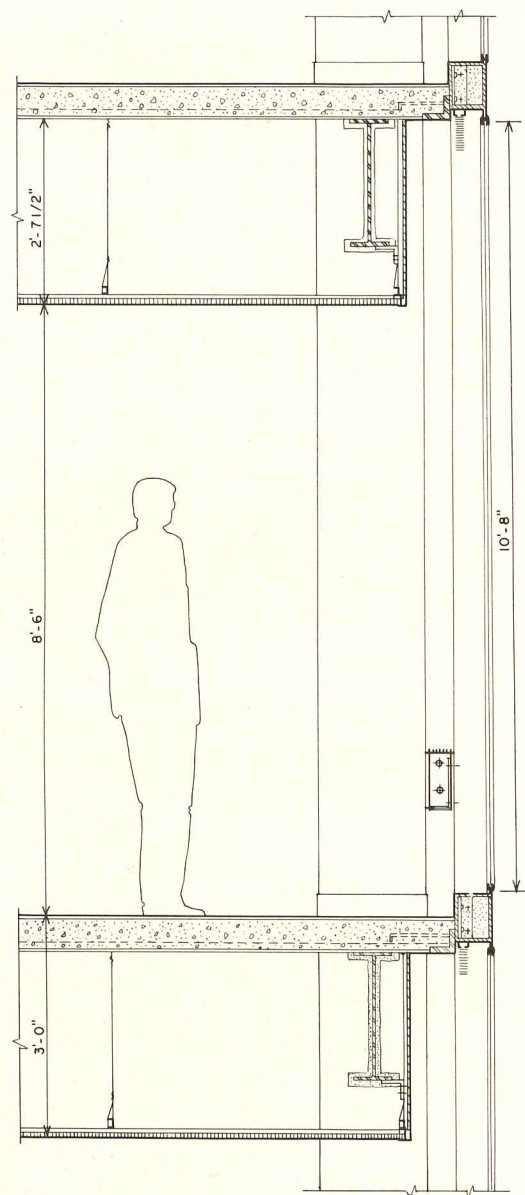

2 HAMMARSKJOLD PLAZA BUILDING

In an unusual agreement, New York City was persuaded to lease part of Dag Hammarckjold Park to owner-developer Harry Macklowe, for 125 years, to build and maintain a public sculpture garden integrated with the arcade of this new 16-story office building.

The handsome results (across page and cover) form a much-needed focus for activities and interest in the underutilized park: large-scale exhibits of the work of established contemporary sculptors, chosen by a board of selection, are changed every three months.

The building itself is a classic example of careful proportions, logic, and utter simplicity. Rental spaces are defined and enclosed by a minimal curtain wall of tinted glass and black-finished aluminum, and the mechanical core—expressed by a slim volume of black face brick—is used to tie the glass tower to existing masonry buildings at the back. The skin design

opts for a new code eliminating requirement of the typical 3-foot-high horizontal fire separation between floors at the exterior. Thus, one carefully calculated piece of glass extends from slab to slab (section above), with only a horizontal mullion along the slab edge; the connector forms an interior protective rail.

Construction cost for the 100,000-sq-ft building was \$30 per sq ft without the sculpture garden which reportedly cost "more than \$150,000." The quality throughout the building is much higher than the typical commercial rental office buildings, partly due, according to the architects, to savings on spandrels. It has rented well as a prestige office location.

2 HAMMARSKJOLD PLAZA BUILDING, New York City. Owner: *Harry Macklowe*. Architects: *Raymond & Rado and Partners*. Engineers: *Paul Weidlinger* (structural); *Picirillo & Brown* (mechanical). Landscape architects: *Raymond & Rado and Partners*. General contractor: *Diesel Construction Company*. Sculptor: *Alexander Liberman*.



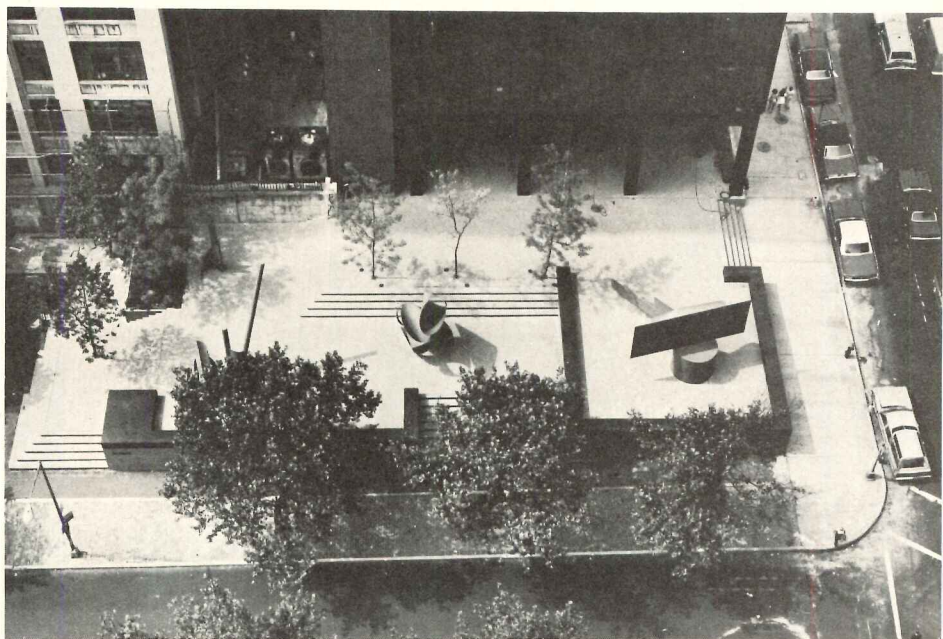
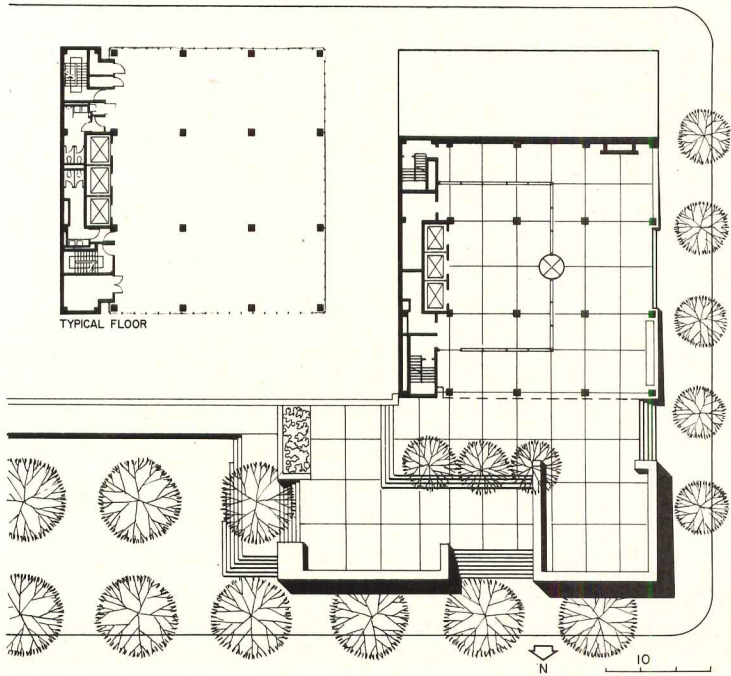

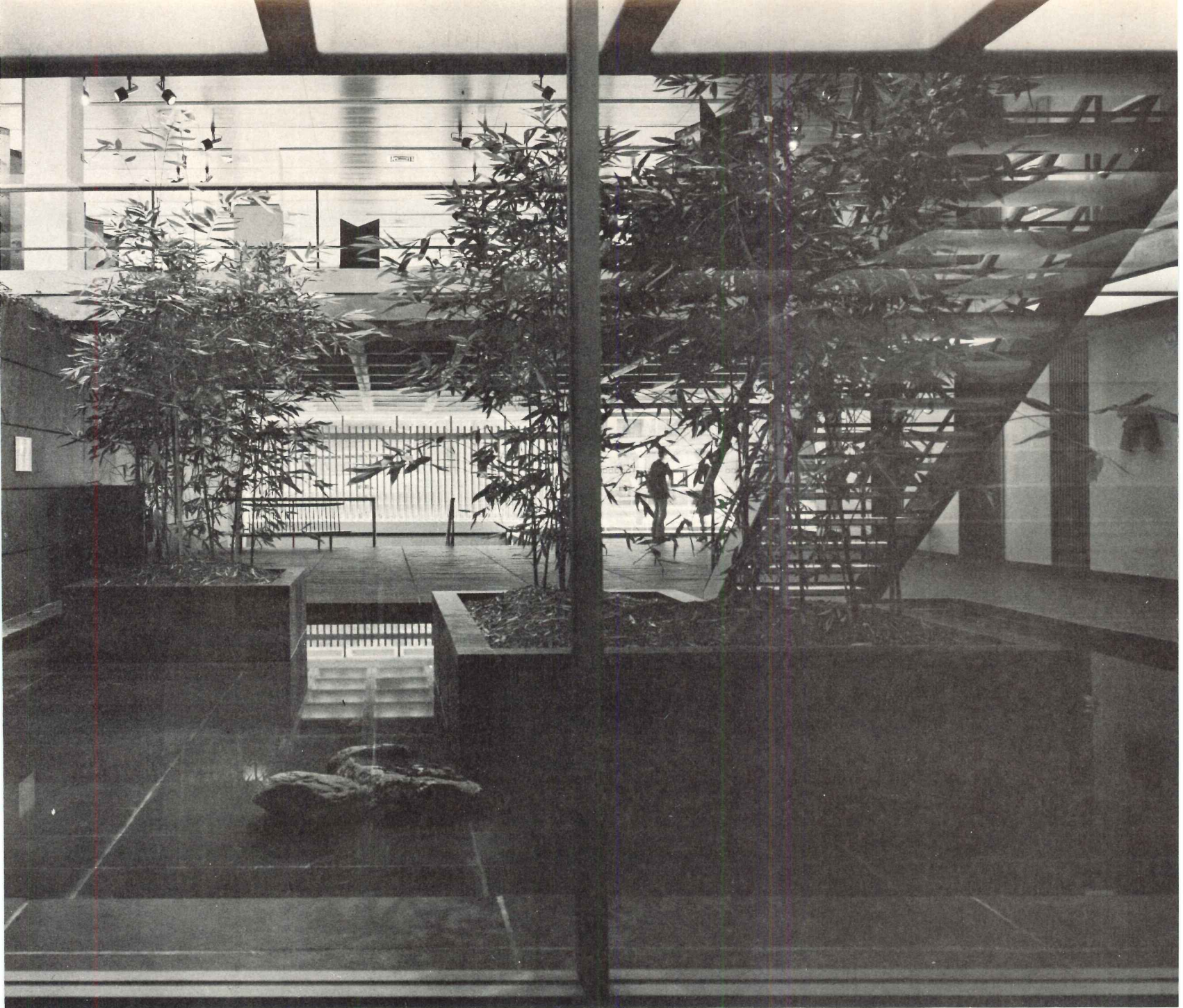

Taisuke Ogawa Photos except as noted

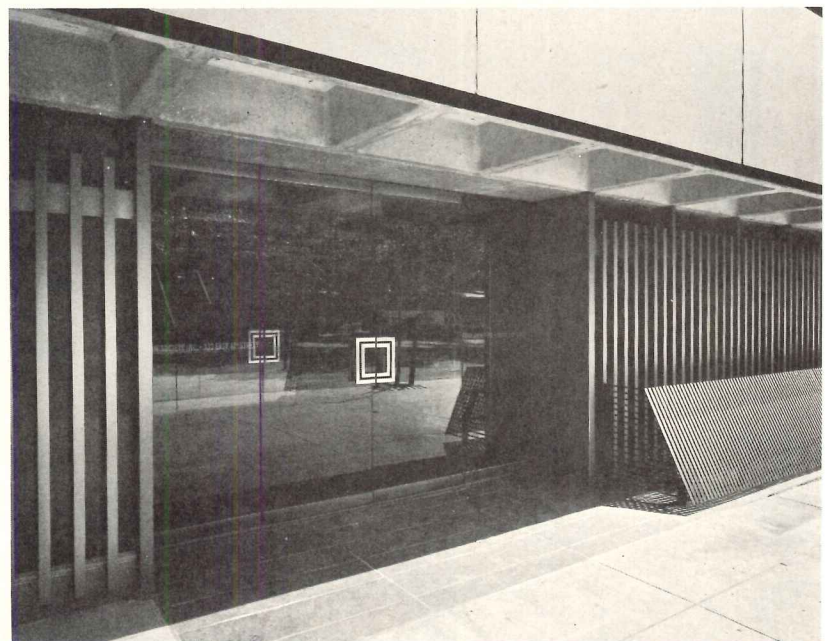

Joseph W. Molitor

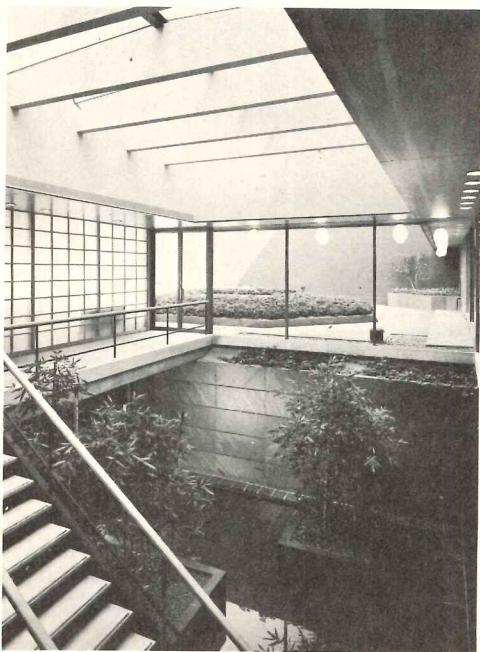

JAPAN SOCIETY'S INTERNAL OASIS

Japan House, the new cultural center and headquarters for the Japan Society, adds quite a dollop of civility and elegance to Dag Hammarskjöld Plaza. Its exterior is quiet, nicely scaled and guardedly transparent: fleeting glimpses of the interior are afforded through bronze anodized aluminum screens and the glass entrance doors (below center).

Even with these hints, the interiors come as a delightful surprise: courts, pools, gardens—and everywhere, superbly finished surfaces of wood and stone that one irresistibly has to touch. Also in contrast to the rather sober coloration of the exterior (precast spandrels, end walls and panels are finished in black), the interiors are in warm, earthy tones with occasional accents of vibrant color.

The ground floor of the building is dominated by a big, and in part, two-story, slate-floored reception area (photos left). A sky-

lighted, bamboo-planted recirculating pool (which has equipment for creating gentle waves of spray-mist rain) separates the reception space from a glass-walled library. Below this level is a sizeable auditorium, with walls of French white ash and blue upholstered seats, and equipped for the performing arts, lectures and multi-lingual meetings.

The second level is connected to the reception area by an open-tread stair over the pool, and is largely devoted to exhibition galleries (below). These, and an adjoining conference room, flank a rooftop garden abstractly planted with evergreens and maples. The galleries feature a changing series of exhibits of Japanese arts of extraordinary quality.

JAPAN HOUSE, New York City. Owner: *Japan Society, Inc.* Architects: *Junzo Yoshimura and Gruzen & Partners.* Engineers: *Severud-Perrone-Sturma-Bandel* (structural); *Consentini & Associates* (mechanical). Contractor: *Turner Construction Company.* Interior designers: *Junzo Yoshimura and Gruzen & Partners.*



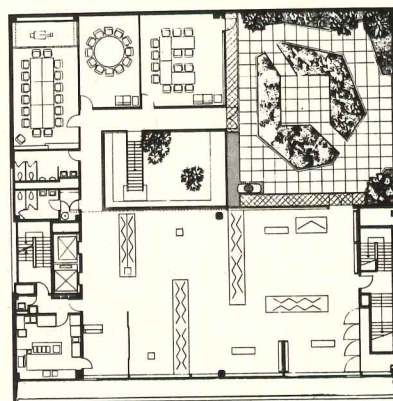
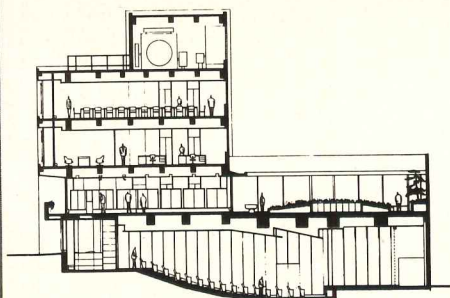
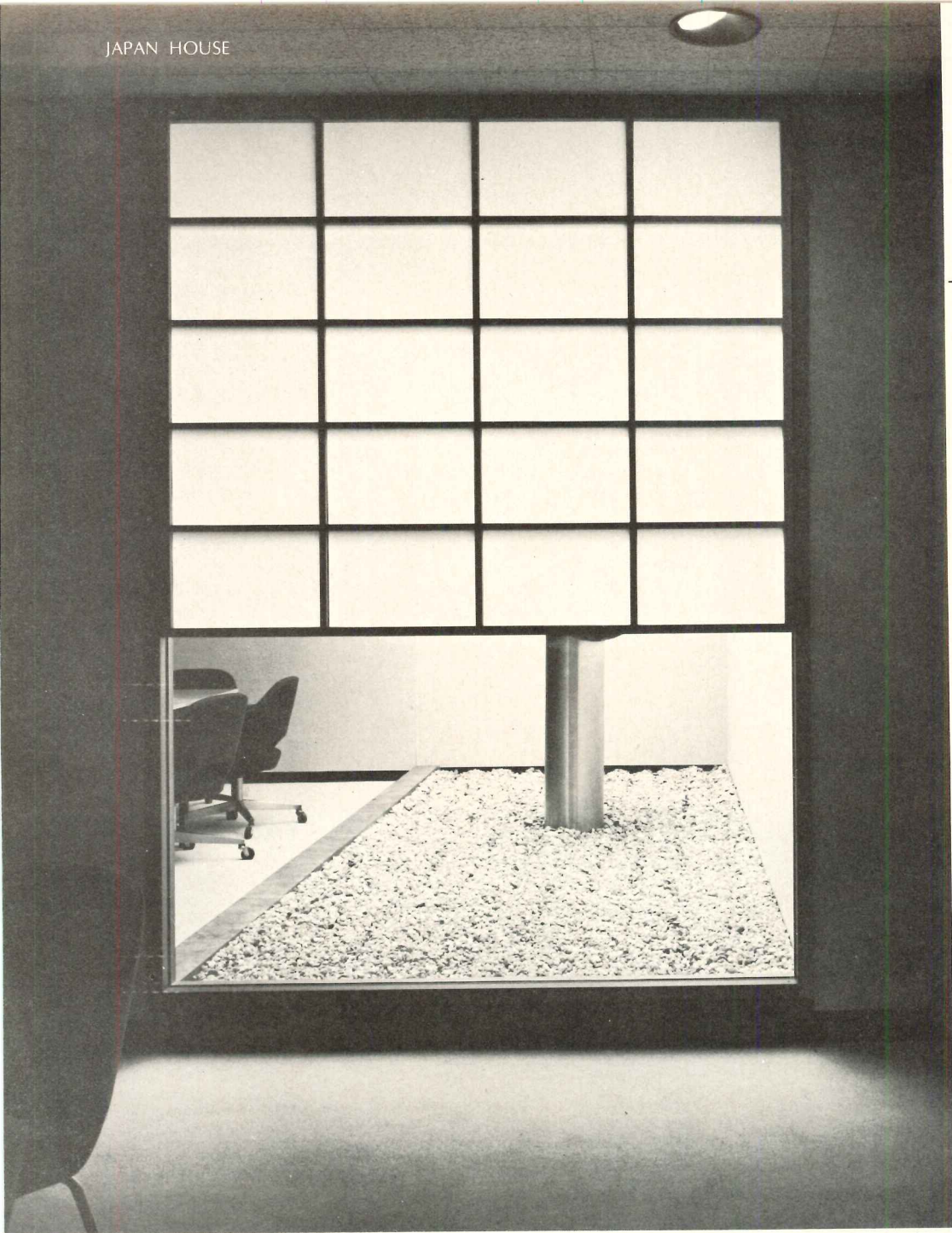

SECOND FLOOR

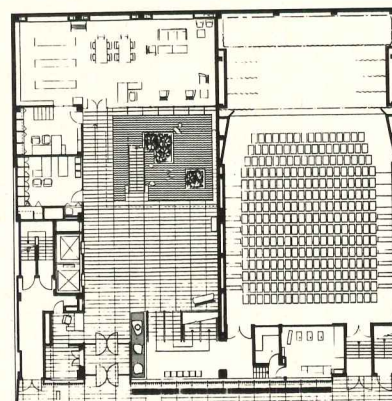

FIRST FLOOR

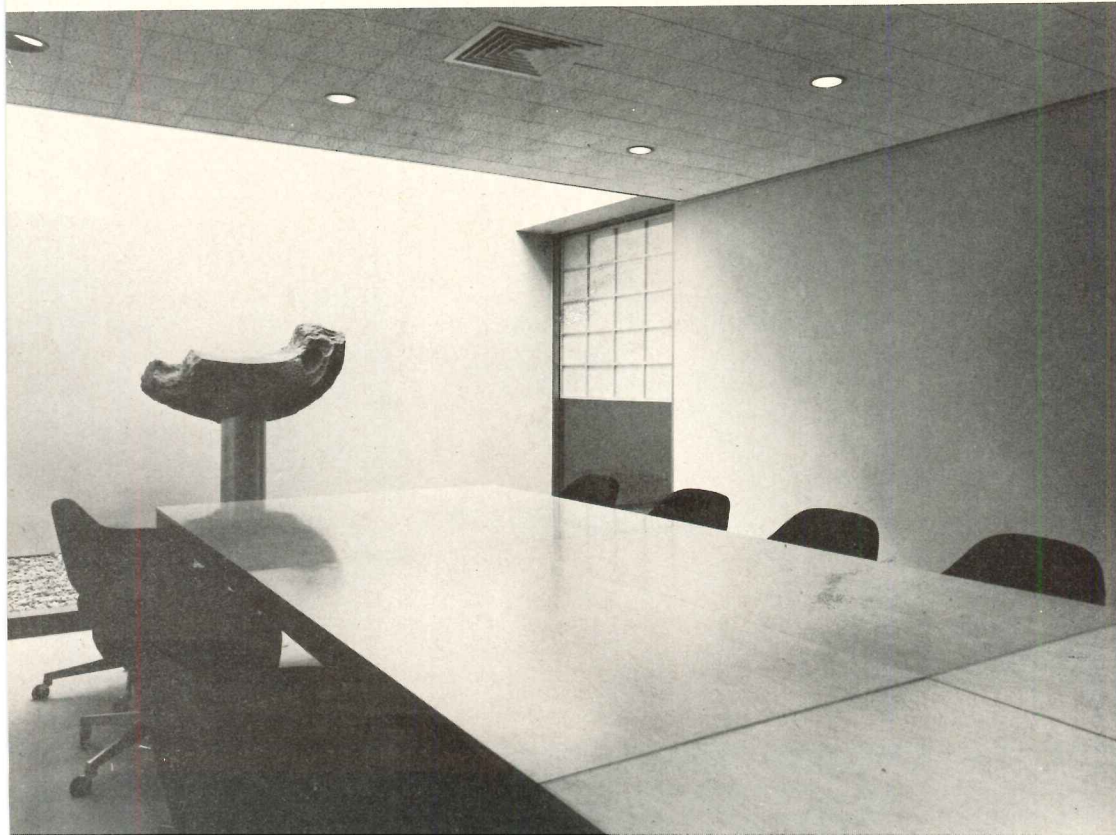

One of the most surprising little courts in Japan House is the skylighted sand and sculpture garden shared by two of the second-level conference rooms (photos left and upper left corner of second level plan). Beyond admitting daylight, it creates an ambience rare in small meeting rooms; artificial lighting creates a similar effect at night.

The building's facilities were designed to accommodate Japan Society's educational, cultural and public affairs activities; in support of Japanese-American understanding and cooperation. Administrative offices are on the upper floors, accessible only by elevator; other areas can be reached by the public via stairs.

HOW YOU CAN WORK WITH DEVELOPERS —AND ACTUALLY ENJOY IT

Louis Sauer of Philadelphia is one architect who does not need to establish his credentials as a designer before he talks about his involvement in development housing. Design awards of all sorts have been showered on him in the 12 years he has been in practice. And that makes all the more important his attitudes and views on how the architect can most effectively work in what has recently been the hottest segment of the building business. And just because the Federal government has frozen activity in subsidized housing, says Sauer, it doesn't mean that developers will stop their work. They will simply turn to conventional financing and go right on building housing. It might not be low-income housing but it will benefit from the architect's input, nonetheless, and will continue to represent a large segment of practice.

Sauer is most emphatically one of those who see the architect as unsuited to be a developer himself. His ideas, however, as to how the architect can accomplish both social and esthetic goals while serving the developer's financial needs are rich in meaning for architects who find themselves doing development housing, perhaps reluctantly, and worried that they are selling out. To begin with, he sees the developer (especially the experienced "pro") as an entirely positive force, serving the real needs of the housing market

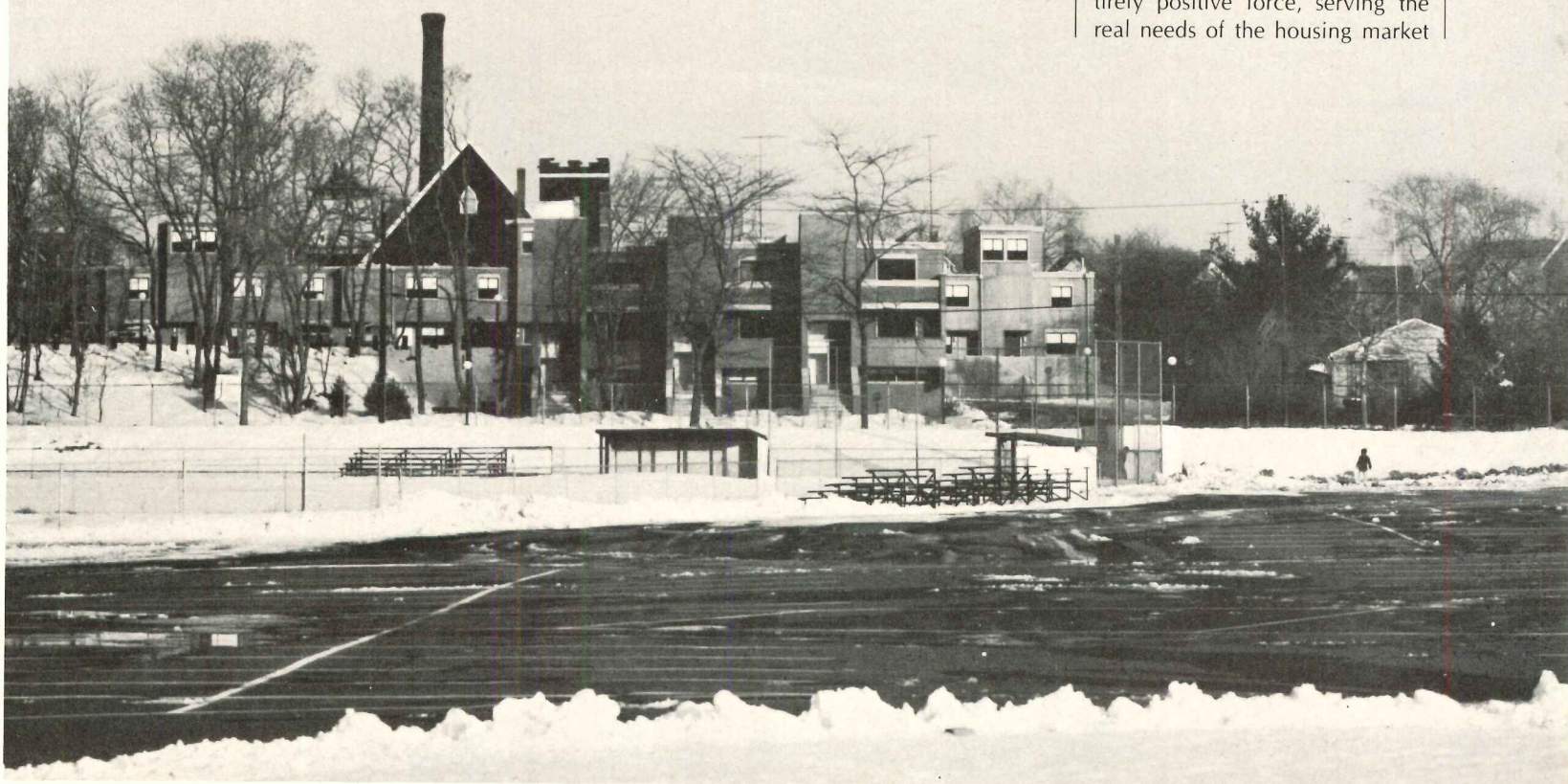

David Hirsch

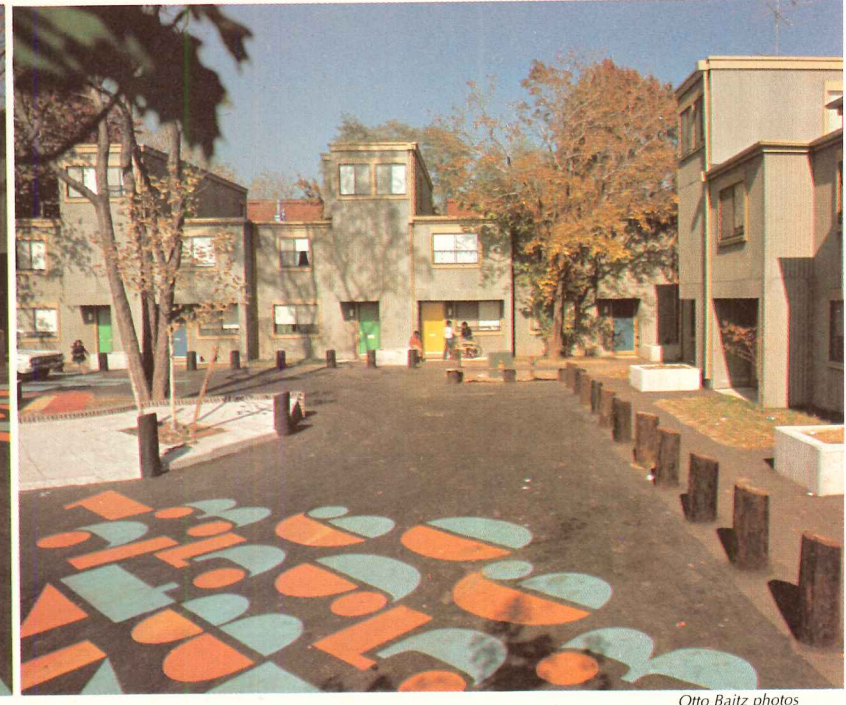
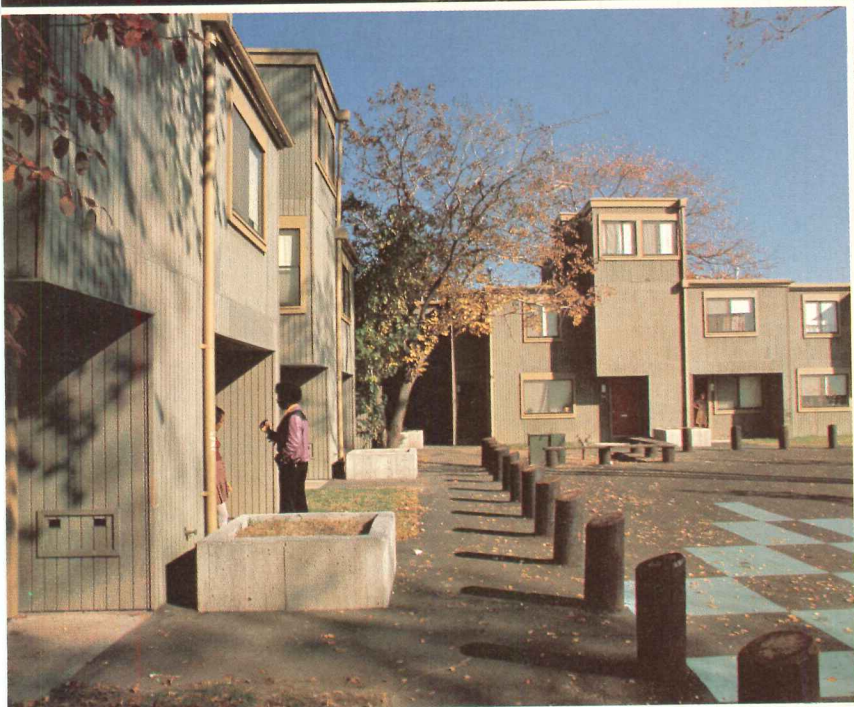
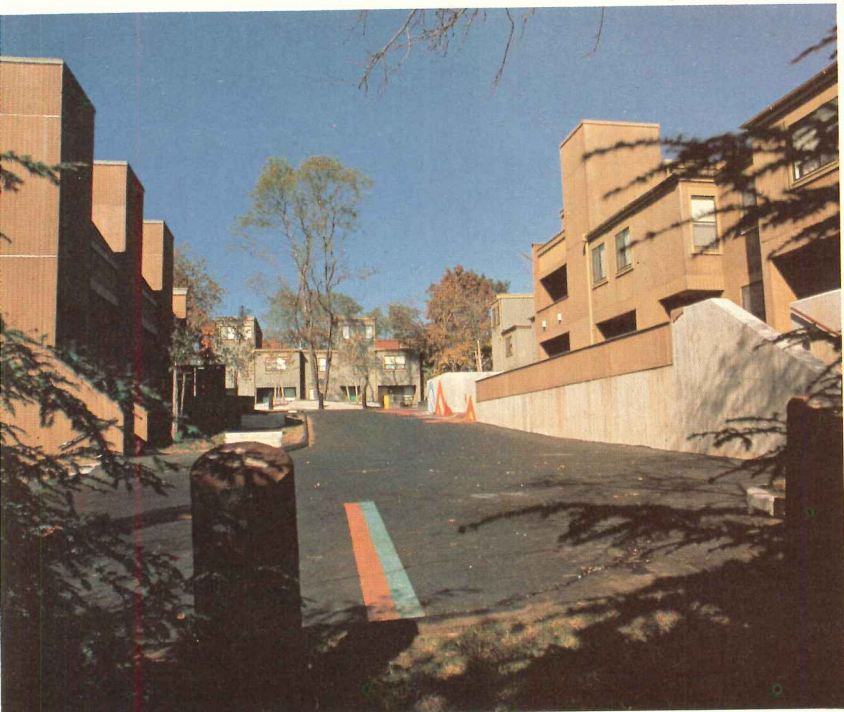

Otto Baitz photos

TOWNHOUSE TYPES A & B

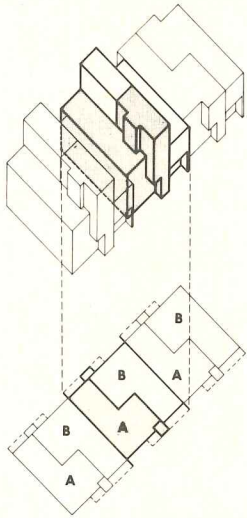

APARTMENT TYPES C & D

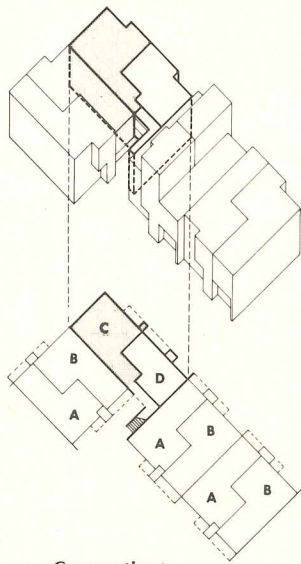

APARTMENT TYPE E

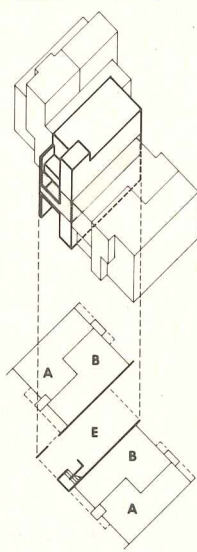

APARTMENT TYPE F

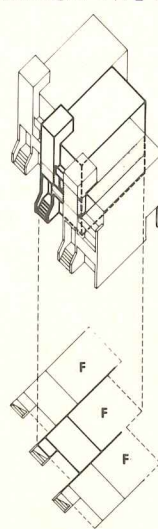

Canterbury Garden, New Haven, Connecticut

Based on a user-need survey conducted by Lou Sauer's office, the floor plans of the townhouses in this 34-unit FHA236 project were substantially changed while the working drawings were in progress. The main floor plans (below) show how the survey affected the design. Living rooms, seen as reception rooms, were put in front and the "kitchen-den," which future tenants identified as the real heart of the house, went to the back. Garbage storage likewise was put in the rear. Townhouse types A and B have four bedrooms each, apartment types C, D and F each have one bedroom, while type E has two. Types E and F are built above garages. Project architect for Louis Sauer Associates: Larry Chapman. Graphics: Malcolm Gear.

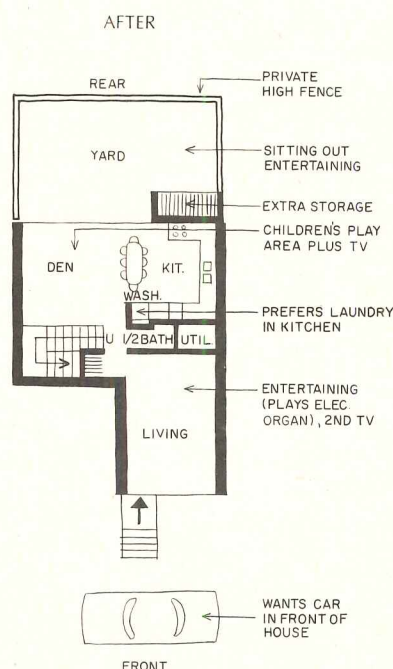
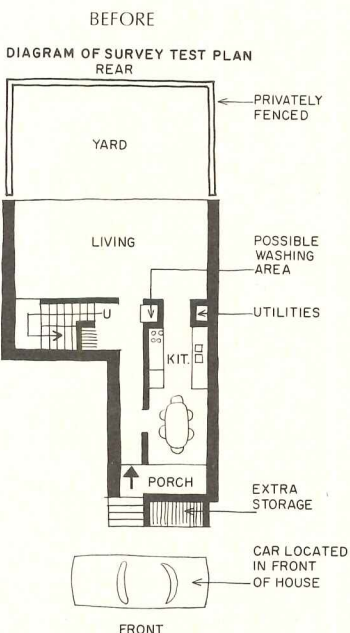
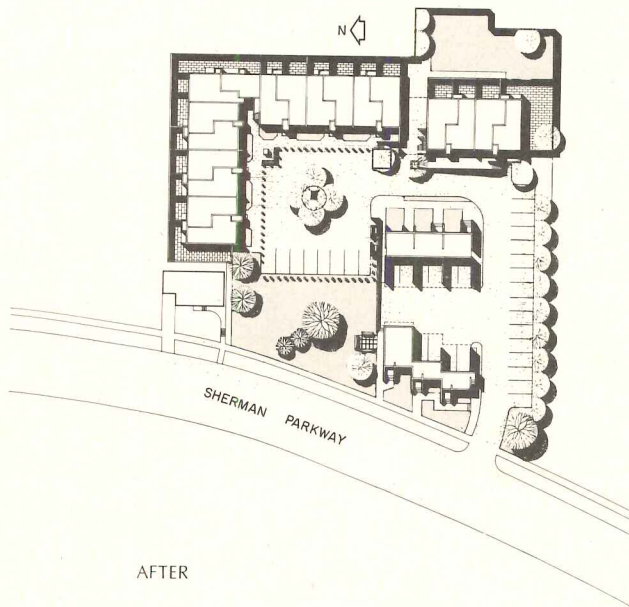

more faithfully than any other agency or institution. That is not an idle opinion, either. Sauer has been one of the most vigorous proponents in the profession for the integration of the behavioral sciences with design. He was making user-need surveys for projects and then evaluating how his designs served the tenants long before such procedures were reported in the architectural press. Canterbury Garden (at left) is an example of how design is affected by its users' real desires.

The market determines what gets built

It would be somewhat misleading to not make clear that such social concern fits neatly into Lou Sauer's concept of his obligation to his client, the developer. It is not something he imposes on clients. Where user-need surveys are the only effective way to find out what prospective tenants of subsidized housing would like, in unsubsidized housing Sauer sees the market itself as the force which determines what should and should not be built. Therefore, his first rule is to supply the developer with designs for units that can be combined easily to suit whatever the market may demand. That implies, of course, that the developer really understands what market he is after and that it exists in the place where the housing will be built. A few painful experiences when that was not so have made Lou Sauer very wary of developers who do not know their business. "I used to assume that any developer knew more about the intricacies of the market than I did," he says, "but it is not always so." Sometimes he will take on an inexperienced developer-client, but he sets fees well above his normal ones to compensate for the education he will be administering as he goes along.

When he is working with a developer who is fully knowledgeable, however, Sauer gives his client a say in "what the buildings will look like" that would make most architects thoroughly uncomfortable. Obviously secure in his own skill as a designer, Sauer goes out of his way to let the developer's ego (and it's often an ego fully as strong as the architect's) have free rein. Naturally, such an approach can lead to chaos, and can be interpreted as an abdication of the architect's design responsibility. "I don't want control over design," he says in answer to that question, "I just want lots of influence."

Wesleyan Hills, Middletown, Connecticut. The client, in the case of this condominium for upper-income families whose children are grown, was a combination of an institutional group (The Hill Development Corporation is related to Wesleyan University), a builder (La Cava Brothers Construction Co.) and a planner (Emil Hanslin) who had been hired to do the programming. Sauer found that because he shared certain ideas with Hanslin, he was able to work well with him and thus to produce a strong schematic design. Although the architect feels he was less involved as the construction went on, his use of the unit building/site system (below right) and introduction of several related but different exterior siding materials ties it all together. Project designer: Cecil Baker.

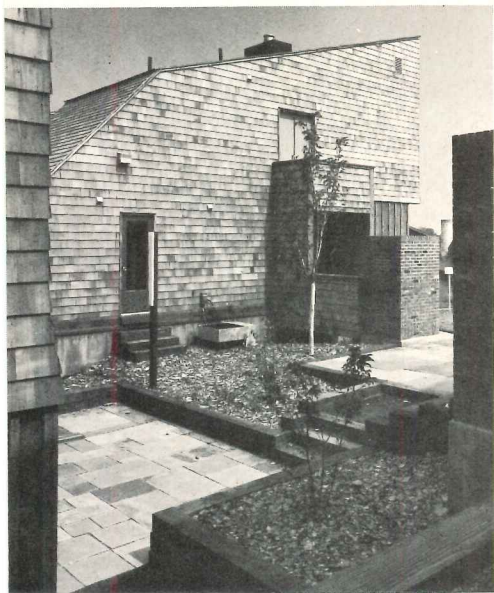
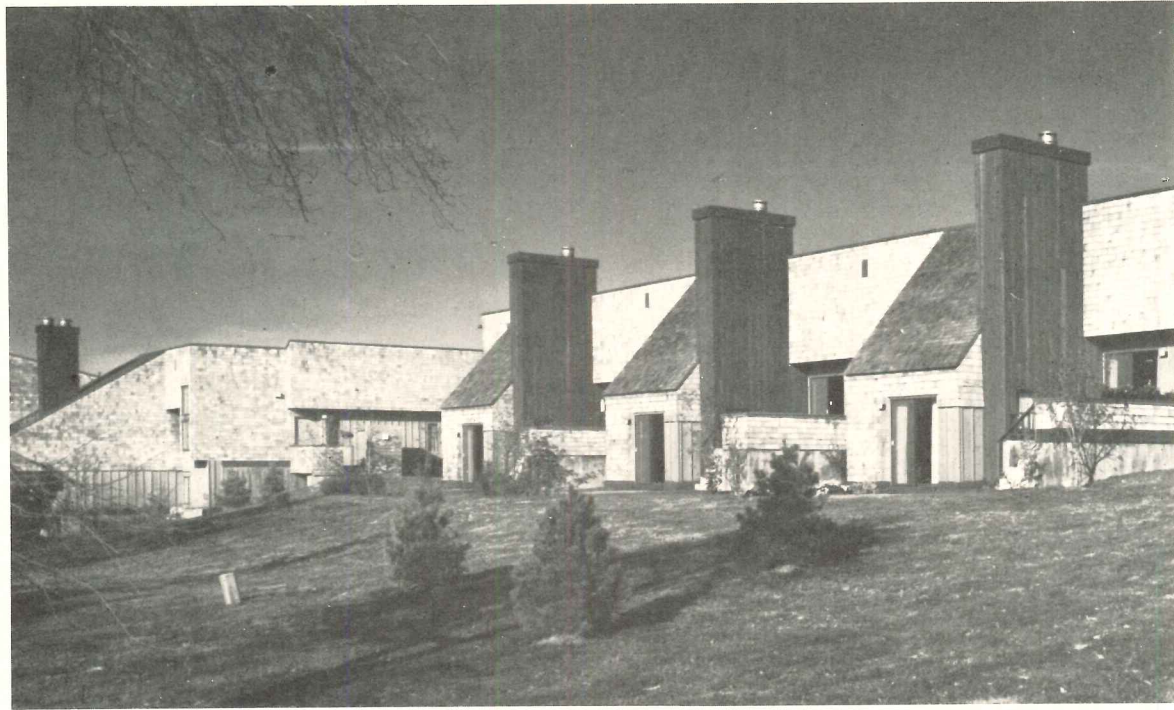

Otto Baitz

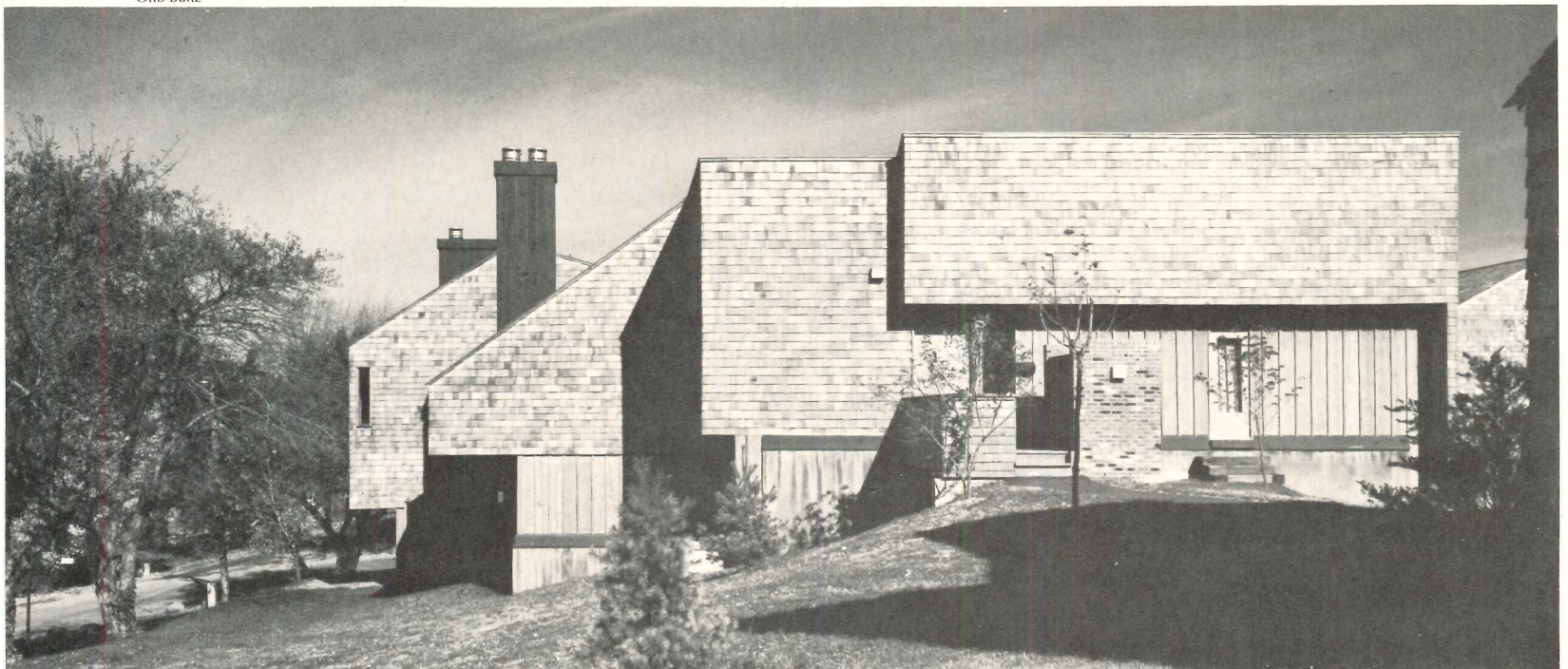
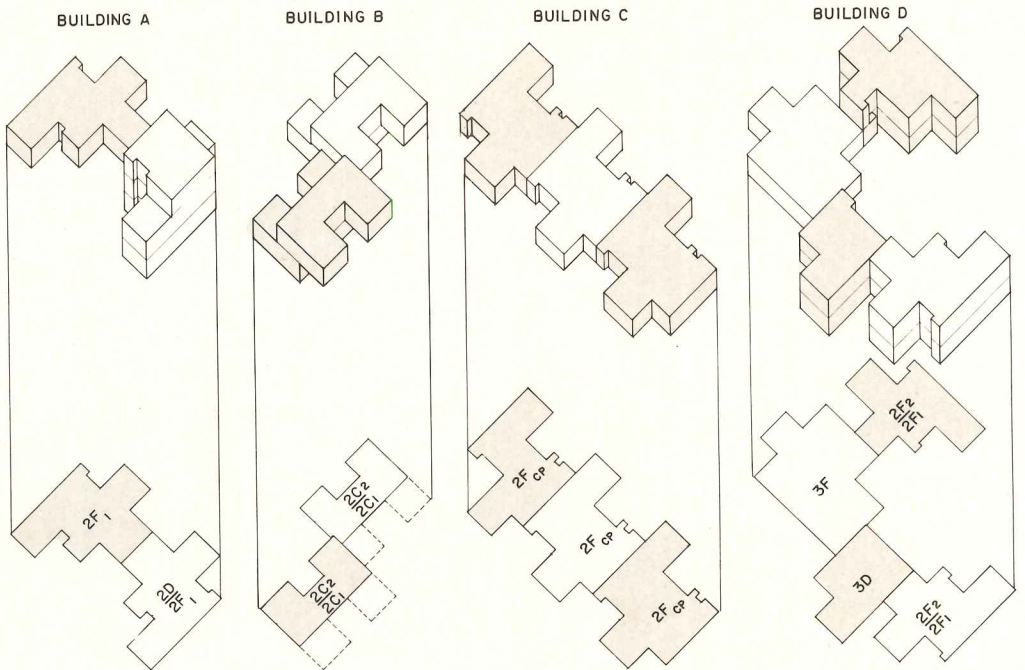

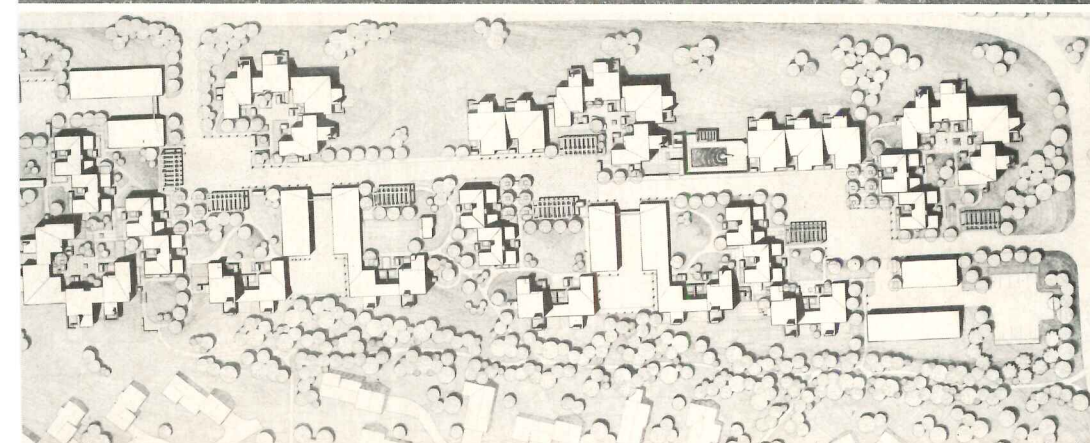

David Hirsch photos

Schematics are used as a programming device

The key, therefore, to Lou Sauer's design strategy in development housing (and he makes a firm distinction between that and other kinds of practice) is that he gives the developer as broad a range of choices for any building decision as he can, consistent with his own design standards, and lets the client combine them as he will. Far from giving the developer a single scheme based on a well researched program, Sauer very often uses schematics as a programming device. "Where institutional clients thrive on the fact-finding efforts that go into program research," he says, "developers are too pragmatic to want to be tied to a set of words that cannot be tested except by a completed building." It is the give and take necessary in the initial design phases of a job that prompts Sauer to call his approach "guerilla architecture." One of his most effective weapons is use of a "unit building/site system" which is a mode of planning. By offering a collection of dwelling unit plans which can be combined as needed to meet market and site demands, as at Wesleyan Hills (opposite), Sauer limits, but does not dictate, the final result. The particular set of unit plans offered to the client is based upon Sauer's assessment of the developer's intent and values as gleaned from the earliest meetings. Obviously such assessments grow more accurate as the architect deals with developers, but Lou Sauer claims that it is largely a matter of listening openly and then taking seriously the developer's expression of his hopes for the project—all carefully examined in terms of economics.

His approach can be explained in a much more detailed way, of course, but the primary fact is that the architect must remain as flexible as possible through the entire process. The goal is to identify the elements and factors of the process which can be predicted so that the architect can move ahead of time to meet those requirements. The first step of Sauer's "design strategy" is to state the several factors which will affect the job and to clarify the interest and needs of each. The factors fall into three groups: users, which cover the individual as well as the community; the construction industry which includes the developer-client, the various control agencies (local as well as HUD), the financial sources, the con-

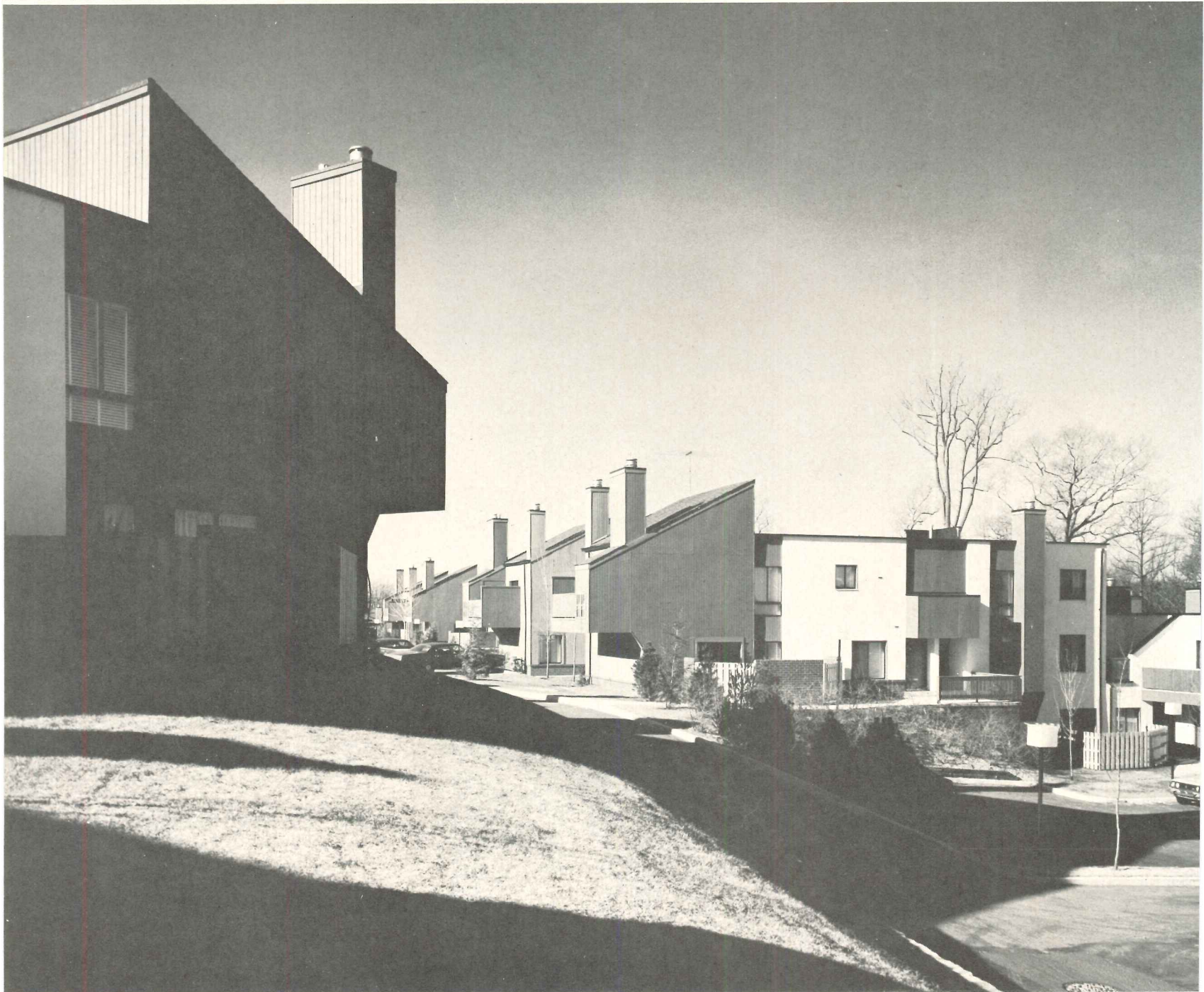

Oak Hill Estates, Philadelphia, Pennsylvania.

When Lou Sauer is working with a developer-builder who knows exactly what he wants to do (as in the case of this upper-income rental project), and who gives the architect little control over budget, construction process or marketing, he makes use of what he calls "symmetrical schemes." Using the unit building/site system in a more rigorous way than he would in a looser situation, Sauer presents the client with simplified planning choices. This procedure sometimes results in elevations (below) whose symmetry seems out of place in a scheme that is otherwise informal and fits a rolling site. But Sauer sees that as a small price for the advantages otherwise gained: instead of building more of the four-story brick apartment buildings which the client had already covered the rest of the site, he found that the individual quality of these townhouses brings in substantially higher rents and allows for significantly lower density. Project architect: John Czarnowski.

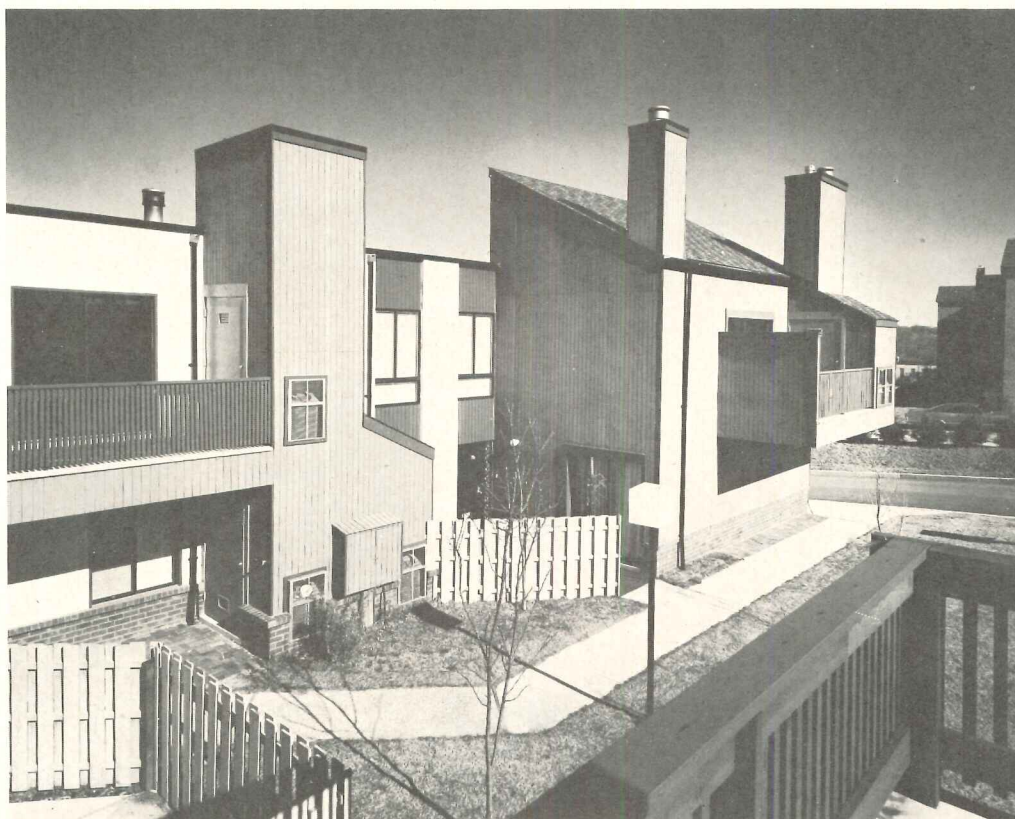
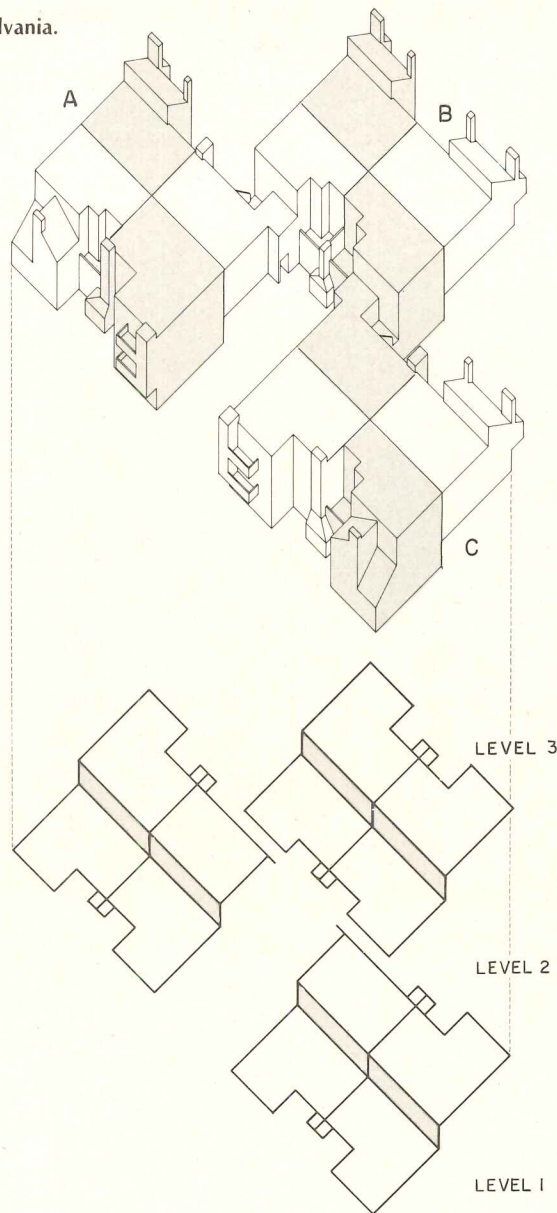

Otto Baitz photos

struction period and procedures, the marketing approach and the cost. And finally there are the design professionals, the architect and his consultants. Not only can the interests of each factor be identified at this stage, but the priority of each factor can be weighed. The second step is to identify which factor has what power to affect the job, again both in descriptive terms and in relative importance. The third step is to then predict the crises that the interaction of the various factors might cause and to anticipate how likely each is to delay the job. In the sense that the procedure makes quantitative evaluations it is more like the PERT system than CPM. Once this analysis is complete, the architect creates a "Physical Design Vocabulary" which each factor identified can manipulate to serve its own interest and need while still getting the project built as efficiently as possible.

Sauer works effectively to participate in budgeting

Since the major factor in development housing is cost, it is useful to examine Sauer's ideas on the way the architect can predict and thus control it. To him, whoever controls the construction budget controls the design. That control is as important in terms of the possible trade-offs as it is in terms of the total amount of the budget. Where some architects might be content to get a general idea from the potential builders as to what the costs may be, Sauer makes it a point to interview sub-contractors as well in order to find out what their limits and potentials are. He uses the illustration of the dry-wall contractor's method of pricing a job—by the square foot or by the sheet—as a determinant of whether he can include extra-height spaces with sloping roofs, for instance. Needless to say, the architect's attitude about building materials must be very flexible in such circumstances. Sauer finds that the closer a developer is to being a builder, the less say he has in what materials will be used. But even here, the willingness to offer a range of choices gives the architect an important influence, if not the kind of control associated with institutional work. As in institutional work, if the architect controls the certificate of payment, says Sauer, he automatically controls the construction budget. That makes HUD 236 jobs, in his estimate, more like standard practice than the usual development housing.

It does boil down to who comes up with the money. Since assembling money plus land is the developer's basic job, it is he who is normally the most powerful factor in the process. To the extent the user has money to spend (as in unsubsidized housing), the developer will respond. To the extent the user can manipulate the money (as in community groups) the developer will respond. To the extent the architect can save him money, the developer will respond. That is why the Sauer office stays with working drawings until after bidding so as to assist with revisions. It is another form of influencing the construction budget.

The architect provides a "sense of place"

It is Lou Sauer's belief that ultimately the architect's unique and necessary contribution to the development housing process is a "sense of place." The developers who come to him want a sense of place that will appeal to the market they have isolated. To them, he says with a smile, beauty means "Will the market like it?" But Sauer's goal goes beyond that. He seeks to develop, through the use of his "design strategy," a means for producing housing environments that will reinforce people's esthetic identity and values, not ignore them as so much of contemporary architecture does. In his opinion it is crucial to reinforcing their personal security, to building a sense of community. "I want to do outstanding architecture within the constraints of the normal world," says Lou Sauer, "and the developer is the closest approximation to that reality I know." The goal, as he sees it, is to get beyond "architected" architecture toward buildings that will respond readily to social and cultural changes whatever they may be. In a time when reactionary forces seem to be so strong, such striving toward a democratic, humanistic architecture is well worth notice.

Jim Morgan

CANTERBURY GARDEN, New Haven, Connecticut. Developer: *New Haven Redevelopment Agency*. Non-profit sponsor: *Parish Church of St. Luke*. Planting: *Robert Gegan*. General contractor: *Kapetan, Inc.* WESLEYAN HILLS, Middletown, Connecticut. Developer: *The Hill Development Corporation with the LaCava Brothers Construction Company*. Planner: *Emil Hanslin*. OAK HILL ESTATES, Philadelphia, Pennsylvania. Developer: *E. J. Frankel Enterprises, Inc.* Landscaping: *Joachim Tourbier*.

Otto Baitz



A wide variety of housing types has been produced by Louis Sauer Associates. Grundy Towers (left), Bristol, Pa. is a 14-story building for elderly housing done as a FHA Turnkey project. Spring Pond, Corning, N.Y. (below) uses a refined version of the unit building/site system. Oakland Mills Village Center (third row, left) in Columbia, Md. was designed around existing dairy barns. It now contains community and retail shopping facilities for one of the new residential areas. North Crossing I, Willow Grove, Pa. (right) is low-cost housing (\$7.80 per sq ft in 1967) whose rents soared because of a strong market. Genesee Crossing, Rochester, N.Y. and the Warbutton-Lamartine townhouses, Yonkers, N.Y. (bottom row) are both projects done for the New York State Urban Development Corp. The former contains low- and high-rise housing.

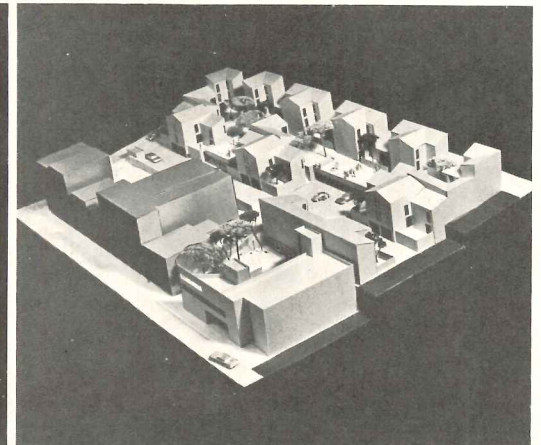
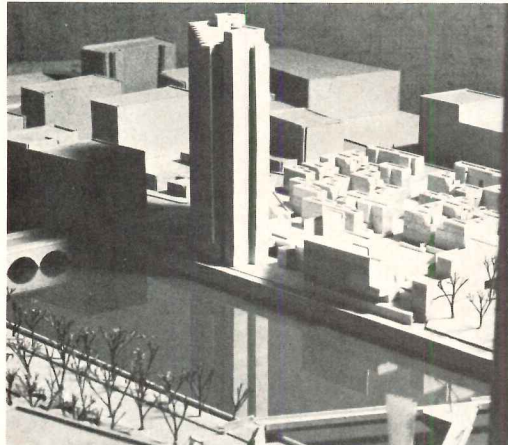
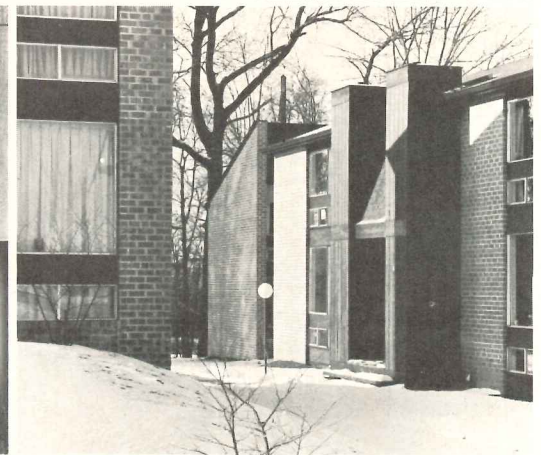
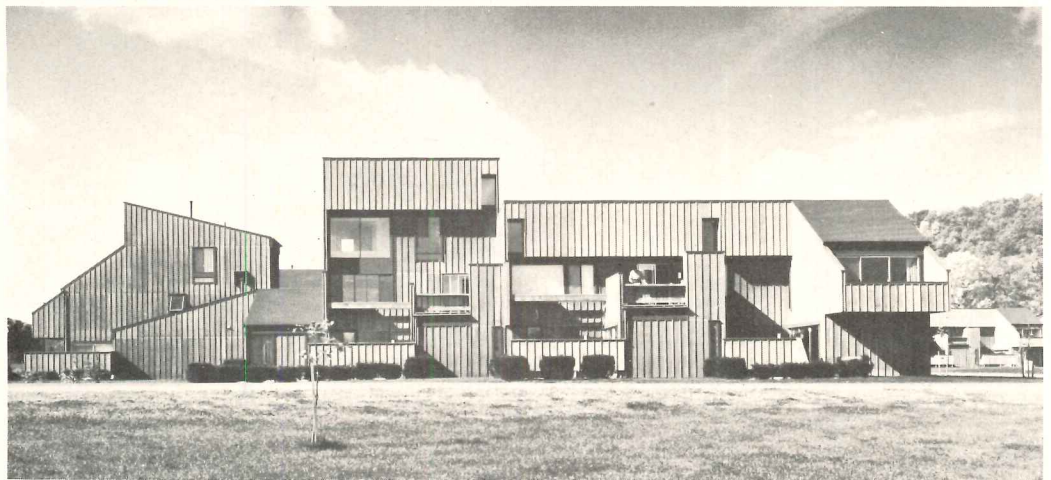

PRESENT AND FUTURE TRENDS IN LIBRARY DESIGN AND PLANNING

BUILDING TYPES STUDY 446

®

The need for new library buildings in the United States is enormous. The flow of information in the form of documents, periodicals and books is constantly increasing, as are new editions of many works out of print. Although among those of college age the percentage who are demanding higher formal education has begun to decline, the belief in learning as a key to upward mobility is far from dead. And as more U.S. citizens become concerned with the quality of life, the demand for books increases. New fields of learning and employment continue to open up, while at the same time increased leisure is making new readers of many people who earlier in their lives had little time for books. The older members of our population share with the younger members the most intensive interest in books and have been the most active users of libraries. The proportion of older people in the United States is increasing.

The present volume of construction of public libraries, particularly in the inner cities, does not begin to meet the needs of the urban poor. Until more public funds are available, today's disadvantaged will not receive the opportunities for learning in libraries which they urgently require. In a number of cities, existing urban libraries, tragically, tend to be opened for less hours on fewer days of the week.

Across the nation, current expenditures for the construction of public library buildings comes to only \$50 million a year for new construction and \$15-20 million a year for remodeling and expansion. Much of this new construction is for small suburban libraries similar to the three shown in case study form on the pages which follow. All three are successful solutions to similar problems—those of providing adequate seating and shelf space for a predetermined level of expansion in a comfortable, inviting and essentially domestic ambience. Of as much interest as the arrangement of functions, facilities and controls in these libraries, is the manner in which each architect has achieved a kind of architectural expression appropriate to the local community.

By far the most important segment of the library construction market in the last few years has been academic libraries. For the five years from 1967 through 1971, nearly a billion dollars was spent for the construction of college and university libraries. The gross area completed amounted to over 34 million square feet, providing accommodations for more than 127 million volumes. A \$3.6 million sciences library for Brown University and a \$15.7 million graduate research library for the University of Chicago have been included here as case studies. These buildings were designed and constructed while new forms of communications technology which have yet to come of age were just experiencing birth pangs. While these latter two buildings have built-in capacity to accept the new computers, they might have been quite different in size and conception had the full potentials of computerized information, storage and retrieval been available, then or now. This Building Types Study concludes with a discussion of the implications of communications technology for library design.—*Mildred F. Schmertz*

The welcoming, sheltering, almost domestic quality of this new public library in an old New England town makes it an unusually attractive environment for books. Located on a tree-lined main street with many good examples of colonial architecture, it is adjacent to the town hall, a Greek Revival church, and a nearby school; and plays a key role as part of the town center. Sherborn, Massachusetts has a population of approximately 3,000 people and is a bedroom community for the city of Boston. Since the library serves such a small community and was not considered a resource for the region, it has been designed for a maximum capacity of only 36,000 volumes. The architect has successfully managed to create a building which is har-

monious with its neighbors in scale and materials. Traditionally handled brick walls, wood floor and roof decking, rough plaster partitions, and bluestone entry flooring are combined in a contemporary fashion with a laminated timber structural frame, a ridge skylight and carpeted floors. The furniture and bookstack ends are wood. The furniture is upholstered in bright shades of orange and yellow and is of an informal character.

SHERBORN LIBRARY, Sherborn, Massachusetts. Architects: James A. S. Walker—associate: John Gerald Horne. Engineers: Abraham Woolf and Associates, Inc. (structural and foundation); John J. McEvoy (mechanical); Thompson Engineering Company, Inc. (electrical). Landscaping: Harriette W. Long. General contractor: Henry E. Wile Corporation.

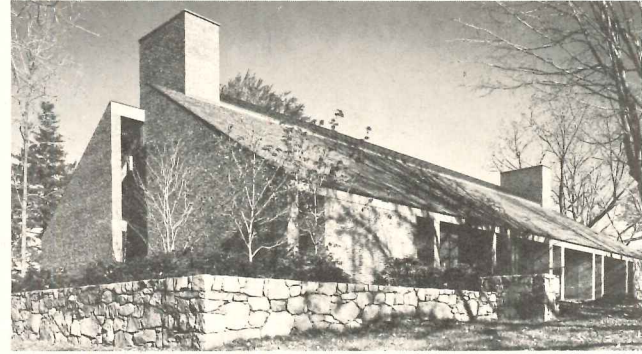
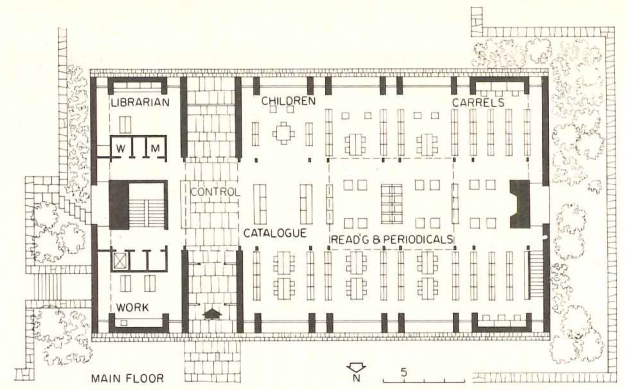

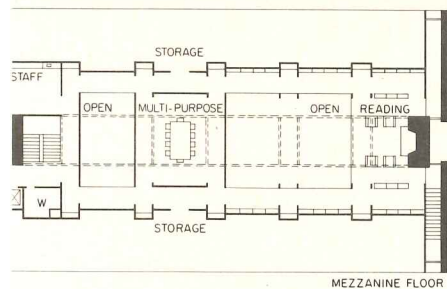

The library consists of a main floor, a mezzanine and a basement. The principal north-south corridor separates the librarian's office and the service areas from the library proper. The latter is separated into three major areas—reference, general reading and a children's section. A large fireplace at the western end of the library functions as the building's focal point (bottom right). In addition, the library furniture is comfortable, generous, and inviting.

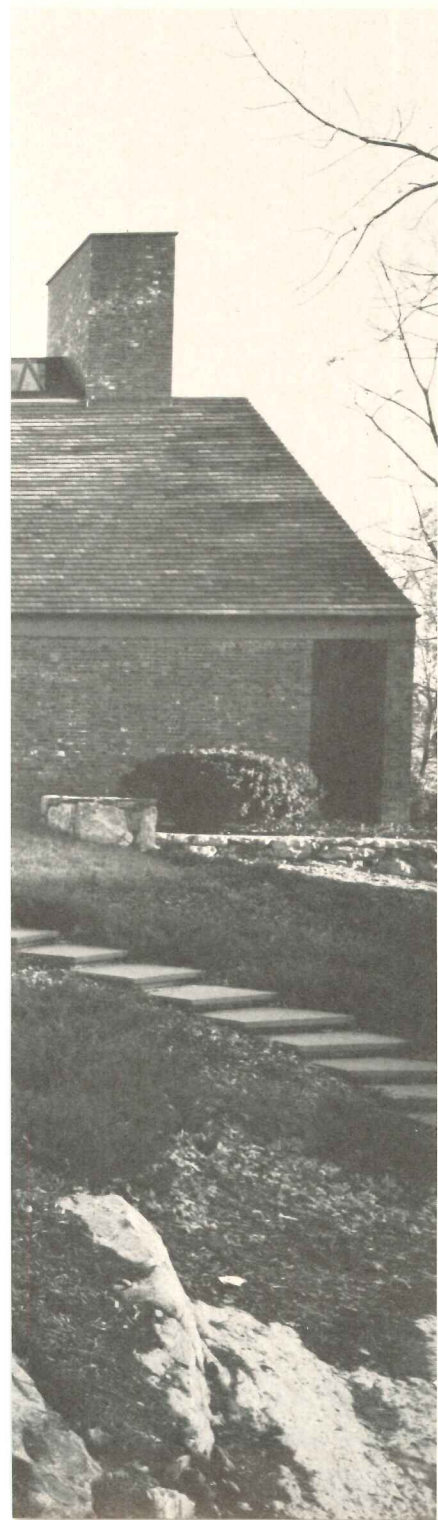

Phokion Karas photos

Because of the steep roof pitch, the mezzanine is narrow along the side—but this design affords a considerable bonus in shelving footage and is a quiet browsing area. In the bay which parallels the main hall and control desk, the mezzanine spans the width of the building adding a multi-purpose room. On the main floor, the stacks are arranged to create small-scaled reading and study spaces which are yet open enough to give the individual a sense of inhabiting a larger room. The double brick piers and the deep overhangs help shade the windows and thus reduce glare in the perimeter bays, while the skylight brings needed brightness to the center.

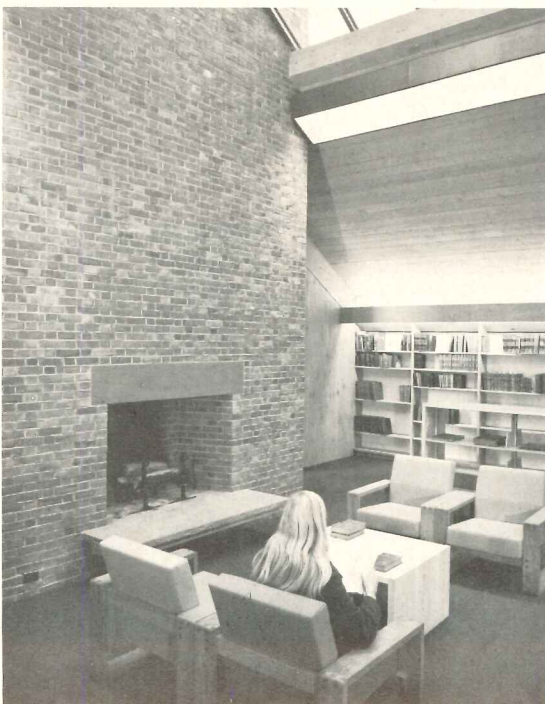

The design concept of this small suburban public library evolved mainly from the desire of the library board, the librarians and their architects, to devise a system of control and operation which would be housed within large open spaces. The reading rooms are organized into a large reading and reference area, functionally separated only by furniture arrangement, and a separate children's reading room. A smaller room houses the rare book collection and offers an area of relative seclusion and quiet for dues-paying members of the library. As the plan (right) indicates, the administrative offices, meeting areas and the circulation workroom are conveniently related to both the main entrance and the service and receiving area. Smaller satellite

workrooms are provided off the main reading room and at the lower level adjacent to these areas. The circulation desk, elevator, toilet and locker facilities are located in the central spine for ease of access and for control.

At the lower level (not shown) is a large meeting room with a stage and audio-visual facilities which serves the community at large, during and after library hours.

FARMINGTON PUBLIC LIBRARY, Farmington, Michigan. Architects and engineers: *Tarapata MacMahon Paulsen Corporation*—principal-in-charge: *Richard K. Albyn*; design: *Peter Tarapata and John Kinsella*; job captain: *C. E. Bentley*; chief structural engineer: *Samuel V. Tavernit*. Consultants: *Mohrhardt & Ulveling* (library); *20th Century Design Inc.* (landscape). Contractor: *Freeman-Darling Inc.*

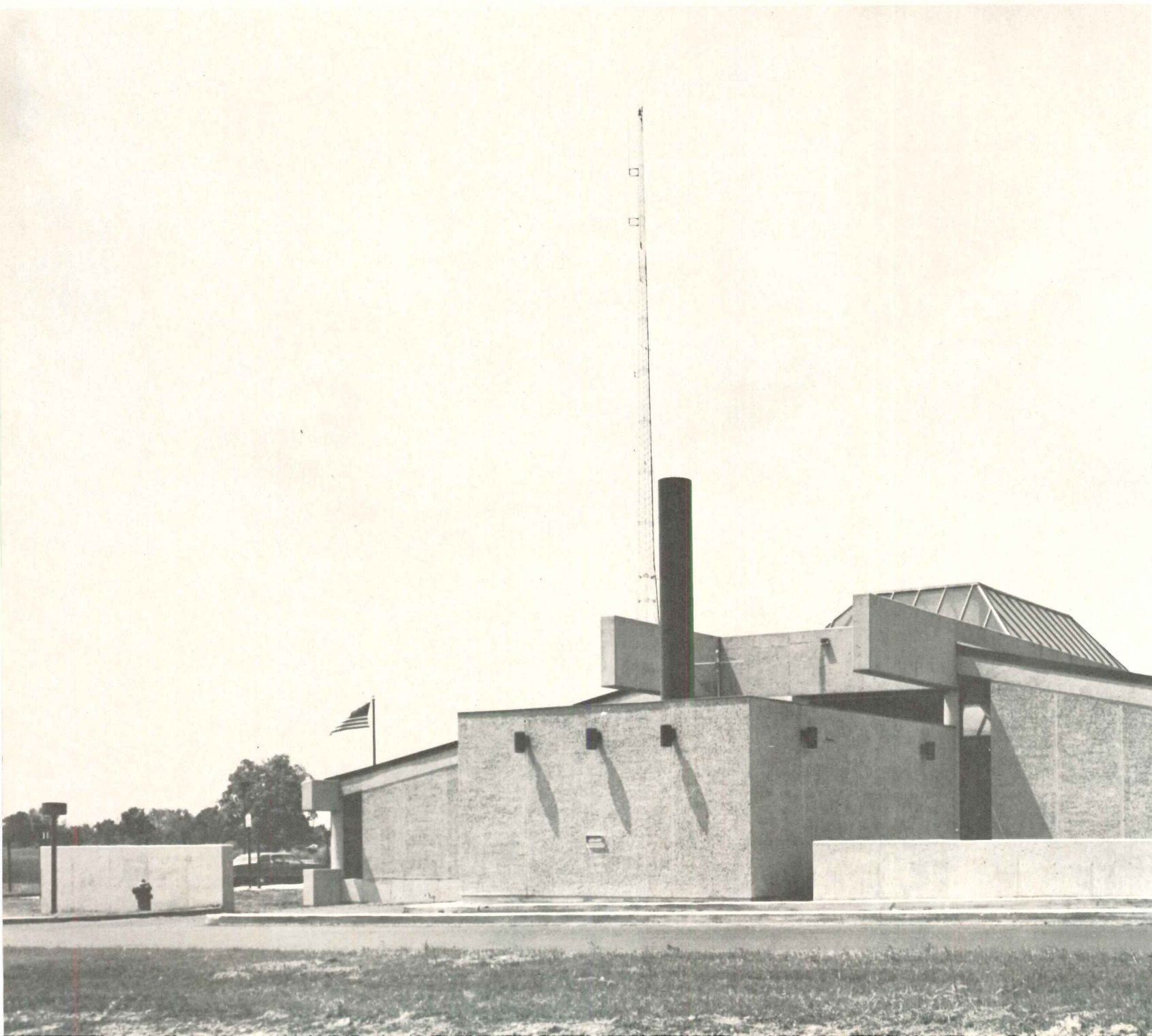
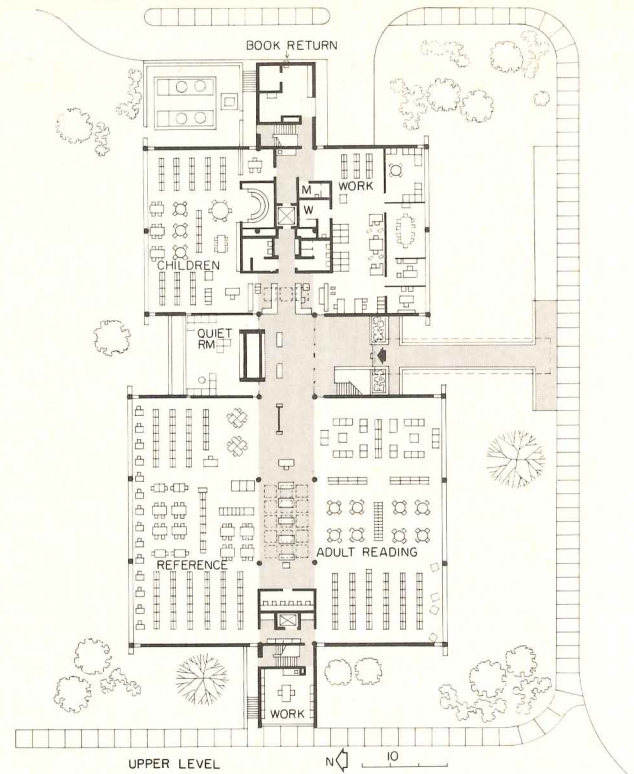

The long, low form of the library is well suited to its rolling site. From the main road (below), it appears to be a single-story building. Service to the upper and lower levels is located at the rear of the sloping site. The central spine, as it bisects the adult reading and reference area (right), serves as the location for the card catalogs. It is differentiated from the reading and research areas by means of its brick paving and higher ceiling. All reading rooms and work stations are carpeted for acoustic control and ease of maintenance. In the children's room is a tiny amphitheater which users call a "story hill" (bottom) where story hours are held. The construction cost of this 31,700 square foot fully air-conditioned building was \$903,770, or approximately \$28.52 per square foot.



Balthazar Korab photos

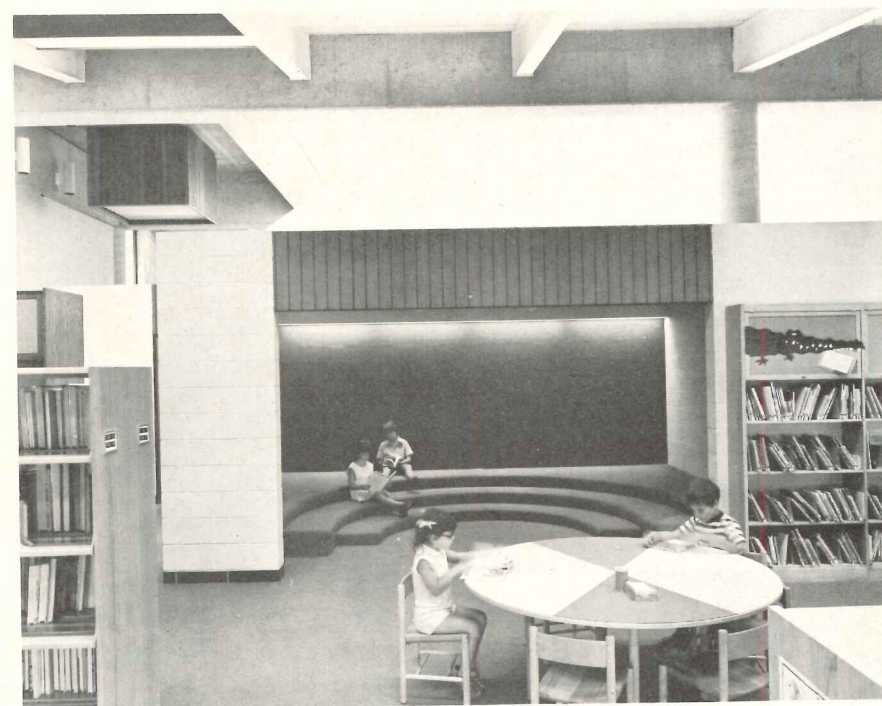
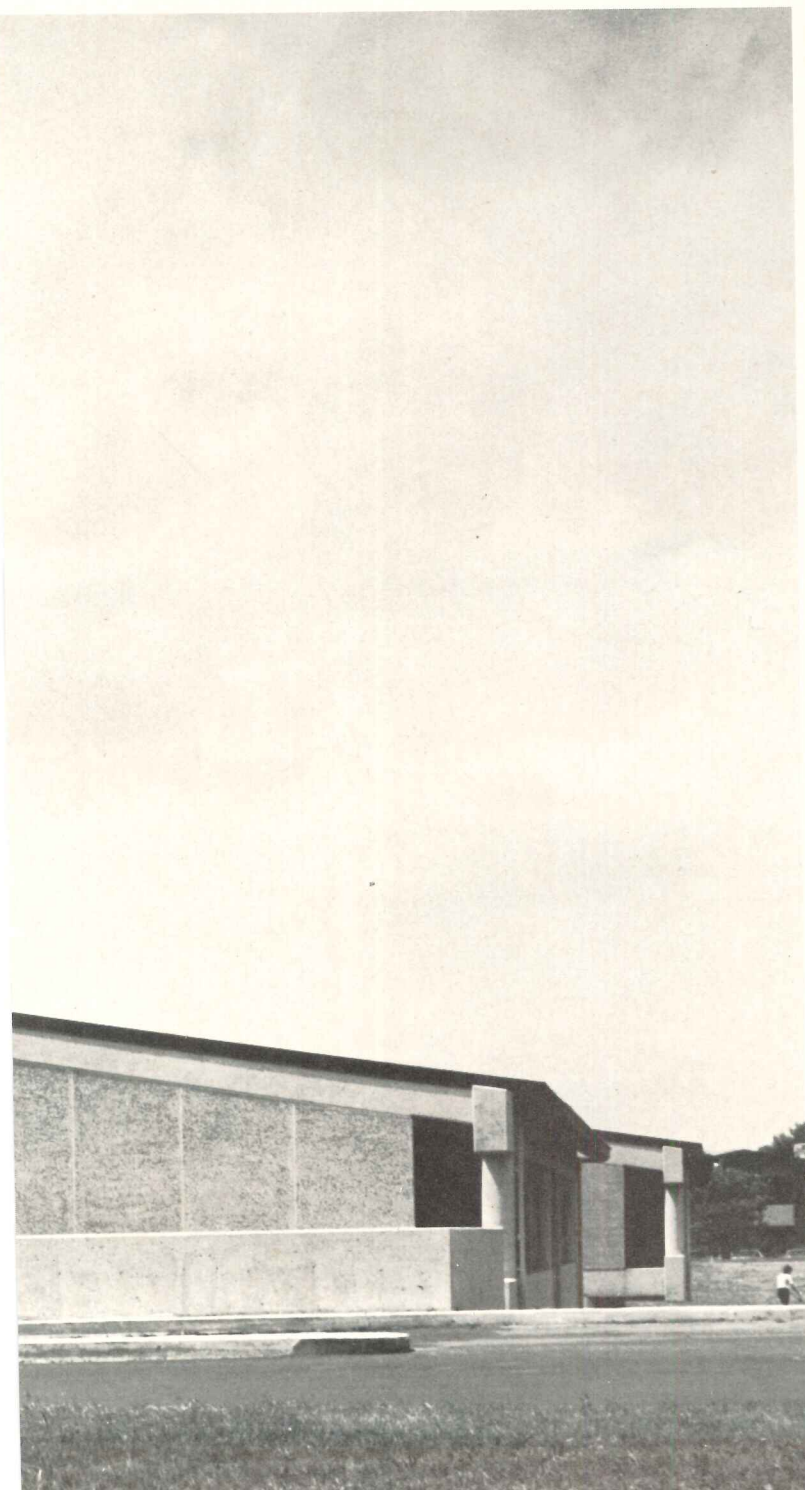

A two-level public library can allow an effective separation of both the child and adult collections by putting each on its own floor, as in this suburban library in the New York City region.

Designed to serve the needs of the town of Greenburgh for the next 20 years, it has a capacity of 125,000 volumes. The upper floor of the library, accessible directly from the upper level parking area by a "flying bridge," serves the needs of the adults and young adults; and the lower floor, the children. The adult collection of 85,000 volumes includes the reference library, magazine and new book selection, bibliography, science, history, fiction, business and industry collection and periodicals. The seating and browsing areas are separated by bookshelves. The audio-visual

section, also located on the upper floor, contains microfilm files, records and tapes. An area next to the main entrance is reserved for art exhibits. The lower level, houses the children's collection of 50,000 volumes.

GREENBURGH PUBLIC LIBRARY, Greenburgh, New York. Owner: *Town of Greenburgh—Nicholas Russo, supervisor.* Client: *Greenburgh Public Library Board of Trustees—Leon B. Siwek, chairman.* Architects for building design, interior design, furnishings and equipment, graphics and landscape: *Max O. Urbahn Associates, Inc.—Max O. Urbahn, president and chief executive officer; Philip F. Moyer, executive vice president; Martin D. Stein, vice-president and director of design; Ronald Gower, designer.* Consultants: *Wenning Associates (engineering); Francis St. John (library).* Contractor: *Romani & Picco, Inc.*

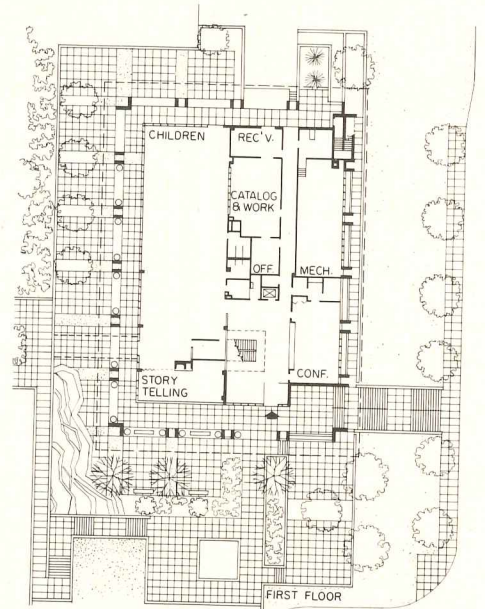

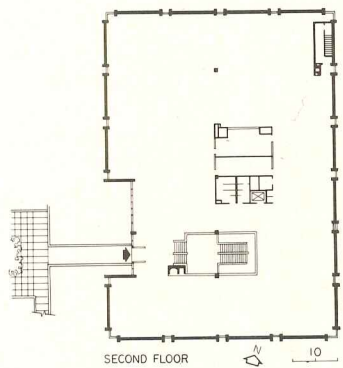

George Cserna photos

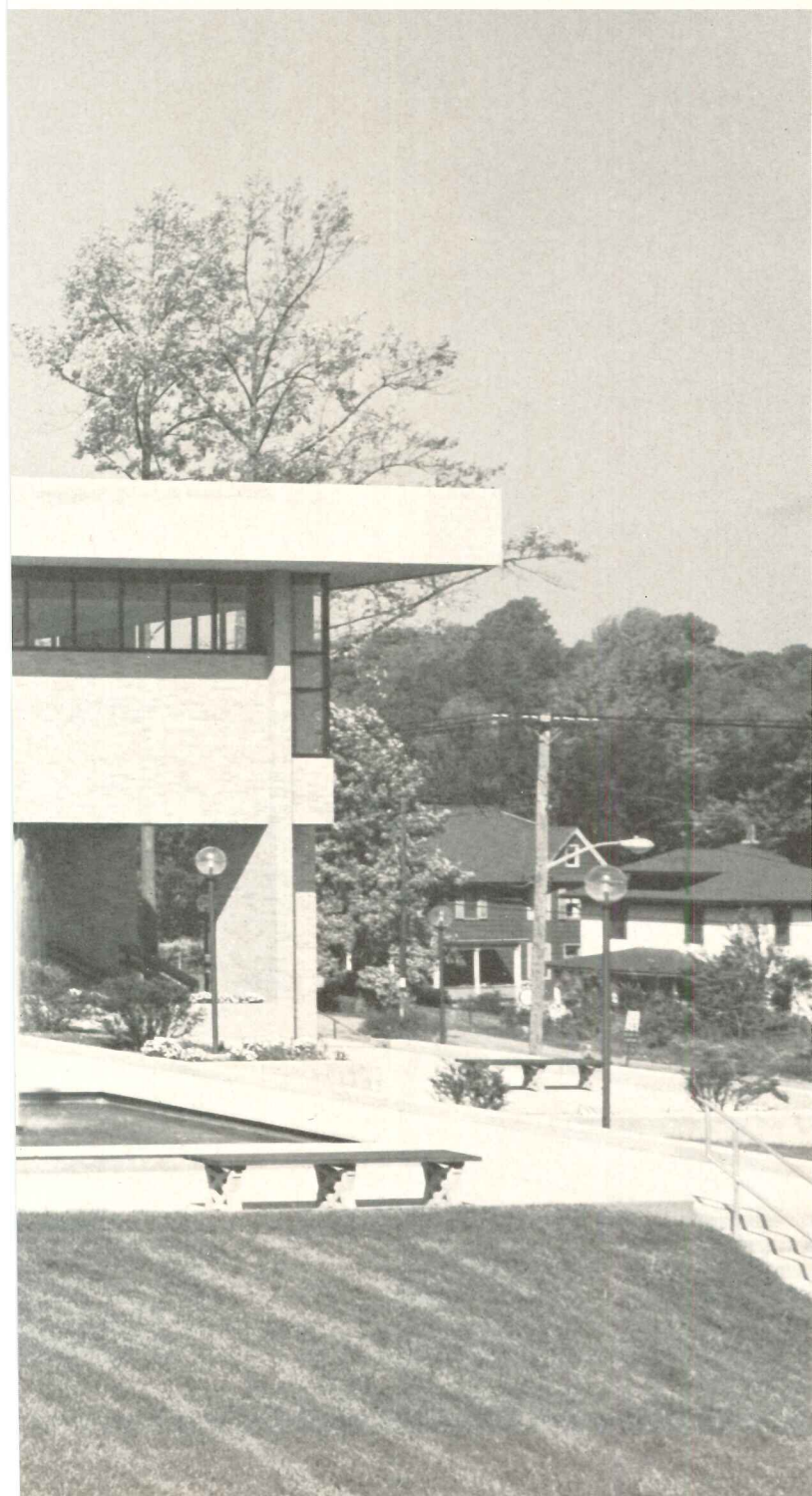

The second floor adult level (above) is a well-scaled space subdivided by shelving into small, comfortably sized reading areas. The children's level (right) has chairs, tables, bookshelves and book cradles scaled to the height and size of young readers. The remainder of the lower level consists of a staff room, receiving area, the cataloguing and work area, toilets, elevator, mechanical equipment room, shops and other ancillary facilities. Not shown is the history room which houses various books and objects depicting the history of the town. It also serves as a meeting room for the community.

The construction cost of this 23,000 square foot library was \$811,000 or a little over \$35 per square foot. The total cost including furniture and landscaping was \$1.2 million.



The new graduate research library at the University of Chicago spreads across a former athletic field and its two biggest floors are each approximately two acres in area. The neo-Gothic campus buildings which surround it average one-tenth of the floor area of the floors in the new library, providing Walter Netsch with the problem of balancing scale relationships.

In his efforts to break down the apparent bulk of the vast facades—by alternately projecting and recessing the perimeter carrel

and office spaces, and by developing a complicated system of floor setbacks—he has achieved an effect which seems to derive more from the geometries of a particular Vasarely painting (opposite page bottom) than from any attempts to approximate a Gothic scale. In any case, the problem Netsch posed for himself may not have been solvable if only because the new library is the largest building ever to be built at the University and one of the largest single campus library facilities in the nation. As such, it can only

be designed in terms of its own scale. This may in fact be what Netsch actually did.

THE JOSEPH REGENSTEIN LIBRARY, The University of Chicago, Chicago, Illinois. Architects and engineers: *Skidmore, Owings & Merrill*—administrative partner: *William E. Dunlap*; partner-in-charge of design: *Walter A. Netsch*; project manager: *Donald E. Ohlson*; project interior designer: *Donald D. Powell*. Associated architect: *Harold H. Hellman (architect for the University)*. Consultant: *Michael J. Kodaras (acoustics)*. Construction manager: *Tishman Construction Co., Chicago, Illinois*



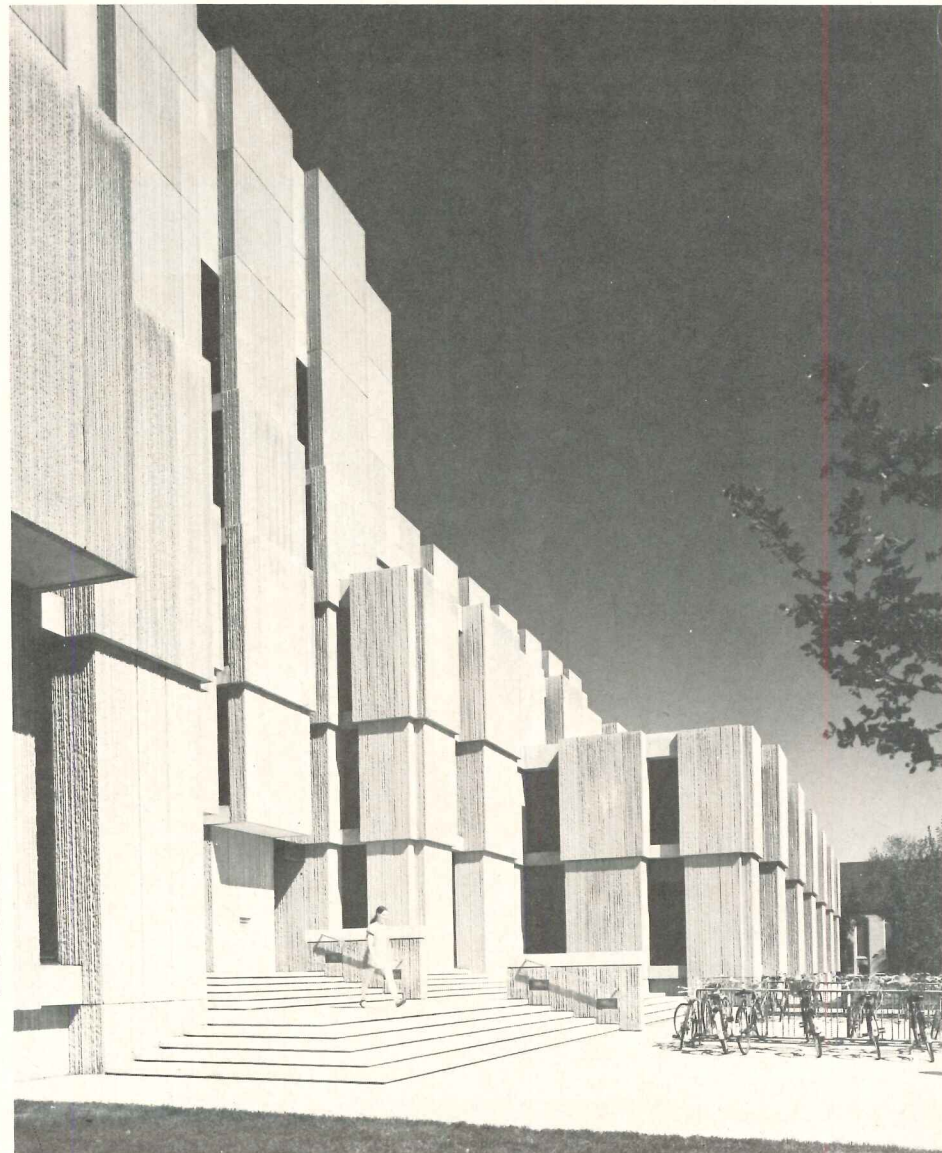
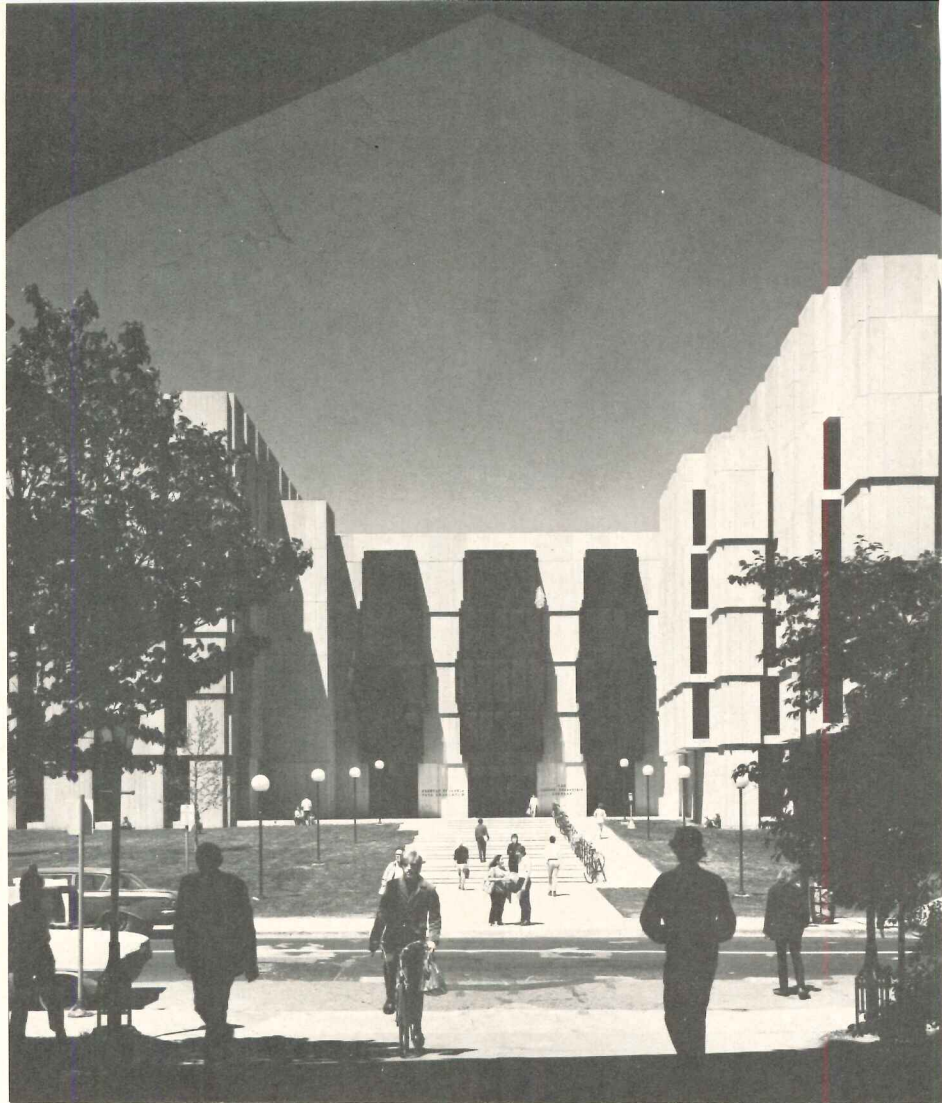
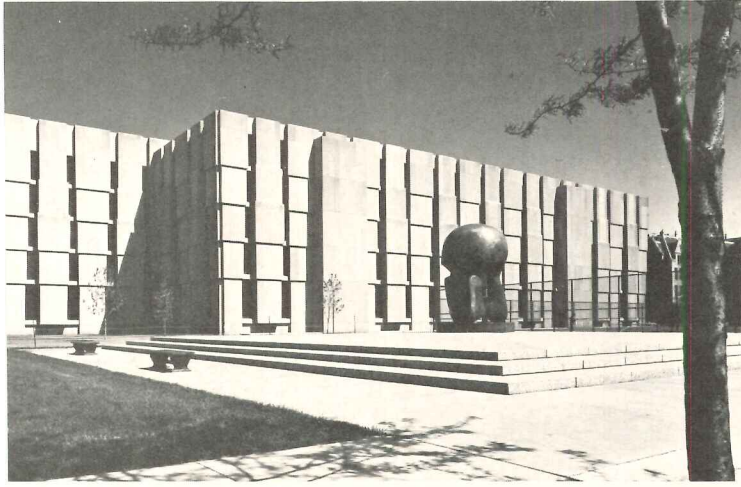

The structural system consists of reinforced concrete columns and waffle slab floors. The exposed columns have a board and fiberglass form finish. The floor slabs were poured in special fiberglass forms and were left exposed and unpainted in stack areas and exposed and painted in the reader areas.

The exterior walls are floor height panels of vertically scored limestone from 4 to 6 inches thick. The walls of the bookstack and reader areas are heavily insulated and protected due to the high relative humidity maintained in these areas the year-round. The bookstack areas have dual glazing of glare-reducing grey glass in neoprene gaskets, and black anodized aluminum frames. Other windows in the library are similar but have single glazing.

The interior finishes and materials are simple and economical. The bookstack and work areas have vinyl asbestos floor tile, exposed ground faced concrete block walls, painted plaster walls, painted hollow metal doors and frames, and exposed concrete waffle slab ceilings. Reader areas, offices, seminar rooms, typing rooms and open shelving areas have carpeted floors, painted plaster walls, oak doors, frames and glazed partitions, painted concrete exposed waffle slab ceilings and suspended acoustic ceilings.

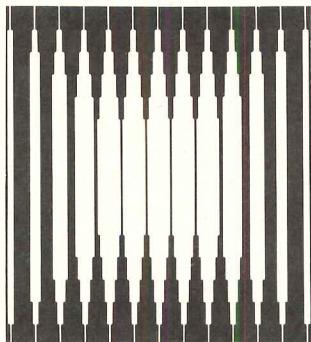

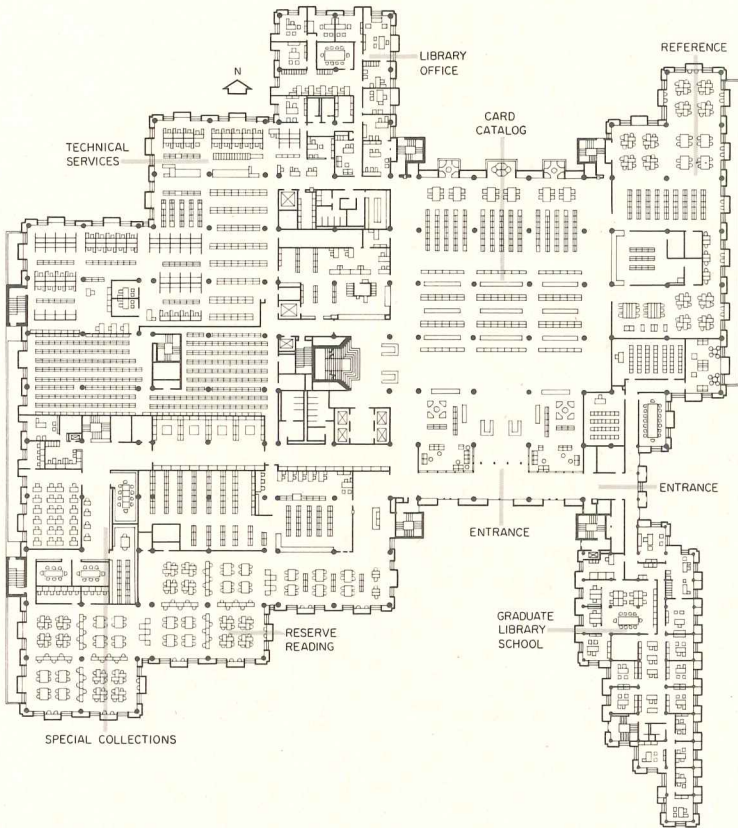
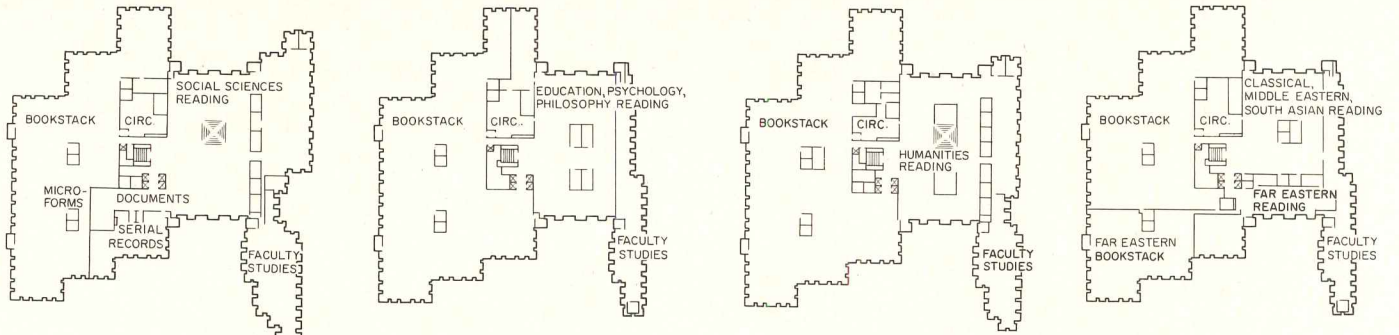

The program called for an ultimate collection within the new building of over 3.5 million volumes; an extremely high per capita use; a constituency in which graduate students and faculty predominate; and teaching and research programs which require that there be access to an unusually wide range of subject materials. Netsch and his clients believed that neither the traditional central tower consisting of multi-storied stacks with surrounding carrels, nor more recent systems of interspersed books and readers, nor the subject-divisional type of reading rooms in combination with a bookstack, would be sufficiently responsive to the intellectual, operational, environmental and economic factors.

Rather, the foregoing requirements suggested the need for a single unified book collection, all parts of which would be arranged so that the portions of the collection most frequently used by a discipline would be as close as possible to the special-

ized reference and service facilities provided for that discipline. Thus, the Regenstein Library draws under one roof all the University's collections in the social sciences and the humanities, with the exception of law, art, social service administration and theology, and merges them into a single collection in a single book stack deployed vertically over seven service floors. On each floor the resources for several related disciplines are associated by bringing together the books in appropriate broad sections of the Library of Congress classification. In this way, the resources on one floor—which can number up to 500,000 volumes—will respond to the needs of the student or scholar working in a concentrated field, or in a group of closely related fields. The scholar whose sources are drawn from several widely-different subject areas may, of course, find his materials on several different floors—frequently, however, adjacent to one another.





On each service floor, with direct access to the book collections assembled on that floor, is a large reading area (photos left and right) which provides the major specialized reference tools for the disciplines to be served on that floor. These materials are located on open shelves near the carrels and other seating and study accommodations, and adjacent to seminar and typing rooms, to the library's specialized bibliographers and reference personnel in each related field, to a circulation, control and information desk for the floor, and to a number of faculty studies. Thus, for each group of related disciplines, the research and study facilities are adjacent to, but not actually within, the corresponding bookstack area.

The lighting consists of 4-foot-square fixtures with low brightness baffles.

The total gross square footage of the library is 584,886 square feet. The total cost including fees, equipment, furniture, landscaping, site preparation, moving and other costs was \$20,750,000 or \$35.96 per square foot.





Brown is one of the first universities in the nation to combine all its science departmental collections into a single library.

In the interest of aiding interdisciplinary research in chemistry, biology, mathematics, physics, engineering, geology, psychology and medicine, the science collection is concentrated in a tower of 14 stories, at the pivot of the science complex.

The tower form, which until recently has been anathema to librarians, was accepted in principle by Dr. David A. Jonah, librarian of the University, with the stipulation to the architects, Warner Burns Toan Lunde, that the typical floors of the tower would have sufficient area to house the largest separate collections (medicine) on not more than two floors of 45,000 volumes

per floor. There was to be room for the appropriate number of carrels, open and locked, faculty study areas, conference rooms and other necessary facilities. The movement of readers and books is accomplished by means of elevators, book conveyors and a pneumatic tube system. The stack functions as an efficient information storage system with ease of access.

BROWN SCIENCES LIBRARY, Brown University, Providence, Rhode Island. Architects: Warner Burns Toan Lunde—partner-in-charge: Danforth Toan; project architect: Michael Willis; interior design: Gertrude Gray. Engineers: Severud Perrone Sturm Conlin Bandel (structural); Joseph Ward & Associates (foundation); Syska & Hennessy (mechanical and electrical). Landscape architects: Sasaki Dawson DeMay. General contractor: Dimeo Construction Company.

Louis Reens photos



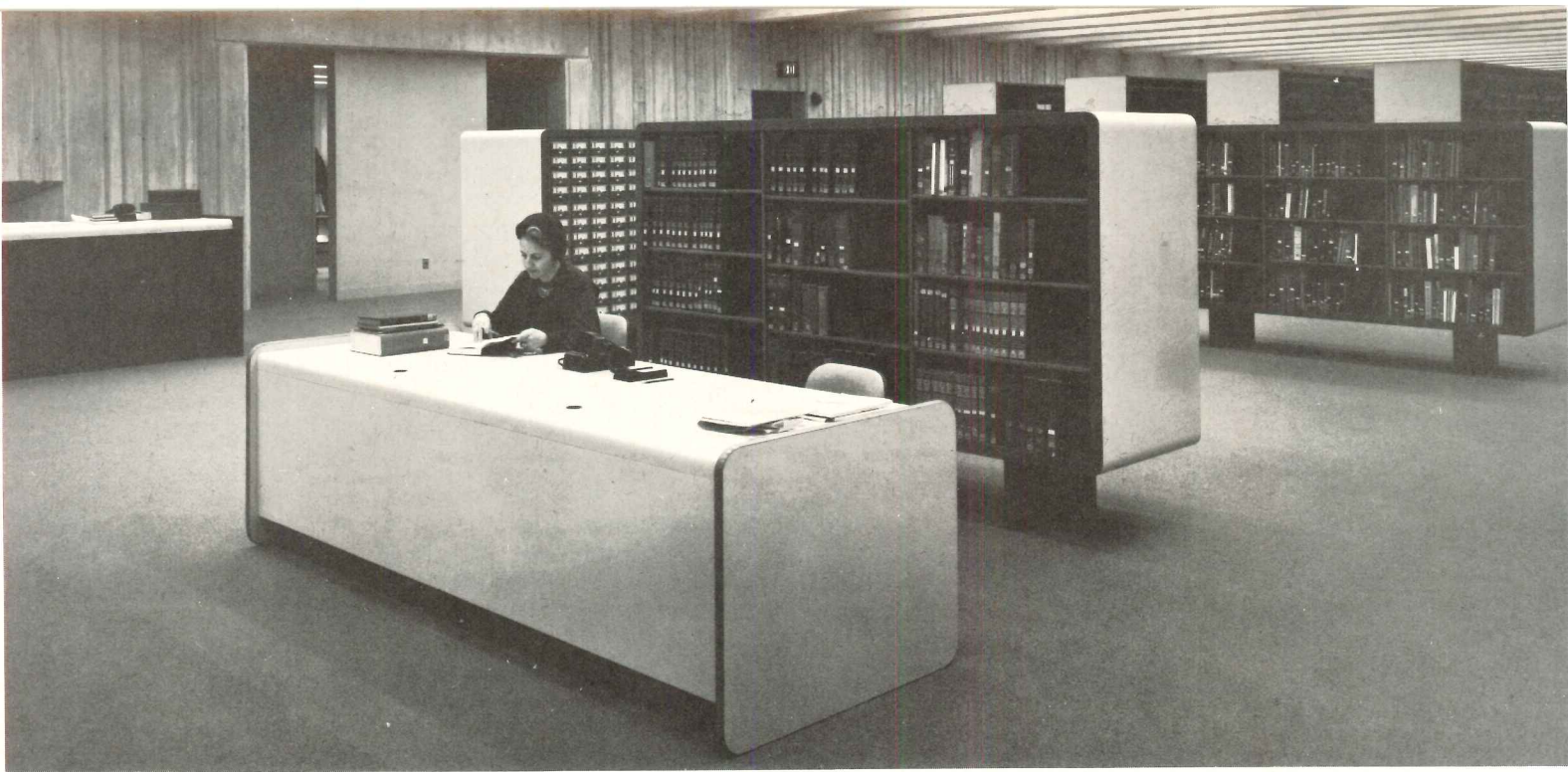

The main library floor on the lower level of 25,000 square feet contains the reference and current periodicals collections, and a technical services area. This floor is dropped below a podium which is skylit at both ends. On the main lobby floor (photo overleaf) is a generous space for exhibitions and lounging with a circular control desk and shelving which houses and regulates the reserve book section. The undergraduate reading room is on the mezzanine just above with access by means of the free-standing stair located on the north side of the building. Sunken patios, attractively planted, are located at the four corners of the tower. The architects designed the interiors, and the carrels, tables, card catalog enclosures, bookshelves, circulation desk and the reserve and rare book displays were all custom designed by them. Wherever possible, the furniture has flexible vinyl nosings to reduce wear and scratching.

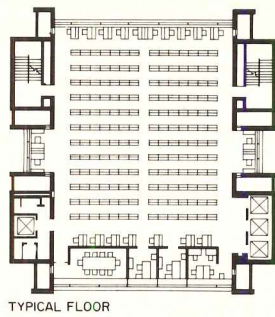

TYPICAL FLOOR

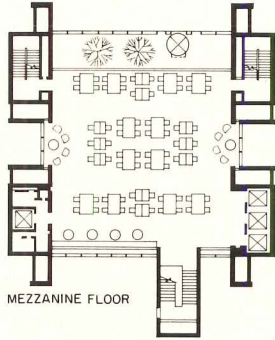

MEZZANINE FLOOR

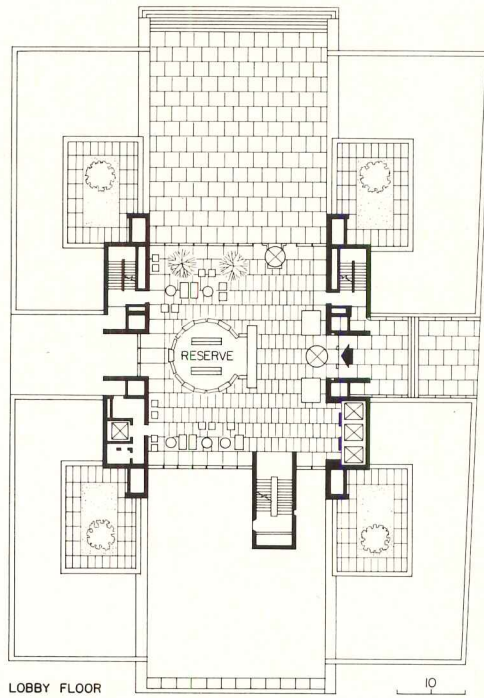

LOBBY FLOOR

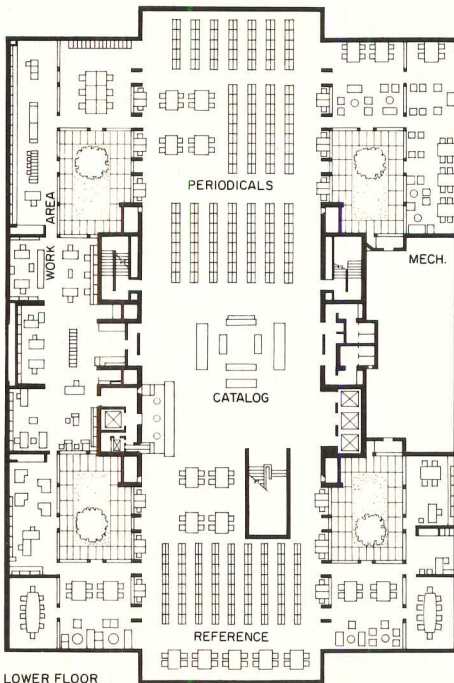

LOWER FLOOR

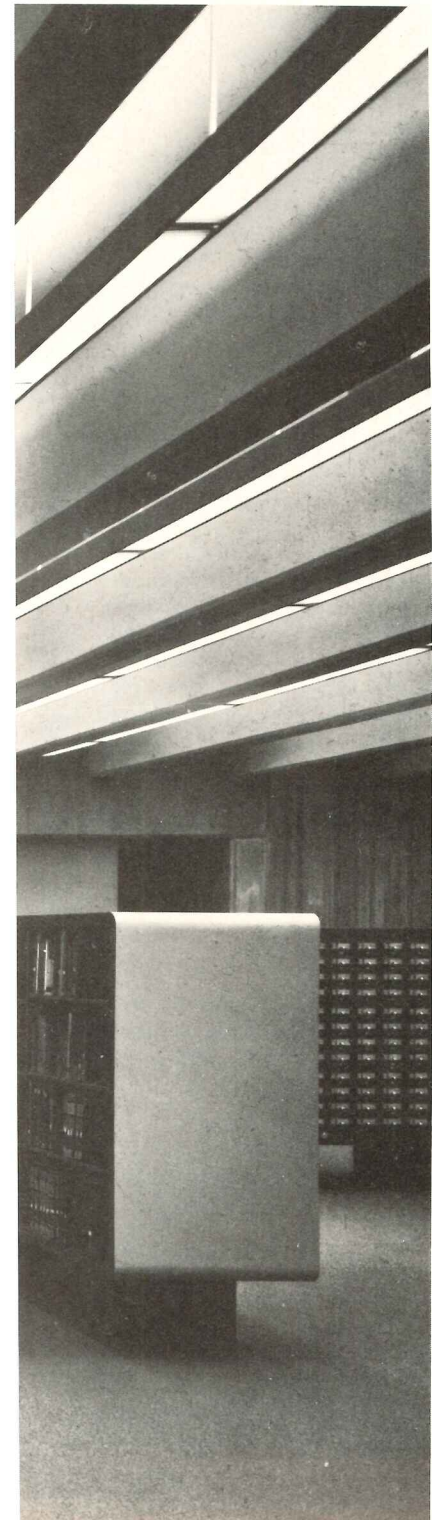
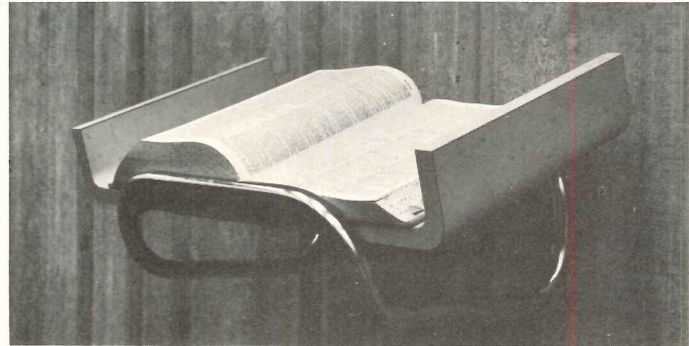
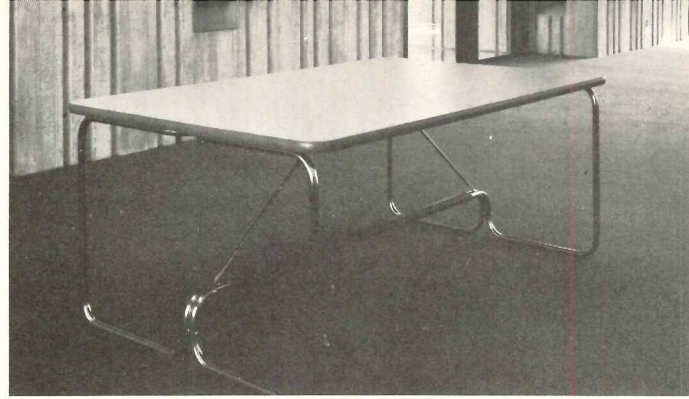

Communications technology and its implications for library design

Early prophets predicted dramatic changes

It is instructive to consider the five libraries presented as case studies on the preceding pages in terms of the prophecies of ten years ago. Had the far-out communications experts been heeded then, and had their visions been implemented, these libraries would not have been designed and built as they are. The three small public libraries, the 220,000 volume science library at Brown University and the immense graduate research library at the University of Chicago with its maximum capacity of 3,525,000 volumes would each have been programmed to contain far fewer books, and the reading and study space within the library would have been minimized. Libraries as we have known them were on their way out, or so it was thought.

The four essential operations by which a library functions—location of information, retrieval of information from storage, the communication of information to the user and the return of information to storage—can all be performed by the computer and auxiliary equipment. As a result, less than a decade ago, architects engaged in the programming and design of libraries were seriously asking themselves if the library as a container of books and a place to read them would not soon be obsolete. Marshall McLuhan was getting more attention then, and he, and other prophets and visionaries, gave librarians and architects and library boards of trustees plenty to worry about. If the book were indeed dying, or already dead, then it was predicted that by today the new library built ten years ago would be nothing but a mausoleum for the lifeless printed artifacts of the last 518 years (Gutenberg printed his first Bible from movable type in 1455).

The reader of the future was envisioned as an individual seated at a console pushing buttons which would call forth onto a screen the printed information which he sought. The console, which would be located in a terminal branch library, or the reader's home, office or dormitory (or possibly in his capsule) would

connect to a central computer and related equipment in which the desired learning was stored. The library building itself would become a simple utilitarian structure to house the computer above or below ground, on a remote inexpensive site.

Implementing predictions has taken much time and money

The technology upon which this vision was based is now available in its most advanced form in Project Intrex, an information storage and retrieval system being developed for large libraries by the Electronic Systems Laboratory at Massachusetts Institute of Technology, under grants from the Carnegie Corporation, the Council on Library Resources, Inc., the Independence Foundation, the National Science Foundation and the Sloan Foundation. The total funding of the project from its inception to the end of 1970 amounted to approximately \$2.5 million. (Funds have presently been used up, additional financial support is proving hard to get, and, therefore, the project is presently discontinued).

As described by one of its developers, Carl F. J. Overhage of the School of Engineering at M.I.T., Intrex works as follows:

Recent advances in digital data processing, when combined with photographic and video technology, lead to an information transfer system concept in which access to centrally-stored information can be obtained by computer controlled telecommunications at many remote terminals of different types. Local information resources can be augmented by links to external stores. The central information store of such a system contains both graphic and digital records. The bulk of the information contained in a library system is in graphic form, either as printed documents or as microform records. A small but growing fraction of the stored information is in digitally encoded form and this latter fraction is more easily handled by the computer and the communication links. . . . The experiments of Project Intrex are concerned with the two main functions of any information transfer system—first, the bibliographic search by

which the user identifies the documents relevant to his needs and second, the display of these documents to the user. The information required for the former is essentially the "catalog" and that required for the latter can be called the "full text." Catalog information is relatively compact; the user wants to manipulate it interactively; it is therefore stored in the computer memory in digitally encoded form. Since full-text information is much more extensive, computer storage by present technology would be economically prohibitive. It is, therefore, stored in graphic form on microphotographic records.

Each document is represented in the Intrex catalog by an entry prepared by catalogers. Such an entry contains considerably more information than conventional references. In addition to author, title and citation date, the entry includes a list of noun phrases that describe in depth the contents of the document. . . . The catalogers use terms employed by the author. An abstract of the document is also included in the catalog entry, and if there is a table of contents that is included too. . .

The full text of the documents selected for the Intrex file is stored in the form of negative-appearing micro-images of the printed pages. At a reduction of approximately 18 times, images of 60 pages are stored on a sheet of photographic film 4 by 6 inches in size. Such a sheet is called a microfiche. . . .

Typically, after logging in and identifying himself at his terminal, the library user starts his interaction with the system by indicating his subject of interest. For example, he may type "subject nonlinear optics." The computer responds with a statement that the catalog contains 90 entries on this subject, and the user shifts to a narrower specification. . . . Presently he calls for titles, authors and citations of documents which match his subject specification. If these look interesting, he may next ask for one or more abstracts. . . . At some point in his search, the user may wish to examine the full text of a document he has identified. If he is at a cathode-ray-tube terminal or a combined terminal which allows the user to transfer easily from catalog search to full text display, he simply types "output text" and the image of the first page of the document in question will appear on the screen. Subsequent pages can be summoned by simple push-button actions. If a new research request is entered on the keyboard, the system will automatically return to the catalog mode. If the user's terminal is a teletypewriter, his access to full text may be either by an adjacent cathode-ray-tube text access terminal, or by the delayed delivery of a photographic copy on microfilm, microfiche, or on paper.

Progress is slow and implementation lags

The architectural implications of Project Intrex helped shape the reconstruction of M.I.T.'s Barker Engineering Library designed by Walter Netsch of SOM (September 1972, pages 119-124), but the system is far from being fully operational. Fortunately, the library was simultaneously designed to function in the conventional manner, without the benefits of advanced technology.

There are several reasons for the lagging implementation of such computerized information, location, retrieval, communication and return systems as Intrex. The principal one is cost and it affects all the others. Even though more and more libraries use the Library of

Congress classification system (and simplify the work considerably thereby) the volume of materials being acquired and the need to make them accessible, makes cataloging still the major task for most libraries engaged in the normal process of increasing their collections. If conventional cataloging of books and documents is time-consuming, the requirements for Intrex as briefly described above are considerably more so. In addition to the increased time and cost involved in the cataloging of each item, are the time and costs consumed in transferring the printed page to microphotographic records.

Making such systems as Intrex appear even more impractical is the fact that the greater proportion of a large library's collection is dormant most of the time. Even in the most active libraries, most items in any collection are seldom called for. Such items must not be thrown away, however, because not only are they of occasional value to the serious scholar, but tastes change. Interest in religion or poetry or guitar playing revives and long-neglected volumes are requested once more. But the impracticality of computer cataloging and microfilming thousands of little-used books and documents makes the implementation of Intrex on a large scale unlikely.

Conversely it is also impractical to computer catalog and microfilm popular books. Where the demand for a book is great it exceeds the capacity of a library to house the cathode-ray-tube terminals upon which it may be read.

Project Intrex appears to be most practical for use in research fields which are narrow and where most of the documents are recent and few in number.

Another system, known as Walnut, developed by IBM for the United States Central Intelligence Agency, functions in a manner similar to Project Intrex. The MEDLARS program at the National Library of Medicine produces by computer a catalog known as the *Index Medicus* by means of which the information search takes place electronically. The Library of Congress is perfecting Project MARC which focuses on the handling of catalog data. Since almost all books in print in the United States receive a Library of Congress catalog number, the success of this library's efforts at automation will influence storage and retrieval methods everywhere.

The sequence and rate of computerization

As set forth in *The Impact of Technology on the Library Building*, a position paper published by the Educational Facilities Laboratories, the course of computer development and use within the library from now to approximately 1990 will probably progress as follows:

Its first general impact will be in the area of housekeeping chores—order records and reports, fiscal control, circulation systems, etc. Application of the computer to bookkeeping operations, such as buying and receiving, is the easiest to accomplish. Moreover, it is the area in which considerable experience in many libraries to date indicates clear cost advantages in large operations.

The second field of general application—and impact—will be the computerization of the library card catalog. Some aspects

of this are now technologically feasible. The promise is that this will extend greatly the usefulness of information contained in the present card catalog. Its advantages lie in its accessibility to users beyond the library, in permitting the interchange of catalog information between libraries, and in mobility within the library itself for checking holdings, changing location records, and the like. While the conversion of any library operation to automation must be undertaken with the greatest care and planning because of the very large costs involved, this is especially so with regard to computerization of the card catalog.

Totally aside from costs, there are technological and intellectual problems of the greatest magnitude to be overcome before computerized catalogs will be generally usable. Direct access files of larger storage capacity than presently available in computer systems will be required to store the catalogs of great research libraries. The capability of simultaneous consultation of the catalog by very large numbers of users must be expanded. Problems of what terms and how many to use in describing catalog information must be resolved. Programs to retrieve only the materials specifically required by a user must be developed. But, despite these problems, it is expected that within 10 or 20 years, the use of computerized catalogs will be widespread.

When dealing with the storage and retrieval of text, equally formidable problems exist. Data or factual evidence of small unit size is easily manipulable by the computer, but much more complex bodies of thought or knowledge are not. As of present, it would appear that most of the literature in the humanities and social sciences will remain primarily useful in book form. There is no signal advantage in converting Plato's dialogues to machine readable form and retrieving them or juxtaposing them by the computer. It is, therefore, economically senseless to attempt a massive conversion of existing library books to machine readable form, since the advantages of doing so are minimal in many subject fields, and the costs enormous. The change to computer storage of full texts, when it comes, will be evolutionary, not revolutionary, and it is unlikely that the library as a repository of books will be replaced in the near future by a computer in the basement consulted by remote consoles.

The first phase of development in information retrieval will use the computer to store and retrieve highly used specialized data, probably in nonalphabetical languages, in the physical and life sciences—as is now being done on a limited scale. Sometime later, perhaps within 10 years, the texts of some highly used materials selected from current science and non-science publications will be originally published in computerized form. But for the next 20 years or more, the great bulk of publication will be in print form, with a gradual increase in the production of microform texts. Retrospective conversion of texts to machine readable form is not expected to any great degree for a very long time in the future. Therefore, the bulk of a scholar's negotiations in a library will be with books even 30 years from now.

Some library authorities predict that computer based automatic bibliography generation will begin to be more widely adopted by 1975, and that question answering and text abstraction and reproduction will be developed by 1980. Home access and retrieval can be ex-

“Marshall McLuhan and other prophets and visionaries, gave librarians and architects and library boards of trustees plenty to worry about. If the book were indeed dying, or already dead, then it was predicted that by today the new library built ten years ago would be nothing but a mausoleum for the lifeless printed artifacts of the last 518 years . . . The reader of the future was envisioned as an individual seated at a console . . .”

pected to be available by 1985, these experts believe.

Some form of mechanization of the cataloging process in terms of inventory keeping by means of punched cards or punched tape will facilitate the transfer of information into a computerized catalog.

One factor which may speed the arrival of computer retrieval is that many large libraries to save shelf space for expansion are already putting part of their collections on microfilm. In addition, in the future, more publishers will offer libraries the choice of buying their publications in microcopy.

Computer typesetting will also lead to more automation of the library. The magnetic tape which is a by-product of this process can be used for secondary retrieval as well as primary publication at little extra cost.

The basic assumption in the foregoing list of possibilities is that information will first arrive at the library in the form of a printed book or document. What keeps the technologists excited and hopeful, however, is the belief that the computer will eventually handle both input and output without benefit of a printed form at any stage. As described by Michael Brawne in *Libraries*:

A research worker wanting to 'publish' his findings would type these direct into the computer (which would immediately check the findings against the existing state of knowledge and report back discrepancies) and someone needing that information would ask for a print-out from the computer. . . . Some of the technical and intellectual problems have been reduced if not necessarily overcome. The likelihood of some such system being operational within the next quarter century is therefore extremely high.

What are the implications for library design?

All of the foregoing developments and predictions lead to the basic question for architects: how will computer technology affect the actual physical design of large libraries? First, it seems apparent that the computer equipment need not be located in the library building itself. Theoretically, as has already been said, the computer can go anywhere. In designing a library which

“Microforming and the decentralization made possible by the computer can halt the aggregation of books before it becomes so gross as to be inefficient and uneconomic. Information is increasing at such a rate that if it continues to be available in the form of books and periodicals alone, the cost of building facilities to house them could bankrupt our richest universities, not to speak of our impoverished cities.”

for any reason should have the computer on the premises, a 2000-square-foot computer space can handle the requirements of a library with as many as one million volumes.

This space should include about 1000 square feet for central processing. This should be a sound-insulated room to prevent the noises from the machines from reaching reading areas. Like most computer equipment rooms, it should have a double floor designed to carry computer cables, a separate air-conditioning system to keep the temperature and humidity constant, and an effective filtration system to remove dust from the air. A network of cables will extend horizontally and vertically from this space to connect with terminals located at the catalog, the card catalog, acquisitions, circulation and other departments.

Adjacent to this central processing room and subject to the same temperature and humidity controls should be two offices—one for the computer director, operators and programmers at 150 square feet per person and the other for the key punch operators at 75 square feet per person. Storage must be provided for tapes, punched cards and other supplies as well as spare parts etc.

According to EFL, computer technology will not dramatically alter seating arrangements within large libraries, except that the square footage allowed per reader will have to increase because of the proliferation of electronic carrels, terminal consoles and teaching machines. There will also be more readers. Since the type of information most likely to be computer-stored and retrieved will be scientific material of current interest, the point of retrieval will increasingly be at consoles located in offices and laboratories at some distance from the library. But the dormitory room is not expected to replace the library as the place for information search and study. The computer is expected to dramatically increase the use of the library rather than reduce it as was once thought.

The card catalog area is expected to gradually transform itself into a collection of furniture designed to hold the large number of consoles and book catalogs which the library will require. In addition to the standard kinds of shelving now provided for books and periodicals,

new types of storage will be developed for tapes and microforms.

Most good library architects as a matter of course coordinate the structural, lighting, HVAC, furniture and shelving systems of a library within a single module. Because the libraries now being designed must gradually accommodate the computer in ways which cannot be precisely forecast, the flexibility and adaptability of modular systems become even more desirable than before.

Further predictions and conclusions

The library and the book are here to stay. Communications technology as it develops will change the relative sizes of the various areas within the library, but these changes must be planned to take place over an extended period. For the present, architects planning a library with an eye to a computerized future, must allow for the expansion of electronic equipment and make sure to provide for the eventual necessary augmentation of mechanical and electrical facilities.

Even such small libraries as the three suburban facilities included in the case study section could one day become branch terminals of a regional library system.

At the other end of the scale, perhaps libraries should not be allowed to get much bigger than the Regenstein Library at the University of Chicago. Microforming and the decentralization made possible by the computer can halt the aggregation of books before it becomes so gross as to be inefficient and uneconomic. Information is increasing at such a rate that if it continues to be available in the form of books and periodicals alone, the cost of building facilities to house them could bankrupt our richest universities, not to speak of our impoverished cities.

So, we await the further developments of the technologies discussed in this article. Ten years from now, or perhaps sooner, RECORD may be able to publish a group of libraries of varying sizes in which advance communications technology systems are installed and actually function. Until then we will continue to publish libraries which are essentially simple buildings with large and small reading areas, stacks, a service zone and a control desk. And we will discuss them in terms of how pleasant and human they are in the ways they serve the reader. These last two considerations must not be lost sight of by the planners of the libraries of the future. It is quite possible, for example, that the library user might not enjoy browsing by means of calling up graphic images on the cathode ray tube. He may tire of sitting for protracted periods at a console. He may require more places within the library in which to stretch, walk around and seek a change of scene, than today's researcher who, from time to time, gets up and hunts for a book or document in the stacks. Seeking relief from communicating with his console, the reader might wish for more human contacts and libraries may become more gregarious places than heretofore. Providing a sense of community, which can yet foster privacy, may be a principal concern of the library architect of the future.

—Mildred F. Schmertz

**HERE IS A PRACTICAL AND ECONOMICAL TEACHING THEATER
BASED ON FOUR
FULLY-INTEGRATED
SYSTEMS**

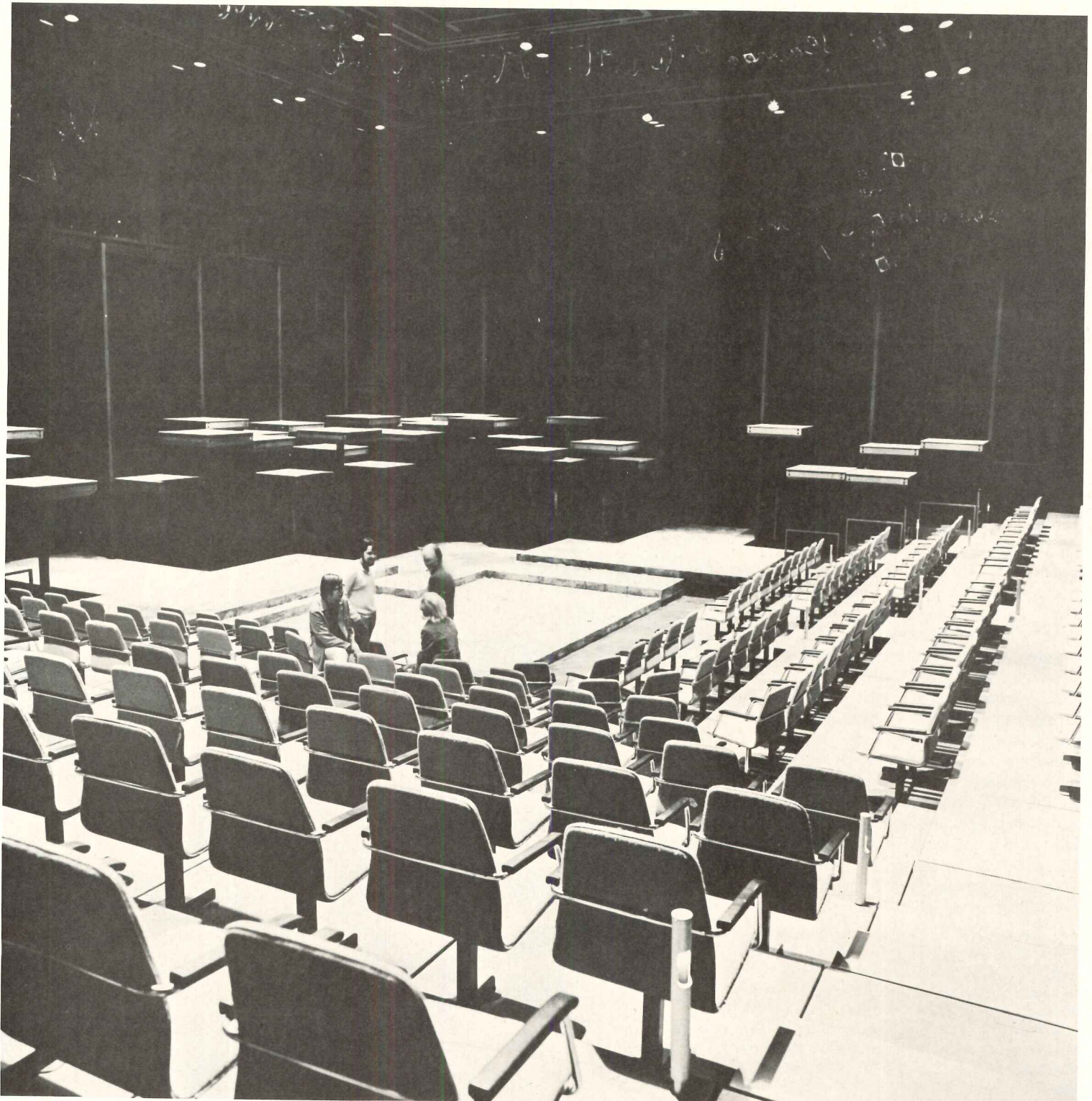
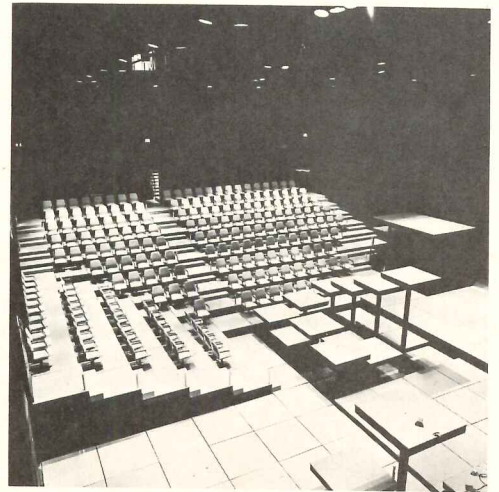

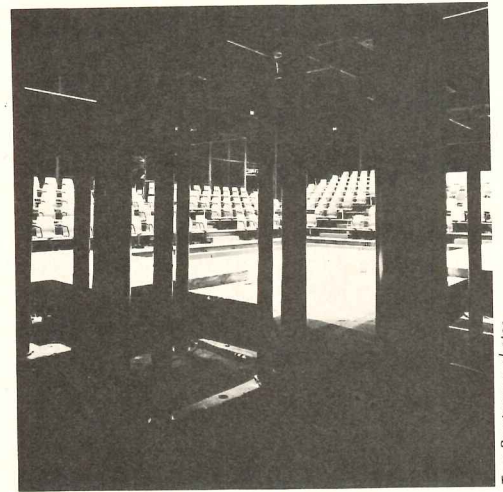
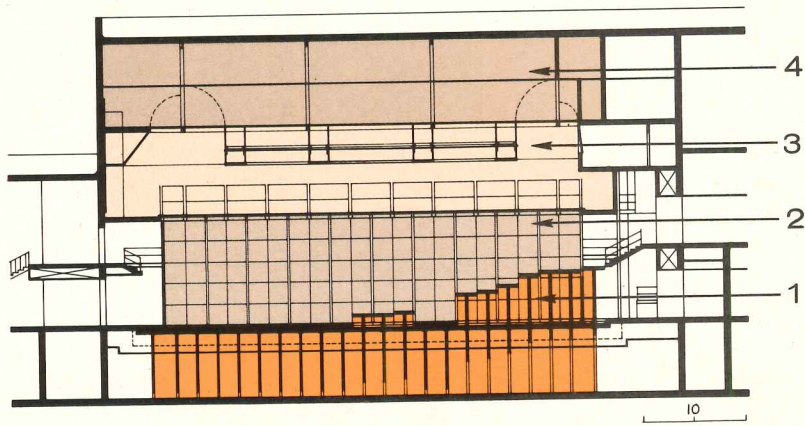

Tom Brosterman photos

The flexible environment for teaching theater is now an established concept. Most drama schools have found an old gymnasium, abandoned church or other such loft space and have turned it into a satisfactory theater. All that is required is a pile of lumber and a legion of drama students who then spend their evenings learning more about carpentry than about the dramatic art. Jules Fisher was one of these. His memories of endless hours wielding hammer and saw helped inspire him to develop a mechanized system for providing that flexibility. Such an installation in itself, of course, hardly guarantees great theater. But it is there for imaginative people to use as they will.

The Modular Theater at the California Institute of the Arts has, in fact, four integrated systems: floor, walls, lights and hoists for flying scenery. Together they offer the student playwright and director a practical means for mounting extremely varied types of productions. In use less than a year, it has already been arranged for concerts, and Shakespearian as well as modern drama. The photographs on the previous page illustrate three such configurations. Although the floor system—pneumatically raised pods—is the most obvious component of the theater, the essential value of Fisher's design is the ease with which the other three elements interact with the floor. It is an integration which relies, only when absolutely necessary, on electronic devices, utilizing instead mechanical techniques to make the changes easy. Thus, it is not an expensive installation, especially when operating costs are taken into account. The Modular Theater contracts totaled \$577,465 (including stage lighting for the entire theater area, \$114,500; floors, walls, seats and other accessories, \$341,300; hoist system, \$121,655). With an area of 8,960 square feet inside the masonry shell, the unit cost for equipping the Modular Theater was \$64.00 per square foot.

CALIFORNIA INSTITUTE OF THE ARTS MODULAR THEATER, Valencia, California. Building architects: *Ladd and Kelsey*. Theater designers: *Jules Fisher Associates in collaboration with Herbert Blau*; project designers: *Marc B. Weiss, Brian Carey, Paul Marantz*. Engineers: *Olaf Sööt Consulting Engineers* (theater systems and modular floor units); *Stanley Pomerantz and Associates* (mechanical); *Frumhoff and Cohen* (electrical). General Contractor: *W. J. Burke Construction Co.*

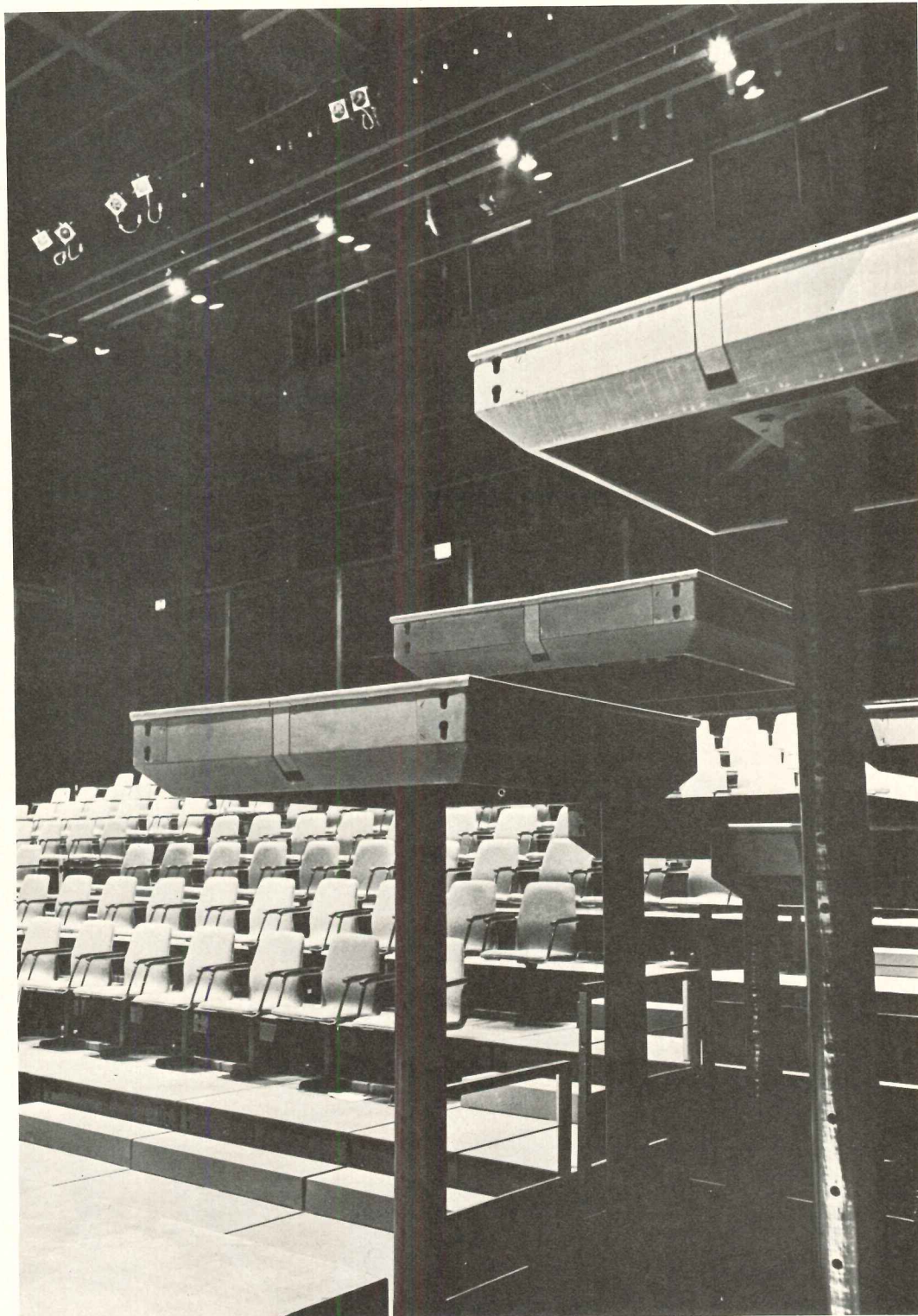

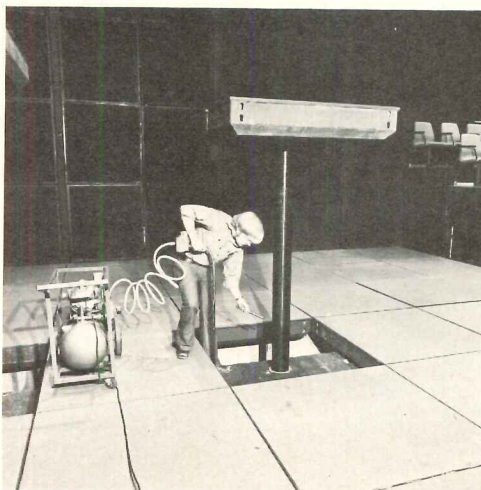
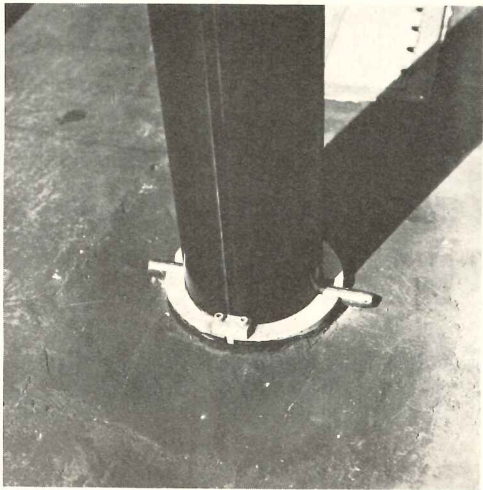
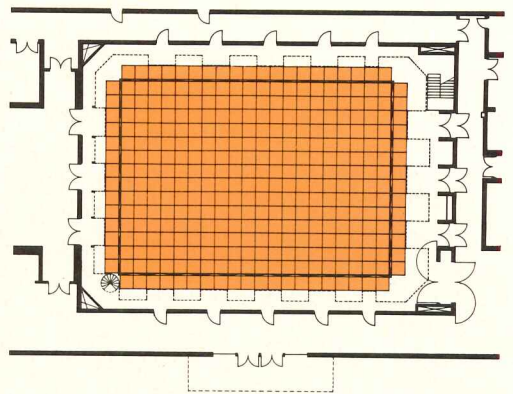
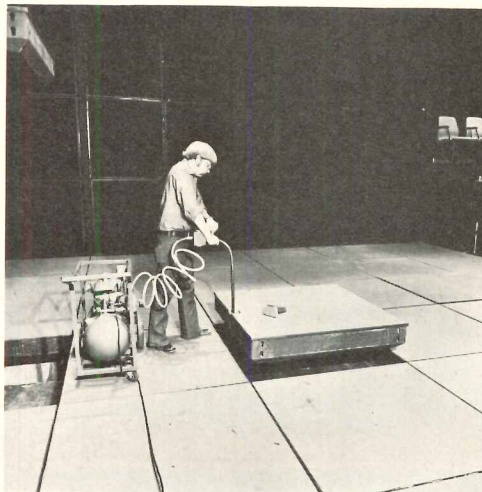
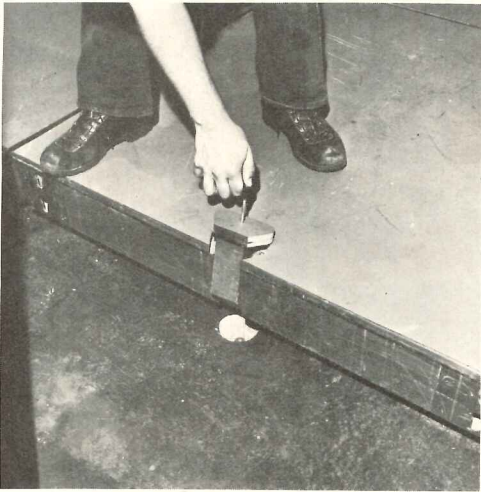

1 The floor system is adjusted pneumatically. Each module—four feet square—is built on a six-inch steel tube which operates like the grease rack in a gasoline station. Using a small portable air compressor, according to Fisher, one man can adjust every one of the 348 modules in less than eight hours. Each module can be adjusted within a 10-foot vertical range and is held in place by a steel pin inserted into holes drilled in the tube at six-inch intervals. The surface of each module is battle-ship linoleum and, in addition to the access for the air gun, has plugs in each corner which align with the frame of the paired, swiveling chair units and which can accommodate aisle light units (below). Railings, when necessary, fit into notches in the side of each module (across page bottom). Olaf Soot engineered the module to require minimal adjustment at the site.

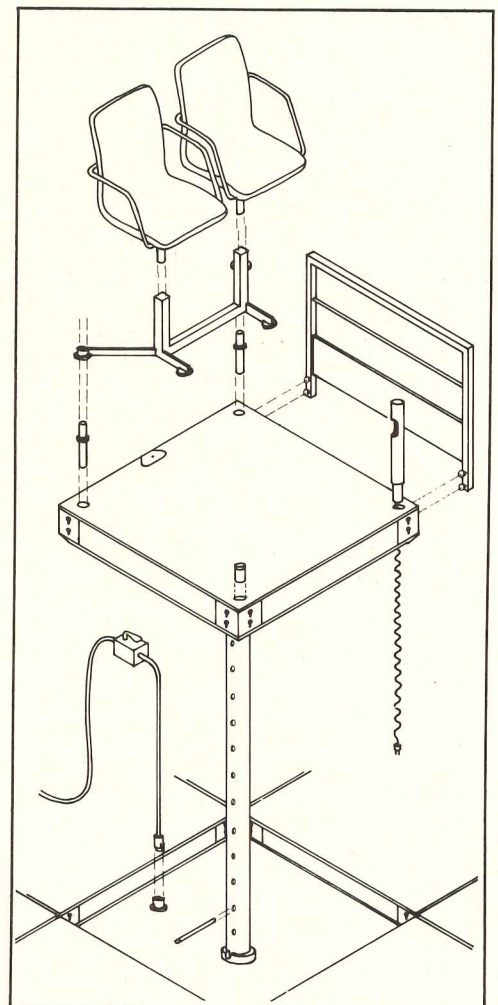
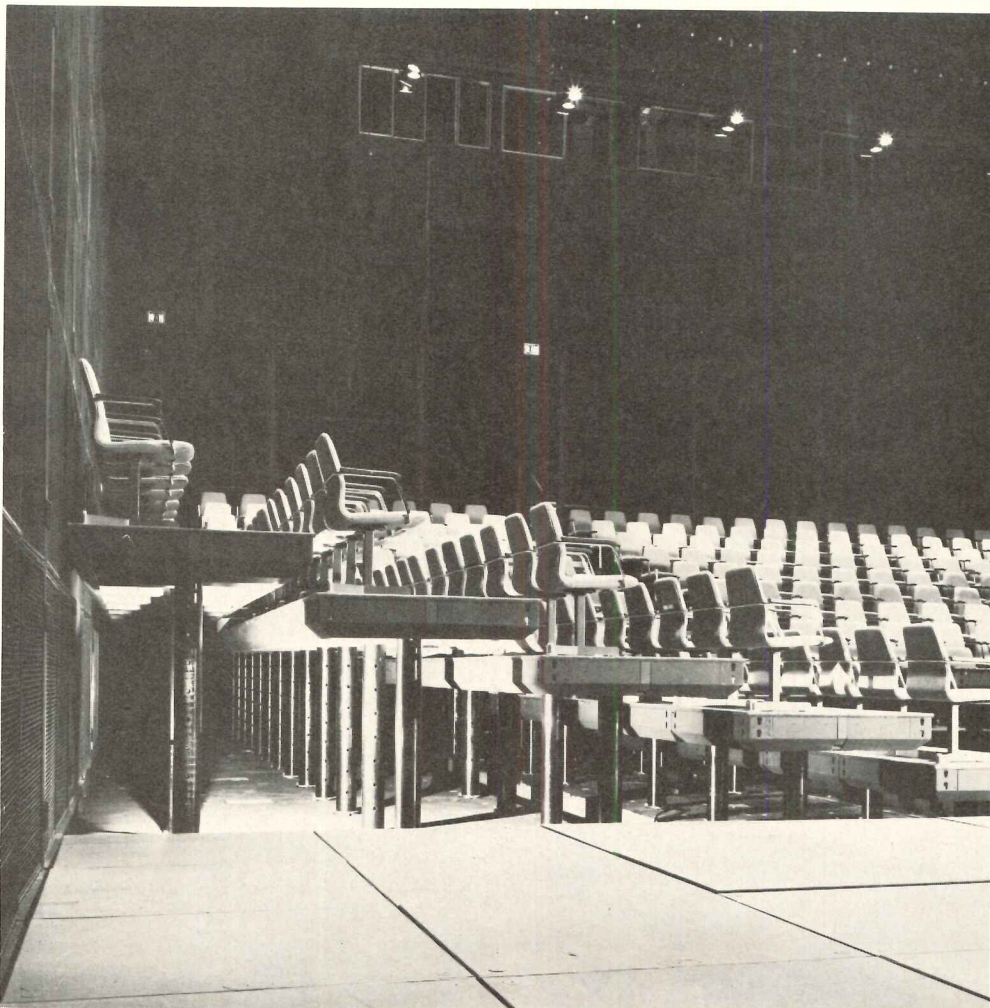

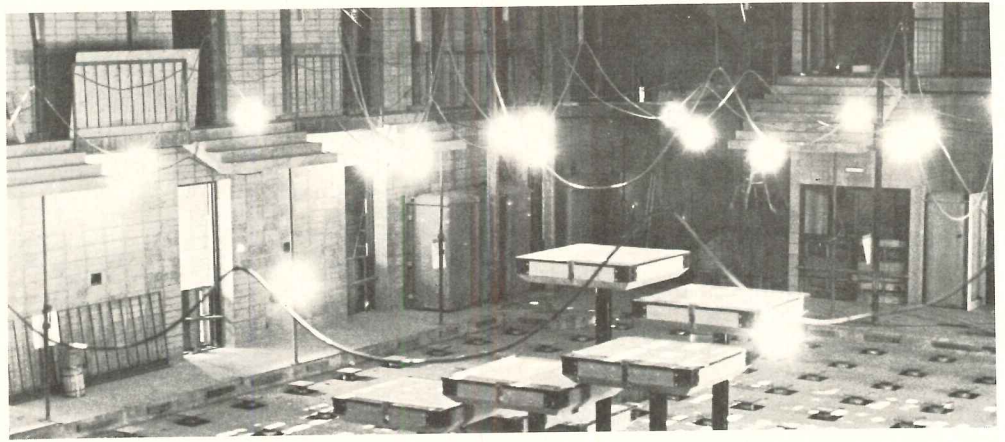

2 A panelized wall system allows entrance at any point. An inner wall of four-foot-square wall panels, 20 feet high, forms the shell of the working theater. Each panel, curved fiberglass with a steel eggcrate louver facing into the room, is hinged on one side so it can serve as an entrance. An access balcony with concrete stairs (right) surrounds the theater outside the acoustic wall. A single row of modules can be adjusted to meet those stairs, and with supplementary steel stairs, provide audience access on two levels and to any level at which the theater floor may be adjusted. It is, in effect, the flexible pedestrian link to the rest of the Arts building complex.

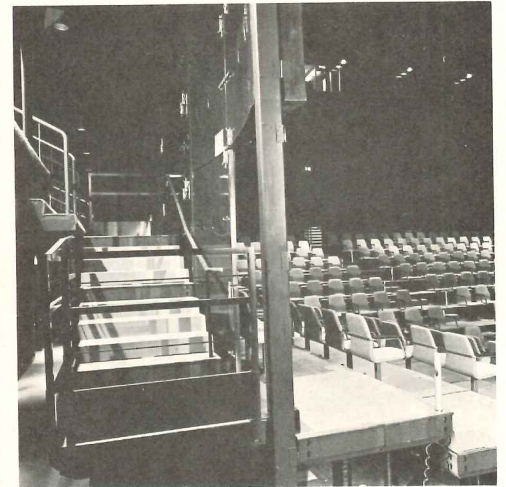
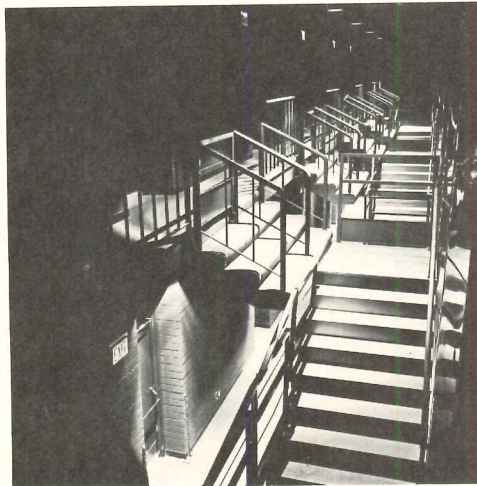

3 Standard stage lighting components have been innovatively combined to assure flexibility. In the main lighting control room (right), a triple board preset panel is connected with the master control panel. The top unit (being adjusted by the technician's right hand) may be moved to another location on the lighting balcony above the acoustical wall or may be operated from a location in the center of the theater floor. The grid of switches behind the technician is a mimic panel which allows house-lights to be set according to any theater configuration. The fourth element is a standard patch panel for assigning any stage lighting circuit in the theater to any dimmer.

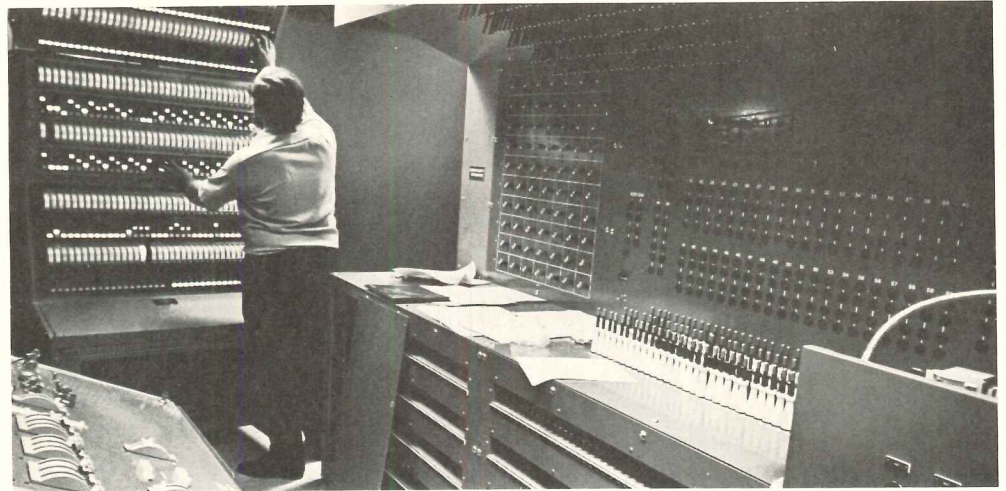

4 The portable hoist system was created especially for the Modular Theater. In conjunction with Paul Birkle, stage machinery designer, Jules Fisher has developed a compact, portable winch which can be positioned anywhere on the grid above the lighting catwalks (far right). The cables from each winch can be coordinated on a special board which controls master units that in turn can control up to six slave units. Thus, as many as seven cables can be operated simultaneously from the control room to allow for the flying of any size piece of scenery. Besides minimal electronics for operation of the stage lighting, the hoists are the only electronic components of the Modular Theater.

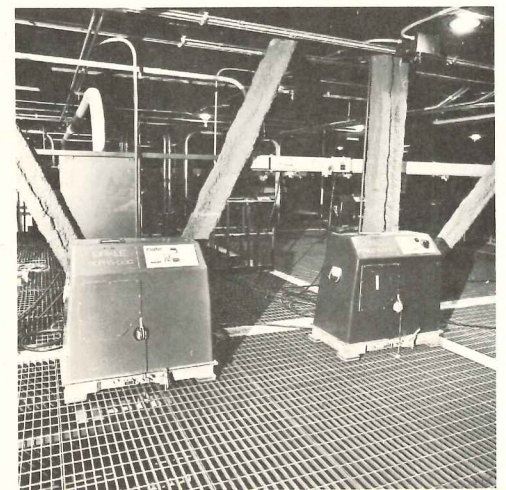

MASTER PLAN FOR TOTAL SERVICE AT TULANE UNIVERSITY MEDICAL CENTER

Tulane University Medical Center, in the heart of downtown New Orleans, is surrounded by a number of loosely related medical and educational institutions with which it forms an urban enclave under general surveillance of the Health Education Authority of Louisiana. A combination of circumstances impelled Tulane to launch not only an expansion and modernization program but a virtual turnabout of administrative policy from inward academic contemplation to active relationship toward the community and toward other institutions in the complex.

Inciting force of this turnabout was the appointment in September, 1969, of Dr. John Walsh as vice president for health affairs. Dr. Walsh says he found the medical center "at a crossroads—with inadequate facilities, failing resources, sagging morale—and under pressure to expand or go out of business." Dr. Walsh had been Assistant Surgeon General of the United States, in which role he had initiated an exhaustive systems analysis on which to base the program and design of a new public health facility in Galveston, Texas. His drive to launch similar studies for the problems of Tulane found active support from Dr. Robert Sparks, dean of the School of Medicine and from the university planning staff headed by Edward Williams.

Another circumstance affecting feasibility of a new program at Tulane was the shift in Federal funding policy away from pure research and toward service-oriented educational programs. Dr. Walsh commissioned a detailed industrial engineering/systems study of projected needs. A. T. Kearney and Associates, management consultants, and the architectural firm of Caudill Rowlett Scott (who had jointly carried out the Galveston study) assembled basic data for programming and master planning a new medical center. These data supported an application for the maximum (66 $\frac{2}{3}$ per cent) Federal grant for new construction.

The gaming technique implements client-participation in solutions

Following the systems study, CRS was retained to go ahead with the master plan and subsequently into design of the medical sciences education building—first phase of the expansion program. The Kearney/CRS study brought together a mass of detailed information based on personal and group interviews with faculty and other involved representatives of the community and the Health Education Authority.

The interview technique had assembled a massive base of data comprising the platform of planning logic; but the orderly assembly of specific detail into a cost-effective package called for another phase of group communications to "bring the whole process to life."

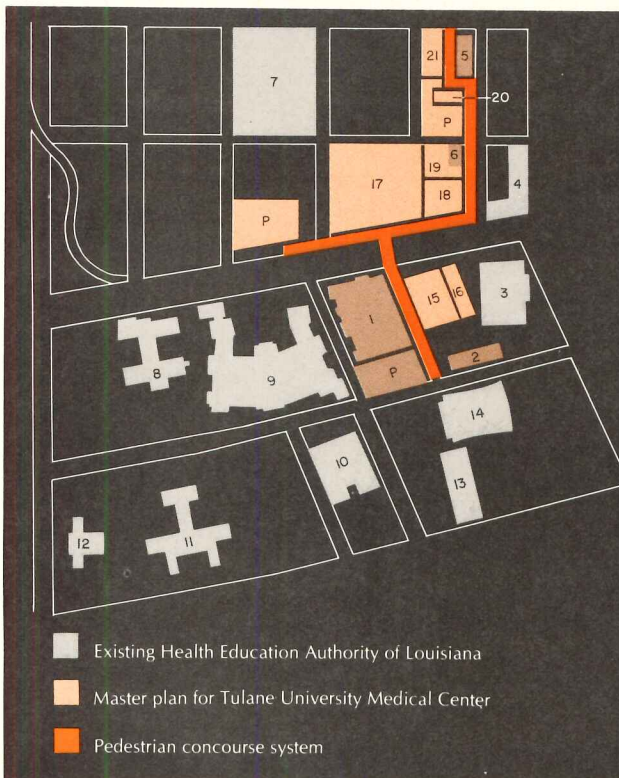
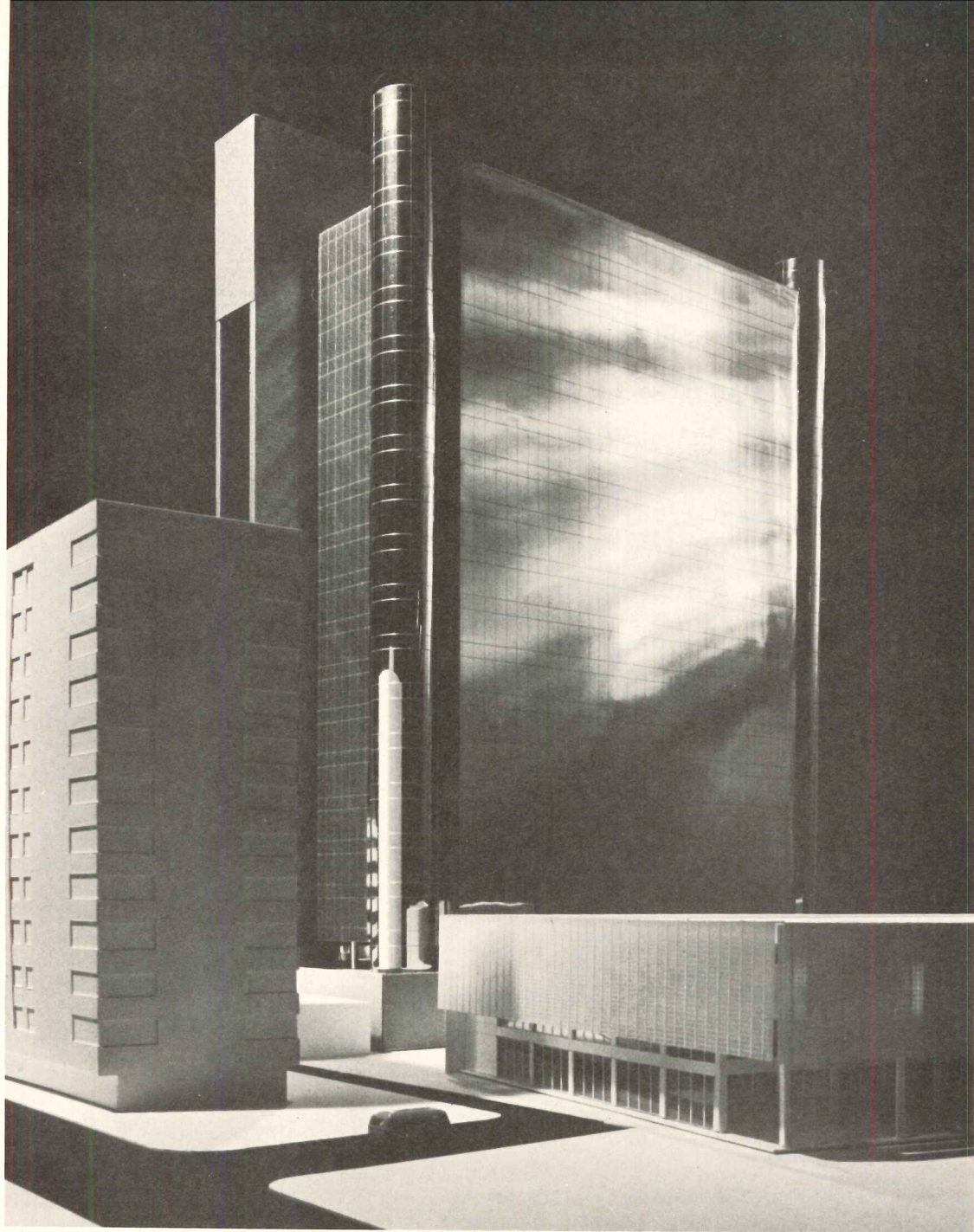

Master plan and phase one of construction at Tulane includes purchase of adjacent properties for new buildings linked by an elevated pedestrian concourse. First construction is the high-rise Medical Science Building.

Existing Health Education Center

- 1 Tulane Medical School
- 2 Warwick Hotel
- 3 Municipal Library
- 4 Eye Ear Nose and Throat Hospital
- 5 Hawthorne Hall
- 6 School of Public Health and Tropical Medicine
- 7 Jung Hotel
- 8 ISU Medical School
- 9 Charity Hospital
- 10 Charity laundry and power plant
- 11 VA hospital
- 12 Charity nursing school
- 13 State office building
- 14 Louisiana Supreme Court

Tulane University Medical Center Master Plan

- 15 Medical Science building
- 16 Research
- 17 University Hospital
- 18 Outpatient clinics
- 19 Mental health center
- 20 Power plant
- 21 Student housing
- P Parking

The CRS team introduced a gaming technique they had used successfully on previous projects. The technique involves a series of intensive on-site work sessions at which architects, consultants, clients and users participate in face-to-face encounter. Questions, demonstrations of alternatives, group decisions resolving possible conflict, and an immediate sense of urgent personal participation are the components of these sessions.

A master plan emerges out of group dynamics

Because of Tulane's location within the central area of New Orleans and its relationship to a newly formed corporate identity called the Louisiana Medical Complex, a certain set of external influences became background to the master planning process. The Louisiana Medical Complex is made up of three primary institutions, Louisiana State University Medical School, Charity Hospital and the Tulane Medical Center. Secondary institutions include a Veterans Administration Hospital and several other health-related facilities. The geographical boundaries of the LMC were established in 1968 when the Legislature created the Health Education Authority of Louisiana and gave that body certain powers and responsibilities to coordinate development of the LMC and its participating institutions. The Authority, however, was not provided with funds with which to discharge its responsibilities. So development of the Tulane master plan is in advance of an essentially overriding LMC plan which is awaiting possible Federal funding. The Tulane plan, then, had to be meshed with a still non-existent LMC plan, but nevertheless had to gain the important support of the Health Education Authority in matters affecting not only its institutional relationships but its eligibility for Federal funding.

The resolution of these quasi-political problems (achieved with the help of the gaming techniques described) cleared the way for dynamic approaches to the Tulane objective. This objective was a dual one of: 1) development of optimum building relationships and 2) creation of an image for Tulane as a prime activity in central New Orleans.

The architect's ultimate mission is a complex of real buildings

Architectural problems in design of the Medical Science Education Building, first phase of the Tulane construction program, centered about a set of primary constraints: 1) Land prices in New Orleans are extremely high, so the problem of assembling land for expansion is crucial. 2) The master plan requires a series of interconnected buildings, almost like a small city with its own infrastructure. Hence, the concept of relatively high-rise buildings with connecting over-street bridges and elevated promenades is a directed one. 3) There was need to work with students, faculty and community in striving for a solution to include not only medical and educational services but possible public uses of auditoriums, promenades and arcades.

The new Medical Sciences Education Building (high-rise in the model photos) is straightforward design on a basis of core-plus-

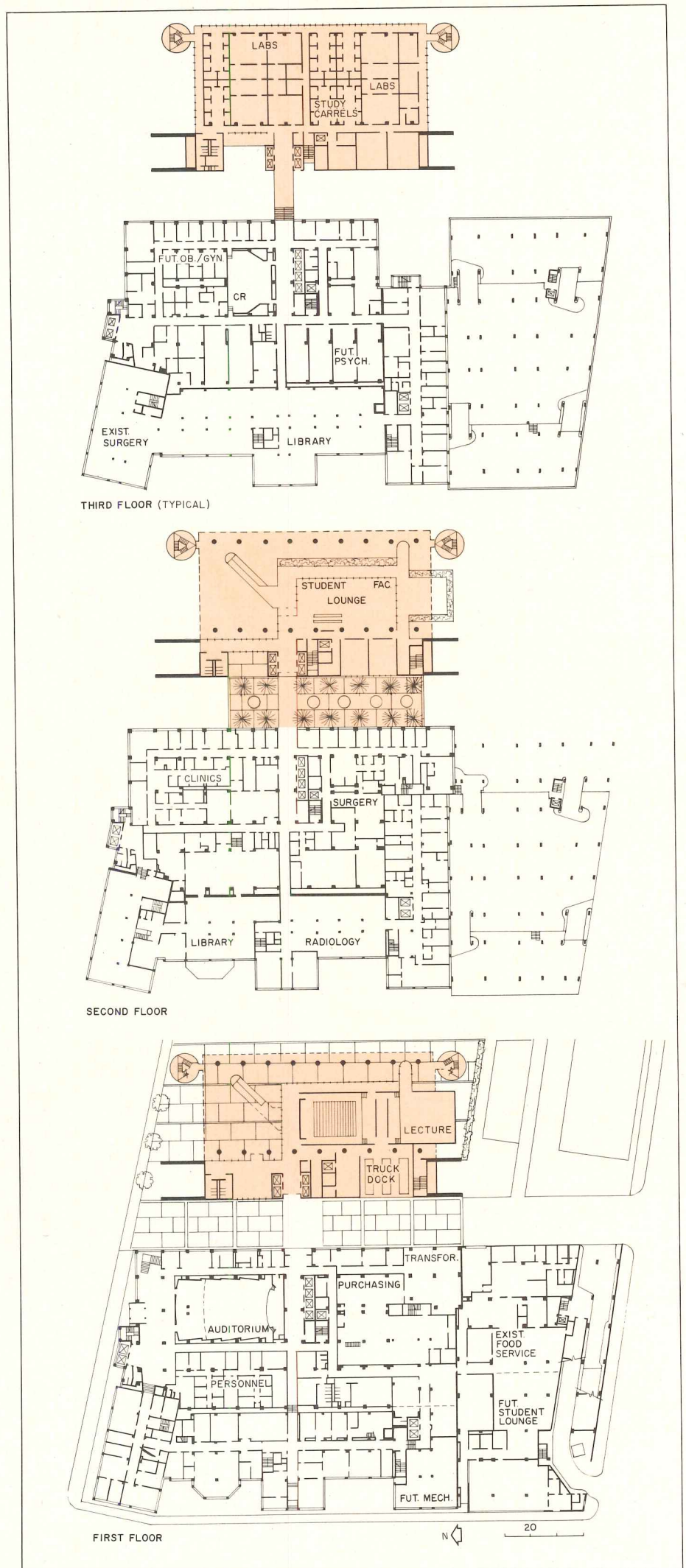

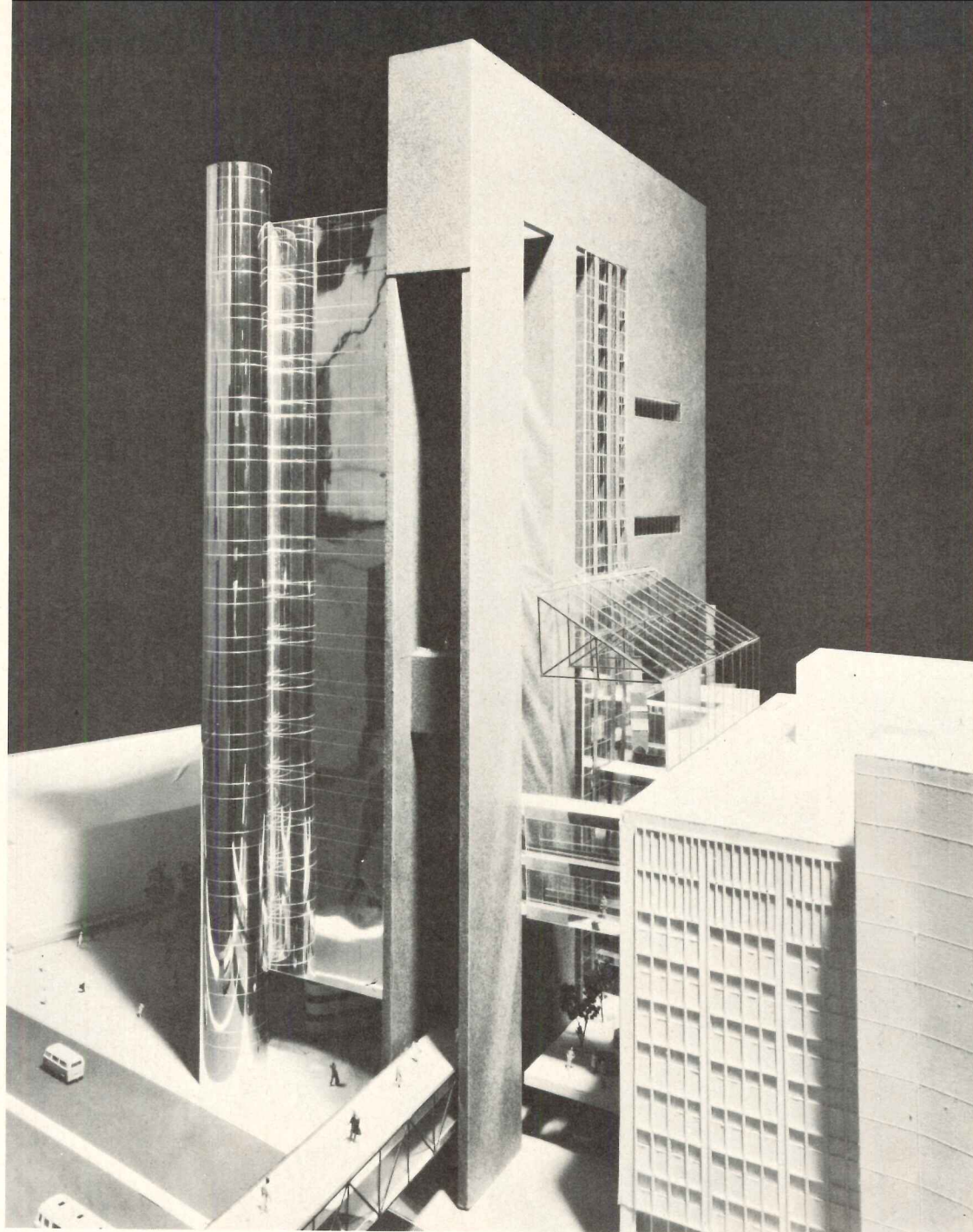
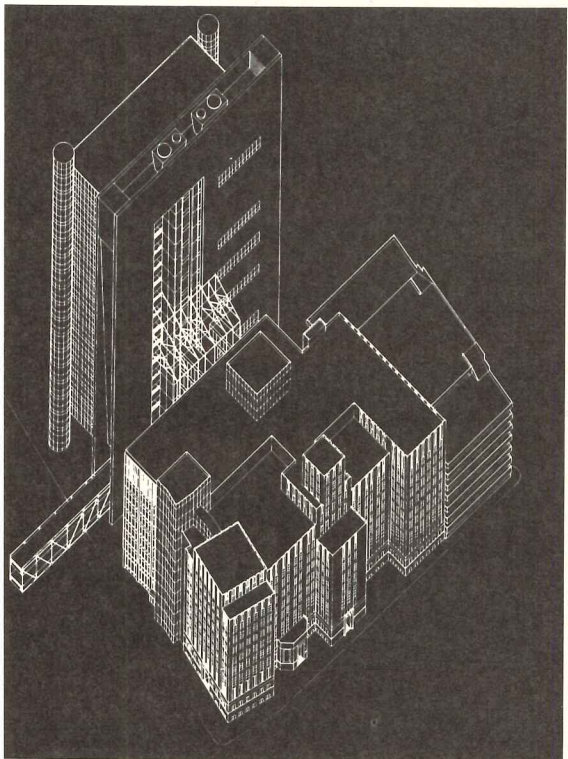
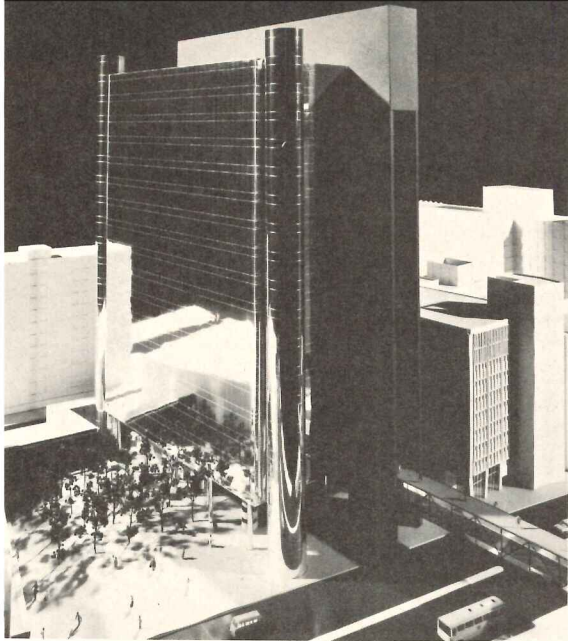

The Medical Science Building is across Tulane Avenue from the existing medical school and connected by pedestrian concourse and layered bridges to upper floors. Interstitial truss spaces in the new structure accommodate mechanical and electrical distribution lines for changeable tenant occupancy that will include laboratory and demonstration spaces. Early decisions based on a systems study provided a work station for each student with desk and storage space for instruments and books. This "home base" concept met

student resistance in planning sessions, on the grounds that office-like space elsewhere than exposed to laboratory bench activity would be more conducive to study. Moreover, those quieter study spaces should be located away from the parking difficulties of the downtown center. So the home base study areas were taken out of the laboratory area and will be closer to student housing. This left the science building free for more utilitarian planning. Additional parking will be in an annex to the existing education building.

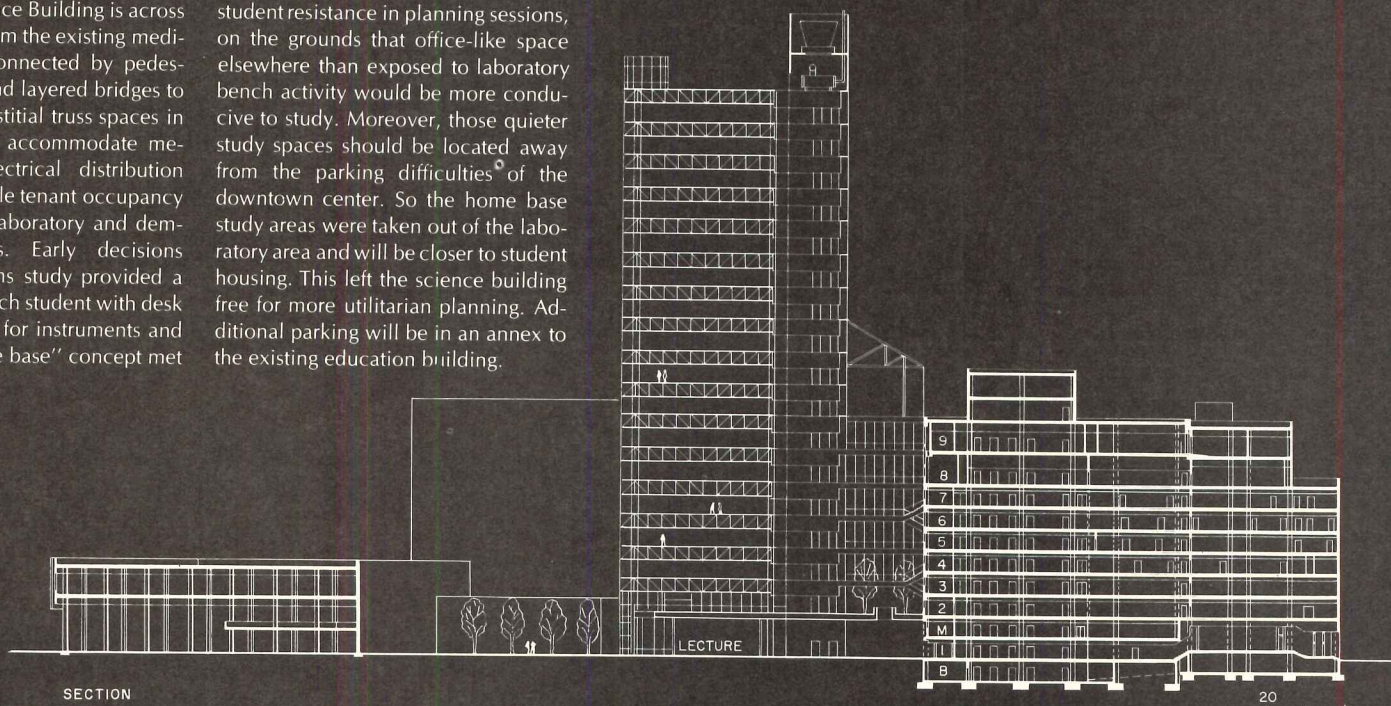

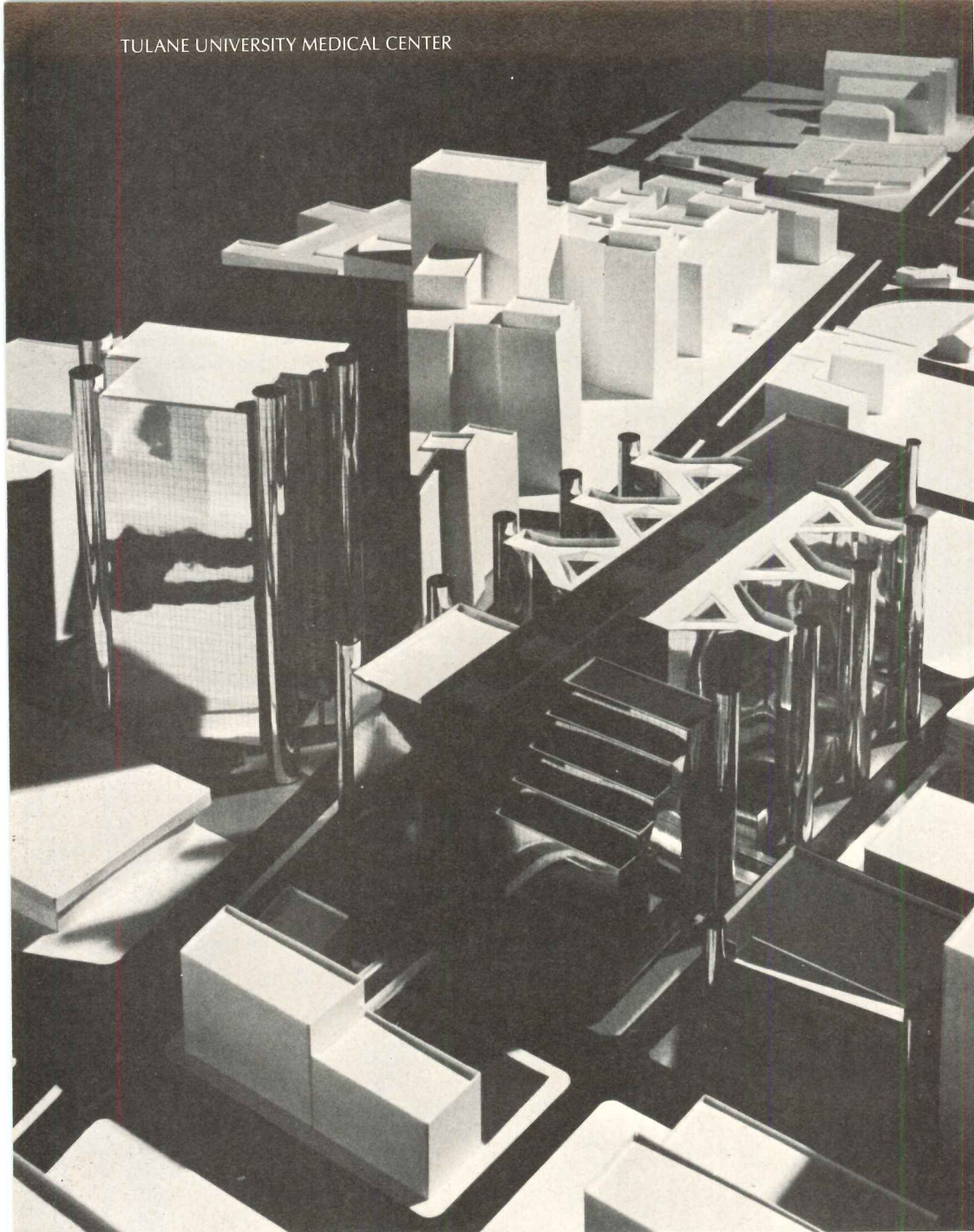

Ultimate development will include expansion of the Medical Sciences Building, construction of the University Hospital (center of model photo above), widening of key streets, and redevelopment of traffic patterns to link with the adjacent interstate highway and handle traffic generated by the nearby superdome. Structural parking and pedestrian concourses open to the public will implement community participation in new clinical and demonstrations centers.

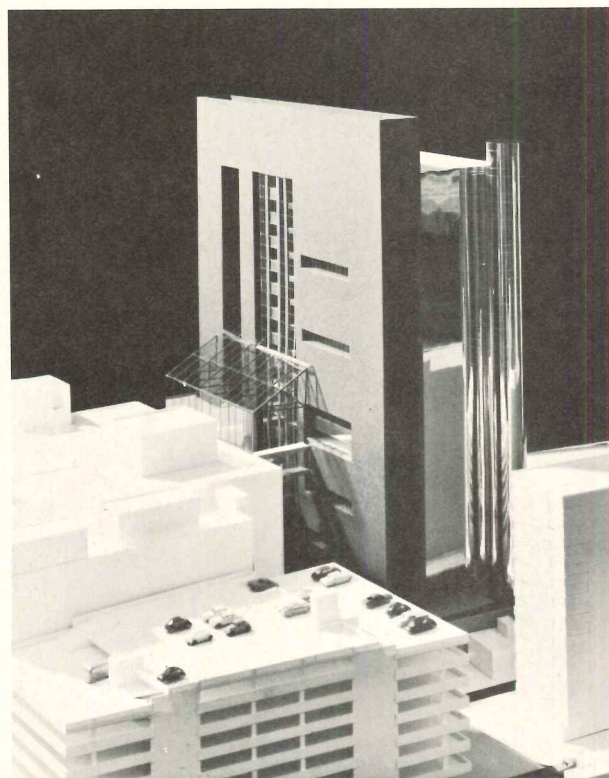

tenant spaces. The idea is that the building will serve a succession of changing tenants as programs change—rather than house an aggregation of academic empires. The tenants, of course, differ from commercial office tenants in that they may require spaces adaptable for scientific demonstrations; but tenant movability is a requirement in common with conventional office space.

The one certainty in modern medical school facilities, says CRS vice president James Falick, is that there will be constant expenditure for change. Hence, flexibility is essential to reduction of the cost of change. And that means flexibility in all three of its aspects: internal convertibility of partitioned spaces, multi-function changeability of mechanical and electrical systems and expansibility of the building—either horizontal, or vertical.

External expansibility is, of course, as important as most architectural interpretations consider it to be, in terms of projected increases of program. But equally important in today's world of changing techniques and personnel is the capacity for internal change. In the case of the Tulane Medical Sciences Education Building, predictions of the probable frequency of internal change were derived from a well documented history of the frequency and cost of changes in the existing education building.

Those considerations—i.e., the life-cycle cost advantages of functional flexibility and the long-span, loft spaces desirable for tenant changeability—led to the decision to design interstitial truss spaces between floors.

The design of quite conventional tenant spaces for health education, with long spans and free access, is substantially different from design of the more form-directing spaces for patient care and clinical techniques. The relatively fixed machines involved in clinical techniques and the substantially coded relationships of bed patients to windows and nurses' stations are factors in defining the two kinds of spaces in medical center design.

Jim Falick makes the point that the investment in cubage and enclosure for interstitial space is not limited in its effects to instant flexibility. The growth or policy transitions of any institution can create a need not only for flexibility but for a whole different scale of mechanical or transport need. The transition from scale A to scale B, if it is at all likely when scale A is designed, should not involve ripping out or tearing down A to make way for B. Realistic life-cycle investment at A prepares a conduit for B, even though everything is not put immediately into it.

The master plan for Tulane calls for construction of a 300-bed University Hospital. This is not to replace but to supplement the university's present relationship with nearby Charity Hospital, where some 700 beds will continue to be related to University teaching programs. Additional beds in the other hospital affiliations will also remain on stream.

TULANE UNIVERSITY MEDICAL CENTER, New Orleans, Louisiana. Systems study: *A.T. Kearney and Company, Inc., and Caudill Rowlett Scott*; master plan and architectural design: *Caudill Rowlett Scott*; associated architects: *August Perez Associates and J. Buchanan Blich and Associates.*

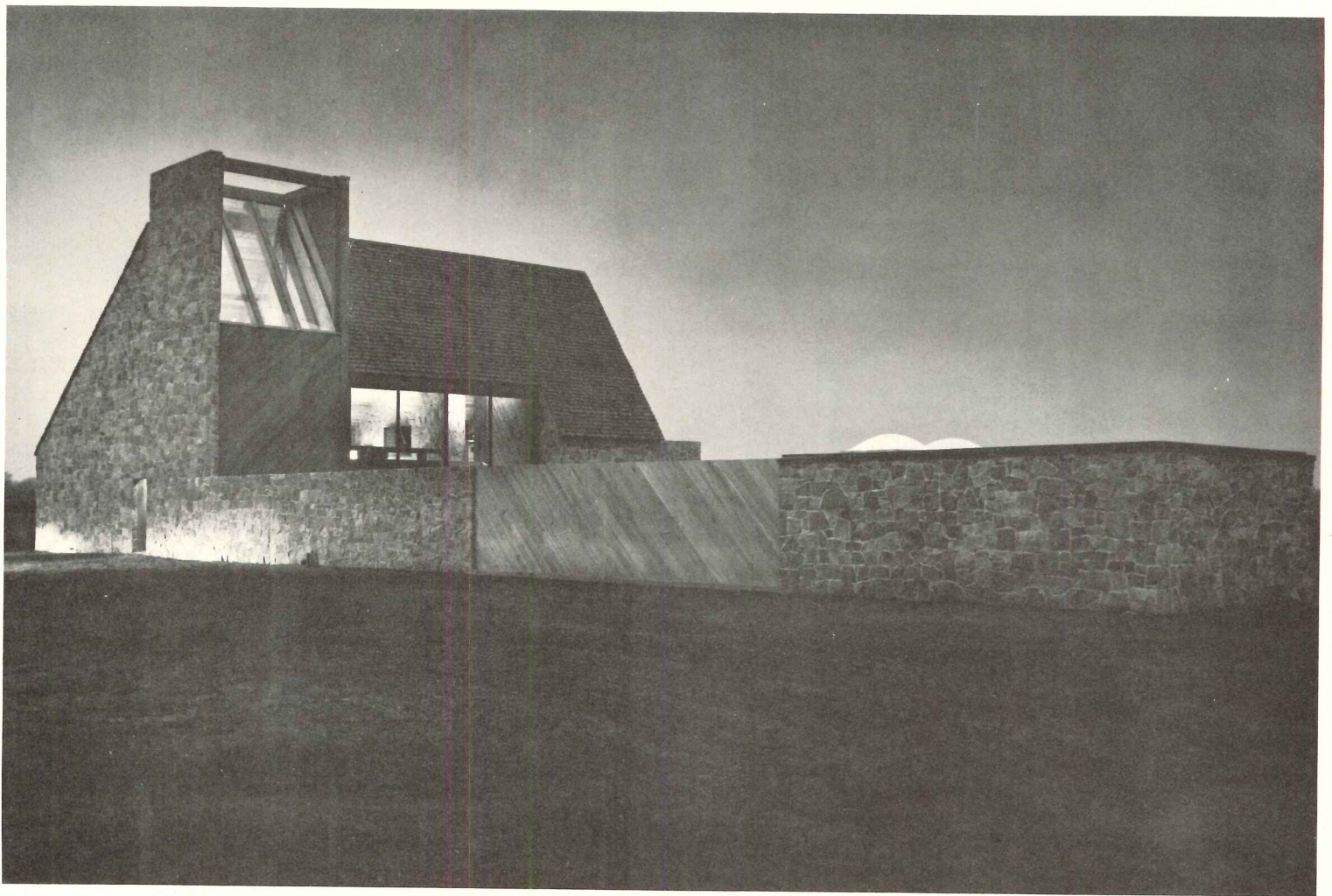

POWERFUL SILHOUETTE FOR LONG ISLAND'S FLATLANDS

With characteristic candor, Norman Jaffe says that his design imagination draws freely from the jumbled and unsorted after-images of hundreds of buildings, old and new, that over the years have printed themselves by reflex on his memory. During the design of this Long Island house for film director Harold Becker, one such graphic fragment intruded itself again and again. It was Jaffe's fragile recollection of an abandoned stone farmhouse, one of its gable ends partially collapsed, that he saw on an Irish meadow years ago. This picturesque image undoubtedly influenced the form of the Becker house, but it was the owner's instruction—"establish a connection with nature and don't break it"—that triggered the recollection and most influenced the choice of materials and the spirit of the detailing.

The plan is uncomplicated and largely self-explanatory. The only unusual elements are a studio/screening room on the ground floor, a small multi-purpose loft reached by a stair from the master bedroom suite and an outside closet where combustible film materials can be stored at a safe remove from the house.

The main structure is framed in massive spruce timbers joined by gargantuan splice plates. The load-bearing masonry walls are laid

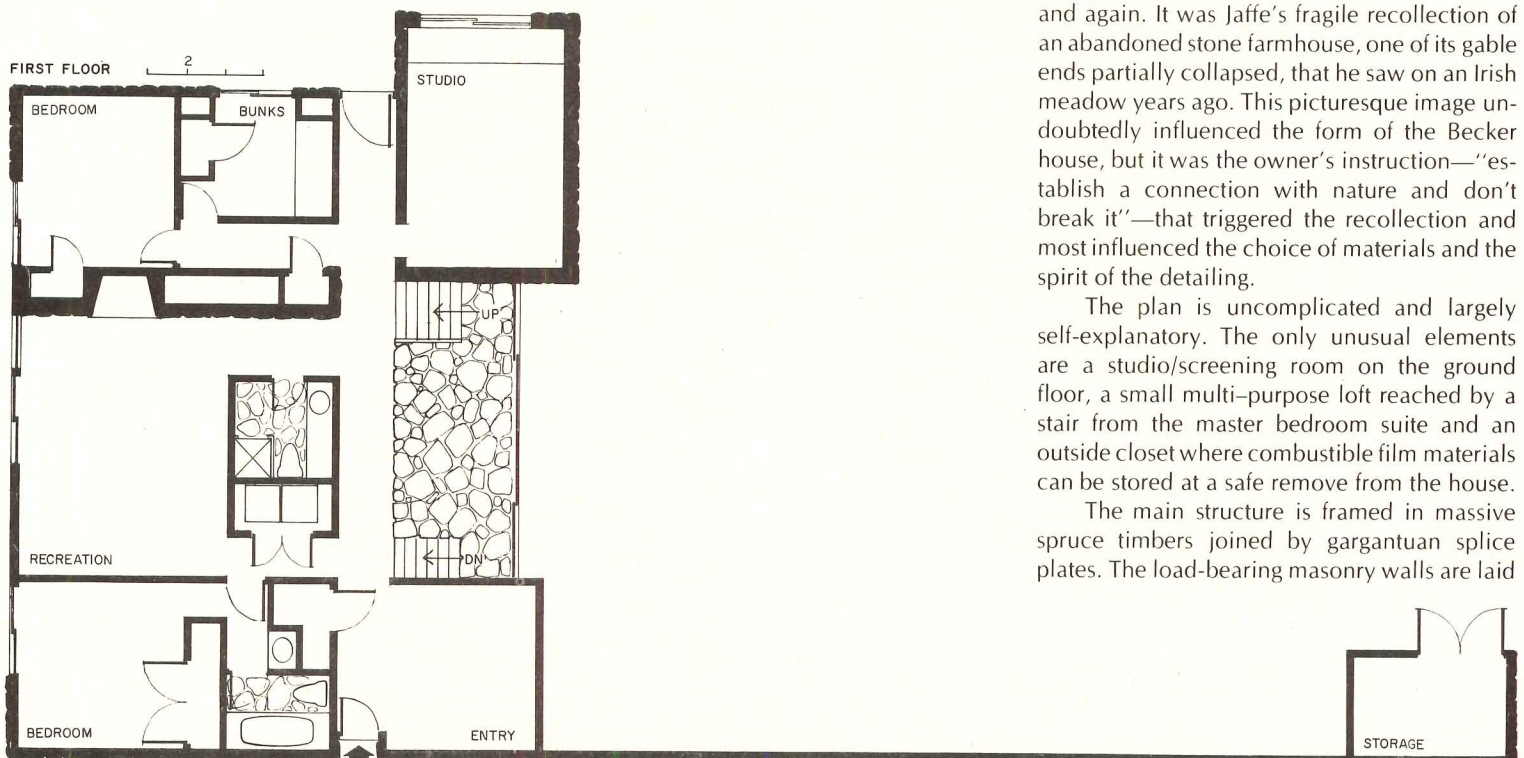

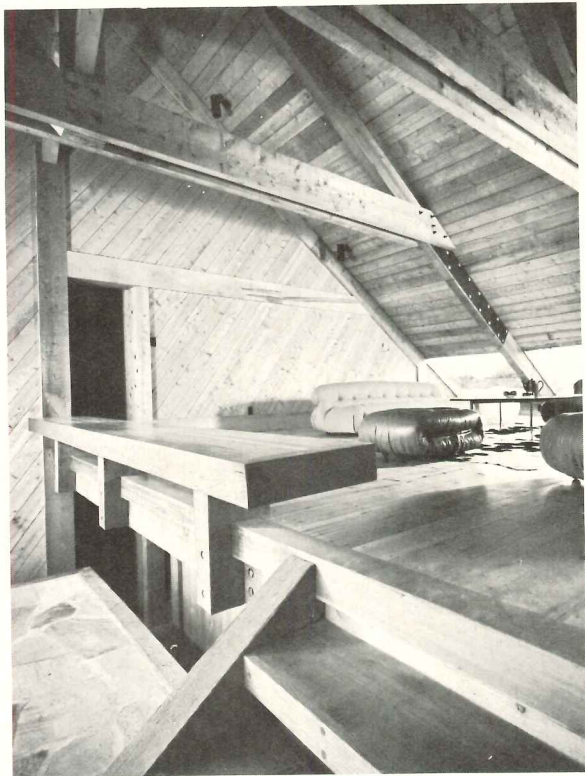

Bill Maris photos

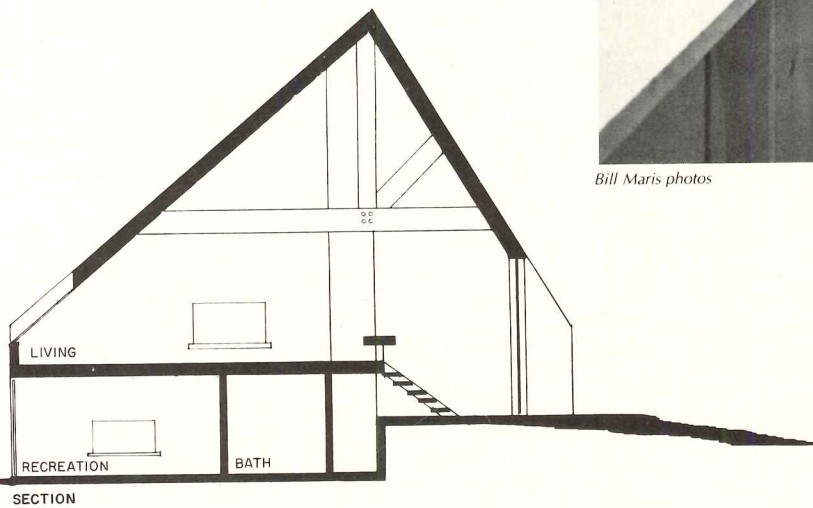

SECTION

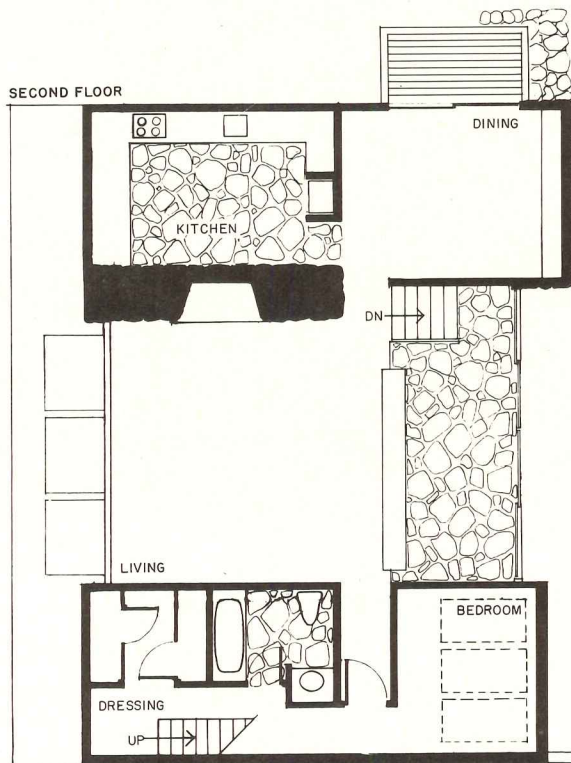

up in a combination of field stone and Delaware River rounds. Plumbing fixtures, kitchen equipment and the extensive use of glass—including sliding glass door assemblies—are sensible concessions to modernity, but almost no prefabricated or manufactured materials were used in the finishes. Ceramic tile, plaster board and plastic laminate, for instance, are shunned in favor of less sophisticated but more natural alternatives. Even the roof shakes were split by the carpenter on the site.

But in spite of the romantic elements in its conception and its indulgent use of materials, the Becker house is plainly contemporary and, most important, designed and constructed with sophistication and skill. The individual spaces are beautifully shaped and sequenced. The relationships between planes are carefully studied. The successful handling of forms and textures, by no means accidental, reflects not only the architect's skill but the owner's well developed graphic sensitivity. Whatever the vulnerability of its premise may be to those inclined toward more matter-of-fact solutions, the Becker house is masterfully designed in its idiom and exquisitely crafted.—*B. Gordon*

HAROLD BECKER HOUSE, Wainscot, Long Island, New York. Architect and interior designer: *Norman Jaffe & Associates*. *Philip O'Brien*, mason; *Clyde Piersal*, carpenter.



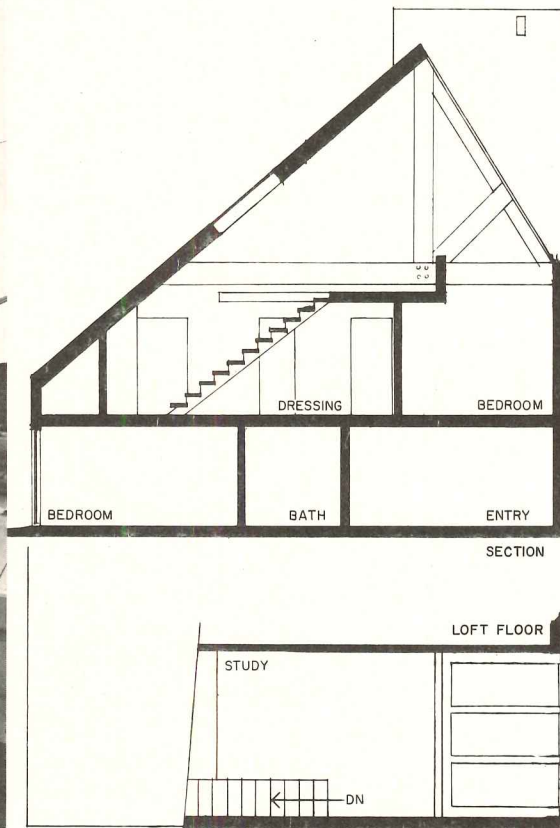

A small loft (photo above), reached by a narrow stair from the dressing room, offers its user privacy but overlooks the master bedroom (photo below). Both spaces admit daylight from the large, canted glass wall. Dining room (photo, lower left) opens across a deck to wide views of Long Island farmland.

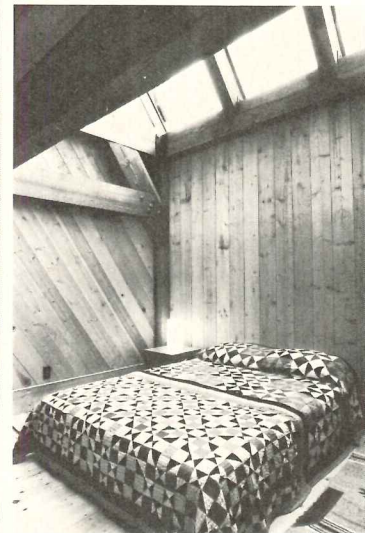

Design-build for student housing: responds to cost, but raises other questions

New systems approaches are being tried to control costs and time. The trouble with design-build is that too few of the right professionals are involved at the right time, starting back with performance specifications and quality standards; and too little of their real expertise is being used. Here is one case example on which time and cost goals were met, but quality of design and construction may not have been the best practically possible. The real question is how does the public get the best results? The answer, unfortunately, has not been found yet.



New Jersey has had a lot of catching up to do in expanding its higher educational institutions. The rapid growth of facilities, and corresponding influx of students, has created a housing shortage—an estimated need for 25,000 student bed units on 16 campuses over the next eight years.

By September of this year, 3900 of these units will have been provided in low-rise and medium-rise apartment buildings, and imminently the State will contract for 1400 more in three-story, low-rise buildings.

The design-build approach is being taken, with contract awards being made on the basis of lowest dollar amount from a prequalified bidder who meets the set of performance specifications developed by the executive architect for the New Jersey Educational Facilities Authority, Ewing Cole Erdman & Eubank of Philadelphia and Princeton.

A feasibility study by ECE&E, and its affiliated company Tecton, Inc., was undertaken in 1970 to find out what the chances were of meeting the EFA's goal of limiting the cost of low-rise housing to \$5000 per student bed (exclusive of site development, land, financing, consultants' fees, and furniture). The study was aided, by a \$25,000 grant from the Educational Facilities Laboratory.

Cost of the low-rise units came close to the EFA's target of \$5000. The \$8000 per bed unit cost of the six-story, medium-rise buildings caused one college to drop out of the first phase, and to rejoin the program in the second (three-story, low-rise) phase. (The six-story buildings are located in the higher-cost, built-up areas of northern New Jersey.)

There is no state financing of student housing except for land and site development. Amortization on bonds and part of the interest are paid for by student rents. The differential in interest between 3 per cent and that on the bonds is made up by HUD.

Faced with the urgency of speed and economy, and encouraged by HUD to consider industrialized techniques, including factory-built modules, the executive architect surveyed



Harris Davis

The talents of design professionals need to be used effectively in systems projects. But how?

Cost and construction time have become paramount for many buildings, especially those that are funded, assisted, or regulated by government agencies. Thus the pressure for new management methods and evaluation processes, new construction techniques—and also for standardization, with variety.

Most of the recent design-build student housing programs have used performance specifications of some sort. Generally, potential bidders have been prequalified in terms of technical and financial capability. Contracts have been awarded by two methods: 1) lowest bid technically meeting the specifications, or 2) best proposal for a fixed contract price (based upon an established evaluation procedure).

Obviously, developers bidding a design-built project are only going to do as much as is actually required, and no more. So if the client deems plan arrangements and architectural character to be of importance, these have to be spelled out in the performance specifications. The advantage to the client of the fixed-price approach is that the developer knows he has to come up with the best over-all scheme to win. On the other hand, the client may tend to offer a rather loose specification in terms of materials and equipment to encourage as much bidding and as much variety of proposals as possible. If this is done quality is not guaranteed in these areas. It is only obtained if the bidders are aware of an implied level of quality that the client expects, and, additionally, depends on how well the evaluation process is conceived and administered, and whether the right professionals are involved in the evaluation.

When low bid is the method of award, the client's tendency is to spell out quality of materials and construction more carefully. If lowest possible cost is the criterion then chances for innovative planning and design solutions are constrained, because the bidder will want to work with familiar approaches, where costs are well known.

The efficacy of design-build in terms of producing the best buildings at the lowest cost depends as much upon how effectively the developer-contractor makes use of professional knowledge and experience, as it does of his own experience in a given building type and market. Where professional involvement is minimal, quality of design results will be minimal.

Client's goals obviously vary widely—some merely wanting safe, inexpensive shelter that works; others wanting much more in the way of amenities. A private client normally gets what he pays for. But when the public is involved, the public's interest (in all its ramifications) needs to be protected, and this is the role of the professions.

In today's parlance, performance specifications have been synonymous with "systems" projects. By and large, there has been little in-depth critiquing of systems projects with respect to their intrinsic accomplishments, and with respect to the way that design professionals have been involved and utilized.

Unfortunately, in some systems projects, the professions not only are underutilized in terms of their talent and experience, but they are expected to "gamble" along with developers and contractors on whether they will get paid for their services—only if they win the competition. With fees being what they are, most professionals cannot really afford to work this way. They can manage only by either providing minimal services, or by absorbing the costs in their overhead—in effect their other clients have to absorb this cost. But even with minimal services, the work involved in interpreting bid documents and attending meetings can be considerable.

In sum, when participation by architects and engineers is too limited: (1) the client loses the opportunity of examining a larger number of alternates and options; (2) the investigations may have to be somewhat superficial; the potential of inventive design and planning solutions is limited.

some 50 design-build contractors, many of whom offered modules or system buildings. After they had had a chance to review the program, many of the industrialized building firms dropped out for a variety of reasons: 1) they could not count on getting a large enough number of apartment units in the program; 2) many firms did not have production facilities within an economic travel distance; 3) some were tied up with other government-supported housing in the region; 4) some felt that they did not have enough time to prepare proposals and bids; 5) it was difficult for module manufacturers to compete with local builders in the lower-cost areas.

A developer/contractor could bid the whole program, or merely one of the campuses

The first phase of the program was set up as six-story, medium-rise buildings for two urban campuses, and two-story low-rise buildings for four suburban campuses. The apartments were to be almost entirely two-bedroom type (only ten per cent of the medium-rise apartments were to be one-bedroom). While some administrators might have preferred a mix of apartments—one, two- and three-bedroom—this simplification probably encouraged more bidding, and also cut costs.

Interested firms with design-construct capability (developers, system builders, module manufacturers, A/E's, etc.) could offer a lump-sum for medium-rise or for low-rise, or for both; but, on the other hand, they also could bid each campus individually. This meant chances were slim that one firm could be assured of getting the entire package, especially in the low-rise buildings. The bidding breakdown has encouraged many "stick" builders to bid the three-story, low-rise buildings in the second phase of the program because of their familiarity with costs and construction in local areas.

The effect of this is that standardization in such subsystems as heating and air conditioning is unlikely to occur, but rather will vary depending upon which approach gives the most favorable costs to individual developers. Standardization, tied in with cost/benefit and life-cycle analyses are highly important, and are usually related to long-term guaranteed maintenance contracts—essential to prove out the best system selection.

Precast medium-rise, factory modules, and conventional construction were low bids

Of the total units, 1,498 are in six-story medium-rise, factory-fabricated, precast concrete buildings; 1,308 are in factory-built modules of wood; and the remaining 1,024 are site-built, with load-bearing masonry walls, precast concrete planks, and vertical wood siding for infill.

The award for the medium-rise buildings at Newark State College and Patterson State College went to Kendall Development Company, a New Jersey apartment house developer, and they engaged J. Robert Hillier as their architect. The precast concrete system was provided by the Formigli Company, a New Jersey precast manufacturer. Cost was approximately \$8,000 per bed unit.

Contract for the low-rise housing at Ramapo College and Rutgers University's New Brunswick campus went to Stirling-Homex,

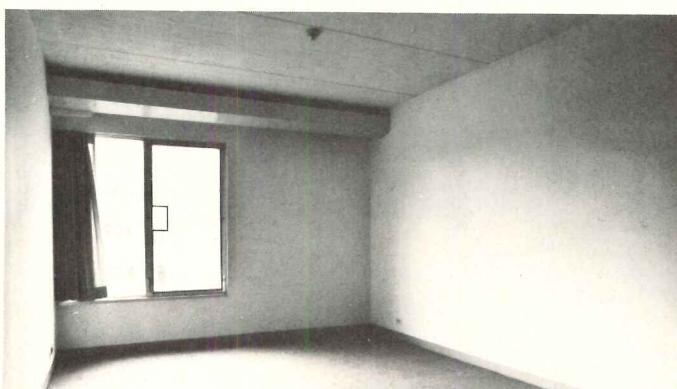
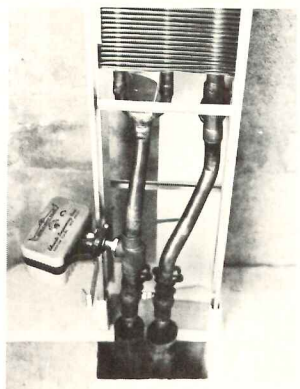

Six-story, precast concrete structures were the lowest bid in New Jersey's first go-around in a design-build program.

Long-span precast planks span the width of the two-bedroom apartments. Partitions between rooms and along corridors are steel-stud framed.

The heating and air conditioning is provided by a proprietary fin-tube valance system. There are no fans, and the heating and cooling effects are mainly convective, but with a high radiant output on heating. The system has been in use in nursing homes and motels. Piping run-outs from corridor mains feed each apartment. Temperature control is by thermostat actuating a zone valve at the head of the valance.

A roof-top, air-cooled chiller provides the cooling effect in summer, and a steam-to-hot water converter provides the heating effect in winter. The chiller and converter are housed in a precast concrete penthouse.

Kitchens are ventilated by roof-top exhausters, bathrooms are ventilated by individual fans on inside common exhaust shafts that go to the roof.

module manufacturer who completely outfitted their units at the factory. Cost was approximately \$6,000 per bed unit. But Stirling-Homex filed for bankruptcy in the midst of site erection. Some of the modules for Rutgers were damaged beyond repair through vandalism, and these are being duplicated by Starrett Modular Construction in a contract with Frank Briscoe Company, general contractor, who took over for Stirling-Homex.

The site-built low-rise housing at Richard Stockton State College was done by Costanza Contracting Company, which also is the general contractor for the academic buildings there (RECORD, March, 1973, pages 103-108). Cost is approximately \$4500 per bed unit. Their architect was Ronald E. Vaughn.

The costs given for bed units at all campuses do not include land and such site-work items as: water, sewers, roads, etc.; or, at Newark State College, a share of the boiler plant.

Construction time for the medium-rise buildings will be about 18 months; for the low-rise buildings it is about 10 months.

Sometimes the level of quality was up to the developer to decide

The specifications adhered solely to space allotments, and to levels of technical performance: durability of materials, acoustical privacy, temperature levels, etc. Architectural qualities such as desirable plan element arrangements (from the students' and administrators' points of view), exterior appearance, relationship of buildings to one another and to the campus were not covered—although campus architects participated in siting the housing.

Over-all finished quality of the student housing is better than commonly seen in the private sector; but, on the other hand, design investigations were not encouraged by the way the program was set up—and perhaps this is attributable to an overriding emphasis on meeting mandated target costs. But no one knows what the results might have been if design alternatives had been given a chance.

The specifications stated that the buildings should be "constructed of durable materials" and should be designed to last 40 years. If gypsum board were used for partitions, it had to be in two 5/8-in. layers; rubbed concrete was permissible. The STC ratings for partitions had to be 45 between rooms; 50 between apartments and between apartments and corridors.

The exterior walls of the medium-rise buildings could be brick veneer, precast concrete or in-situ concrete. The exterior walls of the low-rise units could use wood siding, but only rough-sawn cypress or tongue-and groove redwood.

The mechanical systems varied depending upon the developer's choice, and fuels

The least detailed section of the specifications (as it generally has been with most systems projects) was that for the heating and air-conditioning subsystem. Other than the fact that window air-conditioning units were precluded, the system could have been almost anything, provided that it was based upon, "generally accepted and proven methods and materials," and as long as it could maintain a specified indoor winter temperature, and specified in-

door summer temperature and humidity.

Bidders were required to use the particular energy source brought to the contract limit line on each campus, and the sources might be electricity, gas, or steam, or some combination of these.

The hvac systems used in the program included:

1) valance heating and cooling (fin-tubes above windows) for the medium-rise buildings, with chilled water being provided by a roof-mounted, air-cooled chiller;

2) fan-coil units for the module housing. At Ramapo, two central gas heater-chiller, outdoor, mini-plants supply the chilled and hot water. At Rutgers, steam was available for heating, and cooling was provided by central air-cooled chillers;

3) individual furnaces with direct-expansion cooling coils and rooftop condensers were used for the apartments at Richard Stockton State College.

In an obvious effort to hold costs down, central systems were not allowed in the second phase (three-story, low-rise), and individual furnaces with direct-expansion cooling were what was called for.

In contrast to some of the school systems projects, such as SCSD and SEF, the bidders were not required to make any commitment on maintenance contracts. Materials and workmanship only had to be guaranteed for the usual year from date of acceptance.

The Ewing organization served as the client's "architect" in preparing the performance specifications, and as the client's "agent" in administering the bidding process which was broken into two stages to ensure practicability of the bidders' proposals: 1) presentation of technical proposals, and 2) submission of prices by the bidders. About eight-weeks' time was allowed between the two.

The answer to cost and time has to lie in more effective use of professional talent. But how?

Getting a broader representation of design professionals by involving them solely in consortia bidding on a systems project is not effective enough because this does not encompass interchange or evaluation of ideas prior to the development of performance specifications. Further, with this approach, the consultants know that only one out of many consortia will be successful. Only a very limited amount of "free" architectural and engineering services can be provided on this contingency basis (considered unprofessional in the past).

With the proper use and selection of professionals, the client can get whatever level of quality he really wants. But consultants are needed who are familiar with the quality levels that seem to be demanded by the budget.

Even though the budget is a minimum one, this does not mean that the selection of the architectural and engineering consultants who will execute the design should be left entirely to the discretion of a developer, nor should the scope of professional services provided be left entirely open.

Obviously, the best use of the talents of such consultants would be by calling on them prior to and/or during the preparation of performance specifications.



Gil Amranga

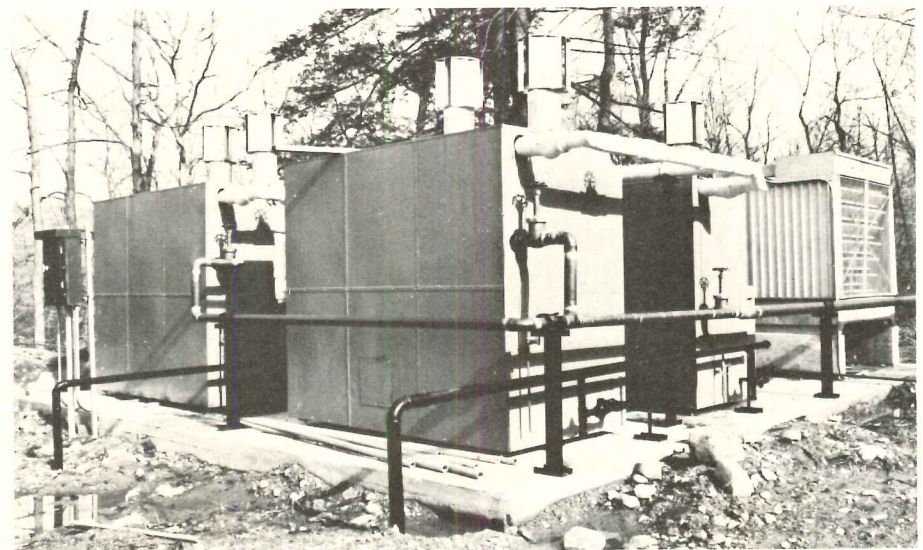

Factory-built modules were used at Ramapo College and Rutgers' New Brunswick campuses. Heating and air conditioning is by fan-coil units in each room.

The heating and cooling effects at Ramapo are produced by weatherproofed gas-fired heater-chiller units set on a concrete pad a short distance from the rows of apartment units. A cooling tower is required for use with the absorption-cycle cooling. At the Rutgers campus, steam was available, and the cooling is by an air-cooled chiller.

The apartments are two-bedroom units—one apartment per floor of each module. Stairs were set back to visually break up the modules.

The exteriors are tongue-and-groove redwood siding.

For more information, circle item numbers on Readers Service Inquiry Card, pages 245-246

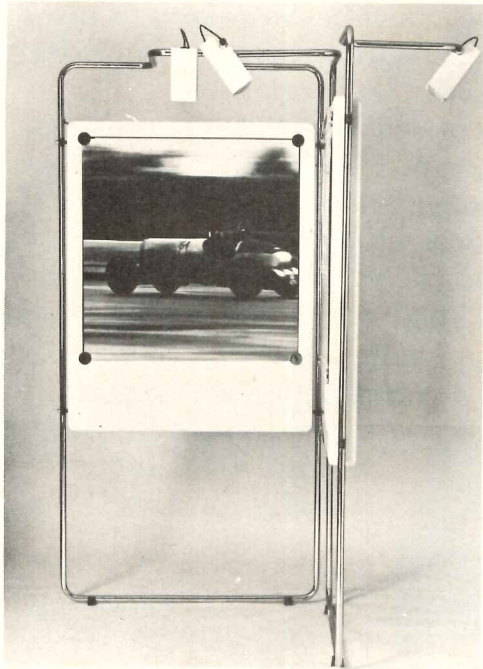

DISPLAY SYSTEM / The chromium-plated, tubular steel frames connect in any of eight positions, and without touching the structure, graphic changes are possible in a few minutes. Adjustable shelving, lighting and other display basics including tables and ash stands, can be easily added to the main structure without tools. *System 8* adapts to many configurations and back projection units can be incorporated. Plastic laminate panel and shelf finishes are supplied to specifications. ■ Peter Pepper Products, Inc., Gardena, Calif.

circle 300 on inquiry card

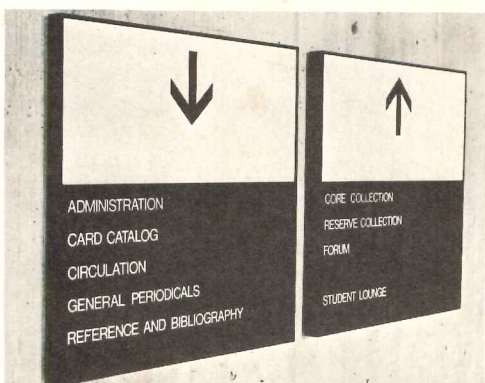
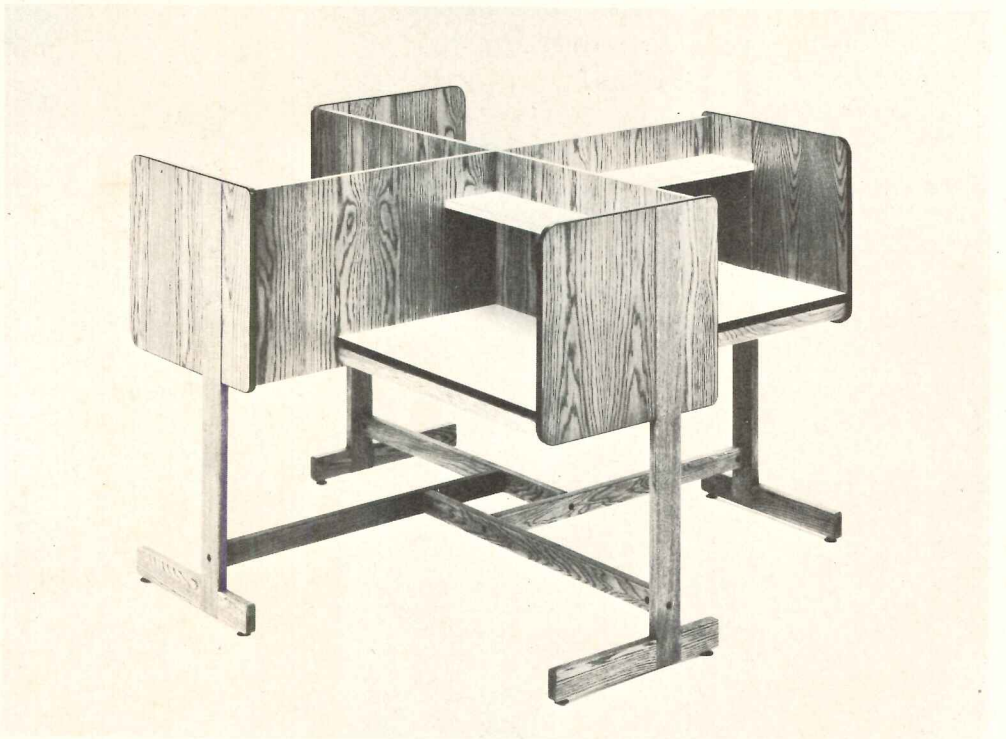
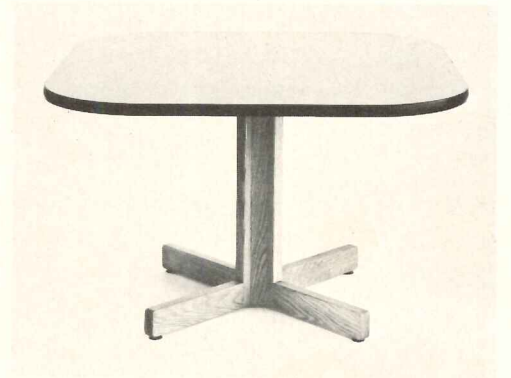
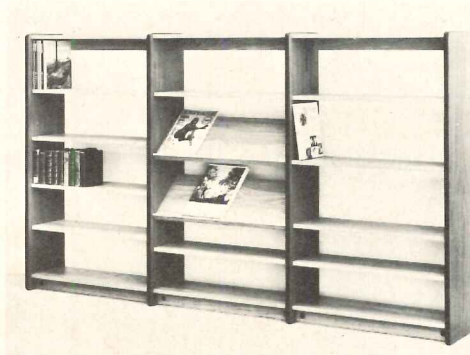

ARCHITECTURAL SIGNAGE / Available in many colors, type styles and sizes—for both interior and exterior use—durable fiberglass signs are furnished with matte finish surface as standard. Special requirements can be met. ■ Architectural Signing, Inc., Marina Del Rey, Calif.

circle 301 on inquiry card

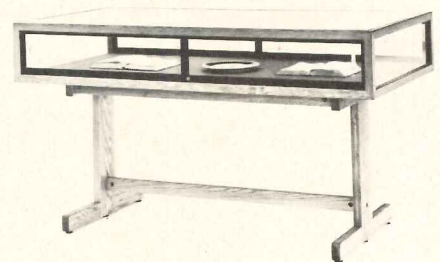
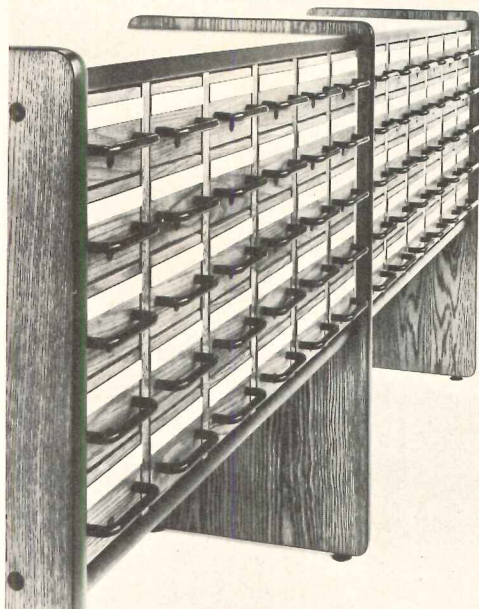

LIBRARY FURNITURE / A wide variety of coordinated furnishings, including tables, chairs, sofas, carrels, card catalogs and shelving is offered in oak. Laminate surfaces may be substituted for wood. Carrels can be arranged singly or in attached configurations as shown. ■ Hiebert, Inc., Torrance, Calif.

circle 302 on inquiry card

more products on page 164

Some sash designs need to put the pressure on glazing tape.

Stick curtainwall systems and pocket-glazed windows provide structural economies in many applications. But they also present you with some formidable glazing problems.

For one thing, the pocket channel allows the glazer very limited working space. This means he must either, 1) position the glass first and then apply a gunnable sealant from the outside —necessitating costly swing stages or, 2) do the glazing from the inside by using a tape sealant and then insert the glass, applying a positive pressure by means of wedges or gaskets.

This tape sealant must be 25%-50% compressible, yet must not squeeze out of the channel despite the pressure.

Another problem — illustrated on the opposite page — is the offset condition of channels in stick system glazing. As you can see, there is a $\frac{1}{8}$ -inch differential between the vertical and horizontal members in the illustration. When glass is put in under pressure, the two tapes are compressed to provide a uniform plane, in order to prevent leaks and distribute stress evenly.

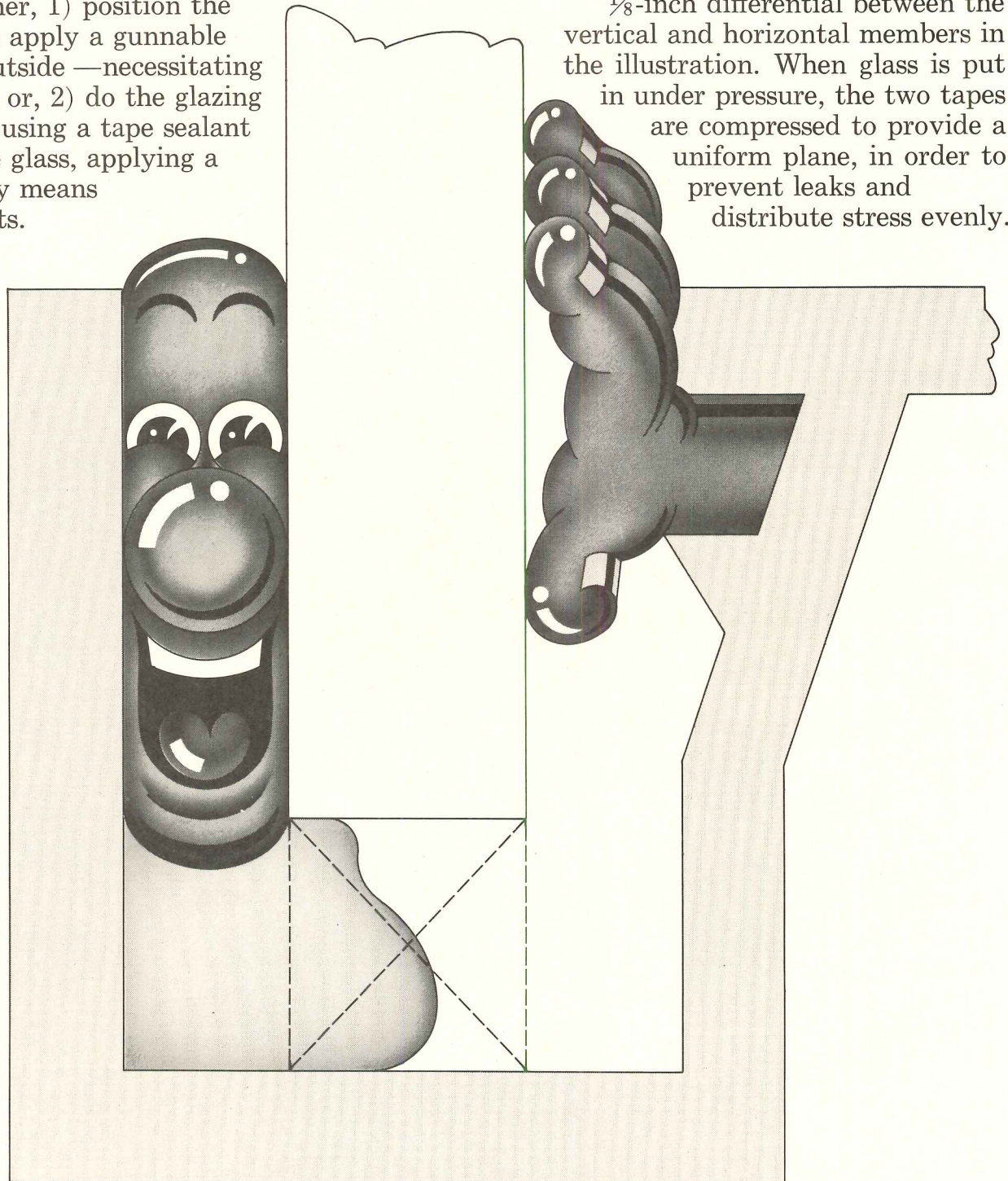

Besides the design problems just mentioned, you and your glazing contractor are faced with increasingly critical glazing conditions as buildings go higher and higher. For example, larger lights of glass, greater pressure differentials and higher windloads all put a bigger burden on glazing techniques. Omitted, misplaced or incorrectly chosen shims compound these problems and raise the possibility of leaks and glass breakage.

All these conditions call for something special in the way of glazing tape. And Tremco has it. It's called POLYshim.[™] And it's designed for use wherever design conditions call for 25% to 50% compression. It contains a continuous, integral reinforced shim that transfers windload from glass to sash evenly around the entire perimeter. This eliminates pressure points or any danger that the sealant will pump out of the sash.

POLYshim can be installed from the inside quickly, easily and accurately. It comes on a specially-treated instant release paper backing that helps

avoid mess, waste and tape distortion. POLYshim is self-adhering and forms a tight seal that effectively prevents water infiltration, resists ultraviolet and withstands temperatures as low as -65°F and as high as 220°F. In addition to practical applications in major buildings around North America, POLYshim has passed independent laboratory tests for dynamic and static water infiltration, buffeting by wind and water, thermal and pressure loading and accelerated aging. So when the pressure's on glazing tapes, specify POLYshim. And if you have any other caulking, glazing or weather-proofing problems, remember your Tremco man can help.

For over 40 years, our business has been solving these problems and providing top-quality leakproof systems and products, such as our job-proven sealants MONO[®], DYmeric[®] and Lasto-Meric[®], liquid polymer Tremproof[™] waterproofing and our new roof edging system, Tremline[™].

The Tremco Manufacturing Company, Cleveland, Ohio 44104. Toronto 17, Ontario

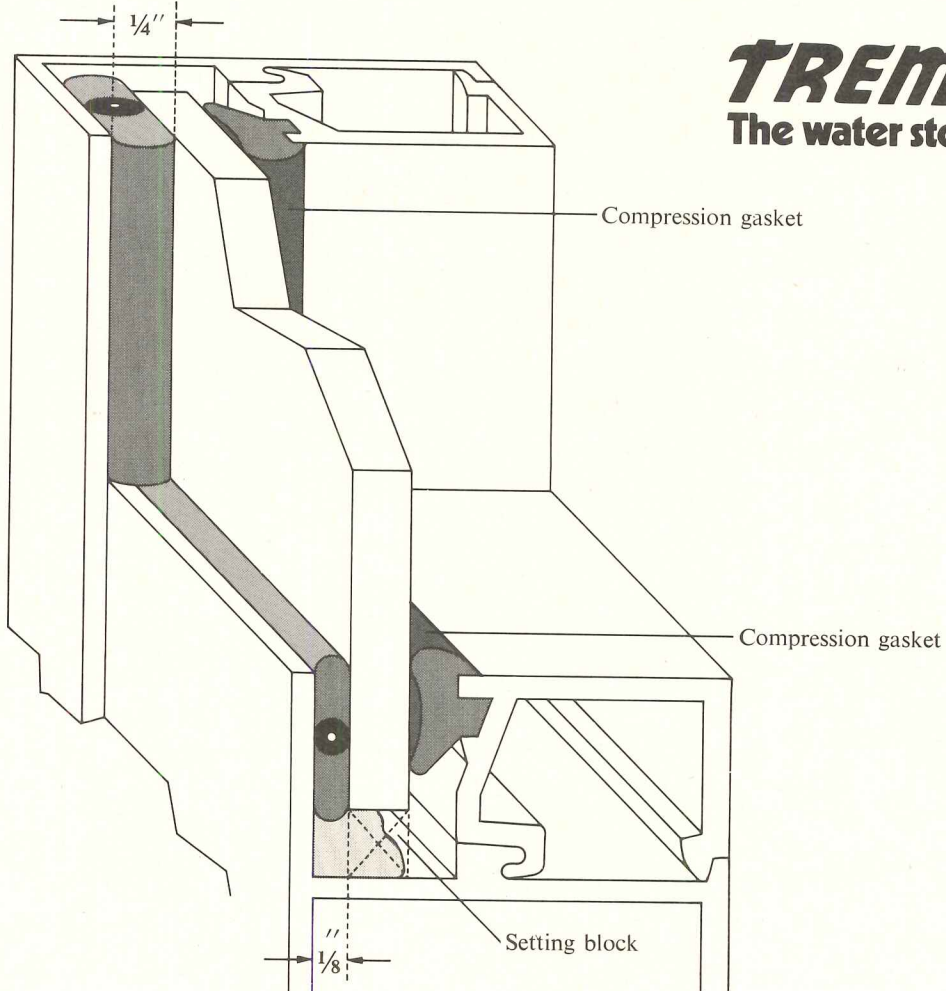
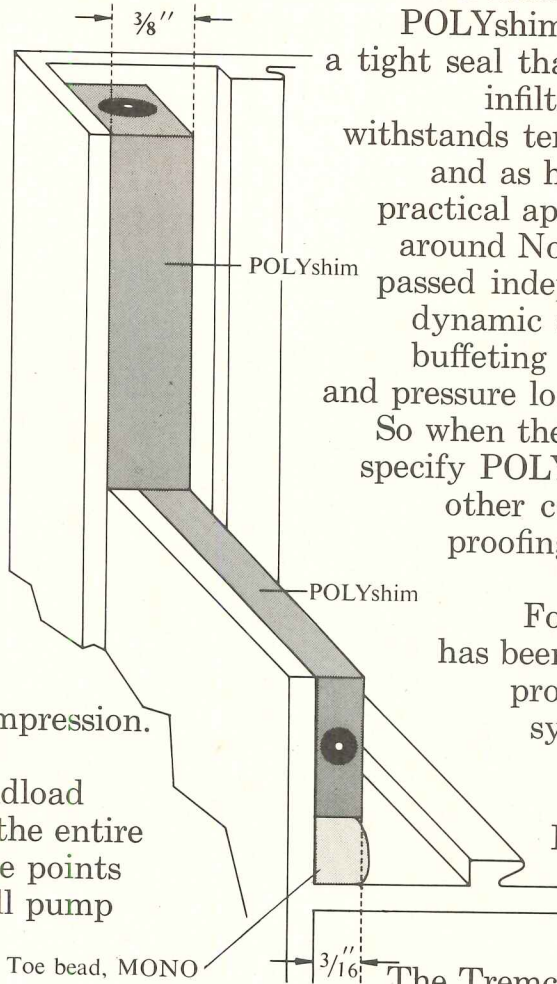

For more data, circle 80 on inquiry card

TREMCO
The water stoppers.

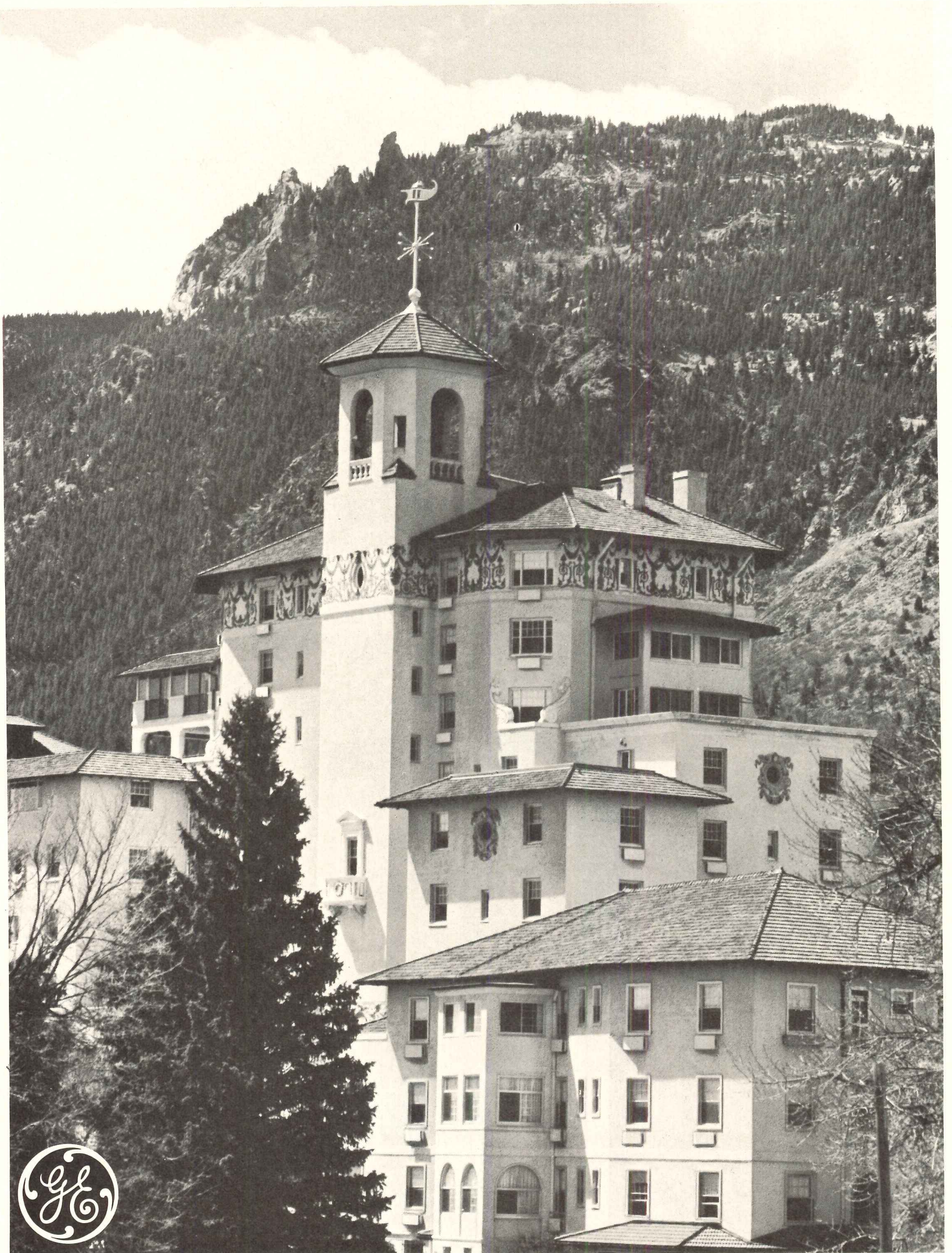

How General Electric Zoneline™ heating/cooling units helped the 54 year old Broadmoor keep its 1918 charm.

This is the Broadmoor Hotel in Colorado Springs, Colorado.

As you can see, it's also a picture of some of the 260 Zoneline heating and cooling units in the Broadmoor.

They didn't spoil the Broadmoor's Mediterranean style of architecture.

A lot of other things didn't happen when the Broadmoor's management chose Zoneline units.

The management didn't have to spend the million dollars that had been estimated for a ducted central air conditioning system. Zoneline units don't need ductwork, or a lot of machinery. All they need is an opening through the wall and an adequate power supply.

The hotel didn't have to be bothered with a flood of workmen. A local contractor was able to install

seven Zoneline units a day with a minimum of fuss.

The Broadmoor management didn't have to decide on the one temperature for all of the guest rooms. Each Zoneline unit has its own thermostat, so each guest can make his own choice.

The best thing was the cost: about \$300,000, roughly one-third the cost of a new two-pipe system.

All of this happened in 1963. That was when the Zoneline units were installed. Since then, they have delivered quiet, reliable air conditioning.

If you have an old-fashioned pipe system that needs replacing, call your local General Electric

Contract Air Conditioning Representative.

He'll show you how easy and economical it is to modernize with General Electric Zoneline units.

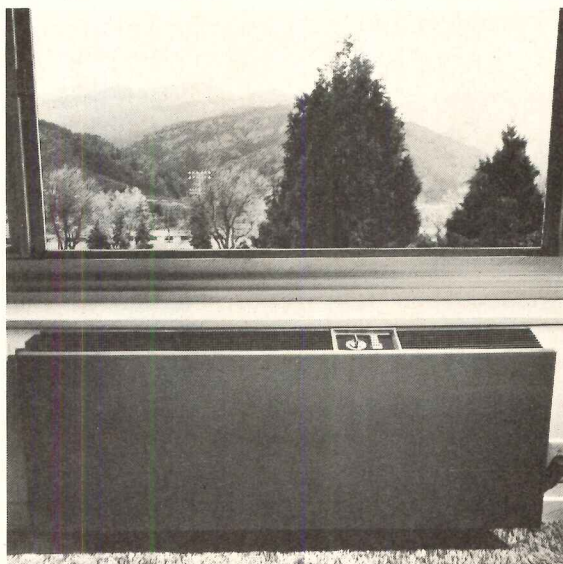

GENERAL  ELECTRIC

For more data, circle 79 on inquiry card

the leakproof plaza... and roof deck

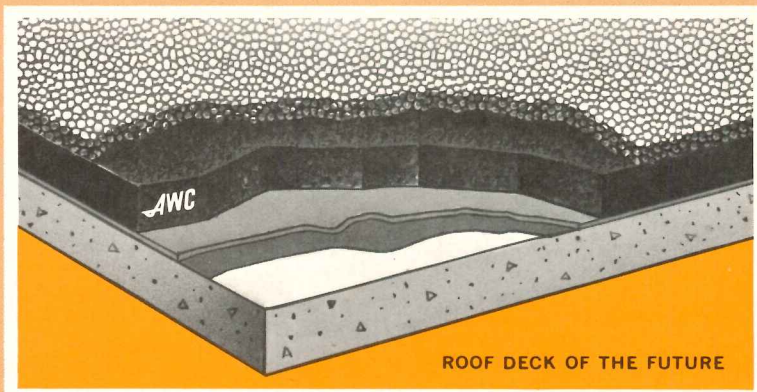
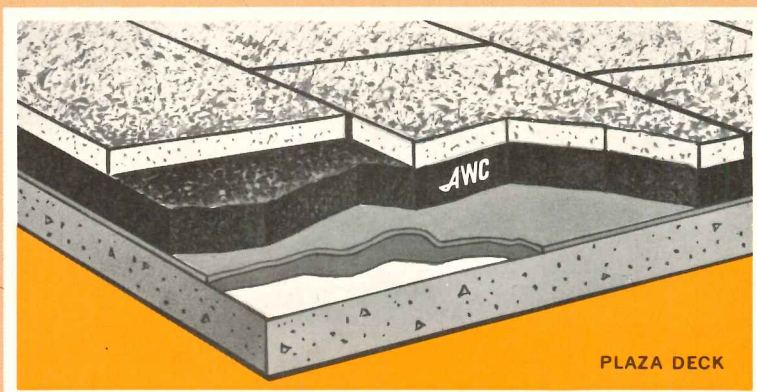

PLAZA DECK: To achieve a truly "leakproof" construction, the waterproof membrane should be protected from the cycling of wide temperature ranges, ultra violet rays and puncture by construction workers. All-weather Crete monolithic insulation provides this protection keeping the waterproof membrane ductile and active for the life of the system. There are eight widely used All-weather Crete plaza designs.

ROOF DECK OF THE FUTURE: Over a decade of designing, testing and practical application have produced this new Silbrico system. All-weather Crete is placed over the waterproofing membrane protecting it from severe thermal change and climatic elements which are major causes of roof failure. All-weather Crete insulation has the properties of being unaffected by these severe conditions.

For complete information, specifications and detail diagrams regarding these and many other successful All-weather Crete systems, write Silbrico Corporation, 6300 River Road, Hodgkins, Illinois 60525. References: Sweets catalog and Spec Data.



For more data, circle 75 on inquiry card

Wouldn't it be great if your new buildings could stay as clean and fresh as you design them, and save your clients money, too. This free catalog tells how.

The Spencer Turbine Company

Drawer E, Station A, Hartford, Conn. 06106

Vacuum Cost Comparisons

Bulletin 250

Even though carpeting looks luxurious, it is the most economical commercial floor covering. Right? Right. But a central vacuum system is really an expensive luxury. Right? Wrong!

For more data, circle 76 on inquiry card

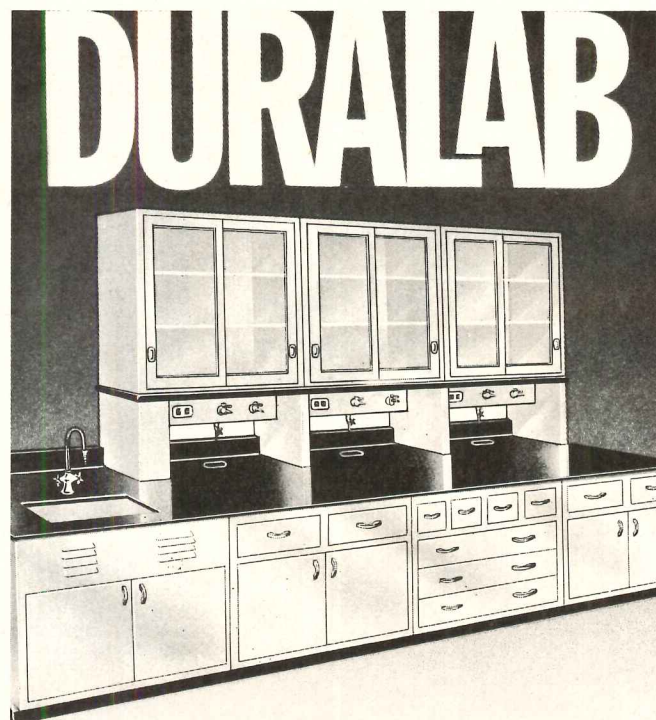

Plan for your Casework needs with Duralab.

Let our factory trained engineering team assist you without obligation.

Call or write the Planning Department now:

DURALAB EQUIPMENT CORP. 107-23 Farragut Rd., Brooklyn, N.Y. 11236
Phone: (212) 649-9600

For more data, circle 77 on inquiry card

Introducing the Radial I

The drafting table with all the moves in the book



...and here's the book.



Write for a free brochure describing the Radial I. We'll even include the name of your nearest Dietzgen dealer.

Up. Down. Flat. Vertical. Around. All the moves. You see, the Radial I was engineered to provide fast, smooth 3-way axial positioning. So you can position the board the way you want it, to minimize glare or cut fatigue. And with fingertip control.

The Radial I provides up to 19 inches of vertical travel to put the board at the most comfortable height for every job. Inner column of pedestal is counter-balanced for fast, smooth operation . . . almost as if gravity didn't exist. And the Radial I rotates a full 360°. Swivel head permits easy turning no matter what the angle or height of the board. Draftsmen can work on any area of the board without stretching. Provides for convenient display of work in progress, too.

Eight friction disc brake surfaces, plus a powerful coil spring counterbalance deliver a 90° range of tilt from horizontal to vertical. Three-way adjustment balances board for adding accessories, such as a lamp or drafting machine.

Special camming action locks board in whatever position is selected. And locks it solid.

The Dietzgen Radial I. It took us 85 years to find a drafting table good enough to put our name on it.

ORTHOGRAPH DRAFTING MACHINE. A beautiful match for the Radial I is Dietzgen's X-Y Beam Tracking Unit. It meets all the requirements for manual drafting and is quickly adaptable to the new electronic components for coordinate measuring and digitizing. Order it with the Radial I. You wouldn't want to break up a winning combination, would you?

DIETZGEN CORPORATION
2425 North Sheffield Avenue
Chicago, Illinois 60614
Phone (312) 549-3300

DIETZGEN

QUALITY PRODUCTS FOR THE
WORLD OF ENGINEERING

make this big first step to stepped-up occupancy

(especially in older buildings)



show your clients what can be
done with those wonderful

Vicrtex[®] VINYL WALLCOVERINGS

- Your building owner clients will find leasing a great deal easier.
- Tenants like Vicrtex Vinyl Wallcovering for their beauty.
- You and your clients will like them for their permanence and easy maintenance: soap and water restores Vicrtex to original glowing color even after years of service.

Write or phone today for quick facts on rapid transformation to income-producing space.

L.E. CARPENTER
AND COMPANY  A DAYCO
COMPANY

964 Third Avenue, New York, N.Y. 10022 • (212) 355-3080
Mill: Wharton, N.J.

DISTRIBUTED IN PRINCIPAL CITIES FROM HAWAII TO THE CARIBBEAN. BY: VICRTEX SALES DIVISION: New York, Chicago, Atlanta, Los Angeles, San Francisco. Boston/HOWELLS, INC.: Salt Lake City/PAUL RASMUSSEN INC.: Honolulu/R. B. ADLER, INC.: Santurce, Puerto Rico.

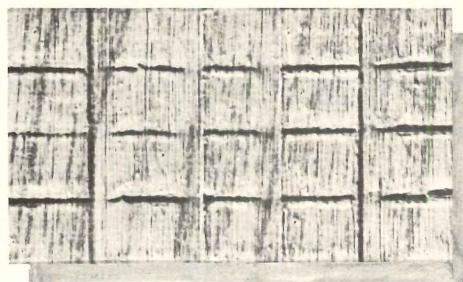
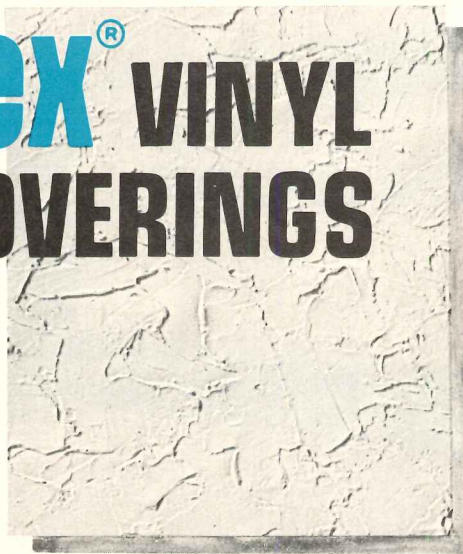

PRODUCT REPORTS

continued from page 157

ROCKER SWITCHES / Designer switches, wall plates and receptacles are UL-listed and meet NEMA standards. Receptacles, in single or duplex configurations, come in 15-amp or 20-amp, 125-volt or 250-volt types. They have break-off fins for easy two-circuit conversion, and feature self-grounding and double-wipe brass contacts. *Decora* switch borders may be selected in either matching or contrasting colors. ■ Leviton Mfg. Co., Brooklyn, N.Y.

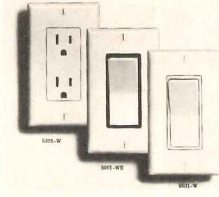

circle 303 on inquiry card

WALL INSULATION / Consisting of rigid *Zonolite* styrene foam insulation and metal furring channels, the *Zonolite Thermo-stud* system is applied to masonry walls to form an insulating base for application of gypsum drywall or other interior surfacing. One-third the usual installation time is claimed, compared to other insulated drywall systems. No adhesives are needed and a complete insulation envelope is achieved without thermal shorts. ■ W. R. Grace & Co., Cambridge, Mass.



circle 304 on inquiry card

INDUSTRIAL ROOFING / Made up of steel-framed, seamless particle board panels five to eight times larger than panels used in conventional roofing systems, this industrial roofing system is also competitive in cost and quality with usual methods. The panels are made using a fabricated steel "C" channel frame covered with high-strength structural particle board in sheets 8 ft wide and up to 30 ft long. The particle board is fastened to the steel frame with self-drilling, self-tapping screws. The particle board is said to have excellent structural strength and be more water-resistant than plywood. ■ Kaiser Steel Corp., El Monte, Calif.



circle 305 on inquiry card

PLYWOOD DECKING / Called *Ruff Cut 44*, this specialty plywood is now available in decking thickness and structural strength. It can be used in applications for exposed ceiling-floor and exposed ceiling-roof combinations. The back side of the panels can be used for either flooring or roofing, leaving the front facing for an attractive exposed ceiling. Available in either fir or Western red cedar. Panels come in three thicknesses: 5/8 in. and 3/4 in. with shiplapped edges for smooth joints; the 1 1/8-in. panel, with tongue-and-groove long edges, is offered in *Fir 44* face only. ■ Pope & Talbot, Inc., Portland, Ore.

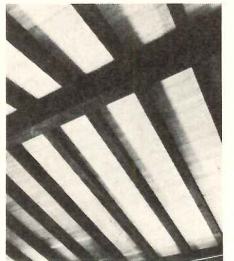

circle 306 on inquiry card

more products on page 172

For more data, circle 81 on inquiry card



Satisfying Supercritical Surgeons

Surgeons are trained to be supercritical of their work. And, their desire for perfection makes them supercritical of everything else, including the plumbingware they use and depend on.

So Eljer designed a new full line of hospital-styled plumbing fixtures and fittings to meet their most demanding needs. Besides the plumbingware shown above, you'll find more than 290 other hospital and commercial line products fully detailed and illustrated in Eljer's new "Hospital/Institutional Plumbing Fixtures and Fittings" catalog.

Hospital-styled plumbingware . . . one example of Eljer's ability to meet any commercial

building need with a complete line of well-designed, quality commercial plumbing products.

If you're planning on satisfying supercritical commercial clients, you should have Eljer's new 62-page catalog on file. Send for the "Hospital/Institutional" catalog: Eljer, Dept. AR, 3 Gateway Center, Pittsburgh, Pa. 15222.

ELJER[®]

Eljer Plumbingware Division
Wallace-Murray Corporation

For more data, circle 90 on inquiry card

For more data, circle 89 on inquiry card

show 'em a better way: raywall air conditioning

Designed for new or conversion applications in homes, apartments and light commercial buildings. Raywall precharged condensing units and evaporator coils are available in a complete range of sizes, with capacities from 18,000 BTUH to 48,000 BTUH. Flexibility requirements are met by three types of coil design... Sloped, "A" and "H."

Raywall air conditioning components are engineered for ease of installation and service. 100% zinc coated steel sheet metal parts. Special fan motors are permanently lubricated to assure longer operational life. The new readily accessible electrical box, on the service side of the unit, contains contactor, transformer and necessary controls. Larger units are equipped with compressor heater. Cabinet is one piece bonderized zinc-coated steel.

Engineered for service and maximum user comfort, Raywall air conditioning is the better way for a variety of cooling needs.

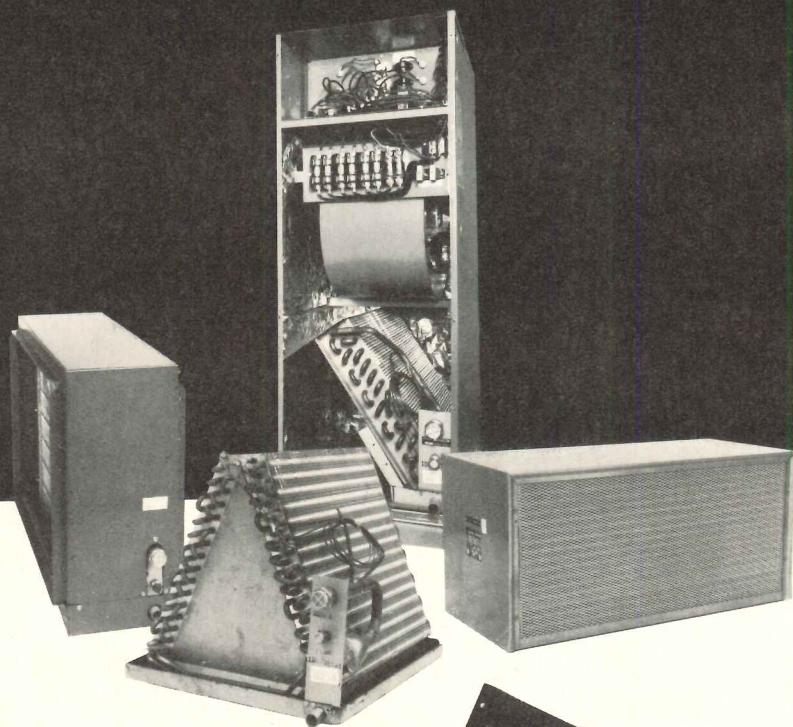

The Electricology Company

P.O. Box T, CRS Johnson City, Tn. 37601 Phone 615/928-8101 Telex 55-3442



We'll show you a better way. Write for our General Products Catalog.

For more data, circle 91 on inquiry card

PRODUCT REPORTS

continued from page 172

URETHANE WALL SYSTEM / A rustic rough-sawn surface is offered in a planked effect, with woodtone finishes in dark oak, random oak, Spanish oak and teak. Sizes are 12-by 48-in., 12-by 96-in. and 24-by 48-in. All panels can be worked with conventional wood-working tools and are easily applied with panel adhesives or finishing nails. ■ Formel Inc., North Kansas City, Mo.

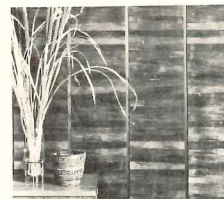

circle 312 on inquiry card

SAFETY ENTRANCE / The exclusive cylinder guard on this entrance prevents pinched fingers because there is no dangerous gap between pivot stile and jamb as in ordinary doors. Flexible vinyl-cushioned locking edge eliminates danger to hands or objects. Safetyline's flush-mounted hardware also eliminates projections that could cause injury. Two-point top and bottom lock increases security. Offered with Amanodic or clear anodized finishes. ■ Amarlite/Anaconda, Atlanta, Ga.



circle 313 on inquiry card

SOLID WASTE COMPACTOR / The Model 45 features a heavy-duty fiberglass hopper added to the bagholder preventing jamming, spillage and bag tearage. The compactor works on cartons, boxes and other packaging materials and a new hopper design ensures compaction in constant bag weights within the prescribed 50- to 75-lb range. ■ Automatic Refuse Systems, Inc., Fraser, Mich.



circle 314 on inquiry card



LEARNING CARPET / Designed for teaching, the Kinder-Karpet line incorporates graphic patterns and learning symbols printed on carpet of Anso nylon fiber from Allied Chemical. Developed in cooperation with educators, the carpeting features instructional patterns showing geometric forms, numbers, alphabet symbols, all of which can be combined in any way. The carpet will be available through the contract division of Sears, Roebuck. ■ Allied Chemical Corp., New York City.

circle 315 on inquiry card

more products on page 184

Medusa White Cement...



... maximum esthetic value
for less than 1/2 of 1%
of total building cost.

Century Center in Atlanta achieved this strikingly handsome architectural effect using Medusa White Cement for a decorative smooth-cast texture. Compare the brilliance of this building with the photo at right showing how it would look if gray cement had been used.

Then compare the use of Medusa White Cement which provides —

- *more uniform physical characteristics and color control than gray,*
- *greater pound for pound strength than gray,*
- *minimum maintenance to retain the clean, bright appearance, and*
- *maximum beauty . . . day and night.*

All of these capabilities and esthetics were available for less than 1/2 of 1% of total building cost.

Can you afford *not* to specify Medusa White Cement?

For more on Medusa White, write Medusa Cement Company, P. O. Box 5668, Cleveland, Ohio 44101.

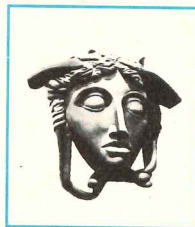

Architect: Newhaus and Taylor, Houston, Texas

Gen. Contractor: Holder Construction Company, Atlanta, Georgia

Precast Producer: Exposaic Industries' Peachtree City, Georgia Plant

MEDUSA CEMENT COMPANY Division of Medusa Corporation

For more data, circle 92 on inquiry card



Heatilator fireplaces stack to any arrangement.

Renters now paying up to \$15 more per month.

Something simple for the builder who hasn't tried Heatilator no-masonry fireplacing.

Shown above is one reason why Heatilator fireplaces are so popular with developers; they make it so easy to include highly competitive fireplace charm in homes and apartments.

Simple installation. These factory-built systems come complete—fireplace, chimney and roof termination, ready to install. Place anywhere in any room, on wooden floors, up against combustible wall materials. No masonry foundation required! Easily stacked for multi-level arrangements.

Extra profits. Builders are boosting rental income up to \$15 more per month, increasing their cash flow, loan and sales value with Heatilator factory-built fireplaces.

Complete selection available—woodburning and gas models, built-in, wall-hung and free-standing. All offer unlimited decorative and trim options.

Call collect, (319) 385-3198 for fireplacing assistance from your Heatilator Man. He'll help you factor fireplacing simplified into your plans, and leave behind a useful Fireplace Planning Guide. Heatilator Fireplace, A Division of Vega Industries, Inc., 3343 W. Saunders Street, Mt. Pleasant, Iowa 52641. Also available in Canada.

See Catalog in Sweet's Architectural and Light Construction File.

heatilator[®]
AMERICA'S LEADING FIREPLACE SYSTEMS



Want fireplacing help?
The Heatilator man makes it
easy to put fireplacing
in your plans.



Built-in wood or gas fireplacing.



Wall-hung gas fireplacing.



Free-standing wood fireplacing.

For more data, circle 93 on inquiry card



Some doors should look good and be kid-proof, too.

Beauty doesn't have to be fragile. It can be exceptionally strong and long-lasting — as in Republic stylable steel doors.

Made of durable steel with a sturdy honeycomb inner structure, these doors last through generations of school kids. But you get much more, too.

You can choose from 36 door sizes and 8 standard styles, all prime-coated or prepainted in one of 19 popular colors.

You can specify your own distinctive light and louver treatment. That's because your local Republic distributor can modify our basic door design right in his own warehouse. And with no delay in delivery.

Plus, when your doors are delivered, they're ready to hang or erect. No planing, notching, or mortising is needed on any Republic door frame and Frame-A-Lite stick system.

Fact is, our doors are so great that we use them in THE ENVIRONMENTAL HOME, Republic's new single-family residential building system that uses prefabricated steel panels and components that lend themselves to mass production and easy on-site assembly.

Like more information? Contact your Republic distributor. He's listed in the Yellow Pages under "Doors-Metal."

Or, send for a free copy of our Architectural Products Manual. Write Republic Steel Corporation, Manufacturing Division, Youngstown OH 44505.

Republicsteel
Manufacturing Division

For more data, circle 94 on inquiry card

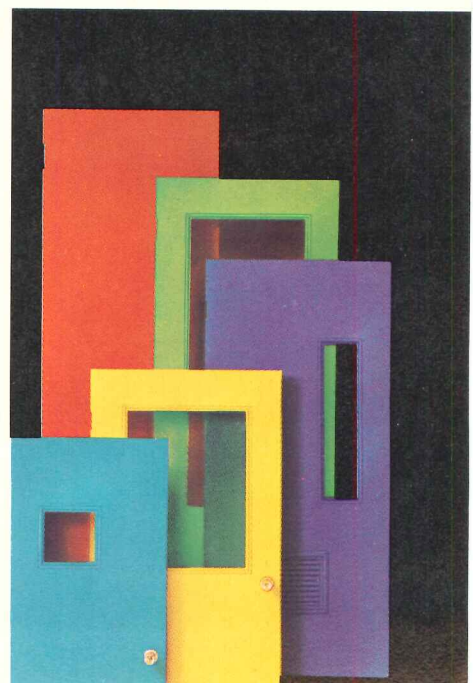

Variable Volume Systems conserve energy

Buffalo Variable Volume Air Handling Systems provide the greatest potential total savings. Buffalo BL Ventilating Fans with backwardly curved blades and variable inlet vanes, and low friction loss coils are combined in a unit which delivers all the advantages of a built-up system with the economy of factory fabrication.

The Buffalo Sales Engineer in your area can show you why this is true. He can also give you good counsel on such things as location of static pressure controllers, air flow stability at low loads, and selection of return fans for Variable Volume Systems. Call him. He's listed in the Yellow Pages. Air Handling Division, Buffalo Forge Company, Buffalo, N. Y. 14205. In Canada, The Canadian Blower & Forge Co. Ltd. Air Handling Equipment • Finned Coils • Centrifugal Pumps • Machine Tools.

Buffalo Variable Volume Systems conserve capital

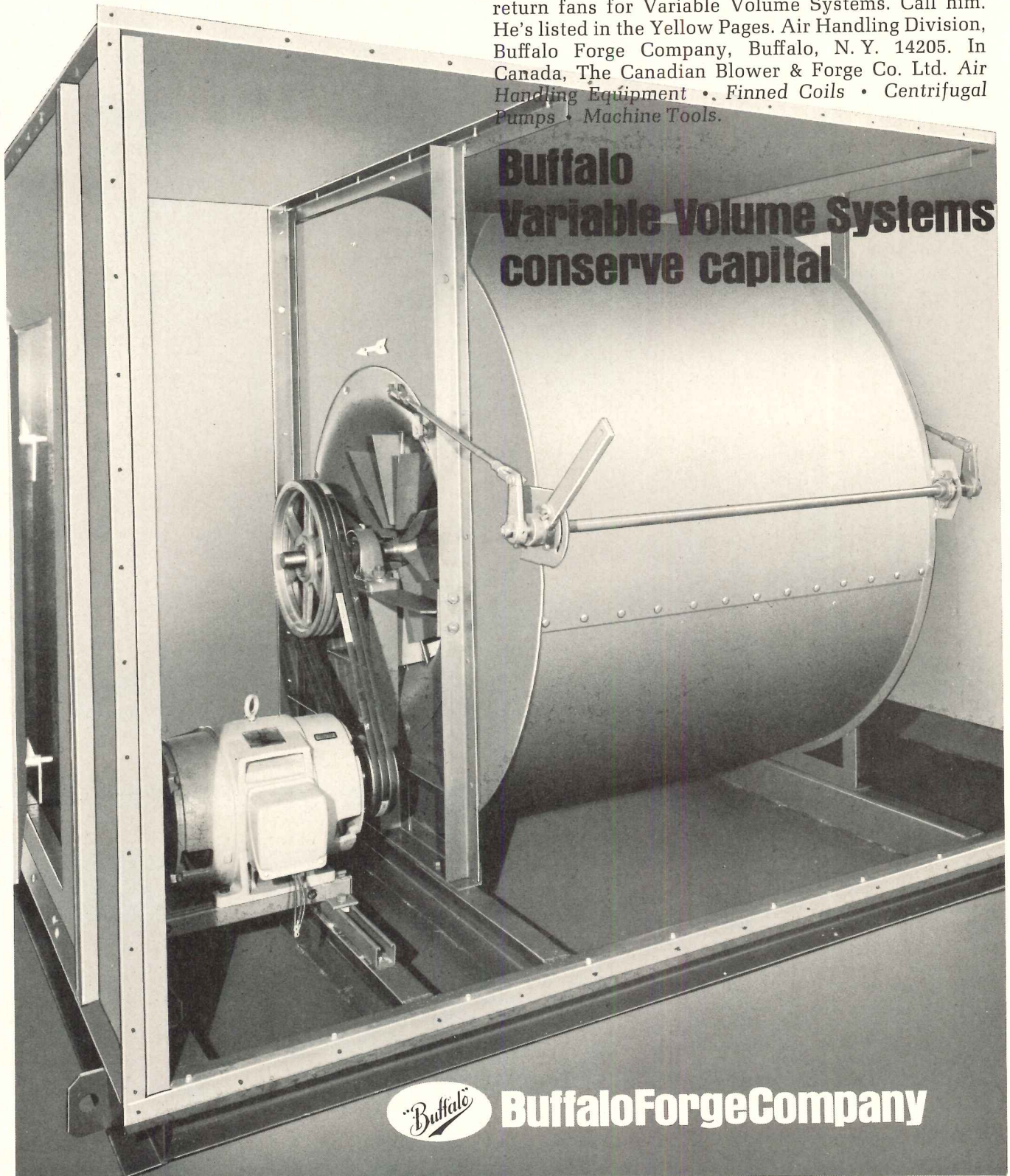

Buffalo Forge Company

For more data, circle 31 on inquiry card

the new washroom:



How do you meet the demands of space, traffic flow, maintenance and budget in today's new washroom?

Bobrick helps with a "Total Design Concept" of coordinated stainless steel washroom accessories and laminated plastic toilet compartments for every type of building.

In this washroom, Bobrick recessed multi-purpose units combine large capacity soap and towel dispensers with two soap valves, serving two

lavatories. Large capacity stainless steel waste receptacles reduce maintenance time. Bobrick "flush-front" laminated plastic toilet compartments and matching counter tops complete this up-to-date washroom.

To help you plan today's new washroom, send for our Planning Guides and Catalogs. Bobrick, Architectural Service Dept., 101 Park Ave., New York 10017. Bobrick products are available internationally.



bobrick

SINCE 1906



MOUNT SINAI PRESCRIBED A BETTER PHARMACY

When the Mount Sinai Medical Center of Greater Miami wanted to dispense with possible problems in their new pharmacy they called in a specialist: Watson. The Watson pharmaceutical casework they installed was custom designed to fit them like a surgical glove. When Watson designs a pharmacy we study your particular situation and design the one pharmacy that's just right for you. As for Watson's quality, well just ask the Mount Sinai Medical Center of Greater Miami.

HOSPITAL DIVISION  **WATSON**
Manufacturing Company, Inc.
Jamestown, New York 14701

For more data, circle 99 on inquiry card



MULTIPLE SEATING / Recommended for institutions, this system features simple framing with one-piece back and seat that can be easily removed and recovered if necessary. The halved and dowelled joints enhance the simplicity of the butcherblock frame. Chair can be used singly, and when grouped together, chairs come with or without intermediate arms. Chair height is 29 in. and seat height is 16½ in. Matching tables are offered. ■ John Adden, Boston, Mass.

circle 316 on inquiry card

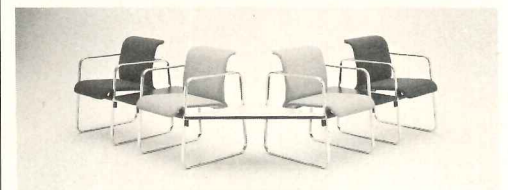

TUBULAR TANDEM TABLES / Four different table top shapes can now be clamped between the chairs of an award-winning tubular seating group. Table tops come in square, rectangular, triangular and trapezium shapes, permitting the chairs to be arranged in configurations of 90 degrees, 45 degrees or straight lines. Table tops are available in either black or grey laminates with black vinyl edges. ■ Herman Miller, Inc., Zeeland, Mich.

circle 317 on inquiry card

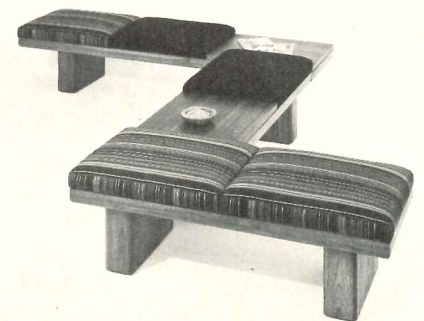

BENCH-TABLE SYSTEM / Based on a 30-in. module, the 60- and 90-in. units are offered with interchangeable, fully-upholstered cushions or table tops that are readily secured to the plinth base. Chair-quality seating comfort is offered. Cushions can be upholstered in a choice of materials and walnut is the standard wood, with six custom colorations available optionally. ■ Marden Mfg., Inc., Chicago, Ill.

circle 318 on inquiry card



***New Seacrest
acoustical ceiling:
as textured as
a surfing sea.***

Exciting Seacrest is the latest large module ACOUSTONE® Ceiling Panel pattern from United States Gypsum. Designed with a fresh-looking, frothy texture, these natural mineral fiber panels soak up sound to a soothing .75 NRC. Bring a hush to the busiest rooms.

But Seacrest is a lot more than just another sound and see-worthy ceiling treatment. These quality panels are also high in fire resistance and light reflectance. Give you the option of 2 x 2' as well as 2 x 4' modules. And foil-backed ACOUSTONE helps hold down air conditioning costs. Keeps ceilings cleaner to trim maintenance costs.

See your U.S.G. Representative for specifics. Or write to us at 101 S. Wacker Dr., Chicago, Ill. 60606, Dept. AR-43.

UNITED STATES GYPSUM 
BUILDING AMERICA

For more data, circle 100 on inquiry card

New PD-80 engineering convenience copier.

Convenience is what the fast, high-quality PD-80 is all about. Install it right in your drafting area, turn it on, feed tracings at once, and get finished prints in seconds. It's the most reliable odorless engineering convenience copier: no ammonia, no venting.

What more can we say? Except that we can set it up and

demonstrate it in about the time it takes to read this.

So, call your local Bruning man. He's ready to show you how you can make quick check prints right where you make your drawings, with the PD-80. And this cost-cutting machine can go to work for you on an attractive rental plan. No capital investment, no long-term commitment. Like all Bruning products, the PD-80 is backed by the famous Bruning tradition of

service and support to the engineering profession.

Your drafting department just has to see this one. Call your Bruning man. Or write Bruning, 1834 Walden Office Square, Schaumburg, Ill. 60172.

Your single best source in engineering graphics.

No odors. No waiting.

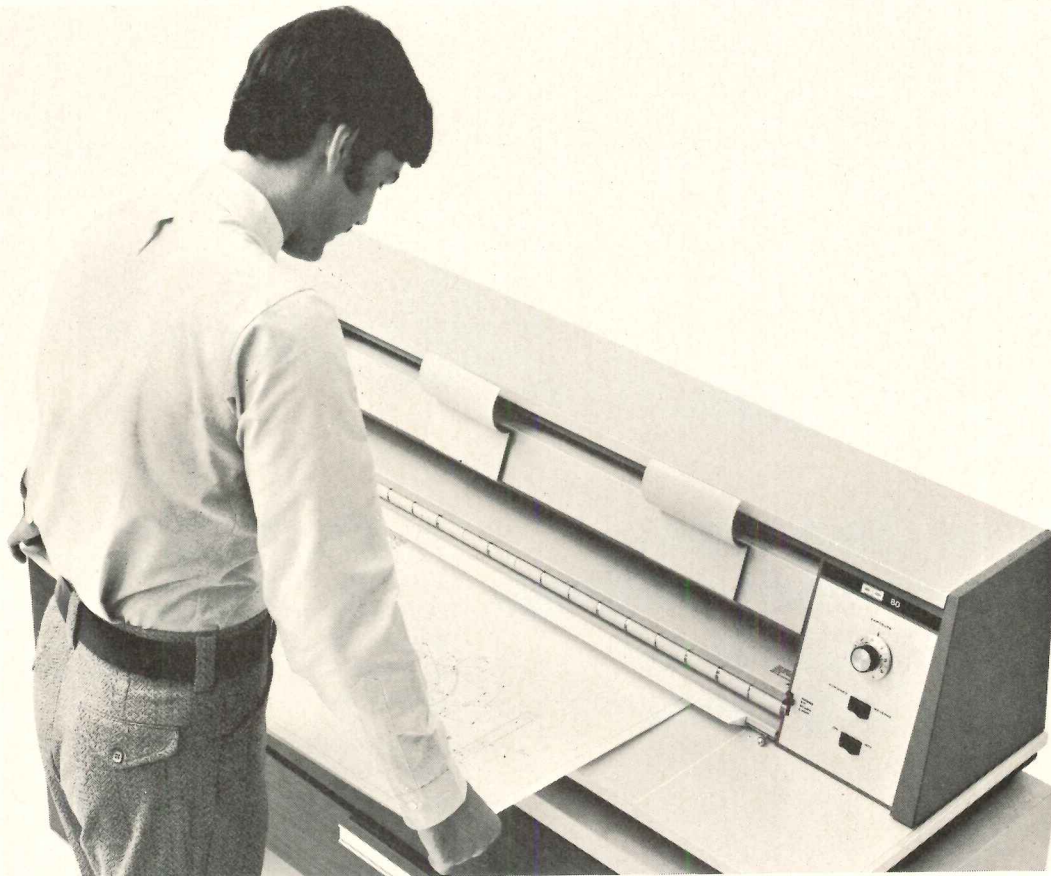

BRUNING

DIVISION OF ADDRESSOGRAPH MULTIGRAPH CORPORATION

For more data, circle 101 on inquiry card



Westinghouse Electric Corporation Homewood Plant, Pittsburgh, Pa. Architect: Walter Roberts Associates, Pittsburgh, Pa. C-Panel System, 4" and 8" Ribbed Exterior Profile.

Smith Walls create an environment for...

industry

A plant doesn't have to look like a plant.

A really attractive industrial building is the starting point for a pleasant working environment. Smith Walls offer design possibilities limited only by the architect's imagination. An architect's idea, brought to life in the bright colors and interesting panel configurations of Smith metal walls, can make an industrial building a happier place to work. And Smith's Single Responsibility concept makes sure the walls are right. Single Responsibility is the Systems Approach to solving your metal wall problems. It's a complete system . . . from the earliest Architectural/Engineering contact through engineering, color coating, manufacturing to placement of the final product fastener on the job site. This Single Responsibility concept is the most important factor in Design Construction.

Specify Smith Walls, and Smith Single Responsibility, for your next building project. For full details and specifications, consult Sweets Architectural File or write.



The Dow Chemical Company, Newark Ohio Industrial Park, Newark, Ohio. Architect: Curtis N. Lindberg, Columbus, Ohio. C-Panel System, Shadowwall Exterior Profile.



ELWIN G. SMITH DIVISION

100 WALLS STREET, PITTSBURGH, PENNSYLVANIA 15202

For more data, circle 102 on inquiry card

EGS-103



International Paper Company, Lewisburg, Pa. Architect: Cassis Associates, Inc., St. Louis, Mo. B-Panel System, Contourwall and Hillinewall Exterior Profiles.



At last ...a fast-acting double-slide industrial door that's also a Class A 3-Hour rated fire door.

Our new Prest-O-Matic® is the first double horizontal slide Class A, 3-hour rated, FM-labeled door that opens so fast that it's ideal for even the busiest industrial doorway.

Installed-cost is lower than that of conventional fire doors because erection is simpler. Everything is supplied in one package, ready to attach to the wall with all hardware in place and electrical components pre-wired.

Although panels are 40-50% lighter than other fire doors, it provides protection and strength equal

to or greater than its heavier competitors.

Heavy duty operator and rugged 10-gauge track assure trouble-free, high-frequency use. This combination has been field tested for "1000 operations a day" over a period of many years without showing undue wear or track sag.

Before you invest in both a conventional door *and* an industrial door, get all the details on the one door that does *both* jobs — the new Clark fire door. Available in both single and double slide models with features you won't find anywhere else.

Doorway specialists since 1878



69 Myrtle Street Cranford, N.J. 07016 (201) 272-5100 Telex 13-8268

For more data, circle 103 on inquiry card

A world to pick from

It's yours in the Borden vinyl film styling library. We take the style excitement from some of the best designers in the world—including our own—and translate it to vinyl for lamination to metals, wood, gypsum, plastics. U.L. rated laminate quality film for enhancing product designs. For beautiful interior finishes in homes, offices, institutions, mobile homes and recreational vehicles. With these colors, patterns, even textures, your customers will recognize the worldly look right away. Ask your Borden Film man for some samples.

Or write us. Our world of designs may make a world of difference in yours.



BORDEN FILMS

Columbus Coated Fabrics
Division of Borden Chemical, Borden Inc.
Columbus, Ohio 43216

Imagination in finishes

For more data, circle 104 on inquiry card

Now Para-flyte deck equipment comes

4,608

different ways to meet any (and we mean any) pool budget.



Paragon's Exclusive New Interchangeable Option Plan of Materials, Lengths, Superstructure, Accessories, Etc. Permits Complete Design Freedom— Within Budget!

Think of what this means for today's creative swimming pool Architect or Engineer. No more settling for "second best" because of budget limitations. Complete design flexibility. Beauty. Quality. And most important—proven performance.

For nearly two decades, Para-flyte equipment has been the choice of leading coaches and experienced competitors. Its rugged construction and functional design means added safety—an important reason why it is consistently specified when building a new or re-equipping an old school, club, municipal or residential pool.

KDI

SEE OUR CATALOG IN SWEET'S. OR WRITE

KDI Paragon Inc. the architect's friend.
Mfrs. Of Quality Deck/Underwater Equipment
12 Paulding St., Pleasantville, N.Y. 10570 • 914-769-6221

OFFICE LITERATURE

For more information circle selected item numbers on Reader Service card, pages 245-246

TWO-WAY TV SYSTEMS / A 12-page brochure explains the patented *J-Jacks* system which provides unusual flexibility and ruggedness to educational and medical television systems. *J-Jacks* systems permit distribution of UHF, VHF, FM, closed-circuit video and audio signals simultaneously throughout the school or hospital. Whereas ordinary TV distribution systems put circuitry behind the wall plate, where it is inaccessible, *J-Jacks* puts the circuitry into convenient, modular plug-in units that are heavily chrome-plated steel castings. ■ Jerrold Electronics Corp., Philadelphia, Pa.

circle 400 on inquiry card

DOOR CLOSER / A new door closer catalog covers three hydraulic models, the *Powr-Closer*, *Rota-Closer* and the *Mity-Closer*, and two pneumatic types for standard or heavy-duty operation. *Powr-Closer* is designed for interior, solid core wood or medium weight metal doors up to 85 lbs. *Rota-Closer* and *Mity-Closer* are for storm and screen doors weighing up to 35 and 25 lbs., respectively. ■ Leigh Products, Inc., Coopersville, Miss.

circle 401 on inquiry card

MECHANICAL DOOR LOCK / A two-page brochure describing a cardkey-operated mechanical door lock outlines the easy installation of the new lock which requires no electrical wiring. The *Model MDL* is recommended for hotels and motels with a high turnover rate in room occupancy and for facilities with varying personnel shifts. ■ Cardkey Systems, Inc., Chatsworth, Calif.

circle 402 on inquiry card

BUILDING AUTOMATION SYSTEM / A four-page bulletin describes a *295 Building Automation System* designed for use in high schools, junior colleges, hospitals, high-rise commercial buildings and manufacturing facilities. The brochure covers a complete system package that commands, indicates, annunciates, reports and communicates. Shown are system components such as printer; address read-out; system graphics; temperature indicator; selection and command push-buttons. Specifications are offered. ■ Powers Regulator Co., Skokie, Ill.*

circle 403 on inquiry card

ROLLING METAL DOORS / This 1973 catalog presents comprehensive architectural details on a broad line of rolling metal doors and fire doors; rolling pass window shutters in standard and packaged units; fire shutters and sliding grills. These products are made in galvanized steel, aluminum and stainless steel. Various finishes. ■ Cornell Iron Works, Inc., Wilkes-Barre, Pa.*

circle 404 on inquiry card

COPPER BUILDING PANEL SYSTEM / A 20-page color brochure introduces the newest technique in the application of sheet copper in the building construction field. This new system of laminated panel construction brings to the architect and design engineer a single complete package. It comprises the various components, giving detail drawings of structural and veneer panels, transverse seams, mansard, fascia, soffit and other roof details. ■ Revere Copper & Brass Inc., Rome, N.Y.*

circle 405 on inquiry card

*Additional product information in Sweet's Architectural File

more literature on page 198

How to ship small packages in a big hurry.

DELTA'S DASH

DELTA AIRLINES SPECIAL HANDLING

Delta guarantees delivery on the flight or routing you specify between most Delta cities.

Packages accepted up to 50 lbs. with length plus width plus height not to exceed 90" total, with only one dimension exceeding 30."

Delivery to Delta's passenger counter or air freight terminal at the airport at least 30 minutes prior to scheduled departure time.

Pick-up at DASH Claim Area next to airport baggage claim area 30 minutes after flight arrival at destination.

Charges for DASH shipments are nominal. Delta reservations will be pleased to quote actual charges between specific points.

Payments accepted in cash, by company check, most general-purpose credit cards, special credit arrangements or on government shipments by GBL. **DELTA**
The airline run by professionals

Rate examples (Tax included)

Atlanta-Washington	\$21.00
Boston-Miami	\$26.25
Cincinnati-Louisville	\$21.00
Cleveland-Phoenix	\$26.25
Los Angeles-New Orleans	\$31.50
Dallas-Los Angeles	\$26.25
San Francisco-Atlanta	\$31.50
Philadelphia-Houston	\$26.25
New York-Tampa	\$26.25

For full details, call Delta reservations.



Delta is ready when you are!

For more data, circle 106 on inquiry card

For more data, circle 105 on inquiry card



New concept in hotel decorating calls for Milliken carpet at Galt House, Louisville's largest.

"The days of hotels with lace curtains and formality are over. What people want now is a warm, comfortable atmosphere. And that's what this hotel is going to have!"

Al Schneider, builder of the handsome new Galt House hotel overlooking Louisville's newly developed riverfront, is a man of his word. Galt House rooms have an aura of warmth and comfort, starting with colorful Milliken carpet on the floor.

Color was a major factor in the carpet choice for this extensive installation. With the exclusive Artisan-Dyed™ process, developed by Milliken Research, color penetrates deep down to the back of these deep-pile, 100% nylon shag carpets. Result: High-fashion styling in dramatic multicolor combinations is now possible and practical.

The carpets, from Milliken's "Decor East" collection, have the long-lasting quality and cleanability essential to hotel use. And they open new vistas for exciting commercial decorating. "We got the right atmosphere and the right carpet," says Mr. Schneider. V. C. Glass Co. in Louisville supplied the carpet for the Galt House installation. For information about all Milliken contract carpets, call or write Deering Milliken, Inc., Contract Carpet Manager, LaGrange, Georgia 30240. (404) 883-5511.



MILLIKEN

Floor Covering Business, LaGrange, Ga.
For more data, circle 107 on inquiry card

Westinghouse outdoor lighting turns the night on with new shapes and colors.

Today's architecture is clean and simple. We've designed an outdoor light that works with it—the ALS (Architectural Lighting System).

The ALS is designed for malls, shopping centers, parking lots, streets—anywhere attractive, functional lighting is required. The important word is "attractive." With its straight line design, the ALS fits with today's architecture.

Available in four shapes, six wattages, three lamp types, and sixteen colors, the ALS is truly versatile.

Westinghouse can also supply square steel, aluminum, and wood poles to complement the ALS. And you can color match the poles to the fixture.

For flexibility, the ALS can be mounted one, two, three, or four to a pole.

Day or night, our ALS will turn people on.

You can be sure . . .
if it's Westinghouse.

If you'd like to learn more about the ALS, write Westinghouse Electric Corporation, Outdoor Lighting Division, P.O. Box 5817, Cleveland, Ohio 44101.

G-1-72

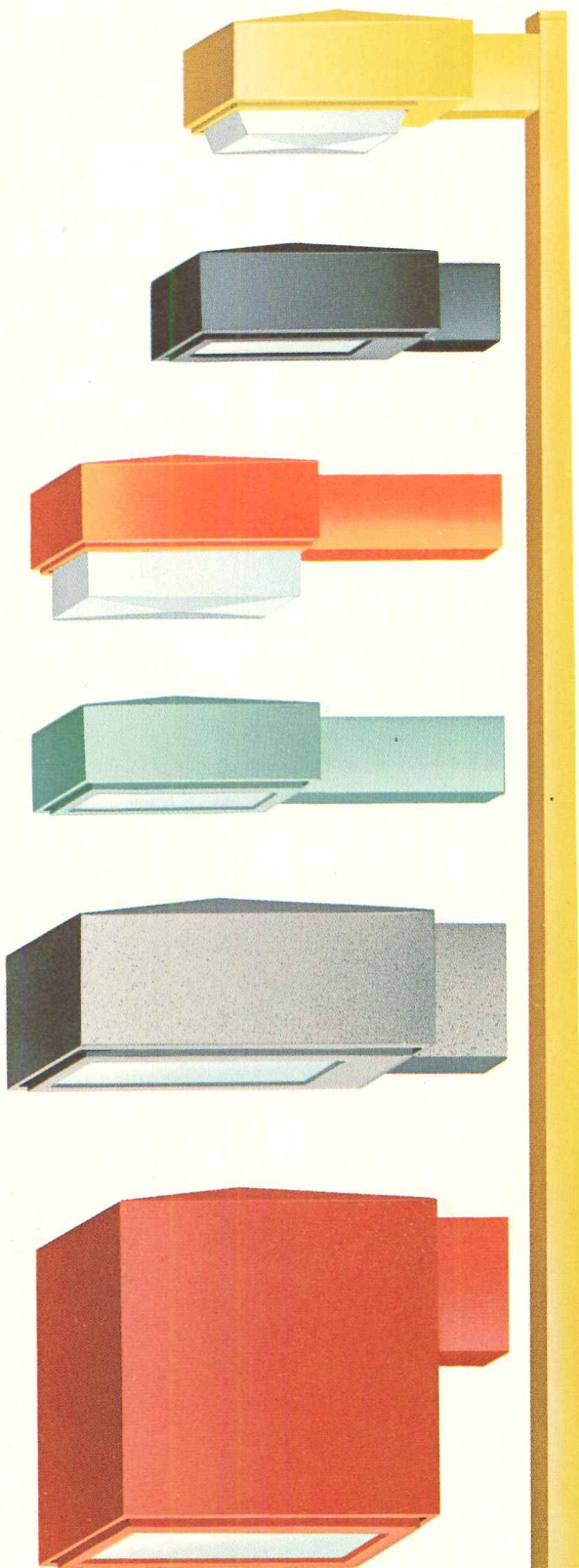

Westinghouse



For more data, circle 108 on inquiry card

She's not crying *because* her hand's not hurt!



New Amarlite **SAFETYLINE** entrance
protects people from injury!

A child's hand is priceless. That and safety for all people is the inspiration for this unique, beautiful entrance.

There is no way to injure hands at either stile, thanks to a cylindrical guard at the pivot edge and a vinyl protector at the locking edge. Flush hardware with recessed pull prevents injuries—no projections to catch clothing, purses, packages or

jewelry. Safetyline must be glazed with tempered or safety glass only.

The first safe and secure entrance has a 2-point top-and-bottom rod lock. Discourages break-ins and eliminates finger-cutting and ring-catching at keeper for dead bolt-type locks. Available in corrosion-resistant Amanodic hard coat finishes (dark bronze and black) and clear anodized aluminum.

*Patent Pending



Unique pivot guard prevents pinched fingers. There is no dangerous gap between the pivot stile and the jamb, as there is when an ordinary door opens. The gap is eliminated by cylindrical design.



Exclusive flexible vinyl finger protector eliminates danger to hand caught by closing door. If a hand gets caught, vinyl "gives", preventing injury. No scissors action as with an ordinary door.



MAIN OFFICE:

P.O. BOX 1719, ATLANTA, GEORGIA 30301
PHONE: 404-691-5750

See us in Booth 705, May 7-10, at
National AIA Convention in San Francisco

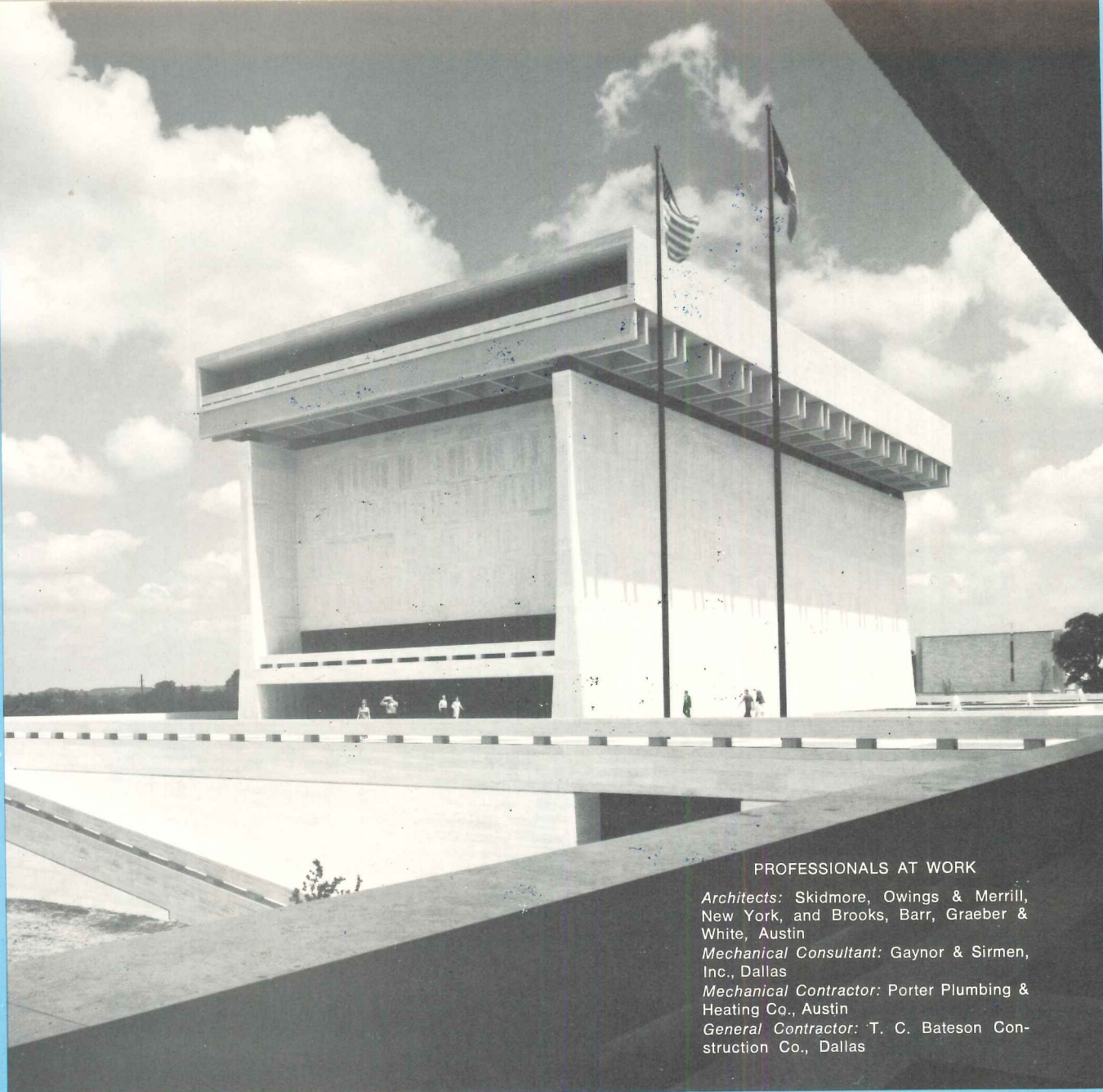

PROFESSIONALS AT WORK

Architects: Skidmore, Owings & Merrill, New York, and Brooks, Barr, Graeber & White, Austin

Mechanical Consultant: Gaynor & Sirmen, Inc., Dallas

Mechanical Contractor: Porter Plumbing & Heating Co., Austin

General Contractor: T. C. Bateson Construction Co., Dallas

PHOTO-EZRA STOLLER © ESTO

Aerofin's balanced environment protects and preserves the historical treasures of the Lyndon Baines Johnson Library

A great documentary collection invites study at the strikingly contemporary Lyndon Baines Johnson Library, University of Texas, Austin Campus.

From the dramatic proportions of the Great Hall to the five floors of archives, Aerofin Heat Transfer Coils contribute to vital custom climate. The critical presidential document stack area has year-around humidity control by use of

dependable Aerofin spray humidifier cooling and reheat coils.

Packaging highly specialized coil requirements has earned Aerofin leadership rating. Call us in on any new or renovation job with demanding controlled environment specs — offices in Atlanta, Boston, Chicago, Cleveland, Dallas, Los Angeles, New York, Philadelphia, San Francisco, Toronto, Montreal.

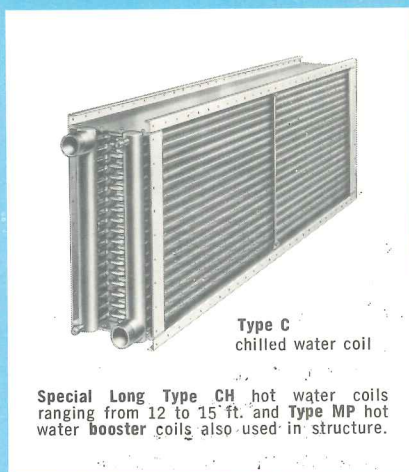

Type C chilled water coil

Special Long Type CH hot water coils ranging from 12 to 15 ft. and Type MP hot water booster coils also used in structure.

AEROFIN CORPORATION
LYNCHBURG, VIRGINIA 24505

Aerofin is sold only by nationally advertised fan manufacturers. Ask for list.

25 years of Aluminum Reliability

Norton® Door Closers

Aluminum is a remarkable metal. It's light, strong and naturally attractive. It can be wrought, cast and clad. It can be brushed, polished, burnished, painted and plated. It resists corrosion... and it can be alloyed for the amount of strength required. This combination of factors makes it an ideal material for door closers.

Reliability

High strength aluminum alloys have been used in Norton Closers since 1948. In fact, this year marks the 25th anniversary of aluminum's use in Norton closers. Twenty-five years of proof of aluminum's reliability.

Design Flexibility

But aluminum offers other major benefits, too. It allows a high degree of design flexibility,

permitting smaller, more unobtrusive, closers. And, yes, more attractive closers, too.

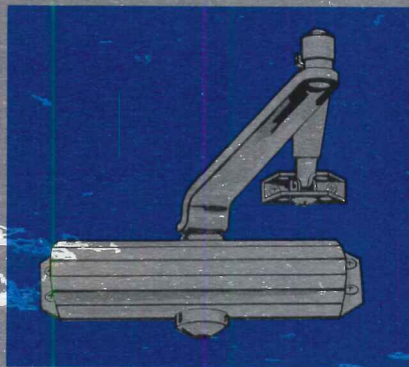

Norton Series 1600 Closers

Simple, functional lines with complete application flexibility. It's non-handed, installs top-jamb, parallel arm or regular arm in a choice of mounting methods. And with a degree of reliability that's almost legendary



Norton Series 7700 Apollo Closers

Incorporate all the features desirable in a door closer: plus or minus 25% spring power adjustment; adjustable back-check protection; 2" narrow projection; non-handed installation. You can specify regular, parallel arm or top-jamb mounting. Select a cover finish of anodized bronze, brass or clear aluminum; or choose from 67 native or imported woods.

25 Years of Reliability

The first closers to incorporate aluminum were Norton Regular Surface Closers. Thousands of these work-horse closers are 25 years old and are in their original installations. Hundreds of thousands have been sold over the years.

Aluminum Strength

It's a fact that aluminum can be alloyed for a wide range of strengths. It's used in small engines like outboards and lawn mowers where normal operating pressures of 1000 psi are usual. And it's used in aircraft, automobile and diesel engines, and hydraulic pumps with operating pressures that exceed 2000 psi. The normal operating range for door closers varies between 75 and 200 psi. Obviously, a number of aluminum alloys are available that can withstand the pressure of door closer application.

Tomorrow

When a better metal comes along, we'll use it. Our commitment is to well-designed, attractive door control, whatever the metal. So far, though, that's aluminum, as proven by millions of installations throughout the world.

Complete Norton Line Featuring Aluminum Reliability



**Norton Regular
Surface Closers**

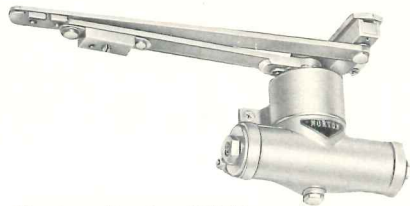

**Norton Series 6130
Unitrol**



**Norton Series 7750
Corner Closers**



**Norton Series 800
Closers**

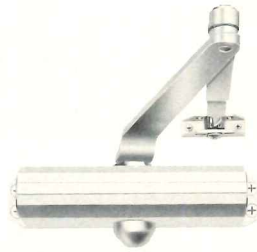

**Norton Series 1600
Closers**

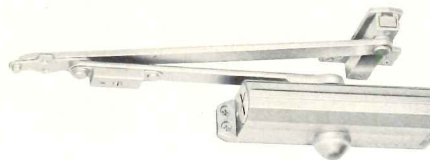

**Norton Series 6120
Unitrol**

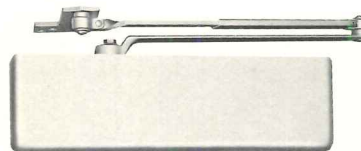

**Norton Series 7400
Closers**

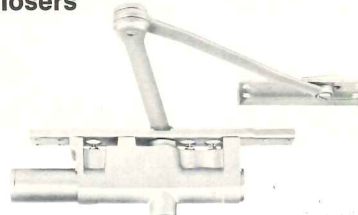

**Norton Series 900
Inadoor Closers**

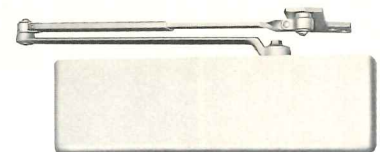

**Norton Series 7700
Closers**

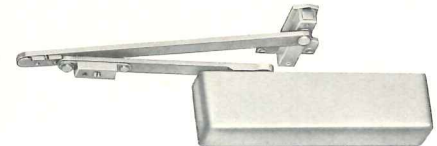

**Norton Series 6170
Unitrol**

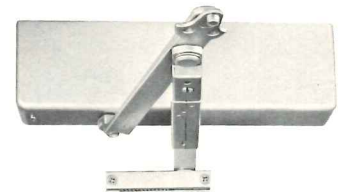

**Norton Series J6170
Unitrol**



**Norton Series 2900
Closers**

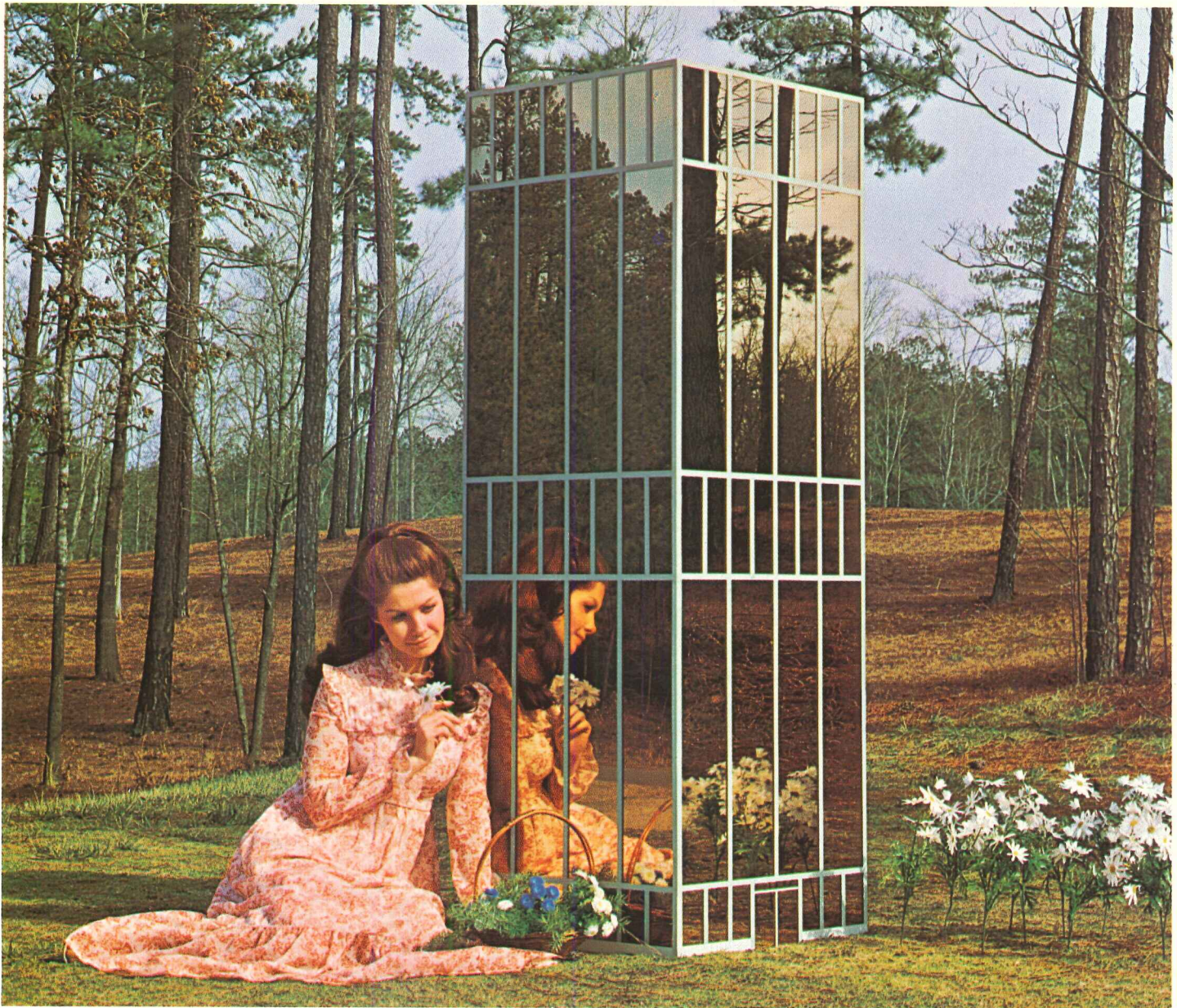

ASG's
Reflectovue.[®]
Not just another
pretty face.

Combining form and function. Aesthetics and reality. That's the role of the American architect as he reaches into the 21st century. To build cities that serve the needs of people as well as commerce. To conceive of buildings that reflect the natural grace and beauty of the environment around them.

And, ASG's Reflectovue is one of the creative tools the architect has to work with to achieve those goals.

Not only is Reflectovue aesthetically pleasing, it is solidly functional and economically rewarding.

For instance, when used with Tru-Therm[®] insulating units, Reflectovue has been proven a superior heat reflector. It has the best thermal performance, the lowest "U" value, and the lowest

shading coefficient when compared, color to color, to any other reflective glass in the industry.

Controlling heat loss and gain means that less equipment is required for heating and air conditioning. Less fuel is required. Creating less pollution.

ASG Reflectovue is available in Gold, Silver and Chrome in Tru-Therm insulating units, or in laminated glass.

ASG Reflectovue. Not just another pretty face, but a new and exciting concept in environmental architecture.

Another reason why now, more than ever, ASG is The Glass Company.



ASG Industries Inc.

The Glass Company P.O. Box 929, Kingsport, Tennessee 37662

For more data, circle 111 on inquiry card

continued from page 190

Advertisement

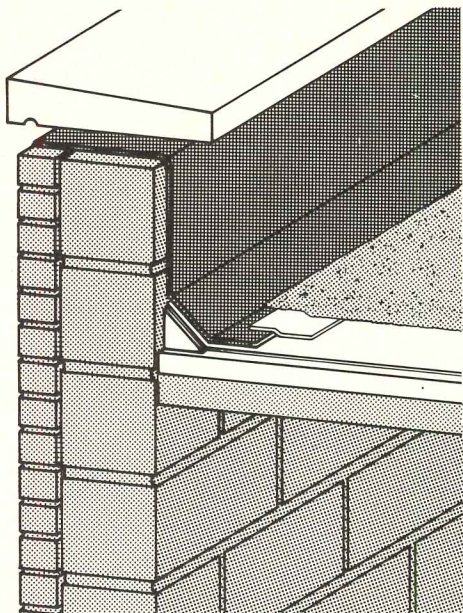

Flexseal. The name tells you why this vinyl flashing is so good.

We didn't name our vinyl flashing by tossing a coin.

We named it Flexseal™ because we know the job it is designed to do.

Flex. The ability to expand and contract to compensate for roof movement.

Seal. The ability to maintain watertightness over the years that a building settles. Without cracking, splitting or drying out.

Flexseal. A vinyl flashing that over the last ten years has meant fewer call backs for roofers. Less maintenance. And increased life.

And Flexseal vinyl flashing is just one of several vinyl products from B.F. Goodrich for moisture and thermal protection.

BFG also makes vinyl expansion joint covers, in sheet and extruded form. Waterstops and membrane waterproofing. Through-wall flashing. Masonry control joints.

They're all modern, job-proven products that live up to the promise of their name.

For a free 24-page booklet on all the Flexseal vinyl systems, write the B.F. Goodrich General Products Company, Dept. 0445, Akron, Ohio, 44318.

B.F. Goodrich

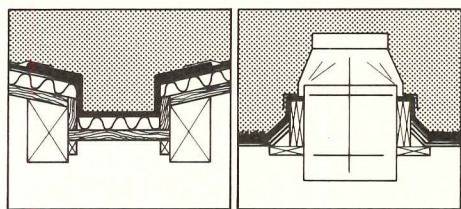

For more data, circle 112 on inquiry card

VISUAL DISPLAY PRODUCTS / A 16-page catalog covering a complete line of visual display products includes chalkboards, bulletin boards, pegboards, easels, glass-enclosed or open-faced directory boards, visual control boards, chalkboard-tackboard combinations, graph chalkboards, map and display rail accessories and versatile space dividers. Unframed sheet material for self-framing is also detailed. ■ Marsh Chalkboard Co., Dover, Ohio.

circle 406 on inquiry card

OSHA ADVICE / A four-page brochure, designed to simplify the selection of wiring devices for OSHA compliance, emphasizes the importance of wiring devices that are listed by Underwriters' Laboratories or other recognized testing laboratories and installed in compliance with the National Electrical Code. The brochure, designed as a hang-up piece or file folder, lists description, catalog numbers, ratings and available colors of such products as dimmers, remote control units, switches, and wall plates. Also listed are both straight blade and locking receptacles, plugs, connectors, flanged inlets, and flanged receptacles. ■ General Electric Wiring Device Business Dept., Providence, R. I.

circle 407 on inquiry card

DIAPHRAGM DESIGN / Structural designers who want to take advantage of the in-plane, horizontal shear strength of steel roof deck assemblies will find a complete guide for diaphragm design—including load tables—in a new 26-page booklet now available at no cost for individual copies. ■ Steel Deck Institute, Westchester, Ill.*

circle 408 on inquiry card

CONCRETE SURFACE PREPARATION / A new surface preparation data sheet on concrete has been developed for architects, engineers and other building professionals. The four-page folder discusses the nature and types of concrete form release agents, moisture content, and surface preparation methods. ■ Glidden Maintenance Coatings, Cleveland, Ohio.

circle 409 on inquiry card

FIRE-RESISTIVE ASSEMBLIES / The Steel Joist Institute has published a new technical digest to aid the designer in finding a fire-resistive steel joist assembly which suits his needs, and to give guidance in the changes which can be made to published design listings without decreasing the fire endurance. The 46-page digest includes such subjects as the history and rationale of fire testing and fire resistance ratings; the design of fire-resistive assemblies with steel joists and procedures for determining the most economical floor- or roof-assembly for ratings from one to four hours, etc. ■ Steel Joist Institute, Arlington, Va.

circle 410 on inquiry card

CERAMIC WALL TILE / A four-page, full-color brochure on a collection of glazed ceramic wall tiles named *Mono-Facade* is offered. The tiles, designed by William Groff, allow a 3-dimension expression of colors on a neutral background without contrasting joint filler pattern. A specification page with all technical data is included. ■ Progressive Designs Inc., Jacksonville, Fla.

circle 411 on inquiry card

*Additional product information in Sweet's Architectural File

more literature on page 241

BLUEPRINT for QUALITY

Serviceability is an ultimate objective for healthcare facilities and equipment. Their performance must be more than satisfactory, they must perform continuously, day after day, year in and year out.

When specifying healthcare and institutional casework, keep this in mind; it takes more than just compliance with detailed material specifications to insure functional and durable casework performance.

At Jamestown Products we do more than meet the material spec. Our custom-built enameled and stainless steel casework is seasoned by over 30 years of direct industry involvement, at all levels. We've worked with and have advised consultants, planners, specifiers, owners, and even the ultimate users. We helped to solve the most typical problems, and some not so typical, too!

Jamestown Products standard construction techniques coupled with modern manufacturing tools and methods produce a product that's geared for today's sophisticated requirements. Our reputation is that of a wide range quality casework producer with a speciality in complex and intricate stainless steel fabrication.

Write for our "Blueprint For Quality." It will quickly show you why we do more than just meet your specs.

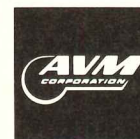

Jamestown Products Div.
178 Blackstone Ave. Jamestown, N.Y. 14701

For more data, circle 113 on inquiry card

It makes you look good, too.

We put beauty, elegance and reliable operation into the Delta faucet.

We left the washer out. And all the problems worn washers cause.

That's why when you specify Delta, you are specifying one of the most efficient, trouble-free faucets made.

One of the safest, too. Because of the Delta pressure balance bath valve.

When flushed toilets or clotheswashers suddenly decrease the pressure on water lines, the valve automatically compensates to maintain the same hot or cold water mix.

So the shower temperature stays constant. And no one gets scalded or hurt.

There are Delta washerless faucets for kitchens and bathrooms. For sinks and showers. Both single-handle and double-handle models. In beautiful new decorator designs.

They're styled to look good and to work better. And to make the specifier look as good as they do.

For illustrated literature, write

*Delta Faucet Company, A Division of Masco Corporation,
Greensburg, Indiana 47240, and Rexdale, Ontario.*

Delta Faucets.

Washerless. To work as good as they look.

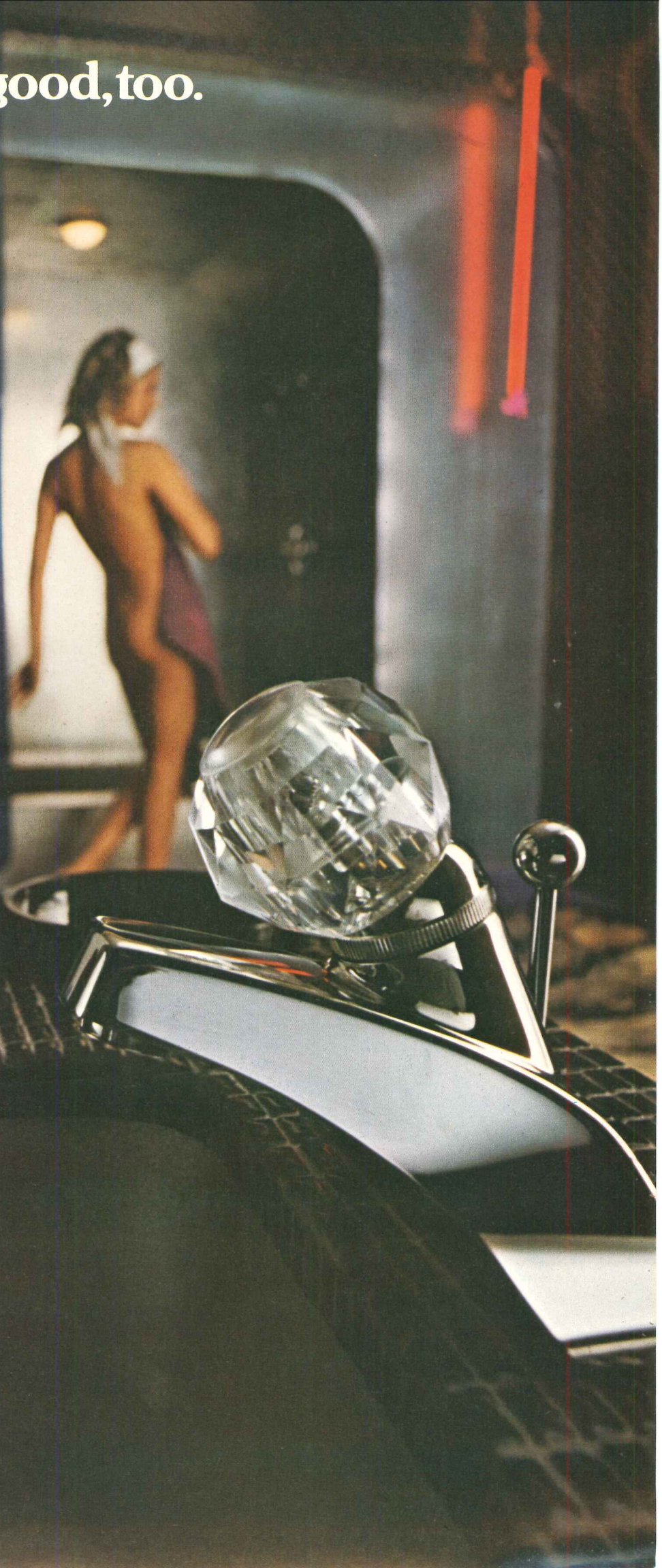

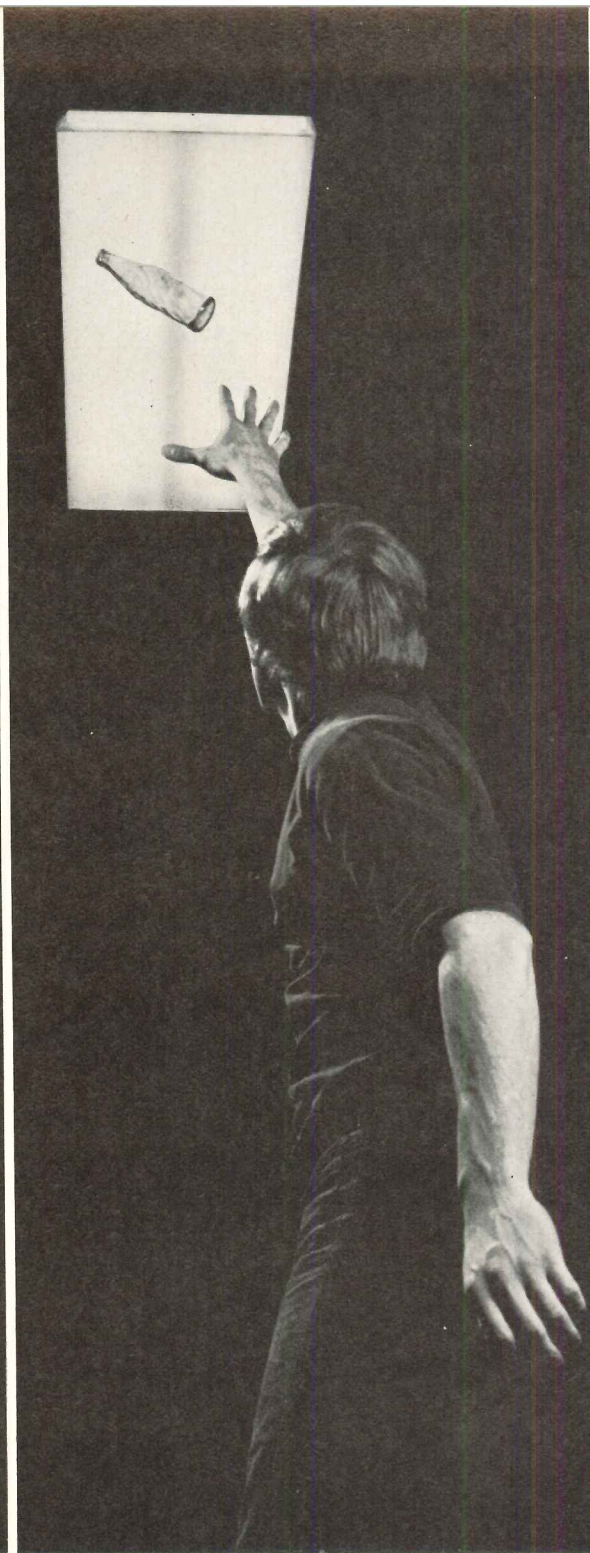
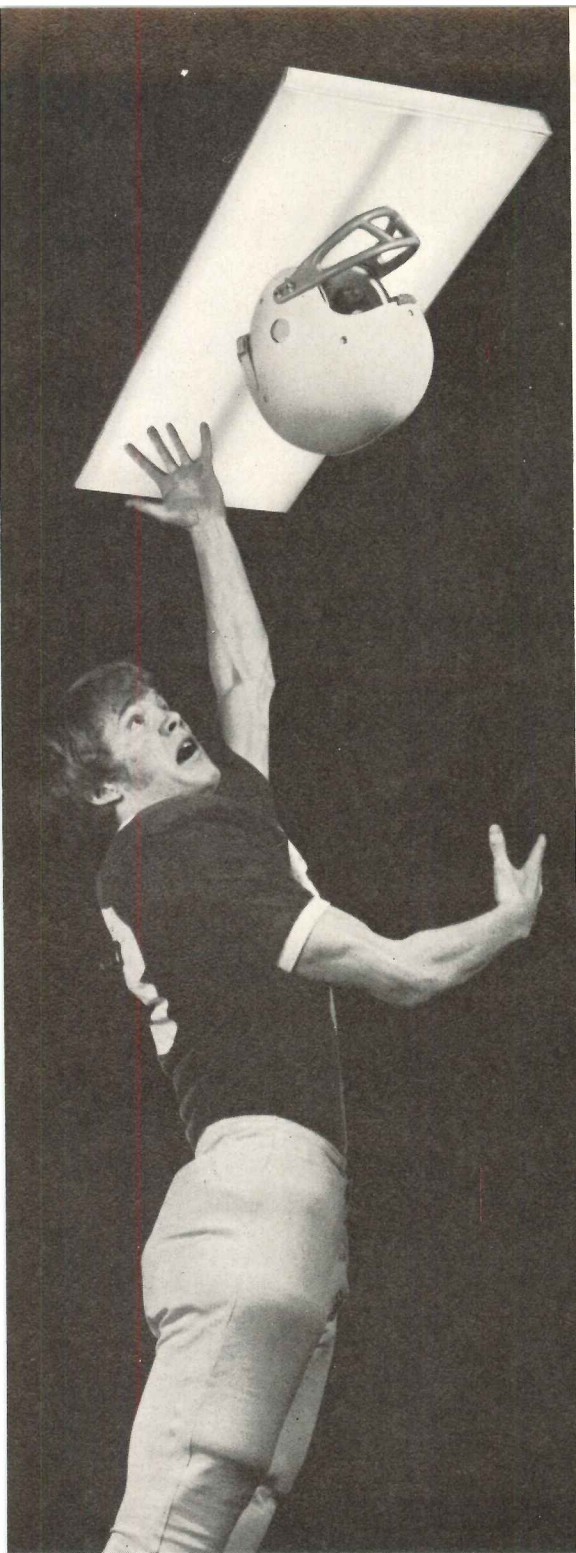

Put PLEXIGLAS® DR between your lighting and UFO's.

Lighting that's under daily attack by unidentified flying objects — indoors or out—does its job best when protected by lighting shields made of Plexiglas DR acrylic. That's because Plexiglas DR produces extremely tough, weatherable lenses which retain color and clarity better than any other high-impact thermoplastic on the market.

Vandal-resistant Plexiglas DR lenses are molded or extruded from Plexiglas DR high-impact all-acrylic molding pellets, the toughest acrylic lens material made. They are optically superior to polycarbonate lenses, for better light control, less glare.

Protect your fluorescent lighting. Select Plexiglas DR lenses — for toughness that virtually ends break-

age worries, and for color and clarity you can count on for years.

Write for technical data and physical properties, and for names of extruders and molders using Plexiglas DR.

**ROHM
& HAAS** 
PHILADELPHIA, PA. 19105

Plexiglas acrylic plastic is a combustible thermoplastic. Observe fire precautions appropriate for comparable forms of wood. For building uses, check code approvals. Impact resistance a factor of thickness. Avoid exposure to heat or aromatic solvents. Clean with soap and water. Avoid abrasives.

For more data, circle 115 on inquiry card

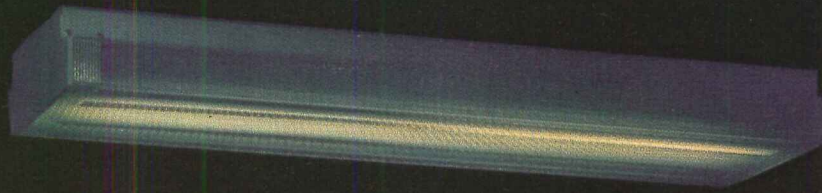

Emergency

When the power goes off, there's a new emergency lighting system to take over

When the power goes off, you still want the safety of light. That's why General Electric is taking action to give you a new emergency lighting system... one that's attractive and economical, and fits into the raceway of the standard fluorescent fixture... one that contains 100 percent solid state switching (no mechanical relays) and special low maintenance components... one that meets or exceeds minimum NEC standards and OSHA requirements for emergency lighting.

The new GE emergency lighting system includes the ballast, battery pack and inverter/charger... GE

total system responsibility. The system can be tailored for either new installations or for use in existing fixtures.

And you get the same GE ballast that's proved itself for greater reliability, longer life, cooler operation, and less maintenance.

Emergency lighting—another way General Electric is building its reputation on action. Get details today. See your fixture manufacturer or GE sales representative; or write: Section 403-24.

Ballast Business Department,
1430 E. Fairchild St.,
Danville, Ill. 61832.

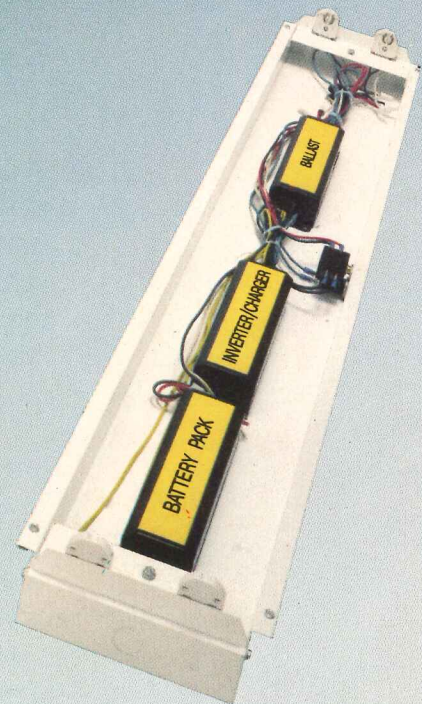

GENERAL  **ELECTRIC**

For more data, circle 116 on inquiry card



OUR NO. 1 GOAL:
TO MAKE
GENERAL ELECTRIC
YOUR BEST BUY

THE FIRST FULLY APPROVED ON-OFF SPRINKLER. AQUAMATIC FROM GRINNELL.

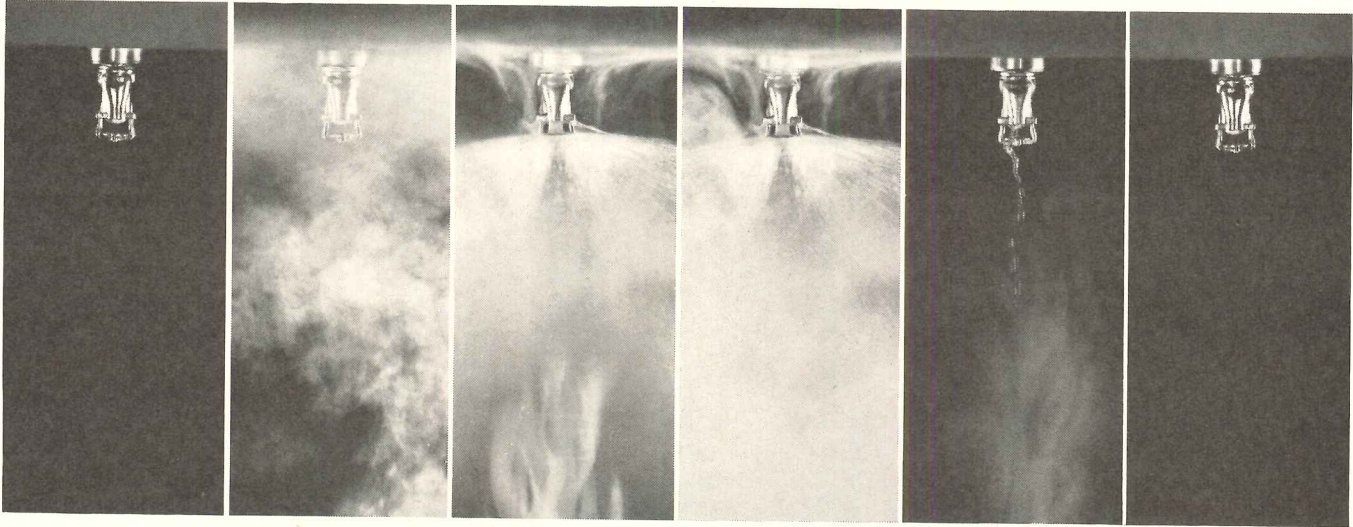

Aquamatic. The first sprinkler head that resets itself automatically after it extinguishes the fire. It's set to go time after time after time without replacement or adjustment. You don't have to turn off the main valve for inspection after a fire.

It's Factory Mutual approved. It's UL listed. And it's new from Grinnell.

Aquamatic is totally interchangeable with other sprinkler heads, too. It can be integrated into any existing system or designed into new construction.

It's also the first sprinkler head that uses water with maximum efficiency by sequentially turning itself on and off automatically. It's ideal for areas containing high value inventories or materials highly sensitive to water. In situations where there's a risk of flash fires or where the water supply is limited. In high rise buildings and many other locations.

Aquamatic Sprinkler.* It's a major breakthrough in sprinkler design. It's made by Grinnell, the world's leading designer, manufacturer, and installer of sprinkler systems. And it's ready now. Write or call us for complete information. We'll help you put the fire out.

*Pat. Applied For



GRINNELL FIRE PROTECTION SYSTEMS COMPANY, INC.

EXECUTIVE OFFICES • 10 DORRANCE STREET • PROVIDENCE, R. I. 02903 • 401-331-3800
Sold throughout Europe by Kopperschmidt Sprinkler G.m.b.H., Kalltenkirchen, Germany

For more data, circle 117 on inquiry card

Take a look at your four walls. Now take a look at ours.

U.S. Plywood presents interiors unlimited:

1. Real wood paneling, from Weldwood.[®] Lustrous hardwood veneers smoothed, rubbed and polished in up to 30 separate steps. For long-lasting finishes that need just an occasional dusting. This DeLuxe Walnut panel is one of over 70 varieties of Weldwood Prefinished Paneling. Lovely to look at, simple to install.

2. Sanspray,[®] the Great Stone Facing. Beautiful, durable stone aggregate bonded to plywood. Can

be sawed, drilled, glued or nailed, and is virtually maintenance-free. In both regular and large aggregates. And a raft of natural stone colors, like Tangerine shown here.

3. Pure sculpture. That's our Facad.[®] Each panel has a depth of relief you'd expect in heavier, precast units, and each weighs just two pounds per square foot. Facad is completely incombustible. You're looking at Composition 1, one of a variety of surfaces to choose from.

4. Bring the outdoors indoors

with U.S. Plywood Textured Sidings. Natural or rough-sawn. Flat panels or lap that play up (or down) any decor. 15 different styles to choose from. Shown here is Oldbridge[®] V-groove, available unfinished or pre-stained in a choice of six earthtone colors.

For more information, call your local U.S. Plywood Branch Office.

 **U.S. Plywood**
A Division of Champion International
777 Third Avenue, New York, N.Y. 10017



1. The paneled wall.

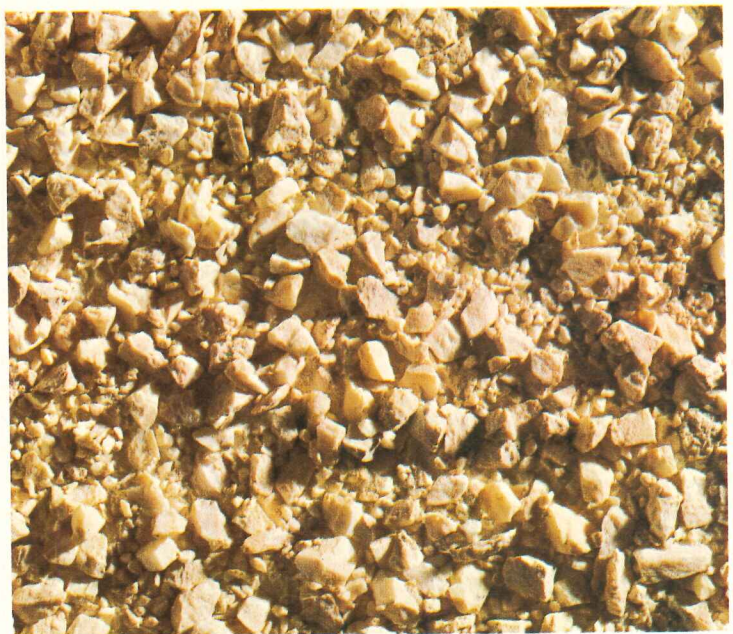

2. The stone wall.



3. The sculptured wall.

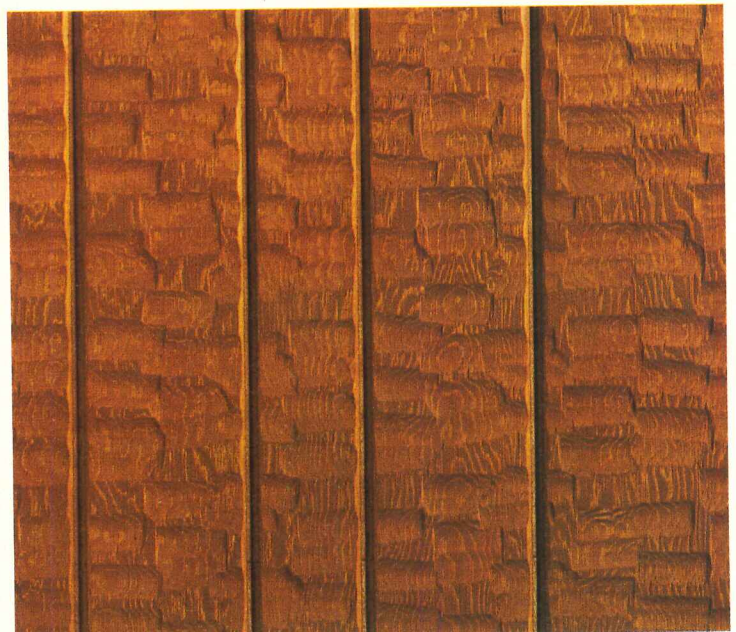

4. The textured wall.



IBG Natural Light
Through Glazed Structures!

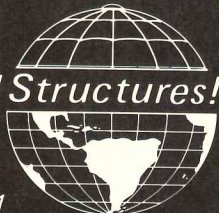

P.O. Box 147, Deerfield, Illinois 60015 312-634-3131
Division of Roper Corporation

See us in Sweet's 13.1/1b-7.8/1b

For more data, circle 119 on inquiry card

P&L RUSTIC STAINS

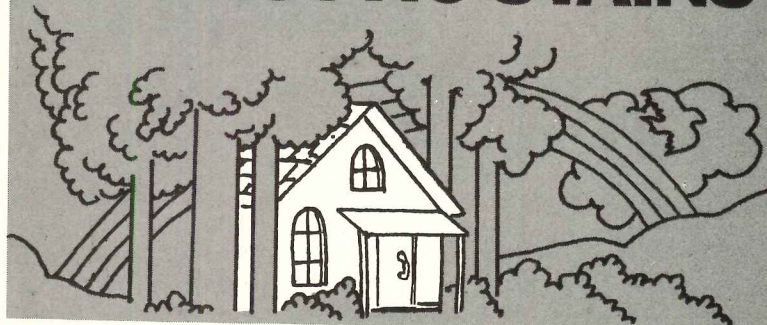

The largest range of environmental and ecological stain colors.

Solid Hide colors. Penetrating colors. Colors that allow for more sophisticated environmental color planning. Colors that give you greater creative freedom than ever before. All Pratt & Lambert. All yours for the specifying.

For details, ask your P&L rep or write on your letterhead:

Pratt & Lambert

Paints/Chemical Coatings/Adhesives
Box Twenty-Two/ Department AR-4
Buffalo, New York 14240



For more data, circle 120 on inquiry card

YOU SAVE WITH Spectra-Glaze® GLAZED CONCRETE BLOCK WALLS

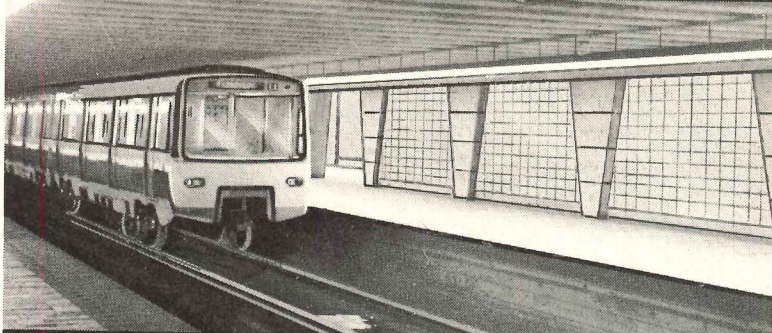

in TRANSPORTATION, INDUSTRIAL, & COMMERCIAL BUILDINGS

Build & finish permanent, sanitary walls in one operation. Faster construction. One trade. Loadbearing, no back-up wall necessary. Factory finish. Can't peel or blister. Impervious to moisture, including steam & most chemicals. Low maintenance. No refurbishing ever! Excellent insulation, fire rating, & sound proofing.

Factory finish. 48 colors. Plain, scored or design faces. Local delivery world wide.

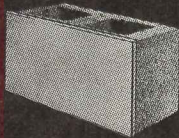

© Reg. U.S. Pat. Off., Canada and other countries by THE BURNS & RUSSELL CO., Box 6063, Baltimore, Md. 21231 • 301/837-0720 • Cataloged in SWEET'S ©

For more data, circle 121 on inquiry card

FOR ANYONE WITH A ROLE IN CAMPUS PLANNING AND DESIGN



CAMPUS PLANNING AND DESIGN

Edited by Mildred Schmetz, AIA
Senior Editor
Architectural Record

SIX SECTIONS:

- Designing the Single Building
- Designing the Library for the Campus
- The Single Building or Complex Designed as Part of the Campus Master Plan
- Architecture Which Gives the Campus the Unity of a Single Building
- Campus Performing Arts Centers
- Designing Campus Interiors

This 266-page volume brings you practical data and creative ideas on handling such campus architecture problems as: designing well-scaled open space; dealing with existing architectural atmosphere; creating flexible prototypes for specialized buildings; planning expandable systems for an entire campus; organizing functional and aesthetic elements in relation to site and surroundings; integrating the building with interior space design, solving problems of architectural scale posed by the surrounding campus.

ARCHITECTURAL RECORD

1221 Avenue of the Americas, New York, N.Y. 10020

Please send me copies of Campus Planning and Design @ \$22.50 each, plus postage and handling. (Include payment and we'll pay the postage and handling.)

Name _____

Street _____

City _____ State _____ Zip _____

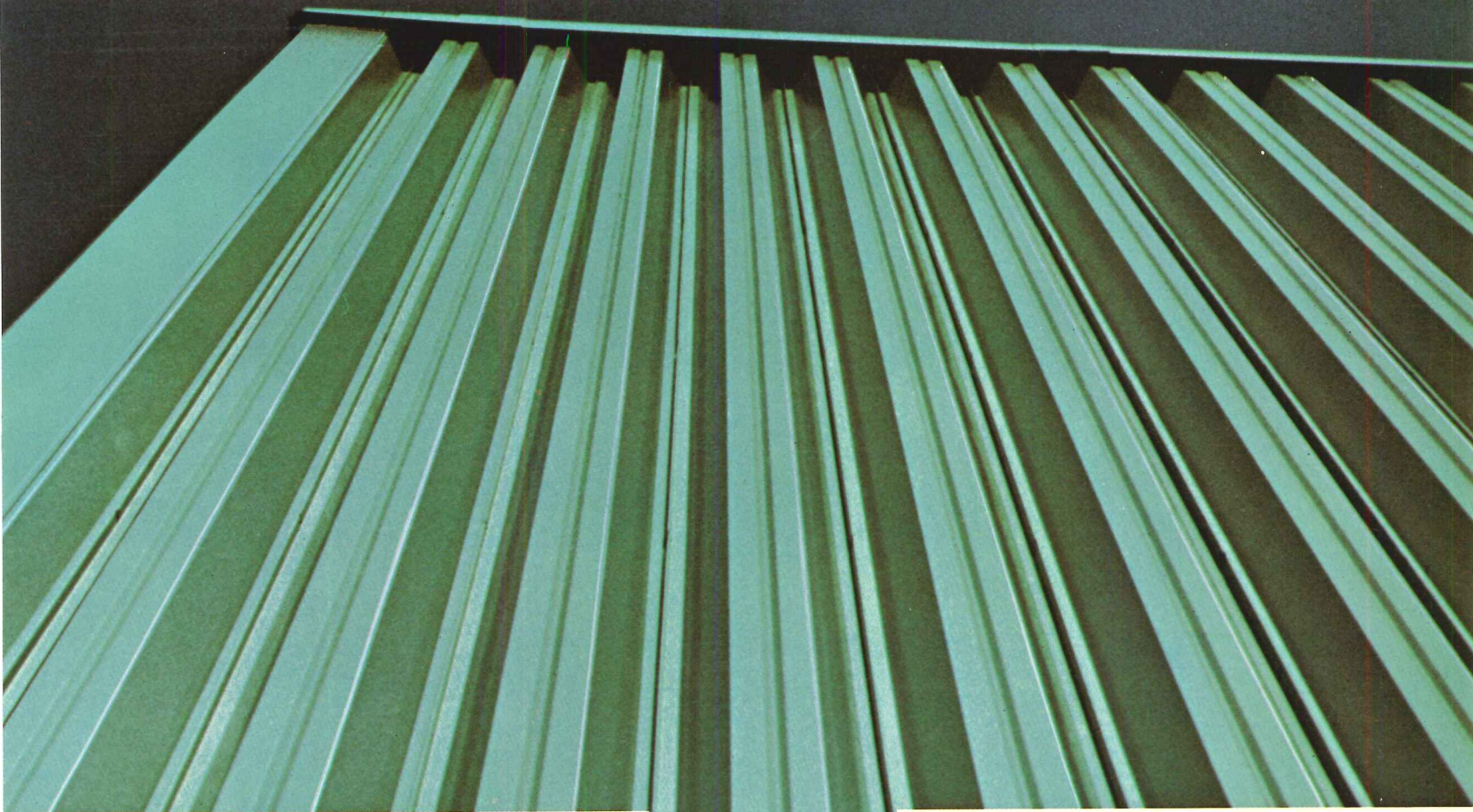

for the high and
the beautiful...



BBR—SPANMASTER PANELS—The NEW shape for towering buildings. Full 4 inches deep and 12 inches wide for long-span erection. Whether used as single skin or as face panels for insulated walls, Spanmaster basks in unmarred beauty when erected with concealed fasteners.

BINKLEY

long-span, deep design panels

Dramatic new dimensions in metal building design. Uncommon strength permits long-span erection—20 feet and even more . . . Plus your choice of shapes with shadow-casting deep valleys . . . Amplifies the beauty of your building. It cannot hide in the sun or the hazy distance.

Using them by themselves or in combination with other Binkley designs, you achieve an infinite variety of architectural effects. Let your imagination soar when designing the lofty ones . . . Build big with Binkley.

Call or write today for brochure, "BINKLEY WALL SYSTEMS" or to have a Binkley Sales Engineer call. **THE BINKLEY COMPANY, Building Products Division, 331 Thornton Avenue, St. Louis, Missouri 63119, phone 314-968-4750.**

**ROLL FORMERS
FOR THE
BUILDING INDUSTRY**



400 DR—CANYON-RIB—Another new shape for today's big buildings. A real beauty with deep 4-inch design (12 inches wide) for long-span benefits.

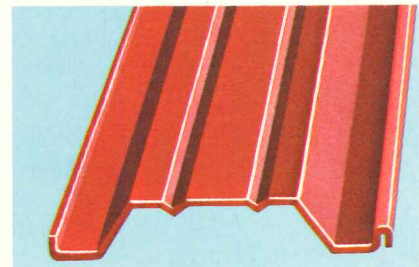

ABCF—MAJESTIC—The shape of buildings to come. A husky, 12-inch wide, 2-inch deep intermediate long-span Binkley original.

For more data, circle 122 on inquiry card

telelift[®] is number



and mosler makes it.

...and has been making it for years. Number one, not just because we were first with a new concept in materials handling, but because we proved to over one hundred and sixty owners of **Telelift** that their confidence in us is not misplaced.

Mosler

An American-Standard Company

Telelift didn't happen over night. It happened because **Mosler** is proud of its reputation for high quality equipment. We couldn't persuade ourselves to introduce an unproven system to people who rely on us for the best.

Only after years of development, engineering, experience and testing are we able to offer the reliable, flexible, proven system **Telelift** is today.

We didn't make **Telelift** Number 1, the confidence of our customers did. Talk with us. We'll show you why **Telelift is going to stay number one.**

MOSLER/AIRMATIC SYSTEMS DIVISION,
415 PATERSON HAMBURG TURNPIKE, WAYNE, NEW JERSEY 07470

TELEPHONE: (201) 278-6300

For more data, circle 123 on inquiry card

TOWER CONTROLS MAINTENANCE COSTS WITH LONG-LIFE DURANAR[®] 200 FLUOROPOLYMER COATING

Looking for ways to add extra years of maintenance-free beauty to metal buildings? Borrow an idea from this new control tower, the first of 96 to be built by Pascoe Steel Corporation.

The tower's brilliant white finish is DURANAR 200, the coating that withstands weathering for 20 years or more. And offers a high level of protection from ultraviolet deterioration

and chemical attack.

What about cost? This unique fluoropolymer coating combines rich beauty and unexcelled durability at a cost significantly under other "long-life" finishes. Which explains why so many architects and metal building manufacturers are putting DURANAR 200 in the specs.

Choose from an exciting spectrum

of colors—all computer-controlled for perfect match. In flat or semi-gloss finishes. See Sweet's Architectural or Industrial Construction Files 9.10/PPG. Or contact your coil coater, panel manufacturer or PPG INDUSTRIES, Inc., Dept. 13S, One Gateway Center, Pittsburgh, Pa. 15222.

PPG: a Concern for the Future



For more data, circle 124 on inquiry card

FAA CONTROL TOWER,
Chino Airport, Chino, California

Tower manufactured and erected
by Pascoe Steel Corporation,
Pomona, California



Congregation Beth El, New London, Conn.; Architect: Paul Rudolph, FAIA, New York, N.Y.; Roofer: H. R. Hillery Company, Groton, Conn.

THE ARCHITECT, METALS AND IMAGINATION

Many critics regard Paul Rudolph as one of the logical heirs to the late Frank Lloyd Wright's professional mantle, and his major projects have clearly influenced the whole range and dynamics of contemporary architecture. As Sibyl Moholy-Nagy once wrote, he has "great courage, comprehensiveness of talent, profound faith in the integrity of the architect's mission."

In conceptual felicity and strength of execution, Congregation Beth El is a notable example of Mr. Rudolph's recent work, and we are indeed gratified that in selecting a metal to sheathe and roof this distinguished building, he chose Follansbee Terne.

FOLLANSBEE

FOLLANSBEE STEEL CORPORATION • FOLLANSBEE, WEST VIRGINIA

For more data, circle 125 on inquiry card

Washfountains that wipe out vandalism while they clean up the kids.



Bradley's "School Board Special" Washfountain. Built right because we developed it to the specific needs of an actual school district. And built dependable because of Bradley's long experience in designing for school markets.

We work with school maintenance people to find features that will help solve their individual vandalism problem. And the result is Washfountains that require less

maintenance and are more vandal resistant. New ideas like the combination soap dispenser/restraining bracket that dispenses soap while anchoring the sprayhead support tube assembly. A pressurized system that dispenses soap with a minimum of effort. A foot controlled tape switch instead of a foot rail. And more.

You can even specify the material that best fits your needs. Stainless steel. Precast

terrazzo. Or new tough Bradglas®. Choose from a wide range of colors and options, too. For complete details, see your Bradley representative and write for latest literature, including a list of communities that have installed these special units. Or call (414) 251-6000. Bradley Corporation, 9109 Fountain Drive, Menomonee Falls, Wisconsin 53051.

Another bright idea from



Bradley

For more data, circle 126 on inquiry card

J-M's new total wall concept. It could change your ideas about walls.

STEEL STUDS
manufactured by Milcor Division of Inland-Ryerson Construction Products Co., provide practical, quickly erected, economical framing systems. Surface facings apply easily with self-drilling, self-tapping screws.

NORTON NORSEAL WEATHER-TIGHT PERMANENT SEAL
between studs and facing panels is provided by Norton Norseal closed cell PVC foam sealant. Stops water, gases, dust.

JOHNS-MANVILLE BUILDING PRODUCTS
include gypsum-board interior panels... fiber glass insulation... plus mineral-fiber cement exterior panels. J-M's wide variety of panels gives the imaginative architect design freedom to meet almost any functional or esthetic requirement. Shown here are just a few...



STONEHENGE PANELS
have the deep cleavage and coloration of quarried Stone, without natural Stone's high cost and weight.

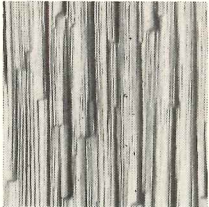

SPLITWOOD FEATURE PANELS are deeply embossed with a linear directional design which blends smoothly with most architectural styles.



QUADRO PANELS with the rich, elegant texture of dressed stone provide an esthetically harmonious visual relationship to many traditional materials.

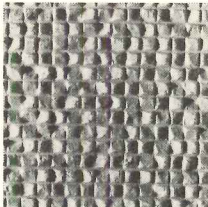

VENETIA PANELS feature a bold mosaic design with handsome embossing, giving new distinction and versatility at an economical price.

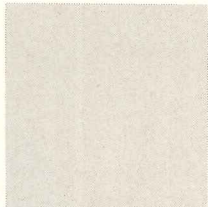

COLORLITH® PANELS have a smooth, polished finish (can be sandblasted)—are as resistant to weather and wear as stone itself, but weigh a third less.

This new concept in exterior panel systems offers the architect and builder new latitude and versatility. At the same time it provides economies through shop fabrication and panelization, faster enclosure, lower construction costs and savings in weight.

The total wall concept is recommended for commercial buildings, middle and high rise apartments.

It permits almost endless design possibilities. And it's particularly suited to exterior treatments combining the appearance and beauty of natural stone in a simulated product with the accent of reverse or bat-joints.

Find out more. Details are yours for the asking from Johns-Manville, Box 5108, Denver, Colorado 80217.

Johns-Manville 

For more data, circle 127 on inquiry card

Caradco sculptured doors: THE FIRST COMPETITIVE ALTERNATIVE TO FLUSH & PANEL DOORS!



THE CARADCO SCULPTURED DOOR

gives you good performance at reasonable cost and superb deep-carved design for a lasting good impression.

Consider the differences in cost, upkeep and appeal. There's really only one choice: Caradco sculptured doors! The proven design that provides a *lasting good impression* at low cost.

Its deep-carved panels are made from one-piece wood-grained faces, which means it won't split, check or shrink. You get durable sculptured beauty. Your cost... about midway between a flush and panel door! Even gives unfurnished rooms a furnished look. A factory prime coat lets you match the finish to any taste, any decor. Make a *Caradco impression* in your homes and apartments. *Call your Caradco Distributor!* All sizes in stock... in every area!

Caradco Window and Door Division

Scovill

Dubuque, Iowa 52001 / Hainesport Assembly Plant Hainesport, New Jersey 08036 / Ohio Assembly Plant Columbus, Ohio 43204.

For more data, circle 128 on inquiry card

ANNOUNCING

A TEST GUIDE FOR PROFESSIONAL EXAM CANDIDATES

THE 1973 ARCHITECTURAL REGISTRATION HANDBOOK

INDISPENSABLE INFORMATION
for candidates taking the new Professional Exam

REQUIRED READING
for all practitioners

The first "test guide" ever sponsored by the National Council of Architectural Registration Boards will shortly be available to assist candidates taking the December 1973 Professional Examination for architectural registration. The NCARB is the organization that prepares the examination which is administered by registration boards who grant individual state registration to those candidates who pass.

Although the primary purpose of this "test guide" is to provide specific guidance for those taking the examination, it also sheds light on the whole institution of registration and licensing as a professional prerequisite. Architects already in practice, both in the U.S. and abroad, could benefit professionally from having their own copy.

The Architectural Registration Handbook features:

- INSTRUCTIONS AND QUALIFICATIONS for applying for the new Professional Examination—as well as the equivalency examination.
- THE MODEL EXAM—includes questions similar to those on the actual Professional Examination which tests candidates' knowledge and judgement in the areas of environmental analysis, architectural programming, design and technology, and construction.

- A GLOSSARY OF TERMS AND IDEAS with which candidates must be familiar to deal effectively with each problem area.
- A BIBLIOGRAPHY OF RECOMMENDED READING AND REFERENCES encompassing the periodicals and books which define the general body of knowledge upon which the Professional Examination is based.
- ANSWERS TO SUCH QUESTIONS AS: How will the Professional Examination compare with the Model Exam? . . . How will the new examination be structured? . . . graded? . . . scored? . . . Is guessing a good idea? . . . Is there a predetermined pass/fail point? . . . What scores will be reported and to whom? . . . Will credit be given for passing individual parts?

In addition, the Handbook describes the philosophy of the new Professional Examination, views the changing role of the architect in today's society, and how the NCARB intends to help the professional after he is registered.

Never before have candidates for professional registration had an opportunity to purchase a test guide specifically prepared by NCARB. This 144-page, hardcover handbook is of the utmost importance to anyone taking the Professional Examination and will be of intense interest to all educators and practitioners.

The first edition of the Handbook is limited. To receive your copy promptly upon publication write to ARCHITECTURAL REGISTRATION HANDBOOK, Architectural Records Books, 1221 Avenue of the Americas, New York, New York 10020 or use the coupon below. (FULL PAYMENT OF \$18.50 PLUS 50¢ POSTAGE MUST ACCOMPANY YOUR ORDER)

ARCHITECTURAL RECORD BOOKS • 1221 Avenue of the Americas • New York, New York 10020

Please send copies of the Architectural Registration Handbook.

NAME _____

ADDRESS _____

CITY _____ STATE _____ ZIP _____

Full payment of \$18.50 per copy (plus 50¢ postage) must accompany your order.

Whatever you want your glass to do, C-E Glass has the light, heat, glare, sound or safety control qualities, plus the colors and patterns to blend beauty with function and to open new horizons for structural design possibilities.

POLARPANE® insulating glass units with 20-year warranted moisture-free construction.

POLARPANE® reflective solar insulating units with pure gold or chrome mirror-like coating.

ARM-R-BRITE® insulated spandrel panels, fully tempered and tailored to your color specifications.

ARM-R-CLAD® tempered safety glass. Clear, tinted and textured. Standard thicknesses from 1/8".

SOUND CONTROL POLARPANE® hermetically sealed units for maximum sound transmission loss.

SUN CONTROL POLARPANE® hermetically sealed units with rotating venetian blind between glasses.

MISCO® wired glass listed fire retardant by Underwriters' Laboratories, Inc. Seven popular patterns.

MISSISSIPPI® PATTERNED GLASS in wide variety of general purpose and decorative patterns.

You
can do
more things
with
light

CEGLASS

COMBUSTION ENGINEERING, INC.

For more data, circle 130 on inquiry card

See our catalog in Sweet's 826 Ce or contact your local C-E Glass office.
C-E Glass, 825 Hylton Road, Pennsauken, New Jersey, 08110, (609) 662-0400.

Campbell Centre, Dallas
Architects: Neuhaus + Taylor
Polarpane Gold #2016

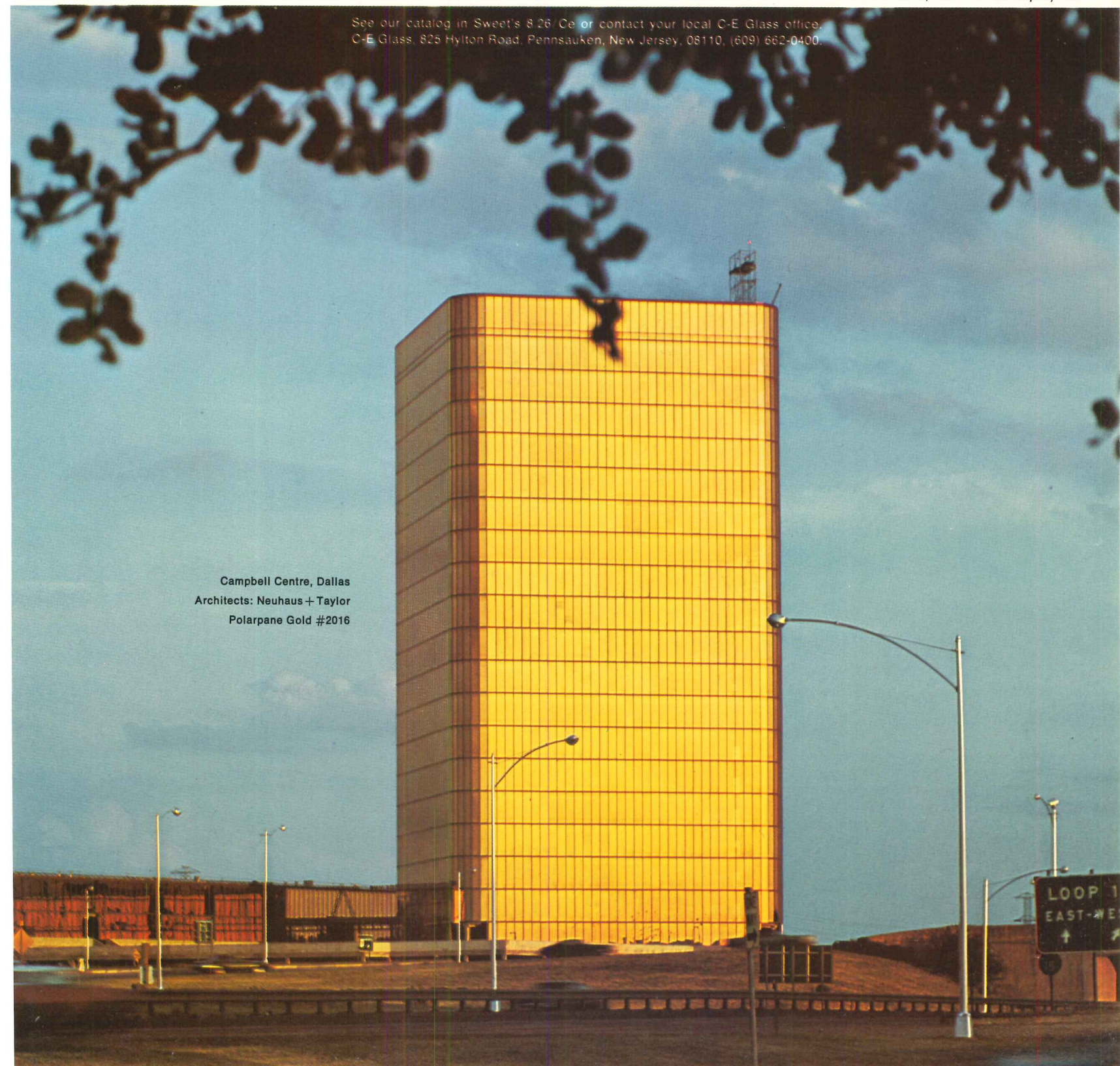



**All the quality
you can use.
At a price
you can't overlook.**

For insulating anything from an apartment building to a cold storage plant, you can't beat ZONOLITE® Styrene Foam. You can pay more and get properties you don't need, but why waste your money?

ZONOLITE Styrene Foam has everything you can use: superior insulation, compressive strength, permeance, and water-resistance.

Yet there is no overkill. On properties or price.

You get all the properties you can use. You don't pay for properties you *can't* use.

We build in the quality that the Grace name assures in all its construction products. And so you can tell whose board it is, we put our name on it.

So don't settle for a no-name alternate. Specify and use ZONOLITE Styrene Foam Insulation. Check your ZONOLITE sales office for complete information, or write: Construction Products Division, W. R. Grace & Co., 62 Whittemore Ave., Cambridge, Mass. 02140.



For more data, circle 131 on inquiry card



the
back-to-nature
look
of wood
comes
to light

New Laminated Wood Poles decoratively combined with graceful architectural luminaires. Together they create an exciting dimension, a back-to-nature look and durability that sheds a whole new light on outdoor illumination. Bring a touch of nature's own wooded splendor to parks, campuses, shopping malls, office court yards, business sites and housing developments.

Idaho White Fir and Southern Yellow Pine species are carefully selected, graded, laminated, and treated under pressure with preservatives to provide long service life. Surfaces allow natural weathering or staining. Center wire way conceals wire. Pre-drilling of arms and tenons assures installation ease and perfect fit of a wide selection of architectural luminaires. Poles range in height from 2 feet to 30 feet.

The Hubbell Architectural Woodlighting system will bring your setting back-to-nature. Write for brochure.

Lighting innovations to believe in.



lighting division
TM

Lighting Division HARVEY HUBBELL INCORPORATED
Electric Way, Christiansburg, Virginia 24073

For more data, circle 132 on inquiry card



Olympic Stain: For people who love wood.

Olympic Stain is one of the most beautiful things you can do for wood.

Olympic brings out the wood's grain and subtle beauty, it also penetrates for protection.

Because Olympic Stain allows wood to breathe, the finish will never crack, peel or blister.

The solid colors are trouble-free for re-do over old paint on rough wood.



For your dealer's name call 800-243-6000, toll-free.
In Connecticut dial 1-800-882-6500. For a free color folder, write:
1148 NW Leary Way, Seattle, Wa. 98107. Olympic Stain. A division of COMERCO, INC.





MORE VALUE PER SQUARE FOOT when you specify Eternaflex Urethane Walking Decks. At last, a system that has everything. Easily applied in one or two days. Ideal for terraces, sun decks, pool walking decks, service ramps and boat or yacht decks. You get a rubber-like waterproof covering for concrete or plywood with no seams or joints. Expands and contracts.

Skid resistant and available in several colors. Send for literature and free sample. The Gibson-Homans Company, 2366 Woodhill Road, Cleveland, Ohio 44106.

For more data, circle 134 on inquiry card

PORTABLE SOLID WASTE AND REFUSE COMPACTORS and systems from The Tony Team, Inc. includes four sizes and great versatility. Pollution Packer™ compactors bale, bag and box all types of wastes and refuse, wet or dry. Machine capacities range from .8 C. Y. to 4½ C. Y. of loose wastes at 10 to 1 compaction ratio . . . operate on low amperage, 110-V60 cycle service. For hospitals, hotels, schools, colleges, restaurants, office and apartment bldgs. Simple adaptation to chute-type disposal systems. Spec sheets and literature available from: The Tony Team, Inc., 7399 Bush Lake Road, Mpls., Minn. 55435.

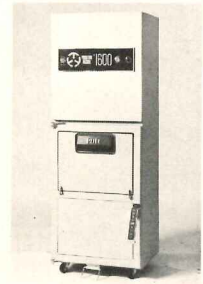

For more data, circle 135 on inquiry card



SPACE-SAVING REFRIGERATORS WITH MODULAR COMPATIBILITY, under-counter and eye-level models in a variety of standard dimensions that form an unbroken line of design. Polished stainless steel exterior (or your choice of finish) and interior. Designed for hospital labs, pharmacies or nurses' stations, explosion safe or total explosion proof construction optional.

Freezers with same dimensions available. Removable front grille facilitates easy servicing. Defrost systems, featuring condensate evaporator and accumulator, eliminate need for floor drain. Write: Jewett Refrigerator Co., Inc., 2 Letchworth St., Buffalo, N.Y. 14213.

For more data, circle 136 on inquiry card

COMPUTER ANALYSIS WITH UNUSUAL SOFTWARE DEVELOPMENT contributes to a whopping 98% successful track record for a Connecticut firm developing costing and network planning (CPM). The approach is to start with the parameters of what ultimate finished funding is available, timing to completion along with overall cost of upkeep, and then control inputs of design, materials and construction methods. The computer then handles and compares the results. The result is 100% predictability. A unique combination of wheelbarrow construction philosophy and computer science has developed. The firm is handling in excess of 30 million in construction each month with several model cities programs waiting analysis and routing. R. H.S. Associates; 19 Fort Hill Road; Groton, CT. 06340, (203) 445-2213

For more data, circle 137 on inquiry card

These Polaris chairs are absolutely guaranteed not to replace teachers.

They just make teaching easier. Massey firmly believes that there is no substitute for teachers. But we do believe that students learn more quickly when they are comfortable. And so we designed these polaris

chairs with tablet arms for lecture halls and auditoriums. Comfortable. Handsome. And durable. Massey chairs. For comfortable students and happier teachers.

Polaris



Massey Seating Co.
NASHVILLE, TENNESSEE 37208

FOR REFERENCE SEE SWEET'S ARCHITECTURAL CATALOG FILE 12.5 MA.

For more data, circle 138 on inquiry card

IDEA BOOSTER



Sixteen stimulating pages for architects. Today's latest ideas, techniques and materials. Contains dozens of interesting new uses for porcelain-on-steel interior and exterior panels in hospitals, schools, food plants, office buildings and industrial plants. Beautifully illustrated in full color with complete specifications.

For your free copy, write: **AllianceWall CORPORATION**

Overseas Factories:
Alliance Europe, N. V.
Box 19
3600 Genk, Belgium

Box 247
Alliance, Ohio 44601
Pentagon A/S
Odense
Denmark

For more data, circle 139 on inquiry card



Top: Ocean House Apartments. Architects: Donald Sandy, Jr. and James A. Babcock. Photographer: Thomas A. Abels.

Above: House in Lincoln, Mass. Architects: Joseph Maybank and Arthur Cohen. Photographer: Nick Wheeler.

Left: Meadgate Condominiums. Architects: Allen Moore, Jr., John B. Rogers and James M. McConnell. Photographer: Carol Rankin.

Right: House in Huntington Bay, N.Y. Architect: Richard Henderson. Photographer: William Maris.

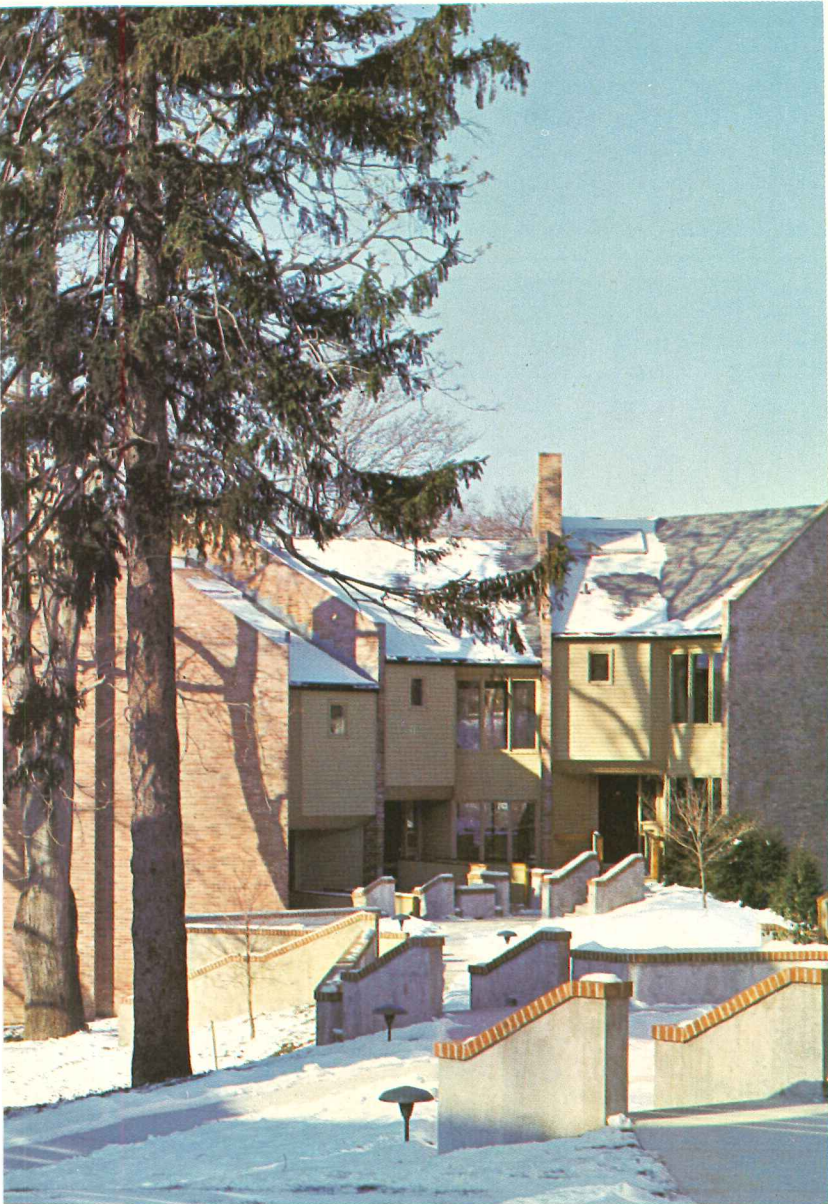

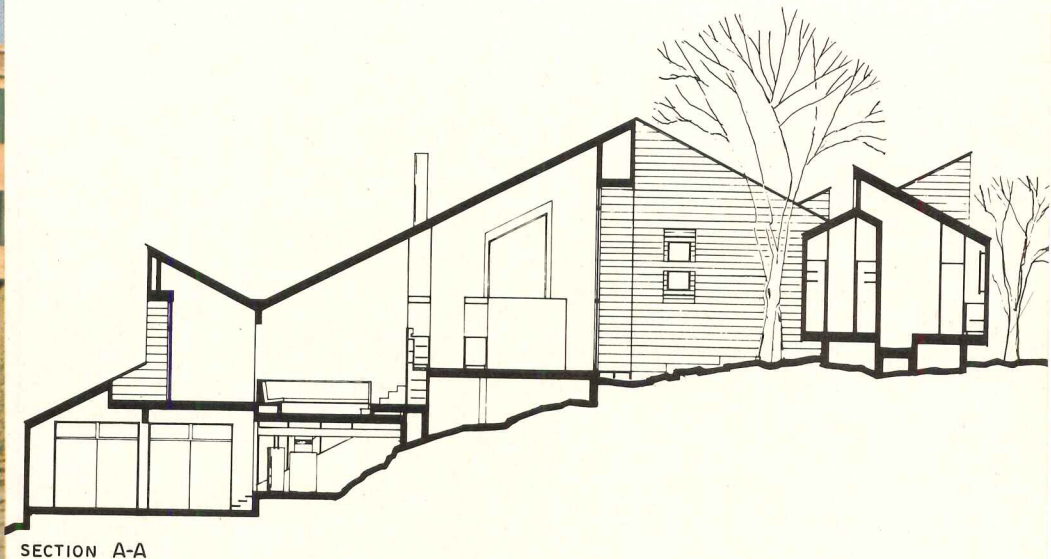

COMING IN MID-MAY...
 ARCHITECTURAL RECORD'S IDEA
 ANNUAL OF THE HOUSING FIELD

RECORD HOUSES AND APARTMENTS OF 1973

According to F. W. Dodge, the years 1971-1975 will be housing's biggest five-year boom since the '50's. During that time more than 11 million housing units will be built.

In mid-May Architectural Record's *Record Houses and Apartments of 1973* offers a timely opportunity for manufacturers of quality building products to exert year-in and year-out influence on those architects and builders who are at the forefront of the continuing housing boom. It will reach all major groups of specifiers and buyers in this market:

- over 42,000 architects and engineers who are verifiably responsible for 87 per cent of the dollar volume of all architect-planned residential building.
- 20,000 of the nation's foremost builders qualified by Sweet's on the basis of annual building activity to receive the Light Construction File.
- 4-5,000 leading interior design offices qualified by Sweet's to receive the Interior Design File.
- in addition, bonus bookstore distribution to an influential segment of the house building and buying public.

Record Houses and Apartments offers its advertisers a unique advantage:

The issue has the longest working life of any issue of any architectural magazine! Architects refer to it five, ten, even fifteen years after publication.

Don't miss it! Closing date: April 15.

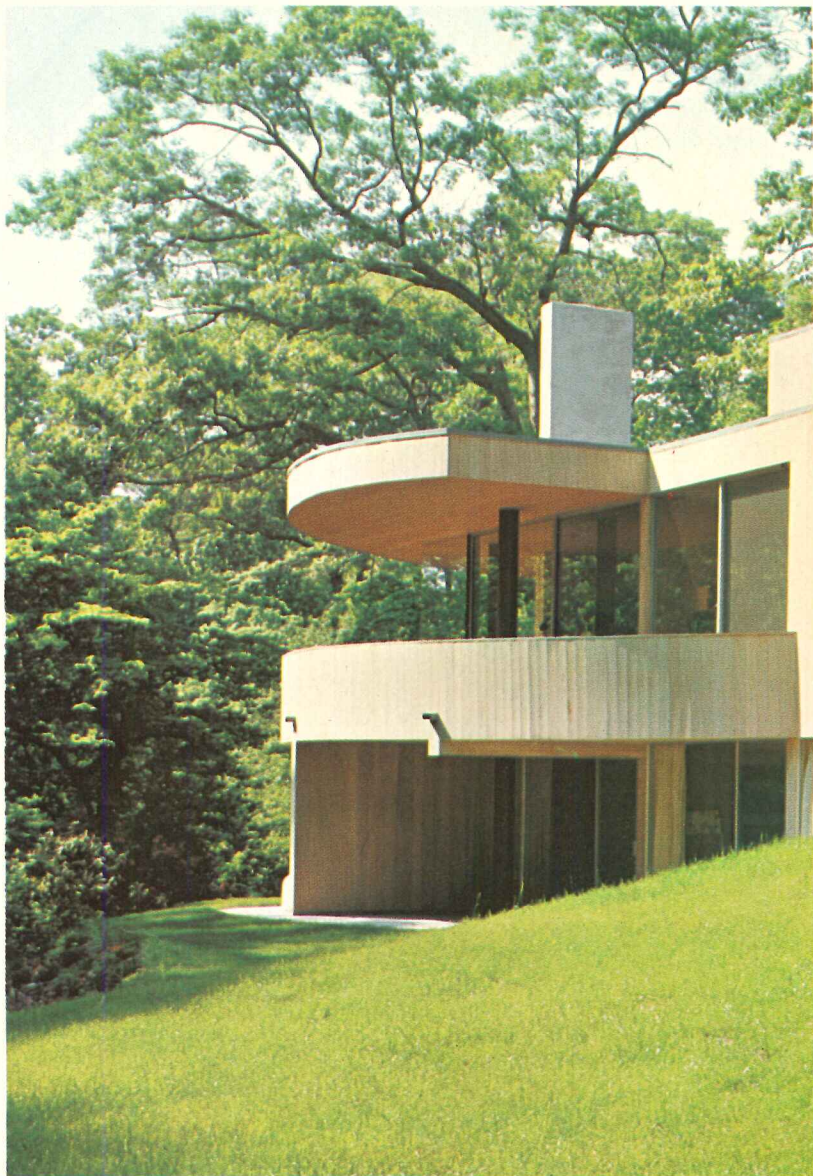



LEAD NEWSLETTER

FOR ARCHITECTS AND BUILDERS

Vol. 17, No. 5

Data for your CSI-9 file

Problem:
How to locate a huge power generating plant in the midst of a "bedroom" community without generating noise problems as well.

Solution:
Extensive use of lead sound barriers.

NOISE CONTROL MATERIAL INSTALLED AT LONG ISLAND LIGHTING COMPANY PLANT AT NORTHPORT, N.Y. (UNIT #3)

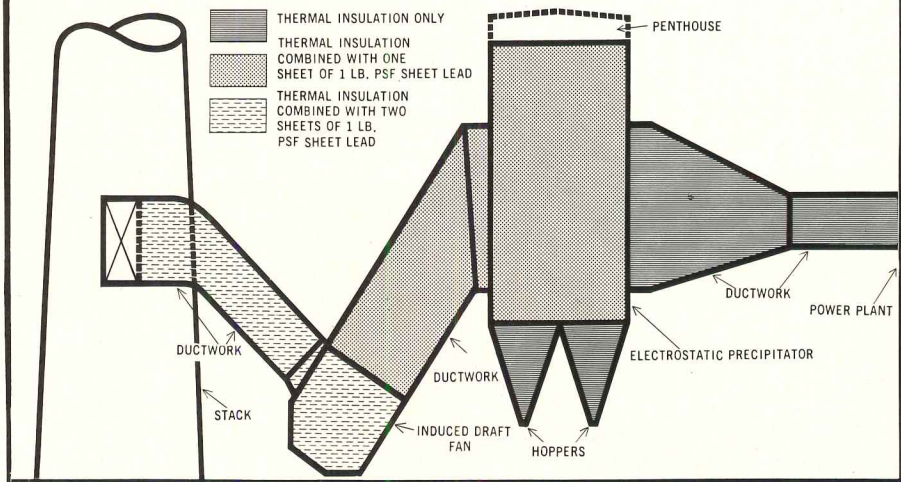

Induction draft fans used in utility air pollution control are powerful noise makers. But today's technology offers an answer in prefabricated, thermally insulated panels designed to provide noise reduction of up to 52 decibels. The panel is of layered construction. Five materials are used to produce the new thermal-acoustical panel: an exterior sheet of corrugated or box-rib galvanized steel or aluminum; a layer of mineral wool insulation; single or double layers of sheet lead sandwiched between one or more additional layers of mineral wool insulation; a layer of aluminum foil; and a wire mesh retainer on the sound-source side of the panel. The box-rib panels are commercially available in 40" widths; corrugated panels in 32" widths. There is a wide variety of lead sheet, lead vinyls and composites now at work helping industry comply with regulatory codes on noise.

Make sure your CSI file on sound insulation is complete. Write to Lead Industries Association, Inc., 292 Madison Avenue, New York, N.Y. 10017.

For more data, circle 140 on inquiry card

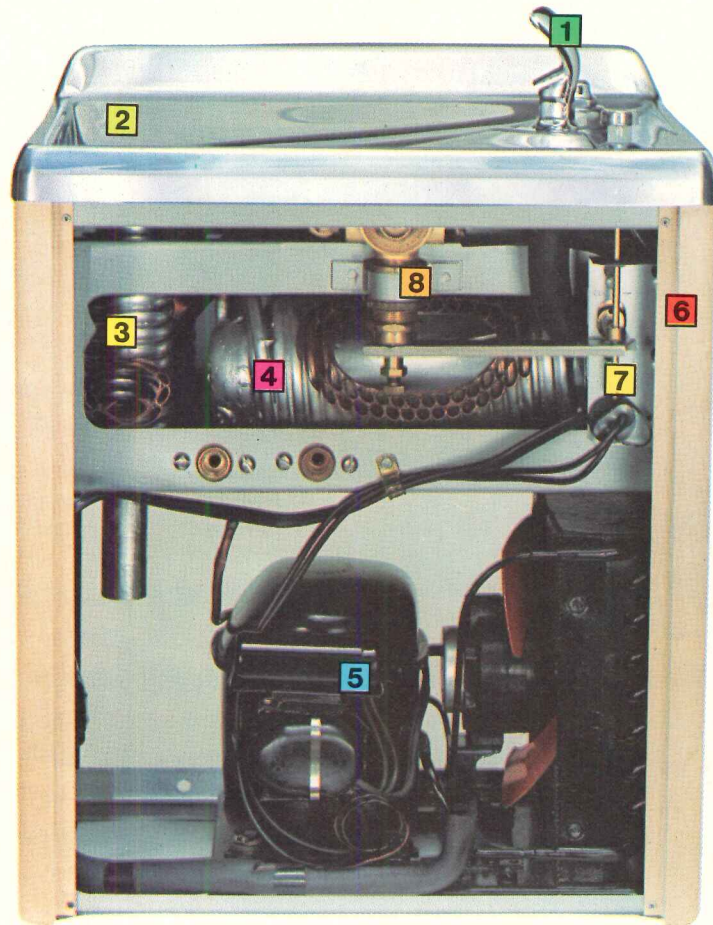

Most water coolers look pretty much the same on the outside. Only one looks like this on the inside.

Halsey Taylor.

Not that you'd recognize it. Very few people ever have to look at the inside of our water coolers. Including repairmen.

That's because we concentrate on what really counts—function. Besides, where could anyone get the idea that an architect specifies functional products on appearance alone?

The ultimate pay-off is a cold, satisfying drink of water. But the pay-off that counts is years of service, extremely low maintenance, quality construction—and knowing that the product you specify is as good as your own reputation.

We put a lot more into it so your customers will get a lot more out of it. Cold water included. Here's how:

- 1 Exclusive 2-stream bubbler.** Builds a large, drinkable mound of water. Squirr-proof and vandal resistant. One piece chrome-plated brass forging prevents contamination.
- 2 Cooler top.** Satin finish stainless steel, polished and buffed for beauty and ease of cleaning. Separate drain strainer removable for easy cleaning without removing cooler top.
- 3 Pre-cooler.** Incoming water line coiled around and tin-bonded to cold water drain. Boosts cooling capacity by 60%.
- 4 Cooling storage tank.** All copper, hot-dipped pure tin lining. Incoming water coil is tin-bonded to refrigerant coil to cool water before it enters tank.
- 5 Condensing unit assembly.** Hermetically sealed, lubricated for life. Automatic re-set overload protector prevents overheating. Capacitor insures compressor startup. All components designed and coordinated for top efficiency and long life.
- 6 Cabinet.** One-piece unitized body of heavy gauge bonderized steel. Baked-on enamel resists wear, moisture, heat, sunlight. Cabinets also available in stainless and vinyl-clad steel.
- 7 Dual temperature controls.** Two thermostats, primary and secondary, provide double protection against freeze-up.
- 8 Automatic regulating/operating valve.** Maintains constant stream height under line pressures varying from 20 p.s.i. to 90 p.s.i. Easy to service. Tamper-proof. Large orifices resist deposits and clogging. All parts are corrosion-resistant.

Halsey Taylor Division, 1554 Thomas Road, Warren, Ohio 44481.

Halsey Taylor
KING-SEELEY  THERMOS CO.

For more data, circle 141 on inquiry card

KINNEAR

STEEL ROLLING DOORS



The Way To Roll Away Door-way Security Troubles

write today for catalog

KINNEAR CORPORATION
and Subsidiaries

1860 FIELDS AVENUE, COLUMBUS, OHIO 43216
OFFICES & REPRESENTATIVES IN ALL PRINCIPAL CITIES
LISTED IN YELLOW PAGES UNDER "DOORS." ALSO SEE SWEET'S!

Saving Ways in Doorways Since 1895



A SUBSIDIARY OF
Harsco
CORPORATION

For more data, circle 142 on inquiry card

**At last! A wall system
that can match your imagination!**

Solid hardwood prefinished wall planks

Random width, random length genuine solid hardwood wall planks, lovingly prefinished, in a choice of 13 woods with the full natural beauty and richness that no imitation can match. Send today for Designer's Sample Kit containing 13 full-size sample species, textures and finishes.



Townsend Paneling

POTLATCH FORESTS, INC.

P. O. Box 916, Stuttgart, Arkansas 72160

Enclosed is my check for \$3 to cover cost of my sample kit.

Please send additional literature.

Name _____ Phone _____

Firm _____

Title _____

Street No. _____

City _____ State _____ Zip _____

For more data, circle 143 on inquiry card

RECORD IMPRESSIONS

A new service offering reprints, reports and back issues.

NEW LISTINGS

- 38 THE YOUNG ARCHITECTS 56 pgs. 4-color 1.00 per copy
- 39 RECORD HOUSES 1972 3.25 per copy
- 40 RECORD INTERIORS of 1973 16 pgs. 4-color 1.00 per copy
- 41 ROLE OF THE ARCHITECT IN DEVELOPMENT HOUSING 16 pgs. 2-color 1.00 per copy
- 42 PRODUCT REPORTS 1973 3.00 per copy
- 43 MUSEUMS (JULY 1972) 16 pgs. 4-color 1.00 per copy

INTERIORS

- 3 RECORD INTERIORS of 1971 20 pgs. 4-color .50 per copy
- 21 SIX INTERIORS—AUGUST 1971 12 pgs. 4-color .50 per copy

BUILDING TYPE STUDIES

- 4 MUSEUMS (JUNE 1969) 16 pgs. 4-color .50 per copy
- 6 DESIGN FOR MERCHANDISING 16 pgs. 1.00 per copy
- 8 AIRPORTS 16 pgs. B&W 1.00 per copy
- 11 CORRECTIONAL ARCHITECTURE 16 pgs. 2-color .50 per copy
- 13 CAMPUS DESIGN FOR SUCF—AN ANALYSIS OF EXCELLENCE 24 pgs. 2-color 1.00 per copy
- 15 BUILDING FOR A BROAD SPECTRUM OF HEALTH CARE 16 pgs. B&W 1.00 per copy
- 16 URBAN HOUSING: 30 pgs. 2-color 1.00 per copy
- 20 LOW-INCOME HOUSING 16 pgs. 4-color 1.00 per copy
- 24 5 CONTEMPORARY SCHOOLS 14 pgs. B&W .50 per copy
- 26 DESIGN FOR A VARIETY OF CAMPUS LIFESTYLES 18 pgs. 4-color .50 per copy
- 27 SHOPPING MALLS IN SUBURBIA 16 pgs. 4-color 1.00 per copy
- 28 SUBURBAN OFFICE BUILDINGS 16 pgs. 4-color 1.00 per copy
- 34 INDUSTRIAL BUILDINGS 16 pgs. 4-color 1.00 per copy
- 35 HOSPITAL PLANNING RESEARCH 18 pgs. 4-color 1.00 per copy
- 36 HOUSING: ONE GOVERNMENT AGENCY REACHES FOR GOOD ARCHITECTURE 16 pgs. 4-color 1.00 per copy
- 37 RESORT HOTELS 16 pgs. 4-color 1.00 per copy

PREPAID ORDERS ONLY

Record Impressions
ARCHITECTURAL RECORD
1221 Avenue of the Americas
New York, New York 10020
Att. Joseph R. Wunk

- | | |
|----------|----------|
| 15 _____ | 35 _____ |
| 16 _____ | 36 _____ |
| 20 _____ | 37 _____ |
| 21 _____ | 38 _____ |
| 24 _____ | 39 _____ |
| 26 _____ | 40 _____ |
| 27 _____ | 41 _____ |
| 28 _____ | 42 _____ |
| 34 _____ | 43 _____ |

No. of copies

- | | |
|---------|----------|
| 3 _____ | 8 _____ |
| 4 _____ | 11 _____ |
| 6 _____ | 13 _____ |

Enclosed is my check Money order for \$ _____
please include local sales tax

NAME _____

FIRM _____

ADDRESS _____

CITY/STATE _____ ZIP _____

valid through 6/30/73

Copper building systems. They cost less because they last longer.

If you are not specifying copper systems—roofing, wiring, plumbing—because some other material looks less expensive, consider these facts:

1. Copper systems are strong selling assets. Buyers look for them.
2. Copper systems last. They're solid and reliable, like a good reputation.
3. In the long run copper systems save money by reducing call-backs for service or replacement.
4. A substitute for copper is just that — a substitute.

Copper Roofing Systems

A copper standing-seam roof is beautiful . . . either bright, like this one, or in natural brown tones, or patinated. Copper adds value, and its life-of-the-building durability is a known fact.

Or, bond copper's beauty and trouble-free service to cost saving structural panels of plywood and other substrates, and you have economical, easy-to-install, light-weight roofing, fascia, and wall systems.

Copper Wiring Systems

Copper wiring is a safe, sound investment, from installation to customer use. It will not break easily when twisted or bent, will fit into tight places, requires no special hardware or preparation to make connections, does not loosen at terminals—even its oxide conducts! It's the safest building wire known.

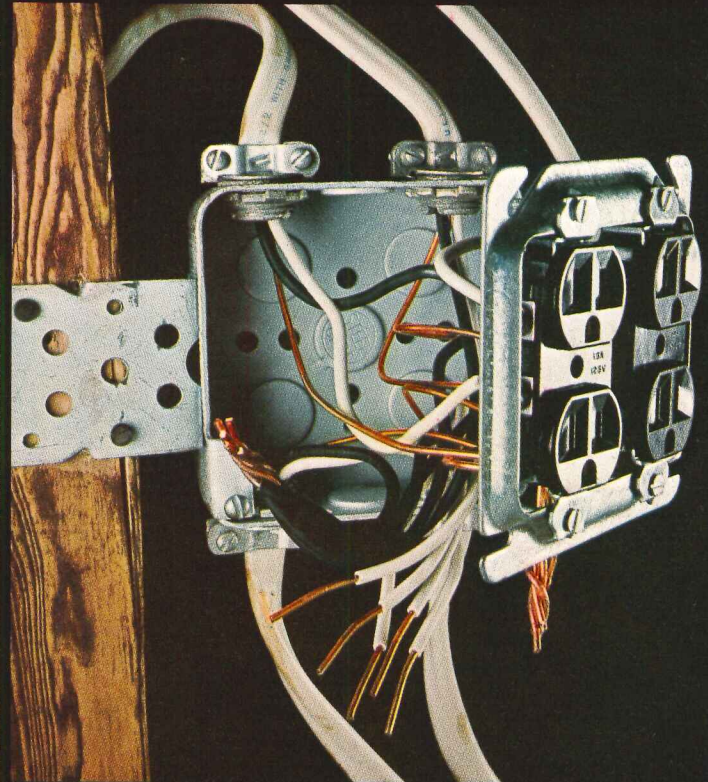

Copper Plumbing Systems

Copper plumbing is just about indestructible and famous for its performance reliability. Buying cheaper materials is false economy. It makes sense to customers to pay a few dollars more for copper and know they have something that stays on-the-job year after year. Why make your house harder to sell because of a small saving in initial material cost?

There's no real substitute for copper . . . it's the most economical in the long run.

If you'd like details on these, or any other building uses of copper and its alloys, brass and bronze, just write us.

Copper Development Association Inc. 405 Lexington Avenue, New York, N.Y. 10017

 **COUNT ON COPPER**

For more data, circle 144 on inquiry card

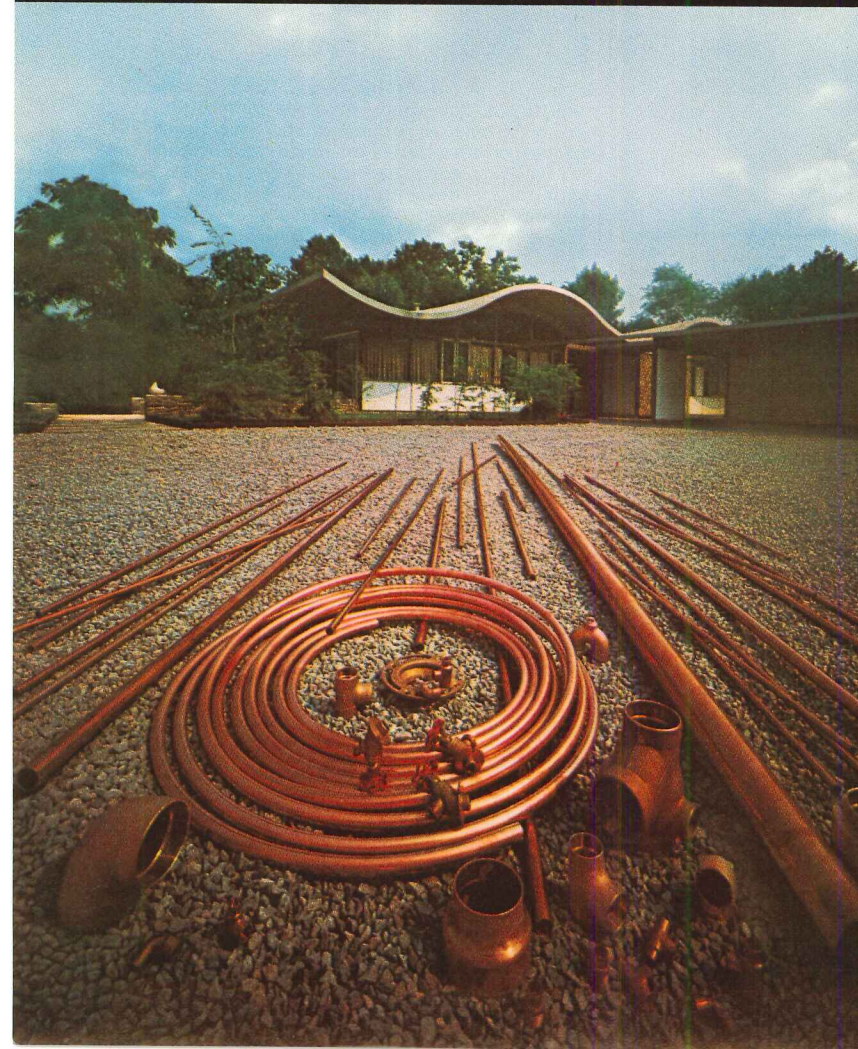

CLASSIFIED SECTION

POSITIONS VACANT

THAT SWELTERING CITY SUMMER WILL BE HERE BEFORE YOU KNOW IT . . .



YOU CAN

COOL IT!

WHEN YOU WORK IN MOUNTAIN-AIR CONDITIONED BECKLEY!

A superb climate... cool, relaxing summers and mild, invigorating winters... just one of the many advantages that are your's when you locate in Beckley. Because Beckley, West Virginia, is located on the clean, high Appalachian plateau, where a myriad of recreational facilities and an array of scenic splendors are minutes from your office... and where the sparkling mountain water is so clean and pure you can drink it straight. There's swimming, boating, fishing, camping, boat races, outdoor drama... even an exhibition coal mine. And here we cool it in more ways than one... you and your family can walk our streets at night in comfort and in safety.

So shuck that big city drag and start to live again! Leslie C. Gates and Associates, a rapidly expanding consultant firm, has immediate openings for architects. Pleasant working conditions, comparable salaries, generous fringe benefits. Leave the crowded canyons and cool it with us in progressive Beckley. Write us your interests and qualifications.

LESLIE C. GATES AND ASSOCIATES

P.O. DRAWER AF, BECKLEY, WEST VIRGINIA 25801. AN EQUAL OPPORTUNITY EMPLOYER

SALES REPRESENTATIVES

Growth oriented division of a Fortune 200 manufacturing Company is seeking experienced sales representatives. Several positions are available in major marketing areas throughout the United States. Prefer industrial and commercial lighting fixture or electrical equipment sales experience.

Send complete resume including educational and experience background and earnings requirements to:

P-2229, Architectural Record
Class. Adv. Dept., P.O. Box 900, New York, N.Y. 10020

An Equal Opportunity Employer

EXPERIENCED METALWORKERS PEACE CORPS

Volunteer two years overseas. U.S. Citizen. Expenses paid—medical, travel, subsistence. Single, married, some families. Information: Bruce Mazzie, ACTION, OCP Box 53, Washington, D.C. 20525

Assistant Professor, Department of Architecture, California State Polytechnic University, Pomona, California 91768. Master's Degree required. Teach design and related subjects. Equal Opportunity Employer. Qualified minority applicants encouraged to apply. Send resume: Attention of Dr. J. Ingraham Clark, AIA.

Architect—Executive position open in office of major developer. Excellent opportunity to head Architectural Department. Salary open. Profit sharing and all fringe benefits. Orchard Lake Corporation, 4200 N.W. 18th Street, Lauderhill, Florida 33313 (305) 735-8899.

Project Architect—Expanding E-A firm needs a capable architect with at least five years experience in institutional, commercial and public building design. Must have ability to oversee entire projects from concept through construction. Send resume to: L. Robert Kimball & Associates, 615 West Highland Avenue, Ebensburg, Pa. 15931 (An Equal Opportunity Employer).

Senior & Intermediate Architectural Draftsman—Exceptional opportunity open for experienced man in the office of major developer. Salary open. Profit sharing and all fringe benefits. Orchard Lake Corporation, 4200 N.W. 18th Street, Lauderhill, Florida 33313 (305) 735-8899.

English Architectural Practice offers opportunity for Architects and Architectural Draftsmen with minimum two years experience to widen experience in an expanding office near London on Town Centre, Office, Shopping, Industrial and Commercial projects in Britain. Interview in New York. Air passage and first fortnight's accommodation paid. Reply P-2232, Architectural Record.

Artists—Architectural Illustrators—Our national reputation as the top source of architectural illustrations and related services exceeded our expectations and opened opportunities for top artists and illustrators who seek to develop their abilities to the fullest and receive a pay level to match. Our standards are by far the highest in our field and we seek personnel capable of improving our product rather than their equaling. A knowledge of architecture is not required but helpful since we match each artist to the area he excels in, producing unmatched artwork all our artists can take pride in and yet consistent in quality for the clientele. Present needs call for specialists in cars, figures, lettering, interior illustration, product illustration, landscapes of all types, plus opening opportunities for graphic designers and model builders. We are also establishing representatives in all major U.S. cities and seeking individuals with a sales approach plus a knowledge of architecture and perspective layout. Further information will be supplied upon receipt of samples, all promptly returned prepaid. Top pros can expect pay scales on a level with their abilities. Inexperienced talent can expect the highest starting salaries in the art field. Art Associates Inc., 4041 W. Central Ave., Toledo, Ohio, 43606.

Director of Architecture—The School of Architecture at Pratt Institute is seeking a director to work with faculty and students in a new and more responsive form of governance requiring energy and dedication. Interested candidates are requested to submit a resume, including references and a statement of their qualifications. The School of Architecture at Pratt offers a creative and innovative curriculum leading to the undergraduate degrees of Bach. of Arch. and a combined Bach. of Arch./M.S. in City and Regional Planning. Graduate degrees of M.S. in Tropical Arch., M.S. in Urban Design, and M.S. in City and Regional Planning. Pratt students use New York City as an environment for living and studying, especially because the metropolitan setting and the school's programs have a natural relationship. All responses should be addressed to: The Search Committee, School of Architecture, Pratt Institute, 215 Ryerson St., Brooklyn, New York 11205.

Architects (R.A.) Architectural Lead Draftsmen. If you have been involved in architectural planning of educational, institutional and industrial facilities for more than 5 years and feel that you have not received the recognition you deserve, then you will want to investigate this ad Today. Comprehensive hospitalization, life and disability insurance, vacation, sick leave and profit sharing plan all company paid. Credit Union privileges. Send resume or contact: Personnel Director, Buchart Associates, 611 West Market Street, York, Penna. 17405. Phone: 717-843-3854. "An Equal Opportunity Employer."

Top Design Architect with Management Ability—Challenging opportunities exist at large Western New York firm for top professional with strong management and design emphasis. Professional license required. Partnership status is open for the right man. Expanding Architectural-Engineering firm is active in the design of significant educational, medical, and industrial facilities throughout Northeastern U.S.A. Send confidential resume, including salary requirements, to: P-2382, Architectural Record.

REPLYING TO BOX NUMBER ADS

ADDRESS BOX NO. REPLIES TO: Box No. Classified Adv. Dept. of Architectural Record NEW YORK, N.Y. 10020 P.O. Box 900

continued from page 198

POSITIONS VACANT

Architectural Illustrators—Nationally known architectural presentation consulting firm offering opportunity for qualified personnel. Relocate in warm climate with top pay plus benefits. Salaries open for qualified artists with extensive professional experience in any of the following categories: background, structural, finishing, cars & figures. Send resume with photos or 35 MM slides to: Prelim, Inc., 3618 Noble Ave., Dallas, Texas 75204. All samples will be returned promptly.

Architect-Designer desired by Midwest Builder/Owner corporation, which is subsidiary of major life insurance company. Corporation has previously used independent architects. Due to increase in residential volume, the corporation desires to employ staff architect. Salary Negotiable. All replies confidential. P-2236, Architectural Record.

Architect—Outstanding opportunity for the right individual. Key position in young, growing St. Louis firm with an exciting diverse practice in Architecture, Planning and Landscape Architecture. Must be competent in design and working drawings. Must have commitment to a better environment and modern design. An individual with initiative and capability to assume complete responsibility. P-2272, Architectural Record.

Wanted: Project Designer with minimum of 5 yrs. experience to join progressive, design orientated architectural firm. Contact Rossetti/Associates Incorporated, Mr. Jim Smith, 1234 Penobscot Building, Detroit, Michigan 48226. Please refer to this ad.

POSITIONS WANTED

Registered Architect & Engineer—16 years varied experience, seeks senior position or partnership in the State of Vermont. PW-2251, Architectural Record.

BUSINESS OPPORTUNITIES

Acquisitions Desired—Major architectural/engineering firm based in the East seeks similar firms interested in joining forces for common cause, expanded activity and increased challenges. Preferences are for firms with revenues of \$500,000.00 and over. All replies confidential. BO-2271, Architectural Record.

EMPLOYMENT SERVICE

Career Builders, Inc., Agency—Complete range if Architectural and Interior Design placement under the direction of Ruth Hirsch, Apprentices to Senior Designers and Project Architects. Professional screening and personalized service. References checked, 501 Madison Ave., New York, N.Y. 10022, PL 2-7640

Classified Section Non-Display Order Form

To place a non-display advertisement, fill out this form, including your name, street address, city & state with ZIP code, attach it to a separate sheet containing your advertising copy, and mail it to:

ARCHITECTURAL RECORD/
P.O. BOX 900
NEW YORK, N.Y./10020

Rates: \$3.80 per line, minimum insertion ten lines, six words to a line, box number counts as one additional line. Display rates on request.

Payment Enclosed \$ Bill me
 Use Name & Address Use Box No.
Advertisement to appear time(s)

.....
Signature

FORMAT PRINTING HANDBOOK / "How to Estimate and Buy Format Printing" is the title of an unusual and complete new handbook designed to help architects, draftsmen, engineers, builders, etc., who have a need for printed formats. It provides a comprehensive word and diagram description of the title blocks, borders, trim lines, "ladders," mortises, zone and arrow markers that constitute what is known as a format or preprint. ■ Accupress Div., Bishop Graphics, Inc., North Hollywood, Calif.

circle 412 on inquiry card

WASTE CONTROL / This 48-page publication deals primarily with the waste and refuse control problems in commercial businesses and institutions. The handbook includes special sections on waste and refuse control for wholesale and retail operations; hospitals; schools; etc. ■ Tony Team Inc., Minneapolis, Minn.

circle 413 on inquiry card

ICE RINK REFRIGERATION / The company's brand is known as *Cold-Flo* and includes the complete manufacture and installation of the refrigeration package. In addition, the company will assist or conduct a feasibility study, cost analysis and render blueprint plans. A brochure describing the firm's services is available. ■ The Fleiter Co., St. Louis, Mo.

circle 414 on inquiry card

SAUNA CATALOG / Authentic Finnish saunas are featured, from small two-seaters to large cabana models; heaters with automatic remote controls are imported from Finland. All heating units are complete with rock and are UL listed. Available prefab or custom-made in a great variety of styles. ■ Helo Marketing Co., Thornwood, N.Y.*

circle 415 on inquiry card

RESIDENTIAL SECURITY SYSTEM / An eight-page brochure and data sheet describes a multifunction residential security system that warns residents in high-rise apartments, condominiums, townhouses or single-family dwellings of fire, intrusion or special emergencies. The brochure is especially geared to the needs of architects showing how the system can be easily specified and incorporated into a wide variety of building designs. ■ Westinghouse Electric Corp., Pittsburgh, Pa.*

circle 416 on inquiry card

PLUMBING FIXTURES / A condensed selection guide of plumbing fixtures and trim from a complete line including brass, closets, bathtubs, lavatories, sinks and decorator fixtures is offered. Large illustrations assist in the selection of fixtures and fittings. ■ Gerber Plumbing Fixture Corp., Chicago, Ill.

circle 417 on inquiry card

FLEXIBLE DUCT / A four-page bulletin describes in detail *Bendway*—an all-metal, hand-bendable duct available in aluminum, galvanized and stainless steel. The bulletin gives complete engineering data on the product; its construction; ease of installation; UL listing; friction loss data; and acoustical properties. ■ Flexaust Co., New York City.

circle 418 on inquiry card

*Additional product information in Sweet's
Architectural File

LET
SURE-KLEAN®
Weather Seal

● PROTECT
● SEAL
● RAIN-CLEAN
YOUR BUILDING

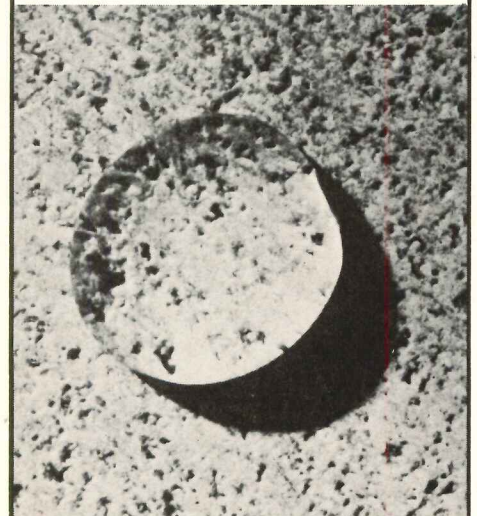

EVERY WALL
CAN BE
THIS
WATERPROOF

The time to use Sure Klean Weather Seal is immediately after cleaning. That's the way to keep dust, dirt and moisture out. Sure Klean Weather Seal out-weather's silicone and common acrylic coatings; is so efficient it gives building that clean, dry, non-streaked appearance even in the rain. Write for free information and complete lab test data. Clip and mail the coupon below today.



Process Solvent Co.
Box 4437
Kansas City, Kas. 66104

Please send me the Weather Seal story.

NAME _____

FIRM NAME _____

ADDRESS _____

CITY _____

STATE _____ ZIP _____

For more data, circle 145 on inquiry card

ADVERTISING INDEX

Prefiled catalogs of the manufacturers listed below are available in the 1973 Sweet's Catalog File as follows.

- A Architectural File (green)
- I Industrial Construction File (blue)
- L Light Construction File (yellow)
- D Interior Design File (black)

A	
Aerofin Corp.	194
A Alliance Wall Corporation	233
A-D Allied Chemical Corp., Fibers Div.	54
A-I-L Aluminum Co. of America	75
Amarlite Products Div.	193
American Appraisal Co.	32-4
A-L American Biltrite Rubber Co., Inc.	27
A-I-L American Plywood Association .	18
American Standard, Plumbing & Heating Div.	11
American Telephone & Telegraph	223
A-L Andersen Corp.	16-17
Architectural Record Books ...	204, 212
A-I-L-D Armstrong Cork Co. ...	2nd Cover to 3
A-L-D Artistic Brass Div.—Norris Industries	46
A-I-L ASG Industries Inc.	197
A AVM Corporation Jamestown Products Division	198
A-L Azrock Floor Products	3rd Cover
B	
A Bally Case & Cooler, Inc.	99
Bethlehem Steel Corp.	20-21
A-I Binkley Co., The	205
Blu-Ray, Inc.	169
A Bobrick Corporation, The	183
A-I Bradley Corporation	209
Bruning Division—Addressograph Multigraph Corporation	186
I Buffalo Forge Co.	182
Burke Rubber	32-1
A-I Burns & Russell Co.	204
C	
A-L Caradco Division of Scovill Mfg. Co.	211
A Carpenter & Co., Inc., L.E. ...	31-32, 164
Carpet Cushion Council	169
A-I Celotex Corp.	14-15
A-I Clark Door Co., Inc.	188
Columbus Coated Fabrics	189
A Combustion Engineering— C-E Glass Division	229
Commercial Carpet Corporation	25
Contemporary Marketing, Inc. ...	225
A Copper Development Association, Inc.	239
Cramer Industries, Inc.	19
Cross Company, A.T.	222
A Crouse-Hinds Company	52-53
D	
Deering Milliken, Inc.	191
Delta Air Lines	190
Delta Faucet Company	199
A-I Detroit Diesel Allison Div.— General Motors	82-83
Dietzgen Corp.	163
A Dover Corp., Elevator Div.	40
D DuPont De Nemours & Co., Inc., E.I.	92-93
A Duralab Equipment Corp.	162
E	
A Eastman Kodak Co.	30
A Eaton Corp., Lock & Hardware Div., Norton Door Closer Dept.	98, 195-196

A-I Ebco Mfg. Co.	70
Eljer Plumbingware Div., Wallace-Murray Corp.	177
Emhart Corp.	91
F	
A Follansbee Steel Corp.	208
G	
A-I-L-D GAF Corp., Building Products Division	102-103
A-I-L GAF Corp., Floor Products Division	50
A-I-L General Electric Co. ...	34-35, 160-161
General Electric Ballast Business Dept.	201
Georgia Dept. of Community Development	223
A-I-L-D Georgia-Pacific Corporation	95
A Gibson Homans Co.	233
A-L-D Goodrich General Products Co., B.F.	8, 198
A Goodyear Tire & Rubber Co. ...	23
A-I-L Grace & Co., Construction Products, W.R.	230
A-I Grefco, Inc., Building Products Division	45
Grinnell Fire Protection Systems Co., Inc.	202
Grumman Motorhome	225
GTE—Sylvania, I/C Lighting ...	76-77
Guth Lighting—Div. Sola Basic Industries	94
H	
Hager Hinge Company ...	173 to 176
A hc Products Co.	227-228
A-I Heatilator Fireplace	180
A-L-D Hercules Incorporated	78-79
Holophane Co., Inc.	24
Honeywell Photographic	224
Hubbell, Inc., Harvey	231
I	
A Ickes-Braun Glasshouses Inc. ...	204
International Masonry Institute .	57
A-D InterRoyal	58
ITT—Lighting Fixture Div.	49
J	
A Jamestown Products Division, AVM Corporation	198
A Jamison Door Co.	74
A Jewett Refrigeration	233
J.G. Furniture Company, Inc. ...	6-7
A-I-L-D Johns-Manville Corp. Architectural Division	210
Jute Carpet Backing Council, Inc.	243
K	
A-I-L Kaiser Aluminum & Chemical Corp.	104
A KDI Paragon	190
Kewaunee Scientific Equipment Corp.	44
A Kim Lighting Inc.	71
A-I Kinneair Corp.	238
A Kohler Company	62
A Koppers Company	165 to 168
A-D Krueger	169
L	
Lead Industries Assn. Inc.	236
A-I-L Libbey-Owens-Ford Co.	100-101
A Lundia Myers Industries Inc. ...	47
M	
A Massey Seating Co.	233
McGraw-Hill Books	32-2
Medusa Corp.	179
Mississippi Agricultural and Industrial Board	216
A Montgomery Elevator Co.	90
A Mosler/Airmatic Systems Division	206

N	
National Fire Protection Assn. ...	172
A-I-L-D National Gypsum Co.	80-81
A-D National Terrazzo	72-73
A-I-L Neenah Foundry Co.	44
A Nor-Lake Inc.	243
O	
A-L Olympic Stain Company	232
A-I-L-D Owens-Corning Fiberglas Corp.	60-61, 67
P	
A-L-D Panelfold Doors, Inc.	169
A Parker Co., Charles	172
A-L Pella Rolscreen Co.	213-214
Pfizer Inc.—Minerals, Pigments, Metals Div.	32-3
A-L-D Potlatch Forests, Inc.	238
PPG Industries Inc.	207, 244
A-L PPG Industries Inc., Commercial Glass	68-69
Pratt & Lambert Inc.	204
Process Solvent Co.	241
R	
Ralph Wilson Plastics	28-29
Rauland-Borg Corp.	46
Record Houses	234-235
Reflector Hardware—Educational Products Div.	63
A-I Republic Steel Corp.	181
R.H.S. Associates	233
A-L Rohm & Haas Company	200
A-I-L-D Ruberoid—GAF Corp. ...	50, 102-103
Russwin, Div. Emhart Corp.	91
S	
A Sargent & Company	12-13
Scope Furniture Inc.	66
Sheaffer World-Wide, Textron Co.	224
A Silbrico Corp.	162
Skycab, Service of Shulman Air Freight	22
Sloan Valve Company	4th Cover
A Smith, Elwin G. Div. Cyclops Corp.	187
A Soss Mfg. Co.	44
A Spencer Turbine Co.	162
Square D Company	96
Stem, Inc. Chester B.	46
Stran Steel	219
T	
A-I Taylor Co., The Halsey W.	237
A-I Thiokol Chemical Corp.	26
Titus Mfg. Corp.	88-89
A Tony Team, Inc., The	233
A TPI Corporation	178
A-I Trane Co.	84-85
A Tremco Mfg. Co.	158-159
Trus Joist Corp.	48
U	
Union Metal Mfg. Co.	65
A-I-D United States Gypsum Co.	185
A-L-D U.S. Plywood Corp.	203
A-I United States Steel Corp.	38-39
A-L Uvalde Rock Asphalt Co. ...	3rd Cover
W	
Watson Mfg. Co.	184
Welded Tube Company of America	51
Westinghouse Electric Corp.	192
Westinghouse Electric Corp.— Architectural Systems	86-87
A-I-L Weyerhaeuser Company	97
A Wide-Lite Corporation	170-171
Winnebago Industries, Inc.	221
A-D Wool Bureau Inc.	153 to 156



33 stories of long-life white: a dramatic first for DURACRON® coatings

ORIENT OVERSEAS ASSOCIATES
BUILDING, New York
Architect: I. M. Pei & Partners
Curtainwall and window fabricator: Lupton
Manufacturing Co., Aluminum Group,
Olin Corporation
DURACRON Coating applicator:
Aluminum Company of America

"88 Pine Street" offers more of special interest to architects and builders than distinctive beauty alone. This striking new addition to Manhattan's skyline is the first building constructed of aluminum curtain wall in a column-and-beam style. And to accentuate its face dramatically, it is also the first high-rise finished exclusively in a white organic coating. The result is a gleaming study in light and shadows—a clean, carefree appearance that will endure for years to come.

All spandrel panels and column covers were fabricated from aluminum extrusions, then factory finished with baked-on DURACRON Super 800 coating. This silicone-fortified acrylic finish from PPG offers outstanding durability and color integrity. In addition to excellent performance characteristics, this DURACRON coating provides the savings of a



moderately priced extrusion finish. For data on PPG color coatings, check Sweet's Architectural or Industrial Construction Files 9.10/PPG. Complete product information is available from Product Manager, Extrusion Coatings, PPG INDUSTRIES, Inc., Dept. 16W, One Gateway Center, Pittsburgh, Pa. 15222.

PPG: a Concern for the Future

Extrusion
Coatings 
INDUSTRIES



Azrock— the almost perfect floor...

for Schools

Azrock vinyl asbestos tile serves more school requirements more perfectly than any other type of flooring. Yet it costs less than half as much as it did 20 years ago. And today it's a better floor. Here's why you can specify Azrock with confidence:

- Styled to coordinate with contemporary interiors
- Long lasting durability
- Fire safe, will not support combustion
- Shock proof
- Easy, economical cleaning and stain removal
- Resilient underfoot comfort
- Lowest motion resistance
- Non-allergenic, mildew proof, no odor retention
- Exceeds federal specifications
- Low-cost maintenance
- Low initial cost

More vinyl asbestos tile is used in schools than any other kind of flooring. Keep taxpayers happy and save funds for better education with low-cost Azrock vinyl asbestos tile—the best floor for schools.

Floor shown: Custom Cortina, one of over 150 colors and styles.

the vinyl asbestos
floor tile people



Write for free samples and No-Wax Maintenance information.
Azrock Floor Products, 521 A Frost Bldg., San Antonio, Texas 78292.

For more data, circle 149 on inquiry card

ARCHITECTS
Kivett and Myers
GENERAL CONTRACTOR
Del E. Webb Corp.

ENGINEERS
Burns & McDonnell Engineering Co.
MECHANICAL CONTRACTOR
Limbach Co.

PLUMBING WHOLESALER
Missouri-Kansas Supply Co.
FIXTURE MANUFACTURER
Eljer Plumbingware

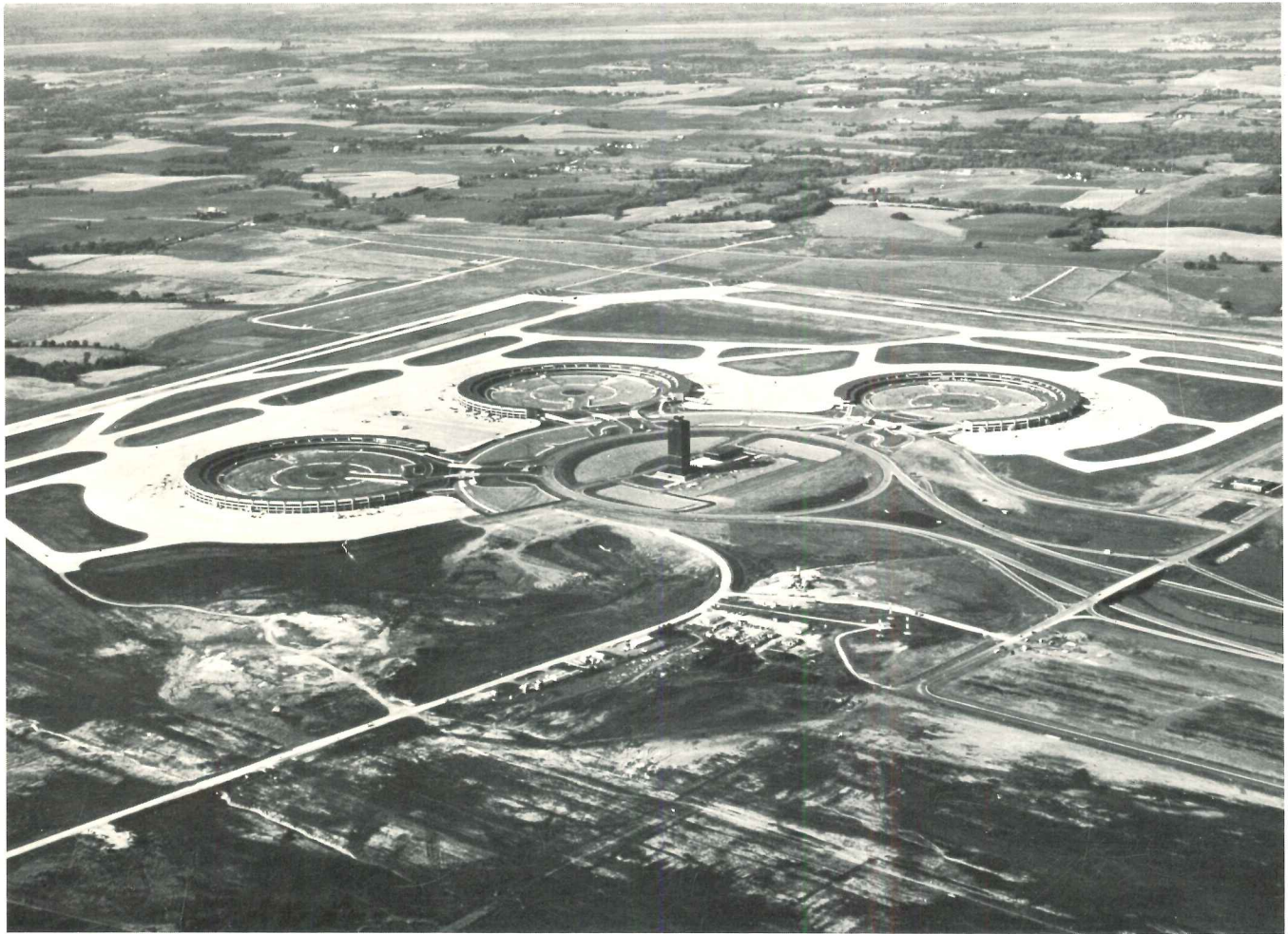

New Kansas City air terminal built from scratch for jet age

A marvel of the jet age is K.C.I.—Kansas City's International airport—a \$250 million dollar installation consisting of three circular terminals, air cargo facilities, two commissaries, a post office and a new control tower.

The new terminal provides Kansas City with a truly competitive airport in terms of size, accommodations for passengers and cargo, and most important, the capacity to handle Category II landings (100 foot ceiling and one quarter mile horizontal visibility).

A visitor is overwhelmed by the features of K.C.I.—three-lane roadways lead to the attractive sand-colored buildings which resemble stone rather than concrete; wood paneling, rough textures, and huge panels of glass complement the inside. Unique are its restrooms with showers and angled entranceways requiring no doors.

The careful planning that brought this

outstanding terminal complex into being resulted in the selection of only the finest components throughout. So, just as in America's finest commercial buildings—wherever good looks, good taste and good performance are imperative—selection of Sloan Flush Valves was a matter of course.

Dramatically restyled, with totally new contours, the new regal appearance of Sloan Flush Valves reflects the traditional quality that has sustained their leadership for over sixty-five years.

For flush valves to match the highest quality of your building components, specify Sloan Flush Valves—most people do.



SLOAN VALVE COMPANY

10500 Seymour Ave. • Franklin Park, Ill. 60131

For more data, circle 150 on inquiry card