

ARCHITECTURAL
RECORD

Business Design Engineering
A McGraw-Hill Publication, Six Dollars a Copy
January 1983

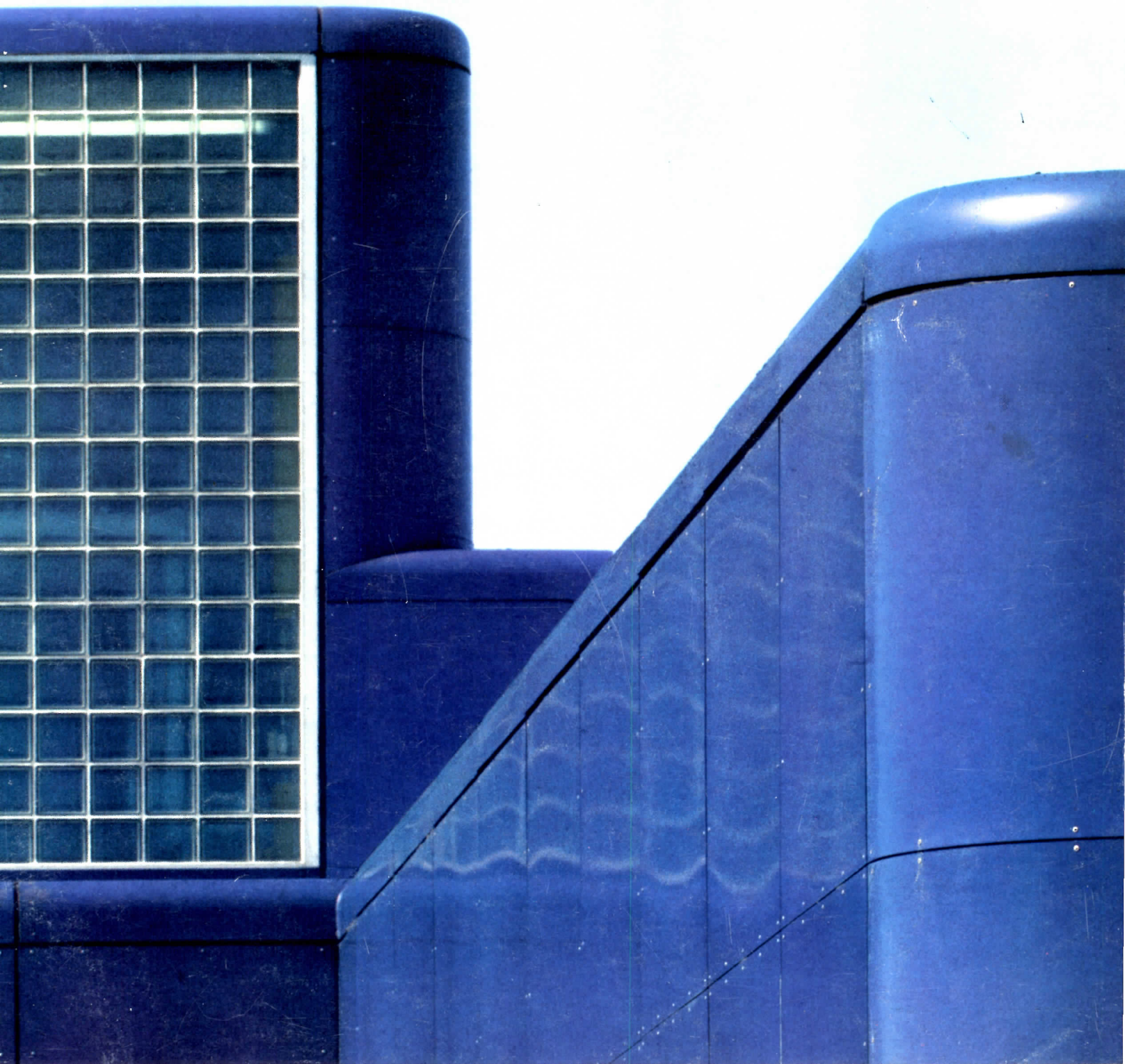

Exceptional looks. Extraordinary logic.

Any way you look at an Elkay water cooler, it looks good.

Outside, you'll appreciate the clean lines and timeless appearance. Ideal for both new construction and retrofit. Inside, dependable, quality engineering. And an open area for easy access and installation. Features that save time and money.

Choose from a full line of energy-efficient floor, wall, compact, and barrier-free models. Available in contemporary colors, stainless steel or bronzetone finishes.

Elkay quality. Reflected in everything we do.

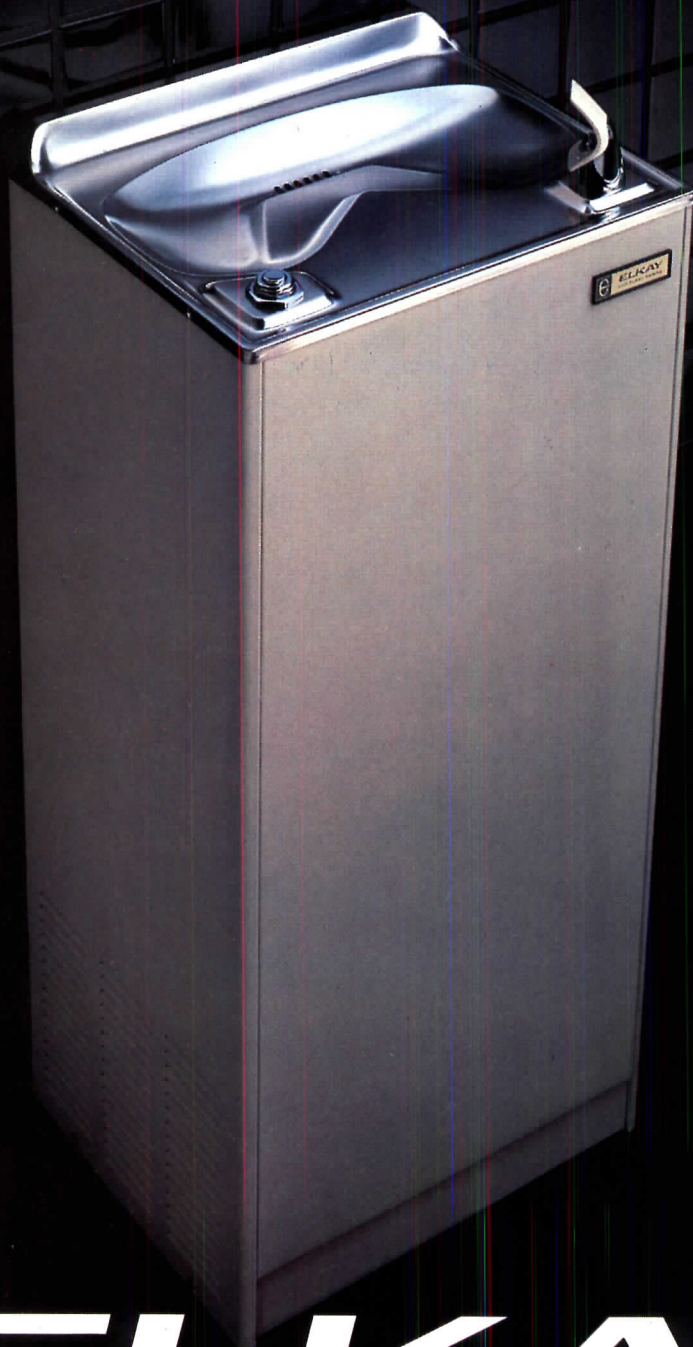

ELKAY®

For more water cooler information, please write:
Elkay Manufacturing Co., 2222 Camden Court, Oak Brook, IL 60521.

Circle 4 on inquiry card

Editor
Walter F. Wagner, Jr., AIA

Executive editor
Mildred F. Schmertz, FAIA

Managing editor
Natalie Gerardi

Senior editors
Robert E. Fischer, engineering
Herbert L. Smith, Jr., AIA, business
Charles K. Gande
Douglas Brenner

Associate editors
Grace M. Anderson
James B. Gardner
Margaret F. Gaskie
Charles K. Hoyt, AIA

Editorial assistant
Lindsay Li

Production editor
Annette K. Netburn
Susan Stein, assistant

Design
Alex H. Stillano, director
Alberto Bucchiameri, senior associate
Anna-Maria Egger, associate
Muriel Cuttrell, illustration
J. Dyck Fledderus, illustration

Design consultant
Massimo Vignelli

Editorial consultants
George A. Christie, Jr.
Jonathan Barnett, FAIA, AICP

McGraw-Hill World News
Peter Gall, director

Circulation director
Richard H. Di Vecchio

Business manager
Joseph R. Wunk
Ellen Muller Siegel, assistant

Marketing services manager
Camille H. Padula

Director of national advertising
Harrington A. Rose

Assistant to publisher
Elizabeth Hayman

Publisher
Paul B. Beatty

Letters/calendar, 4

Cartoon, 6

Editorial: A little anniversary, a little more evolution, 9

Business

News, 35

Management: Coping with insured liability claims, 37

Economics: The rise and fall of the high-rise, 39

Marketing: What are the aggressive firms doing to get their share of design work?, 43

The profitable professional: Target your goals and priorities, 47

Design

News, 59

Design awards/competitions, 64

Building Types Study 589: Mental health care facilities, 85

The Menninger Foundation, Topeka, Kansas, 86

by Skidmore, Owings & Merrill/Kiene & Bradley Design Group

The Harbour Hospital, Jamaica Plain, Massachusetts, 94

by Graham/Meus Inc., Architects

Wyman-Gordon Pavilion, Ingalls Memorial Hospital,

Harvey, Illinois, 98

by Perkins & Will, Architects

"For health care providers too: an outlook of stressful—but hopeful—change," 102

An article by Michael Bobrow and Julia Thomas

North Shore Congregation Israel, Glencoe, Illinois, 104

by Hammond Beeby and Babka, Architects

A minimalist architecture of allusion, 114

Current projects by Frank Gehry

"Still planning with the poor:

Community design centers keep up the good works," 126

by Paul M. Sachner

Covington Restaurant, Armonk, New York, 132

by Mark Cigolle, Architect

Engineering

The right environment means business, 136

Lighting and acoustics work for a trading room

A project that takes passive energy seriously, 138

In a Glasgow complex, a glass envelope saves energy

New products, 144

Product literature, 151

Classified advertising, 196

Office notes, 197

Advertising index, 210

Reader service card, 213

Cover:

North Shore Congregation Israel

Glencoe, Illinois

Hammond Beeby and Babka, Architects

Photographer: Timothy Hursley

Why isn't this wood burning ?



Because it's a fire retardant material so special it's patented.

The U.S. Patent Office recognizes the uniqueness of *Dricon*[®] fire retardant treated wood. So does Underwriters Laboratories Inc. *Dricon* wood is the only low-hygroscopic treated wood of its type with UL's FR-S designation for all species listed. You can specify *Dricon* treated lumber with complete confidence.

You can also specify it without misgivings about moisture-related problems...even where relative humidity could reach 95%. Tests show that *Dricon* treated wood is no more corrosive than untreated wood. Because of its low moisture-absorption property, stains and other finishes will not be harmed. And metal plates, hardware,

pipes and conduits will not be corroded by contact with *Dricon* wood in trusses, joists, studs, beams and other concealed members.

Your client will appreciate its workability. Since it is wood, *Dricon* wood can be cut, drilled, planed, sanded and otherwise worked as readily and inexpensively as wood, during construction or future remodeling. *Dricon* fire retardant treated wood exceeds the requirements of all four national model building codes and qualifies for

DRICON[®]

Fire Retardant Treated Wood

UL Class I roof systems. Specify economical *Dricon* treated lumber and plywood—the patented fire retardant treated wood with an FR-S rating.

Editor
Walter F. Wagner, Jr. AIA

Executive editor
Mildred F. Schmertz, FAIA

Managing editor
Natalie Gerardi

Senior editors
Robert E. Fischer, engineering
Herbert L. Smith, Jr., AIA, business
Charles K. Gandee
Douglas Brenner

Associate editors
Grace M. Anderson
James B. Gardner
Margaret F. Gaskie
Charles K. Hoyt, AIA

Assistant editor
Lindsay Li, products

Production editor
Annette K. Netburn
Susan Stein, assistant

Design
Alex H. Stillano, director
Alberto Bucchianeri, senior associate
Anna-Maria Egger, associate
Muriel Cuttrell, illustration
J. Dyck Fledderus, illustration

Design consultant
Massimo Vignelli

Editorial consultants
George A. Christie, Jr.
Jonathan Barnett, FAIA, AICP

McGraw-Hill World News
Peter Gall, director

Circulation director
Richard H. Di Vecchio

Business manager
Joseph R. Wunk
Ellen Muller Siegel, assistant

Marketing services manager
Camille H. Padula

Director of national advertising
Harrington A. Rose

Assistant to publisher
Elizabeth Hayman

Publisher
Paul B. Beatty

Letters/calendar, 4
Cartoon, 6
Editorial: A nearly-80-year-old architect talks about what seems important now, 9

Business

AIA Convention News, 35
Economics: The economy is positioned for a sustained recovery, 41
Management: The benefits of disability insurance, 43
Computers: Selecting the right CAD system for your office, 45
Construction costs: New upward pressures, 49

Design

News, 65
Design awards/competitions, 70

Building Types Study 590: Multifamily housing, 87
Windswept, Kiawah Island, South Carolina, 88

by Sandy & Babcock, Architects

The Imperial at Brickell, Miami, 92

by Arquitectonica, Architects

Chestnut Place Apartments, Chicago, 96

by Weese Seegers Sickey Weese, Architects

Pensacola Place, Chicago, 98

by Tigerman Fugman McCurry, Architects

Claffin Park, Newtonville, Massachusetts, 100

by Sasaki Associates, Inc., Architects

New layers of meaning, 104

Works in progress by Cesar Pelli

Johnson study/library, New Canaan, Connecticut, 114

by Philip Johnson, Architect

Blue collar buildings, 120

CF-14 (Fire Station), Chicago, 120

by Booth/Hansen & Associates, Architects

Con Edison Customer Service Facility, Bronx, New York, 124

by Richard Dattner, Architect

Independence National Historical Park

Maintenance Facility, Philadelphia, 126

by Mitchell/Giurgola Architects

One Post Office Square, Boston, 128

by Jung/Brannen Associates, Inc., Architects

Engineering

Roofs that work, 136

Product literature, 144

New products, 153

Office notes, 181

Classified advertising, 180

Advertising index, 194

Reader service card, 197

Cover:

The Imperial at Brickell

Miami, Florida

Arquitectonica, Architects

Photographer: Chas. McGrath

Cover:

School of Agriculture

Spilimbergo, Italy

Renato Severino, Architects & Planners

Photographer: Riccardo Toffoletti

Thonet, a legend in furniture design, has crafted a limited edition hexagonal storage unit conceived by R. Buckminster Fuller, the twentieth century design scientist. Because it epitomizes his synergistic and dymaxion theories, every collector of unique furniture will want to own one.

Bucky named his only furniture design and last great invention the HANG IT ALL™ storage unit. It can be ceiling suspended or stand on a base. The six sided unit has twelve parallelepiped storage sections for books, records or memorabilia.

Ultrasonic chrome in color, the HANG IT ALL™ storage unit measures W24" x D21" x H54" when suspended by six cables or W24" x D21" x H60" on its base. A certificate of authenticity and information booklet is provided and each unit has a limited edition signature plaque attached.

Participate in this union of legacies with your purchase of the HANG IT ALL™ storage unit.



20" x 36" Poster
Thonet Recognizes R. Buckminster Fuller
1895-1983
Available in a limited and general edition series

Please send me the following.
My check or money order to THONET is enclosed.

- _____ HANG IT ALL™ Storage Unit. Limited edition of 500.
\$870 delivered, domestic USA.
\$900 to USA Port of Exit, outside USA
(Include shipping instructions).
- _____ Limited edition poster of 250.
Serigraph on metal. \$100 delivered.
- _____ General edition poster of 5000.
Silver ink on paper. \$10 delivered.

Attach this coupon to your letterhead and mail with payment to:
THONET, Dept PM, Box 1587, 491 East Princess Street, York, PA 17405

Circle 4 on inquiry card

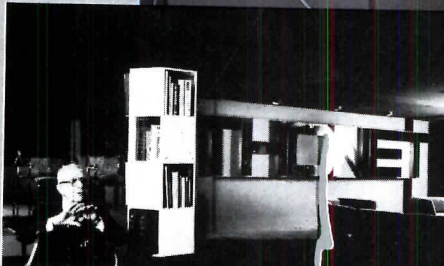

R. Buckminster Fuller

Thonet and
Buckminster Fuller.
A Union of Legacies.

THONET

Editor
Walter F. Wagner, Jr. AIA

Executive editor
Mildred F. Schmertz, FAIA

Managing editor
Natalie Gerardi

Senior editors
Robert E. Fischer, engineering
Herbert L. Smith, Jr., AIA, business
Charles K. Gondee
Douglas Brenner

Associate editors
Grace M. Anderson
James E. Gardner
Margaret F. Gaskie
Charles K. Hoyt, AIA

Assistant editors
Lindsay Li, products
Paul M. Sachner

Production editor
Annette K. Netburn
Susan Stein, assistant

Design
Alex H. Stillano, director
Alberto Bucchianeri, senior associate
Anna-Maria Egger, associate
Muriel Cuttrell, illustration
J. Dyck Fledderus, illustration

Design consultant
Massimo Vignelli

Editorial consultants
George A. Christie, Jr.
Jonathan Barnett, FAIA, AICP

McGraw-Hill World News
Peter Gall, director

Circulation director
Richard H. Di Vecchio

Business manager
Joseph R. Wunk
Ellen Muller Siegel, assistant

Marketing services manager
Camille H. Padula

Director of national advertising
Harrington A. Rose

Assistant to publisher
Elizabeth Hayman

Publisher
Paul B. Beatty

Letters/calendar, 4
Editorial: Product Reports 1984:
The manufacturer as part of the team, 39

Business

News, 15
Computers: CAD versus CAD, 19

Design

News, 23
Battery Park City:
A new residential skyline for downtown New York, 28

Engineering

Round Table: Conserving energy in the rehabilitated
or retrofitted building, 30

Products/Literature

UCI 1 Office equipment and supplies, 40
UCI 2 Site work, 56
UCI 3 Concrete, 59
UCI 4 Masonry, 60
UCI 5 Metals, 60
UCI 6 Wood and plastics, 70
UCI 7 Thermal and moisture protection, 74
UCI 8 Doors and windows, 103
UCI 9 Finishes, 141
UCI 10 Specialties, 157
UCI 11 Equipment, 169
UCI 12 Furnishings, 171
UCI 13 Special construction, 188
UCI 14 Conveying systems, 197
UCI 15 Mechanical, 200
UCI 16 Electrical, 211

Classified advertising, 230
1982 Editorial index, 238
Advertising index, 251
Editorial manufacturers' index, 6
Reader service cards, 9, 253

Georgetown University's Riggs Library, published in *Record Interiors 1983*, brought back memories of studying in the Andrew D. White Room of Cornell University's undergraduate library. Unfortunately, I usually did not get much done there since I would instead gaze distractedly at the wonderful architecture of the room. Like the Riggs Library, the towering space is filled with three levels of an ornate steel shelving structure which features overhead bridges, remote spiral staircases and secluded study alcoves, not to mention the ever-present curlicues of the Victorian style. As the space rises upward, it also expands outward in the form of a sumptuous bay window which provides a magnificent view of Cayuga Lake and the valley below. The ground level of the room contrasts the spaciousness with dark wood paneling, rich hunter-green carpet and robust furniture. As a student, I appreciated this retreat which Cornell's administration permitted me to use, and now, although I admittedly do not know the background of Georgetown's policy, I find it a shame that Georgetown's students are denied a similar privilege.

*Ellen Talbot, Interior Designer
Washington, D.C.*

With reference to your call for submissions to the 1984 *Record Houses* awards program, the jury should consist of people with diverging ideologies: organic, structural, Le Corbu, etc. Lately, it has been heavily weighted toward the monstrosity of "postmodernism," which has set back architecture 50 years, just as the Chicago "Columbian Exposition" did.

If you want fresh new work, also disqualify any firm that has previously appeared in *Record Houses*. We seem to get the same firms year after year.

*Alfredo Larin, AIA
San Diego, California*

May I take this opportunity to express the deep appreciation of all of us at the New York Landmarks Conservancy for the arena of exposure you have provided (October, 1983). The chronicle of our first ten years presented in such celebratory fashion is an inestimable boost to both Conservancy staff and board.

Of equal and far-reaching consequence, the ARCHITECTURAL RECORD piece is the occasion to tell the rest of the world what motivates us and provides the *raison d'être* of the Conservancy.

*Laurie Beckelman
Executive Director
New York Landmarks
Conservancy
New York City*

Corrections

We very much regret our inadvertent omission of Dian Boone's name from the list of consultants that appeared in your article on Wu Hall at Princeton University. Dian Boone's part in the interior design and furnishings of Wu Hall was crucial and we particularly regret the omission because of our long and valued association with her.

We also inadvertently omitted to mention Samuel Y. Harris, from our office, who was responsible for technical coordination and quality maintenance.

*Robert Venturi, FAIA
Philadelphia, Pennsylvania*

Re: ARCHITECTURAL RECORD, June 1983, page 95, I would like to make a correction to your caption for the Arbour Hospital. The building envelope is R-Wall which is manufactured by ISPO, Inc. I apologize for my tardiness in supplying this information to you.

However, the error was just brought to my attention today by Mr. Karl Hanton of Graham/Meus, Architects with whom we had consulted in the design/specification stage.

*William O. Bishop, P.E.
Director of Technical Services
ISPO, Inc.
Mansfield, Mass.*

December 14 to February 19
"Design In America: The Cranbrook Vision 1925-1950." 240 masterworks of the Cranbrook Academy of Art from its creation up until the death of its founder; at the Detroit Institute of Arts, 5200 Woodward Ave., Detroit, Mich. 48202 (313/833-7963).

Through January 15
"Lafayette Square 1963-1983: Architecture, Preservation and the Presidency." President John F. Kennedy's efforts to preserve Lafayette Square are depicted in photographs, drawings, architectural renderings and archives; at the Renwick Gallery, Pennsylvania & 17 St., Washington, D.C. (202/357-1300).

January 24-26
"Window Treatments '84" is a trade show of window treatment products; sponsored by Window Energy Systems (WES) Div. of the Industrial Fabrics Assn. International; at the Sheraton Center in New York City. To register, contact: WES, 345 Cedar Building, Suite 450, St. Paul, Minn. 55101 (612/222-2508).

January 27
Architectural Competitions; sponsored by the Architecture and Design Support Group of the Museum of Contemporary Art. At the UCLA Graduate School of Architecture, Los Angeles, Calif. (213/854-6307).

January 25-27
Business Telecommunications Exposition for communications managers; at Giants Stadium, Stadium Club, East Rutherford, N.J. For further information, contact: Michael C. J. Houston, T.E.G., Inc., 9128 Columbia Ave., North Bergen, N.J. 07047 (201/662-1318).

Through January 29
"Cervin Robinson: Photographs 1958-1983"; exhibition of photos of historic and recent buildings by Frank Furness, Louis Sullivan and Louis Kahn; organized by Rice Univ., at Wellesley College Museum, Wellesley, Mass. (617/235-0320).

February 3-5
Conference, "Leadership and Conflict Resolution for Engineers and Technical Professionals." Sponsored by Engineers Leadership Institute; at Bergamo Conference Center, Dayton, Ohio (614/424-6645).

February 6-9
International Modal Analysis Conference outlines technological advances in modal analysis for vibrating structures. Sponsored by Union College; at the Holiday Inn, International Drive, Orlando, Fla. (518/370-6288).

ARCHITECTURAL RECORD (Combined with AMERICAN ARCHITECT, and WESTERN ARCHITECT AND ENGINEER) (ISSN0003-858X) December 1983, Vol. 171, No. 14. Title® reg. in U. S. Patent Office, copyright® 1983 by McGraw-Hill, Inc. All rights reserved. Indexed in Reader's Guide to Periodical Literature, Art Index, Applied Science and Technology Index, Engineering Index, The Architectural Index and the Architectural Periodicals Index. Every possible effort will be made to return material submitted for possible publication (if accompanied by stamped, addressed envelope), but the editors and the corporation will not be responsible for loss or damage.

Executive, Editorial, Circulation and Advertising Offices: 1221 Avenue of the Americas, New York, NY 10020.
Officers of McGraw-Hill Publications Company: president: John G. Wrede; executive vice presidents: Paul F. McPherson, operations; Walter D. Serwatka, finance and services; Senior vice president-editorial: Ralph R. Schulz. Senior vice president publishers: Harry L. Brown, David J. McGrath, James R. Pierce, Gene W. Simpson, John E. Slater. Vice president publishers: Charlton H. Calhoun III, Richard H. Larsen, John W. Patten. Vice presidents: Kemp Anderson, business systems development; Shel F. Asen, manufacturing; John A. Bunyan, electronic information services; George R. Elsing, circulation; Michael K. Hehir, controller; Eric B. Herr, planning and development; H. John Sweger, Jr., marketing.
Corporation Officers: Harold W. McGraw, Jr. chairman; Joseph L. Dionne, president and chief executive officer; Robert N. Landes, senior vice president and secretary; Ralph J. Webb, treasurer.

Associated Services / McGraw-Hill Information Systems Co.: Sweet's Catalog Files (General Building, Engineering, Industrial Construction and Renovation, Light Residential Construction, Interiors), Dodge Building Cost Services, Dodge Reports and Bulletins, Dodge/SCAN Microfilm Systems, Dodge Management Control Service, Dodge Construction Statistics, Dodge regional construction newspapers (Chicago, Denver, Los Angeles, San Francisco).
Subscription rates for personnel of Architectural, Engineering, Interior Design, Design and other directly related firms and students thereof, are as follows: U.S. and U.S. Possessions \$30.00; Canada \$32.00; all other countries \$60.00. For all other personnel: U.S. and U.S. Possessions \$41.00; Canada \$43.00; all other countries \$68.00. Publisher reserves right to determine subscription rates which apply. Single copy price for Domestic and Canadian: \$6.00; for Foreign: \$7.00.
Change of Address: Forward changes of address or service letters to Fulfillment Manager, ARCHITECTURAL RECORD, P.O. Box 430, Hightstown, NJ 08520. Provide both old and new address; include zip code; if possible attach issue address label.

Guarantee: Publisher agrees to refund that part of subscription price applying to unfilled part of subscription if service is unsatisfactory.
Copyright and Reprinting: Title® reg. in U. S. Patent Office. Copyright® 1983 by McGraw-Hill, Inc. All rights reserved. Where necessary, permission is granted by the copyright owner for libraries and others registered with the Copyright Clearance Center (CCC) to photocopy any article herein for the base fee of \$1.50 per copy of the article plus 10 cents per page. Payment should be sent directly to the CCC, 21 Congress Street, Salem, MA 01970. Include code with request: ISSN0003-858X (\$1.50+.10). Written permission must be secured for any other copying. Write Reprint Manager for such permission at address below, or to obtain quotations on bulk orders.

Subscription List Usage: Advertisers may use our list to mail information to readers. To be excluded from such mailings, subscribers should send a request to: ARCHITECTURAL RECORD, Mailing List Manager, P.O. Box 555, Hightstown, N.J. 08520.
Publication Office: 1221 Avenue of the Americas, New York, New York, 10020. ARCHITECTURAL RECORD (ISSN0003 858X) published monthly except May and September when semi-monthly, by McGraw-Hill, Inc. Second-class postage paid at New York, NY and additional mailing offices.

Postmaster: Please send address changes to Fulfillment Manager, ARCHITECTURAL RECORD, P.O. Box 430, Hightstown, NJ 08520. THIS ISSUE is published in national and separate editions. Additional pages or separate editions numbered or allowed for as follows: Eastern Section 22Ea through 22Ed. Central Section 22Ca through 22Cb. Western Section 22Wa through 22Wd. Sunbelt Section 22Sa through 22Sd.

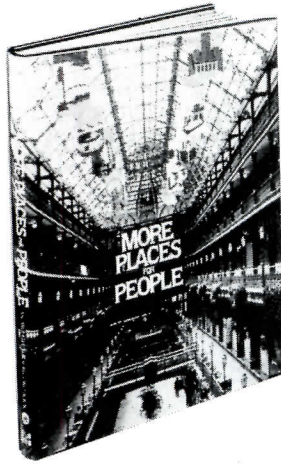

MORE PLACES FOR PEOPLE

edited by Charles K. Hoyt

From its initial spotlight on the exciting theater created by dramatic public spaces in hotels — lobbies that act as magnets to draw guests and passersby alike — to its exploration of stadium and arena design — where increasingly the same space must accommodate not only sports, but theater, dance, concerts, even banquets — the 43 projects in this new sequel to *Places for People* offer hundreds of ideas for designing places where people will gather for leisure events — places that are often breathtaking events in themselves. The case studies include resorts, parks, urban marketplaces, restaurants, and athletic facilities — not only new buildings, but many examples of renovation and adaptive reuse.

200 pgs; over 400 photos, plans and sections; 8 pgs in color
\$39.95

Use the coupon at right to order

Please send the books indicated at left to me for a free examination. At the end of 15 days, I will either remit in full, plus local tax and postage, or return the books.

name _____

street _____

city/state/zip _____

Pay with order and save! Remit in full, plus local tax, and McGraw-Hill pays regular postage and handling. Full return privileges.

The Purrrfect Pair



A table and chair
Made For
Each Other

Write for free catalog

Now you can have a Plan Hold drafting chair and table that not only work well together, they *look great* together! We created just the right chair with a soil and stain resistant Autumn Haze fabric to match our Autumn Haze drafting table. The NEW 402CH Graphic Arts Chair at \$179 list...the 370TA Drafting Tables from \$310 list. See your Plan Hold Dealer for your "Purrrfect Pair"

PLAN HOLD
17421 Von Karman Avenue • Irvine, California 92714-6293

Dealers in all Major U.S. Cities and Canada

Circle 1150 on inquiry card

Send this coupon to
ARCHITECTURAL RECORD
BOOK/REPRINT DEPARTMENT
1221 AVE OF THE AMERICAS
NEW YORK, NEW YORK 10020
Send this coupon to

...the *Architectural Record* books described on this page and on pages 223, 227, and 233...

- MORE HOUSES ARCHITECTS DESIGN FOR THEMSELVES \$34.50
- 25 YEARS OF RECORD HOUSES \$39.95
- NEW LIFE FOR OLD BUILDINGS \$34.50
- MORE PLACES FOR PEOPLE \$39.95

**PLEASE
SEND
ME**

Architectural Record Vol. 171.
January-December 1983.
Published by McGraw-Hill, Inc.,
1221 Avenue of the Americas,
New York, New York 10020.

Copyright 1983.
All rights reserved.

Readers using this index will find buildings entered in at least three ways: by architect's name, by building or owner's name, and by building type (banks, medical facilities, schools, etc.). Projects featured in Building Types Studies are identified by the abbreviation BTS before the page number.

A

Acoustics—Hult Center for the Performing Arts [Acoustics], Eugene, OR; Jaffe Assoc., acoustics, Hardy Holzman Pfeiffer Assoc., archts—May 1983, pp. 130-133 • Steelcase Headquarters Building, Grand Rapids, MI; WBDC, archts, with Steelcase dsgrs—Nov. 1983, pp. 132-135.

Adaptive Use (see also *Additions, Preservation, and Renovations & Restorations*)—Bank of America Plaza [Biltmore Hotel renovation], New York, NY; Environetics Architect P.C., archts—Jan. 1983, pp. 128-133 • Batey & Mack Office, San Francisco, CA; Batey & Mack, archts—Sept-1 1983, pp. 120-121 • Brooklyn Bridge Anchorage Restoration, New York, NY; Smotrich & Platt, archts—Aug. 1983, pp. 124-127 • Church of St. Ann and the Holy Trinity, Brooklyn Heights, NY; Hardy Holzman Pfeiffer Associates, archts—Oct. 1983, BTS, pp. 92-95 • Clafin Park, Newtonville, MA; Sasaki Associates, archts—July 1983, BTS, pp. 100-103 • Federal Archives Building, New York, NY; Warner, Burns, Toan & Lunde, archts—Oct. 1983, BTS, pp. 92-95 • Five 1880s Warehouse Renovations, New York, NY; Stephen E. Jacobs & Associates, archts—Oct. 1983, BTS, pp. 92-95 • Jessica Gunne Sax Headquarters, San Francisco, CA; Hanns Kainz & Associates, archts—Sept-1 1983, pp. 102-107 • Landor Associates Offices, New York, NY; Landor Associates with Penney & Bernstein, archts—Jan. 1983, BTS, pp. 92-94 • Meola Studio and Apartment, New York, NY; Gillis Associates, archts—Nov. 1983, pp. 120-123 • New York University Graduate School of Business Library, New York, NY; Voorsanger & Mills Associates, archts—Aug. 1983, BTS, pp. 80-83 • One Post Office Square, Boston, MA; Jung/Brannen Associates, archts—July 1983, pp. 128-135 • Seagram Museum and Archives, Waterloo, Ontario, Canada; Barton Myers Associates, archts—Feb. 1983, pp. 92-95 • Seattle Garden Center, Seattle, WA; Arne Bystrom, archt—Apr. 1983, pp. 150-151 • Springer Building, Galveston, TX; Taft Architects, archts—Sept-1 1983, p. 144-145 and Oct. 1983, BTS, pp. 102-105 • Station Square, Commerce Court, and The Freighthouse Shops, Pittsburgh History & Landmark Foundation, developers—Oct. 1983, BTS, pp. 96-101 • Town-house Renovation, Boston, MA; Graham Gund Associates, archts—Mid-May 1983, pp. 134-137.

Additions—North Shore Congregation Israel, Glencoe, IL; Hammond Beebe and Babka, archts—June 1983, pp. 104-113 • Russell Sage College, Albany Campus Center, Albany, NY; Architectural Resources Cambridge, archts—Nov. 1983, BTS, pp. 102-103 • Seagram Museum and Archives, Waterloo, Ontario, Canada; Barton Myers Associates, archts—Feb. 1983, pp. 92-95.

Aga Khan Award for Architecture—Azem Palace Reconstruction, Damascus, Syria; Shafiq Imam, archt—Sept-2 1983, BTS, p. 74 • Ca-

kirhan Residence, Akyaka Village, Turkey; Nail Cakirhan, dsgr—Sept-2 1983, BTS, pp. 82-83 • Darb Qirmiz Revitalization, Cairo, Egypt; Philip Speiser, archt—Sept-2 1983, BTS, p. 75 • Great Mosque of Niono, Niono, Mali; Lassine Minta, master mason—Sept-2 1983, BTS, pp. 72-73 • Hafsia Quarter, Medina of Tunis, Tunisia; Wassim bin Mahmoud with Arno Heinz, archts—Sept-2 1983, BTS, pp. 80-81 • King Abdul-Aziz International Airport, Hajj Terminal, Jeddah, Saudi Arabia; Skidmore, Owings & Merrill, archts—Sept-2 1983, BTS, pp. 84-85 • Residence Andalous, Sousse, Tunisia; Serge Santelli, archt—Sept-2 1983, BTS, pp. 76-79 • Sherefudin's White Mosque, Visoko, Yugoslavia; Zlatko Ugljen, archt—Sept-2 1983, BTS, pp. 68-71 • Tanjung Jara Beach Hotel and Rantau Abang Visitors' Center, Kuala Trenggnau, Malaysia; Whisenand, Allison, Tong and Goo, archts—Sept-2 1983, BTS, p. 75 • Tomb of Shah Rukn-i Alam Restoration, Multan, Pakistan; Muhammad Wali Ullah Khan, archt—Sept-2 1983, BTS, p. 74 • Wissa Wassef Arts Center, Giza-Cairo, Egypt; Ramses Wissa Wassef, archt—Sept-2 1983, BTS, p. 81.

AIA—"The AIA reaches out nationally—to influence the government and the public," by Walter F. Wagner, Jr.—Mar. 1983, p. 9 • "AIA seminar yields sophisticated advice on working abroad," by Peter Hoffman—Jan. 1983, p. 33 • "Bylaw changes and resolutions: No revolutions"—July 1983, p. 35 • "Convention mood: Kind of calm and quiet this year"—July 1983, p. 35 • "It is time to register for the annual AIA Convention"—Apr. 1983, p. 35 • "It's convention time... Is it also time to think of conventions as a place to think?", by Walter F. Wagner, Jr.—May 1983, p. 9 • "A nearly 80-year-old architect [Nathaniel Alexander Owings] talks about what seems important now," by Walter F. Wagner, Jr.—July 1983, p. 9 • "Professional development: Seminars on preservation, computers, and business management"—July 1983, p. 37 • "Theme speeches: The role of architecture for the nation, the city and the individual"—July 1983, pp. 39, 52.

Airports—King Abdul-Aziz International Airport, Hajj Terminal, Jeddah, Saudi Arabia; Skidmore, Owings & Merrill, archts—Sept-2 1983, BTS, pp. 84-85.

Ames, Anthony, archt—"Anthony Ames, architect/delineator"—Aug. 1983, pp. 96-103 • Friedrich Stadt, East Berlin, East Germany—Aug. 1983, pp. 102-103 • Garden Pavilion, Atlanta, GA—Aug. 1983, p. 101 • Pickering House, Laurel, MI—Aug. 1983, pp. 98-99 • Villa Augusta, Augusta, GA—Aug. 1983, p. 100 • Villa Chang, Augusta, GA—Aug. 1983, p. 97.

Amoco Building, Denver CO—Kohn Pederson Fox Associates, archts—Feb. 1983, p. 125.

Amsler Hagenah MacLean, archts—Phillips Exeter Academy, Frederick R. Mayer Art Center, Exeter, NH—Nov. 1983, BTS, pp. 96-101.

Anaconda Tower, Denver, CO—Skidmore, Owings & Merrill, archts—Feb. 1983, p. 125.

Anchorage Headquarters Library Competition Entry, Anchorage, AK—Gunnar Birkerts & Associates, archts—Mar. 1983, pp. 108-109.

Anspach Grossman Portugal Offices, New York, NY—Samuel J. De Santo & Associates, archts—Sept-1 1983, pp. 116-119.

Apartments—see *Housing & Apartments*

Arbours Hospital, Jamaica Plain, MA—Graham/Meus, archts—June 1983, BTS, pp. 94-97.

Architect/Designer (*portfolios and retrospectives*)—Ames, Anthony; "Anthony Ames, architect/delineator"—Aug. 1983, pp. 96-103 • Birkerts, Gunnar; "Explorations: Four projects by Gunnar Birkerts"—Mar. 1983, pp. 108-113 • Gehry, Frank; "A minimalist architecture of allusion: current projects of Frank Gehry," by Lindsay Stamm Shapiro—June 1983, pp. 114-125 • Isozaki, Arata; "The recent work of Arata Isozaki: Part I," by Martin Filler—Oct. 1983, pp. 125-137 • Le Corbusier; "An architecture drawn from life [a review of *Le Corbusier Sketchbooks*]," by Kurt W. Forster—Apr. 1983, pp. 142-145 • Mitchell/Giurgola [with Renato Severino]; "Made in Friuli"—Aug. 1983, pp. 104-117 • Murphy/Jahn; "Toward romantic high-tech"—Jan. 1983, pp. 102-115 • Myers, Barton; "Barton Myers proposes warm, lively indoor towns"—Feb. 1983, pp. 92-101 • Pelli, Cesar; "New layers of meaning: Works in progress by Cesar Pelli"—July 1983, pp. 104-113 • Safdie, Moshe; "Purpose and place"—Nov. 1983, pp. 124-131 • Severino, Renato [with Mitchell/Giurgola]; "Made in Friuli"—Aug. 1983, pp. 104-117 • Solomon, Barbara Stauffacher; "Green architecture"—Sept-2 1983, pp. 98-101.

Architectural Business (see also *Building Activity, Building Codes, Building Costs & Financing, Computers, Construction Management, Legal Perspectives, Marketing, and Office Management*)—"Federal design commissions tied to increased authority for OFPP," by Peter Hoffman—Aug. 1983, p. 25 • "Housing affordability index announced"—Sept-2 1983 p. 27.

Architectural Drawing—Ames, Anthony; "Anthony Ames, architect/delineator"—Aug. 1983, pp. 96-103 • Diniz, Carlos; "Are renderings still important in our electronic age?"—Oct. 1983, pp. 45-51 • Le Corbusier; "An architecture drawn from life [a review of *Le Corbusier Sketchbooks*]," by Kurt W. Forster—Apr. 1983, pp. 142-145 • Solomon, Barbara Stauffacher; "Green architecture"—Sept-2 1983, pp. 98-101.

Architectural Education—"Architectural education: questions piled upon questions," by Walter F. Wagner, Jr.—Sept-2 1983, p. 9 • "Educating architects at Berkeley," by Marcy Li Wang—Feb. 1983, pp. 108-117 • "Round Table: The education of architects in interior design"—Sept-1 1983, pp. 35-47 • "Still planning with the poor: community design centers keep up the good works," by Paul M. Sachner—June 1983, pp. 126-131.

Architectural Engineering (see also *Acoustics, Daylighting, Earth-sheltered Buildings, Energy Conservation, HVAC Systems, Lighting, Roofing, Solar Energy, and Structural Headings*)—10 & 30 South Wacker Drive, Chicago, IL; Alfred Benesch & Co., engns, with Fujikawa Johnson, archts; "Unique cantilevers carry 400,000 sq ft of tower"—Nov. 1983, pp. 136-139.

Architectural Resources Cambridge, archts—Russell Sage College, Albany Campus Center, Albany, NY—Nov. 1983, BTS, pp. 102-103.

Area 2 Police Center, Chicago, IL—Murphy/Jahn with the Chicago Dept. of Public Works, archts—Jan. 1983, pp. 105-107.

Argonne National Laboratories Program Support Facility, Joliet, IL—Murphy/Jahn, archts—Jan. 1983, pp. 108-111.

Arquitectonica, archts—Imperial at Brickell, Miami, FL—July 1983, BTS, pp. 92-95.

Art Galleries—Phillips Exeter Academy, Frederick R. Mayer Art Center, Exeter, NH; Amsler Hagenah MacLean, archts—Nov. 1983, BTS, pp. 96-101.

Artemide Show Room, Los Angeles, CA—Vignelli Associates, dsgnrs—Sept-1 1983, p. 138-139.

Austin Junior High School, Galveston, TX—Ben Templin & Associates with Lloyd Pape, archts—July 1983, pp. 140-141.

Aviano Elementary School, Aviano, Italy—Mitchell/Giurgola, archts—Aug. 1983, pp. 112-113.

Azem Palace Reconstruction, Damascus, Syria—Shafiq Imam, archt—Sept-2 1983, BTS, p. 74.

B

Bank of America Plaza [Biltmore Hotel renovation], New York, NY—Environetics Architect P.C., archts—Jan. 1983, pp. 128-133.

Banks-Bankers Trust Company Trading Room, New York, NY; Interior Facilities Associates, interior dsgnrs—June 1983, pp. 136-137 • First Source Center, South Bend, IN; Murphy/Jahn, archts—Jan. 1983, pp. 112-115.

Barclays Bank International Offices, Chicago, IL—Landahl Group, archts—Sept-1 1983, pp. 146-149.

Batey & Mack, archts—Batey & Mack Office, San Francisco, CA—Sept-1 1983, pp. 120-121.

Beneficial Center, Peapack/Gladstone, NJ—The Hillier Group, archts—Apr. 1983, BTS, pp. 114-117.

Benesch, Alfred & Co., engns, with Fujikawa Johnson, archts—10 & 30 South Wacker Drive, Chicago, IL—Nov. 1983, pp. 136-139.

Bentley/LaRosa/Salasky, dsgnrs—Berkliiff Corporation Executive and Sales Offices, New York, NY—Sept-1 1983, pp. 140-143 • Hog Hill House, East Holden, ME—Mid-May 1983, pp. 70-73.

Berger, Horst—"The Brooklyn Bridge at 100,"—Aug. 1983, pp. 118-123.

Berkliiff Corporation Executive and Sales Offices, New York, NY—Bentley/LaRosa/Salasky, dsgnrs—Sept-1 1983, p. 140-143.

BGS Architects with RS Architects, archts—Gallatin County Detention Center, Bozeman, MT—Mar. 1983, BTS, pp. 96-98.

Billerica Public Library, Billerica, MA—James C. Hopkins Associates, archts—Aug. 1983, BTS, pp. 84-85.

bin Mahmoud, Wassim with Arno Heinz, archts—Hafsia Quarter, Medina of Tunis, Tunisia—Sept-2, 1983, BTS, pp. 80-81.

Birkerts, Gunnar & Associates, archts—Anchorage Headquarters Library Competition Entry, Anchorage, AK—Mar. 1983, pp. 108-109 • "Explorations: Four projects by Gunnar Birkerts"—Mar. 1983, pp. 108-113 • US Corps of Engineers Chapel & Educational Facility [with Giffels Associates], Camp Wildflecken, Germany—Mar. 1983, p. 110 • University of Nebraska, Wick Alumni Center Competition, Lincoln, NE—Mar. 1983, p. 111 • Villa Ginny, Kalamazoo, MI—Mar. 1983, pp. 112-113.

Bobrow, Michael, and Julia Thomas—"For health-care providers too: an outlook of stressful—but hopeful—change"—June 1983, BTS, pp. 102-103.

Booth/Hansen & Associates, archts—CF-14 Fire Station [with Joseph Casserly], Chicago, IL—July 1983, pp. 121-123 • Villa Barr, Northville, MI—Mid-May 1983, pp. 116-119.

Bray-Schaible Design, dsgnrs—Rosen Apartment, New York, NY—Sept-1 1983, pp. 150-151.

Brooklyn Bridge, New York, NY—John A. Roebing, archt; by Horst Berger—Aug. 1983, pp. 118-123.

Brooklyn Bridge Anchorage Restoration, New York, NY—Smotrich & Platt, archts—Aug. 1983, pp. 124-127.

Buchsbaum, Alan & Stephen Tilly, archts—Tenenbaum House, Lexington, SC—Mid-May 1983, pp. 120-123.

Building Activity—"Administration gives some mild support for preservation with jobs bill"—May 1983, p. 35 • "Commercial rehab shows big upsurge"—Apr. 1983, p. 35 • "Construction-economy update: The dam is starting to break," by George A. Christie—Apr. 1983, pp. 37, 39, 41 • "Construction-economy update: The outlook continues good, but there are a few more hurdles to overcome," by George A. Christie—Sept-2 1983, pp. 35, 37, 39 • "Design commissions from the new jobs bill?" by Peter Hoffman—June 1983, p. 35 • "Dodge/Sweet's Construction Outlook: Is 1984 the year

for nonresidential building?," by George A. Christie—Nov. 1983, pp. 39-49 • "Economics: The rise and fall of the high-rise," by John Morawetz—June 1983, pp. 39, 41 • "The infrastructure issue: Congress just can't seem to decide," by Peter Hoffman—June 1983, p. 35.

Building Codes—"Financial incentives may not be the way to go on new-codes compliance"—Sept-2 1983, p. 25 • "Largest group of changes ever proposed for BOCA code"—Feb. 1983, p. 35 • "National research effort on building-fire toxicity called for by NIBS"—Oct. 1983, p. 33 • "NIBS fund drive showing success"—Dec. 1983, p. 15 • "A step backward in building research," by Peter Hoffman—Apr. 1983, pp. 35, 71.

Building Costs & Financing—"Cities tighten belts for new economic realities," by Peter Hoffman—Mar. 1983, p. 33 • Construction costs: Better news than anticipated—except for some housing costs," by James Stewart—Oct. 1983, p. 43 • "Construction costs: The economic upswing may bring new upward pressures," by James Stewart—July 1983, p. 49 • "Costs: Are they really coming down?," by James Stewart—Apr. 1983, p. 47 • "Economics: Interest rates should decline—but then watch out," by Phillip E. Kidd—Oct. 1983, p. 35 • "Economics: The economy is positioned for a sustained recovery," by Phillip E. Kidd—July 1983, p. 41 • "Fair Tax Act would eliminate real estate investment incentives"—Aug. 1983, p. 25 • "Fine tuning is needed to spur recovery without more inflation," by Phillip E. Kidd—Mar. 1983, p. 39 • "Is cheaper money really cheap yet?," by Phillip E. Kidd—Jan. 1983, p. 39 • "More favorable news on Davis-Bacon," by Peter Hoffman—Nov. 1983, p. 35 • "Petitions on Davis-Bacon Act hit Congress"—Mar. 1983, p. 53 • "The present period of stability may last a while longer," by James Stewart—Jan. 1983, p. 45 • "Rehabilitation credits in jeopardy from retroactive bill," by Peter Hoffman—Sept-2 1983, p. 27.

Building Type Studies—"Big business preservation," by Nory Miller—Oct. 1983, pp. 91-109 • "Building for the art of the 20th century," [Museum]—Feb. 1983, pp. 79-91 • "Conserving a rich architectural heritage," [Aga Khan Award for Architecture]—Sept-2 1983, pp. 67-85 • "Corporate images," [Offices]—Jan. 1983, pp. 85-101 • "Growing in," [University & College Buildings]—Nov. 1983, pp. 89-107 • "Jails and prisons,"—Mar. 1983, pp. 81-99 • "Libraries: the dawn of the information age,"—Aug. 1983, pp. 73-91 • "Offices go to the suburbs for peace and quiet," [Low-rise Office Buildings]—Apr. 1983, 113-129 • "Product Reports 1984: The manufacturer as part of the team"—Dec. 1983, pp. 39-216 • "Record Houses 1983,"—Mid-May 1983, 69-143 • "Record Interiors 1983,"—Sept-1 1983, pp. 87-159 • "Recreation facilities,"—May

1983, pp. 91-105 • "Rx: Environment," [Mental Health Facilities]—June 1983, pp. 85-103 • "A variety of apartments for city, suburb and beach,"—July 1983, pp. 87-103.

Bumpzoid, archts—Mere House, Flint Hill, VA—Mid-May 1983, pp. 90-93.

Burden, Ernest—"What are the aggressive firms doing to get their share of design work? An important [1982] survey report..."—Feb. 1983, pp. 47, 49 • "What are the aggressive firms doing to get their share of design work? An important [1983] survey report..."—June 1983, pp. 43, 45, 55.

Bystrom, Arne, archt—Seattle Garden Center, Seattle, WA—Apr. 1983, pp. 150-151.

C

CAD—see *Computers*

Cakirhan, Nail, dsgrn—Cakirhan Residence, Akyaka Village, Turkey—Sept-2 1983, BTS, pp. 82-83.

California Aerospace Museum, Exposition Park, Los Angeles, CA—Frank Gehry, archt—June 1983, pp. 122-123.

Canada—Harborview at Kil-Cona Park, Winnipeg, Manitoba; IKOY Architects, archts—May 1983, BTS, pp. 102-105 • IKOY Office Building, Winnipeg, Manitoba; IKOY Architects, archts—Apr. 1983, pp. 146-149 • Royal Conservatory of Music, Toronto, Ontario; Barton Myers Associates, archts—Feb. 1983, pp. 100-101 • Seagram Museum and Archives, Waterloo, Ontario; Barton Myers Associates, archts—Feb. 1983, pp. 92-95 • Unionville Library, Town of Markham, Ontario; Barton Myers Associates, archts—Feb. 1983, pp. 96-97 • Wandich House, Peterborough, Ontario; Jim Strassman Architects, archts—Mid-May 1983, pp. 138-143.

Casserly, Joseph with Booth/Hansen & Associates, archts—CF-14 Fire Station, Chicago, IL—July 1983, pp. 121-123.

Cavaglieri, Giorgio with Davis, Brody & Associates, archts—New York Public Library Renovation, New York, NY—Aug. 1983, BTS, pp. 74-79.

Center for the Elderly, Buia, Italy—Renato Severino, archt—Aug. 1983, pp. 108-109.

CF-14 Fire Station, Chicago, IL—Booth/Hansen & Associates with Joseph Casserly, archts—July 1983, pp. 121-123.

Chapman, Liane Leach—"Disability insurance protects you from possible disaster [Part 2]"—Nov. 1983, p. 37.

Charlton Park, Bronx, NY—Leland R. Weintraub, landscape archt—May 1983, BTS, p. 101.

Chestnut Place Apartments, Chicago, IL—Weese Seegers Hickey Weese, archts—July 1983, BTS, pp. 96-97.

Chicago Dept. of Public Works with Murphy/Jahn, archts—Area 2 Police Center, Chicago, IL—Jan. 1983, pp. 105-107.

Chimera, John, Architect, archts—Cooper & Company Offices and Studio, New York, NY—Jan. 1983, BTS, pp. 96-97.

China—"So you want to do business in China?"—Sept-2 1983, p. 33.

Christie, George A.—"Construction-economy update: The dam is starting to break"—Apr. 1983, pp. 37, 39, 41 • "Construction-economy update: The outlook continues good, but there are a few more hurdles to overcome"—Sept-2 1983, pp. 35, 37, 39 • "Dodge/Sweet's Construction Outlook: Is 1984 the year for non-residential building?"—Nov. 1983, pp. 39-49.

Chrysalis Corp., archts—Reinhard House, Chicago, IL—Mid-May 1983, pp. 94-97.

Church of St. Ann and the Holy Trinity, Brooklyn Heights, NY—Hardy Holzman Pfeiffer Associates, archts—Oct. 1983, BTS, pp. 92-95.

Churches—see *Religious Buildings*

Cidade de Goa Resort Hotel, Goa, India—C.M. Correa, archt—Apr. 1983, pp. 154-159.

CIGNA Office Building, Bloomfield, CT—The Architects Collaborative with Interspace Incorporated, archts—Apr. 1983, pp. 160-167.

Cigolle, Mark, archt—Covington Restaurant, Armonk, NY—June 1983, pp. 132-135.

Clafin Park, Newtonville, MA—Sasaki Associates, archts—July 1983, BTS, pp. 100-103.

Cleveland Clinic, Cleveland, OH—Cesar Pelli & Associates, archts—July 1983, p. 107.

Colleges—see *University & College Buildings*

Computers—Bankers Trust Company Trading Room, New York, NY; Interior Facilities Associates, interior dsgrns—June 1983, pp. 136-137 • "Can computer-aided drafting be effective and affordable for the small firm?" by Eric Teicholz—Feb. 1983, pp. 37, 39 • "Computer congress announced"—Mar. 1983, p. 33 • "Computers: The real opportunities are in design," by Douglas F. Stoker and Nicholas H. Weingarten—Dec. 1983, pp. 19, 21 • "How to protect your rights when you buy [a computer]," by John W. Greenfield—Apr. 1983, pp. 43, 45 • "Lighting those visual display terminals—in the cause of the operator's comfort," by Sylvan R. Shemitz, with Gladys Walker—Oct. 1983, pp. 138-143 • "On learning how to think about computers in architecture," by Walter F. Wagner, Jr.—Apr. 1983, p. 9 • "The personal challenge of CAD," by Barry Milliken—Mar. 1983, pp. 41, 43, 45 • "Professional development: Seminars on preservation, computers, and business management"—July 1983, p. 37 • "Round Table on computers in architecture," by Harry Mileaf and Walter Wagner—May 1983, pp. 39-53 • "Selecting the right CAD system for your office," by Eric Teicholz—July 1983, pp. 45, 47 • "The single-user workstation—A new concept that promises to benefit the design profession," by John C. Dill and Jon H. Pittman—Aug. 1983, pp. 27, 29, 31 • "Systems '83 to be held in Dallas"—Apr. 1983, p. 35 • "Using CAD effectively with reprographics," by Bradley Meade—Sept-2

1983, pp. 29, 31 • "Using reprographics effectively with CAD," by Bradley Meade—Oct. 1983, pp. 37-39 • "Where is your firm to get software?" by Harry Mileaf—Jan. 1983, pp. 41, 43 • "The wonderland of computer language," by Harry Mileaf—Apr. 1983, pp. 51, 73.

Concrete—see *Structural, Concrete*

Consolidated Edison Customer Service Facility, Bronx, NY—Richard Dattner, archt—July 1983, pp. 124-125.

Construction Costs—see *Building Costs & Financing*

Construction Management—"Construction management: A useful service—if you know how to work with it," by Bradford Perkins—Mar. 1983, pp. 35, 37.

Construction Outlook—see *Building Activity*

Contra Costa County Detention Facility, Martinez, CA—Correction Facility Architects, archts—Mar. 1983, BTS, pp. 82-85.

Cooper & Company Offices and Studio, New York, NY—John Chimera Architect, archts—Jan. 1983, BTS, pp. 96-97.

Correa, C.M., archt—Cidade de Goa Resort Hotel, Goa, India—Apr. 1983, pp. 154-159.

Correction Facility Architects, archts—Contra Costa County Detention Facility, Martinez, CA—Mar. 1983, BTS, pp. 82-85.

Cossuta & Associates, archts—Long Wharf Marriott Hotel, Boston, MA—Mar. 1983, pp. 100-107.

Covington Restaurant, Armonk, NY—Mark Cigolle, archt—June 1983, pp. 132-135.

Credit du Nord Offices, New York, NY—Rivkin/Weisman, archts—Sept-1 1983, pp. 96-99.

Crissman & Solomon, archts—Dattelbaum House, Kezar Lake/Center Lovell, ME—Mid-May 1983, pp. 98-101.

Croxton Collaborative, archts—Reynolds Tobacco Company Building [lobby restoration], Winston-Salem, NC—Jan. 1983, BTS, pp. 98-101.

Custom House Renovation, New York, NY—James Stewart Polshek & Partners with MBA/Architects, archts—Oct. 1983, BTS, pp. 92-95.

D

Darb Qirmiz Revitalization, Cairo, Egypt—Philip Speiser, archt—Sept-2 1983, BTS, p. 75.

Dattelbaum House, Kezar Lake/Center Lovell, ME—Crissman & Solomon, archts—Mid-May 1983, pp. 98-101.

Dattner, Richard, archt—Consolidated Edison Customer Service Facility, Bronx, NY—July 1983, pp. 124-125.

Davidow House, Kauai, HI—MLTW/Turnbull Associates, archts—Mid-May 1983, pp. 112-115.

Davis, Brody & Associates, archts—New York Public Library Renovation [with Giorgio Cavaglieri], New York, NY—Aug. 1983, BTS, pp. 74-79 • Philip Morris Operations Center, Richmond, VA—Mar. 1983, pp. 114-121.

Davis, Sam, archt—"Educating architects at Berkeley," by Marcy Li Wang—Feb. 1983, pp. 110-111.

Day Care Centers—see *Schools*

Daylighting—Anchorage Headquarters Library Competition Entry, Anchorage, AK; Gunnar Birkerts & Associates, archts—Mar. 1983, pp. 108-109 • Phillips Exeter Academy, Frederick R. Mayer Art Center, Exeter, NH; Amsler Hagenah MacLean, archts—Nov. 1983, BTS, pp. 96-101.

De Santo, Samuel J. & Associates, archts—Anspach Grossman Portugal Offices, New York, NY—Sept-1 1983, pp. 116-119.

Deer Valley Resort, Park City, UT—Esherick Homsey Dodge and Davis, archts—May 1983, BTS, pp. 92-97.

Dianne B., New York, NY—Voorsanger & Mills Associates, archts—Mar. 1983, pp. 126-127.

Dill, John C., and Jon H. Pittman—"The single-user workstation—A new concept that promises to benefit the design profession"—Aug. 1983, pp. 27, 29, 31.

Diniz, Carlos, illustrator—"Are renderings still important in our electronic age?"—Oct. 1983, pp. 45-51.

District Court of Appeal, First District, Tallahassee, FL—William Morgan Architects, archts—Jan. 1983, pp. 116-121.

Duany, Andres and Elizabeth Plater-Zyberk, archts—Hibiscus House, Coconut Grove, FL—Mid-May 1983, pp. 102-105.

Dubai Bank Limited Offices, New York, NY—Rivkin/Weisman, archts—Jan. 1983, BTS, pp. 86-91.

D'Urso Design, dsgrn—Swid Powell Design Offices, New York, NY—Sept-1 1983, pp. 132-133.

E

Earth-sheltered Buildings—Private Residence, AL; Moshe Safdie and Associates, archts—Nov. 1983, pp. 128-131.

East Germany—Friedrich Stadt, East Berlin; Anthony Ames, archt—Aug. 1983, pp. 102-103.

Economic Outlook—see *Building Activity, Building Costs & Financing*

Editorials [by Walter F. Wagner, Jr.]—"The AIA reaches out nationally—to influence the government and the public"—Mar. 1983, p. 9 • "Architectural education: questions piled upon questions"—Sept-2 1983, p. 9 • "It's convention time... Is it also time to think of conventions as a place to think?"—May 1983, p. 9 • "A little anniversary, a little more evolution"—June 1983, p. 9 • "A nearly-80-year-old architect [Nathaniel Alexander Owings] talks about what seems important now"—July 1983, p. 9 • "On learning how to think about computers in architecture"—Apr. 1983, p. 9 • "On readers, research, and readership"—Feb. 1983, p. 9 • "On Record Houses and Record Interiors, skyscrapers—and design ideas"—Aug. 1983, p. 9 • "On talking to the public about architecture"—Nov. 1983, p. 9 • "On understanding changing marketplaces and changing tactics for getting things built"—Oct. 1983,

p. 9 • "Some thoughts at the start of the New Year"—Jan. 1983, p. 9.

Egypt—Darb Qirmiz Revitalization, Cairo; Philip Speiser, archt—Sept-2 1983, BTS, p. 75 • Wissa Wassef Arts Center, Giza-Cairo; Ramses Wissa Wassef, archt—Sept-2 1983, BTS, p. 81.

Elliott House, PA—Jefferson B. Riley of Moore Grover Harper, archt—Mid-May 1983, pp. 106-111.

Energy Conservation (see also *Day-lighting, Solar Energy*)—Argonne National Laboratories Program Support Facility, Joliet, IL; Murphy/Jahn, archts—Jan. 1983, pp. 108-111 • "Engineers urge clear national energy policy"—June 1983, p. 35 • Flack + Kurtz, engnrs, "Energy conservation in office buildings—a maturing art"—Feb. 1983, pp. 124-131 • Middletown Public Library, Middletown, OH; Lorenz & Williams, archts—July 1983, pp. 138-139 • One Champion Plaza, Stamford, CT; Ulrich Franzen & Associates, archts—Feb. 1983, pp. 102-107 • "Round Table: Conserving energy in the rehabilitated or retro-fitted building"—Dec. 1983, pp. 30-37 • St. Enoch Square, Glasgow, Scotland; G.M.W. Partnership with Reiach and Hall, archts—June 1983, pp. 138-143.

Enerplex, South Building, Princeton, NJ—Skidmore, Owings & Merrill, archts—Feb. 1983, pp. 130-131.

Engineering—see *Architectural Engineering*

Environetics Architect P.C., archts—Bank of America Plaza [Baltimore Hotel renovation], New York, NY—Jan. 1983, pp. 128-133.

EPR, archts—Georgetown University, Riggs Memorial Library, Washington, DC—Sept-1 1983, pp. 134-137.

Esherrick Homsey Dodge and Davis, archts—Deer Valley Resort, Park City, UT—May 1983, BTS, pp. 92-97.

Exposition Buildings—Exposition Multicultural Center, Los Angeles, CA; Barton Myers Associates, archts—Feb. 1983, pp. 98-99 • Louisiana World Exposition 1984 Amphitheater, New Orleans, LA; Frank Gehry, archt—June 1983, pp. 124-125.

F

Facility Programming—"Designing tomorrow's libraries"—Aug. 1983, BTS, p. 91 • "For health-care providers too: an outlook of stressful—but hopeful—change," by Michael Bobrow and Julia Thomas—June 1983, BTS, pp. 102-103 • "Strategies for corrections programming," by Kenneth Ricci—Mar. 1983, BTS, p. 99.

Farm Credit Banks of Spokane Building, Spokane, WA—Walker McGough Foltz Lyerla, archts—Feb. 1983, pp. 128-129.

Federal Archives Building, New York, NY—Warner, Burns, Toan & Lunde, archts—Oct. 1983, BTS, pp. 92-95.

Filler, Martin—"The recent work of Arata Isozaki: Part I"—Oct. 1983, pp. 125-137.

Finance—see *Building Costs & Financing*

Fire Safety—see *Building Codes*

Fire Stations—CF-14 Fire Station, Chicago, IL; Booth/Hansen & Asso-

ciates with Joseph Casserly, archts—July 1983, pp. 121-123.

First Source Center, South Bend, IN—Murphy/Jahn, archts—Jan. 1983, pp. 112-115.

Five 1880s Warehouse Renovations, New York, NY—Stephen B. Jacobs & Associates, archts—Oct. 1983, BTS, pp. 92-95.

Flack + Kurtz, engnrs—"Energy conservation in office buildings—a maturing art"—Feb. 1983, pp. 124-131.

Forbes, Peter and Associates, archts—Wharton House, Seal Cove, Mt. Desert Island, ME—Mid-May 1983, pp. 124-127.

Forster, Kurt W.—"An architecture drawn from life [a review of *Le Corbusier Sketchbooks*]"—Apr. 1983, pp. 142-145.

Franzen, Ulrich & Associates, archts—One Champion Plaza, Stamford, CT—Feb. 1983, pp. 102-107.

Friedrich Stadt, East Berlin, East Germany—Anthony Ames, archt—Aug. 1983, pp. 102-103.

Fujikawa Johnson & Assoc., archts, with Alfred Benesch & Co., engnrs—10 & 30 South Wacker Drive, Chicago, IL—Nov. 1983, pp. 136-139.

Funerary Architecture—Tomb of Shah Rukn-i Alam Restoration, Multan, Pakistan; Muhammad Wali Ullah Khan, archt—Sept-2 1983, BTS, p. 74.

G

Gallatin County Detention Center, Bozeman, MT—BGS Architects with RS Architects, archts—Mar. 1983, BTS, pp. 96-98.

Galveston Historic Foundation, preservationists—"Big business preservation"—Galveston: In-town turnaround," by Nory Miller—Oct. 1983, BTS, pp. 102-105.

Garden Pavilion, Atlanta, GA—Anthony Ames, archt—Aug. 1983, p. 101.

Gehry, Frank, archt—California Aerospace Museum, Exposition Park, Los Angeles, CA—June 1983, pp. 122-123 • Louisiana World Exposition 1984 Amphitheater, New Orleans, LA—June 1983, pp. 124-125 • Loyola Law School, Los Angeles, CA—June 1983, pp. 120-121 • "A minimalist architecture of allusion: current projects of Frank Gehry," by Lindsay Stamm Shapiro—June 1983, pp. 114-125 • Norton House, Venice, CA—June 1983, p. 117 • Private Residence, Beverly Hills, CA—June 1983, p. 116 • Smith House, Los Angeles, CA—June 1983, pp. 118-119 • Spiller Houses, Venice, CA—Mid-May 1983, pp. 84-89.

Gensler & Associates, archts—Harlequin Plaza, Englewood, CO—Apr. 1983, BTS, pp. 118-121.

Georgetown University, Riggs Memorial Library, Washington, DC—EPR, archts—Sept-1 1983, pp. 134-137.

Germany—US Corps of Engineers Chapel & Educational Facility, Camp Wildflecken; Gunnar Birkerts & Associates with Giffels Associates, archts—Mar. 1983, p. 110.

Giffels Associates with Gunnar Birkerts & Associates, archts—US Corps of Engineers Chapel & Educational Facility, Camp Wildflecken, Germany—Mar. 1983, p. 110.

Gillis Associates, archts—Meola Studio and Apartment, New York, NY—Nov. 1983, pp. 120-123.

G.M.W. Partnership with Reiach and Hall, archts—St. Enoch Square, Glasgow, Scotland—June 1983, pp. 138-143.

Goodkind & O'dea, archts—Pier 76 Garage, New York, NY—July 1983, pp. 142-143.

Goody, Joan E.—"A rare and rich response to context"; Keio University Library, Tokyo, Japan—May 1983, pp. 106-113.

Government Buildings—see *Public Buildings*

Grad Partnership, The, with The Gruzen Partnership, archts—Trenton State Prison Rehabilitation, Trenton, NJ—Mar. 1983, BTS, pp. 88-91.

Graham/Meus, archts—Arbour Hospital, Jamaica Plain, MA—June 1983, BTS, pp. 94-97.

Grakal, Stamler, Blackman [Law] Offices, Santa Monica, CA—Eugene Kupper, archt—Sept-1 1983, pp. 122-127.

Great Mosque of Niono, Niono, Mali—Lassine Minta, master mason—Sept-2 1983, BTS, pp. 72-73.

Greenfield, John W.—"How to protect your rights when you buy [a computer]"—Apr. 1983, pp. 43, 45.

Gruzen Partnership, The, archts—Manhattan House of Detention for Men, New York, NY—Mar. 1983, BTS, pp. 86-87 • Trenton State Prison Rehabilitation [with The Grad Partnership], Trenton, NJ—Mar. 1983, BTS, pp. 88-91.

Gully, The, New England—Timothy D. Smith & Associates, archts—Feb. 1983, pp. 118-123.

Gund, Graham Associates, archts—Town-house Renovation, Boston, MA—Mid-May 1983, pp. 134-137.

H

Hafsia Quarter, Medina of Tunis, Tunisia—Wassim bin Mahmoud with Arno Heinz, archts—Sept-2 1983, BTS, pp. 80-81.

Hammond Beebe and Babka, archts—North Shore Congregation Israel, Glencoe, IL—June 1983, pp. 104-113.

Hanlon, John J., Jr.—"Disability insurance protects you from possible disaster [Part 1]"—July 1983, p. 43.

Harbor Plaza, Stamford, CT—Yankee Planning/Do H. Chung, archts; by Mary Woods—Sept-2 1983, pp. 108-111.

Harborview at Kil-Cona Park, Winnipeg, Manitoba, Canada—IKOY Architects, archts—May 1983, BTS, pp. 102-105.

Hardy Holzman Pfeiffer Associates, archts—Church of St. Ann and the Holy Trinity, Brooklyn Heights, NY—Oct. 1983, BTS, pp. 92-95 • Hult Center for the Performing Arts, Eugene, OR—May 1983, pp. 120-129.

Harlequin Plaza, Englewood, CO—Gensler & Associates, archts—Apr. 1983, BTS, pp. 118-121.

Harry Winston "Petit Salon," New York, NY—Adam Tihany, archt—Sept-1 1983, pp. 114-115.

Heery & Heery, archts—Herman Miller Roswell Facility, Roswell, GA—Jan. 1983, pp. 122-127.

Hellmuth, Obata & Kassabaum with TRA Associates, archts—Washington State Medium Security Prison, Monroe, WA—Mar. 1983, BTS, pp. 94-95.

Henderson House Restoration/Fair Oaks Cottages Remodeling, Selma, AL—James Seay with Nicholas H. Holmes, archts—May 1983, pp. 114-119.

Herman Miller Roswell Facility, Roswell, GA—Heery & Heery, archts—Jan. 1983, pp. 122-127.

Hibiscus House, Coconut Grove, FL—Andres Duany and Elizabeth Plater-Zyberk, archts—Mid-May 1983, pp. 102-105.

Hillier Group, The, archts—Beneficial Center, Peapack/Gladstone, NJ—Apr. 1983, BTS, pp. 114-117.

Himmel, Bonner, archts—Himmel, Bonner Architects Offices, Chicago, IL—Apr. 1983, pp. 152-153.

Hog Hill House, East Holden, ME—Bentley/LaRosa/Salasky, dsngnrs—Mid-May 1983, pp. 70-73.

Holabird & Root, archts—Saenger Theater, Pensacola, FL—Aug. 1983, pp. 92-95.

Hollein, Hans, archt—Municipal Museum Abteiberg Monchengladbach, Monchengladbach, West Germany—Feb. 1983, BTS, pp. 79-91.

Holmes, Nicholas H. with James Seay, archts—Henderson House Restoration/Fair Oaks Cottages Remodeling, Selma, AL—May 1983, pp. 114-119.

Hopkins, James C. Associates, archts—BillERICA Public Library, BillERICA, MA—Aug. 1983, BTS, pp. 84-85.

Hospitals—Arbour Hospital, Jamaica Plain, MA; Graham/Meus, archts—June 1983, BTS, pp. 94-97 • Ingalls Memorial Hospital, Wyman-Gordon Pavilion, Harvey, IL; Perkins & Will, archts—June 1983, BTS, pp. 98-101.

Hotels & Motels—Cidade de Goa Resort Hotel, Goa, India; C.M. Correa, archt—Apr. 1983, pp. 154-159 • First Source Center, South Bend, IN; Murphy/Jahn, archts—Jan. 1983, pp. 112-115 • Long Wharf Marriott Hotel, Boston, MA; Cossutta & Associates, archts—Mar. 1983, pp. 100-107 • One Post Office Square, Boston, MA; Jung/Brannen Associates, archts—July 1983, pp. 128-135 • Pin Oak Commercial Center, Houston, TX; Cesar Pelli & Associates, archts—July 1983, p. 109 • Residence Andalou, Sousse, Tunisia; Serge Santelli, archt—Sept-2 1983, BTS, pp. 76-79 • Tanjung Jara Beach Hotel and Rantau Abang Visitors' Center, Kuala Trengganu, Malaysia; Wihsenand, Allison, Tong and Goo, archts—Sept-2 1983, BTS, p. 75 • Tsukuba Civic Center/Dai Ichi Hotel, Tsukuba New Town, Ibaragi Prefecture, Japan; Arata Isozaki & Associates, archts; by Martin Filler—Oct. 1983, pp. 126-137.

- Hough, Reginald—"The secret to quality in architectural concrete: knowing construction"—Mar. 1983, pp. 128-135.
- Houses-Cakirhan Residence, Akyaka Village, Turkey; Nail Cakirhan, dsgnr—Sept-2 1983, BTS, pp. 82-83 • Dattelbaum House, Kezar Lake/Center Lovell, ME; Crissman & Solomon, archts—Mid-May 1983, pp. 98-101 • Davidow House, Kauai, HI; MLTW/Turnbull Associates, archts—Mid-May 1983, pp. 112-115 • Elliott House, PA; Jefferson B. Riley of Moore Grover Harper, archt—Mid-May 1983, pp. 106-111 • Garden Pavilion, Atlanta, GA; Anthony Ames, archt—Aug. 1983, p. 101 • Gully, The, New England; Timothy D. Smith & Associates, archts—Feb. 1983, pp. 118-123 • Henderson House Restoration/Fair Oaks Cottages Remodeling, Selma, AL; James Seay with Nicholas H. Holmes, archts—May 1983, pp. 114-119 • Hibiscus House, Coconut Grove, FL; Andres Duany and Elizabeth Plater-Zyberk, archts—Mid-May 1983, pp. 102-105 • Hog Hill House, East Holden, ME; Bentley/LaRosa/Salasky, dsgnrs—Mid-May 1983, pp. 70-73 • Johnson Study/Library, New Canaan, CT; Philip Johnson, archt—July 1983, pp. 114-119 • Mere House, Flint Hill, VA; Bumpzoid, archts—Mid-May 1983, pp. 90-93 • No.ton House, Venice, CA; Frank Gehry, archt—June 1983, p. 117 • Pickering House, Laurel, MI; Anthony Ames, archt—August 1983, pp. 98-99 • Potatoe Hill Residential District Renovations, Winchester, VA; Preservation of Historic Winchester, preservationists—Oct. 1983, BTS, pp. 106-109 • Private Residence, AL; Moshe Safdie and Associates, archts—Nov. 1983, pp. 128-131 • Private Residence, Beverly Hills, CA; Frank Gehry, archt—June 1983, p. 116 • Private Residence, Fire Island, NY; Rivkin/Weisman, archts—Mid-May 1983, pp. 80-83 • Private Residence, New Buffalo, MI; Veronda Associates, archts—Mid-May 1983, pp. 74-79 • Private Residence, San Juan Islands, WA; Morgan and Lindstrom, archts—Mid-May 1983, pp. 128-133 • Raikes House, Roxbury, CT; Redroof Design, archts—Oct. 1983, pp. 118-124 • Reinhard House, Chicago, IL; Chrysalis Corp., archts—Mid-May 1983, pp. 94-97 • Smith House, Los Angeles, CA; Frank Gehry, archt—June 1983, pp. 118-119 • Spiller Houses, Venice, CA; Frank O. Gehry & Associates, archts—Mid-May 1983, pp. 84-89 • Tenenbaum House, Lexington, SC; Alan Buchsbaum & Stephen Tilly, archts—Mid-May 1983, pp. 120-123 • Town-house Renovation, Boston, MA; Graham Gund Associates, archts—Mid-May 1983, pp. 134-137 • Van Leer Residence, Jerusalem, Israel; Moshe Safdie and Associates, archts—Nov. 1983, pp. 124-127 • Venturi, Scott Brown Residence, Philadelphia, PA; Venturi, Rauch and Scott Brown, archts—Sept-1 1983, pp. 108-113 • Villa Augusta, Augusta, GA; Anthony Ames, archt—Aug. 1983, p. 100 • Villa Barr, Northville, MI; Booth/Hansen & Associates, archts—Mid-May 1983, pp. 116-119 • Villa Chang, Augusta, GA; Anthony Ames, archt—Aug. 1983, p. 97 • Villa Ginny, Kalamazoo, MI; Gunnar Birkerts & Associates, archts—Mar. 1983, pp. 112-113 • Wandich House, Peterborough, Ontario, Canada; Jim Strassman Architects, archts—Mid-May 1983, pp. 138-143 • Wharton House, Seal Cove, Mt. Desert Island, ME; Peter Forbes and Associates, archts—Mid-May 1983, pp. 124-127.
- Housing & Apartments (see also *Mixed-use Buildings*)—Chestnut Place Apartments, Chicago, IL; Weese Seegers Hickey Weese, archts—July 1983, BTS, pp. 96-97 • Claffin Park, Newtonville, MA; Sasaki Associates, archts—July 1983, BTS, pp. 100-103 • Federal Archives Building, New York, NY; Warner, Burns, Toan & Lunde, archts—Oct. 1983, BTS, pp. 92-95 • Friedrich Stadt, East Berlin, East Germany; Anthony Ames, archt—Aug. 1983, pp. 102-103 • "Housing affordability index announced"—Sept-2 1983, p. 27 • Imperial at Brickell, Miami, FL; Arquitectonica, archts—July 1983, BTS, pp. 92-95 • Marriott Residence, Chicago, IL; Krueck & Olsen, archts—Sept-1 1983, pp. 88-95 • "NAHB plans convention and issues warnings"—Oct. 1983, p. 33 • Pensacola Place, Chicago, IL; Tigerman Fugman McCurry, archts—July 1983, BTS, pp. 98-99 • Pin Oak Commercial Center, Houston, TX; Cesar Pelli & Associates, archts—July 1983, p. 109 • Potatoe Hill Residential District Renovation, Winchester, VA; Preservation of Historic Winchester, preservationists—Oct. 1983, BTS, pp. 106-109 • Rosen Apartment, New York, NY; Bray-Schaible Design, dsgnrs—Sept-1 1983, pp. 150-151 • "Round Table: The architect's role in built-for-sale housing"—Mid-May 1983, pp. 33-47 • San Pietro al Natissone Student Housing, San Pietro al Natissone, Italy; Mitchell/Giurgola, archts—Aug. 1983, pp. 116-117 • Tsao Apartment, New York, NY; Calvin Tsao with Zack McKown, dsgnrs—Sept-1 1983, pp. 152-159 • Windswept, Kiawah Island, SC; Sandy & Babcock, archts—July 1983, BTS, pp. 88-91.
- Housing for the Elderly—Center for the Elderly, Buia, Italy; Renato Severino, archt—Aug. 1983, pp. 108-109.
- Hult Center for the Performing Arts, Eugene, OR—Hardy Holzman Pfeiffer Associates, archts—May 1983, pp. 120-129 • Hult Center Acoustics; Jaffe Associates, acoustics—May 1983, pp. 130-133.
- HVAC Systems—Amoco Building, Denver, CO; Kohn Pederson Fox Associates, archts—Feb. 1983, p. 125 • Anaconda Tower, Denver, CO; Skidmore, Owings & Merrill, archts—Feb. 1983, p. 125 • Enerplex, South Building, Princeton, NJ; Skidmore, Owings & Merrill, archts—Feb. 1983, pp. 130-131 • Farm Credit Banks of Spokane Building, Spokane, WA; Walker McGough Foltz Lyerla, archts—Feb. 1983, pp. 128-129 • Rocky Mountain Energy Company Headquarters, Bloomfield, CO; Kohn Pederson Fox Associates, archts—Feb. 1983, p. 127 • St. Paul Town Square Complex, St. Paul, MN; Skidmore, Owings & Merrill, archts—Feb. 1983, p. 126 • World Financial Center, New York, NY; Cesar Pelli & Associates, archts—Feb. 1983, p. 126.
- I**
- IKOY Architects, archts—Harborview at Kil-Cona Park, Winnipeg, Manitoba, Canada—May 1983, BTS, pp. 102-105 • IKOY Office Building, Winnipeg, Manitoba, Canada—Apr. 1983, pp. 146-149.
- Imam, Shafiq, archt—Azem Palace Reconstruction, Damascus, Syria—Sept-2 1983, BTS, p. 74.
- Imperial at Brickell, Miami, FL—Arquitectonica, archts—July 1983, BTS, pp. 92-95.
- Independence National Historical Park Maintenance Facility, Philadelphia, PA—Mitchell/Giurgola, archts—July 1983, pp. 126-127.
- India—Cidade de Goa Resort Hotel, Goa; C.M. Correa, archt—Apr. 1983, pp. 154-159.
- Indiana Tower, White Rock Park, Indianapolis, IN—Cesar Pelli & Associates, archts—July 1983, p. 106.
- Industrial Buildings—"Blue-collar buildings"—July 1983, pp. 120-127 • Consolidated Edison Customer Service Facility, Bronx, NY; Richard Dattner, archt—July 1983, pp. 124-125 • Independence National Historical Park Maintenance Facility, Philadelphia, PA; Mitchell/Giurgola, archts—July 1983, pp. 126-127 • Wissa Wassef Arts Center, Giza-Cairo, Egypt; Ramses Wissa Wassef, archt—Sept-2 1983, BTS, p. 81.
- Ingalls Memorial Hospital, Wyman-Gordon Pavilion, Harvey, IL—Perkins & Will, archts—June 1983, BTS, pp. 98-101.
- Interior Facilities Associates, interior dsgnrs—Bankers Trust Company Trading Room, New York, NY—June 1983, pp. 136-137.
- Interiors (see also *Offices, Showrooms*)—Dianne B., New York, NY; Voorsanger & Mills Associates, archts—Mar. 1983, pp. 126-127 • Georgetown University, Riggs Memorial Library, Washington, DC; EPR, archts—Sept-1 1983, pp. 134-137 • Harry Winston "Petit Salon," New York, NY; Adam Tihany, archt—Sept-1 1983, pp. 114-115 • Janovic Plaza, New York, NY; Voorsanger & Mills Associates, archts—Mar. 1983, pp. 122-125 • Jessica Gunne Sax Headquarters, San Francisco, CA; Hanns Kainz & Associates, archts—Sept-1 1983, pp. 102-107 • Marriott Residence, Chicago, IL; Krueck & Olsen, archts—Sept-1 1983, pp. 88-95 • New York University Graduate School of Business Library, New York, NY; Voorsanger & Mills Associates, archts—Aug. 1983, BTS, pp. 80-83 • Piano, Barcelona, Spain; Riart/Cortes/Gubern/Ordeig/Perez Sanchez, dsgnrs—Sept-1 1983, pp. 128-131 • Private Screening Room, New York, NY; G. Michael Mostoller, archt—Sept-1 1983, pp. 100-101 • Rosen Apartment, New York, NY; Bray-Schaible Design, dsgnrs—Sept-1 1983, pp. 150-151 • "Round Table: The education of architects in interior design"—Sept-1 1983, pp. 35-47 • Springer Building, Galveston, TX; Taft Architects, archts—Sept-1 1983, p. 144-145 • Tsao Apartment, New York, NY; Calvin Tsao with Zack McKown, dsgnrs—Sept-1 1983, pp. 152-159 • Venturi, Scott Brown Residence, Philadelphia, PA; Venturi, Rauch and Scott Brown, archts—Sept-1 1983, pp. 108-113.
- Interspace Incorporated with The Architects Collaborative, archts—CIGNA Office Building, Bloomfield, CT—Apr. 1983, pp. 160-167.
- Islamic Architecture—see *Aga Khan Award for Architecture*
- Isozaki, Arata, archt—"The recent work of Arata Isozaki: Part I," by Martin Filler—Oct. 1983, pp. 125-137 • Tsukuba Civic Center/Dai Ichi Hotel, Tsukuba New Town, Ibaragi Prefecture, Japan; by Martin Filler—Oct. 1983, pp. 126-137.
- Israel—Van Leer Residence, Jerusalem; Moshe Safdie and Associates, archts—Nov. 1983, pp. 124-127.
- Italy—Aviano Elementary School, Aviano; Mitchell/Giurgola, archts—Aug. 1983, pp. 112-113 • Center for the Elderly, Buia; Renato Severino, archt—Aug. 1983, pp. 108-109 • Maniago Technical High School, Maniago; Mitchell/Giurgola, archts—Aug. 1983, pp. 114-115 • Pordenone School of Architecture, Spilimbergo; Renato Severino, archt—Aug. 1983, pp. 110-111 • San Pietro al Natissone Student Housing, San Pietro al Natissone; Mitchell/Giurgola, archts—Aug. 1983, pp. 116-117.
- J**
- Jacobs, Stephen B. & Associates, archts—Five 1880s Warehouse Renovations, New York, NY—Oct. 1983, BTS, pp. 92-95.
- Jacobsen, Hugh Newell, archt—University of Michigan Alumni Center, Ann Arbor, MI—Apr. 1983, pp. 130-137.
- Jaffe Associates, acoustics, Hardy Holzman Pfeiffer Associates, archts—Hult Center for the Performing Arts [Acoustics], Eugene, OR—May 1983, pp. 130-133.
- Jails—see *Penal Institutions*
- Janovic Plaza, New York, NY—Voorsanger & Mills Associates, archts—Mar. 1983, pp. 122-125.
- Japan—Keio University Library, Tokyo; Maki and Associates, archts; by Joan E. Goody—May 1983, pp. 106-113 • Tsukuba Civic Center/Dai Ichi Hotel, Tsukuba New Town, Ibaragi Prefecture; Arata Isozaki & Associates, archts, by Martin Filler—Oct. 1983, pp. 126-137.

Jessica Gunne Sax Headquarters, San Francisco, CA—Hanns Kainz & Associates, archts—Sept-1 1983, pp. 102-107.
Johnson, Philip, archt—Johnson Study/Library, New Canaan, CT—July 1983, pp. 114-119.
Jung/Brannen Associates, archts—One Post Office Square, Boston, MA—July 1983, pp. 128-135.

K

Kainz, Hanns & Associates, archts—Jessica Gunne Sax Headquarters, San Francisco, CA—Sept-1 1983, pp. 102-107.
Karson, Michael, and Michael Silchuck—“Coping with insured liability claims”—June 1983, pp. 37, 53, 78.
Keio University Library, Tokyo, Japan—Maki and Associates, archts; by Joan E. Goody—May 1983, pp. 106-113.
Kiene & Bradley Design Group with Skidmore, Owings & Merrill, archts—Menninger Foundation, Topeka, KS—June 1983, BTS, pp. 86-93.
King Abdul-Aziz International Airport, Hajj Terminal, Jeddah, Saudi Arabia—Skidmore, Owings & Merrill, archts—Sept-2 1983, BTS, pp. 84-85.
Kohn Pederson Fox Associates, archts—Amoco Building, Denver, CO—Feb. 1983, p. 125 • Rocky Mountain Energy Company Headquarters, Bloomfield, CO—Feb. 1983, p. 127 and Apr. 1983, BTS, pp. 126-129.
Kornblut, Arthur, Esq.—“How responsible are you for shop drawings?”—May 1983, p. 37 • “Mostly good news on statute-of-limitations rulings”—Aug. 1983, p. 33 • “Proprietary specifications and the antitrust law”—Feb. 1983, p. 41 • “Who is responsible for construction safety?”—Oct. 1983, p. 41.
Krueck & Olsen, archts—Marriott Residence, Chicago, IL—Sept-1 1983, pp. 88-95.
Kupper, Eugene, archt—Grakal, Stamler, Blackman [Law] Offices, Santa Monica, CA—Sept-1 1983, pp. 122-127.

L

Landahl Group, archts—Barclays Bank International Offices, Chicago, IL—Sept-1 1983, pp. 146-149.
Lander Associates with Penney & Bernstein, archts—Lander Associates Offices, New York, NY—Jan. 1983, BTS, pp. 92-94.
Le Corbusier—“An architecture drawn from life [a review of *Le Corbusier Sketchbooks*],” by Kurt W. Forster—Apr. 1983, pp. 142-145.
Legal Perspectives (see also *Building Codes, Office Management*)—“Arbitrations to be speeded”—May 1983, p. 35 • “Architects and engineers getting part of what they want on antitrust laws,” by Peter Hoffman and Daniel B. Moskowitz—Feb. 1983, p. 35 • “How responsible are you for shop drawings?” by Arthur Kornblut, Esq.—May 1983, p. 37 • “Mostly good news on statute-of-limitations rulings,” by Arthur Kornblut, Esq.—Aug. 1983, p. 33 •

“Proprietary specifications and the antitrust law,” by Arthur Kornblut, Esq.—Feb. 1983, p. 41 • “Who is responsible for construction safety?” by Arthur Kornblut, Esq.—Oct. 1983, p. 41.

LePatner, Barry B., Esq.—“The profitable professional: Protecting ownership and use of plans”—Jan. 1983, pp. 47, 49 • “The profitable professional: Target your goals and priorities”—June 1983, pp. 47, 57.

Libraries—Anchorage Headquarters Library Competition Entry, Anchorage, AK; Gunnar Birkerts & Associates, archts—Mar. 1983, pp. 108-109 • Billerica Public Library, Billerica, MA; James C. Hopkins Associates, archts—Aug. 1983, BTS, pp. 84-85 • “Designing tomorrow’s libraries”—Aug. 1983, BTS, p. 91 • Georgetown University, Riggs Memorial Library, Washington, DC; EPR, archts—Sept-1 1983, pp. 134-137 • Keio University Library, Tokyo, Japan; Maki and Associates, archts; by Joan E. Goody—May 1983, pp. 106-113 • Middletown Public Library, Middletown, OH; Lorenz & Williams, archts—July 1983, pp. 138-139 • New York Public Library Renovation, New York, NY; Giorgio Cavaglieri with Davis, Brody & Associates, archts—Aug. 1983, BTS, pp. 74-79 • New York University Graduate School of Business Library, New York, NY; Voorsanger & Mills Associates, archts—Aug. 1983, BTS, pp. 80-83 • Unionville Library, Town of Markham, Ontario, Canada; Barton Myers Associates, archts—Feb. 1983, pp. 96-97 • Yale University, Seeley G. Mudd Library, New Haven, CT; Roth and Moore, archts—Aug. 1983, BTS, pp. 86-90.

Lighting (see also *Daylighting*)—CIGNA Office Building, Bloomfield, CT; The Architects Collaborative with Interspace Incorporated, archts—Apr. 1983, pp. 160-167 • “Lighting those visual display terminals—in the cause of the operator’s comfort,” by Sylvan R. Shemitz, with Gladys Walker—Oct. 1983, pp. 138-143 • Steelcase Headquarters Building, Grand Rapids, MI; WBDC, archts, with Steelcase dsgrns—Nov. 1983, pp. 132-135.

L.L. Ewan Restaurant, Warwick, RI—Warren Platner Associates, archts—Apr. 1983, pp. 138-141.

Loftis Bell Downing & Partners, archts—Marion Corporation, Daphne, AL—Apr. 1983, BTS, pp. 122-125.

Logan, Donn, archt—“Educating architects at Berkeley,” by Marcy Li Wang—Feb. 1983, pp. 112-113.
Long Wharf Marriott Hotel, Boston, MA—Cossuta & Associates, archts—Mar. 1983, pp. 100-107.

Lorenz & Williams, archts—Middletown Public Library, Middletown, OH—July 1983, pp. 138-139.

Louisiana World Exposition 1984 Amphitheater, New Orleans, LA—Frank Gehry, archt—June 1983, pp. 124-125.

Loyola Law School, Los Angeles, CA—Frank Gehry, archt—June 1983, pp. 120-121.

Lyndon, Donlyn, archt—“Educating architects at Berkeley,” by Marcy Li Wang—Feb. 1983, pp. 114-115.

Lynn, Dorothy A.—“Some useful tips on how to be effective and confident in presentations”—Mar. 1983, p. 47.

M

Maki and Associates, archts—Keio University Library, Tokyo, Japan; by Joan E. Goody—May 1983, pp. 106-113.

Malaysia—Tanjong Jara Beach Hotel and Rantau Abang Visitors’ Center, Kuala Trengganu; Whisenand, Allison, Tong and Goo, archts—Sept-2 1983, BTS, p. 75.

Mali—Great Mosque of Niono, Niono; Lassine Minta, master mason—Sept-2 1983, BTS, pp. 72-73.

Manhattan House of Detention for Men, New York, NY—The Gruzen partnership, archts—Mar. 1983, BTS, pp. 86-87.

Maniago Technical High School, Maniago, Italy—Mitchell/Giurgola, archts—Aug. 1983, pp. 114-115.

Marion Corporation, Daphne, AL—Loftis Bell Downing & Partners, archts—Apr. 1983, BTS, pp. 122-125.

Marketing—“Are renderings still important in our electronic age?”—Oct. 1983, pp. 45-51 • “The market-segmentation approach,” by Kenneth Rohde and Michael Noble—Aug. 1983, pp. 37-45 • “Some useful tips on how to be effective and confident in presentations,” by Dorothy A. Lynn—Mar. 1983, p. 47 • “What are the aggressive firms doing to get their share of design work? An important [1982] survey report...”, by Ernest Burden—Feb. 1983, pp. 47, 49 • “What are the aggressive firms doing to get their share of design work? An important [1983] survey report...”, by Ernest Burden—June 1983, pp. 43, 45, 55.

Marketplaces—see *Shopping Centers & Marketplaces*

Marriott Residence, Chicago, IL—Krueck & Olsen, archts—Sept-1 1983, pp. 88-95.

MBA/Architects & Planners, archts—Custom House Renovation [with James Stewart Polshek & Partners], New York, NY—Oct. 1983, BTS, pp. 92-95 • Merck, Sharp & Dohme Divisional Headquarters, West Point, PA—Sept-2 1983, pp. 102-107.

McFarlane, Robert E., and Robert J. Nissen—“Two-way teleconferencing: room design comes first”—Sept-2 1983, pp. 112-119.

McKown, Zack with Calvin Tsao, dsgrns—Tsao Apartment, New York, NY—Sept-1 1983, pp. 152-159.

Meade, Bradley—“Using CAD effectively with reprographics”—Sept-2 1983, pp. 29, 31 • “Using reprographics effectively with CAD”—Oct. 1983, pp. 37, 39.

Medical Facilities (see also *Hospitals*)—Cleveland Clinic, Cleveland, OH; Cesar Pelli & Associates, archts—July 1983, p. 107 • “For

health-care providers too: an outlook of stressful—but hopeful—change,” by Michael Bobrow and Julia Thomas—June 1983, BTS, pp. 102-103 • Menninger Foundation, Topeka, KS; Skidmore, Owings & Merrill with Kiene & Bradley Design Group, archts—June 1983, BTS, pp. 86-93.

Mental Health Facilities—see *Hospitals, Medical Facilities*

Meola Studio and Apartment, New York, NY—Gillis Associates, archts—Nov. 1983, pp. 120-123.

Merck, Sharp & Dohme Divisional Headquarters, West Point, PA—MBA/Architects & Planners, archts—Sept-2 1983, pp. 102-107.

Mere House, Flint Hill, VA—Bump-Zoid, archts—Mid-May 1983, pp. 90-93.

Middletown Public Library, Middletown, OH—Lorenz & Williams, archts—July 1983, pp. 138-139.

Mileaf, Harry—“Round Table on computers in architecture” [with Walter Wagner]—May 1983, pp. 39-53 • “Where is your firm to get software?”—Jan. 1983, pp. 41, 43 • “The wonderland of computer language”—Apr. 1983, pp. 51, 73.

Miller, Nory—“Big business preservation”—Oct. 1983, BTS, pp. 91-109.

Milliken, Barry—“The personal challenge of CAD”—Mar. 1983, pp. 41, 43, 45.

Minta, Lassine, master mason—Great Mosque of Niono, Niono, Mali—Sept-2 1983, BTS, pp. 72-73.

Mitchell/Giurgola, archts—Aviano Elementary School, Aviano, Italy—Aug. 1983, pp. 112-113 • Independence National Historical Park Maintenance Facility, Philadelphia, PA—July 1983, pp. 126-127 • “Made in Friuli” [with Renato Severino]—Aug. 1983, pp. 104-117 • Maniago Technical High School, Maniago, Italy—Aug. 1983, pp. 114-115 • San Pietro al Natisone Student Housing, San Pietro al Natisone, Italy—Aug. 1983, pp. 116-117.

Mixed-use Buildings—Five 1880s Warehouse Renovations, New York, NY; Stephen B. Jacobs & Associates, archts—Oct. 1983, BTS, pp. 92-95 • Meola Studio and Apartment, New York, NY; Gillis Associates, archts—Nov. 1983, pp. 120-123 • Royal Conservatory of Music, Toronto, Ontario, Canada; Barton Myers Associates, archts—Feb. 1983, pp. 100-101 • Springer Building, Galveston, TX; Taft Architects, archts—Sept-1 1983, p. 144-145 and Oct. 1983, BTS, pp. 102-105.

MLTW/Turnbull Associates, archts—Davidow House, Kauai, HI—Mid-May 1983, pp. 112-115.

Morawetz, John—“Economics: The rise and fall of the high-rise”—June 1983, pp. 39, 41.

Morgan and Lindstrom, archts—Private Residence, San Juan Islands, WA—Mid-May 1983, pp. 128-133.

Morgan, William Architects, archts—District Court of Appeal, First District, Tallahassee, FL—Jan. 1983, pp. 116-121.

Mostoller, G. Michael, archt—Private Screening Room, New York, NY—Sept-1 1983, pp. 100-101.

- Motels—see Hotels & Motels**
- Municipal Museum Abteiberg Monchengladbach, Monchengladbach, West Germany—Hans Hollein, archt—Feb. 1983, BTS, pp. 79-91.
- Murphy/Jahn, archts—Area 2 Police Center [with the Chicago Dept. of Public Works], Chicago, IL—Jan. 1983, pp. 105-107 • Argonne National Laboratories Program Support Facility, Joliet, IL—Jan. 1983, pp. 108-111 • First Source Center, South Bend, IN—Jan. 1983, pp. 112-115 • "Toward romantic high-tech"—Jan. 1983, pp. 102-115.
- Museums—California Aerospace Museum, Exposition Park, Los Angeles, CA; Frank Gehry, archt—June 1983, pp. 122-123 • Municipal Museum Abteiberg Monchengladbach, Monchengladbach, West Germany; Hans Hollein, archt—Feb. 1983, BTS, pp. 79-91 • Portland Museum of Art, Charles Shipman Payson Building, Portland, ME; I.M. Pei & Partners, archts—Nov. 1983, pp. 108-119 • Seagram Museum and Archives, Waterloo, Ontario, Canada; Barton Myers Associates, archts—Feb. 1983, pp. 92-95.
- Myers, Barton Associates, archts—"Barton Myers proposes warm, lively indoor towns"—Feb. 1983, pp. 92-101 • Exposition Multicultural Center, Los Angeles, CA—Feb. 1983, pp. 98-99 • Royal Conservatory of Music, Toronto, Ontario, Canada—Feb. 1983, pp. 100-101 • Seagram Museum and Archives, Waterloo, Ontario, Canada—Feb. 1983, pp. 92-95 • Unionville Library, Town of Markham, Ontario, Canada—Feb. 1983, pp. 96-97.
- N**
- NEOCON—"It's convention time... Is it also time to think of conventions as a place to think?," by Walter F. Wagner, Jr.—May 1983, p. 9.
- New York Landmarks Conservancy, preservationists—"Big business preservation—New York: Wheeling and dealing," by Nory Miller—Oct. 1983, BTS, pp. 92-95.
- New York Public Library Renovation, New York, NY - Giorgio Cavaglieri with Davis, Brody & Associates, archts—Aug. 1983, BTS, pp. 74-79.
- New York University Graduate School of Business Library, New York, NY - Voorsanger & Mills Associates, archts—Aug. 1983, BTS, pp. 80-83.
- Newman, Herbert S. Associates, archts - Northeastern University, Kariotis Hall, Boston, MA—Nov. 1983, BTS, pp. 104-107.
- Nissen, Robert J., and Robert E. McFarlane - "Two-way teleconferencing: room design comes first"—Sept-2 1983, pp. 112-119.
- Noble, Michael, and Kenneth Rohde - "The market-segmentation approach"—Aug. 1983, pp. 37-45.
- North Shore Congregation Israel, Glencoe, IL - Hammond Beebe and Babka, archts—June 1983, pp. 104-113.
- Northeastern University, Kariotis Hall, Boston, MA—Herbert S. Newman Associates, archts—Nov. 1983, BTS, pp. 104-107.
- Norton House, Venice, CA—Frank Gehry, archt—June 1983, p. 117.
- O**
- Office Buildings, High-rise (see also *Office Buildings, Low-rise; Mixed-use Buildings*)—Amoco Building, Denver, CO; Kohn Pederson Fox Associates, archts—Feb. 1983, p. 125 • Anaconda Tower, Denver, CO; Skidmore, Owings & Merrill, archts—Feb. 1983, p. 125 • Bank of America Plaza [Biltmore Hotel renovation], New York, NY; Environetics Architect P.C., archts—Jan. 1983, pp. 128-133 • "Economics: The rise and fall of the high-rise," by John Morawetz—June 1983, pp. 39, 41 • Farm Credit Banks of Spokane Building, Spokane, WA; Walker McGough Foltz Lyerla, archts—Feb. 1983, pp. 128-129 • First Source Center, South Bend, IN; Murphy/Jahn, archts—Jan. 1983, pp. 112-115 • "Energy conservation in office buildings—a maturing art," Flack + Kurtz, engns—Feb. 1983, pp. 124-131 • One Champion Plaza, Stamford, CT; Ulrich Franzen & Associates, archts—Feb. 1983, pp. 102-107 • One Post Office Square, Boston, MA; Jung/Brannen Associates, archts—July 1983, pp. 128-135 • Pin Oak Commercial Center, Houston, TX; Cesar Pelli & Associates, archts—July 1983, p. 109 • St. Paul Town Square Complex, St. Paul, MN; Skidmore, Owings & Merrill, archts—Feb. 1983, p. 126 • 10 & 30 South Wacker Drive, Chicago, IL; Fujikawa Johnson & Assoc., archts, with Alfred Benesch & Co., engns—Nov. 1983, pp. 136-139 • World Financial Center, New York, NY; Cesar Pelli & Associates, archts—Feb. 1983, p. 126 and July 1983, pp. 110-113.
- Office Buildings, Low-rise (see also *Office Buildings, High-rise; Mixed-use Buildings*)—Argonne National Laboratories Program Support Facility, Joliet, IL; Murphy/Jahn, archts—Jan. 1983, pp. 108-111 • Beneficial Center, Peapack/Gladstone, NJ; The Hillier Group, archts—Apr. 1983, BTS, pp. 114-117 • Consolidated Edison Customer Service Facility, Bronx, NY; Richard Dattner, archt—July 1983, pp. 124-125 • "Energy conservation in office buildings—a maturing art," Flack + Kurtz, engns—Feb. 1983, pp. 124-131 • Enerplex, South Building, Princeton, NJ; Skidmore, Owings & Merrill, archts—Feb. 1983, pp. 130-131 • Harbor Plaza, Stamford, CT; Yankee Planning/Do H. Chung, archts; by Mary Woods—Sept-2 1983, pp. 108-111 • Harlequin Plaza, Englewood, CO; Gensler & Associates, archts—Apr. 1983, BTS, pp. 118-121 • Herman Miller Roswell Facility, Roswell, GA; Heery & Heery, archts—Jan. 1983, pp. 122-127 • IKOY Office Building, Winnipeg, Manitoba, Canada; IKOY Architects, archts—Apr. 1983, pp. 146-149 • Marion Corporation, Daphne, AL; Loftis Bell Downing & Partners, archts—Apr. 1983, BTS, pp. 122-125 • Merck, Sharp & Dohme Divisional Headquarters, West Point, PA; MBA/Architects & Planners, archts—Sept-2 1983, pp. 102-107 • Philip Morris Operations Center, Richmond, VA; Davis, Brody & Associates, archts—Mar. 1983, pp. 114-121 • Rocky Mountain Energy Company Headquarters, Bloomfield, CO; Kohn Pederson Fox Associates, archts—Feb. 1983, p. 127 and Apr. 1983, BTS, pp. 126-129 • Seattle Garden Center, Seattle, WA; Arne Bystrom, archt—Apr. 1983, pp. 150-151 • Station Square, Commerce Court, and The Freight House Shops, Pittsburgh, PA; Pittsburgh History & Landmark Foundation, developers—Oct. 1983, BTS, pp. 96-101 • Union Carbide Corporation World Headquarters, Danbury, CT; Kevin Roche John Dinkeloo Associates, archts—Oct. 1983, pp. 110-117.
- Office Management (see also *Computers, Construction Management, Legal Perspectives, and Marketing*)—"AIA seminar yields sophisticated advice on working abroad," by Peter Hoffman—Jan. 1983, p. 33 • "Assessing your liability insurance," by Sara Paretsky and Michael Silchuck—Jan. 1983, pp. 35, 37 • "Calling yourself an interior designer in Connecticut could bring problems"—Oct. 1983, p. 33 • "Coping with insured liability claims," by Michael Silchuck and Michael Karson—June 1983, pp. 37, 53, 78 • "Disability insurance protects you from possible disaster [Part 1]," by John J. Hanlon, Jr.—July 1983, p. 43 • "Disability insurance protects you from possible disaster [Part 2]," by Liane Leach Chapman—Nov. 1983, p. 37 • "Good news for architects—but not engineers," by Herbert Cheshire—Aug. 1983, p. 25 • "Insurance: Reducing your chances of a liability claim," by Michael Silchuck—Aug. 1983, pp. 39, 47 • "Mergers may not work for every firm—but here's why two big ones got together"—Aug. 1983, p. 35 • "On understanding changing marketplaces and changing tactics for getting things built," by Walter F. Wagner, Jr.—Oct. 1983, p. 9 • "Professional development: Seminars on preservation, computers, and business management"—July 1983, p. 37 • "The profitable professional: Protecting ownership and use of plans," by Barry B. LePatner, Esq.—Jan. 1983, pp. 47, 49 • "The profitable professional: Target your goals and priorities," by Barry B. LePatner, Esq.—June 1983, pp. 47, 57 • "PSMA plots new course"—Jan. 1983, p. 33 • "So you want to do business in China?"—Sept-2 1983, p. 33 • "Strategies for survival"—Feb. 1983, pp. 43, 45.
- Offices—Anspach Grossman Portugal Offices, New York, NY; Samuel J. De Santo & Associates, archts—Sept-1 1983, pp. 116-119 • Barclays Bank International Offices, Chicago, IL; Landahl Group, archts—Sept-1 1983, pp. 146-149 • Batey & Mack Office, San Francisco, CA; Batey & Mack, archts—Sept-1 1983, pp. 120-121 • Berkli Corporation Executive and Sales Offices, New York, NY; Bentley/LaRosa/Salasky, dsgrs—Sept-1 1983, p. 140-143 • CIGNA Office Building, Bloomfield, CT; The Architects Collaborative with Interspace Incorporated, archts—Apr. 1983, pp. 160-167 • Cooper & Company Offices and Studio, New York, NY; John Chimera Architect, archts—Jan. 1983, BTS, pp. 96-97 • Credit du Nord Offices, New York, NY; Rivkin/Weisman, archts—Sept-1 1983, pp. 96-99 • Dubai Bank Limited Offices, New York, NY; Rivkin/Weisman, archts—Jan. 1983, BTS, pp. 86-91 • Grakal, Stampler, Blackman [Law] Offices, Santa Monica, CA; Eugene Kupper, archt—Sept-1 1983, pp. 122-127 • Himmel, Bonner Architects Offices, Chicago, IL; Himmel, Bonner, archts—Apr. 1983, pp. 152-153 • Landor Associates Offices, New York, NY; Landor Associates with Penney & Bernstein, archts—Jan. 1983, BTS, pp. 92-94 • Reynolds Tobacco Company Building [lobby restoration], Winston-Salem, NC; Croxton Collaborative, archts—Jan. 1983, BTS, pp. 98-101 • Steelcase Headquarters Building, Grand Rapids, MI; WBDC, archts, with Steelcase dsgrs—Nov. 1983, pp. 132-135 • Swid Powell Design Offices, New York, NY; D'Urso Design, dsgr—Sept-1 1983, pp. 132-133 • "Two-way teleconferencing: room design comes first," by Robert E. McFarlane and Robert J. Nissen—Sept-2 1983, pp. 112-119.
- One Champion Plaza, Stamford, CT—Ulrich Franzen & Associates, archts—Feb. 1983, pp. 102-107.
- One Post Office Square, Boston, MA—July 1983, pp. 128-135.
- Owings, Nathaniel Alexander—"A nearly-80-year-old architect talks about what seems important now," by Walter F. Wagner, Jr.—July 1983, p. 9.
- P**
- Pakistan—Tomb of Shah Rukn-i Alam Restoration, Multan; Muhammad Wali Ullah Khan, archt—Sept-2 1983, BTS, p. 74.
- Pape, Lloyd with Ben Templin & Associates, archts—Austin Junior High School, Galveston, TX—July 1983, pp. 140-141.
- Paretsky, Sara, and Michael Silchuck—"Assessing your liability insurance"—Jan. 1983, pp. 35, 37.
- Parking, Garage—Pier 76 Garage, New York, NY; Goodkind & O'dea, archts—July 1983, pp. 142-143.
- Parks (see also *Recreation Facilities*)—Charlton Park, Bronx, NY; Leland R. Weintraub, landscape archt—May 1983, BTS, p. 101 • Independence National Historical Park Maintenance Facility, Philadelphia, PA; Mitchell/Giurgola, archts—July 1983, pp. 126-127 • Tiffany Plaza, Bronx, NY; Leland R. Weintraub, landscape archt—May 1983, BTS, pp. 98-99 • Washington Market Park, New York, NY; Leland R. Weintraub, landscape archt—May 1983, BTS, p. 100.
- Pavilions—see *Exposition Buildings*
- Pei, I.M. & Partners, archts—Portland Museum of Art, Charles Shipman

- Payson Building, Portland, ME—Nov. 1983, pp. 108-119.
- Pelli, Cesar & Associates, archts—Cleveland Clinic, Cleveland, OH—July 1983, p. 107 • Indiana Tower, White Rock Park, Indianapolis, IN—July 1983, p. 106 • “New layers of meaning: Works in progress by Cesar Pelli”—July 1983, pp. 104-113 • Pin Oak Commercial Center, Houston, TX—July 1983, p. 109 • Rice University, Herring Hall, Houston, TX—July 1983, p. 108 • World Financial Center, New York, NY—Feb. 1983, p. 126 and July 1983, pp. 110-113.
- Penal Institutions—Contra Costa County Detention Facility, Martinez, CA; Correction Facility Architects, archts—Mar. 1983, BTS, pp. 82-85 • Gallatin County Detention Center, Bozeman, MT; BGS Architects with RS Architects, archts—Mar. 1983, BTS, pp. 96-98 • Manhattan House of Detention for Men, New York, NY; The Gruzen Partnership, archts—Mar. 1983, BTS, pp. 86-87 • Spokane County Correction/Detention Facility, Spokane, WA; Walker McGough Foltz Lyerla, archts—Mar. 1983, BTS, pp. 92-93 • “Strategies for corrections programming,” by Kenneth Ricci—Mar. 1983, BTS, p. 99 • Trenton State Prison Rehabilitation, Trenton, NJ; The Grad Partnership with The Gruzen Partnership, archts—Mar. 1983, BTS, pp. 88-91 • Washington State Medium Security Prison, Monroe, WA; Hellmuth, Obata & Kassabaum with TRA Associates, archts—Mar. 1983, BTS, pp. 94-95.
- Penney & Bernstein with Landor Associates, archts—Lander Associates Offices, New York, NY—Jan. 1983, BTS, pp. 92-94.
- Pensacola Place, Chicago, IL—Tigerman Fugman McCurry, archts—July 1983, BTS, pp. 98-99
- Performing Arts Buildings—Brooklyn Bridge Anchorage Restoration, New York, NY; Smotrich & Platt, archts—Aug. 1983, pp. 124-127 • Church of St. Ann and the Holy Trinity, Brooklyn Heights, NY; Hardy Holzman Pfeiffer Associates, archts—Oct. 1983, BTS, pp. 92-95 • Exposition Multicultural Center, Los Angeles, CA; Barton Myers Associates, archts—Feb. 1983, pp. 98-99 • Hult Center for the Performing Arts, Eugene, OR; Hardy Holzman Pfeiffer Associates, archts, Jaffe Associates, acoustics—May 1983, pp. 120-133 • Louisiana World Exposition 1984 Amphitheater, New Orleans, LA; Frank Gehry, archt—June 1983, pp. 124-125 • Royal Conservatory of Music, Toronto, Ontario, Canada; Barton Myers Associates, archts—Feb. 1983, pp. 100-101 • Saenger Theater, Pensacola, FL; Holabird & Root, archts—Aug. 1983, pp. 92-95 • Tsukuba Civic Center/Dai Ichi Hotel, Tsukuba New Town, Ibaragi Prefecture, Japan; Arata Isozaki & Associates, archts; by Martin Filler—Oct. 1983, pp. 126-137.
- Perkins & Will, archts—Ingalls Memorial Hospital, Wyman-Gordon Pavilion, Harvey, IL—June 1983, BTS, pp. 98-101.
- Perkins, Bradford—“Construction management: A useful service—if you know how to work with it”—Mar. 1983, pp. 35, 37 • “Form & Purpose, by Moshe Safdie” [review]—Jan. 1983, pp. 77-79.
- Philip Morris Operations Center, Richmond, VA—Davis, Brody & Associates, archts—Mar. 1983, pp. 114-121.
- Phillips Exeter Academy, Frederick R. Mayer Art Center, Exeter, NH—Amsler Hagenah MacLean, archts—Nov. 1983, BTS, pp. 96-101.
- Piano, Barcelona, Spain—Riart/Cortes/Gubern/Ordeig/Perez Sanchez, dsgrs—Sept-1 1983, pp. 128-131.
- Pickering House, Laurel, MI—Anthony Ames, archt—Aug. 1983, pp. 98-99.
- Pier 76 Garage, New York, NY—Goodkind & O’dea, archts—July 1983, pp. 142-143.
- Pin Oak Commercial Center, Houston, TX—Cesar Pelli & Associates, archts—July 1983, p. 109.
- Pittman, Jon H., and John C. Dill—“The single-user workstation—A new concept that promises to benefit the design profession”—Aug. 1983, pp. 27, 29, 31.
- Pittsburgh History & Landmark Foundation, preservationists—“Big business preservation—Pittsburgh: Virtuoso preservationists,” by Nory Miller—Oct. 1983, BTS, pp. 96-101.
- Planning (see also *Urban Design*)—“Still planning with the poor: community design centers keep up the good works,” by Paul M. Sachner—June 1983, pp. 126-131.
- Platner, Warren Associates, archts—L.L. Evan Restaurant, Warwick, RI—Apr. 1983, pp. 138-141.
- Polshak, James Stewart & Partners, archts—Custom House Renovation [with MBA/Architects & Planners], New York, NY—Oct. 1983, BTS, pp. 92-95.
- Pordenone School of Architecture, Spilimbergo, Italy—Renato Severino, archt—Aug. 1983, pp. 110-111.
- Portland Museum of Art, Charles Shipman Payson Building, Portland, ME—I.M. Pei & Partners, archts—Nov. 1983, pp. 108-119.
- Potatoe Hill Residential District Renovations, Winchester, VA—Preservation of Historic Winchester, preservationists—Oct. 1983, BTS, pp. 106-109.
- Preservation (see also *Adaptive Use, Additions, Renovations & Restorations*)—“Administration gives some mild support for preservation with jobs bill”—May 1983, p. 35 • “Big business preservation—Galveston: In-town turnaround [Galveston Historic Foundation],” by Nory Miller—Oct. 1983, BTS, pp. 102-105 • “Big business preservation—New York: Wheeling and dealing [New York Landmarks Conservancy],” by Nory Miller—Oct. 1983, BTS, pp. 92-95 • “Big business preservation—Pittsburgh: Virtuoso preservationists [Pittsburgh History & Landmark Foundation],” by Nory Miller—Oct. 1983, BTS, pp. 96-101 • “Big business preservation—Winchester, VA.: No-frills preservation [Preservation of Historic Winchester],” by Nory Miller—Oct. 1983, BTS, pp. 106-109 • “Churches challenge landmark designation”—Sept-2 1983, p. 25 • “Design commissions from the new jobs bill?,” by Peter Hoffman—June 1983, p. 35 • “Louisiana legislation sets new preservation models”—Dec. 1983, p. 15 • “Professional development: Seminars on preservation, computers, and business management”—July 1983, p. 37 • “Rehabilitation credits in jeopardy from retroactive bill,” by Peter Hoffman—Sept-2 1983, p. 27 • “Setback for preservation tax incentives”—Nov. 1983, p. 35.
- Preservation of Historic Winchester, preservationists—“Big business preservation—Winchester, VA: No-frills preservation,” by Nory Miller—Oct. 1983, BTS, pp. 106-109.
- Princeton University, Gordon Wu Hall, Princeton, NJ—Venturi, Rauch and Scott Brown, archts—Sept-2 1983, pp. 86-97.
- Prisons—see *Penal Institutions*
- Products (see also *Specifications*)—“Innovative customer guarantees announced by Manville”—Mar. 1983, p. 33 • “NIBS fund drive showing success”—Dec. 1983, p. 15 • “Product Reports 1984: The manufacturer as part of the team”—Dec. 1983, pp. 39-216 • “A step backward in building research,” by Peter Hoffman—Apr. 1983, pp. 35, 71.
- Public Buildings (see also *Exposition Buildings, Fire Stations, Libraries, Parks, Penal Institutions, and Recreation Facilities*)—Area 2 Police Center, Chicago, IL; Murphy/Jahn with the Chicago Dept. of Public Works, archts—Jan. 1983, pp. 105-107 • Azem Palace Reconstruction, Damascus, Syria; Shafiq Imam, archt—Sept-2 1983, BTS, p. 74 • District Court of Appeal, First District, Tallahassee, FL; William Morgan Architects, archts—Jan. 1983, pp. 116-121 • Tsukuba Civic Center/Dai Ichi Hotel, Tsukuba New Town, Ibaragi Prefecture, Japan; Arata Isozaki & Associates, archts; by Martin Filler—Oct. 1983, pp. 126-137.
- R**
- Raikes House, Roxbury, CT—Redroof Design, archts—Oct. 1983, pp. 118-124.
- Recreation Facilities (see also *Parks*)—Deer Valley Resort, Park City, UT; Esherick Homsey Dodge and Davis, archts—May 1983, BTS, pp. 92-97 • Harborview at Kil-Cona Park, Winnipeg, Manitoba, Canada; IKOY Architects, archts—May 1983, BTS, pp. 102-105 • Indiana Tower, White Rock Park, Indianapolis, IN; Cesar Pelli & Associates, archts—July 1983, p. 106.
- Redroof Design, archts—Raikes House, Roxbury, CT—Oct. 1983, pp. 118-124.
- Reiach and Hall with G.M.W. Partnership, archts—St. Enoch Square, Glasgow, Scotland—June 1983, pp. 138-143.
- Reinhard House, Chicago, IL—Chrysalis Corp., archts—Mid-May 1983, pp. 94-97.
- Religious Buildings—“Churches challenge landmark designation”—Sept-2 1983, p. 25 • Great Mosque of Niono, Niono, Mali; Lassine Mint, master mason—Sept-2 1983, BTS, pp. 72-73 • North Shore Congregation Israel, Glencoe, IL; Hammond Beebe and Babka, archts—June 1983, pp. 104-113 • Sherefudin’s White Mosque, Visoko, Yugoslavia; Zlatko Ugljen, archt—Sept-2 1983, BTS, pp. 68-71 • US Corps of Engineers Chapel & Educational Facility, Camp Wildflecken, Germany; Gunnar Birkerts & Associates with Giffels Associates, archts—Mar. 1983, p. 110.
- Renovations & Restorations (see also *Adaptive Use, Additions, Preservation*)—Austin Junior High School, Galveston, TX; Ben Templin & Associates with Lloyd Pape, archts—July 1983, pp. 140-141 • Azem Palace Reconstruction, Damascus, Syria; Shafiq Imam, archt—Sept-2 1983, BTS, p. 74 • “Commercial rehab shows big upsurge”—Apr. 1983, p. 35 • Covington Restaurant, Armonk, NY; Mark Cigolle, archt—June 1983, pp. 132-135 • Custom House Renovation, New York, NY; James Stewart Polshek & Partners with MBA/Architects, archts—Oct. 1983, BTS, pp. 92-95 • Darb Qirmiz Revitalization, Cairo, Egypt; Philip Speiser, archt—Sept-2 1983, BTS, p. 75 • Georgetown University, Riggs Memorial Library, Washington, DC; EPR, archts—Sept-1 1983, pp. 134-137 • Gully, The, New England; Timothy D. Smith & Associates, archts—Feb. 1983, pp. 118-123 • Henderson House Restoration/Fair Oaks Cottages Remodeling, Selma, AL; James Seay with Nicholas H. Holmes, archts—May 1983, pp. 114-119 • Manhattan House of Detention for Men, New York, NY; The Gruzen Partnership, archts—Mar. 1983, BTS, pp. 86-87 • New York Public Library Renovation, New York, NY; Giorgio Cavaglieri with Davis, Brody & Associates, archts—Aug. 1983, BTS, pp. 74-79 • Phillips Exeter Academy, Frederick R. Mayer Art Center, Exeter, NH; Amsler Hagenah MacLean, archts—Nov. 1983, BS, pp. 96-101 • Pier 76 Garage, New York, NY; Goodkind & O’dea, archts—July 1983, pp. 142-143 • Potatoe Hill Residential District Renovations, Winchester, VA; Preservation of Historic Winchester, preservationists—Oct. 1983, BTS, pp. 106-109 • Reinhard House, Chicago, IL; Chrysalis Corp., archts—Mid-May 1983, pp. 94-97 • Reynolds Tobacco Company Building [lobby restoration], Winston-Salem, NC; Croxton Collaborative, archts—Jan. 1983, BTS, pp. 98-101 • “Round Table: Conserving energy in the rehabilitated or retrofitted building”—Dec. 1983, pp. 30-37 • Royal Conservatory of Music, Toronto, Ontario, Canada; Barton Myers Associates, archts—Feb. 1983, pp. 100-101 • Saenger Theater, Pensacola, FL; Holabird & Root, archts—Aug. 1983, pp. 92-95 • Tomb of Shah Rukn-i Alam Restoration, Multan, Pakistan; Muhammad Wali Ullah Khan, archt—Sept-2 1983, BTS, p. 74 • Trenton State

- Prison Rehabilitation, Trenton, NJ; The Grad Partnership with The Gruzen Partnership, archts—Mar. 1983, BTS, pp. 88-91 • Van Leer Residence, Jerusalem, Israel; Moshe Safdie and Associates, archts—Nov. 1983, pp. 124-127.
- Research Buildings—Philip Morris Operations Center, Richmond, VA; Davis, Brody & Associates, archts—Mar. 1983, pp. 114-121.
- Residence Andalous, Sousse, Tunisia—Serge Santelli, archt—Sept-2, 1983, BTS, pp. 76-79.
- Restaurants—Covington Restaurant, Armonk, NY; Mark Cigolle, archt—June 1983, pp. 132-135 • L.L. Evan Restaurant, Warwick, RI; Warren Platner Associates, archts—Apr. 1983, pp. 138-141 • Station Square, Commerce Court, and The Freight-house Shops, Pittsburgh, PA; Pittsburgh History & Landmark Foundation, developers—Oct. 1983, BTS, pp. 96-101.
- Reynolds Tobacco Company Building [lobby restoration], Winston-Salem, NC—Croton Collaborative, archts—Jan. 1983, BTS, pp. 98-101.
- Riart/Cortes/Gubern/Ordeig/Perez Sanchez, dsgrns—Piano, Barcelona, Spain—Sept-1 1983, pp. 128-131.
- Ricci, Kenneth—"Strategies for correction programming"—Mar. 1983, BTS, p. 99.
- Rice University, Houston, TX—Herring Hall; Cesar Pelli & Associates, archts—July 1983, p. 108 • Seeley G. Mudd Computer Science Library, Charles Tapley Associates, archts—Nov. 1983, BTS, pp. 90-95.
- Riley, Jefferson B. of Moore Grover Harper, archt—Elliott House, PA—Mid-May 1983, pp. 106-111.
- Rivkin/Weisman, archts—Credit du Nord Offices, New York, NY—Sept-1 1983, pp. 96-99 • Dubai Bank Limited Offices, New York, NY—Jan. 1983, BTS, pp. 86-91 • Private Residence, Fire Island, NY—Mid-May 1983, pp. 80-83.
- Roche, Kevin, John Dinkeloo Associates, archts—Union Carbide Corporation World Headquarters, Danbury, CT—Oct. 1983, pp. 110-117.
- Rocky Mountain Energy Company Headquarters, Bloomfield, CO—Kohn Pederson Fox Associates, archts—Feb. 1983, p. 127 and Apr. 1983, BTS, pp. 126-129.
- Roebing, John A., archt—Brooklyn Bridge, New York, NY; by Horst Berger—Aug. 1983, pp. 118-123.
- Rohde, Kenneth, and Michael Noble—"The market-segmentation approach"—Aug. 1983, pp. 37-45.
- Roofing—"Roofing in transition: Implications of a new technology"—May 1983, pp. 134-141 • "Roofs that work: when everybody observes the rules"—July 1983, pp. 136-143.
- Rosen Apartment, New York, NY—Bray-Schaible Design, dsgrns—Sept-1 1983, pp. 150-151.
- Roth and Moore, archts—Yale University, Seeley G. Mudd Library, New Haven, CT—Aug. 1983, BTS, pp. 86-90.
- Round Table Discussions—"The architect's role is built-for-sale housing"—Mid-May 1983, pp. 33-47 • "Conserving energy in the rehabilitated or retrofitted building"—Dec. 1983, pp. 30-37 • "The education of architects in interior design"—Sept-1 1983, pp. 35-47 • "Round Table on computers in architecture"—May 1983, pp. 39-53.
- Royal Conservatory of Music, Toronto, Ontario, Canada—Barton Myers Associates, archts—Feb. 1983, pp. 100-101.
- RS Architects with BSG Architects, archts—Gallatin County Detention Center, Bozeman, MT—Mar. 1983, BTS, pp. 96-98.
- Russell Sage College, Albany Campus Center, Albany, NY—Architectural Resources Cambridge, archts—Nov. 1983, BTS, pp. 102-103.
- S**
- Sachner, Paul M.—"Still planning with the poor: community design centers keep up the good works"—June 1983, pp. 126-131.
- Saenger Theater, Pensacola, FL—Holabird & Root, archts—Aug. 1983, pp. 92-95.
- Safdie, Moshe—*Form & Purpose* [book reviewed]; by Bradford Perkins—Jan. 1983, pp. 77, 79.
- Safdie, Moshe and Associates, archts—Private Residence, AL—Nov. 1983, pp. 128-131 • "Purpose and place"—Nov. 1983, pp. 124-131 • Van Leer Residence, Jerusalem, Israel—Nov. 1983, pp. 124-127.
- St. Enoch Square, Glasgow, Scotland—G.M.W. Partnership with Reiaich and Hall, archts—June 1983, pp. 138-143.
- St. Paul Town Square Complex, St. Paul, MN—Skidmore, Owings & Merrill, archts—Feb. 1983, p. 126.
- San Pietro al Natisone Student Housing, San Pietro al Natisone, Italy—Mitchell/Giurgola, archts—Aug. 1983, pp. 116-117.
- Sandy & Babcock, archts—Windswept, Kiawah Island, SC—July 1983, BTS, pp. 88-91.
- Santelli, Serge, archt—Residence Andalous, Sousse, Tunisia—Sept-2 1983, BTS, pp. 76-79.
- Sasaki Associates, archts—Clafin Park, Newtonville, MA—July 1983, BTS, pp. 100-103.
- Saudi Arabia—King Abdul-Aziz International Airport, Hajj Terminal, Jeddah; Skidmore, Owings & Merrill, archts—Sept-2 1983, BTS, pp. 84-85.
- Schools—Austin Junior High School, Galveston, TX; Ben Templin & Associates with Lloyd Pape, archts—July 1983, pp. 140-141 • Aviano Elementary School, Aviano, Italy; Mitchell/Giurgola, archts—Aug. 1983, pp. 112-113 • Maniago Technical High School, Maniago, Italy; Mitchell/Giurgola, archts—Aug. 1983, pp. 114-115 • Pordenone School of Architecture, Spilimbergo, Italy; Renato Severino, archt—Aug. 1983, pp. 110-111 • Royal Conservatory of Music, Toronto, Ontario, Canada; Barton Myers Associates, archts—Feb. 1983, pp. 100-101 • San Pietro al Natisone Student Housing, San Pietro al Natisone, Italy; Mitchell/Giurgola, archts—Aug. 1983, pp. 116-117 • Wissa Wassef Arts Center, Giza-Cairo, Egypt; Ramses Wissa Wassef, archt—Sept-2 1983, BTS, p. 81.
- Scotland—St. Enoch Square, Glasgow, G.M.W. Partnership with Reiaich and Hall, archts—June 1983, pp. 138-143.
- Seagram Museum and Archives, Waterloo, Ontario, Canada—Barton Myers Associates, archts—Feb. 1983, pp. 92-95.
- Seattle Garden Center, Seattle, WA—Arne Bystrom, archt—Apr. 1983, pp. 150-151.
- Seay, James with Nicholas H. Holmes, archts—Henderson House Restoration/Fair Oaks Cottages Remodeling, Selma, AL—May 1983, pp. 114-119.
- Severino, Renato, archt—Center for the Elderly, Buia, Italy—Aug. 1983, pp. 108-109 • "Made in Friuli" [with Mitchell/Giurgola]—Aug. 1983, pp. 104-117 • Pordenone School of Architecture, Spilimbergo, Italy—Aug. 1983, pp. 110-111.
- Shapiro, Lindsay Stamm—"A minimalist architecture of allusion: current projects of Frank Gehry"—June 1983, pp. 114-125.
- Shemitz, Sylvan R., with Gladys Walker—"Lighting those visual display terminals—in the cause of the operator's comfort"—Oct. 1983, pp. 138-143.
- Sherefudin's White Mosque, Visoko, Yugoslavia—Zlatko Ugljen, archt—Sept-2 1983, BTS, pp. 68-71.
- Shopping Centers & Marketplaces (see also *Stores & Shops*)—Station Square, Commerce Court, and The Freight-house Shops, Pittsburgh, PA; Pittsburgh History & Landmark Foundation, developers—Oct. 1983, BTS, pp. 96-101.
- Showrooms—Artemide Show Room, Los Angeles, CA; Vignelli Associates, dsgrns—Sept-1 1983, p. 138-138 • Berkliiff Corporation Executive and Sales Offices, New York, NY; Bentley/LaRosa/Salasky, dsgrns—Sept-1 1983, p. 140-143 • Jessica Gunne Sax Headquarters, San Francisco, CA; Hanns Kainz & Associates, archts—Sept-1 1983, pp. 102-107.
- Silchuck, Michael—"Assessing your liability insurance" [with Sara Paritsky]—Jan. 1983, pp. 35, 37 • "Coping with insured liability claims" [with Michael Karson]—June 1983, pp. 37, 53, 78 • "Insurance: Reducing your chances of a liability claim"—Aug. 1983, pp. 39, 47.
- Skidmore, Owings & Merrill, archts—Anaconda Tower, Denver, CO—Feb. 1983, p. 125 • Enerplex, South Building, Princeton, NJ—Feb. 1983, pp. 130-131 • King Abdul-Aziz International Airport, Hajj Terminal, Jeddah, Saudi Arabia—Sept-2 1983, BTS, pp. 84-85 • Menninger Foundation [with Kiene & Bradley Design Group], Topeka, KS—June 1983, BTS, pp. 86-93 • St. Paul Town Square Complex, St. Paul, MN—Feb. 1983, p. 126.
- Smith House, Los Angeles, CA—Frank Gehry, archt—June 1983, pp. 118-119.
- Smith, Timothy D. & Associates, archts—Gully, The, New England—Feb. 1983, pp. 118-123.
- Smotrich & Platt, archts—Brooklyn Bridge Anchorage Restoration, New York, NY—Aug. 1983, pp. 124-127.
- Solar Energy (see also *Daylighting, Energy Conservation*)—Tenenbaum House, Lexington, SC; Alan Buchsbaum & Stephen Tilly, archts—Mid-May 1983, pp. 120-123.
- Solomon, Barbara Stauffacher, archt—"Green architecture"—Sept-2 1983, pp. 98-101.
- Solomon, Daniel, archt—"Educating architects at Berkeley," by Marcy Li Wang—Feb. 1983, pp. 116-117.
- Spain—Piano, Barcelona; Riart/Cortes/Gubern/Ordeig/Perez Sanchez, dsgrns—Sept-1 1983, pp. 128-131.
- Specifications (see also *Building Codes, Products*)—"Proprietary specifications and the antitrust law," by Arthur Kornblut, Esq.—Feb. 1983, p. 41.
- Speiser, Philip, archt—Darb Qirmiz Revitalization, Cairo, Egypt—Sept-2 1983, BTS, p. 75.
- Spiller Houses, Venice, CA—Frank O. Gehry & Associates, archts—Mid-May 1983, pp. 84-89.
- Spokane County Correction/Detention Facility, Spokane, WA—Walker McGough Foltz Lyerla, archts—Mar. 1983, BTS, pp. 92-93.
- Sports Facilities—see *Recreation Facilities*
- Springer Building, Galveston, TX—Taft Architects, archts—Sept-1 1983, p. 144-145 and Oct. 1983, BTS, pp. 102-105.
- Station Square, Commerce Court, and The Freight-house Shops, Pittsburgh, PA—Pittsburgh History & Landmark Foundation, developers—Oct. 1983, BTS, pp. 96-101.
- Steelcase Headquarters Building, Grand Rapids, MI—WBDC, archts, with Steelcase dsgrns—Nov. 1983, pp. 132-135.
- Stoker, Douglas F., and Nicholas Weingarten—"Computers: The real opportunities are in design"—Dec. 1983, pp. 19, 21.
- Stores & Shops (see also *Shopping Centers & Marketplaces*)—Dianne B., New York, NY; Voorsanger & Mills Associates, archts—Mar. 1983, pp. 126-127 • Harry Winston "Petit Salon," New York, NY; Adam Tihany, archt—Sept-1 1983, pp. 114-115 • Janovic Plaza, New York, NY; Voorsanger & Mills Associates, archts—Mar. 1983, pp. 122-125 • Piano, Barcelona, Spain; Riart/Cortes/Gubern/Ordeig/Perez Sanchez, dsgrns—Sept-1 1983, pp. 128-131.
- Strasman, Jim Architects, archts—Wandich House, Peterborough, Ontario, Canada—Mid-May 1983, pp. 138-143.
- Structural, Concrete—"The secret to quality in architectural concrete: knowing construction," by Reginald Hough—Mar. 1983, pp. 128-135.
- Swid Powell Design Offices, New York, NY—D'Urso Design, dsgrn—Sept-1 1983, pp. 132-133.
- Synagogues—see *Religious Buildings*
- Syria—Azem Palace Reconstruction, Damascus; Shafiq Imam, archt—Sept-2 1983, BTS, p. 74.
- T**
- Taft Architects, archts—Springer Building, Galveston, TX—Sept-1 1983, p. 144-145 and Oct. 1983, BTS, pp. 102-105.

Tanjong Jara Beach Hotel and Rantau Abang Visitors' Center, Kuala Trengganu, Malaysia—Wihsenand, Allison, Tong and Goo, archts—Sept-2 1983, BTS, p. 75.

Tapley, Charles Associates, archts—Rice University, Seeley G. Mudd Computer Science Library, Houston, TX—Nov. 1983, BTS, pp. 90-95.

Teicholz, Eric—"Can computer-aided drafting be effective and affordable for the small firm?"—Feb. 1983, pp. 37, 39 • "Selecting the right CAD system for your office"—July 1983, pp. 45, 47.

Templin, Ben & Associates with Lloyd Pape, archts—Austin Junior High School, Galveston, TX—July 1983, pp. 140-141.

10 & 30 South Wacker Drive, Chicago, IL—Fujikawa Johnson & Assoc., archts, with Alfred Benesch & Co., engns—Nov. 1983, pp. 136-139.

Tenenbaum House, Lexington, SC—Alan Buchsbaum & Stephen Tilly, archts—Mid-May 1983, pp. 120-123.

The Architects Collaborative with Interspace Incorporated, archts—CIGNA Office Building, Bloomfield, CT—Apr. 1983, pp. 160-167.

Theaters—see *Performing Arts Buildings*

Thomas, Julia, and Michael Brown—"For health-care providers too: an outlook of stressful—but hopeful—change"—June 1983, BTS, pp. 102-103.

Tiffany Plaza, Bronx, NY—Leland R. Weintraub, landscape archt—May 1983, BTS, pp. 98-99.

Tigerman Fugman McCurry, archts—Pensacola Place, Chicago, IL—July 1983, BTS, pp. 98-99.

Tihany, Adam, archt—Harry Winston "Petit Salon," New York, NY—Sept-1 1983, pp. 114-115.

Tilly, Stephen & Alan Buchsbaum, archts—Tenenbaum House, Lexington, SC—Mid-May 1983, pp. 120-123.

Tomb of Shah Rukn-i Alam Restoration, Multan, Pakistan—Muhammad Wali Ullah Khan, archt—Sept-2 1983, BTS, p. 74.

Town-house Renovation, Boston, MA—Graham Gund Associates, archts—Mid-May 1983, pp. 134-137.

TRA Associates with Hellmuth, Obata & Kassabaum, archts—Washington State Medium Security Prison, Monroe, WA—Mar. 1983, BTS, pp. 94-95.

Transportation—Brooklyn Bridge, New York, NY; John A. Roebling, archt; by Horst Berger—Aug. 1983, pp. 118-123.

Trenton State Prison Rehabilitation, Trenton, NJ—The Grad Partnership with The Gruzen Partnership, archts—Mar. 1983, BTS, pp. 88-91.

Tsao, Calvin with Zack McKown, dsgrs—Tsao Apartment, New York, NY—Sept-1 1983, pp. 152-159.

Tsukuba Civic Center/Dai Ichi Hotel, Tsukuba New Town, Ibaragi Prefecture, Japan—Arata Isozaki & Associates, archts; by Martin Filler—Oct. 1983, pp. 126-137.

Tunisia—Hafsia Quarter, Medina of

Tunis; Wassim bin Mahmoud with Arno Heinz, archts—Sept-2 1983, BTS, pp. 80-81 • Residence Andalous, Sousse; Serge Santelli, archt—Sept-2 1983, BTS, pp. 76-79.

Turkey—Cakirhan Residence, Akyaka Village; Nail Cakirhan, dsgr—Sept-2 1983, BTS pp. 82-83.

U

Ugljen, Zlatko, archt—Sherefudin's White Mosque, Visoko, Yugoslavia—Sept-2 1983, BTS, pp. 68-71.

Underground Buildings—see *Earth-sheltered Buildings*

Union Carbide Corporation World Headquarters, Danbury, CT—Kevin Roche John Dinkeloo Associates, archts—Oct. 1983, pp. 110-117.

Unionville Library, Town of Markham, Ontario, Canada—Barton Myers Associates, archts—Feb. 1983, pp. 96-97.

US Corps of Engineers Chapel & Educational Facility, Camp Wildflecken, Germany—Gunnar Birkerts & Associates with Giffels Associates, archts—Mar. 1983, p. 110.

University & College Buildings—Georgetown University, Riggs Memorial Library, Washington, DC; EPR, archts—Sept-1 1983, pp. 134-137 • Keio University Library, Tokyo, Japan; Maki and Associates, archts; by Joan E. Goody—May 1983, pp. 106-113 • Loyola Law School, Los Angeles, CA; Frank Gehry, archt—June 1983, pp. 120-121 • Northeastern University, Kariotis Hall, Boston, MA; Herbert S. Newman Associates, archts—Nov. 1983, BTS, pp. 104-107 • Phillips Exeter Academy, Frederick R. Mayer Art Center, Exeter, NH; Amsler Hagenah MacLean, archts—Nov. 1983, BTS, pp. 96-101 • Princeton University, Gordon Wu Hall, Princeton, NJ; Venturi, Rauch and Scott Brown, archts—Sept-2 1983, pp. 86-97 • Rice University, Herring Hall, Houston, TX; Cesar Pelli & Associates, archts—July 1983, p. 108 • Rice University, Seeley G. Mudd Computer Science Library, Houston, TX; Charles Tapley Associates, archts—Nov. 1983, BTS, pp. 90-95 • Russell Sage College, Albany Campus Center, Albany, NY; Architectural Resources Cambridge, archts—Nov. 1983, BTS, pp. 102-103 • University of Michigan Alumni Center, Ann Arbor, MI; Hugh Newell Jacobsen, archt—Apr. 1983, pp. 130-137 • University of Nebraska, Wick Alumni Center Competition, Lincoln, NE; Gunnar Birkerts & Associates, archts—Mar. 1983, p. 111 • Yale University, Seeley G. Mudd Library, New Haven, CT; Roth and Moore, archts—Aug. 1983, BTS, pp. 86-90.

University of Michigan Alumni Center, Ann Arbor, MI—Hugh Newell Jacobsen, archt—Apr. 1983, pp. 130-137.

University of Nebraska, Wick Alumni Center Competition, Lincoln, NE—Gunnar Birkerts & Associates, archts—Mar. 1983, p. 111.

Urban Design (see also *Planning*)—Hafsia Quarter, Medina of Tunisia, Tunisia; Wassim bin Mahmoud with Arno Heinz, archts—Sept-2 1983, BTS, pp. 80-81 • Pin Oak Commercial Center, Houston, TX; Cesar Pelli & Associates,

archts—July 1983, p. 109 • "Theme speeches: The role of architecture for the nation, the city and the individual"—July 1983, pp. 39, 52.

V

Van Leer Residence, Jerusalem, Israel—Moshe Safdie and Associates, archts—Nov. 1983, pp. 124-127.

Venturi, Rauch and Scott Brown, archts—Princeton University, Gordon Wu Hall, Princeton, NJ—Sept-2 1983, pp. 86-97 • Venturi, Scott Brown Residence, Philadelphia, PA—Sept-1 1983, pp. 108-113.

Vernacular Architecture—Great Mosque of Niono, Niono, Mali; Lassine Minta, master mason—Sept-2 1983, BTS, pp. 72-73.

Veronda Associates, archts—Private Residence, New Buffalo, MI—Mid-May 1983, pp. 74-79.

Vignelli Associates, dsgrs—Artemide Show Room, Los Angeles, CA—Sept-1 1983, p. 133-139.

Villa Augusta, Augusta, GA—Anthony Ames, archt—Aug. 1983, p. 100.

Villa Barr, Northville, MI—Booth/Hansen & Associates, archts—Mid-May 1983, pp. 116-119.

Villa Chang, Augusta, GA—Anthony Ames, archt—Aug. 1983, p. 97.

Villa Ginny, Kalamazoo, MI—Gunnar Birkerts & Associates, archts—Mar. 1983, pp. 112-113.

Voorsanger & Mills Associates, archts—Dianne B., New York, NY—Mar. 1983, pp. 126-127 • Janovic Plaza, New York, NY—Mar. 1983, pp. 122-125 • New York University Graduate School of Business Library, New York, NY—Aug. 1983, BTS, pp. 80-83.

W

Wagner, Walter F., Jr.—"The AIA reaches out nationally—to influence the government and the public"—Mar. 1983, p. 9 • "Architectural education: questions piled upon questions"—Sept-2 1983, p. 9 • "It's convention time, . . . Is it also time to think of conventions as a place to think?"—May 1983, p. 9 • "A little anniversary, a little more evolution"—June 1983, p. 9 • "A nearly-80-year-old architect [Nathaniel Alexander Owings] talks about what seems important now"—July 1983, p. 9 • "On learning how to think about computers in architecture"—Apr. 1983, p. 9 • "On readers, research, and readership"—Feb. 1983, p. 9 • "On Record Houses and Record Interiors, skyscrapers—and design ideas"—Aug. 1983, p. 9 • "On talking to the public about architecture"—Nov. 1983, p. 9 • "On understanding changing market-places and changing tactics for getting things built"—Oct. 1983, p. 9 • "Some thoughts at the start of the New Year"—Jan. 1983, p. 9.

Wali Ullah Khan, Muhammad, archt—Tomb of Shah Rukn-i Alam Restoration, Multan, Pakistan—Sept-2 1983, BTS, p. 74.

Walker McGough Foltz Lyerla, archts—Farm Credit Banks of Spokane Building, Spokane, WA—Feb. 1983, pp. 128-129 • Spokane County Correction/Detention Facility, Spokane, WA—Mar. 1983, BTS, pp. 92-93.

Wandich House, Peterborough, Ontario, Canada—Jim Strasman Architects, archts—Mid-May 1983, pp. 138-143.

Wang, Marcy Li—"Educating architects at Berkeley"—Feb. 1983, pp. 108-117.

Warner, Burns, Toan & Lunde, archts—Federal Archives Building, New York, NY—Oct. 1983, BTS, pp. 92-95.

Washington Market Park, New York, NY—Leland R. Weintraub, landscape archt—May 1983, BTS, p. 100.

Washington State Medium Security Prison, Monroe, WA—Hellmuth, Obata & Kassabaum with TRA Associates, archts—Mar. 1983, BTS, pp. 94-95.

WBDC, archts, with Steelcase dsgrs—Steelcase Headquarters Building, Grand Rapids, MI—Nov. 1983, pp. 132-135.

Weese Seegers Hickey Weese, archts—Chestnut Place Apartments, Chicago, IL—July 1983, BTS, pp. 96-97.

Weingarten, Nicholas, and Douglas F. Stoker—"Computers: The real opportunities are in design"—Dec. 1983, pp. 19, 21.

Weintraub, Leland R., landscape archt—Charlton Park, Bronx, NY—May 1983, BTS, p. 101 • Tiffany Plaza, Bronx, NY—May 1983, BTS, pp. 98-99 • Washington Market Park, New York, NY—May 1983, BTS, p. 100.

West Germany—Municipal Museum Asteberg Monchengladbach, Monchengladbach; Hans Hollein, archt—Feb. 1983, BTS, pp. 79-91.

Wharton House, Seal Cove, Mt. Desert Island, ME—Peter Forbes and Associates, archts—Mid-May 1983, pp. 124-127.

Wihsenand, Allison, Tong and Goo, archts—Tanjong Jara Beach Hotel and Rantau Abang Visitors' Center, Kuala Trengganu, Malaysia—Sept-2 1983, BTS, p. 75.

Windswept, Kiawah Island, SC—Sandy & Babcock, archts—July 1983, BTS, pp. 88-91.

Wissa Wassef, Ramses, archt—Wissa Wassef Arts Center, Giza-Cairo, Egypt—Sept-2 1983, BTS, p. 81.

Woods, Mary—Harbor Plaza, Stamford, CT—Sept-2 1983, pp. 108-111.

World Financial Center, New York, NY—Cesar Pelli & Associates, archts—Feb. 1983, p. 126 and July 1983, pp. 110-113.

Y

Yale University, Seeley G. Mudd Library, New Haven, CT—Roth and Moore, archts—Aug. 1983, BTS, pp. 86-90.

Yankee Planning/Do H. Chung, archts—Harbor Plaza, Stamford, CT; by Mary Woods—Sept-2 1983, pp. 108-111.

Yugoslavia—Sherefudin's White Mosque, Visoko; Zlatko Ugljen, archt—Sept-2 1983, BTS, pp. 68-71.

**We'd like to complement
your building . . .** *while we're cooling it.*

**Masonry shell
water
cooling towers by**



Circle 1151 on inquiry card

The Marley Cooling Tower Company • 5800 Foxridge Drive • Mission, Kansas 66202 (Kansas City, Mo.) • 913/362-1818

KETCHAM BATHROOM EQUIPMENT

An extensive selection of Shower Doors and Shower Enclosures — including Steam-Proof models — that are

- Custom Designed
- Custom Finished: Chrome Plated Brass, Polished or Satin Brass, Gold Plated, Anodized Aluminum or Gold Anodized Aluminum.
- Custom Measured and Installed
The ultimate in quality.
"Clean" trim styling.

A complete line of Bathroom Accessories is also available . . . Medicine Cabinets, Hampers, Shelves, Towel Bars, Paper Holders, Soap and Tumbler Holders, Custom Grab Bars, etc. as well as Public Washroom Equipment, Hotel-Motel Specialties and Janitorial Accessories.

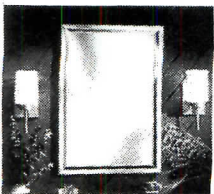
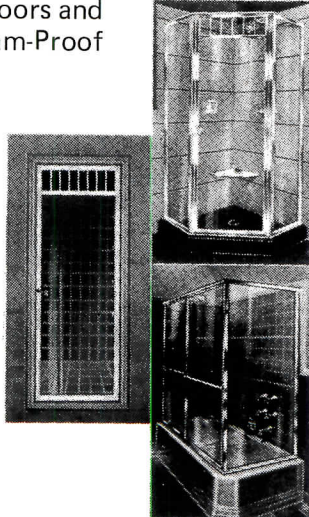

*Custom Size Framed Mirrors and
Medicine Cabinets Our Specialty.*

COMPLETE CATALOG SENT ON REQUEST

G.M. KETCHAM COMPANY INC.
132-06 89th AVENUE, RICHMOND HILL, N.Y. 11418 • 212-847-9316

Circle 1152 on inquiry card

THE (UN) HIDDEN ADVANTAGE

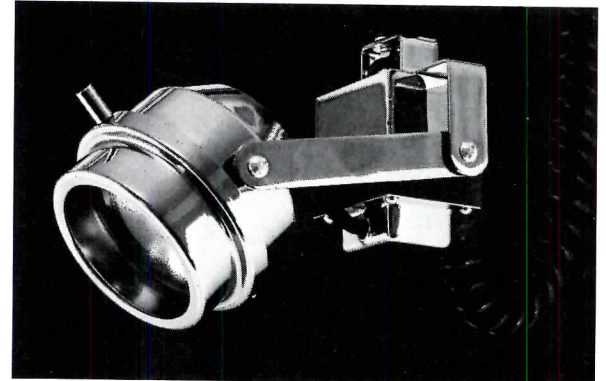

(Shown: LPB-9A)

Because flexibility, precision and ease of installation are pre-requisites for effective lighting design, LINE AND LOW VOLTAGE SURFACE-MOUNT FIXTURES have a clear advantage over recessed.

Directional flexibility without cut-off and a variety of interchangeable beamspreads allow surface mount fixtures to provide a greater range of design possibilities, upon installation and as user requirements change.

Let your local Rep show you the solutions Litelab has to offer for your creative lighting project.

Litelab
corp.

NEW YORK (212) 675-4357
LOS ANGELES (213) 936-6206

Circle 1153 on inquiry card

I have just skimmed our newly arrived November issue of RECORD, and both my partner and I were so delighted by Kevin Roche's new building for John Deere that I felt compelled to write and thank you for continuing to publish what we see as thoughtfully designed, beautifully crafted buildings that will endure and transcend current fads in our profession. *James H Crissman, AIA
Crissman & Solomon Architects
Watertown, Massachusetts*

Just a line of admiration—and appreciation—for your superb critique of [Michael] Graves's Portland Building [RECORD, November 1982, pages 90-99]. Keep it up!
*G. E. Kidder Smith, FAIA
New York City*

Commentary on Portlandia:
YEA! for fun at \$51 per square foot, non-curtain wall glazing, color, something that gets us worked up, Douglas Brenner's marvelous analysis.

BOO! for simply oppressive interiors, zero solar utility, tacky detailing, rather bleak exterior spaces.
*Duo Dickinson, Architect
Louis Mackell & Partners
Branford, Connecticut*

May I express my appreciation of Martin Filler's fine article on Clarence Stein [ARCHITECTURAL RECORD, August 1982, pages 122-127], as I should have done also for his earlier article on Lewis Mumford? My congratulations as well to you for publishing them.

Stein was undoubtedly one of the more important planners of the first half of the century, as Mr. Filler's piece clearly demonstrates. If he has not already done so, I hope that the author will give us the benefit of his scholarship on the careers of some of the other important planners of that productive period in American planning and housing, such as Frederick Bigger, Jacob Crane, Henry Klaber, Elbert Peets and, of course, Stein's partner, Henry Wright.

I hope, too, that RECORD will continue to give us such good reading.
*Wallace G. Teare, FAIA
Teare & Harman, Inc., Architects
Cleveland*

I am writing in response to your editorial "On fees, fairness and fungibility" and on Barry LePatner's article in the July 1982 issue of RECORD [page 9 and page 29 et seq.].

I congratulate you for bringing

to front stage the "unspeakable" aspect of architecture—MONEY. We need more editorials and articles about the real world of the profession and less about the debates, dialogues and self-flagellation of the post-modern/Bauhaus. The entire issue is superb, with an abundance of solid, meaty substance. Delicious.

The only way the profession or an individual architect can command higher fees for services is to prove to potential clients that the fee paid to the architect is not the key issue. It is the bottom line that counts—is the architect worth more than a drafting service? Prove it! How? Provide a better project costing less than the competitors, better design, better relations, better service, better documents, etc., etc. When the bottom line shows the client you are worth more, you'll get higher fees without even asking, as well as repeat clients who will then be accustomed to your "high" fees. It is incumbent on the architect to demonstrate his value.

I agree with LePatner [regarding an architect's receiving "the retainer" from a client], but his "15-20 per cent of the total anticipated fee" is absurd—or is this a typing error? I don't believe it is realistic or necessary to receive a retainer of that percentage on total fees above \$100,000. A retainer of \$10,000 shows ample good faith.

In closing, let me say that architects with experience, wisdom, attention to detail, intelligence and desire can "teach" the others how to merit better fees, how to produce the architectural product more efficiently and for less money, and maintain high integrity.
*William Krisel, AIA
Los Angeles*

Corrections

It should be made clear that the model shown in all photographs in the article on Richard Meier's Renault project (RECORD, October 1982, pages 116-123) was the sole work of Maloof Architectural Models, Inc., of which Albert Maloof is president.

The aerial photograph published in RECORD's report on the Colgate University library (September 1982, page 123) should have been credited to William Oostenink.

The project architect for the offices of the U. S. Trust Company of New York at 770 Broadway, whose name was misspelled in RECORD's article (October 1982, pages 124-125), was Norberte Misthopoulos.

Through January 28
"Pattern: An Exhibition of the Decorated Surface," at American Craft Museum II, International Paper Plaza, 77 W. 45th St., New York City.

Through April 10
Exhibition, "Chicago Architects Design: A Century of Architectural Drawings from The Art Institute of Chicago," 90 drawings, largely contemporary, drawn from the Burnham Library of Architecture, at the Art Institute of Chicago, Michigan Ave. at Adams St., Chicago.

January 14 through March 6
"The Goetheum: Rudolf Steiner's Architectural Impulse," Cranbrook Academy of Art Museum, Bloomfield Hills, Mich.

January 16
16th Annual Workshop on Human Factors in Transportation, sponsored by Transportation Research Board, National Research Council, in Washington, D. C. Contact: Emilie E. Larson, National Institute for Safety Research, 966 Hungerford Dr., Suite 31, Rockville, Md. 20850 (301/762-6474).

January 22-25
Convention and exhibition, National Association of Home Builders, in Dallas. Contact: Convention Office, NAHB, 15th and M Sts. N.W., Washington, D. C. 20005 (202/822-0420).

January 24
Lecture, "Classicism and Innovation," by Bob Maxwell, Dean of the School of Architecture and Urban Planning, Princeton University, at the University of Pennsylvania, Philadelphia. The series will also include a lecture on January 31 about "Jersey Devil Architecture," by architect Steve Badanes. Contact: Jennifer Pearson, The Graduate School of Fine Arts, University of Pennsylvania GSFA Lecture Series, 34th and Walnut Sts., Philadelphia, Pa. 19104 (215/898-5728).

February 4
"Second Western States Exhibition/The 36th Corcoran Biennial Exhibition of American Painting"; at the Corcoran Gallery of Art, Washington, D. C. The exhibition will travel later.

ARCHITECTURAL RECORD (Combined with AMERICAN ARCHITECT, ARCHITECTURE and WESTERN ARCHITECT AND ENGINEER) (ISSN0003-858X) January 1983, Vol. 171, No. 1. Title® reg. in U. S. Patent Office, copyright® 1983 by McGraw-Hill, Inc. All rights reserved. Indexed in Reader's Guide to Periodical Literature, Art Index, Applied Science and Technology Index, Engineering Index, and The Architectural Index.

Every possible effort will be made to return material submitted for possible publication (if accompanied by stamped, addressed envelope), but the editor and the corporation will not be responsible for loss or damage.

Executive, Editorial, Circulation and Advertising Offices: 1221 Avenue of the Americas, New York, N.Y. 10020.
Officers of McGraw-Hill Publications Company: president: Paul F. McPherson; executive vice president: Gene W. Simpson; senior vice president-editorial: Ralph R. Schulz; vice presidents: R. Bernard Alexander; Kemp Anderson, business systems development; Shel F. Asen, manufacturing; Harry L. Brown, special markets; Robert B. Doll, circulation; James E. Hackett, controller; Eric B. Herr, planning and development; H. John Sweger, marketing.

Corporation Officers: Harold W. McGraw, chairman of the board and chief executive officer; Joseph L. Dionne, president and chief operating officer; Robert N. Landes, senior vice president and secretary; Ralph J. Webb, treasurer.

Associated Services / McGraw-Hill Information Systems Co.: Sweet's Catalog Files (General Building, Engineering, Industrial Construction and Renovation, Light Residential Construction, Interiors), Dodge Building Cost Services, Dodge Reports and Bulletins, Dodge/SCAN Microfilm Systems, Dodge Management Control Service, Dodge Construction Statistics, Dodge regional construction newspapers (Chicago, Denver, Los Angeles, San Francisco). *Subscriptions:* Position, firm connection, and type of firm must be indicated on subscription orders. Please allow 4-12 weeks for shipment. Subscription rates for personnel of Architectural, Engineering, Interior Design, Design and other directly related firms and students thereof, are as follows: U.S. and U.S. Possessions \$30.00; Canada \$32.00; all other countries \$60.00. For all other personnel: U.S. and U.S. Possessions \$41.00; Canada \$43.00; all other countries \$68.00. Publisher reserves right to determine subscription rates which apply. Single copy price for Domestic and Canadian: \$6.00; for Foreign: \$7.00.

Change of Address: Forward changes of address or service letters to Fulfillment Manager, ARCHITECTURAL RECORD, P.O. Box 430, Hightstown, NJ 08520. Provide both old and new address; include zip code; if possible attach issue address label.

Guarantee: Publisher agrees to refund that part of subscription price applying to unfiled part of subscription if service is unsatisfactory. *Copyright and Reprinting:* Title® reg. in U. S. Patent Office. Copyright® 1983 by McGraw-Hill, Inc. All rights reserved. Where necessary, permission is granted by the copyright owner for libraries and others registered with the Copyright Clearance Center (CCC) to photocopy any article herein for the base fee of \$1.50 per copy of the article plus 10 cents per page. Payment should be sent directly to the CCC, 21 Congress Street, Salem, MA 01970. Include code with request: ISSN0003-858X (\$1.50+.10). Written permission must be secured for any other copying. Write Reprint Manager for such permission at address below, or to obtain quotations on bulk orders.

Subscription List Usage: Advertisers may use our list to mail information to readers. To be excluded from such mailings, subscribers should send a request to: ARCHITECTURAL RECORD, Mailing List Manager, P.O. Box 555, Hightstown, N.J. 08520.

Publication Office: 1221 Avenue of the Americas, New York, New York, 10020. ARCHITECTURAL RECORD (ISSN0003-858X) published monthly except May and September when semi-monthly, by McGraw-Hill, Inc. Second-class postage paid at New York, NY and additional mailing offices.

Postmaster: Please Send Form 3579 to Fulfillment Manager, ARCHITECTURAL RECORD, P.O. Box 430, Hightstown, NJ 08520. THIS ISSUE is published in national and separate editions. Additional pages or separate editions numbered or allowed for as follows: Eastern Section 32Ea through 32Eb; Western Section 32Wa through 32Wf.

Double dribble.

Keeping the water off the roof. And off the floor.

That's the name of the game.

And the reason why it pays to specify Johns-Manville—the first name in lasting built-up roof protection.

With J-M, you get expertise based on over 120 years of solving roofing problems. You get quality that's consistently tops throughout a complete

line of roofing products, components and systems. Plus technical assistance from America's most experienced team of roofing specialists. And a degree of roof guarantee coverage that tops any in the industry.

Score with the built-up roof that offers real protection. For details, consult Sweet's. Or contact George Constantin, Johns-Manville, Ken-Caryl Ranch, Denver, Colorado 80217, 303/978-3281.

**Keeping the water out.
That's what this business is all about.**



Johns-Manville

Circle 2 on inquiry card

Some thoughts at the start of the New Year

Let me start with a happy note: I hope you have already noticed, on page 6, the first cartoon to appear in RECORD since 1974, when Alan Dunn died (after doing a monthly piece for RECORD for 37 years). Alan was of course "not just a cartoonist"; his work as it evolved over the years came to be recognized as architectural criticism of a high order. Indeed, in 1973, the AIA awarded Mr. Dunn its Architectural Critics Citation. For a long time we had no heart for searching for another person who could—in the unique way of the skilled cartoonist—jab gently at the fashions of architecture and the foibles of architects, and make us laugh—and think about what we do and what we talk about. Some months ago, executive editor Mildred Schmertz came into my office with a large envelope and suggested that "Maybe it's time—and I think this is the man." And showed me a series of roughs she had asked the distinguished cartoonist Charles Saxon to do for us. It seemed like old times. And so, with this start of the new year, we start publishing Mr. Saxon's work—which we hope will make you laugh—and think. While neither we nor Mr. Saxon can promise anything like a 37-year run, it is great fun to begin again.

At the beginning of every New Year, it is traditional for editors to make predictions (preferably optimistic) about the coming year. It's hard to do that this year, of course. I mean it's hard to be optimistic—and it's hard to predict. Consider how quickly things are changing: The decline in interest rates has happened faster than anyone could have hoped for even a few months ago, with the result that almost everyone (including most economists and in particular George Christie, vice president and chief economist of McGraw-Hill Information Systems Company and our chief advisor on such matters) are raising their sights on housing starts. That's good and important news. Further, since the election, there has been a clear instinct in Congress to prime the public-works pump—which should bring at least \$5 billion a year into the construction industry—and if that is better news for the industry in general than it is for architects in particular, it is nonetheless important news. Of course, both of these moves in the up direction have occurred because general economic conditions are worse; so what of nonresidential building? George Christie tells me he'll stick with his original Dodge/Sweet's Construction Outlook (RECORD, November) in this sector. While building and manufacturing will be off sharply (24 per cent in both cases), stores and commercial buildings should follow housing up (plus 19 per cent) and smaller gains (but gains) in educational, health, and hospital, and "other" nonresidential will hold over—all nonresidential at \$54 million, only slightly less than last year. The point has to be this: glooming and dooming doesn't help anything; what we need to do is look hard for targets of opportunity and go for them. And when a commission does come along, let us all resolve to remember that what we are about is not just running a business, but being part of a profession—and that the main name of the game is good design. *W.W.*

We do more than keep up with trends in professional liability protection.

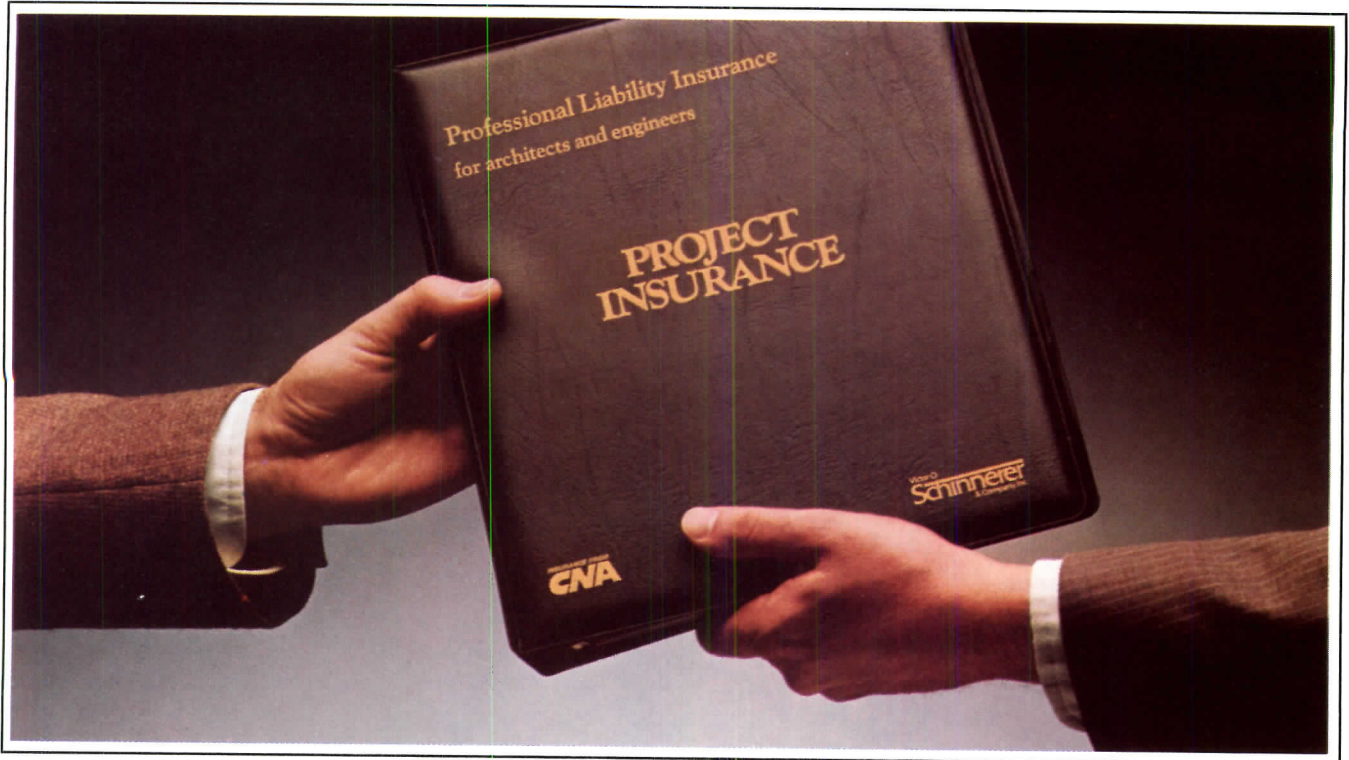

We set them!

CNA and Victor O. Schinnerer & Company, Inc. started the trend twenty-six years ago with our professional liability insurance for architects and engineers. Our program started a trend so innovative and dependable that competitors never hesitate to follow suit.

During the past twenty-six years, technology and business have become more complex – and so have your insurance needs. CNA and Schinnerer continue to respond to the problems such changes bring – before other insurance companies know these problems exist.

Project insurance is just one example. A solution introduced by CNA and Schinnerer in 1975 today sets an industry standard. One policy, one limit cover all members of your design team. Coverage is provided for the life of the project, from design through construction – and up to five years after completion.

To be sure your project is in the best hands, have your broker or agent contact Victor O. Schinnerer & Company, Inc., Program Administrators and Underwriting Managers.

5028 Wisconsin Avenue, N.W.,
Washington, D.C. 20016 (202) 686-2850
303 E. Wacker Drive,
Chicago, Illinois 60604 (312) 565-2424

Victor O.

Schinnerer
& Company, Inc.

26 years and still building together.

40 Wall Street,
New York, N.Y. 10005 (212) 344-1000
595 Market Street,
San Francisco, California 94105 (415) 495-3444

Coverage for this program is provided by Continental Casualty Company, one of the CNA Insurance Companies.

Circle 6 on inquiry card

AIA seminar yields sophisticated advice on working abroad

Approximately 30 participants attended a seminar, "International Business Risks and Opportunities," sponsored last November by the American Institute of Architects in Washington. Said Michael Reich of the National Bank of Washington: "If a company (including an architectural or engineering firm) is paid in foreign currency, the best protection against exchange losses is to stay in that currency. If the project involves some investments, a line of credit in that currency is probably best."

Gillian M. Spooner, staff accountant of the U.S. Congress' Joint Committee on Taxation, recalled that the latest wrinkle in tax legislation affecting Americans working abroad reinstated the tax exclusions cut out only three years earlier. At the time, this caused a reduction of architects and engineers working overseas by some 10 per cent. Now the exclusions are back with a vengeance, tripling from the \$25,000 maximum allowed previously to \$75,000, and rising by an additional \$5,000 every year for several years hence.

Spooner noted in general that the new improved tax formula for expatriates "makes it cheaper to send employees abroad." The new law makes for a "less complicated tax return." But, she warned: "It still could be expensive to make mistakes." In high-tax countries such as Germany where Americans have to pay taxes in addition to being taxed by the United States, Spooner said: "It may pay you *not* to elect the \$75,000 exclusion, and rather to pay German taxes and get credit for that."

Also, an overseas architect should check carefully whether to elect the housing exclusion. Said Spooner: "The housing exclusion is separate from the \$75,000 exclusion—you can elect one, both or neither. In a high-cost country it might be more advantageous not to take the United States exclusion.

"Similarly, the expatriate should weigh whether he should try to minimize his foreign taxes. In the past it didn't matter since you could use them against your United States taxes. Now it does.

"These provisions are much more complicated than you think. You need to ask the right questions in negotiating with your employer."

One bit of advice: "It's important to seek expert help. Go to an established expatriate practice." *Peter Hoffmann, World News Washington, D.C.*

PSMA plots new course



The latest semi-annual meeting of the Professional Services Management Association was held in Long Beach aboard the newly refurbished ocean liner *Queen Mary* (photo above). Incoming PSMA president and long-time Heery International president Ennis Parker revealed new bylaws at the meeting that recognize the growing size of the organization, and stated his and the executive committee's belief that the need for regional chapters is here.

Incorporated in 1976 in recognition of the growing importance of management functions in design firms, the association has grown by roughly 20 per cent each year to its current size of 1,200 member executives, located in every state and Canada. The association's concerns range from government audits to personnel problems to computerization (a fast-growing topic with PSMA) to research projects—such as the current study of firm ownership transition being conducted by Weld Cox.

Underscoring the importance of the association's work, the results of a survey of 272 larger firms—averaging 69 persons—was released at the meeting. Conducted by Birnberg & Associates and sponsored jointly by the PSMA and the independent *Professional Services Management Journal*, the survey revealed that—as suspected—there had been some shrinkage in workload over the last two years. But more important, it indicated a decline in profits from work in hand.

A major cause was escalating overhead costs. Other causes included length of time to collect

on bills (currently up to an average of 69 days), and a decline in chargeable time—indicating that firms may not have cut back quickly enough on personnel in the face of shrinking workloads. An alarming decline in cash on hand was found.

Ironically—considering the new alliance of the PSMA and the Society of Marketing Professional Services—the lowest levels of profitability were found in Midwestern states, where the most money per firm was spent on marketing. The first of a series of joint seminars by the two groups was held in four cities late last year.

This year's annual firm management award went to Geddes, Brecher, Qualls, Cunningham, and focused on that firm's new manual on practice in providing "quality control and clarifying the firm's operational character and standards."

The workshops on computer use included one conducted by lawyer John Greenfield on protecting buyers' interests during the purchase period. Basic to his detailed advice was not to get swept away with enthusiasm, to put off acceptance of the new equipment until every detail is right and to negotiate the seller's standard contract. Lewin Associates president Marsha Lewin conducted a workshop on the computer selection process. First of "ten commandments" was not to narrow choices too fast, and last was not to overemphasize lowest price.

GSB Associates president George Borkovich conducted a workshop on micro-computers, noting that there are now some 20 graphics systems available for under \$30,000, and one that can slide under an airplane seat.

A workshop on quality control in the design process was conducted by architects David LaKamp and Gerald Weisbach. Said LaKamp: "Quality can be as an ambiguous word as 'freedom.'" Covered subjects included the differing views of quality held by clients, the designer, the public and contractors. *C.K.H.*

Jeanne M. Davern, who was on the staff of RECORD for 21 years and managing editor from 1963 to 1969, died on November 15th. Jonnie was a fine writer and editor, and her help in shaping this magazine over all those years was important—and remembered. I remember with gratitude the guidance she gave me in my early days at RECORD 17 years ago. There are literally

thousands of others in the publishing and architectural communities who benefitted from Jonnie's knowledge and skills and enthusiasm and friendship. At a memorial service in New York on December 14th, Ed Bacon, Jonathan Barnett, Paul Rudolph, Martin Filler, Fritz Gutheim and Mildred Schertz spoke about Jonnie. It was her kind of company. *W.W.*

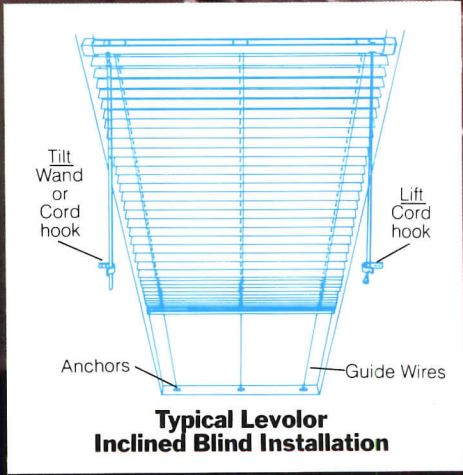

Levolor. Helping you solve beautiful problems.

Regardless of the size, shape, space or special problem, Levolor will manufacture the perfect blind to fit your solution. Whether it's special assemblies or an extra small Bantam™ head, Levolor will give you the capability to create light, temperature and glare control in places and spaces where blinds have never gone before. For a guide to many of the beautiful solutions from Levolor, write Levolor Lorentzen, Inc., 1280 Wall St. West, Lyndhurst, N.J. 07071.

LEVOLOR®
Extending your
creative options.

©1982 Levolor. A product of Levolor Lorentzen, Inc.

Management: Assessing your liability insurance

In this first of a series, two managers from the CNA Insurance Companies tell what to look for—and where to get help

By Sara Paretsky and Michael Silchuck

The following article is written for the smaller firm or the firm just starting out. Accordingly, the authors have told their tale through the experiences of a fictional architect, Albert Baumeister, who finds his new business in a dilemma. CNA is a leading underwriter of architects' and engineers' liability insurance. The company and their managing agent, Victor O. Schinnerer, have the commendation of the national AIA. But, the authors do not limit the criteria for selection to one company, and—in fact—point out that a number of companies can meet the criteria, depending on the available agents in the state in which the insured is located. They also point out that liability claims involved between one-third and two-fifths of all architectural and engineering firms last year, and settlements averaged \$33,000. As both the frequency and dollar amount of such claims are expected to rise considerably, the advice they offer should be all the more welcomed. C.K.H.

Albert Baumeister was 40 years old when he resigned as a partner from a large firm and started his private architectural practice. The risk manager in his old firm bought professional liability insurance for the partners, and Albert had never paid much attention to what covers the firm had.

He knew he needed the insurance—his former firm had been involved in two claims during his 15 years in practice, and it made him aware that people will sue professionals. But he thought that all errors and omissions insurance was pretty much alike. A few weeks after his new office opened, he applied to a company that advertised very inexpensive errors and omissions insurance. He paid the premium, got the policy, locked it in a safe with his other business documents, and thought no more about it.

Nor did he talk to his local independent agent who handled his other business insurance. Albert assumed, since all insurance is alike, his new policy would cover him for any claims arising out of alleged errors and omissions that might be committed in his architectural practice—regardless of the type of structure or the type of business arrangement entered.

It also did not occur to him to check with his old firm to see if it was still naming him for projects worked on while he was a partner there.

One of Albert's first projects in his private practice involved a joint venture with an engineering firm. They designed a combined office and factory facility for a small electronic components assembly company.

Albert had never participated in a joint venture, and it did not occur to him to see whether his insurance covered it. Whatever might happen, his professional liability policy was paid up, and that was all he worried about.

About 18 months after the factory complex was finished, one of the ceiling joists cracked. Part of the ceiling collapsed, damaging some inventory. An employee was injured when an acoustic tile struck her arm. The factory had to close for two days while the damage was repaired.

The factory owner sued both Albert and the engineer. Albert kept his head, and called the local independent agent.

He then got his first shock. The agent said that because the policy had been bought through the mail, he was not his agent, and could not handle the claim for him.

He asked Albert who the carrier was and what his policy said to do in the event of a claim.

When Albert told him, the agent said he had chosen a company which only allowed one agent in the whole state to handle all its business in the state. Albert had to work through that agent, even though he was in a city 150 miles away, and knew neither Albert nor the local business climate.

Albert was annoyed, but he sent all the claim information to the company agent. The following week, he got his second shock, far worse than the first. His policy excluded joint ventures.

Albert now had serious problems. The claim—which was asking for compensation for lost time, damaged property and bodily injury—totaled \$100,000. If it was settled against him, it would completely wipe out his assets.

Even if he could prove he had not been negligent, his legal fees would still be a major burden. The engineer's insurance company wanted to settle out of court, but Albert wanted an investigation to prove his innocence.

How Albert resolved his legal problems—and indeed the subject of liability in a partnership—makes enough subject matter for a future article. The point is that Albert had not done his homework in selecting adequate coverage.

Where do you look for help before you buy insurance?

Two weeks later, Albert went to a loss prevention seminar sponsored by his national professional society, although he did not often go to professional meetings. Afterwards, he introduced himself to a panelist, and told his tale of woe.

The man was a fellow private-practice architect, and happy to help. "We have a list of things to look for when you buy professional liability insurance," he said. "Of course, it does not cover every contingency, but it is a good place to start."

When Albert took the list and studied it, he cursed himself for not having asked for professional advice before. He would have avoided several mistakes.

Following are the guidelines that Albert read:

Look at the financial strength of your insurance carrier

Find out its "Best rating." A.M. Best is a firm which rates the strength and stability of insurance companies. It issues an annual report on all insurance companies which shows company reserves and assets. Best gives each company a rating indicating its opinion of the company's long-term financial strength.

Try to stay with a company rated "A" or "A+." Your insurance agent can tell you what the company's Best rating is. Or you may find copies of Best's rating report in your public library. Since Best puts out two guides, it is important to know that the property-casualty guide is the one you want.

Company reserves show how much money the insurance firm has on hand to pay claims. Companies with strong reserve positions are better for design professionals—as well as all insurance buyers. Claims settled against design professionals are increasing, as Americans become more lawsuit-prone and juries more generous. If you had a \$5- or \$10-million claim, would your company have the necessary reserves to settle it? What if there were four such claims?

Find out how long your company has been in the professional liability market

If you start a project today, any claims against it will emerge—on the average—about four years from now. You want to be sure that your insurance company will still be around to cover them.

Insurance companies, like other businesses, are looking for profit opportunities. Professional liability is one such opportunity

because of the cash flow it offers.

However, professional liability is a high-risk business. Insurance companies may get into it without realizing its pitfalls. When claims start coming in, a company may find that its claim costs are greater than expected. Its rates may skyrocket—or it may leave the business.

If you are thinking about insuring with a company which has sold professional liability insurance only a short time, ask your agent to check its record in other volatile markets. If the company has a history of going into certain products for three or five years and then leaving when the claims start to come in, watch out.

Have your agent find out, too, whether your insurance carrier offered errors and omissions insurance to design professionals in the past. Many companies left that market in the 1970s when claim experience became very poor, then wanted to re-enter in the 1980s when interest rates—and profit opportunities—rose.

Also, note that all professional liability insurance available to architects and engineers is written on a "claim-made" basis. This usually means that you must be insured (by the same company) during the time you did the design and at the time a claim is brought against you.

Make sure your carrier provides retroactive coverage and watch exclusions

Make sure your firm provides retroactive coverage, sometimes known as prior acts. This covers you for claims arising out of professional services conducted before you began insuring with your present carrier. Some partners carry former members for work they did while part of the firm; others do not. Most insurance companies make this coverage available at little or no charge. However, you must ask for it.

(When Albert read this section, he realized his prior work with his old firm might not be covered. He called the old partners and learned that they had dropped him from their policy and that he would have to buy his own coverage.)

Many insurance companies exclude coverage for joint ventures, contractual liability, bridge, tunnel and dam work. If you design any of these kinds of projects, you may have to pay to remove exclusions. A few carriers include insurance for joint ventures, contractual liability, bridge and dam work as part of the policy at no extra charge.

The revitalization of old urban centers—bringing every building up to code—is among the greatest challenges to contemporary American architects.

Schlage is your most comprehensive source for new locks for old buildings with new looks. In every type of function, finish and keying, you'll find our famous strength and design integrity. Whether



remodeling or new construction, commercial or residential, quality endures with Schlage. And our distribution centers are stocked with best sellers ready for delivery now. Architects plan for decades; that's why Schlage is securely their source.

For complete details, call your wholesaler or Schlage representative.

SCHLAGE

Part of worldwide Ingersoll-Rand

For Creative Redesign When All Downtown Needs Remodeling.



Lock onto the source.

Find out how your carrier handles claims

The value of any insurance policy is its ability to cover claims when they arise. Based on the 25-year claim history at CNA, 44 claims arise annually for every 100 firms insured. Your insurance company's experience and the kind of personnel they hire are very important.

Find out if the company has its own claim adjusters or if it assigns your claim right away to legal counsel. Counsel costs affect you. They may apply against your deductible or against your limits. Company claim adjusters are paid by the company, and their costs do not apply against claim costs.

Since few claims (about five per cent) ever actually go to trial, do not get into a situation where you will be paying \$75 to \$100 an hour for attorney fees, when an attorney's services may not be required.

If your company has its own claim adjusters, ask if they are specialists in claims against design professionals. Some carriers have the same person adjusting auto losses or homeowner claims to handle the problems of design professionals. Make sure your carrier has trained specialists.

Find out where your claims will be handled. Does your company have claim offices around the country with one near you, or will your claims be handled by someone hundreds or thousands of miles away?

Finally, discover the quality and experience of the defense counsel who works on architects' and engineers' claims, if they do go to trial. A number of carriers have defense counsels around the country who specialize.

Look at the limits available

Your independent agent can help you decide what is best for your needs. The minimum limits are usually \$100,000. Do not look just for the minimum, although this may be adequate for some firms—or for some projects. The cost per unit of coverage drops dramatically as higher limits are purchased. Get a quote for \$1 million, \$5 million, \$10 million or more; higher coverage may not cost as much as you think. And it may prove well worth the cost in the event of some unanticipated disaster. Make sure you can get the limits you need.

Remember, your deductible is there to cover minor day-to-day claims and losses. Your professional liability insurance is primarily for the major claims. It is really an excess coverage.

See how the deductible is used

Your policy premium may not be your only cost for professional liability insurance. All policies carry a deductible. Depending on the type of claim you have, your deductible may mean you will be required to spend several thousand dollars beyond your premium. The insurance companies offering this coverage require minimum deductibles, generally ranging from \$1,000 to \$5,000 per claim. But companies do not always apply them the same way. So a policy that has a lower premium may end up costing you considerably more, depending on how the deductible is applied to a claim.

Claim costs are basically divided into two categories. The first is payment for the damages for which you are liable; i.e. the loss to a third party. The other is claim expenses, or the costs to defend the claim. These typically include attorneys, court fees, witnesses, investigation, etc.

Some deductibles apply to both damages and claim expenses, some only to damages. Some waive the deductible if no damages are paid. If the claim involves only bodily injury, some companies waive the deductible. Ask your company how its deductible applies. Ask what options are offered. For slightly higher or lower cost, you may be allowed to have the deductible apply as you think best for you.

Also, remember your deductible costs are a business expense and should be treated as such for tax purposes. Choose a deductible level that you feel you can afford. It does you little good if you purchase a policy with a high deductible to save relatively few premium dollars, and then are faced with a strain on your business's cash flow.

Does your carrier offer loss control services?

Claims against architects are strongly influenced by inflation—both that built into the economy and into changing social attitudes toward awards. As claim costs keep going up, it is important that you get the best information available on how to control exposure.

Some carriers provide loss control seminars and printed material to their insureds. Make sure yours offers you this kind of help. One of the most common hazards in your practice is the contracts you sign. They may make you liable for certain acts that should be the responsibility of the owner, the contractor or someone else. Some carriers will review your contracts with you to

see what your exposure is.

If you do not employ full-time counsel in your firm, it is especially important that your carrier provide this free service. The American Institute of Architects has a documents committee that develops standard wording for architect's contracts, documents and other forms. Your carrier should work closely with them, because this wording has been court tested.

Can you work with your independent agent to get your liability insurance?

Some carriers require you to work with one designated agent for them in your state. Unlike your independent agent who is working for you, this designated agent is working for the insurance company, and may not always have your best interests in mind when selling coverage.

Your independent agent performs a valuable service for you. The agent can help you evaluate your total coverage needs, and can be on the spot if you have a claim or a question. Your agent knows the local business climate (having the same stake in it you do).

Is your professional society involved in insurance?

Your local professional society may have reviewed the coverage and exclusions of the major companies in your area. Consider any comments it may offer, and carefully compare them to your needs. There is an ongoing dialogue between professional societies and the insurance industry in efforts to get better, more appropriate coverage.

The society is there to represent your interests with the carrier—so see that your questions get answered, your claims handled and your coverage needs met.

Occasionally, societies do a survey of the professional liability market, evaluating the different carriers providing insurance. Write your national society, and ask for their most recent market evaluation.

But, what happened to Albert?

Albert studied his professional society's guidelines, and talked them over with his society's insurance committee. He felt that he had solved some problems before they arose, particularly in the area of retroactive coverage.

A few days later, the First State Bank asked him to interview for the design of a 40-story office building. Albert had never handled a project this size,

so he asked several firms with experience in big projects to work on it with him. He was to be the lead architect.

He got the contract. He called his friend on the professional liability insurance committee, and asked if there was anything special he needed to do about his insurance. He was not going to be caught twice.

"Good thing you asked," his friend said. "You may want to buy a project policy. One project policy covers all members of the design team. The policy has a single limit, that is exposed only to claims arising from the project. The policy is typically issued to last until the date of substantial completion and for several years beyond.

"A project policy will guarantee that all the other design professionals who end up working with you will have insurance. You can get rid of the nightmare of looking after insurance certificates. Also, you can include the cost of insurance in your contract with the client.

"You know the cost of the project policy and you do not have to guess what all your subcontractors' and partners' insurance may cost. And you will be able to get higher aggregate limits than on a practice policy.

"Several carriers offer project policies. Your agent will help you choose the best one.

"Another special purpose policy is for design/build. This covers you if you decide to become legally responsible for the construction of projects."

Albert thanked him for his help, and said the guidelines the society prepared had helped him make a better insurance decision.

"Just remember," the committee member said, "you have the ultimate responsibility for seeing that your insurance policy covers your practice. Your agent can give you advice, but you need to review your policy to see that it meets your needs, because you are the person who has the legal liability for anything that goes wrong with your practice. You do not want someone who does not share your liability making the final decisions affecting it.

"Also remember: Price is not the most important nor the only criterion you should use in buying insurance. You would not recommend a certain kind of window in your buildings just because it was the cheapest. You want your clients to have the best. Your practice deserves the same quality protection that your clients' buildings do."

From Haworth. A truly articulated keyboard pad for the electronic office.



In-out, up-down, side to side, swiveling back and forth, or tucked away from view; Haworth's UniTek™ Adjustable Keyboard Pad accommodates like no other. Pads fit all standard or UniTek work surfaces or task tables. And along with the rest of the UniTek Electronic Support offering — panel-mounted, freestanding, mobile, carousel and corner designs — they enhance the planning options unique to Haworth's UniGroup® open office interior system. For total, systems support in today's electronic office.



Send for the "UniTek Electronic Support Package". Write: One Haworth Center, Holland, MI 49423.

HAWORTH®

Circle 29 on inquiry card

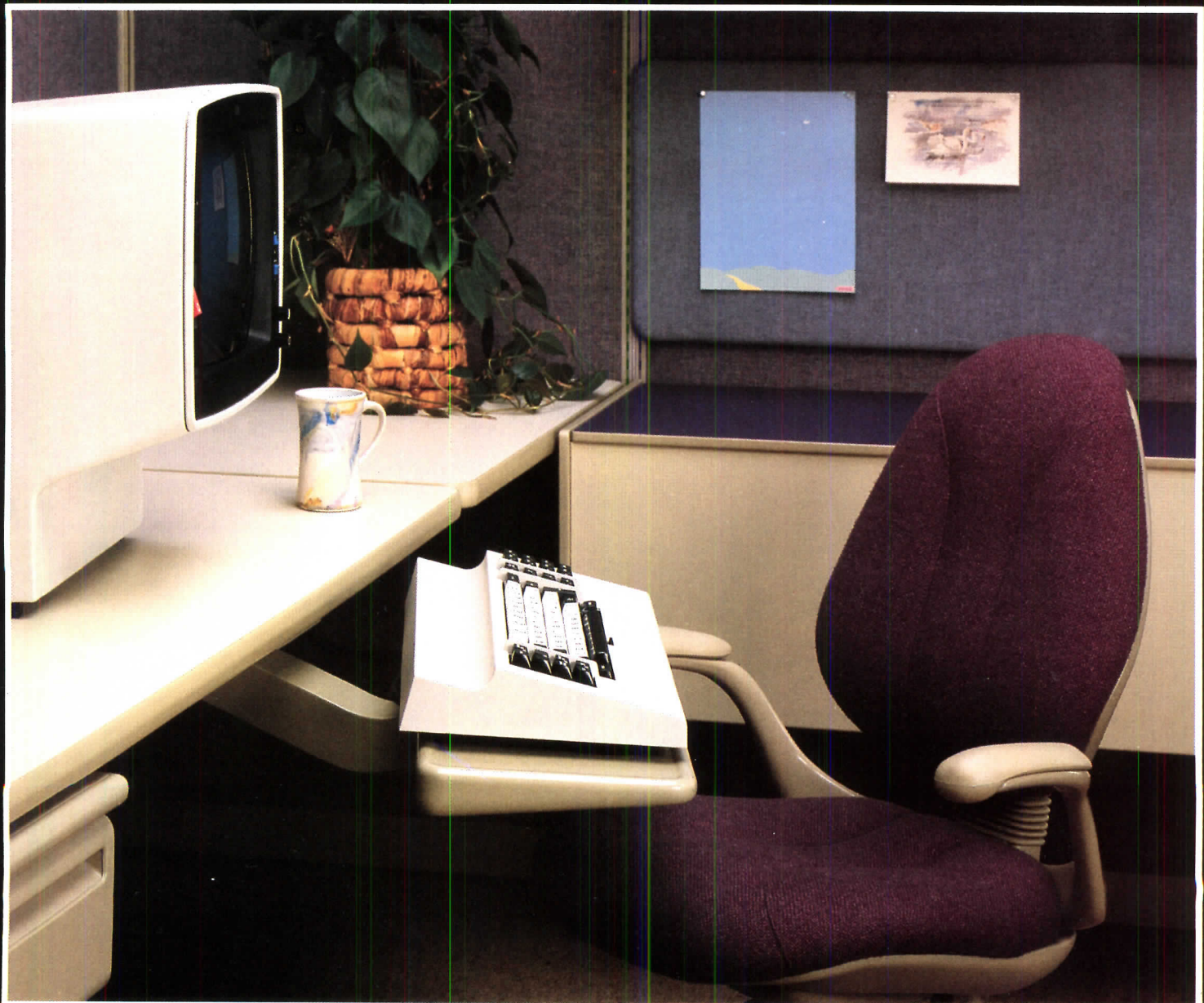

Finance: Is cheaper money really cheap yet?

By Phillip E. Kidd

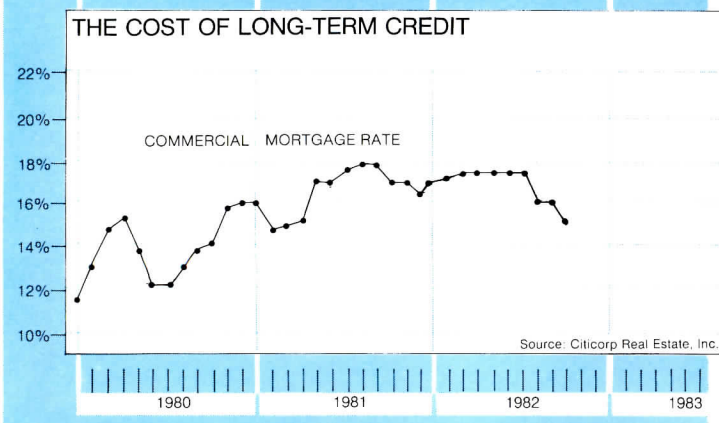
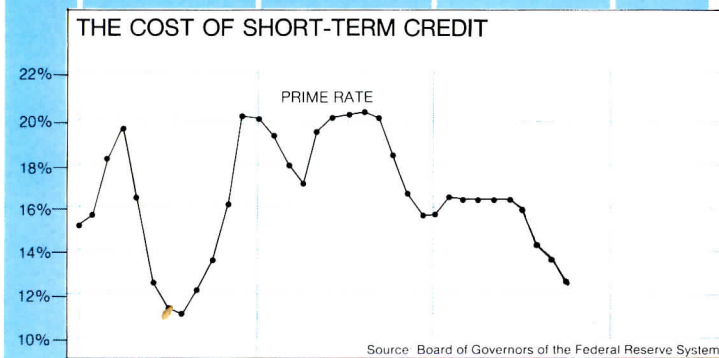
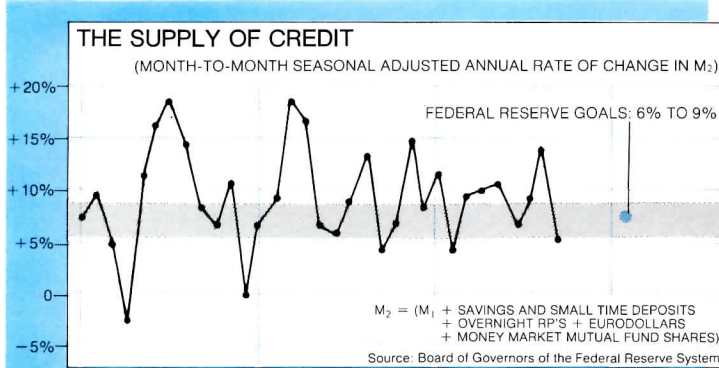
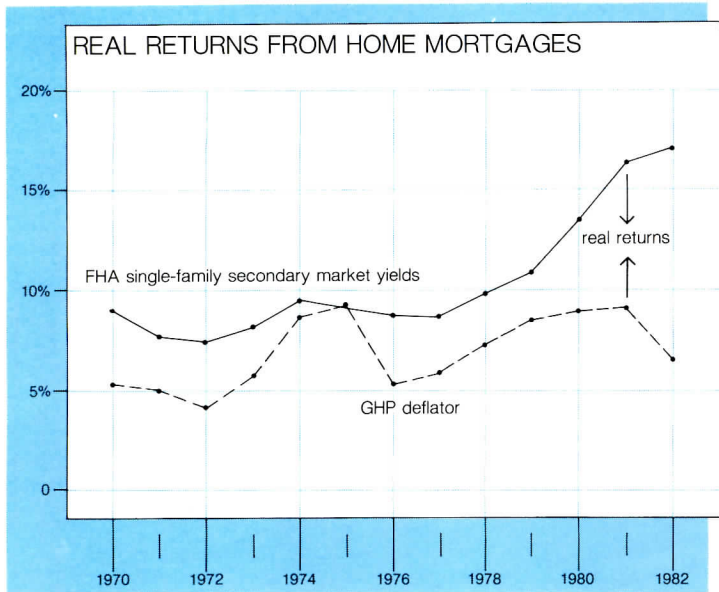

During the past three years, the nation's attention has been riveted on the extraordinary high level of interest rates. For most of that time, forecasters have searched vainly for evidence that rates were about to tumble, a signal that would herald the transition from recession to the beginning of a recovery.

Since early last summer, short-term rates have indeed plummeted, with long-term rates following at a lag. Yet we still await unambiguous signals that the slump is over and that the economy is growing again. Moreover, nervousness is mounting that even when the recovery arrives, it will not be a very strong one.

Normally, when interest rates fall so steeply, the relative cheapness of credit entices consumers back into the market for housing and other expensive durable goods. As their purchases rise, the demand for housing and goods and services expands, encouraging the hiring of more people, which boosts income. With employment improving and earnings advancing, the process gains momentum. The economy shakes off its recession lethargy, and demand for new building spreads from residential to non-residential construction.

However... Despite the significant drop in interest rates, credit has not become inexpensive this time around. To understand that apparent contradiction, the makeup of an interest rate must be examined. Any investor—individual or institution—wants the interest rate on a loan or a savings account to cover the current and expected rate of inflation and to provide a real rate of return.

In the past year, the rate of increase in the GNP deflator (the broadest measure of inflation) has shrunk by almost a third. It took a long while, but as inflation clearly subsided, investors lowered their inflation expectations, contributing materially to the second-half break in interest rates. However, when nominal (or money) interest rates are adjusted for reduced inflation, real interest rates remain abnormally high (see charts).

During the course of the double-digit inflation/interest era, consumers became fully cognizant of the many functions of interest rates. They learned to distinguish nominal rates from real rates, developing their own methods of estimating the real cost of borrowing. When they

judged that those costs were low, they accelerated their credit purchases of housing and other goods and services, as they did in the late 1970s.

But once they realized real rates were becoming excessive, as in 1981-82, they sped up their debt repayments, curtailed on-time spending, and boosted their savings. Instead of spending the July 1982 tax cut, consumers have continued building their nest eggs, delaying the energetic renewal of consumer spending that was expected to lead the economy into a recovery.

Over time, consumers increased emphasis on savings, coupled with an easing of monetary policy, will swell the available supply of credit. It is the current tremendous mismatch between credit supply and credit demand (not just from Federal deficits, but also from businesses, mortgage borrowers, and state and local governments) that is keeping real rates so high.

But with more funds, more credit needs can be met. Gradually, real rates will inch downward in 1983, encouraging erratic gains in consumer spending.

Over-all, a moderate build-up in consumer spending will leave the economy growing sluggishly, especially early in 1983. However, every reduction in real rates, no matter how small, will have a buoyant effect on residential construction. As housing and consumer sales trudge slowly upward, signs of recovery will become evident on retail building. Nevertheless, a vigorous, broad-based revival in residential and non-residential construction must await even lower real rates toward the end of the year.

Mr. Kidd is a prominent economic consultant and former Director of Economics Research for the McGraw-Hill Information Systems Company.



**ALLIANCEWALL PORCELAIN ENAMEL ON STEEL.
GOODBYE, OLD PAINT.**

The attractive interior walls you plan today... will stay that way. For years to come. AllianceWall panels never need painting, because the porcelain enamel color is actually fused to the steel. Creating a hard, smooth surface. You can choose from more than 50 vivid and neutral colors. Beautiful by any standards. And made to stay that way. Contact us soon to see how we can help you plan your next interior. Porcelain enamel on steel— for one-time color, easy maintenance and lasting beauty.



**AllianceWall[®]
Corporation**

The World's Largest Producer
of Architectural Porcelain Enamel on Steel

Computers: Where is your firm to get software?

In this fourth part of a series, Sweet's computer expert, Harry Mileaf, tells where various firms are looking for software to solve their problems

By Harry Mileaf

The previous article in this series (RECORD, October 1982, pages 35-37) covered the problems associated with obtaining software for the specific applications for which architects are interested. The problems are real, and inhibit designers from getting the most out of their investment in computers.

As was explained, the hardware manufacturers and the systems suppliers, since they are not in the software business, generally make available just a limited amount of software, enough to make their equipment and systems useful enough to sell. They do not have enough software to allow the designers to take complete advantage of the capabilities of the computer, or to develop expansion plans very far into the future.

The hardware suppliers realize that having more software available on the market for their equipment would make their equipment more useful to the designers, but they resist investing in the development of that software themselves. Instead, they tend to adopt or distribute the software developed by others to work with their system.

Thus, independent software developers, not directly involved with specific systems or equipment, have evolved as a separate group. There are a great many such software suppliers—numerically they probably equal the number of hardware suppliers, systems suppliers, service bureaus, and on-line systems combined.

This suggests these suppliers might be filling the void. But are they? No, at least not yet. There are still more programs available from the equipment and systems suppliers than can be bought from the software suppliers. Despite their large number, most of the suppliers are small and have relatively few programs for sale—60 per cent have 10 or fewer programs available to the marketplace and 80 per cent have 25 or fewer available.

The software suppliers are vying to fill niches in the marketplace

They produce applications programs for specific manufacturers' computer models, to work with specific computer languages within that model, as well as with specific operating systems. For a designer to find an applications program to do what that designer wants, and still work on his or her computer with compatible computer language and method of operating, can sometimes be like an Easter egg hunt.

In other industries, where one computer supplier might attain giant status, the presence of its equipment produces an almost de facto standard, and software suppliers hone in on those computers with software that can then be used at many locations.

But in the construction industry, there is no such giant, and thus no de facto standards. And research evidence shows that this state of incompatibility will continue in the foreseeable future.

All this means is that the designer looking for software will have to function like a consumer in a world without shopping malls and department stores—spend time searching and evaluating, or pay someone else to do so.

In most cases he or she must settle for several alternative methods of using computers. Besides having the firm's own method for the principal applications, the designer might have to use service bureaus and/or on-line systems for additional applications—maybe more than one of each. Or he or she might have to have someone prepare the software, either in-house or with a consultant.

What the designer does depends on how eager the designer is to expand computer use—or how forced he or she is. The latter condition comes about after a firm buys a computer and finds that though it is up and running, it is not up and running often or long enough to pay for itself.

Some firms are finding that running a computer on a single eight-hour shift is not enough for the computer to pay for itself. It is hard to tell, in cases of where a design firm's business has risen after they acquired a computer, whether the increased business was due to the associated increased productivity or back pressure to get new business to keep the computer running at profitable levels.

What are the designers doing?

Generally speaking, persistency in a software search pays off. But persistency takes dedication and time and money.

How the designers approach the problem usually depends on the size of the practice. A large practice usually has the money to support persistency. But a small practice does not. Dedication is more a factor here. Research evidence shows that the combined architectural-engineering offices, which are often the larger offices, tend as a group to strive toward increasing their computer involvement much more than do the smaller offices, and are more willing and able to support the internal development of software.

Across the board, when we group the entire design profession of architects and engineers, software developed in-house and that purchased from the equipment and systems suppliers are about neck and neck as the leading sources of software, with that sold by software suppliers coming next.

In a study completed in November 1982, the results showed that the average architectural-engineering firm spent twice as much on in-house development of software as they did on purchased and leased software. The average smaller architects spent almost the same amount for in-house software as they did for outside software. Over-all, the architect-engineer spends on the average about six times as much as the architect for software, and about 10 times as much as the architect for in-house software.

A point of information, though, about these statistics, which also is important. The statistical medians and means are widely dispersed, indicating that a cluster of firms in each category is skewing the data; actually, only a few firms are making significant expenditures. This will be dealt with later.

When an analysis is made of the outside sources of software used by designers, the graph in Figure 1 (see overleaf) applies. The computer and systems suppliers are the principal sources of outside supply, with software suppliers following next.

The architects, since they rely less on in-house development, rely more on these sources than do the architect-engineers. The architects get 40 per cent of their software from equipment and systems suppliers, and buy 40 per cent from the software supplier, each of which is about six to

eight per cent ahead of the architect-engineers. Neither group makes much comparative use of leased software or service bureaus, but the architect-engineers make much more use of on-line systems than do the architects. The average combined-services office spends almost \$23,000 on purchased software, and a little under \$2,000 for leased software. For the architects, the figures are a little under \$6,000, and a little under \$2,000, respectively.

How much software is used?

Figure 2 shows the number of programs that architectural and architectural/engineering offices obtain from outside sources. The average office in the A/E group gets about 11 programs from a supplier, while the average smaller architect gets about four programs. When in-house developed software is included, the average design office (all design groups combined) has about 18 programs. Without the engineering influence, which relies heavily on number-crunching programs, and without the in-house software, the average number drops significantly to that shown in Figure 2.

Again, a caution about the average. It is skewed considerably higher by the deep involvement of a few firms. As Figure 2 shows, 30 per cent of the architectural firms, and 20 per cent of the combined-service firms have only one program from an outside source. Over 40 per cent of the architects and about 33 per cent of the latter group have between two and five programs from an outside source. This means that over 70 per cent of the architects and about 53 per cent of the architect-engineers have limited their outside purchases of software to five or fewer programs.

To carry it a step farther, 83 per cent of the architects and 71 per cent of the combined-service organizations limited their outside acquisition of programs to less than 10. This is not a deep commitment to heavy involvement with computers. Although the surveys show that a large percentage of designers are involved with computers, most of them are involved in a small way.

Of course, when in-house programming is added into the picture, the average number of programs in use rises. But again, this is skewed by a relatively few. Most designers, and especially the small architect, are little affected by this. Although

ENCORE

AT LOS ANGELES MUSIC CENTER

The performance was a classic lasting 17 years! Then, they called for an encore. The star: 100% pure wool carpet, custom designed in honey and olive with the Center's sunburst emblem.

Wool was chosen as the only fiber that could provide the luxurious beauty and rich color needed to complement the elegance of the Grand Hall and the Dorothy Chandler Pavilion.

Over a million patrons annually attend 400 performances and other events. Only wool offered the soil and stain resistance, cleanability, easy maintenance and durability required to cope with the crowds, drink spills and cigarette ends. Daily vacuuming and periodic cleaning removed spots and soil. Burns brushed away leaving no ugly melt scars.

After 17 years, when the carpet was replaced, the Los Angeles Music Center insisted on an encore and specified a 100% pure wool duplicate of the original carpet!

Want more encores from your clients? Specify pure wool. Its easy cleanability, economical maintenance and lasting beauty make it the most cost-effective carpet investment.

Again 100% pure wool sets the standard for carpet excellence.



PURE WOOL PILE

The Standard of Carpet Excellence.

The Wool Bureau, Inc. U.S. Branch
of International Wool Secretariat
360 Lexington Ave., NY, NY 10017
212/986-6222

The Woolmark is a registered certification mark owned by The Wool Bureau, Inc.

Circle 31 on inquiry card

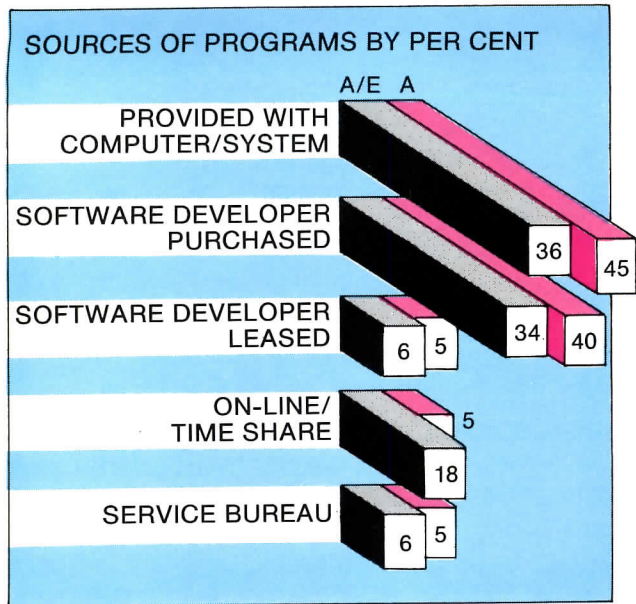
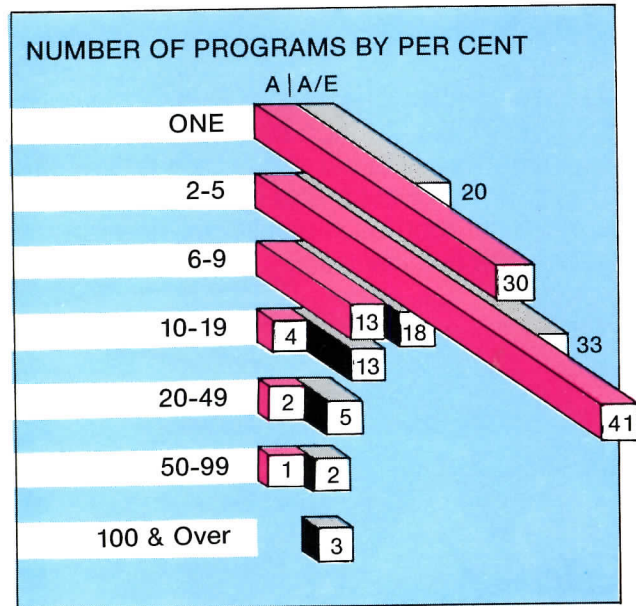

Figure 1 (top) shows the sources of programs that designers are buying from outside sources. A stands for architectural offices and A/E for firms that supply both architectural and engineering services.

Figure 2 (middle) shows the number of programs from outside sources that the two different kinds of firms have. The average for architectural offices is 4.1 and for architect-engineers 10.9. When in-house programming is included, the average for architects, architect-engineers and engineers is 18.



the statistics show that about 53 per cent of all designers do some in-house programming, this is skewed heavily by the architect-engineers and engineers. And the only significantly large commitment to in-house programming is by the larger, better financed firms.

Most designers are busy trying to run their practice, and do not have the required time to devote to the software hunt. In some firms, this time is allocated. In most, though, it is not.

After some initial searching, which often is discouraging, computer users tend to fall into a pattern as to where they get the limited number of programs they use. Figure 3 shows the average number of programs obtained from the various sources, by those who use those sources.

As shown, the average designer who does in-house programming has developed about 20 programs this way. The average designer who gets his software from the equipment or systems supplier, gets about five programs, whereas those who buy software from a software supplier average about eight. These last two figures are interesting, because—as we have seen—the over-all statistics show that across the entire design profession, most of the software comes from the equipment and systems supplier. While more designers rely on this source, they get a smaller average number of programs each than those fewer designers who deal with software suppliers.

Those designers who lease software, and there are not many, have access to an average of between four and five programs. Those who use on-line systems have access to about six programs, and those who use service bureaus have access to five.

As Figure 3 shows, the designers who are most deeply involved do their own in-house programming.

Why in-house programming?

It is not to save money. While software generally is an expensive item, in-house programming is the most expensive way to get it. Generally speaking, designers feel that their expansion software is not available in the form they want it, or it just cannot perform to their requirements.

In the most recent survey excluding strictly engineering firms, about a third of the computer users said that they would like to acquire software, but feel that what they want is

either not available or not adequate. The most interesting part of this recent survey is that about 44 per cent using computers did not know whether they would acquire software, or whether it was available or adequate. About 21 per cent had no intentions of getting more software. Only one-third of those using computers have plans to expand their usage, but are having difficulty in doing so.

You do not have to run or jump into anything!

Considering that the depth of involvement of most designers who use computers is low to start with, and the growth of that use also appears to be low, the application of the term "automation" to a designer's practice appears to be a bit premature. The designers are moving in that direction, but not quickly.

The heralds of computerization give publicity to some select firms who are dedicated to deep involvement, but these are not representative of the typical practice. The activity right now is not as high as the interest.

It is quite likely that the economic climate of the last couple of years has a part in this, and it is likely that a turnaround in the economy will spur deeper involvement. It should. The computer promises to be one of the most important tools of the designers, and it behooves the designers to make the most of it that they can. Ultimately, the pressure for doing so will come from the government and sophisticated owners, and this has already started.

But, spend your time evaluating. Do not feel pushed. Walk or maybe trot, with the speed you use being inversely proportional to the price. For those of you who have been worried about being left out in the cold, you still have time enough to knit yourself a sweater.

Mr. Mileaf is director, Technology and Product Development for Sweet's Division, McGraw-Hill Information Systems Company. His achievements for Sweet's include Mechanical, Electrical and Civil Engineering Catalog Files, technological planning over the past 15 years, and 11 research studies over the past 3 years on influences in the construction industry. Mr. Mileaf is the author of 16 books on technical subjects.

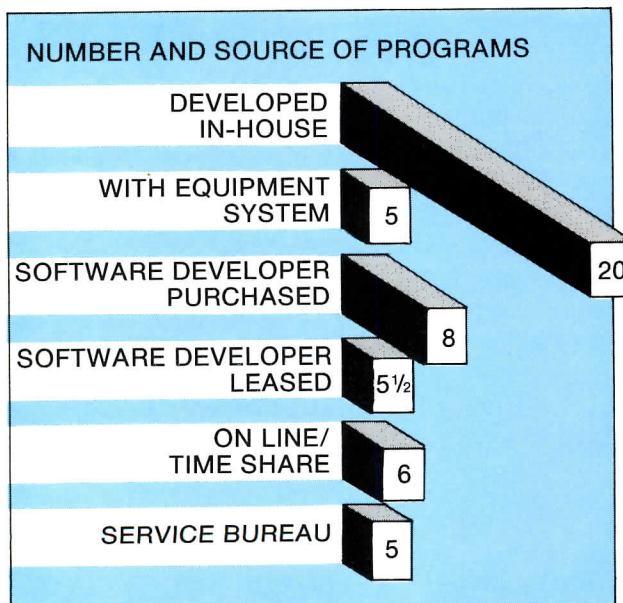

Figure 3 (bottom) shows the average number of programs that users obtain from each source.

GET TWICE THE INSULATION

How to get power from here to there And look good doing it.

All that fresh, free, open office space in your design – now you can keep it that way with Wiremold's new Fantom Flex™ undercarpet wiring system. Our Flatwire™ cable is the flattest, narrowest, most flexible flat conductor cable on the market. And the attractive Fantom Flex low profile, cast pedestals are designed to accommodate flat communication and data cable.

Yes, the system is UL listed. Yes, it meets NEC requirements. Yes, it's easy to install.

Let your imagination run with it! Run the new Fantom Flex System under your carpet squares. It's yet another approach to design freedom from the leader in electrical wiring systems, The Wiremold Company, Electrical Division, West Hartford, Connecticut 06110. Telephone: (203) 233-6251.

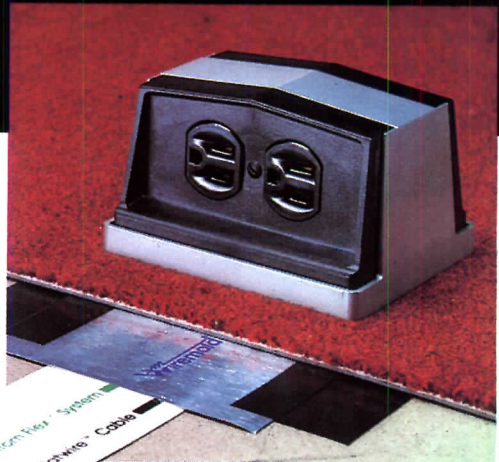

 **Wiremold**

The profitable professional: Protecting ownership and use of plans

Too many architects give up, or give away without a struggle, the rights to their plans. It can cost you money, and increase your liability

By Barry B. LePatner, Esq.

It is quite possible that the most important but least understood provision in a contract for architectural services is that relating to the rights of ownership and use of plans. So important is this provision to the successful business operation of an architectural firm that failure to insist upon retaining these rights can often result in a substantial loss of profits and an increase in a firm's liability for potential claims.

Architects have too often conceded to their clients the valuable rights in their plans. And, too often, such rights have been given away merely for the asking. Recognizing the value of a designer's creative work product is critical to an understanding of the arguments in favor of preserving these rights. The importance of securing and protecting the ownership and use of one's plans, as many architects have learned, is an imperative step towards the goal of becoming a profitable professional.

Perhaps the most direct way of proving how little is known about this area of the law is a simple true and false test:

- True or False? When a client retains a design professional to prepare a set of plans, the fees paid for the design give the client an absolute right to use the plans as he wishes.
- True or False? In the absence of a provision in a contract as to the ownership of the plans, the client is legally entitled to them.
- True or False? The Copyright Act of 1976 fails to provide any means for the protection of architectural plans.
- True or False? Where an architect is terminated without cause during a project and paid for services performed to the date of termination, the client may continue the project with the original plans under the purview of a new architect.

If your answer to any of these questions was "True," you will find a different correct answer below.

Understanding the standard AIA provision

The latest edition of the standard AIA Owner-Architect Agreement (B141 June 1977) sets out the rights of the parties to an architect's instruments of service—including ownership and use of documents—as follows: 8.1 *Drawings and Specifications as instruments of service are and shall remain the property of the Architect whether the Project for which they are made is executed or not. The Owner shall be*

permitted to retain copies, including reproducible copies, of Drawings and Specifications for information and reference in connection with the Owner's use and occupancy of the Project. The Drawings and Specifications shall not be used by the Owner on other projects, for additions to this Project, or for completion of this Project by others provided the Architect is not in default under this Agreement, except by agreement in writing and with appropriate compensation to the Architect.

Seen in its most simple context, the inviolate right of an architect to retain absolute ownership over the plans seems to be unassailable. However, in practical terms, neither architect nor client is usually able to discuss the concepts underlying this provision in comprehensive terms. To the contrary, in spite of this language, most clients truly believe that upon payment of an architect's fees (in whole or in part) they assume complete rights to the plans.

Unfortunately, most architects also believe this to be the case. As such, we come to the first of several important rules necessary to a full understanding of this subject.

RULE 1: Unless expressly granted to the client, the rights to ownership and future use of the plans belong exclusively to the architect.

It is, of course, necessary for the architect, as a condition of asserting this right, not to be in substantial default of the agreement for services. Thus, should a client arbitrarily wish to change architects in the middle of a project, the architect is fully entitled to demand the return of all plans in the possession of the client, the contractor and any other party to the project without permitting their continued use.

Recognizing this concept leads directly to the logical next question: What precisely is the client paying for when he retains an architect or engineer? The answer to this question is the second of our general rules.

RULE 2: A client's payment of fees, as they relate to the design, is limited to the preparation of the plans and specifications for the project and the right to build from those plans on one occasion.

In my experience, no other concept has met with more universal incredulity than this one. So unsettling is this revelation that many clients dismiss it out of hand—though they can be confronted with reality by being faced with an

action for copyright infringement. Nevertheless, it bears repeating: An architect's fees do not include compensation for the rights to the plans, merely for the preparation and use thereof for the project in question.

Nor does a client get the right to use the plans for extensions to the original project or for repeated uses on other sites without the payment of additional compensation to the designer. All of this becomes clearer when one understands the true value of these special creative documents.

Understanding the copyright laws

As described in The Copyright Act of 1976, copyright protection "subsists . . . in original works of authorship fixed in any tangible medium of expression . . ."

Works of authorship include "pictorial, graphic and sculptural works," which have been construed to include "two-dimensional and three-dimensional works of fine, graphic, and applied art, photographs, prints, and art reproductions, maps, globes, charts, technical drawings, diagrams and models."

Architectural drawings are plainly "technical drawings," and also fall within several other categories of copyrightable works.

The Act is clear regarding an architect's copyright in the drawings he or she prepares when it provides that "copyright in a work protected under the Act vests initially in the author or authors of the work." A recent Federal court decision reaffirmed this concept by stating: "The architect who originates a set of blueprints for a dwelling is as much an author for copyright purposes as the writer who creates an original novel or the dramatist who pens a new play. . . ."

The above reasoning is enhanced when it is recognized that an architect's design is truly a unique intellectual work product; no two are quite the same. Each design is the amalgam of that particular architect's collective experience.

Much as a painting or a sculpture can bear the unique imprint of creative genius, so too does an architect's design concept bear his or her own stylistic signature. The reputation for uniqueness that each designer develops creates in each finished work product a right to prevent further use of the work without express permission.

How do you secure protection? The means by which an architect secures protection against any unauthorized use of plans is summarized in the following rules:

RULE 3: All contracts for design services should specifically reserve unto the architect the sole and exclusive right to ownership and use of the plans prepared by the design team.

As will be discussed below, any unauthorized use by a client, or any agent or employee of the client, will enable the architect to take direct, affirmative action to recover the plans and any damages which resulted from the infringement.

RULE 4: All plans, specifications and related design documents should include a copyright notice at the bottom of the title block or on the front page of each document.

Although not a necessary precondition to asserting a copyright, such notice (e.g. Copyright © 1982 Johnson, Smith & Associates, All Rights Reserved) serves to effectively alert third parties, i.e. contractors, suppliers, and prospective purchasers of the property from the client, that any unauthorized use of these materials will subject them to an action for copyright infringement.

Under The Copyright Act of 1976, plans prepared after January 1, 1978 should include a copyright notice. Although the notice should include the language of the example noted above, the legal requirements can equally be met by placing on each drawing this simple notation: © 1982 Johnson, Smith & Associates.

More importantly, a failure to include a notice on copyrightable work will not preclude one from asserting all such rights if only a relatively small number of copies were issued or if (1) registration of a copyright claim is made within five years after publication without notice and (2) reasonable efforts are made to add a notice to copies distributed in the United States.

You may even want to register a copyright

Registration of a copyright is not a precondition for asserting a claim of copyright. And while such registration has been infrequently undertaken by architects, the advantages of registration are highly desirable where a design can, in any way, be deemed significant.

Continued on page 49

Glass-terpiece

The beautiful new Collin Creek mall in Dallas' suburban Plano area is another evidence of Naturalite's expertise in glass skylights.

The 28,000 square foot system of Lean-To and Structural Pyramid skylights was designed and installed by Naturalite in less than four months and utilizes energy-conserving mirrored glass. The fast-track installation was delivered on budget and on time. The mall was opened in mid-1981. Federated Realty, Cincinnati, is the owner-

builder-developer. General contractor, Walker Const. Company, Fort Worth, Tx. Architects, R.T.K.L. Associates, Inc., Baltimore.

Whatever your design calls for, Naturalite can execute it beautifully in acrylic, glass or polycarbonates. And, we are equipped to install larger custom applications almost anywhere.

See Sweets insert 7.8/Na or contact the factory. Naturalite, America's largest skylight company. Your single source for skylights.



NATURALITE, INC.

3233 West Kingsley Road, Garland, TX 75040
For information call: Jim Wozniak, VP Arch. Design
(Toll Free) 1-800-527-4018

Circle 34 on inquiry card

The procedure for registration is quite simple. A copy of the plans, accompanied by a brief application form and a \$10 fee, is deposited with the Copyright Office in Washington, D.C. There, the application and copies will be reviewed to ensure that they are in general conformance with the law. No comparison to the designs of others or plans already on file will be made.

Although in a recent filing the Copyright Office advised of a four-month backlog in the issuance of a Copyright Certificate, expedited review (as where an action for infringement must be started) can be effectuated within days upon payment of an additional fee.

Registration provides benefits in several ways: (1) It can preserve a copyright when notice has been omitted upon issuance; (2) It can alert parties with whom the architect is not contractually bound as to the rights being asserted in the documents; (3) It is a required first step before an action for infringement can be brought; (4) It can simplify a proceeding for infringement as it constitutes *prima facie* evidence of the designer's copyright and; (5) Early registration may enable the architect to recover additional monetary damages including attorneys' fees incurred in an infringement action.

Infringement—affirmative action is imperative

Instances of design-document infringement appear to be increasing. Since the inception of The Copyright Act, several important cases have established the right of an architect to claim a proprietary interest in the plans prepared for a client.

Nor have courts hesitated to protect the ownership rights of architects where there is a real and immediate need to prevent the wrongful use of the designer's plans. Moreover, if the architect can demonstrate a likelihood of irreparable harm that may result from such unauthorized use, a preliminary injunction against further use, including a halt to any construction utilizing the plans, can be a potent remedy available to an architect.

The variety of situations where clients have sought to usurp the ownership rights to an architect's plans is shown by the following brief recitation of several of the copyright cases which my office has handled during the past year:

• During construction of a major hotel, the client decides to have

another architect substitute a different (and unauthorized) facade than that designed by the architect for the project. This was done notwithstanding the fact that the original design was approved for construction by the client, the lenders and all appropriate governmental entities.

• As construction of a renovation in an historic landmark district is proceeding, the client, seeking to save the designer's fees for construction-phase services, hires a young architectural student to assume the responsibility of the architect while demanding the right to continue using the architect's sealed set of plans.

• A corporation, in the middle of a \$65 million renovation, and without prior warning, terminates the architect's contract, advising that all future services are to be performed by a new firm of architects. The plans prepared by the original design team are to be carried out by the successor architect.

In each of these situations, the design architects were faced with both substantial economic loss as well as liability for the continued use of their plans. In each of these situations the architects had legal right to assert a claim to ownership and use of the plans—i.e., to recover the plans from the client, collect the fees due them for services and secure the necessary protection against future liability on the project for any changes to their plans which might result in claims of design defect. And in each of these situations the architects accomplished these objectives.

You should not allow use of plans after terminating your contract because . . .

Clearly, no architect can insist upon continuing as architect of record where a client seeks to retain another designer. Nevertheless, such a situation, however unfortunate, requires attention to the details of termination. Such details include, among other things, the need to protect against the substantial liability that can result from a client's use of plans in the absence of the designing architect.

The potential liability that can result from continued use of the plans by others encompasses any and all changes to the plans during construction that can materially affect the integrity of the design and result in damage to the property itself or to third parties who occupy the premises.

This potential for liability represents a dual dilemma for

the architect: not only must the designer forego the opportunity to complete the project, but, more significantly, he or she must also face the uncertainties of being named as a party to a lawsuit for damages without the opportunity of readily ascertaining if such a claim is based on plans changed by the owner, the contractor, or the successor architect.

Thus, unless an architect takes affirmative action to prevent the further use of the plans, substantial immediate and irreparable harm becomes a real possibility, if the client is not restrained from such continued use. Such irreparable harm includes the inability to avoid (or gain recompense for) the cost, time and disruption to business if litigation ensues.

Such litigation will, of necessity, require a determination as to whether the architect's original design was the cause of the damage in question. In fact, it may be impossible at a later date to ascertain whether any resultant liability was caused by the original design or any modifications made after termination.

The opportunity to review one's plans during the construction phase is an integral part of an architect's services. When this opportunity is taken away, an architect's exposure is greatly increased. Such review can avoid significant extra costs to a client during construction; it allows the designer to incorporate any revisions or substitutions suggested by the client or the contractor into the total context of the design in such a way as to ensure that such changes will have no deleterious effect upon its integrity.

It is worth noting, as a Federal court judge has recently held, that it is the custom and practice in the construction industry for architects to retain ownership and use of their plans. This custom and practice results both from the special nature of an architect's design product as well as the economic concerns and potential exposure discussed above.

Retaining rights to one's plans is not only a question of custom and practice; it is inherently fair. When an architect is retained, the client is paying for his or her services; the plans are a separate and independent by-product of that engagement.

An architect's compensation is for design services and coordination of the elements of the design and construction

process. It is well recognized that the client's right to use the documents is a right which is conditioned upon the client's compliance with the terms of the agreement with the architect. An owner has no inherent right to use the plans independent of his or her obligations under that agreement.

One need only consider the increased potential for liability that exists should the client decide to sell a project under construction to a third party. It is unlikely that such a sale would not include the plans of the architects.

Yet, the architect could find that a new purchaser desires to proceed with the project under the purview of a different architect. Protecting the rights to the plans and ensuring against this incursion on the designer's copyright is essential if all architects are to gain the benefit of the laws which exist for their protection.

Undoubtedly there will be clients who will insist upon their "right" to own the plans, to hire and fire architects, and otherwise do as they see fit on their projects. It is unrealistic to expect that all architects will have the business acumen or the desire to resist a client who threatens to give the project to another designer unless such a concession is made.

Yet the fact remains that clients can be told that this provision is non-negotiable; that the Federal copyright laws vest ownership of plans in the architect; that custom and practice does not permit gratuitous concessions on this issue; and that the potential for liability in such situations is far in excess of the fees for the project and the amount of liability insurance maintained by the architect.

The ability to say "no" to any client's attempt to strip an architect of the inherent rights to ownership of the plans will be a testament to that architect's professionalism and integrity.

Mr. LePatner has law offices in New York City, where he specializes in the representation of architectural and engineering firms. He is co-author with Sidney M. Johnson of Structural and Foundation Failures: A Casebook for Architects, Engineers and Lawyers, published this year by McGraw-Hill. Portions of this article appeared in the "LePatner Report," a newsletter for the design professionals published by the author. Copyright © 1982 by Barry B. LePatner, Esq. All rights reserved.

Steelcase

Steelcase Movable Walls.[®]

**The effective way to divide space
and subtract costs.**

Steelcase Movable Wall Power Panels now cost significantly *less* than before. Yet they include many important new features. All tackable surfaces are now acoustical. Glass panels can now carry wiring. And all Walls can accommodate EIP, three electrical branch circuits, plus large-capacity cables for powering computers and communications equipment.

In addition, these Movable Walls can support a full range of hang-on components and blend beautifully with all existing Steelcase furniture and Movable Wall systems.

See them at one of our Regional Offices or contact your Steelcase Representative. For worldwide product, service or sales information, write Steelcase Inc., Grand Rapids, Michigan 49501. Or, call toll-free 800-447-4700.

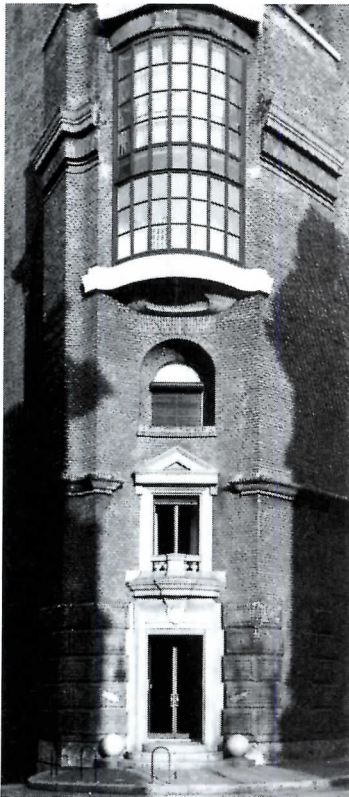

Top: "Ca Brutta," Giovanni Muzio (1919-22)
 Above: Corner detail, Palazzo Fidis, Aldo Andreani (1924-30)

So complete was the eventual triumph of the International Style that it is easy to forget it was by no means unchallenged in the theoretical and stylistic ferment surrounding architecture at the time of its inception. A useful—and fascinating—reminder is contained in a photo exhibition of contemporaneous work, now touring nationally after a stay at New York City's Urban Center. *Precursors of Postmodernism: Milan 1920-30s*, a collection of photos by Gabriele Basilico, documents the "Novecento" style of a group of neoclassicist Milanese architects whose use of classical forms and ornament anticipated by half a century the experimentation by today's post-modernists with shapes and surface treatments rooted in historical antecedents. The show is accompanied by a 16-page catalog featuring an essay by Fulvio Irace, the exhibition's curator, who illuminates particularly the metaphysical and surrealist aspects of the work presented. The exhibit will be shown at the Institute for Advanced Study, Princeton, N.J., February 15-March 31, Walker Art Center, Minneapolis, June 26-August 27, and Lawrence Institute, Southfield, Mich., October 2-November 12.

AIA names Nathaniel A. Owings 1983 Gold Medallist

Nathaniel Alexander Owings, FAIA, cofounder of Skidmore Owings & Merrill, has been chosen to receive the AIA's highest award, the Gold Medal, at the institute's 1983 national convention in New Orleans next May. The noted architect and urban designer was selected by the AIA board of directors in recognition of "most distinguished service to the

© Ezra Stoller/ESTO

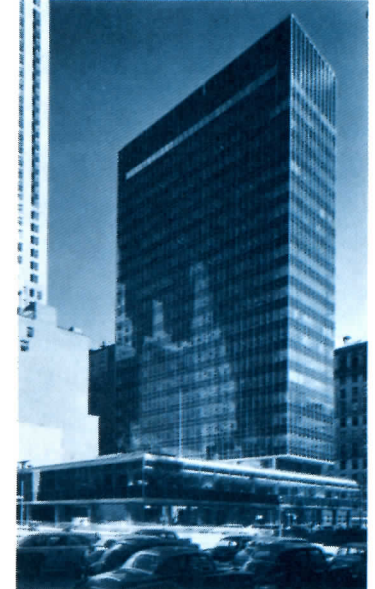

At the ripe old age of 30, Lever House, a de facto landmark in New York City (and in the annals of modern architecture) since its construction, has been given official landmark status by the city's Landmark Preservation Commission. And none too soon, in light of recently confirmed rumors of plans to replace the building with a structure that would fully exploit the allowed zoning envelope. Designed by Gordon Bunshaft of Skidmore Owings & Merrill and completed in 1952, the building was immediately hailed as the distillation of the International Style in the service of corporate expression. A startling departure from the heavy inflected towers of the time, the slender slab of blue-green glass floating above an open courtyard became the catalyst for transforming city skylines and streetscapes throughout the world—the original and still quintessential model for the now ubiquitous glass box.

architectural profession and to the Institute." In the nomination for the Gold Medal, Owings was cited particularly for his contributions to urban design in several major cities, including his successful 20-year campaign to revitalize Washington's Pennsylvania Avenue and the Capitol Mall.

FORMICA CORPORATION INVITES YOU TO JOIN

EMILIO AMBASZ
WARD BENNETT
FRANK GEHRY
MILTON GLASER
HELMUT JAHN
CHARLES W. MOORE
SITE, INC.
STANLEY TIGERMAN
VENTURI, RAUCH
AND SCOTT BROWN
MASSIMO AND
LELLA VIGNELLI

IN REVOLUTIONIZING AN INDUSTRY

LAST CALL FOR ENTRIES IN THE
COLORCORE
"SURFACE AND ORNAMENT"
DESIGN COMPETITION I.

Formica Corporation invites the design community to explore the potential of its revolutionary new surfacing material: COLORCORE™ laminate, the first laminate with integral solid color.

Competition I closes February 15, 1983. In addition to the open

competition, there will be invited designs by the architects and designers above.

For samples and information call (800) 543-3000, ask for Operator 375. In Ohio, call (800) 582-1396. Formica Corporation, Wayne, NJ 07470.

COLORCORE™ is a trademark of Formica Corporation. © 1982 Formica Corporation.

Circle 42 on inquiry card

We're looking for more architects who have a job we can be proud of...



trucks and doing maintenance. Red Roberts, who is in the picture with me, learned auto repair with the National Youth Administration during the Depression. He joined the company in 1943, left to serve in the Navy, and since 1946 he's driven the truck that brings blocks from the quarry to the mill. He recently gave up ice fishing because of arthritis, and his main passion now is flying. He keeps thinking about getting a license, but says he'll wait until he can catch plenty of rides by hanging around the airport at Glen Ferris most every weekend. I think Bill Markcrow and I spend most of my time on the telephone selling. We cut and split a million square feet of slate a year for stock stuff for pavers and those boxes you buy in the lumber yard. That's a good volume and we make a good profit. But

Which would you rather do? Split two tons of roofing slate or work on a fine contemporary house like this?

"I was reminded of this beautiful slate installation we did 10 years ago while looking through '25 Years of Record Houses.' The house is a beauty designed by Barbara and Julian Neski, who do a lot of beautiful houses as part of their practice. The slate is set in a European pattern, with very nice cutting and finishing around that diagonal wall opening to the terrace. The living room floor and the outdoor space seem like just one big plane. Everybody around the quarry and mill take pride in custom jobs like this—when they get the shop drawing they like them to understand how our part of the work fits into the whole. . . ."



We have plenty of slate and all the skills needed to handle more jobs like this—jobs we'll all be proud of.

"Our slate is good quality, and we've got purples, greys, mottled, and reds. If you're visualizing slate for a job you're designing, don't worry about the budget until you've talked to me. I'll make a good price for a job that will be more challenging for us than splitting stock slate. Call me at 1-800-343-1900. (By George we're getting there—we don't have a corporate jet, but we do have a toll-free number.)"

—Bill Markcrow

VERMONT STRUCTURAL SLATE COMPANY FAIR HAVEN, VT 05743 1-800-343-1900

Regal homes for the silver screen

GSD course of study: an appreciation of nature as an organizing principle; an understanding of historic monuments; and a sensitivity to the psychic content of architecture.

Johansen and several other speakers took pains to draw a distinction between the modern movement and the International Style. They emphasized that Gropius was interested in the process of design rather than questions of style. His ideas, they declared, had been simplified and distorted by both his admirers and detractors. "One of the great tragedies of the Bauhaus," Wilhelm Viggo von Moltke (MARCH'42) claimed, "was that it was introduced into this country as the International Style."

Gropius's writings confirm this view. He wrote that he never intended to use his Harvard appointment to preach one stylistic truth. In a 1937 article for *ARCHITECTURAL RECORD* he said: "My intention is not to introduce a so-to-speak cut-and-dried 'Modern Style' from Europe, but rather to introduce a method of approach which allows one to tackle a problem according to its peculiar conditions . . . It is not so much a ready-made dogma that I want to teach, but an attitude towards problems of our generation which is unbiased, original, and elastic. It would be an absolute horror for me if my appointment would result in the multiplication of a fixed idea of 'Gropius architecture.'"

The GSD alumni blamed social and economic forces for reducing Gropius's method to a fixed and sterile repertoire of forms. John Harkness (MARCH'41), a founding partner with Gropius of TAC, stated that the building market's explosion after World War II made it impossible for modern architecture to develop naturally over a period of time. As architects struggled to keep pace with demand, they multiplied modern schemes *ad infinitum* whether or not such a wholesale application was justifiable. If a firm adopted a style that eschewed ornament and differentiation, Richard Stein commented, it could expand rapidly and still control its own projects.

The Gropius legacy for the GSD classes of 1936-53 was a set of principles which taught them to think about architecture as society's servant rather than as an end in itself. The alumni were especially concerned that no such guidelines were now being taught in the architectural schools. John Harkness worried that the

prevailing pluralism cast students adrift. "All that they can do," he said, "is read the magazines and see what's right this week and then take a shot at it." Richard Stein also found that post-modernism trivialized architecture by denying its primary social function and turning it into a private world of salon gestures.

Yet Gerald McCue, the present GSD dean, made it clear that there would be no return to the Gropius curriculum. He stated that the modern movement was a response to a very special historical moment when an old architectural system was dying and a new one just emerging. McCue warned the alumni not to condemn post-modern design simply because its forms were not those they had learned under Gropius. "It is just as unfair," he said, "for you to miscast this group as it is for them to miscast the objectives of your era. Just as unjust and just as wrong."

The Harvard reunion demonstrated that these first-generation modernists are fundamentally hostile to current architectural trends. Loud cheers erupted from the audience whenever the speakers excoriated the post-modernists. The alumni agreed with John Harkness when he asserted that there were far too many fundamental design problems left unsolved for architects to waste their time quibbling over facades. Unfortunately, Philip Johnson, the group's only convert to post-modernism, was not present to explain his apostasy.

It was clear, however, that the GSD alumni are not unaffected by revisionist attitudes toward modern architecture. They acknowledge that the International Style was flawed by its failure to take into account different bio-physical environments, architectural tradition, and the need for symbolically rich design. Yet they are convinced that a new direction can arise from what was basically sound in Gropius's method: a rational approach to design and the belief that architecture can enhance human well-being. If the Harvard reunion is any indication, the first-generation modernists are trying to mount a counterattack. Although they are now more critical of their past, they are not about to recant it. After due deliberation the convening GSD alumni appeared to concur in Paul Rudolph's prediction that "what will come will be a continuation of what has been." *Mary N. Woods*



Cooper-Hewitt Museum, Smithsonian Institution photo

It would be difficult to say where the greatest fantasy lay in the moving-picture palaces erected during the early decades of this century: While the Barrymores and Valentinos may have attracted the masses there were surely many who came as well for the spectacle of the palaces themselves. Now playing at the Cooper-Hewitt Museum in New York is an exhibition of these palaces spanning their golden years from the days following World War I through the Great Depression. The work of many of the leading movie-palace architects is shown in architectural renderings and photographs that illustrate the diversity of styles used in their designs: the Italian Renaissance recalled by John Ebersohn in Loew's Paradise of the Bronx; Morgan, Walls & Clement's

Mayan Theater in Los Angeles; the Oriental style of Thomas Lamb's design for Loew's State in Syracuse, New York; and the Art Deco of Donald Deskey's Radio City Music Hall. Artifacts such as a brass ticket chopper, carpet remnants, and lamps exemplify the pains architects took in designing every detail. David Naylor, author of *American Picture Palaces* (Van Nostrand Reinhold, 1981), is the guest curator of the exhibition. Showing through February 27. *L.L.*

Above: John Ebersohn's *Paradise Theater in Chicago (1928)*

New addition treats venerable hospital with tender loving care



The centerpiece of the riverside campus of New York Hospital/Cornell Medical Center in upper Manhattan is the 50-year-old main hospital building, a handsome and reposeful Gothic mass that architects Coolidge, Shepley, Bulfinch & Abbott modeled (loosely) after the Palace of the Popes at Avignon. Adding to it is a task any architect would approach with trepidation. Happily, architects Perkins & Will also approached the task with sensitivity, designing a new addition that does full justice to the original. The 180,000-square-foot C.V. Starr pavilion, built over the street at the north end of the hospital, repeats its materials—white brick, limestone, glass, and steel—and reinterprets its style, echoing its bays and setbacks as well as its strong verticals.

Sheraton Hotel reserved the best roof in town.

They specified Carlisle single-ply.

Once again, a Sheraton Hotel showed good "taste". Owners of the Sheraton Motor Hotel at Station Square did so by selecting today's premier roofing product to cover their stunning new 14-story motor hotel overlooking the dynamic skyline of Pittsburgh, PA. They specified Carlisle's Sure-Seal™ single-ply to cover the 56,000 sq. ft. roof, including the ground-level restaurant area at lower right. And they did it for a lot of good reasons.

Carlisle helped pioneer single-ply; our first roof installed over twenty years ago is still going strong. And Carlisle provides the complete system: EPDM membrane produced in extra-wide widths at our two American plants. Insulation. Flashing. Edging. Factory pipe leads. And application materials. We even train our approved single-ply applicators at our school in Carlisle.

What's more, a Carlisle single-ply roof can be easily installed in almost any weather. And it can be warranted for up to 10 years!

Call or write today for more information about the single-ply roof that American business is banking on. The Carlisle Sure-Seal roof. Carlisle SynTec Systems, Division of Carlisle Corporation, P.O. Box 7000, Carlisle, PA 17013.

DIAL CARLISLE 800-233-0551
in Pennsylvania call 800-932-4626

Carlisle and Sure-Seal are trademarks of Carlisle Corporation.
© 1982 Carlisle Corporation.

Circle 43 on inquiry card

*Owner: Station Square Hotel Associates
Arthur Santomo, Managing General Partner*

Roofing Contractor: Mak-Lyn, Inc., Pittsburgh, PA

Architect: Archeon, Inc., Memphis, TN

The roof that's requested by name.
Carlisle SynTec Systems

CARLISLE

Competition calendar A builder's romance with the city

• The Design Arts Program of the National Endowment for the Arts has established a public recognition program through which to honor completed design research projects that have contributed or can contribute to design excellence and quality of life and can serve as models of such research. The program welcomes as candidates for recognition a wide range of research types and methods. Contexts for research may include cities, urban places, and communities; buildings and interiors; open spaces and landscapes; industrial products, graphics, furniture, and clothing; and design for particular groups of people such as children, the elderly, and the handicapped. Information about projects selected as models by a jury of prominent designers and researchers will be disseminated to policy- and opinion-makers across the country. Projects for consideration should be submitted by February 21, 1983. Contact: NEA Design Research Recognition Program, c/o BOSTI, 1479 Hertel Avenue, Buffalo, New York 14216.

• Formica Corporation is sponsoring two "Surface and Ornament" competitions to explore the use of *Colorcore* laminate. Competition I for conceptual designs of products or objects is open to architects, designers, and fabricators, with students having their own category. Submission deadline is February 15. Competition II for completed room installations and in-production product designs is open only to architects and designers and will be judged in March 1984. For samples and rules manual call toll-free 1-800/543-3000, operator 375. (In Ohio, 1-800/582-1396.) Entries or requests for information may be addressed to *Colorcore* "Surface and Ornament" Competitions, Formica Corporation, One Cyanamid Plaza, Wayne, N.J. 07470.

• The University of California, Santa Barbara, is sponsoring a two-stage competition for the design of a new University Art Museum. Construction is estimated to cost \$5.3 million. Deadline for first-stage registration is February 1, 1983. For registration information, contact the University Art Museum, UCSB, Santa Barbara, CA 93106 (805/961-2951).

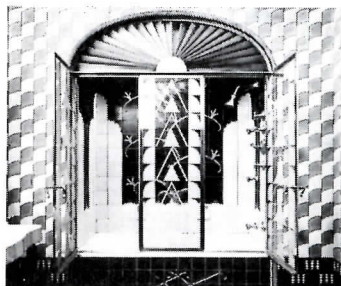
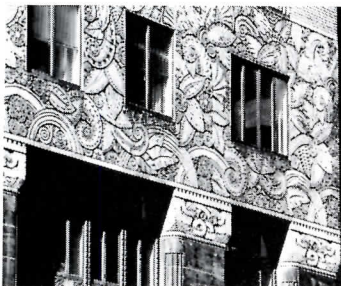
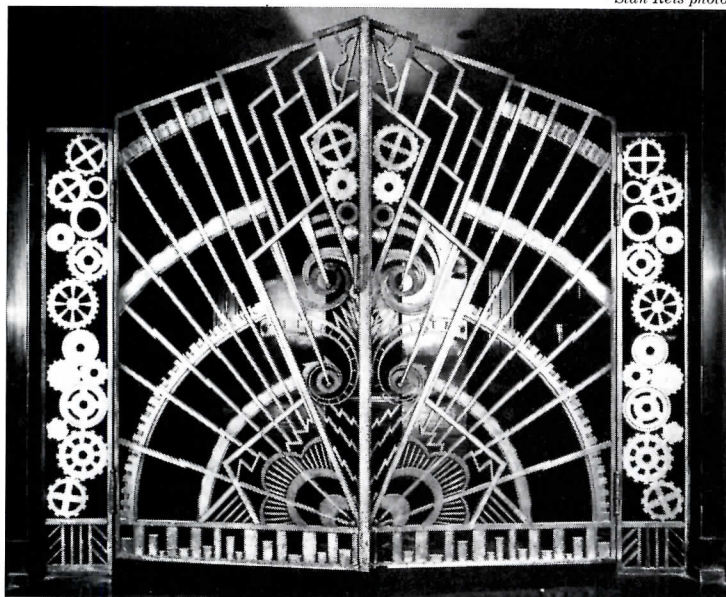

A Romance with the City, at the Cooper Union's Houghton Gallery through January 28, explores through photos, artifacts, and historical documents the work of Irwin S. Chanin, a developer active in New York City in the '20s and '30s. An architect and engineer as well as builder, theater producer, financier, and philanthropist, Chanin enjoyed a multifaceted career inspired by an affection for the city that was, as newspapers of the time observed, embodied in stone and steel across the skyline itself. Chanin is best known for the Chanin Building and the Century and Majestic apartment buildings in Manhattan, but also gave the city a number of notable theaters, some still in use. A visit to the 1925 Paris exposition of decorative arts made of Chanin an ardent champion of Art-Deco—as attested by the exuberant decoration in and on the Chanin Building, which is a central focus of the exhibition.

1. Grillwork in the Chanin Building
2. A detail of the facade ornament
3. A detail of the executive suite
4. A Hugh Ferriss rendering of the Chanin Building

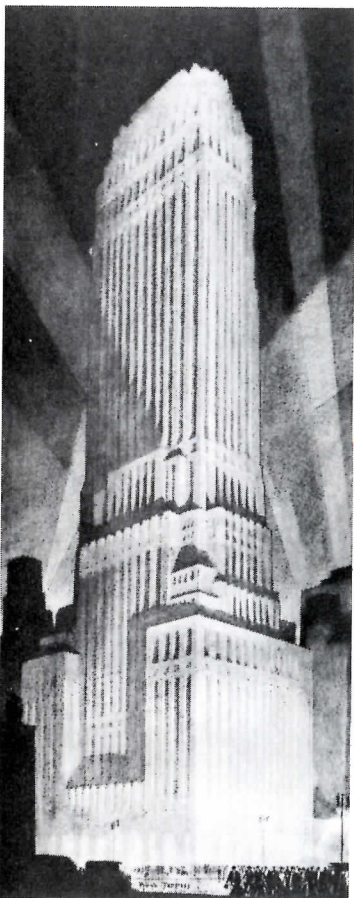

Continuing motifs in a changing Back Bay



Architects Jung/Brannen Associates have produced for a prime site at the corner of Boylston and Exeter streets a mid-rise office building consistent with the fast-disappearing traditional architecture of Boston's Back Bay. The chunky (14 stories, 190,000 square feet) structure, which replaces a parking lot, recalls—albeit writ large—such familiar Back Bay themes as oriel window projections and a glazed mansard "roof" at the upper three stories. A projecting tower marks the corner and signals entrance to a three-story atrium that lends exposure to retail spaces at the street and lower levels. Recessed shop entrances and a broad patterned and planted sidewalk create a people-scaled base for the brick and glass facade.

AIA installs president, other officers for 1983

Robert C. Broshar, FAIA, was inaugurated early last month as president of the American Institute of Architects for 1983, succeeding Robert M. Lawrence, FAIA. Broshar is principal in the Waterloo, Iowa, firm of Thorson-Brom-Broshar-Snyder. Other national officers installed with Broshar are first vice president/president-elect George M. Notter Jr., FAIA, of Boston; vice presidents Leroy E. Bean, AIA, of Sioux Falls, S. Dak., John A. Busby Jr., FAIA, of Atlanta, and R. Bruce Patty, FAIA, of Kansas City; and secretary Harry W. Harmon, FAIA, of Long Beach, Calif. Henry W. Schirmer, FAIA, of Topeka, Kan., continues in his two-year term as treasurer.

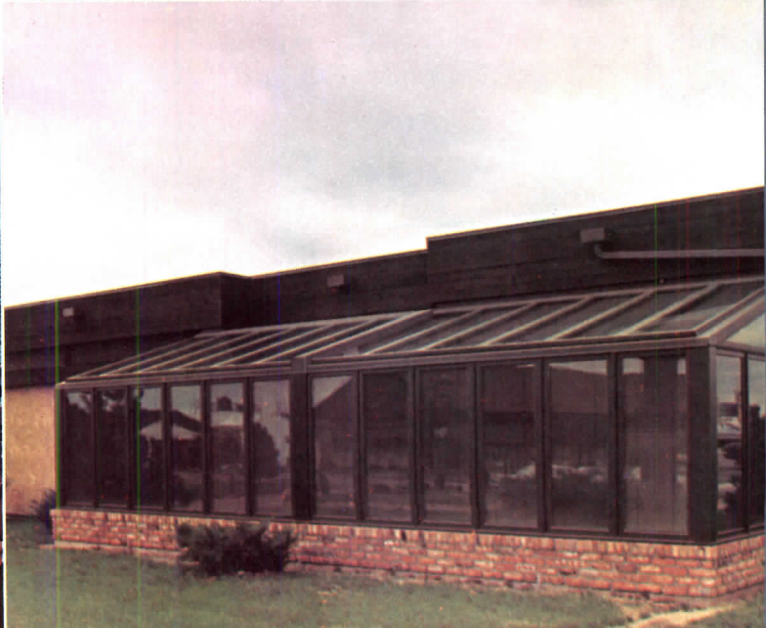

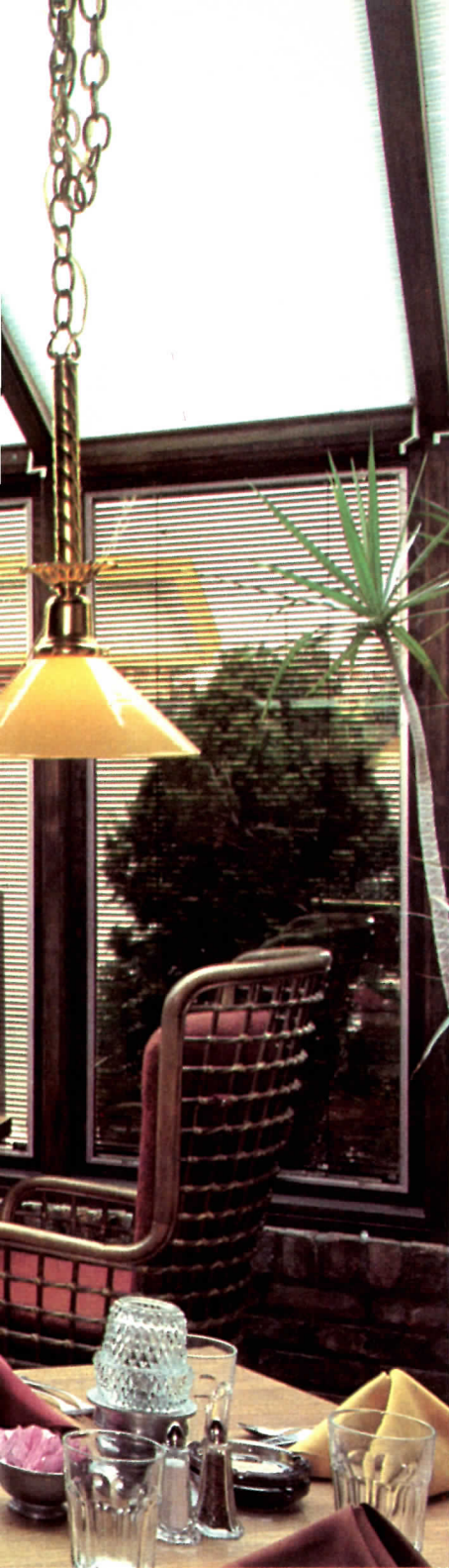

A table by the window is no problem in a Pella Sunroom.

Because even the roof is by Pella.

And because there are three Pella Sunroom additions to accommodate all the requests for "window" seating here at the Amalgamated Spirit and Provision Company restaurant in Cedar Rapids.

The original building, only about five years old, was built with very few windows, which was the trend in restaurants way back then. But today the owners wanted to brighten up the place and expand seating at the same time. Adding Pella Sunrooms was the enlightened solution. Pella Clad Sunroof panels combined with Pella Clad Casement and matching Pella Clad Fixed Windows created over 60 linear feet of light and lively Sunroom space that pleases both the owners and the customers.

The Pella Clad Sunroof. Modular for design flexibility. Fixed and ventilating Pella Clad Sunroof units can be joined side by side or stacked end to end to satisfy most dimensional requirements. All Sunroof units are solid wood construction of select western pine that's treated with a water and insect repellent preservative. Units are glazed with 7/8" tempered insulating glass. As an option, or if local codes require, units can be furnished with an inner pane of heat-strengthened laminated glass.

Ventilating Pella Sunroof Units. All that gets through is sunshine. Three weatherstripping and sealing systems — two in the frame and one in the sash — effectively seal out moisture and air on ventilating units. Operation is simple with a crank operated locking chain mechanism that opens the bottom of the unit 8". Units can be operated by means of an easy-to-handle aluminum extension pole where required.

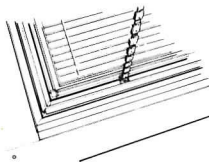

Convenient control of light and privacy with the Pella Slimshade®. These narrow-slat metal blinds are installed beneath the glass of Pella Sunroof and Skylight units. Adjustment

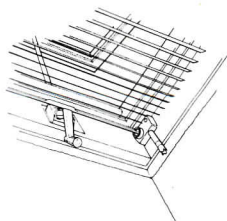

is quick and convenient either directly by hand or with an extension pole. In Pella Clad vertical windows with the Double Glass Insulation System, the blinds are installed between the panes of glass where they're protected from excessive dust and damage.

An exterior cladding that can survive constant exposure. Covering the exterior of all Pella products — Sunroofs, Skylights, Windows, and Sliding Glass Doors — is a sturdy aluminum cladding that doesn't need painting. Its tough, baked enamel finish resists fading, chipping, peeling, cracking and a host of other plagues.

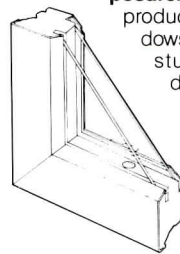

Yet, for all this protection on the outside, all you see inside is real wood, ready for stain or paint.

For more information on Pella Clad Sunrooms, Skylights, Windows, Sliding Glass Doors and Wood Folding Doors, call your local Pella Distributor. You'll find your nearest Pella Planning Center in the Yellow Pages under "Windows". Call Sweet's BUYLINE or simply send this coupon.

Please send me your 1982 Pella Catalogs.

Name _____
 Firm _____
 Address _____
 City _____
 State _____ Zip _____
 Telephone _____

Mail to: Pella Windows & Doors, Dept. T31A3, 100 Main Street, Pella, Iowa 50219. Also available throughout Canada. This coupon answered within 24 hours. © 1982 Rolscreen Co.

Architect: David L. Brost, Architects & Planners, Cedar Rapids, Iowa
 General Contractor: Shamrock Construction Co., Palo, Iowa
 Owner: The Amalgamated Spirit & Provision Co., Cedar Rapids, Iowa



Pella. The significant difference in windows and sunrooms.



Design awards/competitions: Owens-Corning Fiberglas Energy Conservation Awards

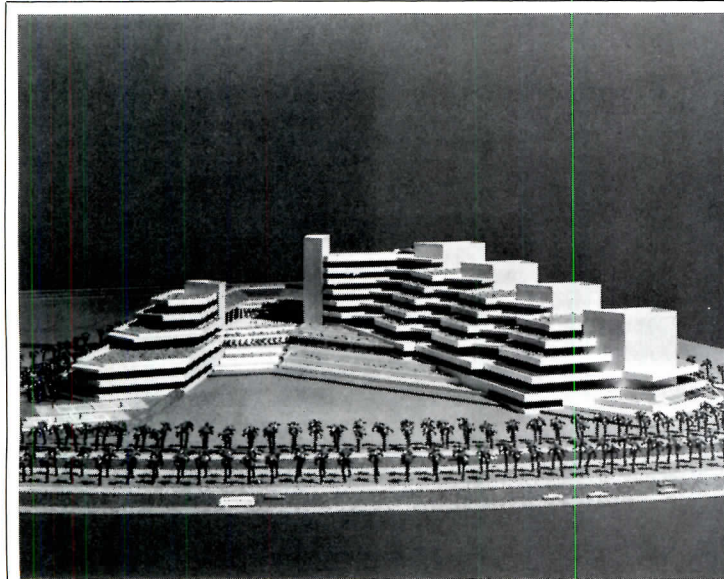
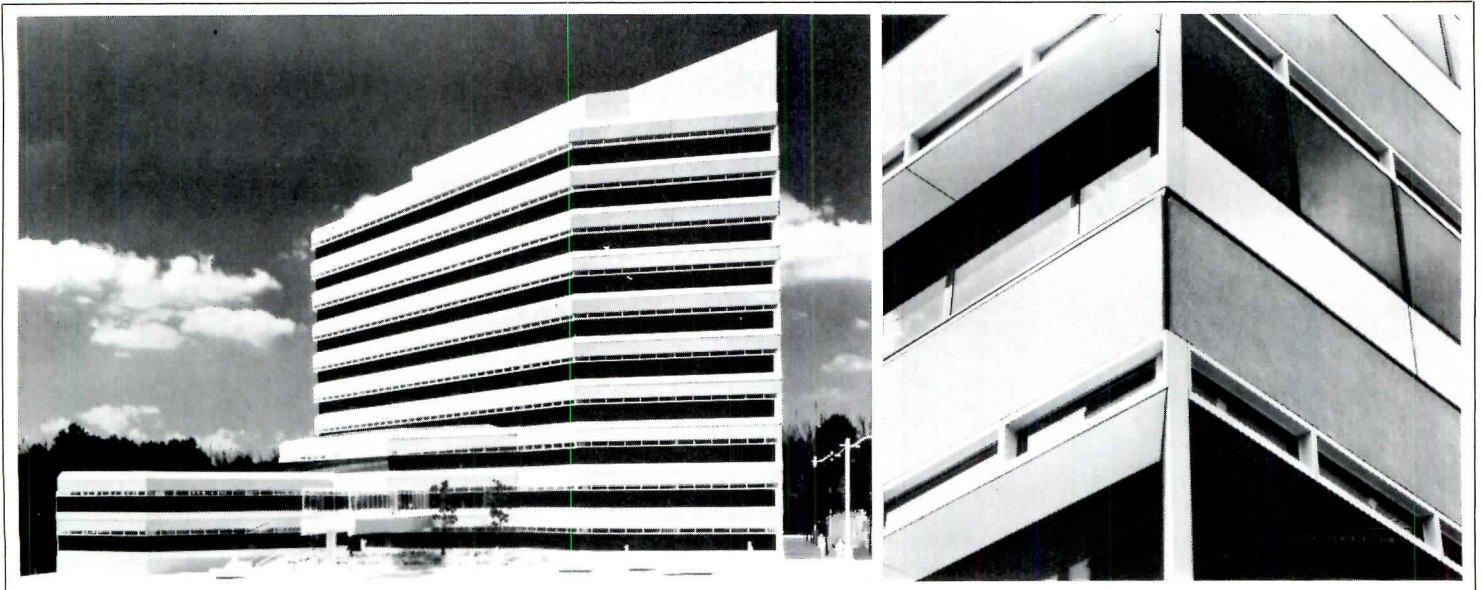

The energy awards jurors were Jack Beech, P.E., vice president and chief mechanical engineer of Joseph R. Loring & Associates, Inc.; Parambir S. Gujral, of Skidmore, Owings & Merrill; David L. Hartman, a mechanical engineer and business analyst with Booz-Allen & Hamilton Inc.; Vivian E. Loftness, an adjunct associate professor at Carnegie-Mellon University; Robert G. Shibley, chairman of the department of architecture at the State University of New York, Buffalo; R. Randall Vosbeck, FAIA, past president of the AIA; and John I. Yellott, professor emeritus at Arizona State University's College of Architecture.

1. The Norstar Building, Buffalo, New York; Cannon Design Inc., Architects. Angled dramatically across a central

downtown site, the \$15-million headquarters of Liberty National Bank combines energy efficiency with the strong corporate image the client desired. By composing the tower segment of the 220,000-square-foot structure as an elongated hexagon only 80 feet wide, the architects also provided ample perimeter window offices—an important attraction for tenants who rent half of the building. This layout also leaves much of the property open for a public plaza, which is shielded from the wind by the tall slab. The shallow plan and northeast/southwest orientation allows daylight to reach 15 feet into the interior. Windows in the precast concrete facades are recessed or flush according to their exposure (see corner detail above) in order to minimize summer heat gain and supply natural illumination

to nearly two-thirds of the work areas. Where artificial light is required, fiber optic sensors control high-efficiency, parabolic fluorescent fixtures. Inside a 135-foot-long skylighted atrium, peak heating and cooling loads are moderated by roof-mounted phase-change solar collectors that utilize a calcium salt solution for heat transfer.

2. Government Service Insurance System Headquarters Building, Manila, Philippines; The Architects Collaborative Inc., Architects. Scheduled for completion in 1984, the 1.35-million-square-foot complex will comprise a banking hall, 760,000 square feet of open-plan offices, a library, retail shops, an art gallery, and a variety of other facilities. The jury praised the architects' adroit use of lighting

and passive solar strategies to minimize cooling loads in a tropical climate. Primary facades face north and south, so that heat gain and daylight may be controlled most directly. The building's stepped masses are inset with trellised courts that admit breezes and views of Manila Bay. In conjunction with exterior light shelves, the trellises direct daylight into offices while reducing glare. Indirect fluorescent fixtures supplement this illumination and task lighting counteracts shadows (see section above). Cross breezes cool facades, outdoor program spaces, and some interior areas; vertical sunshades help to channel ventilation. However, most of the interior is air-conditioned by centrifugal refrigeration machines with induced-draft

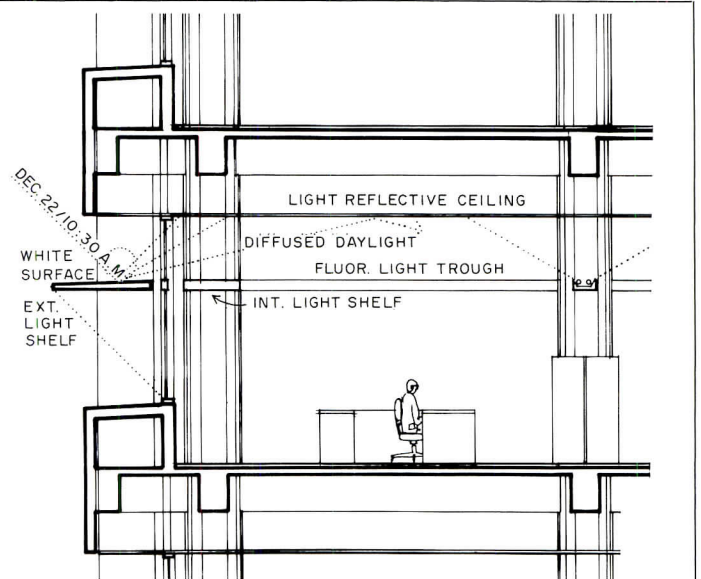

It was refinement of established technology and design rather than innovation that characterized the majority of projects submitted for the 1982 Owens-Corning Fiberglas Energy Conservation Awards, according to jury chairman Robert G. Shibley (we illustrate the winning designs below). Mr. Shibley remarked, "Energy is reuniting the architectural and engineering disciplines, demonstrating the value of close collaboration through the entire process of design . . . The jury was pleased to find several urban buildings among the 1982

competitors . . . However, we regret the lack of exceptional small-scale or multi-family housing projects. We also encourage submission of more renovation projects. Clearly, the existing building stock is one of the new frontiers for energy-conscious design." Enrichment of the urban fabric and reuse of existing structures were also major themes in a recent competition for the Beverly Hills Civic Center (overleaf) and a design awards program for office buildings sponsored by the Reliance Development Group (see page 75).

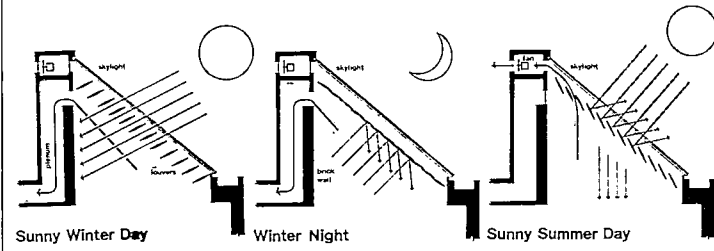
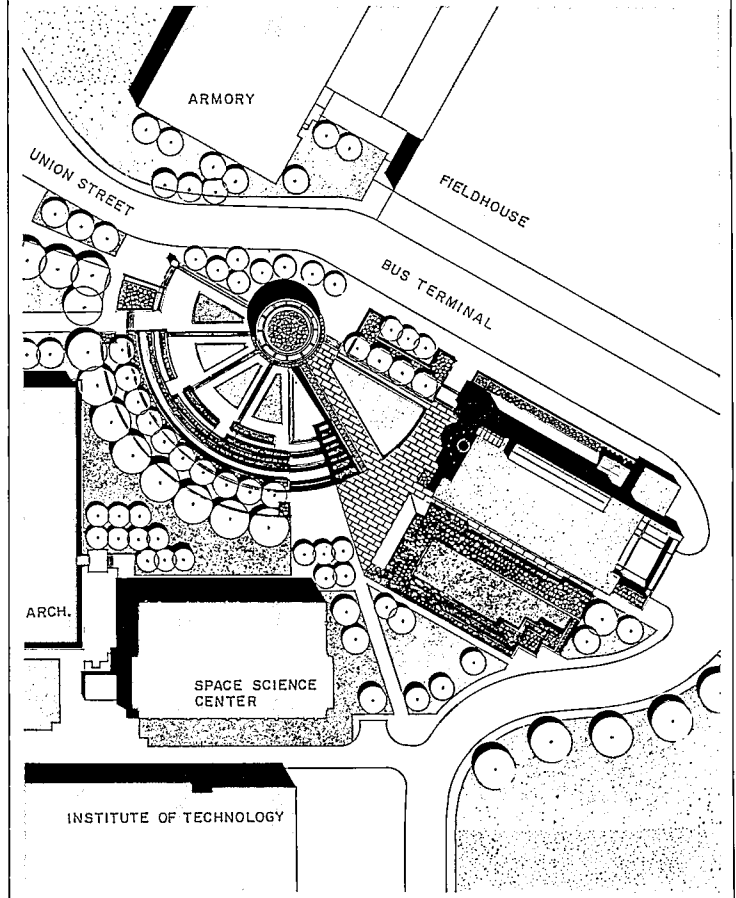
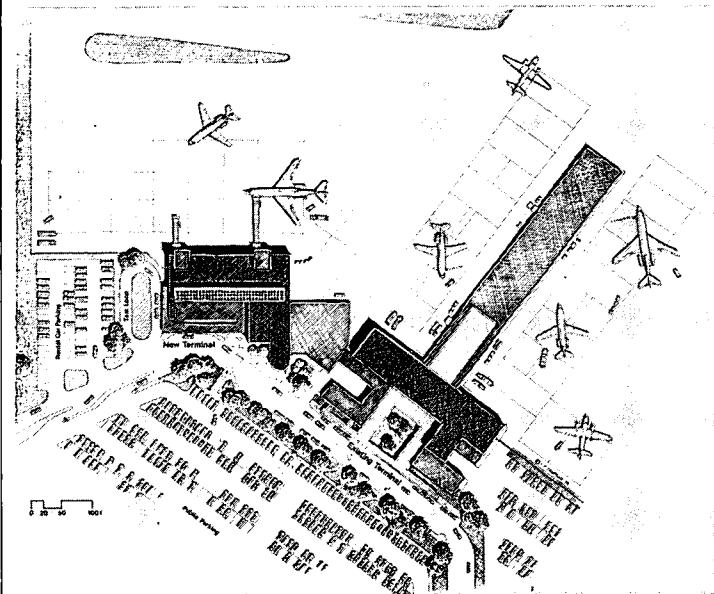
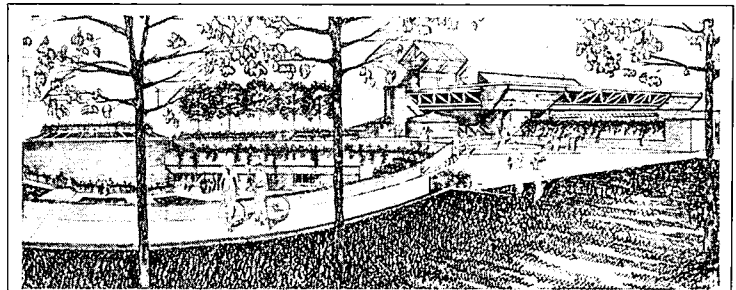
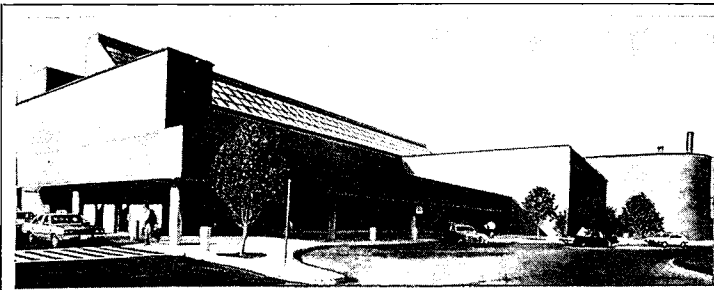

cooling towers. Condenser water preheats domestic hot water. A computerized energy and building management system governs equipment duty cycling, programmed start and stop, load shedding, and lighting control, and monitors equipment performance.

3. Albany County Airport Passenger Terminal, Colonie, New York; Einhorn Yaffee Prescott Krouner, P.C., Architects. "I have analyzed a number of other airport terminals and most of them are tremendous energy users," commented juror David Hartman. "The excellent design of this structure proves that you can have both an interesting and very practical airport terminal and at the same time achieve substantial energy savings." The new 57,000-square-foot building

uses 75 per cent less energy than the 1960 terminal to which it has been added, even though the structures are nearly identical in area. A 180-foot-long skylighted "solar court" supplies 40 per cent of the illumination and 20 per cent of the heat required by the south-facing facility. A mini-computer adjusts foam-insulated louvers to the most energy-efficient angle, and a masonry wall below the glass roof provides a direct-storage thermal mass and plenum (see diagrams). The effectiveness of these solar devices is augmented by coordination with an advanced VAV air distribution system, high-efficiency dual fuel boilers, and a 180-ton chiller. A multiple fan/VAV system with economizer cycle adapts to the fluctuating occupancy loads typical of airports.

4. Civil/Mineral Engineering Building, Minneapolis, Minnesota; BRW Architects. Perhaps the most innovative of the award-winning designs, in the jury's estimation, the \$12.9-million facility is 95 per cent underground. Having found a major aquifer on the site, the architects decided to exploit ground water as a cooling agent for computer systems in the building. Although the location of 94,500 square feet of program space immediately below grade follows established precedents, the mining of 48,000 square feet of laboratories in a sandstone and limestone cavern 110 feet down is quite unusual. Areas requiring exact temperature and light control occupy subterranean sections of the project, where they are artificially illuminated. Total energy usage is minimal,

however, owing to the employment of both passive and active solar systems. Windows clad with deciduous vines (for seasonal sun shading) face onto a sunken courtyard. Behind the windows is a water-filled Trombe wall that acts as a solar collector in the winter. A series of fresnel lenses in above-ground labs reflects daylight into a walkway two stories below grade. Another set of lenses and angled mirrors transmits light into the mined labs. A remote-view optical system based on the principle of the periscope creates the illusion of a three-dimensional vista from this cavelike space. One juror estimated that the construction cost of less than \$78 per square foot was only about 10 per cent above that of a conventional building with a similar program. *More design awards on page 72*

Design awards/competitions: Beverly Hills Civic Center Design Competition

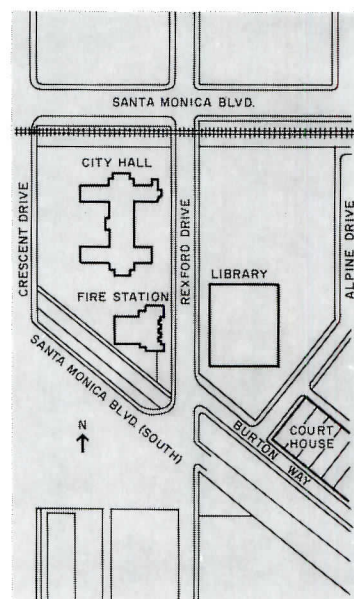
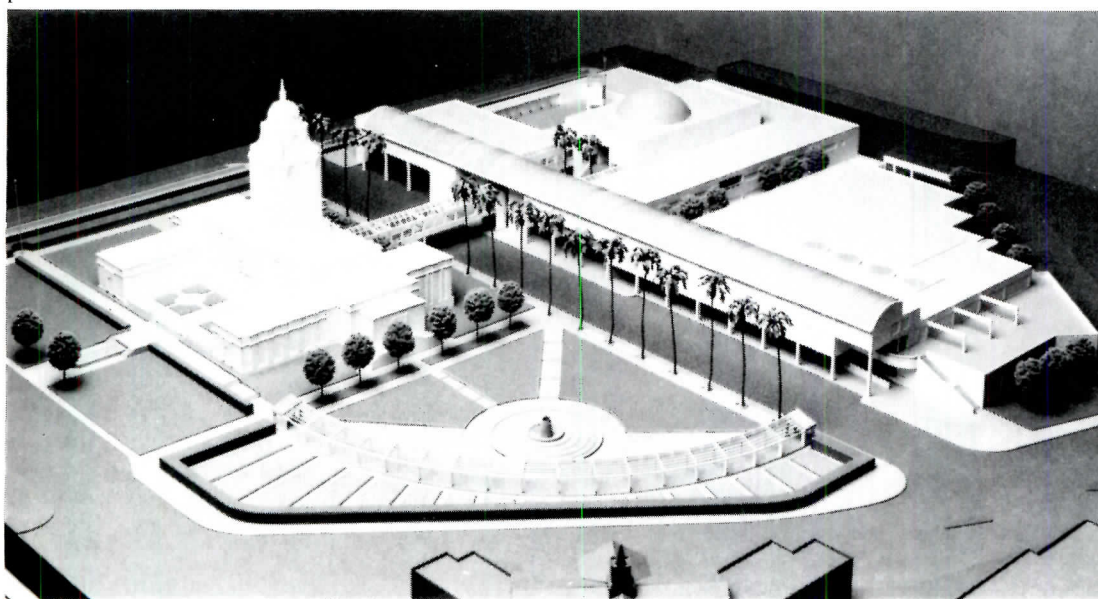
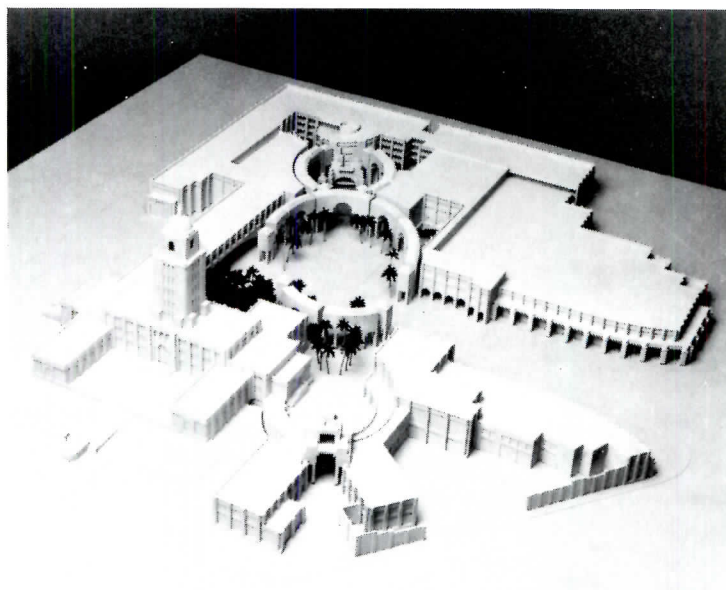
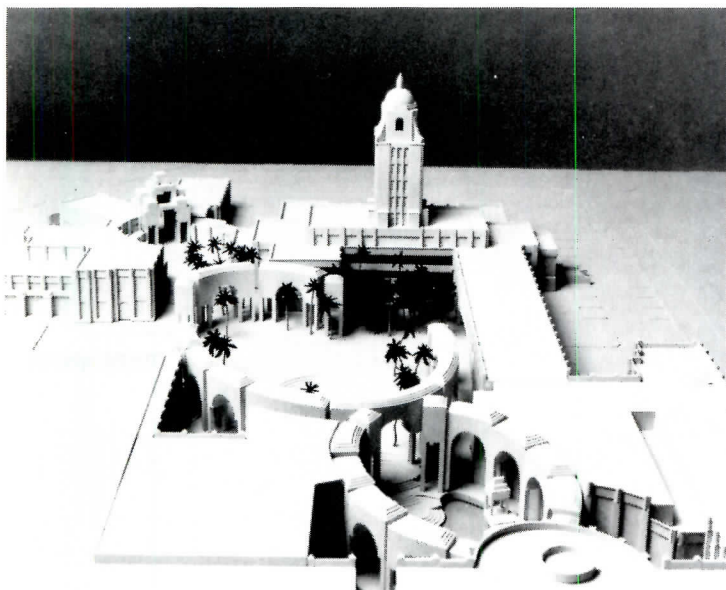

1. **Charles W. Moore, Architect (premiered design).** The jury lauded the winning scheme as “a brilliant and beautiful design which thoroughly addresses the specific issues at hand, and also assimilates what is best and most positive in urbanism and urban theory throughout the world today and advances its cause.” Jury comment focused on the continuation of Rexford Drive through the grandest of the three elliptical courts that organize the entire project. “The automobile, here so central to the life of the town, has been made to engage the architecture romantically and joyously and in a way that will be experienced by thousands of people each day.” The jury found the organization of pedestrian circulation within the parking structures to be this project’s weakest element, and

suggested that the central rotunda be adapted more effectively to automobile entry and drop-off. “Unlike some other submissions, this design does not treat the existing City Hall as an isolated and mummified object from some remote other culture, but considers it as part of a larger, still living, still vital organism. The scheme proposes a language of construction that will permit newly made buildings to reside directly proximate to the old one and for City Hall to assume a new role as the dominant vertical element in a far more significant complex.”

2. **Gwathmey Siegel & Associates, Architects.** Remarking on the uniqueness of this project in locating all new facilities east of Rexford Drive, the jury observed, “The overriding intent of this concept

is to minimize any competition between the new facilities and the beautiful City Hall On Rexford and South Santa Monica the sight lines [for passersby] are improved by the removal of the Fire Station building and its relocation at the northeast corner of the site. The architecture of the new facilities is reserved in character Their neutral presence is ordered by the long three-story building placed along Rexford acting as a backdrop to the existing City Hall. Public spaces other than the major garden are limited The minimal geometry of the garden makes the expanded park empty, arid, and vacuous. The garden is located where it would be least experienced by the users of the City Hall complex.”

3. **Moshe Safdie & Associates, Inc., Architects.** It was

generally agreed by the jury that this design represents “significant urbanism and that it creates a fine public space. There are, however, certain deficiencies, some growing out of the closure of Rexford Drive and the burden this places on the north-south perimeter streets Such alternatives as moving the cultural facility somewhat to the west and shortening the pool would weaken the scheme, for central to [it] are the grandiose proportions of the space. These enhance the baroque grandeur of City Hall. It seems appropriate to Beverly Hills, a city of large estates, that City Hall appear as a great house above the pool The exclusion of traffic from the heart of the Civic Center, while ideal from a pedestrian point of view, creates major conflicts of ingress and egress. Spiral ramps

Participants in the invited competition for the design of a Beverly Hills Civic Center were asked to address problems of orientation and relationships among new and old buildings rather than developing highly detailed proposals for individual structures. The program for the 10-acre site entails an addition to the existing City Hall and construction of a new police facility, fire headquarters, library, cultural resources center, and parking. In addition to the Spanish Baroque City Hall designed in 1932 by William Gage, the two-block area already comprises

the present fire department headquarters, a public library, and parking (site plan below). Models submitted by the six competitors are shown below. The winning design by Charles W. Moore was chosen unanimously by jurors M. Paul Friedberg, FASLA; Anthony J. Lumsden, FAIA; Esther McCoy, an architectural critic and historian; Daniel Solomon, FAIA; and Richard Saul Wurman, FAIA. Donald J. Stastny, AIA, AICP, served as professional advisor.

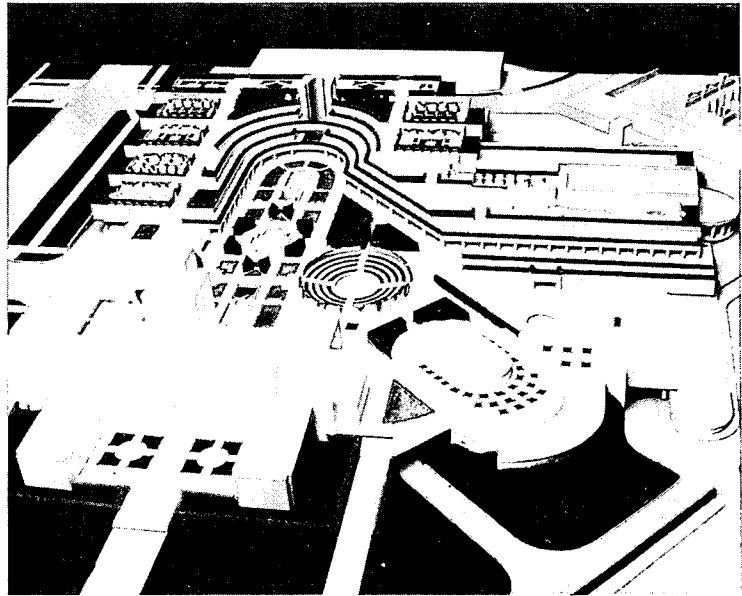
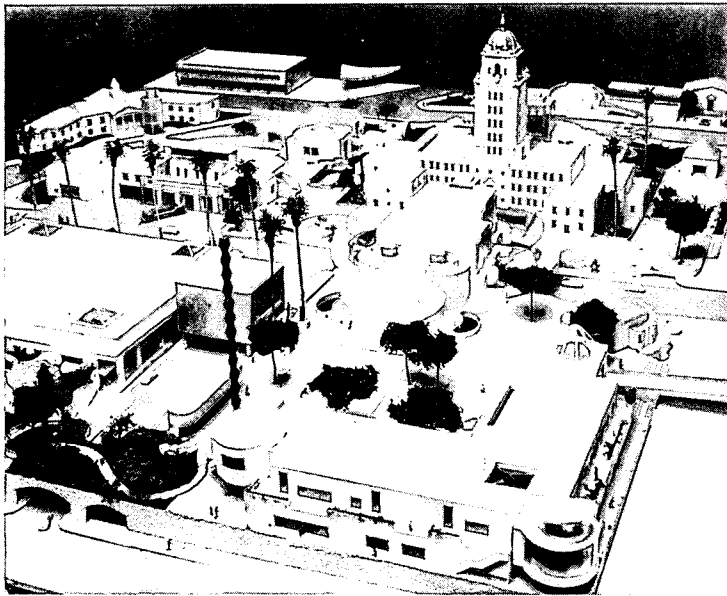
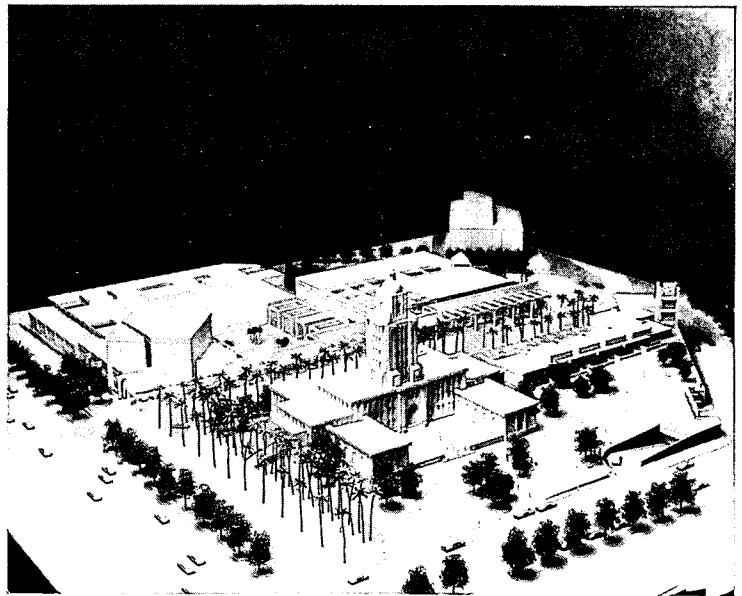
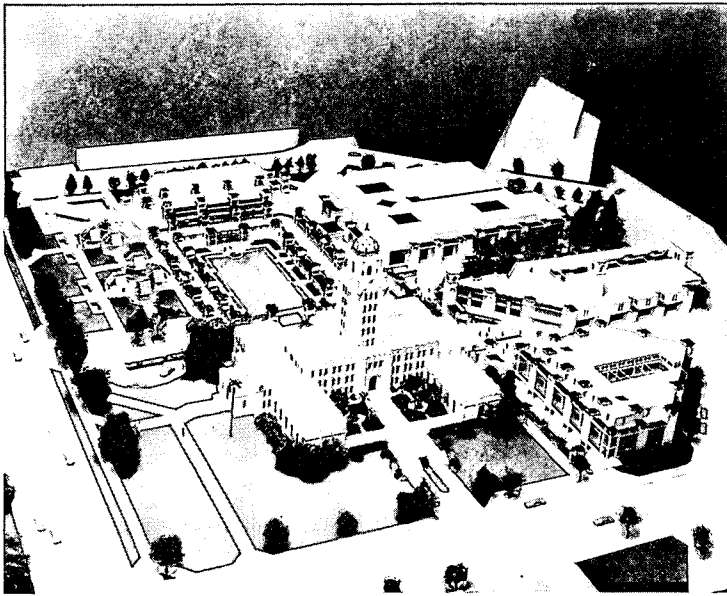

leading to high traffic streets would cause major backup during garage unloading at peak traffic periods. This could seriously offset the enjoyment of the garden."

4. Eisenman/Robertson, Architects. "A simple large colonnade paralleling Rexford neutralizes and screens a variety of program elements and presents a dignified facade complementing City Hall. Rexford becomes a ceremonial street for automobiles and pedestrians . . . This is the only concept that proposes an alternate use for the existing library. The police department is located in the existing library building near the courthouse. A new library is adjacent to the cultural facility, both sharing an outdoor court on axis with City Hall. A monumental stair would

act as amphitheater seating; this and the courtyard would allow City Hall to be a focal background to any event. The grouping of these cultural/public service elements on the site is excellent . . . Remodeling the library as a police facility would be difficult to phase. A new library would have to be built before the police facility modifications could be carried out . . . The jury found little merit, formally or programmatically in the rotated cube serving as the cultural center."

5. Frank O. Gehry & Associates, Inc., Architects. A varied assemblage of small structures contrasts with the monumental symmetry of City Hall. A baroque staircase, punctuated by small domed pavilions that echo the City Hall

cupola, rises to an open plaza. The jury commended the project's economical solutions to program requirements and circulation. "The major criticism of this concept was that it created a large space that was not grand, and that the tribute to the Spanish Steps did not make up for the loss by allusion . . . The spirit of the buildings [has] a counterpart in many of the art collections in the city, in the great variety of residential design in Beverly Hills, and in the unexpected nature of Los Angeles in general. However, most jurors felt that small images were out of place in an urban civic center."

6. Arthur Erickson Architects. This project closes off Rexford Drive and plants public gardens on the terraced rooftops of program buildings east of City

Hall. The jury admired the axial framing of City Hall and deemed the scale of Erickson's scheme "bold and appropriate." Nevertheless, the panel also observed that "the rigid geometries of its great gesture create a series of unresolved and probably unresolvable conflicts with elements of the program and circulation." The formal garden terraces "would be agreeable if a little surreal, but . . . they are so remote from workaday circulation that they would be little used . . . Underneath the grand geometries of the public gardens, parking, the library, and the police and fire facilities are fit with considerable awkwardness . . . Clarity of circulation within the buildings and from the parking has been sacrificed for the sake of the over-all form."

CHOOSE THE COLOR OF THE SKYLINE

Buchtal's architectural ceramics conjure images of striking, memorable facades... a new dimension to the skyline.

Frost-proof and unaffected by acid rain, Buchtal ceramics can open up imaginative design possibilities never previously thought of for exterior ceramics.

MONO-GLAZE offers a range of 30+ colors — each equally vibrant and color-fast with an absorption rate as low as .5%.

KERAION® ceramic panels from 1' x 1' to a giant 4' x 5', are only 3/8" thick for a lightweight, yet extremely dense facade skin.

UNGLAZED tiles were designed to resist the most bitter of climates and freeze-thaw conditions.

RUSTIC's earth-toned fireblends present an incredibly beautiful range of tones and hues.

All Buchtal ceramics are remarkably durable with surfaces as hard as that of cutting steel. As a result of superior bond strength and manufacturing technology, state-of-the-art ceramics are now a reality for exterior facades.

BUCHTAL USA

Shape a new world around you.

Architectural Ceramics
Suite 450

5780 Peachtree Dunwoody Road, N.E.

Atlanta, Georgia 30342

Telephone: (404) 256-0999

TWX: 810-751-8485

Circle 45 on inquiry card



TOP: ADP BUILDING; PITTSBURGH, PA ARCHITECT: WILLIAMS/TRIBELCOCK/WHITEHEAD
BOTTOM LEFT: RAINBOW CENTRE; BUFFALO, NY ARCHITECT: D. I. ARCHITECTURAL, INC.
BOTTOM RIGHT: KKB&A OFFICE BLDG; DENVER, CO ARCHITECT: BARKER-RINKER-SEACAT
Refer to Sweets 9.18/BU.

Design awards/competitions: Reliance Development Group Awards for Distinguished Architecture

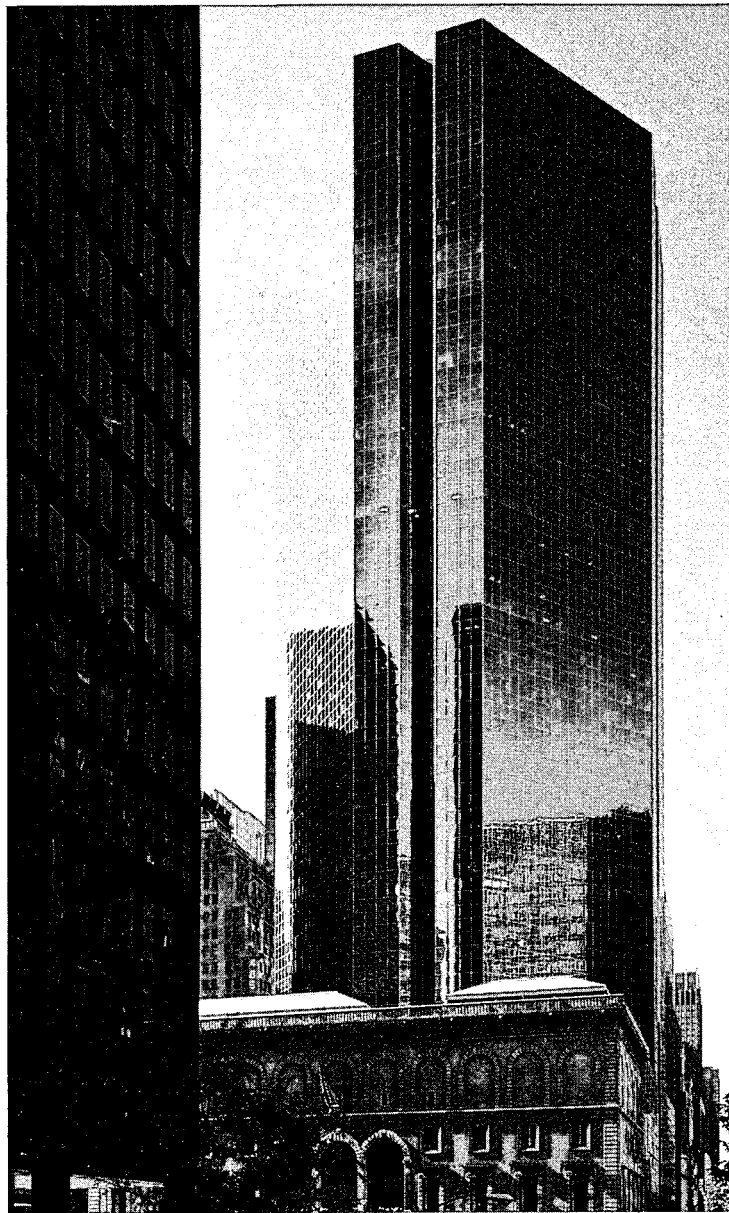

1
The Reliance Development Group has presented \$30,000 to both of the design teams receiving top honors in the firm's second annual awards program for office building design (Figures 1 and 2). In addition to Henry Lambert, president of Reliance, the jury consisted of A. Eugene Kohn, AIA; William J. LeMessurier, P.E.; Marvin W. Redeker, director of real estate for Amoco Realty; Mildred F. Schmertz, FAIA, executive editor of ARCHITECTURAL RECORD; Denise Scott Brown, APA; and Thomas R. Vreeland, FAIA.

1. **Park Avenue Plaza, New York, New York;** Skidmore, Owings & Merrill, Architects (First Award, Investment Building Category). Rising behind the neo-Renaissance masonry facades of McKim, Mead and White's Racquet Club,

the green solar glass curtain walls of Park Avenue Plaza enclose 41 office floors, a three-story interior plaza, and a shopping arcade running the depth of a city block. Air rights transferred from the landmark club enabled the new high rise to have a volume of one million square feet, although chamfered corners and notched sides reduce its apparent bulk. The jury commented, "Immense as it is, the building is almost a quiet presence, a background to the club, Lever House in the next block, and the Seagram Building across the street."

2. **Chicago Board of Trade Addition, Chicago, Illinois;** Murphy/Jahn/Shaw, Swanke, Hayden, Connell Joint Venture, Architects (First Award, Institutional Building). The \$45-million structure adds 584,000

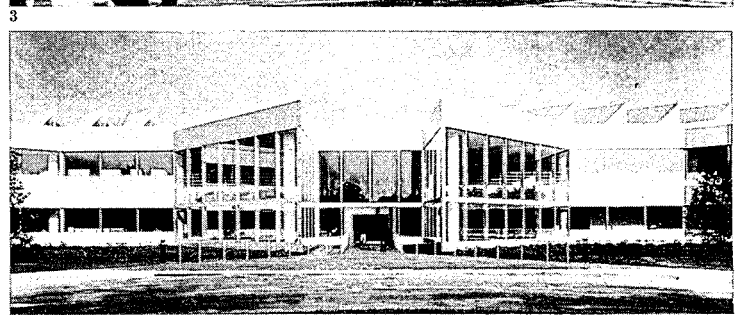
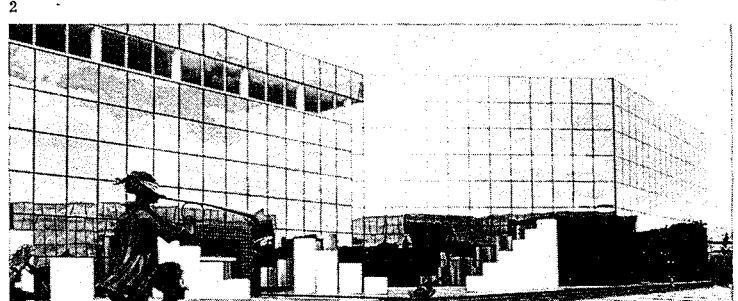

square feet of trading floors to an existing Art Deco tower, as well as furnishing support spaces and offices. Mounted above 12 stories of large bulk spaces, an energy-efficient skylighted atrium provides the focus for another 12 floors of offices. The massing and fenestration of glass and limestone facades constitute an abstract replication of the original Board of Trade.

3. **Harlequin Plaza, Engelwood, Colorado;** Gensler and Associates, Architects; The SWA Group, Landscape Architects (Special Citation). This 357,000-square-foot complex comprises two low-rise buildings situated in a suburban office park. In order to evoke a sense of urbanity in the midst of an 18-acre site with parking space for 1,020 cars, Gensler and SWA deployed the two office structures as framing

devices for a plaza. Cooling towers, flues, and ducts from below-grade mechanical systems penetrate the checkerboard plaza to pose sculptural silhouettes against mirrored glass walls.

4. **Philip Morris U.S.A. Operations Center, Richmond, Virginia;** Davis, Brody & Associates, Architects (Special Citation). The 570,000-square-foot structure accommodates a broad range of functions: administrative and engineering offices, research labs, a pilot plant, a cafeteria, conference rooms, and other support areas. A skylighted atrium follows the diagonal axis of two square building masses and joins them to the pilot plant. By locating most circulation along outside walls, Davis Brody have given daylight and campus views to all Philip Morris staff.

ELIMINATE COSTLY "SPRAY-ON" FIREPROOFING

New Raceway Fire-Rated Aftersets Save Hundreds of Thousands of Dollars
By Eliminating Fireproofing of Series 900 Decks... Substantially Reduce
Fireproofing on Series 700 and 800 Decks.

- Fire protection no matter what deck is specified
- Installs faster with fewer steps and parts
- No price penalty compared to conventional afterset and fittings
- Fully adjustable—no additional parts required
- Eliminate secondary drilling

Raceway's new Fire-Rated Afterset eliminates fireproof spraying under a Series 900 Cellular Deck. In Series 700 and 800 Decks it typically reduces "spray-on" to a minimal $\frac{3}{8}$ ". Since the blend ratios are usually at least 60% cellular to 40% non-cellular, more than half the building is thus relieved of the enormous cost burden of a heavy "spray-on" coating.

FIRE-RATED AFTERSETS ARE MUCH MORE ECONOMICAL AND VERSATILE THAN PRESETS

Until now, the only way to reduce "spray-on" in Series 700 and 800 Decks was to install fire-rated preset inserts in a rigidly aligned, modular configuration. Few deck manufacturers offer this alternative which is limiting, *since the savings earned from reduced "spray-on" are consumed by numerous unused inserts.* The Open Office Plan, with its random placement of work stations, increases the number of unused inserts to the point of counterproductivity—especially where

a single baseboard in a partition services several work stations.

The Raceway Fire-Rated Afterset requires you to pay only for the few activated locations. It frees you from the constraint of limited options. The designer may now consider virtually any brand of deck as capable of activation without penalty. Difficult field installation problems are eliminated or minimized. The building process is simplified, improved and speeded. Learn more about this important development from Raceway, the acknowledged leader in through-floor penetration technology.

Write:—

Raceway Components, Inc.,
263 Hillside Avenue, Nutley, N.J. 07110
Or call:—800-RACEWAY
(800) 722-3929.

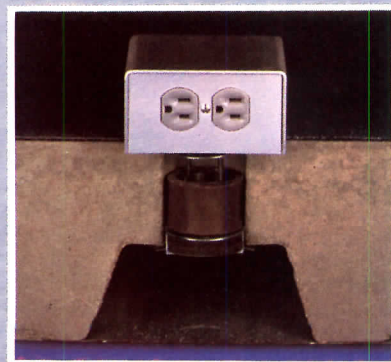

U.L. Classified and Rated Mfg. I.B.E.W.



RACEWAY COMPONENTS, INC.

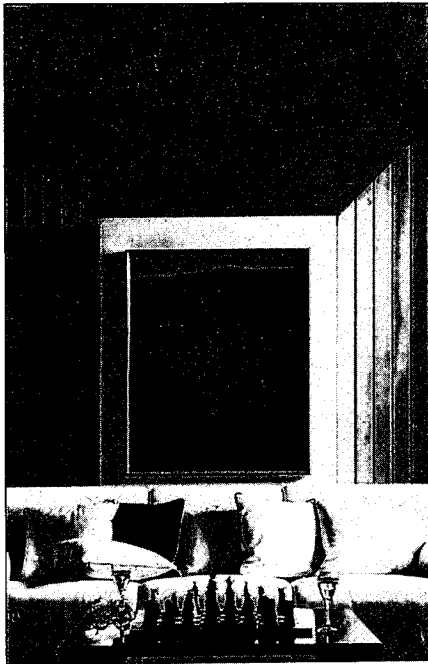

A little bit of Europe comes to America.

Now you can experience the natural beauty of Europe's most popular solid wood ceiling and wall system here in America. Wood this clear in lengths this long—to 20 feet—is worth the investment.

Profilewood is only available in the clearest grades of California redwood, Western red cedar, Western hemlock, Douglas fir and Sitka spruce. And it's only available from Ostermann & Scheiwe, U.S.A.

Send for free information. Or send \$5 for a Profilewood Specifier Kit

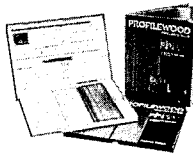

PROFILEWOOD Solid Wood Ceiling and Wall System

- Please send free Profilewood literature.
 - Please send Profilewood specifier kit including panel samples. I have enclosed \$5.00.
 - Please have a sales representative call.
- Name _____
 Company _____
 Address _____
 City _____ State _____ Zip _____

Ostermann & Scheiwe USA.
 P.O. Box 668, Spanaway, WA 98387

Circle 48 on inquiry card

Books continued from page 77

- The central tenet of mannerist theory was that "the judgment of the eye... elevated the judgment of the artist above all other criteria for excellence." This is the 16th-century version of "form is everything."
- Complexity, variety and novelty were also "worthy of goals of the artist..."
- And these and the other aspects of mannerist theory were immortalized in a prolific written output by the artists of the period in their efforts to both publicize themselves and establish their claim to intellectual leadership in their art.

But to use mannerism as a pejorative parallel—as Safdie does—overlooks some important facts. Mannerism was the esthetic vocabulary explored not only by mediocre artists and architects remembered now by only a handful of art historians. Among those breaking with the excessive rationalism of the High Renaissance were such major figures as El Greco and Michelangelo.

Safdie's favorite target is Robert Venturi. Venturi, however, is a more careful writer than Safdie. In his recent Gropius Lecture at Harvard, the latter sums up his own review of post-modernism in a more balanced way. "It is too easy to hate our fathers in attempting to transcend them. In so doing we find refuge once again from a complex and contradictory world in simple formulas for our work and simple dogmas for our philosophy." In contrast, Safdie's caricatures of Venturi's views do not add credence to the basic strength of his main themes. Based on other conversations with Moshe, I know that part of his problem with Venturi is the fact that he (Safdie) cannot separate his reactions to Venturi's built architecture from his response to Venturi's theory. In spite of the profession's and the press's current fascination with paper architecture, this confusion of some people's written and built work is an understandable and common problem for practicing architects such as Safdie. Over-all, his main themes, and his passionate presentation of them, overcome the uneasiness caused by his occasional lapses in judgment, research or understanding. It is important to have a major figure—and particularly a major academic figure (Safdie is director of the Urban Design Program at Harvard)—reminding us that architecture has a purpose within which art—however it is defined—is only a part. Architecture is not just the currently fashionable theory or just beach houses for mom. Architecture is something more important that should transcend the fashion of the moment. Thus, it is valuable to get a dose of the old-time religion, that architects do have an important role in shaping a more livable environment.

Telephone 617 492-4000
 Telex 951650

14 Story Street
 Cambridge, Massachusetts 02138

Kroin Architectural Complements

Anchors and ganging clamps insure configuration integrity and deter vandalism when moveable seating is grouped in sequence.

Mobil is part of a series of Park and Garden Furniture, manufactured in synthetic coated tubular steel and wire mesh, available exclusively from Kroin.

Circle 8 on inquiry card

Mobil stationary and moveable outdoor seating is unique in its ability to conform to sharp angles and uneven topography. Unlimited seating arrangements facing inside or out are possible by altering the sequence of the three modules offered in this system. Simultaneous back-to-back seating is possible through the use of 2-sided Seat Bowls.

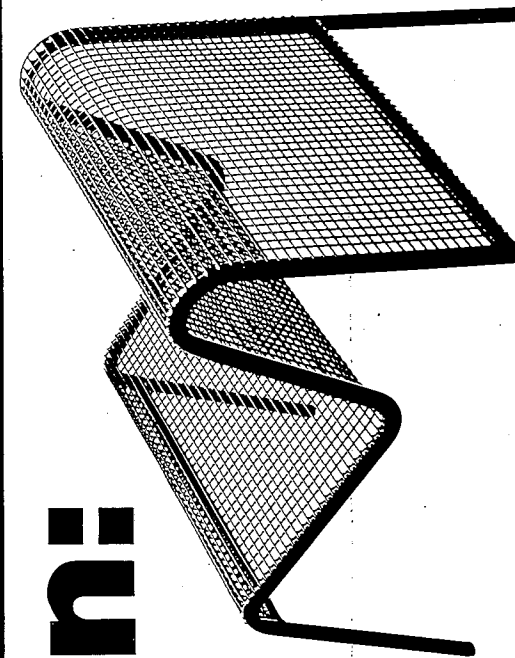

Kroin

**New
USG[®]
Acoustical-Plus
spray
texture
absorbs
sound,
resists fire.**



Another U.S.G. first! A multi-function spray texture finish, specially-formulated to meet today's concrete ceiling needs ... *old or new!* New USG[®] Acoustical-Plus Spray Texture is in a class by itself. Sound-rated .40 at 1/2" thickness. Class A Flame Spread rating. And an aesthetically pleasing difference in appearance. You'll find USG[®] Acoustical-Plus Texture elegantly suited for commercial, institutional, high rise apartments and retrofit construction.

- *Call your U.S.G. Representative. Or write to us at 101 S. Wacker Dr., Chicago, IL 60606, Dept. AR183.*

UNITED STATES GYPSUM
BUILDING AMERICA

©1982 United States Gypsum

Circle 49 on inquiry card

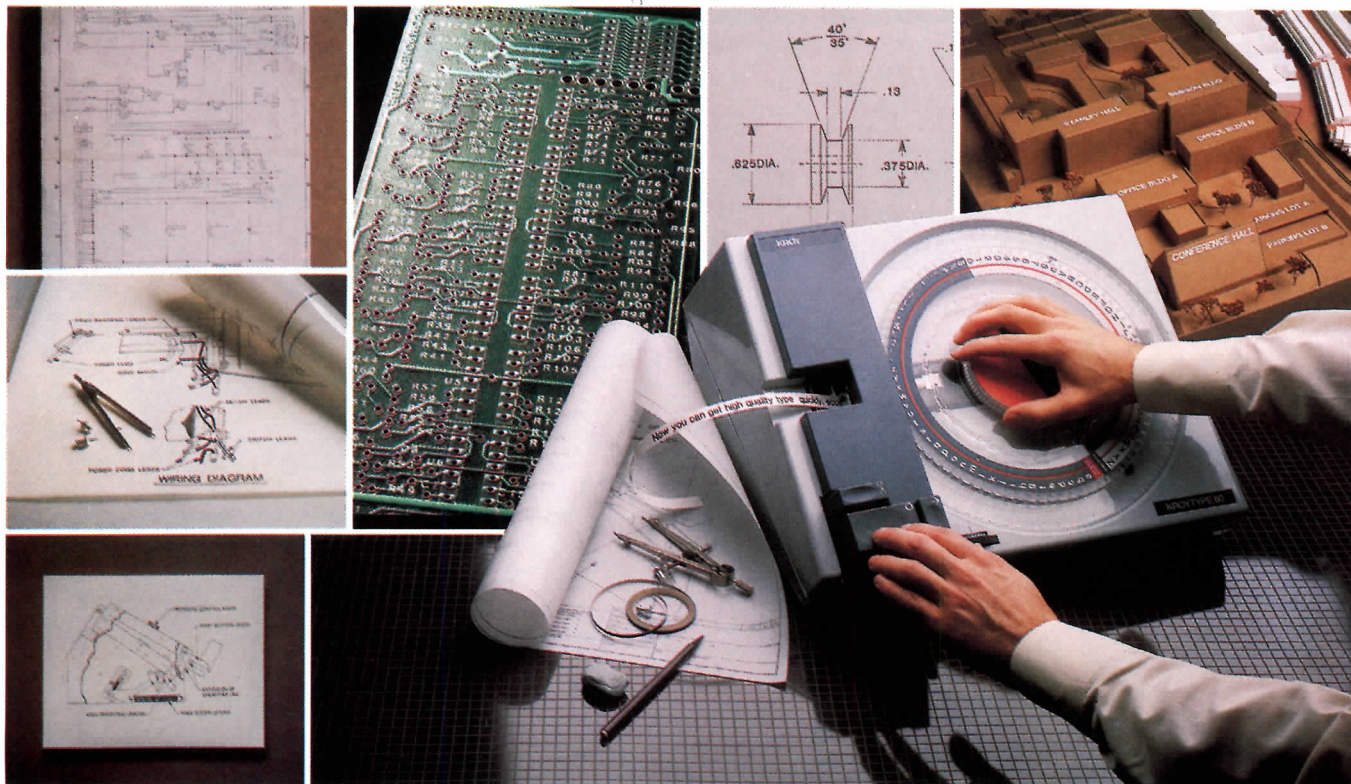

Now there's a fast, easy, economical way to get lettering that meets the same high specifications as your drawings.

Most architects and engineers are perfectionists. They're simply not satisfied with any project until every detail is just right—including the lettering.

Until recently, this attention to detail meant painstaking hours using press-on or mechanical drafting lettering. Or perhaps even hand lettering your drawings, presentations, finished models, and preliminary designs.

Now there's a much faster, easier way to get the professional lettering look you want. It's the remarkable Kroy® lettering system.

Kroy lettering is a unique, patented process that prints Type-on-Tape™. Simply turn the typedisc to the letter, number, or symbol you want and press the print button. You'll get neatly spaced, good looking lettering on adhesive-backed tape. Peel the



tape from its backing, and it's ready to position in place.

Kroy lettering comes in 25 different typestyles, (including Microgramma and Helvetica), and a wide range of sizes from 8-point to 192-point (1/16 to 2 inches). Typestyles

and sizes depend on which Kroy lettering machine model is used.

There are four types of specialized Kroy lettering supplies. Kroy 100 provides sharp edgeline definition (at up to 200% enlargement) for photo reproduction.

Kroy 200 Diazo minimizes ghosting, or shadow, during diazo reproduction.

Kroy 300 Labeling and Kroy 400 All-Purpose are suited to a wide variety of lettering projects. Like all Kroy lettering tape, they adhere quickly and easily to virtually any clean, dry surface—even photographs and negatives.

There are five Kroy lettering machine models currently available, including the deluxe Kroy 80® lettering machine pictured here.

Call toll-free 1-800-328-1306 for a free sample of Kroy lettering.

Find out why architects and engineers all over the country are using Kroy lettering in place of slower, more expensive lettering methods.

Call toll-free, 1-800-328-1306. (In Minnesota, please phone 612-738-6100.) If you prefer, complete and return the coupon.

We'll send you a free sample of Kroy lettering, and a copy of our latest, full-color brochure. Or, we can

arrange for a no-cost, no-obligation demonstration of the Kroy lettering system right in your office. Call or mail the coupon today.

Kroy®, Kroy 80® and Type-on-Tape™ are registered trademarks of Kroy Inc.
Headline set with Kroy® lettering.

KROY

Free sample of Kroy® lettering and full-color brochure.

- Please arrange to have a representative call on me for a no-cost, no-obligation demonstration of the Kroy lettering system.
- Please send me a free sample of Kroy lettering, and a copy of your latest brochure.

Name _____ (please print)

Title _____

Company _____

Address _____

City _____ State _____ Zip _____

In order to complete your request we must have your telephone number.

Area Code/Number _____ / _____

Complete this coupon and mail to Kroy Inc., Post Office Box 43716, St. Paul, Minnesota 55164

1827

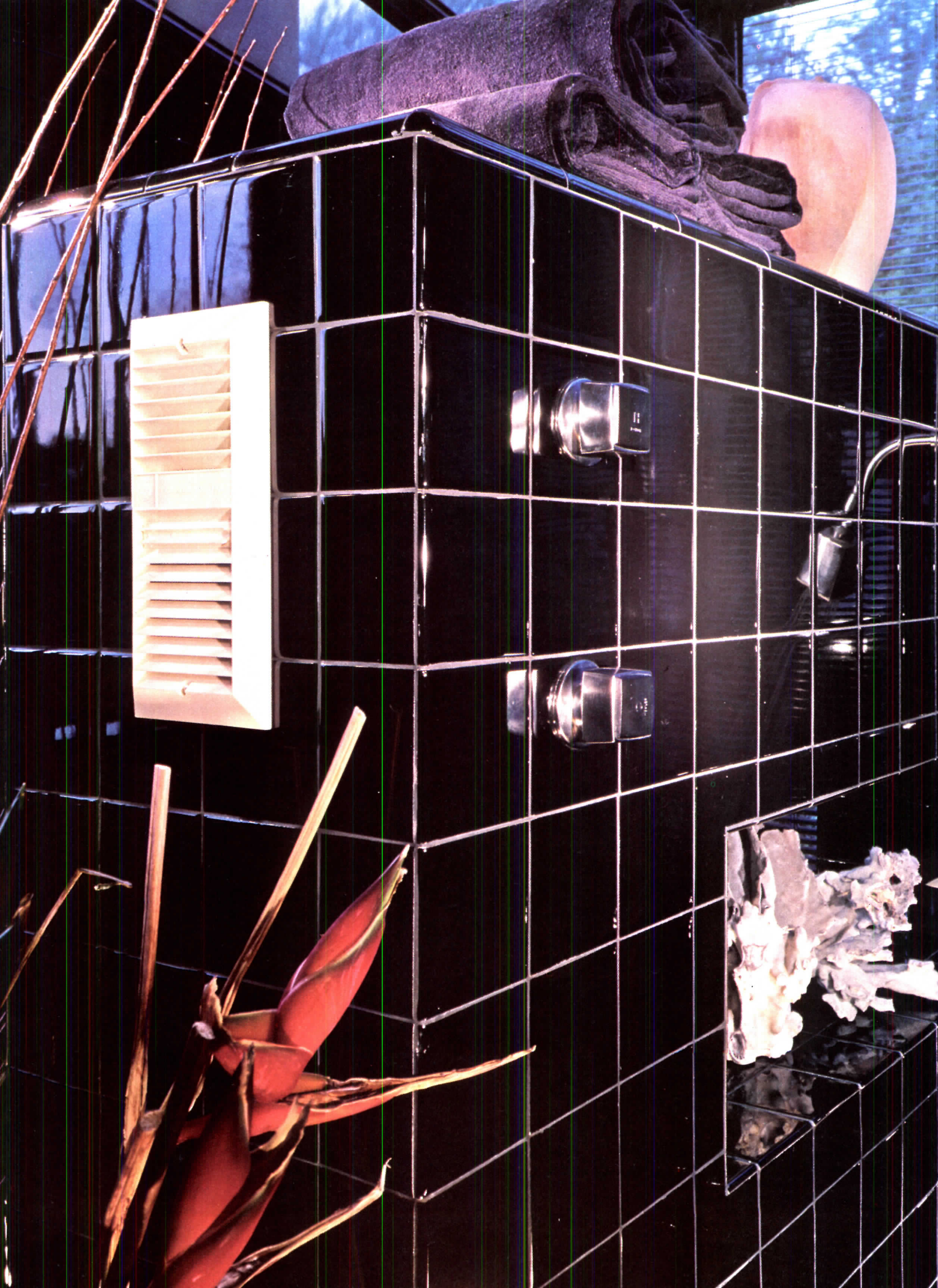

Corporate images

“For a long time, too many architects have been foisting on the public, and too many manufacturers have been producing for the public, a sort of anonymous esthetic. . . . We dream up efficient-looking, modern-looking offices and the staff brings in endless plants and miles of macramé to try to ‘humanize’ it.” There’s generally at least a shard of truth in architect Robert A.M. Stern’s hyperbole. And his reflective words at last year’s RECORD Interiors Round Table (mid-February 1982, pages 95-100) rang true to many of us; especially those of us who work in “efficient-looking, modern-looking offices.” But Mr. Stern, as others, will take happy note of the fact that the times, they are a changin’. (And since from nine to five, from Monday to Friday, approximately 45 per cent of the total employed work force may be found in an office, the times, they are a changin’ none too soon, for none too few.)

According to the four design firms whose work is featured in this portfolio, “modern,” “efficient,” and “anonymous” need not be inextricably bound: The last can be (and has been) neatly chiselled away without adverse effect on the former. Or as Stephen Lesser, of Rivkin/Weisman Architects, suggests (paraphrasing Gertrude Stein), “There is a there there.” The “there there” *here* includes Rivkin/Weisman Architects’ offices for Dubai Bank Limited, Penney & Bernstein’s offices for Landor Associates, John Chimera Architect’s offices for Cooper & Company, and the Croxton Collaborative’s renovation and restoration of Shreve & Lamb’s R.J. Reynolds Tobacco Company headquarters. Each has been designed—nay, fine tuned—to the esthetic requirements of their clients; yet none require macramé for humanization.

There are no lines at Dubai Bank Limited. In fact, the receptionist complains of loneliness. But before rushing to open an account, know you can't cash a \$10 check, make payment on a Visa charge, or apply for a new car loan. It's not that kind of branch bank. The "home office" is in a sheikdom of the Trucial Oman on the east coast of the Arabian Peninsula. One might infer as much, simply stepping off the elevator (photo right). First National was never like this.

We expect a certain level of richness in a bank that bears the name of a sheikdom—even if the bank is a "trading arm" in stocks and securities extended 8,365 miles to the 21st floor of a midtown Manhattan office tower. Indeed, we expect a *high* level of richness. Though Rivkin/Weisman Architects did not hesitate to satisfy our collective expectations, neither did they hesitate to include "medium" and "low" levels of richness, along with "high." And though this 9,000-square-foot bastion of international finance is by all but the most elite standards consistently *luxe*, the young New York firm makes a persuasive argument for graduated levels of richness: it's a matter of degree, and it's a question of appropriateness. Which is to suggest there are places that asked to be grand (entry), places that asked to be not so grand (reception/conference), and places that asked to be not grand at all (office). Rivkin/Weisman listened; then effectively doled out color, material, texture, and form—i.e., richness—relative to request.

Our perception of precisely which place got how much of what, and why, is manipulated by a rigorous plan that isolates the bank's three programmatic requirements (entry, reception/conference, office) in three progressively larger and more discrete rectangles (plan page 88). Such resolute segregation ensures autonomy for each, which ensures that passage from entry to reception/conference to office, from small rectangle to medium rectangle to large rectangle, from semipublic to semiprivate to private, and from grand to not so grand to not grand at all does not go unnoticed. By pulling apart the main elements of the plan, each element is rendered more distinct. And because the edges are strong, the pools of richness do not leak.

But a diagram, regardless of how disciplined, merely assists in presenting an *articulate* design statement: for eloquence, the ultimate measure of success, one looks to vocabulary and delivery. The view supplied by Rivkin/Weisman is compelling, whether from the entry (photo right), where a luxurious *aver verde* marble runway terminates in a shimmering etched glass logo grandly framed by overscale arches and an aedicula, from the reception/conference (photos overleaf), where a humble hollow-metal framing system has been elevated to ornamental high-tech *shoji* screen wrapping and layering the three rooms, or from the office (photos pages 90-91), where the building's structural system is so engaged and exploited as to, if not *discreetly* decorate, at least modulate the essentially open office plan. While a pink and green palette, classical references, a conspicuous interest in surface embellishment . . . do not allow us to take exception to project architect Stephen Lesser's evaluation—"We are influenced by the times . . . our eyes are, our tastes are, our judgments are"—Rivkin/Weisman's adroit handling of the *de rigueur* might at least allow one to add, "Influenced, but not intoxicated."





The white porcelain enamel panels of the arches and aedicula ushering visitors along the marble entry corridor from elevator to receptionist (photo below left) were specified for their durability, glassine finish, and hard acoustical properties—each considered appropriate to an entry corridor shared with a subtenant, emphasizing the publicness of the entry. One is intended to feel, if not

quite “outside,” at least not yet “inside.” Assisting the sensation—and also the outside-looking-in perception—are the stepped pilasters (“buttress-like,” according to project architect Lesser) punctuating and visually enriching the hollow metal framing system which encloses the reception/conference rooms (axonometric below). The north wall of the shoji-like grid is infilled with metal

panels because the adjacent corridor is legally “public,” and thus necessarily “rated.” If the bank should reclaim its subleased space, the opaque panels could be popped out and replaced with milky translucent glass, as on the south “interior” corridor-facing wall (photo below right). If that time should come, the enclosure “would glow like Mies’s IIT building,” anticipates Lesser. Implicit in the

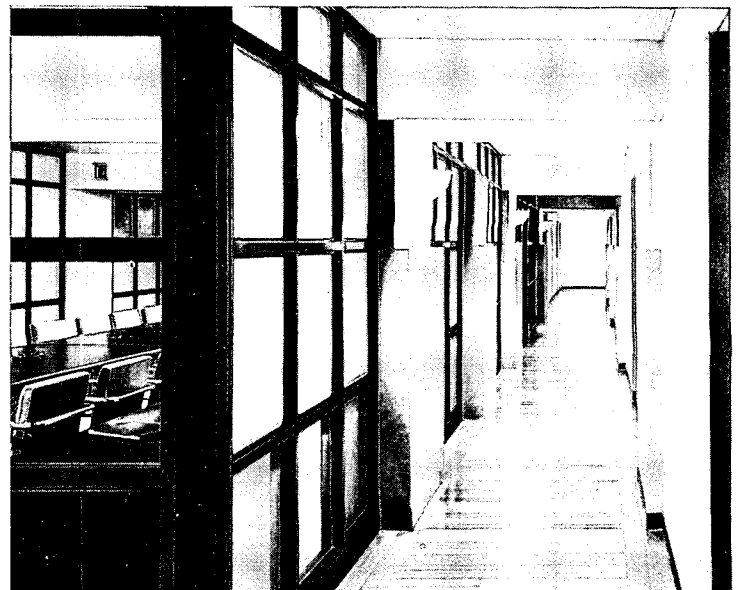
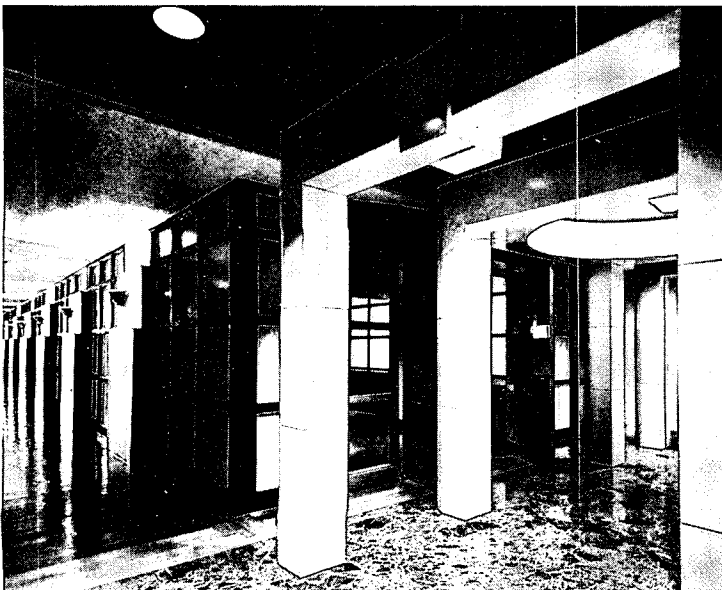
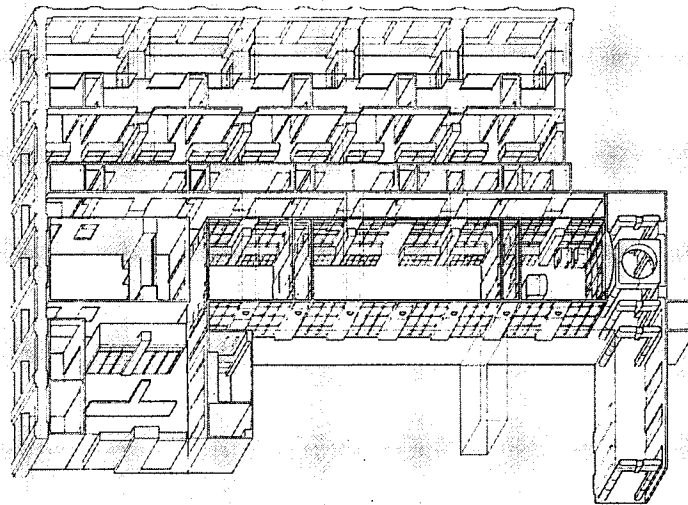
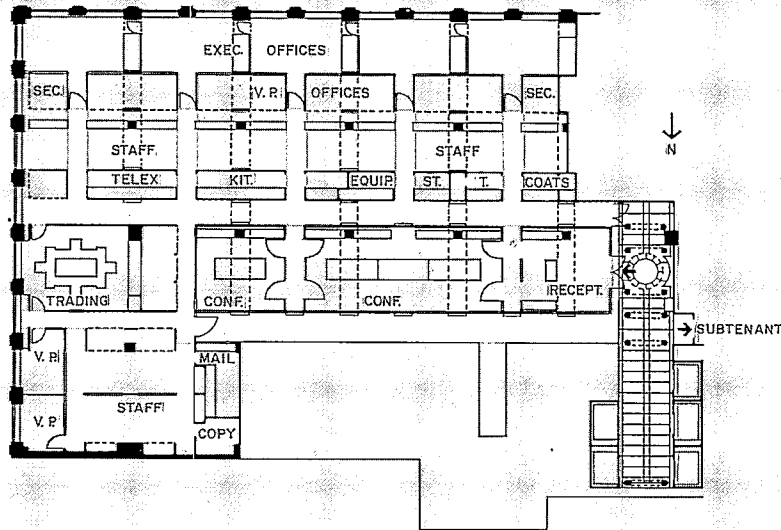

materials and motifs of the reception/conference enclosure—the second level of richness—is Rivkin/Weisman's analogue to a "building"—the buttress-like pilasters, the hollow-metal-frame curtain wall, the "front door," the outside-looking-in character... the enclosure as distinct, clearly defined volumetric object. Although the architects admit the analogy is "lost on the client," it's

unimportant. The "interior" of the "building," however, is. The metal grid re-emerges as lateral room partition (dividing reception from large conference from small conference), clear-glazed for an enticing perspective (photo below).



"A staff should not have to deal with a dense, strongly-marked image," argues Rivkin/Weisman project architect Stephen Lesser; consequently, the work area of the bank is intended as a relatively "neutral" environment. Unlike the entry (page 87), where classical references, deep colors, and expensive materials provide a "high" level of richness, or the reception/conference (page 89),

where a muted palette, not-quite-so-conspicuously expensive materials, but highly-variegated surfaces provide a "medium" level of richness, the office area offers modest pastels and sheetrock for a "low" level of richness. To avoid the "sea of furniture" effect in the essentially open-office area, however, the building's structural system has been engaged: dropped soffits, encasing hvac and

mechanical systems, wrap structural beams to divide the work area into bays, and to relieve the otherwise smooth acoustical tile ceiling plane; Australian oak crosswalks supply further punctuation within each bay. The bank's corporate hierarchy is reflected in the degree of enclosure and material finish accorded each work station: Level A (photo top left) claims the window wall, full

height (though partially glazed) partitions, and marble top desks; Level B (photo middle left), partial enclosure and light oak desks; and Level C (photo bottom left), no enclosure and plastic laminate-finished desks.

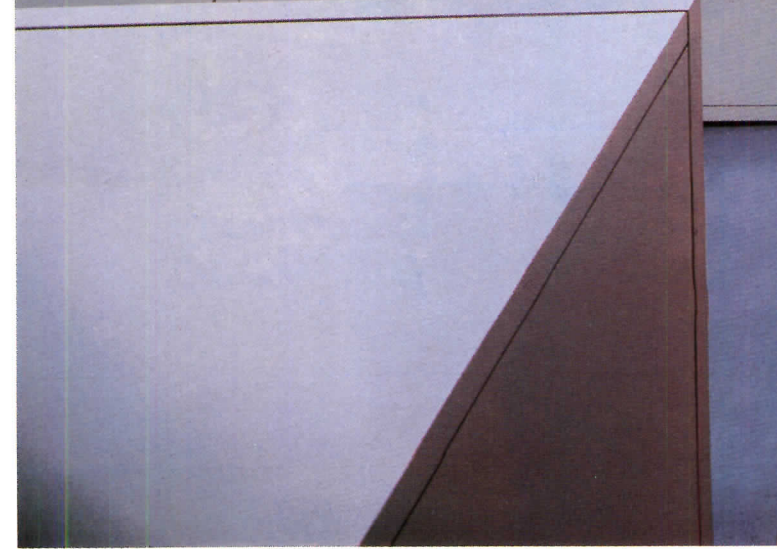
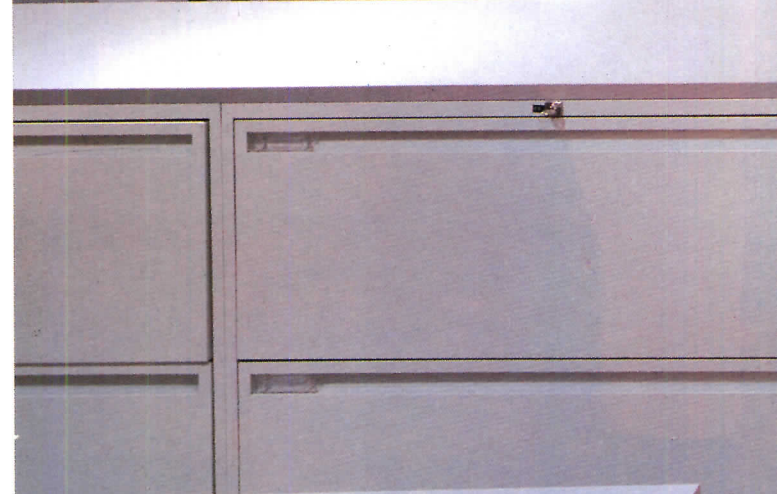

*Offices for Dubai Bank Limited
New York, New York*

Owner:
Dubai Bank Limited

Architects:
*Rivkin/Weisman Architects—
William Rivkin, Hugh Weisman,
Stephen Lesser, Jonathan Stark,
Kathy Kling, project team*

Engineers:
*Jose Honrado (mechanical); Jaros,
Baum and Bolles (consulting)*

Consultant:
Laurie Rolfe (interiors)
General contractor:
Rudin Management Company, Inc.

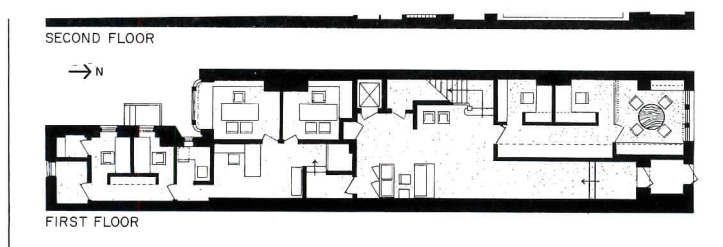

A smooth blend

R.J. Reynolds Tobacco Company
Winston-Salem, North Carolina
Restoration/renovation architects:
Croxtton Collaborative,
Architects of original building:
Shreve & Lamb

In 1929, the R.J. Reynolds Tobacco Company set the nickel-silver revolving doors of its new corporate headquarters in motion, and the good ol' boys along Main Street had reason to sit up and take notice. The sky over Winston-Salem, North Carolina, was ablaze with floodlights aimed on the setbacks of the "tallest building in the Southeast." Architects Shreve & Lamb returned to New York, and began work on The Empire State Building.

Fifty years later, the revolving doors were not turning so smoothly; the lights up above had been extinguished. But rather than sit back and watch while the grand dowager faded, Reynolds commissioned New York architect Randy Croxtton to restore Shreve & Lamb's legacy to its original splendor. And then some.

Croxtton's program called for a range of repairs to the exterior (not least of which was turning the lights back on the setbacks) and an almost pure restoration of the sadly deteriorated elevator corridor; the revolving doors were disassembled, rebuilt, and reinstated; the materials, patterns, and details of the crumbling floor were scrupulously reproduced; a forties handrail was replaced with a more "sympathetic" design; a fifties elevator control panel was removed and the marble patched; and "original" light fixtures recreated to match those either lost or broken. And since Reynolds' goal was to spruce up the company store, so to speak, four commercial tenants were relieved of their leases and the resultant 4,500 square feet of space annexed to the restored elevator lobby as "Exhibition Hall" (to the south) and "Main Hall" (to the north). The tobacco company saw the additional rooms as an opportunity to share with the public Reynolds' (particularly rich) history, the history of Reynolds' building, the history of tobacco, the history of Deco architecture, and the history of cigarette advertising. The various histories are deployed around both halls by means of backlit panels encased in the marble walls. Tobacco, and tobacco's history, is also the theme of an extraordinary gold-leaf mural and carved-glass panels.

Although architect Croxtton refers to the Exhibition and Main halls as "sympathetic" but "modest" extensions of the original "fabric" supplied by Shreve & Lamb, the graceful flares of the elegant Deco-esque columns, the zigzag coffers of the plaster ceilings, the rotated grid of the terrazzo and marble floors . . . will still give the good ol' boys along Main Street reason to sit up and take notice.

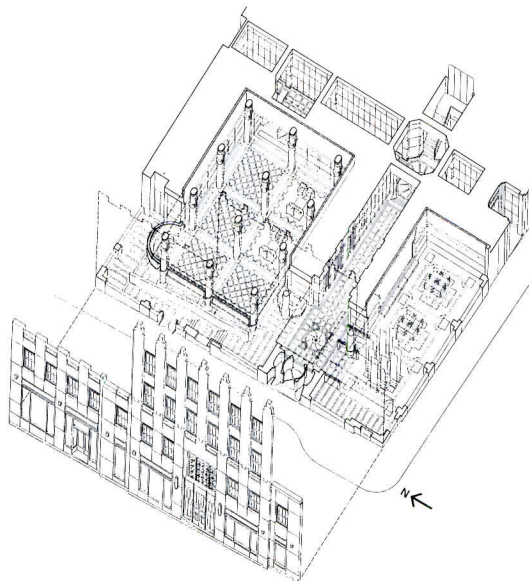

R.J. Reynolds Tobacco Company Building (restoration/renovation of ground floor lobby and ground level building exterior) Winston-Salem, North Carolina

Owner:

R.J. Reynolds Tobacco Company

Original architects:

Shreve & Lamb

Restoration/renovation architects:

Croxtton Collaborative, Architects—Randolph R. Croxtton, principal-in-charge; Eduardo Faxas, project manager; David Arnold, project architect; John Obelenus, project designer

Associated architects:

Hammill-Walter Associates, Inc.

Engineers:

McMichael & McCracken, Inc. (mechanical/electrical); Sutton-Kennerly & Associates (structural)

Consultants:

Fisher-Marantz Inc. (lighting); Page, Arbitrio & Resen Ltd. (graphics); Dennis Abbe (mural artist); Dennis Abbe, Page, Arbitrio & Resen Ltd. (carved glass panels artists)

General contractor:

Fowler-Jones Construction Co.

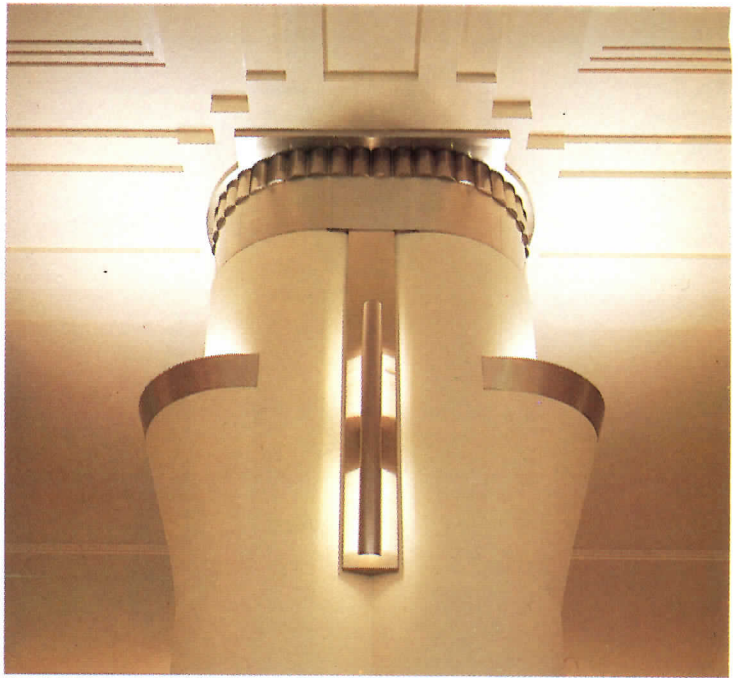

Timothy Hursley—Hursley/Lark/Hursley photos



The client's desire for a complex whose scale and siting respect the beauty of their surroundings in no way precluded an architectural design with its own clear identity. In any event, it would have been absurd in a project of this size to imitate the farm buildings down the lane or Roswell's Greek Revival plantation houses. Heery & Heery elected to assemble sleek metal and glass components into as elegant an industrial product as Herman Miller's office systems—and one

that is just as carefully adapted to the user's expectations. Even though company management policy frowns on hierarchical distinctions in facility planning, Herman Miller wanted the building to convey a welcoming sense of entry and progression. At present, the portico shown above frames a ceremonial front door for all employees. When the next phase of construction is in place, this shelter will be extended to form a gateway to the entire complex.



As though in a tableau contrasting the old agrarian South with today's industrialized Sun Belt, the frame farmhouse where Herman Miller's groundskeeper lives (vignette) confronts its metal and glass neighbor across the field. In fact, the new building is a distant cousin of the old insofar as it too uses cast shade and natural ventilation for climate control. The awning-like red wing structures that Heery &

Heery have suspended above the windows are sun screens and wind deflectors, whose exact depth and angle of projection vary according to the exposure of each facade. Anodized aluminum wall panels reflect the summer sun, and operable windows admit cooling breezes to the production pods, which have exhaust fans but require no air conditioning. In the winter, steam projection units

furnish heat to these areas. Offices are fully air conditioned by packaged direct expansion rooftop units, and heated by steam coils. Solar collectors mounted on the roof supply domestic hot water.



Herman Miller insisted that workers in every sector of the building have a view of both the ground and the sky, and that there be no "front" or "back" facade distinguished by quality of finish or detailing. Accordingly, even apparatus such as the mechanical dust collector that towers over the loading docks (below left) has been positioned with an attention to visual effect that lends it the cool

dignity of a Precisionist still life. Inside the production and warehouse areas (below right), translucent double-dome skylights, and broad banks of insulated windows admit plentiful natural illumination. These spaces are also equipped with energy-conserving high-bay, high-intensity discharge lamps and fluorescent task lighting. High block walls screen lockers and break areas from the work floor,

emphasizing that these are "non-negotiable" spaces where employees can relax in privacy.

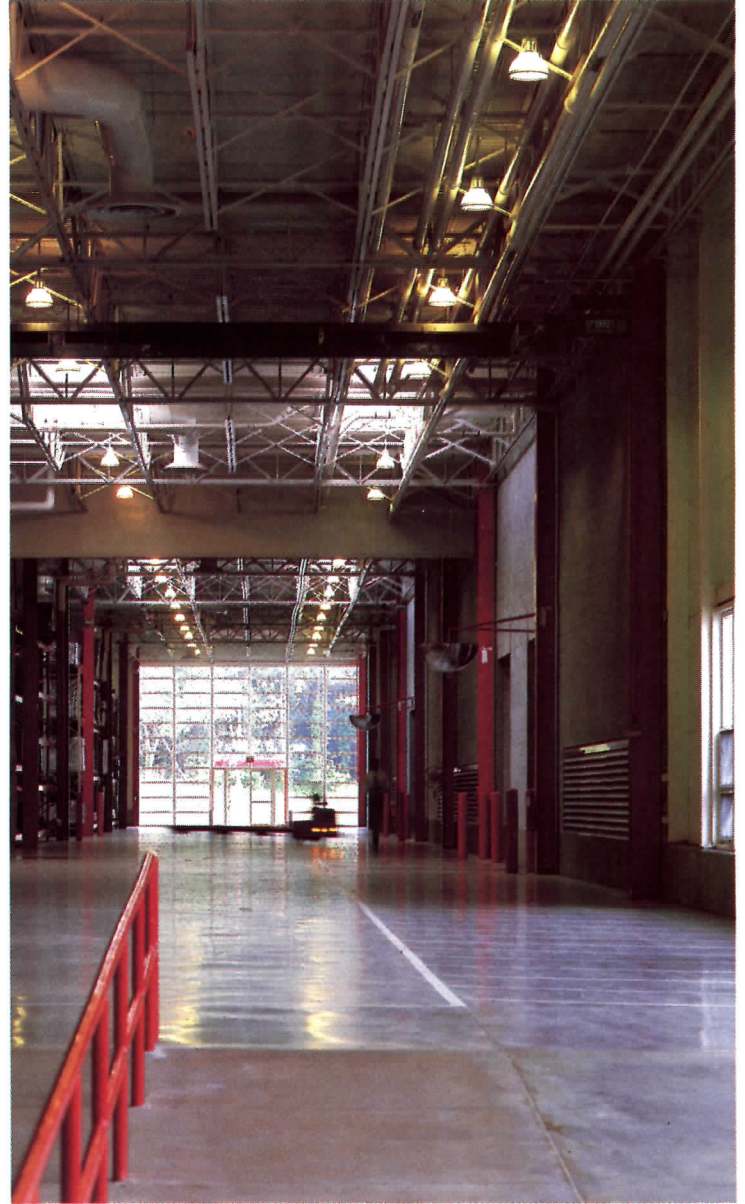

The reception area (below right) marks the beginning of the circulation spine that Heery & Heery describe as the project's "Main Street." Informal gathering places and open-plan offices flank the two-story gallery. Some office systems installations also serve as demonstration displays, where customers can see different configurations of furnishings in actual use.

The "front porch" to the south of the entrance is an outdoor dining area commanding the gentle slope down to the ponds (opposite). Herman Miller has set aside this land for the recreational use of all employees, designating it a "people place." Fortunately, despite the cuteness of such nomenclature, most of the landscape still shows the rough edges of genuine country life (vignette).



*Herman Miller Roswell Facility
Roswell, Georgia*

Owner:

Herman Miller

Architects:

*Heery & Heery, Architects &
Engineers, Inc. —*

Mack Scogin and Bob Petras,

*principals; Al Morrison and Mike
Miller, project architects;*

*J. Maurice Spang, Jr., engineering
project manager*

Engineers

*Heery & Heery, Architects &
Engineers, Inc.*

Consultants:

*Heery Energy Consultants; Heery
& Heery, Architects & Engineers,
Inc., (landscape and land*

*management planning); Heery
Interiors Inc.; Heery Graphics Inc.*

General contractor:

McDevitt & Street Co.



Structural and design ingenuity aids historic hotel transformation

New York's 70-year-old midtown Biltmore Hotel seemed an unlikely candidate for transformation into a modern office building. But the arithmetic was very appealing—zoning restrictions for a new building on the site would have reduced allowable floor area by 20 per cent from what was there. This persuaded the developer that the Biltmore should be stripped to its skeleton and reworked in its architecture and engineering systems to create viable office space in the prime real-estate area of Grand Central Terminal. The realization, however, tested both the skills and patience of the architects, Environetics Architect P.C., and their engineering consultants, The Office of James Ruderman.

Aside from the fact that the architects and engineers knew they were bound to encounter anomalies and unusual problems in a modernization of this scope, the Biltmore posed additional difficulties because it was grossly under-elevated, and because at least half of the site had a "landmark" space (a part of Grand Central Terminal) directly under it.

The architects determined that the best approach for elevators was to create a new elevator core and lobby and to position this new space across the two wings of the hotel structure, to at once provide convenient access for occupants and to create a new atrium space that gave office spaces on the interior a pleasant view. Unfortunately, the optimum location for this core occurred directly above the landmark space, which couldn't be touched, and this meant that the supporting structure had to be routed around it and carried down to existing footings at the track level of Grand Central. This resulted in the development and construction of an unusually shaped system of trusses to pick up loads from the uniformly spaced columns of the elevators and transfer them to the irregularly spaced columns that came up from the track level.

The engineers also showed their resourcefulness in providing a new wind-bracing system for the building once it had been stripped to its bare skeleton. Originally the masonry facade and interior partitions braced the frame against wind load. With masonry removed, the question was how to once again make the structure rigid. The engineers came up with a novel approach—encasing the perimeter columns and spandrel beams in reinforced concrete—that solved several other unrelated problems as well. The concrete provided rigidity, acted as fireproofing and served as a convenient attachment medium for the new curtain wall. To

stiffen the structure before concreting, the engineers installed a temporary system of cross cables—not a simple task because most of the connection points were covered with existing building materials.

Other structural aberrations on the upper and lower portions of the building interfered with placing the concrete for the permanent wind system. One of these involved 22 perimeter columns at the top of the building, originally offset from those below to accommodate a different fenestration pattern from the rest of the building. All 22 had to be moved to align with columns below to conform to the new window design.

Also, several transfer girders over large entrances interfered with the new facade and had to be relocated.

And finally, a new transfer girder had to be installed for a truck entrance added in the new design.

As fast as architect, engineer and construction crews worked to create the conditions for new construction they uncovered additional conditions that required more field measurements, consultation between trades, and new drawings for structural, mechanical, electrical and plumbing systems. The urgency of a December 1983 completion date for the fast-track project complicated matters even more.

Not all of the Biltmore's structural anomalies could be corrected however; some conditions dictated that structural modifications be made:

- Tight floor-to-floor heights (as low as 10 ft 6 in.) necessitated the use of shallow ducts and the development of a decentralized air-conditioning system.
- The curtain wall had to be designed and fastened to conceal some irregularities of the original structure that would have cost too much to correct.
- Certain column enclosures in the finished building will have to be slightly larger than planned because of unanticipated connection details that were discovered between existing steel columns.

On this building, in contrast to the job organization and skills required for new work, Michael Gordon and his structural engineer, Murray Shapiro, had to spend almost as much time on site as off. Asked if he had any advice for other designers tackling major renovation, Gordon said: "Go carefully, because you never know what's behind the skin—be prepared to run a gauntlet of unique conditions." *James B. Gardner*

The Biltmore, its twin towers formed by a light court 70 ft wide and 136 ft deep, opened on New Year's Day, 1913. Here, it is shrouded by scaffolding, for the removal of its heavy facade. Work commenced in August, 1981.



Architect Michael B. Gordon's solution to the Biltmore's limited elevator capacity was to create an architectural core by connecting its two wings with a multi-level steel bridge. Thus an atrium plan (bottom right) was created from the original U-shaped plan (bottom left). The new core, which extends partly into existing space, contains vertical circulation, restrooms,

stairs and mechanical and electrical equipment rooms. Existing elevator shafts (with elevator equipment removed) became locations for toilets, vertical shafts and mechanical closets. The bridge/core is supported principally by six new steel columns erected over the landmark space. Channeling the loads from these new columns to existing building columns

required the development of a uniquely configured system of trusses (axonometric below right and illustrations overleaf). Before a granite and glass curtain wall could be attached to the building (axonometric left), perimeter columns and spandrel beams were encased in reinforced concrete to resist wind forces. But first, many structural modifications had to be

performed such as relocating existing transfer girders (axonometric right) which interfered with new window designs. When the concrete was in place, the curtain wall was attached. The Cornelian granite, and gray vision and spandrel glass, will mask many of the original structure's shortcomings, such as irregularly spaced columns and floors.

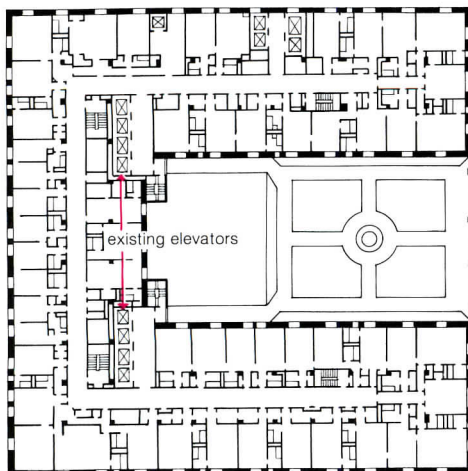
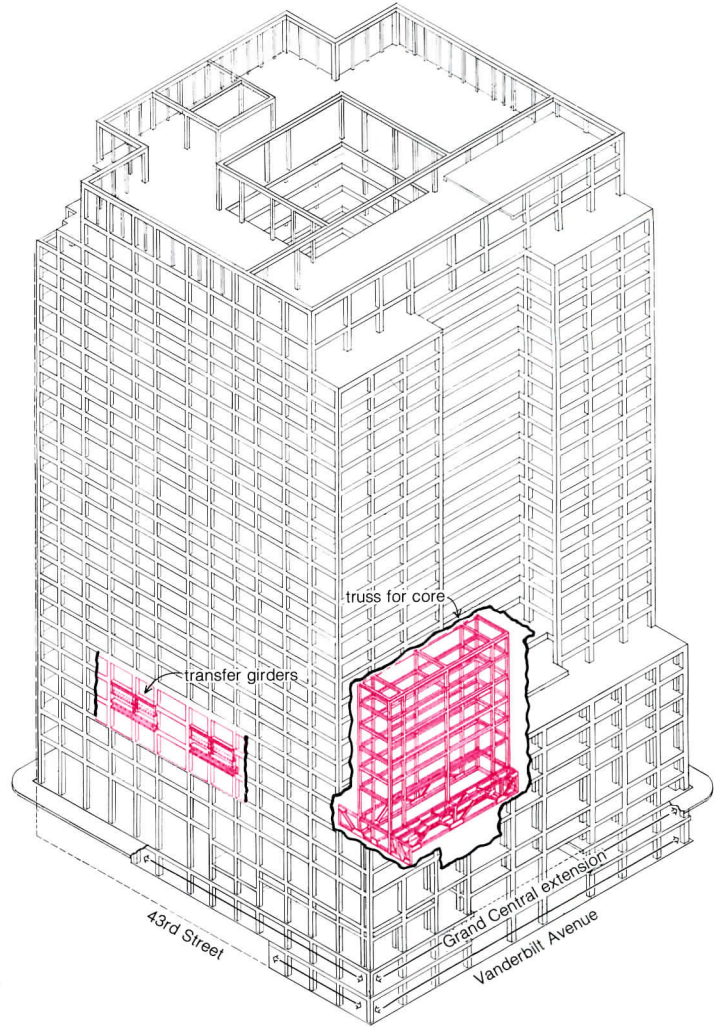
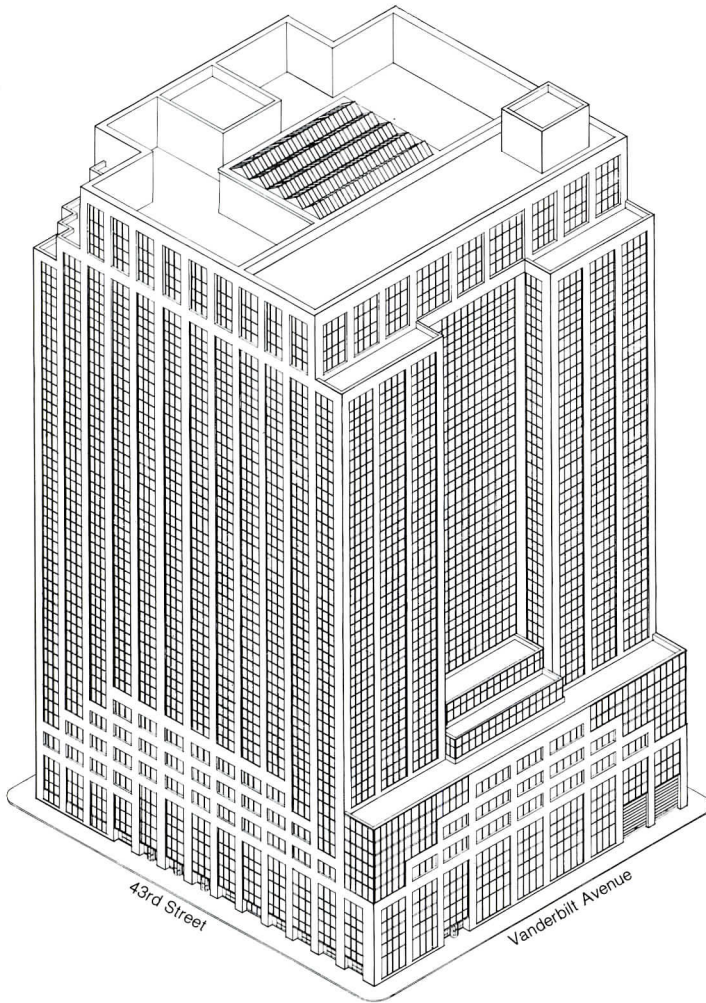

PLAN OF OLD BILTMORE

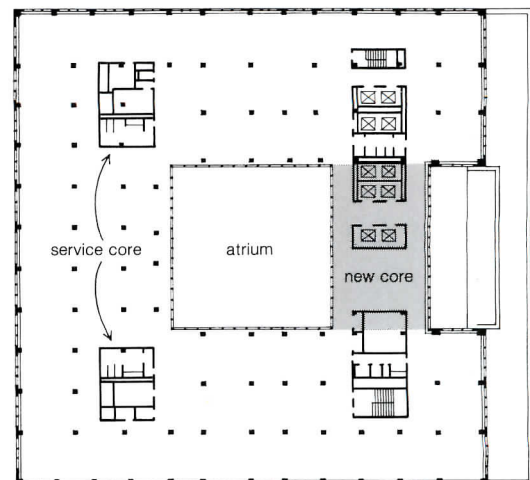

BANK OF AMERICA PLAZA—HIGH MID-RISE PLAN

Because the new columns of the core were not allowed to penetrate the Grand Central landmark space, they are intercepted by a structural buffer—a system of trusses, shown in the model below. The unusual configuration of the trusses was required since the existing footings had limited capacities for new loads, and, therefore, these loads had to be

routed somewhat circuitously. This accounts for the extra planes of the truss. Because the existing columns were built-up sections with protruding rivets, engineers made connections to new steel by welding steel plates to the edge of column flanges. Elevator pits for the new vertical transportation system will be supported within the trusses, just several feet over the landmark space.

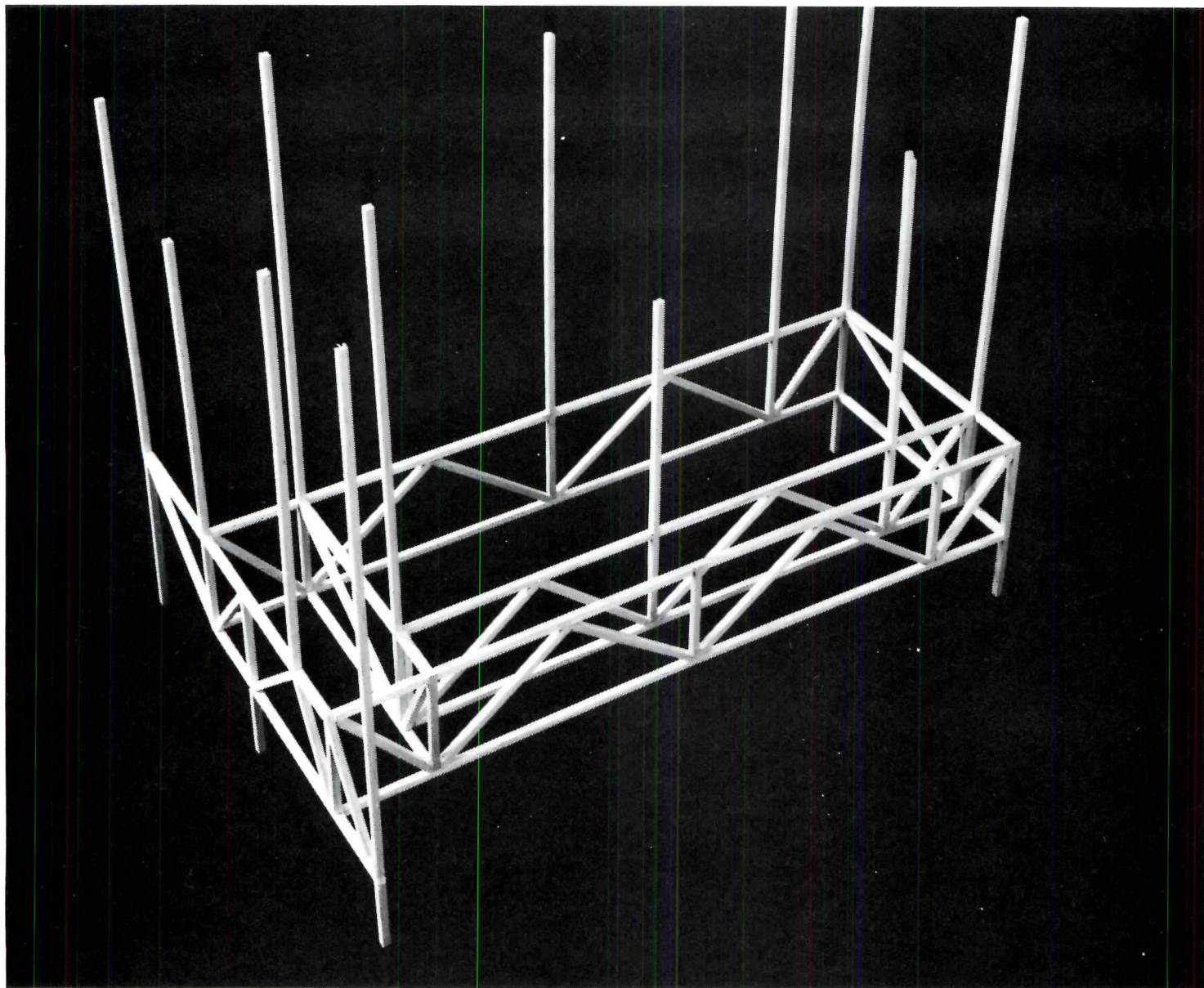

A workman, in the lower left foreground, lends scale to the trusses. The transfer structure is 12 ft deep, 36 ft wide and spans 73 ft across the most westward arrival area of Grand Central Terminal (under the Biltmore).



Since there could be no new construction within the landmark space, loads from the truss system are channeled to existing double girders and thence to existing columns which go to footings below track level (drawing and companion photo below). The footings had the capacities for these loads because they no longer needed to support the heavy weight of the original facade and

because the original structure was designed conservatively. The relationship of the Biltmore to landmark space is shown in both drawings at the right, below. Railroad tracks, which loop entirely around Grand Central Terminal, begin their long, radial sweep here. This accounts for the irregular spacing of foundation columns (pochéed in blue, bottom right). Elevator lobby space

cantilevers into the atrium at its east face. On the other three faces occupants of perimeter offices will have a view. The extended cantilevering of floors at lower levels in the atrium helps modulate the 66- by 68-ft space and creates better office layouts for the building's prime tenant—Bank of America.

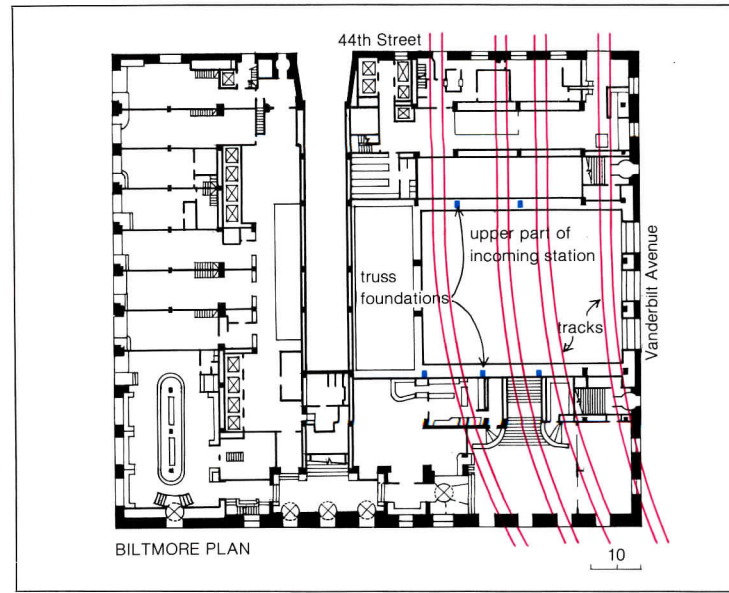
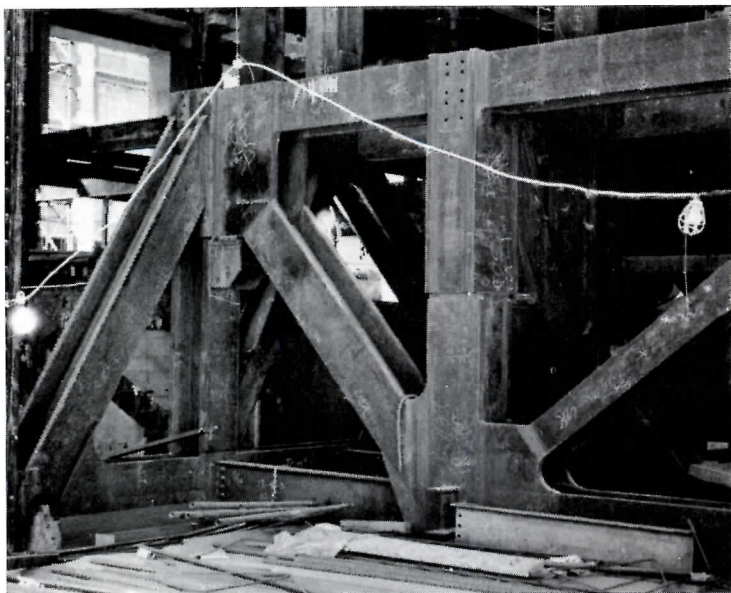
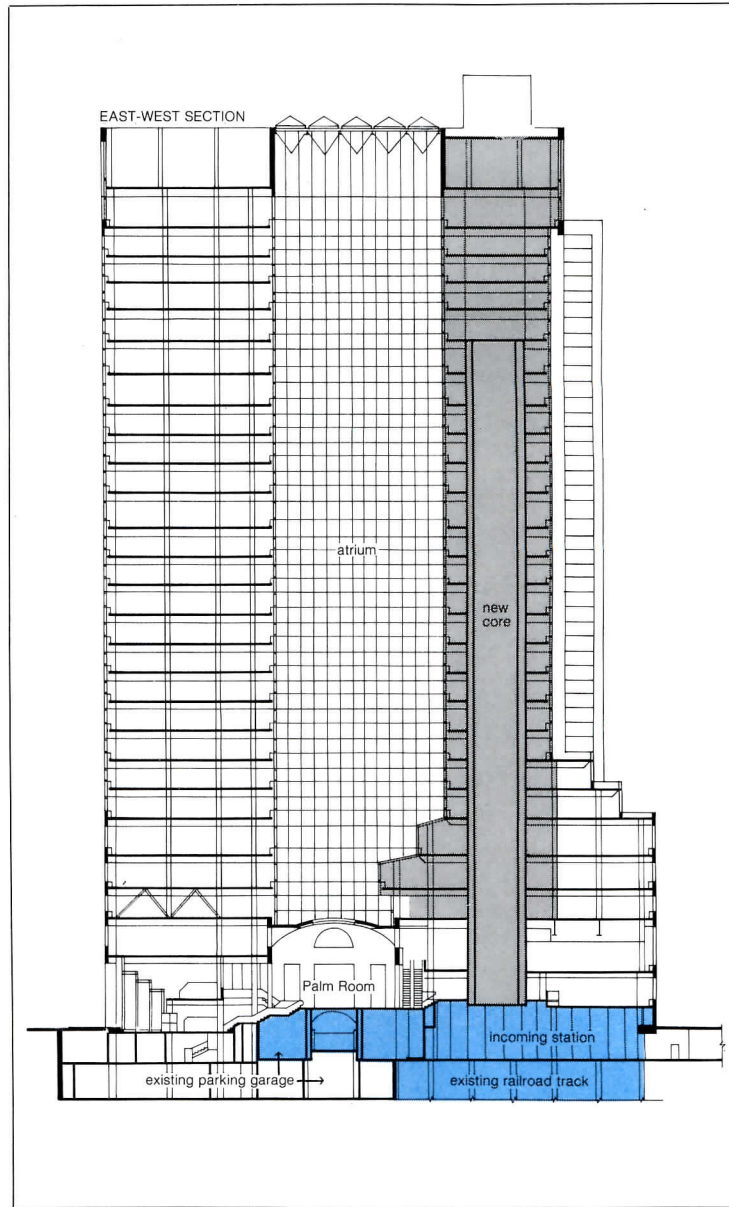
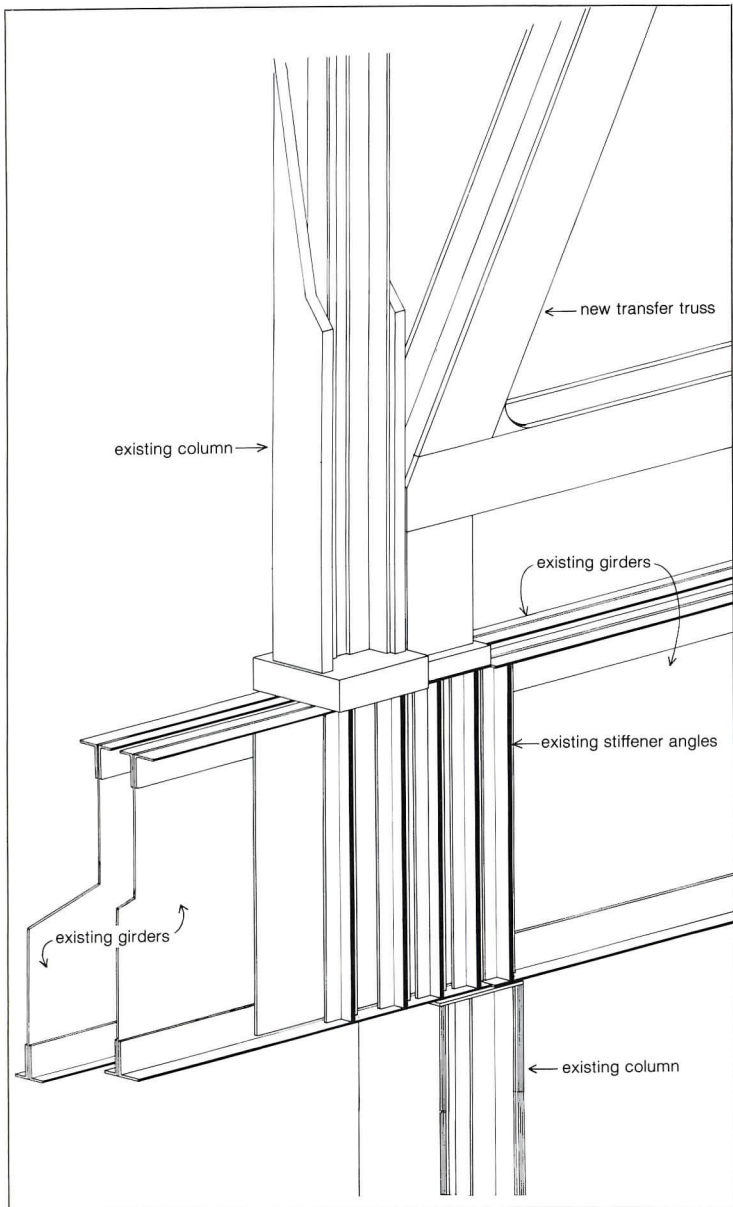

Reinforced concrete, which encases perimeter columns and spandrel beams, braces the new building for wind load, acts as fireproofing, and enables a new curtain wall to be easily installed. This concrete replaces the structure's original wind system which consisted of 12- to 24-in.-thick exterior masonry walls and interior partitions. The contractor started first on the middle of the building because little

other work had to be done in this area. They could not work on upper floors until new steel was installed after the Biltmore's ballrooms, located at the top of the building, were demolished (see photo). Further, on upper floors, offset perimeter columns had to be lined up to conform to the new fenestration pattern (see facing page). At lower floors, several transfer girders, such as the one

shown (bottom left), interfered with the new window design. Here, a new girder was installed at floor level. Then, a new column support was wedged into position between the two girders. Finally, the top portion of the existing girder was removed. This process had to be repeated in several locations. Temporary bracing of the exposed steel structure from wind forces was accomplished with cross cables.

Their installation was complicated because connection points had to be welded to steel which, at the time, was covered with existing building materials.

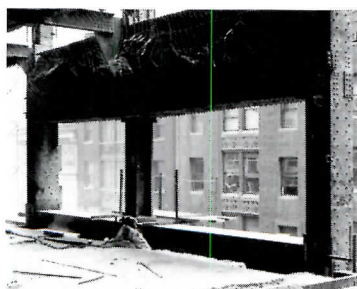
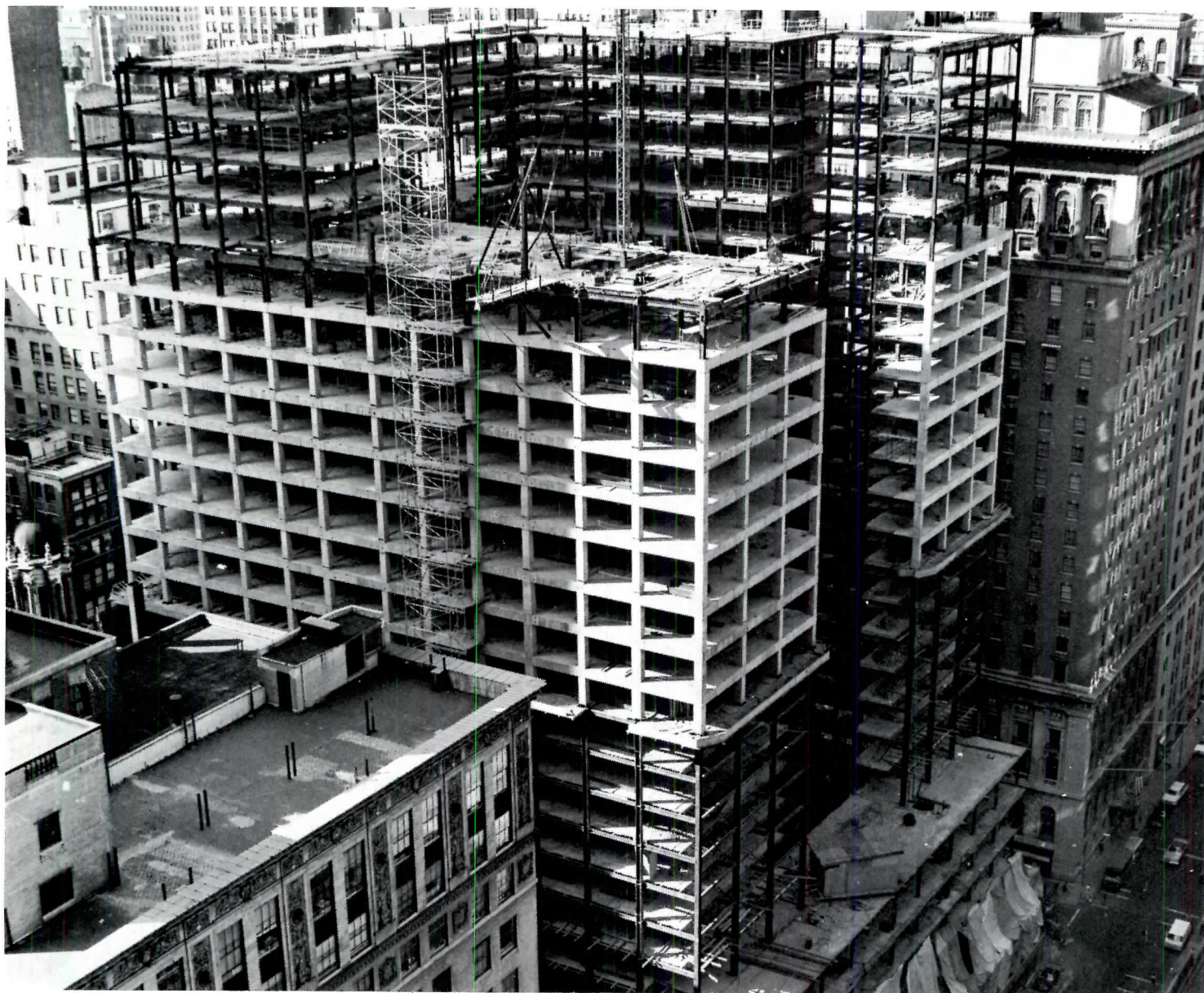

On upper floors in the original design the architect offset 22 perimeter columns to modulate window treatments differently than below. Since this did not suit the new window pattern, columns had to be moved and lined up with those below. New steel columns were inserted into the structure manually with block and tackle, and set atop existing columns (left column, photo bottom left). Loads

from existing floor steel were transferred to new columns with a bracing member and two 10-in. channels that cantilevered from the existing column shown in the photo, lower right (sighting up a newly inserted column). With loads transferred, welders torched out the original columns.

Bank of America Plaza (formerly Biltmore Hotel)
New York, New York
Owner:
Builtland Partners
Architects:
Environetics Architect P.C.—
Richard Korchien AIA, Michael B. Gordon AIA, partner-in-charge;
Peter Paul Liesandt, project architect; Winston Williams, Moulton Mayers, Linda

Aslanian, production; Alfred Karman, contract administration
Engineers:
Office of James Ruderman—Leo Plofker, principal; Murray Shapiro, partner-in-charge (structural); Cosentini Associates, David Michaeli, partner-in-charge (mechanical/electrical)
Construction manager:
Lehrer/McGovern, Inc.

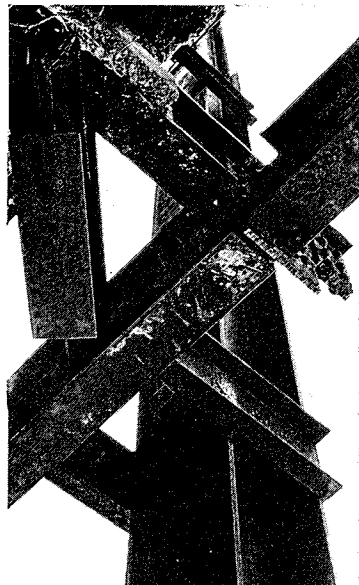
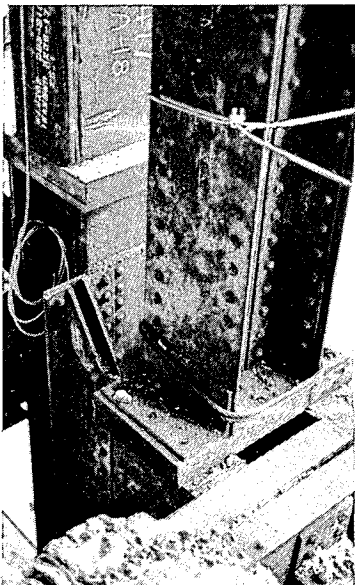
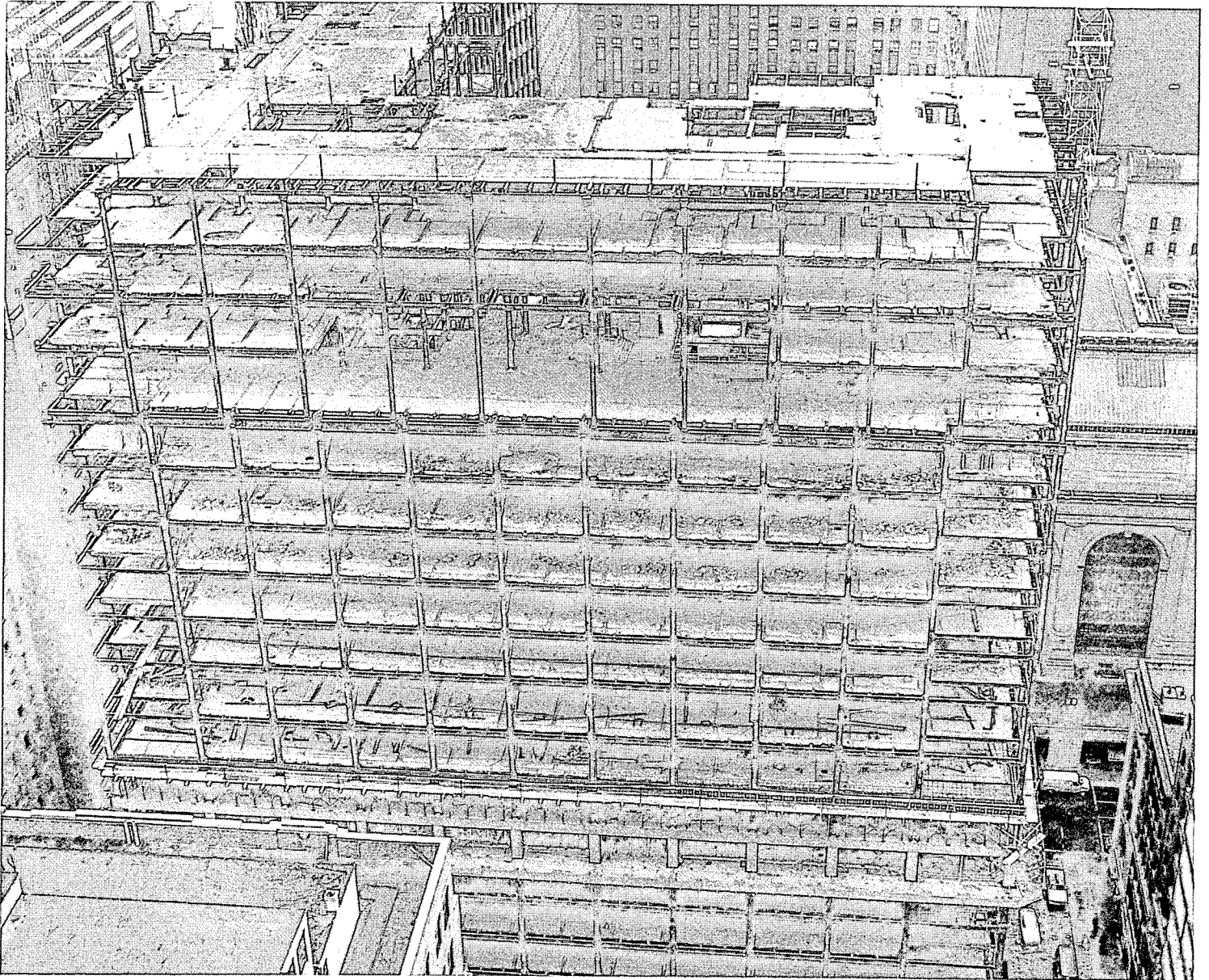

Certification: a step towards preventing failure of insulating glass

Of all glass going into buildings, latest industry figures show that sealed insulating glass accounts for over 60 per cent of the total sold for residential buildings, and 45 per cent of the total sold for nonresidential buildings. With so much insulating glass being used, and with liability continuing to be a major problem, architects can be expected to want assurance that insulating glass will not fail in their buildings.

The insulating glass industry took steps in 1978, with the formation of the Insulating Glass Certification Council, to provide a significant measure of that assurance. This is a certification program through which manufacturers can certify that a particular insulating-glass product is a "faithful replica" of glass that has passed a program of accelerated laboratory testing on the seal between lights of glass.

To find out what the IGCC programs means to architects, RECORD recently assembled a group of five from the IGCC organization who addressed a number of issues: the reason for the program, how it works, how the glass is tested, who is involved, what the three certification categories—C, CB and CBA—mean, and why the program provides unbiased results. The five included*: Colin S. Brady, president of IGCC; Robert G. Spindler, chairman of the IGCC Certification Committee; Claude F. Robb, administrator of the program; Dr. Joseph E. Minor, P.E., public interest participant on the board of governors; and Alfred G. Sanford, supplier participant on the board.

Why IGCC? The basic reason is the industry recognized the need for independent testing to protect the consumer. Forty years ago only two manufacturers made insulating glass. Today, industry sources estimate, nearly 1600 companies fabricate insulating glass, while only 100 of these derive their major sales from this product, and, of the 100, 58 certify insulating glass. With 1600 companies in the market, variations in quality are inevitable, and the only way an architect can have assurance a manufacturer is furnishing glass that meets a commonly-agreed-upon quality level with respect to the seal, says IGCC, is to specify manufacturer-certified insulating glass.

Accelerated testing of insulating glass is not new. The original manufacturers of insulating glass, and some sealant manufacturers, for many years had their own test equipment and procedures. Because of the severe climate in Canada, that government has required testing of insulating glass since 1961. SIGMA (Sealed Insulating Glass Manufacturers' Association) in 1968 urged its members to test their products voluntarily. The industry soon recognized the need for an ASTM standard on insulating glass because there was no uniform procedure at the time. As a prelude to a standard, an ASTM committee proposed an extensive program of reviewing existing testing facilities and accumulating field experience. As a second step, industry and regulatory agencies supported a research associate, Dr. Mahn He Hahn, at the National Bureau of Standards to design and build prototypical test apparatus. This paved the way for ASTM to issue proposed standards in 1975, which were adopted in 1981.

But prior to this, sometime after 1971, the federal government began to discourage trade-sponsored testing programs, and strongly recommended that trade groups set up independent testing facilities and organizations. In 1977 the board of directors of SIGMA directed that an ad hoc committee be formed to develop such an organization, resulting in the setting

* Colin Brady is president, Twin Pane Division, Philips Industries, Inc; Robert Spindler is senior engineer, Technical Services, Flat Glass Division, PPG Industries; Claude Robb is manager, Mechanical Division, ETL Testing Laboratories, Inc.; Dr. Joseph Minor is professor, Texas Tech University and head of the Institute for Disaster Research; and Alfred Sanford is market development specialist, General Electric Silicone Products Division.

up of IGCC. Because of its makeup, IGCC is not a manufacturer-controlled organization. Its board of directors has six members who represent the public interest and six members who represent industry. It has a certification committee comprising a representative number of licensees and the six public-interest members from the board. Significantly, any one of the public members has veto power over certification activities. All the licensees are part of the organization. Suppliers of materials can enter discussions, but not vote. Other participants are public-interest members and specifiers.

IGCC directs a program of periodic accelerated laboratory testing and unannounced plant inspections to ensure continuing product performance through specified standards. The program is supervised and administered by ETL Testing Laboratories, which, by the rules, cannot test insulating glass products for certification.

To be in the certification program, a manufacturer of insulating glass must submit prototype specimens to an approved testing laboratory (of which there are four, currently) that tests them according to ASTM E 773-81, Standard Test for Seal Durability of Sealed Insulating Glass Units, and ASTM E 774, which specifies specimen size, test duration and performance requirements.

The administrator of the program supervises preparation of the test specimens and conducts two unannounced inspections annually to verify that production-line insulating glass units conform to the materials and construction of the test specimens. Each year a licensee must repeat having specimens tested. Also, if a manufacturer changes his units significantly, such as a change in spacer material, spacer, surface, corner design, reflective coating, desiccant, or sealant, he must submit new specimens for testing and be assigned a different certification number. Reflective coatings, for example, are not freely substitutable. Manufacturers must have specimens tested with the thinnest and thickest reflective coatings used, and one color of reflective glass cannot be substituted for another.

How does an architect make sure that his building is supplied with IGCC-certified glass units? First the architect should state "IGCC Certified" in his specifications—merely specifying a product from a manufacturer listed in the IGCC directory is not enough because that manufacturer also may make non-certified glass. Secondly, a manufacturer supplying certified insulating glass must identify the glass with an IGCC certification number permanently affixed to the unit, usually on the spacer, but it also can be on one pane of the glass. The certification number identifies the manufacturer and includes a date code which is changed every six months to indicate when the unit was made. Even though a manufacturer has had a particular unit tested, he need not certify all of the production of that product, if he so chooses; but then he may not use the IGCC label.

The tests have been designed to check two different quality aspects of the glass seals: 1) resistance to the continuing effects of moisture, cycling temperatures, and ultraviolet light, and 2) absence of volatile components in the sealant that could migrate from the sealant and fog glass over a period of time. Details of the test procedures and apparatus are given across page.

Certification is not a warranty. Neither is certification a guarantee. Nor does certification tell anything about the credibility or financial strength of a manufacturer. But it does tell the architect that the manufacturer has an obligation to give a faithful replica of the specimens tested. And it says that the manufacturer has made a public commitment to certification quality and to unannounced inspections.

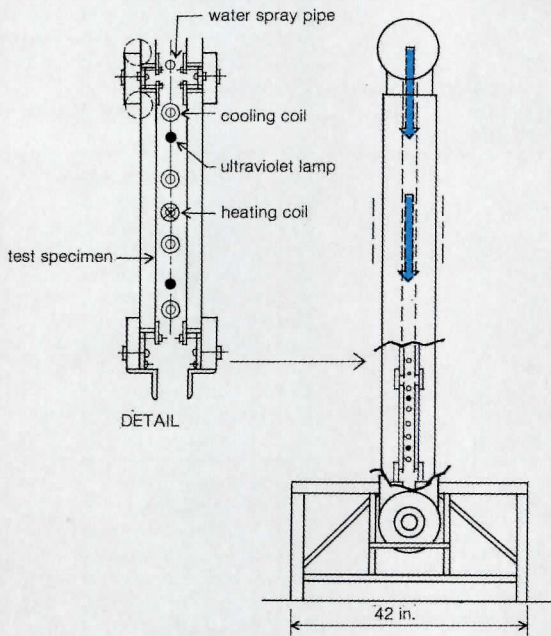
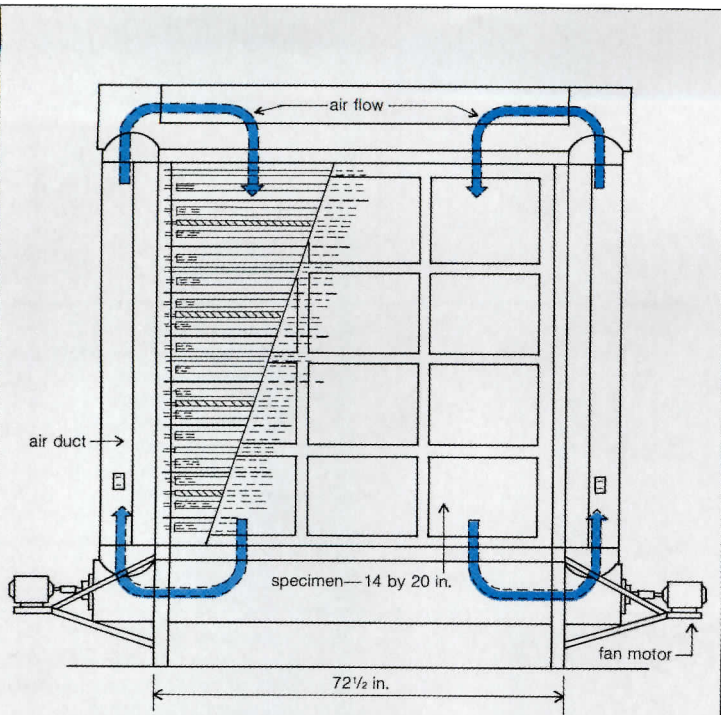

TYPICAL ACCELERATED WEATHER CYCLE TEST APPARATUS

Accelerated laboratory testing of insulating glass specimens is designed to determine if: 1) the seals will limit moisture penetration into the air space to acceptable levels (no condensation at sub-freezing temperatures), and 2) the sealant is of sufficient quality to avoid fogging of the glass because of volatiles migrating from the sealant.

The weathering apparatus shown here subjects specimens to heat, cold, ultraviolet light, and water spray. The ultraviolet light tests the sealant for possible loss of adhesion to the glass.

A different apparatus checks the specimens for fogging, utilizing ultraviolet light to maintain the glass surface at 150 F, and a copper-tubing cooling plate centered on the back of the specimen to induce deposition of volatiles if they are present.

Prior to the weathering test, six 14-by 20-in. specimens are first placed in a separate chamber with an environment of 95 per cent relative humidity and 140 F temperature for two weeks. Before and after this test the laboratory determines the frost point of the specimens, lowering temperature to -80 F or below. Frost point is the temperature at which frost forms on the interior surface of the unit. It is found by placing dry ice in a metal tube containing alcohol or acetone set atop the glass specimen. Specimens installed in the weathering apparatus have one side of the glass at room temperature and the other side exposed to "weather" conditions. The "weather" side starts at room temperature, slowly drops to -20 F, stays at this temperature for an hour, then slowly rises to room temperature. "Rain" starts; "rain" stops; the "sun" comes out.

Temperature rises to 140 F with UV lights on, stays at this level for an hour, and then drops to room temperature. The total cycle takes six hours, and this is repeated for five weeks. If the frost point of the unit is lower than -30 F, the unit has reached "C"-level qualification. The specimens go back to the humidity chamber for two weeks, back into the weathering apparatus for two weeks, and if the frost point is lower than -20 F, the unit achieves a "CB"-level rating. With the same sequence repeated a third time, the unit achieves a "CBA"-level rating. A "CBA" level is the highest qualification given in the certification process.

Manufacturers need not have glass submitted to all three cycles, though most do. Licensees and IGCC numbers for certified products are listed in IGCC's Certified Products Directory.

While the certification process does not include testing for structural or mechanical loading of the glass units, such tests are performed by independent testing laboratories.

How do these tests relate to reality? To find out, SIGMA three years ago initiated a six-year field study, funded by HUD, of 2250 insulating glass units, representing 49 certified models, 47 plants, and 43 manufacturers, placed in buildings in cold, warm, damp, dry and coastal climates. Every year the frost points of these units, which are between four- and six-years old, have been checked by Jim Spetz Testing Laboratory. Spetz has found some upward movement of the frost points in the "C"-level units, but, so far, of all the 2250 units, only two have failed. Also during the field checks, Spetz has made a visual inspection of between 40,000 and 50,000 units.



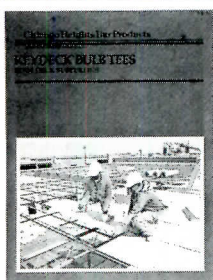

Subpurlins

Strong, lightweight structural members for roof construction, the subpurlins described in this 4-page brochure can be used with poured gypsum, lightweight concrete and structural wood fiber roof tiles. Chicago Heights Bar Products, Chicago Heights, Ill.

Circle 400 on reader service card

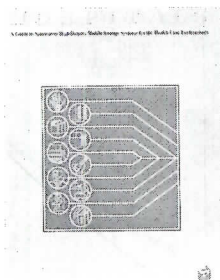

Hospital space

A 22-page color booklet describes space-saving systems for health-care facilities. A computer program which calculates the return on investment for installations is discussed on the last page. Spacesaver Corp., Ft. Atkinson, Wis.

Circle 406 on reader service card

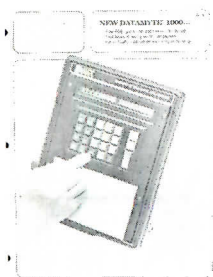

Portable terminal

The *Datamyte 1000* described in this 8-page brochure is a general purpose, portable data entry (PDE) terminal with a solid-state memory which stores up to 64,000 characters. The PDE operates on rechargeable battery power. Electro General Corp., Minnetonka, Minn.

Circle 401 on reader service card

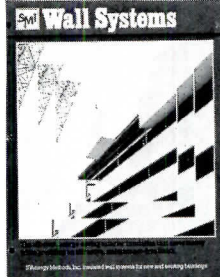

Wall systems

An 8-page color brochure describes exterior insulation with a maintenance-free finish. Photographs of installations are accompanied by section details. Diagrams illustrate how the system works and test results are listed. SYenergy Methods, Inc., Cranston, R.I.

Circle 407 on reader service card

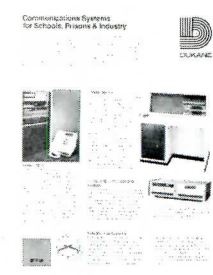

Communications systems

Systems for schools, prisons, industry, hospitals and nursing homes are pictured and described in a 4-page brochure. Included are sound equipment components such as mixers, amplifiers and speakers. Dukane Corp., St. Charles, Ill.

Circle 402 on reader service card

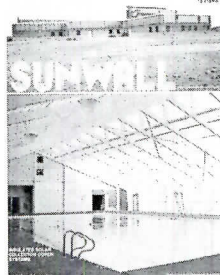

Solar window system

A 2-page color brochure illustrates *Sunwall*, a panel system which may be installed as a wall, skylight, clerestory, or skyroof. Panels have 3 "U" Factor options of .41, .35, or .28 and light transmission options of 77, 70, or 65 per cent. Kalwall Corp., Manchester, N.H.

Circle 408 on reader service card

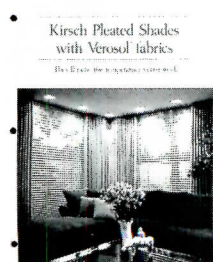

Shades

The aluminized shades described in this 4-page color brochure reflect sunlight and insulate as useful components in passive solar heating. The fabrics shown perform different functions. Specifications are included. Kirsch Co., Sturgis, Mich.

Circle 403 on reader service card

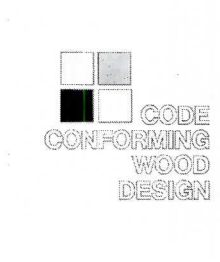

Wood

The *Code Conforming Wood Design Guide* summarizes allowances for wood in major model building codes. Four building use categories are included with the remainder to follow in early 1983. One copy per firm is available. American Wood Council, Washington, D.C.

Circle 409 on reader service card

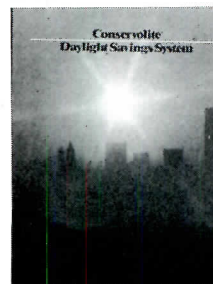

Light savings

A 6-page color brochure describes a daylight savings system that combines fiber optics with a light sensor and regulates the light level for each fluorescent fixture. Conservolite, Inc., Oakdale, Pa.

Circle 404 on reader service card

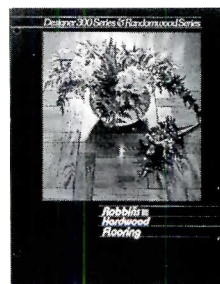

Hardwood flooring

The *Randomwood Series* of plank flooring described in a 6-page color brochure is tongue-and-groove milled, 3/4-in. thick and is available in walnut or almond finish. The series comes in 5 patterns. Specifications are included. Robbins, Inc., Louisville, Ky.

Circle 410 on reader service card



Space

A 28-page booklet that discusses space-saving includes design details, case studies and specifications. Section drawings illustrate track layouts while typical installations are shown in photographs. Spacesaver Corp., Ft. Atkinson, Wis.

Circle 405 on reader service card

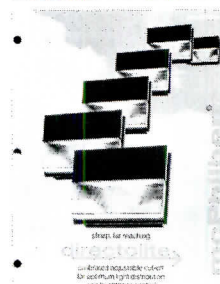

Area lighting

Constructed of a cast aluminum housing and polycarbonate door/enclosure with diffusing prisms, this high-pressure-sodium and metal-halide lamp is described in a 14-page color booklet. It may be mounted on walls or 4-in.-square poles. McPhilben Lighting, Melville, N.Y.

Circle 411 on reader service card

Continued on page 141



40



Roofing

The *CoolTop 40* is a white polyester single ply membrane roofing system for fully exposed installations. It is described and illustrated in an 8-page color brochure that includes performance charts and graphs. Cooley Roofing Systems, Inc., Pawtucket, R.I.
 Circle 412 on reader service card

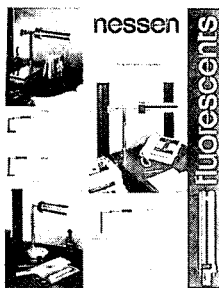

Fluorescents

Lamps which use 9-W bulbs said to provide the equivalent of 60 watts of incandescent light for an average of 10,000 hours are featured in a 2-page brochure. Photographs of all table, floor and wall lamps as well as cross-sections with dimensions are included. Nessen Lamps, Inc., Bronx, N.Y.
 Circle 418 on reader service card



Large screen projectors

A 6-page color brochure illustrates and describes applications for large screen TV projection such as in lectures, simulation training and entertainment. Operating information and specifications are included. General Electric Co., Syracuse, N.Y.
 Circle 413 on reader service card

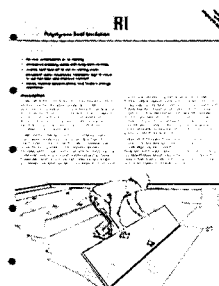

Roof insulation

A product data sheet describes and illustrates *Foamular* extruded polystyrene roof insulation. New and retrofit applications under single-ply membrane roofing systems are shown accompanied by specifications. A variety of sizes and thicknesses is available. UC Industries, Chicago, Ill.
 Circle 419 on reader service card

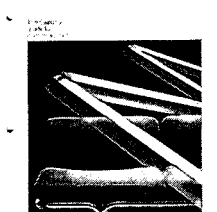

Luminaires

As shown in a 12-page glossy color booklet, 3 series of *Gardco* luminaires allow for direct, indirect or rotatable lighting in a number of patterns or in lines. A number of design options are available in a variety of shapes, sizes, mountings and finishes. Gardco Lighting, San Leandro, Calif.
 Circle 414 on reader service card

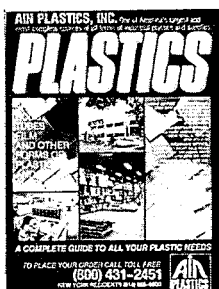

Plastics

A 128-page 1983 catalog covers an inventory of plastics such as acrylic, polycarbonate, *Teflon*, nylon and polyurethanes as well as a variety of cements and accessories. AIN Plastics, Inc., Mount Vernon, N.Y.
 Circle 420 on reader service card



Track lighting

As explained in a color booklet, all configurations of 3-track systems may be broken down into corresponding order numbers. Systems, plug-mount adapters, accessories and fixtures are all illustrated and described. Swivelier Co., Inc., Nanuet, N.Y.
 Circle 415 on reader service card

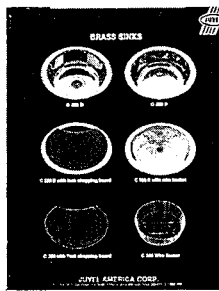

Sinks

Brass, stainless steel and enamelled sinks are featured in a packet of literature. Photographs illustrate sinks and accessories while charts list dimensions and model numbers. Diagrams show a variety of options. Abbaka Trading Co., Inc., San Francisco, Calif.
 Circle 421 on reader service card



Modular seating

The *Elysee* line of sofa seating is described and illustrated in a 6-page color brochure. Included in the group is a corner section, single back section, multi-purpose section and ottoman. A dimension chart is included. Steelcase, Inc., Grand Rapids, Mich.
 Circle 416 on reader service card

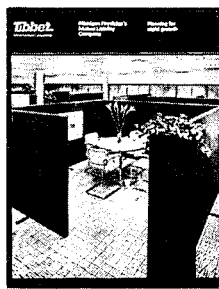

Office furniture components

An 8-page color brochure describes a case study of the effect on a growing company of freestanding space dividers. Acoustical control and expandability are discussed and illustrated in photographs of typical installations. Tibbet, Inc., Toledo, Ohio.
 Circle 422 on reader service card

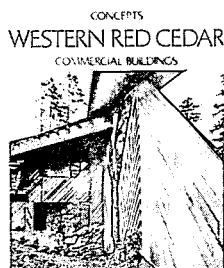

Cedar

Typical applications of red cedar in siding, walls, ceilings, decks, posts and beams are pictured and described in a 4-page color brochure. Clear and tight-knotted patterns are also discussed. Western Red Cedar Lumber Association, Portland, Ore.
 Circle 417 on reader service card

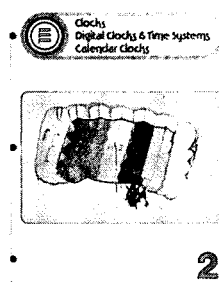

Clocks

A collection of wall clocks, digital clocks and calendar clocks is shown in a 36-page color catalog. Specifications covering more than 100 products are included with a range of 22 colors. Peter Pepper Products, Inc., Compton, Calif.
 Circle 423 on reader service card

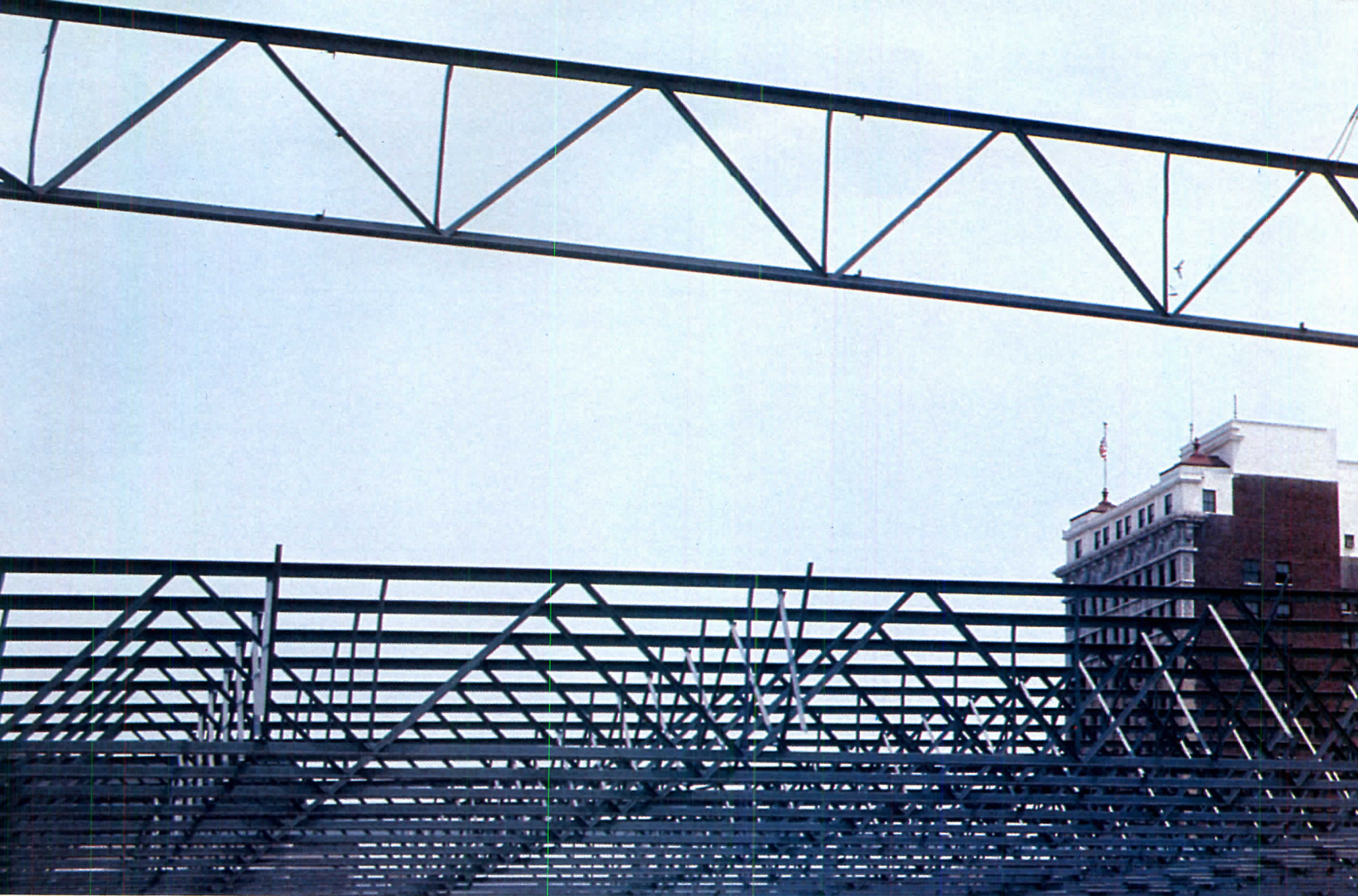

VULCRAFT SUPER LONG SPANS



The uniform depth of the steel joists and joist girders added important aesthetic qualities to the arena.

St. Joseph, Missouri, is justly proud of its new Civic Arena. And Vulcraft is proud of the super long span joists and joist girders that play such an important part in this exciting structure.

Working closely with the architect and structural engineer from the beginning of the project, Vulcraft provided design assistance and cost analysis that clearly demonstrated the outstanding economies of the Vulcraft system.

Besides being the least expensive method of construction, uniform depth of the steel joists and joist girders added important aesthetic qualities to the arena.

Not only can Vulcraft supply special needs such as the super long span joists in St. Joseph, but it can serve you in whatever locations you work. Because only Vulcraft has five joist plants around the country.

So if you're planning to span a large area, consider Vulcraft super long span joists and joist girders. Together, they may be able to offer you the same economies found in the St. Joseph Civic

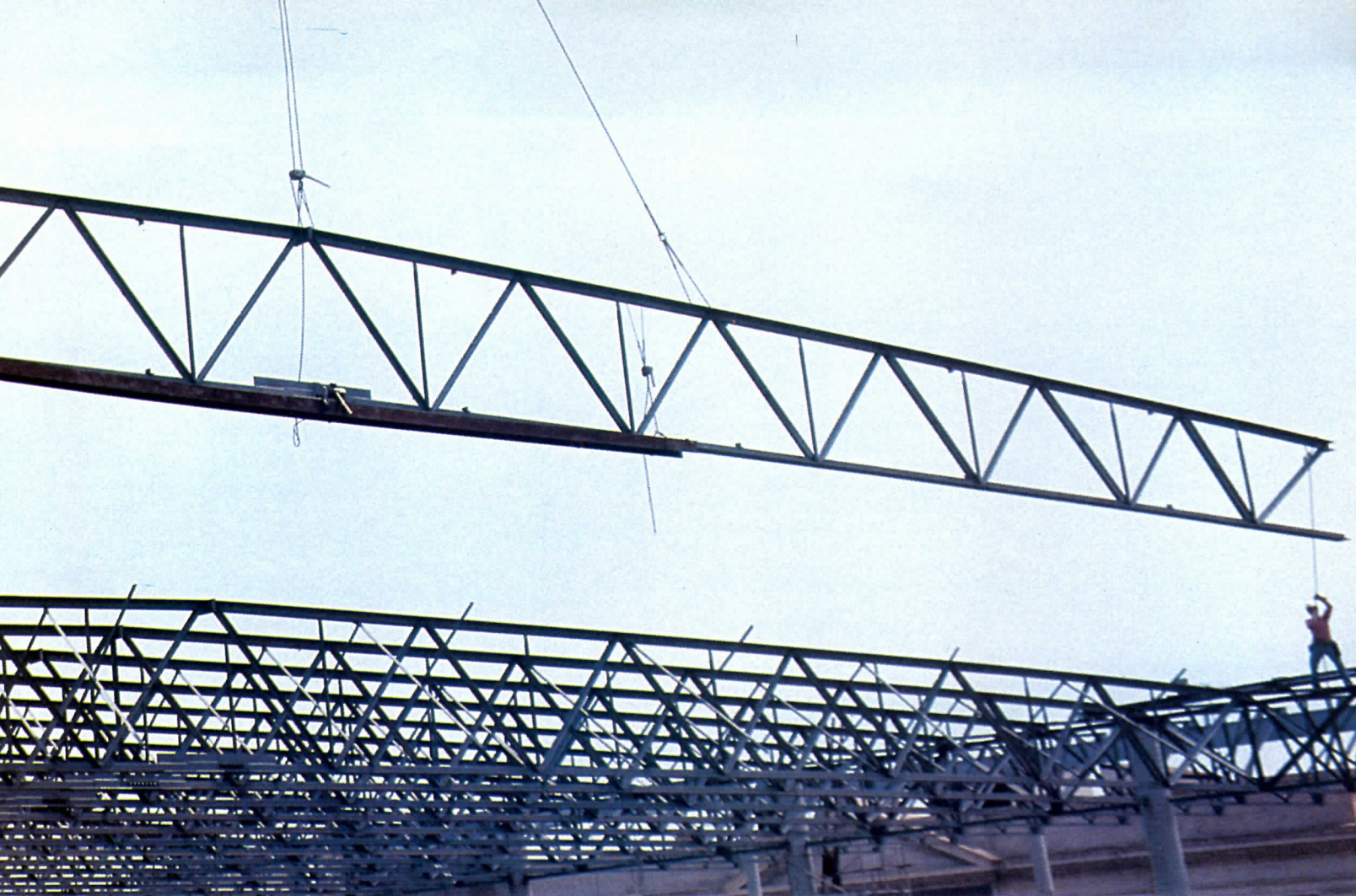

172' super long span joists were used in the St. Joseph Civic Arena.

...FOR A SUPER ARENA.

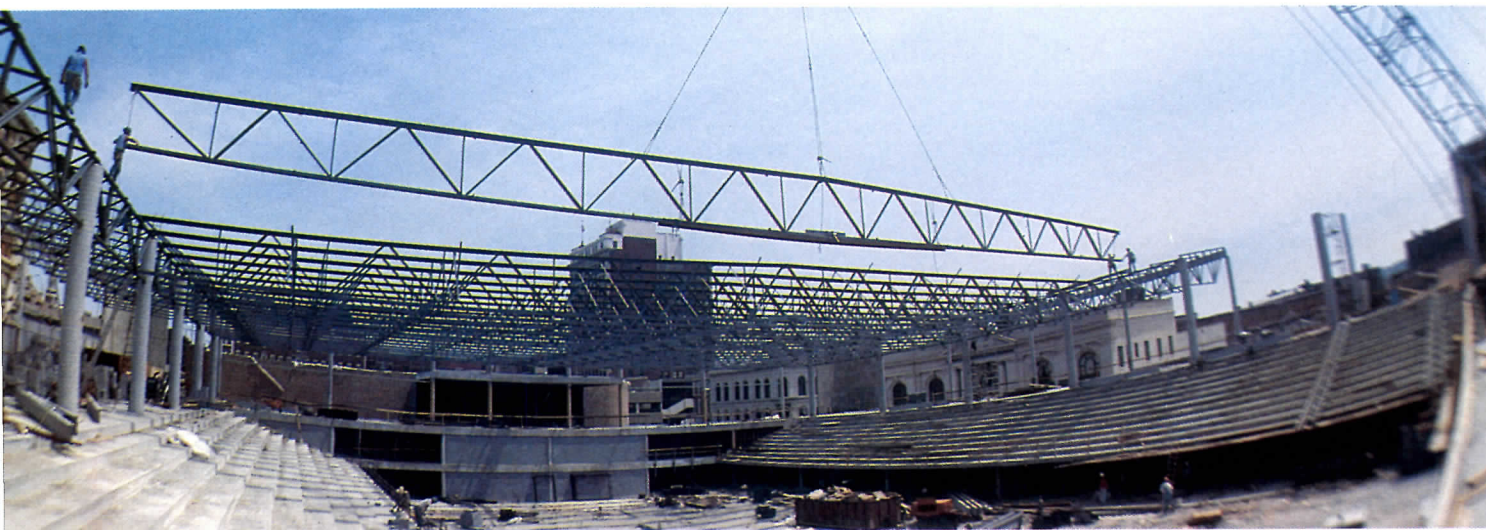

The main arena area is 232' x 224', and was designed for multi-purpose use.

ena. And that could mean a super job for you.
 For more information, contact your local
 Vulcraft representative, or write P.O. Box 220646,
 Charlotte, North Carolina 28222, for our joist
 and steel deck catalogs. You can also call us at
 (414) 366-7000 or see Sweet's 5.2/Vu and 5.5/Vu.

- P.O. Box 637, Brigham City, Utah 84302 801/734-9433
- P.O. Box F-2, Florence, SC 29502 803/662-0381
- P.O. Box 169, Fort Payne, AL 35967 205/845-2460
- P.O. Box 186, Grapeland, TX 75844 713/687-4665
- P.O. Box 59, Norfolk, NE 68701 402/371-0020
- P.O. Box 1000, St. Joe, IN 46785 219/337-5411

VULCRAFT
 A Division of Nucor Corporation.

Architects: Patty Berkebile Nelson Associates General Contractor: Wm. Grace Construction Inc. Structural Engineers: Stevson-Hall & Wade
 Steel Fabricators: Midland Structural Steel Inc. Steel Erectors: Havens Steel Co.

Circle 53 on inquiry card

New products

Danish exhibit focuses on creative process of product design

The Danish have been widely recognized as design leaders, and once again their ingenuity is demonstrated in a traveling exhibit of industrial products recently shown at The Cooper Union in New York City. The exhibition theme is "Design: the problem comes first," organized by the Danish Design Council. The show, however, looks at the subject of design from a different angle than just displaying finished products, although it does that, too. It is intended to explore the creative design process of 26 products, which range from kitchenware, toys, telephone and stereo to lighting, furniture and industrial fittings and equipment. The Council wants to prove that good design is as much a matter of asking the right questions as answering them. The very statement of a problem often holds the key to its solution—the decisive factor is the quality of the statement. Although the products exhibited span a period of 50 years, each is in production today. Some are Danish Industrial Design Award winners, but all are listed in the Danish Design Index (a file of industrial products of outstanding design). As would be expected, the manner in which the individual products are displayed is pristinely designed by using a space framework with invisible joints, upon which are hung custom-made etched metal panels with detailed drawings and text which examine the design process for each item (see exhibit photo number 2; framework is described below, number 1). The exhibit is now appearing in Chicago at the Museum of Science and Industry, and will later be in Washington, D.C., at the American Institute of Architects' headquarters. Published in connection with the exhibition is a handsome 120-page book (with the identical title of the show); available at the exhibit or for \$25 from the Danish Design Council (H.S. Andersens Blvd. 18, DK-1553 Copenhagen V, Denmark). Selected products from the exhibition are shown and described here.

Janet Nairn

1 & 2. Abstracta display and construction system: designed by Poul Cadovius, 1960; manufactured by Abstracta Structures Inc. The star-shaped joining nuts are concealed within the tubes that form the lattice rods; framework made of round tubing, cut to required length and calibrated internally.

Circle 300 on reader service card
3. In-line centrifugal pumps: designed by Poul Due Jensen and Niels Due Jensen, 1977; manufactured by Grundfos Pump Corp. Well-proportioned external form was response to stress, efficiency and size requirements—all in relationship to interior technical functions.

Circle 301 on reader service card
4. MO 8000 chair: designed by Rud Thygessen and Johnny Sorensen, 1981; manufactured by Magnus Olesen A/S; distributed by Rudd International Corp. A ring of laminated wood holds two plywood discs forming the seat; top disc is concave, underneath disc is convex.

Circle 302 on reader service card
5. Super-elliptical table: designed by Piet Hein and Bruno Mathsson, 1968; manufactured by Fritz Hansens Eft. A/S. An evolution of Hein's design of a traffic roundabout for Stockholm, the table's shape is a modified ellipse. Detail shown of span-leg is a sophisticated, but simple solution.

Circle 303 on reader service card
6. Circular extension table 54: designed by Poul Kjaerholm, 1963; manufactured by Fritz Hansens Eft. A/S. Table adjusts from 140 cm to 210 cm without losing its circular nature; uses extension ring consisting of six identical 60-degree sections that interlock with table top and each other.

Circle 304 on reader service card
7. PH lamp: designed by Poul Henningsen, 1981; manufactured by Louis Poulsen & Co. Styled with multi-shades, the size, shape and position of shades determine light distribution without glare; design emphasizes modeling effect of shadows, tube and fixture colors and materials.

Circle 305 on reader service card
8. Telephone booth: designed by Trolle Trap-Friis, 1981; manufactured by The Copenhagen Telephone Co. This competition winner, called "the green roof" is partially enclosed in wire-mesh with transparent acrylic sheeting on the inside to screen user from wind and rain; wide enough for two people or use by handicapped in wheelchair.

Circle 306 on reader service card
 More products on page 153

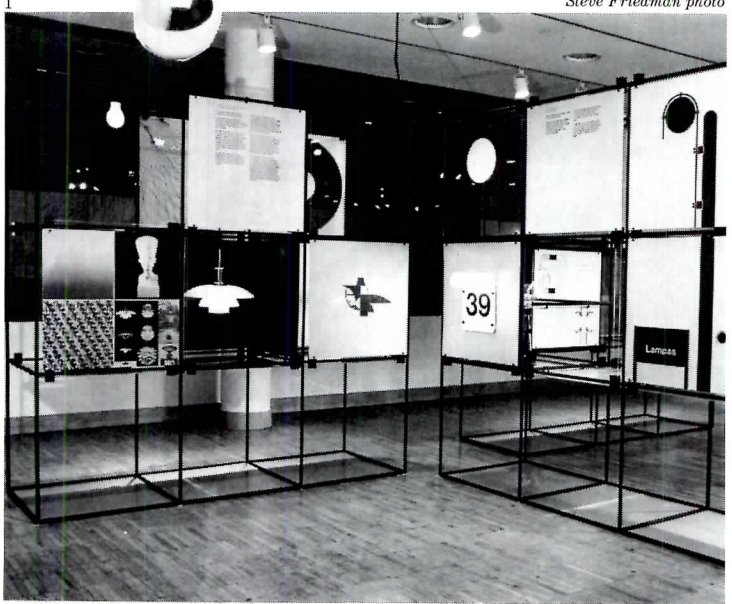
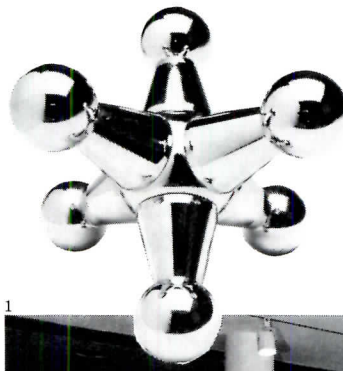

Steve Friedman photo

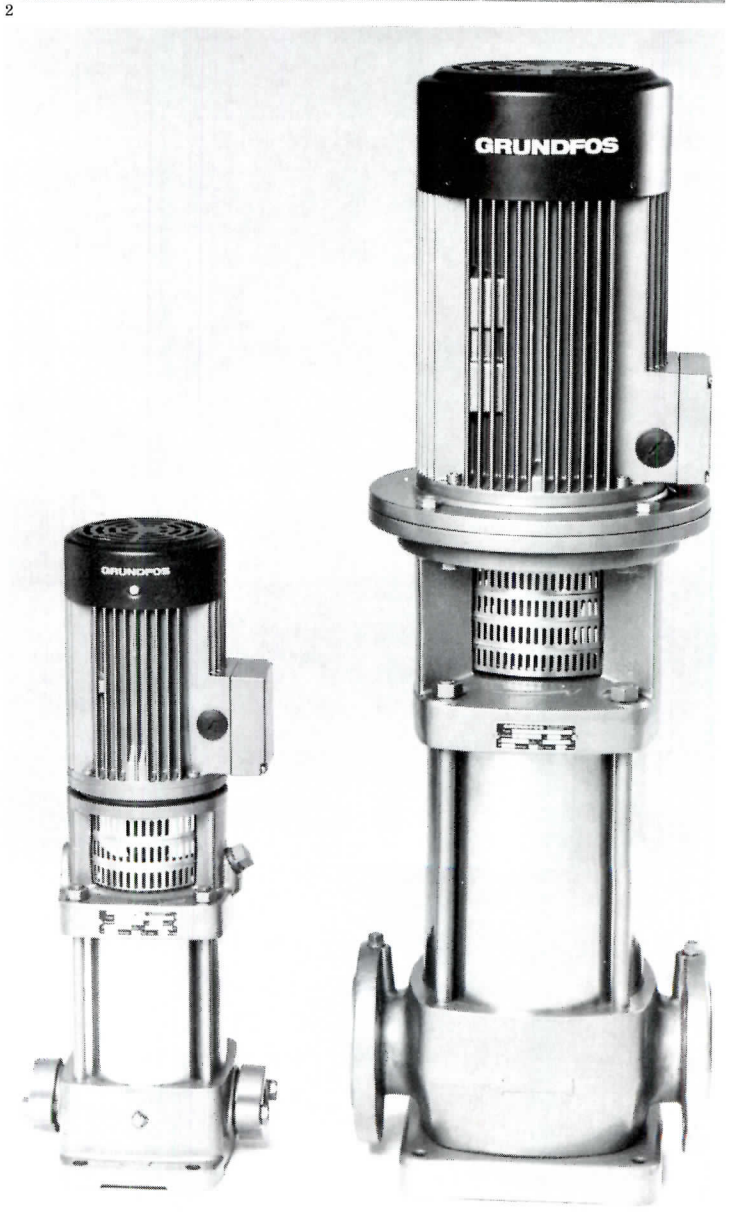

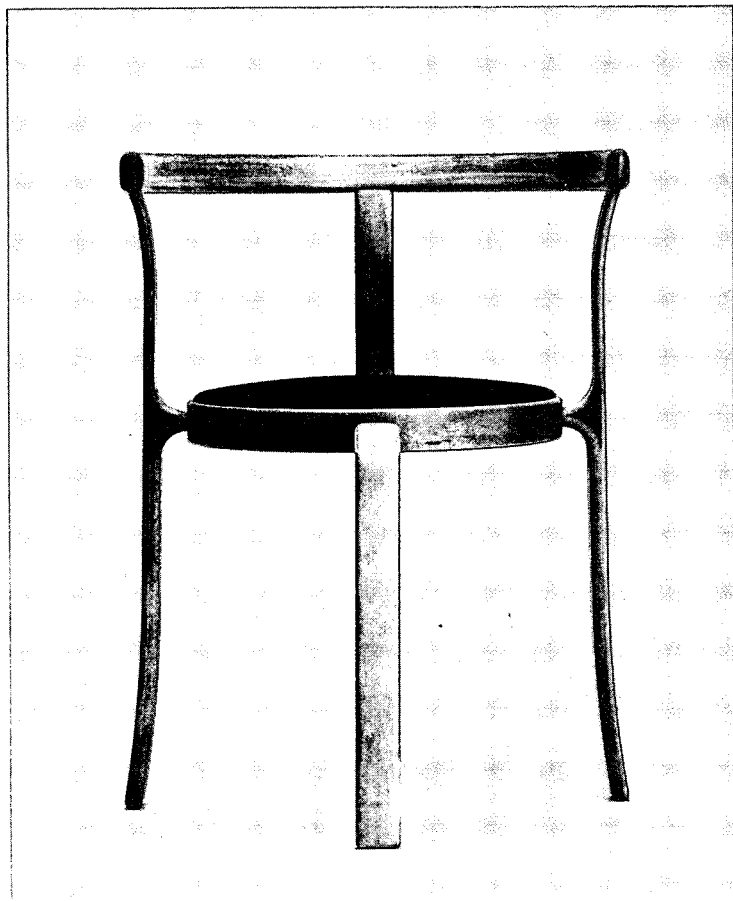

4



6

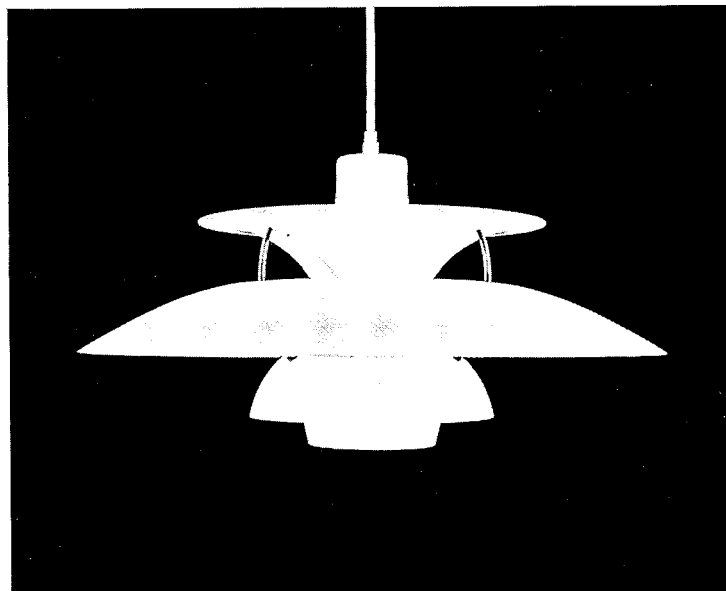

7

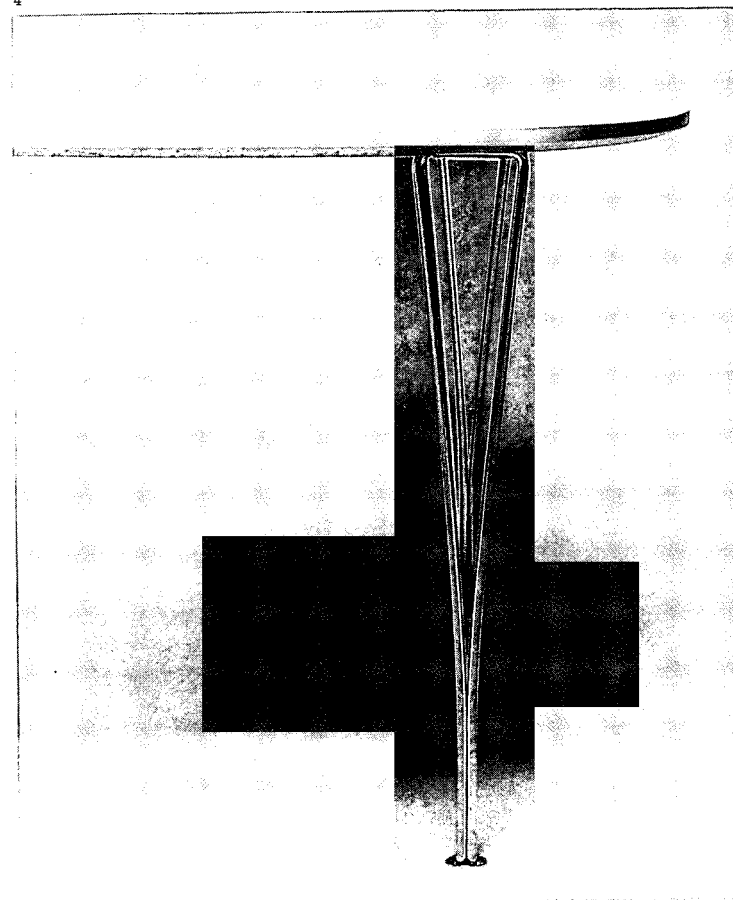

5

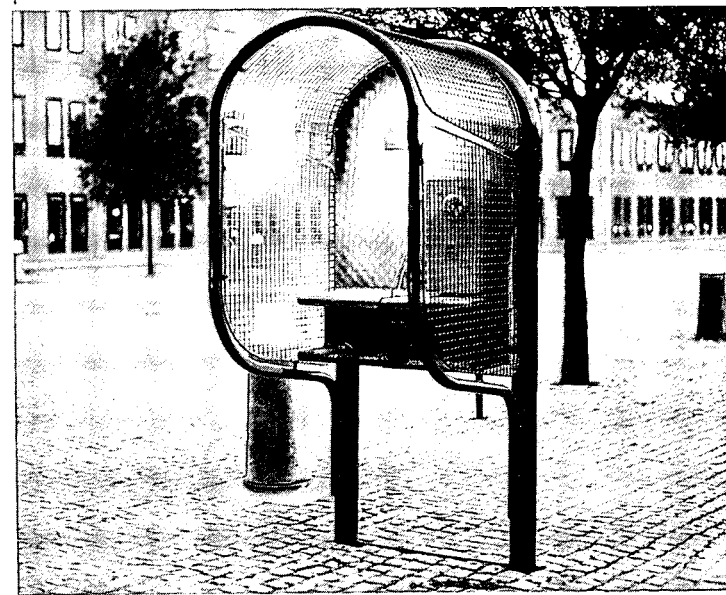

8



©1982 Interface

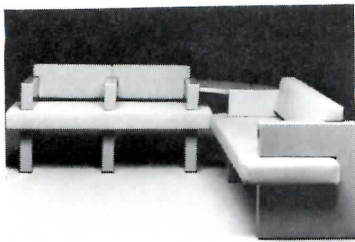

Seating

Interloc seating has a universal notched arm unit which combines seat and back elements of different lengths to form chairs, sofas and tandem seating runs which can be joined by straight, 45 deg or 90 deg tables. Arms and tables are finished in opaque lacquer. Harvey Propper, Inc., Fall River, Mass.
 Circle 307 on reader service card



Desk storage

An integrated desk and storage system, *Radius 3* combines rounded wood tops with metal pedestals. Tops are available in rift oak or walnut, or non-grained laminate with wood edging. This system allows a choice between wood or metal elements or a combination of both. Corry Jamestown Corp., Corry, Pa.
 Circle 310 on reader service card



Mahogany office

The *Series 3* line of desks, credenzas and breakfront cabinets features bookmatched mahogany veneer framed in solid mahogany with a 1/8-in. satin bronze reveal strip on the desk and credenza tops and on all sides. Cumberland Furniture Corp., New York City.
 Circle 311 on reader service card



Office seating

A variety of models of single shell office chairs is offered in the 6000 Series. Low back or high back with head rests, glides or casters, arms or armless, each chair consists of a polyurethane shell with the back covered in vinyl and the front upholstered. Castelli Furniture, Bohemia, N.Y.
 Circle 312 on reader service card
 Continued on page 159

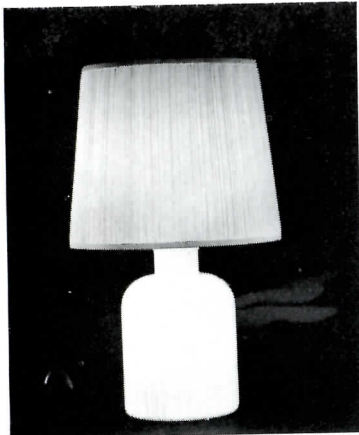

Table lamp

The *Opali* is made of European hand-blown glass and is lit by two bulbs—one inside the glass base causes the lamp to glow. The lamp stands 27 1/2 in. high and is available in white glass with a white muslin pleated shade. Koch + Lowy, Long Island City, N.Y.
 Circle 308 on reader service card



the finest in
 decorative and
 architectural
 ceramic tile



AMSTERDAM CORPORATION

NEW YORK: 950 Third Avenue (corner 57th St.), New York, NY 10022/(212)644-1350
 PHILADELPHIA: 2275 Washington Avenue, Philadelphia, PA 19146/(215)732-1492
 SAN FRANCISCO: Galleria-Design Center, 101 Henry Adams Street, San Francisco, CA 94103/(415)861-3354
 HAYWARD: 25029 Viking Street, Hayward, CA 94545/(415)887-2050
 For full color catalog, send \$2.50 to Amsterdam Corporation, 950 Third Avenue, New York, NY 10022

BURDINE'S
 Miami, Florida
 Architect: Walker Group; New York, NY
 Tile: Porcelain Dust Pressed Paver Tile

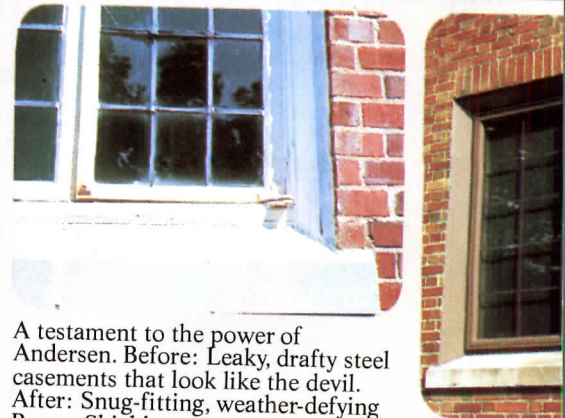
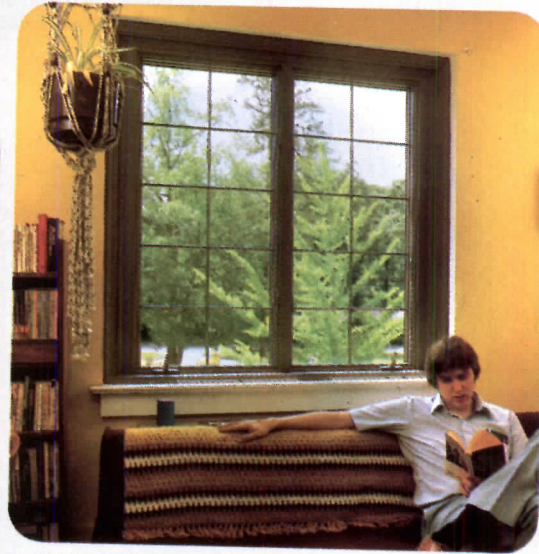

A testament to the power of Andersen. Before: Leaky, drafty steel casements that look like the devil. After: Snug-fitting, weather-defying Perma-Shield casements in dignified Terratone color.



Terminal display stands

Designed for video display terminals which have detached keyboards, this stand is claimed to increase operator comfort by adjusting to eliminate glare. Two models are available: one is freestanding, the other (not shown) is a portable unit designed for use on any worksurface. The model shown supports the screen and keyboard on separate surfaces, the angle and height of which are adjustable. Keyboard reach can be adjusted by moving the keyboard surface in or out. Steelcase, Grand Rapids, Mich. Circle 313 on reader service card



Chairs

The *Encore Series* includes 8 models from an executive chair to a work stool for drafting and clerical applications. Chairs feature posture control allowing a 20 deg movement in the chair back. Westinghouse Architectural Systems Division, Grand Rapids, Mich. Circle 316 on reader service card

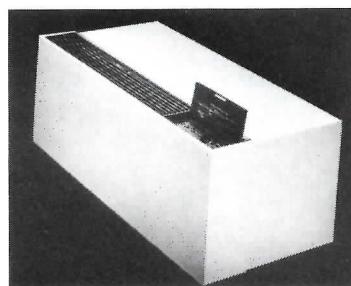

Heat pump package

The *Zoneline IV* electronic heat pump offers a number of new energy and reliability features. An internal condensate removal system automatically dissipates wintertime condensation generated during heat-pump operation. General Electric, Louisville, Ky. Circle 317 on reader service card

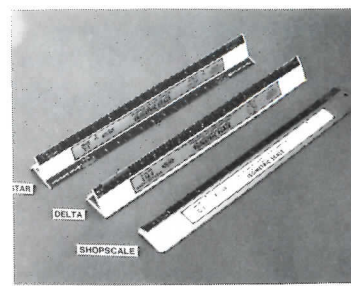

Drafting scale

For use with the *Trimetric 525*, two triangular scales provide two and one bevels on each of their three sides. These are arranged so the T-1, T-2 and T-3 graduations in a matched set appear in "use" position as the scale is rotated. Graphic-Standard Instruments Co., Troy, Mich. Circle 318 on reader service card
Continued on page 182



Sofa

Designed by Kenneth Bergenblad, the *Cicero* sofa is framed with polished chrome and upholstered with two seat cushions and straight armrests. Dux Interiors, Inc., New York City. Circle 314 on reader service card



Sofa

Leather and textiles cover this two- or three-seat *Pantera* sofa. A compatible chair is available as well. Back and seat cushions are removable and rest on a fully upholstered platform base. Brayton International Collection, High Point, N.C. Circle 315 on reader service card



CONDOR® Interlocking Rubber Tiles

New 5/8" thick, 12" x 12" high traffic lobby tiles are easy to install without adhesives. Easy maintenance, long lasting and ideal for sound absorption. The hidden interlocking tabs assure tight connections between tiles. The knob back provides aeration under tiles - no odor or mildew. They may be installed on the surface with a contrasting beveled border for safety. Recessed installations also available. Write or call Standard Products Division for full details.

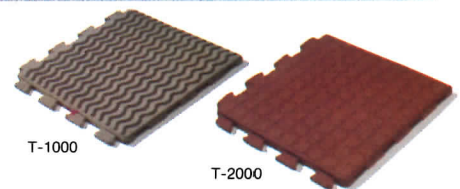
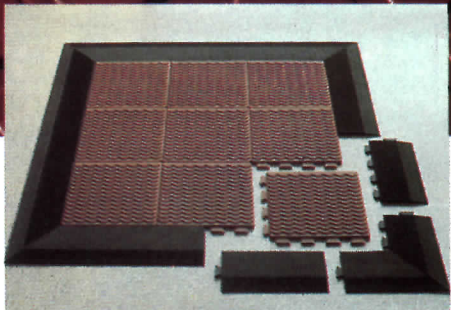

Available in 2 surfaces: T-1000 - curvilinear is 1/8" deep x 1/4" wide. T-2000 - 1/16" raised, 3/4" x 3/4" cubes. Both surfaces supplied in black, brown, terra cotta, tan, gray, blue, green.

STANDARD PRODUCTS DIVISION
Pawling Rubber Corporation
P.O.Box X, Pawling, New York 12564 / 914-855-1000



SWEET'S CATALOG (12.17/Pa)

LCN's new open door policy is as easy as this.



LCN's new Auto-Equalizer™ brings the benefits of barrier-free passage to people who are handicapped, disabled, or elderly.

At the push of a button, the pneumatically-powered Auto-Equalizer gently swings doors open automatically. Doors remain open for up to 30 seconds, allowing people who are handicapped to pass through unimpeded. And Auto-Equalizer does not require the use of warning mats or guardrails.

Auto-Equalizer does all this without sacrificing full door control or full closing power. It operates in both new construction and retrofit applications.

New Auto-Equalizer, for automatic door opening.



To get complete information about the new Auto-Equalizer, send for free information or contact your local LCN representative.

LCN CLOSERS

Part of worldwide Ingersoll-Rand

LCN Closers, Princeton, IL 61356. 815/875-3311, LCN Canada, Mississauga, Ontario L5G 4L5. 416/278-6128

Circle 61 on inquiry card



ELEVATORS BY DOVER

**Modern technology
blends with
contemporary
charm.**

Adding to the revitalized downtown area of San Antonio is the new Hyatt Regency, a \$38-million, 633-room luxury hotel on the Riverwalk along the San Antonio River. A series of waterfalls flows through the atrium lobby as an extension of the river. Six glass-walled, cylindrical Dover Elevators add their own excitement as they move guests through this dramatic space. For more information on Dover's complete line of Traction and Oilraulic® Elevators, write Dover Corporation, Elevator Division, Dept. 688, P.O. Box 2177, Memphis, Tennessee 38101.

DOVER®

The elevator innovators.



Hyatt Regency San Antonio
ARCHITECT:
Thompson, Ventulett, Stainback
& Associates, Atlanta
ASSOCIATE ARCHITECT:
Ford-Powell & Carson, San Antonio
GENERAL CONTRACTOR:
Hardin International, Inc., Atlanta
Dover Elevators sold and installed by
Dover Elevator Company, San Antonio

Tanks for the memories.

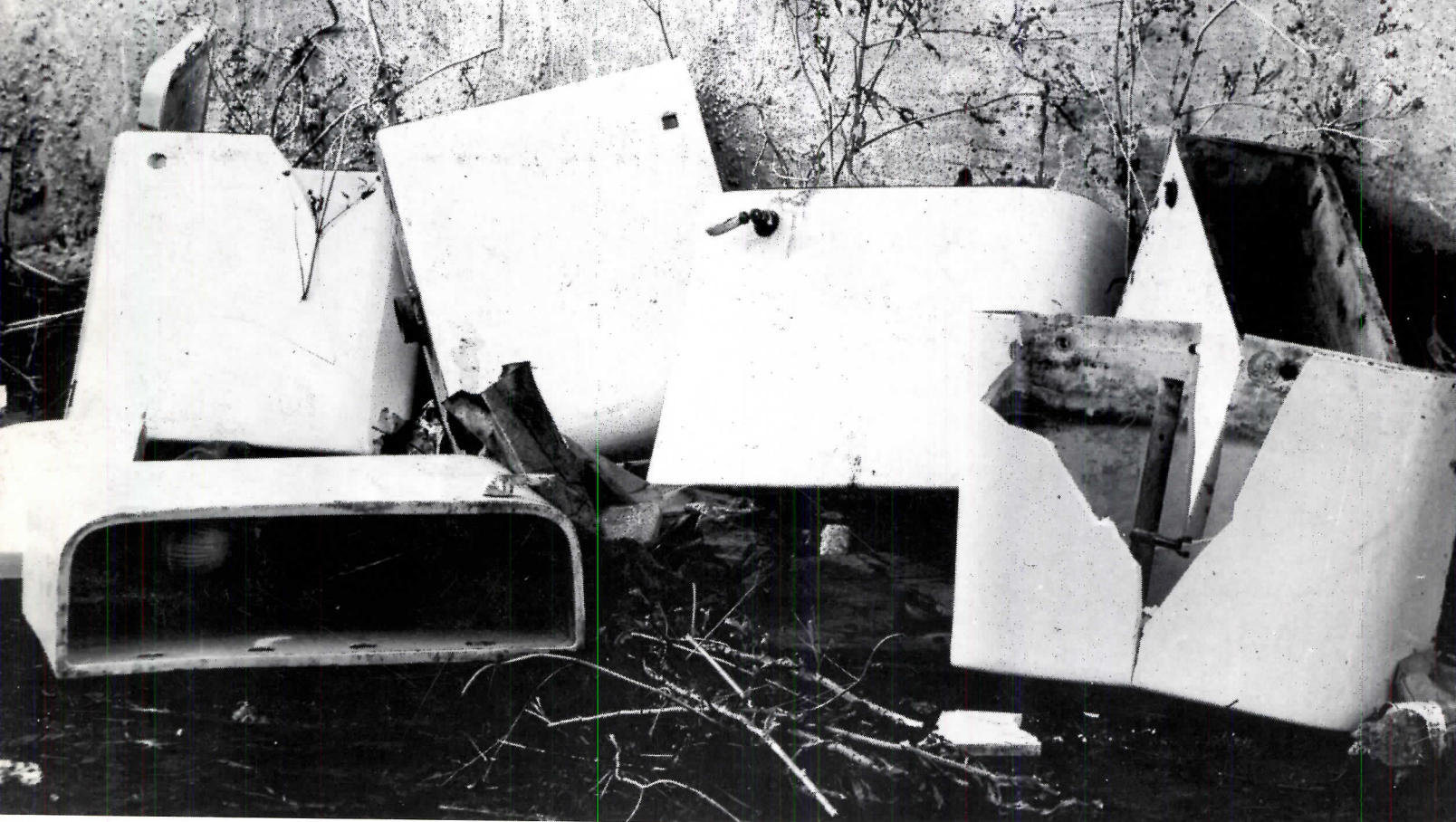

What's the point of equipping a toilet with a flush tank that (1) needs up to seven gallons of water to flush; (2) takes three minutes or more to refill; (3) wastes valuable bathroom space; (4) can leak and waste precious water; (5) contains far too many parts that need too much repair; and (6) is made of breakable porcelain?

The point is, a Sloan flushometer (flush valve) brings bowl flushing into the 20th century. A Sloan flushometer saves water on every flush, as much as 12% compared to a tank. It frees up floor space. It has far fewer parts and needs less maintenance than a tank. It makes cleaning the bathroom a lot easier. And it's a lot quieter than you think.

And with every Sloan flushometer, good looks go with superior function. It can be

exposed, with its gleaming chrome a highlight. Or it can be hidden out of sight. It can be flushed by our new hydraulic pushbutton.

These points (and more) are discussed in detail in an objective report, "Selecting the Proper

Flushing System for Your Building." It's yours, without obligation. Write us for a copy.

The next time you have to decide what goes in *your* bathrooms, you may find yourself saying, "Thanks, but no tanks."

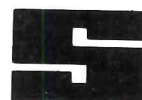
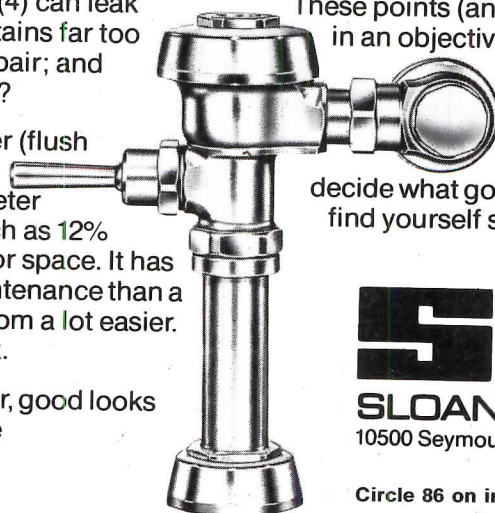

SLOAN VALVE COMPANY
10500 Seymour Avenue, Franklin Park, IL 60131

Circle 86 on inquiry card