

ARCHITECTURAL

RECORD

Business Design Engineering
A McGraw-Hill Publication, Six Dollars a Copy
December 1983



6420 MNE220 44DA3 SEP85
DB MINECOFF
MINECOFF INC
BOX 220592
CHARLOTTE NC 28222
JAN 5 1984

Armstrong redefines ceilings in geometric form.

New Suprafine™ Acoustical Ceilings

Armstrong introduces a remarkably high-style acoustical lay-in ceiling with exceptional design impact.

The tilelike appearance of Suprafine is created by a unique configuration of small-scale geometrics. The result is a sleek, sophisticated look, successfully disguising the ceiling's suspension system. That's because each Suprafine panel is precisely scored to incorporate its new narrow 9/16" grid.

But there's more to this ceiling than meets the eye. Suprafine provides fine acoustical control. Plus, 2'x2' tegular lay-in panels offer easy accessibility and low installation cost.

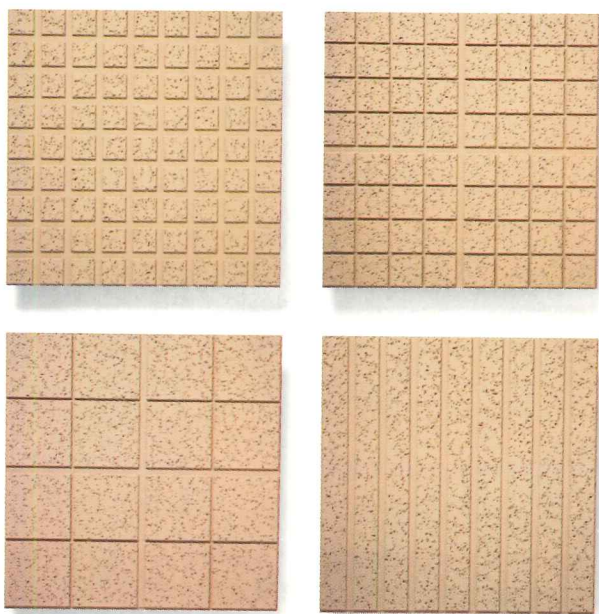

Available in three colors and five patterns (as shown in the interior and the four insets), Suprafine can help define the look of any space you design with a quality you get only from Armstrong.

For details on Suprafine acoustical ceilings, write Armstrong, Dept. 3CNAR, Box 3001, Lancaster, PA 17604.



Circle 1001 on inquiry card



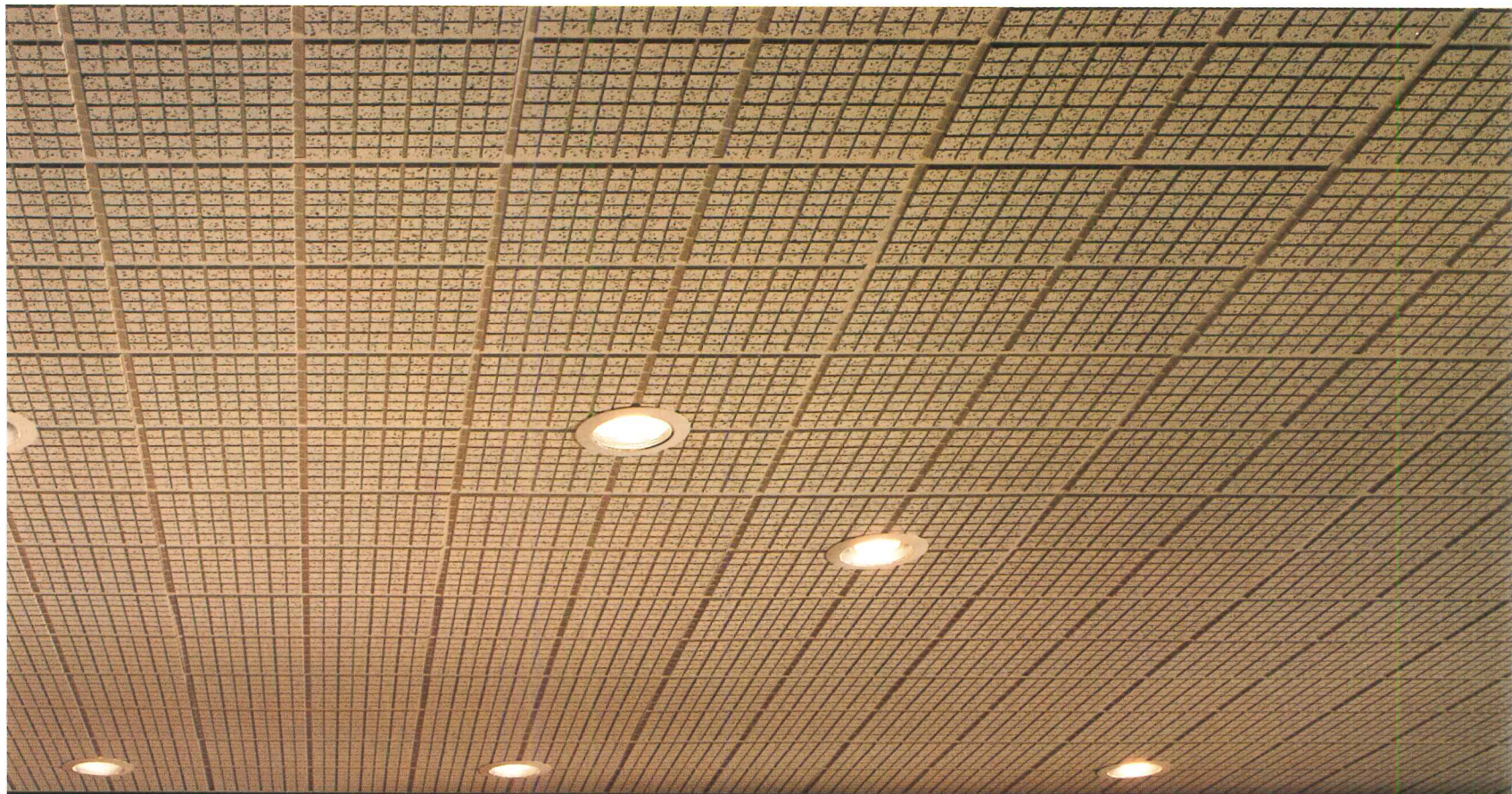

How to get microchips to Milan, lyrics to London and patents to Paris by noon tomorrow.

With TWA's Next Flight Out[®] Service your small packages get to Europe and the Middle East in a big hurry.

TWA can deliver anything from software to menswear. As long as it weighs 50 lbs. or less, we'll guarantee to pick it up and deliver it by the very next day.* And we'll even arrange for customs clearance. All for one low price. Just call us at 1-800-638-7380 to arrange for door-to-door pickup and delivery.

Over 20 flights daily to 10 international cities.

We can match our schedule to yours because TWA has over 20 nonstops a day from the U.S., to cities all over Europe and the Middle East. Including 7 daily nonstops to London. Plus nonstops to Athens, Cairo, Frankfurt, Lisbon, Paris, Milan, Madrid and Rome. And direct service to Tel Aviv.

Service to over 50 U.S. cities.

Within the U.S., TWA's Next Flight Out Service lets you choose from over

500 flights to more than 50 cities. We'll deliver any package up to 70 lbs. And for material weighing up to 2.2 lbs., you'll want to try our

convenient 13" x 17"

Next Flight Out Pak.

Either way, TWA guarantees Next Flight Out Service or we'll give you

your money back and ship it out on the next available flight, free of charge.

Just bring your package to the nearest NFO airport service center. For an additional charge TWA can arrange door-to-door pickup. Just call us at least 2 hours before flight time. For further information or to arrange pickup call us at 1-800-638-7380.

So no matter what you're sending, call TWA first. Because our Next Flight Out Service helps small packages meet big deadlines.

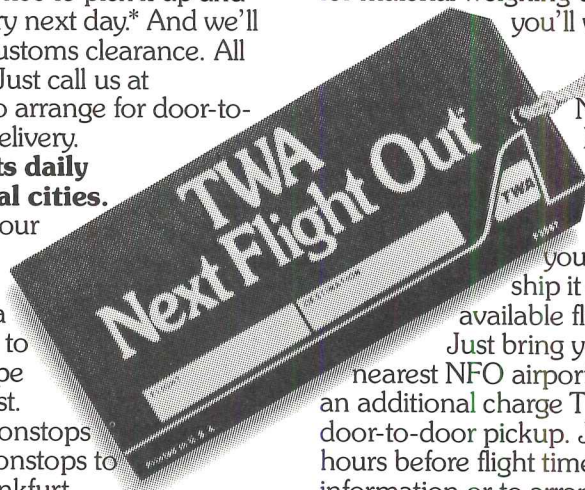

You're going to like us



*Or a partial refund will be provided.

Circle 1002 on inquiry card



Editor
Walter F. Wagner, Jr. AIA

Executive editor
Mildred F. Schmertz, FAIA

Managing editor
Natalie Gerardi

Senior editors
Robert E. Fischer, engineering
Herbert L. Smith, Jr., AIA, business
Charles K. Gandee
Douglas Brenner

Associate editors
Grace M. Anderson
James B. Gardner
Margaret F. Gaskie
Charles K. Hoyt, AIA

Assistant editors
Lindsay Li, products
Paul M. Sachner

Production editor
Annette K. Netburn
Susan Stein, assistant

Design
Alex H. Stillano, director
Alberto Bucchianeri, senior associate
Anna-Maria Egger, associate
Muriel Cuttrel, illustration
J. Dyck Fledderus, illustration

Design consultant
Massimo Vignelli

Editorial consultants
George A. Christie, Jr.
Jonathan Barnett, FAIA, AICP

McGraw-Hill World News
Peter Gall, director

Circulation director
Richard H. Di Vecchio

Business manager
Joseph R. Wunk
Ellen Muller Siegel, assistant

Marketing services manager
Camille H. Padula

Director of national advertising
Harrington A. Rose

Assistant to publisher
Elizabeth Hayman

Publisher
Paul B. Beatty

Letters/calendar, 4
Editorial: Product Reports 1984:
The manufacturer as part of the team, 39

Business

News, 15
Computers: CAD versus CAD, 19

Design

News, 23
Battery Park City:
A new residential skyline for downtown New York, 28

Engineering

Round Table: Conserving energy in the rehabilitated
or retrofitted building, 30

Products/Literature

UCI 1 Office equipment and supplies, 40
UCI 2 Site work, 56
UCI 3 Concrete, 59
UCI 4 Masonry, 60
UCI 5 Metals, 60
UCI 6 Wood and plastics, 70
UCI 7 Thermal and moisture protection, 74
UCI 8 Doors and windows, 103
UCI 9 Finishes, 141
UCI 10 Specialties, 157
UCI 11 Equipment, 169
UCI 12 Furnishings, 171
UCI 13 Special construction, 188
UCI 14 Conveying systems, 197
UCI 15 Mechanical, 200
UCI 16 Electrical, 211

Classified advertising, 230
1982 Editorial index, 238
Advertising index, 251
Editorial manufacturers' index, 6
Reader service cards, 9, 253

Georgetown University's Riggs Library, published in *Record Interiors 1983*, brought back memories of studying in the Andrew D. White Room of Cornell University's undergraduate library. Unfortunately, I usually did not get much done there since I would instead gaze distractedly at the wonderful architecture of the room. Like the Riggs Library, the towering space is filled with three levels of an ornate steel shelving structure which features overhead bridges, remote spiral staircases and secluded study alcoves, not to mention the ever-present curlicues of the Victorian style. As the space rises upward, it also expands outward in the form of a sumptuous bay window which provides a magnificent view of Cayuga Lake and the valley below. The ground level of the room contrasts the spaciousness with dark wood paneling, rich hunter-green carpet and robust furniture. As a student, I appreciated this retreat which Cornell's administration permitted me to use, and now, although I admittedly do not know the background of Georgetown's policy, I find it a shame that Georgetown's students are denied a similar privilege.

*Ellen Talbot, Interior Designer
Washington, D.C.*

With reference to your call for submissions to the 1984 *Record Houses* awards program, the jury should consist of people with diverging ideologies: organic, structural, Le Corbu, etc. Lately, it has been heavily weighted toward the monstrosity of "postmodernism," which has set back architecture 50 years, just as the Chicago "Columbian Exposition" did.

If you want fresh new work, also disqualify any firm that has previously appeared in *Record Houses*. We seem to get the same firms year after year.

*Alfredo Larin, AIA
San Diego, California*

May I take this opportunity to express the deep appreciation of all of us at the New York Landmarks Conservancy for the arena of exposure you have provided (October, 1983). The chronicle of our first ten years presented in such celebratory fashion is an inestimable boost to both Conservancy staff and board.

Of equal and far-reaching consequence, the ARCHITECTURAL RECORD piece is the occasion to tell the rest of the world what motivates us and provides the *raison d'être* of the Conservancy.

*Laurie Beckelman
Executive Director
New York Landmarks
Conservancy
New York City*

Corrections

We very much regret our inadvertent omission of Dian Boone's name from the list of consultants that appeared in your article on Wu Hall at Princeton University. Dian Boone's part in the interior design and furnishings of Wu Hall was crucial and we particularly regret the omission because of our long and valued association with her.

We also inadvertently omitted to mention Samuel Y. Harris, from our office, who was responsible for technical coordination and quality maintenance.

*Robert Venturi, FAIA
Philadelphia, Pennsylvania*

Re: ARCHITECTURAL RECORD, June 1983, page 95, I would like to make a correction to your caption for the Arbour Hospital. The building envelope is R-Wall which is manufactured by ISPO, Inc. I apologize for my tardiness in supplying this information to you.

However, the error was just brought to my attention today by Mr. Karl Hanton of Graham/Meus, Architects with whom we had consulted in the design/specification stage.

*William O. Bishop, P.E.
Director of Technical Services
ISPO, Inc.
Mansfield, Mass.*

December 14 to February 19
"Design In America: The Cranbrook Vision 1925-1950." 240 masterworks of the Cranbrook Academy of Art from its creation up until the death of its founder; at the Detroit Institute of Arts, 5200 Woodward Ave., Detroit, Mich. 48202 (313/833-7963).

Through January 15
"Lafayette Square 1963-1983: Architecture, Preservation and the Presidency." President John F. Kennedy's efforts to preserve Lafayette Square are depicted in photographs, drawings, architectural renderings and archives; at the Renwick Gallery, Pennsylvania & 17 St., Washington, D.C. (202/357-1300).

January 24-26
"Window Treatments '84" is a trade show of window treatment products; sponsored by Window Energy Systems (WES) Div. of the Industrial Fabrics Assn. International; at the Sheraton Center in New York City. To register, contact: WES, 345 Cedar Building, Suite 450, St. Paul, Minn. 55101 (612/222-2508).

January 27
Architectural Competitions; sponsored by the Architecture and Design Support Group of the Museum of Contemporary Art. At the UCLA Graduate School of Architecture, Los Angeles, Calif. (213/854-6307).

January 25-27
Business Telecommunications Exposition for communications managers; at Giants Stadium, Stadium Club, East Rutherford, N.J. For further information, contact: Michael C. J. Houston, T.E.G., Inc., 9128 Columbia Ave., North Bergen, N.J. 07047 (201/662-1318).

Through January 29
"Cervin Robinson: Photographs 1958-1983"; exhibition of photos of historic and recent buildings by Frank Furness, Louis Sullivan and Louis Kahn; organized by Rice Univ., at Wellesley College Museum, Wellesley, Mass. (617/235-0320).

February 3-5
Conference, "Leadership and Conflict Resolution for Engineers and Technical Professionals." Sponsored by Engineers Leadership Institute; at Bergamo Conference Center, Dayton, Ohio (614/424-6645).

February 6-9
International Modal Analysis Conference outlines technological advances in modal analysis for vibrating structures. Sponsored by Union College; at the Holiday Inn, International Drive, Orlando, Fla. (518/370-6288).

ARCHITECTURAL RECORD (Combined with AMERICAN ARCHITECT, and WESTERN ARCHITECT AND ENGINEER) (ISSN0003-858X) December 1983, Vol. 171, No. 14. Title® reg. in U. S. Patent Office, copyright© 1983 by McGraw-Hill, Inc. All rights reserved. Indexed in Reader's Guide to Periodical Literature, Art Index, Applied Science and Technology Index, Engineering Index, The Architectural Index and the Architectural Periodicals Index.

Every possible effort will be made to return material submitted for possible publication (if accompanied by stamped, addressed envelope), but the editors and the corporation will not be responsible for loss or damage.

Executive, Editorial, Circulation and Advertising Offices: 1221 Avenue of the Americas, New York, NY 10020.

Officers of McGraw-Hill Publications Company: president: John G. Wrede; executive vice presidents: Paul F. McPherson, operations; Walter D. Serwatka, finance and services. Senior vice president-editorial: Ralph R. Schulz. Senior vice president publishers: Harry L. Brown, David J. McGrath, James R. Pierce, Gene W. Simpson, John E. Slater. Vice president publishers: Charlton H. Calhoun III, Richard H. Larsen, John W. Patten. Vice presidents: Kemp Anderson, business systems development; Shel F. Asen, manufacturing; John A. Bunyan, electronic information services; George R. Elsinger, circulation; Michael K. Hehir, controller; Eric B. Herr, planning and development; H. John Sweger, Jr., marketing.

Corporation Officers: Harold W. McGraw, Jr. chairman; Joseph L. Dionne, president and chief executive officer; Robert N. Landes, senior vice president and secretary; Ralph J. Webb, treasurer.

Associated Services/McGraw-Hill Information Systems Co.: Sweet's Catalog Files (General Building, Engineering, Industrial Construction and Renovation, Light Residential Construction, Interiors), Dodge Building Cost Services, Dodge Reports and Bulletins, Dodge/SCAN Microfilm Systems, Dodge Management Control Service, Dodge Construction Statistics, Dodge regional construction newspapers (Chicago, Denver, Los Angeles, San Francisco). Subscription rates for personnel of Architectural, Engineering, Interior Design, Design and other directly related firms and students thereof, are as follows: U.S. and U.S. Possessions \$30.00; Canada \$32.00; all other countries \$60.00. For all other personnel: U.S. and U.S. Possessions \$41.00; Canada \$43.00; all other countries \$68.00. Publisher reserves right to determine subscription rates which apply. Single copy price for Domestic and Canadian: \$6.00; for Foreign: \$7.00.

Change of Address: Forward changes of address or service letters to Fulfillment Manager, ARCHITECTURAL RECORD, P.O. Box 430, Hightstown, NJ 08520. Provide both old and new address; include zip code; if possible attach issue address label.

Guarantee: Publisher agrees to refund that part of subscription price applying to unfilled part of subscription if service is unsatisfactory. *Copyright and Reprinting:* Title® reg. in U. S. Patent Office. Copyright© 1983 by McGraw-Hill, Inc. All rights reserved. Where necessary, permission is granted by the copyright owner for libraries and others registered with the Copyright Clearance Center (CCC) to photocopy any article herein for the base fee of \$1.50 per copy of the article plus 10 cents per page. Payment should be sent directly to the CCC, 21 Congress Street, Salem, MA 01970. Include code with request: ISSN0003-858X (\$1.50 + .10). Written permission must be secured for any other copying. Write Reprint Manager for such permission at address below, or to obtain quotations on bulk orders.

Subscription List Usage: Advertisers may use our list to mail information to readers. To be excluded from such mailings, subscribers should send a request to: ARCHITECTURAL RECORD, Mailing List Manager, P.O. Box 555, Hightstown, N.J. 08520.

Publication Office: 1221 Avenue of the Americas, New York, New York, 10020. ARCHITECTURAL RECORD (ISSN0003 858X) published monthly except May and September when semi-monthly, by McGraw-Hill, Inc. Second-class postage paid at New York, NY and additional mailing offices.

Postmaster: Please Send address changes to Fulfillment Manager, ARCHITECTURAL RECORD, P.O. Box 430, Hightstown, NJ 08520. THIS ISSUE is published in national and separate editions. Additional pages or separate editions numbered or allowed for as follows: Eastern Section 22Ea through 22Ed. Central Section 22Ca through 22Cb. Western Section 22Wa through 22Wd. Sunbelt Section 22Sa through 22Sd.

BEAUTIFUL CERAMICS

**Metropolitan Ceramics
goes 100% natural gas to
produce its high-quality
IRONROCK® tile.**

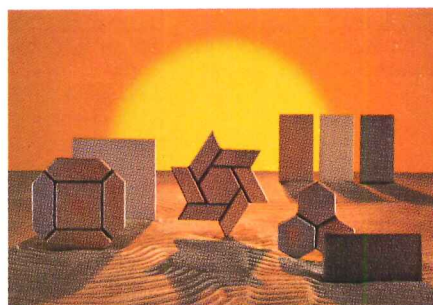

"We've taken out our dual-fuel capability, and we only use gas," says J. Steven Renkert, president of Metropolitan Ceramics, one of the country's leading tile manufacturers, located in Canton, Ohio. "Gas is more precise. It's cleaner and gives us better quality control for our critical color uniformity," he says.

Metropolitan's IRONROCK® tile is recognized as one of the best unglazed, high density tile lines made in the U.S. It is admired for the beauty of its natural earth-tone colors, and for its exceptional durability. 100 million shuffling feet a year haven't scuffed the IRONROCK that paves 10 acres of the new Atlanta airport.

For over 80 years, Metropolitan paving tiles and bricks have been used for flooring, walls, sidewalks and roads—including part of the original Lincoln Highway and several of the Manhattan tunnels. Using new technology, Metropolitan now produces IRONROCK split tile and the new Normandie® line for residential and fine commercial applications. Both lines are as durable as brick, but easier to ship, install and maintain.

The tiles get their reduction-fired or clear-toned colors from the firing process in two large kilns. They were designed to burn either oil or gas, but after experimenting with both, Metropolitan decided to stick with gas exclusively.

Like Metropolitan Ceramics, more and more manufacturers are finding that clean, efficient natural gas works best to meet their energy needs.

Gas gives you more for your money.

© 1983 American Gas Association

Manufacturers' index for Product Reports 1984

Names and addresses of companies whose products and literature appear in the editorial section of Product Reports, pages 39-216, are alphabetically listed below; following the company names are Reader Service Numbers. The Index to Advertising appears on page 251.

- A**
A&J Washroom Accessories, div.
A&J United Machine & Metal Products Corp., 396
ABBAKA Trading Co., Inc., 611, 617, 660
Abstracta Structures Inc., 409
Acorn Wire and Iron Works, Inc., 408
Acoustics Development Corp., 397
ACTRON Inc., 424
Adden Furniture, Inc., 457, 529
ADT, 652
Advance Lifts, Inc., 410, 425
Advance Transformer Co., 709
Advanced Color Technology Inc., 58
AEP/SPAN, 148
Agati Manufacturing, Inc., 437
Aiphone Intercom Systems, 721
Air-Tech Industries, Inc., 5, 57
Alcan Building Products, 105
Algoma Hardwoods, Inc., 231
All-Steel Inc., 528, 541, 553
AllianceWall Corp., 197
Allied Fibers & Plastics Co., 337
Allmetal, Inc., 244
Alma Desk Co., The, 475
Am-Finn Sauna Co., 564
AMCO Engineering Co., 15
American Ceramics, 347
American General Products Inc., 117
American Glass Light Co., The, 665
American Hydrotech, Inc., 185
American Institute of Timber Construction, 136, 138
American Locker Security Systems, Inc., 379
American Olean Tile Co., 306, 314
American Plywood Assn., 139, 140
American-Standard, 620
American Wood Council, 137
AMSCO/American Sterilizer Co., 423
Amsterdam Corp., 299
Andco Industries Corp., 395, 407
Andersen Corp., 212, 238
Anderson Hardwood Floors, 336
Appropriate Technology Corp., 540
ARCAD, 48
Architectural Aluminum Manufacturers Assn., 257
Architectural Area Lighting, subs. Kidde, Inc., 674
Architectural Signing Inc., 394, 406
ARCO Chemical Co., div. Atlantic Richfield Co., 183
Arena Dome Assoc., 568
Aristokraft, 502
Armstrong World Industries, Inc., 278, 297, 312, 324, 360
Arrigoni Computer Graphics, 16, 54
Artec, div. Kimball International, 465
Artistic Brass, div. NI Industries, Inc., 606
Artograph, Inc., 417
ASC Pacific, Inc., 184
Atelier International Lighting, 695
Atelier International, Ltd., 482
Atlas Door Corp., 242
Auto-trol Technology Corp., 26
Autoquip Corp., 422
Aydin Controls, 34
Azrock Floor Products, 282
- B**
B&B America, div. Stendig International, 442
Babcock & Wilcox Co., Insulating Products Div., 637
Badische Corp., 335, 347
Ball Zinc Products Div., 164, 187
Bally Case & Cooler, Inc., 151
Baltimore Aircoil Co., Inc. subs. Merck & Co., Inc., 649
Bausch & Lomb Interactive Graphics, 22
Bell & Howell Automated Systems Div., 588
Benchmark Doors Div., General Products Co., Inc., 240
Best Manufacturing Co., 366
Beylerian Limited, 511
Bieffeplast USA, 435, 455
Bigelow-Sanford, Inc., 284, 293, 311
Bilco Co., The, 107
BLU-RAY, Inc., 30
Bobrick Washroom Equipment, Inc., 365
Bogen Div., Lear Siegler, Inc., 672, 676, 715
Bomanite Corp., 65, 72
Bradley Corp., 385, 636, 648
Brand-Rex Co., Telecommunications Div., 708
Brandir International, Inc., 69
Brayton International Collection, 472
Broadcast & Related Products/3M, 661
Brueton Industries, 473
Bruning, 20, 29
Buchtal, 186
Burke Co., The, 90, 91
Burndy Corp., 656
Burns & Russell Co., The, 98, 101
- C**
Cabot, Inc., Samuel, 359
CADAM Inc., 3
California Cooperage, 577
California Redwood Assn., 127, 141, 143
Canam Hambro, div. Canam Steel Corp., 109
Canterbury International, div. Canterbury Designs, Inc., 66
Capaul, div. Acoustiflex Corp., 361
Capri Lighting, 680
Carlisle SynTec Systems, 167
Carolina Seating Co., div. U.S. Furniture Industries, 504
Castelli Furniture, Inc., 468
Caterpillar Engine Div., 635
Ceco Corp., The, 93, 272
Ceramic Radiant Heat, 370
Certainteed Corp., 159
Cervitor Kitchens, Inc., 420
Challis Stairways, Inc., 128
Champion International Corp., 132
Charrette Corp., 488
Chartpak, 12
Chessell-Robocom Corp., 6
Chicago Faucet Co., The, 618
Chief Industries, Inc., Building Systems Div., 188
C I Designs, Inc., 507
Claridge Products & Equipment, Inc., 363, 405
Clayburn Industries Ltd., 115
Cobb Co., T.M., 224
Cold Spring Granite Co., 102
Coleman Co., Inc., The, 619
Colorado Electro Optics, Inc., div. Linear Corp., 690
Columbia Cascade Timber Co., 63
Columbia Lighting, Inc., subs. U.S. Industries, 720
Computer Applications Corp., 7
Computer Devices, Inc., 41
Concrete Reinforcing Steel Institute, 86
Congoleum Corp., Resilient Floor Div., 323
Conproco Corp., 111
Conservolite, Inc., 655
Consoweld Corp., 124, 134
Construction Specifications Service, 59
Contempra Furniture Div., Fisher Scientific Co., 526
Continental Instruments, 666
Contract Lighting Systems, div. TSAO Designs Inc., 681
Conwed Corp., 304, 384, 501, 552
Coppes Napanee, 449
Corbin Div., Emhart Hardware Group, 211
Cota Industries, Inc., 170
Couristan, Inc., 281, 300
Cramer Inc., 445
Creative Glassworks International, Inc., 234
Crystal Tips Ice Products, 413
Cumberland Furniture Corp., 466, 527
Cumberland Woodcraft Co., Inc., 477
Cupples Products Div., H.H. Robertson Co., 245
Cy Mann Designs Ltd., 495
- D**
D + W Inc., 28
Da-Lite Screen Co., Inc., 706
DACOR Corp., 414
DATA TEChnology, Inc., 18
Datapoint Corp., 24
Dataprint Corp., 43
Decoustics, 319, 346
Design Logic, Inc., 50
Design Selections International, 460, 486
DesignNetwork International, div. Xetron Corp., 49
DesignTex Fabrics, Inc., 489, 512
DeSoto, Inc., 358
DeVAC, Inc., 247
Diazit Co., Inc., 32
Digital Equipment Corp., 450
DISCO Aluminum Products Co., div. Circle "S" Industries, 246
Domore Corp., 539, 551
Donghia Textiles, 434
Donn Corp., 302, 404
Dow Chemical Co., The, 161, 189

Dryvit System, Inc., 190, 290
Du Pont Co., 334, 349
Dual-Lite, Inc., 719
Dukane Corp., 689
Dur-O-Wal, Inc., 103, 112, 113,
114

E

Eagle Manufacturing Co., 248
Eastern Cyclone Industries, Inc.,
599
Eaton-Kenway, Inc., subs. Eaton
Corp., 415
Eckel Industries, Inc., Eckoustic
Div., 554
Edward Fields Inc., 285
Elden Computer Systems, 25
Elden Enterprises, Inc., 53
Eljer Plumbingware, 607
Elkay Manufacturing Co., 612
ELR Enterprises, Inc., 374
EMCO, Inc., 392
Endura, div. The Biltrite Corp.,
295
Engineered Components, Inc., 194
Envirovac Inc., 556, 576, 647
Epic Metals Corp., 718
Ernest Treganowan, Inc., 309
Eurotex, 308
Evans Products Co., Forest-Fiber
Products Group, 152
Evans Products Co., Permaglas
Div., 182, 191
Executive Office Concepts, 517
Exit-Us, Inc., 650

F

Ferro Enameling Co., 249
Fiat Products, Inc., 614
Fibergrate Corp., 142
Fisher Skylights, Inc., 195
Flax, Sam, 538
Form Products Div., Wausau
Tile, Inc., 71
Forms & Surfaces, 61, 67, 215,
218, 239
Four Seasons Solar Products
Corp., 575

G

Gabbianelli, dist. by Hastings
Tile, 289
GAF Corp., 193
Gardeco Lighting, 664, 685
General Binding Corp., 10
General Electric Co., Lighting
Systems Department, 696
General Electric Co., Plastics
Operations, 123
General Elevator Corp., 587
General Glass International
Corp., 274
Geocel Coating Systems Inc., 192
Georgia-Pacific Corp., 135
Gerber Scientific Instrument Co.,
9
GF Furniture Systems, Inc., 550
Glass Tempering Assn., 273
Globe Amerada Glass Co., 275
GMT/Contract Vinyl Tile, 317
Gold Bond Building Products, 321
Gory Associated Industries Inc.,
160

Grace & Co., W.R., Horticultural
Products, 75
Graphic Horizons, Inc., 11
Gretchen Bellinger Inc., 470
Groundworks, Inc., 499
Grunau Sprinkler Manufacturing
Co., Inc., 615
GTE Lighting Products, 655, 705
Guardian Industries Corp., 243,
267
Gulistan Carpets by J.P. Stevens,
313
Gunlocke Co., The, 462

H

Halo Lighting Div., McGraw-
Edison Co., 663, 675
Hanna Industries, 426
Hardwood House, Inc., 441, 447
Harry Lunstead Designs, Inc.,
106
Hartco, Inc., 279, 292
Harter Corp., 481
Harvard Software, Inc., 4
Harvey Probber Inc., 487
Hastings Pavement Co., Inc., 92
Hastings Tile & Il Bagno
Collection, 608, 634
Haworth, Inc., 506, 525, 537
Haws Drinking Faucet Co., 605
Heatilator Inc., 403
Heller Contract, div. The Heller
Co., Inc., 500
Herman Miller, Inc., 454
Hewi, Inc., 271
Hickman Co., W.P., 171
Hiebert, 524, 536, 549
High Performance Coatings Div.,
Porter Paint Co., 303
Holguin & Assoc., Inc., 37
Holmsten Ice Rinks, Inc., 558, 563
Honeywell Commercial Div., 717
Hope's Architectural Products,
Inc., 208
Hordis Brothers, Inc., 277
Howard Mfg. Co., 84
Howe Furniture Corp., 548
Howmet Aluminum Corp.,
Architectural Products Div.,
276, 391
Hunter Douglas Inc., 235, 371,
383, 402
Huntington/Pacific Ceramics,
Inc., 316
Hurd Millwork Co., 210
Hurlbut, Inc., P.S., 390
HydRadiant, Inc., div. Gyp-Crete
Corp., 559
Hydrozo Coatings Co., 333, 357

I

ICF, Inc., 444, 480
Image Graphics, Inc., 17
IMLAC Corp., 51
Impo Glaztile, Inc., 315
Inclinor Co. of America, 598
Information Displays, Inc., 27
Inlite Corp., 662, 704
Innocrete Systems, Inc., subs.
Construction Specialties, Inc.,
393
Inryco, Inc., 266
Insoport Industries Inc., 255
INSUL/CRETE Co., Inc., 172

Intalite Louvers and Ceilings
Inc., 562
Integrated Ceilings, Inc., 294
Interactive Graphic Services Co.,
Inc., 47
Intergraph Corp., 31
International Building Products,
Inc., 154
IPF International, 459
Iron-A-Way, Inc., 411, 421
ITT Outdoor Lighting, 678

J

Jacuzzi Whirlpool Bath, 623
James Systems Div., James Metal
Products Co., 523
Jarvis Steel & Lumber Co., Inc.,
121
JG Furniture Systems, div.
Burlington Industries, 505, 535
Johnson Controls, Inc., 686

K

Kalwall Corp., 162
Karastan Rug Mills, div.
Fieldcrest Mills, Inc., 283
Kardex Systems, Inc., 547
Kathabar Systems, div. Midland-
Ross Corp., 633, 646
Kawneer Co., 252, 268
Kelley Co., Inc., 251
Kelley Energy Systems, Inc., 198
Kelvinator Appliance Co., 428
Kenall Manufacturing Co., 669,
716
Kentile Floors Inc., 345
Kentucky Wood Floors, Inc., 356
Kim Lighting, Inc., 683
Kimball Office Furniture Co.,
div. Kimball International, 469,
522
Kinetics Furniture, 490
Kinnear, div. Harsco Corp., 256
Kitchen Kompact, Inc., 491, 534
Kittinger Co., 509
Kleidon & Assoc., Inc., 13
Knoll International, 453, 508
Knox Manufacturing, 427
Koch + Lowy Inc., 692
Koh-I-Noor, 2
Kohler Co., 603
Koppers Co., Inc., 144, 199
Kroin Inc., 70, 382, 364, 625
Krueger, 456
Kwik-Wall Co., 401

L

Labconco Corp., 416, 429
LAM Inc., 657
Landscape Forms, Inc., 439
Landscape Structures, Inc., 62, 78
Lapeyre Stair, Inc., 126
Laticrete International, Inc., 173,
574
LCN Closers, 216
Lee Jofa, 438
Lees Carpets, 332
Lehigh-Leopold, div. Litton
Business Systems, 471
Lennox Industries Inc., 624, 645
Letraset USA, 44
Leviton Manufacturing Co., Inc.,
703

Liberty Industries, Inc., 632
Lighting Assoc., Inc., 651, 697
Lighting Services Inc., 667
Litecontrol Corp., 682
Litelab Corp., 687
Litton UHS, 586
Logan Co., a Figgie International
Co., 119
Lonseal, Inc., 318
Lord Chemical Products Group,
355
LouverDrape, Inc., 378
Lowenstein, Inc., 476, 503
Lyon Metal Products, Inc., 381

M

Majestic Co., subs. American-
Standard, 375, 389
Manuel Canovas, Inc., 461
Manville Corp., The—Manville
Building Materials Div., 149,
196
Mapes Industries, Inc., 168
Marathon Carey-McFall Co., 373
Marazzi USA, Inc., 310
Marble Technics, Ltd, 150
Maren Engineering Corp., 412
Marlee Electronics Corp., 659, 702
Marvel Metal Products Co., 497,
546
Marvin Windows, 207, 229
Masonite Corp., Commercial Div.,
301, 344
Mayline Co., Inc., 52
McKinney, subs. Kidde, Inc., 400
McNichols Co., 118
mcPhilben Lighting, div.
Emerson Electric Co., 693
Means Co., Inc., R.S., 36
Mercantile Development, Inc., 79
Mercer Plastics Co., Inc., 286
Merida Meridian, Inc., 325, 331,
483
Merillat Industries, Inc., 521
Metal Sales Manufacturing Corp.,
174
Metropolitan Furniture Corp.,
467
Microphor, Inc., 602, 644
Mid-State Tile Co., 343
Midland-Ross, Electrical
Products Div., 654
M M Systems Corp., 354
Modern Maid, 418
Modern Mode, Inc., 448, 516
Mohawk Sign Systems, div.
Mohawk Engraving Co., Inc.,
399
Monarch Tile Manufacturing,
Inc., 330
Montgomery Elevator Co., 585,
597, 600
Moore Co., The, 372, 388
Mosler, subs. American
Standard, 419, 430
Mueller Furniture Corp., 492
Multronic-Zurich AG, dist. by
Swiss Blinds, Inc., 387
Musson Rubber Co., The R.C., 307
Mutoh Industries, Ltd., 14
MW Manufacturers, 206
Mylan Industries Inc., 108
Myrtle Desk Co., 514

- N**
 Nanik, div. Wausau Metals Corp., 227
 National Fire Protection Assn., 631
 National Partitions & Interiors, 555, 573
 National Products Div.—Potter Industries, 352
 National Woodwork Manufacturers Assn., 269
 Naturescapes, 342
 Neenah Foundry Co., 68
 Neo-Ray Products Inc., 668
 New England Lock & Hardware Co., 220
 Nixalite of America, 83
 Nora Flooring, 291
 Norco Windows, Inc., 236, 258
 Nord Co., E.A., 219, 253
 NuTone Div., Scovill Inc., 165, 200, 677
- O**
 Oce-Industries Inc., 21
 O'Keeffe's, Inc., 175
 Otis Elevator Co., 584, 589, 595, 601
 Owens-Corning Fiberglas Corp., 163
 Ozalid Corp., 19
- P**
 Pace Collection, The, 436
 Pacific Lumber Co., The, 122, 133
 Paddock Pool Equipment Co., Inc., 571
 Panel Concepts, Inc., 451
 Panelfold, Inc., 223, 376
 Parker Co., The Charles, 362, 377
 Pass & Seymour Inc., Wiring Device Div., 714
 Patcraft Mills, Inc., 353
 Peachtree Doors Inc., 237
 Peerless Electric Co., 691
 Pella Rolscreen Co., 209, 217, 222, 241
 Pellerin Milnor Corp., 431
 PermaGrain Products, Inc., 320, 329
 Phillips Fibers Corp., subs.
 Phillips Petroleum Co., 201
 Phillipsburg Div., Bell & Howell, 40
 Piemme of the Americas Ltd., 288, 341
 Pittsburgh Corning Corp., 254
 Plan Hold Corp., 35
 Plaskolite, Inc., Commercial Div., 259
 Playfield Industries, Inc., 561
 Plymouth Booths, 478
 Poggenpohl USA Corp., 496
 Porter Carpet Mills, Inc., 533
 Portland Cement Assn., 85, 89, 94
 Potlatch Corp., 130
 PPG Industries—Coatings and Resins Div., 328
 Prestressed Concrete Institute, 88
 Preway Inc., 367
 Prime Computer, Inc., 56
- Project Software & Development, Inc., 57
 Proudfoot Co., Inc., The, 99
 P.S. Decor, div. Photographic Specialties, 545
 Pyrotronics, 643
- R**
 R-Way, 520
 Raceway Components, Inc., 658
 Rally Racks, div. Rally Enterprises Inc., 73
 Ralph Wilson Plastics Co., 145
 Rambusch, 673
 Rauland-Borg Corp., 684, 701
 R.C.A. Rubber Co., an Ohio Corp., 340
 Recreonics Corp., 566
 Republic Powdered Metals, Inc., 204
 Reynolds Metals Co., 202
 Rhoflex Div., Teltex Inc., 176
 Ricoh of America, Inc., 23
 Rixson-Firemark Div., 228, 261
 Robbins, Inc., 296
 Robertson Co., H.H., 380
 Robertson Co., H.H., Western Architectural Systems Div., 260
 Roofing Systems, J.P. Stevens & Co., Inc., 146
 Roppe Rubber Corp., 280, 351
 Rosemount Office Systems Inc., 443
 Royal Business Machines, Inc., 60
 Rubber & Plastics Compound Co., Inc., 203
 Runtal—North American Energy Systems, Inc., 630
 Rush-Hampton Industries, Inc., 642
 Russwin Div., Emhart Hardware Group, 230
- S**
 Sanspray Corp., 156
 Scheirich Co., H.J., 479
 Schindler Haughton Elevator Corp., 583, 594
 Schlage Lock Co., 226
 Scope Furniture Ltd., 464
 Scotsman Ice Systems, 432
 Security Engineering, Inc., 214, 233
 Sedgwick Lifts, Inc., 582, 593
 Seton Name Plate Corp., 368
 Shakertown Corp., 166
 Shakespeare Electric Utility Products Group, 81
 Sherwin-Williams, Chemical Coatings Div., 327
 Sigma Design, Inc., 33
 Simplex Ceiling Corp., 339
 Simplex Security Systems, Inc., 270
 Simplimatic Engineering Co., 581
 Simpson Timber Co./Door Div., 232, 263
 Siplast, 169
 Sitecraft by Rosenwach, Inc., 74
 Slant/Fin Corp., 629
 Slater Electric Inc., 688
 Sloan Valve Co., 621
 Smith Metal Arts, 498, 531
 Solar Industries, Inc., 560, 570
- Solar Power Corp., 565
 Solomon Grind-Chem Service, Inc., 97
 Sonneborn Building Products, Rexnord Chemical Products, Inc., 87
 Spacesaver Corp., 532, 544
 Spec'built—Specification Built Corp., 519
 Spring City Electrical Manufacturing Co., 80
 Square D Co., 699, 712
 Stanley Hardware, div. The Stanley Works, 221
 Star Manufacturing Co., 205
 Stark Ceramics, Inc., 110
 Steelcase Inc., 8, 55, 485, 543
 Stendig, subs. Stendig International, 513
 Sterling Gas-Fired Heating Equipment, 641
 Sterling Radiator, 628
 Sterner Lighting Systems Inc., 670, 700
 Stiebel Eltron North America, 713
 Stow/Davis Furniture Co., 452
 Stretch Forming Corp., 120
 Summagraphics Corp., 42
 Sun-Dor-Co, 262
 Sunar Hauserman, 440, 518
 Sunroc/Western Corp., 610
 Super Sky Products, Inc., 177
 Synergy Methods, Inc., 157
 Symons Corp., 96
- T**
 TAB Products Co., 463
 Tandem Fabrics, dist. by Gilford Inc., 474
 Tate Architectural Products, Inc., 369
 Teledyne Post, 45
 Temcor, 569, 572
 Terak Corp., 38
 Thermal Concepts, Inc., 640
 Thermal Technology Corp. of Aspen, Inc., 305
 Thomas & Betts, 711
 Thomas Industries Inc., 671
 Thonet, 458, 484, 494
 3M/Broadcast & Related Products, 661
 Tielsa Kitchens/Contemporary Systems, Inc., 493
 TimberForm Div., Columbia Cascade Timber Co., 77
 Tnemec Co., Inc., 350
 TransLogic Corp., 580, 592, 596
 Tricad, 46
 Tropical Industrial Coatings, Inc., 178
 Trus Joist Corp., 125, 129
 Tuf-Seal Corp., 433
 Tuohy Furniture Corp., 515
 Tyler Elevator Products Inc., 579
- U**
 Ulrich Planfiling Equipment Corp., 39
 Unistrut Building Systems—div. GTE Products Corp., 104
 United States Ceramic Tile Co., 298
 United States Gypsum Co., 82
 United Technologies—Carrier Air Conditioning, 622
 U.S. Borax, 398
 U.S. Brass, div. Household International, 609, 627
 U.S. Elevator, subs. Cubic Corp., 591
- V**
 Vanguard Plastics Inc., 604, 639
 Vecta Contract, 510
 Velux-America Inc., 179
 Vent-Axia Inc., 626
 VENTARAMA Skylight Corp., 153
 Vermont Stove Co., The, 386
 Vetonite, Inc., 95
 Viertex, div. L.E. Carpenter & Co., 322
 Villeroy & Boch (U.S.A.), Inc., 326, 638
 VIP Enterprises, Inc., 147
 Visual Products and Supply Corp., 5
 VPI, 338
 V'Soske, 446
- W**
 W & W Glass Products, Ltd., 265
 Wade Div., Tyler Pipe, 616
 Walker Div., Butler Manufacturing Co., 679
 Walker Systems, Inc., 530
 Wasco Products, Inc., 158
 Watpro Corp., 180
 Watson Bowman Assoc., Inc., 181
 Waupaca Elevator Co., Inc., 578
 Wausau Tile, Inc., 76, 155
 Webb Manufacturing, Inc., 213
 Western Wood Products Assn., 131
 Western Wood Structures, Inc., 64, 567
 Westinghouse Elevator Co., div. Westinghouse Electric Corp., 590
 Wheelock Signals, Inc., 698
 Wide-Lite Corp., 694, 710
 Wilson Corp., The J.G., 250
 Windoor Door, div. The Ceco Corp., 264
 Winona Industries, Inc., 287
 Woodbridge Ornamental Iron Co., 116
 Woodform Div., Columbia Cascade Timer Co., 707
 Wright Line Inc., 542
- X**
 Xerox Corp., 1
- Z**
 Zazzeri S.A.S. c/o Watercolors Inc., 613
 Zero International, Inc., 225

Louisiana legislation sets new preservation models

Three bills passing the state's legislature this season give pointers for other states and communities considering new preservation bills. Most important of these, according to Ron Pursell writing in *New Orleans Preservation*, is a bill that allows limited tax exemption for developers in downtown development districts, historic districts and economic development districts. The exemptions freeze property-tax valuations of qualifying properties for five years at the level set before restoration and/or renovation began.

Another important bill is one that allows the New Orleans city government to lease space in the many designated historic buildings it owns without seeking competitive bids (the usual requirement by most governments). The government agencies can judge leases by the compatibility of the intended use with the buildings and districts, by the applicants' financial qualifications and by fair-market rental when compared with other nearby properties. This bill, according to Pursell, will, by allowing greater flexibility, "provide a mechanism for matching the tenant to the premises."

A third bill, which might seem antipreservation on its face, is expected to have a supportive effect by eliminating a source of antagonism towards preservation legislation in the confusion and complications that grow out of multiple control groups. This bill limits the number of possibly overlapping and conflicting historic commissions by allowing only three district preservation groups and three landmark groups (or three combinations thereof) to function in each of the state's parishes with populations of between 60,000 and 150,000. *C.K.H.*

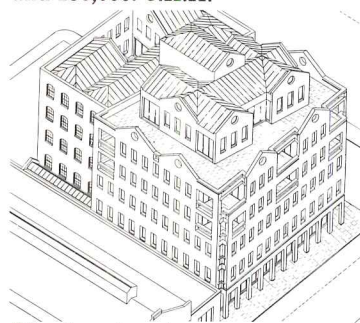

The drawing above is one of several hypothetical proposals (this one is by architects Labouisse and Waggoner) funded by the NEA and sponsored by New Orleans Preservation to study alternatives for infill in historic districts.

Moynihan-Stafford bill promises better public buildings

A new bill introduced in Congress would require the appointment of a supervising architect at an executive level within the General Services Administration and would assign priority in GSA renovation, acquisition or leasing to buildings with historical, architectural or cultural significance.

The Public Buildings Act of 1983 (S. 452), introduced by Senators Daniel P. Moynihan and Robert T. Stafford, is designed to "preserve and enhance the nation's legacy of architectural excellence." A companion bill is coming out of the House Public Works and Transportation committee.

Writing each member of the Senate Environment and Public Works Committee in support of the Senate bill, AIA president Robert Broshar said that appointing a supervising architect would insure that "a broad range of esthetic and economic concerns are given full consideration in design decisions and are not overridden by bureaucratic expedience." *Peter Hoffman, World News, Washington, D.C.*

NIBS fund drive showing success

The National Institute of Building Sciences announced that it has collected more than a third of the target of \$750,000 in its first year of a fund drive to assure its continuing activities in the research, development and regulation of building products and techniques. Started in 1978 with congressional authorization to "encourage a more rational building regulatory environment," the Institute had been funded by Federal seed money, independent contracts and membership dues, and must now strengthen its private-sector support.

For further information about the Institute or its fund drive, contact NIBS at 1015 Fifteenth N.W., Washington, D.C. 20005

Uniform conservation law picks up support

Model legislation designed to simplify and encourage the preservation of open land and historic buildings through receipt of tax-deductible contributions or purchase of development rights by nonprofit organizations has been adopted by Arkansas, Nevada and Wisconsin and has been considered by six other state legislatures in the past year. Fashioned in 1981 by the National Conference of Commissioners on Uniform State Laws (a group of some 300 representatives selected from their legal communities by each of the 50 states), the law is seen as a way of achieving the goals of preservation without undue burden on tax dollars or the problems of mandatory public action. It follows in the wake of similar legislation already adopted by, for instance, New York, and has the added advantage of being easily understood from state to state because of its uniform nature. The easements would exist in perpetuity in accordance with the requirements of the IRS for full tax advantages unless otherwise specified in the transfer agreement. Contact Jacquie Walsh of the Uniform Law Commissioners at 645 N. Michigan, Chicago, Ill. 60611.

Course on avoiding liability claims offered

A one-day program will be presented in various cities throughout the United States during the first half of the year by Victor O. Schinnerer and Company, Inc. It includes a workshop on contracts in which legal and professional liability experts describe in detail the areas to be aware and wary of in architects' and engineers' service contracts. For registration information on this and other professional liability courses, contact Diane Lash at Schinnerer and Company (202/686-2850).

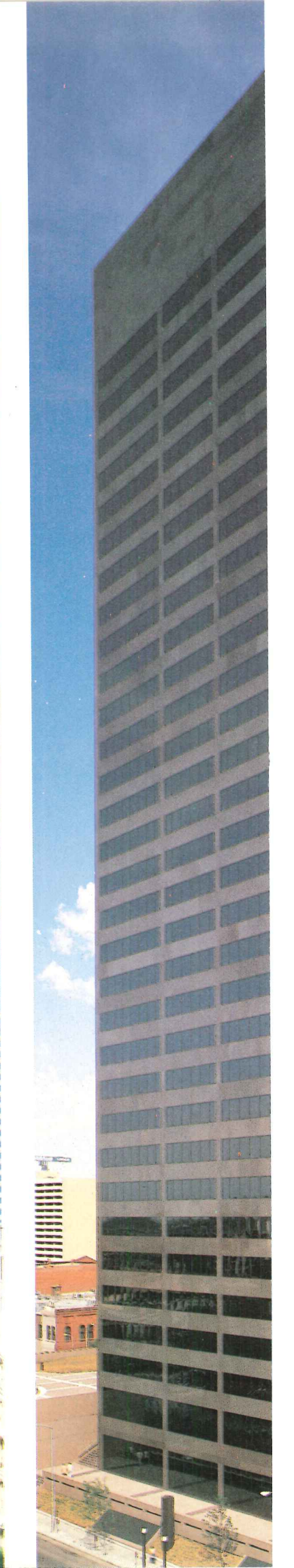

BLAESING

IS WRITTEN IN GRANITE AND MARBLE IN DENVER

We designed, engineered, assembled and erected the granite and marble support systems on these three Denver buildings: Hudson's Bay Centre in Pearl Anglais granite from Sweden (Skidmore, Owings and Merrill, Denver) Seventeenth Street Plaza in Imperial brown granite from Sweden (Skidmore, Owings and Merrill, Denver) and Carrara Place in Carrara marble from Italy (Murata, Outland Associates, Inc., Denver). Whether your project is tall or not so tall, call us at (503) 646-8161.



BLAESING

Blaesing Granite Company, P.O. Box 648, Beaverton, Oregon 97075
Telephone (503) 646-8161. Telex 360-982.

Circle 1010 on inquiry card

WILEY: Your Professional Library of Excellent References

ENERGY-EFFICIENT PRODUCTS AND SYSTEMS A Comparative Catalog for Architects and Engineers, 1st Edition, 1983

Energyworks, Inc.

Organized according to building components, this sourcebook describes 400 state-of-the-art product lines in comparative format. Includes generic index, brand name index, manufacturers' index, cross-referencing for each product. Updated every six months.
860 pp. (1-87336-5) 1983 \$125.00

INTERIOR LIGHTING FOR ENVIRONMENTAL DESIGNERS, 2nd Edition

James L. Nuckolls

This new edition covers all aspects of interior lighting design, including theory, effects, fixtures, techniques, calculations, and more. Deals with lighting design as an esthetic as well as scientific procedure.
approx. 408 pp. (1-87381-0) October 1983 \$39.95

GEOMETRY IN ARCHITECTURE

William Blackwell

This well-illustrated volume explores new principles and innovative applications of geometry in the functional, technical, and aesthetic aspects of design.
approx. 224 pp. (1-09683-0) January 1983 In Press

THE BUILDING SITE Planning and Practice

John M. Roberts

Represents the first attempt to examine the legal, technical and procedural inter-relationships among physical design professionals. Addresses potential areas of conflict, primarily among landscape architects, architects and engineers.
186 pp. (1-08868-4) 1983 \$24.95

PLANNING THE NEW CORPORATE HEADQUARTERS

Bryant Putnam Gould

This reference covers all aspects of planning office buildings for use as corporate headquarters. Focuses on the predesign phase of a building program, and emphasizes functional criteria.
196 pp. (1-09025-5) 1983 \$34.95

CONSTRUCTION REGULATIONS GLOSSARY

A Reference Manual

J. Stewart Stein

An up-to-date reference covering the simple and complex terms used in construction ordinances, codes, controls, and regulations. Includes current definitions used in such developing areas as solar systems, and environmental controls.
approx. 930 pp. (1-89776-0) 1983 \$66.95

ALSO AVAILABLE:

CONSTRUCTION GLOSSARY

An Encyclopedic Reference and Manual

J. Stewart Stein

1,013 pp. (1-04947-6) 1980 \$79.95

CONSTRUCTION DETAIL BANKING Systematic Storage and Retrieval

Philip M. Bennett

Demonstrates how to establish banks of architectural details in a systematic manner allowing efficient, quick retrieval. Provides advantages in offices, the tremendous savings in time and money achieved through use of details on more than one building.
approx. 184 pp. (1-88621-1) March 1984 In Press

ADOBE AND RAMMED EARTH BUILDINGS Design and Construction

Paul G. McHenry, Jr.

Covering everything from soil selection to building codes, this comprehensive sourcebook treats the engineering and architectural principles involved in the design and construction of adobe and rammed earth buildings.
approx. 256 pp. (1-87677-1) 1983 \$35.00

Ramsey/Sleeper's ARCHITECTURAL GRAPHIC STANDARDS, 7th Edition

Prepared by the American Institute of Architects
Robert T. Packard, AIA Editor

Seventh edition of a recognized classic reference, containing approximately 70% new material organized according to the principles of the Uniform Construction Index. Includes new coverage on design needs for the handicapped, energy conservation, environmental protection, anthropometrics, and the Metric system (SI)
785 pp. (1-04683-3) 1981 \$99.95

ARCHITECTURAL WORKING DRAWINGS, 2nd Edition

Ralph W. Liebing & Mimi Ford Paul

The only book to deal with the production of working drawings without advocating a "set" system for the production. Liberally illustrated with actual drawings produced by professionals and used on various projects. Introduces a variety of problems and the step-by-step routines used to solve them.
349 pp. (1-86649-0) 1983 \$29.95

BEGINNINGS

Louis I. Kahn's Philosophy of Architecture

Alexandra Tyng

The first book to trace the development of Louis I. Kahn's philosophy of architecture from its beginnings in the 1930s to his death in 1974. Clear, concise and illustrated with personal anecdotes and descriptions, it clarifies the chronological origins of concepts and establishes their relevance to architectural projects.
approx. 224 pp. (1-86586-9) December 1983 In Press

OLYMPIC ARCHITECTURE

Building for the Summer Games

Barclay F. Gordon

Documents the contributions of numerous international architects to the architecture of the modern Summer Olympic Games. From 1896 through 1984, it illustrates how building design has given each Games a distinct physical entity.
186 pp. (1-88281-X) \$17.95 Paper
(1-06069-0) \$29.95 Cloth

CONTEMPORARY THEATER

Evolution and Design

Christos G. Athanopoulos

Presents and analyzes theater architecture from its early beginnings to the present. Defines the components that have shaped theater designs of our era, and identifies the result in contemporary trends and movements. Heavily illustrated, it provides analysis and descriptions of more than 50 periods.
approx. 341 pp. (1-87319-5) 1983 \$60.00

PLANNED UNIT DEVELOPMENTS

Design and Regional Impact

Seishiro Tomioka & Ellen Miller Tomioka

This reference/guide covers the design, development processes, planning and construction of planned unit developments (PUD). Includes case studies of important examples in many locations in the U.S.A.
approx. 272 pp. (1-08595-2) December 1983 In Press

SOLAR ANGLE REFERENCE MANUAL

Ron Sibson

A handy guide to solar angles, building overhangs, solar collectors, etc., for use in design and construction of buildings for optimum heat gain in winter and solar shading in summer. Provides a direct readout of solar angles for the latitudes of the continental United States and corresponding latitudes around the world.
188 pp. (1-88996-2) 1983 \$19.95

Order through your bookstore or write **L. Sullivan, Dept. 4-1514.**

FOR FASTER SERVICE

CALL TOLL FREE

1 800 526-5368



WILEY-INTERSCIENCE

A division of John Wiley & Sons, Inc.

605 Third Avenue,
New York, N.Y. 10158

In Canada: 22 Worcester Road,
Rexdale, Ontario M9W 1L1
Prices subject to change and
higher in Canada.

In New Jersey, call collect (201) 342-6707

Order code #4-1514

VISA, MasterCard, American Express

accepted on phone orders.

092-4-1514

Computers: CAD versus CAD

Two computer experts from SOM argue that computer-aided drafting production is OK, but design creativity is the future

By Douglas F. Stoker and Nicholas H. Weingarten

While the computer is generally acknowledged to be a benefactor to numerous fields, it has inflicted upon the English language a plethora of confusing, contradictory and frequently meaningless acronyms. Such is the case with the term CAD, which has come to assume the two completely different and mutually exclusive identities of computer-aided design and computer-aided drafting, because of the very different process that they involve.

The first accepted use of the term CAD is unknown, but it most likely referred to computer-aided design. Only more recently has CAD come to mean computer-aided drafting as well. This ambiguity has been promoted by manufacturers and architects who either confuse drafting with design, or hope to capitalize on someone else's failure to recognize and understand the differences between the two.

The production of two-dimensional working drawings should never be confused with the derivation of the design itself. Drafting is a deterministic procedure which may be computerized with relative ease. Design requires a flexible and ever-changing set of tools to identify and manipulate the abstract relationships between a project's components.

Computer-aided drafting is only a facet of the meaning of CAD

The proponents of computer-aided drafting have focused much attention on productivity in order to justify the high cost of computer technology in the design environment. Such analyses are aided by the fact that computer-aided drafting is one of the few activities that can be directly compared to a manual task while producing a nearly identical product. The cost effectiveness can therefore be estimated without raising subjective questions about quality or uniqueness.

This view is a narrow one, even from a profit motive point of view. A theoretical reduction in the time required to construct a working drawing, and the implied reduction in its cost, can impact only the cash outflow of an office. It will not bring new work into the firm, unless clients can be persuaded that such technology is of mutual benefit.

Mr. Stoker is the director of computer services and Mr. Weingarten the assistant director in the Chicago office of Skidmore, Owings & Merrill.

Three arguments in favor of computer-aided drafting are typically put forth by the suppliers of such products:

- First, it is said that reduced overhead can be passed on to the client in the form of reduced fees. This does not take into account that an architect utilizing computer-aided drafting equipment incurs many increased costs. Besides the initial purchase price of the system, there are the training costs to improve productivity, the maintenance charges to keep the system running, the increased salaries for labor to operate it and the professional staff needed to manage it. These additional costs have forced many buyers of large systems to run them for three shifts per day to recover their expenses.

- Second, it is stated that the use of computer-aided drafting will result in higher quality and more accurate working drawings. Fewer construction errors will therefore occur, resulting in a less expensive building for the client. An argument can be made that better design standards and more careful construction management would more directly impact the cost of any project. Poor design and inadequate attention to details cannot be compensated for by more accurate drawings and shorter production schedules.

- Finally, there is the argument that reducing the time used for the production of construction documents will allow greater time to be devoted to the design phases of a project. Even if this statement were true, which it is not, it would suggest that a firm should invest large amounts of time and money to automate its draftspersons who make five dollars per hour, so that its senior designers who make twenty dollars per hour can spend more time on each project. This is tantamount to giving a \$50,000 pencil to the most inexperienced, least important person in the firm.

Computer-aided design is the real area to spark new services and quality

Greater productivity neither creates a new product nor increases the quality of an existing one. As professionals, we should be using the computer to explore new services and to generate new ideas, not solely to speed up the existing process of architectural drafting. In contrast, a good computer-aided design system, used by trained professionals, can have a direct impact on the central issues of

design. The benefits are not just reduced time or lower overhead, but an over-all increase in the quality of the design.

This improvement, while difficult to demonstrate, is becoming an increasingly important asset in the market for architectural services. In such an environment, it will be an office's use of the computer to improve the quality and control of its work, not the accuracy of its drawings, that will attract new clients.

Unfortunately there are no systems currently on the market that provide totally appropriate tools for architectural design. This shortcoming is often attributed to the difficulty in quantifying or formalizing the architectural design process. More likely, it stems from the false impression by turnkey drafting suppliers that architectural design procedures parallel those of other design professionals.

This has led many manufacturers to introduce architectural systems as modifications of products initially developed for other disciplines. Some, for instance, provide architects with tools originally designed for mapping and process piping. Others are derived from electronics or machine-part design systems. To put these products in perspective, we must examine the three major components of any computer-aided design system; its graphics capabilities, its database structures and its applications programs.

Graphics capabilities and color are still problems in design applications

Only in architecture is the visual presentation of a design problem so closely linked with its solution. The very method we use to interact with our drawings determines the result of the process. This manifests itself in several general areas.

First, the number of components in an architectural solution is larger than in most other design disciplines. Contextual backgrounds alone may require many thousands of lines. Accurate facade descriptions may encompass over 100,000 elements ranging in size from hundreds of feet to fractions of an inch.

This difference between an architectural project's over-all size and its smallest tolerance is two or three orders of magnitude (100 to 1,000 times) larger than problems in other professions. Few systems except the very

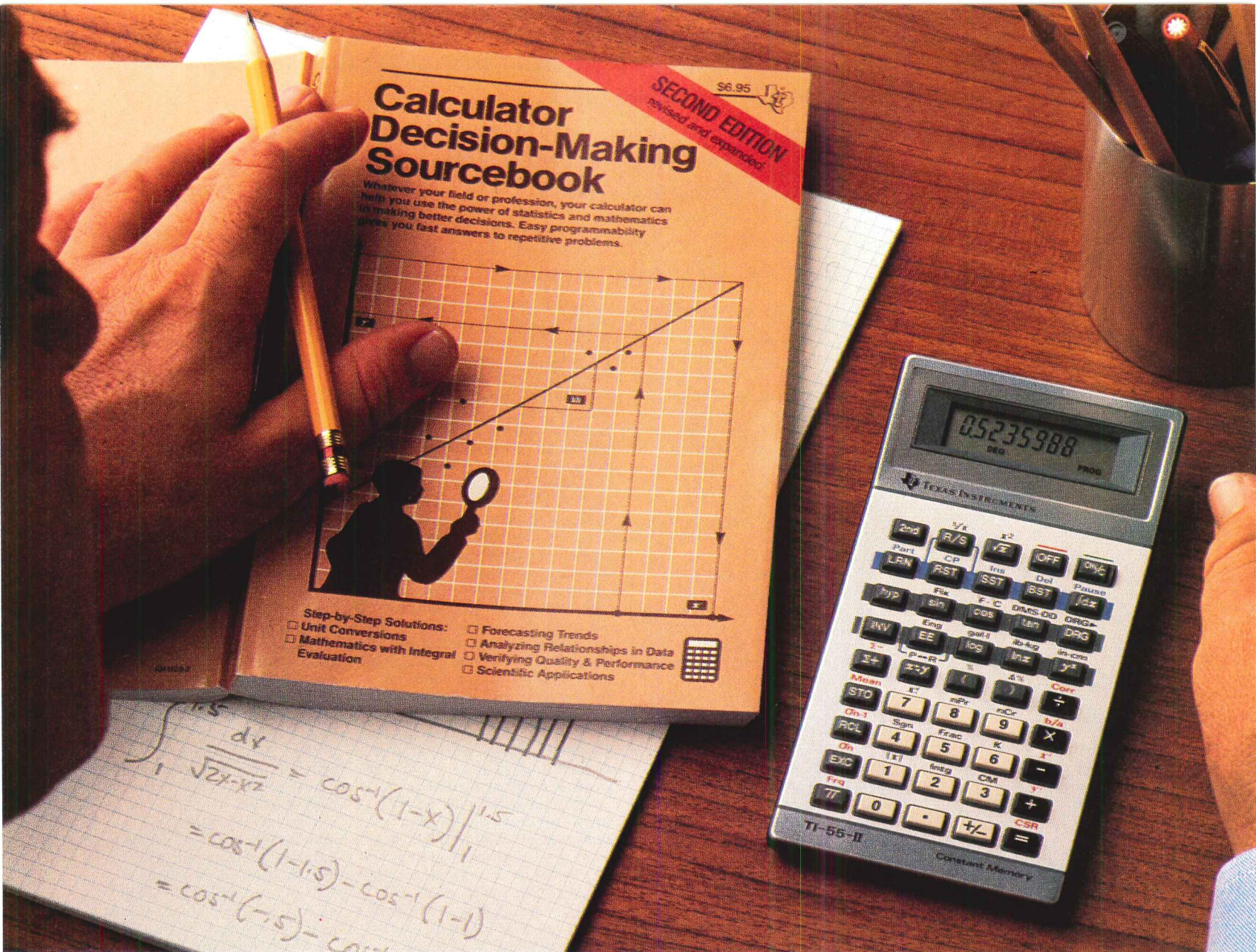

How the TI-55-II makes short work of long problems.

Whenever you can solve complex problems quickly and accurately, you're ahead of the game. And that's exactly what the TI-55-II does for you. By giving you 112 pre-programmed functions (like definite integrals), it allows you to take short cuts without losing accuracy. You'll accomplish a lot more in less time which means increased efficiency.

With our TI-55-II you can tackle problems you thought could only be solved with higher-priced programmables. You're not only getting the standard slide rule functions but also statistical

capabilities. This way you can work out linear regressions, permutations and combinations, just to name a few.

The TI-55-II also gives you enough programmability to eliminate a lot of repetitive key punching. Our Constant Memory™ keeps programs and data on tap, even when the calculator is turned off. So once you've entered a formula, you can simply put in the variables to get your solution. The Liquid Crystal Display shows your answers in standard, scientific or engineering notations — clearly and precisely.

We also help you get the most

out of your calculator with the Calculator Decision-Making Sourcebook. It gives you step-by-step examples of the best techniques used for solving mathematical, scientific and statistical problems. And we've included a special section on how to program your TI-55-II.

So next time you're facing another time-consuming problem, cut it down to size with the TI-55-II.



**TEXAS
INSTRUMENTS**

Creating useful products
and services for you.

largest are prepared to display these ranges and amounts of data that architects have traditionally manipulated on tracing paper.

The application and use of color is critical to architectural design, separating it from other design fields. In other design disciplines color is used to partition data into separate, identifiable categories. Its purpose is to differentiate between layers or elements on a display screen or drawing. In architectural design it is necessary for the effective rendering of surface and void. Techniques such as smooth shading and shadow casting, requiring large numbers of colors, are crucial to the architectural design process and the communication of spatial concepts. These capabilities are of only secondary interest to other design professions.

A drafting system need only present 8 or 16 colors at a time to the user. An effective architectural design system, however, may require a palette of over four million. Turnkey drafting systems available today do not offer the range of color and the image-making capabilities that the average architect can achieve with a box of felt-tip markers.

The variety of ways in which architects view their designs is also a unique aspect of their profession. Few other designers rely so heavily upon perspective and axonometric projections. The example of "architectural" or "view-camera" perspective is particularly unique to the architectural environment. Flexible axonometric systems and the ability to display interior perspective views are also important.

These techniques, while possibly irrelevant to other design disciplines, are at the heart of the architectural design process. Systems on the market today do not support these aides as well as a skilled hand and a roll of yellow tracing paper.

Broad database structures to accept abstract, unorganized data are another problem

The organization of data employed by an architect during the design process is very different than that used by other professionals. Its structure may be characterized as broad, encompassing many types of data with relatively few copies of each type. A building may be composed of many thousands of loosely related, generic elements such as stairs, windows, beams,

ductwork, carpeting, sprinklers, chairs, etc. There are few copies of each element, usually numbering in the tens or hundreds.

Many other design disciplines, by contrast, use data structures that are deep in nature, with large numbers of elements divided into very few categories. An electronics engineer, for instance, may use only a few different types of circuits, repeating many of them thousands of times on a single chip.

These deep databases have an a-priori structure based upon previously assembled expertise in a narrow field. It is no accident that the expert systems available today are organized around such narrow, deep bodies of knowledge. They are far easier to program and are more closely aligned with the procedures of the expert user in their particular field. Databases for structural analysis or elevator design fall into this category.

A database for architects may contain subsets of information organized in this fashion, but it must also be prepared to accept the abstract, unorganized data of the architectural design process. These broad databases have no predefined organization or structure. They become the repository for whatever information is deemed appropriate by their users. They must allow for any discovered relationship or link, even between dissimilar types of data.

The relationship between a desk and an elevator, for example, may be only that the owner of the desk is included in the population figure used to determine the elevator cab size. Another linkage may specify that the cab doors be wide enough to allow the desk to be moved in by elevator. Such abstract, ambiguous and occasionally contradictory information is a typical component of the design process. It is the selection and prioritization of these overlapping criteria that make design an individual and intuitive process.

Broad database systems are not as imaginary as one might suppose. The standard office filing cabinet and the designer's desk, strewn with program notes, cardboard models and scraps of paper are common examples. Both of these devices perform amazingly well in structuring random, ill-defined data for access by many individuals engaged in many different activities.

Their contents can be quickly

assessed and mentally reordered to suit particular tasks. Retrieval and sorting methods for these devices may be as diverse as the color of the paper upon which the information is printed, or its position in a pile of other papers. Drafting system databases cannot provide the equivalent degrees of freedom and flexibility.

Applications programs to integrate graphic and nongraphic data are needed

In most design fields, including architecture, the creative process is enhanced by a series of specific analyses and design tools. In architecture, however, these programs span a broader range of disciplines. A thorough architectural design system must support a full set of engineering analyses (structural, mechanical, electrical and civil), programs for the design of special components (elevators, solar shading devices, transportation networks, etc.) and a series of more general problem-solving systems (facade design, core layout, architectural programming, etc.) to facilitate true interactive design. A design system for architects would not only provide these capabilities but integrate them with the graphic and nongraphic data in the system.

It is the issue of integration that separates architecture from other design disciplines. Only in architectural design does the process revolve around so many professionals defining individual abstractions of a central design concept. These discipline-dependent models are each manipulated by a set of procedures unique to their particular professions. It is the recombination of these "spin-off" models with the central concept that causes such problems with turnkey computer systems.

The problem is heightened by the inability of most managerial structures to normally control these "subprocesses." A proper architectural design system must therefore include project management software in addition to the standard set of disciplinary design programs.

This software includes manpower projections, client bill-back programs and advanced plotting packages. Most turnkey systems overlook these features in favor of concentrating development on specific engineering applications.

We must not think of CAD just in terms of cost benefits but stress creativity

It may be that more sympathetic

systems for architects do not exist because of the manner in which their use is justified. A cost-benefit analysis cannot be easily applied to a computer-aided design system, even if it can be proven that such a system would enhance a firm's creative capabilities. In the end, this raises a question that architects and their clients have always avoided: What is the value of good design? Were the cost of computer aids minimal, their use for drafting would get far less emphasis. Were the value of good design more quantifiable, few expenses would be spared to realize it.

The current confusion over the meaning of CAD only highlights the confusion over the role of the architectural profession. Does it produce designs or drawings? Does it provide a service or produce a product? Can architects really focus on the automation of their drawings while abandoning the opportunities that computers can give in the pursuit of their ideas?

AMERICAN EXPRESS CARDMEMBERS NO LONGER HAVE ANY EXCUSE FOR RUNNING OUT OF GAS.

NOW TEXACO WELCOMES THE CARD.

Now you can use the American Express® Card at thousands of participating Texaco retail facilities across the country.

Just pull in at the Texaco star and look for the sign welcoming the American Express Card. You'll see it at all participating stations.

Use the Card for motor fuel and all of Texaco's products and car services.

Now there's no excuse for running out of gasoline. You've got the Card. Don't leave home without it.®



© American Express Travel Related Services Company, Inc. 1983

STARK STANDS ALONE

For a reputation that endures,
specify the wall that endures: **Stark SGFT**

Too often, a wall material that looks good today may prove to be an embarrassment tomorrow. The problem is particularly acute when it comes to prefaced masonry materials.

A wall of Stark Structural Glazed Facing Tile (SGFT) will endure decades of use and abuse, while a wall built of "glazed" concrete block may look faded and shabby within a few years. Yet the installed cost of a four-inch SGFT wall is usually less than that of a similar "glazed" concrete block wall.

The reason for the superiority of SGFT is quite simple: it is the **only** faced masonry material manufactured as a single unit from clay. The body and ceramic glaze are fired together at over 2000° F. This process gives SGFT a wear factor of less than 15 with unmatched durability and ease of maintenance. In fact, SGFT wipes clean with plain soap and water.

SGFT stands alone in its resistance to chipping, peeling and fading – even in the presence of harsh chemicals, steam or direct sunlight. It is far superior to any other faced masonry material in fire resistance and thermal efficiency.

Stark stands alone in offering a unique combination of benefits and cost effectiveness, as the following chart reveals.

Material	Cost Inst. (per sq. ft.)	Taber Wear Factor	Flame Spread	Smoke Density	Mfg. to ASTM C-126	Minimum Compressive Strength*
SGFT	\$6.90	less than 15 @ 1000 g 1000 cycles	0	0	Yes	1500 psi
"Glazed" Concrete Masonry Unit (CMU)	7.10	less than 130 @ 1000 g 500 cycles	under 25	under 50	No	600 psi
Ceramic Tile/CMU	6.90-8.12	varies	under 25	0	No	600 psi
Epoxy Painted CMU	up to 6.83	needs repainting	varies	varies	No	600 psi
Epoxy Painted Drywall/CMU	4.06-9.36	needs repainting	varies	varies	No	600 psi

Sources on request.

*Hollow loadbearing masonry units

Before you specify your next masonry job, see our complete catalog in SWEET's 4.4/St. For direct assistance, call our toll-free service hotline: 1-800-321-0662. In Ohio, call collect (216) 488-1211. Stark Ceramics, Inc., P.O. Box 8880, Canton, Ohio 44711.



Circle 1011 on inquiry card

**YOU'LL GO BANANAS OVER
OUR NEW
HOME ELEVATOR PACKAGE!**

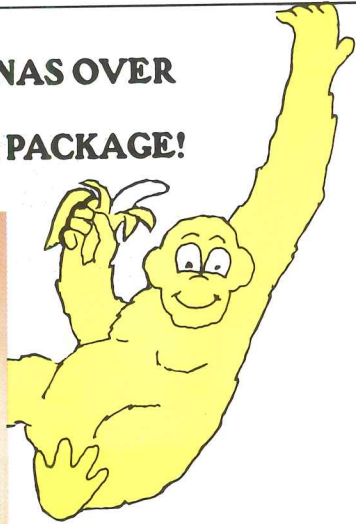

HOMVATOR.

For complete information refer to
Sweets or call for specifications.
5950 Precision Dr.
Orlando, Florida 32819
305-351-1011
In Florida Toll Free: 1-800-432-0561
Sales and Service locations Nationwide

AR5 "The Competitor 450" and "Homvator" are registered trademarks by General Elevator Corp. All Rights Reserved.

Circle 1012 on inquiry card



The bookstore edition of *Record Houses 1982*
—regularly \$7.95— is now available at half price.

All orders must be prepaid.

Send your check or money order for \$3.95 per copy to:

ARCHITECTURAL RECORD

Single-copy sales

1221 Avenue of the Americas

New York, NY 10020



Record Houses

☆ reprise ☆

Close your eyes. Now have someone read this to you.

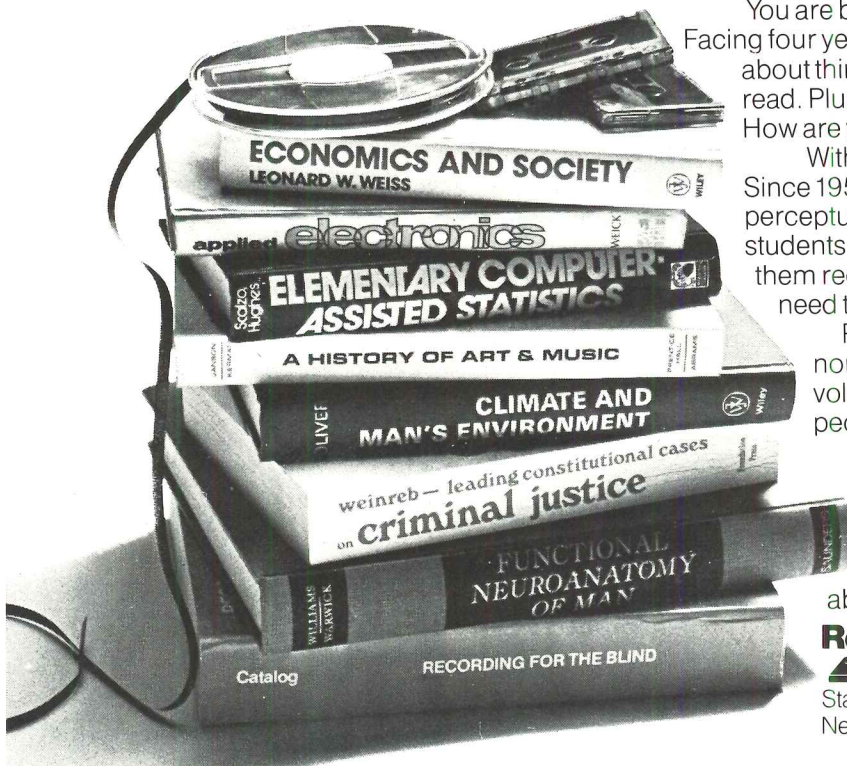

You are blind. A student.
Facing four years of college. With
about thirty-two textbooks to
read. Plus fifty supplemental texts.
How are you going to manage?

With Recording for the Blind.
Since 1951, we've helped over 53,000 blind,
perceptually and physically handicapped
students get through school. By sending
them recordings of the books they
need to read. Free.

Recording for the Blind is
non-profit, and supported by
volunteers and contributions from
people like you who can imagine
what it's like to be blind.

Your tax-deductible donation
will help our students meet their
educational goals. We'd all be grateful.

If you want to know more
about us, write:

Recording for the Blind, Inc.

 an educational lifeline.

Station E, 215 East 58th Street
New York, New York 10022, (212) 751-0860.

1. Bostonian Hotel At Faneuil Hall Marketplace
Architects: Sy Mintz and Associates



6. Liberty State Park, Jersey City, NJ
Architects: Geddes, Brecher, Qualls and Cunningham

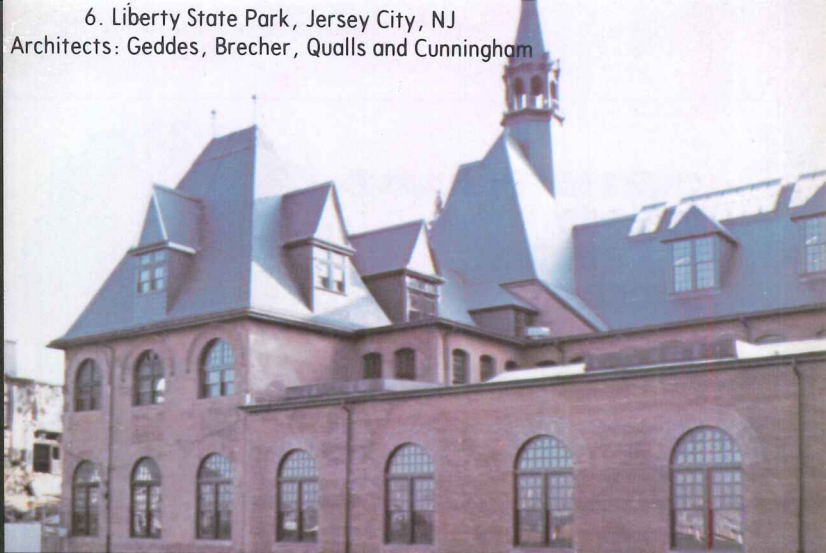

(No Centerpost)

3. J. Zeluck's
3 point locking hardware

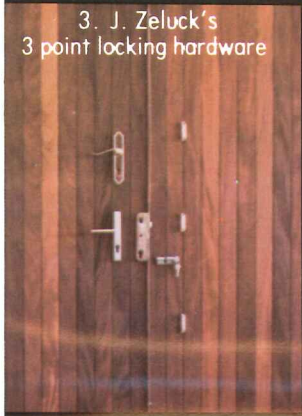

1. The old world charm of the Bostonian Hotel is enhanced by J. Zeluck's combination Balcony Door unit. The unit features J. Zeluck's hardware and operating casements on each side of the doors.

2. J. Zeluck's French Balcony Door design eliminates the centerpost and allows the full width and opening of both doors to be utilized. Other features include J. Zeluck's hardware, incorporating a 3 point locking system, with interlocking aluminum saddle. Available in mahogany or mahogany and teak.

3. J. Zeluck's hardware, utilizing a 3 point locking system, offers the architect the beauty and simplicity of 2 door arrangements with guaranteed seal and freedom from warpage and infiltration. It also aids in home security. Options include brass back plates and handles.

4. Palladium Windows are available in any size or design concept. All units can be had with or without true muntins. Flankers are available fixed or operable. Complete with trim.

5. J. Zeluck's entrance systems enhance any style from traditional to contemporary. With matching sidelights, transoms, etc.



4. Palladium Window



5. Entrance Systems

J. ZELUCK INC.

Over 60 years of know-how manufacturing Architectural Wood Windows and Doors.

6. Liberty State Park is one of the largest restoration projects in the U.S. All wood windows were restored to circa 1870. J. Zeluck Inc. can conform to landmark specifications on windows and doors using insulated glass and true muntins.

7. J. Zeluck's Vertical Pivot window meets class "A" window tests. Size range is unlimited. Venetian blinds are available with triple glazing giving the lowest "U" rating of any window made. Available in mahogany or mahogany and teak.

8. Any shape, any size available with insulated glass as a fixed transom or as a separate feature in a wall. Inverted muntins are available.

9. True Muntins add the final touch to any window or transom design.

10. Tilt and turn windows feature multiple operations, open in or tilt giving draft free opening with unbroken visibility. J. Zeluck uses a reliable and tested gear with single handled operation.

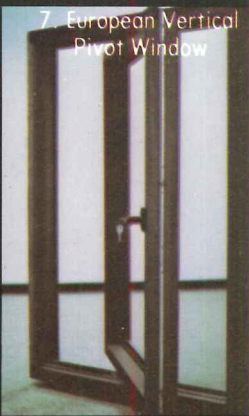

7. European Vertical Pivot Window

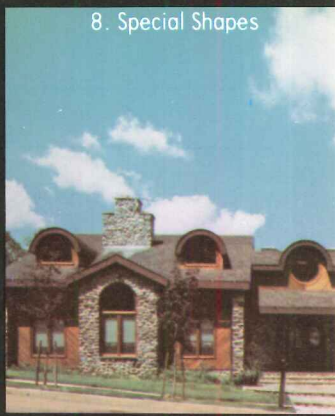

8. Special Shapes



9. True Muntins



10. Tilt & Turn Window

J. ZELUCK INC.

5300 Kings Highway Brooklyn, N.Y. 11234

Tel: (212) 251-8060

Telex: 971838 Zel Window NYK

High Production Custom Manufacturers
Any Design in Any Size

Circle 1013 on inquiry card

**OUR PERFORMANCE
RECORD
IS A ROARING
SUCCESS**



PLANTER'S INN
Architect: Liollo Associates, Inc.
Contractor: Ruscon Construction Co.

**GENERAL
ELEVATOR®**

For complete information refer to
Sweets or call for specifications.
5950 Precision Dr.
Orlando, Florida 32819
305-351-1011
In Florida Toll Free: 1-800-432-0561
Sales and Service locations Nationwide

AR3

Circle 1012 on inquiry card

READ ALL ABOUT IT.

AGAIN AND AGAIN AND AGAIN.

**this publication
is available in
microform**

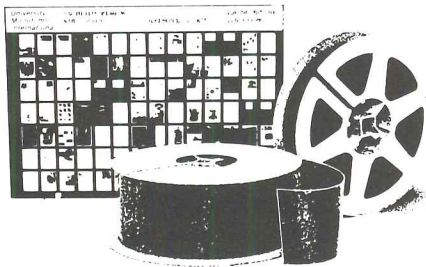

Please send me additional information.

University Microfilms International

300 North Zeeb Road
Dept. P.R.
Ann Arbor, MI 48106
U.S.A.

18 Bedford Row
Dept. P.R.
London, WC1R 4EJ
England

Name _____

Institution _____

Street _____

City _____

State _____ Zip _____

You can order reprints of any articles that have appeared in *Architectural Record*, whether in color (if the article was published in color) or black-and-white (if published in black-and-white), in whatever quantities (minimum 100) you need, for use in your own mailings and presentations.

For more information, price quotes and help with layout and format of your reprints, call:

Carol Frances
212/512-6081

ARCHITECTURAL RECORD



The bookstore edition of *Record Houses 1982*
— regularly \$7.95 — is now available at half price.

All orders must be prepaid.

Send your check or money order for \$3.95 per copy to:

ARCHITECTURAL RECORD

Single-copy sales

1221 Avenue of the Americas

New York, NY 10020



Record Houses

☆ reprise ☆

HOW IS A CERTIFIED ENGINEER DIFFERENT?

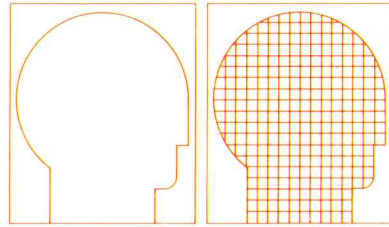

Certification goes beyond the limitations of the registration laws with regard to client protection and public safety and applies to the approximately five percent of the registered engineers in Colorado who are in private practice and who provide professional services to the public on a full-time fee basis.

Commission For Certification Of Consulting Engineers Of Colorado

1111 South Colorado Boulevard, Suite 305,
Denver, Colorado 80222,
Telephone (303) 757-3379,
Sondra S. Smith, Executive Secretary

Circle 1017 on inquiry card

Close your eyes. Now have someone read this to you.

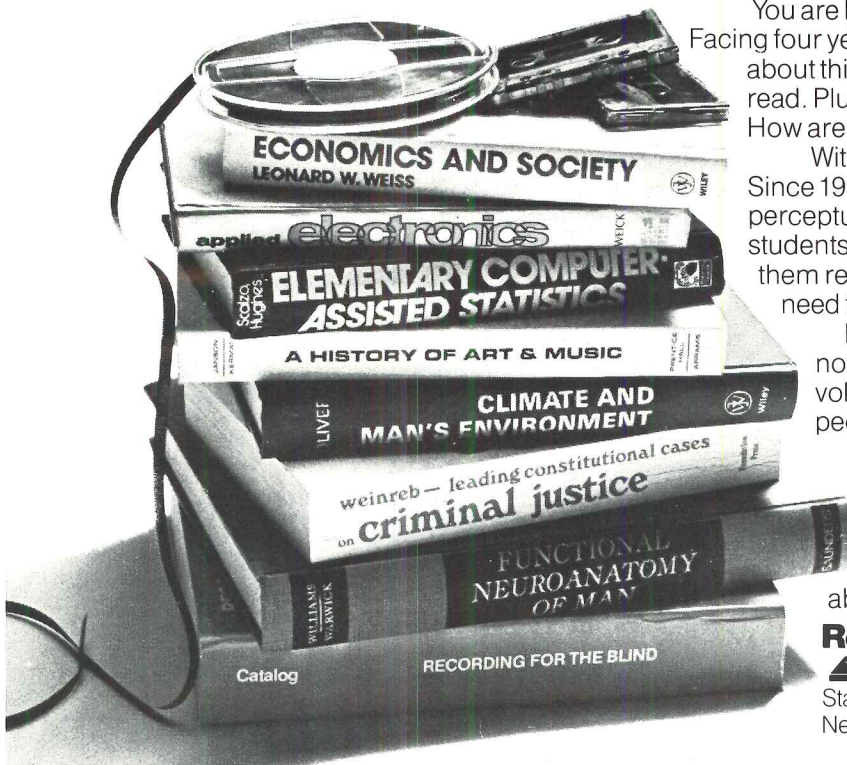

You are blind. A student. Facing four years of college. With about thirty-two textbooks to read. Plus fifty supplemental texts. How are you going to manage?

With Recording for the Blind. Since 1951, we've helped over 53,000 blind, perceptually and physically handicapped students get through school. By sending them recordings of the books they need to read. Free.

Recording for the Blind is non-profit, and supported by volunteers and contributions from people like you who can imagine what it's like to be blind.

Your tax-deductible donation will help our students meet their educational goals. We'd all be grateful.

If you want to know more about us, write:

Recording for the Blind, Inc.

 an educational lifeline.
Station E, 215 East 58th Street
New York, New York 10022, (212) 751-0860.

Sunlight resistant spun yarn looks too good to be Indoor/Outdoor carpet.

BUT IT IS. And no other carpet yarn gives you all these advantages:

Sunlight resistant, new Marvess® olefin SR colored staple fiber resists fading like no other carpet fiber under the sun.

Tests confirm that Marvess olefin SR will not significantly lose or change color even after 17,000 hours of Florida exposure.

Resists rot, mildew and the effects of salt water and chlorine.

Luxurious good looks, because Marvess olefin SR spun yarn in carpet is soft, comfortable to bare feet even in blistering heat, and elegant enough to be installed anywhere.

Color fast, with the fascinating color styling locked in, solution-dyed for good looks indoors and outdoors, rain or shine.

Comfortable and livable, with anti-shock qualities, stain resistance for easy cleanability, and good bulk for lasting comfort and lightweight for easy installation.

Real value, durable and uniquely luxurious indoors and outdoors, available in a wide range of color-coordinated patterns for discriminating decoration.

Marvess olefin SR – truly the everywhere carpet yarn, for residential, commercial and marine applications, indoor or out. Nothing else looks this good, wears this well, lasts this long.

For information contact:



PHILLIPS FIBERS CORPORATION

A SUBSIDIARY OF PHILLIPS PETROLEUM COMPANY

OLEFIN FIBERS MARKETING
P.O. BOX 66, GREENVILLE, SC 29602
(803) 242-6600

MAN MADE FIBERS/LIFE MADE BETTER

*Trademark Phillips Petroleum Company

Circle 1018 on inquiry card

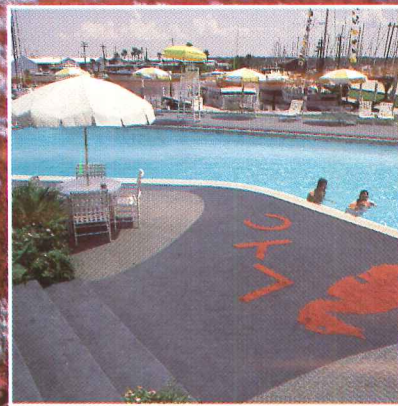

Lakewood Yacht Club –
near Houston, Texas
Marvess SR carpet used
everywhere inside and out.



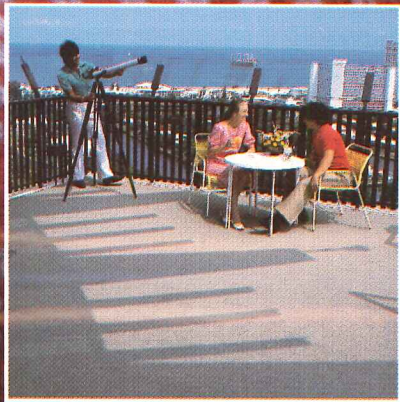

Pier 66 – Fort Lauderdale, Florida
Marvess SR carpet used at hotel and restaurant on balconies, walkways, entrances.

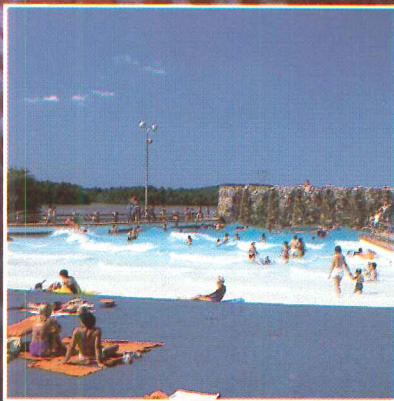

Point Mallard Recreational Park – Decatur, Alabama
1800 square yards of Marvess SR carpet surrounding wave pool.

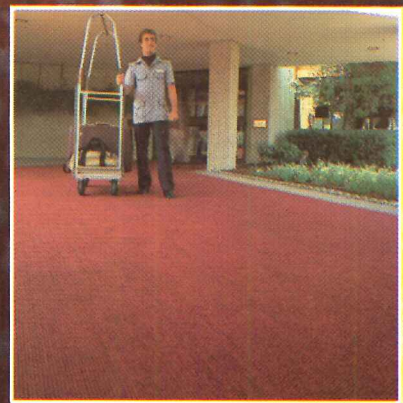

Marriott Northwest – Atlanta, Georgia
Marvess SR carpet used in a high-traffic main entrance.

REPRINTS OF ARCHITECTURAL RECORD ARTICLES

You can order reprints of any articles that have appeared in Architectural Record, whether in color (if the article was published in color) or black-and-white (if published in black-and-white), in whatever quantities (minimum 100) you need, for use in your own mailings and presentations.

For more information, price quotes and help with layout and format of your reprints, call:

Carol Frances
212/512-6081

ARCHITECTURAL RECORD

Competition calendar

- The Architectural League has issued a call for entries to its third annual national competition for young architects who are ten years or less out of school. Winning entries will be presented at a series of four evening seminars to be held this spring in New York. For further information write or call The Architectural League, 457 Madison Avenue, New York, N.Y. 10022 (212/753-1722).
- The City of Columbus, Indiana and the Irwin Sweeney Miller Foundation have announced a national competition for the design of a 200-car surface parking lot in downtown Columbus. The deadline for entry is April 1, 1984. For further information contact Theodore Liebman, AIA, Liebman Ellis Melting, 330 West 42nd Street, New York, N.Y. 10036.

Harvard announces Loeb Fellows

The Harvard Graduate School of Design has named 12 recipients in its Loeb Fellowship program in Advanced Environmental Studies. Currently in its thirteenth year, the annual program offers leading mid-career designers and planners the opportunity for full- or part-time study at the school while maintaining their outside professional commitments. Loeb Fellows for 1983-84 include Ellen Beasley, a preservation planning consultant from Galveston; Rifat Chadirji, an architect from Iraq; Constance Eiseman, project manager for Westway Park in New York; Glenn Garrison, an architect from New York; Wendy Milner Herrett, a district ranger for the U.S. Forest Service in Meeker, Colorado; Michael Jacobs, redevelopment director at the Boston Housing Authority; Charlotte B. Kahn, executive director of Boston Urban Gardeners; Jane Lidz, an architectural photographer from Palo Alto; Philip A. Morris, executive editor of *Southern Living* magazine; Shanker M. Pradhan, town planner of Kathmandu, Nepal; Michael Pyatok, an architect from Berkeley; and James Vaseff, an architect for the Georgia Power Company.

A capital idea

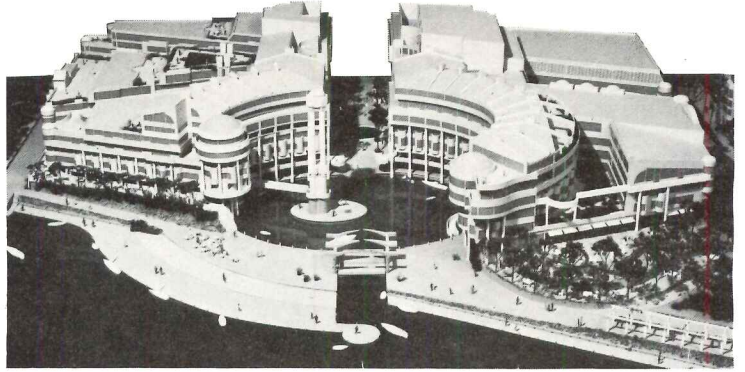

Situated on the last remaining parcel of privately owned riverfront land in the District of Columbia, Washington Harbour is a mixed-use development near Georgetown that comprises offices, retail space, and 38 luxury condominium apartments. The 725,000-square-foot project lies opposite Theodore Roosevelt Island and occupies the site of a former concrete batching plant (aerial photograph right).

Architects Arthur Cotton Moore/Associates have produced a brick and limestone complex with classically inspired design details and radiating pedestrian malls that refer both to the architecture of familiar Washington monuments and to the city's 18th-century street plan. Two curving residential arms, arranged asymmetrically, form a colonnade that embraces



an elliptical pool, while a riverfront promenade connects the new buildings with existing walking and bicycle lanes running along the Potomac to the nearby Watergate and Kennedy Center complexes.

Reprieve for an Adirondack camp

Responding to the rare appearance of a preservation-related issue on the public ballot, the residents of New York State have approved an amendment to the state constitution that will help save Camp Sagamore, the turn-of-the-century enclave of 25 rustic buildings near Raquette Lake in the Adirondacks. The legislature-passed amendment was necessary because 11 outbuildings in the complex are situated on ten acres of state-owned land that is part of the Adirondack Forest Preserve, a vast wilderness tract mandated by an 1894 law to remain "forever wild." The New York Constitution requires that any buildings within the preserve may not be used or repaired—a provision that effectively calls for the demolition by neglect of several camps in the region.



The amendment authorizes a land swap between the state, which owns the outbuildings, and the not-for-profit Sagamore Institute, which owns the main structures at Sagamore and operates them as a year-round educational center. In exchange for the endangered buildings, the Institute will donate a 245-acre parcel to the state that will be added to the forest preserve. Although the amendment had bipartisan support from numerous preservation, environmental, and economic development groups throughout New York, it was mildly opposed by some officials at the Sierra Club, who are normally strong advocates of preservation but feared that this particular measure might set a precedent and weaken the constitutional protection of the forest preserve.



Curtain wall

Thermalized windows

Sliding patio doors

Balcony railings

HOW ALUMINUM KEEPS DOWN THE COST OF KEEPING UP THE DEVONSHIRE.

Savings start with the Devonshire building's 230,000 square feet of low-maintenance aluminum exterior panels that make it a standout on Boston's skyline. They're coated with a new fluoropolymer finish in a shade of gray that matches across the entire facade.

Savings continue with 7,000 thermalized aluminum windows that reduce the likelihood of condensation, and reduce heating and cooling costs.

Exterior balconies on the 36 residential floors that rise above the

seven commercial floors of the Devonshire have sliding access doors and railings of aluminum for its durable and attractive finish with a minimum of maintenance.

Aluminum gives architects other opportunities to build-in operational and maintenance economies. For example, aluminum modular flooring systems to reduce the cost and disruption of installing and changing underfloor wiring and conduit. Aluminum ceiling systems for a rich choice of colors, styles and finishes as well

as easy access to overhead lighting and wiring. Even aluminum-louver solar control systems on windows to help control heat gain and reduce costs of cooling.

For more information write the Aluminum Association, Inc., Dept. B, 818 Connecticut Avenue, N.W., Washington, D.C. 20006.

Building owner: Devonshire Associates, New York; architect: Steffian/Bradley Associates, Inc., Boston; curtain wall fabricator and erector: Maddison Associates, Revere, Mass.



MAKE IT WITH ALUMINUM

Postscript: Designer's Saturday

It seems only fitting that a report on Designer's Saturday, the slightly misnamed three-day period in October when 49 manufacturers of residential and contract furnishings throw open the doors of their New York show rooms, appear in this RECORD product issue. While many of the new "nuts-and-bolts" items reviewed on the following pages are of primary importance to architects planning a building from the ground up, the proliferation of office and residential renovations has led some architects to the indoor domains once reserved exclusively for interior designers. Besides, the sensory experience of the latest CAD or hvac system still can not compete with the look and feel of a new leather lounge chair.

Following the trend developed over the last few years, Designer's Saturday 1983 was a happy combination of the frivolous and the serious. Heavy rains that had plagued the city earlier in the week gave way on Friday to glorious autumn weather. East Side strollers carrying shopping bags emblazoned with the unlikely logos of Artemide, Brueton, and Jack Lenor Larson mingled with those conveying the more-expected Bloomingdale's and Altman's. Red-and-white balloons bearing the Harvey Prober label were sighted along Second Avenue. In the show rooms food vied with furniture for visitors' attention. At least three manufacturers—Howe, Stendig, and All-Steel—distributed hot dogs beneath striped umbrellas. Knoll had colored popcorn, while ICF's buffet featured fried chicken. GF Furniture Systems set up a makeshift Viennese pastry cafe, complete with a classical string quartet. One could literally eat one's way from 32nd to 63rd Street and back.

Amid the festive atmosphere in the show rooms and at evening receptions held at the Asia Society and the Metropolitan Museum of Art, there was a good deal of thoughtful discussion, especially regarding the direction that corporate design will follow in the wake of the technological changes currently affecting all levels of office operations. The well-attended Facilities Management Day seminar on Thursday at the McGraw-Hill Building featured Michael Clevenger, planning programs manager for the real estate division of Xerox, who referred to the need for corporations to address the problem of "an alien

Robert J. Machalaba photos



technology overlaid on existing hostile environments." Flexibility to accommodate automation and worker relocation is key, noted Clevenger, and to illustrate the point he showed a short video tape of the complete dismantling and reconstruction of two hardwall offices and adjoining secretarial workstations carried out in the time span of an hour. James Morgan, national director of project consulting at Cushman & Wakefield, dealt with the threat of dehumanization in the electronic office but in the end concluded that there seems to be a "quiet revolution" of users taking control of corporate design projects. The increasing application of portable workstations, he added, is leading to a lessening of "status differentials" in offices in favor of a more egalitarian environment.

If the overriding concerns of Facilities Management Day were flexibility, adaptability, and productivity, the Friday evening program at the Fashion Institute of Technology, entitled *Meet the Press*, offered a considerably wider overview of the latest trends in interior design by six magazine and newspaper editors. Douglas Brenner of ARCHITECTURAL RECORD reviewed some of the magazine's featured

interiors for 1983 to demonstrate ways that architects use the interior commission as a laboratory to test out innovative design ideas. Edie Cohen of *Interior Design* reported on the Milan Furniture Fair, where she observed a renewed emphasis on quality, inventiveness, and flexibility. Anne Fallucchi of *Facilities Design & Management* discussed the functional and esthetic considerations that went into the design of two recent corporate projects—the W.C. Decker Engineering Building for Corning Glass by Davis Brody & Associates and the Western Home Office of Prudential Insurance by Albert C. Martin & Associates. Suzanne Slesin of *The New York Times* told of the factors that lead to coverage of an architect's work in the Home Section of her newspaper—and the impact that inclusion can have on a professional career. Pilar Viladas of *Progressive Architecture* spoke of "a new modernism" in interior design that features historical allusions appearing in more and more abstract form, while Beverly Russell of *Interiors* called the marriage of function and esthetics in corporate design "high tech/high touch."

High tech/high touch: that pretty well sums up the qualities

1. Michael Clevenger, planning programs manager for the real estate division of Xerox, delivering keynote address at Facilities Management Day.
2. Suzanne Slesin of The New York Times, Beverly Russell of Interiors, and Joan Burgasser, president of Designer's Saturday, at the Friday evening Meet the Press program.

that characterize many of the products unveiled in the Designer's Saturday show rooms. The ubiquitous system workstation, shown in updated versions that accommodate computer keyboards and terminals, is increasingly being offered with elegant wood finishes—especially mahogany—and fabric panels in soft postmodernist colors. Although office seating by such companies as Haworth and Prober is also being continually refined for the comfort and productivity of those sitting at word processors, manufacturers are showing the ergonomically correct chairs in an unprecedented array of fabrics, materials, textures, and colors. Even Buckminster Fuller's cable-suspended, six-sided *Hang it all* book storage unit, introduced by Thonet, combines the high tech of the designer's synergetic and dymaxion theories with the smooth tactile quality of a glossy "ultrasonic chrome" paint job.

Whether one is drawn to the sleek efficiency of a Westinghouse workstation or the traditional luxe of a Helikon desk, the overwhelming success of this year's Designer's Saturday and the generally high standards of the products on display clearly confirm the viability of New York as a design center and of the \$4.2 billion contract market as a whole. The big question on everyone's mind was not the continuance of the city as a mecca for the interior design world, but whether future Designer's Saturdays would remain at various sites in Manhattan or under one roof at the proposed International Design Center across the East River in Queens. Although a presentation by IDC president Emmett L. Dineen indicated that the project to convert two million square feet of former industrial space into show rooms is advancing toward a 1985 opening, there seemed to be no consensus among the design community on the extent to which the companies will abandon their centrally located, if cramped, quarters in Manhattan for the wide open spaces of Long Island City. If IDC announcements of preliminary lease-signings are any indicator, contract manufacturers seem more willing at this time to make the shift to the Queens site than residential firms, which depend more heavily on walk-in business. A clearer picture of IDC's long-range prospects should emerge over the next several months. P.M.S.





TACO BELL



CRYSTAL
CONFECTIONERY

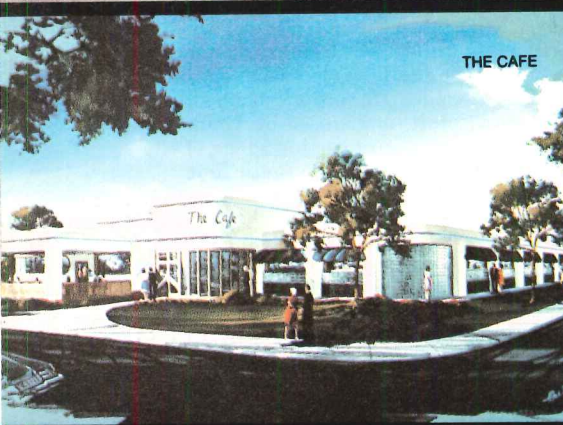

THE CAFE



MOXIE'S

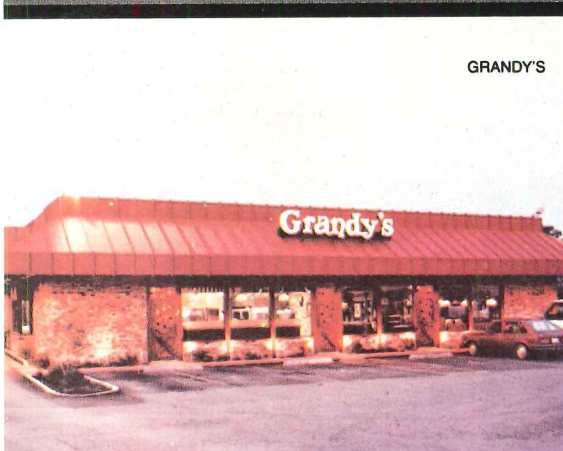

GRANDY'S

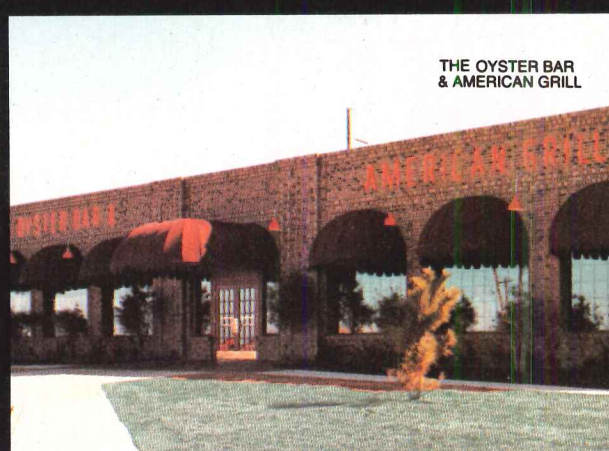

THE OYSTER BAR
& AMERICAN GRILL

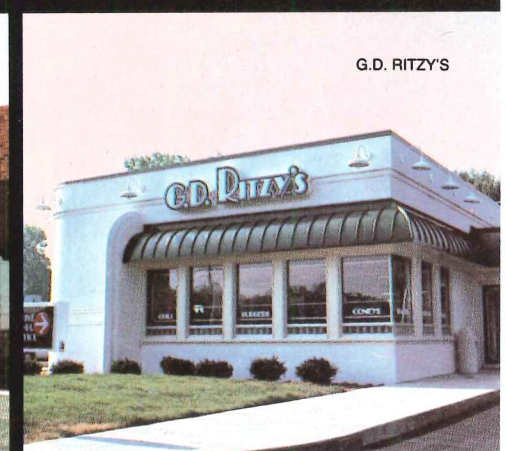

G.D. RITZ'S

BEAUTIFUL RESTAURANTS

Hamill & McKinney Architects and Engineers have designed thousands of restaurants and specified gas for all of them.

Obviously, Hamill & McKinney know the value of natural gas as an efficient fuel for today's energy-conscious building designs. "Anywhere gas is available, it's our first choice for all energy needs," says Earl McKinney, engineer.

He and his partner, Jim Hamill, started Hamill & McKinney Architects and Engineers, Inc., in 1978. Success came quickly, and today they have seven offices: Lexington, Ky., Dallas, Orlando, Denver, Los Angeles, San Francisco and Atlanta.

They are professionally registered in architecture and engineering in 49 states. Fifty percent of their work is restaurant renovation, most of which has to be completed in 30 days, but their expertise also extends to multi-family, hotel/motel, office buildings, shopping centers, adaptive reuse and commercial/retail/industrial design.

Their success, they feel, comes from understanding their clients' needs. "That means how to get the most from a specified budget, and how to get the job done fast to make a property start paying for itself," says Jim Hamill, architect.

In looking at operating costs, they feel the energy choice is one of the most important considerations. That's why they believe a restaurant should choose gas as its primary fuel. They find gas equipment more reliable and easier to maintain. For cooking, gas has no equal, providing high heat, fast response and total control. And it can't be beat for efficient space conditioning and water heating, especially with the new generation of energy-saving gas equipment now available.

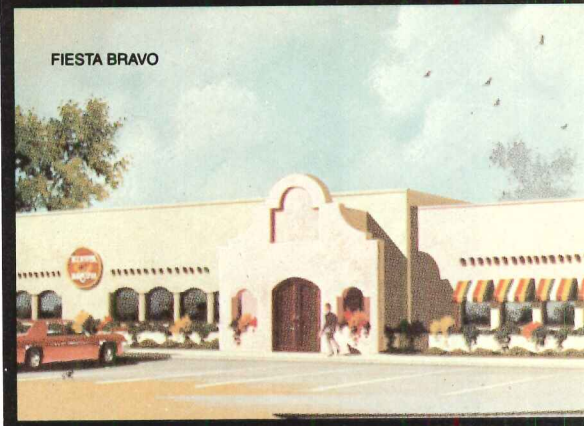
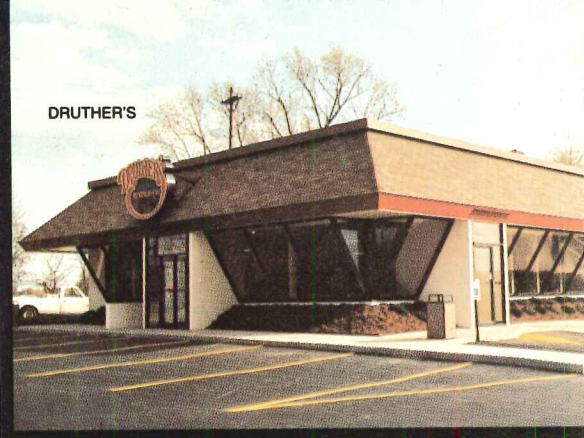

Gas gives you more for your money.

© 1983 American Gas Association

Circle 1020 on inquiry card

Battery Park City: A new residential skyline for downtown New York



Rector Place: view of model from Hudson River

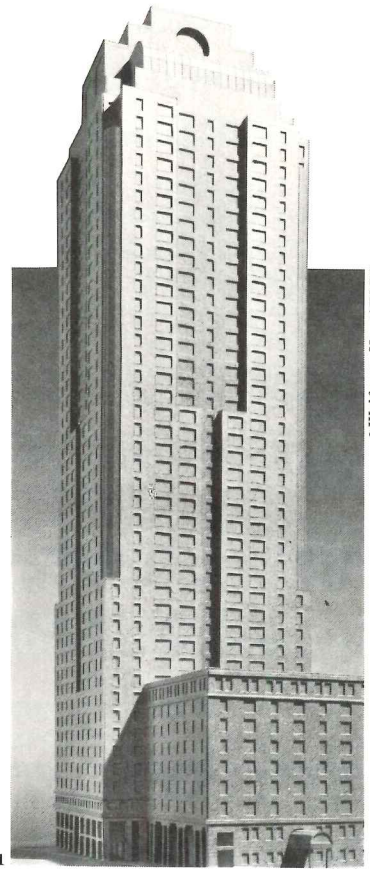

© Wolfgang Hoyt/ESTO

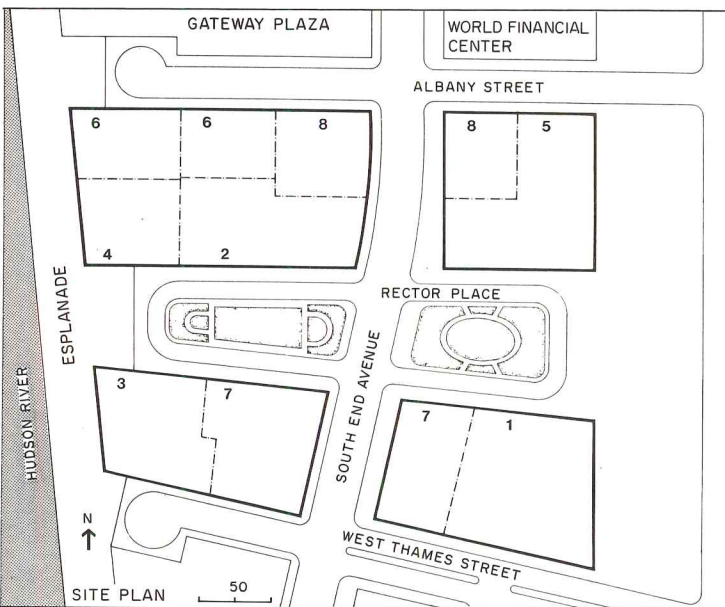

In 1968 the New York State Legislature established the Battery Park City Authority as a public benefit corporation with the mandate to develop a new residential and commercial community on 92 acres of Hudson River landfill in lower Manhattan. A master plan drawn up in 1979 by Cooper, Eckstut Associates calls for 14,000 units of privately developed rental, cooperative, and condominium housing situated to the north and south of the six million-square-foot World Financial Center, a four-building commercial complex currently under construction that was designed by Cesar Pelli & Associates (see RECORD, July 1983, pp. 110-113). In addition to offices and housing, the plan stipulates that 30 per cent of the entire site be given over to public parks,

plazas, and a riverfront esplanade. Work completed to date includes the 1,712-unit Gateway Plaza apartment development and a quarter-mile segment of the esplanade.

The latest and perhaps most eagerly anticipated phase of Battery Park City was recently unveiled to the public by Authority officials. Called Rector Place, the new residential complex comprises 2,000 apartments and town houses in 12 buildings that have been designed by some of the city's most prominent architectural firms. Unlike Gateway Plaza, which was conceived prior to the completion of the 1979 master plan, the new buildings have to conform to rather detailed design guidelines, unusual in New York, that seek to avoid the "project" look of many large-scale

developments—"a conscious rejection," in the Authority's words, "of the 'urban renewal' approach to city planning adopted by architects of the Modern period."

The guidelines specifically call for an extension of the city's historic grid street system into the area and require that the new buildings be grouped around Rector Park, a two-acre green space designed by Innocenti-Webel in joint venture with Vollmer Associates (model and site plan above). In order to reinforce the feeling of a typical city street, the plan provides for a continuous building wall at the edge of the property lines with no open plazas. Ground floors are to be residential around the park, while commercial frontage will be within arcades on cross streets and along South End

Avenue, the community's "Main Street." Each building must have a two-story stone base, and the preferred material on the upper floors is earth-toned brick. Metal-and-glass curtain walls are prohibited.

Most unusual are the Authority's guidelines for "articulated rooftops" and "expression lines" on all 12 structures. Upper floors "must be consciously designed to create a special and interesting effect that will complement the skyline of lower Manhattan." Taller buildings, moreover, are required to have cornices, or some change in window configuration or corner detail, at intervals between 60 to 85 feet and between 110 to 135 feet—a provision aimed at reducing the apparent scale of the facades and unifying the street wall.

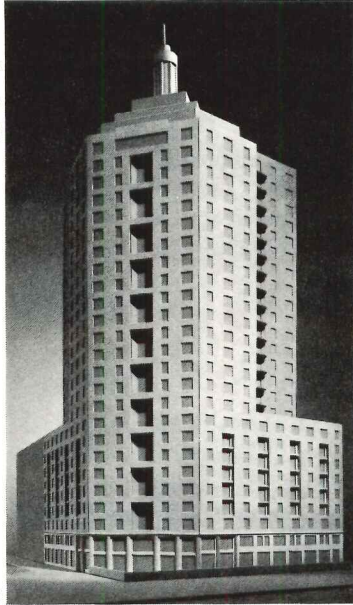

3

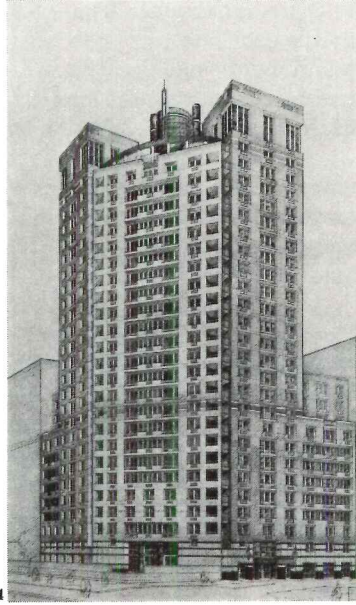

5

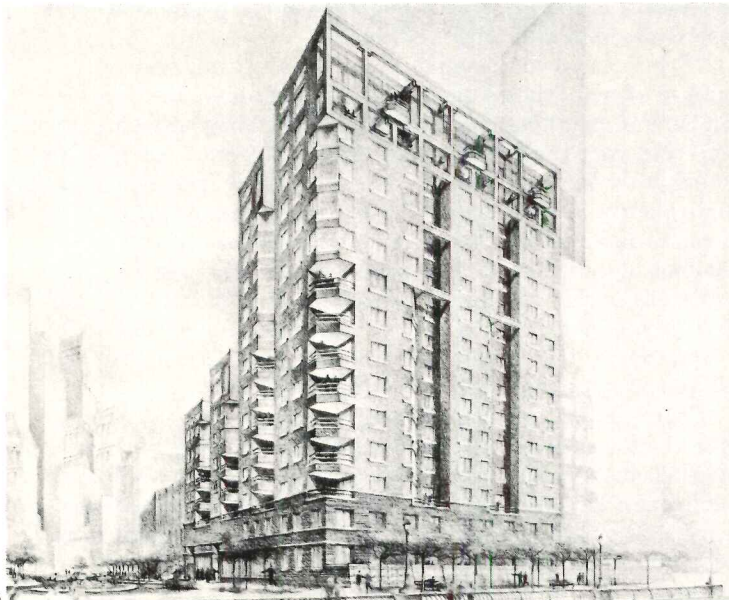
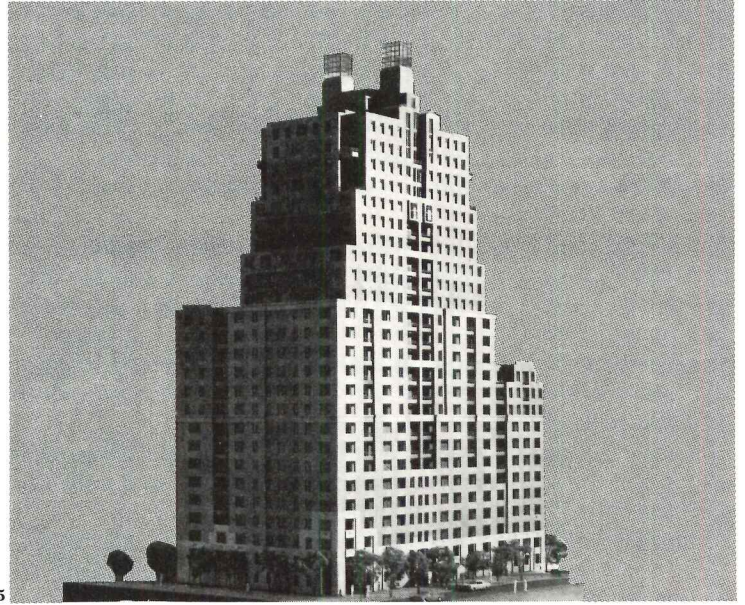

6



7

Working within the framework of the Authority's guidelines, eight architects have come up with an assemblage of buildings that range in height from six to 44 stories. If the results appear on paper as a hybrid of the qualities that characterize such older, well-established New York City neighborhoods as the Upper West Side and Gramercy Park, it is no accident: The formulators of the master plan purposely tried to emulate the diversified architectural ambience of these areas and apply past lessons to a new residential community. Although the architects' models and renderings illustrated here reveal the visual potential of this concept, how well Rector Place ultimately succeeds as a unified ensemble will not be known until late-1985, the development's scheduled completion date.



8

1. Ulrich Franzen & Associates, 44-story rental apartments.
2. Charles Moore and Rothzeit, Kaiserman, Thomson & Bee, 14-story rental apartments.
3. Ulrich Franzen & Associates, 26-story rental apartments.
4. James Stewart Polshek & Partners, 27-story rental apartments.
5. The Gruzen Partnership, 25-story condominium apartments.
6. Davis, Brody & Associates, 15-story condominium apartments.
7. Bond Ryder James, Architects, 9-story condominium apartments.
8. Conklin Rossant, 9- and 18-story cooperative/condominium apartments.

Note: photograph numbers correspond to building locations on site plan.

Round Table:

Conserving energy in the rehabilitated or retrofitted building

ARCHITECTURAL RECORD invited a group of architects, engineers and energy consultants to discuss how well energy conservation is doing in older buildings—how the “arithmetic” is working out, what new techniques and processes are needed, how skillful professionals are at predicting results for the client. And the key to success (one more time) seems to be effective architect-engineer-owner collaboration—starting on Day 1.

The Round Table began with this general premise, generally accepted: Energy conservation is now an integral and important part of the design of almost every new building, and, as a result, energy usage is much less than it is in comparable buildings designed only 10 years ago. As engineer Jack Beech said: “If the automobile industry had done as well as we did, today’s Cadillacs would be getting 35 or 40 miles to the gallon.”

So the opening questions were: “Is the same kind of progress in energy conservation being made in older buildings being restored, recycled, retrofitted?” And, related: “Is there the same enthusiasm and commitment to energy conservation that we saw a few years ago?” Engineer Beech: “I’m not sure that enthusiasm is the right word. Engineers and architects have certainly felt a *commitment* to doing a good job of energy conservation. But the majority of owners—especially of office buildings where the operating expenses are borne by the tenants—have been *reluctant* to spend the necessary up-front costs, no matter how small a percentage of first cost, if they couldn’t get an awfully fast payback.”

Architect Earl Flansburgh: “In some respects, energy conservation has lost its ‘premier’ status. But it remains as a major consideration in the mind of every good architect and engineer. Take solar collectors as one example: For a while we were putting them on every roof and thought of them as a solution to everyone’s problem. Now, at least in the Northeast, we still use them extensively for hot water but don’t try to use them for heating. And we’ve begun to understand that older buildings may actually be fairly energy efficient—many of them have thick stone or masonry walls and fairly small window areas. That’s a good beginning.”

“The answer to your question about progress in existing buildings compared with new buildings has to be mixed,” said engineer Larry Spielvogel. “There are some existing buildings whose performance is equal or superior to new buildings being built today, but the majority still need a lot of work. I see the big hang-up as the lack of skilled operating personnel. Except in those few cases where the operation of a building is critical, such as a hotel or hospital, the people who operate the building don’t have much more status than a custodian or janitor. The efficient operation of a building needs much more emphasis and importance placed on it by management.”

Architect Flansburgh agreed: “Five or six years ago we embraced some fairly complicated energy conservation systems, and it’s now clear that few owners are willing to hire qualified technical personnel to run them. The people running some fairly sophisticated systems are not just treated as custodians—they indeed may be the custodian, and the end result is simply that the systems don’t run as efficiently as everyone was led to believe.

“One other change in attitude: Five years ago, we were enthusiastic about making everything as tight and efficient as we knew how. Today, we don’t make all windows that we replace in existing buildings triple glazing because we can now analyze with great accuracy and swiftness on our computers how much energy conservation we need. Guidelines are beginning to take the place

of thorough analysis. That means we may fail to address problems of infiltration, which are critical in some older buildings. Or take lighting. We now have all kinds of state codes and standards, but they don’t really take into account the effect of the darker colors that are now in fashion. Fifteen years ago, when you gave everybody 100 footcandles, color didn’t matter. So energy conservation as we now see it, I think, isn’t just a design engineering problem—it spills over into operation, into esthetics, and into all the special and particular problems associated with older buildings.”

How about owner attitudes?

As in so many first-cost decisions, it seems to depend on the type of owner

Steve Fewtrell, senior operations engineer of the Prudential Center management department, introduced some client/tenant thinking: “It’s probably more difficult to make progress in conserving energy in retrofit buildings. When you design a new building, you can study the cost feasibility of alternative solutions and make life-cycle analyses, whereas in a retrofit building you tend to think in terms of payback on improving or upgrading existing systems. You can’t afford to ignore what is there now, and that affects efficiency.

“Even in those office buildings where operating costs are passed along to the tenants, don’t underestimate the owner’s stake. For one thing, if you keep your operating costs down, you can keep your rents down—your property is more competitive. Further, we’ve found tenants receptive to the idea of sharing the first costs of an energy retrofit. We’ve been going back to tenants and showing them engineering analyses of the energy savings of a retrofit. If they agree with the analysis, we modify the lease so that they agree to participate in the first cost and later reap the benefits of reduced operating-cost escalation.”

Spielvogel: “More and more owners are doing just that; and more and more tenants are proving receptive.”

Engineer John Altieri: “Among owners, we find that the degree of enthusiasm for and receptivity to energy conservation depends on who they are. Universities are the most interested and concerned—in most situations are willing to buy energy conservation systems and retrofits if they are well engineered and offer a reasonable payback period. We find the major corporations who build a lot—like Bell Telephone or IBM—are still very enthusiastic about using and applying energy conservation systems in existing as well as new buildings. We find museums coming to us for energy retrofit. Granted, there seems to be less interest among owners of speculative office buildings, but with those net-net leases that Mr. Fewtrell spoke of, tenants are willing to participate in the first costs of energy retrofits in return for lower operating costs. And we find that leasing agents are more and more insisting on quality-engineered buildings even for speculative tenant situations. We find that effective mechanical systems and effective lighting systems are right on top of the heap of what owners want—because they realize that their tenants are becoming more sophisticated and the owners need to be competitive.”

Engineer Sidney Greenleaf: “Especially in existing buildings, you have to be careful not to be over-enthusiastic and over-engineer the job. Most owners have found that they can with relatively small expenditure accomplish a great deal of the total potential in energy conservation. To make my point: In 1975 or ’76, the state of Massachusetts established a program to do energy conservation at state universities and colleges. As those things go, it took several years for those programs to be

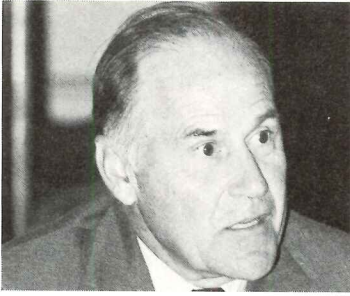

*John L. Altieri
John L. Altieri, P.E.,
Consulting Engineers
Norwalk, Connecticut*

*Jack Beech
Joseph R. Loring & Associates
New York City*

*Tage Carlson
OCF Technical Center
Granville, Ohio*

financed. We were given one of the universities to work on. We did a very complete computer study, and were predicting an immense amount of money to be saved—I don't remember the exact numbers—with the expenditure of about \$750,000 in retrofit costs. During the time that we were working on the project, the university hired a maintenance man—not an engineer, a technician—who had been laid off from one of the local industrial plants. Without mentioning it to us, he went out and put in about 200 timeclocks at \$35 apiece, shut a few fresh-air dampers—and accomplished about 85 per cent of the total savings we were predicting. The moral: Never forget that in existing buildings you can sometimes get the biggest part of your energy savings by giving a screwdriver to the right man.”

Tage Carlson, manager of the Energy Research and Insulation Products Laboratories of Owens-Corning Fiberglas, pointed to some elements of energy conservation that cannot be applied in existing buildings: “There is no way you can move the building around to orient it better for the sun. There is usually little you can do on the exterior in terms of preventing solar gain or allowing solar energy in because seldom can you justify changing the window openings. These kinds of problems are compounded in historic buildings. There's seldom an acceptable way of running new ducts, or putting more insulation in those lovely vaulted ceilings, or replacing small-paned windows with reasonably tight double-glazed fenestration. On the other hand, look at the changes in lighting systems, the new control systems, the more efficient mechanical systems that we have today that didn't even exist 10 or 12 years ago. I think the idea that energy conservation has lost its glamour is unimportant; what is important is that energy conservation has become part of our day-to-day thinking and habit.”

Engineer Gary Vanderweil: “I agree. If energy conservation has lost its cutting edge, it is because the new products and systems we needed came out in the '70s and have been diffused into our every-day design technology; codes were changed and have been diffused; energy rates escalated rapidly in the '70s and we have diffused them into the economic system and have gotten used to them.

“As to how far we are progressing with energy conservation in older buildings: As others have said, it depends on the job. We do quite a few 'gut' jobs on older buildings, and on that kind of rehab the entire range of energy conservation opportunities in the mechanical and electrical areas are available, though the opportunity to make changes in the skin or envelope of the building is usually quite limited. The energy-conservation retrofit of post-World-War II buildings is really a different ball game entirely. For one thing, it is much harder to work in a building that is occupied. And the economics are tougher—all the owner wants to know is how much it will cost and what's the payback period. In both cases, it's harder to conserve energy than it is with the design of a new building, where you can orient the building correctly, design the skin of the building to allow natural light, use better insulation and window systems, design in heat storage—indeed, use the full menu of engineering techniques.”

Lighting engineer Sy Shemitz: “There's lots more progress to be made, perhaps especially in lighting. We have to get leaner, think more, be more creative. Sure, you can save energy by cutting fixtures from two lamps to one or from four lamps to two, and by changing ballasts. But those kinds of quick fixes aren't the answer. You walk into most places that are 'saving energy' and they are flat, uninteresting, boring places. The wattage is down (along with visual acuity) and the only exciting

thing is that somebody has stuck a lamp on a desk that has a little bit of brightness and glitter and creates a little bit of shadow.

“If we want to save energy without that terrible loss in the quality of the working environment, we have got to think in terms of lighting selectively rather than by the square foot. When we do, we will create more interesting environments and renew the support for energy conservation. These techniques are not something you can apply with a wash; they have to be applied with a fine point, and it takes skill, dedication, and enthusiasm. I believe there are endless things we can do to save energy in any building, be it old or new, and we haven't even scratched the surface....”

Architect Tad Stahl: “I think there is a kind of cultural status we are trying to find: Where are we in this field of energy conservation? Where does it fit? Energy conservation compared to what?”

“I agree that it depends on the client, and it depends on the building type. University clients find it very easy to deal with what they see as a sort of technical course of action: hire a consultant, look at alternative systems, evaluate them, and decide what to do. They find it very difficult to look at other places where there is wholesale waste—such as underutilized buildings where the solution lies not in engineering but in scheduling and internal management.

“I think the important thing in keeping energy conservation in perspective is to make sure that common sense is the first thing you try. Sometimes it's hard for us to get our clients to understand where the effort ought to go. For some clients, it's easier to justify a sophisticated program than it is to upgrade their own internal thinking and personnel.”

Architect Peter Forbes: “I think with the ascendancy of common sense, energy conservation has taken its rightful place as one of the many important things to bear in mind when designing a building. There was a period when you would have thought there was no other consideration, which was a bit like designing around the invention of the flush toilet. Or maybe architects who knew something about energy conservation were looking for a way to sell services. But I think we are back to realizing that the quality of the space, with all its different considerations, is what we are after. Some of those considerations are lighting and heat and ventilation, but some are proportion and massing and color.

“I would agree that you have two very different animals in the old building compared with the not-so-old building. Buildings built in the 19th century were built to last for 100 years; I don't think we assume most buildings built since World War II are going to have to last that long. And in that change of thinking, I think there are vast implications for how efficient that building can and should be made.”

**The Round Table was asked:
To what extent is the arithmetic
of energy conservation working out?**

Larry Spielvogel argued that “owners' attitudes towards energy conservation are tempered substantially by credibility—many owners are reluctant to look at what appear to be viable energy-conservation techniques because they have been oversold left and right, not only by their professionals but also by a lot of vendors. Too many promises and predictions for various energy goodies have not come through. The Department of Energy has just released its evaluation of the School and Hospital Grant Program in which we taxpayers have invested several hundred

John Cook
Energy Services &
Management Corporation
Boston

Earl Flansburgh
Earl Flansburgh and
Associates Inc., Boston

Steve Fewtrell
Prudential Center Management
Boston



million dollars to date, and while the facts do show that energy consumption has been reduced as a result, I believe the majority of those reductions have come about not because of the money invested in hardware but because the building owners became aware of energy conservation and have done better in terms of operating and maintaining those buildings.

"And while we're considering the arithmetic of energy conservation, the costs versus the paybacks, I'd like to temper the enthusiasm many people have for Btus per square foot. That is a good measure and indicator of a building's performance—but is not as important to building owners as *dollars* per square foot.

"Life-cycle cost is another good indicator, but not necessarily a good criterion. Everybody talks about life-cycle costing, but rarely is it truly employed. Even in government buildings where life-cycle cost analysis is required, the owner says, 'Yes, use life-cycle costing—but don't exceed the budget.'"

Engineer Boggarm Setty: "If time is spent by the architect and engineer, it is possible to design buildings that are architecturally, electrically, and mechanically innovative. The first cost may be higher, but, increasingly, third-party financial institutions are willing to invest money in those first costs in return for the tax credits."

Energy consultant John Cook: "My company works solely with investment people in energy conservation. Since 1973, we have done an average of 40 buildings a year, all retrofit. Every one of those projects has been done with third-party financing from banks and investors. I personally have taken a risk reinvesting some of my company's earnings in these projects. Statistically, the average payback period ranges from 2.19 to 2.2 years, and the longest was something over five years. The arithmetic does work, because energy-conservation projects can be financed third-party, shared savings, joint venture. As energy consultants, we don't engineer buildings or design them, but we may well select the engineer and architect—and make sure they are paid a fee sufficient to do a really thorough job of energy-efficient design. And then we as consultants take complete responsibility for the results. . . .

"I sat as the representative for the building owners and managers (and Gary Vanderweil was on the same committee) as the state of Massachusetts considered its energy code. We found that there are a lot of vested interests involved in energy conservation, and people are constantly complaining that if you invoke this kind of standard or that kind of standard it is going to affect my business—as a masonry contractor or glass contractor or architect or engineer. The cooperation, the institutional changes, that are necessary to handle a diminishing energy supply are matters of communication and of fact. Every existing building and every building in design should be looked at as an oil well—do we dig the oil well or do we save the oil by good design?"

Frank Hendrigan of Boston Edison spoke of energy-conservation arithmetic from the utility's point of view: "The rate structure of a utility can really affect what's 'efficient' from an energy conservation point of view. It's a mistake not to pay attention to the incentives and penalties imposed by the utility—an energy-conservation plan appropriate for a building served by Green Mountain Power or Utah Power may not be effective at all for the Boston Edison system. For example: We are a summer-peaking utility, the only one in New England. That means that under our rate structure, the energy we sell for space heating is as price-competitive as we can make it. So designing in heat storage is not nearly as cost-efficient as stored cooling,

since you are buying electricity for air conditioning at a high peak rate cost during the summer. That's just one example, but I think it makes the point that you should be knowledgeable about rate structures in your area and take into consideration what the utility has to offer in terms of operating expertise."

Architect Peter Forbes: "Let me speak for the small firm doing small buildings. In our role as the only architect in Southwest Harbor, Maine, we're dealing with clients who are unsophisticated and enormously skeptical of anything told them by anybody who wasn't born there. We did, for example, the Southwest Harbor Town Office Building, an adaptive reuse of a public school building. The town was only willing to go ahead with the project because the people figured they could pay back the cost of renovation/recycling over 15 years because they wouldn't have to pay any rent for the space. They wouldn't buy the idea of spending any money on hardware or systems to save energy. I didn't argue too much, but simply by designing in good use of natural light and effective insulation, we're getting an eight-year payback. Further, in situations like that, I'm skeptical of sophisticated systems because they do break down, and when they do there is nobody to fix them. Maintenance there is done by one of the volunteer firemen. My client is happy because he likes the way the building looks and because it is paying off in half the time he thought it would; all I used was an application of common sense and knowledge of the site and the client and the program. As I've listened to this discussion, I've been disturbed by the isolation of the notion of energy conservation from the general notion of architecture. I don't think you can separate the two because then either the tail will wag the dog or you will get into enormously conflicting ideas and aspirations."

The problem, some panelists argued, is not just with the tools, but with accurate prediction of results

Said engineer Sid Greenleaf: "After 10 years of struggling to save energy, I'd have to say we're still woefully short of tools for predicting results. In 1973, when the crunch came, the government started throwing money at the situation, especially at demonstration projects. But today, owners and architects and engineers have to make decisions and then stand pretty much on their own. I don't think we have the tools to make those decisions. Over the years our office has spent a lot of time going back to basic transient heat-flow equations and feeding those basics into the computer—trying to develop programs we can make decisions from. But after 10 years we don't really have the matrix we need to do the work. We have plenty of engineering material from companies like Owens-Corning Fiberglas and PPG—but they don't make any attempt to integrate their data for over-all systems analysis. The government and the AIA have funded a lot of research in this field, and they haven't come up with the tools. We engineers are pretty much on our own, and if we get results that are within a reasonable percentage of our projections, we're extremely happy."

Engineer Gary Vanderweil: "The arithmetic is difficult, for a number of reasons. For one thing, when an engineer is called for the retrofit type of job, we often find that the owner has already done many of the most cost-effective things—like taking out half the lighting. This means that the remaining energy conservation opportunities have less attractive payback periods. I also believe that owners tend to judge the incremental investment for energy saving more harshly than they budget other alternative investments. We have worked with two of the energy-investment firms—third-party investors—within the last few months and

"The owner says to use life-cycle costing—just don't exceed the budget."
Larry Spielvogel

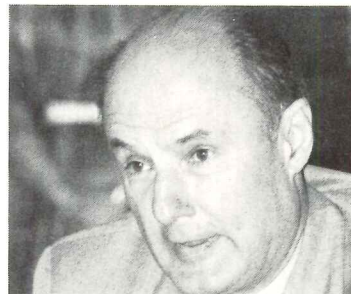
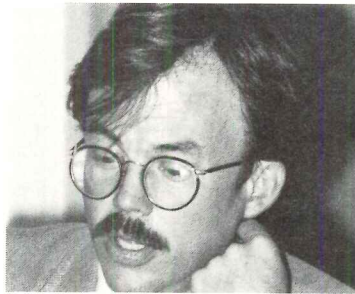

*Peter Forbes
Peter Forbes and
Associates Inc.
Boston*

*Bruce Campbell Graham
Bruce Campbell Graham
Associates
Westport, Connecticut*

both are very emphatic that they are looking for payback periods of three years or less. That seems to be a very good investment indeed—if you can get it. I would invest my hard-earned savings for payback periods like that. Finally, I agree with Sid Greenleaf's contention that the analytical tools for predicting payback have not kept pace. But I do think experienced engineers can come pretty close. In the kinds of buildings we deal with every day—such as office buildings that are lighting-intensive and power-intensive, and laboratory buildings that are ventilation-intensive—we can usually predict annual energy use within 10 per cent, on the back of an envelope."

Architect Pat Morse of Anderson-Notter-Feingold argued that major savings can be assembled from a lot of little savings: "It's one thing to talk about sophisticated systems on major projects. But there are still a lot of building owners with run-of-the-mill buildings that are looking for ways to save money for themselves. We have the advantage with existing buildings of being able to make before-and-after comparisons. When you make an improvement, you can fairly quickly get a good reading on energy usage and cost. For a simple example, take the room we're meeting in [in the Algonquin Club, a 19th-century building on Boston's Commonwealth Avenue]. Think of the number of approaches available to energy saving just in this room, which is just one part of the building. The lights are all on, at midday—because the sun has been pouring in, we've been opening and closing the drapes—and we've turned off the room air conditioning because the unit is too noisy. I'm sure you could find a historic precedent for awnings on a building like this, and I can imagine blinds and interior storm sash installed in such a way that the small-paned windows would look as nice as they do now. It would probably be difficult to add insulation without destroying the paneling in the room—but there might be a cavity in the wall where you could slip in material to cut heat loss. It's almost certain you could install a centralized cooling system and snake a pipe system through to small terminal units.

"On another scale: I designed and built our house about 12 years ago—and we made it all-electric to hold down first costs and because we all knew then that nuclear energy would be the least expensive form of energy available. You can imagine what happened to our electric rates about five years ago, and since then we have gone through a program of energy conservation. We have an active solar domestic hot-water system, we've gone to quadruple glazing of some openings, we have quite sophisticated thermal shades on the south-facing glass, and we have a five-kilowatt windmill, so we are even into cogeneration. Last year it produced 10,000 kilowatts and I am looking for it to pay for itself in 15 years—which maybe is not so good an investment. At any rate, it pays to keep making improvements until you say to yourself that one more improvement is not going to make enough difference in your utility costs to justify itself. These incremental improvements are extremely effective, in a house or a building being rehabbed, in areas like New England where you have such high rates to begin with that the payoff is fast. I think you simply have to take each building as its own case—and then apply the common-sense approach."

Tage Carlson: "I agree that the analytical tools for predicting savings are not what they should be. We are just beginning to fully understand how the envelopes of residential structures perform over time—and a house is very easy to understand compared to a large nonresidential building. And in older houses, as well, as older buildings in general—most of which are quite small—it is difficult to understand what you have to begin

with, what condition the building is in. How do you know where you are to start so you can measure the effect of what you have done? My point is that when you are trying to tell a client what kinds of benefits he is going to see from various retrofit techniques, you are still on shaky ground. It is very, very difficult."

Engineer Jack Beech: "The trouble with making predictions about energy use is that things change along the line. Example: We worked on the design of a building and went through sophisticated engineering calculations on energy use. We had an independent consultant verify our calculations and he came within five per cent of our figures—and on that basis we gave the owner some pretty strong assurances of what his savings would be. After the building was designed, it was fitted with CRTs on almost every desk, and all our figures are out the window. We are using far more power than we said we would, and for a while everyone thought we should add refrigeration. I suggested we wait until we got through last summer, which was one of the hottest on record in New York. In fact, we were never fully loaded on refrigeration. You'd think the owner would be deliriously happy because his building coasted through that long hot summer, but in fact he's not too happy because he now thinks he spent too much money on refrigeration up front.

"The point is that energy usage calculations are tough enough in theory; in practice they are very very difficult. With the tools available today, I don't really have confidence in telling the owner that you are going to be saving so many dollars—better, so many Btus—if you do this or that."

Some panelists wondered out loud whether a restructuring of the professions—and of attitudes—is needed

Architect Tad Stahl: "In listening to John Cook's comments on third-party investors and his role as energy consultant/entrepreneur, I wonder once again about the traditional operation of the professions. Architects have problems of fees, problems of scope of services, and, most importantly, problems of structuring the team to respond to what is needed. I have restructured my own practice to deal with those problems, and it's now much more of a consulting practice than it is a traditional A/E practice. Unless we get architects and engineers and operating people and contractors and subcontractors and the product and equipment manufacturers and the financial people to truly collaborate and understand each other, and allow themselves to fit into a new scenario, I don't think we are going to have the necessary flexibility and achieve the level of confidence and respect to respond to today's kinds of design problems."

Consultant John Cook: "I'm sorry to say that I think too many buildings going up today are not being built by professionals in the true sense of the word and are being impacted primarily by finance and risk—by the construction business. The building contractor should not be the guy making the decisions. You architects and engineers make your studies and write your reports and then I walk into a meeting and find that the decisions are made with respect to financing and risk-taking. To me, energy conservation—whether it be for retrofit or new construction—is a risk-taking business. How much is it going to cost and how quickly will it pay off? Well, the questions are broader than that. Recently, I attended a seminar here in Boston put on by the Swedish government. They talked about waste energy and district heating and combined power and heating systems—and I came away with the feeling that all of the people

*Sidney Greenleaf
Greenleaf Engineers
Needham, Massachusetts*

*Frank Hendrigan
Boston Edison Company
Boston*

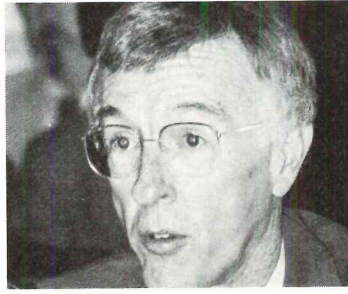

*"What is important is that energy conservation has become part of our daily thinking."
Tage Carlson*

involved in building in that country work together. We have a lot of good technology in this country, and the people who know how to apply it. We have enormous people resources—in architecture, in building, in planning, in economics, in finance—and we need to understand how to make that system work better.”

The biggest need, said the Round Table, is better and earlier communications

Said architect Flansburgh: “I don’t really think we need different systems, products, equipment to conserve energy in older buildings than we do in new buildings. The systems design may be very different—for example, in an historic building you are less likely to design a central air system because you don’t want to spoil those lovely ceilings with ducts. No, I don’t think we need new or different technology—I think we need new and different ways of working with each other.

“Generally what happens is that the architect designs a building and then gets the engineers involved. Engineers always say they want to get involved earlier—but if we get together on the first day, maybe with only a site plan but not a line on paper, and ask the engineer what he would do, you don’t get an answer. Well, yes you do. It may not come out in a single sentence, but what you get in effect is ‘Call me back when you have the building designed.’ And why is that?

“The reason there is not more working together is that our educational systems are not linked and because the two professions haven’t really tried very hard to work together. Instead they tend to work within their own boundaries—this is my territory and that’s your territory. [Engineer] Gary Vanderweil made a very interesting point at lunch: ‘If you think the architects are badly trained in terms of engineering, what do you think the engineers know about architecture? Answer: Zip.’ With retrofitting of older buildings—including energy conservation—we badly need better cooperation and understanding among the design professions. We have got to do a better job because we are going to have trouble making it to the year 2000 with the energy system we have now. That is a societal problem, but I think the best way to solve it is to get a lot more communication and understanding among the design professionals, the owners, and lenders, and that means involving not just the people like us who run the firms but the people who deal with the problems every day.”

Engineer Jack Beech: “I think it’s impractical to talk about the architect and engineer getting together from the very inception. I have dealt with a few hundred architects and a few thousand projects, and if you ask me what I think on that Day 1, I will tell you to build a windowless bunker. That will be very energy conserving, but it wouldn’t be at all what you architects have in mind. I’d rather have the architects come up with a number of designs, sketch designs, that we can comment on.

“The person you need up front—about the time you call in the engineers—is a contractor or professional cost estimator who can verify the dollar costs of what you are proposing as architect. Too often, we end up way over budget, and then comes cut, cut, cut; and too often what goes is the first costs for energy conservation.

“Of course, a lot depends on the reception of the owner to the idea of investing in lower operating costs. Enlightened, engineering-oriented owners experienced in building and operating are a pleasure to deal with; on the other hand are the speculators who have to be assured they will use practically no energy and get practically an instant payback before they will go

ahead with energy-efficient design.

“Finally, whether you are dealing with an enlightened owner or one of those instant-payback owners, you can’t ignore the general economy or the marketplace at the moment when you are trying to design in energy efficiency. For the last year and a half, with interest rates high and money tough to get, your good intentions tend to get sidetracked.”

Architect Flansburgh went back to the question of working together from the beginning of the project: “We as professionals have a lot of intellectual horsepower, and if we shared more of it, it would work very well. The responsibility for running the project is the architects, and if the architect believes that there ought to be better communication, then the responsibility for setting it up ought to be the architect’s. Jack Beech says he’d rather wait for sketch designs and comment on them. Well, I’d still rather start communicating—working together—on Day 1, because before you can start a design you have to sort out the pieces, the ideas, that count. Especially in retrofit design, you have to sort out priorities. The sequences of things that have to happen are different than with new buildings. The decisions, the alternatives are different. I’d like to be talking over those decisions and alternatives with my engineers from the very start.”

Said architect Peter Forbes: “I’d also like to respond to Jack Beech’s comment on architects and mechanical engineers not communicating with each other at the earliest stages. An architect might be reluctant to reduce the amount of glass in a building, for instance, if he is well into design. But he would be foolish to disregard such a suggestion if it was made by a thoughtful engineer at the inception of a project. In dealing with structural engineers, we architects learn early the implications of column size and slab thickness. We don’t seem to have the same kind of general understanding of the implications of what goes into the mechanical systems. I think that the architectural profession is enormously receptive to sitting down with the mechanical engineer at the inception of a project—if the mechanical engineer is prepared to operate at that early stage and if also he gives a damn about how the building is going to look.”

Sy Shemitz: “There are, of course, an increasing number of universities that are stressing the need for a marriage of architecture and engineering. The two schools used to work much more closely than they do now at most universities—maybe we’re talking about remarriage.”

Jack Beech: “A footnote comment on costs. I have found the big costs in energy conservation are not primarily the mechanical systems—except for controls, which we have gone overboard on in the last 10 years. But my records show that an energy-efficient building has a lot more money in the skin and high-efficiency fixtures than in high-efficiency heating and cooling.”

“Nonetheless,” Flansburgh persisted, “how would you suggest that architects take advantage of the engineering knowledge that you have—that affects the mechanical system input, or lighting? How do we get that information so that we can use it in our designs?”

Answered Beech: “I’m not saying that we’re standing off and are unwilling to give you any insights you want. But I’d argue that a lot of things we have to say, a lot of suggestions we might make from an energy point of view, are unacceptable to the architect. I am an engineer who believes that the architect should have dominion over the entire project—he knows what the owner wants, he knows what he wants to create. And many



*Charles Ince
AIA Foundation
Washington, D.C.*

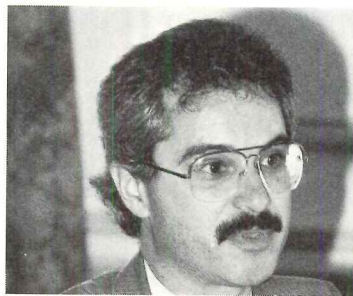

*Daniel Meus
Graham/Meus Inc./Architects
Boston*



*Sherman Morse
Anderson Notter Finegold
Boston*

times, at least in our market, when the architect gets a project, he has already conceived of a building and probably sold the owner on that concept. If the architect really changes his mind—for instance, on the basis of some energy conservation thinking we have—the owner is likely to be up in arms over the ‘changes.’”

Peter Forbes: “Maybe in the New York market you have to make such a presentation of a building to a client before you have it completely in mind. But in general I think the architect can make a more powerful and persuasive pitch to the potential client if he has spoken to the engineer ahead of time.”

Sy Shemitz: “I find increasingly that leading architects in that New York market are bringing me in as part of the pitch to a potential client. Our job is to talk about the kinds of things we can do, the kinds of concepts we have—and increasingly we are talking not just from the point of view of lighting in general, but highly efficient lighting.”

Engineer Sid Greenleaf: “I argue for early communication between the architect and all the engineers—structural, mechanical, lighting—because they are all part of a very specific team that is trying to create something special for the owner. This information will be used by the architect if it is given to him in usable form.

“Like more and more engineering offices, we have developed computer programs that can analyze the factors involved in energy-efficiency—the orientation of the building, its massing, its proportions, the amount of glazing, the setback of the glass, the use of skylights or atriums, and so on and on. These things can all be programmed. As soon as the architect puts the first line on paper, we can feed in alternatives; rotate the building on the site, raise or lower it, change the glazing percentages, or simulate shading. We can explore all the trade-offs of architectural design. If you want to increase the glass area and not set it back for shading, you pay a certain price for it. Systems like this can really help the architect unless he has already made up his mind about a particular design and is unwilling to change it, and they certainly give you and the architect credibility with the owner. This doesn’t mean that the architect has to go along with every device that will conserve energy; it just shows what price you are paying in energy dollars to go either side of what you might call optimum.”

John Altieri: “We can indeed offer the architect priorities. We tend to look at the major energy users in any building type, and attack those major users in selecting our system designs. In our practice, after studying a lot of office building situations, we find that 50 per cent of the power is used in lighting, about 30 per cent in running the plant, another 17 per cent in computer load, about 2½ per cent in elevator usage. So one of the first areas we attack is lighting, and one of the things we do regularly is regulate voltage so that we can control not only the average demand, the average usage, but also peak demand.

“We also look at lighting control. Last night, as we all have done, I looked out of my hotel room and saw half of the lights in office buildings still on at 9:30—obviously and absolutely unnecessary. Computer-controlled lighting control is therefore an obvious way to reduce energy usage—though you don’t hear the utilities pushing to cut that use because it’s after-hours and off peak.

“Since the plant itself is such a big user—again, 30 per cent by our reckoning—we always look at heat reclamation and the transfer of heat from the central part of the building to the exterior.

“We are also pushing energy-control systems. We think that

matching system capacity to load is something that has been neglected by consulting engineers for a long time. And we find we are moving away from the big central-air-conditioning systems in the direction of unitized control. We’re also separating the ventilation load requirements from the environmental control systems. This is the means we can properly control the amount of outside air we take into the spaces—and save a lot of energy.”

“There’s only one trouble, and we’ve talked about it before,” said Sid Greenleaf. “We engineers have those tools and techniques in our mind when we get to looking for ways to save energy. When we are on the job, we have the tools. But by then it is often too late. The architect has already determined the general shape of the building and its orientation and insulation and glazing and roof system. I don’t doubt for a minute that we can design highly efficient systems, sets of systems, after the architectural design is set. It’s predicting and setting priorities before that that interest me the most.”

Do we need more new techniques and more new products to do a better job of energy conservation?

Said Larry Spielvogel: “I think the answer is no, and yes. I think as far as the basic principles and systems and properties of materials are concerned, we’re pretty far along. The big weakness, as some have suggested, is the ability and judgment of the professional using those design tools to establish what’s going to go on in a building. For a simple example, if we were going to estimate energy consumption in this room, how would we begin to judge or estimate how many hours lights would be on, how many hours the windows would be open, how many hours the air conditioning would be running? Those are not technical problems: Those are professional judgments—well, maybe they’re just guessing—and that’s a serious weakness in predicting energy usage no matter how good our systems analyses are.

“I’d have to disagree with Earl Flansburgh about the need and desirability for more products and materials in this field of energy conservation. I think we’re beginning to see a dramatic increase in the number of new products and manufacturers serving the need for energy efficiency—probably more in the past five years than in the 20 years before that. Now these may not be the kinds of products that corporate planners like, which lend themselves to mass production. Rather, they tend to be specialized products that are developed in three-car garages. Even I, who tend to be pretty conservative, have taken some chances with these new products whenever I see the potential for a major benefit without too great a cost risk.”

Sid Greenleaf: “What do we need for the future? In order to fit the necessary mechanical equipment into rehabbed buildings—especially historic buildings that you don’t want to spoil in the process—there is a need for miniaturization of existing types of equipment—equipment that can be localized, that is quiet, that is unobtrusive. Another need is the ability to move energy from one point to another more efficiently. For instance, the interiors of most buildings need cooling year-round; the perimeters need heating or cooling depending on season. With our present technology, you can’t control the interior of a building and transport that energy to the outside where it’s needed. We use heat pumps to do it now, but that is not really efficient.

“So I think we do need new equipment for energy conservation and rehabilitation. We can’t expect the manufacturers to do the

*Boggarm Setty
The Benham Group East
Vienna, Virginia*

*Sylvan Shemitz
Sylvan R. Shemitz &
Associates
West Haven, Connecticut*

*Larry Spielvogel
Larry G. Spielvogel Inc.
Syncote, Pennsylvania*

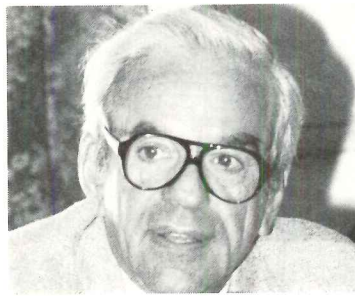

necessary research and development without a market, or in advance of a market. Supporting this kind of R&D would be a good place to apply some sort of subsidy."

Engineer Boggarm Setty: "While in general the techniques for energy conservation are the same in rehabilitated buildings as in new design, I think innovative systems can be achieved. For instance, we are doing a retrofit job on an industrial type of facility. In the end we found we had a lot of excess cooling and chilling capacity—which we used in a new building on the site at a saving of over \$1 million in mechanical equipment. That's just one example...."

**Near the end of the Round Table,
each panelist commented on
what had seemed most important**

John Altieri: "A final comment on architect/engineer collaboration: I try to wear an architect's hat all the time, and I just can't conceive of not being part of the conceptual design of a building. We affect the design of many buildings—and I mean the architectural design, not the engineering design. During the schematic design phase, we do schematic design drawings right along with the architect.

"In terms of the techniques for conserving energy in retrofit buildings, we see the development of new control systems as most important. Control of heat transfer and movement throughout the building will, I think, become more important. So will techniques for energy transfer. We need to be able to adjust the operation of all the systems in a building—including the air-handling systems, the pumping systems, the refrigeration systems, and the lighting—to match usage to the real need. You wouldn't run your car engine at 7,500 rpm just so you can meet the occasional need for a burst of speed...."

Tage Carlson of Owens-Corning Fiberglas: "As the representative of a manufacturer, I think that you architects and engineers need to be more involved in evaluating products and equipment. Lots of claims are made that are not substantiated.

"One thing we haven't talked about is the comfort and productivity of the people working in the buildings we rehabilitate or retrofit. When we are worrying about whether or not to spend money on energy conservation, we must remember that those costs—indeed, all first costs—are minor compared to the cost of paying the people who work there. A couple of percentage points off productivity because of inadequate air conditioning or lighting—comfort-related considerations—can easily wipe out the 'savings' from skimping on good environmental control."

John Cook: "Since we are talking today about rehabilitation, I'd like to say my final word on rehabilitation of low- and moderate-income housing. One of the reasons that more such housing is not being built, and that many projects are being abandoned, is that energy costs are running up to 35 per cent of the income of the people who are living in that housing. Yet the subsidies for energy usage in that housing is in many cases higher than subsidies used to build it in the first place. One of the criteria that I have suggested to the Boston Housing Authority for the rehabilitation of a big project is that they select a development team that will address the problem of making that housing energy-efficient. There is a great deal of money coming to the states as a result of some of the overcharges on fuel, and if it can take some of that money and put it into housing programs, we can all direct our talents to a level of society that is being bypassed."

Steve Fewtrell: "Two final points on the arithmetic of energy conservation: 1) If an energy conservation technique is not acceptable to the tenants, then the payback isn't there because it won't be used. Example: the owner being told he can do duty cycling in a building and finding that his tenants won't accept the fans going down because they can't hear the air conditioning. 2) Architects and engineers can design the most efficient systems, but if the operating people are not maintaining or operating the system correctly, the savings go out the window."

Sid Greenleaf: "In the end, I don't think we've done nearly enough about energy conservation, and I'm concerned about what would happen if the energy crunch came upon us again. It wouldn't take much—a little more trouble in the Middle East, for example—to put us right back in 1974. And over these last 10 years, I don't think that very much of substance has happened. There have not been really great steps forward in products and materials as a result of the manufacturers' research and development. You may disagree with me on specifics, but it seems to me that research and development is not accelerating, but dropping off."

Frank Hendrigan of Boston Edison: "I'd like to re-emphasize that there are many ways any utility can be of real assistance to the design community—if we can be made a part of the communication you've been talking about all day. For one thing, we have records on 100,000 commercial customers and half a million residential customers—energy usage records going back to the time the building was constructed. That has to be worth something in terms of predicting energy usage, or the savings from energy-conservation measures. Further, as a utility, we're continually being romanced by purveyors of conservation and load-management techniques. I can think of no better clearing house for that kind of material than your local utility. But you are in the best position to make a judgment on how we and other utilities can work with you—we are ready to do what we can to contribute."

Chuck Ince of the AIA Foundation, and one-time assistant commissioner of the Department of Energy: "I'd agree that in the last five years the DOE has not really provided us with any new techniques or opportunities. Maybe it's because if they really solve the problems, they would have to go out of business.

"The point I would like to stress is that we really need better evaluation of total performance with respect to client objectives; stressing efficiency, not necessarily savings; and stressing that energy redesign need not reduce comfort. We need to make a long-term commitment to building performance. We need better postoccupancy evaluation, with careful monitoring of performance, better maintenance of equipment and better training of operating personnel.

"I think the techniques for energy conservation are not necessarily different for a new building and for retrofit and recycling—the design effort and approach should be pretty much the same.

"Finally, I would agree that we really have a major gap in our training of architects and training of engineers. The problem is at the faculty level as well as the student level and it's not going to change until both architects and engineers get more involved in the gap between the educational environment and the practicing professional."

Architect Dan Meus: "I think the innovations that have developed in the past 10 years have come from the engineering side. Most of the savings in energy usage that have come from the architects' side are the use of techniques that we learned back in school. We're simply using them more and using them

"The best tool for conserving energy is a screwdriver in the hands of the right man."
Sidney Greenleaf



*Frederick Stahl
Stahl Associates
Boston*

*Gary Vanderweil
R. G. Vanderweil Engineers
Boston*

more effectively now. I very much agree that a closer relationship between architect and engineer is essential to effective energy conservation."

Architect Pat Morse: "My summation is along the same lines. As architects and engineers, we can never forget that our first premise of practice is to be good designers. It's our job to integrate esthetics, which is mostly the responsibility of the architect, with technical design, which relies heavily on engineering input.

"If I remember the numbers right from attending the AIA energy workshops, if decisions haven't been made on energy-conservation techniques during schematic design, you have lost 30 per cent of your opportunities. By the time you have finished design development, you have probably passed 75 per cent of your opportunities. After that, you are pretty much limited to material and equipment substitutions. The things that are really going to save energy come pretty early in the design process. The need for early decision is heightened in an existing building undergoing rehabilitation because so many decisions are made for you—the building is already in place, the fabric is there, the bearing walls are there, there are existing systems in place. The need for a closely knit team working together from the start is heightened."

Boggarm Setty: "I am for the team approach, which is surely the best way to assure the best design for energy conservation. I am for the common-sense approach, though I would emphasize that common sense can be applied to some very sophisticated systems, including sophisticated solar-collector design. I would argue that whatever energy conservation systems are applied to a building, the bottom line should be that the owner gets the same initial cost as he would get in any conventional building. Again, this does not mean that sophisticated systems are not justified: In a California state office building we designed, we have concentrated solar collectors, ice storage tanks, and high-temperature hot-water storage. The cost of those mechanical systems is equal to conventional mechanical systems built in that area of the country. I think that control-system technology is developing so quickly that architects and engineers alike need education before they even try to apply the new systems. Finally, I would urge the manufacturers to develop the expertise of technical selling—as new products and systems come out, the manufacturers must at the same time have good technical back-up to assist the engineer in his design."

Sy Shemitz: "Four points. One, individual metering. We had a subtenant in Rockefeller Center insist on a separate check meter and on paying his electrical energy costs based on what he actually consumed. He has a great payback on his investment in energy-saving lighting equipment. This is an idea whose time has come. Second, the fee structure of the engineer. Too many projects are let on a percentage basis of the cost of projects rather than on the kind of work that energy-conservative design requires. Too often more work—the kinds of investigations that should be made—mean less building cost and less fee—which means things get out of whack very quickly. Three, I would like to support the little vendor. We conservative engineers tend to talk about reliable sources, large companies that we can fall back on to take responsibility. But if we take that attitude all the time, we are not going to get the kind of research and development in the building field that we have experienced in the electronics field, say, where small companies have stuck their necks out. We professionals should have the talent to evaluate with intelligence these young chance-takers. Finally, I would not be a responsible lighting consultant if I did not

mention—in the midst of all this talk about energy conservation—the impact of lighting on your ability to see and the contribution lighting can make to mood and atmosphere and the environment in our buildings."

Larry Spielvogel: "To predict the performance of any particular energy-conservative design, we don't need research—we need application performance data, which can be obtained very simply and very readily by simple measurement, either in your client's building or in the manufacturer's laboratory. Simply using the results of that measured data along with all the parameters of the building should enable the professional to design for good performance. I worship at the meter. That's what tells the truth about performance. On every building where energy conservation work is being done, we probably ought to have one meter for every thousand dollars per year of energy consumption—a meter on every air-conditioning unit and every motor-control center and every major piece of equipment. The cost of the meter is insignificant. You can't begin to know how much energy you can save until you know how much you are using. Logs are another valuable tool. Every mechanical equipment room has a closet filled with energy usage records that no one even looks at, and if the logbooks are intelligently designed and reviewed by someone who is knowledgeable about the building and its systems, a tremendous amount of invaluable information can be gained to modify the operating and maintenance instructions and, often, to make possible dramatic improvements in performance."

Tad Stahl: "Energy conservation in buildings being rehabilitated or recycled for new use is important because rehabilitation and recycling are important. Our older buildings have something special that our modern ones don't; they have qualities that appeal to the general public. So making them work, making them efficient, making them cheaper to operate, increases their worth and importance to all of us..."

Gary Vanderweil: "Many of the 19th-century buildings we have been involved with have really been energy conserving in their own right because they were designed with thick granite or masonry walls, moderate expanses of glass, courtyards that encouraged natural ventilation and daylighting. With that as a start, we've been able to make tremendous strides—the buildings we are rehabbing today are far, far more efficient than those we worked on 10 years ago. And there is plenty of room for more advancement—especially in equipment efficiency and lighting."

And architect Bruce Campbell Graham had the last word: "I think the most important thing to remember is that the energy crisis is still with us. We've done a good job of conserving energy in new and old buildings alike, we're meeting all the new codes and standards. But all the threats are still there. New sources of energy still seem a long way off. We might have to go back to coal—but that raises serious problems of pollution that we cannot and will not be permitted to ignore. Even if oil supplies prove reliable and steady, the problems of energy supply and pollution are not going to go away. So the need for energy conservation is as pressing and important as it ever was."

And so ended the Round Table. A tale, it seems, of continued accomplishment and commitment. A reaffirmation of an old truth: What is needed more than new techniques and new technology is the right consultant with the right expertise at the right time. And a strong statement that energy conservation is as important in rehabilitating older buildings as it is in designing new buildings, and as important as it was when the energy crisis first burst upon us some 10 years ago.

Walter F. Wagner, Jr.



If you're running out of ways to tell your boss the copier broke again, it's time for a Panasonic.

Before your copier causes a breakdown in communications between you and your boss, tell him about the Panasonic FP-2520. It uses advanced electronics and has four compact flat motors to help prevent breakdowns. But, like all Panasonic copiers, the FP-2520 is designed to be more than reliable. With its patented Magnefine™ Toning Process you'll make crisp, clean copies, from edge to edge, copy after copy. Even the subtle details of photographs are captured. And with

three sizes of enlargement and four sizes of reduction, the FP-2520 can solve almost any copying problem. Add a few accessories, and this Panasonic becomes a complete copying system that can feed and collate up to 25 copies per minute. Once you get the Panasonic FP-2520 copier, you may never have to speak to your boss again. If you're afraid to talk to your boss, talk to us. Call 1-800-526-0354. In New Jersey, call (201) 384-0275.

Panasonic®
just slightly ahead of our time.

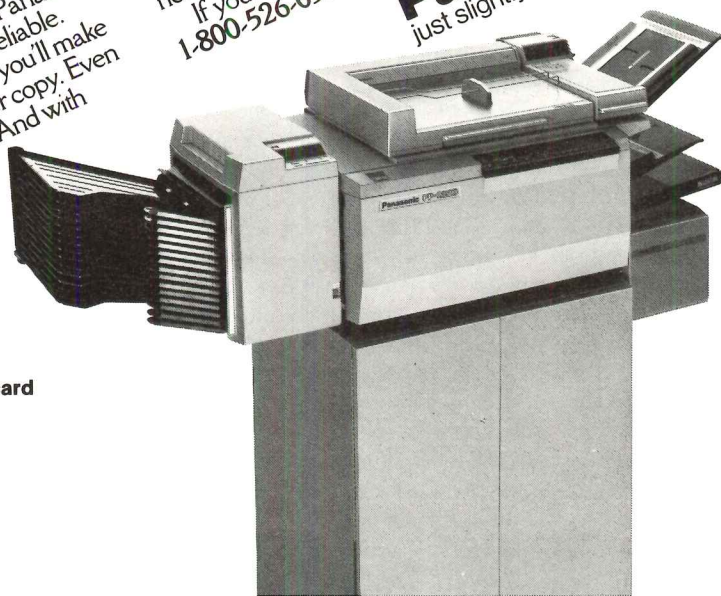

Circle 1021 on inquiry card

Product Reports 1984

The manufacturer as part of the team

During the Round Table on energy conservation that appears in this issue, the panelists devoted a good deal of discussion to architect-engineer collaboration. Some engineers thought that the most useful role for the engineer was to comment on the architect's preliminary design—to suggest alternatives and to put price tags on the design choices made by the architect. Most of the architects and most of the engineers opted for an earlier and more activist kind of collaboration, working together from Day 1, on the grounds—as architect Peter Forbes put it—that “an architect might be reluctant to reduce the amount of glass in a building, for instance, if he were well into design, but would be foolish to disregard such a suggestion if it was made by a thoughtful engineer at the inception of a project.”

Since we have just completed several months of work on this Product Reports issue, I am reminded that more of the same kind of collaboration might usefully take place between architect and manufacturer. For one thing, this annual issue serves as a good reminder of the enormous input and contribution that the manufacturers and suppliers of building products and materials and furniture make to the process of creating architecture. On the pages that follow are hundreds of product- and material-use ideas—and, through the catalog offerings, hundreds of pages of technical information—that can inform an architect's choices at each stage of the design process.

I don't need to tell architects (or manufacturers) that—the collaboration between architect and manufacturer is (and needs to be) somewhat different than the collaboration between architect and engineer. From the manufacturers, we hear too many complaints that architects never are willing to take the time to see a manufacturer's representative, and are much too quick to give up a spec under cost pressure. From the architects, we hear too many complaints that when they do ask for information on a product or material the technical information is too thin, or that when they do see a technical representative he very often doesn't have the information that the architect needs and sometimes doesn't know where or how to get it.

I think there is too much talk on such generalizations from both sides. The truth is that architects need to know what is available in the marketplace on a continuing basis. For one thing, they need to know what is new. For another thing, there is a new class every year—young architectural graduates and interns to whom the marketplace is a brand new candy box.

We hope this issue meets that need to know, and serves as a reminder of that input and contribution that the manufacturers make to the profession. And of the enormous need for collaboration between architect and manufacturer in the difficult course of the design process.

As in the past, this year's Product Reports is organized on the 16-division UCI format. Page numbers for each division are listed in the Table of Contents, page 3. More information on any product or literature item in this issue can be easily obtained by writing the item numbers on the Reader Service cards on pages 9 and 253. Companies whose products appear in this issue are indexed on pages 6-8; advertisers are listed on pages 251 and 252. *W.W.*

1 Office Equipment

UCI 1, Office equipment:
Computers
Information systems
Instruction manuals
Maintenance/operational
equipment
Office machines
Office supplies
Reproduction equipment

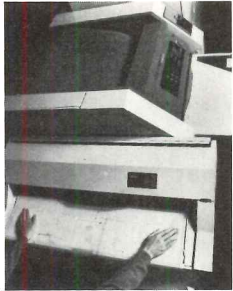

1



4



7



10

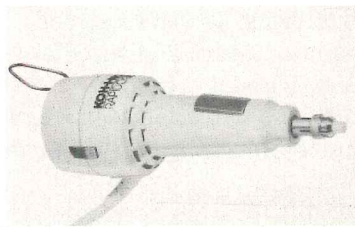

2

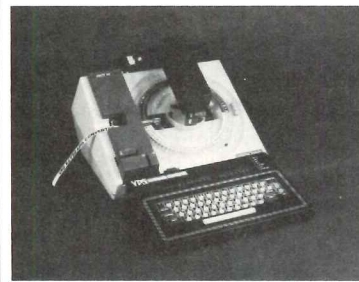

5

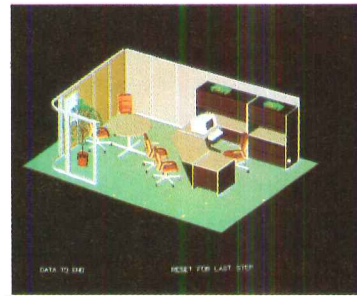

8

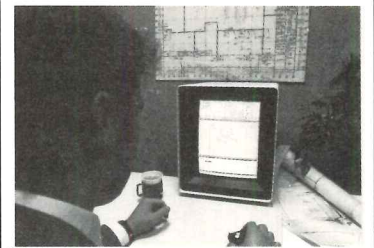

11



3



6

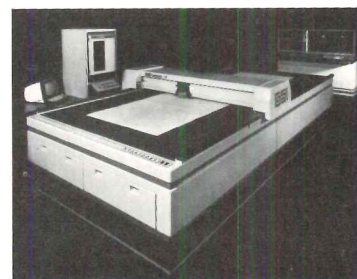

9



12

1 Drawing copier

The large document handler of the 7080 *Engineering Printing System* accepts E-size drawings and makes C-size prints, which can be fed into the main document handler to produce A- to C-size prints. Prints can be stamped, sorted and Z-folded automatically. Xerox Corp., Rochester, NY.

2 Electric eraser

The 2800 electric eraser removes both graphite and ink from drawing paper and coated drafting film. The 2800 uses white vinyl strips for removing graphite or film lead and yellow vinyl strips made with erasing fluid for dissolving ink. Koh-I-Noor Rapidograph, Inc., Bloomsbury, NJ.

3 3D CAD software

CADAM is described as a "high-function, general purpose design drafting package." It features 2-D and 3-D capability and can separate plans into details, which can then be magnified. It functions on a mainframe computer or as a stand-alone system. CADAM, Inc., Burbank, CA.

4 Project management

The *Harvard Project Manager* software package runs on IBM and compatible personal computers and requires no extra hardware. It displays projects in bar charts showing the progress of each task or in "roadmaps" of tasks, milestones and subprojects. Harvard Software, Inc., Harvard, MA.

5 Automatic typesetting

The *VPS Keyboard Converter* makes possible high-speed typesetting with any Kroy or 3-M machine. It features a visual display and a memory that holds 5,500 characters. Copy can be reviewed and changes made before printing. Visual Products and Supply Corp., Cleveland, OH.

6 CAD software

The *Robographics CAD-1* is designed for use with the Apple II+ or IIe. It produces graphics and technical drawings. Finished drawings are stored on library diskettes. No computer knowledge is needed to operate the system. Chessell-Robocom Corp., Newtown, PA.

7 Cost accounting software

Cost-Acumen is a cost accounting and project management software package that uses a microcomputer or word processor to monitor and control operating costs and expedite invoicing. It is claimed to spot cost overruns before they occur. Computer Applications Corp., Memphis, TN.

8 Facility planning

A 3-D rendering of an open plan office can be created with the *Design* program. The program was developed for Intergraph hardware and software to aid in interior design and facility management and has a special data base of symbols for this company's products. Steelcase, Inc., Grand Rapids, MI.

9 Flatbed plotter

The *Model 78* high-speed plotter can plot areas from 5 by 6 ft to 6 by 24 ft. It comes with a 4-pen head for ballpoint, wet ink or scribe plotting. A 24-position pencil head, pressurized ink head and cutter head are also available. Gerber Scientific Instrument Co., South Windsor, CT.

10 Project accounting

BusinessPower is a turnkey project management system that ties project management to general accounting with a package said to emulate the AIA's "Standardized Accounting for Architects." Feasibility study and cost estimating packages are also available. General Binding Corp., Northbrook, IL.

11 CAD workstation

The *GRAPH/NET Computer Integrated Design* workstation has a 1024 byte memory, a 24Mb Winchester disk and a 15-in. printer/plotter. A variety of integrated software packages assists designers in space and equipment planning and layered working drawings. Graphic Horizons, Inc., Boston, MA.

12 Matting

Transfix matting equipment seals a flat printed or photographic image, behind clear or matte acrylic. The image is bonded to acrylic in a single cold rolling operation to result in a rigid, permanently sealed product. Chartpak, Leeds, MA.

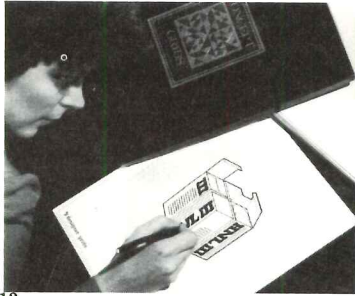

13

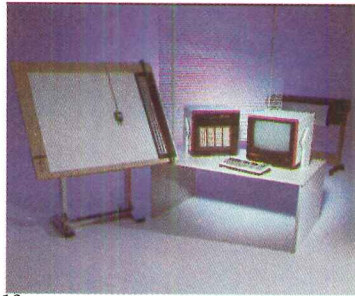

16



19

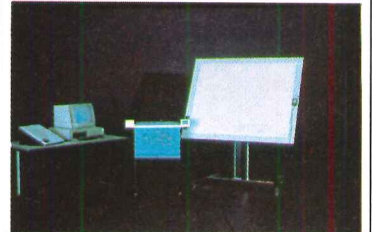

22

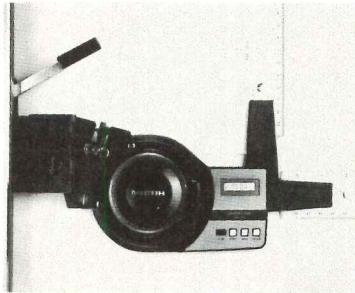

14

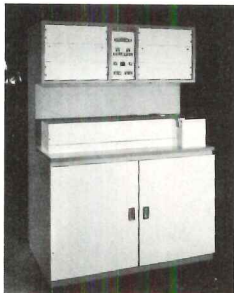

17



20

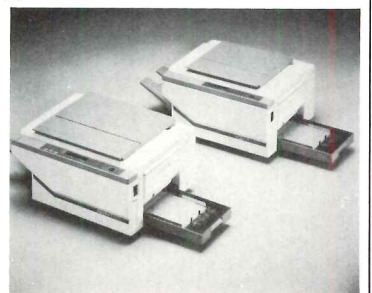

23



15

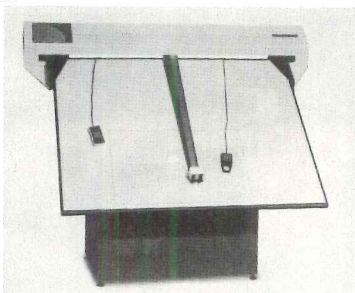

18



21

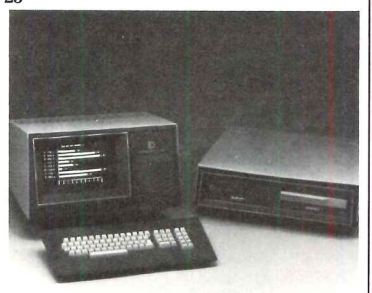

24

13 Drafting grids

Concept Grids, used as underlay guides, include 1-, 2- and 3-point perspectives, layouts, interior and exterior views, paralines and an orthographic. Each is 10 by 13 in. and will fit transparent and opaque drawing projectors. There are 16 grids in all. Kleidon & Associates, Inc., Akron, OH.

14 Drafting machine

The *Model-LG05* drafting machine has a 5 min angle digital display. Other features include a reset, recall and memory keys, a head float mechanism and a movable horizontal brake control. When not in use, the head may be rotated out of the way. Mutoh Industries, Ltd., Tokyo, Japan.

15 Electronic enclosures

Consoles and desk-top cabinets have black frames and textured blue panels. Desks have white writing surfaces. Console panels range from 21 to 78 3/4 in. high and are 19 in. wide. Desks are 26 or 30 in. high and come 24-, 45 1/2- or 72-in. wide. AMCO Engineering Co., Schiller Park, IL.

16 Stand-alone system

The *Touch'N Draw II* has 5 hardware components: a keyboard, a terminal screen, a graphics control station, a digitizing tablet and an 8-pen, E-size plotter. Software includes architectural CAD, cost estimating and facilities management. Arrigoni Computer Graphics, Los Gatos, CA.

17 Microfilm recorder

The 35mm *Micrographics EBR* records drawings on roll film for 35mm aperture cards from vector and raster digital data inputs. It may be used with main-frame computers, with CAD systems or alone with its own magnetic tape input and minicomputer controller. Image Graphics, Inc., Fairfield, CT.

18 Digitizer/plotter

The *DP4060* allows an operator to digitize information and plot back on the same surface. With a digitizing area of 42 by 60 in. and a plot area of 40 by 60 in., the *DP4060* is said to take up less floor space than a conventional digitizer and plotter. DATA TECHNOLOGY, Inc., Woburn, MA.

19 Diazo printer

The *Print VAC 600* prints sheets up to 47 1/4 in. wide. It offers a system that removes ammonia fumes from prints, an automatic print separator and non-vent operation. An enclosed compartment holds a 50-yd roll; 2 light-tight shelves offer sheet storage. Ozalid Corp., Mahwah, NJ.

20 Drawing copier

The *PD788* requires no venting. It features 7 fluorescent lamps for on-off operation, a 7-in. printing cylinder to minimize distortion, and automatic separation of original and copy. It accommodates two 50-yd rolls and a mobile taboret stores sheets. Bruning, Itasca, IL.

21 Microfilm system

The *3760 Enlarger/Printer* accepts aperture cards, 16 and 35mm roll film and microfiche. Prints from 8 1/2 by 11 in. to 24 by 36 in. may be made from either positive or negative film. Magnification is variable from 7-30X. Oce-Industries, Inc., Chicago, IL.

22 CAD system

ProDraft hardware includes a menu tablet with hand-held cursor, a plotter that handles A to D size drawings, and a minicomputer-based control with a Winchester disk drive. Menus include residential, commercial and renovation. Bausch & Lomb Interactive Graphics, Austin, TX.

23 Low-volume copiers

The *FT3020* and *FT3050* are low-volume dry tone copiers, which feature illuminated touch sensor controls and bypass feed tables to permit copies on a wide range of paper sizes. The *FT3050* also has 3-level reduction and 2-level enlargement capacities. Ricoh of America, Inc., Fairfield, CT.

24 Disk-diskette system

The *3625* entry level system includes a 10MB Winchester disk with a 1MB back-up diskette, a processor, 128K memory, serial port for a printer or a terminal, and an ARC local area network interface. An additional 128K of memory can be added. Datapoint Corp., San Antonio, TX.

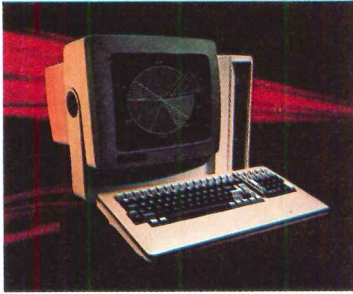

25



28

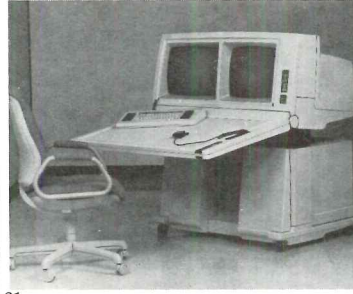

31



34



26



29



32



35



27



30



33

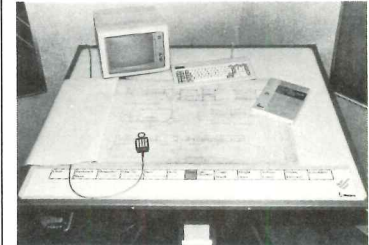

36

25 Stand-alone systems

The *TS 1602G* and *TS 1602GH* 16-bit computers both use a graphics processor and a 32K bit map memory RAM for graphics capabilities. Keyboards have keys that manipulate cross-hair cursors to implement pan, zoom and rubberband functions. Elden Computer Systems, Charleston, WV.

26 Graphics workstation

The *Advanced Graphics Workstation II* includes a stand-alone, 32-bit processor and an AEGIS virtual memory operating system and uses either Series 5000 or Series 7000 graphics software. Its keyboard features a touch-pad cursor. Auto-trol Technology Corp., Denver, CO.

27 Stand-alone CAD

The *CADalyst 200 Series* features 32-bit parallel processing with 7 sub-systems. Each unit supports 16Mb of memory. Each sub-system has its own program and data storage facility. The system is compatible with IDRAW graphics software. Information Displays, Inc., Armonk, NY.

28 Drafting table

Der Kunstler Tisch (The Artist Table) has a solid steel base and a 29- by 41-in. particle board top with a white laminate surface. The top tilts from 0 to 90 deg and adjusts in height from 29 to 47 in. for users in sitting or standing positions. D + W, Inc., Elkhart, IN.

29 CAD

The *ARCADE* computer system is said to handle almost all phases of architectural projects, both business and design. It includes a 68000 processor, 1.75Mb of memory, a monitor and a 24- by 36-in. 8-pen plotter. It can be used alone or in a network of 12 stations. Bruning, Itasca, IL.

30 Fluorescent whiteprinter

The *Model 452* prints up to 40 ft per min. Features include a 52-in. printing throat and front or rear print delivery. A light-tight cabinet stores 24- by 36-in. cut stock; a roll stock cabinet is optional. A vapor eliminating system removes ammonia fumes from prints. BLU-RAY, Inc., Essex, CT.

31 Graphics workstation

The *Interact* workstation has more than 3/4Mb of memory. Two 19-in. screens display drawings. Display operations include dynamic pan, continuous zoom and real-time rotation of 3-dimensional elements. Screens and work surfaces are adjustable. Intergraph Corp., Huntsville, AL.

32 Diazo copiers

Both the *Professional Automatic* and the *Professional Manual* copiers feature 4 super diazo fluorescent lamps, which allow printing up to 30 ft per min. An ammonia odor control and a stacking tray, which takes prints up to 30 by 42 in., are standard features. Diazit Co., Inc., Youngsville, NC.

33 CAD workstation

The *Sigma III*, which works independently or in a network, features graphics display, communications display and any mix of a touch menu, keyboard or graphics tablet. Other components are a processor, disk, tape and plotter, printer or digitizer. Sigma Design, Inc., Englewood, CO.

34 Turnkey CAD

The stand-alone *AYCAD Series 100* includes graphics software, a 30Mb Winchester disk drive, a color raster monitor, an ASCII keyboard with a calculator pad and a 36- by 48-in. digitizer table. Pen plotters and video screen plot units are optional. Aydin Controls, Ft. Washington, PA.

35 Drafting table

The *370 Drafting Table* has a steel frame with a baked enamel finish and laminate top. Tops feature 60-deg tilt adjustments and come in 3 sizes. A locking tool drawer has a tray large enough for a 12-in. scale; a plan drawer has a hood to keep plans flat. Plan Hold Corp., Irvine, CA.

36 Cost estimating software

The *Galaxy* software package, designed for construction cost estimating, adapts to this company's microcomputer and to IBM's Datamaster and Personal Computer. It provides unit prices, extended costs and total costs for all building components. R.S. Means Co., Inc., Kingston, MA.

1 Office Equipment Product literature

For more information
write item numbers on
Reader Service Cards

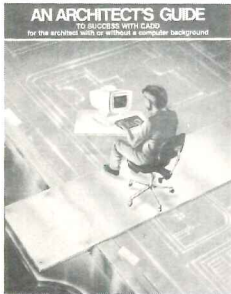

37 CAD training
Management and staff training that comes with the purchase of a *CEADS-CADD* turnkey drafting system is described in a 4-page color brochure. System hardware is made by Hewlett-Packard and software is provided and maintained by this manufacturer. Holguin & Associates, Inc., El Paso, TX.



43 Drafting supplies
A 1983 drafting supply catalog features brand-name drafting, print and plotter supplies and drafting furniture and equipment. Some products are illustrated. Prices are included. Dataprint Corp, San Mateo, CA.



38 Color graphics display
A 4-page color brochure describes and illustrates the *8600* color graphics display system. Hardware, optional equipment, software (including CAD), and applications are described, while photos show typical displays. Terak Corp., Scottsdale, AZ.

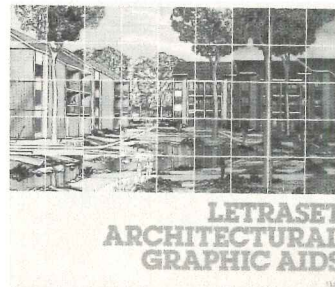

44 Architectural graphic aids
A 56-page color catalog features dry transfer sheets of symbols and illustrations, including foliage, titles, scales, figures, vehicles, furniture and fixtures. Sheets are offered in a size of 7½ by 9¼ in. Letraset USA, Paramus, NJ.



39 Drawing storage
Cabinets for storing both rolled drawings and flat sheets are covered in an 8-page color brochure. Charts list options of tube slots and sizes. A cut-away diagram illustrates cabinet features. Two models of lofting boards are also shown. Ulrich Planfiling Equipment Corp., Lakewood, NY.

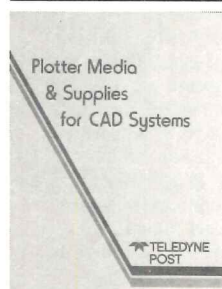

45 Plotter media
Samples of vellum, drafting films and translucent bond are included in a packet of literature covering media for drum-type, flat-bed and electrographic plotters. Media are described, and tables list specific types and dimensions for respective plotters. Teledyne Post, Des Plaines, IL.



40 Automatic mail delivery
A 20-page color brochure covers the *Mailmobile*, an automatic mail delivery system. Comparisons with messenger costs, a delivery system layout, a diagram of vehicle features and photographs of installations are included. Phillipsburg Div., Bell & Howell, Zeeland, MI.

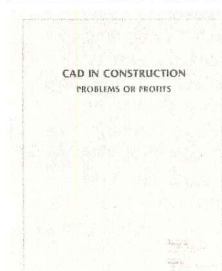

46 CAD report
CAD in Construction—Problems or Profits is a report reprinted from the NCGA '82 Conference proceedings. It covers the use of CAD in construction, from selection through installation and training. Managing the use of a CAD system once it is installed is also covered. Tricad, Milpitas, CA.

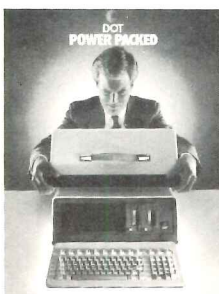

41 Portable computer
The *DOT* portable computer featured in an 8-page color brochure has a 16-bit microprocessor, dual floppy diskette storage, video display and a built-in printer. Available software includes word processing, accounting and financial analysis. Computer Devices, Inc., Burlington, MA.

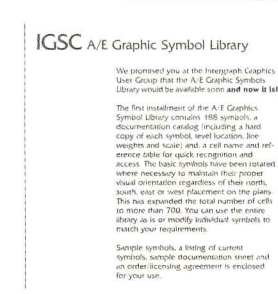

47 Graphics library software
A 4-page brochure describes the *A/E Graphic Symbols Library*, which contains 388 symbols in categories such as site, electrical, mechanical and materials. Items covered are listed and some examples shown. Interactive Graphic Services Co., Inc., Indianapolis, IN.



42 CAD
A packet of literature covers the *Series 8000* CAD systems. Among the features illustrated and described are a menu and cursor system controlling a range of complex geometric functions, available type fonts and sizes, and software packages. Summagraphics Corp., Fairfield, CT.

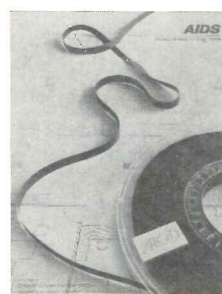

48 CAD software
A packet of literature describes the *Architectural Interactive Design System*. Sample floor plans, elevations, renderings and axonometrics produced by the system are illustrated. The software described is compatible with VAX general purpose computer hardware. ARCAD, Los Angeles, CA.

For more information
write item numbers on
Reader Service Cards



49 Interior design

Reference books on interiors products and services include volumes on corporate buyers of design services, open plans and filing and storage. References also come in software, which operates on the IBM Personal Computer. DesignNetwork International, Div. of Xetron Corp., Chicago, IL.

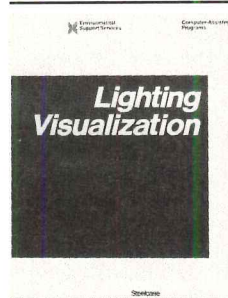

55 Lighting plans

A 4-page color brochure describes a computer program that assists a designer in visualizing a lighting plan. Photos show sample graphics of light distribution based on individual specifications. Renderings from any angle are also available. Steelcase, Inc., Grand Rapids, MI.



50 Computer service

A 4-page brochure describes a service bureau that provides graphics processing, database management, text processing and systems analysis. Each capability is described, and sample printouts of drawings and tables are illustrated. Design Logic, Inc., Oakland, CA.



56 CAD workstation

A 4-page bulletin describes the *PW200* series interactive graphics workstation, which has 2-dimensional design and 3-dimensional solid modeling capabilities. It includes a 32-bit graphics processor with 1Mb of memory and a 68Mb Winchester disk. Prime Computer, Inc., Natick, MA.

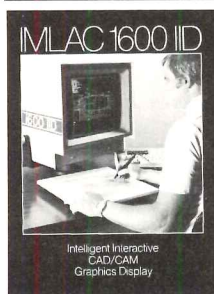

51 CAD workstation

The *1600 IID* workstation is featured in a 4-page color brochure. Systems with which it is compatible, including the *ANVIL-4000*, are listed, and overlays, which can be used with its interactive graphics tablet are described. Specifications are included. IMLAC Corp., Needham, MA.

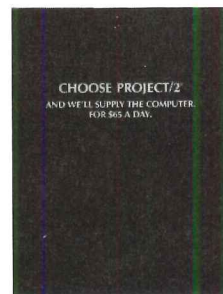

57 Project control

A 4-page color brochure introduces *Project/2* project management software for Digital Equipment's *VAX-11/730* minicomputer. System components are shown, and monthly rental costs are listed. Project Software & Development, Inc., Cambridge, MA.

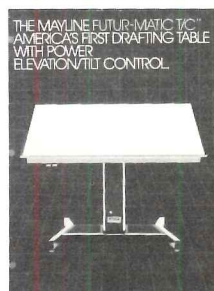

52 Drafting table

The *Futur-Matic T/C*, with electronic elevation and tilt control, is featured in a 6-page color brochure. Photos show features, such as 3-wire grounded outlets, adjustable floor levelers and available surfaces and finishes. Tables come in 5 sizes. Mayline Co., Inc., Sheboygan, WI.

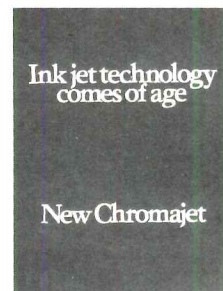

58 Ink jet printing

A 4-page color brochure, which includes a construction diagram and specifications, describes the capabilities of the *Chromajet ACT II* color ink jet printer. The printer uses 125 color shades and can print on film for overhead projection. Advanced Color Technology, Inc., Chelmsford, MA.

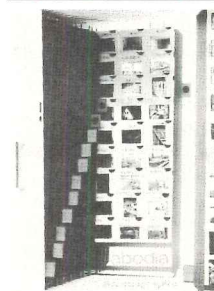

53 Slide storage

Several models of slide storage cabinets and accessories as well as light tables are illustrated in photos in a 20-page color brochure. Diagrams showing options are accompanied by lists of dimensions. Prices are also listed. Elden Enterprises, Inc., Charleston, WV.

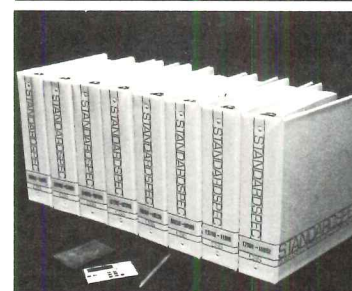

59 Specifications

Standardspec, a master specification system for general construction, comes in hard copy or can be converted to word processing systems. It conforms to the CSI Manual of Practice and the 1983 CSI Masterformat. Construction Specifications Service, Chicago, IL.

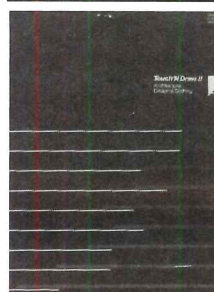

54 CAD

Sample drawings produced by the *Touch 'N Draw II* CAD system and a diagram of the system's functions throughout a project are included in a 4-page color brochure. Text describes these functions, which include drawing floor plans and sections and cost estimating. Arrigoni Computer Graphics, Los Gatos, CA.



60 High-volume copier

Speed and reduction capabilities are among the features of the *145R* high-volume, non-stop copier covered in a 4-page color brochure. Information on its automatic document feeder and specifications are also included. Royal Business Machines, Inc., Windsor, CT.

HOW MANY
TIMES
CAN YOUR
VELLUM
GET AWAY
WITH THIS?



For the draftsman, the more erasable a drafting paper, the better. For fifty years, Clearprint 1000H vellum has proven itself the best, time after time. That's how 1000H became the industry standard – and only Clearprint makes it.

But erasability isn't all our drafting paper offers. It's made from 100% new cotton fiber so it doesn't crack or discolor with age. And it's remarkably transparent with a consistency of texture that is unexcelled.

To guarantee these

characteristics, our proprietary process is checked by 38 individual quality control measures. These steps are of utmost importance because they insure the highest performance in both

manual drafting and computer aided design applications.

1983 is our 50th anniversary and nothing would make us happier than for you to know that all Clearprint products – including the popular 1020 – are made with the same ingredients and controls.

Your vellum has a lot of work to do. Hold it to the light. When you see the Clearprint watermark, you'll know it's up to the job.

**MAKING
PAPER
WORK.**

CLEARPRINT®

Please send us your catalog of samples and suggested price lists.

We use drafting paper for: _____
Name _____
Title _____
Firm Name _____
Address _____
City _____
State _____ Zip _____

P.O. Box 8703, Emeryville, California 94662

AR/V

TM Reg. U.S. Pat. & TM Off. by Eberhard Faber Inc.

Circle 1022 on inquiry card

HOW COMPUTERVISION IS CREATE A MORE

*I*t is an assignment worthy of H.A. Simons (International) Ltd., one of Canada's largest consulting engineering firms. Take the city of Vancouver and put it in a computer.

Digitize all 4,000 buildings, plus streets, parks, waterways and mountains. Then, use this information to conceptualize a massive 25-year urban development project.

It's the first time anyone ever attempted such a huge task. But, equipped with computer-aided design tools by Computervision, Simons is meeting the challenge.

*T*he project, British Columbia Place, is located on a 224 acre site in downtown Vancouver. When completed, B.C. Place will include some 10 million square feet of new housing, 6.85 million square feet of business

and office space, and 900,000 square feet of hotels. Linked to the city by a new rapid transit system.

Simons is using Computervision to ensure that the project fits comfortably into the context of an attractive harbor city nestled amid beautiful mountains.

A Computervision CAD system lets Simons see single buildings, or entire cityscapes, in three dimensions from any



HELPING VANCOUVER PERFECT CITY.

perspective. And during development it can quickly generate accurate architectural, electrical, mechanical, structural and site engineering drawings and documentation. All from a single stored data base.

In 1986, Vancouver will be 100 years old, and folks there want to make it a birthday to remember. From May to October that year, they'll host the next world's fair, Expo 86. B.C. Place will grow out of the exposition grounds.

The citizens of Vancouver know that the best way to celebrate the past is to plan for the future. And never before have the residents of any city been able to see themselves, and their future, so clearly.

We're helping Simons put Vancouver on the map. And whether you're handling large projects, or small, Computervision will help you too.

For more information about Computervision's full range of products, write to us, Dept. 425, 100 Crosby Drive, Bedford, MA 01730.



• Architecture Engineering and Construction • Electrical Machinery/Electronics •
• Aerospace • Mechanical Machinery • Fabricated Materials • Automotive •

Circle 1023 on inquiry card

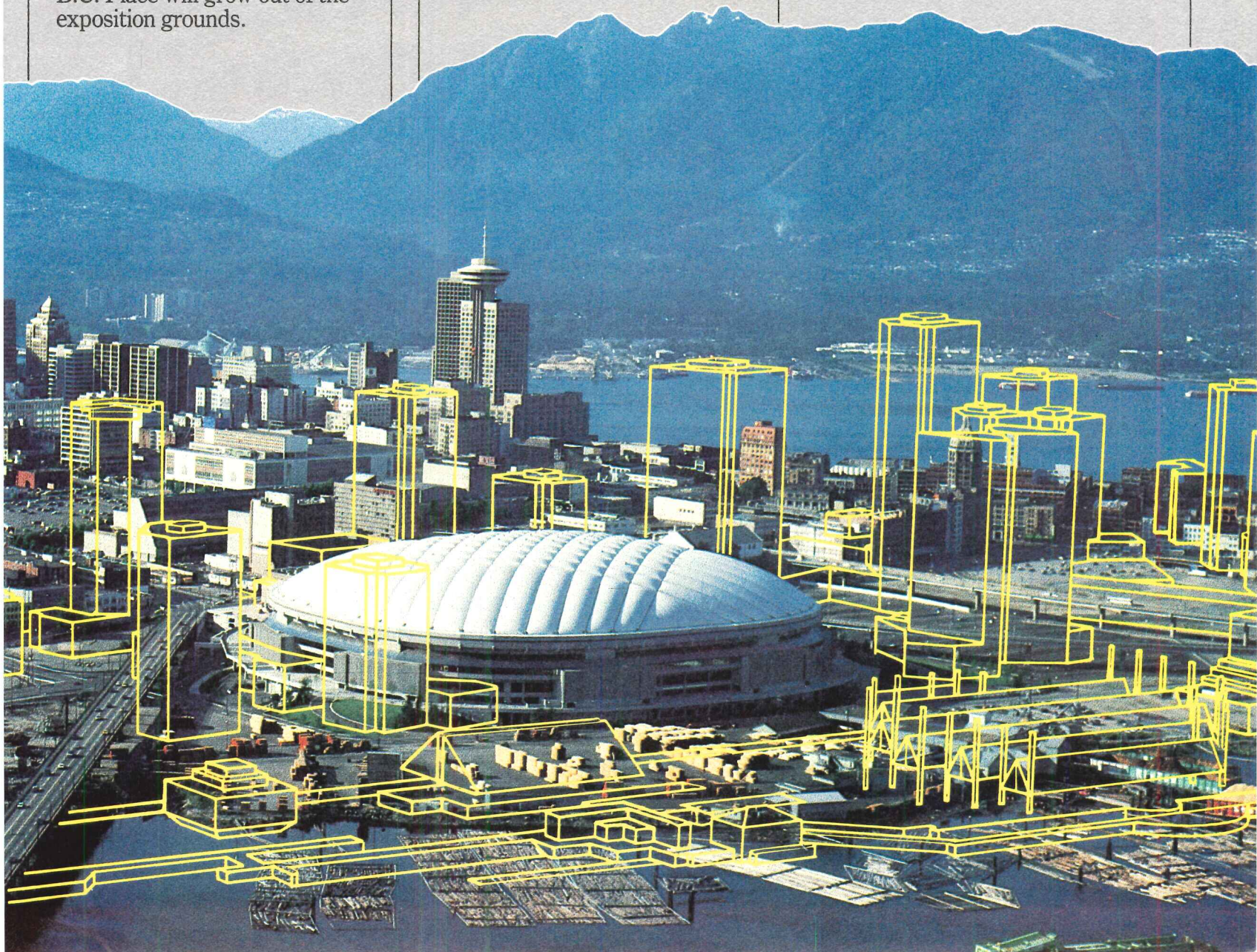

When you have responsibility for design and construction, you have new liabilities.

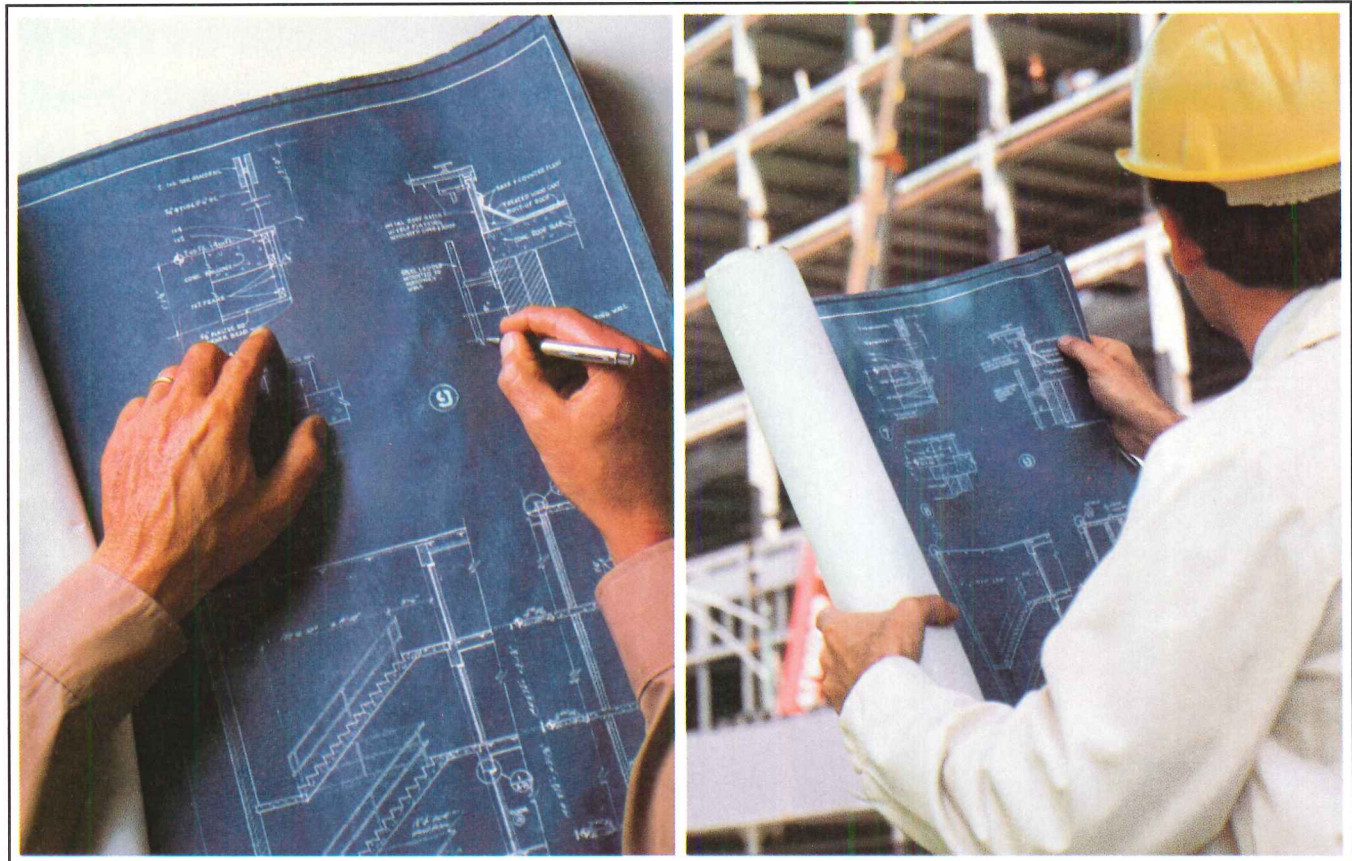

We have the coverage!

CNA Insurance and Victor O. Schinnerer & Co., Inc., have professional liability coverage that meets the evolving needs of architects and engineers. Our new Design/Build policy, for example, provides broad professional liability protection for services in the areas of design and construction management on Design/Build projects.

Coverage is tailored specifically for two types of firms: design firms who contract for construction services and construction firms with in-house designers. Coverage, liability limits and deductibles can be adjusted to the needs of each firm.

The ability to respond to your ever-changing needs is the natural result of the close working relationship which CNA and Schinnerer have maintained for 26 years with The American Institute of Architects and the National Society of Professional Engineers/PEPP. When design professionals talk about a new problem or coverage need – we listen!

For the total support that only the largest, most stable professional liability program for architects and engineers can provide, have your agent or broker contact Victor O. Schinnerer & Company, Inc., Program Administrators and Underwriting Managers.



26 years and still building together.

5028 Wisconsin Avenue, NW,
Washington, DC 20016 (202) 686-2850
303 East Wacker Drive,
Chicago, IL 60601 (312) 565-2424

Victor O.
Schinnerer
& Company, Inc.

40 Wall Street,
New York, NY 10005 (212) 344-1000
595 Market Street,
San Francisco, CA 94105 (415) 495-3444

Coverage for this program is provided by Continental Casualty Company, one of the CNA Insurance Companies.

Circle 1024 on inquiry card

Announcing for Architects:

A profitable solution to a creative problem. ProDraft™ from Bausch & Lomb.

ProDraft, the system for architects

Bausch & Lomb has been working side-by-side with architects to gain a clear insight into the special needs of your profession. To design a productivity tool which links your creativity to the power of a computer. To produce an electronic design/drafting system which is easily integrated into your daily work. Which is an economical and profitable asset for small and large architectural firms alike.

The result: ProDraft. The newest addition to Bausch & Lomb's growing line of electronic drafting systems.

The designer's companion

As a designer, you'll appreciate ProDraft's desktop compactness and the self-paced video training program that makes learning easy. With step-by-step instructions, you'll quickly begin using ProDraft to create drawings three to ten times faster than with manual methods. To make changes in minutes—not hours or days. To reduce design errors that occur in drafting. And to produce perfect original drawings every time.

As a manager, you'll profit from ProDraft's speed, accuracy, automatic scaling, lettering and dimensioning. And its ability to handle up to 16 perfectly-registered layers in a single drawing.

And that's not all. Five application packages are offered—residential, commercial, light commercial, renovation and HVAC.

Just to make sure ProDraft fits your firm's special area of practice.



Easy to implement

ProDraft also features a unique Implementation Guide—a comprehensive plan that shows you exactly how ProDraft affects your billing, marketing, design control, and other important areas. It shows you specifically how to use ProDraft to produce high-quality working drawings. And how to speed up working drawing production while maintaining your control over the project. With this plan, Bausch & Lomb eliminates the guesswork of implementation, and ensures that ProDraft becomes a working, profitable part of your firm immediately.

Low on cost, high in productivity

Priced at only \$29,995, ProDraft comes complete with a high-resolution graphics terminal, detached keyboard, D-size digital plotter, and custom menu which allows you to operate the system immediately and effectively without memorizing computer commands. Each system also features Bausch & Lomb's extensive Drafting Library, containing hundreds of predrawn symbols—from plumbing fixtures to landscape art.

ProDraft increases your firm's productivity while improving profitability. And with its low price, it can pay for itself in less than a year—especially when you consider that projects are handled three to ten times faster.

Discover how ProDraft can be the profitable solution to your creative problems. For more information, contact the authorized Bausch & Lomb dealer in your area, or return the coupon below.

BAUSCH & LOMB

P.O. Box 14547 • Austin, Texas 78761
512 837-8952

A brochure on ProDraft is included in Sweet's
1984 Catalog, Section 1.9.

Please forward information on ProDraft.
Attached is my business card.

Bausch & Lomb, Interactive Graphics Division
P.O. Box 14547
Austin, Texas 78761
512 837-8952



Rapidograph® Renderings

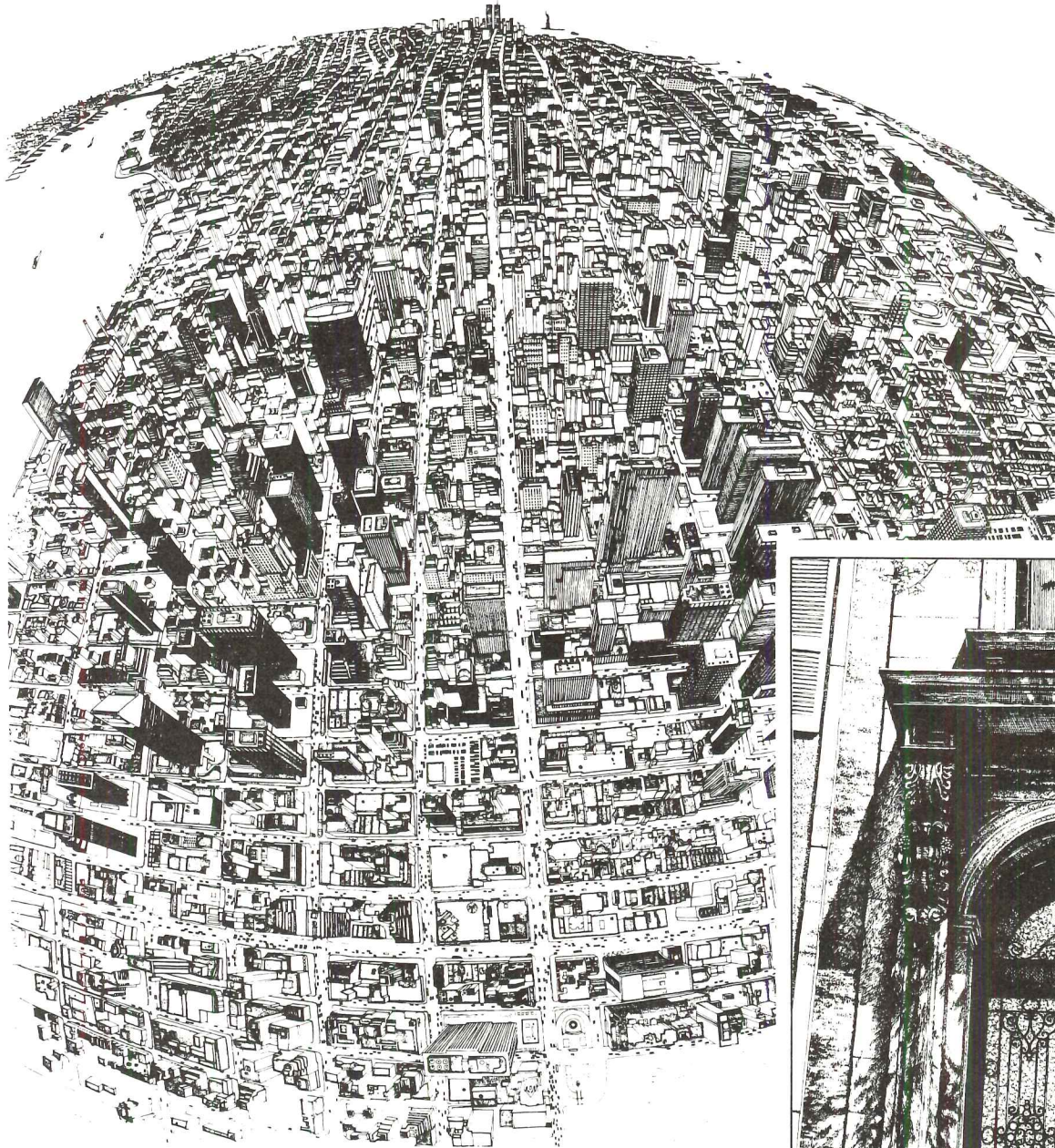

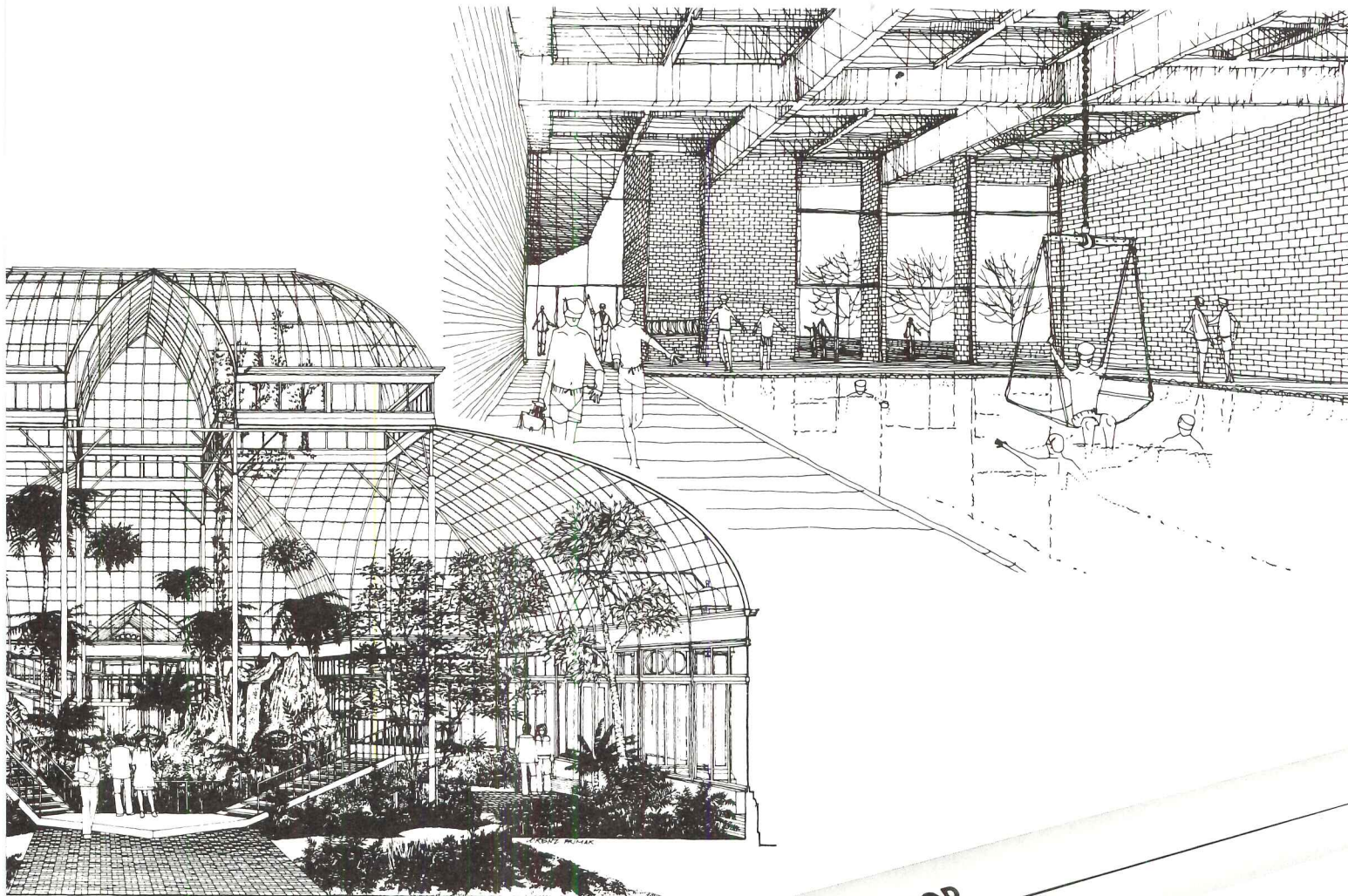

...the versatility of Albert Lorenz

With a Koh-I-Noor Rapidograph Technical Pen and a lot of imagination and skill, artist Lorenz turns architects' proposals into clean, crisp, client-pleasing visuals. His Rapidograph® renderings range from traditional perspectives to fish-eye lens panorama, with loose sketches and tight elevations in between. To assist in this prodigious and versatile output, Al Lorenz relies on Rapidograph® dependability. It is this dependability that makes the Rapidograph the most widely used technical pen in the United States and Canada.

Rapidograph was the first technical pen. It was born in industry in the early 1950's to provide the precision drafting required by engineering design and aerospace industries. It established new and very stringent standards in all disciplines when it was experienced that the Rapidograph made possible high precision engineering drafting with the additional benefits of economy and time savings.

The Koh-I-Noor Rapidograph Pen glides over drawing surfaces with the ease of a pencil because its tubular nib will not snag. In fact, it doesn't require the hand pressure used with pencil; its own weight

on the drawing surface provides a consistent ink laydown. The drafter or artist has only to guide it with an easy, non-fatiguing hold.

A patented DRY DOUBLE-SEAL™ provides an airtight bond between the pen cap and pen body, keeping ink throughout the balanced ink-flow system clog-free, ready for instant startup after days, weeks or even months of storage. The refillable ink cartridge is another appreciated feature, permitting longer, uninterrupted drawing sessions.

Your office or studio might now be using Rapidograph® precision for clean, crisp floor plans and elevations; so let exciting Rapidograph renderings help further your proposals' chances of approval.

Rapidograph is a registered trademark of Koh-I-Noor Rapidograph, Inc. A technical pen is Rapidograph® only if it says Koh-I-Noor Rapidograph® on the barrel.

Consult our Customer Service Department if you would like to know more about technical pens, drawing materials and techniques. Or if you want information about choosing the right inks for your projects,

Koh-I-Noor offers the largest single-source selection of waterproof black india drawing inks, as well as opaque and transparent colored inks:

201-479-4124.

In Canada: 416-671-0696.

KOH-I-NOOR RAPIDOGRAPH®

Please send me complimentary Koh-I-Noor Catalog A, describing Koh-I-Noor Rapidograph Technical Pens, Point Sizes, Koh-I-Noor and Pelikan inks and other materials.

I would like the names of Koh-I-Noor dealers in my area.

NAME _____
(please print or type)

COMPANY _____

ADDRESS _____

CITY _____ STATE _____ ZIP _____

Koh-I-Noor Rapidograph, Inc.
100 North St., Bloomsbury, NJ 08804
In Canada: 1815 Meyerside Dr.,
Mississauga, Ont. L5T 1B4

AR-12/83





The entire crack team of specialists required to install a Western Electric building wiring system.

You might say Western Electric's Building Distribution System (BDS) isn't such a big deal.

All our building wire and apparatus is compact. Space-saving. Easy to install. Most everything comes factory pre-wired and plugs right in. So it doesn't require a lot of time. Or labor.

And since BDS is the most complete line of fully compatible building wire and apparatus available, it eliminates the headaches of dealing with three or four separate suppliers.

So whether you need undercarpet or riser cable, protector units or connecting blocks, building terminals or interface jacks, BDS is the solution.

When you learn more about our system for building wire management, you'll wonder how you ever managed without it. For more information, contact your Western Electric Representative, or write on your business letterhead to: Western Electric, P.O. Box 1278R, Morristown, N.J. 07960.



AT&T
Western Electric

PLAN AND MANAGE FACILITIES SO FAST, YOU'LL WONDER HOW YOU MANAGED BEFORE.

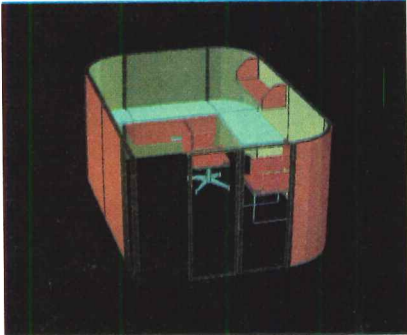

The building is a tangle of wires, walls, pipes and personnel offices. Yet, it all must be arranged for maximum operating efficiency in a minimum amount of time.

And it is. Your CalComp IGS 500 computer-aided design system helps you design, plan, manage, remodel or revise your company's facilities with electronic speed and precision that are many times more productive than manual methods.

The IGS 500 automates repetitive drawing tasks, drafting and generation of furniture and equipment reports. In addition, powerful 3-D rendering and immediate access to update information further increase your company's productivity.

The IGS 500 is just one example of CalComp's computer graphics line, the broadest in the industry. We are a leading supplier of pen and ink plotters, desktop plotters for business use, electrostatic plotters, digitizers, and the CalComp line of Vista-graphic™ vector and raster displays.

CalComp computer graphics products share a wide base of the highest technology with Sanders' other major business area: defense electronics. And like our defense electronics systems, CalComp computer graphics products are designed, produced and maintained to the highest standards of reliability and operator convenience.

The CalComp IGS 500 is an example of our response to your need for convenience and economy. Learn more about it and CalComp's complete line of computer graphics systems and products.

Contact CalComp, Inc., 2411 West La Palma Avenue, Anaheim, CA 92803. Or call CalComp at 800-556-1234, Ext. 156. In California, 800-441-2345, Ext. 156.



CALCOMP

A Sanders Graphics Company

 **SANDERS**

Circle 1027 on inquiry card

THREE REASONS WHY MAYLINE'S NEW FUTUR-MATIC T/C™ SURPASSES ALL DRAFTING TABLES ON THE MARKET

1. Convenient fingertip controls coupled to independent, bearing-actuated electric drive systems offer simultaneous lift and tilt adjustment.

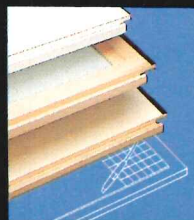
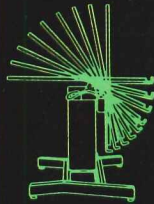
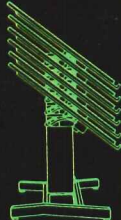
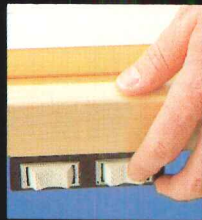

pieces with everything you need to lay out your design department.

So when innovation, solid engineering, versatility and styling really matter, look for the table that offers them all; the Futur-Matic T/C. Only from Mayline.

2. Superior-rated tilt and lift capabilities. The Futur-Matic T/C drive systems offer 250 pounds of lifting capacity with a 30" to 50" travel range and 150 foot pounds of tilting torque with 88° of angle adjustment.

3. Designed for a variety of drafting tops.

Whether you're looking for basswood, melamine, steel... or a light top with solid-state control, the Futur-Matic T/C offers them all. If all you need is the

base, that can be arranged — whether you're an end-user or OEM.

Best of all, when you buy the Futur-Matic T/C you open the door to a full line of matching companion

MAYLINE

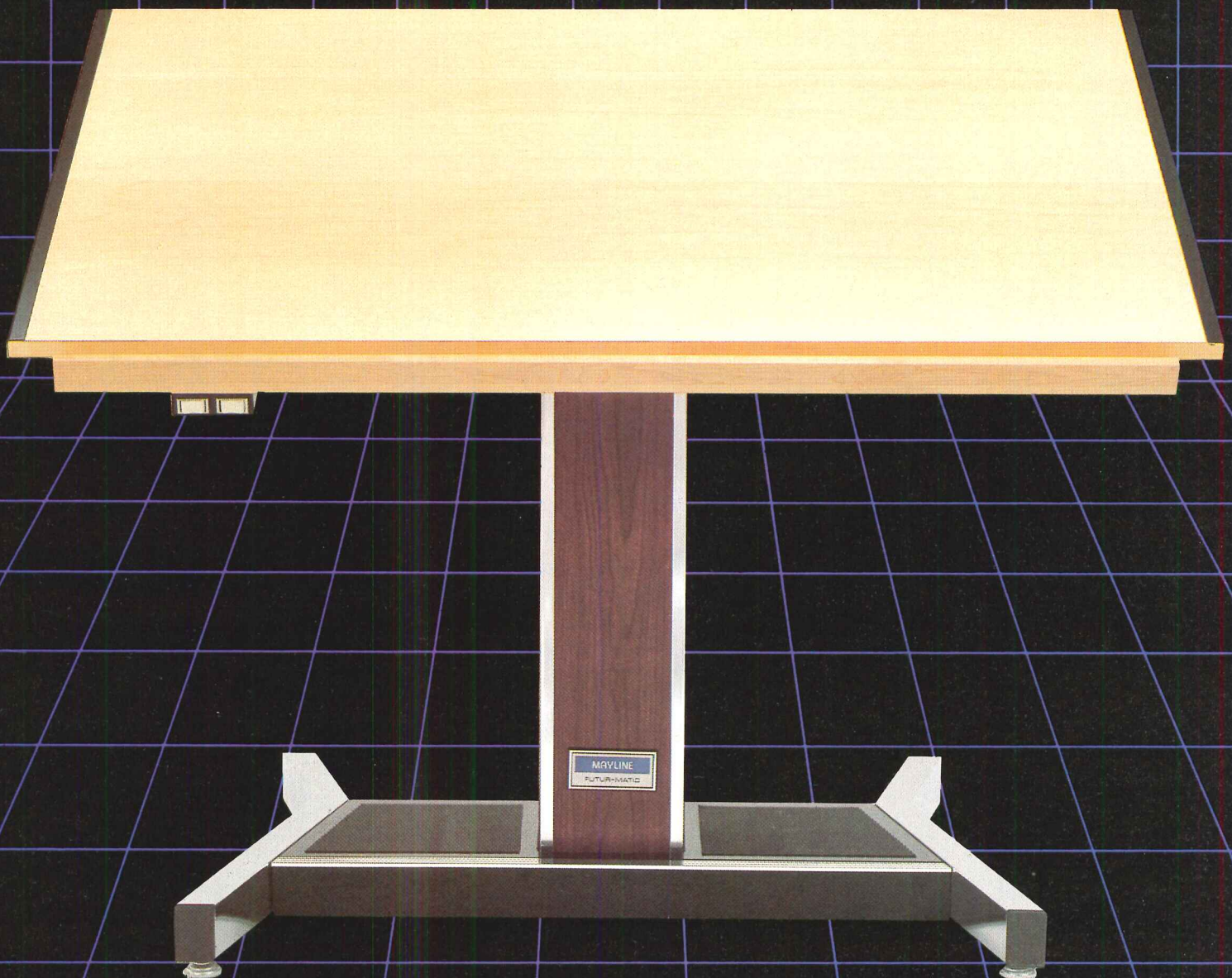

Mayline Company, 619 N. Commerce Street, Sheboygan, WI 53081

Circle 1028 on inquiry card

2 Site Work

UCI 2, Site work:
 Earthwork
 Fences and gates
 Fountains and pools
 Irrigation systems
 Landscaping
 Paving and surfacing
 Recreational facilities
 Site drainage
 Site furnishings
 Site utilities
 Soil treatment

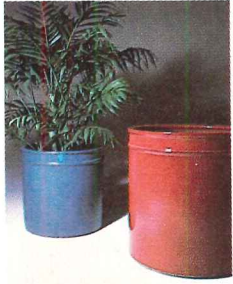

61

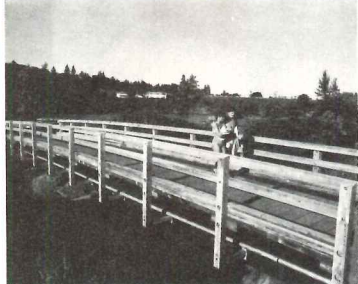

64

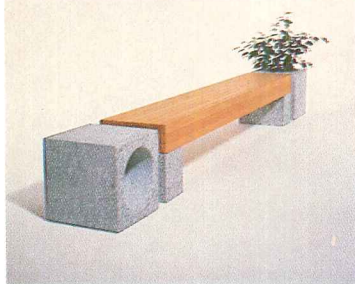

67

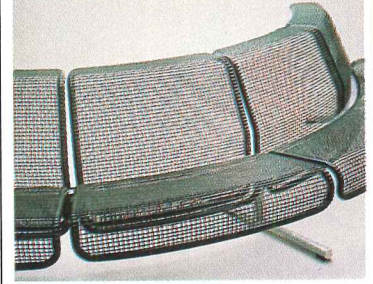

70



62



65



68



71



63

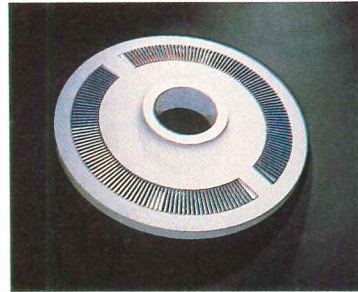

66



69



72

61 Planters

The *AE900 Series* is a group of high-fired stoneware planters. They are available in 15- and 20-in. diameters and come in 7 colors. Unglazed colors and white are available for quick shipment. Forms & Surfaces, Santa Barbara, CA.

62 Site furnishings

The *CornerForm* line of benches, planters and a receptacle features shaped, laminated corner pieces. Items come with redwood or mahogany slats and have button head socketed screws. Benches have brown powder-coated steel or polished chrome legs. Landscape Structures, Inc., Delano, MN.

63 Outdoor lights

Woodform Lighting is a series of California redwood fixtures that comes in wall- and post-mount and bollard styles. Fixtures come in several models and take high-pressure sodium, fluorescent and incandescent luminaires. Columbia Cascade Timber Co., Portland, OR.

64 Wood bridges

Glulam bridges can be manufactured in different shapes, including curved girders and arches, and bridge components can be prefabricated to allow assembly by semi-skilled labor. *Glulam* is not affected by de-icing salts. Western Wood Structures, Inc., Tualatin, OR.

65 Porous pavement

Grasscrete is a reinforced poured-in-place concrete grid with holes that can be seeded. It forms load-bearing lawns for parking areas while allowing drainage and erosion control and is claimed to meet zoning requirements for parking and green space in urban areas. Bomanite Corp., Palo Alto, CA.

66 Tree grates

Round tree grates made of sandblasted, reinforced concrete are 4 and 5 ft in diameter with center openings of 12- or 15-in. diameters. Grilles are cast iron, bronze, stainless steel or aluminum. Canterbury International, Div. of Canterbury Designs, Inc., Sherman Oaks, CA.

67 Site furniture

System 200 features modular geometric forms in granite and marble that can be combined with a selection of wood bench slabs to form site furniture for large spaces. Bench slabs come in redwood, oak, teak or white fir. Forms & Surfaces, Santa Barbara, CA.

68 Tree grates

Decorative cast-iron tree grates are designed for use in paved areas where trees are a part of the landscape plan. Grates are available in over 85 shapes, sizes and styles. Special sizes and styles can be custom manufactured. Neenah Foundry Co., Neenah, WI.

69 Bike racks

Ribbon Racks are of 1-piece tubular steel construction and are said to use 50 per cent less space than other designs. Installation is by in-ground anchoring or optional flange mounting. Brandir International, Inc., New York, NY.

70 Modular bench

The *Olympia 2-seat* benches, designed by Heinz Wirth, are made of tubular steel and wire mesh and are finished with a synthetic coating in white or green. They can be linked to form straight or curved seating; curved seating can face inside and/or outside. Kroin Inc., Cambridge, MA.

71 Planters

Precast concrete reservoir planters feature wicks, attached to a porous membrane, that lead from the reservoir to transfer moisture throughout the soil ball. Planters are available in several sizes in both square and round shapes. Form Products Div., Wausau Tile, Inc., Wausau, WI.

72 Paving

Bomacron is a finish that creates patterns and textures over concrete paving surfaces. Textures include slate, used brick and roughsawn wood. The finish is available in a wide range of colors. Bomanite Corp., Palo Alto, CA.

Kroin

Olympia
Design: Heinz Wirth, 1971

Installation: Lenox Square Mall, Atlanta, GA
Architect: Greenberg Farrow & Associates

Kroin Architectural Complements
14 Story Street
Cambridge, Massachusetts 02138
Telephone 617 492-4000
Telex 951650

Selected for its unique ability to shape custom arrangements of curved seating facing inside or out. From the Kroin Series of Park and Garden Furniture. Available in green or white synthetic coated steel and wire mesh.

Circle 1007 on information card.

Represented in:
Boston, Cincinnati, Denver, Los Angeles,
Miami, New York City, Philadelphia,
San Francisco, Seattle, Washington DC



4 Masonry

5 Metals

For more information
write item numbers on
Reader Service Cards

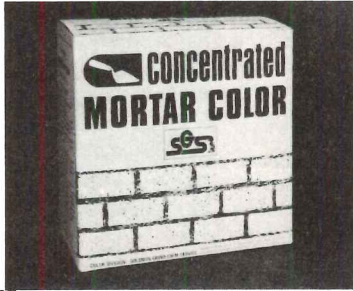

97



101

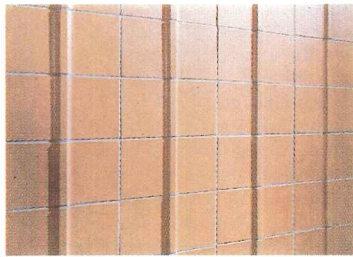

98

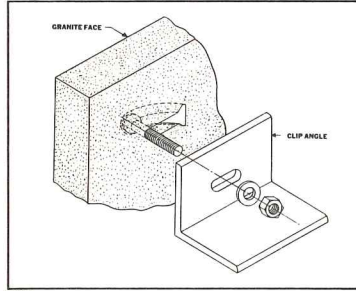

102

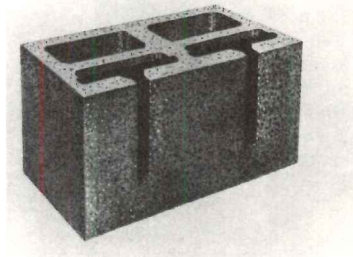

99



103

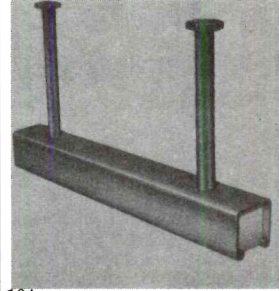

104



107

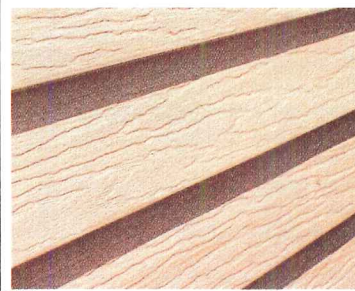

105

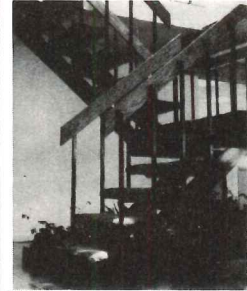

108



106

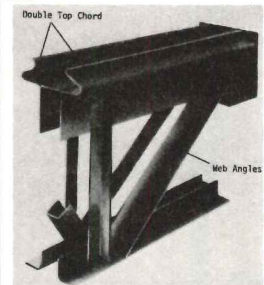

109

97 Colored mortar

Finely milled iron oxide pigments are added to mortar to complement or accentuate the colors of brick, stone and colored block units. Mortars are for exterior and interior commercial and residential use. Solomon Grind-Chem Service, Inc., Springfield, IL.

98 Rib-faced block

Spectra-Glaze Rib concrete face blocks feature either vertical or horizontal ribs. Blocks are available in 60 standard colors in all standard shapes. Corner and trim pieces are also available. The Burns & Russell Co. (licensor to manufacturers), Baltimore, MD.

99 Reinforceable masonry

The *Soundblox* acoustical masonry unit features an inner core construction for vertical reinforcing and utility runs. Cavities accommodate re-bars, grout, vertical conduits or insulating material. The Proudfoot Co., Inc., Greenwich, CT.

101 Acoustical glazed block

Spectra-Glaze/Soundblox are acoustical concrete blocks with a permanent, glazed finish. The blocks come in 60 standard colors in all standard shapes. Corner and trim pieces are also available. The Burns & Russell Co. (licensor to manufacturers), Baltimore, MD.

102 Granite anchor

The *31 Anchor Application* is a factory-made slot that allows a granite panel to be anchored to the support system from its back surface rather than from its edge. This design is said to provide a more positive anchor, preventing it from slipping out. Cold Spring Granite Co., Cold Spring, MN.

103 Stucco

Dur-O-Fibar is a 1/2-in. long alkali-resistant glass fiber made to be used with Portland Cement Plaster (stucco). The fibers are designed to improve the physical properties of stucco while controlling random cracking. Dur-O-Wal, Inc., Northbrook, IL.

104 Concrete insert

The *P3753*, used in curtain wall applications, has a hot dip galvanized continuous channel for easy bolt alignment and is said to eliminate the welding required for curtain wall attachments. Recommended loading is 5,000 lb. Unistrut Building Systems, Div. of GTE Products Corp., Wayne, MI.

105 Aluminum siding

Cedarwood siding features a multi-toned random wood grain pattern. It is available in 4 colorways in what is claimed to be a low gloss, low chalk, fade resistant finish. The siding also features this manufacturer's positive lock system. Alcan Building Products, Warren, OH.

106 Metal laminates

Lunstead metals come with polyurethane-based protective finishes of etched brass and pewter and polished brass and chrome. They are claimed to be scratch resistant and stain and burn proof. Applications include paneling, counter tops and trim. Harry Lunstead Designs, Inc., Kent, WA.

107 Ladder extension

LadderUP is a spring balanced safety post that attaches to fixed ladders. It is raised to provide a hand hold when going through a roof hatch or a floor or pit door. It is available in black enamel or hot dip galvanized finishes and adjusts to various rung sizes. The Bilco Co., New Haven, CT.

108 Stairs

Architectural Stair Systems feature open risers, steel stringers and balusters and oak treads, rails and newell posts; other woods may be specially ordered. Treads are 1 1/2 or 2 in. thick and are nosed on 3 sides. Mylen Industries, Inc., Peekskill, NY.

109 Steel joists

The *LH Series* steel joist is designed for use in long-span applications of composite steel and concrete floor construction systems. It features a double top chord, an open web of light channels and a new range of heavier bottom chord angles. Canam Hambro Div. of Canam Steel Corp., Needham Heights, MA.



Watertower Place, Chicago, IL. / Architect: LoebI, Schlossman & HackI, Chicago, IL.



Georgia Marble®... for Elegance & the Test of Time

An exclusive address in Chicago, Watertower Place stands out as a landmark of excellence in all respects. Not only is it an office building, it also has a luxury hotel, condominiums, and a mall with department stores as well as specialty shops of all kinds.

Georgia Marble® was chosen as the material for the exterior of Watertower Place. The architects combined the dark veining of Mezzotint with a lighter quarry range of Cherokee®, achieving a balance that is visually pleasing and distinctive in design. Marble will add prestige to any structure, and Georgia Marble® adds that extra feature . . . *Permanence.*

 **georgia marble** company
structural division nelson, georgia 30151 (404) 735-2591
a Jim Walter company



Boise, Idaho



Towson, Maryland



Las Vegas, Nevada



San Diego, California



Denver, Colorado



New York City, New York



Oahu, Hawaii



Portland, Oregon



Pacific Palisades



Fresno, California



Newport, California



Plantation, Florida



Houston, Texas



Reno, Nevada



Universal City, California



Reno, Nevada

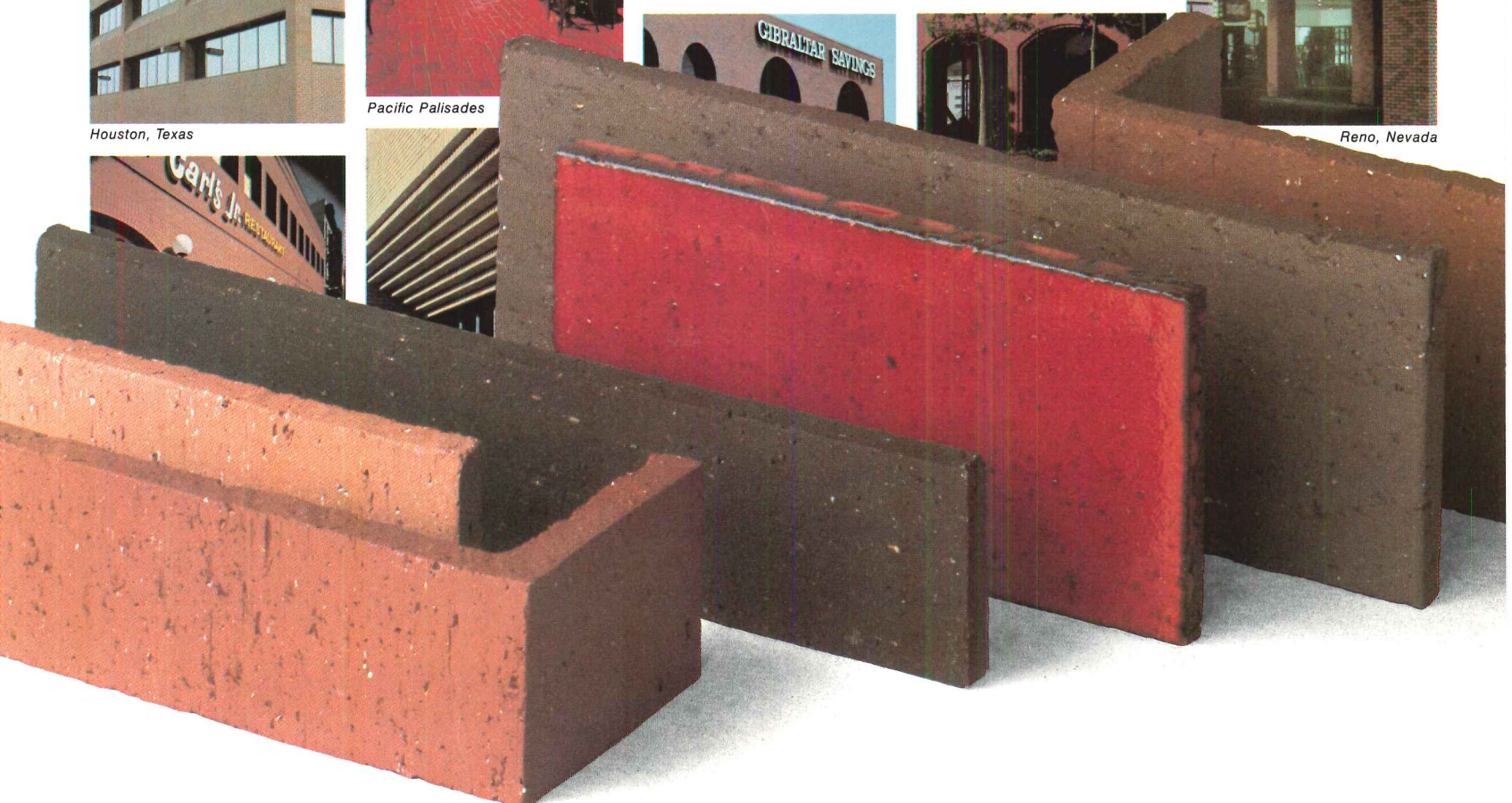

Mini-Brick/Maxi-Experience

More Mini-Brick has been installed on more types of buildings than any other thin brick. Coast to coast. Inside and out. In fair weather and freeze/thaw foul.

That's a lot of experience with a lot of jobs. Over 38 million units have been produced in the last five years. And that experience is all yours to build on.

We've learned that consistent, high quality is a must. So every Mini-Brick is made from pure Alberhill clay, wire-cut to 7/16" and carefully kiln-fired.

And we've shaped our line to give you the variety you

need, too. Eight distinctive glazes and nine unglazed colors in four sizes.

You can match several of our unglazed Mini-Brick colors with pavers or full-sized brick of the same color in order to use the different sizes in combination.

Blends become another story. An endlessly fascinating one as you look at what's been done with both factory and on-site blending of our unique, natural finishes.

But get all the details. You'll find many of them in Sweet's General Building File #9.18/Hu. Or ask us, and we'll get our latest brochure to you.

Huntington/Pacific Ceramics, Inc.
Building a tradition of innovation.

P. O. Box 1149, Corona, CA 91720 / (714) 371-5320 / Telex #676-377

Circle 1030 on inquiry card

4 Masonry Product literature

5 Metals Product literature

For more information
write item numbers on
Reader Service Cards



110 Facing tiles and brick
A 12-page color catalog covers a line of structural glazed facing tile and brick. Special sections cover acoustical tiles and a lower-priced series. Details illustrate typical wall sections. Specifications, colors, shapes and sizes are included. Stark Ceramics, Inc., Canton, OH.

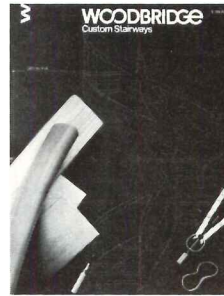

116 Custom stairways
Photos show a number of installations of spiral and custom stairways in an 8-page color brochure. Diagrams show different types of risers and platforms. Suggested specifications are included. Woodbridge Ornamental Iron Co., Chicago, IL.



111 Surface bonding
Exterior and interior installations of *Structural Skin* surface bonding for concrete block walls are shown in a 6-page color brochure. Textures achieved with the material are shown in detail. Information on code compliance and tables listing allowable design stresses are included. Conproco Corp., Manchester, NH.

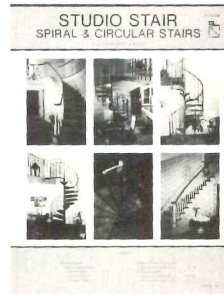

117 Stairs
Both metal and wood spiral and circular stairs are featured in a 12-page color catalog. Photos show installations and details of construction. Tables of dimensions and specifications are included. American General Products, Inc., Ypsilanti, MI.

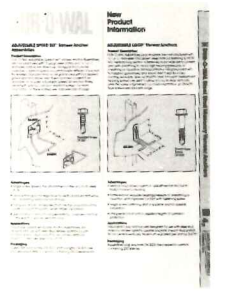

112 Masonry veneer anchors
A page of literature features product data and application information for 2 types of steel stud masonry veneer anchors, the *Adjustable Speed Set* and the *Adjustable Loop*. Installations of each anchor type are shown in section details. Dur-O-Wal, Inc., Northbrook, IL.

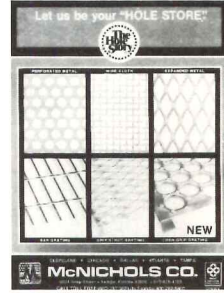

118 Metal grating
Wire cloth, perforated and expanded metal and bar, grip strut and open grip gratings are included in a 48-page catalog. Details illustrate product construction and tables list available dimensions and load-bearing capacities. McNichols Co., Tampa, FL.



113 Masonry wall fillers
A product data sheet covers *Rapid Soft-Joint*, which accommodates vertical movements in brick-clad framed buildings, and *Rapid Expansion Joint*, a vertical joint filler that accommodates horizontal expansion in brick. Details are included. Dur-O-Wal, Inc., Northbrook, IL.

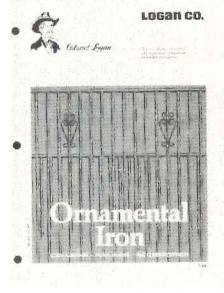

119 Ornamental iron
Cast iron and wrought iron railings and columns are shown in photos and line drawings and described in a 15-page brochure. End fittings, base plates, rail supports and ornamental accessories are included along with tables listing dimensions. Logan Co., a Figgie International Co., Louisville, KY.

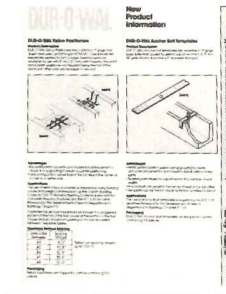

114 Rebar positioners
A product information sheet describes rebar positioners and anchor bolt templates. Applications for each product are described. Dur-O-Wal, Inc., Northbrook, IL.

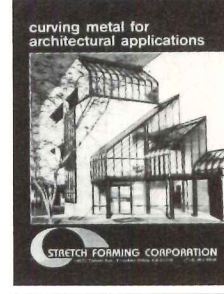

120 Curving aluminum
Curving Metal for Architectural Applications is a 4-page color catalog that features photos of curved aluminum glazing installations. The method used to curve the glazing sections is described, and details show those sections which can be curved. Stretch Forming Corp., Fountain Valley, CA.

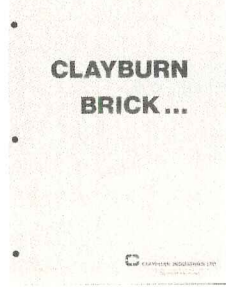

115 Brick
A 30-page booklet features the *Giant* brick system. Bricks in a multitude of shapes and sizes are shown along with dimensions and physical data. An extensive set of construction details and specifications is also included. Clayburn Industries Ltd., Burnaby, B.C., Canada

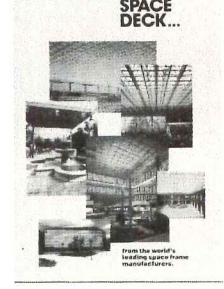

121 Space frames
The design, fabrication and erection of steel space frames are shown and described in a 22-page color brochure. Photos show a variety of frame installations. Clear-span tables for standard, heavy and light loads are included. Jarvis Steel & Lumber Co., Inc., Baltimore, MD.

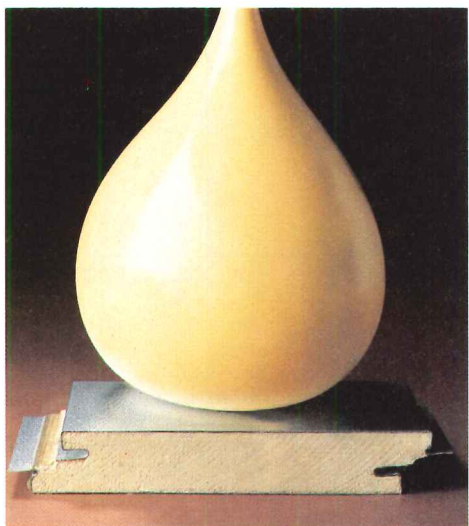

Elwin G. Smith asks: Who needs fat paint?

Some companies in the curtainwall industry apply color coatings as thick as six to eight mils or more to metal wall panels. The theory, of course, is that extra thickness gives extra protection.

Not so, unfortunately.

Many thick coatings tend to crack, chip or peel due to weathering or when formed into the flowing curves and sharp angles often required by modern design. Nor does thickness insure protection against color change.

In an attempt to achieve higher coatings standards, some companies have changed their coatings from time to time in an effort to satisfy the demands of architects, engineers, contractors and owners for better performance.

Elwin G. Smith, on the other hand, has not changed its premier coating since 1965. There's been no need to. Smith's tough, durable, Kynar-based fluoropolymer coating has withstood corrosive atmospheres, acid rain, abrasive sand and dust, burning summer sun and bitter winter cold on countless buildings without failure for more than 18 years. To this day, these Kynar® coatings continue to maintain color integrity without fading, chalking, cracking, chipping or generally deteriorating.

Until color coatings that give better performance come along, Elwin G. Smith will continue to supply curtainwall systems with these time-tested, flexible extended life coatings. The advantages are yours.



ELWIN G. SMITH INTERNATIONAL

100 WALLS STREET, PITTSBURGH, PA 15202 | (412) 761-7474
KINGSWICK HOUSE, SUNNINGHILL, BERKSHIRE, ENGLAND SL5 7BJ | (990) 23491
AL-HOWAISH - ELWIN G. SMITH CO. LTD., P.O. BOX 11181, JEDDAH, SAUDI ARABIA 21453 | 637-8000

®KYNAR is a registered Trademark of Pennwalt Corporation

Circle 1031 on inquiry card

ONLY THE STRONG SURVIVE.

IT TOOK THE STRENGTH OF FLUROPON® COATING TO MATCH THE DURABILITY OF STILE™ ROOFING

Metal roofing requires a tough exterior coating that will protect the surface and make an attractive statement to the community.

DeSoto's full strength Kynar 500 Fluropon® coating is tough and flexible enough to be the choice for the newest design in metal roofing. Fluropon's longevity and color integrity were necessary to meet the durability demands of Stile™ roof system. Fluropon and Stile combine

successfully to resist the effects of rain, sun, snow, and dirt for a long, long time!

So, get what you demand in a roof system. Good looks with the durability of prepainted steel. Now Fluropon and Stile prove that metal building products can have architectural meaning for residential and commercial uses. For your next roof system, specify Stile, with the Fluropon finish.



DeSoto, Inc.

Performance Coatings for Performance Companies
1700 South Mount Prospect Road
Des Plaines, Illinois 60018
(312) 391-9000

Stile® is manufactured in the USA by Metal Sales Manufacturing Corporation.

For information on Stile circle 1019

For information on Fluropon circle 1032



VISUALLY SIGNIFICANT ROOFS

... a trend of major significance in contemporary architecture—and architects everywhere are finding that Follansbee Terne uniquely incorporates the essential values of form, color and function in such roofs. In this non-traditionally designed mental health center the architects expunged the age-old stigma of such institutions by creating a warm, residential, more home-like atmosphere.

Terne helped to create this welcome departure from the "antiseptic line," for Terne has the important advantage of providing maximum creative latitude at relatively moderate cost. We'll be happy to send you substantiating evidence.

FOLLANSBEE

HUNTSVILLE-MADISON HEALTH CENTER • HUNTSVILLE, ALABAMA
ARCHITECTS: CHARLES McCAULEY & ASSOCIATES, BIRMINGHAM, ALABAMA
ROD W. WHATLEY, PROJECT DESIGNER
ROOFER: TIP TOP ROOFING & SHEET METAL, HUNTSVILLE, ALABAMA

FOLLANSBEE STEEL CORPORATION • FOLLANSBEE, WEST VIRGINIA

Call us toll-free 800-624-6906

Circle 1033 on inquiry card

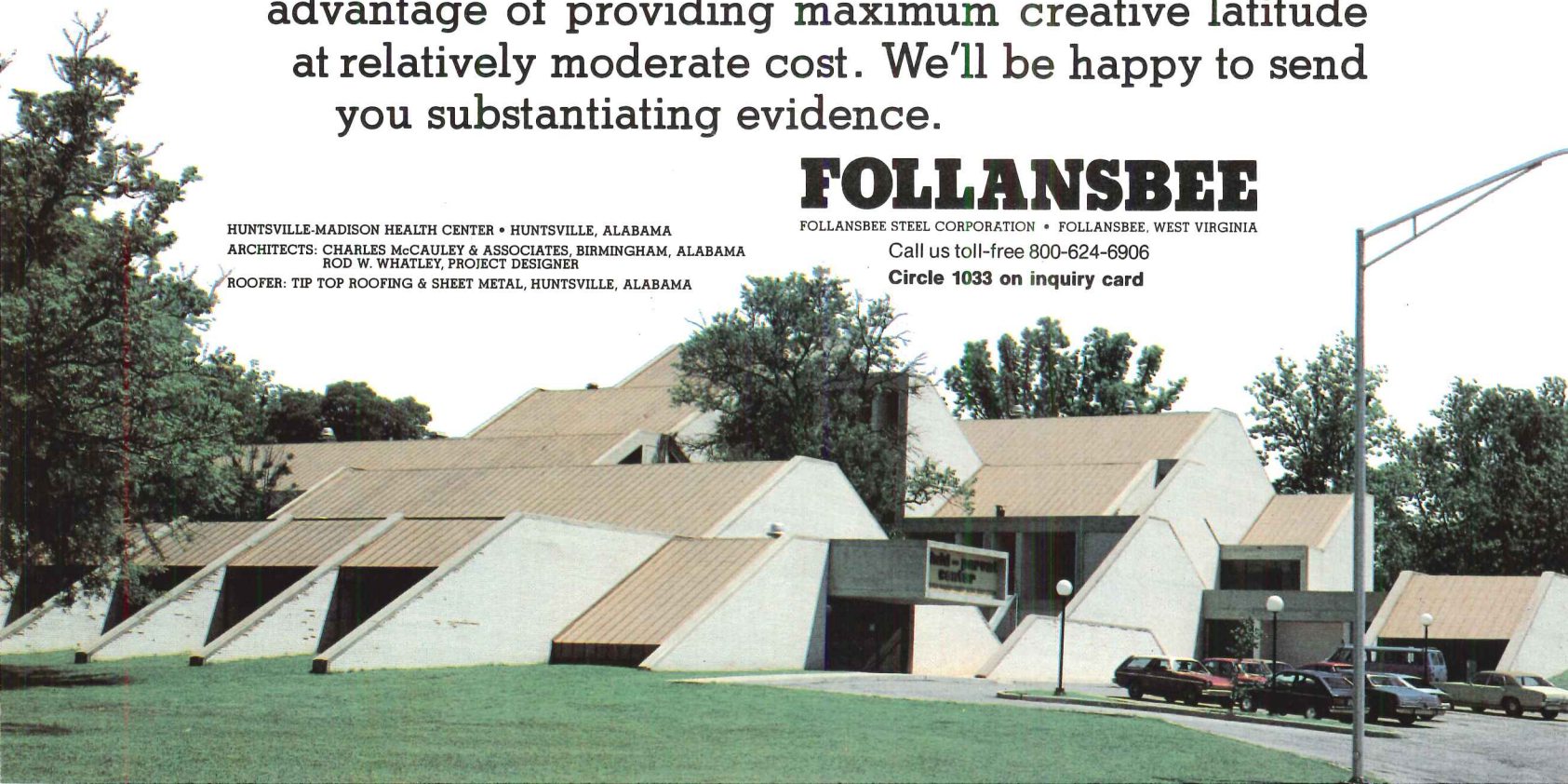

THINK HORIZONTALLY



North Central Mental Health Services, Columbus, Ohio Architect: H. B. Trautwein Associates Contractor: McClellan Construction Co.

Design in a new direction with the horizontal look from Robertson



There's a new option for design flexibility from Robertson: Formawall® flat metal wall panels have been redesigned for horizontal use - in addition to traditional vertical installation.

Now you can design horizontally in lengths up to 30 feet - in 24" to 30"-high modules - in our standard 2" thickness. Use our foam core insulated Formawall

1000 and select from long-life stucco-embossed finishes such as Vitralume® (a superb porcelainized finish at new competitive prices), Versacor®, Durasil® or PVF₂. Or utilize Formawall 2000 with a honeycomb core and baked enamel finishes - and choose smooth or stucco-embossed.

In either case, you'll take advantage of this latest Robertson innovation: we've eliminated the customary weather-exposed sealants at all horizontal joints, so we can now provide a bolder, deeper shadow line.

The horizontal look: another new concept in walls from Robertson, designed to make your building come to life.

For further details on horizontal or vertical Formawall applications, call or write: H. H. Robertson Company, Department AR-12A, 400 Holiday Drive, Pittsburgh, PA 15220. Phone: (412) 928-7522.

Horizontal Formawall Typical Joint Details

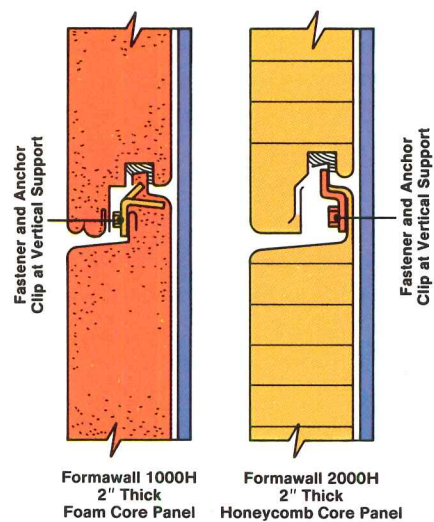

1+1+1=4

It took not one, not two, but three steel design concepts to make the building of Four Allen Center, Houston, possible.

And it was a difficult challenge for the designers. The extremely narrow tower, an elongated rectangle with semi-circular ends, had a height-to-width ratio in excess of 6.85, and the constraint of a central sheer truss core depth of only 25.75 ft. In hurricane-prone Houston, that meant a unique approach was required.

As it evolved, the architect and engineer combined existing concepts and molded them into one structural system:

1. an innovative hybrid framing method consisting of a four-celled bundled "frame tube" system.
2. the perimeter frame was assembled from two-story high "tree column" modules located at 15 ft. on center around the building perimeter in order to cope with high strength and serviceability requirements.
3. cross frames that subdivided the plan into its four-celled grid were formed by horizontal "tree beam" modules interacting with diagonal trusses in the shallow center-core area.

And although the tree beam concept introduced six vertical stub columns — added at midspan to moderately heavy horizontal wind girders — in the lease area of most floors, they in actuality

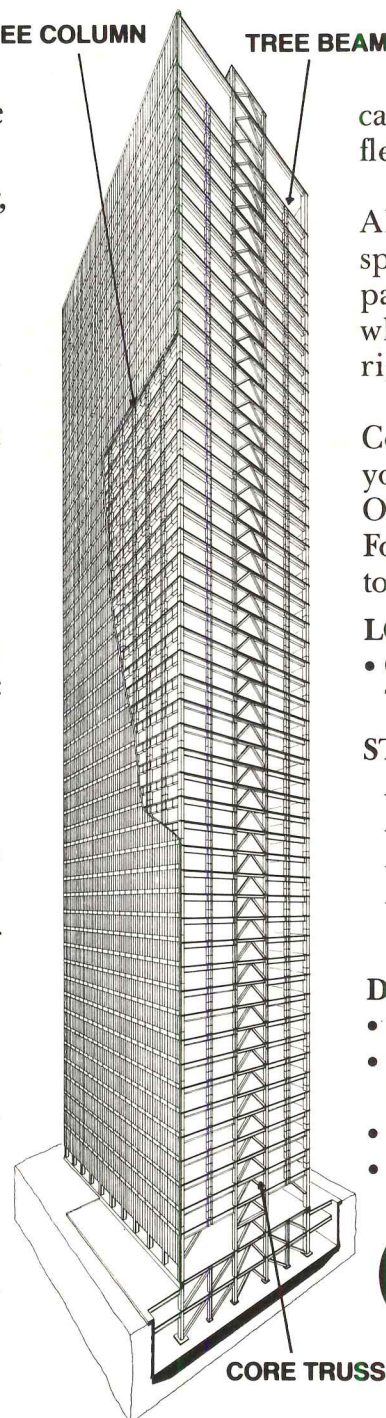

caused only a minimal loss of spatial flexibility.

The resulting new building, Four Allen Center Tower, not only provides space planning flexibility and exciting panoramic views, but also proves that when steel is used, it always adds up right.

For more information, contact a USS Construction Representative through your nearest U.S. Steel sales office. Or write for our Building Report on Four Allen Center (ADUSS 27-8470-01) to Box 86 (C-1835), Pittsburgh, PA 15230.

LOCATION:

- Central business district, Houston, Texas, south of Antioch Park.

STRUCTURAL STEEL:

ASTM A588	1,288 tons
ASTM A572-42	142 tons
ASTM A572-50	4,666 tons
ASTM A36	13,165 tons
TOTAL	19,261 tons

DESIGN FEATURES:

- Overall dimensions 109.4 ft. by 259.4 ft.
- 50 levels above grade and 2 levels below grade.
- Gross area 1.44 million sq. ft.
- Rentable area 1.20 million sq. ft.



United States Steel

OWNER: Allen Center Company; A joint venture of Century Development Corporation, Centennial Equities Corp. (subsidiary of Metropolitan Life) and American General Realty Co., Houston, Texas. DEVELOPER: Century Development Corporation, Houston, Texas. ARCHITECT: Lloyd Jones Brewer Associates, Houston, Texas. STRUCTURAL ENGINEER: Ellisor & Tanner, Inc., Houston, Texas. SHELL CONTRACTOR: McGregor Construction Co., Houston, Texas. STEEL FABRICATOR: Mosher Steel Company, Houston, Texas. STEEL ERECTOR: American Bridge Division, U.S. Steel Corp., Pittsburgh, Pennsylvania.



6 Wood & Plastics

UCI 6, Wood & plastics:
 Architectural woodwork
 Connectors & supports
 Laminated & processed sheets
 Lumber
 Plastic fabrications
 Plastic laminates
 Prefabricated structural plastics
 Prefabricated structural wood
 Simulated wood
 Stock millwork
 Wood treatment



122

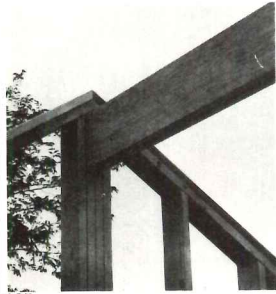

125



128

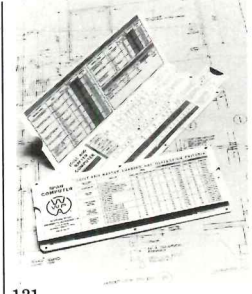

131

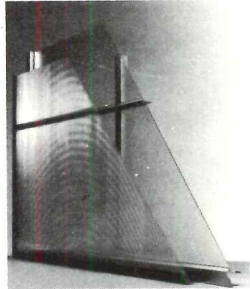

123



126

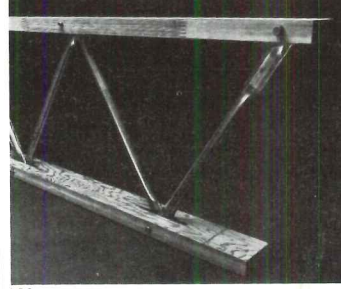

129



132



124

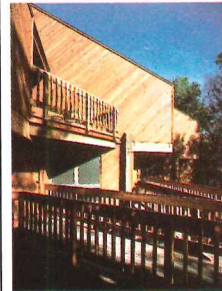

127



130



133

122 Redwood paneling

PALCO LOC paneling comes in a 3/8-in.-thick tongue-and-groove pattern in widths of 4, 5, 6 and 8 in. It is finger-jointed with waterproof glue and offers a choice of surfaces, with a saw texture on one side and a smooth texture on the other. The Pacific Lumber Co., San Francisco, CA.

123 Insulating glazing

Lexan profiled sheet is a double-walled extruded sheet recommended for applications where increased insulation and impact strength are needed. Its dead air space design results in an R-value of 1.54 and a U-value of 0.65. General Electric Co., Plastics Operations, Pittsfield, MA.

124 Woodgrain laminate edge

Almond and *Chamois Woodmate* are postforming laminates that integrate 3 1/2-in. woodgrain edges with 2 different laminate surfaces. While they can be used on all edge profiles, they are recommended for use on waterfall or 180 deg wraps. Consoweld Corp., Wisconsin Rapids, WI.

125 Laminated beams

Rough-sawn *MICRO-LAM* beams come in depths of 9 1/2, 11 1/8 and 14 1/4 in. Two 1 3/4-in. beams provide the 3 1/2-in. width necessary to match wall framing and eliminate shimming. They are accepted for structural use by all major building code agencies. Trus Joist Corp., Boise, ID.

126 Space-saving stairs

Wood stairs with a 56-deg angle of inclination are 24 in. wide and feature alternating 10-in. treads and high, close handrails. They are computer designed and custom-built of oak with fir stringers. Available heights are from 4 to 12 ft. Lapeyre Stair, Inc., New Orleans, LA.

127 Rustic wood sidings

Tight knots and streaks are features of redwood sapwood siding. Rustic sidings come in 3 patterns: bevel, channel and tongue-and-groove. All are air-seasoned for minimum checking, warping or cupping. California Redwood Association, Mill Valley, CA.

128 Spiral stairs

Hardwood spiral stairs come in standard and custom designs. Railings, newels and balusters may be turned in custom designs as well. Stairs come up to 12 ft high without a landing. They can be shipped either assembled or knocked down and are field finished. Challis Stairways, Inc., Sandy, UT.

129 Open-web truss

The *TJLX* truss is suitable for flat or sloped roof as well as floor applications. High-strength structural lumber in the high-stress areas of each chord provides up to 20 per cent more load-bearing capacity. The web is made of tubular steel. Trus Joist Corp., Boise, ID.

130 Cedar siding

Bitterroot is the name given to this kiln-dried inland red cedar siding, which features a 1 1/16-in.-thick butt in a Dolly Varden or bevel pattern. Siding comes in 6-, 8- and 10-in. widths with 2 saw kerfs on the back of each piece. Potlatch Corp., San Francisco, CA.

131 Span computer

A pocket-sized span computer features design-value tables for use in selecting sizes and grades of wood for joists, rafters and beams. Western Wood Products Association, Portland, OR.

132 Knotty pine paneling

Pine Crest 2 paneling is smooth on one side and rough-sawn on the other. It is cut in 8-ft lengths, tongue-and-groove, may be finished in shellac, lacquer, varnish or stain, and may be applied vertically, horizontally or diagonally. Champion International Corp., Stamford, CT.

133 Flooring

Interior and exterior flooring for use over subfloors or directly over joists is manufactured from 1- by 4-in. tongue-and-groove kiln-dried vertical grain Douglas Fir. It is finger-jointed and glued with waterproof adhesive. The Pacific Lumber Co., San Francisco, CA.

TAKE A BITE OUT OF CONSTRUCTION COSTS.

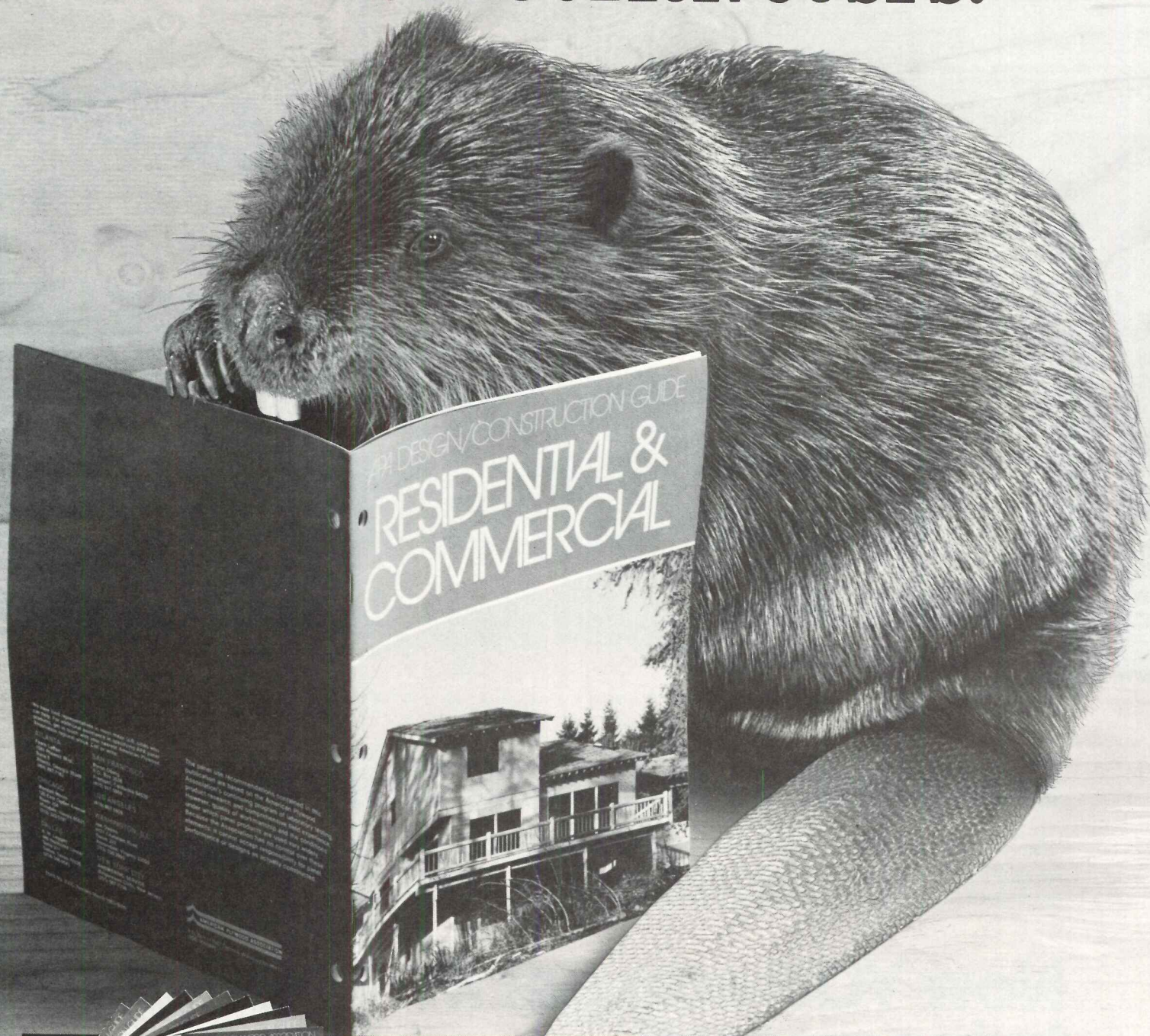

APA systems can save you money on construction, from foundations to roofing. So, if you've got designs on cutting costs, start by cutting this coupon. And mail it to: **American Plywood Association, P.O. Box 11700, Tacoma, WA 98411.**

Design & Construction Guides

1. Residential & Commercial
2. Engineered 24" Framing
3. Non-Residential Roof Systems
4. All-Weather Wood Foundations
5. Fire-Rated Systems
6. Noise-Rated Systems
7. Concrete Forms

Product Guides

8. 303 Plywood Siding
9. Panel Care & Installation
10. Grades & Specifications
11. Performance-Rated Panels
12. Pressure-Preserved Plywood
13. HDO/MDO Plywood
14. Publications Index

I'm eager to cut building costs. Please send me the booklets I have circled below:

1 2 3 4 5 6 7
8 9 10 11 12 13 14

Name _____

Title _____

Firm _____

Address _____

City/State/Zip _____

AR-123

P.O. Box 11700, Tacoma, WA 98411



AMERICAN PLYWOOD ASSOCIATION



THE LAKE APARTMENT CLUB FACILITY, CHARLOTTE, NC. ARCHITECTS: REG NARMOUR/THE ARCHITECTURAL GROUP, P.A. OWNER/DEVELOPER: FIRST PROPERTY MANAGEMENT CORP. PHOTO: RICK ALEXANDER.

They got **THE LOOK** they wanted.

"We chose shingles to fit with other buildings in the community, and to permit more dominant sculptured shapes. Shakertown Panels provided the flexibility for curved and flat surfaces," says architect Reg Narmour. He specified single course panelized shingles with 7-inch exposure.

Now **YOU** can get it twice as fast!

For flat surfaces, those single course 7-inch exposure shingles are now available in two-course panels called Colonial II. Same look. Same quality. But go up twice as fast. (Three times as fast as individual shingles.) Self-aligning. No shorts. No grade fall down. Free nails. Matching corners. Ask Joe Hendrickson about Colonial II. Call him free at 1-800-426-8970.

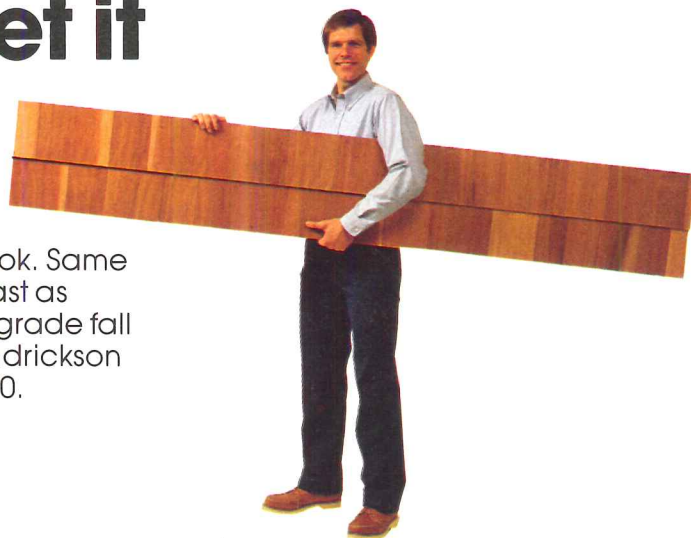

Shakertown Siding

P.O. Box 400, Dept. AR, Winlock, WA 98596 (206) 785-3501

6 Wood & Plastics Product literature

For more information
write item numbers on
Reader Service Cards

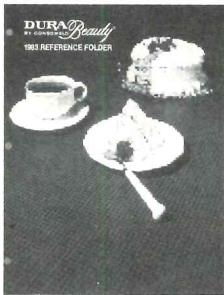

134 Laminates
The *DuraBeauty* line of high-pressure laminates is featured in an 8-page color brochure. As shown, the line includes laminates in solid colors, wood grains, patterns and marbles. New introductions to the line are highlighted and specifications are included. Consoweld Corp., Wisconsin Rapids, WI.

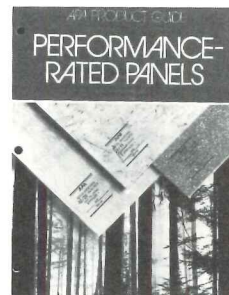

140 Performance-rated panels
Composition, testing criteria, span ratings and code recognition of structural wood panels are covered in a 12-page brochure. Plywood, composite, waferboard, oriented strand board and structural particleboard are shown in photos and described. American Plywood Association, Tacoma, WA.

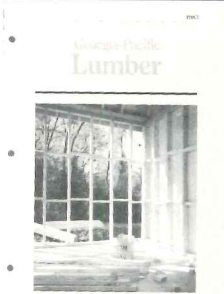

135 Lumber
An 8-page color brochure describes grades and applications of lumber from a number of wood species. Charts listing typical lumber product classifications and nominal sizes for softwood lumber as well as information on pressure-treated lumber are included. Georgia-Pacific Corp., Atlanta, GA.



141 Redwood lumber
An 8-page color brochure features photos of interior and exterior commercial and residential installations of redwood lumber. Also shown and described are 5 grades of heartwood and sapwood. California Redwood Association, Mill Valley, CA.

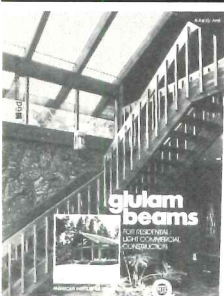

136 Laminated wood beams
An 8-page color brochure, *Glulam Beams for Residential/Light Commercial Construction*, contains photos and details of installations. Span tables and design values are included, as well as a table of conversions from steel or solid sawn timber to glulam. American Institute of Timber Construction, Englewood, CO.

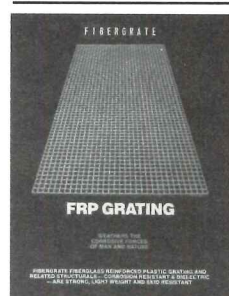

142 Fiberglass grating
Fiberglass gratings, stair treads and elevated floor systems are illustrated and described in a 16-page brochure. Product composition and corrosion-, fire- and impact-resistance are described. Clips, fasteners, nuts and threaded rods are also covered. Fibergate Corp., Dallas, TX.

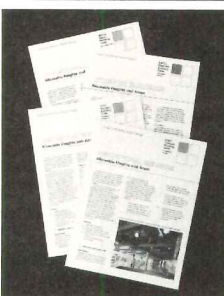

137 Wood design guide
Four building classifications have been added to the *Code Conforming Wood Design Guide*: institutional, storage, residential and educational. Allowable heights and areas under each code for sprinklered and unsprinklered buildings in each category are described and listed in tables. American Wood Council, Washington, DC.

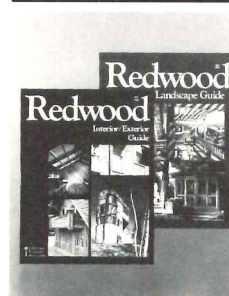

143 Redwood construction
Two specification and application booklets contain information on grades, sizes and characteristics of redwood products for siding, interior and landscaping designs. Details of a number of siding pattern installations are included. California Redwood Association, Mill Valley, CA.

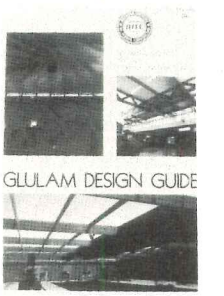

138 Laminated timber
A guide for designing with structural glued laminated timber (glulam) includes stress tables, standard sizes, typical connection details and information on specifying by stress values. American Institute of Timber Construction, Englewood, CO.

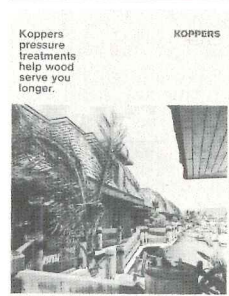

144 Wood treatments
Several pressure treatments for wood are described and illustrated in a 12-page color brochure. A selection chart covers the uses, advantages and limitations of each type of treatment. Photographs of treated wood installations are included. Koppers Co., Inc., Pittsburgh, PA.

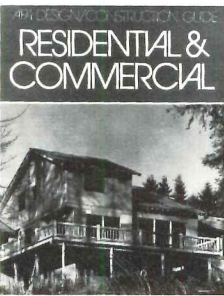

139 Plywood design
Plywood panel floor, wall and roof construction are covered in an extensive guide. Section details show methods of construction, and tables list recommended shear and loads. Information on specifying and building requirements is included. American Plywood Association, Tacoma, WA.

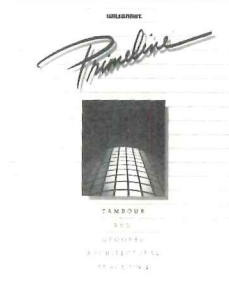

145 Surfacing
A color brochure features *Primeline*, a collection of tambours and grooved architectural surfacing. Included in 21 surfaces are high-gloss, solid-color laminates, brushed and polished metallics, woodgrain and millstone pattern laminates and natural oak. Ralph Wilson Plastics Co., Temple, TX.

7 Thermal & Moisture Protection

UCI 7, Thermal and moisture protection:
 Cladding/siding
 Composite building panels
 Flashing
 Insulation
 Membrane roofing
 Metal roofing
 Roof accessories
 Sealants
 Shingles and roofing tiles
 Waterproofing and dampproofing



146



149

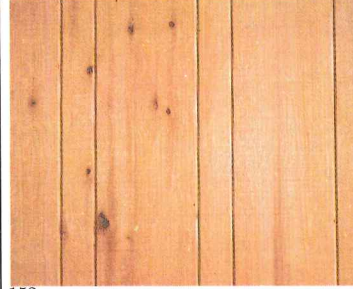

152



155



147



150



153



156



148

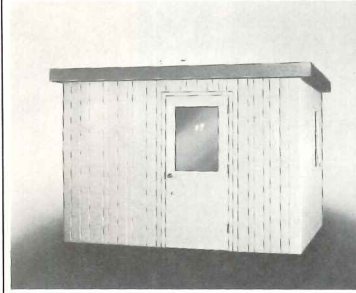

151



154

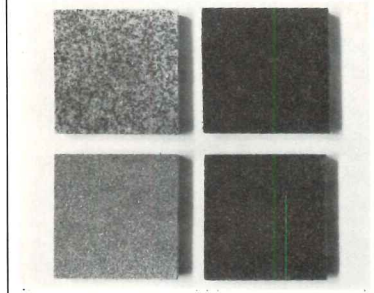

157

146 Roofing

Hi-Tuff single-ply roofing features a scrim-reinforced membrane, which is mechanically fastened to the roof deck, and hot-air welded seams. Roofing is Factory Mutual approved for wind resistance and carries a UL Class A fire rating. Roofing Systems, J.P. Stevens & Co., Inc., East Hampton, MA.

147 Sealants

#5000 *Ter-Polymer Sealants* are elastomeric emulsion acrylics said to resist heat, cold, ultraviolet radiation, salt water and chemical pollutants. They are used for precast or poured-in-place concrete, window and door frames and perimeter areas. VIP Enterprises, Inc., Miami, FL.

148 Metal roofing

Steel and aluminum roll-formed roofings are available in 16 different profiles and 14 colors. Designed for both new construction and retrofit, they are installed with concealed clip fasteners and can be applied over rigid insulation and concrete or plywood decks. AEP/SPAN, Dallas, TX.

149 Fiberglass roof

The *Woodlands* roof shingle carries UL approval for the use of staples as well as a UL Class A fire rating. Shingles feature *Seal-O-Matic* adhesive stripes to secure them in place. They come in a variety of colors. The Manville Corp., Manville Building Materials Div., Denver, CO.

150 Thin granite panels

Granite panels for outdoor applications come 3/8 in. thick with a polished or honed finish, or 1/2 in. thick with a thermal-flamed or diamond-sawn finish. Panels may be installed by a tile setter using latex thin-set mortars without anchors. Marble Technics, Ltd., New York, NY.

151 Pre-engineered panels

The building shown is made of 2-in.-thick insulated panels designed for special purpose buildings standing up to 10 ft 6 in. high. Panels come in galvanized steel, aluminum with a stucco finish and galvanized steel covered with white polyester. Bally Case and Cooler, Inc., Bally, PA.

152 Cedar-faced plywood siding

Western Red Cedar-faced plywood siding and paneling is 5/8 in. thick, 4 in. wide and comes in 8-, 9- and 10-ft lengths. Veneers comply with the APA 303 Specialty Siding Natural Rustic Grade. Panels come ungrooved or grooved vertically in a choice of 7 patterns. Evans Products Co., Portland, OR.

153 Skylight

The *Lo-Dome* skylight is approximately 3 in. high. It features a double-insulated dome of plexiglass, which is claimed to be shatterproof and weighs less than glass. The skylight comes in fixed or venting models in a number of sizes. Ventarama Skylight Corp., Hicksville, NY.

154 Roofing shingles

Classic Slate roofing shingles are manufactured of mineral fiber to be more uniform in strength and half the weight of natural slate. They carry a UL Class A fire rating and come in black, gray, green and red. International Building Products, Inc., New Orleans, LA.

155 Pavers

Terra-Stone pavers are designed to protect substrates from traffic and allow local access to substrates for repairs. Typical applications include new or rehab roofs and roof decks, concourses and plazas. A variety of colors and textures are available. Wausau Tile, Inc., Wausau, WI.

156 Composite stone panels

Minerit is a non-asbestos substrate, which is combined with a natural stone face to form a new line of composite stone panels. The bonding agent is Hycon 75 epoxy resin. Panels are approximately 5/16 in. thick, 4 ft wide and 8 or 10 ft long. Sanspray Corp., Santa Clara, CA.

157 Exterior wall finishes

Stone Caste and *Sand Caste* are natural stone finishes for wall systems made of insulation board, fiberglass reinforcing fabric, and a synthetic plaster and cement base coat. Finishes come in several colors and can be used on new or retrofit construction. Synergy Methods, Inc., Cranston, RI.



158



159



160

158 Skylights

A commercial extruded aluminum tubular skylighting system allows rafters to be spaced up to 54 in. apart; straight lean-to spans can reach 25 ft and arches can span up to 50 ft. Snap-in retainers for inner nonsealed glass or wire screen are available. Wasco Products, Inc., Sanford, ME.

159 Spray-on insulation

CertaSpray is a fiberglass insulation particularly suited to irregular or hard-to-reach areas. When it is sprayed to a 5-in.-thickness it yields a rating of R-20. It has a Class 1 fire rating, STC ratings up to 56 and NRC ratings up to 1.10. Certainteed Corp., Valley Forge, PA.

160 Concrete roof tiles

Earth-toned concrete barrel roof tiles are colored with *Bauferrox* iron oxide pigments made by Mobay Chemical. They carry a Class A fire rating and are said to require little maintenance and to resist fading. Gory Associated Industries, Inc., North Miami, FL.

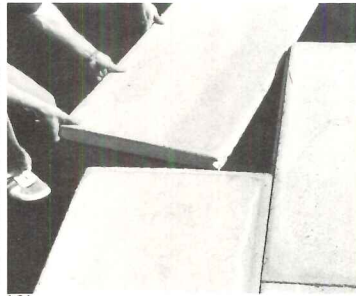

161



162



163

161 Roof insulation boards

Insulation boards are composed of a 3/8-in. layer of factory applied, latex modified concrete mortar bonded to boards of *Styrofoam*. The boards create a ballasted roofing system that weighs 4.5 lb/sf. The Dow Chemical Co., Midland, MI.

162 Skylights

Kalcurve skylight panels are 2 3/4 in. thick, come in standard widths of 4 and 5 ft and in lengths up to 20 ft along the arc. Light transmission ranges from 3 to 83 per cent. Panels carry U values from .15 to .40. Kalwall Corp., Manchester, NH.

163 Shingles

UL Class A rated *Classic Plus* glass fiber roofing shingles are claimed to last up to 1/3 longer than comparably-priced organic products. They are said to resist curling, blistering and buckling. Shingles are available in 7 colors. Owens-Corning Fiberglas Corp., Toledo, OH.



164



165



166

164 Zinc roof

Microzinc 80 textured panels form a watertight roof system, which weathers to a gray patina. The system installs over solid sheathing or lath and is claimed not to stain adjacent materials. Ball Zinc Products Div., Greenville, TN.

165 Roof fan

A roof fan for attics delivers 1250 CFM with a 1/2 Hp motor. Housed in zinc-coated steel with a baked enamel finish, the unit is 22 in. in diameter and 9 in. high. Its automatic thermostat is preset at 110 deg and adjusts from 70 to 130 deg. Nutone Div., Scovill Inc., Cincinnati, OH.

166 Cedar shingles

Fancy Cuts shingles are made of #1 grade Western red cedar. They each measure 5 by 18 in., have a vertical grain and are knot free. Shingles are available in 9 shapes, including round, square, hexagonal and octagonal. Shakertown Corp., Winlock, WA.

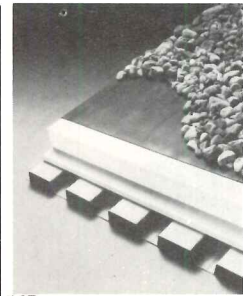

167



168



169

167 Roofing system

The system offered by this company features a single-ply membrane, insulation panels, a fastening system for metal, wood and concrete decks, molded EPDM pipe flashings and counter-flashing. The system is said to fit virtually any roof design. Carlisle SynTec Systems, Carlisle, PA.

168 Skylights

Solar Deck acrylic skylights for walkway covers and canopies come in 6-, 8- and 10-ft modules and can be used singly or in continuous patterns. They are produced in pyramid, gambrel and bubble shapes and may be tinted to an architect's specifications. Mapes Industries, Inc., Lincoln, NE.

169 Roof surfacing

Trafbloc is a protective surfacing for roof traffic areas. It is composed of chopped rubber particles and synthetic binders, is 310 mil thick and comes in rolls. It can be cut to sizes needed and is applied with hot asphalt or rubber-based adhesives. Siplast, Arkadelphia, AR.

7 Thermal & Moisture Protection Product literature

For more information write item numbers on Reader Service Cards

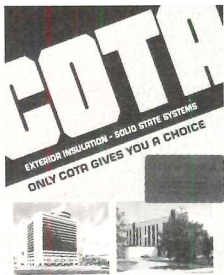

170 Exterior insulation
Two solid-state insulation systems are featured in a 20-page color brochure. Details of system components, installation procedures and the fabrication of insulation panels are illustrated. Physical data, insulation values and specifications are listed. Cota Industries, Inc., Des Moines, IA.

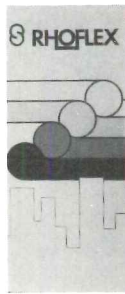

176 Bitumen roofing
The *Rhoflex* roofing system, an asphalt-based polymer-modified bitumen with polyester, is described in a brochure. It can be installed on almost all surfaces without adhesives, coatings or stones and can be used for repair, flashing and general waterproofing. Rhoflex Div. of Teltex Inc., North Branford, CT.



171 Roof drains
Roof drains, sumps, scuppers and flexible bellows are illustrated and described in a 4-page brochure. Section details with labeled components and dimensions are included for each model. Information on installation and specifications are also included. W.P. Hickman Co., Asheville, NC.



177 Skylights
Photos of skylight installations in a 36-page color booklet illustrate designs that may be achieved with this company's products. Details show basic construction methods for single-slope, pyramid, ridge, dome and vault skylights. Specifications are included. Super Sky Products, Inc., Mequon, WI.

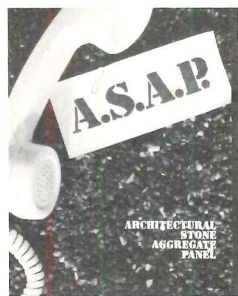

172 Aggregate panels
Installations of stone aggregate panels and the 6 colors in which they are available are shown in photos in a 4-page color brochure. Typical construction details show joints and moldings. INSUL/CRETE Co., Inc., McFarland, WI.



178 Roofing sheet
Tropiseal modified bitumen roofing sheet is described in a 4-page brochure. Each of the 3 layers of the sheet is described, while photos show a variety of applications. Technical data are listed. Tropical Industrial Coatings, Inc., Brunswick, OH.

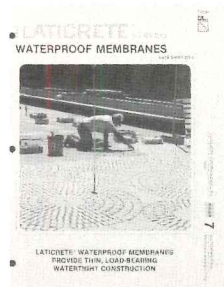

173 Waterproof membrane
A membrane that provides thin, load-bearing, watertight construction is featured in a 4-page color brochure. Photos show installation procedures and finished projects. A detail illustrates the use of the membrane with ceramic tile over a concrete slab. Laticrete International, Inc., Bethany, CT.



179 Roof windows
Photos show installations of roof windows, awnings, blinds and safety features in a 24-page color brochure. A graph compares air infiltration with this company's windows to that of standard prime and thermal windows. Flashing types, technical data and sizes are included. Velux-America Inc., Greenwood, SC.

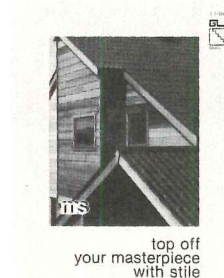

174 Metal roofing
Stile galvanized steel roofing, made to look like clay tile, is featured in an 8-page color brochure. Product data and installation instructions are included. Roof system components and available colors are illustrated. Fire ratings and specifications are listed. Metal Sales Manufacturing Corp., Louisville, KY.

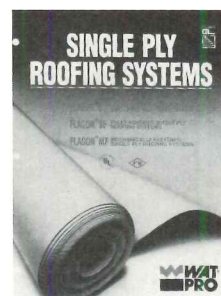

180 Single-ply roofing
Flagon single-ply loose-laid, ballasted, mechanically fastened and fully adhered roofing systems are featured in a 4-page color brochure. Installation techniques and physical data are included for each system. The brochure also describes this company's quality control procedures. Watpro Corp., Manasquan, NJ.

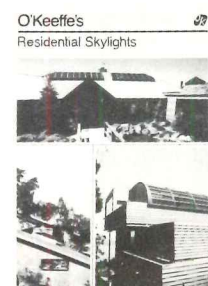

175 Residential skylights
An 8-page color brochure features several photos showing installations of residential skylights in a wide variety of sizes and styles. Accompanying the photos is a description of different ways skylights can function in design. O'Keeffe's, Inc., San Francisco, CA.

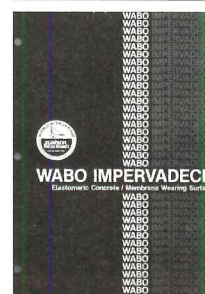

181 Bridge/parking surface
The *Wabo-Impervadeck*, a waterproofing membrane/wearing course system for bridge decks and parking structures, is covered in a 4-page brochure. A diagram shows the paving layer sequence of the system, and installation procedures are described. Watson Bowman Associates, Inc., Amherst, NY.

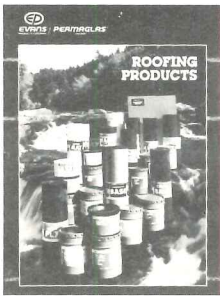

182 Roofing products
Compositions, coverage rates and applications of a series of commercial and industrial built-up roofing products are described in a 32-page catalog. Included are roofing membranes, coatings, adhesives and insulations. Evans Products Co./Permaglas Div., Corvallis OR.

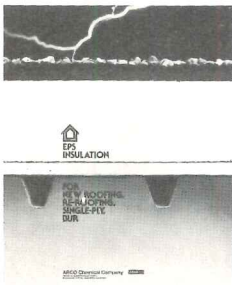

183 Roofing insulation
Design guidelines for systems using expanded polystyrene EPS insulation are covered in a 10-page color brochure. Details show the use of EPS with single-ply membranes and built-up systems over metal and concrete decks. Tables list physical properties. ARCO Chemical Co., Div. of Atlantic Richfield, Philadelphia, PA.



184 Cladding
Wall, roof and liner panels for industrial and commercial applications are covered in an 8-page color brochure. Diagrams with dimensions are featured with tables listing live loads per square foot. Photos of installations, specifications and a chart of standard colors are included. ASC Pacific, Inc., Carson, CA.



185 Roof membrane
The *Hydroseal* EPDM sheet-rubber roof membrane for new construction and re-roofing is featured in a 4-page color brochure. Four different methods of application are illustrated and described. Physical properties are listed. American Hydrotech, Inc., Chicago, IL.

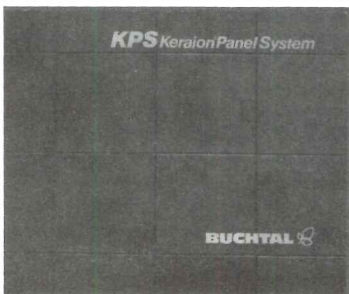

186 Panel system
Keraion prefabricated, tile-clad panels are featured in a 24-page color booklet. Details show panel composition and joints. Punched-window, spandrel and formed-wall panels are shown in details with dimensions and renderings. Specifications and seismic information are included. Buchtal, Atlanta, GA.



187 Metal roofing
The use of *Microzinc 70* and *80* sheet metals in sloped roofing systems is shown and described in an 8-page color brochure. Details and specifications of factory-formed roof systems and accessories using the metals are featured. Photos show commercial and residential installations. Ball Zinc Products Div., Greenville, TN.



188 Standing-seam roofs
The energy efficiency and ease of installation of *Chief LTC* self-seaming standing-seam roof systems are described in a 4-page color brochure. Section details illustrate panel installation, and diagrams show dimensions. Specifications are included. Chief Industries, Inc., Building Systems Div., Grand Island, NE.



189 Exterior wall insulation
A 4-page color brochure covers insulated finishing systems featuring *Styrofoam* brand insulation and polymer modified cement. Charts show comparisons to molded bead polystyrene insulation for moisture resistance and R-value retention. A section detail illustrates installation. The Dow Chemical Co., Midland, MI.

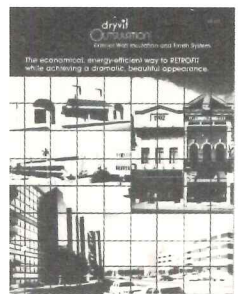

190 Retrofit insulation
An 8-page color brochure describes how the *Outsulation* wall insulation and finish system is used to retrofit old buildings. It also describes *Revyvit*, a sandy textured latex acrylic coating for use over *Outsulation*, concrete, stucco, brick, cement or cement building boards. Dryvit Systems, Inc., West Warwick, RI.



191 Built-up roofing
An 86-page manual features built-up roofing applications and specifications. Section details illustrate components of various roof systems and a chart lists comparative insulation thicknesses for obtaining required "C" and "R" factors. Evans Products Co./Permaglas Div., Corvallis, OR.

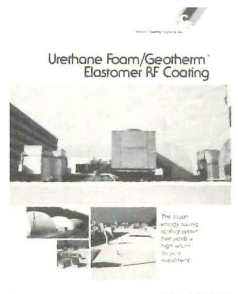

192 Roofing system
The composition of *Geotherm Elastomer FR Coating*, which is designed to protect urethane foam insulation systems, and urethane foam are described in a 4-page color brochure. The physical properties of *Geotherm* and short-form application specifications are listed. Geocel Coating Systems, Inc., Elkhart, IN.

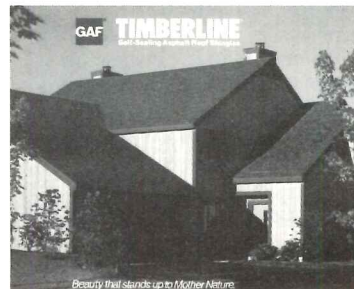

193 Roof shingles
Self-sealing asphalt roof shingles are illustrated in photos of residential installations in a 12-page color brochure. The 7 colors in which they are available are also illustrated, and their weather- and fire-resistance is described. GAF Corp., New York, NY.

For more information
write item numbers on
Reader Service Cards

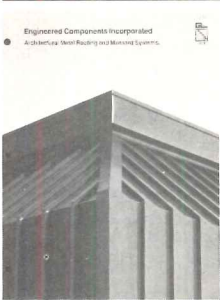

194 Metal roofing systems
Metal roofing and mansard systems are featured in a 12-page color brochure. Details with dimensions show components, framing and flashing. Information on materials and coatings and a finish color chart are included. Engineered Components, Inc., Stafford, TX.

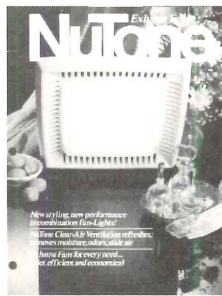

200 Exhaust fans
Exhaust fans with and without light fixtures are illustrated and described in a 20-page color catalog. Diagrams and photos show typical installations. A guide helps to determine the minimum CFM rating required in an area. NuTone Div., Scovill Inc., Cincinnati, OH.

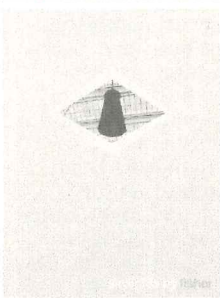

195 Skylights
Photos show installations of a variety of skylights in a 24-page color booklet. Diagrams show unit shapes, and details are included for both tubular aluminum and all-metal framed skylights. Roll-away and ventilating models are also covered. Fisher Skylights, Inc., West Nyack, NY.

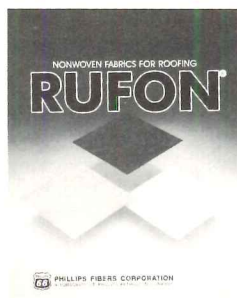

201 Roofing fabric
An information kit on *Rufon* nonwoven fabric includes a page on cold applied systems, one for stone separator mats and one on slip sheet applications. Information on functions, properties and applications is included. Phillips Fibers Corp., Greenville, SC.

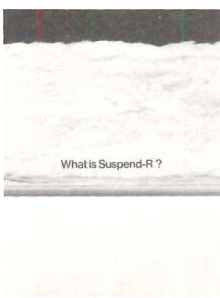

196 Ceiling insulation
A 6-page color foldout brochure describes *Suspend-R*, a suspended ceiling insulation system with an insulating value of up to R-44. System properties, components, applications and installation procedures are all covered. The Manville Corp., Manville Building Materials Div., Denver, CO.

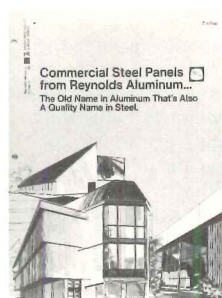

202 Steel panels
An 8-page color brochure features steel commercial roofing and siding panels. Load/span data for 9 panel designs and for insulated walls is listed. Design criteria, suggested specifications and a chart of standard colors are included as well. Reynolds Metals Co., Eastman, GA.



197 Exterior steel panels
Exterior panels made of steel and finished in porcelain enamel are covered in an 8-page brochure. Sections on veneer and insulated panels include construction guides, wind load charts and specifications. AllianceWall Corp., Atlanta, GA.

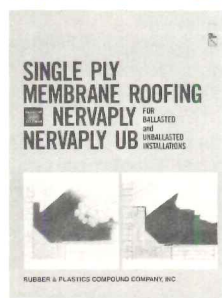

203 Roofing
An 8-page brochure describes single-ply membrane roofing for ballasted and unballasted installations. Details, photos of installation procedures and charts of test values and applications for two different membranes are all included. Rubber & Plastics Compound Co., Inc., Long Island City, NY.

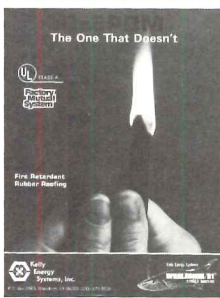

198 Rubber roofing
A spec sheet on *Whaleskin/81* fire retardant rubber roofing includes section details for plywood, metal and concrete decks. Both systems are UL Class A rated. Kelly Energy Systems, Inc., Waterbury, CT.

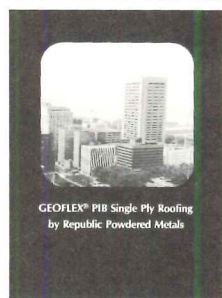

204 Single-ply roofing
Photos show installation procedures of GEOFLEX PIB roofing in a 24-page booklet. Reroofing specifications include applications and maintenance. Several section details of gutters, drains, flashings and more are included. Republic Powdered Metals, Inc., Medina, OH.

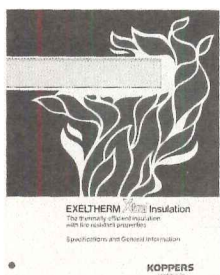

199 Roof insulation
Exeltherm Xtra roof insulation with fire resistant properties is described in a 4-page brochure. Charts list physical properties and thermal performance data. A detail shows a steel deck application, and suggested application procedures are listed. Koppers Co., Inc., Pittsburgh, PA.

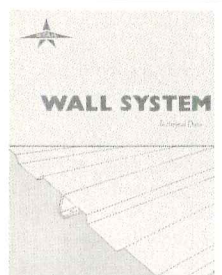

205 Wall system
A 4-page brochure features technical data on the *StarCFW* steel wall system. Sections and details illustrate typical installation, and tables list maximum total uniform loads. Information on color finishes and specifications are included. Star Manufacturing Co., Oklahoma City, OK.

7.13/STO

STO INDUSTRIES
INCORPORATED

QUALITY LANE, BOX 219, RUTLAND, VERMONT 05701 / 802-775-4117 • 2189 F FLINTSTONE DRIVE, TUCKER, GEORGIA 30084 / 404-939-9590



the originator and world's leading producer of synthetic resin coatings and exterior insulation systems

* phone collect for the new **sto**
PRODUCTS & SYSTEMS
BROCHURE

...these **sto** advantages are unequaled :

- * **sto** has a world-wide reputation for research & development.
- * **sto** originated synthetic resin coatings in Europe 30 years ago.
- * **sto** coatings offer the widest choice of color and texture in the industry.
- * **sto** exterior insulation systems with STO adhesives and STO 100% synthetic resin coatings can meet all of your exterior insulation needs.

Specify

sto

or equal

Damora

Circle 1123

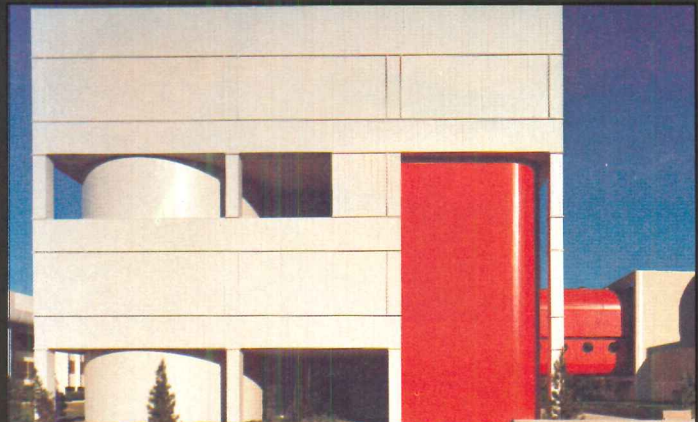
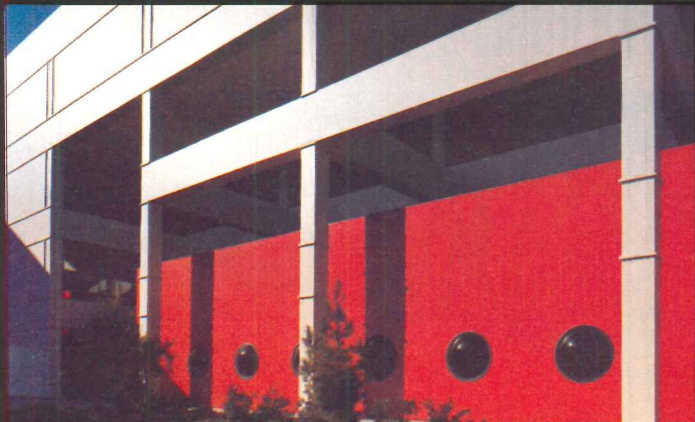

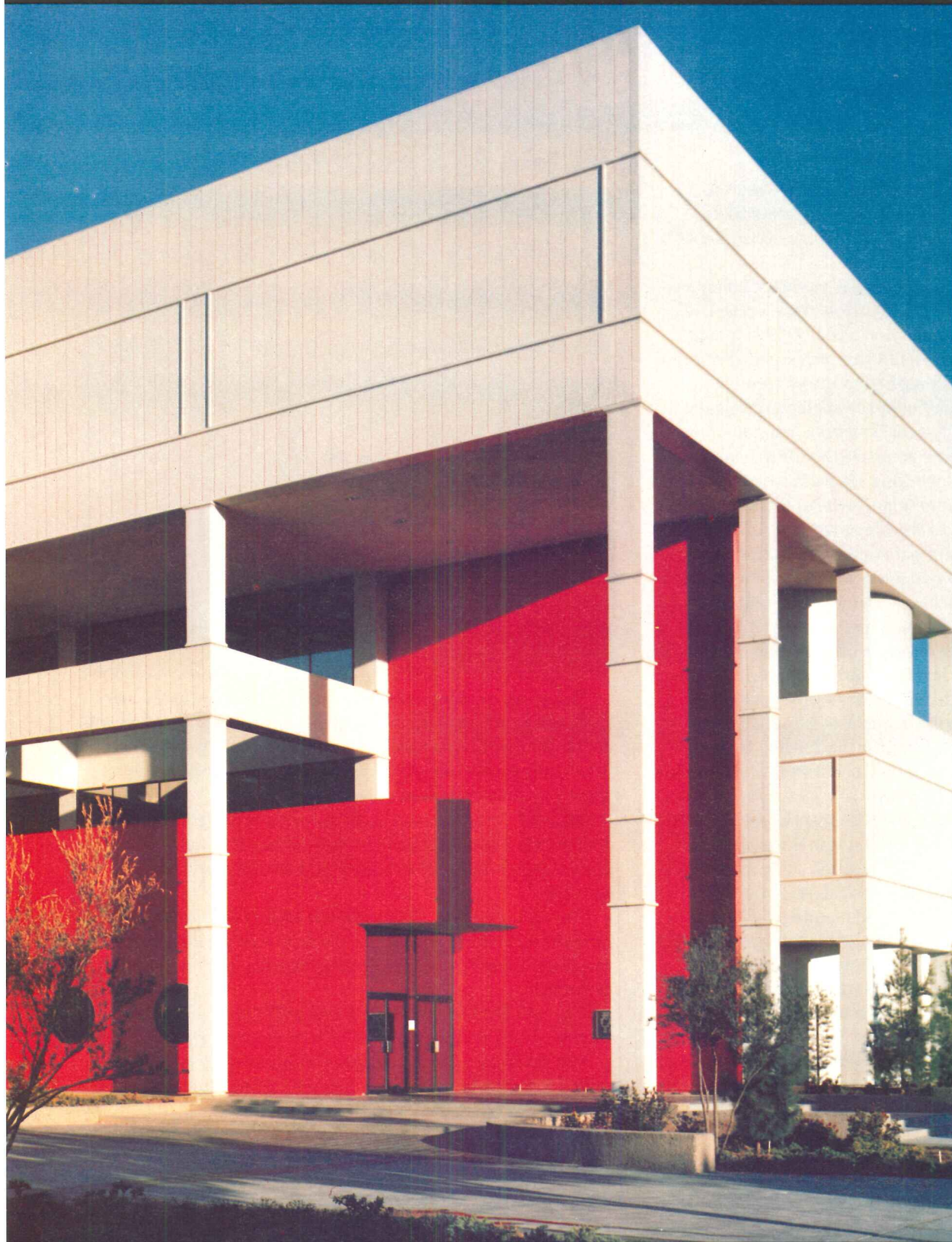

A new freedom of design is made possible for low and mid-rise construction by Inryco Curtain Walls. Sweeping curves, sculptured surfaces, subtle or striking colors, matte or glossy finishes— as you want them.

Send for more information in Catalog 13-1. Write INRYCO, Inc., Suite 4033, P.O. Box 393, Milwaukee, WI 53201.



Inryco
an Inland Steel company

CURTAIN WALLS BY INRYCO

Circle 1036 on inquiry card

Fourteen years of interstitial design

Fourteen years ago, the initial application of the Veterans Administration Building System emphasizing interstitial service space was incorporated into the design of Saddleback Hospital in Laguna Hills, California.

The concept of interstitial service space has since influenced the design of hospitals, both VA and private, here in the United States and abroad. And its application has also been incorporated into the design of non-hospital structures, such as hotels and laboratories, that could benefit from the system.

The key to all interstitial service space applications has been the accessibility of services for construction, maintenance, repair, and change. The service zone has therefore been constructed with an over-all working platform which doubles as the ceiling subsystem in functional areas of the structure. This service ceiling provides a working platform, an acoustic and thermal block, support for partitions, and a fire retardant. With the added capability of being cut and patched with hand tools, the service ceiling allows easy penetration and closure for duct openings and pipe connections.

With interstitial design the question of increased cost was a consideration. The building itself would necessarily be somewhat larger and the cubage would be higher because of the interstitial space. But trade-offs in cost can be anticipated.

The service ceilings constructed for the 300,000 sq. ft. Froedtert Memorial Lutheran Hospital in Milwaukee, Wisconsin allowed work to go on simultaneously in interstitial and functional floors. Rather than having to erect scaffolding to install utility and air conditioning runs – causing an interruption of continued work in the functional floor areas – the service ceilings supported men and materials during installation. After completion of the hospital, operational maintenance in the interstitial service areas is being conducted without disturbing patient care activities on the floors below.

According to a study by the VA, the additional cost of interstitial design is totally offset by savings in construction expenses.

Contractors interviewed say the system can cut construction time by as much as 20% and also save 15 to 20% on labor costs of mechanical installation. They say fewer coordination drawings are necessary, more trades can work simultaneously, and fewer change orders are processed.

The VA hospital in Loma Linda, California, for example, came in two months ahead of schedule with labor costs cut by 25%. Service ceilings went in fast with gypsum pours reaching 5,000 sq. ft. per day.



The service ceiling assembly most often specified – over 6 million sq. ft.– consists of Keydeck® Truss Tee subpurlins and Keydeck® Reinforcing Mesh manufactured by Keystone Steel & Wire. Formboard and poured gypsum or U.S.G. Span-Rock® gypsum planks complete the assembly.

Keydeck Truss Tees are welded beneath, or between main structural beams for support, while Keydeck Reinforcing Mesh adds strength and uniform structural soundness to the poured gypsum.

The open web design of Keydeck Truss Tees allows the subpurlins to be strongly embedded into the gypsum concrete resulting in a greater load carrying capacity and minimum deflection.

Keydeck Reinforcing Mesh meets ASTM tensile, bending, and coating requirements; and conforms to Federal Specifications.

The resulting service ceiling assembly is fire resistant, provides increased insulation capabilities, and helps control noise.

Additional information and detailed literature about Keydeck service ceiling components along with a complimentary truss tee deflection calculator can be obtained by writing the Construction Products Manager at Keystone Steel & Wire Company, 7000 S. W. Adams, Peoria, Illinois 61641. A toll free telephone service is also available for inquiries: 800-447-6444 (in Illinois call 800-322-2632).

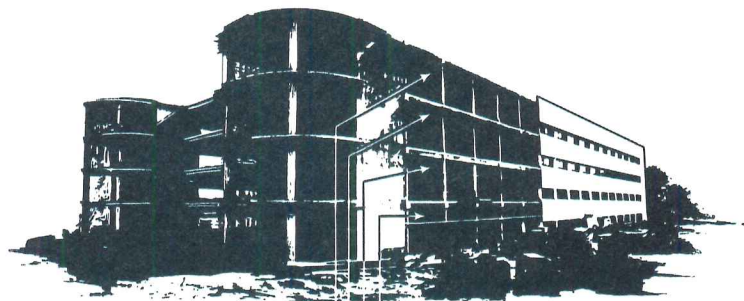

Interstitial service ceilings on four levels

Froedtert Memorial Lutheran Hospital Milwaukee, Wisconsin
Architect:

A joint venture of Stone, Marraccini & Patterson and Brust-Zimmerman

Construction manager:

A joint venture of Findorff and Hutter

Service ceiling components manufacturer:

Keystone Steel & Wire Company

Service ceiling fabricator:

Anning-Johnson Company

Keystone Steel & Wire Company

Circle 1037 on inquiry card



We're not impressed.

Manville Fesco® Board roof insulation board has long been a favorite with specifiers and installers. For several reasons.

Thermal efficiency for one. Then there's dimensional stability. Still another is its rigid composition. Its ability to resist compression. To provide a sound, solid substrate for the new built-up roof.

And Fesco Board solves another problem important to the decision to re-roof. It is ideal for correcting slope as well as adding insulation to existing roofs. Fesco Board can be easily applied in multiple layers to build up low spots or to achieve desired R-values with no "shorts" or through joints.

Then, by using an ordinary power lawn rake, Fesco Board can be shaved or tapered to remove irregularities and to achieve positive slope to drain.

Find out more about Manville Fesco Board, the versatile problem-solver, performance-proven in almost 30 years of on-the-roof service. For details, consult Sweet's or contact Bart Roggensack, Manville Roofing Systems Division, Ken-Caryl Ranch, Denver, Colorado 80217. (303) 978-2781.

Manville

Circle 1038 on inquiry card

***This
fireproofing
passes
UL fire tests.
Is that
enough?***

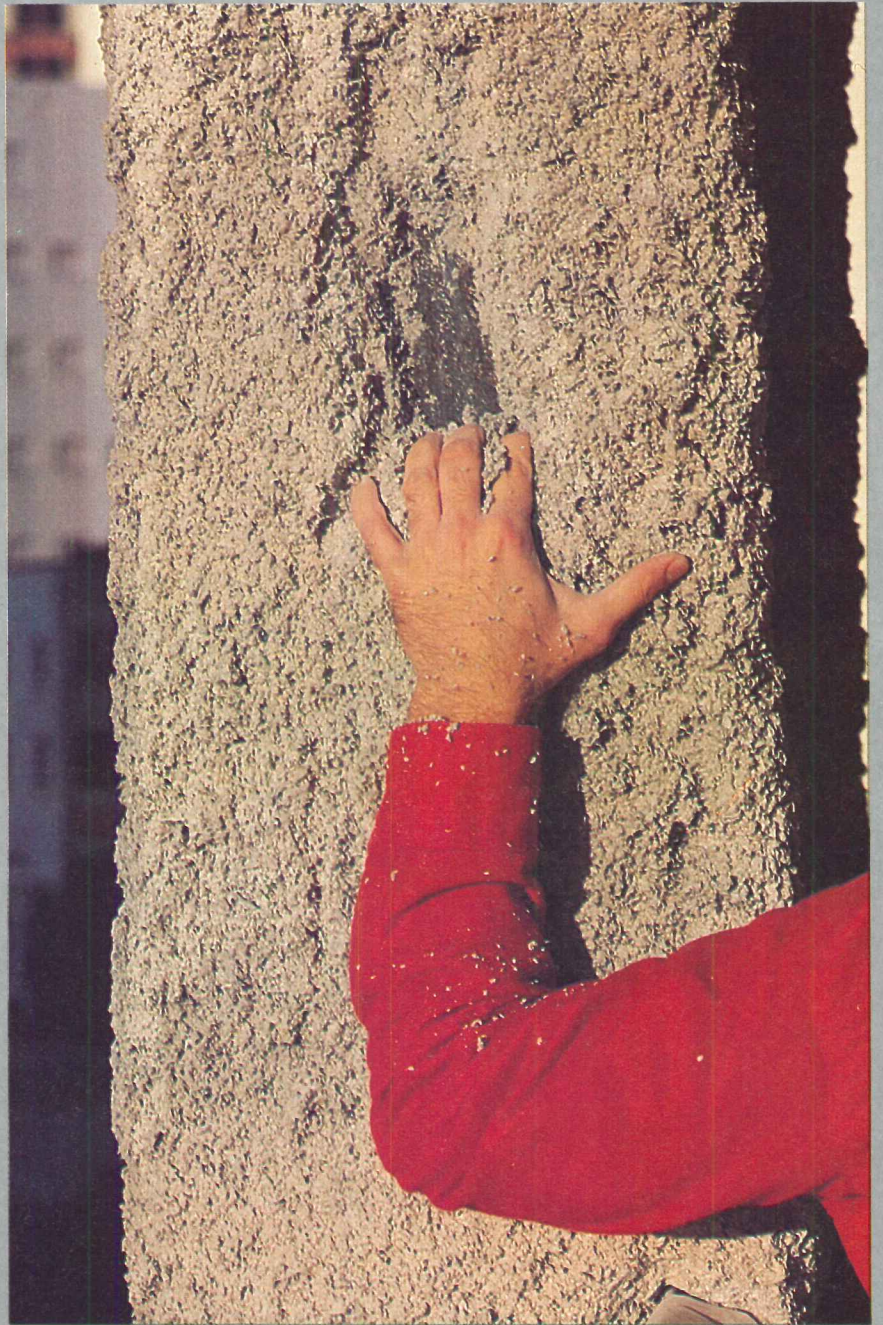

Sprayed-Fiber Fireproofing

No, it's not enough!

Structural steel fireproofing is the first line of defense in protecting a building and its occupants should a fire occur. It can only perform this critical task if it remains in place during construction and building occupancy.

Compliance with building codes and specifications requires UL fire ratings. But, UL fire tests don't tell the whole fire protection performance story. They only evaluate the capability of a material to provide fire resistance under ideal laboratory conditions. They can *not* evaluate other important characteristics which predict long term effectiveness.

As the photo at left shows, soft, friable materials with poor adhesion are unable to resist normal job-site abuse. The result can be loss of fire protection capability.

There is now a way to insure long term fireproofing reliability—fireproofing specification performance standards. Code bodies, government officials and fireproofing manufacturers, working together, have developed test procedures which provide a basis for establishing standards for fireproofing to insure in-place performance. Use of these standards for fireproofing will reduce the risk of specifying unreliable and inadequate structural fire protection materials.

The new tests measure the ability of fireproofing to resist damage by hammers and ladders (impact, abrasion and penetration resistance); to adhere

to steel (bond strength) and to resist flaking and dusting (air erosion). All these standards are critical to insure proper selection and performance of all fireproofing materials.

By incorporating these performance standards into your fireproofing specification you can be assured that owners will receive quality fire protection materials with reliability for the life of the building.

Fireproofing Performance Standards

Characteristic Measured	Performance Standard	Test Reference
Impact Penetration	6 cm ³ maximum	City of San Francisco
Abrasion Resistance	22 cm ³ maximum	City of San Francisco
Compression	500 lbs/ft ² minimum	ASTM E-761-80/Grace
Bond Strength	200 lbs/ft ² minimum	ASTM E-736-80/Grace
Air Erosion	.025 gm/ft ² maximum	ASTM E-859-82/GSA

Monokote® Fireproofing



For further information or test results, contact W. R. Grace & Co., Construction Products Division, 62 Whittemore Avenue, Cambridge, MA 02140, (617) 876-1400.

GRACE

The Snap-on Roof is here!



The Mercer Area High School, Mercer, PA
Roofing Contractor: J.A. Burns & Sons, Mercer, PA

Carlisle introduces America's first mechanically attached single-ply roof that doesn't penetrate the membrane.

It's here...M.A.R.S. Design NP™ (Mechanically Attached Roofing System—Non-Penetrating). This is the ultimate single-ply roof system, combining the lightweight advantage of adhered systems with the low cost holding power of ballasted systems. But with a plus! It also offers the economical advantage of mechanically attached systems *without penetrating the membrane!*

Used in Europe for nearly a decade, this innovative system will save you time, money, materials and weight.

Fast, easy installation.

Carlisle's performance-proven Sure-Seal™ membrane is held in place by simple three-part assemblies. These are a snap to install...as easy as one, two, three. No special equipment. Even in marginal weather. A small crew of Carlisle approved applicators can install an entire roof in record time.

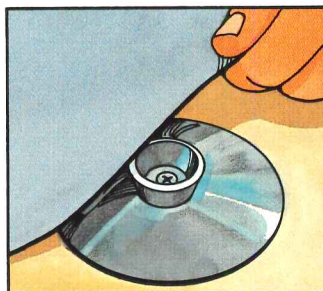

1 Roll membrane over knobbed base plate.

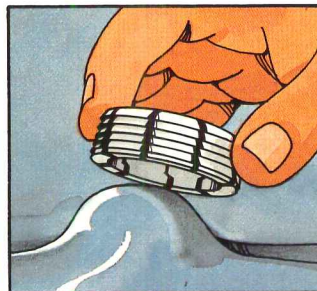

2 Roll and snap on white retainer clip.

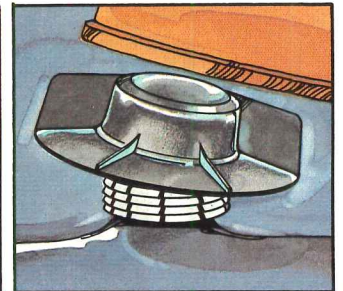

3 Snap and screw on threaded black cap.

Flexible design.

Goes right over failing built-up roofs and those that can't support much weight. The system fastens to most substrates and can even be moved to another location.

Best of all, it's from Carlisle.

Trust Carlisle to bring you the best and most innovative roofing systems. We

promise single-source responsibility, trained professional applicators and over 20 years experience. Best of all, we offer a watertight warranty of up to 15 years.

For more information on our snap-on roof, call toll-free, (800) 233-0551, in PA (800) 932-4626. Call today, this is one snap decision your roof...and budget...will never regret!

The roof that's requested by name

CARLISLE

Carlisle SynTec Systems

Division of Carlisle Corporation, P.O. Box 7000, Carlisle, PA 17013

Sure-Seal, M.A.R.S. Design NP and Carlisle are trademarks of Carlisle Corporation.
M.A.R.S. Design NP Patent Pending.
© 1983 Carlisle Corporation

Call toll-free, 800-233-0551
In PA, 800-932-4626

DRYVIT® HOW THE TRUST WAS EARNED.

We believe in quality.

When we introduced the concept of an exterior insulation and finish system to the United States in 1969, we had to prove the System could perform better than traditional materials.

And so our commitment to stringent testing and quality control was born.

We began with a proven formula for our Finish coat and cementitious adhesive.

We know there is no substitute for the performance level of a 100% pure acrylic co-polymer product.

Valuable properties such as flexibility, fade-resistance, alkali-stability, moisture-resistance and wet adhesion are lost when substitutes are added.

And add to this, our special impact system, Panzer® Mesh, and you have all the ingredients for a building that will live up to the high standard you set.



We offer technical support in the field and at the planning stage.

Design assistance is available from our technical staff.

And for fast local assistance, our distributors are nearby and always available.

You can trust the Dryvit Difference to come through when you need it.

Demanding fire and structural testing goes beyond code minimums.

The Dryvit System is recognized by all three model code agencies: ICBO, BOCA, SBCCI.

We've subjected our System further, to Full Scale Fire Tests with 1500 and 1250 pound fire sources as well as the Factory Mutual Corner Test.

Positive and negative wind load testing has been conducted on full scale wall assemblies in accordance with ASTM E330 procedures.

Dryvit performs even under demanding conditions.

Dryvit retrofit gives office building a fashionable Art Deco facade.

5500 Yale Street, Englewood, Colorado, was a precast concrete eyesore before architects Ginsler and Associates designed this retrofit. Taking advantage of

Dryvit's design flexibility and the expertise of the applicator, they were able to incorporate aesthetic relief. Bands of 1½" x 7" Dryvit Insulation Board create flowing lines, adding drama to the balconies.

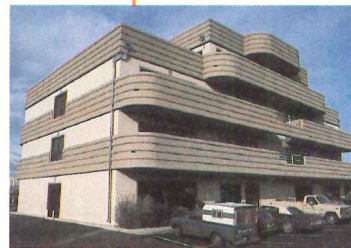

Face-saving retrofit adds insulation to St. Paul's Housing for the Elderly.

Detroit, Michigan, winters had taken their toll of this 12-story uninsulated building.

Smith Associates, Inc., the architects, chose Dryvit Outsulation to solve their problems. In addition to adding needed insulation, the Dryvit retrofit provided an attractive weather-resistant surface. Occupants now enjoy a better level of comfort while the building's appearance upgrades the entire area.

Gardner Student Center serves as entrance gate to the University of Akron, Ohio.

Believe it or not, a road goes through this building. Karl R. Roher & Associates, architects, turned to Dryvit to accomplish the archways and soffits their design required. Dryvit's impact system, employing Panzer® Mesh, was used in high traffic areas. Also gained: a cost-effective, energy-efficient building that blends beautifully with the campus.

Over 40,000 buildings stand as proof of our performance.

Over 30 years of Dryvit experience in this country and Europe offer peace of mind to the developer and architect specifying Dryvit.

Call or write for information.

DRYVIT SYSTEM, INC.

TOLL FREE HOT LINE:

1-800-556-7752

DRYVIT® SYSTEM, INC., One Energy Way
P.O. Box 1014, West Warwick, RI 02893

dryvit

Plant Locations:
West Warwick, RI; Tulsa, OK;
Columbus, GA; Woodlake, CA

Trust Our Proven Performance.
It's the Dryvit Difference.

OUTSULATION®

Circle 1041 on inquiry card

A Waterproofing System Doesn't Have to Look Good to Work...But Ours Does.



For the Maxwell House Hotel in Nashville, Tennessee, two coats of VIP 7300 Ter-Polymer Waterproof Coating (a low-texture grade) were roller-applied. The color chosen was one of VIP's standard colors. Custom colors are also available. Prior to the application of VIP 7300, VIP 5100, a textured buttering grade ter-polymer sealant was used to fill the larger cracks. A total surface area of 65,000 sq. ft. was involved.

VIP Ter-Polymer Coatings offer a waterproofing system that is available in a wide range of textures and colors to provide the effect, as well as the effectiveness, you want.

A combination of unique resins has given VIP Coatings exceptional flexibility to bridge hairline cracks and long-lasting reliability.

Easy to apply, non-chalking, mildew resistant and excellent color retention are just a few more of the outstanding advantages that will make that building and you look very good.



For more information contact:

VIP Enterprises, Inc.

Dept. AR-1283

9690 NW 41st Street, Suite 1/Miami, Florida 33178/(305) 592-6045

National WATS: (800) 327-7479/Florida WATS: (800) 432-4616

Flexible Solutions to Concrete Problems.™

Circle 1042 on inquiry card

©1983 VIP

The new Robertson Total Performance Roofing System saves energy, stays weathertight and lasts beautifully!

Keeping roof overhead down—both initial *and* life cycle costs—is the whole idea behind the new TPR System.

"U" values as low as 0.050 (R = 20)

The Total Performance Roof is especially designed for maximum insulation—and minimum heat transfer. This outstanding thermal performance is based on full-scale *tested* values, not on "calculated" numbers, which can be inaccurate by as much as 100%.

TPR Insulation	Tested "U" Value*
6" glass fiber w/sub-girt	0.050
2" rigid foam w/sub-girt	0.055
4" glass fiber w/sub-girt	0.076
4" glass fiber w/o sub-girt	0.082

*Winter conditions, heat flow up, 15 mph wind outside, still air inside.

Weathertightness from thermal responsiveness

A roof's temperature can vary 150°F or more, inducing enormous stress on the total roof system and ultimately causing leakage. That's why Robertson's Total Performance Roof System is secured with hidden clips that are thermally responsive to temperature-induced roof movement. The clips allow the panels to literally "float" as the roof responds to the thermal loadings, and still hold firmly against wind uplift and live load forces.

With the Robertson subgirt and clip system, roof panels snap quickly and easily into place—and stay there. In fact, all components have been tested and carry the highest wind uplift rating available from Underwriters' Laboratories—Class 90.

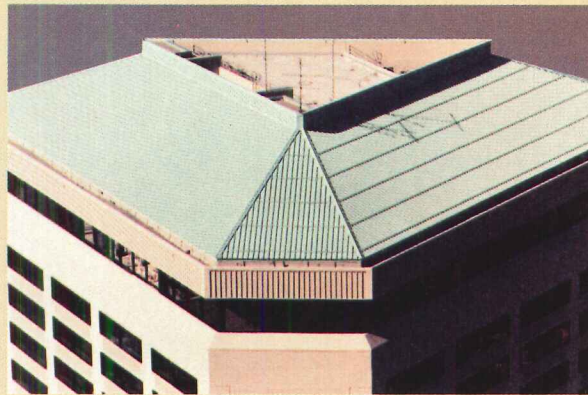
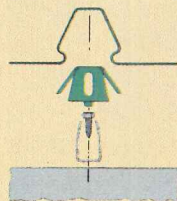

The beauty of total performance

In new construction, or when retrofitting on versatile sub-girts right over an old roof, the Robertson TPR System looks as good as it works. The 12" module, highlighted by clean ribs that add strong shadow lines, can enhance the appearance of any building...and its bottom line.

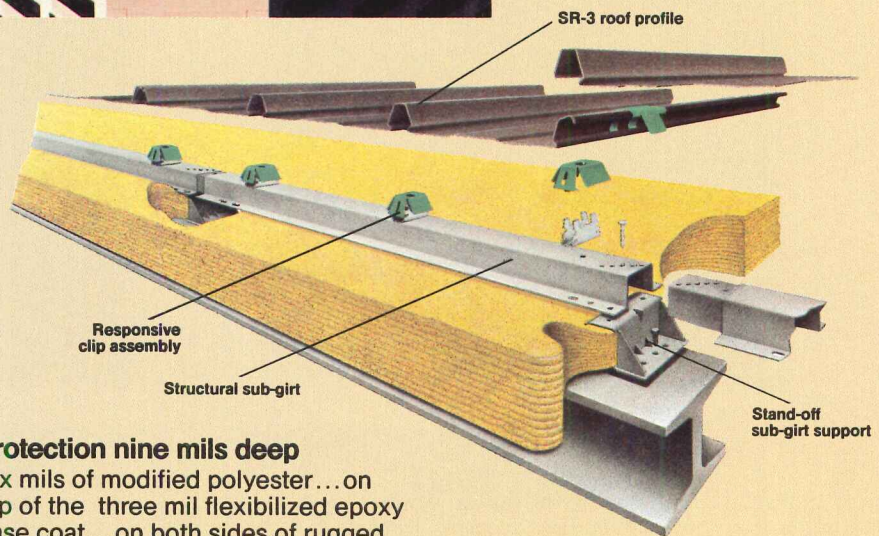

Protection nine mils deep

Six mils of modified polyester...on top of the three mil flexibilized epoxy base coat...on both sides of rugged hot-dipped galvanized steel. Available in 17 standard colors, the Robertson Versacor® protective coating system was specifically developed to stand up under the world's most severe acid rain conditions—and it has, for over 15 years. (For less severe environments, 1 mil finish coats are also available over the Versacor base coat.)

Cost-effective from the outset

The 36-inch-wide panels provide efficient load/span performance with fewer panels, and thus, fewer side joints than narrow panel designs. That reduces field labor and installation costs significantly.

Your single source for total performance

Robertson can do it all, from design and engineering, to manufacture, through installation...all backed by over 75 years' experience. Get complete details from H. H. Robertson Company, Dept. AR-12B 400 Holiday Drive, Pittsburgh, PA 15220. Telephone 412-928-7508.

Sheraton Hotel, Seattle, Washington
Architect: John Graham Company
General Contractor: Howard S. Wright Construction Company

Robertson



DUROCK™

the new tile backer board



before.

*Water soaks through to soften walls.
Tile loosens and falls off. Unsightly!*

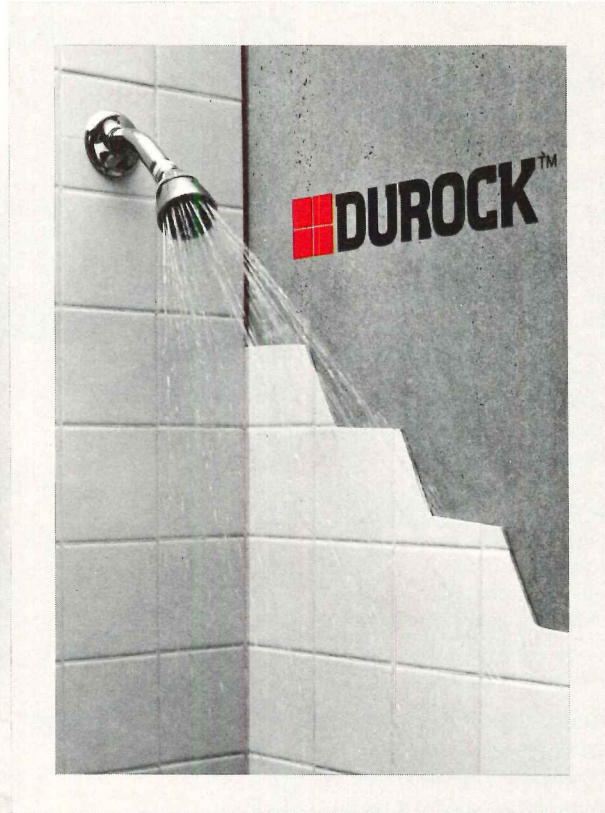

after. 

*Tile stays put beautifully with
water-compatible DUROCK cement
backer board.*

Won't deteriorate when exposed to water!

*It's the no-call-back backer to specify
for your new construction and for remodeling ceramic tile
walls and floors. DUROCK is DURable
ROCKlike portland cement reinforced with glass fiber.
Lighter, easier to install than any competitive
cement board. ■ Available through ceramic tile distributors.
Or write us at 101 S. Wacker Dr., Chicago, IL 60606, Dept. AR-1283*

Durabond Products Co., Subsidiary

UNITED STATES GYPSUM
BUILDING AMERICA

© 1983 United States Gypsum

Circle 1044 on inquiry card

Nothing tops a Hi-Tuff[®] roof.

Sweets 7.1/St

Circle 1045 on inquiry card

STEVENS
Roofing Systems

J. P. Stevens & Co., Inc.
Elastomeric Products Department

FIRESTONE **FasTrac**™

Introducing the first non-penetrating mechanically- anchored system that truly meets the demands of single-ply.

FasTrac.* Firestone's new single-ply fastening system that you'll like for what it does. And, for what it doesn't do.

FasTrac doesn't require sheet penetration. Ballast. Substrate adhesives. Time-consuming batten strip hand sealing. And, FasTrac doesn't increase labor costs. In fact, it can even reduce them.

FasTrac does go down easy. Retaining tracks are screw-fastened to the roof substrate. The EPDM sheets are easily laid over the strips. Then, insert strips are rolled-in to tuck and lock the EPDM sheets to the roof.

Get on the right track.
Use Firestone's new FasTrac system on your next job. It's a better way for a better roof.

*The specially designed
FasTracker™ tool tucks the
EPDM sheets down, and locks
the insert strips into the track.*

Firestone
INDUSTRIAL PRODUCTS COMPANY



Division of The Firestone Tire & Rubber Company

Firestone Industrial Products Company
Roofing Products Department
3500 Depauw Blvd., Indianapolis, IN 46268
SALES: (800) 428-4442 TECHNICAL: (800) 428-4511
In Indiana: (317) 875-9921 **Circle 1046 on inquiry card**

21 years of Constant Insulating Value... FOAMGLAS® Roof Insulation

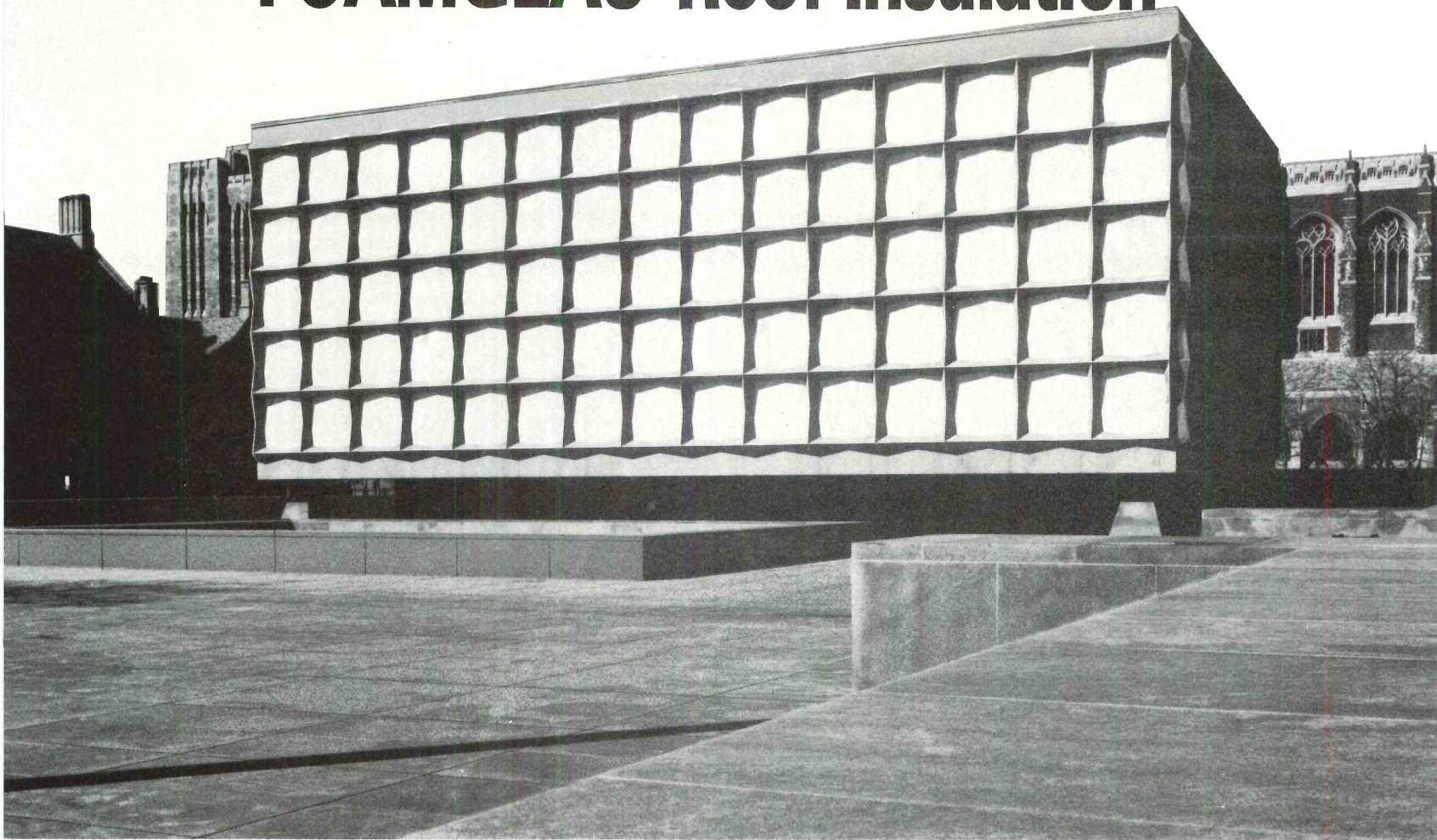

Beinecke Rare Book and Manuscript Library, Yale University, New Haven, Connecticut

In 1961, FOAMGLAS® cellular glass insulation was installed on Yale's Beinecke Library. The roofing system consisted of a 2-ply vapor barrier, FOAMGLAS® Insulation and a 4-ply built-up roof with a double layer of marble chips.

Recently, it was discovered that water had penetrated the roof at its perimeter for years. But when the roofing was torn off, it was also found that none of the water had penetrated the FOAMGLAS® insulation.

This meant that for 21 years, even after the leak began, FOAMGLAS® insulation continued to provide constant insulating value. That's because FOAMGLAS® insulation's closed-cell, cellular glass structure totally resists moisture in liquid or vapor form. Other insulating materials do absorb moisture which, in turn, destroys their insulating capability.

FOAMGLAS® insulation specified again.

When it came to selecting insulation for the re-roof, a Tapered FOAMGLAS® Roof Insulation



Tapered FOAMGLAS® Roof Insulation Systems drain water off the roof quickly and eliminate ponding.

System was specified. Now, Beinecke Library's roof provides constant insulating value, plus the Tapered System drains water off the roof fast. This eliminates ponding which was a direct cause of the old roofing system's failure.

For more information contact Marketing Department FB-3, Pittsburgh Corning Corporation. In the U.S.A., 800 Presque Isle Drive, Pittsburgh, PA 15239, Tel: (412) 327-6100. In Canada, 5075 Yonge Street, Willowdale, Ontario M2N 6C6, Tel: (416) 222-8084.

PITTSBURGH
PC
CORNING®
THE INNOVATIVE INSULATION PEOPLE

Circle 1047 on inquiry card

TOP THIS.



AND THIS. AND THIS. AND THIS.

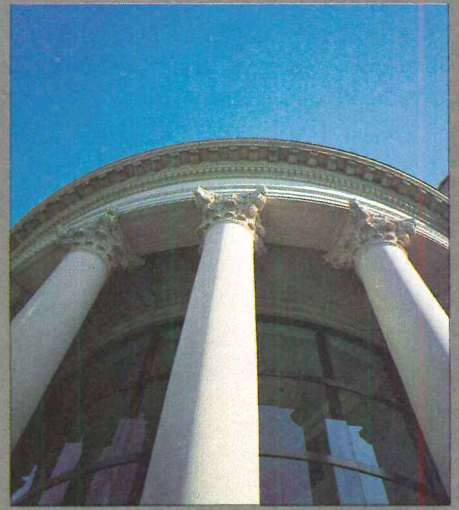
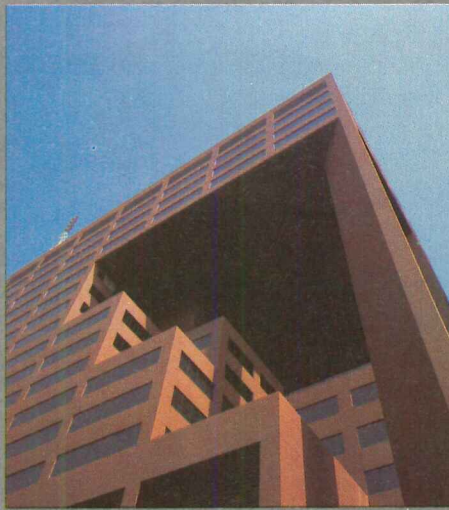
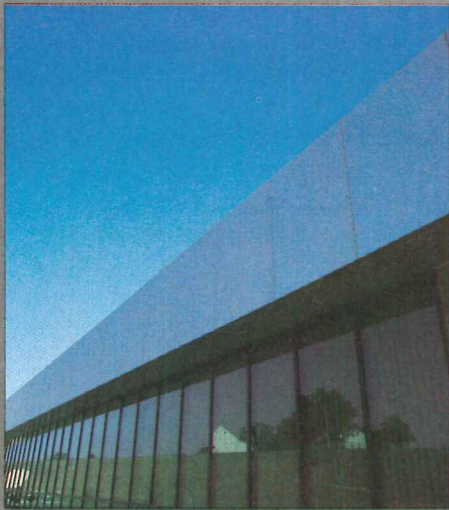

GRACE ROOFING SYSTEMS. VERSATILITY AND PERFORMANCE TO TOP THEM ALL.

From single-ply membranes to high-performance insulation, Grace Roofing Systems provide new dimensions in versatility and the highest standards of performance.

Whether you require a roof for a new state-of-the-art structure or a conventional retrofit, Grace offers an unsurpassed combination of design flexibility and product excellence built on five decades

of specialized research and experience. Grace representatives offer unparalleled technical assistance in selecting and designing a system that's a perfect fit for your roofing needs.

Grace Roofing Systems are meeting the industry's most exacting design requirements and are delivering dependable service under a demanding battery of climates. Backed by some of the

strongest warranties in the field, Grace Roofing Systems are installed by a nationwide network of Grace-approved applicators.

For full facts on how to top them all, call the Sweet's Buyline. Or, dial us directly at (617) 876-1400, ext. 3186. Grace Construction Products, 62 Whittemore Ave., Cambridge, MA 02140.

GRACE
Construction Products

Circle 1048 on inquiry card

"18 years' service and still counting. That's the performance record of single-ply roofing of Hypalon.[®]"

—John Breitenstein, DuPont

"Single-ply roofing membranes of DuPont HYPALON synthetic rubber have been weathering everything under the sun for the past 18 years," says John Breitenstein, Programs Manager. "That's because HYPALON is a high-performance rubber with durability benefits that meet the most demanding roof requirements."

A single-ply membrane of HYPALON is installed quickly and easily. Since it is thermoplastic when put down, seams are as strong and reliable as the membrane. The mem-

brane gradually cures in place to produce an integral, tough, strong elastomeric roofing surface.

Roofing membranes of HYPALON also offer:

- Reflective white color for energy efficiency.
- Resistance to flame propagation.
- Excellent resistance to oils, chemicals and pollutants.
- Excellent resistance to ozone and UV rays.

- Serviceability over a temperature range from -40°C (-40°F) to 93°C (200°F).
- Colorability for a range of aesthetic designs.

Specify HYPALON—made only by DuPont*—for durable, low-maintenance roofing membranes. Call toll free, 800-441-7111, ext. 44, for further information. Or for free literature, write: DuPont Company, Room X-40097, Wilmington, DE 19898.

*DuPont manufactures HYPALON, not single-ply roofing membranes or systems.



Circle 1049 on inquiry card



WAUSAU.

Aluminum
window
& curtain
wall
systems.

Outstanding structural integrity.

On every project, whether it's high rise, small or the unusual, you need a window system you can trust.

At Wausau Metals, we believe structural integrity is so important we go beyond recommended AAMA quality standards. We design window and curtain wall systems for you that will perform beautifully, under the most extreme conditions, years and years after your project is completed.

Our own *certified* test lab, supervised by experts in testing and trouble shooting, maintains these strict standards.

It's another reason why more and more architects across the country are putting their trust in Wausau for high performance window and curtain wall systems.

Look for us in Sweet's to find the Wausau Metals Representative nearest you. Or, call or write us today for assistance in your next window design.

Our solid growth is built on trust.



WAUSAU
Metals Corporation

1415 West Street, P.O. Box 1746 • Wausau, WI 54401

Ph: 715/845-2161

Circle 1050 on inquiry card

Madison Plaza • Chicago, Illinois
Skidmore Owings & Merrill Chicago, Illinois
Window wall and curtain wall by Wausau Metals.



What Do These Prestigious Buildings Have In Common?

FORDHAM UNIVERSITY

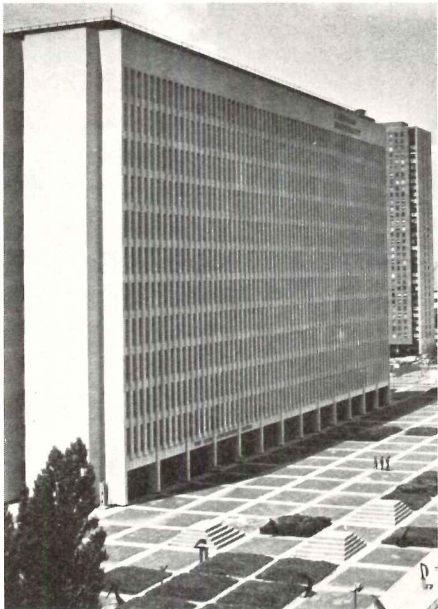

SEALED WITH POLYSULFIDE 1965

*Lincoln Square of Fordham University
New York, NY
Architect: The Perkins & Will Partnership*

CARPENTER CENTER, HARVARD UNIV.

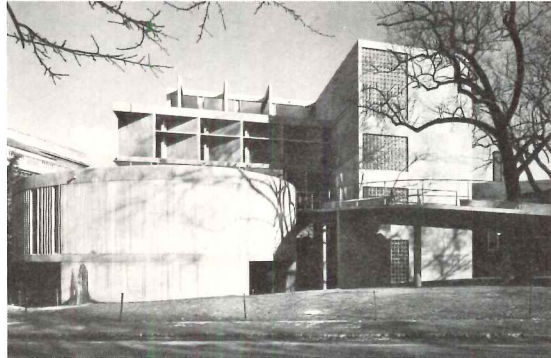

SEALED WITH POLYSULFIDE 1963

*Carpenter Center For The Visual Arts
Harvard University
Cambridge, Massachusetts
Architect: Le Corbusier*

UNITED AIRLINES HEADQUARTERS



SEALED WITH POLYSULFIDE 1966

*United Airlines Headquarters
Libertyville, Illinois*

It all started here...



For more than 30 years, LP Polysulfide base sealants have been effectively sealing curtain against the elements.

Thiokol

To find out about other prestigious buildings that have been sealed for more than 15 years with Morton Thiokol LP polysulfide base sealant, send for your copy of, "It All Started Here".

Morton Thiokol, Inc.
Morton Chemical Division
Mkt. Comm. Dept. AR
101 Carnegie Center
Princeton, NJ 08540

Circle 1051 on inquiry card

Hitchcock Office Park,
Aiken, S.C.

SUREWALL® SBC Insulation System

When you choose the SUREWALL® SBC Insulation System, we want to be sure that everything is done right. After all, we've designed every element of this complete exterior insulation, weather-proofing and finish system to assure that nothing is left to chance. So we thoroughly train applicators from selected plastering contractors to install the system. And, frankly, we don't want an applicator installing our system unless he's certified by the SUREWALL Producers Council.

Our Certified Applicators are skilled at installing the economical SUREWALL SBC Insulation System either on new construction or over almost any kind of surface on a building that's to be renovated and modernized.

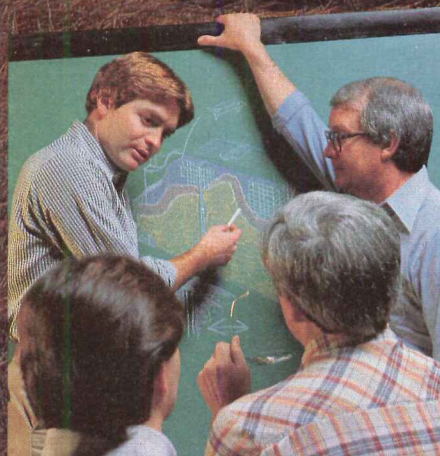

They're experts in the use of every part of our system: SUREWALL® Surface Bonding Cement, Expanded Polystyrene Insulation Board, and the special SUREWALL® Adhesives, Fastening Clip, Joint Reinforcement Tape and Trim Accessories.

In fact, our Certified Applicators are an important reason why we can give you a four-year warranty.

For a brochure explaining the SUREWALL SBC Insulation System, see Sweet's 9.10/Bon or write to the SUREWALL® Producers Council, P.O. Box 241148, Charlotte, N.C. 28224. Or call 704/525-1621.

We'll give you the inside story on outside insulation.

Circle 1052 on inquiry card

OUR CERTIFIED APPLICATORS GIVE YOU THE INSIDE TRACK ON OUTSIDE INSULATION.

Architect: Alexander & Moorman. General Contractor: Morton Construction. Surewall Applicator: Purseley, Inc.

SUREWALL® is a registered trademark of the W. R. Bonsal Company, Charlotte, N.C., and Best Concrete Products Company, Atlanta, Ga.

Member, Exterior Insulation Manufacturers Association (EIMA)



New CertaSpray.[®]

The spray-on fiber glass that lets you insulate up to R-20.

A fiber glass spray insulation for complete design flexibility. Sidewalls on high-rise projects. Ceilings on clear-span structures. Over beams and joists, into cracks, around corners and onto the next area.

CertaSpray[®] has an R-value of R-4 per inch and can be applied up to 5" thick on vertical surfaces, up to 3 1/2" overhead in one application. It covers walls and ceilings completely, without thermal breaks. It's noncombustible and U.L. listed.

CertaSpray's noise reduction characteristics are outstanding: as little as 2" carry the

highest NRC rating. In addition, CertaSpray reflects up to 90% of available light and can help lower lighting requirements.

It won't absorb moisture. It won't corrode pipes. It won't bunch, shift, flake or crack. And it won't disappoint you.

For free information and specifications on new CertaSpray, write CertainTeed, Dept. AR-12, P.O. Box 860, Valley Forge, PA 19482.

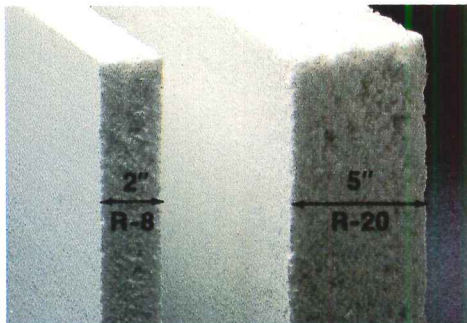

CertaSpray achieves a 4.0 R-value per inch of thickness.

CertainTeed

How is Johns-Manville celebrating 125 years of designing better roofing?

Designer125.

For a century and a quarter, we've been making better roofing. And making roofing better.

Example: Shingles with a self-sealing adhesive strip was a Johns-Manville innovation.

Another: Shingles built with fiber glass for extra long life—and Class A fire resistance—were perfected by Johns-Manville.

And now, to celebrate 125 years of designing better roofing, we introduce Designer125.

Architects tell us that the thing

about Designer125 that strikes the eye right off is the rustic look, the look of slate or wood shakes.

Designer125 affords you the opportunity to give a roof texture and warmth—at a very affordable price.

For the eye appeal of a much more expensive roof, specify Designer125.

Johns-Manville fiber glass roofing shingles are sold exclusively by Manville Building Materials Marketing Division, Box 5108, Denver, CO 80217.

For a full line catalog, see Sweet's General Building and Light Residential files under 7.7/Mam.

For more information, see your local Manville Sales Representative. Or write to Ken Hunter, Merchandising Manager, at the address above.



Johns-Manville

Circle 1054 on inquiry card



Ful-O-Mite™ IDF* the exterior insulation system from H.B. Fuller that sets new performance standards.

Ful-O-Mite IDF is the most beautiful way we know to beat the heat of summer and the chill of winter.

As reported by independent laboratories, Ful-O-Mite™ IDF* is equal to or surpasses leading competitive exterior insulation decorative finishes in all tested areas, including strength and durability.** It withstands impact and has the flexibility to accommodate building movement. The system stands up to airborne pollutants and salt spray.

The Ful-O-Mite IDF exterior insulation system forms a solid barrier against weather's worst; keeping winter's freezing temperatures and summer's scorching heat outside... where they belong, maintaining an interior atmos-



phere which is both comfortable and cost efficient.

Ful-O-Mite is not only beautiful to look at, it offers greater maintenance economy, both in time and material cost.

H.B. Fuller is not only the manufacturer of Ful-O-Mite IDF, we are also the manufacturer of the resin latex raw

material specifically designed for our product. In our finish coat, this latex promotes a tougher, harder cure, increasing the finished product's weather resistance. This same raw material provides a longer "working time" allowing the installing contractor to achieve the texture desired.

Our primer coat of Ful-O-Mite IDF has excellent initial tack, the ability to grab and hold on... eliminating the need for baseboard support when installing the EPS foam board. And, embedding the reinforcing fiberglass mesh is made easier too! Both the primer and finish coats offer freeze/thaw stability in the pail and in their cured states.

At H.B. Fuller, developing our own resin raw materials is just part of our commitment to providing our customers quality, consistency and compatibility within the bonding system.

If you'd like to have all of the facts regarding Ful-O-Mite IDF, write to: H.B. Fuller, Attn: Ful-O-Mite IDF, Department M, 315 South Hicks Road, Palatine, IL 60067 or call (800) 323-7407 or if in Illinois, call (312) 358-9500 and request a free copy of the test results.

*Insulation Decorative Finish
**based on competitive published data

Expanded polystyrene insulation, recommended in 3/4" to 4" thicknesses.

Fiberglass reinforcing mesh for heavy-duty strength.

Unique Ful-O-Mite IDF binder/primer, used to bond the foam to the substrate and embed the fiberglass mesh.

H.B. Fuller® exclusive polymer finish coat, available in a variety of colors and textures to create your own architectural decorative finish.

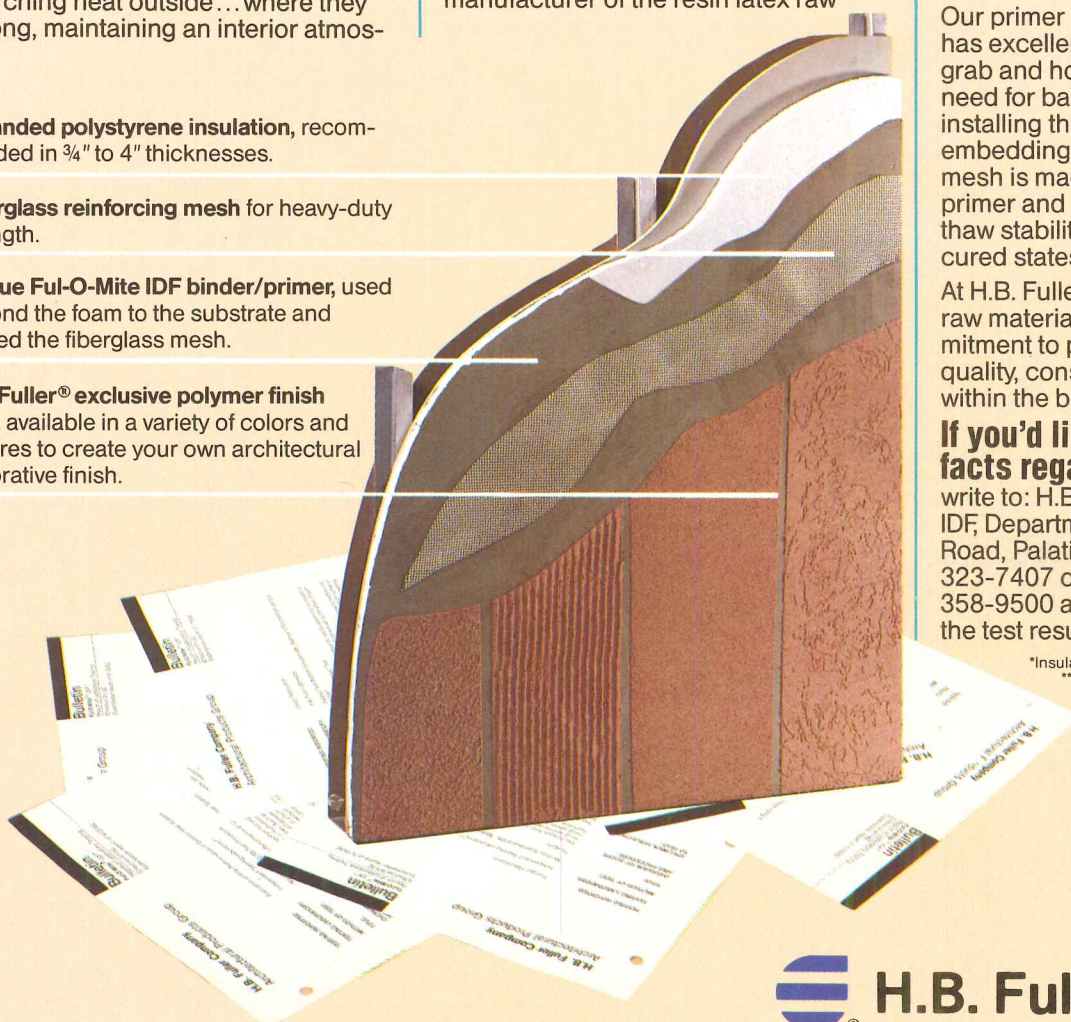

 **H.B. Fuller Company**

8 Doors & Windows

UCI 8, Doors and windows:
Entrances and storefronts
Glazing
Hardware and specialties
Metal doors and frames
Metal windows
Skylights
Special doors
Special windows
Windows/curtain walls
Wood and plastic doors
Wood and plastic windows

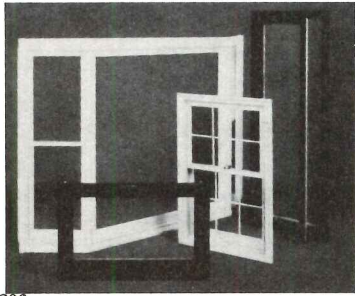

206



209

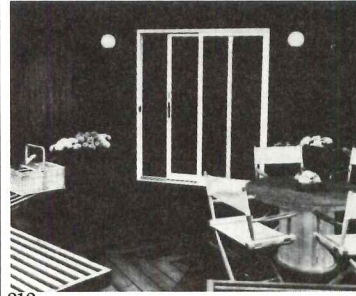

212



215

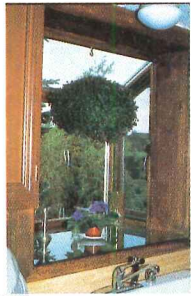

207



210

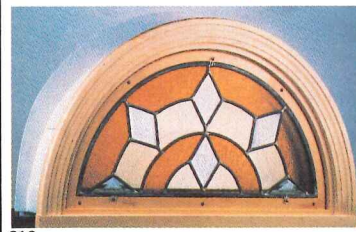

213

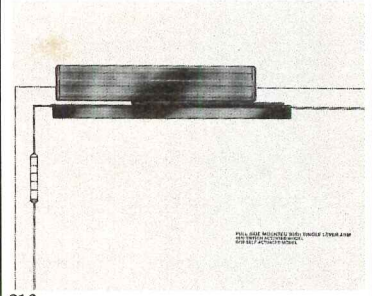

216

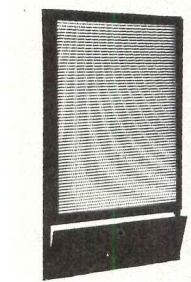

208

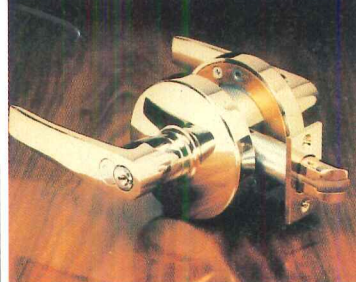

211

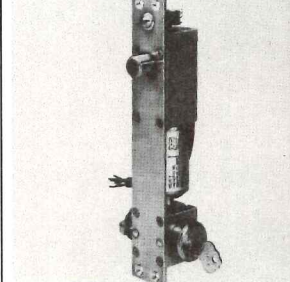

214

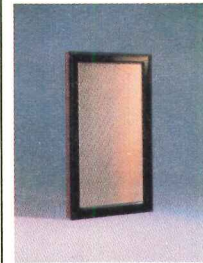

217

206 Wood windows
Regal Ponderosa pine windows include double-hung, casement, awning, stationary and combination models. They feature insulating glass with primary butyl rubber seals and secondary polysulfide seals. Frames come in brown or white. MW Manufacturers, Rocky Mount, VA.

207 Bay window
The sash, frame and seat board of the *Sun Bay* are of Ponderosa pine. The unit comes in bare wood, primed or pre-finished, with double glazing, or single or tripane insulating glass. Other options include interior pre-finishing in walnut, fruitwood, maple or white. Marvin Windows, Warroad, MN.

208 Integral blind windows
Windows with integral blinds feature steel exterior construction and interior aluminum access panels. They have machine-groove-mounted weatherstripping and carry a U value of .41. For ventilation they can be combined with vents. Hope's Architectural Products, Inc., Jamestown, NY.

209 French door
A line of traditional French doors features aluminum-clad wood construction and double-glass insulation. Doors come with both panels swinging inward or with one panel stationary and the other, hinged at the center, operable. Pella Rolscreen Co., Pella, IA.

210 Double-hung windows
Frames and sashes of these windows are clad in .050 aluminum, and windows are claimed to have an air infiltration rate of .12. Optional *Heat Mirror* film gives them an R value of 3.7 and a U value of .27. Sashes tilt in and are removable. Hurd Millwork, Co., Medford, WI.

211 Security bolt lockset
The *700 Series* lever-handle cylindrical lockset works in a 1/2-in. throw latch position and can be extended to a 1-in. bolt position. It is made of cast bronze and stainless steel with internal mechanisms of hardened steel. It fits a 161 cut-out. Corbin Div./Emhart Hardware Group, Berlin, CT.

212 Gliding patio doors
The 5-ft. *Perma-Shield* patio door can be used to replace worn out gliding doors without involving major carpentry. It also can be used for new construction. It is sheathed in rigid vinyl and comes with 1-in. dual pane or triple pane insulating glass. Andersen Corp., Bayport, MN.

213 Half-round windows
Seamless molded polyurethane half-round windows feature either standard wooden grilles or 3 leaded insert options. They come in 2 sizes in brick mold and slimline styles to match double-hung windows as well as in casement styles. Webb Manufacturing, Inc., Conneaut, OH.

214 Electric lock
Factory prewired with crimp connectors, the *1316S* fail secure lock has a 3/4 by 3/4 in. throw automatic deadbolt. A manual override option accepts any standard mortise cylinder and may be released from either or both sides of a door. Security Engineering, Inc., Bristol, CT.

215 Glass wall system
The *Reglit Profile Glass* wall system provides translucent areas without intermediate supporting members. Its glass unit has a channel profile that is available in a number of widths and installation and performance options. Forms & Surfaces, Santa Barbara, CA.

216 Door opener
The pneumatically operated *Auto-Equalizer* is designed to automatically open doors for handicapped users. Doors are held open for up to 30 seconds, and the timing cycle is field adjustable. LCN Closers, Princeton, IL.

217 Reflective blinds
Type E Slimshade blinds feature slats coated with a gold tone that reflects heat. Unlike low-emissivity films, *Slimshades'* tilting slats allow light control. They may be installed between the double panes in this manufacturer's windows and patio doors. Pella Rolscreen Co., Pella, IA.

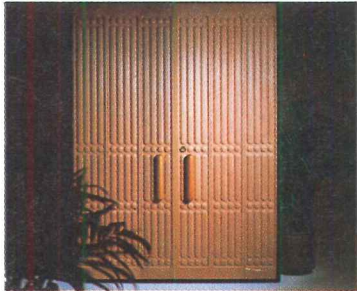

218

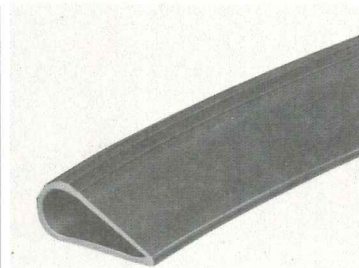

221



224

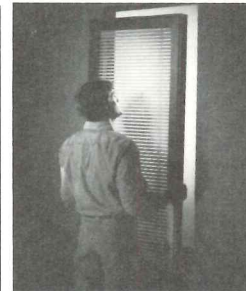

227

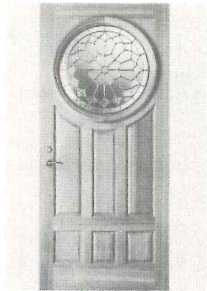

219

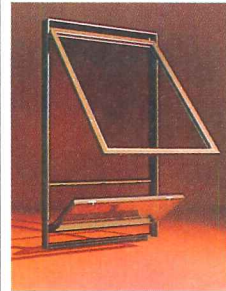

222

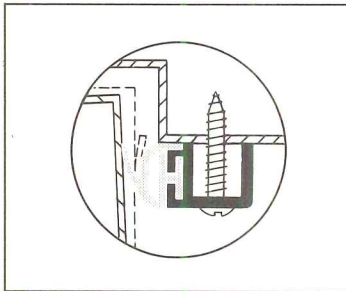

225

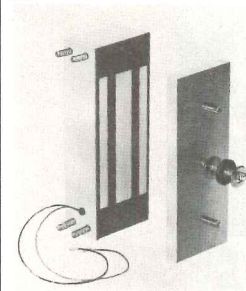

228



220



223



226

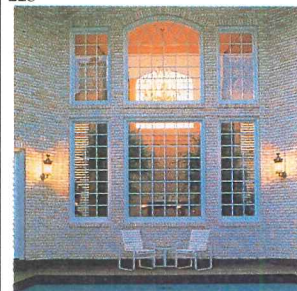

229

218 Carved door panels

Panelcarve A.O.S. panels are designed to convert plain flush doors into carved doors. They may be applied to new doors or doors that are already hung. Panels come in a wide range of designs. Forms & Surfaces, Santa Barbara, CA.

219 Wood door

The *Morning Sun* is made of Western hemlock and features a circular leaded glass inset of clear and feathery glue chip glass. The door is 1 1/4 in. thick and measures 3 ft by 6 ft 8 in. The glass is 25 1/8 in. in diameter. A decorative molding kit is optional. E.A. Nord Co., Everett, WA.

220 Horizontal deadbolts

The *Model 520* has a solid brass barstock single cylinder outside and a Hines 5-pin mechanism and thumb knob inside. The bolt has a 1-in. throw. The steel pin and ring on the cylinder face are designed to prevent drilling. New England Lock & Hardware Co., South Norwalk, CT.

221 Pressure-sensitive gaskets

Double Guard gaskets for application to painted or plain steel, aluminum and wood are UL listed for metal and wood fire door assemblies. They restrict thermal, light and sound infiltration, but do not impair door closure. Stanley Hardware, Div. of The Stanley Works, New Britain, CT.

222 Window series

The *Clad Monumental* window series consists of wood and aluminum commercial windows. Four types of units are available: inswinging casement, hopper, top-hinged inswing and fixed. All units are custom-sized and come with 13 standard glazing options. Pella Rolscreen Co., Pella, IA.

223 Room dividers

Carvedor room dividers feature 6-in.-wide panels that are hinged together and hang from overhead aluminum tracks. Dividers come in heights up to 12 ft, with panels available in oak, walnut, birch and mahogany veneers and plastic laminates. Panelfold, Inc., Miami, FL.

224 Garden window

A window for plants has an aluminum frame with a baked enamel finish as well as a bronze tempered glass top and a plywood floor. Other features include adjustable slatted wood shelves and side vents. Dual glazing and front vents are optional. T.M. Cobb Co., Irvine, CA.

225 Door seal

The #485 *Compress-O-Matic* for door perimeter applications has an elliptically shaped neoprene seal. In addition, the device features a flap that creates a positive seal where uneven surfaces are encountered. Zero International, Inc., Bronx, NY.

226 Interchangeable locks

A new cylinder core, #23-020, is interchangeable with several of this company's cylindrical and mortise locks and deadbolts. It is removed with a control key; a spring-loaded locking pin allows a new core to be inserted by hand without a control key. Schlage Lock Co., San Francisco, CA.

227 Window system

The *Secondary System* installs over existing windows to create double-paned windows with Venetian blinds between panes. Unit frames feature knobs to control the tilt of the blinds and continuous bulb neoprene weather stripping for airtight seals. Nanik, Div. of Wausau Metals Corp., Wausau, WI.

228 Magnetic lock

The *FM 62 Series* of electromagnetic locks features 1,200 lb of holding force. Locks install on door and frame surfaces and allow locking of doors on both sides. Their steel housing accommodates all anodized finishes. Rixson-Firemark Div., Conrac Corp., Franklin Park, IL.

229 Special shape windows

Round Top (shown) and a variety of other special shapes and sizes of windows are available in laminated Ponderosa pine. Windows feature 1/2-in. or 1-in. insulated glass or triple glazing. A starburst or similar design is available with authentic divided lites. Marvin Windows, Warroad, MN.



230



231

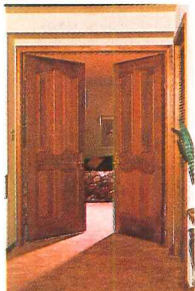

232

230 Lockset

The *900 Series* is a security bolt cylindrical lockset that functions both as a 1/2-in. throw latch and as a 1-in. throw dead bolt. It is made of cast bronze and stainless steel and comes in both straight- and return-lever designs. Russwin Div./Emhart Hardware Group, Berlin, CT.

231 Door system

The *Superfire* door system consists of a 4-ply stile edge for attaching mortised butts and a reinforcement system for attaching surface-mounted hardware. The latter consists of 1 1/16-in. plywood sandwiched between noncombustible material. Algoma Hardwoods, Inc., Algoma, WI.

232 Interior doors

Chateau interior doors are made of vertical grain Douglas fir or Western hemlock. They come in widths of 2 ft 6 in., 2 ft 8 in., and 3 ft. Their standard height is 6 ft 8 in. but 7-ft heights are available on special order. Simpson Timber Co./Door Div., Seattle, WA.

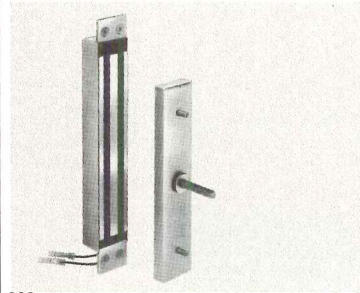

233

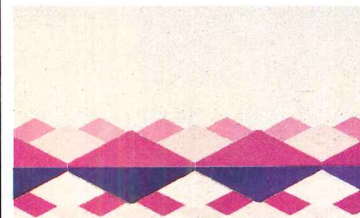

234

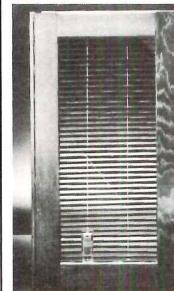

235

233 Electromagnetic lock

The *M3900* lock, less than 1 1/2 in. wide, permits retrofitting without jamb modifications. It has 650 lb of direct holding force and draws less than 1/4 Amp at 12 or 24 Volts. Options include time delay and door and power status reporting. Security Engineering, Inc., Bristol, CT.

234 Stained glass

Stained glass windows, screens, ceilings, etc. are made with a technique that creates an almost invisible bond rather than with leaded bonding, offering flexibility in design and better light penetration. Creative Glassworks Int'l, Inc., Fairfield, IA.

235 Between-glass blinds

This between-glass blinds system features a magnetically controlled tilt mechanism. It fits most double-glazed windows with a minimum dead air space of 3/4-in. Blind slats are available in horizontal or vertical styles and in 5 color combinations. Hunter Douglas, Inc., Owensboro, KY.



236



237

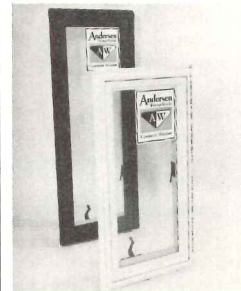

238

236 Replacement windows

The *Nor-clad* line of aluminum clad slide-by windows is sized to replace existing aluminum units without reframing. Designed to be energy efficient, windows are made of wood and aluminum and have aluminum clad frames and sashes. Norco Windows, Inc., Hawkins, WI.

237 Window system

Described as casement/awning/fixed windows, the *Ariel* system features interior components made of clear Ponderosa pine. Exterior components are made of pre-finished tubular aluminum extrusions. Windows come in a variety of sizes. Peachtree Doors, Inc., Norcross, GA.

238 Narrow windows

Windows in 6 different sizes are designed to fit narrow openings, such as in bathrooms, utility rooms or along stairwells. Options include left- or right-hand operation, removable divided light grilles and triple-pane insulating glass. Anderson Corp., Bayport, MN.

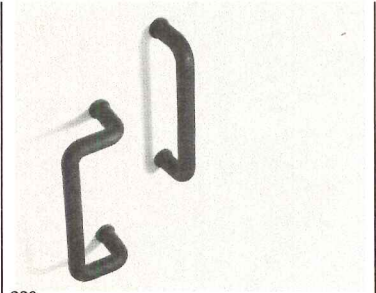

239

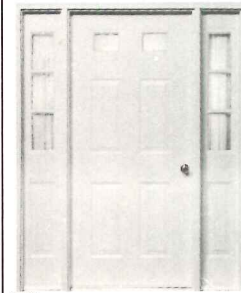

240

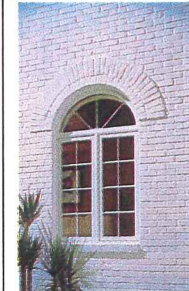

241

239 Doorpulls

HD500 Series doorpulls are made of matte black neoprene molded over a rigid brass core. Straight and offset versions are available; both models come with 9-in. c.c. bolt spacing. Forms & Surfaces, Santa Barbara, CA.

240 Sidelights

Insulated galvanized steel sidelights are pre-formed and pre-painted. To strengthen door/sidelight units, they are installed with 10 heavy-duty steel screws. They come in 12- and 14-in. widths. Benchmark Doors Div., General Products Co., Inc., Fredericksburg, VA.

241 Arch window

The aluminum-clad *Circlehead* window uses 3/4-in. of insulating glass. Its frame fits standard 4 1/2-in. wall construction without requiring curved extension molds. Snap-out wood windowpane dividers are optional. Pella Rolscreen Co., Pella, IA.

8 Doors & Windows Product literature

For more information
write item numbers on
Reader Service Cards



242 Rolling doors
A 28-page catalog contains details and specifications for rolling service doors, fire doors, shutters and grilles. An insulated series of rolling doors called *Enermaster* is included. Photos show typical installations. Motor operators are also shown and described. Atlas Door Corp., Edison, NJ.



248 Windows and patio doors
A 16-page brochure features extruded aluminum cladding over wood for residential and light commercial windows and patio doors. Auxiliary frames for trapezoids, octagons and 1/4 and 1/2 circle windows are included. Sizes are listed. Eagle Manufacturing Co., Dubuque, IA.

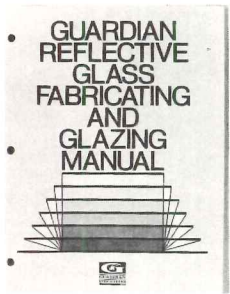

243 Reflective glass
A 10-page manual covers the fabrication and glazing of this manufacturer's reflective glass. The reflective coating process, available coatings and product types are discussed. Fabricating, glazing, care and cleaning, and inspection guidelines are given. Guardian Industries Corp., Carleton, MI.



249 Curtain walls
Photos and details of the *Ferrowall* system are covered in a color brochure. The system combines a non-combustible, insulated assembly with standard or silicone glazing. Panels come in custom colors of smooth or textured porcelain enamel on steel. Ferro Enameling Co., Oakland, CA.

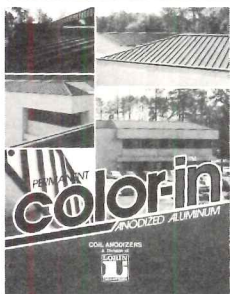

244 Pre-anodized aluminum
A 4-page color brochure features *Color-in* permanent bronze pre-anodized aluminum. Several installations are shown in photos, and the process of making this product is contrasted with other types of anodizing. Allmetal, Inc., Bensenville, IL.

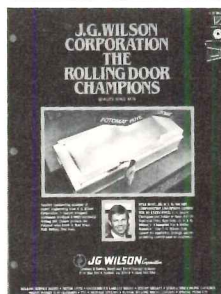

250 Rolling doors and grilles
Horizontal and vertical rolling doors and grilles are featured in a 24-page brochure. Details and technical backup charts and text are included for each model. Pass window units and small rolling-front storage containers are also shown and described. The J.G. Wilson Corp., Norfolk, VA.

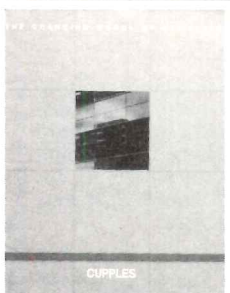

245 Curtain walls
A 20-page color brochure highlights the use of stainless steel as an element or as an accent in aluminum curtain walls. Several case studies of buildings around the country include photos and details of curtain wall installations. Cupples Products Div., H.H. Robertson Co., St. Louis, MO.

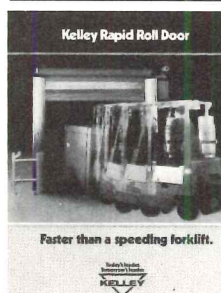

251 Roll doors
A 6-page color foldout brochure features rolling doors for loading dock applications claimed to reduce energy losses and forklift damage by opening and closing in just 8 seconds. Photos and specifications are included. Kelley Co., Inc., Milwaukee, WI.



246 Thermal windows
A 1983 catalog covers aluminum windows with built-in blinds. Photos and line drawings illustrate each series. Section details, tables listing performance data and specifications are included. DISCO Aluminum Products Co., Inc., Div. of Circle S Industries, Inc., Selma, AL.

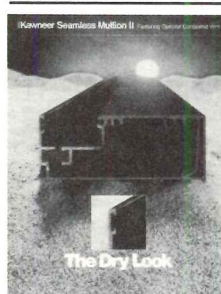

252 Mullions
The *Seamless Mullion II* with an optional concealed vent and a U value of .60 is described and illustrated in a 4-page color brochure. Photos show installations, and details show various mullion features. Kawneer Co., Niles, MI.

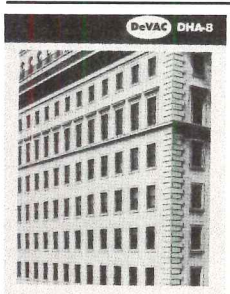

247 Replacement windows
Thermal windows, which may be custom fit to replace windows in old buildings, are described and illustrated in a 4-page brochure. Performance data and section details are included. DeVAC, Inc., Minneapolis, MN.



253 Patio door
The *Solarium Door*, made of Western Hemlock with a solid oak sill, is featured in a 6-page color foldout brochure. Photos show door hardware, typical installations and installation procedures. Specifications include details of door components. E.A. Nord Co., Everett, WA.

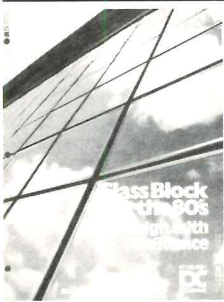

254 Glass block
Interior and exterior curved and straight installations of glass block are shown in a 16-page color brochure. Several types, including a solar reflective series, are shown and described. Physical properties and accessories are also included. Pittsburgh Corning Corp., Pittsburgh, PA.

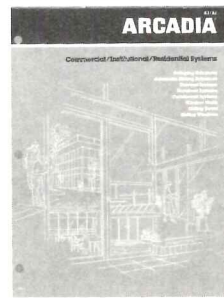

260 Glass entrances
Arcadia swinging and sliding doors, storefronts, window walls and curtain walls are illustrated and described in a 28-page catalog. Photos of installations and section details are included with specifications. H.H. Robertson Co., Western Architectural Systems Div., City of Industry, CA.

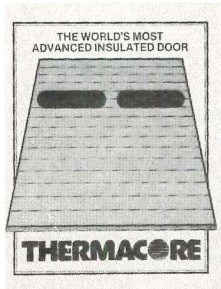

255 Insulated doors
Thermacore industrial doors are featured in a 20-page brochure. Details and diagrams show door composition, the seal system and balancing as well as roller and corner brackets, end caps, locks and trussing. Track systems for different headrooms are diagrammed. Insoport Industries, Inc., Williamsport, PA.

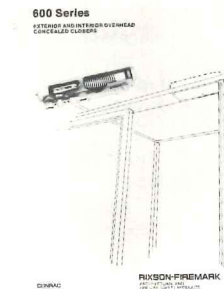

261 Concealed closers
The *600 Series* of exterior and interior overhead concealed closers is covered in a new brochure. As described, they are designed for medium-traffic doors weighing up to 200 lb and fit 1 3/4-in. by 4-in. aluminum frames. The brochure lists optional accessories. Rixson-Firemark Div., Conrac Corp., Franklin Park, IL.

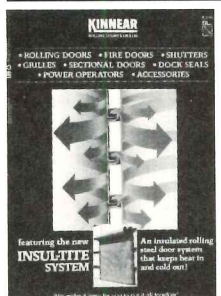

256 Rolling doors
Rolling doors, fire doors, shutters and grilles are featured in a 24-page catalog. Diagrams and details illustrate door and grille construction and mounting. Power operators are also illustrated and described. Suggested specifications are included. Kinnear, Div. of Harsco Corp., Columbus, OH.

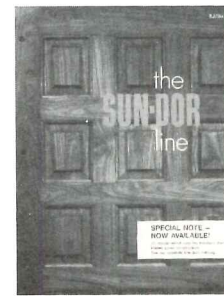

262 Doors
A line of hardwood doors and sidelights is featured in a 16-page color booklet. Photos show several installations. A selection guide illustrates a wide variety of available designs both with and without windows. Details showing basic door sections and specifications are included. Sun-Dor-Co, Wichita, KS.

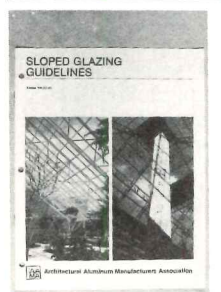

257 Sloped glazing
Guidelines for sloped glazing are described in an 8-page brochure. Among the aspects covered are design and performance considerations, glass and plastics. Architectural Aluminum Manufacturers Association, Chicago, IL.

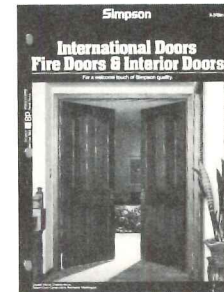

263 Carved wood doors
Carved entry doors and bifolds made of Douglas fir or Western hemlock are featured in a 4-page color brochure. Also covered is the *Centurion* series of 20-min fire-rated wood doors. Standard sizes and grades are listed and available panel designs are shown. Simpson Timber Co./Door Div., Seattle, WA.

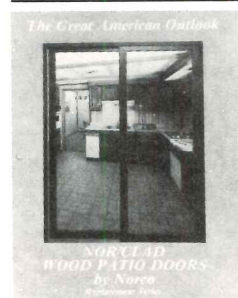

258 Wood patio doors
A cut-away drawing highlights the components of *Norclad* patio doors in a 4-page color brochure. Elements, such as aluminum extruded frame exteriors and wood interiors are described and shown again in close-up photos. Diagrams showing available sizes and details are included. Norco Windows, Inc., Hawkins, WI.

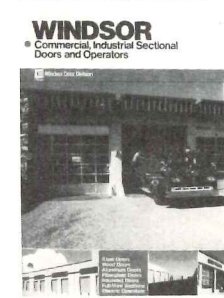

264 Sectional doors
Upward-acting sectional doors and operators for commercial and industrial applications are featured in a 20-page catalog. Insulated steel and combination doors are included, as well as special designs with removable posts for clear span applications. Windsor Door, Div. of The Ceco Corp., Little Rock, AR.

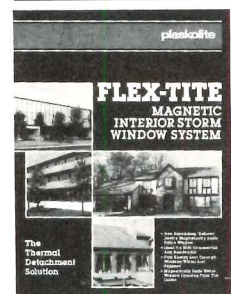

259 Magnetic storm windows
Flex-Tite magnetic interior storm windows are illustrated and described in a 4-page color brochure. Section details show installations on flat and contoured moldings as well as window system components. U values and specifications are listed. Plaskolite, Inc., Commercial Div., Columbus, OH.



265 Glass curtain wall
A packet of literature features *GlasWal*, a vertical low-rise glass curtain wall, which requires no exposed metal framing. Design techniques are described. An elevation and section details of a base, joint, head and typical patch as well as specifications are included. W&W Glass Products, Ltd., Spring Valley, NY.

For more information
write item numbers on
Reader Service Cards



CURTAIN WALLS BY INRYCO

266 Curtain walls
Exterior steel panels in 16 varieties are part of a curtain wall system, based on a steel stud framework, which is featured in an 8-page color brochure. Photos show several installations. Technical data and applications are described. Inryco, Inc., Milwaukee, WI.

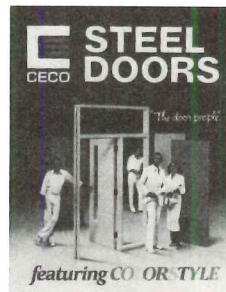

featuring CO OR-TYLE

272 Steel doors
This manufacturer's line of commercial steel doors, including fire doors, is featured in a 32-page color catalog. Sections on doors, frames, hardware and an applications chart are included. All doors are available in 13 baked enamel colors. The Ceco Corp., Oak Brook, IL.

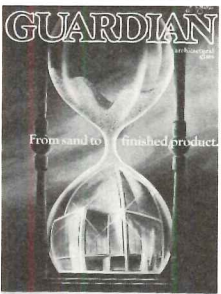

267 Glass
Float, reflective, insulating, safety and acoustical glass are featured in a 24-page color brochure. Photos showing installations and tables of performance data and sizes are included. Glazing details and sloped glazing applications are described. Specifications are included. Guardian Industries Corp., Carleton, MI.

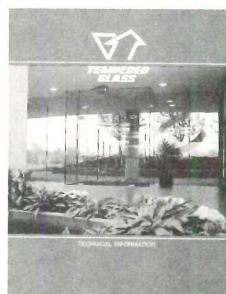

273 Tempered glass
The manufacturing process, uses—including sloped glazing and skylights—and installation of tempered glass are described in an 8-page color brochure. Photos show residential and commercial applications. Reference materials and specifications are listed. Glass Tempering Association, Topeka, KS.

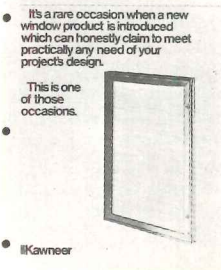

268 Casement window systems
Thermal casement windows with options of built-in blinds, locks and limited opening for ventilation are featured in a 6-page color brochure. Photos, section details and charts of thermal and acoustical performance are included. Kawneer Co., Niles, MI.

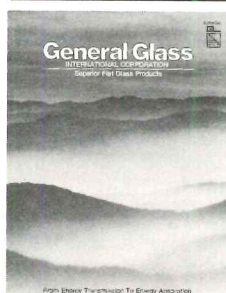

274 Flat glass
Installations of *Solakleer* passive solar glass and *Bronze Glass* for solar control are shown in an 8-page color brochure. Tables list technical data and charts show performance comparisons to other glazing systems. Applications are described. General Glass International Corp., New Rochelle, NY.

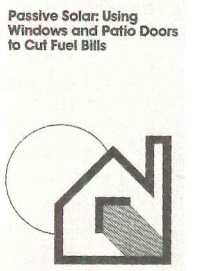

269 Passive solar design
A 16-page brochure tells how to use windows and patio doors in passive solar design. Diagrams and charts illustrate sections on choosing materials and collecting, controlling and storing solar energy. National Woodwork Manufacturers Association, Park Ridge, IL.



275 Laminated glass
A 1984 brochure covers this manufacturer's laminated and insulated glass products. The brochure includes solar energy performance data and information on beveling and mitering. Globe Amerada Glass Co., Elk Grove Village, IL.



270 Push-button locks
A product data sheet features typical installations and details with dimensions accompany installation data. Simplex Security Systems, Inc., Collinsville, CT.



276 Sliding glass doors
Windbreaker doors for high-rise commercial buildings, designed to withstand hurricane-force winds, are featured in a 6-page color foldout brochure. Photos show typical installations. Specifications and section details are included. Howmet Aluminum Corp., Architectural Products Div., Terrell, TX.



271 Entrance hardware
Brightly colored mail slots, door bell buttons, numerals, door pulls and levers, all made of nylon, are featured in a 6-page color foldout brochure. Products are shown in photos and in details with dimensions. Hewi, Inc., Allendale, NJ.

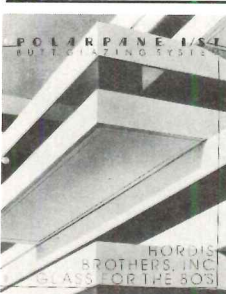

277 Butt glazing system
The *Polarpane I/ST* system, designed for structures using insulating glass units, is described in a new brochure. The system can be installed around outside or inside corners of any angle and needs no interior vertical supports. Hordis Brothers, Inc., Pennsauken, NJ.

Glass-terpiece

The beautiful new Collin Creek mall in Dallas' suburban Plano area is another evidence of Naturalite's expertise in glass skylights.

The 28,000 square foot system of Lean-To and Structural Pyramid skylights was designed and installed by Naturalite in less than four months and utilizes energy-conserving mirrored glass. The fast-track installation was delivered on budget and on time. The mall was opened in mid-1981. Federated Realty, Cincinnati, is the owner-

builder-developer. General contractor, Walker Const. Company, Fort Worth, Tx. Architects, R.T.K.L. Associates, Inc., Baltimore.

Whatever your design calls for, Naturalite can execute it beautifully in acrylic, glass or polycarbonates. And, we are equipped to install larger custom applications almost anywhere.

See Sweets insert 7.8/Na or contact the factory. Naturalite, America's largest skylight company. Your single source for skylights.



NATURALITE, INC.

3233 West Kingsley Road, Garland, TX 75040
For information call: Jim Wozniak, VP Arch. Design
(Toll Free) 1-800-527-4018

Circle 1056 on inquiry card



Hi-Hatch

AN IDEAL CEILING INSPECTION HATCH



To provide a safe and comfortable environment, modern buildings hide their critical building equipment and facilities in the ceiling. Wiring, heating and cooling ducts, sprinklers, water pipes and gas lines are only some of the building services that require periodic inspection and sufficient access for maintenance where necessary. Hi-Hatch is an easy and efficient access for behind the ceiling inspections. Keeps the ceiling free from damage and soiling.

Hi-Hatch's many features:

- Good for all type of ceilings and match any ceiling materials.
- Easy installation in new and old buildings.
- No damage and soiling to the ceiling from repeated inspections.
- Easy and smooth opening and closing of hatch.
- Aluminum alloy extrusion with white and dark brown coating.

Hi-Hatch is the solution to the inspection problems in servicing behind the ceiling.

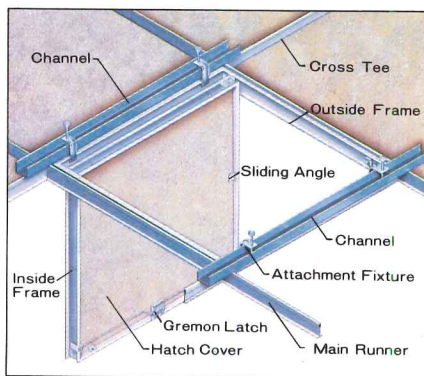

Airtight types

Model	Frame Size	
C-24	24" x 24"	605 x 605mm
O-24	24" x 24"	605 x 605mm
D-22	22" x 22"	552 x 552mm

Standard types

Model	Frame Size	
SD-12	12" x 12"	303 x 303mm
SD-18	18" x 18"	454 x 454mm
SD-24	24" x 24"	606 x 606mm
OP-24	24" x 24"	600 x 600mm

Los Angeles office:
 11272 Washington Place, Culver City, California 90230
 Telephone (213) 390-9771
TOLL FREE: 800-421-9977, 800-352-8211 (California)



New York office:
 230 Park Avenue, Suite 1426 New York, New York 10169
 Telephone (212) 697-8551

Circle 1057 on inquiry card

Sargent Mortise Locks:
7700 Line • 8100 Line

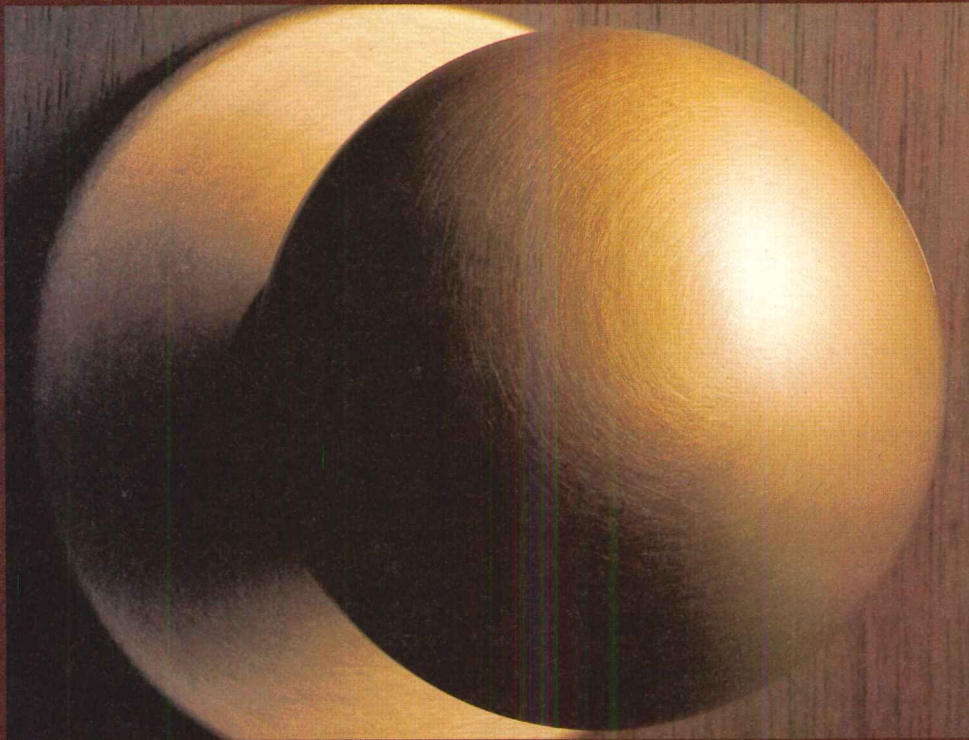

**At Sargent,
attention to design
comes naturally.**

Beauty joins form and function in nature to create perfection. So it is with Sargent, where designers work closely with craftsmen to please the eye and provide the protection, performance and durability you demand.

Proof: Sargent Mortise Locks enhance both the design and security of any door. Small wonder they've been the first choice of generations of architects (and specifiers) for aesthetics and peace-of-mind.

Look to Sargent, where attention to design is second nature.

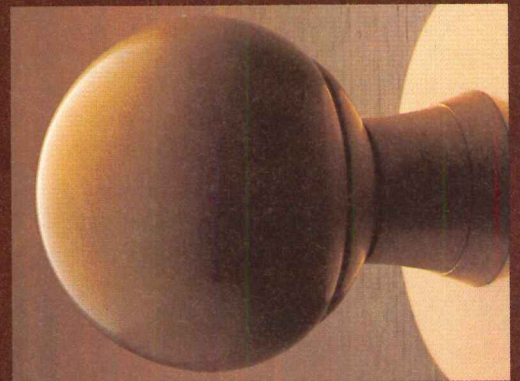
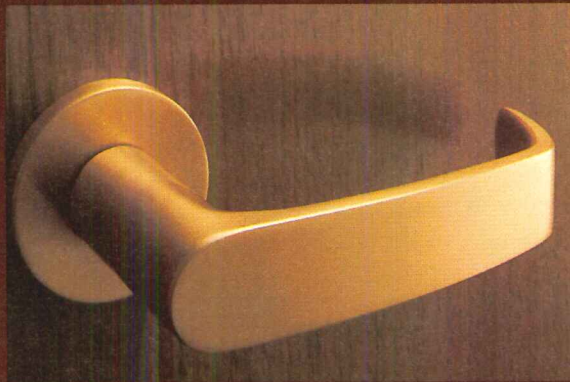

SARGENT

Division of Kidde Inc.

KIDDE

Sargent, New Haven, Connecticut 06511
Sargent (Canada)

Circle 1058 on inquiry card



Washington D.C.'s Crystal City residential and commercial complex was designed by Weihe, Black, Jeffries, Strassman & Dove of Washington D.C., and is managed by Charles E. Smith Building Corporation

How Laminated Glass handles noisy neighbors at Crystal City.

To keep noisy neighbors like cars, trains—and 150 jet takeoffs from nearby Washington D.C. National Airport—from disturbing Crystal City tenants, laminated glass with a Saflex® polyvinyl butyral



interlayer by Monsanto was the ideal, cost-efficient solution.

The Saflex interlayer is only 0.030-inch thick—but it is the key sound-reducing component, thanks

to its acoustical damping characteristics. In fact, laminated glass alone stops noise more effectively than monolithic or air-spaced glass. And using laminated glass in an insulated, air-spaced configuration, further improves acoustical and thermal performance.

Tests identified peak dBA levels of 76-79 at Crystal City. Design criteria called for an STC performance of 37-40. The final configuration for 55,000 sq. ft. of windows is detailed in the illustration:

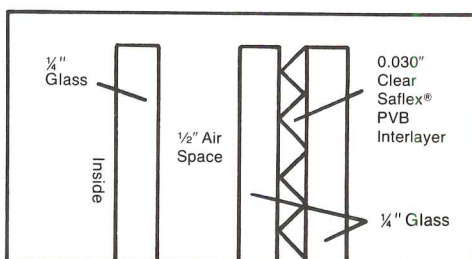

And laminated glass was more cost-efficient than other sound control glass configurations. According to J. Scott Ogden, vice president of Charles E. Smith Building Corporation, "We found that laminated glass was the most cost-effective way to solve the sound problem. We got the best design at an economical cost and solved the problem without overkill!"

So, while the jets and trains haul people all over the world, Crystal City tenants can enjoy a peaceful, quiet world of their own.

If you need to quiet noisy neighbors too, write us for a list of suppliers. Monsanto Polymer Products Company, Dept. 804, 800 N. Lindbergh Blvd., St. Louis, Missouri 63167.

SAFLEX®

PLASTIC INTERLAYER BY **Monsanto**

THE STANDARD BY WHICH OTHERS ARE MEASURED.

Reliable Benchmark Secura-Fit™ Remodeling Door and Frame

The Golden Gate—since 1937 the ultimate in engineering reliability. The bridge, with its imposing steel towers, remains incomparable in the magnificence of its setting.

Benchmark has engineered this same reliability into the Secura-Fit™ door and frame system. The remodeling unit has fast become the distinctive new entryway for thousands of homes. Secura-Fit is pre-hung in its steel door frame and is ready to slip into the entrance, where it beautifully engages itself in enhancing the surroundings.

Secura-Fit also has the steel-to-steel security homeowners want and need today. Full weatherstripping and insulation. And a wide variety of deep-embossed patterns to complement home styles.

Design all your entryways to include the reliable qualities of the Secura-Fit system—the standard by which others are measured.



Benchmark™

General Products Company, Inc.
P.O. Box 7387, Fredericksburg, VA 22404
Phone 703/898-5700 • Telex 827-468

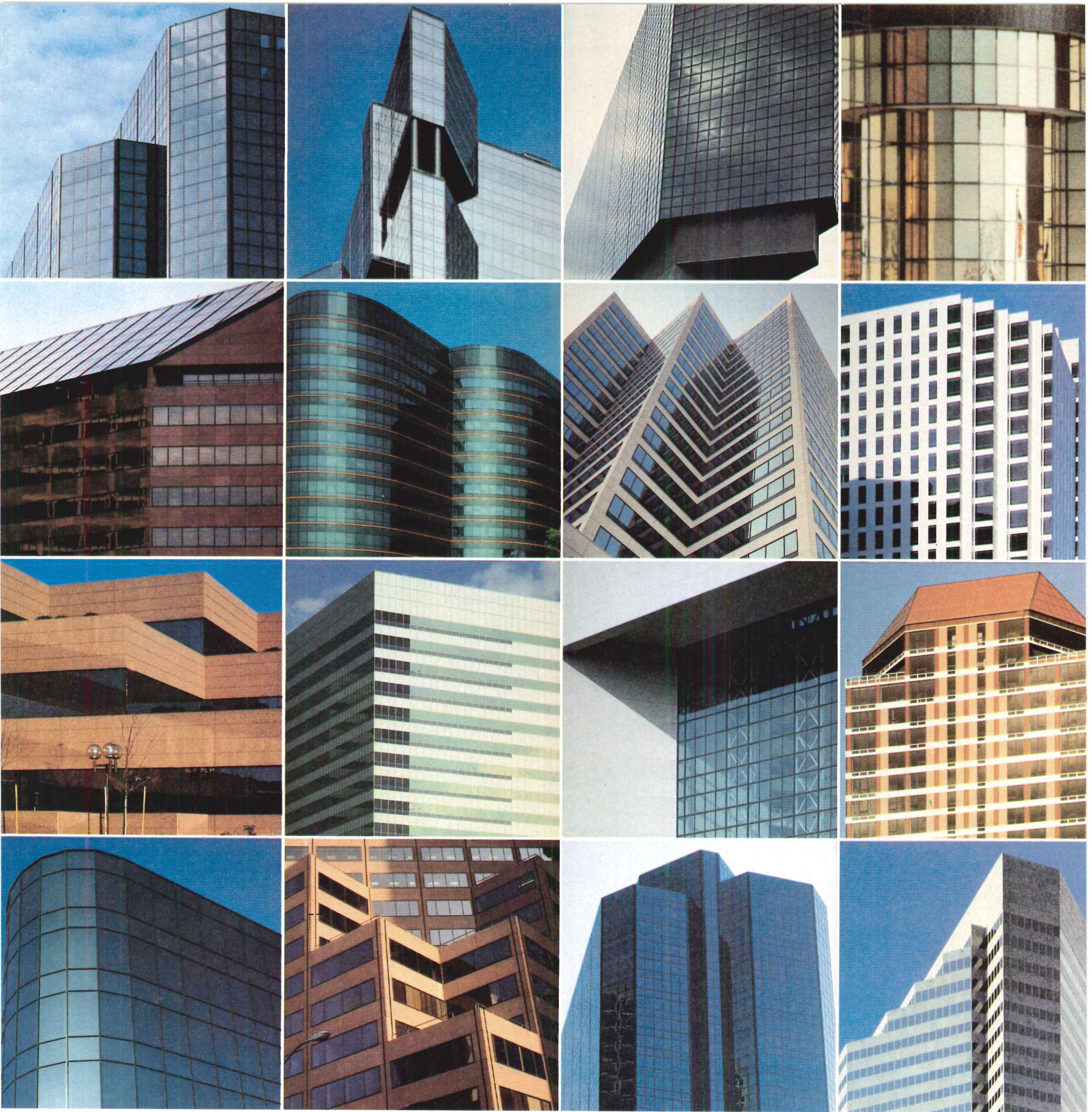

The right glass. Right to



In the success of a new commercial building, the glass can carry as much weight as the foundation.

Of course, the successful buildings you see here do far more than please the eye. They've had to please architects, owners, contractors and tenants alike.

The right glass company can give you the edge on every count, too. And PPG does. Starting with your initial contact with our architectural representatives.

Unlike most suppliers, PPG's approach to commercial construction isn't just product-oriented. It's project-oriented. And dependable. From the moment you ask our representative for a computer analysis of your preliminary specifications until long after the building is complete, you have a responsive team on your side with unmatched experience in doing things right.

Experience in beginning-to-end service that enhances the value of our glass significantly. From field experience to experience in the details of technical service, quality assurance, and new product development that's made PPG the world's leading glass supplier.

We can help build your success, too. For details on the right glass, see Sweet's 8.26a/Pp. For the right support, contact your PPG architectural representative. And for details on the successful buildings shown here, write: "Building Details," PPG Industries, Inc., Glass Advertising, One PPG Place, Pittsburgh, PA 15272.

You'll get what you want right away.

Circle 1061 on inquiry card



The right support. the last detail.

Hurd has a *new* energy edge.

**Heat
Mirror™**

Hurd is the first wood window to offer the incredible energy benefits of Heat Mirror™ film. This amazing, space age material makes the Hurd window line—already known for the highest quality construction—even better. Performance that no one else matches. That's the Hurd profit edge.

Extruded Aluminum Cladding

Hurd encases the exterior of the frame *and* sash with the heaviest, most weather-resistant cladding on the market. Where some use light roll-form, vinyl, or even paint—Hurd takes no shortcuts. We use extrusions—the very best.

Real Wood Beauty

Hurd natural wood interior offers excellent thermal benefits and a choice of decorating options. Again, no shortcuts. We use only the finest, select pine.

**We're the
wood window
with a profit edge
in the middle.**



Hurd Millwork Company
Medford, Wisconsin 54451

Transparent insulation

The remarkable, 2 mil thick sheet of colorless, Heat Mirror™ film we suspend and seal between two panes of insulating glass boosts the R-Value to more than double the 2.0 average achieved by most windows.

Why? Because Heat Mirror™ selectively reflects 85% of the radiant heat trying to pass through the window—keeping the inside glass surface nearly the same temperature as the room air.

Heat Mirror™ never stops working. Day or night, winter or summer, it continually offers the ultimate window insulation. Clearly.

- **Saves Energy** (cuts waste by 50%)
- **Weights Less** than Triple Pane
- **Pays Back Faster** than any other home or building insulation improvement

Call us. We'll be glad to show you the full story.
715-748-2011.

Don't let drafty doors waste energy dollars

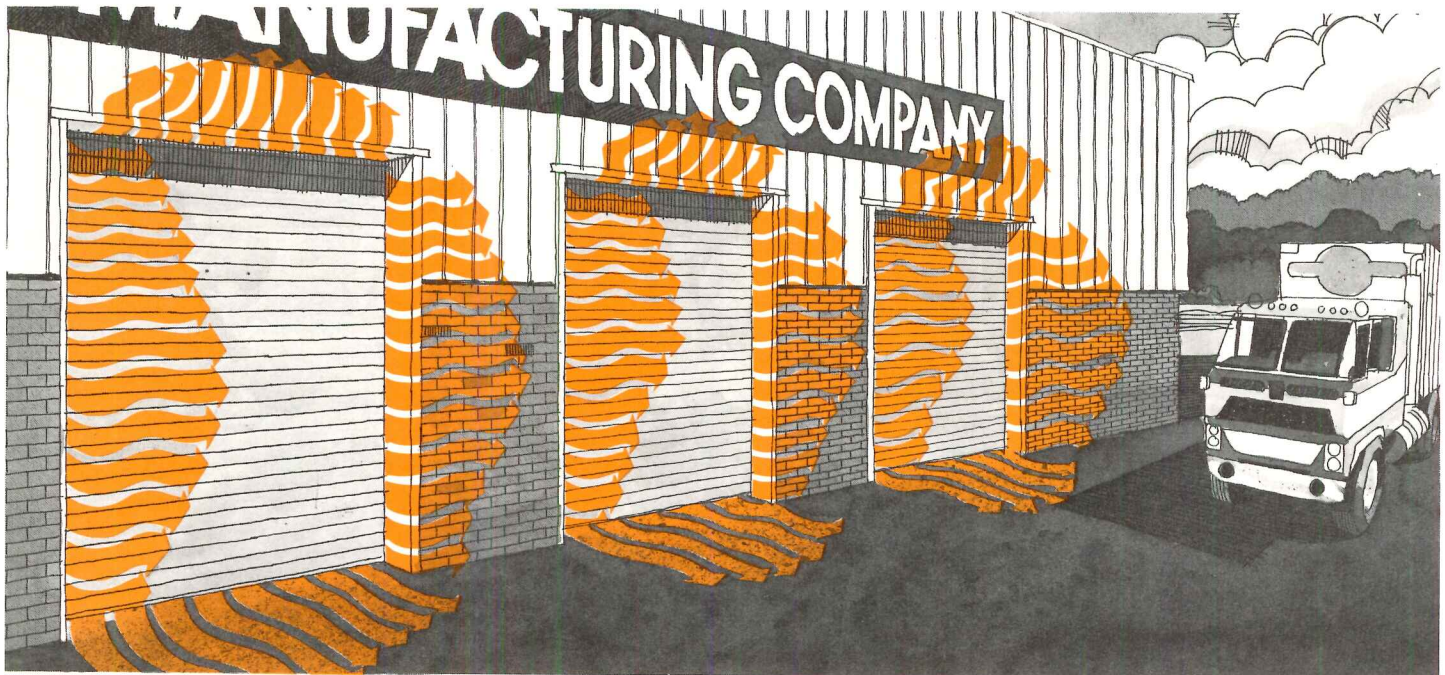

The Inryco[®] Telescoping Door reduces air leakage for long range savings!

Air infiltration through vehicle door perimeters wastes energy — can add hundreds of dollars per door per year to a building's operating costs.

The Inryco Telescoping Door reduces such waste dramatically. Tested at 1.56psf air pressure (25mph wind) it achieved an infiltration rate of only 0.93cfm per foot of perimeter. Calculated rates for most other doors are at least three to six times higher. That translates into substantial life cycle savings.

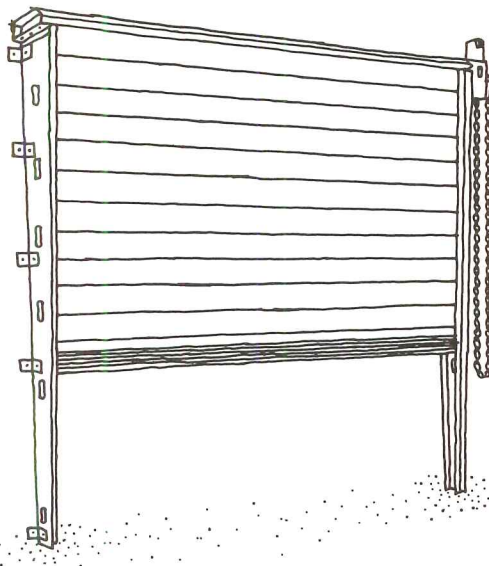

Check the Inryco Telescoping Door before you specify. In addition to energy conservation, its unique design provides high cycle usage, offers long term maintenance savings, reduces down time and curtails noise.

For full details, see our Catalog 36-1 in Sweet's, section 8.8/In, or write for a copy: Special Products Group — Milcor Division; INRYCO, Inc.; Dept. M-4033; P.O. Box 393; Milwaukee, WI 53201.

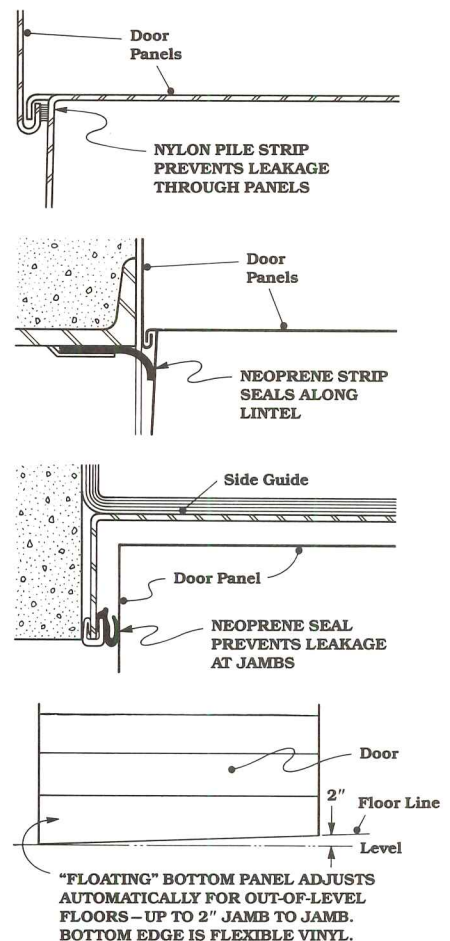

Inryco
an Inland Steel company

Thank goodness this ad only runs once a year.

We'd rather be telling you about the many time, money and fuel saving features of Andersen® windows, roof windows and gliding patio doors.

But our lawyer advises us that once a year, in your best interest as well as ours, we run an ad about the Andersen® and Windowalls® trademarks.

You see, they've been our signs of quality for many years and some companies may try to trade on them.

By either incorporating part of our trademarks with theirs or perhaps just by spelling them a little differently.

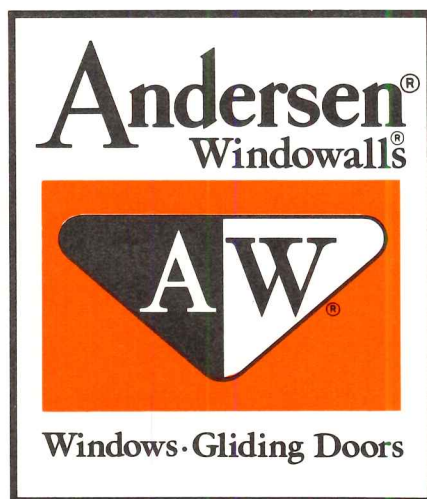

And from your standpoint that can be very misleading.

Our trademarks shouldn't be used for anything other than identifying our products. Because only Andersen makes Windowalls® brand windows, roof windows and gliding patio doors.

So look for the Andersen® and Windowalls® trademarks, remember Andersen is spelled with an "sen" and we'll return you to our regular schedule of product advertising. Thank you. Andersen Corp., Bayport, MN 55003.

Andersen®, Windowalls®, the AW triangle, Perma-Shield®, Only the Rich Can Afford Poor Windows® and Come home to quality. Come home to Andersen® are some of the registered trademarks of Andersen Corporation.

83141 Copyright © 1983 Andersen Corp., Bayport, MN.

Circle 1064 on inquiry card

Provide positive protection against fire and smoke with LCN Sentronic[®]

Containing fire and smoke within a limited area is one of the most effective ways of minimizing danger to life and property. The capability to do this is absolutely essential in hospitals, nursing homes, schools and other public buildings.

The LCN line of Sentronic Closer/holders for fire and smoke barrier doors provides a key part of this containment capability. Sentronics are designed to control doors and to close them automatically when and if fire strikes.

For technical details, write for our Sentronic brochure, or see LCN Sentronics in Sweets section 8.

LCN Closers,
Princeton, IL 61356.
LCN Canada,
Mississauga, Ontario,
L5G 4L5.



MED series closer/holder has unlimited hold-open positions and a built-in detector. Modular design for ease of maintenance and field modification.

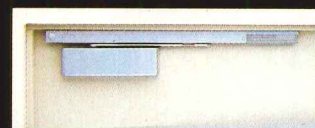

SED series closer-holder has adjustable single point hold-open and a built-in detector. SED models mount on the hinge face or stop face.

LCN CLOSERS

Part of worldwide Ingersoll-Rand
Circle 1065 on inquiry card

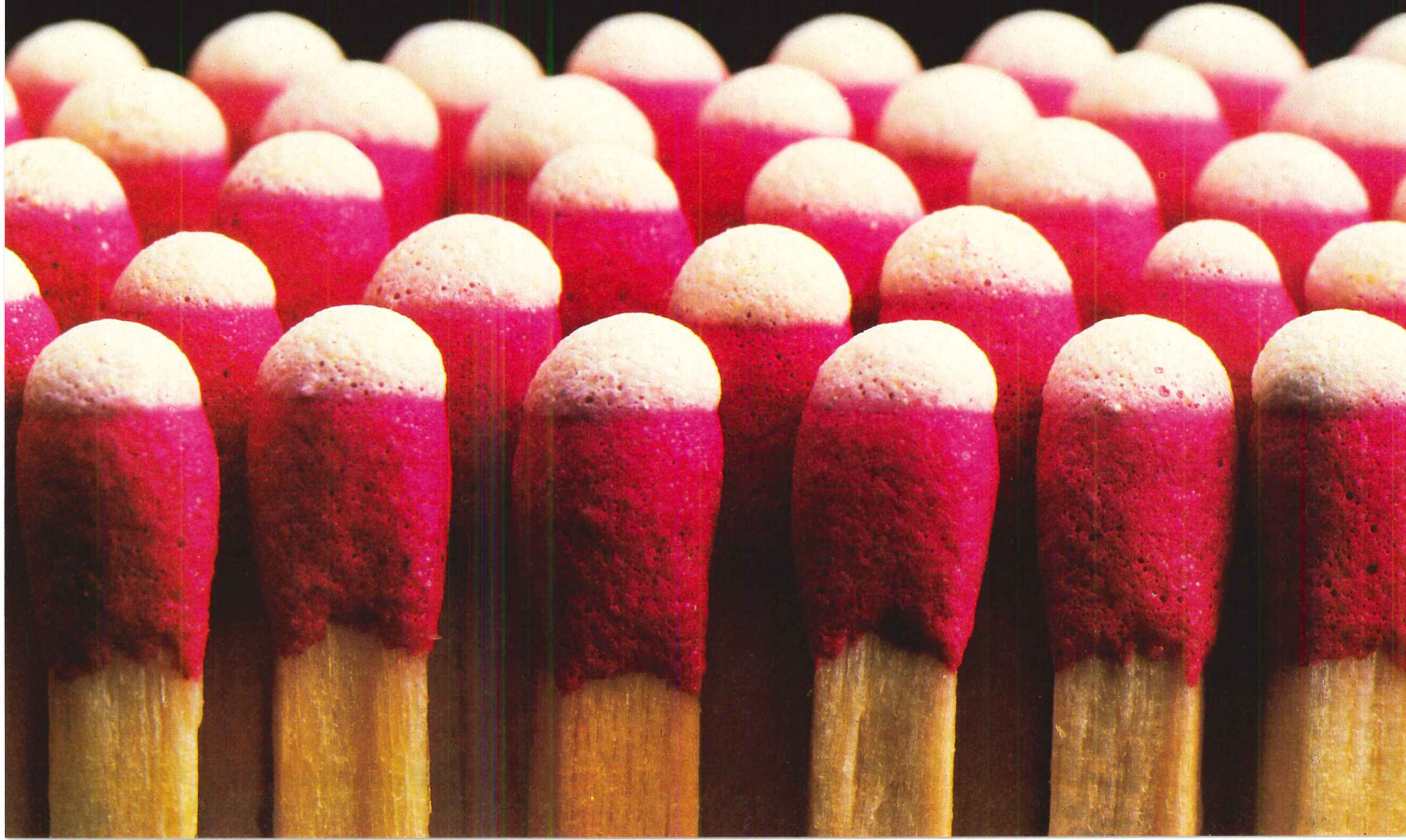

SEARS ROEBUCK DISTRIBUTION CENTER, CHICAGO, ILLINOIS

*Architect: A. Epstein & Sons, Chicago, Illinois
Construction Manager: Schal & Associates, Chicago, Illinois*

Because the Sears Roebuck Company insists that only the best available construction products be specified for their own building — they chose Raynor S-24 Steel Doors for their new Chicago Distribution Center.

Why? Because the construction team responsible for the building reviewed and tested all the alternatives . . . and decided on Raynor. The next time you're looking for a top quality door, large or small, look to Raynor.

For complete information on industrial/commercial doors, call the local factory trained Authorized Raynor Distributor nearest you. You will find their number in the Yellow Pages under DOORS. Or contact Raynor Manufacturing Company • Dept. AR • East River Road • Dixon, Illinois 61021.

Circle 1066 on inquiry card



RAYNOR
GARAGE DOORS

A RAYNOR RECORD: 544 DOORS ON ONE BUILDING.





Once you start using VELUX roof windows, it's difficult to stop.

With over 40 years experience specializing in roof windows and working closely with architects around the world, we've learned a thing or two. In terms of design, function, ease of installation, weather tightness and the availability of a complete program of options, including special glazings, you could not ask for more. Economically priced from about \$200 to \$500, they conform to all major building codes and may be used in passive solar applications.

VELUX. The world leader in roof windows and skylights!

VELUX[®]

Roof Windows

VELUX-AMERICA INC.
P.O. Box 3268
Greenwood, SC 29648

In Canada
VELUX-CANADA INC.
2525a J. B. Deschamps
Lachine
P.Q. Canada H8T1C5

Architect:
D. F. Trees Associates
©VELUX-AMERICA INC.

Circle 1067 on inquiry card

Circle 68 on information card

There's a word for
a *folding fire door*
with a 1½ hour
UL fire rating! . . .

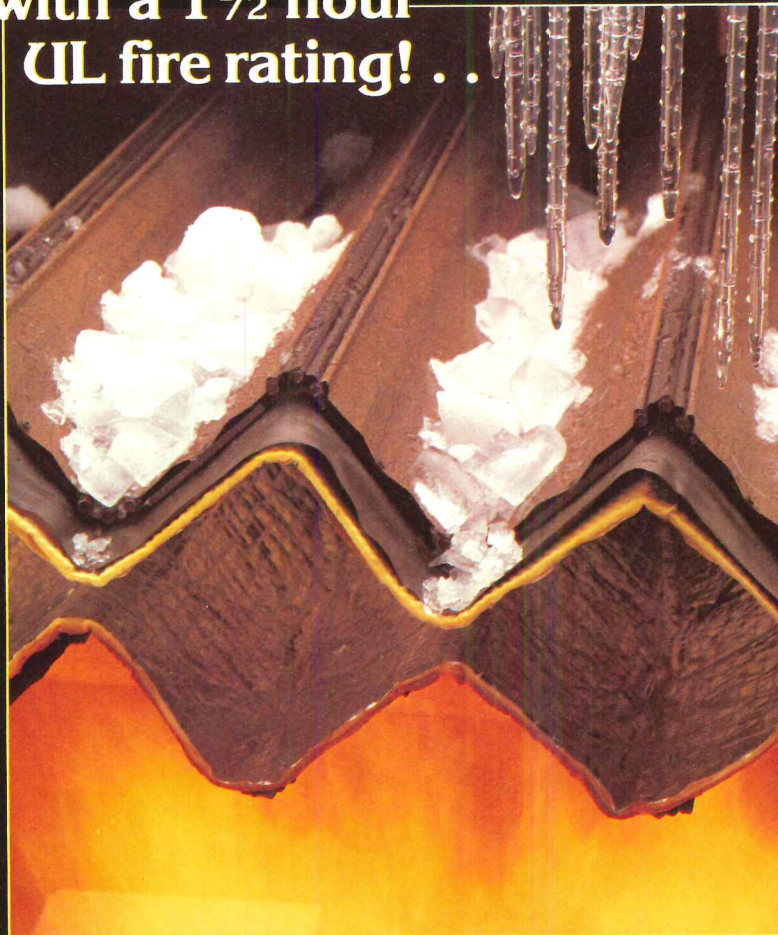

. . . Revolutionary!

WON-DOOR FIRE GUARD

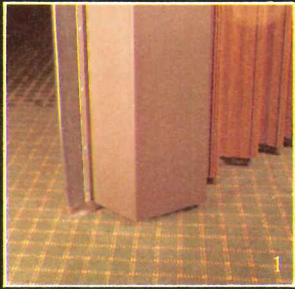

Think of the problem-solving implications!

The beauty, simplicity, and versatility of a *horizontal folding fire door* that folds neatly into the wall . . . combined with the incredible fire and *smoke* stopping abilities of a *fire barrier* with *these credentials*:



- UL LISTED (both 1 and 1 ½ hour fire ratings)
- FACTORY MUTUAL LISTED
- NRB RECOGNIZED
- ICBO RECOGNIZED (see research report #3890)
- CALIFORNIA STATE FIRE MARSHAL LISTED & APPROVED
- RECOGNIZED BY MANY STATE AND LOCAL GOVERNMENTS
- SPECIAL TAX INCENTIVES SUCH AS CAL. STATE SENATE BILL #460 WHICH PROVIDES SIGNIFICANT TAX SAVINGS FOR THEIR INSTALLATION
- SPECIAL RAPID DEPRECIATION ALLOWANCES
- POSSIBLE INSURANCE PREMIUM SAVINGS

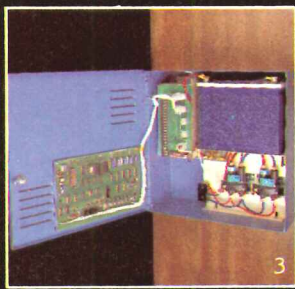

The Won-Door Fire Guard Doors are the only folding fire barriers to meet the new code requirements for elevator lobby separation.

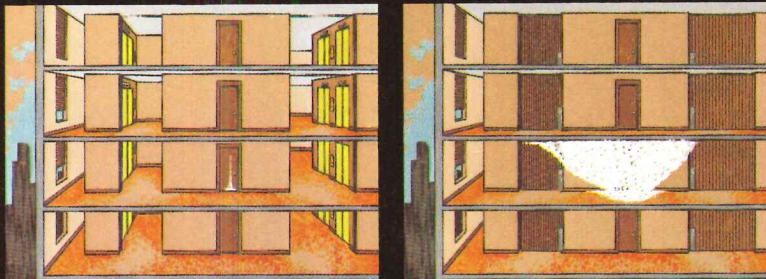

With the optional *Fire Guard System*, all doors on all floors of a multistory building may be programmed to close automatically 24-hours per day on a 12-volt fail-safe back-up DC power supply activated by any smoke alarm in the building. The doors quickly isolate the fire and separate *all* elevator lobby areas (as required by code) from the rest of the building.

Other fire code applications include creating "safe refuge areas" on each floor for the handicapped, critical fire protection of non-replaceable property, sensitive electronic equipment, special hazard areas, stage prosceniums, occupancy separation and many more.

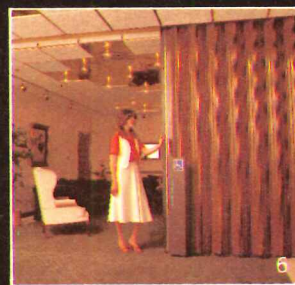

- 1) Requires no floor track! Yet blocks smoke and fumes!
- 2) Stacks completely out of the way at just 3" inches per linear foot!
- 3) State of the art microprocessor control system.
- 4) Optional "Crash bar" handle for the handicapped requires just a light bump to open, permits passage, then recloses automatically.
- 5) Spans unlimited widths and heights up to 23 feet!
- 6) Effortless manual open/close.

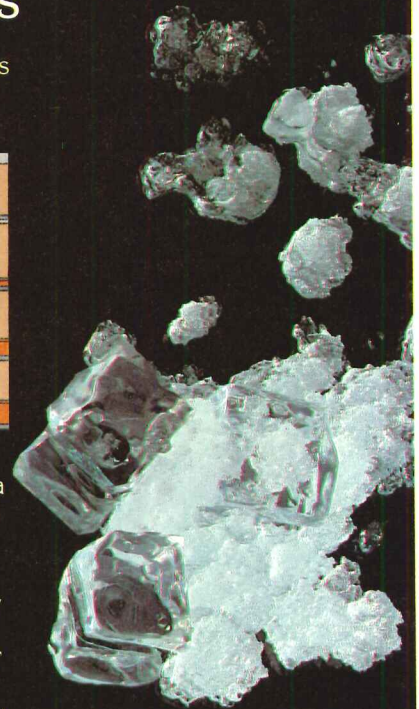

WON-DOOR CORPORATION

1865 South 3480 West
Salt Lake City, Utah 84104
1 (801) 973-7500
Call toll free 1 (800) 453-8494

BRUCE ENGINEERING COMPANY

“Lean on us to answer
your glazing questions.”

When Heery and Heery Architects in Atlanta, Georgia wanted assistance in designing and budgeting an all glass curtainwall for the corporate headquarters of the Georgia Power Company, they called Bruce Engineering Company. Because of high public exposure, the curtainwall had to be both thermally efficient and economical. Because of the aesthetic requirements, the curtainwall had to utilize four side structural silicone factory glazing, thus providing “flush” exterior appearance. Bruce Engineering helped achieve all of these criteria from concept to finished product.

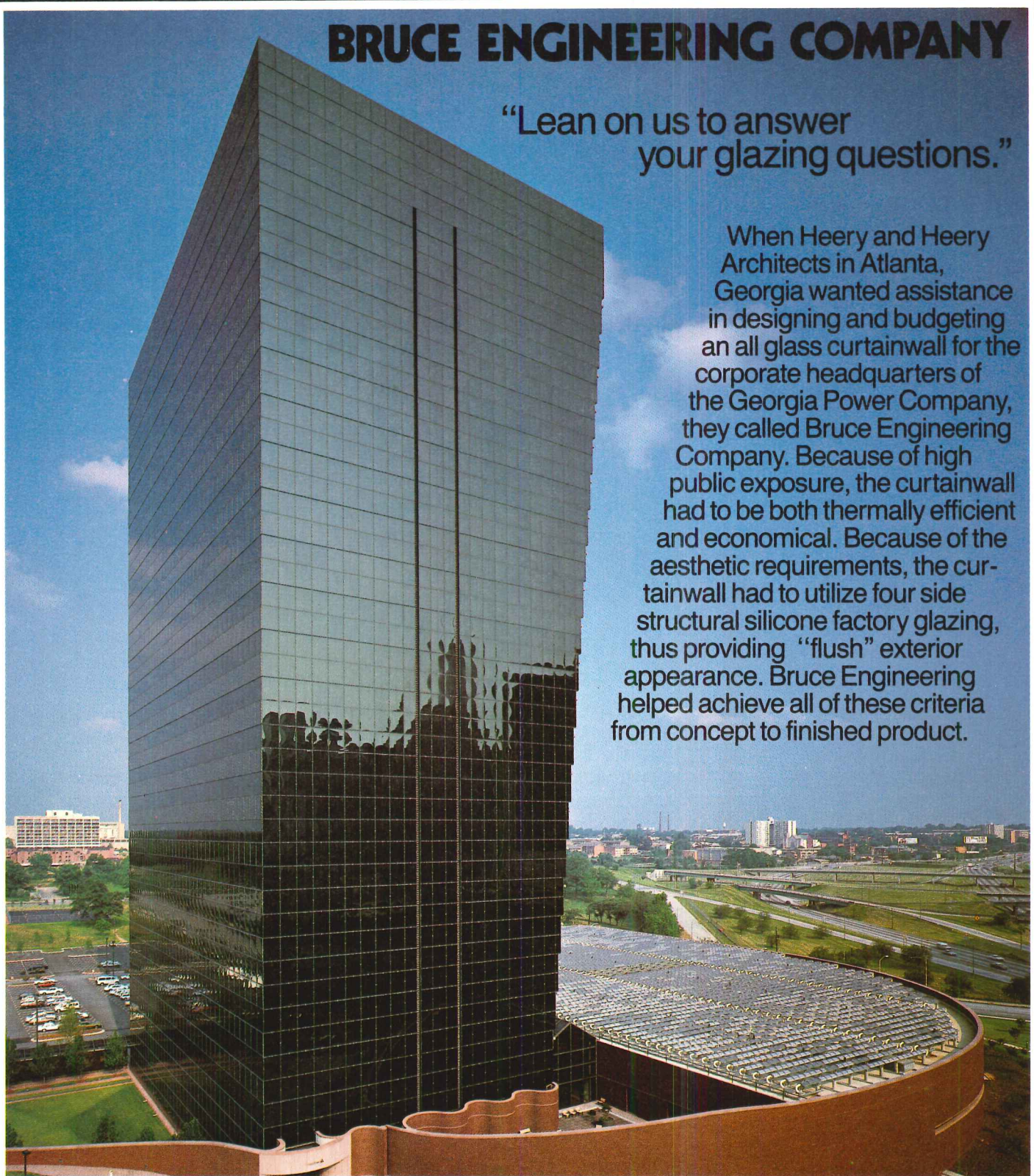

Fireman's Fund Building—Atlanta, GA
Smallwood, Reynolds, Stewart & Stewart—Arch.

Renaissance Center Hotel—Detroit, MI
John Portman & Associates—Arch.

Hyatt Regency Hotel—Tampa, FL
Welton-Beckett & Assoc.—Arch.

Georgia Power Company Corporate Headquarters—Atlanta, GA
Heery & Heery, Architects & Engineers, Inc.—Arch.



BRUCE ENGINEERING COMPANY
bec

2000 TUCKER INDUSTRIAL ROAD
TUCKER, GEORGIA 30084
PHONE 1-404-939-4460

For more information, see our 1983 Sweets
inserts 8.14 Bru and 8.15 Bru.

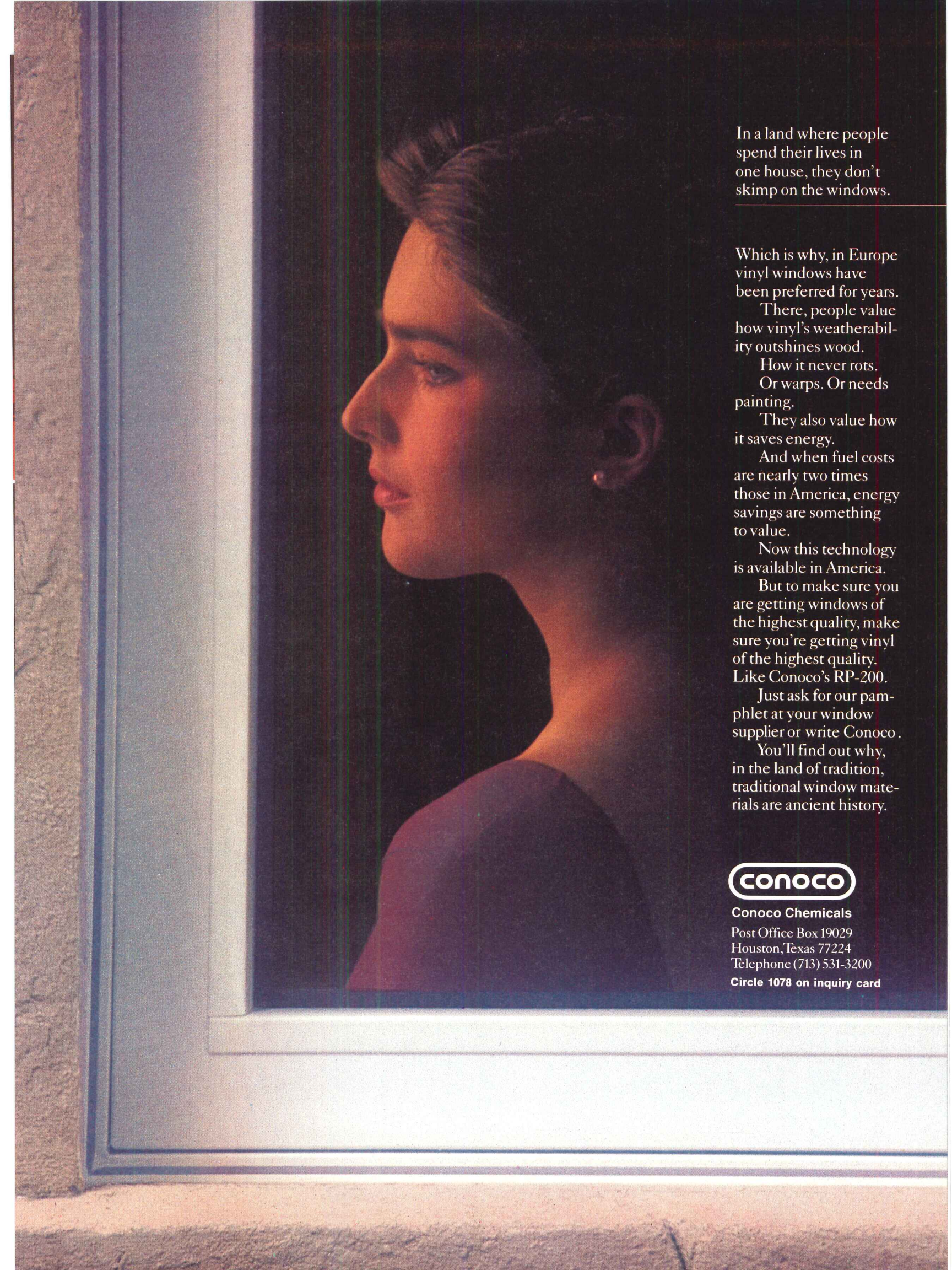
A black and white photograph of a woman in profile, looking out of a window. The lighting is dramatic, with strong highlights on her face and the window frame, and deep shadows elsewhere. The window frame is visible on the left side of the image.

In a land where people spend their lives in one house, they don't skimp on the windows.

Which is why, in Europe vinyl windows have been preferred for years.

There, people value how vinyl's weatherability outshines wood.

How it never rots.

Or warps. Or needs painting.

They also value how it saves energy.

And when fuel costs are nearly two times those in America, energy savings are something to value.

Now this technology is available in America.

But to make sure you are getting windows of the highest quality, make sure you're getting vinyl of the highest quality. Like Conoco's RP-200.

Just ask for our pamphlet at your window supplier or write Conoco.

You'll find out why, in the land of tradition, traditional window materials are ancient history.

CONOCO

Conoco Chemicals

Post Office Box 19029

Houston, Texas 77224

Telephone (713) 531-3200

Circle 1078 on inquiry card

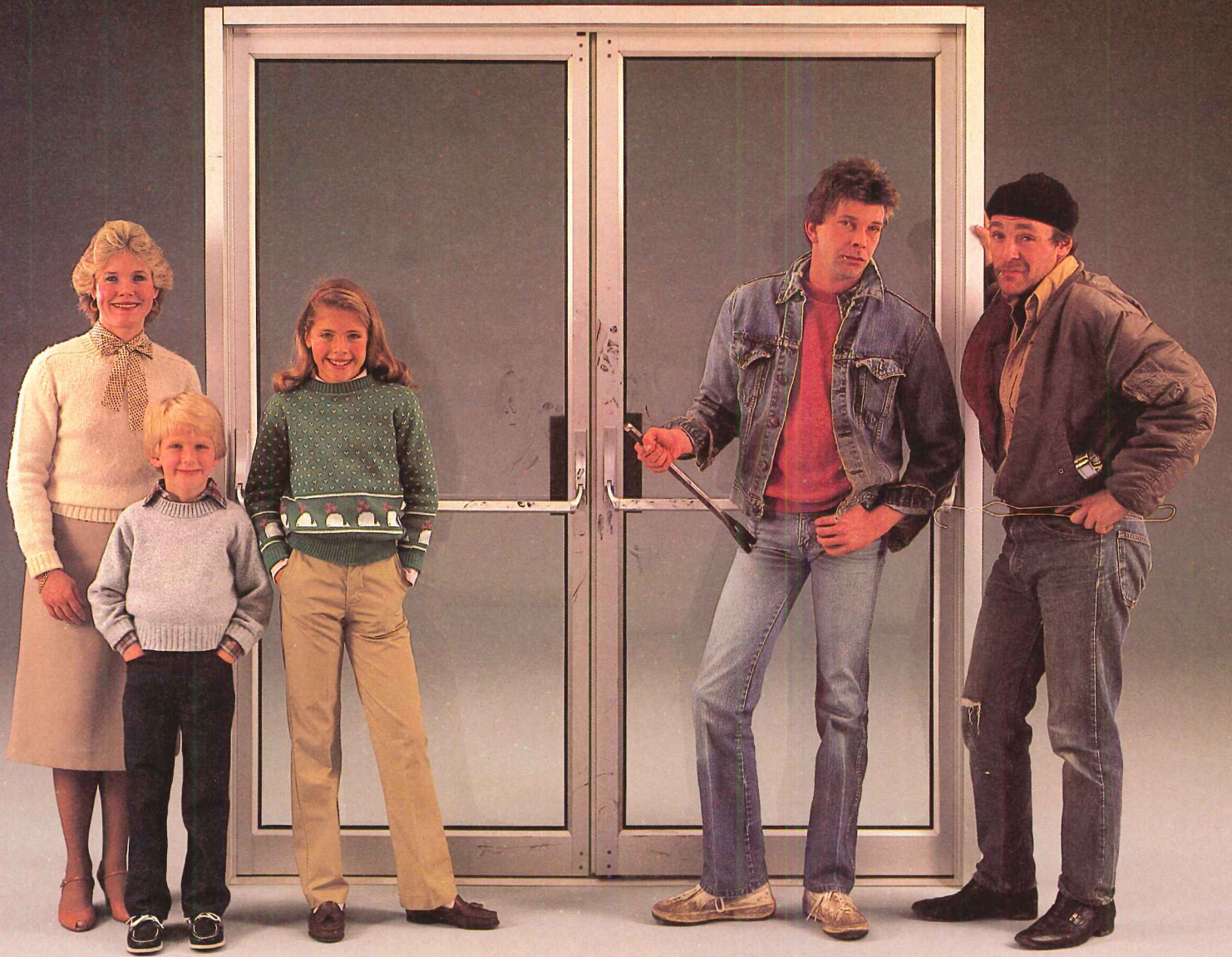

The good, the bad, and the ugly.

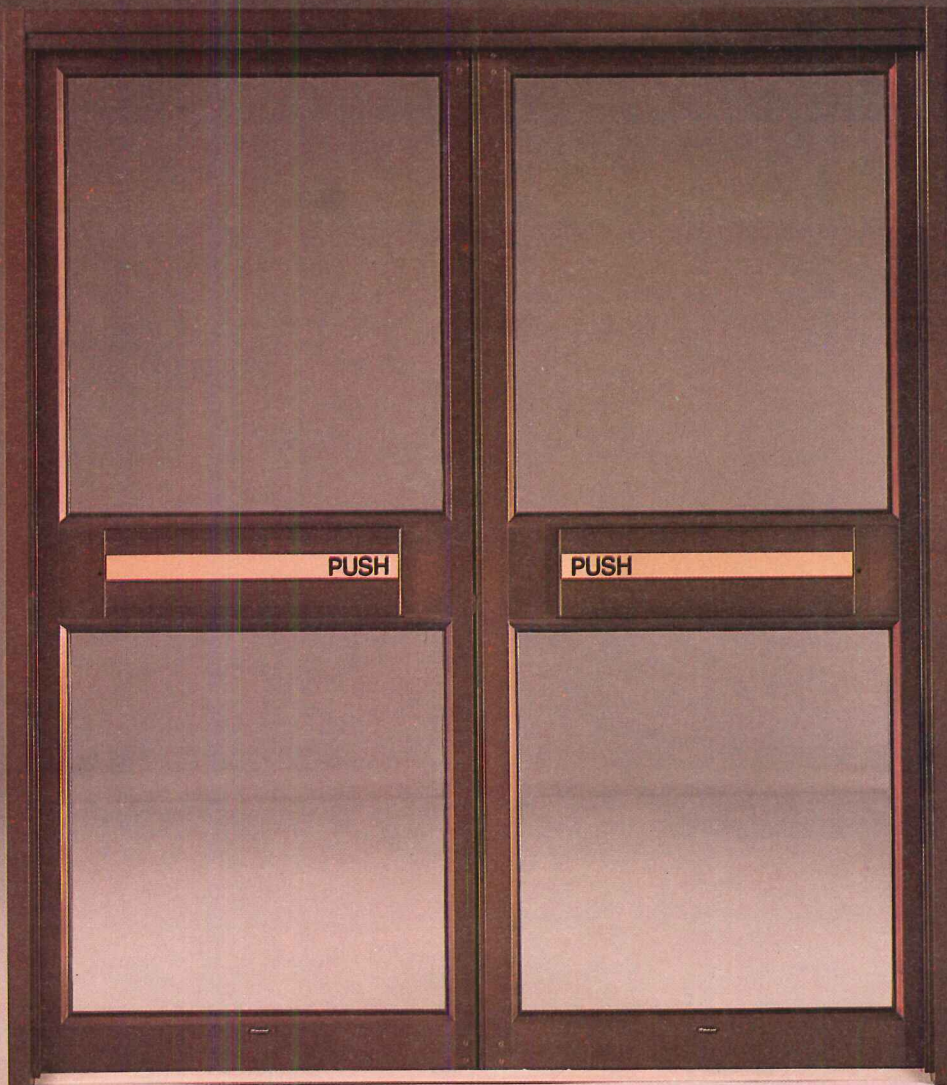

The safe, the secure, and the beautiful.

Kawneer Panic Guard® with Paneline®

Life Safety Codes. Building Security. Aesthetic Appeal. By themselves, there are answers for each of these entrance questions. But put these requirements together and the problems are multiplied. Effective Life Safety compliance may mean diminished security. And until now, aesthetic appeal has always been lost in the shuffle of performance compromises.

Kawneer Entrances with Panic Guard and Paneline are the answer no matter what the question is. The integrally-designed push panel responds quickly and easily to pressure for fast emergency exit. This same design also prevents chaining

and blocking of the entrance, something that happens all too often in the interest of security of conventional panic exit device doors.

And speaking of security, Kawneer Panic Guard ingeniously defeats the intrusion of wires or coat hangers. The patented astragal bar design blocks insertion of devices to release the exit mechanism while continuous stops at the jamb and threshold prevent foreign object entry at these points. The recessed lock cylinder, which is also protected by the pull handles, prevents lock removal by tongs, pipe wrenches, or other burglary tools. And, Kawneer Sealair® weathering in the frame and an exclusive adjustable weathering between the door leaves help make the entrance secure against the elements, too.

The aesthetic appeal of Paneline virtually speaks for itself. The contemporary styling complements any entrance and optional matching panels can be specified for vestibule doors along with fixed rails for sidelights and centerlites.

Kawneer Entrances with Panic Guard and Paneline. They are proof that you can have the good without having to accept the bad and the ugly, too.

For additional information, write:
The Kawneer Company, Dept. C,
1105 North Front Street,
Niles, MI 49120.

Kawneer
The designer's element

Why
have
this...

when
you can
have
Color-In*



Allmetal is the leading manufacturer of air spacer and muntin bar for insulating glass and decorative design applications.

We believe your interest in form and function create a delicate balance which we strive to maintain through our engineered solutions to specific problems...

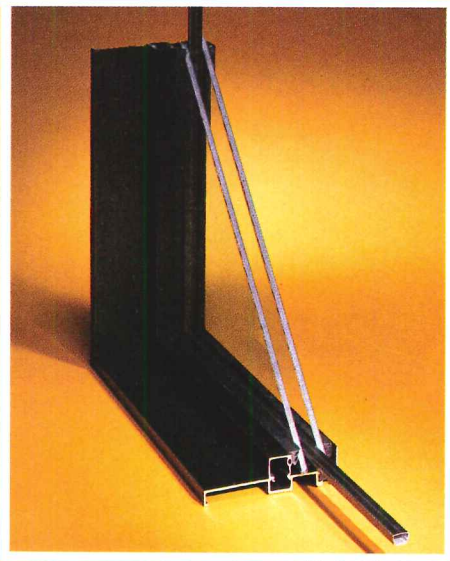

Test results reveal no appreciable heat build-up, no fading and resistivity to ultraviolet light in assembled units utilizing Color-In bronze spacer. No effects on spacer, sealant or glass temperature levels were found. Test results available, contact Allmetal.

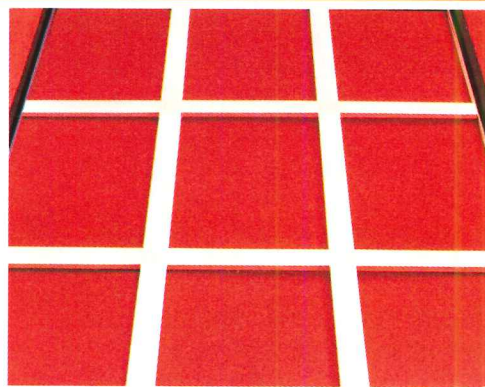

Allmetal muntin bar configurations add a decorative optical dimension to the insulating value of ig units. Assorted finishes permit various design options.

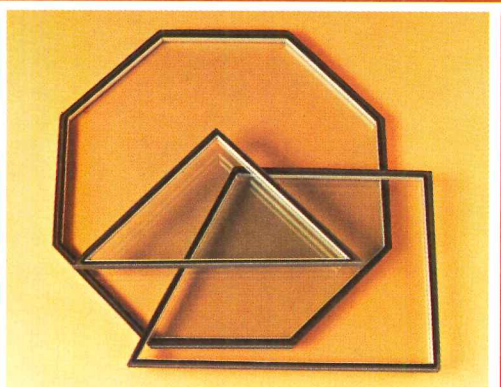

Flexible corner keys and air spacer remove the 90° restriction, meaning the practical uses of ig units are considerably increased. Whether in window, wall, skylight, dome or other application, Allmetal components yield performance.

ALLMETAL
INC.
SINCE 1915

Corporate Headquarters—
755 Busse Road •
Suite 203 • Bensenville, Illinois
60106 • (312) 860-1330

*A product of Lorin Industries

Allmetal plants in Chicago (312) 766-8500 • Dallas (214) 245-9264
• Reno (702) 358-6448 • Somerset, NJ (201) 560-8585

Circle 1081 on inquiry card

9 Finishes

UCI 9, Finishes:
Acoustical treatment
Carpeting
Ceiling suspension systems
Painting materials
Prefinished panels
Resilient flooring
Special flooring
Terrazzo
Tile
Wall covering
Wood flooring



278



279



280

278 Vinyl flooring
Medintech is 6-ft-wide vinyl flooring, which may be heat-welded at the seams and flash-coved to prevent the accumulation of dirt and moisture. Flooring comes in 9 colorways in a jaspe design. Armstrong World Industries, Inc., Lancaster, PA.

279 Parquet flooring
Bran solid oak parquet flooring, light brown in tone, is designed for commercial and residential use. It comes in 12-in. squares and is backed with either wood or foam. The foam backing serves both to control noise and to insulate. Hartco, Inc., Oneida, TN.

280 Raised rubber tiles
Rubber tiles with a raised square design are claimed to be slip resistant, reduce noise and be easy to maintain. Tiles, cove bases, stair treads and accessories are all available in 10 colors. Roppe Rubber Corp., Fostoria, OH.



281



282



283

281 Carpet
Berber-knit features a knitted loop pile construction with a blend of 7 natural wool fibers. It is available in 6 different colors. Couristan, Inc., New York, NY.

282 Vinyl floor tiles
Genera Marble resilient composition floor tiles feature chips of translucent vinyl containing fine particles of marble. Tiles are suitable for heavy traffic applications. They measure 12 in. square and come in 10 colorways. Azrock Floor Products, San Antonio, TX.

283 Carpet
Perrault is a commercial *Kara-loc* woven carpet, which features alternating rows of cut and looped *Antron* nylon yarns. It is part of the "Walker Group Designs" of coordinated architectural furnishings. Karastan Rug Mills, Div. of Fieldcrest Mills, Inc., New York, NY.

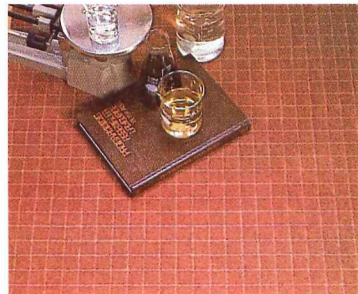

284

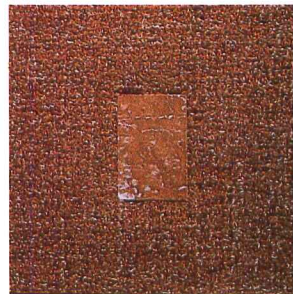

285

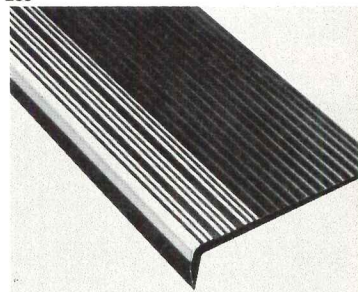

286

284 Woven carpet
Cubes is 1 of 4 woven designs in this manufacturer's *Corporate Concepts* collection, a grouping of *Antron XL* carpets styled to complement each other. This design is available in 10 colorways. Bigelow-Sanford, Inc., Greenville, SC.

285 Carpets
Soft Rock is the name of a series of wool carpets designed to relate to hard floor and wall surfacing materials, such as marble, terrazzo and stone. Ten standard designs, as well as custom designs, are available. Edward Fields, Inc., New York, NY.

286 Stair treads
The *Maxxi-Tread* features a reinforced nose and front cleats co-extruded from *Vythene*, a PVC/polyurethane alloy. Treads come in a 2-tone design for increased visibility and are available in 6 color combinations. Mercer Plastics Co., Inc., Newark, NJ.

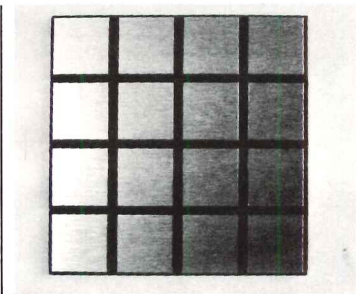

287



288

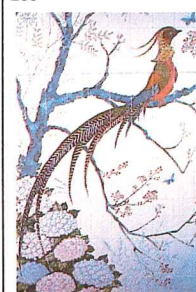

289

287 Tambours
The *FlexTech Series* of tambours can be used on walls and ceilings, as decorative moldings and as furniture surfacings. The series comes in several materials, including solid red oak, red oak veneer, aluminum, acrylic, brass and vinyl. Winona Industries, Inc., Winona, MN.

288 Bathrooms
The Total Look is the name for a series of coordinated tiles, furniture, fabric and accessories designed by Athos Pratesi. Ceramic 8- by 8-in. tiles and fabrics come in 4 patterns. All furniture is made of solid wood. Piemme of the Americas Ltd., New York, NY.

289 Hand-painted tiles
Italian ceramic tiles are hand-painted and grouped to form murals. Several designs are available, including bouquets and forest scenes. Tiles come in 2 sizes: 5 by 10 in. or 8 in. square. Gabbianelli, dist. by Hastings Tile, New York, NY.



290

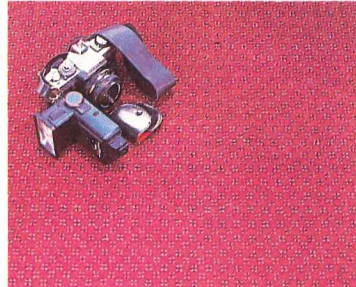

293



296

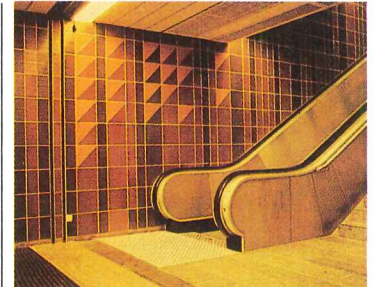

299



291



294



297

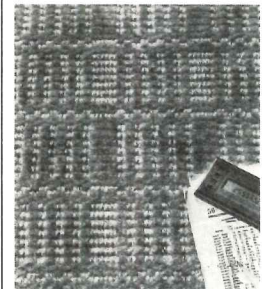

300

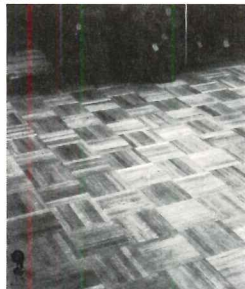

292



295



298



301

290 Interior finishes

Intones are textured acrylic finishes containing aggregates and integral color; custom colors are available. Finishes can be applied to drywall or cement board and can be used for new construction or renovation. They are claimed to be chip resistant. Dryvit System, Inc., West Warwick, RI.

291 Rubber flooring

Norasquare rubber flooring tiles are 39.37 in. square. They feature a raised rounded corner square pattern and come in 5 standard colors; other colors are available for orders over 500 square meters. Tiles come with either smooth or studded backings. Nora Flooring, Madison, IN.

292 Acrylic/oak flooring

Camden is a light-colored oak flooring that is claimed to be more durable than regular oak flooring due to its being saturated with both acrylic and stain. It comes in 12-in. squares with either a wood or a foam backing. Hartco, Inc., Oneida, TN.

293 Woven carpet

Quartet is a woven design made from *Antron XL* yarns. It is 1 of 3 designs in this manufacturer's *Weavepoint II* grouping and it comes in 9 standard colorways, as well as in custom colors. Bigelow-Sanford, Inc., Greenville, SC.

294 Open cell ceiling

SpaceCube is an aluminum louvered ceiling that hangs in a standard 2- by 4-ft lay-in grid but provides a visual plane that conceals the normal plenum cutter. It may be used wall-to-wall or to highlight specific areas within a space. Integrated Ceilings, Inc., Los Angeles, CA.

295 Rubber studded floors

Rubber tiles are designed for use in any commercial, industrial or residential application. They may be self-coved without heating or special treatment. They measure 36-in.-square and come in 11 colors; custom colors are available. Endura, Div. of The Biltrite Corp., Chelsea, MA.

296 Hardwood flooring

The *Pioneer Plank* flooring pattern is created with a combination of 3 plank widths in random lengths. Planks are prefinished 3/4-in. oak available in 2 tones. Walnut plugs are optional. Robbins, Inc., Cincinnati, OH.

297 Acoustical ceilings

Glass Look is a 2- by 2-ft lay-in acoustical ceiling panel with a clear mirror surface. Three colors are available: silver, bronze and gold. Typical applications include lobbies, executive suites and conference rooms. Armstrong World Industries, Inc., Lancaster, PA.

298 Wall and floor tiles

Prestige glazed wall tiles in 6 colors and *Regency* single-fired floor tiles in 8 colors are coordinated to form unified designs. Wall tiles come in 4 1/4-in. and 6-in. squares and floor tiles come in 8-in.-square and 4- by 8-in. sizes. United States Ceramic Tile Co., East Sparta, OH.

299 Tile color system

VIVA is a vitreous ceramic tile color system based on 56 natural shades; 40 in. glazed and 16 in. unglazed tiles. Tiles come in squares, rectangles and triangles, as well as in strips, all with grooved surfaces. Amsterdam Corp., New York, NY.

300 Carpet

Bedouin Grid is woven of a yarn that is a blend of 55 per cent wool and 45 per cent acrylic. The design is available in a 12-ft width and comes in 4 colorways. Couristan, Inc., New York, NY.

301 Display wall panels

Displawall is a slotted wall panel system that features T-shaped grooves in industrial quality fiberboard. Panel finishes include wood veneers and laminates. Trim strips designed to match or accent panels are also available. Masonite Corp., Commercial Div., Dover, OH.

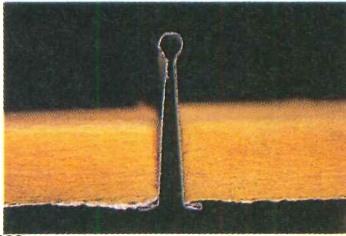

302

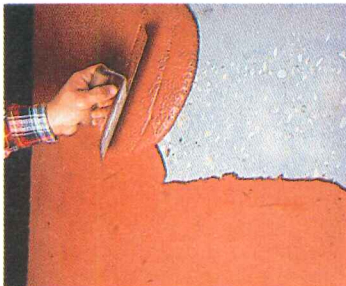

303

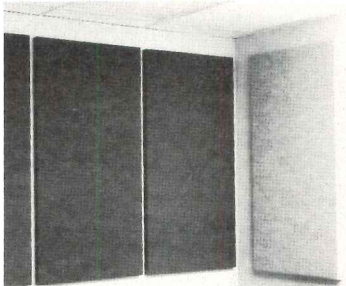

304

302 Ceiling grid system

The *Thinline* grid system comes in a 3/16-in.-wide white profile with a 3/16 in. recess. The system features a standard grid assembly design and accepts standard NEMA "G" type light fixtures and air delivery units. Donn Corp., Westlake, OH.

303 Concrete surfacer

The *PERMA-LOCK* concrete surfacer is said to require only a few hours to cure and needs no surface preparation, acid etching, scarifying or blast cleaning. In addition, it can be applied to damp surfaces. High Performance Coatings Div., Porter Paint Co., Louisville, KY.

304 Acoustical panels

Silent Accents are acoustical panels designed for mounting on metal file cabinets, columns and any other noise-reflecting surface. They measure 2 by 4 ft or 2 by 6 ft, feature adhesive strips for mounting and come in nine fabric colors. Conwed Corp., St. Paul, MN.



305

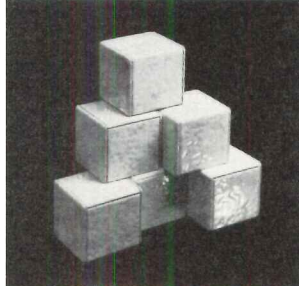

306



307

305 Insulating shade

The thermal *SuperShade* consists of 3 layers of fabric. It comes with a head-case, bead chain drive and cleat. The case is 3 1/2 in. by 4 1/2 in. and tracks are 1 3/4 in. by 1 3/4 in. Shades come in 3 earth-tone colors. Thermal Technology Corp. of Aspen, Inc., Broomfield, CO.

306 Glazed tiles

Dimensions tiles come in 6 pale pastel shades and are designed for wall and counter installations. They measure 4 1/4 in. square and are 1/4 in. thick. Color coordinated grout and 4 matching trim shapes are available. American Olean Tile Co., Lansdale, PA.

307 Floor covering

Heavy-duty 12-in.-square carpet tiles feature wide-rib surfaces of 100 per cent continuous filament nylon fibers fused to cord-reinforced rubber. Tiles come in 3/16- or 3/8-in. thicknesses. Three earth-tone colorways are available. The R.C. Musson Rubber Co., Akron, OH.

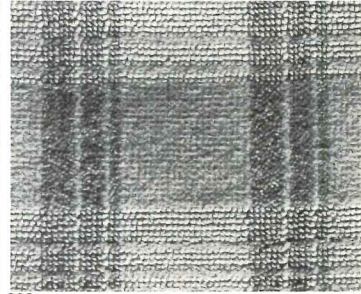

308

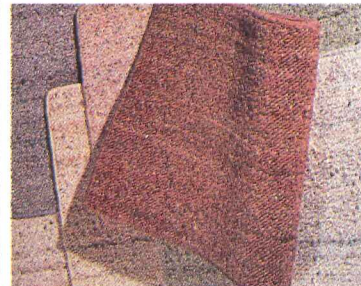

309



310

308 Broadloom

Federal is a broadloom carpet with a 100 per cent wool face, 8 rows per in. and 216 pitch. It is 12 ft wide with 48 oz face weight per square yd. A velvet construction is woven through the carpet back for durability. The carpet is available in 6 colors. Eurotex, Philadelphia, PA.

309 Carpet

The *Pastel Berber Collection* is available in 8 colorways in 6 different qualities, including a patterned cut pile. It comes in either all-wool or wool blends in widths up to 12 ft and is suitable for both residential and contract application. Ernest Treganowan, Inc., New York, NY.

310 Tiles

Canyonstone tiles feature slip-resistant surfaces and are made for heavy-duty areas, such as food services and swimming pools. They come in modular systems to form patterns and are available in 7 colors and 4- by 8-in. and 8-in.-square sizes. Marazzi USA, Inc., Sunnysvale, TX.

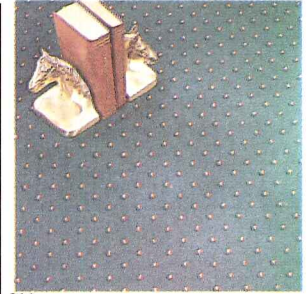

311



312

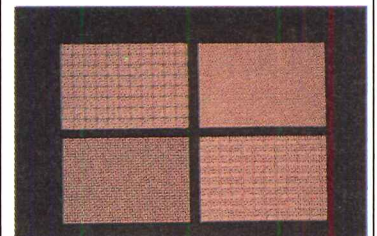

313

311 Carpets

Domino is 1 of 3 woven designs in this manufacturer's *Weavepoint II* grouping. It is made of *Antron XL* yarns and comes in 9 standard colors, as well as in custom colors. The carpet may be ordered in both large and small quantities. Bigelow-Sanford, Inc., Greenville, SC.

312 Ceiling system

The standard *Trimlok System* features a 2-ft-by-2-ft module, incorporating integral air distribution and a number of lay-in acoustical panel options. To ease installation, the system includes only main runners and cross tees. Armstrong World Industries, Inc., Lancaster, PA.

313 Carpets

The *MICRO* series consists of 4 contract carpets that are all woven through the back using *Zeftron 500 ZX* nylon yarns from Badische Corp. Carpet designs feature cut and uncut square and check patterns and velvet textures. A wide variety of colors is available. Gulistan Carpets by J.P. Stevens, Aberdeen, NC.



314

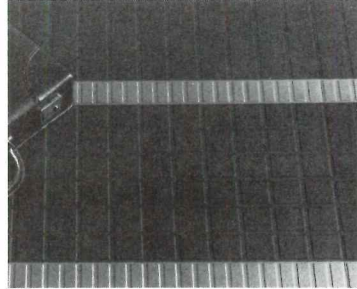

317



320

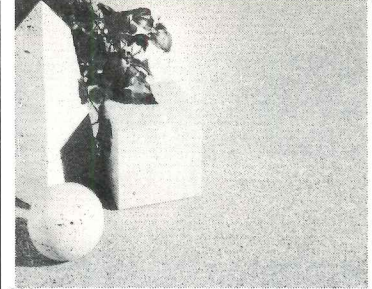

323

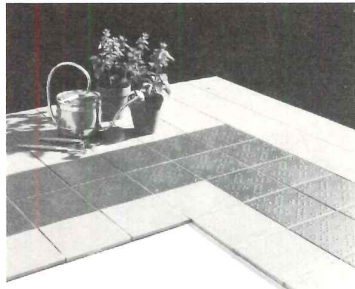

315

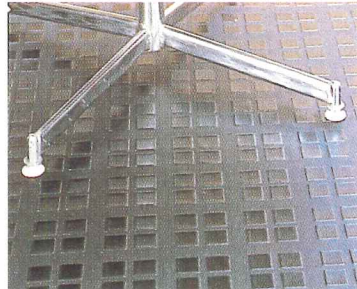

318

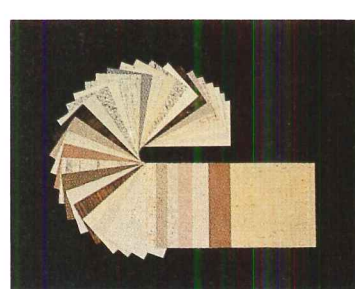

321

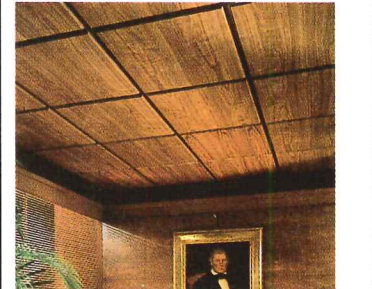

324

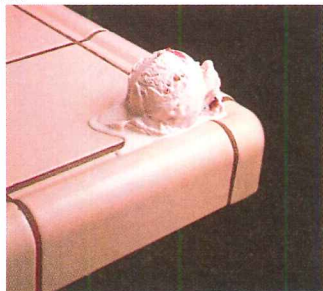

316

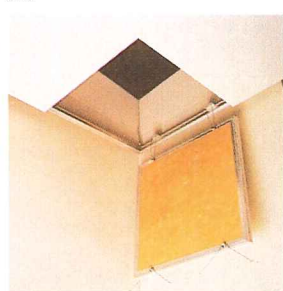

319



322



325

314 Pavers

Ultra Pavers for commercial and residential use are made of heavy-duty rated ceramic tile with a matte glaze and are claimed to be stain and acid resistant. They come in 4 sizes and are 1/2 in. thick. They are available in 6 colors. American Olean Tile Co., Lansdale, PA.

315 Tiles

The *Atrium Series* of porcelain unglazed ceramic tiles includes both smooth and slip-resistant tread surfaces. Tiles measure 6 by 6 in. and come in 6 colors. They may be used on both floors and walls. Impo Glaztile, Inc., Markham, IL.

316 Tiles

Crema de la Crema is the name of a line of tiles that is suitable for countertops, walls and light-duty floors. Tiles come in 6-in.-square and 6- by 3-in. sizes and have a semi-matte glaze. A variety of trim pieces is available. Huntington/Pacific Ceramics, Inc., Corona, CA.

317 Vinyl tile

Hi-Tech vinyl tile comes in 4 patterns and 4 colors in slab sizes of 2 by 3 ft and 2 by 4 ft. Designed for commercial applications, it is installed with a water soluble adhesive and is claimed to conform to subfloor irregularities without cracking. GMT/Contract Vinyl Tile, Bronx, NY.

318 Flooring

Lonquid resilient sheet flooring comes in 6 colors and can be covered and welded for seamless installation. It is available in 6- by 60-ft rolls. Vinyl wall coverings that match 3 of the flooring colors are also available. Lonseal, Inc., Torrance, CA.

319 Downward access ceiling

System G is a concealed suspension system for an acoustical ceiling, which requires little clearance. Panels hinge down for easy access. Grid sections can be removed individually. Panels and grids come in a variety of shapes, sizes and finishes. Decoustics, Toronto, Canada.

320 Brick flooring

PermaBrick is a 3/16-in.-thick acrylic-permeated brick, which is claimed to be 60 per cent stronger than required by ANSI standards. It is said to be water and stain resistant and is designed for both indoor and outdoor application. PermaGrain Products, Inc., Media, PA.

321 Wall panels

Durasan vinyl-surfaced wall panels come in 37 colors and patterns. Panel cores are gypsum or fire shield and are 1/2 to 3/8 in. thick. The panels measure 4 ft wide and from 8 to 12 ft long and feature wrapped edges. Gold Bond Building Products, Charlotte, NC.

322 Wallcoverings

Vicrlite is a collection of Class A fire-rated "type 1" wallcoverings for light commercial use. It includes 31 patterns in 500 colorways and 3 weight categories: 10 1/2, 13 and 19 oz./yd. Vicrtex, Div. of L.E. Carpenter & Co., Wharton, NJ.

323 Vinyl flooring

Seascope is one of this manufacturer's *Flor-Ever* commercial vinyl floors. It is available in 6 colorways. To reduce the number of floor seams and cut installation costs, it is available in both 9- and 12-ft widths. Congoleum Corp., Resilient Floor Div., Kearny, NJ.

324 Wood ceiling panel

Woodcuts 2-ft-by-2-ft tegular ceiling panels are made of walnut or light oak veneers applied over mineral fiber substrates. Panels install in conventional metallic suspension grids. Armstrong World Industries, Inc., Lancaster, PA.

325 Wallcoverings

Mexican Sisal is a natural fiber wall covering collection that carries a Class A flame spread rating and NRCs from .45 to .65. The collection features a wide variety of textures, colors and weights. Merida Meridian, Inc., Syracuse, NY.

9 Finishes Product literature

For more information
write item numbers on
Reader Service Cards

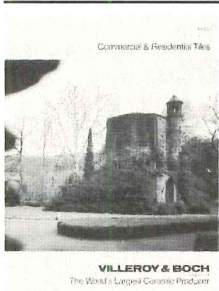

326 Ceramic tiles
Glazed and unglazed vitreous tiles and glazed nonvitreous tiles are shown in pictures of installations in a 28-page color brochure. Available tile shapes and colors are shown in close-up photos. Applications for each series are listed. Villeroy & Boch (U.S.A.), Inc., Pine Brook, NJ.

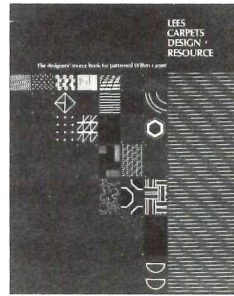

332 Wilton carpets
Several different designs, as well as installations, of Wilton carpets are illustrated in an 8-page color brochure. Carpet yarn and construction and custom designs, such as corporate logos, are described. Lees Carpets, Valley Forge, PA.

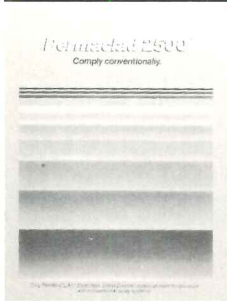

327 High-solids enamel
Permaclad 2500, a baking enamel for metals, designed for application by any spray system, is featured in an 8-page color brochure. A discussion of its VOC compliance and a chart of test comparisons are included. Sherwin-Williams, Chemical Coatings Div., Chicago, IL.

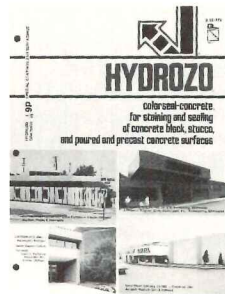

333 Concrete sealant
Colorseal-Concrete, a one-coat stain and seal system for stucco, concrete block and poured and precast concrete wall surfaces, is featured in a 4-page color brochure. Available colors and photos of installations before and after are included. Technical data is listed. Hydrozo Coatings Co., Lincoln, NE.

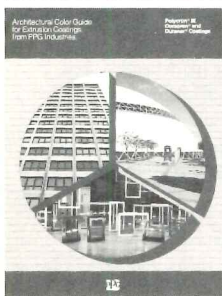

328 Aluminum coatings
Compositions and applications of each of 4 coatings for aluminum panels and extrusions—*Polycron III*, *Duracron*, *Duranar* and *Flexanar*—are described in a 4-page color guide. The 36 colors in which they are available are shown in samples. PPG Industries, Coatings and Resins Div., Pittsburgh, PA.

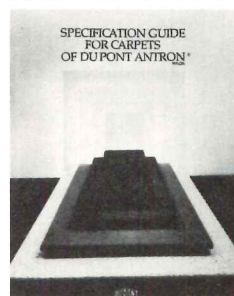

334 Nylon carpet
Information on performance, installation and maintenance of carpets made with *Antron* nylon is included in a 16-page specification guide. Results of tests comparing this product to other nylons are illustrated and described. Photos show several *Antron* carpet installations. DuPont Co., Wilmington, DE.



329 Wood flooring
A product sampler of *GenuWood II* hardwood flooring includes 12 species. In addition, a selection of pre-assembled panels is shown in 3 patterns. Flooring is bonded in vinyl and is designed for either residential or contract application. PermaGrain Products, Inc., Media, PA.

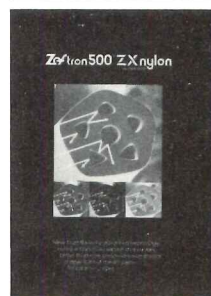

335 Nylon carpet yarn
Zeftron 500 ZX yarn with solution-dyed colors and antimicrobial protection is featured in an 8-page color brochure. Its pentagonal 6-hole fiber structure, claimed to refract light for a softer look and to facilitate cleaning, is shown and described. Badische Corp., Williamsburg, VA.

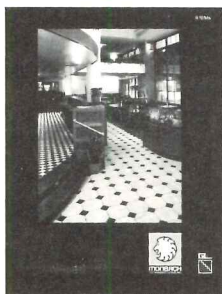

330 Tiles
Several series of vitreous and nonvitreous floor and wall tiles are featured in a 16-page color brochure. Tiles are shown in installation shots and close-ups. Tile dimensions and trim and angle shapes are shown in diagrams. A table lists series characteristics. Monarch Tile Manufacturing, Inc., San Angelo, TX.

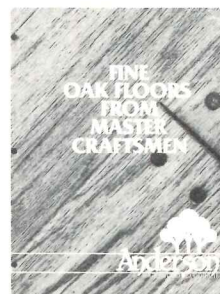

336 Hardwood floors
Oak plank and parquet floors are described and illustrated in a 4-page color brochure. A section detail illustrates the floors' blind nailing pocket, and installation is described. Tables list available plank and tile sizes and finishes. Anderson Hardwood Floors, Clinton, SC.



331 Wallcoverings
A catalog features the *TexturWorks Collection* of sisal, coco and wool wallcoverings, which are manufactured in Belgium and Mexico. The collection carries Class A flame ratings throughout and NRCS from .45 to .65. Merida Meridian, Inc., Syracuse, NY.

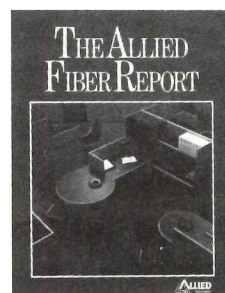

337 Nylon
The Allied Fiber Report on the evolution of nylon includes an explanation of the difference between nylon 6 and nylon 6,6. Also covered are antimicrobial systems, heavier denier fiber and fiber for computer room carpets. Allied Fibers & Plastics Co., New York, NY.

For more information
write item numbers on
Reader Service Cards

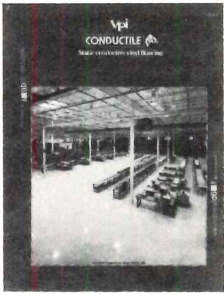

338 Vinyl flooring
Conductile static-conductive vinyl flooring is featured in an 8-page color brochure. Flooring properties and applications, such as computer rooms, are described. Information on installation and maintenance and specifications is also included. VPI, Sheboygan, WI.



344 Wood ceiling
A product data sheet features the *Marlite Brand* linear wood ceiling system. Types of installation and available wood species are described. Photos of installations are included. Masonite Corp., Commercial Div., Dover, OH.



339 Suspended ceiling
A page of literature features *Specular* mirror ceiling tiles, which may be hung from either concealed or exposed suspension systems. Five available finishes are listed. A photograph and section drawing of typical installations are included. Simplex Ceiling Corp., Hoboken, NJ.

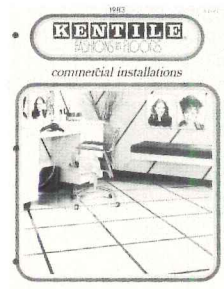

345 Vinyl tiles
A 1983 color catalog illustrates commercial installations of several series of solid vinyl tiles. Available tile colorways and patterns as well as the available colors in vinyl wall bases are shown in close-up photos. Kentile Floors, Inc., Brooklyn, NY.

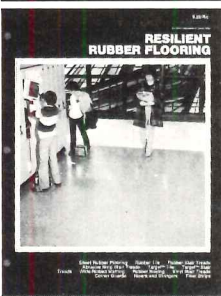

340 Rubber flooring
Specifications for rubber sheet and tile flooring and stair treads are listed in a 12-page color brochure. Rubber studded tiles and treads are also featured. Photos showing installations and diagrams with dimensions are included. Maintenance procedures are described. R.C.A. Rubber Co., an Ohio Corp., Akron, OH.

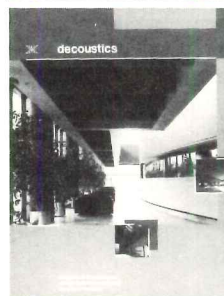

346 Acoustical panels
Acoustical panel systems for ceilings, walls and baffles are featured in a 16-page color brochure. Variations in panel types, configurations, finishes and mounting systems are illustrated in several photos of installations. Decoustics, Rexdale, Ontario.



341 Tiles
An 18-page color catalog covers both *Kerastone* monocottura tiles and this manufacturer's lines of double-fired tiles. Photos show installations, and close-ups show individual tiles. Symbols indicate tile application and acid and weather resistance. Dimensions are listed. Piemme of the Americas Ltd., New York, NY.

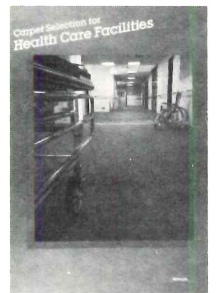

347 Carpets
Carpet Selection for Health Care Facilities is an 18-page color brochure that includes information on *Zeftron 500 ZX* solution dyed nylon yarns. Photos show installations, and tables list suggested traffic classifications and methods of removing 50 different types of stains. Badische Corp., Williamsburg, VA.



342 Photo murals
A 14-page color brochure illustrates 12 different photo murals available from this manufacturer. All murals are of nature scenes; 4 of the scenes can be repeated indefinitely to cover any wall length. The murals are washable and stain resistant. Naturescapes, Milwaukee, WI.

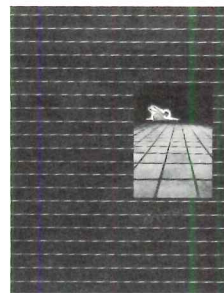

348 Tiles
Landmark unglazed tiles, designed for exterior and interior residential and commercial applications, are featured in a 6-page color foldout brochure. Available colors are shown, and available sizes are listed. Performance standards and specifications are also listed. American Ceramics, Washington, PA.

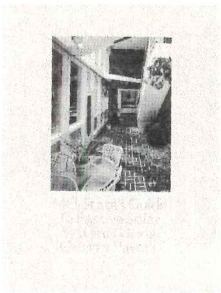

343 Quarry pavers
A 4-page color brochure describes the use of thermal mass in passive solar design. A section drawing shows quarry pavers and the sequence and make-up of underlying layers in a heat sink. Photos show paver installations and the 5 colors in which they are available. Mid-State Tile Co., Lexington, NC.

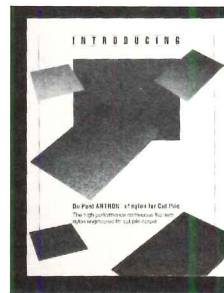

349 Cut pile carpet
A 4-page color brochure describes a fiber technology that permits the use of continuous filament nylon in cut pile carpet. *Antron cf*, the resultant 4-hole filament claimed to be soil and wear resistant, is shown in close-up photos and diagrams. DuPont Co., Wilmington, DE.

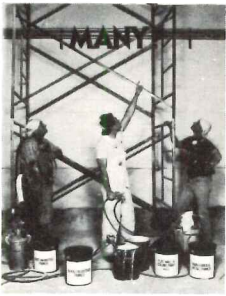

350 Coating

Uni-Bond, an oil-modified alkyd coating for use on structural steel, bar joists, hangers, hvac conduit and decking, is described in a 4-page color brochure. Photos show installations, and performance data is listed. Tnemec Co., Inc., Kansas City, MO.

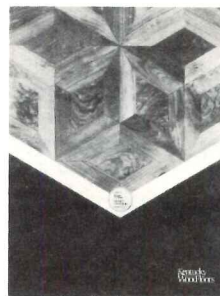

356 Hardwood floors

Several series of hardwood floor designs, including parquet, plank and strip, are shown in installation photos and described in a 12-page color brochure. Diagrams and dimensions are included as well as information on installation and maintenance. Kentucky Wood Floors, Inc., Louisville, KY.

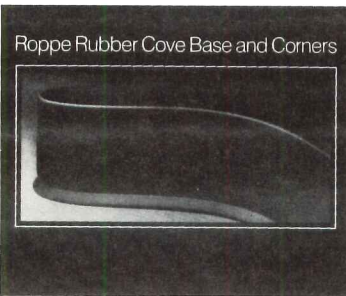

351 Cove bases and corners

Rubber cove bases and corners are illustrated and described in a color foldout brochure. Diagrams show 4 available cove designs and 3 available inside and outside corner designs. A chart of available colors and specifications is included. Roppe Rubber Corp., Fostoria, OH.

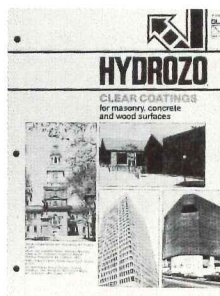

357 Water-repellent coatings

Clear coatings for masonry, concrete and wood surfaces are featured in a 4-page brochure. Technical data, applications and a product selection chart are included. Specifications are listed. Hydrozo Coatings Co., Lincoln, NE.

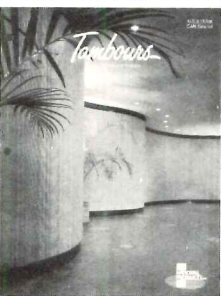

352 Tambours

Hardwood, wood veneer, cork and aluminum tambour wallcoverings in 9 series are featured in a 4-page color brochure. Photos show installations, and diagrams illustrate tambour slat profiles. Dimensions of slats are listed. National Products Div., Potter Industries, Louisville, KY.

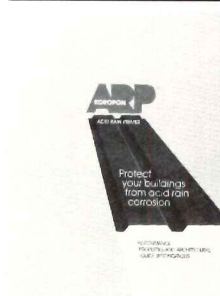

358 Acid-resistant primer

A new brochure features *Koropon ARP*, an acid-rain resistant primer for use on galvanized steel and any other metal substrate. As described, the primer is made of a combination of acid-resistant resins and corrosion-inhibiting pigments. DeSoto, Inc., Des Plaines, IL.

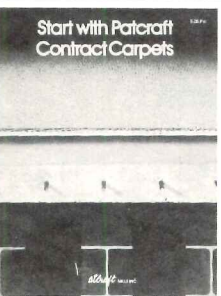

353 Contract carpets

A 16-page color catalog is filled with photos of contract carpet designs and installations. A table lists fiber content, traffic class, backings and technical data for each of the designs featured. Patcraft Mills, Inc., Dalton, GA.

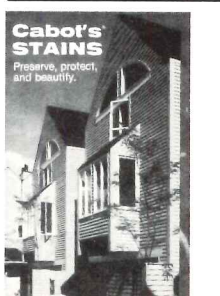

359 Stains

Photos showing typical applications of interior and exterior stains are featured in a 16-page color booklet. The booklet also includes a guide to staining that offers information on color selection, application and maintenance. Samuel Cabot, Inc., Boston, MA

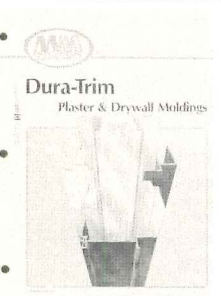

354 Moldings

Screeds, trims and moldings for plaster and drywall are shown in section details and described in an 8-page brochure. Both vented and nonvented types are covered. Specifications and a color chart are included. MM Systems Corp., Tucker, GA.



360 Acoustical wall panels

Photos show typical installations of several series of *Soundsoak* acoustical wall panels. Dimensions, flame spread ratings and insulation values are listed with each series. Charts list sound absorption coefficients. Armstrong World Industries, Inc., Lancaster, PA.



355 Floor treatment

Chemglaze polyurethane coatings for concrete floors, which are said to be abrasion- and chemical-resistant, are featured in a new brochure. Applications for both new and existing concrete are described. Lord Chemical Products Group, Erie, PA.

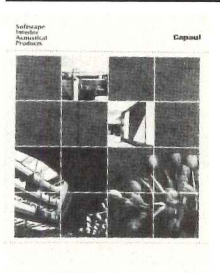

361 Acoustical products

Softscape acoustical conceal reveal-edge ceiling and wall panels, as well as baffles, are featured in an 8-page color brochure. Product construction, NRC ratings, sizes and finishes are described. Specifications are included. Capaul, Div. of Acoustiflex Corp., Plainfield, IL.

SEALED AGAINST WEATHER

Mt. Washington Observatory White Mountains, New Hampshire



Even the world's worst weather can't penetrate the Thoroseal® armor protecting Mt. Washington Observatory.

Bitter weather here is an almost daily fact of life. The mountain recorded the highest wind in history (231 mph).

But Mt. Washington Observatory is more than concrete; it is concrete sealed for life with Thoroseal. Thoroseal is unique. It bonds with and becomes part of the concrete, allowing it to breathe.

The exterior beauty, too, of Thoroseal is not superficial, but impregnable, timeless.

For specification and application information on Thoro products, call or write:
Thoro System Products,
7800 NW 38th St.,
Miami, FL 33166. Dept. AR 8312
(305) 592-2081, Telex 51-9674
A Unit of Beatrice Chemical,
Division of Beatrice Foods Co.

THOROSEAL

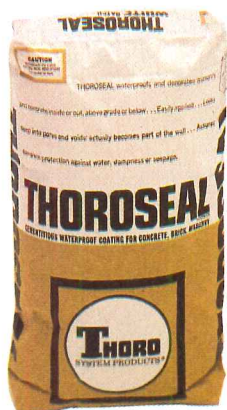

Thoroseal is a registered trademark of Thoro System Products.



THE SEAL OF PERMANENCE

... against water, against weather, against time

Circle 1082 on inquiry card

©1983 Thoro System Products



**ALLIANCEWALL PORCELAIN ENAMEL ON STEEL.
GOODBYE, OLD PAINT.**

The attractive interior walls you plan today...will stay that way. For years to come. AllianceWall panels never need painting, because the porcelain enamel color is actually fused to the steel. Creating a hard, smooth surface. You can choose from more than 50 vivid and neutral colors. Beautiful by any standards. And made to stay that way. Contact us soon to see how we can help you plan your next interior. Porcelain enamel on steel— for one-time color, easy maintenance and lasting beauty.



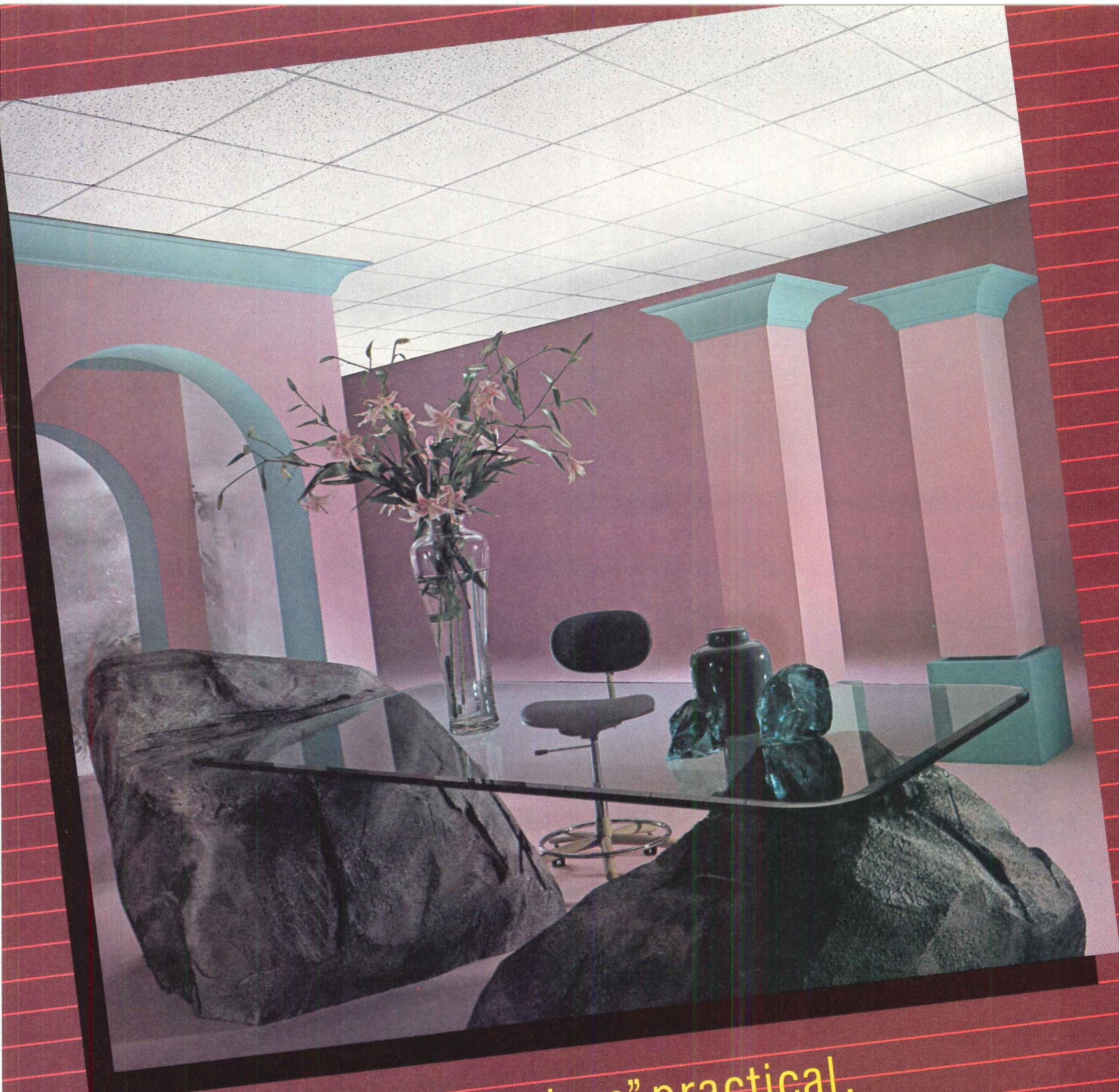

Donn makes "premium" practical.

Donn Thinline™ ceiling grid system gives you the look of a premium, tailored ceiling for a lot less than you expect. ■ The Thinline System uses standard, square edge, 2' x 2' or 2' x 4' acoustical panels instead of expensive reveal edge panels. That alone can save you 20%. ■ Get the look of fine architectural detailing for less with the Thinline ceiling grid system. Donn makes a premium ceiling look practical.

Donn makes sense.

©1983, Donn Corporation

DONN

DONN CORPORATION

1000 Crocker Road ■ Westlake, Ohio 44145 ■ (216) 871-1000

Circle 1084 on inquiry card

Hartco solid oak meets the code in critical fire areas.



Hartco Acrylic Impregnated Solid Oak Parquet flooring with wood back meets the requirement for a Class B Flame Spread Rating, (ASTM E-84) and a Class I Rating from the Radiant Panel Test. Now you can specify the warmth and beauty of Hartco Solid Oak in projects where fire retardant materials are required. Hartco oak flooring can beautify projects such as hospitals, nursing homes, child care facilities, hotels.

No premium price.

Wood back Hartco Acrylic Impreg-

nated Solid Oak Parquet is immediately available through your local Hartco distributor. No special order. No premium price. The Fire Rated material is now a Hartco standard. Not an expensive option.

Best cost per foot.

Hartco Solid Oak Parquet may cost a little more than other floor materials. But ease of installation and maintenance combined with exceptional durability make it a superior, cost-efficient floor in the long run.

When your design calls for a natural, beautiful, long-wearing

floor in a fire sensitive area, specify Hartco Acrylic Impregnated Solid Oak Parquet. It meets the fire rating standards beautifully.

For more information see Sweet's 9.22/Hat. Call Sweet's Buyline toll-free. Or contact Hartco, Incorporated, Oneida, Tennessee 37841. Telephone 615-569-8526.

 The
Quality
Wood
Hartco Flooring

Circle 1085 on inquiry card

You can really get "burned" with substitute products that cost more than ceramic tile!



Why are so many floor and wall products available in "tile" patterns? Obvious! Genuine ceramic tile has an almost universal appeal. For ages, the inherent natural beauty and low maintenance durability of ceramic tile have made it the preferred product.

But in every comparison, the imitators can't stand the heat . . . they can char or ignite and some emit dangerous toxic fumes when burned.

**Don't
Get Burned by
Quarry Tile
Imitations!**

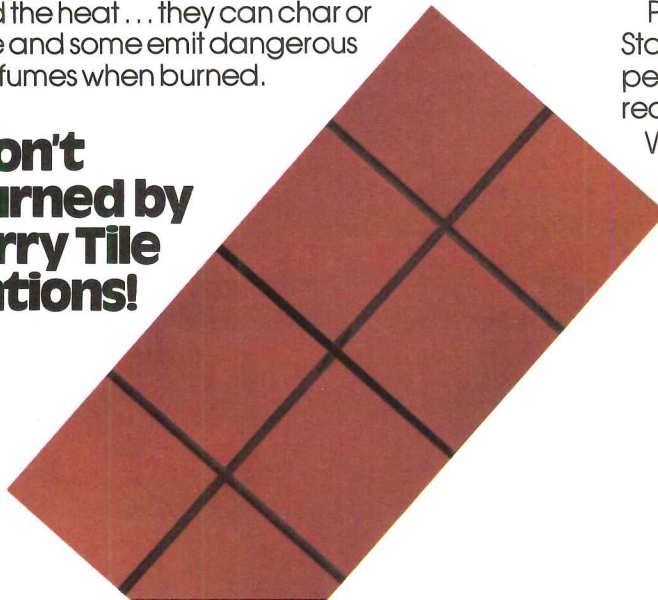

Genuine ceramic tile won't dent, fade, rot, peel, blister, warp, splinter or ever need waxing.

For everyone who wants the real tile look but thinks it's too costly, let's compare total costs . . . the substitutes lose again – by significant margins. Recent studies show that genuine ceramic tile costs less.*

Perhaps these are the reasons why the United States is entering the "ceramic era" . . . value, performance and product integrity will be the real buying influences.

Write Summitville Tiles, Summitville, OH 43962, for your copy of "Life Cycle Cost Study,"

*Tile Council of America, Inc. 1979 Comparison Report.

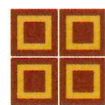

Summitville®

Member: Tile Council of America/CTDA/Construction Products Manufacturing Council

Circle 1086 on inquiry card

FINALLY. CLASS I ANODIZING IN A WIDER RANGE OF COLORS.

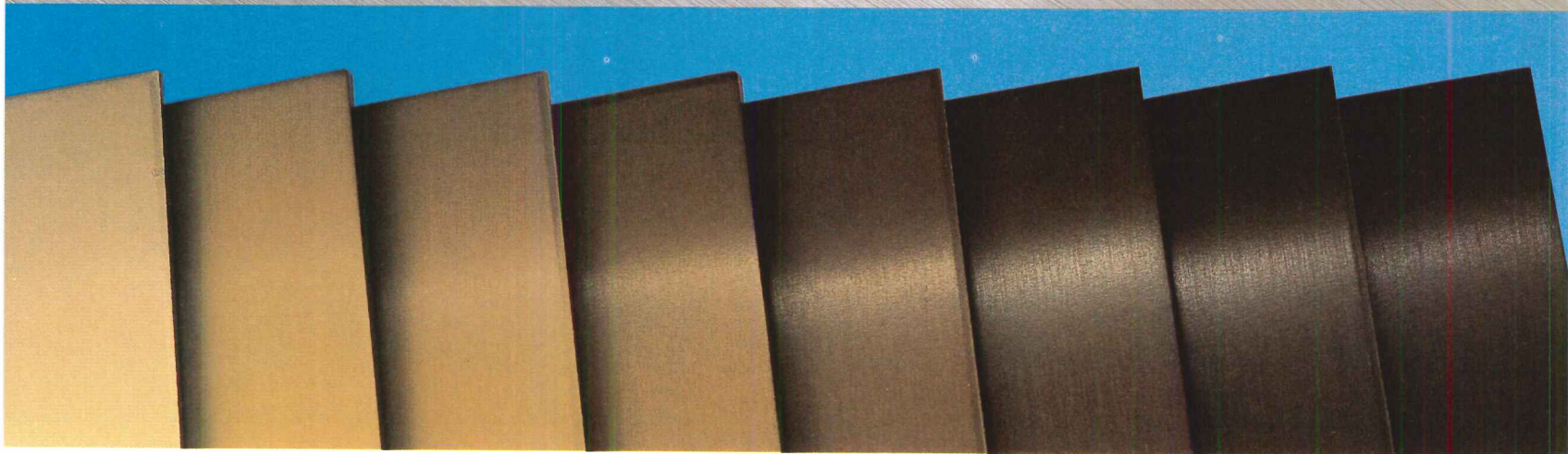

Amchem's remarkable P3 almeicolor™ system can create a range of electrolytic colors from pale champagne to a midnight black. And every shade and hue in between. P3 almeicolor permits anodizers to achieve Class I specifications with every color. So now you have a greater choice than ever before.

Best of all, any P3 almeicolor shade

you pick is reproducible. Time, after time, after time. There's minimal batch to batch variation. And P3 almeicolor™ electrolytic coloring is useable with every frequently specified aluminum alloy.

Where do you find a source for this consistently impressive new electrolytic coloring process? By calling us at

Amchem. Even though we don't anodize aluminum, we market chemicals and technology to color it. So we're a good source for a good anodizer who's close to where you work.

For a free package of information on P3 almeicolor™ and a list of the anodizers who use it, write or call Amchem Products, Inc., 19002. (215) 628-1000.

Circle 1087 on inquiry card



a Henkel company



In hotels:
Carpets of Antron® perform with style.

*Du Pont registered trademark. Du Pont makes fibers, not carpets.

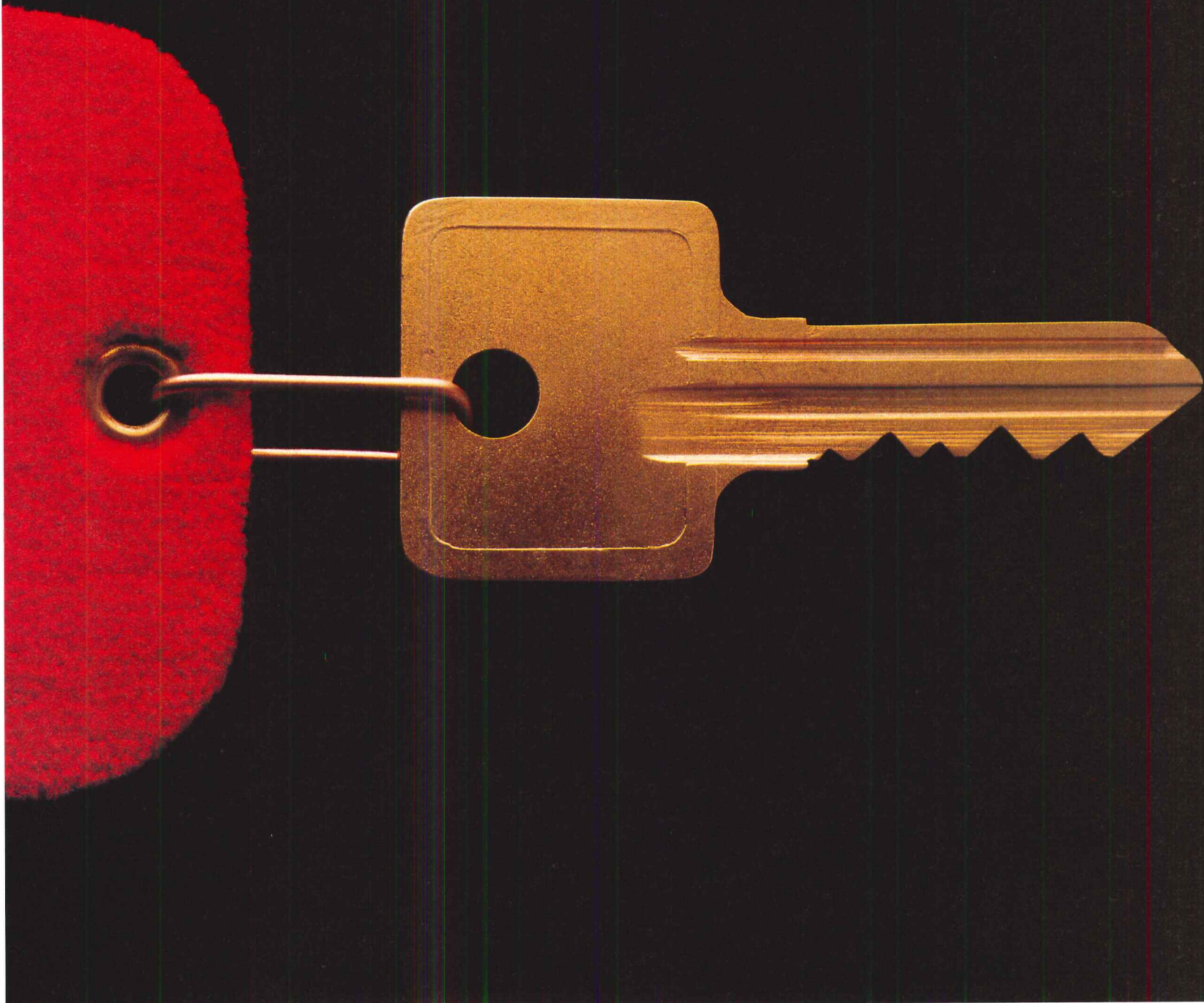

When The Beverly Wilshire and The Waldorf-Astoria—as well as many of America's other leading hotels—"roll out the red carpet," that carpet is DuPont ANTRON.*

Only ANTRON nylon can bring your most exciting designs to life in so many styles and colors and textures. More than any other single carpet fiber.

Carpet of ANTRON has the stamina to stand up to the pounding of hundreds of thousands of feet. And luggage carts and laundry carts and serving carts. And still look good.

And in restaurant and bar areas, carpet of ANTRON can

take almost anything the staff—or guests—dish out.

In short, carpet of DuPont ANTRON projects a look of luxury, while providing the soil, stain and wear-resistance that means lasting beauty with easy maintenance.

That's performance with style. And that's what makes DuPont ANTRON the most specified commercial carpet fiber in America.

For a free copy of our new Specification Guide, write DuPont Carpet Fibers, Rm. X-39830, Wilmington, DE 19898.

DUPONT ANTRON® AMERICA'S MOST SPECIFIED CARPET FIBER.

Circle 1088 on inquiry card



New
USG[®]
Acoustical-Plus
spray
texture
absorbs
sound,
resists fire.

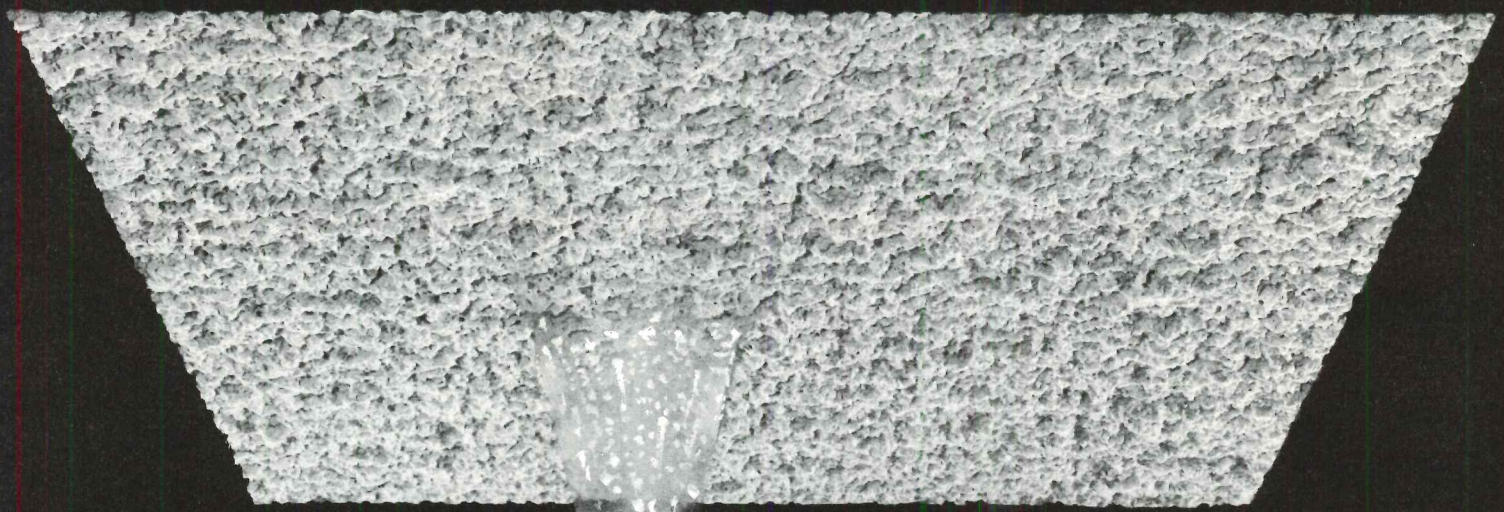

Another U.S.G. first! A multi-function spray texture finish, specially-formulated to meet today's concrete ceiling needs ... *old or new!* New USG[®] Acoustical-Plus Spray Texture is in a class by itself. Sound-rated .40 at 1/2" thickness. Class A Flame Spread rating. And an aesthetically pleasing difference in appearance. You'll find USG[®] Acoustical-Plus Texture elegantly suited for commercial, institutional, high rise apartments and retrofit construction.

- *Call your U.S.G. Representative. Or write to us at 101 S. Wacker Dr., Chicago, IL 60606, Dept. AR1283*

UNITED STATES GYPSUM
BUILDING AMERICA

©1982 United States Gypsum

10 Specialties

UCI 10, Specialties:
 Access flooring
 Fireplaces
 Flagpoles
 Identifying devices
 Lockers
 Partitions
 Pest control
 Storage shelving
 Sun control devices
 Toilet and bath accessories
 Wardrobe specialties



362



365

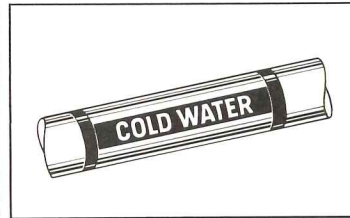

368

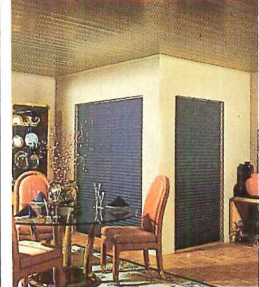

371

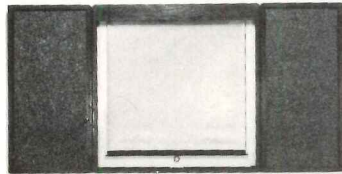

363

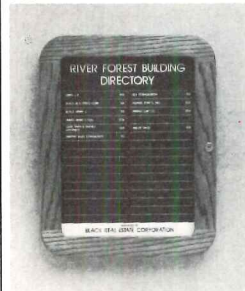

366

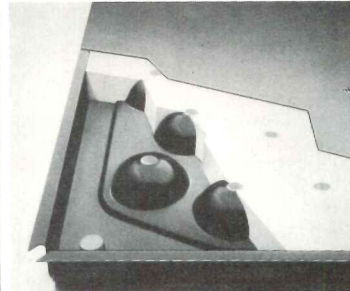

369



372

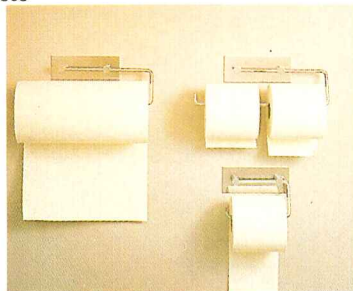

364

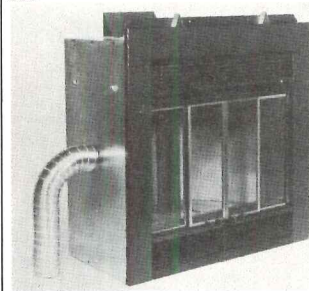

367



370

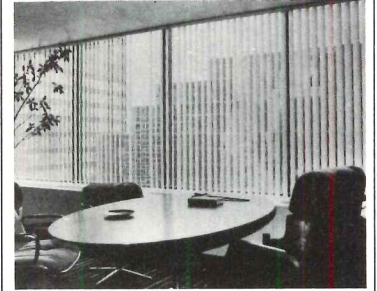

373

362 Shower seat

The slats in a folding shower seat are made of *Colorium*, an integrally colored solid material consisting of polymer resins. The seat also features a stainless steel frame, support braces, hinges and bolts. Slats come in 5 colors. The Charles Parker Co., Meriden, CT.

363 Presentation cabinet

A 4- by 4-ft wood cabinet contains a tack board, a white porcelain enamel writing surface and an optional 40- by 40-in. projection screen or fluorescent light. The cabinet is 3½ in. deep and comes in oak or walnut. Claridge Products & Equipment, Inc., Harrison, AR.

364 Tissue roll holders

Designed by Arne Jacobsen and selected for The Design Collection at the Museum of Modern Art in New York, these kitchen and bathroom tissue roll holders are made of brass and come in 10 epoxy colors, polished brass or chrome. Kroin Inc., Cambridge, MA.

365 Soap dispensers

Models *B-111* and *B-112* soap dispensers feature corrosion-proof liquid valves designed to prevent leaking and clogging. Large tank openings allow for quick and easy filling and, to prevent vandalism, hinged stainless steel tops can be locked. Bobrick Washroom Equipment, Inc., Los Angeles, CA.

366 Directories

A line of directories is available with square or radius corners on frames of solid oak, walnut or any other hardwood. They also come with glass and *Lexan* frames. Directories are 2 in. deep and are custom made to match furnishings. Best Manufacturing Co., Kansas City, MO.

367 Fireplace

The *Energy Miser* features an air-flow design that takes air in through the hottest parts of the firebox. Louvers above the heat return panel force air out into a room. The fireplace comes with sliding glass doors framed in antique brass. Preway, Inc., Wisconsin Rapids, WI.

368 Pipe markers

Opti-Code pipe markers are made of pressure-sensitive vinyl and have letter heights and colors and background colors that comply with ANSI and OSHA standards. Special markers with symbols, foreign languages or custom color coding systems may be ordered. Seton Name Plate Corp., New Haven, CT.

369 Access floor system

ConCore floors consist of 24-in.-square steel panels filled with a cementitious material. The system is designed to support rolling loads, such as automated mail carts, and is claimed to be acoustically superior to other systems. Tate Architectural Products, Inc., Jessup, MD.

370 Ceramic tile stoves

The design of 4 models of wood- and coal-burning ceramic tile stoves features a cast iron firechamber surrounded by thick ceramic tile sections with an air space in between to allow for primary and secondary combustion. Stoves come in 8 different colors. Ceramic Radiant Heat, Lochmere, NH.

371 Shades

Sunpleat shades come in translucent, opaque and opaque metalized woven polyester. Shades feature a flush-mounted cord locking system. Shade fabrics are available in widths up to 60 in. and in a wide variety of colors. Hunter Douglas, Inc., Maywood, NJ.

372 Automated daylighting

A daylighting system combines exterior movable louvers and electronic controls to respond automatically to the sun's position, thermostat readings and changing light conditions. The system is claimed to cut lighting costs by up to 70 per cent. The Moore Co., Marceline, MO.

373 Vertical blinds

Bali Classics vertical blinds feature vanes made of aluminum, PVC, laminates and a variety of fabrics. Blinds are available in widths from 24 to 186 in. and lengths from 36 to 144 in. They come in a wide selection of colors. Marathon Carey-McFall Co., Houston, TX.



374



377

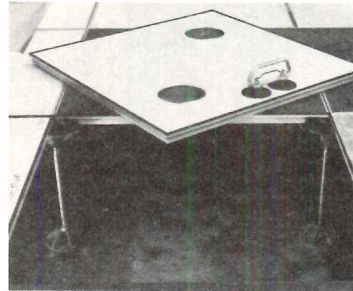

380

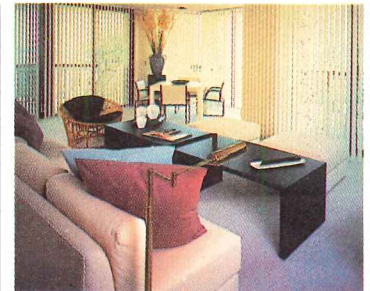

383

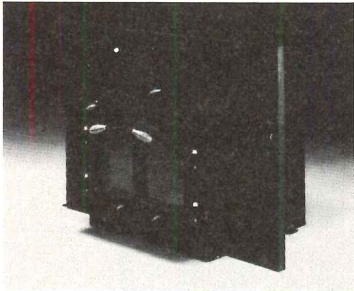

375



378

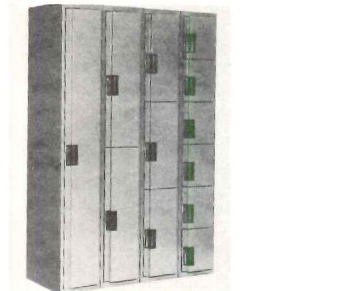

381



384

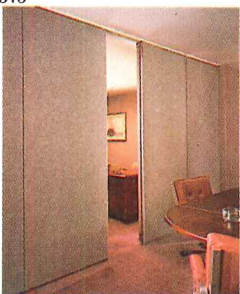

376



379



382

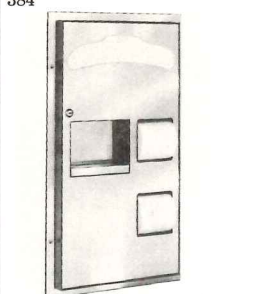

385

374 Roll-down shutters

Soleil roll-down shutters come in naturally finished Douglas fir or extruded aluminum. They are lockable and meet South Florida Building Code requirements for hurricane protection. Shutters are available with electrically operated cranks. ELR Enterprises, Inc., Miami, FL.

375 Fireplace insert

The UL-listed *Accent* insert is designed to turn a fireplace into a heating system without ruining esthetic appeal. It is available in 3 sizes with 3 door styles. Available door inserts include clear and etched ceramic glass and cast iron. Majestic Co., an American Standard Co., Huntington, IN.

376 Operable walls

Moduflex Series 800 operable walls feature 14-gauge steel frames welded to 14-, 20- or 24-gauge steel faces. They are faced in wood veneers or laminates and come in heights from 8 to 48 ft. Walls carry acoustical ratings to STC 54. Panelfold, Inc., Miami, FL.

377 Wash station

The *Handi-Wash* is an all-in-one surface-mounted unit for washing. It is made of type 304 satin finish stainless steel with 3 push buttons on the front panel, one each for soap, water and warm air. Water and air are controlled by an adjustable timer. The Charles Parker Co., Meriden, CT.

378 Vinyl louvers

Hanging solid vinyl louvers serve as vertical blinds; they are suspended from tracks, and each louver rotates 180 deg. They are said to be more effective in reducing heat loss than horizontal blinds because they can be closed more tightly. LouverDrape, Inc., Santa Monica, CA.

379 Small article lockers

Aluminum *Mini-Check* lockers have stainless steel locking mechanisms that are coin and key operated. Units of 12 measure 24 by 19½ by 7½ in. Accessories include 2 spare lock cylinders and 6 masonry mounting anchors per module. American Locker Security Systems, Inc., Jamestown, NY.

380 Access flooring

The panels of this access flooring system are available in sizes up to 60 by 60 in. They have laminated aluminum honeycomb cores and are supported by adjustable pedestal heads. A 4-by-4-ft panel weighs 45 lb. H.H. Robertson Co., Pittsburgh, PA.

381 Lockers

Val-Tec steel lockers, finished in baked enamel, feature reinforced shelves and recessed handle and padlock hasps. Double-paneled doors have offset inner and outer louvers for indirect ventilation. Nylon catches keep doors from slamming. Lyon Metal Products, Inc., Aurora, IL.

382 Towel rings/brackets/bars

Towel bars, rings and brackets are made of brass and come in 10 epoxy colors, polished brass or chrome. They were designed by Arne Jacobsen and were selected for The Design Collection at the Museum of Modern Art in New York. Kroin Inc., Cambridge, MA.

383 Vertical draperies

Flexalum vertical draperies come in a variety of wool, acrylic, PVC and aluminum vanes. They can be used as room dividers and are said to be suitable for oddly shaped windows, angles or arches. Hunter Douglas, Inc., Maywood, NJ.

384 Acoustical panels

The *Group 1600* acoustical panel is available with an optional electrified base (shown). Freestanding panels come curved or straight and are available in a variety of sizes and a wide range of colors. Conwed Corp., St. Paul, MN.

385 Dispenser

The *Model 590 Series* includes units that have dual-roll toilet tissue dispensers, toilet seat cover dispensers and flip-type ashtrays. They feature 1-piece heavy-gauge stainless steel doors with tumbler locks. Bradley Corp., Menomonee Falls, WI.

10 Specialties Product literature

For more information write item numbers on Reader Service Cards



386 Fireplace/stove
A 12-page brochure features the *Fireplace/Stove*, a stove unit on wheels, which fits snugly into a fireplace. Section details illustrate the stove's design and function. Photos of installations and specifications are included. The Vermont Stove Co., Shelburne, VT.

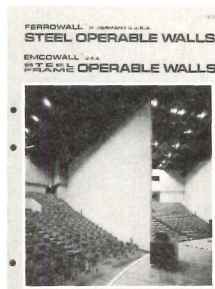

392 Operable walls
Photos show several models of 2 different types of steel operable walls in a 12-page color brochure. Graphs show acoustical properties and details show suspension, seals and head construction. Design options are also illustrated. Specifications are listed. EMCO, Inc., Lenexa, KS.

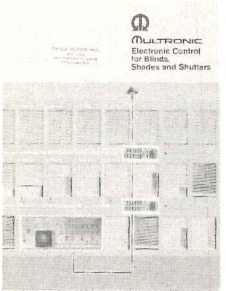

387 Automatic blinds
A 4-page brochure describes custom, computer-controlled operating systems for blinds and shutters. As described, controls may be programmed to respond to storm warnings, to sunlight sensors and to the time of day. Multronic-Zurich AG, Dist. by Swiss Blinds, Inc., DesPlaines, IL.



393 Access flooring
The *S-Floor*, a stringerless elevated modular slab access flooring system, is described and illustrated in an 8-page color brochure. Specifications feature assembly details, including ramps, which list flooring components. Innocrete Systems, Inc., a subsidiary of Construction Specialties, Inc., Cranford, NJ.

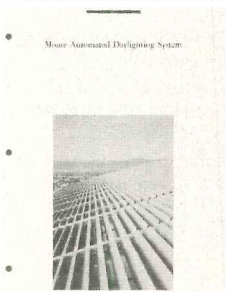

388 Daylighting
The *Mark III* automated daylighting system, with modular louvered units and manual or automatic operation, is featured in a 16-page brochure. Details show louver and electric actuator designs. Operation with other building controls is described. The Moore Co., Marceline, MO.



394 Interior signs
Interior sign systems for offices, including directories, tackboards and poster holders, are illustrated in a 4-page color brochure. Installations of each type of sign available are shown. Architectural Signing, Inc., Marina Del Rey, CA.

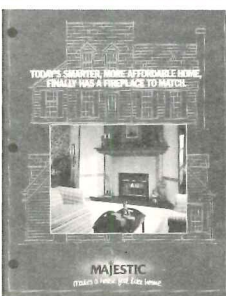

389 Heat-circulating fireplace
The *Energy Circulator* fireplace is featured in an 8-page brochure. Drawings show how it circulates heat and how it is installed. Photos show typical installations. An accessory and chimney component selection guide is included. Majestic Co., an American Standard Co., Huntington, IN.

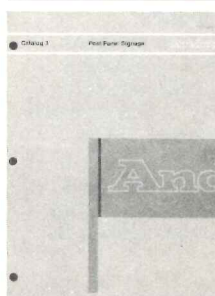

395 Sign systems
Several series of illuminated and nonilluminated post/panel signs are shown in section details and described in a 12-page brochure. Photos showing installations, tables of available dimensions and mounting configurations and information on specifying are included. Andco Industries Corp., Greensboro, NC.

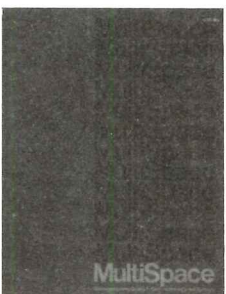

390 Lockers
Lockers made of 3/4-in. high-density industrial flakeboard and surfaced in vinyl and high-pressure laminates are featured in a 20-page color brochure. Photos show installations and individual units. Locker door and installation specifications are included. P.S. Hurlbut, Inc., Santa Clara, CA.



396 Washroom accessories
A 40-page catalog includes dispensers, receptacles, grab bars and cabinets. Diagrams with dimensions accompany descriptions of each model shown. Accessories, such as soap dishes, towel bars and coat hooks are also shown and described. A & J Washroom Accessories, Peekskill, NY.

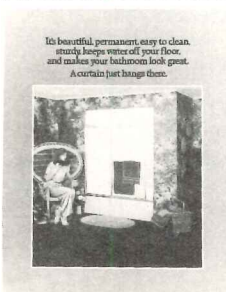

391 Shower doors
Several installations of sliding and swinging shower doors are shown in photos and described in a 12-page color brochure. Detail photos show track systems, adjustable pivot jambs and available finishes. Howmet Aluminum Corp., Architectural Products Div., Terrell, TX.



397 Barrier-free phone booths
A 4-page color brochure covers 4 models of barrier-free phone booths, all of which feature a vandalproof mounting system. Details with dimensions and photos illustrate each model and the mounting system. Specifications are included. Acoustics Development Corp., Northbrook, IL.

For more information
write item numbers on
Reader Service Cards



398 Soap dispenser
Built-in and surface-mounted liquid and powdered soap dispensers are featured in a 4-page brochure. Photos and diagrams with dimensions illustrate available models. Specifications are included. U.S. Borax, Los Angeles, CA.

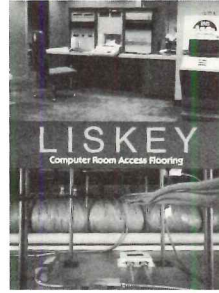

404 Access flooring
Liskey computer room and general office access flooring systems are described and illustrated in a 16-page color brochure. Tables list respective design loads and grid systems. Sections show support system details. Specifications are included. Donn Corp., Westlake, OH.



399 Signage
The 28-page *83/84 Architectural Graphics Handbook* includes information on processes and materials, frames, mounting methods, symbols and interior graphic systems. Available colors and specifications are included. Mohawk Sign Systems, Div. of Mohawk Engraving Co., Inc., Schenectady, NY.

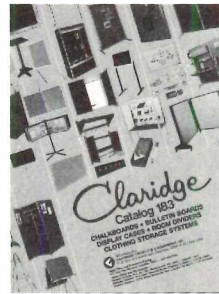

405 Chalkboards
Chalkboards, bulletin boards and projection screens are among the items shown and described in a 72-page color catalog. Lecterns and display cases are also featured. Construction, prices and available sizes are listed for all models. Claridge Products & Equipment, Inc., Harrison, AR.

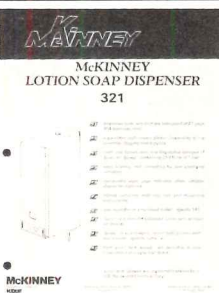

400 Soap dispenser
A product data sheet features the 321 surface-mounted stainless steel lotion/soap dispenser. A diagram illustrates dimensions. Technical data include information on construction and installation. McKinney, a subsidiary of Kidde, Inc., Scranton, PA.



406 Signs
Exterior and interior illuminated and nonilluminated signs are featured in an extensive color catalog. Information is included on typography, symbols and specifications. Available colors and finishes are illustrated. Architectural Signing Inc., Marina Del Rey, CA.

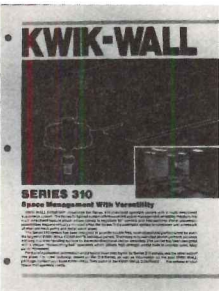

401 Operable panels
A page of literature features *Series 310* system of operable panels with multidirectional carrier assembly. A photo shows a typical installation, and a diagram shows a typical floor plan. A reference guide gives panel dimensions and weights. Kwik-Wall Co., Springfield, IL.

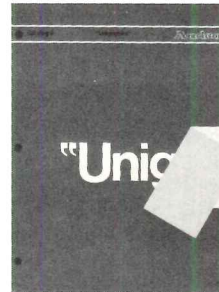

407 Graphics
Unigraphics, computer-generated graphics produced on vinyl or reflective film, are described and illustrated in an 8-page brochure. Available type faces and symbols are shown and colors are listed. Application instructions are included. Andco Industries Corp., Greensboro, NC.

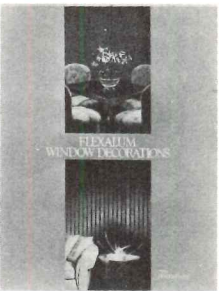

402 Blinds
Photos show residential installations of *Flexalum* window blinds and room dividing blinds throughout a 16-page color brochure. Materials and colors in which blinds are available are illustrated. Hunter Douglas, Inc., Maywood, NJ.



408 Folding gates
Several types of single and double folding gates, including portable models, are shown in line drawings in a 16-page brochure. Details show locks, track mounting, gate construction and installation. Specifications are included. Acorn Wire and Iron Works, Inc., Chicago, IL.

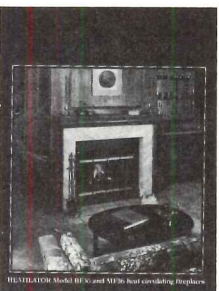

403 Fireplace
Photos show components and installations of a convective and radiant heating fireplace in a 4-page color brochure. A cut-away drawing illustrates fireplace construction, and diagrams give dimensions. Options of bifold glass doors and an outside air kit are also shown. Heatilator, Inc., Mt. Pleasant, IA.



409 Display structures
Tubular steel structural systems for displays, exhibits, store fixtures and furniture are illustrated and described in a 4-page brochure. Photos show typical applications as well as system components. Accessories, such as casters, adjustable legs and lights are also featured. Abstracta Structures, Inc., New York, NY.

S-FLOOR, THE NO-POUR ACCESS SLAB!

Poured slab floors have been doing a great job for a long time. They're strong and feel solid underfoot. But, the "eighties office" imposes new demands. Changing computer terminals, open plans and their need to be easily re-configured often exceed the scope of traditional slab floors. And, raceways, flat wire systems and the like are partial solutions at best. You just can't hide air handling ducts or pipe conduits under a carpet!

Enter *Innocrete's S-Floor*. Now architects and owners alike can specify a floor system which combines the solid feel of a poured slab with the total accessibility of a *stringerless*, raised modular floor. It's S-floor, and please don't confuse it with products adapted from computer flooring. S-Floor will not creep, rattle, shake or become deformed under normal rolling loads.*

S-Floor's remarkable properties: exceptional strength, yet dramatically lower weight than concrete are the result of intensive research and space-age materials. Beginning with the Innocrete compound, two foot square panels are formed into mini-slabs, each

with an engineered reinforcing steel-grid network. Panels are then torque fastened into the floor system resulting in a stable mass you have to walk on to believe. Of course, one or several panels may be removed at any time without disturbing the system's integrity.

Since S-Floor helps prevent premature building obsolescence many users predict it can quickly pay for itself.

So if total flexibility is for you, look into S-Floor's elevated modular slab. Call or write for literature or samples, without obligation, of course.

*Independent lab test report available.

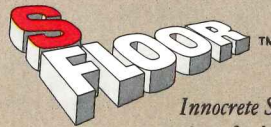

Innocrete Systems, Inc.

Cranford, New Jersey, Tel: (201) 272-0573

Mississauga, Ontario, Tel: (416) 274-1490

Al Khobar, Saudi Arabia, Tel: 857-4984

Circle 1090 on inquiry card



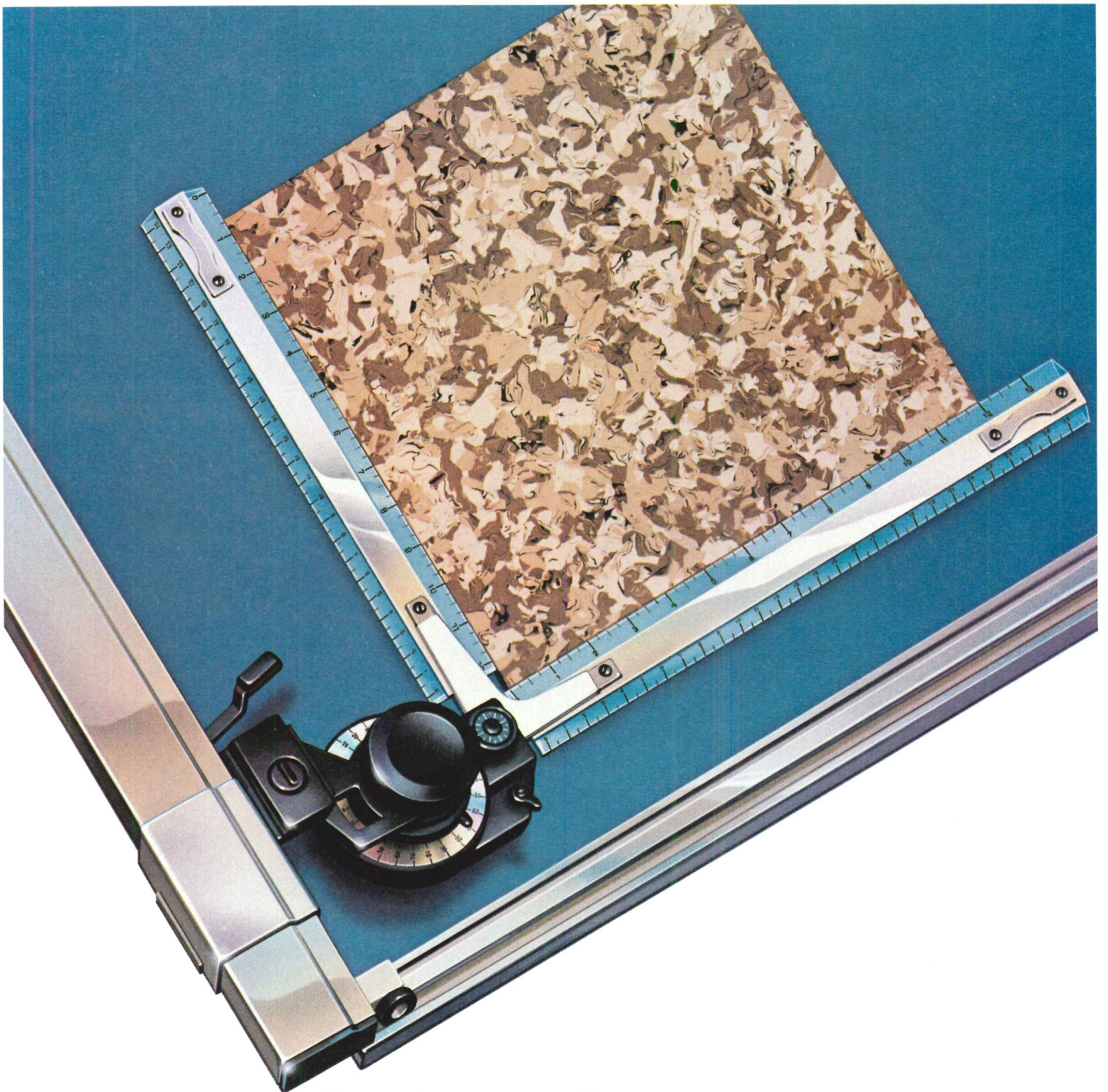

Our better fit begins with our better fitness program.

You can't get a better fit with any other tile! VPI solid vinyl tile is Micro-squared,[™] a VPI exclusive that gives you tighter fitting floors with a virtually seamless appearance.

Vertical edges are cut perpendicular to the surface, too. And gauge is precision controlled to eliminate high edges and assure a smooth, continuous surface. No other tile manufacturer goes to such lengths to make sure you get the very best flooring results.

And VPI solid vinyl tile shows its quality year after year. It keeps its good looks under hard use, and even abuse. It resists indentations and

shrugs off most common chemical spills. Its resiliency makes it easy on the legs. And it stays attractive with routine washing and spray buffing.

VPI solid vinyl tile. Micro-squared to fit, manufactured to keep looking fit. Available in 12" x 12" tiles and a variety of handsome colors and patterns. For information write VPI, 3123 South 9th Street, P.O. Box 451, Sheboygan, WI 53081. Or call 414-458-4664.

2108

VPI FLOOR PRODUCTS

Circle 1091 on inquiry card



Forget everything you thought you knew about floor-to-ceiling wall panels!

Especially if you associate "movable" with skilled labor, dust and debris, permanent attachments and personnel disruption.

Introducing Spacesetter III; a unique, completely portable floor-to-ceiling wall panel unlike anything else available.

With Spacesetter III portable panels you can anticipate the inevitable changes in personnel and equipment that come with growth and success. You'll keep your options open for tomorrow without sacrificing the privacy and sound control you need today. When your office layout begins to become uncomfortable or inefficient, Spacesetter III can be relocated simply and quickly without affecting the daily routine.

Meet the challenge of planning for the present and the future.

Spacesetter III panels enable you to relocate permanent-looking floor-to-ceiling walls whenever and wherever you need them. They're available with all the options you're ever likely to need, including doors, windows, transoms and electrical circuits. Changes of any type can be absorbed in hours instead of days without loss of comfort, efficiency and morale.

Get a whole new perspective on portable panels with Spacesetter III. For more information, contact the company that's first in walls that move. Write Modernfold, Box 310, New Castle, Indiana 47362. Or call (317) 529-1450. In Canada, write P.O. Box 399 - Station E, Toronto, Ontario, M6H9Z9, Telex: 27-2285.

Modernfold

An American-Standard Company

AURORA

QUICK-LOK®

S H E L V I N G S Y S T E M S

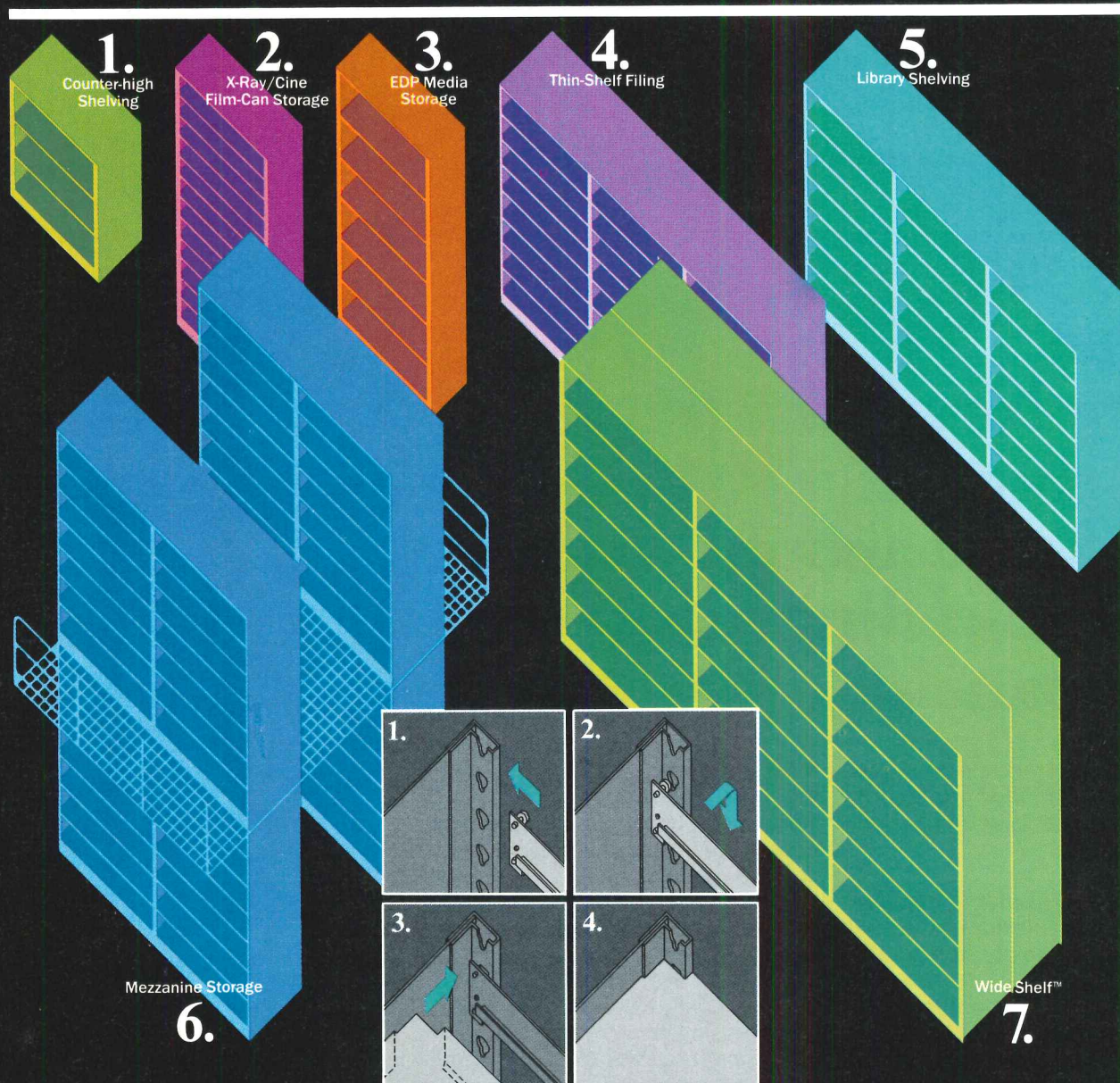

Aurora Quik-Lok®...The Shelving Concept That Grows With You.

The key to effective use of storage space is flexibility. Question is, can your specified storage system be reconfigured to meet the client's growing needs? Aurora's solution is Quik-Lok®... the freshest idea in shelving in the last 25 years. And it's so simple—3 components (1) uprights; (2) shelf supports and (3) shelving panels are

available in a wide range of sizes...ready to be configured to any storage criteria. No hardware is needed for assembly, so units can be rearranged or relocated...fast. Office, commercial, warehouse, industrial...Quik-Lok® works. Create storage spaces that work for you and let your imagination grow with Quik-Lok.®

Aurora Steel Products, 580 South Lake Street, Aurora, IL 60507, Tel: (312) 892-7696



Circle 1093 on inquiry card

Sheer Elegance.



Panelfold introduces Moduflex® Series 800... a new generation of high performance, all-steel operable walls. New four inch thick panels engineered to offer total flexibility in space planning for executive suites... for hotel/resort conference centers... for megaconvention centers.

Featuring outstanding acoustical qualities with sound control to STC 54 and sound absorption to NRC.90. A wide choice of panel surfaces that wrap around the vertical edges for a sheer look that will satisfy the most discriminating tastes.

A steel operable wall that outperforms most permanent walls.

Moduflex®
SERIES 800
New from
Panelfold®

Panelfold, Inc. PO Box 680130 Miami, Florida 33168 (305) 688-3501 Telex 52 3173

Circle 1094 on inquiry card



Scanamurals® make walls work.

Depending on your imagination, a 3M Scanamural® wall can project anything from a Caterpillar coming on strong, like this one at the Wheeler Machine Co. in Salt Lake City, to a peaceful panorama of a mountainside. It enables you to add vistas, depth, mood, history, corporate identity and excitement to virtually any dimension you design or remodel. Walls several stories high, long hallways, curved walls, even moveable office partitions come alive with Scanamurals.

But behind the showmanship is common sense. The Scanamural process actually computer-generates the color

image using durable, fade-resistant pigmented paints. A Scanamural can be made from original art, photo, transparency, oil painting or litho print. Depending on your choice of substrate — canvas, vinyl, carpet or polyester — you can even make a Scanamural graffiti resistant, fire retardant, sound absorbing, washable and anti-fungal. Beauty is as beauty does.

Find out more about Scanamurals. For more information, and the name of the Scanamural dealer nearest you, call (612) 778-5605. Or write 3M Architectural Murals Department, 3M Center, St. Paul, MN 55144.

3M hears you...

ID-1983015
Architectural Murals Department/3M
3M Center
St. Paul, MN 55144

3M

Circle 1095 on inquiry card

SPACESAVER

HIGH-DENSITY MOBILE STORAGE SYSTEMS



S

pacesaver understands the value of space... and commends its intelligent and creative use. By recapturing wasted non-productive aisles, we double storage capacity without increasing the original space... or save 50% of space with the same storage density.

Spacesaver is the leading manufacturer of high-density mobile storage systems in North America. Ongoing investments in superior engineering, advanced "state-of-the-art" electronics and dedicated personnel continuously yield innovative products that excel in the marketplace. Coupled with a life-long commitment to quality, Spacesaver assures distinctive high-density mobile storage systems in appearance, reliability and performance.

Spacesaver Corporation, 1450 Janesville Avenue, Ft. Atkinson, WI 53538 Tel: (414) 563-5546





Above, weekend overtime workers in various offices use local override controls to open own blinds to enjoy natural daylighting.

Large selection of colors offers alternative to dull, unattractive buildings and the sameness of standard dark glass vision bands.

free ~~and~~ Daylighting vs solar shading

"... the lowest life cycle cost and energy use were obtained with daylighting coupled with clear glazing and exterior sun-control blinds," according to a study of life cycle costs and energy use analyzing various sun control and daylighting options on high rise office buildings, commissioned by the **Department of Energy**.*

Consider these facts which affect office building operating costs:

FACT: 50% of the energy bill in a typical office is for artificial lighting.

FACT: 50% of office cooling energy is required just to remove heat generated by the artificial lighting.

FACT: 25–50% of the normally required tons of perimeter air conditioning can be eliminated by using **Baumann Exsotrol™™™ blinds**.

FACT: 50% of a commercial building's electric bill represents "peak demand"—the 30 minute period in the year when the most electricity is used.

Solar control—outside blinds, "7 times better" ... HUD***

The most effective way to stop solar heat gain is to block the sun before it strikes the glass. Exterior blinds are 7 times more effective for

cooling than interior window treatments. Clear glazing and **Baumann Exsotrol** blinds have a shading coefficient of 0.14—more protection from radiant and conductive heat than any tinted or reflective glazing and interior blind combination.

Daylighting—clear glass 10 times better

Clear glazing transmits 10 times more visible light than the best reflective glazing. With the blinds in their working position, every slat is a light shelf. Work stations 20 ft. from windows maintain an illumination level of 200–500 lux. Workstations near windows remain cool and glare free. **Baumann** blinds provide diffused "northlight" quality light on all elevations.

Using clear glazing alone as the daylighting concept only reshuffles the energy use ratio. Daylighting concepts are optimized when combined with **Baumann Exsotrol** blinds.

Flexibility—accept or reject the sun

Flexibility is the reason **Baumann Exsotrol** blinds are the most effective solar control product in the market today.

Just before the sun strikes the glass, the blinds can be lowered and adjusted to the proper angle to give 100% solar protection while allowing natural daylight to enter. The raising, lowering and adjustment of the blind slats may be motorized or manual. Motorized blinds can be computer controlled to respond to sun, wind, rain, time of day and weekend occupancy.

Having dark glass on a building is like wearing sun glasses 24 hours a day. Unlike fixed shading systems (including dark glass) **Baumann Exsotrol** blinds can be completely retracted when not needed on cloudy days, or when the sun is shining on other elevations. Blinds can be retracted on sunny winter weekends when solar gain is desirable, during window washing or window replacement.

Perfect protection for all seasons

Unlike overhangs, setbacks or fixed louvers, **Baumann Exsotrol** blinds provide 100% shading of the glass, regardless of season or elevation.

Overhangs are designed primarily for protection against the south summer noon sun. They are impractical on east and west elevations, and

ineffective against the glare and heat of low sun angles during fall, winter and spring.

Baumann blinds \$ave more than they cost

- Eliminate up to 50% of perimeter air conditioning.
- Eliminate need for costly special glazing.
- Eliminate need for most interior window treatments.
- Reduce perimeter lighting requirements.
- Lower "peak demand" and total electrical operating costs for the life of the building
- Provide excellent hurricane protection.
- When programmed as movable insulation, help stop winter nighttime heat loss.

Send for additional information. Also available from Baumann: rolling shutters and European Style awnings.

IF YOUR BUILDING HAS WINDOWS, IT NEEDS BAUMANN BLINDS.

**Baumann, Inc., Box 160
Barrington, IL 60010
1-800-247-8368 in IL (312) 526-7755**



*Report LBL-12298 of DOE contract W-7405-ENG-48 with Lawrence Berkeley Laboratory.

***U.S. Department of Housing and Urban Development publication, "In the Bank or Up the Chimney?"

**Exsotrol = EXterior SOLar conTROL

Circle 1097 on inquiry card

11 Equipment

UCI 11, Equipment:
 Bank & vault equipment
 Darkroom equipment
 Food service equipment
 Laboratory equipment
 Laundry equipment
 Library equipment
 Loading dock equipment
 Medical equipment
 Parking equipment
 Residential equipment
 Waste handling equipment



410

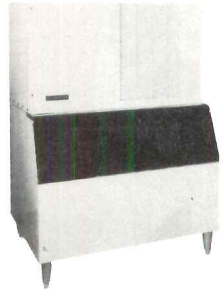

413



416



419

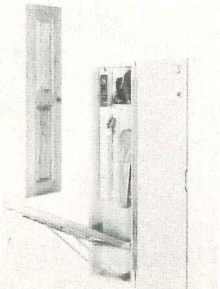

411

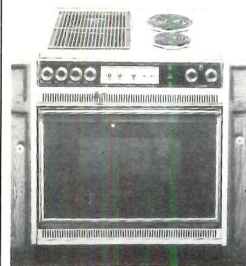

414

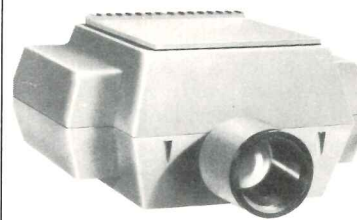

417



420

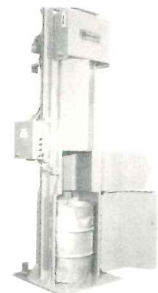

412



415

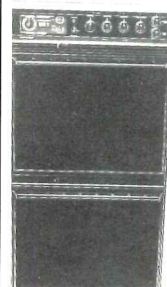

418



421

410 Dock lifts

The 6000 Series has 3 models: a 6-by 8-ft, 5,000-lb-capacity unit for manual pallet jack loads; a 6-by 10-ft, 8,000-lb-capacity unit for small powered equipment loads; and a 6-by 12-ft, 12,000-lb-capacity unit for fork truck loads. Advance Lifts, Inc., St. Charles, IL.

411 Ironing center

Sized to be recessed between studs, an ironing board cabinet features a piano-hinged door and a 42- or 46-in. ironing board as well as an iron storage shelf and an electrical outlet with an automatic timer and signal light. Board height is adjustable. Iron-A-Way, Inc., Morton, IL.

412 Drum packer

A 10-ft-2-in.-high drum packer is capable of compressing many types of material, including contaminated wastes, into a 55 gal. drum. It has a 10 HP motor, weighs 2365 lb and handles drums measuring 35 in. high, 23 in. in diameter. Maren Engineering Corp., South Holland, IL.

413 Ice cube maker

The C-065 model ice cube maker provides 626 lb of cubes in 24 hours. It is available with stainless steel exterior panels and comes with air-cooled, water-cooled or remote condensers. Crystal Tips Ice Products, Minneapolis, MN.

414 Drop-in range/oven

A modular drop-in range/oven with surface ventilation for island installation features a 2-speed blower with a 520-cfm capacity. A number of stainless steel cooktop modules are available for barbecue, canning and rotisserie. Self-cleaning is standard. Dacor Corp., Pasadena, CA.

415 Industrial load transporter

A computer-controlled unit load transporter is designed for industrial assembly and automated material handling applications. Steering orders are transmitted through an in-floor guidepath. Codes in the floor define locations. Eaton-Kenaway, a subsidiary of Eaton Corp., Salt Lake City, UT.

416 Laboratory fume hood

Protector Series hoods are of molded 1-piece fiberglass construction with epoxy-coated steel exteriors. Options include add-air or bypass models, explosion-proof models with or without service fixtures and integral or remote motor/blower models. Labconco Corp., Kansas City, MO.

417 Opaque projector

The AG100 projects horizontally from 2 to 20 times enlargement and, with a stand accessory, it will reduce 60 per cent and enlarge up to 3 times vertically. A copy cover holds copy flat to assure accurate projection. Artograph, Inc., Minneapolis, MN.

418 Microwave/electric oven

The Trimode Model DDO 880 is a microwave and electric double wall oven. Both the lower electric oven and the combination oven feature slow-cook operation, self-cleaning and lift-off doors. Modern Maid, Tipton, PA.

419 Drive-in teller station

The carrier opening of the Trans-Vista 2000 is at the top of the unit to accommodate customers in any size vehicle. The unit, housed in structural polystyrene, is 16 in. wide and fits into a 24-in.-wide island. Mosler, an American Standard Co., Hamilton, OH.

420 Compact kitchen

A compact kitchen includes a stove and a double-door unit housing a refrigerator and a zero-degree freezer. The refrigerator/freezer unit is surfaced in hardwood veneer. Cervitor Kitchens, Inc., South El Monte, CA.

421 Fold-out table cabinet

The Handi-Cabinet stores a 42-in.-long butcher-block-style table, which folds down and out. The cabinet also features pantry shelves. The entire unit can be recessed between the studs in a wall or surface-mounted. Iron-A-Way, Inc., Morton, IL.

11

Equipment Product literature

For more information
write item numbers on
Reader Service Cards

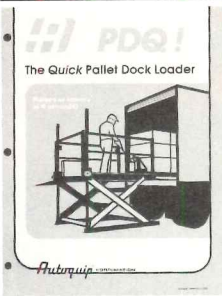

422 Hydraulic dock loader
The PDQ portable powered dock loader, said to raise or lower in 9 seconds, is outlined in a 4-page brochure. Photos and a diagram illustrate dock components. Dimensions are listed. Autoquip Corp., Guthrie, OK.



428 Appliances

A 52-page color catalog covers refrigerators, ranges, laundry equipment, dishwashers, air conditioners and dehumidifiers. Photos show individual models and detail appliance features. Tables list capacities and diagrams give dimensions. Kelvinator Appliance Co., Pittsburgh, PA.



423 Laboratory furniture
A 10-page color brochure features the *unicell* line of modular laboratory cabinets and work surfaces. Photos show installations and components and illustrate design features, such as rounded corners, and the bright colors in which the system is available. AMSCO/American Sterilizer Co., Erie, PA.

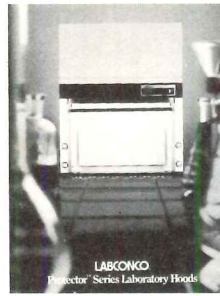

429 Laboratory fume hoods

A 16-page color brochure features the *Protector Series* of fume hoods. Photos show the different models available and a section drawing shows hood components. Diagrams with dimensions, tables listing performance data and specifications are included. Labconco Corp., Kansas City, MO.

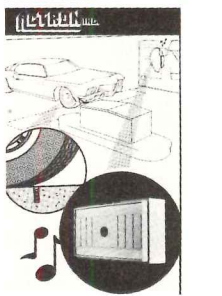

424 Drive-in teller alert
A page of literature describes an alert system that signals the approach of a car to a drive-in teller station by sounding a chime. An optional counter, which records the number of customers, and a carrier activator are also described. Actron, Inc., Elk Grove Village, IL.

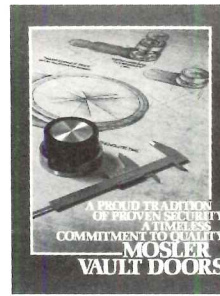

430 Vault doors

A packet of literature features product data sheets on 5 different vault doors. Each sheet includes a photo of a typical installation, diagrams with dimensions and information on locks. Other features, such as hinges, right- and left-hand swings and ventilation, are described. Mosler, an American Standard Co., Hamilton, OH.



425 Dock lifts
Standard features of the three *Series 6000 Superdocks* are covered in an 8-page color brochure. Internal cylinder stops, aluminum handrails and ramps and options of canopies and dock lights are illustrated and described. Specifications are included. Advance Lifts, Inc., St. Charles, IL.



431 Washer-extractors

A 6-page brochure features *Hydro-Cushion* open pocket extractors with capacities from 200 to 700 lb. Stationary, tilt-to-unload, and tilt-to-load/unload models are covered. Photos show washers and components, such as timers. Specifications are included. Pellerin Milnor Corp., Kenner, LA.



426 Car wash systems
A 4-page brochure features 3 different car wash systems. Systems are shown in photos as well as in diagrams with dimensions. Guidelines for determining the system needed are included. Hanna Industries, Portland, OR.

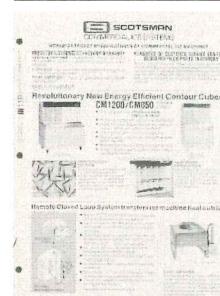

432 Ice systems

Several different models of ice cubers and flakers are featured in an 8-page brochure. Photos show each model along with lists of capacities and construction materials. Product selection charts include dimensions and technical data. Scotsman Ice Systems, Albert Lea, MN.

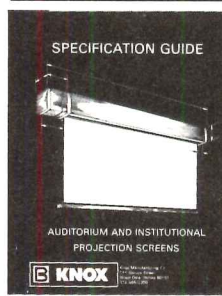

427 Auditorium screens
A guide features specification requirements for auditorium and institutional projection screens. Details with dimensions show installation options. A description of a low voltage system and a solution claimed to eliminate keystone are included. Knox Manufacturing, Wood Dale, IL.

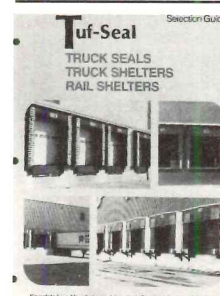

433 Dock seals and shelters

A 6-page color foldout brochure features truck seals and shelters and rail shelters. Photos show several installations, and drawings show standard equipment and options. A product selection chart, color chart and specifications are included. Tuf-Seal Corp., Muskego, WI.

12 Furnishings

UCI 12, Furnishings:
 Artwork
 Cabinets and storage
 Fabrics
 Floor mats
 Furnishing accessories
 Furniture
 Rugs
 Seating
 Window treatment



434

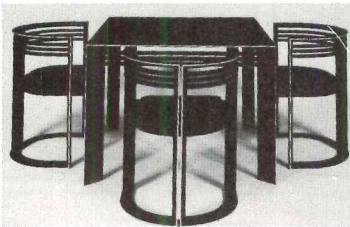

437



440



443

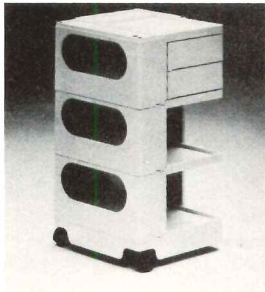

435

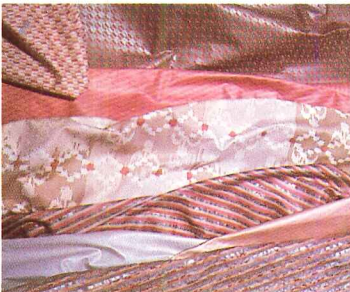

438

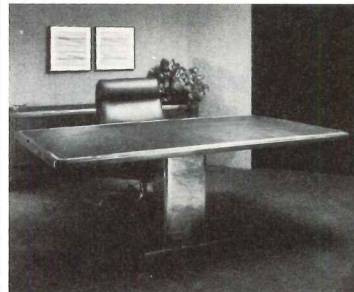

441



444



436

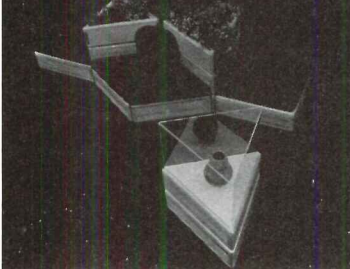

439

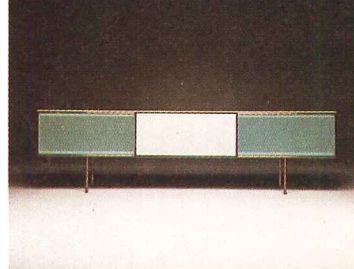

442

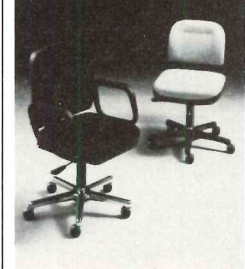

445

434 Textiles

Merrimack is a mohair and worsted wool blend with a steam finish. The weave, a variation of a classic cord, is a combination of vertical and diagonal cords. The fabric is available in 8 colors in a width of 54 in. Donghia Textiles, New York, NY.

435 Rolling taboret

The *Boby C* is a rolling taboret designed by Joe Colombo. It features 3-in.-deep drawers, large oblong accesses, modular shelving and 5 *Kevi* casters. It is available with 2, 4 or 6 drawers in a 21- or 30-in. height and comes in a choice of 5 colors. Bieffeplast USA, New York, NY.

436 Conference table

The #7321 modular octagonal conference table is part of the *Meteora Saddle Leather Series*, which includes desks, chairs and cabinets. All are covered in 3-mm-thick saddle leather. Conference tables are available in several sizes. The Pace Collection, Inc., New York, NY.

437 Tables and chairs

The *Petro Set* includes black tables and chairs with red and yellow detailing and finished in polyurethane enamel. The table shown is 42-in.-square and 29 in. high. Occasional tables are 18- and 24-in.-square and are 16 in. high. Agati Manufacturing, Inc., Chicago, IL.

438 Fabrics

The *Shibusa* collection of 39 cotton fabrics with soft glazed finishes features 4 designs. They come in neutral colorways, sometimes accented with metallics. Five coordinated printed voiles are also available. Lee Jofa, New York, NY.

439 Modular furnishings

The *Concourse System* is made of 3 basic forms, which adapt as seating units, planters or tables. The system, composed of wood and fiberglass, is designed to coordinate with related display cases, receptacles and directories. Landscape Forms, Inc., Kalamazoo, MI.

440 Office furniture

The components of the *Cameron Group* are modular: wood and plastic laminate tops, natural or painted wood bases, and natural or painted wood or steel pedestals which are interchangeable. Wire raceways are accessed from end panels or longitudinally from runoffs. Sunar Hauserman, Cleveland, OH.

441 Table

The *Avatar* executive work table comes in walnut or mahogany. Bases come in stainless steel or polished brass. Options include drawers and a variety of tops, base inserts and reveals. Hardwood House, Inc., Rochester, NY.

442 Cabinets

The *Quadrante* system of cabinets and bookcases features frames in light glossy or matte or dark gray anodized aluminum. Polyester center drawer panels come in 4 colors. Doors come in clear, frosted or cobalt-blue glass. B&B America, Div. of Stendig International, New York, NY.

443 Shared workstation

The *Pass-Thru-Panel* is claimed to accommodate computer terminals of all sizes. Work surfaces are 26 in. high and have enough room for turntables with terminals and keyboard surfaces. Rosemount Office Systems, Inc., Lakeville, MN.

444 Tables

Gwathmey Siegel's *DeMenil* tables come in rounds, squares and rectangles in cocktail and dining heights. Legs penetrate tops to create patterns. Tables come in combinations of cherry, mahogany, walnut or natural-, ebony- or rosewood-stained ash veneers and solid woods ICF, Inc., New York, NY.

445 Office chairs

Magnum GS seating features pneumatic seat height control. Seats tilt 1 deg for every 3 deg of back tilt. Seats and backs can be locked in any position or allowed to move with body movements. Chairs come with polished aluminum or powder epoxy frames. Cramer Inc., Kansas City, KS.

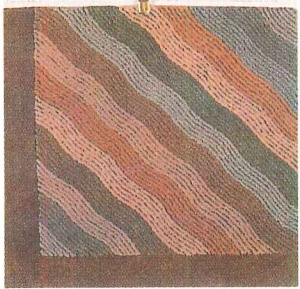

446



449



452



455



447



450



453



456



448



451

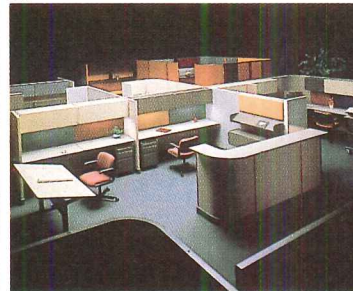

454

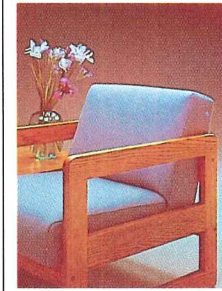

457

446 Rug

Described by the manufacturer as "an exploration of color and texture," an alternation of loop line and cut pile creates a continuous wave pattern in *Water Reflections*. All of this company's rugs are 100 per cent wool. V'Soske, New York, NY.

447 Credenza

The *Avatar* wall-mounted credenza comes in walnut or mahogany with tambour doors and a variety of tops and reveals. Interior options include shelves, box drawers, file drawer bins and dividers. Hardwood House, Inc., Rochester, NY.

448 Seating

Additions to the *20/20* series designed by Norman Cherner include a guest chair, 3-seat lounge and swivel chair, each with a molded 3-in. radius shell and flared arms. The swivel base comes in chrome, bronze and solid oak, mahogany, ash, cherry or walnut. Modern Mode, Inc., Oakland, CA.

449 Cabinets

Cambridge cabinets are available in oak, maple or cherry in a variety of stain or enamel finishes. Design features include a swinging spice rack, beverage storage drawers, a pull-out chopping block and adjustable sliding trays. Coppes Napanee, Napanee, IN.

450 Desk

A computer workstation desk is made of injection molded polyurethane structural foam with a wood grain texture. The material used is claimed to provide high dielectric strength and thermal and acoustical insulation. Digital Equipment Corp., Maynard, MA.

451 Open plan office system

System 2Plus features bi-level power distribution with access to as many as 39 duplex receptacles from a single power source, and up to 12 25-pair communications cables. Computer support includes EDP-depth shelves, turntables and printer stands. Panel Concepts, Inc., Santa Ana, CA.

452 Panel system

Elective Elements 1 features a welded steel frame that houses power distribution and supports acoustical material and veneer or fabric surfaces. A leveling bar permits continuous panel contact with the floor. Wire management at the working level is also available. Stow/Davis Furniture Co., Grand Rapids, MI.

453 Task chair

Diffrient task and operational chairs have been updated by the addition of new functions. Fingertip controls tilt the back or lock it into an upright position, and the back height can be adjusted up and down by the user while in a sitting position. Knoll International, New York, NY.

454 Color system

A color system, which involves a palette of light, medium and dark tones in fabrics, finishes and textures, is designed to lend individuality to each station of an open office plan. Thirty-eight new colors in 6 new fabrics increase the range of design options. Herman Miller, Inc., Zeeland, MI.

455 Seats

Designed by Rodney Kinsman, molded metal tractor seats come in counter and table heights and feature loop bases said to be extremely stable. The counter model features rubber-clad footrests. Seats are finished in mirror chrome or a choice of baked enamel colors. Bieffeplast USA, New York, NY.

456 Computer office system

The *DataBord 920* features a hand crank with which a user can adjust worksurface height while seated. Keyboard and VDT surfaces adjust from 23 to 30 in. All surfaces are finished in oak or beech veneers. Frames are steel or aluminum finished in baked enamel. Krueger, Green Bay, WI.

457 Seating

The *Profile Rounder Group* includes 1-, 2- and 3-seat models, all with solid red oak frames, radiused corners and rounded edges. Upholstered frames are removable. All units are 30 in. high by 31 in. deep. Seat height is 16 in. and arm height is 23 in. Adden Furniture, Inc., Lowell, MA.



458

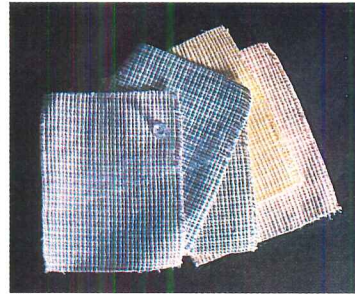

461

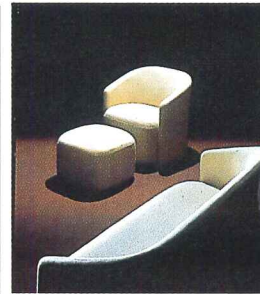

464

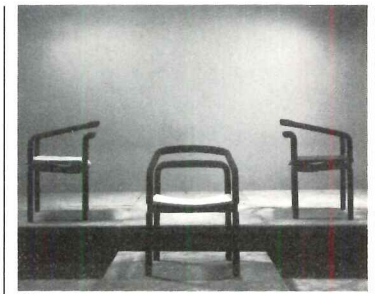

467



459

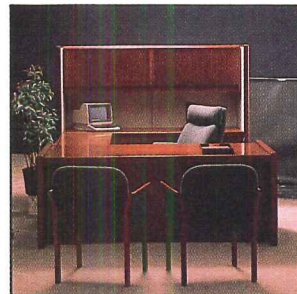

462



465



468



460

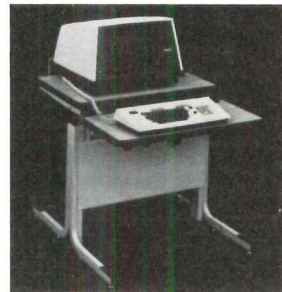

463

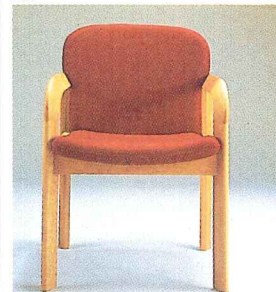

466

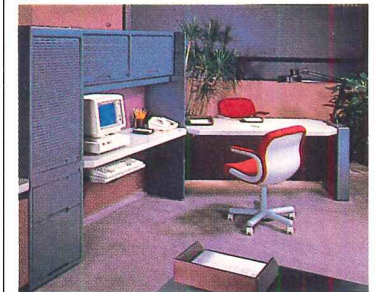

469

458 Seating

CRT Communications Task Seating was designed for this manufacturer by Robert Aronowitz and Bernard Katzanek. Chairs come with or without arms and are available in operational and management sizes. Thonet, York, PA.

459 Chair

The *Art Moderne* side chair, part of this manufacturer's *Avatar Collection*, is available with a right- or a left-facing back. It comes in 3 aniline finishes and 18 lacquer finishes, as well as custom colors. IPF International, Paterson, NJ.

460 Chair

The *Regia* chair features a leather seat and an extruded aluminum frame. The frame is available either covered in leather in a choice of 5 colors or finished in anodized black, gun metal, bronze or epoxy gray. Design Selections International, New York, NY.

461 Fabric

Designed for both traditional and contemporary applications, *Rayure Palatine* is a light upholstery fabric which is made of 60 per cent cotton and 40 per cent rayon. It is available in 24 colors and it comes in a width of 51 in. Manuel Canovas, Inc., New York, NY.

462 Executive office units

A collection of mahogany desks, cabinets, pedestals, lateral files and wardrobes is designed to form a variety of office configurations. Panels are upholstered in complementary fabrics. Chrome or mahogany raceways conceal power and communication lines. The Gunlocke Co., Wayland, NY.

463 Computer stand

The *Humanetics* computer stand keyboard and VDT surfaces can be raised or lowered at the same time or independently. The keyboard surface slides 6 in. horizontally and the VDT surface tilts 10 deg both up and down. Modesty panels are a standard feature. TAB Products Co., Palo Alto, CA.

464 Seating

The *Ovid Collection* includes a sofa, a chair and an ottoman. Each has a frame, made of kiln-dried ash, that is double-dowelled and glued and then shaped to the line of the design. Scope Furniture Ltd., New York, NY.

465 Office furniture system

The *TFS* system features beveled solid walnut tops, wood raceway covers, bronze pulls for drawer and door faces and a central locking system. Panels, which are glazed or come in wood and fabric combinations, come in heights up to 84 in. Artec, Div. of Kimball International, Jasper, IN.

466 Chair

The *Bevel Chair* has an oak frame finished in a choice of natural, walnut or cordovan stains. Seat and back upholstery may be chosen from a variety of fabrics and leathers. The chair stands 31 in. high, is 21 in. wide and 20 in. deep. Cumberland Furniture Corp., New York, NY.

467 Chair group

The *Rubber Chair Group* features tubular steel frames and polypropylene back rails encased in EPDM rubber tubing. Seat options include stained wood, black plastic-coated wood and upholstered cushions. Seat units are removable on-site. Metropolitan Furniture Corp., South San Francisco, CA.

468 Chair

The *Penelope* chair, designed by Charles Pollock, features a frame comprised of an 18-ft-long rod of chromium-plated tempered steel curved to form legs, arms and back and seat support. The seating shell is resin-finished woven steel wire net. Castelli Furniture, Inc., Bohemia, NY.

469 Computer support furniture

Network, a computer workstation system, features 29- and 66-in. rectangular storage shells. System work surfaces come in 24- and 30-in. depths and lengths of 36 and 60 in. Finishes are available in 5 colors. Kimball Office Furniture Co., Div. of Kimball International, Jasper, IN.



470

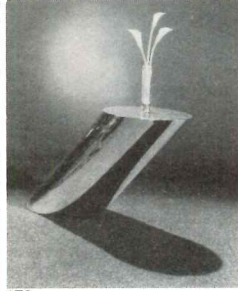

473



476

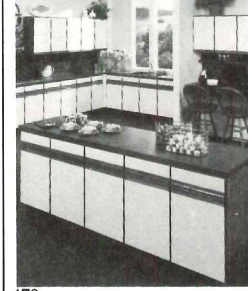

479



471

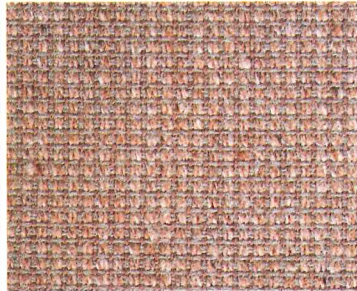

474

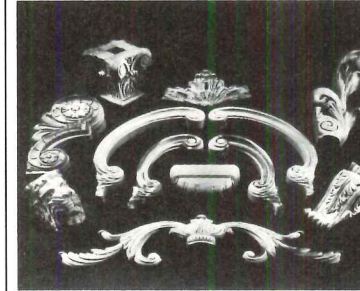

477



480

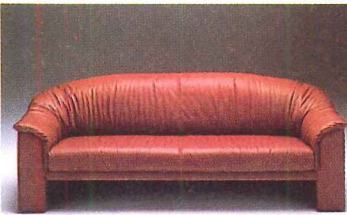

472



475



478

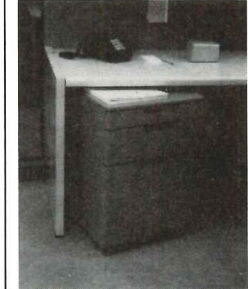

481

470 Fabric

Applause is a 100 per cent cotton velvet. It comes in 12 bright colors and 8 neutrals in a width of 54 in. It is treated for stain, crush and soil resistance and is designed for contract and residential application. Gretchen Bellinger, Inc., New York, NY.

471 Side chairs

The *Zeta Collection* features cantilevered chairs with or without arms and a sled base chair with arms. Chairs come in rift-sawn oak or American Black Walnut veneers. Fabric is from this manufacturer's collection. Lehigh-Leopold, Div. of Litton Business Systems, Burlington, IA.

472 Sofa

The *Allegro* sofa is 31 in. high, 64 in. long and has a seat height of 16 in. It has a frame of molded plywood and hardwood and comes upholstered in a choice of fabrics and leathers. Brayton International Collection, High Point, NC.

473 Table

The *Zephyr Table*, designed by J. Wade Beam, is a polished stainless steel column truncated at a 45 deg angle. It stands 21 in. high and features seamless welding. Brueton Industries, Springfield Gardens, NY.

474 Fabric

Bagpiper is one of 80 fabrics in this manufacturer's *Software Panel Fabric* collection. It is a combination of wool, verel and nylon and comes in a width of 72 in. It weighs approximately 31 oz/yd and carries a Class A flame spread rating. Tandem Fabrics, dist. by Gilford Inc., New York, NY.

475 Chairs

The *1001 Series*, designed by O.J. Holohan, features upholstered arms as well as solid wood open arms. Swivel and side chairs are designed to be used with open plan furniture. Four models are available in oak or walnut. The Alma Desk Co., High Point, NC.

476 Armchair

The *Enrico* chair features a frame of steel tubing which comes chrome-plated or finished in white, black, green, red or brown epoxy. The 1-piece seat and back is also made of steel and comes upholstered in any of this manufacturer's materials. Lowenstein, Inc., Fort Lauderdale, FL.

477 Carved wood ornaments

Solid kiln-dried oak or poplar carvings are based on original Victorian designs. They may be used as corbels, located under soffits, under mantles, as corner brackets or as shelf supports. Cumberland Woodcraft Co., Inc., Carlisle, PA.

478 Correctional seating

Four-person cluster seating features 1-piece construction with reinforced seats and tabletops on welded tubular steel frames. Steel floor glides are adjustable. Frames are finished in black enamel and tabletops and seats come in 4 colors with a slate finish. Plymouth Booths, Kenyon, MN.

479 Kitchen cabinets

Gardencourt Impasto cabinets are surfaced in almond-colored laminate and feature hand-finished oak trim, which serves both as an accent and as drawer and cabinet pulls. Cabinet shelves are adjustable, and drawers are mounted on ball bearing rollers. H. J. Scheirich Co., Louisville, KY.

480 Sofas

Banco, designed by Pat Hoffman, has a steel and marine plywood panel structure covered in the same soft leather as the reversible cushions. *Banco* comes in 2-, 3- or 4-seat versions and as a chair. Cushions and decks may also be covered in fabric. ICF, Inc., New York, NY.

481 Mobile pedestal

Mobile pedestals are available in 2 depths of 20 or 30 in. and 2 widths of 15 or 19 in. They feature 6-in. drawers for regular-sized media, and 15-in. drawers for either side-by-side or front-to-back EDP printout filing. Harter Corp., Sturgis, MI.



482



485

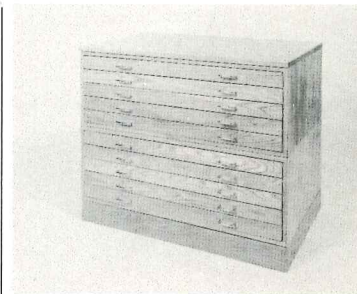

488



491



483

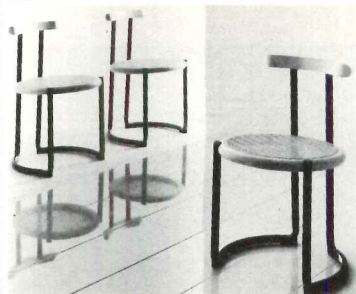

486



489



492



484

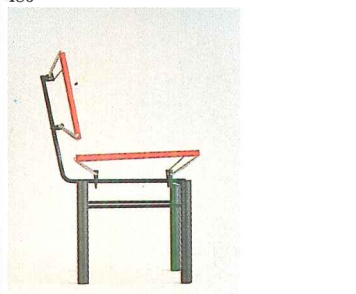

487

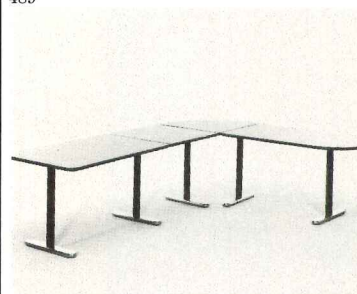

490



493

482 Seating

Torso seating includes an armchair, chaise longue and sofa, each with exposed steel legs—extensions of welded frames—and polyurethane and *Dacron* padding. Back and seat upholstery may be contrasting fabrics or leathers. Atelier International, Ltd., New York, NY.

483 Woven area rugs

1600 Series Tasiwool area rugs are made of natural prefelted white wool interwoven with neutral or pastel-colored sisal. Rugs range in size from 2 ft 3 in. by 4 ft 7 in. to 9 ft by 12 ft. Merida Meridian, Inc., Syracuse, NY.

484 Table and chairs

The *Interlock* conference table and stacking chair collection is designed by Warren Snodgrass. Natural or painted wood tables feature oval tubular metal frames. Chairs feature sled bases and arms with or without arm pads. Thonet, York, PA.

485 Upholstery fabrics

The *Counterpoint Collection* includes 3 new fabrics. *Hampstead*, a crepe weave of 80 per cent worsted wool, 20 per cent nylon, comes in 12 colors, as does the 100 per cent wool *Galloway*. And *Ballantrae*, a tweed made of 96 per cent wool, 4 per cent nylon, comes in 8 colors. Steelcase, Inc., Grand Rapids, MI.

486 Chair

The frame of the *Cantha S* chair is made of tubular aluminum in a choice of 4 epoxy color or 5 anodized finishes. Seat trim and backs are black-stained or natural ash in a matte urethane finish. Seats are caned or upholstered in any of a variety of fabrics. Design Selections International, New York, NY.

487 Chair

The *Bitsch Chair* comes in many versions: with or without arms, ganged or used alone in a slightly lower model. Seats and backs come in woven steel, leather or canvas. Metal frames are in polished or satin chrome or a choice of 4 enamel colors. Harvey Propper, Inc., New York, NY.

488 Wood flat files

Flat file cabinets have 5 drawers and are made of kiln-dried oak with mortise and tenon joints. Drawers have hardboard bottoms and 4-in. protective hoods at the rear. Drawer pulls are chrome-plated solid brass. The finish is clear conversion vinyl. Charrette Corp., Woburn, MA.

489 Drapery fabrics

Classic Woolens is a collection of 100 per cent wool drapery fabrics in coordinated solid and stripe patterns. Weaves include a wool challis and a striped pattern formed by textural weave changes. DesignTex Fabrics, Inc., Woodside, NY.

490 Modular tables

The *400/601 Modular Table Series* features connectors that may be tightened by hand. Tabletops are surfaced in veneers and plastic laminates. They are supported by T-bases, which come in chrome or 17 colors. Kinetics Furniture, Rexdale, Ontario.

491 Wood cabinets

The *Chadwood* line features solid oak drawer fronts and door frames and red oak facing on 3-ply door panels. Cabinets have adjustable shelves, brass hardware and nylon drawer rollers. The line is face framed with solid kiln-dried rails. Kitchen Kompact, Inc., Jeffersonville, IN.

492 Table

The *Propeller Table* has a twisted heavy bar stock steel base. The table comes in a variety of square and rectangular sizes and is available in oak, walnut and mahogany in a variety of veneer patterns. Mueller Furniture Corp., Grand Rapids, MI.

493 Kitchens

Polo kitchen cabinets feature plastic laminate surfaces with vertical rounded edges and rounded grooves. They are available in white, beige or gray-blue with white porcelain knobs, white laminate interiors and white baseboards. Tielsa Kitchens/Contemporary Systems, Inc., Woburn, MA.



494



497

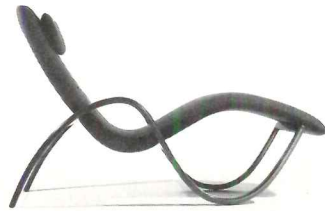

500



503

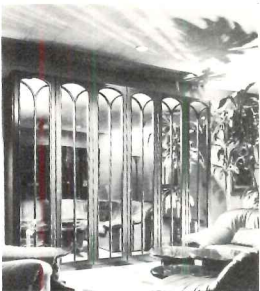

495

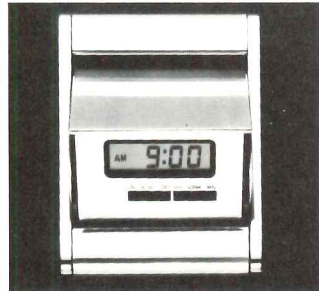

498

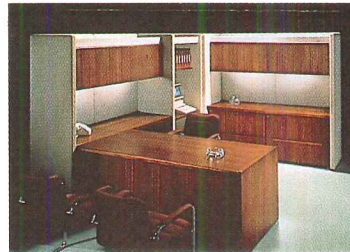

501

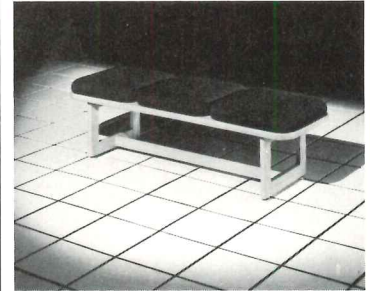

504



496



499



502



505

494 Office seating

MGT seating, designed for this manufacturer by Don Pettit, features frames of molded plywood. Chairs come with or without arms and have either 4 legs or 5-star pedestal bases with double casters. Thonet, York, PA.

495 Wardrobe

The *Nouveau* wardrobe system features components in widths of 20 and 40 in. and heights of 84½ and 94½ in. Wardrobes have interior fittings claimed to meet any storage need. They are available in mahogany, cherry or 10 lacquer finishes. Cy Mann Designs Ltd., New York, NY.

496 Kitchen/bath cabinets

Lacquered Profile Front cabinets feature white panels with blue-gray inlays in the frame and handles. Surfaces have a matte finish. Cabinet features include a swing-out waste bin unit and pull-out bottle cupboards. Poggenpohl USA Corp., Teaneck, NJ.

497 Top access file

Putty-colored textured steel files with plastic laminate locking tops feature access from the top and will store letter and legal file folders, computer printouts and magnetic media in any combination. Marvel Metal Products Co., Chicago, IL.

498 Desk clock

A folding desk clock is an addition to the *Radius Two Collection* of desk accessories, designed by William Sklaroff. Clocks feature liquid crystal displays and are available in 6 metal finishes. Smith Metal Arts, Buffalo, NY.

499 Fabric

The *Shibumi Collection*, reproductions of Japanese cloths, consists of hand-woven refined and coarse cottons. The collection includes both muted and bright colors. Cloths are woven to form stripes of colors and textures. Groundworks, Inc., New York, NY.

500 Seating

The *828 Series* designed by Lewis Epstein includes a bentwood chaise longue and a bentwood lounge chair. Both come in a choice of cherry or ash with a selection of 3 finishes. Heller Contract, Div. of The Heller Co., Inc., Newton, MA.

501 Workstation

The *System 2* workstation features furniture made of Sapele African mahogany. The system includes a variety of credenza and drawer configurations. Design features include recessed drawer pulls and radius edges. Conwed Corp., St. Paul, MN.

502 Swing-out pantry

A pantry cabinet has a top section with two 10½-in.-deep adjustable shelves. The bottom section has 2 swing-out shelves and, behind them, 4 adjustable 6-in.-deep shelves. Door shelves are 4 in. deep. Several styles are available. Aristokraft, Jasper, IN.

503 Stacking chair

The *Sultana* stacking side chair features expanded steel seats and backs, which come in red, black or white. The frame is chrome-plated solid bar stock. Chairs are 18 in. wide, 19 in. deep, 29½ in. high and have a seat height of 18 in. Loewenstein, Inc., Fort Lauderdale, FL.

504 Bench

A bench designed by Marcel Beck comes in 6 frame colors. It is part of this company's *Institutional/Healthcare* line. Safety features include fire-retardant foam cushions and nonskid adjustable glides. Carolina Seating Co., Div. of U.S. Furniture Industries, High Point, NC.

505 Fabrics

The *Imprimatur System* offers combinations of 16 base color fabrics, 5 patterns and 6 print colors. Fabrics are 70 per cent wool and 30 per cent nylon and come in a 70-in. width. Custom colors are available. JG Furniture Systems, Div. of Burlington Industries, Quakertown, PA.



506

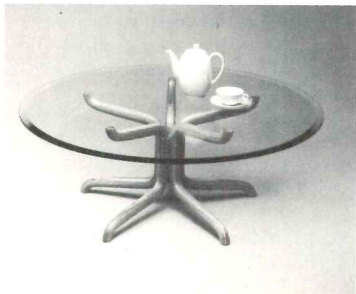

507



508

506 Office seating

SystemSeating II ergonomic chairs feature seamless 1-piece fabric upholstery. Task, side and conference chairs are included, some with seat and back height adjustments and some with swivel-tilt posture devices. Chairs are available in 7 textures and 77 colors. Haworth, Inc., Holland, MI.

507 Coffee table

A coffee table designed by Warren Platner has a base of laminated bentwood in white oak, walnut or colored maple. Tops are available in glass, wood or leather with a wood edge. The table measures 42 in. in diameter and stands 14½ in. high. C I Designs, Inc., Medford, MA.

508 Computer office furniture

Additions to the *Zapf System* include 73-in. work surfaces and 37-in. overhangs. Storage components are 18 in. deep and have adjustable shelves in 13- and 18-in. depths. Unit surfaces come in mahogany veneer in 3 finishes, laminate or *Techgrain*. Knoll International, New York, NY.

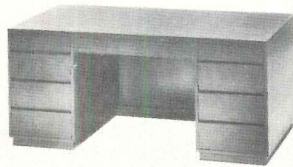

509



510



511

509 Desk

The *Georgian Collection 9000 Series* desk stands 30¼ in. high, is 68 in. long and 34 in. wide. It is made of solid mahogany and mahogany veneers. Design features include 2 kneehole locking devices and writing panels in the top drawers of each end. Kittinger Co., Buffalo, NY.

510 Lounge chair and ottoman

The *Wilkhahn FS* executive lounge chair and ottoman, designed by Franck and Sauer, are upholstered in leather. The chair features a tension controlled tilt and swivels on a base with glides. Base finish options include polished aluminum and bronze. Vecta Contract, Grand Prairie, TX.

511 Chair

The *Grilli* arm or side chair, designed by Simonit, is of beechwood construction. It is available in a variety of wood stains and finishes. An upholstered back version is also available. Beylerian Limited, New York, NY.

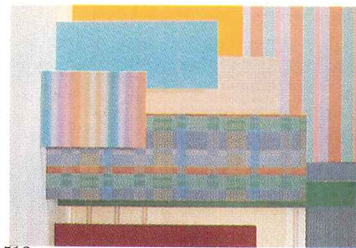

512

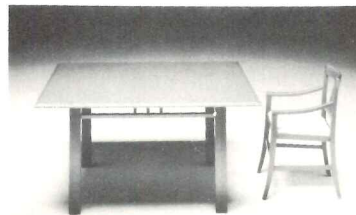

513



514

512 Health-care fabrics

The *EnviroTex* collection is made of 100 per cent *Trevira Polyester*, which fulfills all flame retardance requirements and is washable at 160 deg. The collection includes 102/104-in.-wide knitted fabrics and 72-in.-wide woven fabrics. DesignTex Fabrics, Inc., Woodside, NY.

513 Chairs and tables

An armchair has an upholstered seat and a solid beech frame in a natural finish or a choice of 6 colors. Square and rectangular tables have beech frames and tops of ash veneer with beech stepped, rounded and tapered edges. Stendig, Subsidiary of Stendig International, New York, NY.

514 Office furniture

The *9800 Series* of desks, tables, credenzas and files features a full panel design in oak solids and veneers. End panels have reveal lines on outside and inside faces; tops have centered reveal lines. Series components accommodate CRT equipment. Myrtle Desk Co., High Point, NC.

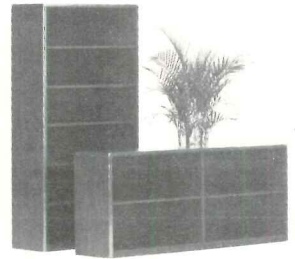

515

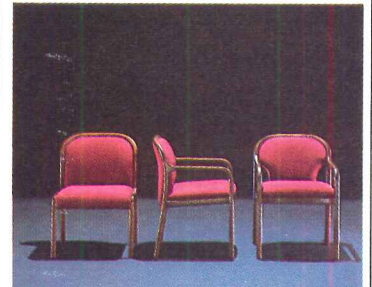

516

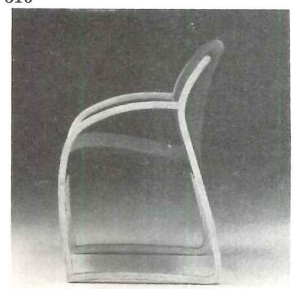

517

515 Shelves

The *Executive Shelving Group* is available in heights of 29, 42 and 72 in.; depths are 12 and 16 in. Shelves are adjustable in 1-in. increments. Modules are 36 in. on center. Shelf surfaces are oak, walnut or mahogany veneers; edges are in matching solid woods. Tuohy Furniture Corp., Chatfield, MN.

516 Chairs

The *Westport Collection* features frames of solid oak, cherry, mahogany, walnut or ash. Seats and backs are upholstered. Armed chairs come with 2 back variations: cut-out corners below the arms, or an inner panel of 2 vertical concave wood frame elements. Modern Mode, Inc., Oakland, CA.

517 Chairs

The frame of the *Lisberg Chair* is made of laminated oak. The seat and back feature a steel-reinforced molded plastic inner shell. The upholstery, foam and inner shell are bonded together. Chairs come with or without arms in standard and stacking models. Executive Office Concepts, Compton, CA.

12 Furnishings Product literature

For more information
write item numbers on
Reader Service Cards

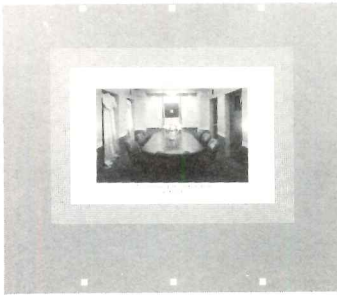

518 Furnishings

An extensive color catalog features office furniture collections, textiles and objects created by such notable designers as the Vignellis, Douglas Ball, Niels Diffrient and Don Pettit. Photos show collections in show rooms and in actual installations. Sunar Hauserman, Cleveland, OH.

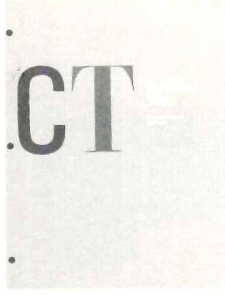

524 Office furniture

Option Two, a system that features basic components detailed in either contemporary or traditional styles, is described and illustrated in a 20-page color brochure. Desks, pedestals, tables and credenzas in oak or mahogany are illustrated in each of the two styles. Sizes are listed. Hiebert, Carson, CA.



519 Custom-built furniture

An 8-page color brochure features custom-designed furniture claimed to be offered at mass-production prices. Capabilities and processes are described and illustrated in photos. A number of installations are also shown. Spec'built—Specification Built Corp., Carlstadt, NJ.

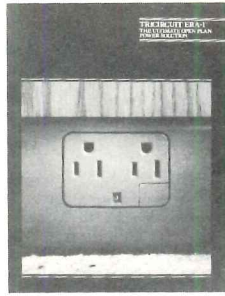

525 Pre-wired panels

TriCircuit ERA-1 open plan power panels are featured in a 12-page color brochure. Installation details show panels that contain 3 separate 20-amp circuits within base raceways to provide 60-amp capacity per panel. Sections show panel construction. Haworth, Inc., Holland, MI.



520 Stacking chair

Photos illustrate the *Skagen* stacking chair in a 4-page color brochure. Diagrams with dimensions show chairs both with and without arms. A dolly and a cart designed for transporting stacked chairs are shown. A close-up photo shows the optional ganging device. R-Way, Sheboygan, WI.

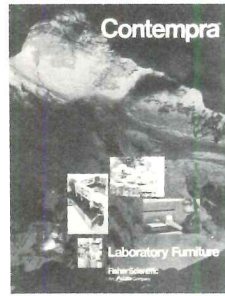

526 Laboratory furniture

An extensive catalog features *Chromatic* laboratory furniture, made of heavy-gauge steel finished in modified acrylic and available in several tones of 5 bright colors. Also covered in photos and diagrams are wood and laminate furniture and safety equipment. Contempra Furniture Div., Fisher Scientific Co., Indiana, PA.

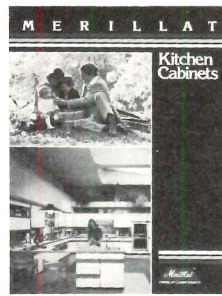

521 Kitchen cabinets

Photos show installations of several styles of solid oak and *Formica* laminate-surfaced kitchen cabinets in a 12-page color brochure. Close-up photos show design details, such as self-closing hinges, slide-out trays and adjustable shelves. Optional accessories are also shown. Merrilat Industries, Inc., Adrian, MI.



527 Round reception desks

Diagrams with dimensions and photos of 4 different configurations of *Series 12* modular wood reception desks are featured in a 4-page color brochure. Desks, which stand 32 in. high, are available in walnut or oak. Cumberland Furniture Corp., New York, NY.



522 Seating

Focus I chairs, with arms and pedestals in a choice of woods and sculpted urethane foam shells, are featured in a 12-page color brochure. Each of the operational and management chairs and a stool are shown in photos and diagrams. Kimball Office Furniture Co., Div. of Kimball International, Jasper, IN.

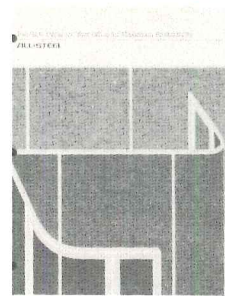

528 Open office panels

A diagram shows the structural components of *8000 Series* panels in an 8-page color brochure. Configurations with both fabric-covered and glazed curved and straight panels are shown in photos. Dimensions of acoustical and nonacoustical panels with and without power raceways are listed. All-Steel Inc., Aurora, IL.



523 Computer furniture

Furniture modules with metal bases and cantilevered laminate surfaces are featured in a 4-page color brochure. Items covered include mobile and stationary printer stands and shared terminal workstations with turntables. Diagrams with dimensions are included. James Systems Div., James Metal Products Co., Chicago, IL.



529 Lounge seating

A 4-page color brochure features the *Profile Series* of chairs, 2- and 3-seat sofas and coffee and end tables. All pieces have frames made of red oak. Photos show each item as well as samples of the 4 available finishes. Adten Furniture, Inc., Lowell, MA.

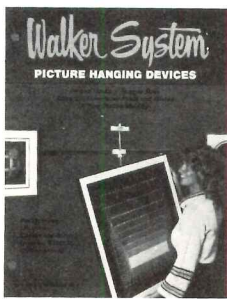

530 Picture-hanging devices
A 6-page color brochure describes and illustrates picture hooks, hanger rods, clips and holders. Photos show installations, and line drawings show individual devices and installation details. Technical data are included. Walker Systems, Inc., Duluth, MN.

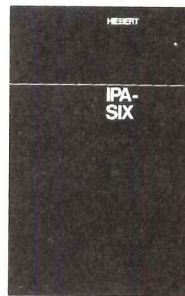

536 Open office delivery
A 16-page color brochure describes *IPA-SIX*, a plan by which this company offers over 75 per cent of its systems configurations with 6 weeks' delivery. System components are illustrated in photos and isometrics with dimensions. Panel fabric color options are shown. Specifications are listed. Hiebert, Carson, CA.



531 Desk accessories
The *Radius One* and *Radius Two* series of desk accessories are featured in a 58-page catalog. Photos illustrate individual items and design features, available colors, dimensions and prices are listed. Construction materials are described and specifications listed. Smith Metal Arts, Buffalo, NY.

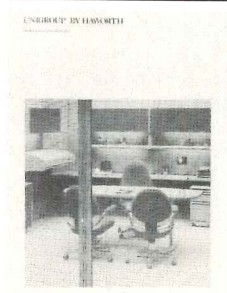

537 Open office system
The *UniGroup* open office furniture system is featured in a 26-page color brochure, which includes illustrations of work spaces created from user studies. Other open plan elements from this company, such as lighting, prewired panels and filing, are also covered. Haworth, Inc., Holland, MI.

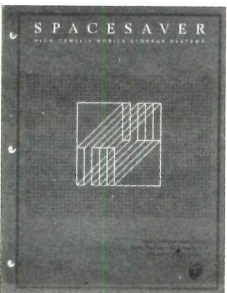

532 High-density storage
A 30-page color brochure illustrated with photos and drawings covers 15 aspects of high-density mobile storage and filing systems, including floor loading, safety, security and architectural constraints. Case studies are described. Spacesaver Corp., Fort Atkinson, WI.



538 Seating
The *Omni* and *Ultra* series of ergonomic chairs are shown and described in a 6-page color brochure. Features such as pneumatic adjustments and double casters on 5-prong bases are highlighted. A desk chair and a drafting stool are also covered. Product data and a color chart are included. Sam Flax, New York, NY.

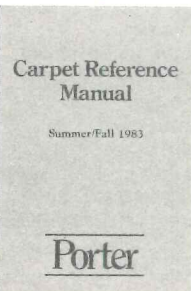

533 Carpets
A reference manual includes specifications for over 30 carpet styles. Also included is information on building code requirements and flammability. A chart lists methods of removing several different types of stains from both wool and synthetics. Porter Carpet Mills, Inc., Cartersville, GA.

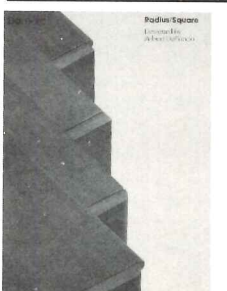

539 Desks and credenzas
A 6-page color foldout brochure features the *Radius/Square* executive furniture collection designed by Robert DeFuccio. Photos show details of wood desks, such as recessed wood drawer pulls and a stationery drawer with adjustable slide-out shelves. Domore Corp., Elkhart, IN.

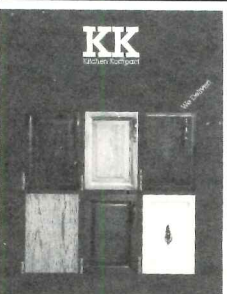

534 Wood cabinets
A 4-page color brochure features a line of kitchen cabinet and vanity styles. Detailed elevations show all units, dimensions and trim. Construction and finishes are described. Specifications are listed. Kitchen Kompact, Inc., Jeffersonville, IN.



540 Insulating window shades
Two styles of insulating shades are featured in an 8-page color brochure. Photos show several installations and diagrams show installation details and shade composition. Insulating values, a color chart and specifications are included. Appropriate Technology Corp., Brattleboro, VT.



535 Open plan furniture
An 8-page color brochure features the *IOP* open plan system. Detail photos show panel hinges, wire management, storage and task lighting. Photos of typical workstations show furniture fabric and wood combinations. JG Furniture Systems, Div. of Burlington Industries, Quakertown, PA.

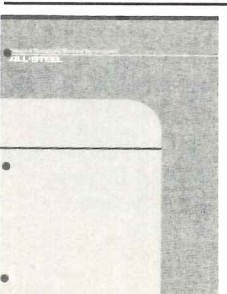

541 Open office system
An open office system of panels and workstations as well as reception lounge furniture is illustrated and described in an 18-page color brochure. Photos show a wide variety of office configurations and options, such as shared workstations and open or closed filing. All-Steel, Inc., Aurora, IL.



542 EDP media filing
Open and closed mobile and stationary filing systems for EDP printouts, tapes and disk packs are featured in a color catalog. Photos of items are accompanied by tables listing product descriptions and unit prices. Computer station work surfaces and accessories are also covered. Wright Line Inc., Worcester, MA.

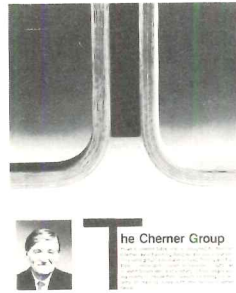

548 Tables
A brochure features the *Cherner Group* of tables, which comes in fixed, folding or flip-top versions. Table surface materials include oak veneer and Natural Oak or Almond *Formica*. Table shapes are rectangles, squares and circles in a number of sizes. Howe Furniture Corp., New York, NY.



543 Keyboard shelf
The *Ultronic 9000* articulated keyboard shelf is featured in a 4-page color brochure. As described, the metal shelf has a 6 7/8-in. vertical adjustment and a 5-in. horizontal adjustment and can be rotated up to 30 deg. Steelcase, Inc., Grand Rapids, MI.



549 Open office system
An extensive color brochure features the *IPA* system of glazed or wood-capped fabric acoustical panels and wood furniture for the open office. Office furniture, filing and storage and secretarial workstations as well as wire management and locking systems are shown in photos and described. Hiebert, Carson, CA.

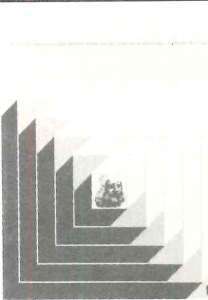

544 Museum storage
A space-planning guide uses schematics of installations to demonstrate how museum storage capacity can be increased 100 per cent with the use of manual or automatic mobile storage systems. Case studies discuss storing materials from rock specimens to historical costumes. Spacesaver Corp., Fort Atkinson, WI.

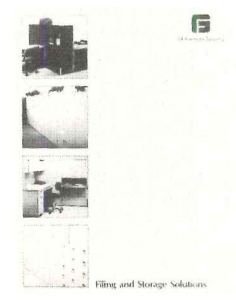

550 Filing and storage
Photos of installations show a wide variety of file cabinets in a 34-page color brochure. Diagrams show file drawer capacities. Drawings show drawer suspension and standard units and configurations. Lists of available dimensions are included. GF Furniture Systems, Inc., Youngstown, OH.



545 Photographic murals
A 12-page brochure features selections from *The Past Tense Collection* of photographic images. Pictures may be color toned, enlarged, laminated and installed. Clients' photos may be produced to specifications as well. P.S. Decor, Div. of Photographic Specialties, Minneapolis, MN.

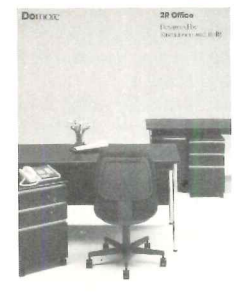

551 Office furniture
A 6-page color foldout brochure features the *2R Office* series of desks, tables, credenzas and mobile pedestals. Photos illustrate design features, such as a drop leaf hinged to a desk to convert it to a conference table. Pedestals are shown in 3 models with and without casters. Domore Corp., Elkhart, IN.

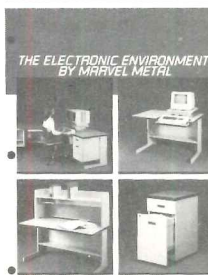

546 Computer furniture
Workstations and storage accessories are featured in a 16-page color catalog. Design features, such as steel frames, cantilevered surfaces and a wire control system are described and shown in detail. Marvel Metal Products Co., Chicago, IL.

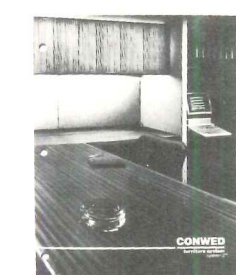

552 Open office system
System 2, a furniture system that combines wood and fabric, is covered in a 10-page color brochure. System features, such as shared CRT workstations with terminal turntables, task lighting and acoustical panels, are described and shown in photos. Overhead storage and file drawers are also covered. Conwed Corp., St. Paul, MN.

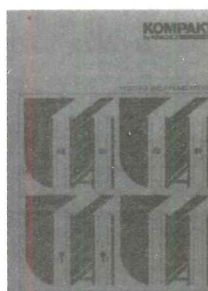

547 Movable filing
A 20-page brochure features *Kompakt*, a high-density movable filing system. The brochure includes diagrams, applications and specifications and covers new construction, floor loads and office interior arrangements. Kardex Systems, Inc., Marietta, OH.

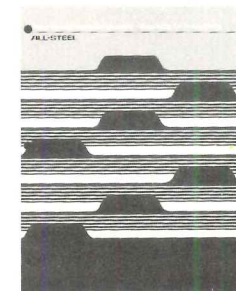

553 Filing systems
Photos of installations of open and closed filing systems are featured in an 8-page color brochure. Systems include vertical and lateral files, panel-mounted storage, EDP filing units and suspended and independent pedestals. An insert includes diagrams and dimensions of each unit. All-Steel Inc., Aurora, IL.

Trilogy called for intelligent flexibility.

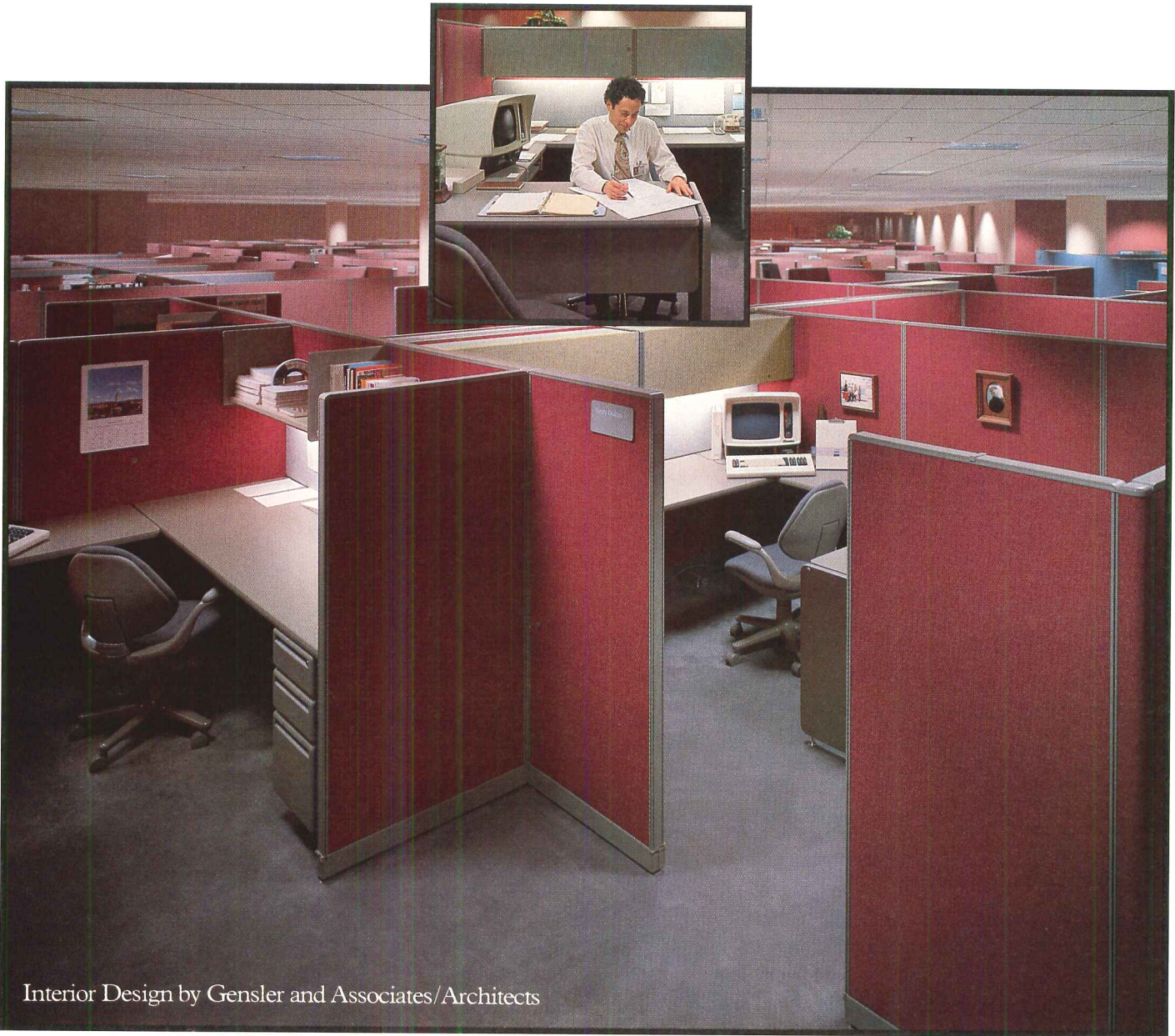

Interior Design by Gensler and Associates/Architects

Thoughtful planning and Haworth open office systems provided it. Computer designers Trilogy Systems Corporation wanted their new headquarters to emphasize high technology, while affording intelligent solutions for growth. The project architects and designers created a contemporary open plan approach with standardized Haworth work stations that are easily reconfigured.

Haworth's comprehensive offering of UniTek™ Electronic Support componentry plus the electrical distribution capabilities of TriCircuit ERA-1® panels best accommodated Trilogy's widely applied office electronics. The result—an intelligent, aesthetically pleasing, systems solution.

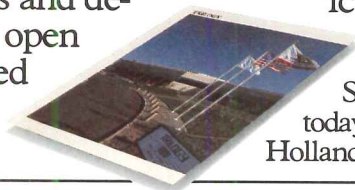

Send for the "Haworth Case Study Package" today: Haworth Inc., One Haworth Center, Holland, MI 49423 U.S.A.

HAWORTH®
OFFICE INTERIOR SYSTEMS

Circle 1098 on inquiry card



NEW KIRSCH VERTICALS MADE OF TRIANTI[®] FIBER GLASS. COME TOUCH OUR SOFT TEXTURED YARNS.

The feeling is remarkable. The yarn is Trianti. It's a new generation of multi-strand, textured fiber glass yarn from PPG Industries. And it has just allowed Kirsch designers to create a wider range of patterns—from open designs to heavy homespun—but all soft to the touch. These new Kirsch vertical blinds give you more choice in control of sunlight, and each has been treated with a soil release, so dust shakes loose or whisks away with a vacuum brush. Firesafe? A given with fiber glass. Colorfast, too.

Contact your Kirsch representative to see current color choices and new patterns. And touch PPG's soft new fiber glass yarns.

PPG Industries, Inc., One PPG Place, Pittsburgh, PA 15272.

Circle 1099 on inquiry card



HIEBERT

You've met Hiebert's IPA! Now meet IPA-SIX!

IPA-SIX is Hiebert's commitment to ship you over 75% of systems configurations most often ordered... in six weeks or less...and with universal components!

Other Advantages?

Besides the obvious advantages of being able to obtain an almost endless selection of configurations or clusters of stations on a six week basis, remember:

- Growing companies can count on an orderly supply of systems furniture on an ongoing basis.

- Large corporate users can standardize on IPA-SIX parts and use this program as if it were their own warehouse or "attic stock."

- All accounts can count on a large selection of free standing furniture and seating to blend in to their systems requirements, most of these items also being available on a six week basis.

HIEBERT P.O. Box 6266, Carson, CA 90749

Manufacturing Facilities: California, North Carolina, Pennsylvania

Showrooms: Dallas, Houston, Kansas City, Minneapolis, Los Angeles, San Francisco, Chicago, Philadelphia, St. Louis, and Washington, D.C.

DIVISION, HON INDUSTRIES

Circle 1100 on inquiry card

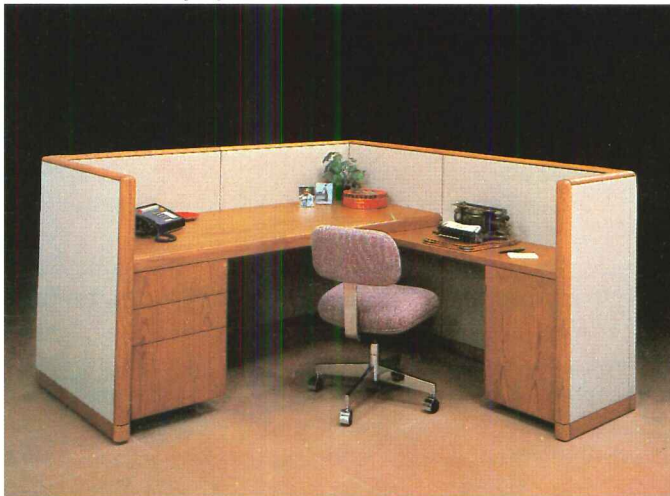

Systems with a Commitment to Choice and Performance

SunarHauserman boasts more systems to divide space effectively than any one in the marketplace—ceiling to floor,

wall to wall and many in between.

Elements which link SunarHauserman Systems are the S Drawers,

bullet tops, and edge detail, shown here in a Cameron workstation.



And all are compatible one with another. Skillfully detailed, they work well together but avoid unnecessary regimentation. Designer Glynn Brown sums it up: "The appeal to the client is performance—the Race® system's capacity for physical change and wire handling that no other system has."

What's true of the wire and space management Race System, designed by Douglas Ball, is also true of Douglas Ball's post/panel PAS System and his Douglas Group of desks and enclosures in wood. His Uniwall and S Drawer storage systems are another of the unifying links in all his system designs. And now, the recently introduced Cameron Group, is Ball's design response to the continuing necessity and place in the world of office work, for the free-standing desk with attendant work and

Douglas S work module. Maple wall-mounted shelf and runoff.



storage units. The electrical and communication raceways are accessed from end panels or longitudinally on runoffs.

The Cameron Group combines Ball's design skill and knowledge of production in wood and metal with the company's manufacturing and engineering capability in both. The details, finishes, and colors of Cameron are designed to fit with Race®, with Design Option™ Wall and Panel Systems. The latter is the first system to offer virtually unlimited choice: full-height walls, panels and post/panels. These systems have modular, interchangeable components—worktops, drawers, storage units in a wide selection of material, fabric, and finish.

And the Electronic Support Furniture, introduced in Chicago this year,

is design-engineered to work smoothly with Design Option™ post/panel or full-height walls as well as with sophisticated electronic equipment. It consists of free-standing elements, combined with connecting tops—in almost unending ways—for data entry and retrieval, systems analysis, programming—in fact, any function of the electronic workplace.

All systems reflect quality, care, and commitment from SunarHauserman people—from designers, engineers, installers and servicemen. Full-height walls, low walls, panels and pads—all are movable, with unique visual and functional features designed into them. The systems work together for a total environment that fits usual and unusual needs of office, manufacturing facility, or institution. With their special perspective,



SunarHa

Design Option wall panels covered in Donegal with mahogany Cameron.

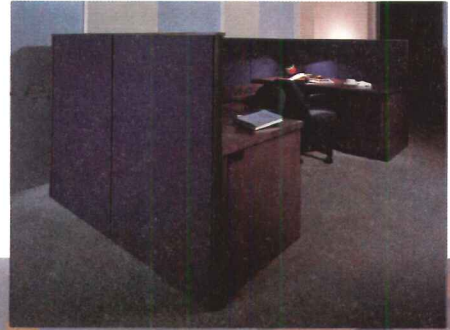

Cameron management station with Design Option clerestory wall panels covered in Donegal.



Design: Bonnell Design Associates Inc., NYC

Race System beam with mounted single point tops. DST, Inc., Glynn Brown Designer, Kansas City.

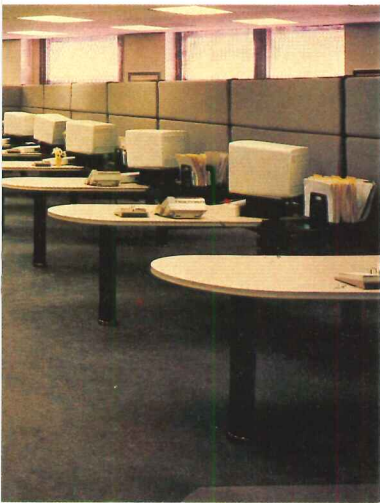

based on decades of experience in the production of responsive product, SunarHauserman is expert in environments which support business goals. They have an obligation to choice and performance.

For more details may we send you our brochure *SunarHauserman: A Structure for the future?*

SunarHauserman, Inc.
5711 Grant Avenue, Cleveland, OH 44105

SunarHauserman, Ltd.
One Sunshine Avenue, Waterloo, Ontario, Canada N2J 4K5

Are you on our *Leading Edge* mailing list? If not please write on your letterhead.



PAS System with Uniwall. Wells Fargo Data Center, Skidmore, Owings & Merrill, architects, interior design.



left: Electronic Support Furniture System.

above: Full-height moveable Design Option walls and panel system.



Circle 1101 on inquiry card

userman

Behind every chair you'll find its best feature.

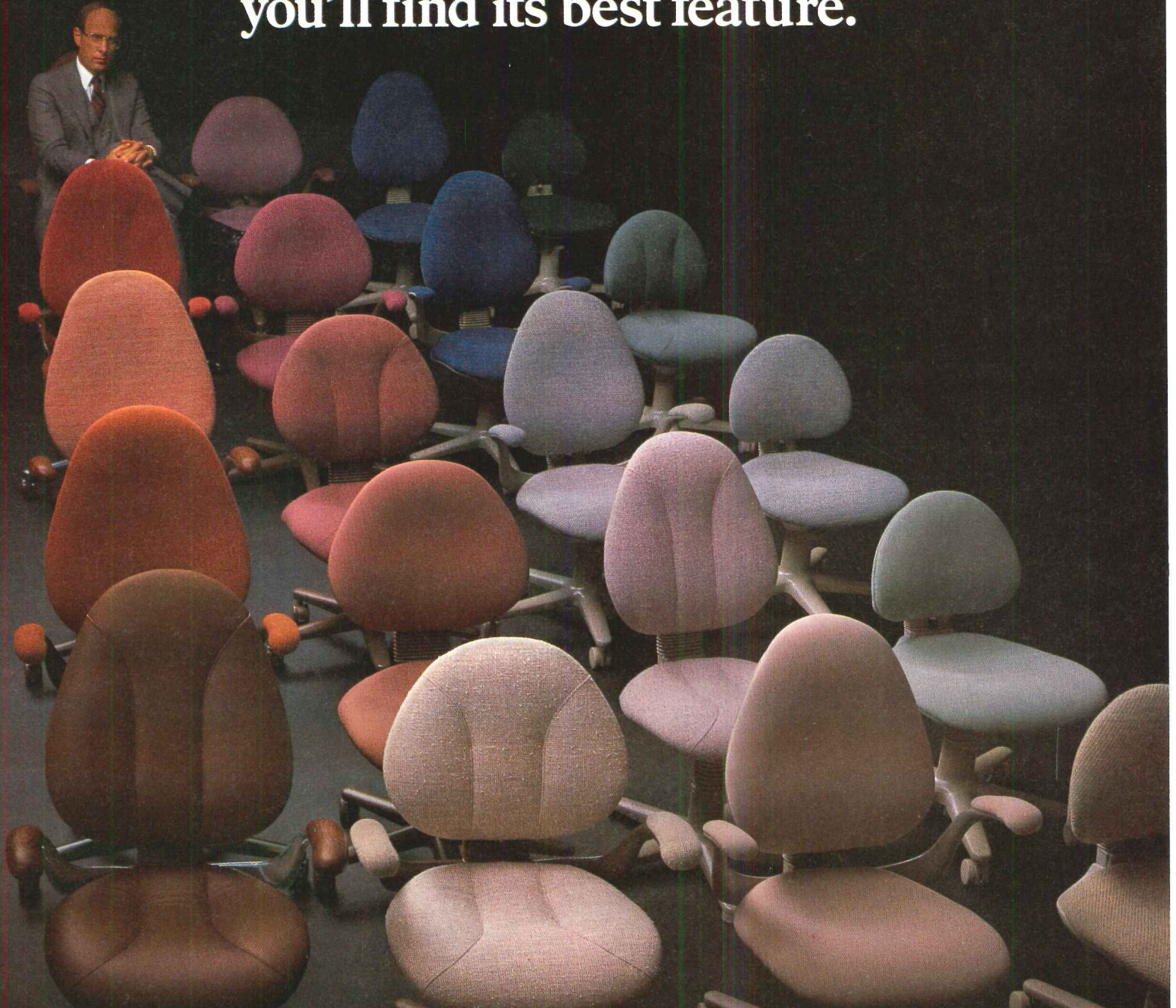

SystemSeating by Haworth is deep in options and innovative tradition. As fundamentally versatile as the office interior systems that bear the Haworth name, SystemSeating can be tailored to every task and situation. Scaled for today's open office interior systems environment, engineered for the human anatomy, SystemSeating represents a broad, visually consistent

seating offering with distinctive options in performance, construction and cost. All in a vast selection of colors, fabrics, textures and finishes that you can mix and match to meet any seating situation. All backed by one, good family name.



Send for the "SystemSeating Package" today: Haworth Inc., One Haworth Center, Holland, MI 49423 U.S.A.

HAWORTH
OFFICE INTERIOR SYSTEMS

Circle 1102 on inquiry card

You create flexible space.
We create flexible tables.

Howe Furniture Corp. ©1983



When one of our many flip-top or folding tables is being flipped or folded, it's helping change the nature of your space in minutes. Any other time, of course, it's doing what a table gets paid to do. And just how solidly it sits and feels while performing its traditional duties is something that interests our engineers no end. In fact, their stability standards are *very* high. Just think of the Rock of Gibraltar on a hinge.

HOWE, 155 East 56, N. Y., N. Y. 10022 (212) 826-0280

**TABLES
= HOWE**

Circle 1103 on inquiry card

13 Special Construction

UCI 13, Special construction:
 Air & tension support structures
 Integrated assemblies
 Integrated ceilings
 Prefabricated buildings
 Radiation protection
 Radio-frequency shielding
 Sound & vibration control
 Special purpose rooms & buildings
 Swimming pools
 Total energy systems

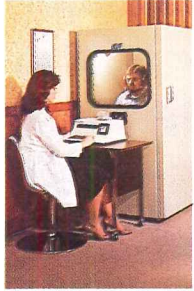

554



555

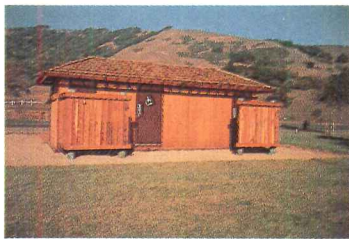

556

554 Audiometric booth

The *Eckoustic Model AB-200EC* booth for testing hearing is 29½ in. deep and comes preassembled. Typical noise reduction is claimed by the manufacturer to be 36 dB at 500 Hz, 46 dB at 1000 Hz, and 52 dB at 2000 Hz. Eckel Industries, Inc., Eckoustic Div., Cambridge, MA.

555 Instant computer rooms

Self-contained computer room units come in any size. They are designed to provide thermal and sound insulation and to keep computer areas dust free. Units are available with independently controlled lighting. National Partitions & Interiors, Hialeah, FL.

556 Restroom buildings

Both permanent restroom buildings and ones that can be relocated feature 3-pint flush vacuum toilets. The systems, which need only electricity and water to operate, feature vacuum holding tanks and require no sewers. Envirovac, Inc., Rockford, IL.

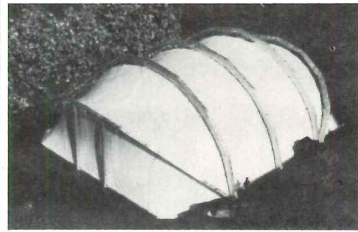

557

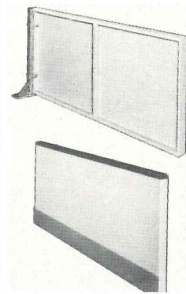

558

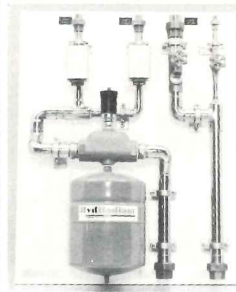

559

557 Fabric structures

Ten Star tension membrane structures are 40 to 120 ft wide and 20 to 30 ft long. They are supported by arches that are stabilized by bias cable net bracing. Exterior and interior linings meet NFPA 701 for flammability. Air-Tech Industries, Inc., East Rutherford, NJ.

558 Arena dasher panels

Rinkmaster Fiberglass II panels for hockey rinks and soccer arenas weigh 80 lb per 8-ft section. They are made of fiberglass bonded to wood frames with 2-in.-square plated steel tubing supports and 8-in. reinforced steel mounting plates. Holmsten Ice Rinks, Inc., St. Paul, MN.

559 Radiant floor heating

A radiant floor heating system uses EPDM tubing embedded in *Gyp-Crete* floor underlayment. Warm water flows through the tubing to radiate heat through the thermal mass. Components include manifolds, a water heater and a control panel. HydRadiant, Inc., Div. of Gyp-Crete Corp., Hamel, MN.

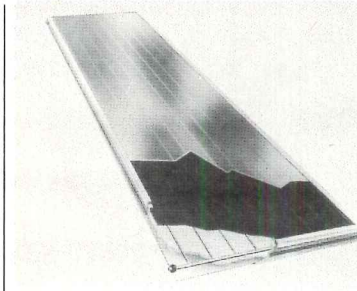

560



561



562

560 Solar collectors

Trimline medium temperature solar collectors for commercial applications feature advanced absorber plates with integral selective surfaces, reinforced aluminum housings and modular mounting systems. Sizes are 4 by 12 ft, 4 by 8 ft and 3 by 8 ft. Solar Industries, Inc., Manasquan, NJ.

561 Swimming pool decks

Ruffian is a grasslike surface designed for commercial pool deck applications. It is made of a 11,400 denier *Polyloom* yarn system and a vinyl backing, and it is claimed to be unaffected by exposure to the sun and water. Playfield Industries, Inc., Chatsworth, GA.

562 Ceiling/lighting system

The *Aspect* system incorporates standard sizes of luminaires without breaking the ceiling plane. It features an open cellular ceiling, into which downlighting units fit in square cells and accent lights and wall washers in rectangular cells. Intalite Louvers and Ceilings Inc., Northbrook, IL.



563



564



565

563 Synthetic soccer surface

Varsity is an indoor/outdoor surface with grasslike fibers and 2 secondary backings. One backing is a vinyl coat that locks tufts of fiber into the primary backing. The second is a high-density vinyl foam. Surface units are 6 or 12 ft wide and 80 ft long. Holmsten Ice Rinks, Inc., St. Paul, MN.

564 Saunas

Custom made *Executive* saunas in sizes from 4 by 4 by 7 ft to 9 by 12 by 7 ft feature solid redwood interiors and finished plywood exteriors. They have stainless steel heaters, which produce both dry heat up to 190 deg and rock steam. Rocks are included. Am-Finn Sauna Co., Valley Forge, PA.

565 Generating kit

A solar-powered electric generating kit designed for residential application furnishes 12 volts DC current. Components include a photovoltaic power module, electronic controls and 3 high-efficiency fluorescent lights. Solar Power Corp., Woburn, MA.

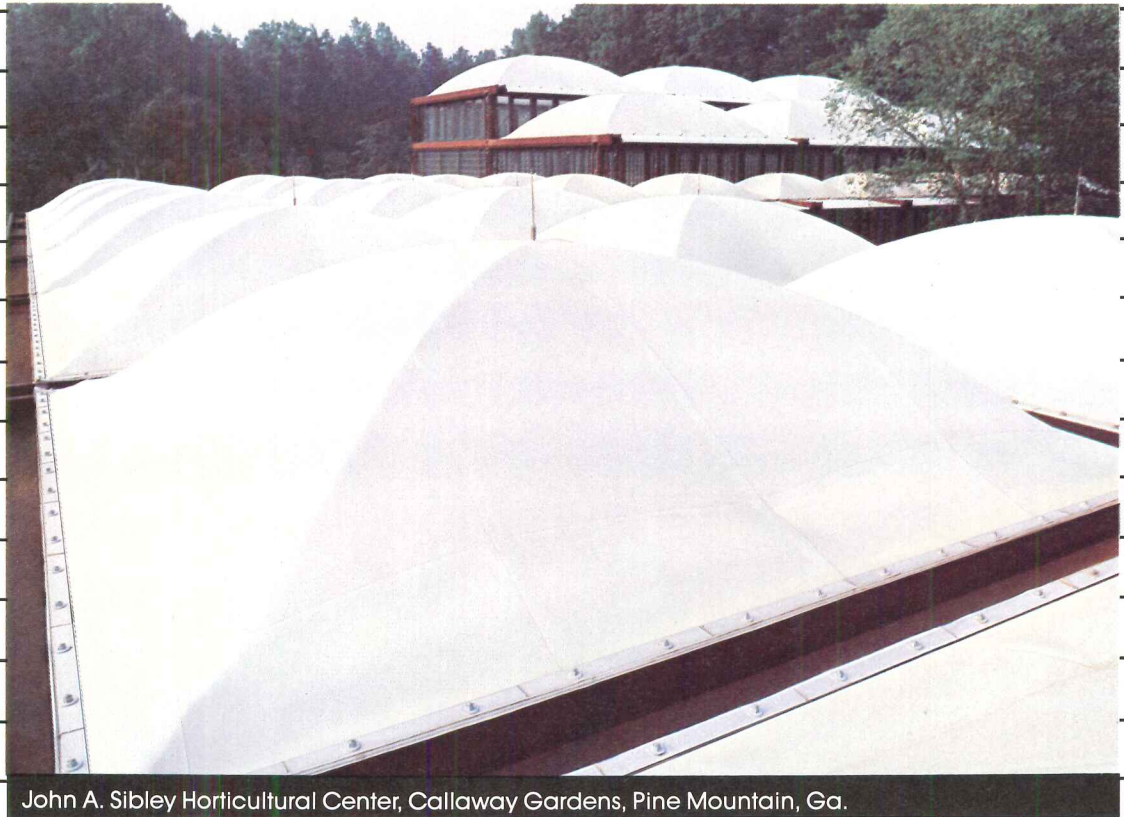

John A. Sibley Horticultural Center, Callaway Gardens, Pine Mountain, Ga.

CREATE A LASTING IMPRESSION WITH ODC'S ENGINEERED SILICONE FABRICS



Research & Development



Patterning & Fabrication



Installation & Supervision

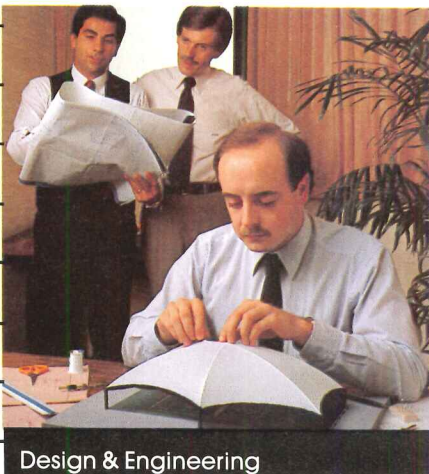

Design & Engineering

ODC's capabilities go far beyond fabric coating. We provide design, engineering, fabrication, and installation of tension and air-supported structures. Contact us for specific information about our pre-engineered structures and custom design and engineering services. Refer to Sweet's 13.1/ODC or call Sweet's BUYLINE®

ODC INC. A JOINT VENTURE OF OAK INDUSTRIES INC AND DOW CORNING CORPORATION
4291 COMMUNICATIONS DRIVE/NORCROSS, GEORGIA 30093 (404) 923-3818

Circle 1104 on inquiry card

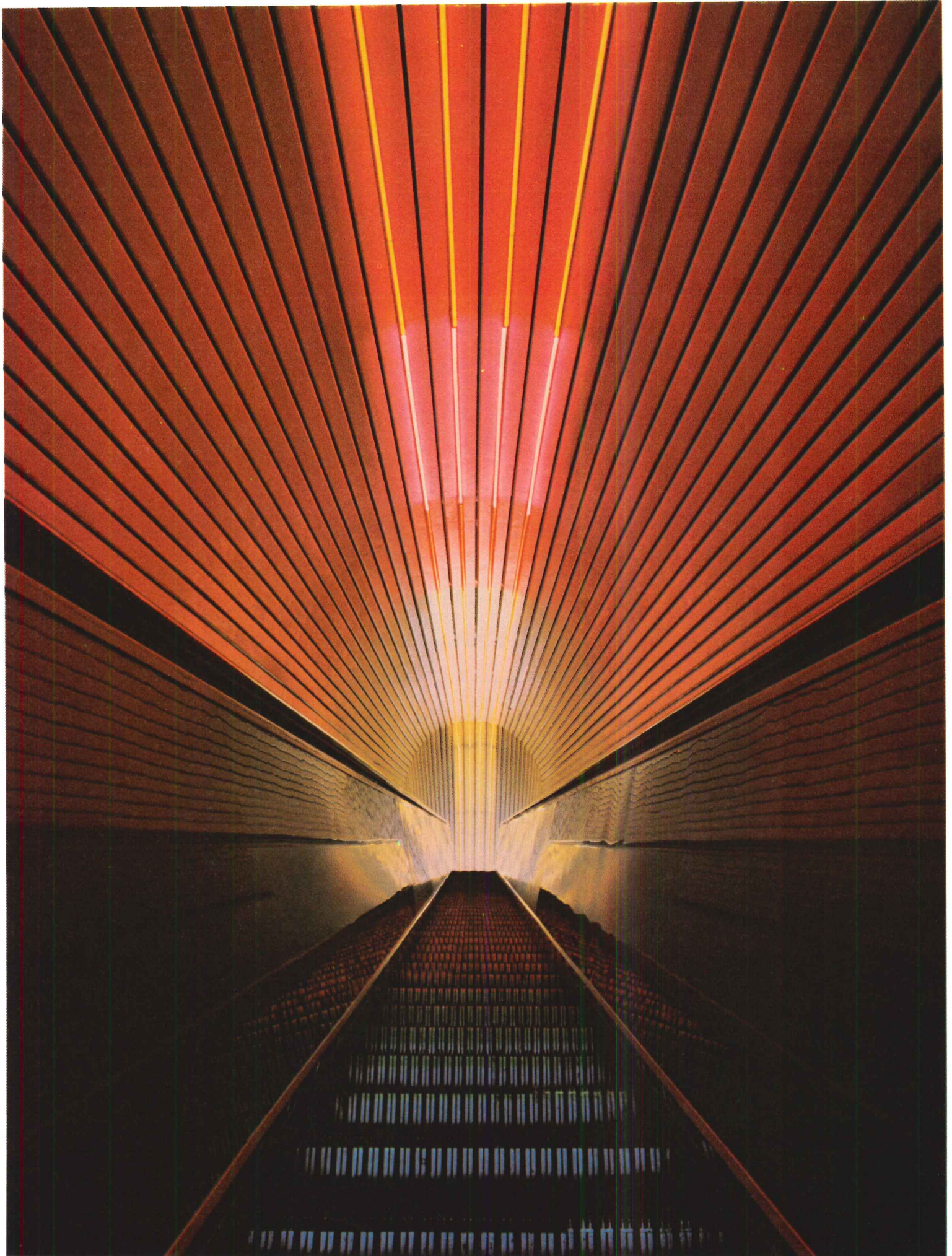

A futuristic look using Hunter Douglas Luxalon linear ceiling graces the Detroit Science Center. The colors are produced with carefully planned lighting.

YOU'LL BE AMAZED WHAT YOU CAN DO WITH HUNTER DOUGLAS ARCHITECTURAL PRODUCTS

Hunter Douglas began simply manufacturing and coating aluminum strip. But today we do much more.

We worked with the metal every day, finding out its needs and its abilities, much as a potter learns the strength and beauty hidden within his clay.

Our growth into engineering and manufacturing culminates today in one of the most complete lines of architectural products available in the United States. Or in the world.



The Commerce Court in Toronto is comfortably lit with one of the world's largest banks of blinds, made by Hunter Douglas. They're electrically operated.

YOU CAN SAVE ENERGY WITH BLINDS

We have completed actual-use testing of the Hunter Douglas Thermostop® coating, a special finish for slat used in Hunter Douglas Flexalum® energy saving blinds. It can save money on utility bills.

Not merely a shiny finish like you find on some energy blinds, the Thermostop finish actually slows the radiation of heat through the blind slat. The Thermostop finish also acts to reflect infrared rays, so you get a double benefit. And it does it without limiting the aesthetic considerations that come into play in the design or remodeling of a building; the opposite side of the slat comes in a number of decorator colors.

Independent researcher John Yellott has referred to Thermostop as, "the

®A registered trademark. A product of Hunter Douglas.

best energy-saving coating for blinds so far tested."

Where did the Thermostop finish come from? Hunter Douglas' coating laboratories.

YOU CAN INSTALL A BETTER WINDOW

The Thermostop coating isn't the only innovation we've come up with for turning blinds into energy saving devices. We've also developed the next generation of between-glass blinds.

The Hunter Douglas Flexalum magnetically operated between-glass blind is the first that can be installed in hermetically sealed as well as regular double-glazed windows.

The key is in our magnetic operator, which doesn't require a mechanical transfer. It also allows easy retrofitting in non-hermetically sealed double-glazed windows.

YOU CAN TURN YOUR IDEAS INTO A CEILING

We introduced linear aluminum ceilings in the United States. More important, we still offer a wider range of carriers, making the Hunter Douglas linear aluminum ceiling the most versatile system available. Our ceilings fit your ideas instead of the other way around.

We also have a wide range of colors and finishes for indoor and outdoor use. Luxalon® linear ceiling is versatile. And, frankly, it can be very good looking. You'll find our products in some of North America's most exclusive shopping malls, fashionable stores, and grandest office buildings.



Hunter Douglas makes it easy to turn ideas into fact. This imaginative ceiling uses materials straight from the Luxalon catalogue.

YOU CAN RENOVATE AN EXTERIOR, QUICKLY AND INEXPENSIVELY

Hunter Douglas Luxalon aluminum facades can do amazing things for the surfaces of old, worn buildings. They make an attractive design statement, in a wide range of colors, styles and profiles.

The fastening system is easily installed on your building's old facade. Panels literally snap into place.

And they're coated with our new fade-resistant premium finish.

It's quick, it's tough, it's inexpensive, and the results can be nothing short of spectacular.



Hunter Douglas specializes in the development of corporate design programs made easily and inexpensively in the wide range of styles and colors available through the Luxalon facade package. Custom colors are also available.

YOU CAN BE SURE OF WHAT YOU'RE GETTING

This is just the beginning. After fifty years in the business of making aluminum functional and durable, we're making it beautiful.

You'll find Hunter Douglas' mark in architectural design and planning in 85 different countries.

In the area of architectural products, we make everything from sun louvres to ceilings, to facades to window coverings; we are, in fact, the largest producer of venetian blinds components in the world.

Find out more. Contact your Hunter Douglas representative, or Hunter Douglas Architectural Products, 87 Route 17, Maywood, New Jersey 07607, 1-800-631-7274.

HunterDouglas Architectural Products

CHOOSE THE COLOR OF THE SKYLINE



*KPS facade utilizing the most advanced ceramic tile, Keraion 2x2 Bordeaux.
PROJECT: Nissan Regional Headquarters, Portland, OR ARCHITECT: MCOG Architects, Denver, CO*

KPS. A MOST EXTRAORDINARY DEVELOPMENT IN PRE-FABRICATED BUILDING SKIN SYSTEMS.

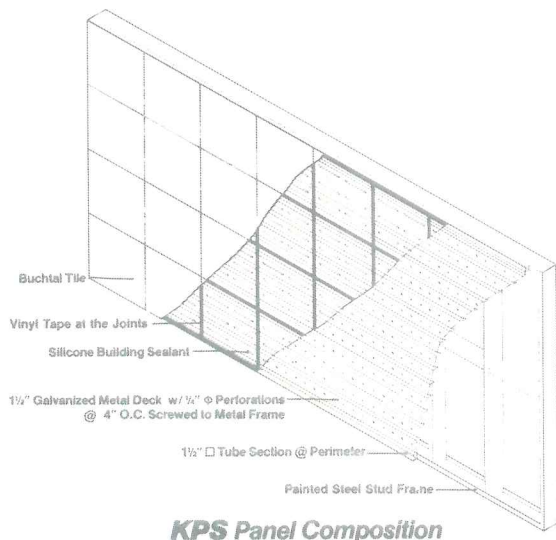

KPS (Keraion® Panel System) is the end result of two major technological advances. That of the manufacture of the world's most advanced ceramic tile, Keraion . . . and that of the unparalleled bonding characteristics of structural silicone.

Affording the designer a wide choice of grid modularity, color, texture and design flexibility, KPS technology incorporates the most desirable facade properties: lightweight (7.2psf), economical, excellent insulation values, resiliently bonded skin allowing movement capability, frost-proof and non-fading and test results that will satisfy the architectural connoisseur.

BUCHTAL 

Quality Ceramics

Suite 450
5780 Peachtree Dunwoody Rd., NE
Atlanta, Georgia 30342
Telephone: (404) 256-0999

Circle 1106 on inquiry card



Levolor color-T-grid is an exposed T-suspension system in over 100 designer colors plus brushed, burnished, polished and mirror metallic finishes. Matching-finish, aluminum-capped main beams, cross tees and edge moldings are available. For fire-rated or Class A assemblies.

LEVOLOR
Ceiling Systems

Levolor color-T-grid introduces style and color to ceilings on slim budgets.

For pennies more per square foot than you'd pay for ordinary T-grid ceilings, you can specify the new Levolor color-T-grid Suspension System.

And color-T-grid can be perfectly color-coordinated with Levolor Linear Ceilings and famous Levolor Blinds to create exciting drama. Color-T-grid comes in over 100 matching Levolor designer colors and finishes.

A slim budget is no longer an obstacle. Levolor color-T-grid makes ceilings with flair affordable.

© 1983 Levolor Products of Levolor Lorentzen, Inc.

Please send additional Levolor color-T-grid information.
Levolor Lorentzen, Inc., 1280 Wall Street West, Lyndhurst, NJ 07071

Name _____ Title _____
Firm _____ Address _____
City _____ State _____ Zip _____
AR 1283

Circle 1107 on inquiry card

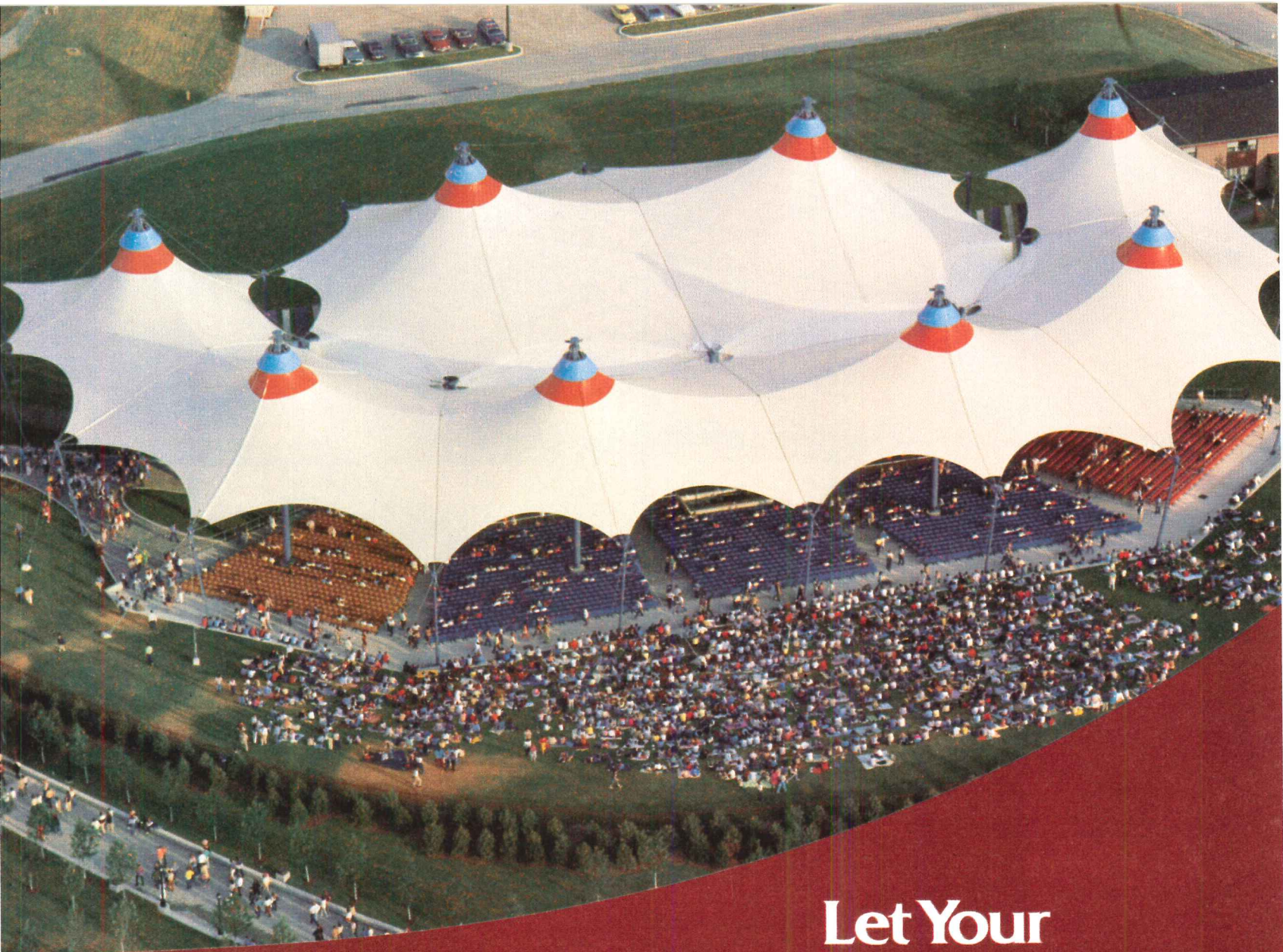

Break away from routine corners and walls by designing a Helios Soft Shell Structure. Discover the endless possibilities of working with soft fluid lines. Combine translucent texture with vibrant colors. But best of all, bring in natural open-air feeling into your environmental statement.

with flexibility, practicality and economy...

Creativity doesn't exclude professional practicality. Helios tensioned membrane structures offer realistic and economical solutions to a variety of structural applications, from vast arenas—like the one shown here from Canada's Wonderland in Toronto—to totally enclosed structures.

With Helios Industries behind you, your creative freedom is virtually limitless. They'll translate your design into a tangible full scale structure. Or their in-house design team can work *with* you to create the most people-pleasing and practical solution to your project.

Let Your Imagination Soar with Helios



(CANADA'S)
WONDERLAND

So, if your imagination is ready to take off, contact the people at Helios Industries.

Helios Industries, Inc.
20303 Mack Street
Hayward, California 94545, U.S.A.
Telephone (415) 887-4800
Telex 176226

Circle 1108 on inquiry card



HELIOS INDUSTRIES INC.
Soft Shell Structures

13 Special Construction Product literature

For more information write item numbers on Reader Service Cards



566 Swimming pools
The *Swimming Pool Buyer's Guide and Operations Handbook* features stainless steel perimeter systems, acoustical panels and other commercial swimming pool equipment. Technical data, drawings and sections on conserving energy and filtration are included. Recreonics Corp., Indianapolis, IN.

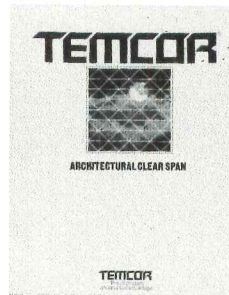

572 Clear-span domes
Three types of aluminum clear-span domes are illustrated in photos of installations in a 12-page color brochure. Spans, functions and benefits of the domes are described. Drawings detail dome frame joint construction. Temcor, Torrance, CA.

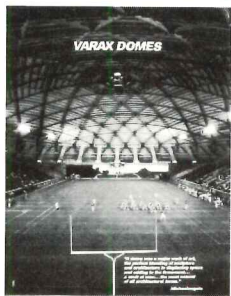

567 Domes
A brochure and specification sheet cover *VARAX* domes, which can span a 40-ft playshed or an 800-ft major sports stadium. Specifications include general data and information on materials and installation. Western Wood Structures, Inc., Tualatin, OR.

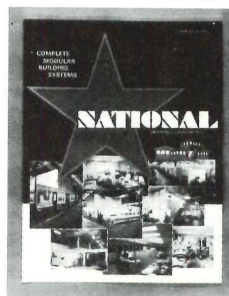

573 Modular offices
A new brochure features modular in-plant offices for industrial applications. As described, the modular system is based on 4- by 8-ft panels that are 3 in. thick. Panels come in solid versions or with windows or doors, all of which are reusable and interchangeable. National Partitions & Interiors, Hialeah, FL.

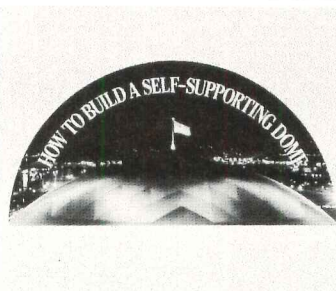

568 Domed arenas
A 6-page color brochure on multi-use domed arena design features a pop-up 3-dimensional page to illustrate this company's design solution. The financing of building and maintenance costs is discussed in detail. Arena Dome Associates, Tualatin, OR.



574 Acoustical floors
An underlayment that reduces sound transmission through hard flooring is featured in a 4-page color brochure. Section details show installation components. Applications are described and a table of physical properties and specifications are listed. Laticrete International, Inc., Bethany, CT.

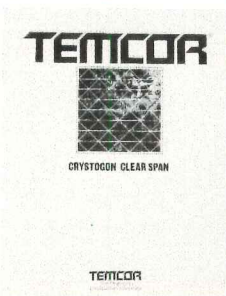

569 Clear clear spans
Crystogon domes of all-aluminum geodesic and space truss configurations with clear acrylic glazing are covered in an 8-page color brochure. Photos show installations while dome structural data, functions and benefits are described. A drawing details dome frame joint construction. Temcor, Torrance, CA.



575 Passive solar structures
Photos showing residential and commercial installations of greenhouses and solarium structures as well as automatic shading devices are featured in a 32-page color brochure. Details show construction features and tables list available dimensions. Four Seasons Solar Products Corp., Farmingdale, NY.

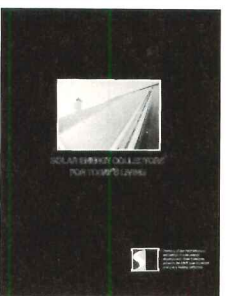

570 Solar collectors
A packet of literature includes product data sheets for 3 models of solar collectors. Diagrams with dimensions, details of mounting systems and panel construction, performance charts and technical data are included. Diagrams of solar-heated water systems are also shown. Solar Industries, Inc., Manasquan, NJ.

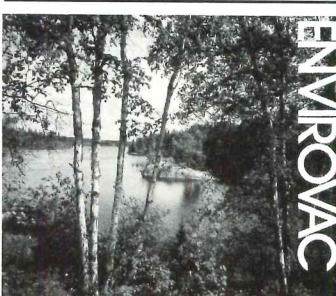

576 Waste vacuum collection
Vacuum collection systems for both permanent and portable restroom facilities, which reduce water consumption and waste volume, are featured in a 4-page brochure. Diagrams illustrate system construction and function. Envirovac Inc., Rockford, IL.



571 Pool system
The *SCRS* system, designed to maintain "fast" water during swimming competitions, is featured in a new brochure. As described, the stainless steel perimeter recirculator quells turbulence while the overflow system returns water in pace with the rate of overflow. Paddock Pool Equipment Co., Inc., Rock Hill, SC.

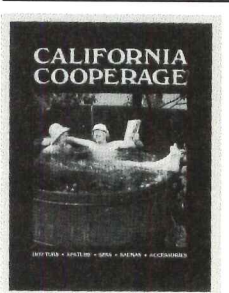

577 Hot tubs and saunas
Spas, hot tubs and saunas are featured in a 56-page color catalog. Photos of installations accompany descriptions of each model. A combined hot tub and spa, called a *Spatub*, is highlighted. Accessories, including roll-tops and decks, are also covered. California Cooperage, San Luis Obispo, CA.



More architects specify The Intelligent Elevator.™

U.S. ELEVATOR MICROPROCESSORS FOR EVERY TYPE OF ELEVATOR.

U.S. Elevator created it, a microprocessor-control installation so intelligent that it can command every facet of your entire elevator system. Allowing more creative design solutions to modern construction problems.

It's no wonder that we've built more microprocessor-controlled elevators than any other company. Machine room space is significantly reduced. Traffic is speeded with quicker response times, flight times, priority service. Operating costs are reduced, with instant computer printout analysis to prove it. In addition, this is the only microprocessor system with a Remote Performance Monitor which can communicate over a phone line to

the service office. Trouble spots can then be immediately identified and corrected.

Whatever type of building you design, whatever elevator application you specify, we can provide the right microprocessor-control system at the right price. Gearless or geared and even hydraulic elevators . . . all systems will benefit from our most sophisticated third generation of microprocessor-control systems.

MORE RELIABILITY, LESS COST.

U.S. Elevator microprocessors are more reliable and less costly to maintain. They operate the elevator system more efficiently so passengers (and building owners) are more satisfied. They are programmable, so if traffic patterns change, the system can be quickly

adjusted to compensate. And because we are the most experienced in building microprocessor-controlled elevators, we are also the most experienced in servicing them.

Let us in on the ground floor of your construction plans. Call: 619-460-1000. Dept. AR-292 10728 U.S. Elevator Rd., Spring Valley, CA 92078

U.S. ELEVATOR

A member of the Cubic Corporation family of companies

Circle 1109 on inquiry card

14 Conveying Systems Product literature

UCI 14, Conveying systems:
Conveyors and chutes
Dumbwaiters
Elevators
Hoists and cranes
Lifts
Moving stairs and walks
Pneumatic tube systems
Powered scaffolding
Turntables



578 Custom elevators
Elevators for residential application are featured in a 4-page color brochure. Photos show 3 available cab designs. Diagrams highlight the components of the lift mechanism and show the total lift design. Specifications are included. Waupaca Elevator Co., Inc., Waupaca, WI.

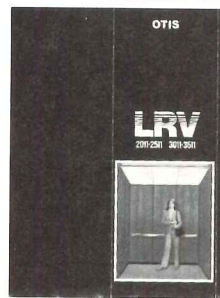

584 Low-rise elevator
The LRV hydraulic elevator is featured in a 6-page color brochure. Photos illustrate elevator installations and details, while a diagram shows a typical hoistway arrangement. Available interior panel laminate finishes are shown. Otis Elevator Co., Farmington, CT.

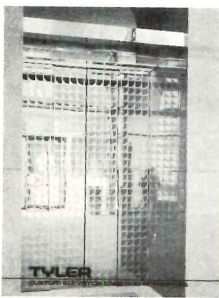

579 Elevator cabs
Several designs of elevator cabs and entrances are illustrated in photos of installations in an 8-page color brochure. Section details show the construction of various cab components and cab lighting options. Tyler Elevator Products, Inc., Cleveland, OH.



585 Hydraulic elevators
Premanufactured oil hydraulic elevators are featured in a new brochure. Loose-leaf inserts for each of 8 styles, including one for hospital applications, show plans and optional equipment and list specifications. Montgomery Elevator Co., Moline, IL.



580 Vertical conveyors
Diagrams of typical building plans and sequences of operation for 3 different models of Recordlift selective vertical conveyors illustrate a 10-page brochure. A table lists system features, and photos show component parts. Fiberglass trays are shown with lists of their dimensions. Translogic Corp., Denver, CO.

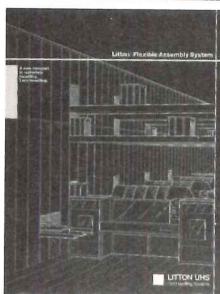

586 Materials handling
ToteStacker, a computerized system for automatically delivering parts to appropriate stations on an assembly line, is featured in a 6-page color brochure. Diagrams and photos of installations are included with descriptions of system hardware, installation and operation. Litton UHS, Florence, KY.



581 Table top conveyors
Photos of the manufacturing process and installations of Seco table top conveyors illustrate a 6-page color foldout brochure. Standard features, such as interfaced connections with associated equipment and steel shafting, and optional features are listed. Simplimatic Engineering Co., Lynchburg, VA.

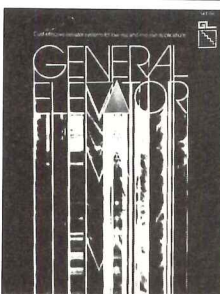

587 Elevators
Hydraulic, traction and freight elevators for low- and mid-rise buildings are covered in an 8-page color brochure. Drawings of system installations and technical data are included. Also shown in photos and diagrams are various opening and cab designs. General Elevator Corp., Orlando, FL.



582 Residential elevators
Two models of residential elevators are described in a 4-page brochure. A drawing illustrates and a table lists each model's cab dimensions. Specifications are included. Sedgwick Lifts, Inc., Poughkeepsie, NY.

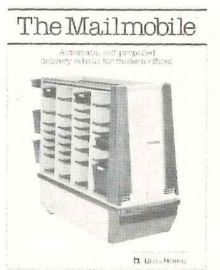

588 Mail delivery
The Mailmobile, a battery driven automatically guided delivery vehicle, is covered in a 6-page brochure. Product features and installation data, as well as specifications, are listed. Bell & Howell Automated Systems Div., Zeeland, MI.

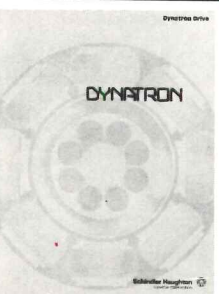

583 Elevator drive system
A 6-page color brochure details the benefits of the Dynamatron elevator drive system. As described, the system uses a single-speed AC motor and is best suited to low- to mid-rise office or apartment buildings or garages. Schindler Haughton Elevator Corp., Toledo, OH.

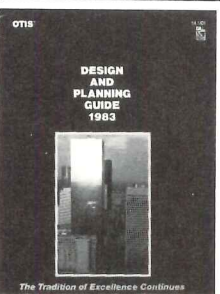

589 Elevators
Hydraulic and geared elevator systems for low-, mid- and high-rise buildings are featured in a 24-page design and planning guide. Diagrams and details show system arrangements and tables list hoistway dimensions. Hospital elevators and escalators are also covered. Otis Elevator Co., Farmington, CT.

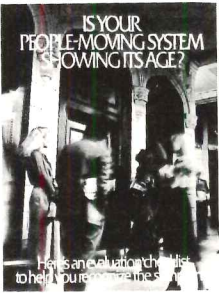

590 Elevator performance
A 4-page color brochure serves as a checklist for use in evaluating the performance of existing elevator systems. It is composed of 10 questions designed to diagnose typical problems that may be remedied by modernization. Westinghouse Elevator Co., Div. of Westinghouse Electric Corp., Short Hills, NJ.

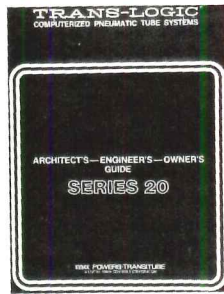

596 Pneumatic tubes
Series 20 computerized tube systems are featured in a 22-page brochure. Component parts, including carriers, transfer units, blowers and controls, are illustrated in photos and diagrams and described. Sample control center computer screen displays are also shown and described. Translogic Corp., Denver, CO.



591 Geared traction
Presidential Series geared traction elevators with microprocessor controls are covered in a 4-page brochure. Model capacities and speeds, a drawing of a typical system and cab finishes, ceiling options and fixtures are featured. U.S. Elevator, member of the Cubic Corp. family of companies, San Diego, CA.

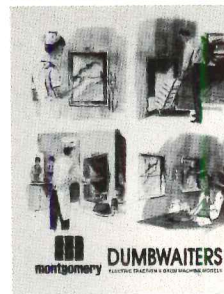

597 Dumbwaiters
An illustrated planning guide shows elevations and plan views for counter- and floor-loading lift systems. Systems covered include heavy-duty, high-speed traction, moderate-speed traction, electric drum drive and letter lifts. Montgomery Elevator Co., Moline, IL.

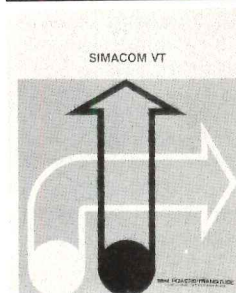

592 Electric track conveyor
Simacon VT, a mini electric car system for vertical or horizontal transport of materials, is featured in a 24-page brochure. Typical system layouts, stations and track construction are shown in drawings. Photos show component parts. Architectural details and data are included. Translogic Corp., Denver, CO.



598 Dumbwaiter
A page of literature illustrates and describes the *Homewaiter 75* dumbwaiter. Photos show 2 views of an installation, and text describes design features and construction. Section details with dimensions illustrate system components. Inclinator Co. of America, Harrisburg, PA.



593 Lifts and dumbwaiters
Drum and traction dumbwaiters and parcel lifts are featured in an 8-page brochure. Information on applications, features and modifications and specifications are included. Section details show installations and door options. Sedgwick Lifts, Inc., Poughkeepsie, NY.

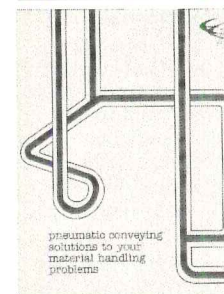

599 Conveying solutions
Seven typical cases in which this company's material handling system solved handling problems are listed in a 4-page bulletin, which also describes how the negative pressure pneumatic system operates. Eastern Cyclone Industries, Inc., Fairfield, NJ.



594 High-rise elevators
A 16-page color brochure details the *Miconic V* elevator control system for high-rise buildings. The operation of the traffic handling system is explained along with information on drive controls and installation. Schindler Haughton Elevator Corp., Toledo, OH.



600 Traction elevators
A new brochure features standard traction elevators. Cabs, doors, openings, fixtures and controls are illustrated. Specifications for each of 8 models, including one for hospital applications, show standard and optional features. Montgomery Elevator Co., Moline, IL.

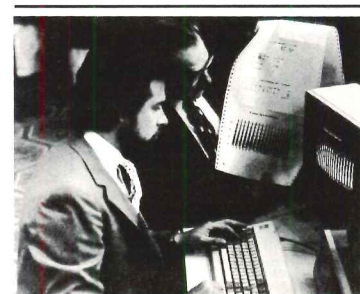

595 Elevator schedule planning
A packet of literature covers *OTISPLAN*, a computerized planning program that evaluates data, such as traffic patterns, on a proposed installation and selects optimum elevator configurations. As described, printouts list results in numerical, chart and graph form. Otis Elevator Co., Farmington, CT.

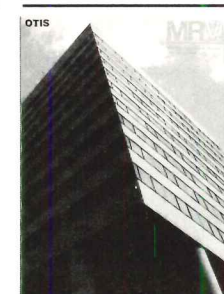

601 Mid-rise elevator
A mid-rise elevator system with variable frequency drive control is featured in a 16-page color brochure. Graphs show energy consumption and flight time comparisons with conventional systems. Photos show components and a diagram shows a typical hoistway. Otis Elevator Co., Farmington, CT.

A "living" building that adapts to its environment.

ELEVATORS BY DOVER

From night to day, season to season, the dynamic skin of the Hooker Chemical Center is in a constant state of change. The exterior consists of two glass walls about four feet apart, with louvers between these walls that open and close, adjusting automatically to outside light. The result is an extraordinary energy consumption less than half that of a conventional structure. This energy-efficient building is served by four Dover Traction Elevators. For more information on Dover Elevators for all types of buildings, write Dover Corporation, Elevator Division, P.O. Box 2177, Memphis, Tennessee 38101.

DOVER® ELEVATORS

Hooker Chemical Center
Niagara Falls, New York

ARCHITECT:

Cannon Design Inc.

GENERAL CONTRACTOR:

Siegfried-Scrufari,

Joint Venture

Dover Elevators sold and
installed by Dover Elevator Co.,
Buffalo, N.Y.



Oasis® makes ice a solution, not a problem.

When the coil or tank ices up on ordinary water coolers, you can have a problem. It can be as annoying as no water from the bubbler. Or as damaging as a burst water line.

Oasis water coolers, however, use a patented "ice bank" design to put that ice to work. The system allows us to intentionally create just enough ice to help cool the water. But not enough to stop the water flow or damage the system.

This carefully controlled ice buildup results in a constant supply of cool, refreshing water.

Our unique cold water storage tank design also results in longer life for the entire system. In any location an Oasis water cooler has far fewer compressor starts than ordinary coolers. And that means less wear and tear on the thermostat, overload, relay and compressor.

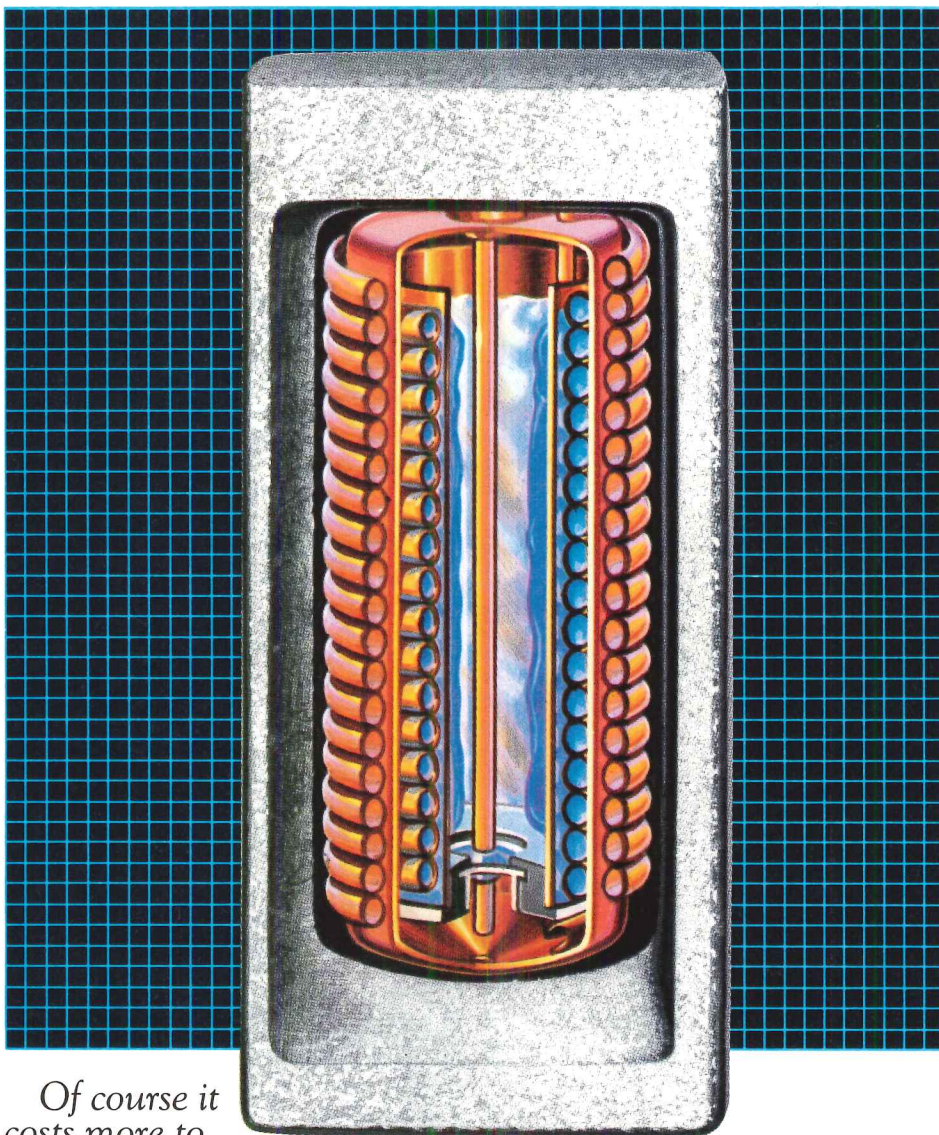

Of course it costs more to build this kind of cooling system. But if we built it any other way, it wouldn't be an Oasis. And the cold fact is, you don't need the problems that could present. Get full details in the Sweet's or Hutton Files. Or write: Ebco Manufacturing Co., 265 N. Hamilton Road, Columbus, Ohio 43213.

OASIS

WATER COOLERS BUILT WITHOUT SHORTCUTS.

Circle 1110 on inquiry card

Kroin

Sanitary Fittings

Design: Arne Jacobsen, 1967.
Selected for The Design Collection, MoMA.

Uncompromising design and quality are reflected in this all brass modular plumbing system for the kitchen, lavatory and bath. Represented here by a variety of wall-mounted fixtures and accessories finished in 10 epoxy colors, polished brass or chrome. Part of a series available exclusively from Kroin.

Circle 1006 on information card.

Kroin Architectural Complements

14 Story Street
Cambridge, Massachusetts 02138
Telephone 617 492-4000
Telex 951650

Represented in:

Boston, Cincinnati, Denver, Los Angeles,
Miami, New York City, Philadelphia,
San Francisco, Seattle, Washington DC

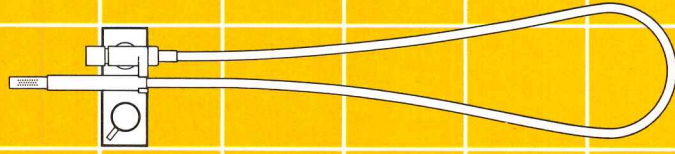
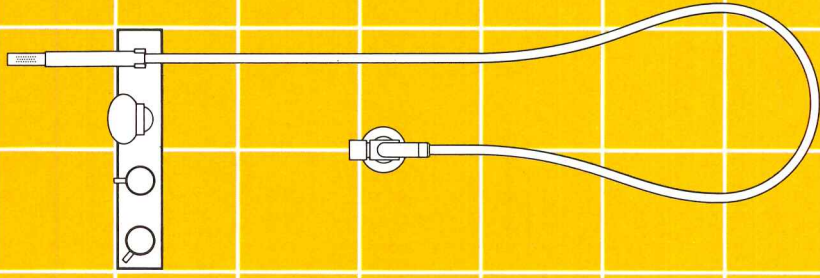
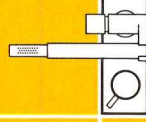
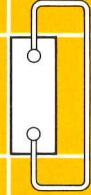
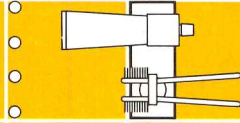
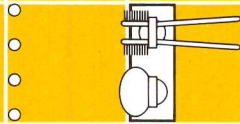
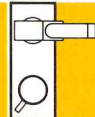

HAWS: 75 years of perfecting the drinking fountain.

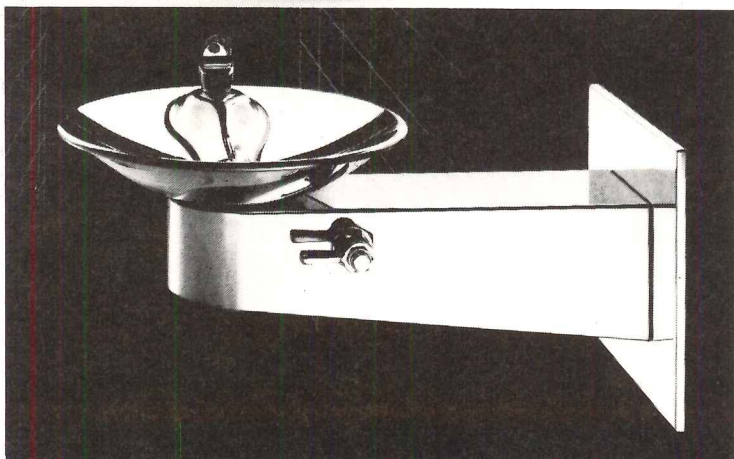
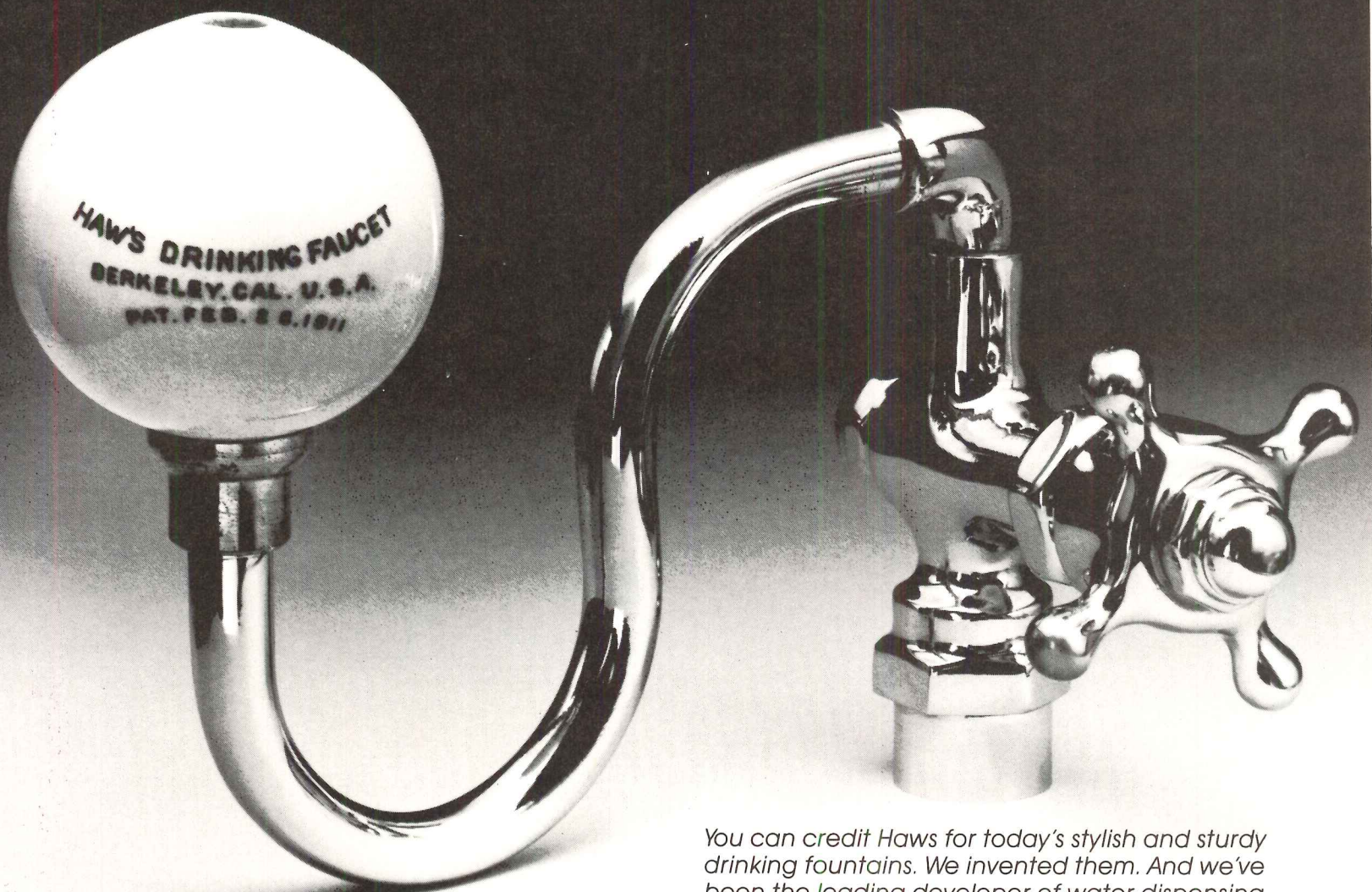

You can credit Haws for today's stylish and sturdy drinking fountains. We invented them. And we've been the leading developer of water dispensing equipment ever since.

We've expanded our line considerably since the first Haws Bubbler was patented in 1911. We offer a large selection, and our clear and concise catalogs make it easy for you to specify exactly what you need.

Look to Haws for precision engineered drinking fountains to meet any plumbing specifications. We're the Original. We're the Source. Haws.

Call or write us for more information.

Haws

HAWS DRINKING FAUCET COMPANY

P.O. Box 1999 · Berkeley, CA 94701

(415) 525-5801 Telex: 33-6358

Circle 1111 on inquiry card

What's so different about this metering faucet?

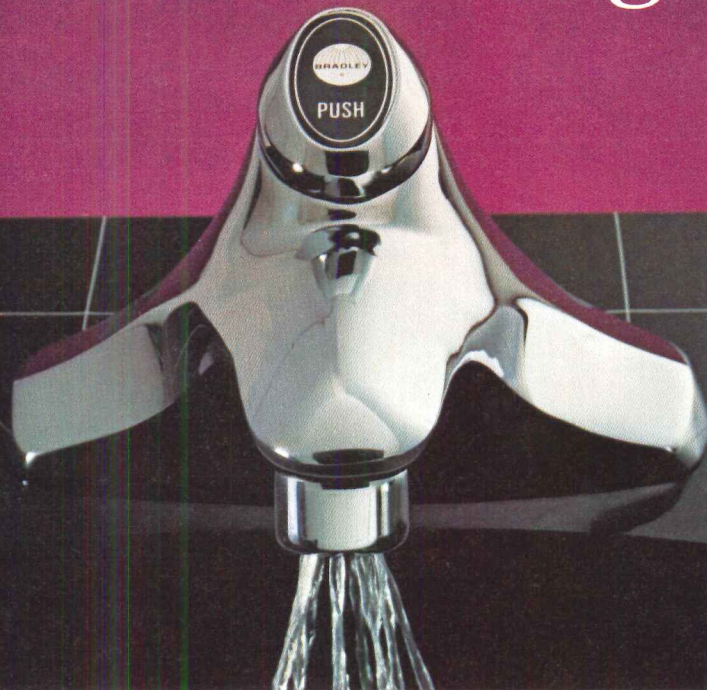

It works!

The Bradley 90-75

Until Bradley designed the 90-75, savings from metering faucets seldom outweighed the headaches.

Faucets that turn off too quickly or stay on too long, sprays that either splash or dribble, maintenance that never seems to end – the Bradley 90-75 has eliminated these headaches once and for all. It works!

Unlike many faucet designs that severely restrict an orifice to vary their metering cycles, the 90-75 utilizes a generously sized bypass orifice and variable piston stroke. The orifice is protected from waterborne sediment by two filters; one at the stop and one within the cartridge.

This unique configuration assures consistent timing – at water pressures from 20 to 100 psi.



All working parts, including the flow control, are contained in a compact cartridge.

Because it's hidden inside the faucet, the cartridge can't be removed by vandals. Yet if maintenance is ever needed, a new cartridge can be popped

into place in seconds – just about as easily as you'd change a flashlight battery.

The 90-75 keeps a reliable rose spray pattern, thanks to a unique self-cleaning feature. Every time the faucet is turned on, water pressure forces a rubber diaphragm inside the spray former to "flex" off any mineral deposits. So the nonsplash action *stays* nonsplash.

Easy to adjust, the 90-75 can be set for cycles from 5 to 20 seconds by turning a screw – without turning off the water.



And because it's so easy to activate, the 90-75 meets all barrier-free codes.

These are just a few of the ways our 90-75 meters water better. Find out the rest by returning the coupon, by calling 1 414 251-6000, or by contacting your Bradley Representative.

I'd like to know more.

AR122

Send me the comprehensive Bradley brochure with acetate overlays showing exactly how the 90-75 gets the job done better.

Have a Bradley representative call to show me how the 90-75 works better.

Name/Title _____

Company _____

Address _____

City _____ State _____ Zip _____

Telephone _____

Return coupon to: Bradley Corporation,
Dept. A, 9101 Fountain Blvd.
Menomonee Falls, WI 53051.

Bradley 90-75 is a trade name and not an ASHRAE designation.

Bradley
CORPORATION
We get the job done better.

Circle 1112 on inquiry card

Suddenly... everything else seems old heat.

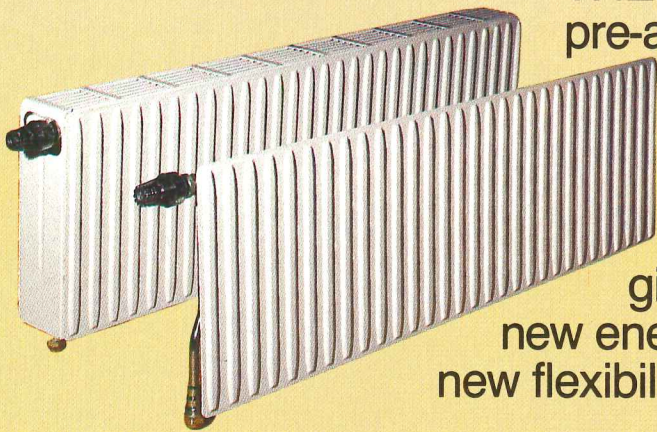

THERMOPANEL! A complete pre-assembled radiation and valve system featuring an exclusive self-contained thermostat.

A breakthrough from Sweden, giving new aesthetics to form—
new energy consciousness to function—
new flexibility to design!

It's the future, and it's beautiful...offering advantages welcomed by every thoughtful architect. Faithful to the Swedish tradition of excellence, Thermopanel introduces a new standard of hydronic radiation quality. Its economy of installation (saves a full day of labor) plus its aesthetic refinements and high performance characteristics will influence heat planning for years to come.

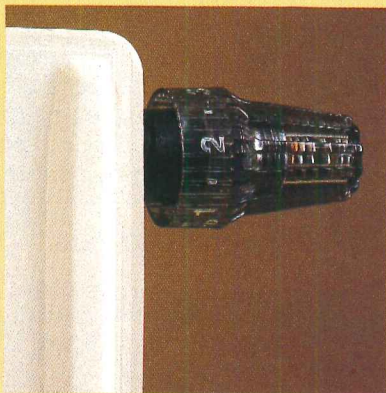

Delivers high output...

smaller and fewer Thermopanel units outperform conventional types. Used as 'modulars', they combine easily to meet any heating requirement—and provide a ready solution to difficult space challenges.

Each one its own zone...the non-electric thermostat (accurate to $\frac{1}{2}^{\circ}$) allows every area to be individually regulated for comfort and energy savings of 20% to 30%!

Enduring trouble-free operation...

silently, without soiling walls. Performance, versatility, a clean streamlined profile, everything to make Thermopanel ideal for a broad diversity of architectural concepts and projects—homes to apartment and office buildings to industrial structures. In every way, the superior choice an architect can be proud to specify!

Thermopanel is 11 7/8" high, comes in nine lengths from 15 3/4" to 110 1/4" in both single and double widths: a total of 18 sizes, providing a wide range of capacities.

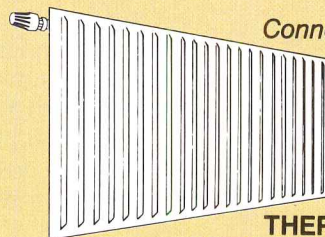

Connect with tomorrow...today!

TCI

THERMAL CONCEPTS, INC.
843 Merrick Road • Baldwin, N.Y. 11510
(516) 379-6955 • Telex #968965
Rep Inquiries Invited

What You See Is What You Get.

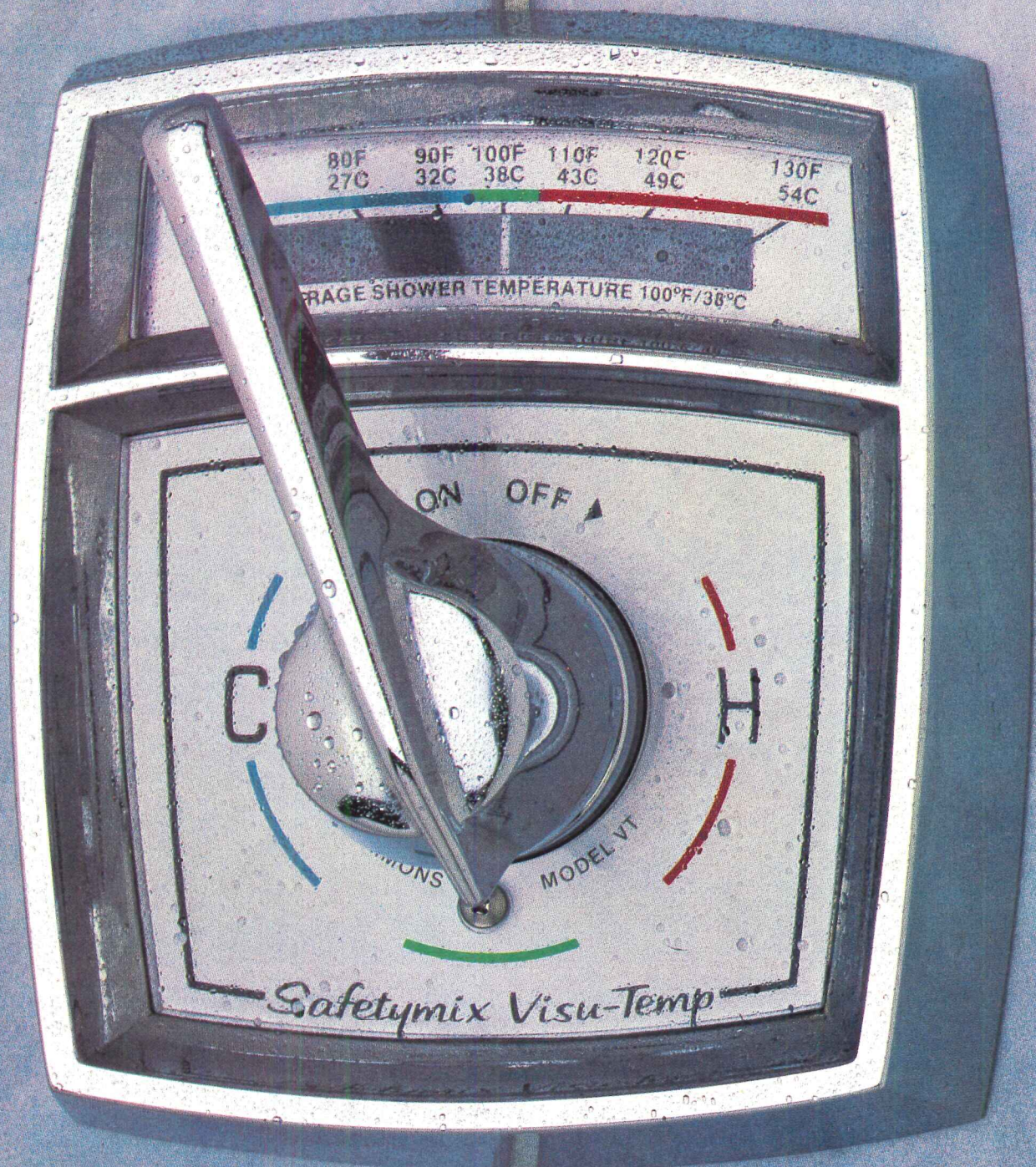

Visu-Temp shows, controls tub/shower temperature. For residential, commercial, and health care applications. Safetymix Visu-Temp is the ideal pressure-balancing mixing valve to specify. Its visible, integral thermometer and color-coded valve plate take the guesswork out of bathing temperatures. And its patented

pressure-balancing design (which you can't see) maintains the preselected temperature, when pressure disturbances occur in the system.

For a closer look, circle the number below or contact Symmons Industries, Inc., 31 Brooks Drive, Braintree, MA 02184 (617) 848-2250.

Symmons®

Circle 1114 on inquiry card

28 STORIES VOUCH FOR THE ZONELINE® IV HEAT PUMP WITH ICR

The Madison Hotel • Seattle
Denny Onslow, Project Director, R.C. Hedreen Company
Anthony Callison, John Swolgaard, Michael Whalen,
Architects, The Callison Partnership, P.S.
Stephen Wood, Gerry Hughes, Consulting Engineers,
Wood/Harbinger, Inc.

As Project Director for Seattle's new 28-story, 575-room Madison Hotel, Denny Onslow of the R.C. Hedreen Company needed to select a heating and cooling system. He wanted a self-contained system with zonal flexibility, a system that was energy efficient, practical to install and aesthetically pleasing. He knew that a standard packaged terminal heat pump would meet the first two requirements.

However, although standard heat pumps are often specified for single and even some multi-story projects, they present a problem that has plagued high-rise construction for years—winter condensate. In the past, the problem could only be solved by installing an expensive interior drain system or an unattractive exterior system to handle condensate runoff.

Onslow found that General Electric offers a more practical solution: the Zoneline® IV Packaged Terminal Heat Pump with ICR—Internal Condensate Removal. ICR minimizes winter condensate by redirecting it back into the room, producing a pleasant, humidifying effect.

The Zoneline IV Heat Pump, with the exclusive ICR option, provides zonal flexibility, energy efficiency and virtually eliminates the condensate problem. For these reasons, as well as his previous positive experience with Zoneline units, their ease of maintenance and GE product

service, Denny Onslow selected the Zoneline IV with ICR for The Madison Hotel • Seattle.

Today, the hotel contains a heating and cooling system that combines state-of-the-art technology with solid-state electronics—electronics that make the Zoneline IV one of the most energy efficient and reliable units in the industry today. The Zoneline IV offers energy management interface, temperature limiting, freeze sentinel and a solid-state compressor protection circuit, to name just a few of its standard features. And simple styling, coupled with sophisticated electronic touch controls, makes the Zoneline IV with ICR a handsome addition to any room on any level.

To get the whole Zoneline story, write J.A. Michelsen, Manager Contract Marketing, General Electric, AP4-130, Louisville, KY 40225.

**WE BRING
GOOD THINGS
TO LIFE.**

GENERAL  ELECTRIC

Circle 1115 on inquiry card

16 Electrical

UCI 16, Electrical:
 Communications
 Electrical heating-cooling
 Lighting
 Power generation
 Protective systems
 Raceways
 Wiring devices



650

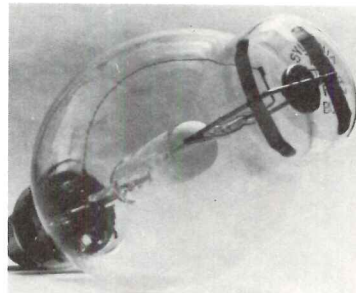

653



656

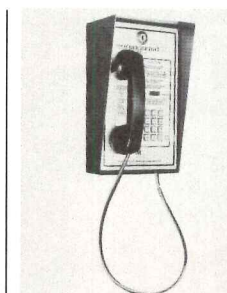

659

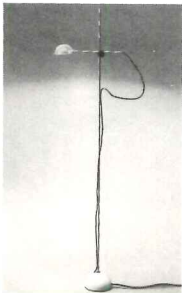

651

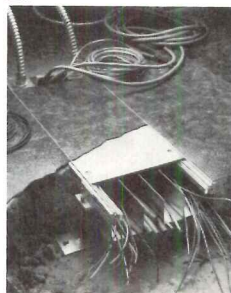

654



657

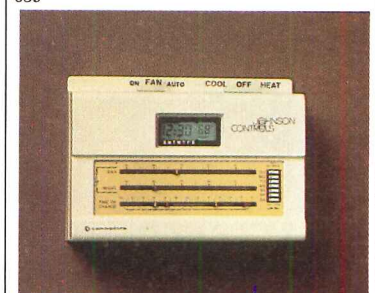

660

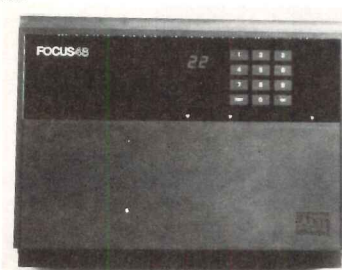

652

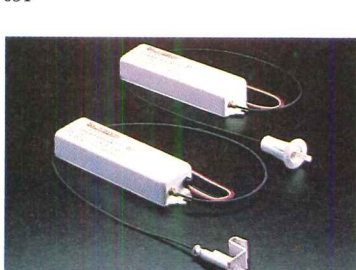

655

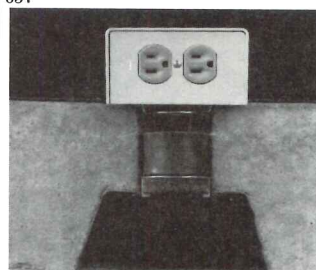

658



661

650 Talking exit signs
 Microprocessor-controlled signs that broadcast in synthesized speech operate during power failures. Multimessage units feature combinations of 4 messages and a public address function. Multilanguage units broadcast the word "exit" in 3 languages from a selection of 11. Exit-U's, Inc., Easton, CT.

651 Floor lamp
 The *Iside* floor lamp stands 58 in. high. It features an adjustable arm. The arm and stem are chrome; the base and reflector come in white or black. The lamp accepts a 50W, 12 volt tungsten halogen bulb. Lighting Associates, Inc., New York, NY.

652 Alarm systems
 The *Focus 48* can provide 5 separate alarm systems and 24-hour electronic surveillance with 1 control unit. It can also connect to a central computerized station that will monitor the system continuously and relay problems to police or fire stations. ADT, New York, NY.

653 Floodlighting
 The *Sylvania Metalarc 750W* lamp, designed for recreation and sports lighting, carries a lumens per watt rating of 110 and has an average rated life of 5,000 hours. It has a clear bulb with a mogul screw base and operates in the base-up position. GTE Lighting Products, Danvers, MA.

654 Underfloor wire system
Multi-A-Zone is a steel trench system with compartments for regular power, dedicated power, phone and electronic cable and removable steel covers. It is designed to provide wiring for checkout counters with scanning devices and cash registers. Midland-Ross, Electrical Products Div., Pittsburgh, PA.

655 Fluorescent lighting control
 The *Series III* employs a solid state unit, an optical sensor and fiber optics, which are mounted above or in a fluorescent fixture to automatically adjust individual lighting levels. The system is claimed to cut costs by up to 70 per cent. Conservolite, Inc., Oakdale, PA.

656 Undercarpet wiring
 The *Flexway* undercarpet system for power, telecommunications and data distribution meets the requirements of Article 328 of the National Electrical Code. It includes transition boxes, flexible flat conductor and a connector tool designed to facilitate installation. Burndy Corp., Norwalk, CT.

657 Ambient lighting
Staxx freestanding cylindrical units are designed to maximize low-angle light distribution and minimize overhead brightness in open offices. The fixture shown is 15 in. in diameter. Other shapes, sizes and mounting options are available. LAM, Inc., Wakefield, MA.

658 Fire-rated aftersets
 A fire-rated afterset, which provides access to power and communications wiring from the cellular portion of the deck, is claimed to eliminate or reduce the need for spray-on fireproofing in concrete decks. Raceway Components, Inc., Nutley, NJ.

659 Entry control
 The *Model 4A-40* access control system has a memory for up to 40 tenants and 10 digital keyboard codes. It features a removable printed circuit board, stainless steel face plate, door release light and variable strike time of up to 99 sec. Marlee Electronics Corp., Culver City, CA.

660 Automatic thermostat
 The *T53 Micro Electronic Thermostat* automatically adjusts building temperatures at selected times. Slide selectors set times for up to 4 temperature changes per day. Models for heating only or for heating/cooling are available. Johnson Controls, Inc., Control Products Div., Oak Brook, IL.

661 Intercom
 The *D-20 Intracom* links 6 points and accepts external music and automatic messages. It mounts on a pedestal, table or wall and connects to hand sets and stations for internal communication. Stations may be reached individually or all at once. Broadcast & Related Products/3M, St. Paul, MN.



662

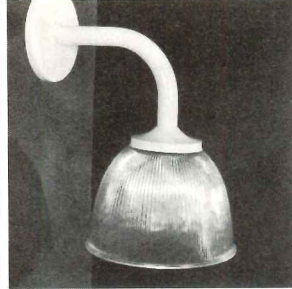

665

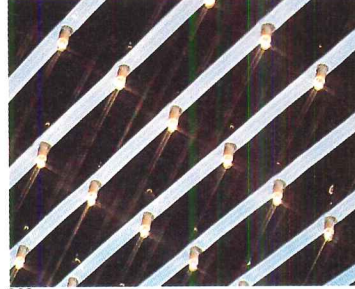

668

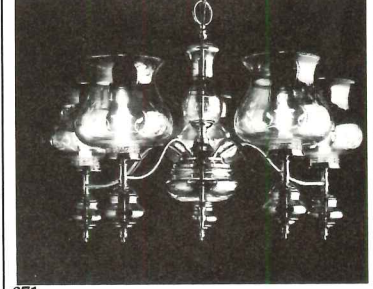

671

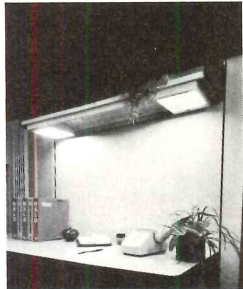

663



666

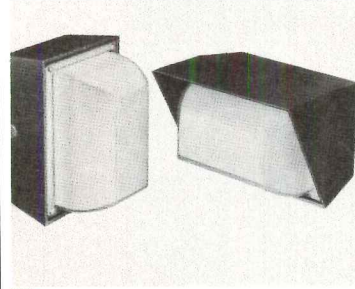

669



672

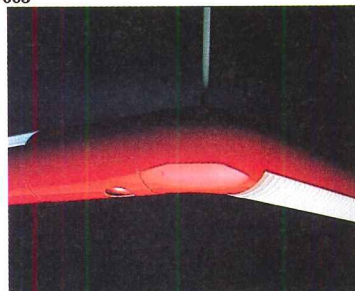

664

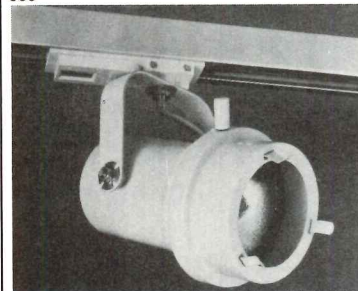

667

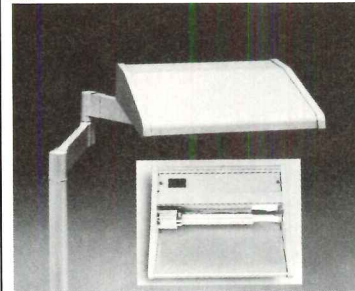

670

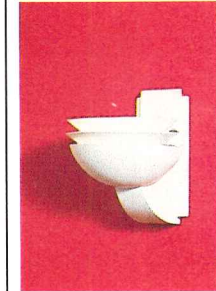

673

662 Track lighting

The 3000 series of duo-circuit track and fixtures is claimed to be the smallest single- or double-track available. It measures $\frac{5}{8}$ in. high by $1\frac{1}{8}$ in. wide. The series features a patented "twist clip" mounting designed to reduce installation time. Inlite Corp., Berkeley, CA.

663 Task lights

The UL-listed *STC-32* twin task light contains two 14W U-shaped fluorescent lamps, one on each side of a single housing. The light has a 10-in. cord and may be mounted on steel shelves, shelves with a return flange and wood shelves. Halo Lighting Div., McGraw-Edison Co., Elk Grove Village, IL.

664 Low-voltage fluorescents

Accent One is a low-voltage addition to the *Focus One* series of fluorescent fixtures. The series of round, square and round rotatable extruded aluminum units with stems or adjustable cables comes in anodized, painted or high-polish finishes. Gardco Lighting, San Leandro, CA.

665 Light fixture

The *215-WM* wall-mounted dome can be aimed up or down. It is 25 in. high, has a clear glass ribbed dome measuring 15 in. in diameter. It comes in any color or finish and in several sizes and shapes. It is also available in vandalproof materials. The American Glass Light Co., New York, NY.

666 Access control

The *CardAccess 150* system features a microcomputer with programming capability and data memory storage. Its console has a printer, will monitor up to 10,000 card holders, 64 doors and 512 alarm points and provides 16 access levels and 8 time zones. Continental Instruments, Westbury, NY.

667 Accent lighting

The *35 Series* of low-voltage units consists of compact high-intensity PAR-36 pinspots, which produce brilliant narrow shafts of light to illuminate individual objects and displays. They are available with a variety of finishes and types of mounting. Lighting Services, Inc., New York, NY.

668 Light tapes

Bare Bud Tape highlighting and accents come on pressure-sensitive flexible flat-wire tapes. Four different lamp shapes are available on 2- or 3-in. centers. Tapes are powered by a Class II UL-approved transformers. Neo-Ray Products, Inc., Brooklyn, NY.

669 Vandalproof lighting

The *Protector* series of HPS lighting fixtures features a choice of 35, 50 or 70W lamps. The lamps are protected by cast aluminum housings with polycarbonate refractors. Two styles of fixtures are available for wall or ceiling mountings. Kenall Manufacturing Co., Chicago, IL.

670 Task light

An addition to the *Inlite* HID lighting system is a task light that comes in a choice of 7, 9 or 13W. Options include under-cabinet mounting, 3-pivot mounting to drawing boards, and a desk lamp model. Lamps come in 3 different baked acrylic colors. Sterner Lighting Systems, Inc., Winsted, MN.

671 Chandelier

The 5-light *Deauville* chandelier features handblown etched glass shades. The fixtures are 17 in. high and measure $25\frac{1}{2}$ in. in diameter. They will take candleabra base lamps up to 60W. Thomas Industries, Inc., Louisville, KY.

672 Amplifiers

The *C10B* and *C20B* 10 and 20 watt amplifiers have 2 microphone connections and provide for a 500/600-ohm line matching transformer for paging or background music. A thermostat in the transformer protects against overloads. Bogen Div., Lear Siegler, Inc., Paramus, NJ.

673 Wall sconce

The *Model TF-360* aluminum wall urn features louvers that allow the passage of 80 per cent of upward light. It is $10\frac{1}{4}$ in. high with a projection of $10\frac{1}{8}$ in. It takes a 150 or 300W flood or spot and comes in brushed aluminum, matte white or custom color finishes. Rambusch, New York, NY.



674



675



676

674 Area lighting

The *RLM Look* is a series of area lighting luminaires and ornamental poles available in a variety of glossy acrylic enamel finishes. The fixtures accept HID lamps. Architectural Area Lighting/subsidiary of Kidde, Inc., Santa Fe Springs, CA.

675 Emergency exit lights

An emergency power pack for this manufacturer's *Warrior* exit lights illuminates both the sign face and the floor below for more than 90 min. When power is on the pack recharges. The pack includes a system test switch. Halo Lighting Div., McGraw-Edison Co., Elk Grove Village, IL.

676 Sound console

The *Series 233* console for 3-channel operation permits school administrators to make announcements and distribute programs to rooms over 2 program channels and to have conversations on an intercom channel. Capacities range up to 225 rooms. Bogen Div., Lear Siegler, Inc., Paramus, NJ.

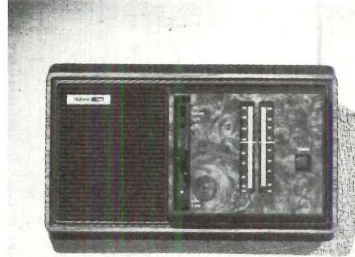

677



678

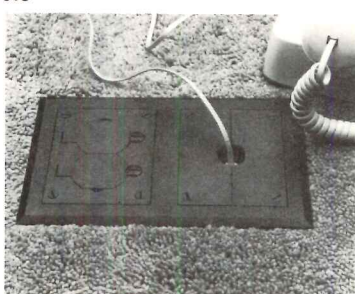

679

677 Office intercom

The power supply of the *I-600* selective call intercom provides DC power to up to 14 master stations, or 13 stations and 1 door speaker. The intercom includes a privacy button and a "listen in" button for monitoring unattended offices. Nutone Div., Scovill, Inc., Cincinnati, OH.

678 Outdoor light fixture

An addition to this manufacturer's *Sidelite* series of outdoor fixtures, the polycarbonate edition features a 1-piece front housing and a back housing made of cast aluminum. It accepts both high- and low-pressure sodium and mercury vapor lamps. ITT Outdoor Lighting, Southaven, MS.

679 Raceway fitting

Compatible with this company's raceway systems, the *Source II* services wire distribution of any 2 types of wiring, including communications, power and data. The fitting installs flush with the floor to maintain the uncluttered look of an open office. Walker Div. of Butler Manufacturing Co., Parkersburg, WV.

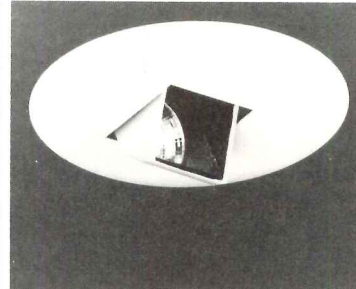

680

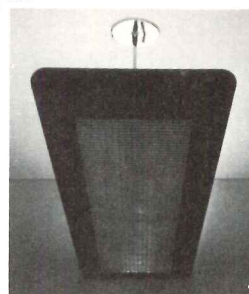

681

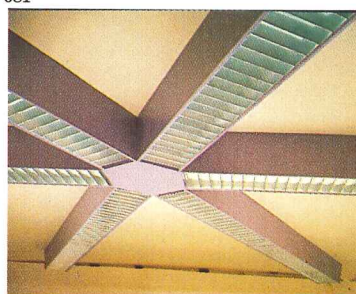

682

680 Recessed ambient lighting

The *Mirror Light* is a low-voltage recessed fixture, which uses a mirror to create even wall wash illumination high up on a wall. It may also be used for lighting floor and wall displays and can be installed in any of this manufacturer's LV100, LV300 or LV3E housings. Capri Lighting, Los Angeles, CA.

681 Fluorescent lighting

The *Series 400* features fixtures in black or white textured polyurethane enamel. They come with two or four 40W rapid-start lamps and have specular chrome louvers at the bottom. Open tops provide ambient light. Contract Lighting Systems, Div. of TSAO Designs, Inc., New Canaan, CT.

682 Linear lighting

Mod II and *SuperMod II* 6- and 8-in. wide modules feature continuous, uninterrupted baffles. Fixtures are made of steel and have joints with splines and gasketed ends to assure alignment. They come in recessed, surface and pendant models in 16 color finishes. Litecontrol Corp., Hanson, MA.

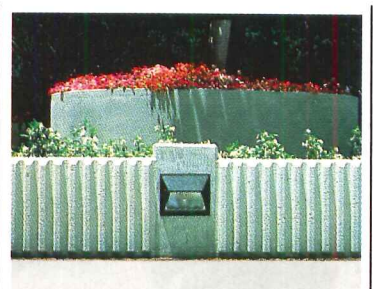

683



684

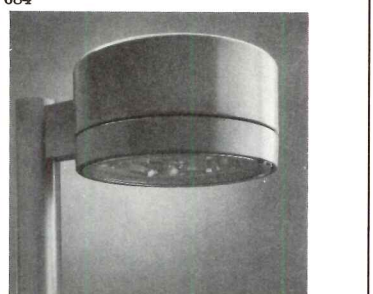

685

683 Floodlight

UL-approved incandescent and HID *Low Level Floodlights* are designed to light pathways, courtyards and stairways. They feature cast aluminum housings and, where walls or planters are not available for mounting, may be embedded in concrete pedestals. Kim Lighting, Inc., City of Industry, CA.

684 Digital clocks

Secondary clocks for commercial and institutional application feature 1.8-in.-high digital displays and come in surface-, flush-, or double-faced mountings for ceilings or walls. They may be used with this company's master program clocks or operate alone. Rauland-Borg Corp., Chicago, IL.

685 Luminaires

Form Ten luminaires feature permanently sealed spun aluminum housings with silicone gaskets, extruded aluminum arms, concealed hinges and spring-loaded latches. They come in bronze or black enamel finishes and will accept HID lamps to 400W. Gardco Lighting, San Leandro, CA.



686

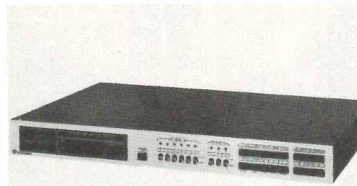

689



692

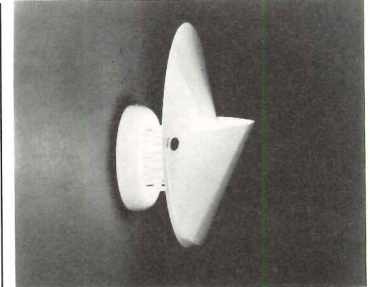

695

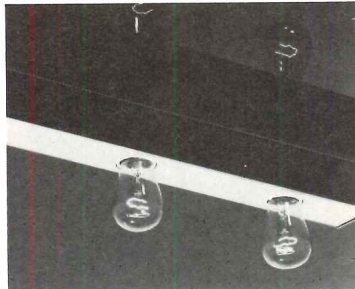

687

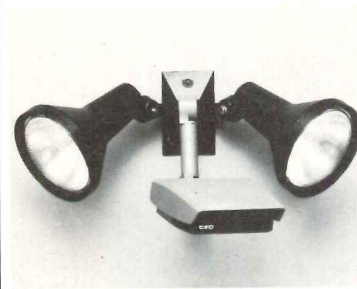

690



693



696

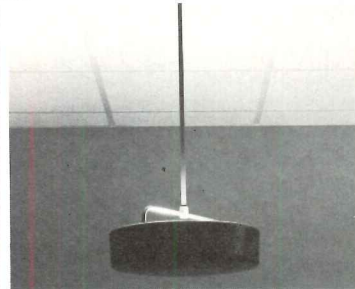

688

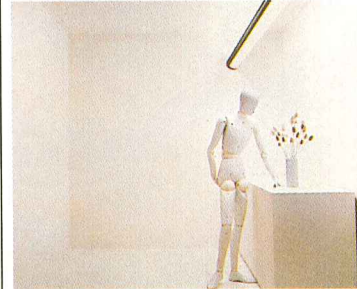

691

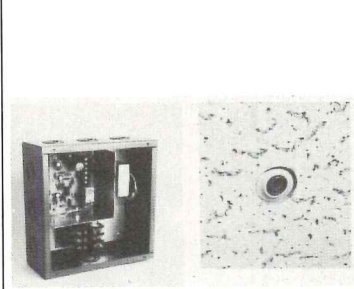

694

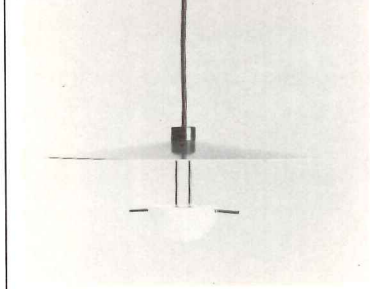

697

686 Building automation

The UL-listed *JC/85/20* computerized system integrates control of energy management, building security and fire-safety functions for buildings ranging in size from 50,000 to 200,000 square feet. It may be used for any of the functions individually as well. Johnson Controls, Inc., Milwaukee, WI.

687 Linear lighting

The *LiteTrax* system features 2-by 2-in. aluminum extrusions in brass, chrome or satin finishes. Six lengths and a variety of corner connectors and fittings are available with medium screw base sockets on 6- or 12-in. centers. The system accepts 25-60W 120 volt lamps. Litelab Corp., New York, NY.

688 Ceiling-mounted luminaire

The *Systems 30* ceiling-mounted luminaire provides indirect HID lighting. The ballast and upper support of the unit are mounted on a metal pan, which spans the ceiling grid. The fixture may be adjusted to hang anywhere between 2 and 3 ft below the ceiling. Slater Electric Inc., Glen Cove, NY.

689 Time-program clock

The FCC-approved and UL-listed *Master Time-Program Clock* controls up to 6 zone devices. Any of the zones may also be manually activated. A key pad sets time and programs (bells, lights, music, etc.) and runs tests. The system will run 7 days on battery back-up power. Dukane Corp., St. Charles, IL.

690 Security lighting

The UL-listed 120 volt *LightWatch II* is an automatic outdoor lighting control that uses passive infrared sensors to detect rapid temperature changes within its field. The system includes an adjustable timing delay circuit. Colorado Electro Optics, Inc., Div. of Linear Corp., Boulder, CO.

691 Fluorescent light

When mounted at 10 ft or higher, the 6-in. tubular *Narrow Up and Down Light* is said to provide a soft ambient light. Its widespread up light produces a wash on the ceiling and reduces contrasts. The fixture may also serve as a corridor light. Peerless Electric Co., Berkeley, CA.

692 Desk lamp

The 16-in.-high *Bellissima* is a solid brass lamp with its shade attached to a clutch, which slides vertically and rotates around its stem. The shade features a universal swivel. The lamp comes in polished brass or chrome or "California" brass. Koch + Lowy, Inc., Long Island City, NY.

693 Exit signs

UL-listed exit signs, designed for flat wall, ceiling or extended wall mounting, operate at 10 volts. They are made of molded flame-retardant resin, have 6-in. stenciled letters and come with either a single or a double face. mcPhilben Lighting Div., Emerson Electric Co., Melville, NY.

694 Light-sensor system

The *SmartCell* lighting control system includes low-voltage light sensors and a control module that may be connected to 120 or 277 volt circuits. The system supplements daylight with just enough artificial illumination to attain selected light levels. Wide-Lite Corp., San Marcos, TX.

695 Wall lamp

The *Giovi* wall lamp has a snap-on reflector and produces a combination of indirect upward, reflected downward and ambient light. The UL-listed lamp is 11 in. in diameter and 6¼ in. deep and has a white enameled metal housing. Atelier International Lighting, New York, NY.

696 Security light

The *Owl* light takes 35W to 50W HPS lamps. Ceiling and wall brackets and ballast housings are made of black fiberglass reinforced polyester. The industrial reflector shown is one of a number of available assemblies. General Electric Co., Lighting Systems Department, Hendersonville, NC.

697 Pendant light fixture

A pendant light fixture designed by Vico Magistretti features a white hemispheric globe. It measures 20 in. in diameter and is designed to take a 50W low-voltage tungsten halogen lamp. Lighting Associates, Inc., New York, NY.

16 Electrical Product literature

For more information
write item numbers on
Reader Service Cards



698 Telephone signals
Strobe lights, horns, bells, chimes and combinations for commercial and industrial applications are covered in an 8-page brochure. Telephone ringing relays and explosion proof bells are also included. Devices are shown in photos and features, and operating voltages are listed. Wheelock Signals, Inc., Long Branch, NJ.



704 Light track
A 4-page color brochure features the 3000 series light track components, adaptor, mounting system and lamp fixtures. Photographs and diagrams with dimensions are included. Inlite Corp., Berkeley, CA.

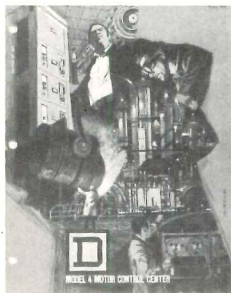

699 Motor-control centers
Model 4 motor-control-center units, bus barriers and bus bars, wire troughs and wire termination are shown in photos and described in a 16-page color brochure. Center features are listed, and structures in 2 arrangements and 2 depths are illustrated and described. Square D Co., Peru, IN.

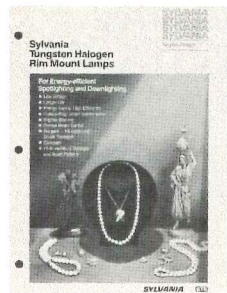

705 Display lighting
A 4-page brochure features 10 types of *Sylvania* tungsten halogen rim-mounted lamps for applications such as stores, galleries and restaurants. Energy-saving performance curves are shown for each lamp, along with tables of design and operating data. GTE Lighting Products, Danvers, MA.

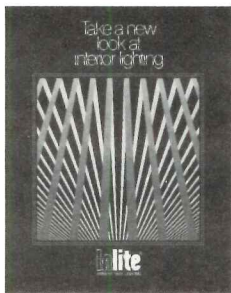

700 HID lighting
A 12-page color brochure featuring this company's HID task and ambient lighting fixtures discusses the quantity, quality and operation costs of different types of lighting. Such factors as intensity, uniformity, glare and reflections are illustrated. Sterner Lighting Systems, Inc., Winsted, MN.



706 Projection screens
An 8-page brochure covers a line of projection screens that includes models for recessed ceiling installation. Photos and diagrams illustrate each model. Methods of installation are also shown. Size charts and specifications are included. Da-Lite Screen Co., Inc., Warsaw, IN.



701 Hospital communications
A 6-page foldout brochure features the *Responder III*, a microprocessor-based system with bedside, emergency and staff stations and corridor and zone lights. Functions of the control station are described in detail. Installation and maintenance are also covered. Rauland-Borg Corp., Chicago, IL.

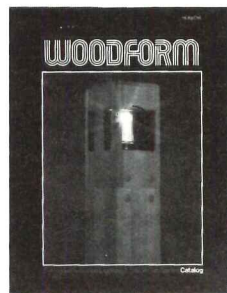

707 Site lighting
California redwood bollard-, wall- and post-mounted lighting series are featured in a 36-page color catalog. Drawings with dimensions and diagrams of light patterns are included for each model. Mounting details and photos of installations are also shown. Woodform Div., Columbia Cascade Timber Co., Portland, OR.



702 Entry-control systems
Entraguard systems for both buildings and parking lots are featured in a 12-page color brochure. System units are shown in photos and described. Optional printers, cassette recorders and mounting systems are also featured. Specifications are listed. Marlee Electronics Corp., Culver City, CA.



708 Undercarpet wiring
Teletape undercarpet telephone and data-distribution cable systems are featured in an 8-page color brochure. Photos illustrate installation procedures and highlight system components. Specifications are listed. Brand-Rex Co., Telecommunications Div., Willimantic, CT.



703 Switches and receptacles
Rocker switches, receptacles, wallplates and dimmers are shown and described in a 6-page color brochure. Selection charts for each product line include sizes and finishes. Leviton Manufacturing Co., Inc., Little Neck, NY.

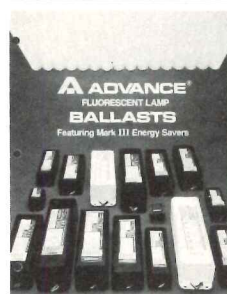

709 Lamp ballasts
A 24-page catalog covering this company's line of fluorescent lamp ballasts includes a section on the *Mark III* ballasts for F40 and 800 MA rapid-start and F96 *Slimline* energy-saving lamps. Lamp and electrical data and wiring diagrams are included for the entire line. Advance Transformer Co., Chicago, IL.

For more information
write item numbers on
Reader Service Cards

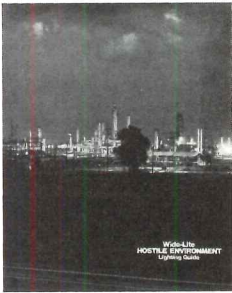

710 HID floodlights

A 32-page color catalog features this company's line of HID floodlights for marine, Class 1, Division 2 hazardous locations and heavy industrial applications. Information on fixture temperatures, ballasts and special coatings is included. Dimensions and specifications are listed. Wide-Lite Corp., San Marcos, TX.



716 Vandalproof lighting

A 4-page brochure describes and illustrates the *Defender* series, which features cast aluminum housings and polycarbonate refractors. Specifications include details with dimensions and data for asymmetric and symmetric lighting patterns. Kenall Manufacturing Co., Chicago, IL.

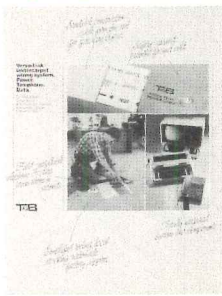

711 Undercarpet wiring

A 4-page color brochure features the UL- and NEC-approved *Versa-Trak* undercarpet wiring system for power, telephones and data. Photos illustrate system components and a diagram shows a typical layout. Thomas & Betts, Raritan, NJ.



717 Fire alarm and security
Sentara 324, a microcomputer controlled system, is covered in a 12-page brochure. The system's video display terminal, printer and software are shown in photos. How it works is extensively described and illustrated in diagrams. Honeywell Commercial Div., Minneapolis, MN.

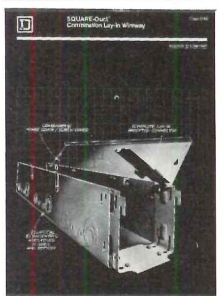

712 Lay-in wireway

An 8-page color bulletin features the *SQUARE-Duct* combination of both a hinge- and a screw-cover system in the same assembly. Photos show components and installation procedures. A typical layout is diagrammed, and charts list dimensions. Square D Co, Palatine, IL.

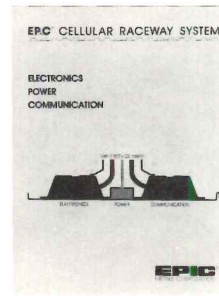

718 Raceway distribution

The *EPC* system, an in-floor system with 3 separate cellular raceways to carry electronics, power and communications lines in one unit, is featured in a 4-page brochure. A diagram shows how the system is constructed and details show a typical layout and module configurations. Epic Metals Corp., Rankin, PA.



713 Electric thermal storage

Electric storage heaters for contract and residential applications are featured in an 8-page color brochure. Heater components and operation are shown in diagrams and photos and described. System controls are also described and specifications are listed. Stiebel Eltron North America, Westwood, MA.



719 Emergency lighting

The *EZ-2R* recessed emergency lighting unit is featured in a 4-page color brochure. Photos show a typical installation and a close-up view that highlights construction details. Operation and installation are described. A diagram of the fixture includes dimensions. Dual-Lite, Inc., Newtown, CT.

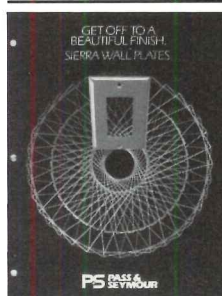

714 Wall plates

Stainless steel and plastic wall plates in over 50 colors and finishes are featured in a 4-page color brochure. Finishes include brass, copper, chrome, gold, silver and aluminum. Pass & Seymour Inc., Wiring Device Div., Syracuse, NY.

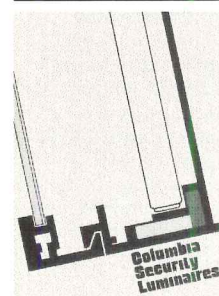

720 Security lighting

A packet of literature features data sheets on extruded aluminum and steel luminaires for maximum-, medium- and minimum-security installations. Section details, diagrams of typical layouts and specifications are included. Columbia Lighting, Inc., subsidiary of U.S. Industries, Spokane, WA.



715 Sound equipment

A 20-page catalog features amplifiers, speakers, microphones, receivers, specialized audio equipment and accessories. Typical applications range from stadiums and airports to small stores, schools and clinics. Bogen Div., Lear Siegler, Inc., Paramus, NJ.

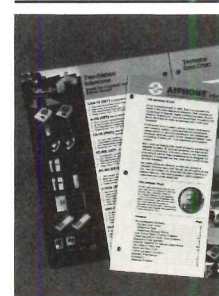

721 Intercom systems

A brochure illustrates and describes features, functions and installation specifications for a line of intercom systems. The brochure includes 27 different systems, which cover a range of capacities from 2 to 128 stations. Aiphone Intercom Systems, Bellevue, WA.

Project: Offices, Environmental Planning & Research, Inc., Los Angeles
Interior Architect: Environmental Planning & Research, Inc.
Lighting: 6" Lite Duct Wide Spread Down Light with specialized Softshine optics
and 6" Lite Duct Up Light with baffles. Lite Duct is one of the 13 Longlite systems and
comes in seven diameters and configurations, in any finish, and extends to any length.

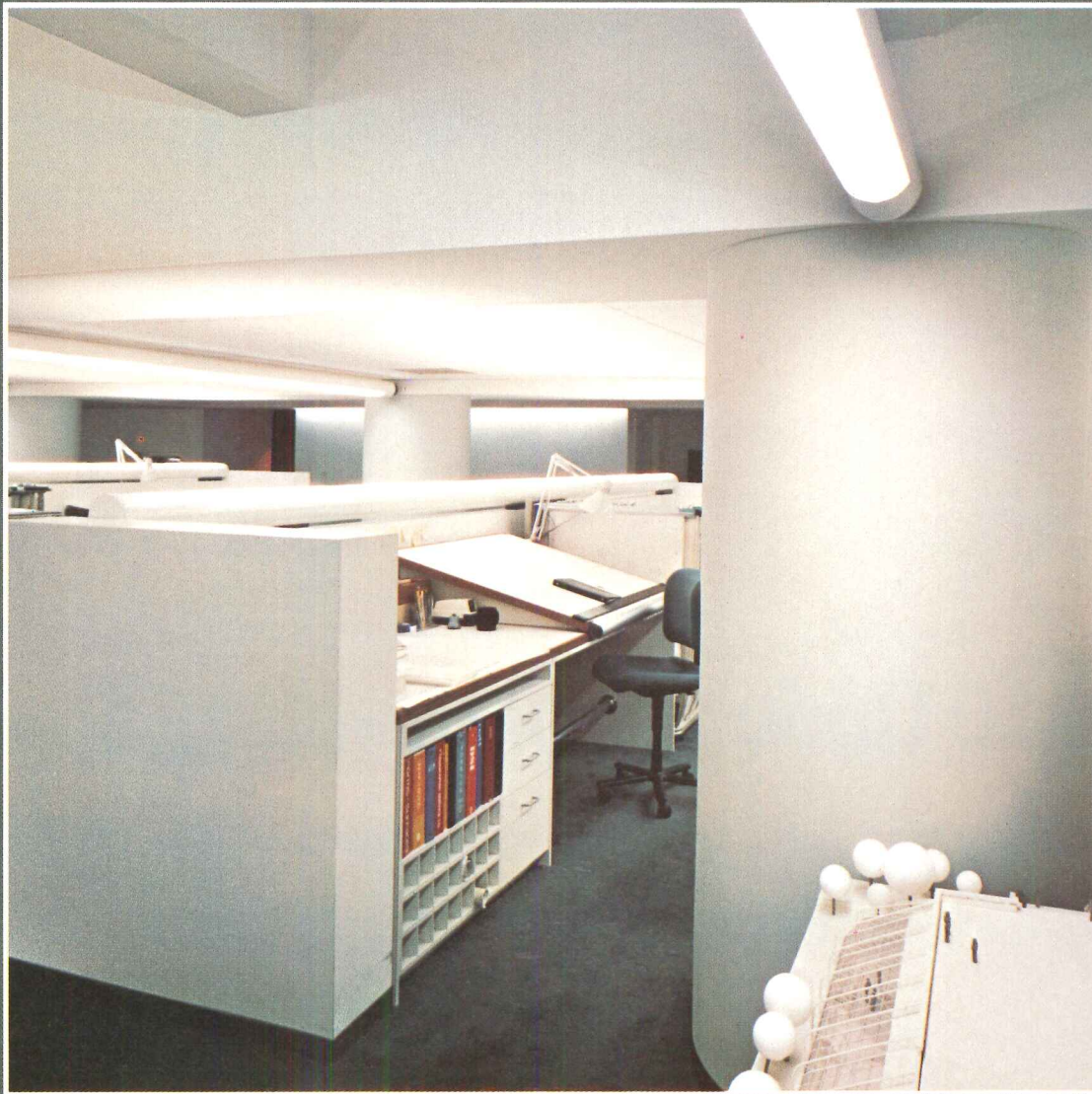

LIGHTING REINVENTED

Consider this problem: lighting a central drafting area at .85 watts/ft²—under a 7'6" ceiling! Impossible, without the high efficiency, wide distribution and low brightness of Softshine optics. Here, down lights and up lights alternate at 8' intervals, giving every station comfortable work light, even at night. The desk lamps are there just to make the architects feel at home. Contact us to see more reinventions, more impossibilities.

LONGLITES BY PEERLESS

PEERLESS ELECTRIC COMPANY, BOX 2556, BERKELEY CA 94702-0556. TELEPHONE (415) 845-2760

"PEERLESS," "LONGLITES," "LITE DUCT" AND "SOFTSHINE" ARE TRADEMARKS OF PEERLESS ELECTRIC COMPANY

Circle 1116 on inquiry card

**As easy to change
as it is to install.**

AMP Undercarpet Cabling System III.

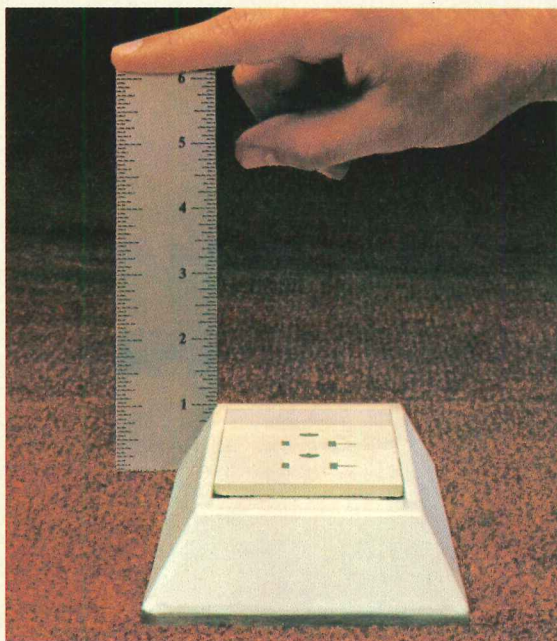

The new, low-profile pedestal is available for all three functions: power, telephone, and data distribution.

See our Sweet's Catalog listing 16.2c/AMP.

Whether it's a new building or an old one, a need for greater flexibility or a need for increased profitability, AMP Undercarpet Cabling System III fits the bill beautifully.

This surface-mounted cabling concept is available for power, telephone, and data distribution. Only AMP makes all three. It's the most intelligent system going. All you do is lay it out on the flooring and cover it with standard carpet squares. It's made to take the pounding of foot traffic as well as furniture moving. The system can be economically rearranged at any time.

Electricians can easily install it in just one visit with no comeback time. Construction schedules are flexible. It's UL® listed and in the 1981 printing of the National Electrical Code, Article 328. And, of course, it's profitable any way you look at it.

For more information see your Authorized AMP Undercarpet Distributor. For the name of your nearest AMP Distributor, call 800-852-5000, Ext. 80.

AMP means productivity.

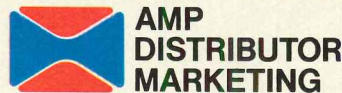

A Division of AMP Products Corporation
AMP is a trademark of AMP Incorporated.





Photo: Peter B. Kaplan

If you still believe in me, save me.

For nearly a hundred years, the Statue of Liberty has been America's most powerful symbol of freedom and hope. Today the corrosive action of almost a century of weather and salt air has eaten away at the iron framework; etched holes in the copper exterior.

On Ellis Island, where the ancestors of nearly half of all Americans first stepped onto American soil, the Immigration Center is now a hollow ruin.

Inspiring plans have been developed to restore the Statue and to create on Ellis Island a permanent museum celebrating the ethnic diversity of this country of immigrants. But unless restoration is begun now, these two landmarks in our nation's heritage could be closed at the very time America is celebrating their hundredth anniversaries. The 230 million dollars needed to carry out the work is needed now.

All of the money must come from private donations; the federal government is not raising the funds. This is consistent with the Statue's origins. The French people paid for its creation themselves. And America's businesses spearheaded the public contributions that were needed for its construction and for the pedestal.

The torch of liberty is everyone's to cherish. Could we hold up our heads as Americans if we allowed the time to come when she can no longer hold up hers?

Opportunities for Your Company.



You are invited to learn more about the advantages of corporate sponsorship during the nationwide promotions surrounding the restoration project. Write on your letterhead to: The Statue of Liberty-Ellis Island Foundation, Inc., 101 Park Ave, N.Y., N.Y. 10178.



Save these monuments. Send your personal tax deductible donation to: P.O. Box 1986, New York, N.Y. 10018. **The Statue of Liberty-Ellis Island Foundation, Inc.**

CLASSICS

See the entire collection at our showrooms,
or write on your letterhead for our new
catalogue. Or design your own fixture.
We'll do the contract work.
We do it all. And we do it here in the U.S.A.

KOCH+LOWY INC.
THE PAST, PRESENT, AND FUTURE
OF MODERN LIGHTING

200 Lexington Ave., # 1409, New York, N.Y. 10016
Pacific Design Center, 8687 Melrose Ave., Los Angeles, Calif. 90069
10044 World Trade Center, Dallas, Texas 75258

Circle 1118 on inquiry card
1245 Merchandise Mart, Chicago, Illinois 60654
Galleria Design Center, 101 Kansas Street, San Francisco, Calif. 94103
C423.2 Commerce Wing, Southern Furniture Center, High Point, N.C. 27261

Julian Weiss Architect

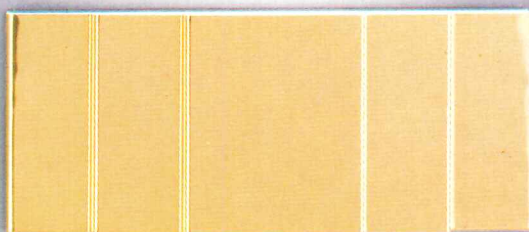

STEPS

Crisp architectural lines
reveal soft up and down light.
Available with regular 100 watt or
new 10,000 hour fluorescent bulb.
Brass, chrome, white, black or brown finish.

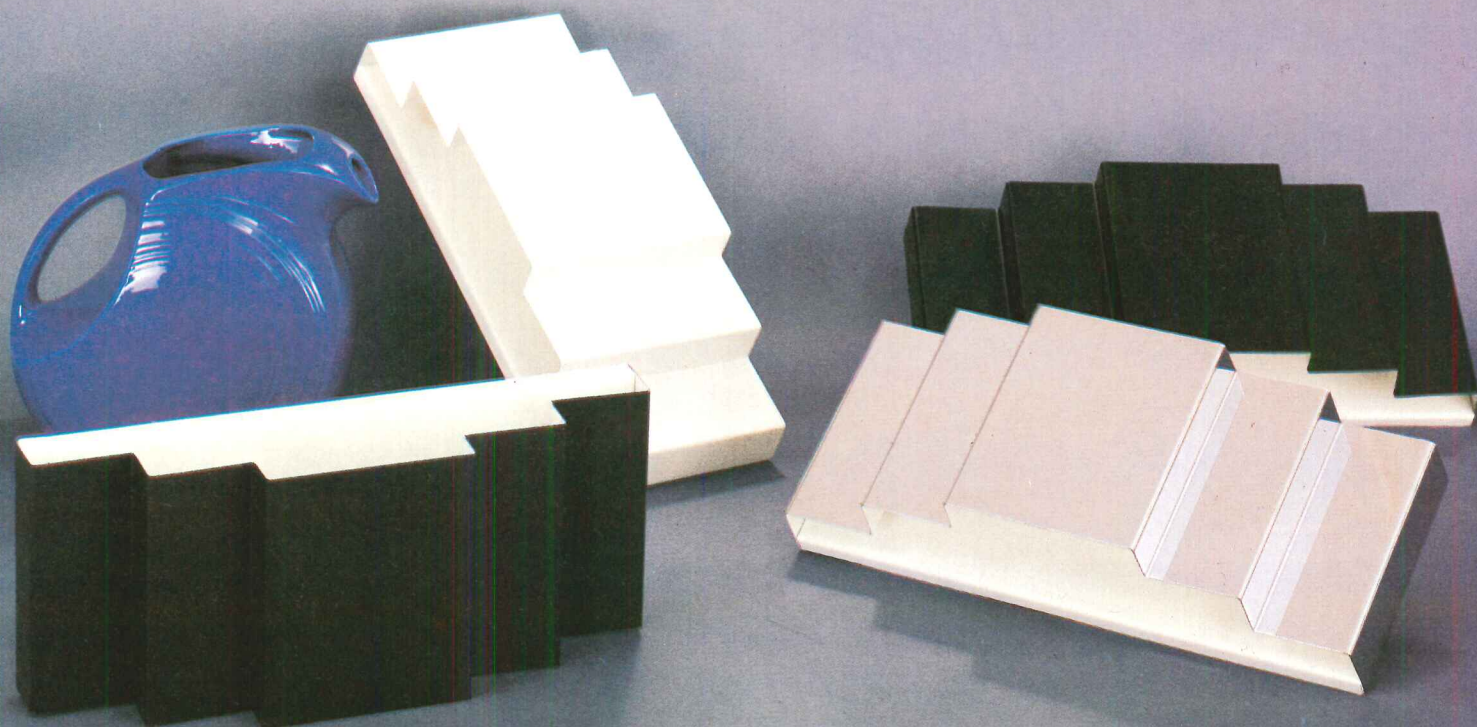

Light... Years Ahead.

P2 Parabolume® . . . For Maximum Efficiency

First introduced in 1980, the super-low brightness P2 features an optical system that maximizes lighting distribution and efficiency while retaining the high visual comfort levels that are the trademark of quality lighting.

Designed as an energy saver for the 80's, P2 has proven itself to be the most practical and reliable parabolic innovation since Columbia introduced the original Parabolume 18 years ago.



Columbia
Lighting
Inc

P.O. Box 2787
Spokane, WA 99220
(509) 924-7000

USI
A Subsidiary of
U.S. INDUSTRIES, INC.

P3 Parabolume® . . . For Maximum Air Handling Performance

P3 Parabolume is high-technology lighting at its best. Combining the classic appearance of Columbia's 1965 original Parabolume with the advanced performance of P2 optics, the P3 is the latest in a long line of successful Columbia designs.

P3 matches aesthetics with optimum performance. For more information on the P2 or P3 Parabolumes, contact your Columbia Lighting representative or write us.

“A must for those who dream of the future.”

—Dr. Gerard K. O’Neill, Princeton University, Author of *The High Frontier*

A continental water system using the Great Lakes as its reservoir ... a transatlantic rail tunnel that will replace ship and air transport ... a cross-continent bikeway between Maine and Southern California... Fantasies? No, argues M.I.T.’s Macro-Engineering Coordinator, Frank P. Davidson as he presents his bold, optimistic, and realistic vision of the future: a broad spectrum of large-scale engineering projects—some he considers necessary for our very survival—that are as technologically feasible as they are exciting. “Dr. Davidson writes with great imagination, and reinforces his arguments with anecdotes that add to his book.” —Sir Robert Jackson, Under Secretary General, United Nations

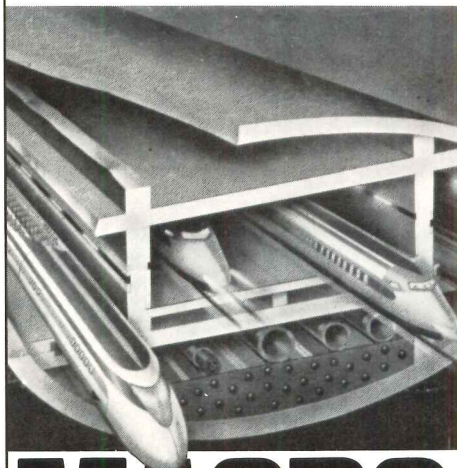

MACRO

A Clear Vision of How Science and Technology Will Shape Our Future

FRANK P. DAVIDSON
with **JOHN STUART COX**

Illustrated with more than 120 pages of b&w photographs • Selected by the Macmillan Book Clubs • \$17.95

William Morrow
105 Madison Avenue, New York, N.Y. 10016

MORE HOUSES ARCHITECTS DESIGN FOR THEMSELVES

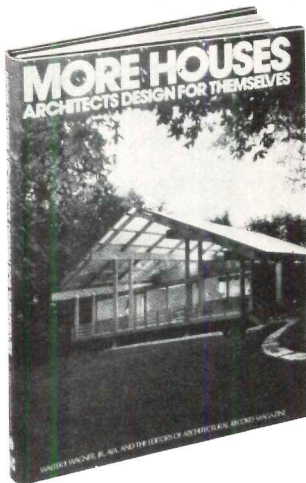

edited by *Walter F. Wagner, Jr.*

This long-awaited sequel to our bestselling *Houses Architects Design for Themselves* will aid anyone who is considering building a custom house. Distinctive and livable, these 41 houses were used as architectural laboratories to develop designs that required great imagination and ingenuity, not great sums of money. You’ll find special chapters on houses for small, close-in lots, where outdoor living and privacy must be designed in; on vacation houses designed for relaxed living and low maintenance; on apartments; on houses for hot climates, where shading and ventilation are important; and on houses designed to take advantage of solar energy.

160 pgs; over 320 photos, plans and sections; 16 pgs in color
\$34.50

Use the coupon on page 237 to order

Sentinal by **kenall**

Lighting unequalled in style, efficiency and durability.

The Sentinel series by Kenall has been designed for the eighties and beyond. With its stylish, compact design, Sentinel can be used in any indoor or outdoor application where aesthetics and durability are important. Sentinel is available with several different trim effects and refractor combinations.

The Sentinel series combines contemporary looks and features. Included are a one piece injection-molded polycarbonate lens for unbreakability, a choice of several efficient low-wattage fluorescent lamps that provide energy savings, gasketing and an anodized aluminum backplate for weatherproof protection. A single tamperproof POSIGRIP screw or a standard slot screw is provided.

The Sentinel is here, providing all of the features you expect from a Kenall lighting fixture!

© 1983 Kenall Manufacturing Company Patents Pending
4140 W. Victoria Street • Chicago, IL 60646 (312) 463-8500 • Telex: 721481

Circle 1120 on inquiry card

IRON-A-WAY Built-In Ironing Centers

Specified by architects
World-wide for new
construction and remodeling.

46" ventilated steel board
supported by telescoping
steel rods.

Steam iron
insulated
compartment.
Folding sleeveboard.
Work area light.
Electric control panel.
Neatly folds away. Safety
door switch turns off power.
Recesses between studs or
mounts on surface.

— For more information, see Sweet's Section
— 11.27a/lro, or

Contact the Contract Sales Division of
IRON-A-WAY, INC.

220 West Jackson • Morton, IL 61550 • (309) 266-7232

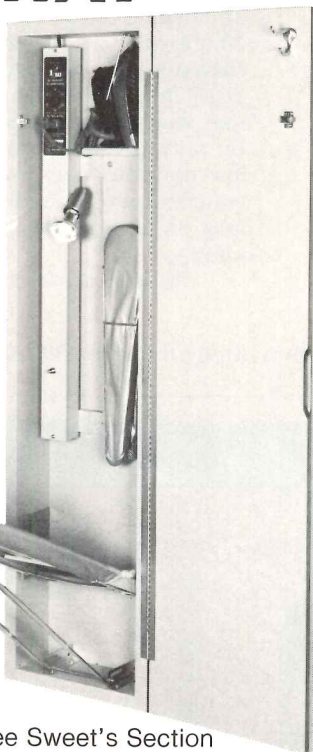

Circle 1121 on inquiry card

GET TWICE THE INSULATION EFFECTIVENESS WITH ENERMMASTER™ ROLLING DOORS

Compare for yourself and get:

1. Twice the insulation
2. Insulation 1-1/2 inches deep
3. A 13/16" Thermal break
4. Insulation with the highest (R) resistance factor
5. No gaps or voids inside the slat
6. Two faces of galvanized steel to protect the insulation

atlas

Atlas Door Corp.
116 Truman Drive, Edison, New Jersey 08818
(201) 572-5700 Telex No. 710-480-6564

Circle 1122 on inquiry card

bold cel®



Reflector down lights – polished reflector, mounted for wall washing and overall illumination.

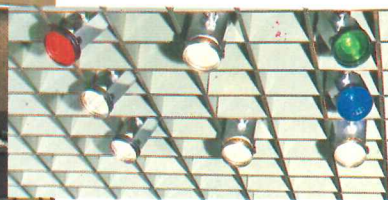

Raylites® – low voltage, accent or display luminaires.



Counterpoint – decorative, mirror finished incandescent fixtures.



Bare-Bud® lamps – low voltage sub-miniature lamps, mounted within cells for a decorative ambiance.

Bold Cel, a luminous ceiling system enabling the specifier to provide diversified illumination techniques within a single unbroken ceiling surface. Send for our new 1983/84 Designers Portfolio for more information about Bold Cel and many more lighting products for the 80's.

NEO-RAY PRODUCTS INC 537 Johnson Avenue Brooklyn, New York 11237
Phone 212/456-7400 Telex 64-5909

neoray
NATURALLY

Circle 1124 on inquiry card



Water leaked through the Ohio Edison building for years.

Hydrozo stopped it. From the time construction was completed on the 19-story Ohio Edison, water leakage was a persistent problem.

Despite repeated applications of an exterior sealer, water continued to migrate through the masonry to the building interior.

In the summer of 1980, Hydrozo Clear Coatings were applied by Charbetz Co. of Columbus. The building hasn't leaked since. In fact, the **Murdock Management Company** is so impressed with Hydrozo's performance they're planning to use it on the Akron Centre Plaza, their 12-story building adjacent to the Ohio Edison building.

Unique Formulation Hydrozo's unique formulation penetrates masonry up to depths of 1/2" (depending on substrate density) to provide long-lasting protection.

Hydrozo preserves surfaces without changing their natural appearance. It protects masonry and concrete against water penetration, freeze/thaw damage, airborne chemical deterioration, staining and efflorescence. Plus, Hydrozo helps maintain total insulation value of the wall system.

Superior Test Performance Improved technology since 1902 gives Hydrozo its outstanding performance. Typical tests show these characteristics:

Wind-driven Rain Test (ASTM E 514) Reduction of Leakage Brick Wall — 96.3% Concrete Block Wall — 98.6%
Moisture Vapor Transmission rate — 37.5%
Weatherometer (2500 hrs.) — 96.3% Repellency
Outdoor Exposure Tests — 96.1%

Lifecycle cost proves Hydrozo to be the most effective long-term and economical way to preserve masonry, concrete, stucco, stone and wood.

Just phone or write for additional information and references, job list for inspection, or to discuss your particular maintenance problems.

Proven Performance
Products
Since 1902



HYDROZO®

HYDROZO COATINGS COMPANY

P.O. Box 80879
Lincoln, NE 68501
Phone (402) 474-6981

INSTALL AND
EXTERIOR T

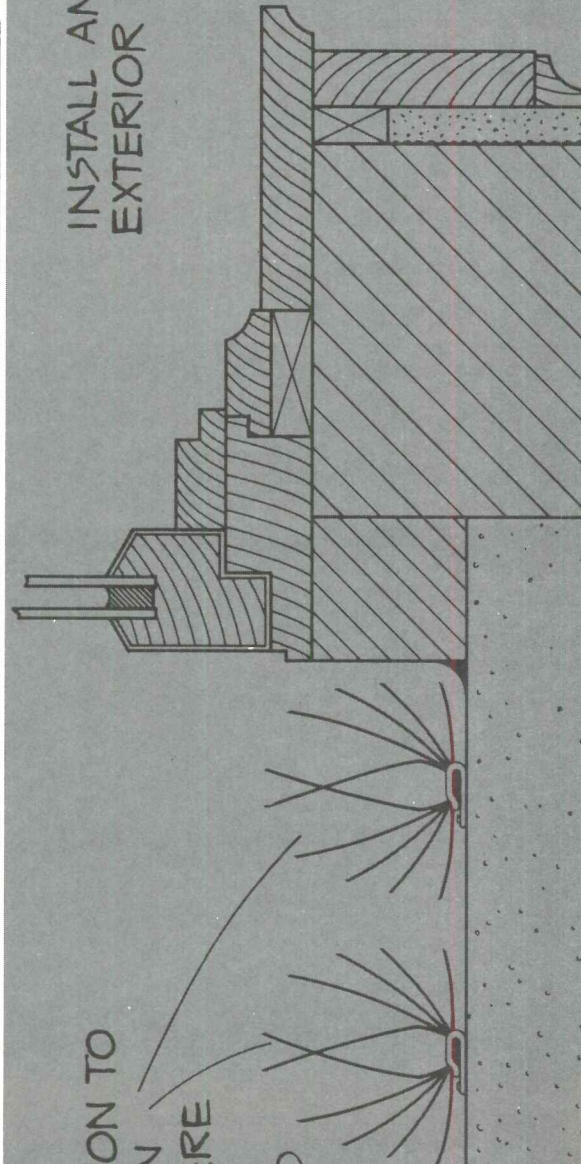

NIXALITE STAINLESS STEEL
NEEDLE STRIPS — INSTALLATION TO
BE ON ALL LEDGES, COLUMN
CAPS, PEDESTALS, ETC. WHERE
BIRDS ARE A PROBLEM!
INSTALL AS RECOMMENDED
BY NIXALITE OF AMERICA

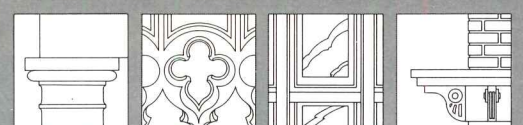

Answers bird control problems for any new, existing or restoration building projects.

NIXALITE of AMERICA

417-25th STREET • MOLINE, ILLINOIS 61265 • PHONE 309-797-8771

Circle 1126 on inquiry card

Circle 1125 on inquiry card

THE TOP FLOOR. IT MUST BE JASON/PIRELLI

Shown: ribbed design

Insist on Pirelli: the original ribbed rubber flooring that has become the international standard of excellence for quality, beauty and durability.

Jason, the standard of excellence for service and reliability.



Jason Industrial Inc.
Rubber Flooring Division
340 Kaplan Drive
Fairfield, NJ 07006
201-227-4904

Circle 1127 on inquiry card



Solving the tough problems a new way

Tectum III is a composite of three well known and reputable products - Tectum, Styrofoam* brand insulation (which is water resistant), and waferboard. The synergistic effect is the new product has much more structural strength than any of the individual products, and retains the key physical properties of each to make a superior overall building product - and Tectum III is easy to install. Three thicknesses available. • Longer spans • Lighter weights-approx. 4.5 psf • Nailable surface • Approved surface for single-ply roofs • Excellent insulation, noise absorbing values • Attractive Tectum texture • Fast, one-trade installation

*Trademark of The Dow Chemical Company

IT DECORATES AS IT INSULATES AS IT TAKES ABUSE AS IT DEADENS SOUND

TECTUM

Tectum Inc., P.O. Box 920, Newark, OH 43055, 614/345-9691

Circle 1128 on inquiry card

PORCH-LIFT®

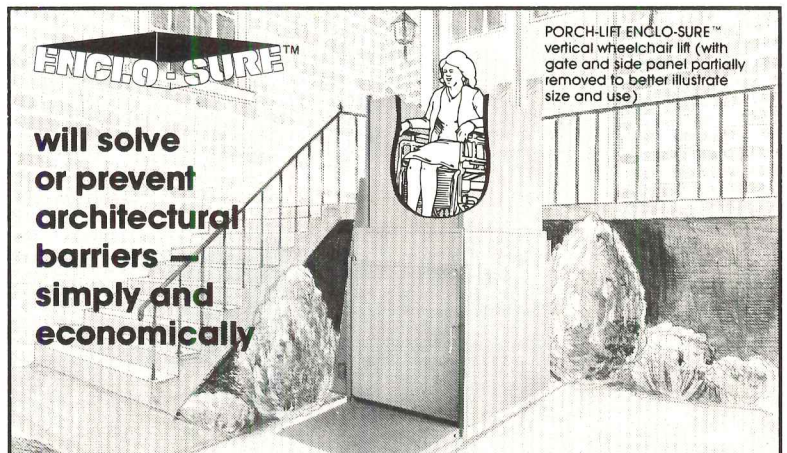

will solve
or prevent
architectural
barriers —
simply and
economically

PORCH-LIFT ENCLO-SURE™
vertical wheelchair lift (with
gate and side panel partially
removed to better illustrate
size and use)

Whether you're modifying an existing building or designing a new one, accessibility to the handicapped is of the utmost importance. PORCH-LIFT is the answer. Its exclusive telescoping lift design results in total enclosure of the sides of the platform and under the platform when it's elevated. Mechanical and electrical mechanisms are totally enclosed. Constant pressure control and optional "Call-Send" controls are key-actuated. Runs on 110 volt current. Available in models and varying heights to fit specific needs, indoors and outdoors. Shipped ready for installation.

WRITE FOR FREE BROCHURE AND NAME OF DEALER NEAREST YOU.
AMERICAN STAIR-GLIDE CORPORATION
4001 East 138th Street, P.O. Box B, Dept. AR1283.
Grandview, Missouri 64030

Circle 1129 on inquiry card

25 YEARS OF RECORD HOUSES

edited by Herbert L. Smith, Jr.

This exciting collection of 57 houses reflects the freshness, innovation, and practicality that characterize the best residential architecture of the last quarter-century. The book is organized into chapters describing major developments in the design of contemporary houses — from experiments with structure and form to the expression of new ideals of convenience and efficiency for servantless modern living. Selected from the more than 500 houses that have been designated *Record Houses* since 1956, these houses affirm the continuing inventiveness and talent of architects who design houses — and provide a valuable history of an architectural era only beginning to be documented and analyzed.

224 pgs; over 425 photos, plans and sections; 16 pgs in color
\$39.95

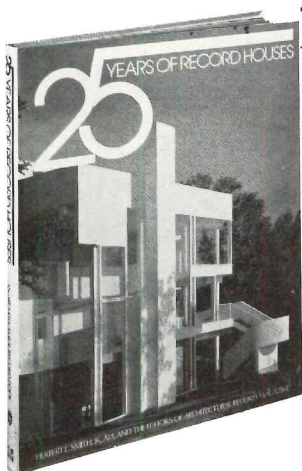

Use the coupon on page 237 to order

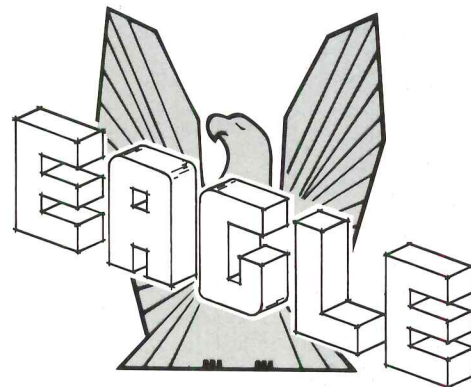

Consider what we have to offer—Eagle Dura-Sheathe® wood casements, awning and patio doors have the warmth of wood on the inside, (that can be factory finished) and a heavy extruded aluminum on the exterior. Note the various geometric configurations illustrated—these are only a few of the many that can be achieved for your design consideration and within this total modular system you can meet today's esthetic and energy challenges for any commercial, residential and retrofit construction. Air infiltration the best in the industry.

If you don't have Eagle—you've settled for less.

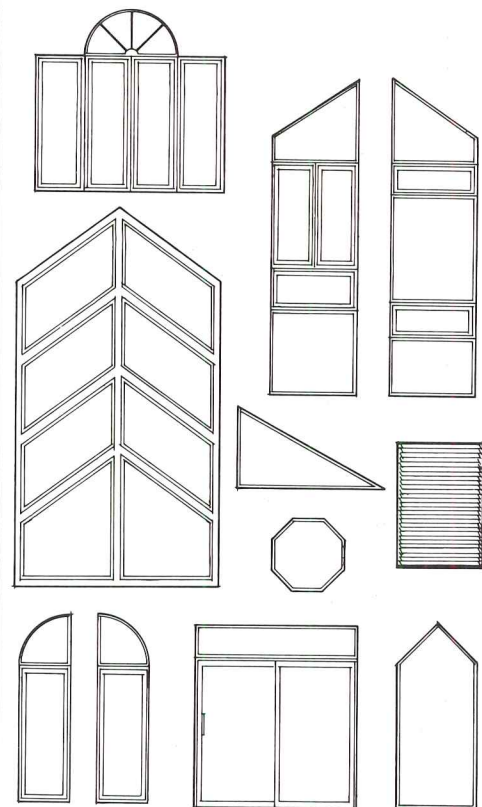

For further information mail to:

EAGLE MANUFACTURING CO.
Box 1072 Dubuque, Iowa 52001

Name _____

Firm _____

Address _____

City _____ Zip _____

State _____

Telephone _____

Circle 1131 on inquiry card

Spring-Summer-Fall-Winter...

Solid rubber lobby tiles for all seasons

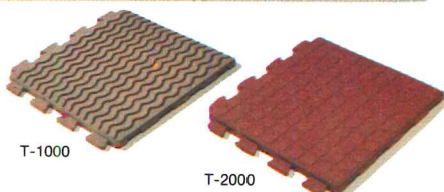
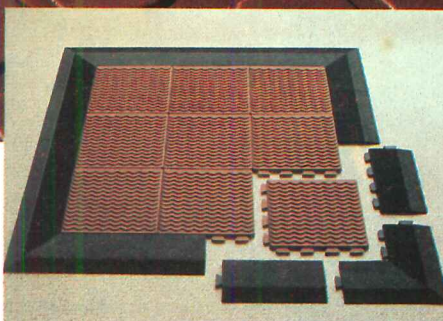

T-1000

T-2000

CONDOR®
Interlocking Rubber Tiles

New 5/8" thick, 12" x 12" high traffic lobby tiles are easy to install without adhesives. Easy maintenance, long lasting and ideal for sound absorption. The hidden interlocking tabs assure tight connections between tiles. The knob back provides aeration under tiles - no odor or mildew. They may be installed on the surface with a contrasting beveled border for safety. Recessed installations also available. Write or call Standard Products Division for full details.

STANDARD PRODUCTS DIVISION

Pawling Rubber Corporation

P.O. Box X, Pawling, New York 12564 / 914-855-1000



Available in 2 surfaces: T-1000 - curvilinear is 1/8" deep x 1/4" wide. T-2000 - 1/16" raised, 3/4" x 3/4" cubes. Both surfaces supplied in black, brown, terra cotta, tan, gray, blue, green.

SWEET'S CATALOG (12.17/Pa)

Circle 1130 on inquiry card

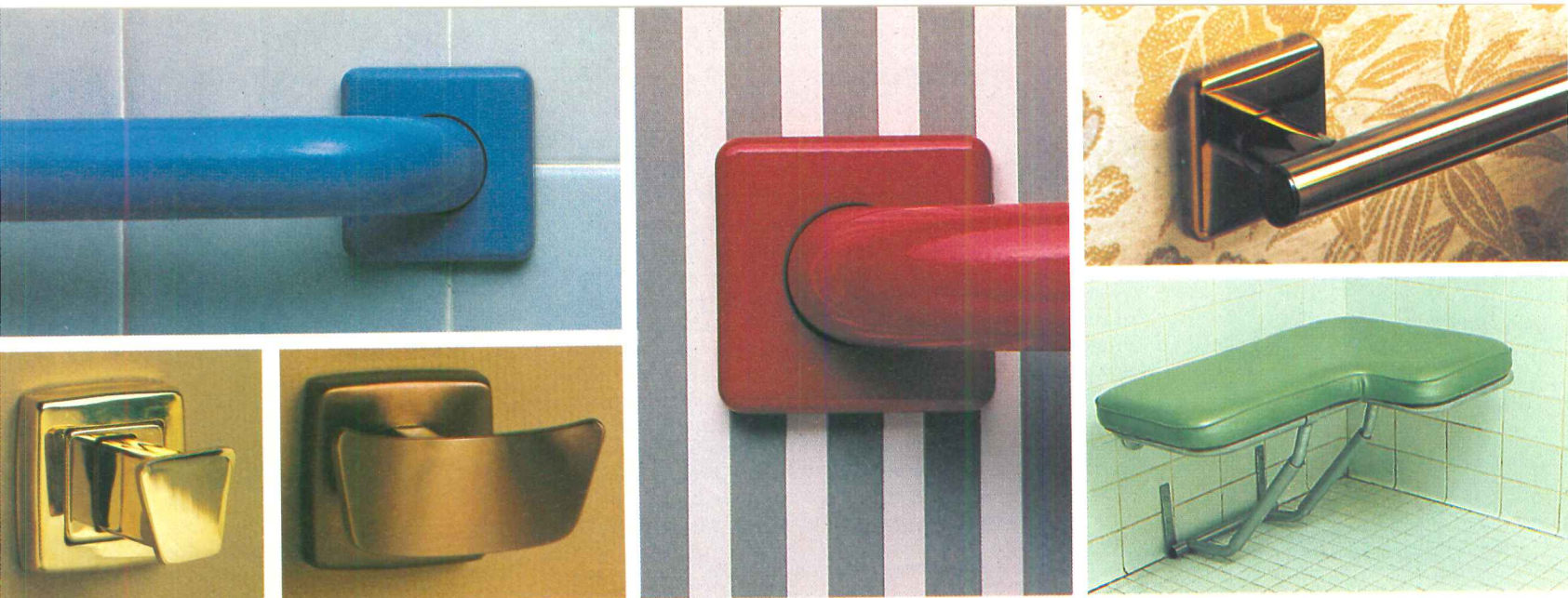

Say goodbye to drab accessories!

Every TSM product—from grab bars to corner guards—is now available in an exciting palette of coordinated finishes and colors to match your imagination and decor.

Choose gold, antique brass, bronzetone or any one of 20 metallic finishes and brightly colored epoxy coatings for TSM's stainless steel grab bars, railings or Field-Safe bath accessories.

Then select your TSM shower seats from 14 Naugahyde colors, handsome teakwood, woodgrain phenolic or six ABS plastic colors. Discover a rainbow of nylon taffeta shower curtains for TSM

shower rods and six acrylic hues for corner guards.

See all these colorful products including the new FS-1 square flange grab bar to match existing accessories by requesting TSM's new full color, 32-page catalog. And say hello to more dramatic interiors.

tsm TUBULAR SPECIALTIES MFG., INC.
 13011 South Spring Street, Los Angeles, Calif. 90061
 213/515-4801 • Toll-free outside Calif.: 800/421-2961

Circle 1132 on inquiry card

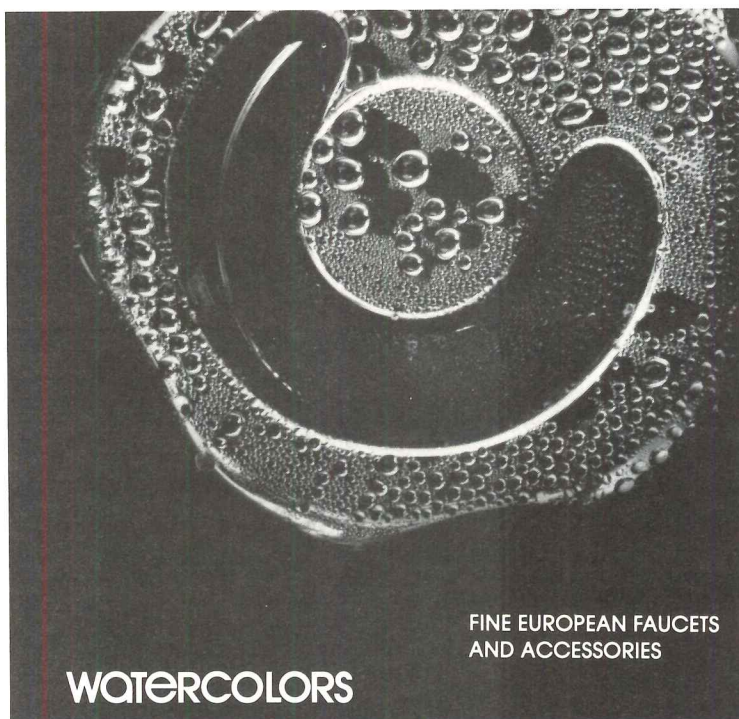

Watercolors

FINE EUROPEAN FAUCETS
AND ACCESSORIES

GARRISON ON HUDSON
NEW YORK 10524
914 424 3327

Circle 1133 on inquiry card

OUTSIDE to INSIDE SPECULAR TILE "Living" Ceiling

HIGHLY POLISHED FLUSH ALUMINUM PANELS HUNG FROM
SNAP-IN (CONCEALED) SUSPENSION SYSTEM TO
PROVIDE TIGHT FLUSH JOINTS

EXTERIORS,
UNPERFORATED
FOR UTMOST
REFLECTING
QUALITIES
AND TO KEEP OUT
WIND, INSECTS, ETC.
OR INTERIORS,
PERFORATED
FOR ACOUSTICAL
CORRECTION.

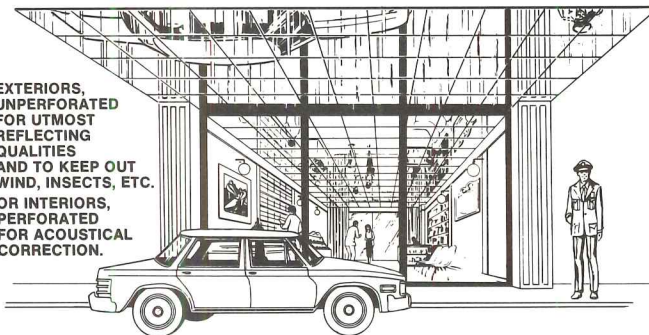

Ceilings reflect with mirror-like quality

- Lively dramatic ceiling and wall treatment
- Mirrors your merchandise, fixtures and features
- Creates illusion of spaciousness without adding an extra inch
- Makes showrooms appear more lively and full of customers

Mirror anodized aluminum Coilzak for the exterior (resistant to oxidation and finger print stains.) Ceiling installed as per manufacturer's specs., can withstand 60 mile per hour winds (30 lbs. per sq. foot of positive or negative wind loads). Brite finish (highly polished aluminum) interior ceilings match the Coilzak at less cost.

For sizes, finishes or prices, call or write • Refer to SWEET'S Section 9.1/51

SIMPLEX CEILING CORP.

50 HARRISON ST., HOBOKEN, N.J. 07030 • PHONES (212) 349-1890, (201) 864-6630

• Sales "Reps" needed—Write to Simplex for information •

Circle 1134 on inquiry card

We're looking for more architects who have a job we can be proud of...

trucks and doing maintenance. Red Roberts, who is in the picture with me, learned auto repair with the National Youth Administration during the Depression. He joined the company in 1943, left to serve in the Navy, and since 1946 has driven the truck that brings the blocks from the quarry to the mill. He recently gave up ice fishing to arthritis, and his main passion now is flying. He keeps thinking about getting a license, but seems to catch plenty of rides by hanging around the airport at Glen Falls most every weekend. I think he wishes we had a corporate jet with a built-in bar. My name is Bill Markcrow and I spend most of my time on the telephone selling. We cut and split a million square feet of slate a year—stock stuff for pavers and those boxes you buy in the lumberyard. That's a good volume and we make a good profit. But...



"Up here in Vermont I own a quarry full of good quality slate. About 60 of us work here—eight in the mill, 30 in the quarry, four in the office, others driving

Which would you rather do? Split two tons of roofing slate or work on a fine contemporary house like this?

"I was reminded of this beautiful slate installation we did 10 years ago while looking through '25 Years of Record Houses.' The house is a beauty designed by Barbara and Julian Neski, who do a lot of beautiful houses as part of their practice. The slate is set in a European pattern, with very nice cutting and finishing around that diagonal wall opening to the terrace, so the living room floor and the outdoor space seem like just one big plane. Everybody around the quarry and mill take pride in custom jobs like this—when they get the shop drawings I like them to understand how our part of the work fits into the whole. . . .

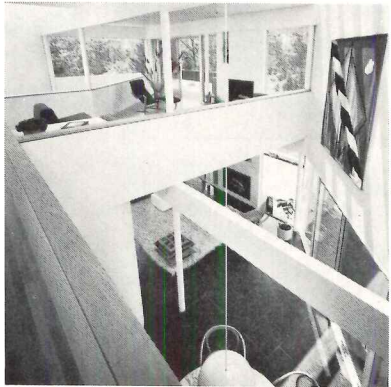

MARIS/SENELE ©

We have plenty of slate and all the skills needed to handle more jobs like this—jobs we'll all be proud of.

"Our slate is good quality, and we've got purples, greens, mottled, and reds. If you're visualizing slate for a job you're designing, don't worry about the budget until you've talked to me. I'll make a good price for a job that will be more challenging for us than splitting stock slate. Call me at 1-800-343-1900. (By George we're getting there—we don't have a corporate jet, but we do have a toll-free number.)"

—Bill Markcrow

VERMONT STRUCTURAL SLATE COMPANY FAIR HAVEN, VT 05743 1-800-343-1900

Bright Idea

Introducing The LIGHTHOUSE

New fixture for low level lighting. Handsome bollard design. Laminated of custom selected, kiln dried *Western Red Cedar*. Easy access to lamp and ballast compartment. Incandescent, mercury vapor or high pressure sodium.

Write on letterhead for catalog of wood lighting standards and accessories.

Ryther-Purdy Lumber Company, Inc.

212 Elm Street
P.O. Box 622
Old Saybrook, CT 06475
Phone (203) 388-4405



Lighting Standards
Fixtures • Signs
Guide Railings • Custom Millwork
Benches • Trash Receptacles

Circle 1135 on inquiry card

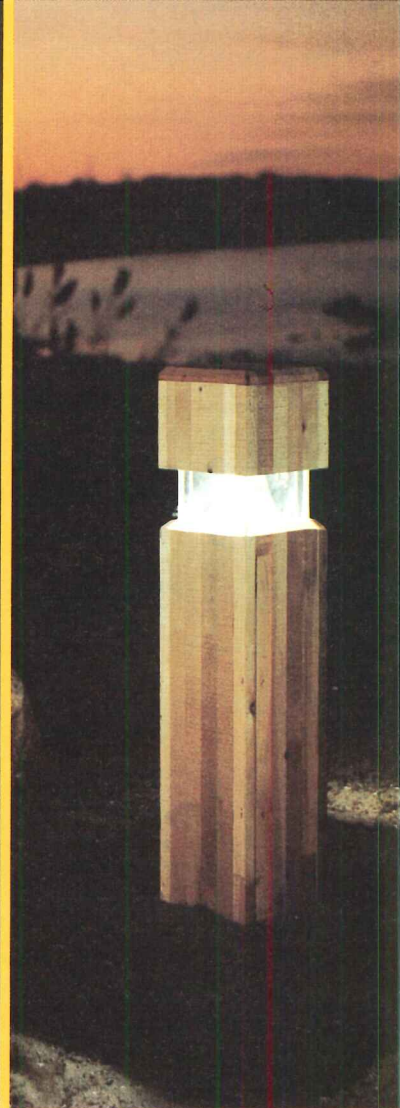

The best colored pencils ever. At the best price yet.

Create with the fabulous Derwent Artist pencils—made in England and packaged in a 72-color set. Because of a special purchase, we can offer these pencils for \$22.50—about half what they'd cost if you could find them somewhere else!

Free \$3 Color Catalog
You'll find these pencils in the 30,000-item Flax catalog of values. Buy the pencils, and you get the 192-page catalog free. Send the coupon or call—Visa, MasterCard OK. Satisfaction guaranteed.

Toll free (800) 547-7778. In California (800) 348-8008.

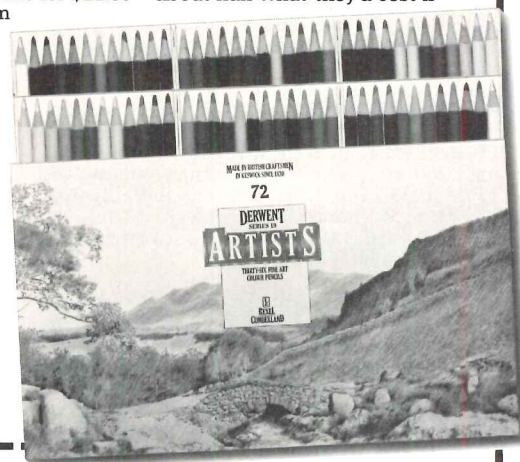

FLAX Artists Materials
1699-A Market, San Francisco CA 94103

Please send me the Derwent Artist 72-color pencil set.
 Check enclosed for \$22.50. Catalog only, \$3. In Calif, add 6 1/2%.

Visa or MC number _____

Exp. _____

Name _____

Address _____

City _____

State/Zip _____



Circle 1136 on inquiry card

CLASSIFIED SECTION

POSITIONS VACANT

UNIVERSITY OF PETROLEUM AND MINERALS DHAHRAN — SAUDI ARABIA

The Architectural Engineering Program in the College of Environmental Design is seeking applications for faculty positions in the following areas of specialization. Positions are available starting 1 September 1984.

BUILDING MATERIALS, COST ESTIMATING AND SPECIALIZATION WRITING

First degree in Architectural/Civil Engineering/Building with five or more years of teaching and/or research experience after Masters degree. Candidates with extensive professional experience will be preferred.

BUILDING SERVICES

First degree in Architectural/Engineering with five or more years of teaching/research/professional experience after Masters degree. Ph.D. will be preferred.

Language of instruction is English.

Minimum regular contract for two years, renewable. Competitive salaries and allowances. Air conditioned and furnished housing provided. Free air transportation to and from Dhahran each year. Attractive Educational Assistance Grants for school age dependent children. All earned income without Saudi taxes. Ten months duty each year with two months vacation with salary. There is also possibility of selection for the University's on-going Summer Program with good additional compensation.

Apply before 30 January 1984 with complete resume on academic, professional and personal data, list of references, publications and research details, and with copies of transcripts and degrees, including home and office addresses and telephone numbers to:

University of Petroleum & Minerals
Houston Office (Dept. 130)
5718 Westheimer, Suite 1550
Houston, TX 77057



Job Hunting? Professionals, do you want to work in the USA? We are an American Company. Write for information and an introduction form. FAM II, Rue De La Presse 4, 1000 Bruxelles, Belgium.

We are a dynamic, medium sized architectural firm in Boca Raton, Florida, organized toward design excellence, quality architecture, and sound business practice. We are sensitive to our clients' needs, the public's awareness of architecture, and our staff's ability to work together and respond to these needs. If you are team oriented, thrive on challenge and change, strive for excellence: tell us how your goals match our goals. We have needs for recent graduates for residential and commercial projects. Reply with resume to: Kenneth Hirsch Assoc. Architects, Inc. 2200 Glades Rd. Suite 302 Boca Raton, Fla. 33433 (305) 368-5577.

Senior Designer — Medium size architectural firm with national practice in institutional work is seeking a Senior Designer with 8-10 years experience. Must be able to work with clients, have interest in marketing and able to supervise junior designers on staff. Must have experience in Type I construction and institutional projects. Possible growth to Director of Design. Interested candidates are invited to submit resume / salary expectations to: Senior Designer Search, P.O. Box 852, Montrose, CA 91020.

Structural Coordinator — Serve as Project Manager for design of residential, commercial and office buildings using multi-story atrium designs and low to mid-rise steel and reinforced concrete structures. Conduct structural analysis. Prepare construction documents. Coordinate with structural engineers. 40 hours / week; \$21,000 per year; Master's in Architecture; 1 year experience; required 6 graduate units in structural analysis / design. Apply at Texas Employment Commission, Houston, Texas, or send resume to Texas Employment Commission, TEC Building, Austin, TX 78778. Job Order #2511101. Ad paid for by an equal opportunity employer.

FACULTY POSITIONS VACANT

The University of Pennsylvania seeks two full time appointments at the assistant or associate professor level. Teaching responsibilities include introductory studios in architecture and lecture courses in some aspect of history and theories of architecture. Candidates should hold a Master of Architecture degree or a Ph.D. from an accredited institution and have had prior professional and teaching experience. Application deadline is February 15, 1984. Contact Search Committee, University of Pennsylvania Graduate School of Fine Arts, Department of Architecture, 110 Meyerson Hall, Philadelphia, PA 19104. An Equal Opportunity / Affirmative Action Employer.

TO ANSWER BOX NUMBER ADS

Address separate envelopes
(smaller than 11" x 5")
for each reply to:

Box Number (As indicated)
Classified Advertising Center
Architectural Record
Post Office Box 900, NY 10020

COMPUTER SOFTWARE

Design and Testing Software

Aggregates and Production
Asphalt Concrete
Portland Cement Concrete
Soils and Foundations

Choose from over 25 programs.
Most formats available. Call or write for free catalog.

Mix Design Methods, Inc.
Post Office Box 113
Pennel, Pennsylvania 19047
215-757-3350

Since 1970

ARCHITECTS—BUILDERS—ENGINEERS

34'-8 3/4" +
7 9/16" +
9'-3 1/2" -
0 7/8" +
???????????

EXACT DIMENSIONS! software turns your Apple into a powerful printing calculator that works in three systems of measurement simultaneously:

- Feet/inches/fractions
- Decimal inches
- Metric

For brochure or to order CALL NOW!
24-Hour Toll-free 800/824-7888, ext. 175

ASPEN INCHware Corp. • Box 3203 • Aspen, CO 81612
(dealer Inquiries Invited)

BOOKS

Space Structures

PUBLICATIONS DIVISION



SPACEFRAME BASICS

A Handbook for Spaceframe Design and Engineering
By WENDEL²

A most authoritative and comprehensive handbook written for architects and engineers. Explains and illustrates in 12 chapters, spaceframe forms, uses, networks, geometries, engineering, systems, supports, interfaces, cladding, finishes, installation and more 350+ pages with 100+ illustrations. This handbook is a must for incorporating the latest spaceframe technology and design alternatives. A time-saving tool that professionals find indispensable. Send \$14.95 to Space Structures Inter. Corp., Publications Division, 155 Dupont Street, Plainville, New York 11803.

The Small Scale Master Builder: Selected Readings on Professional Practice as an Architectural Designer — Builder — Investor at the Personal Scale. 8 1/2 x 11, xii, 158pp. \$15.00 postpaid. SSMB, PO Box 5, San Luis Obispo, CA 93406.

PERT and CPM: Network Methods for Project Planning, Scheduling and Control. 5 1/2 x 8, iv, 56 pp. \$5.00 postpaid. SSMB, PO Box 5, San Luis Obispo, CA 93406.

Europe: Architectural Guide 1860-Today, Jerryl Habegger, 13 countries, 500 buildings with address, architect, and dates. 150 illus. \$10. Postage included. Architectural Guidebook, 421 West Belden, Chicago, IL 60614.

PROFESSIONAL SERVICES

Designing

Specifying

Kent J. Chatagnier

Consultant in Roofing Services

300 Emory Lane
Port Arthur, Texas 77642

(409) 985-2930

FACULTY POSITIONS VACANT

Opening Sept. '84 for two faculty positions in 4-yr. constr. curriculum. BS & MS in Bldg. Constr., Arch., CE, or ME and appropriate bldg. constr. exper. reqd. Teaching exper. desired. Position one is to teach estimating — both quan. survey and pricing. Position two is to teach statics, strngth. of matls., formwk. desn. and constr. surveying. Send resume to Paul Brandt, Head, Dept. of Bldg. Science, Auburn University, AL 36849. Applications will be recvd. until 2/1/84 or positn. is filled. Auburn University is an equal opportunity / affirmative action employer.

Architectural Technology Positions — The Department of Architecture at Cornell University is seeking candidates at Assistant or Associate Professor level for tenure track positions in the technology area of the curriculum. Candidates should be qualified to teach in at least two of the following areas: building materials and methods, site planning, lighting and acoustics, and energy analysis and thermal design. Positions require collaboration with design faculty in studios. Appointment criteria; previous teaching experience; professional degree at the graduate level; knowledge of computer applications in architectural technology; professional experience and research in the field. Academic scholarship and administration are obligations of these positions. Rank and salary are commensurate with experience. Curriculum vitae and supporting materials must be submitted by January 15, 1984 to: Jerry A. Wells, Chairman, Department of Architecture, 143 East Sibley Hall, Cornell University, Ithaca, New York 14853. Cornell University is an Equal Opportunity / Affirmative Action Employer.

American Architectural & Urban History Position — The Department of Architecture at Cornell University is seeking candidates in American architectural and urban history. Should be scholars with a strong record in publication; a Ph.D. degree and previous teaching experience are required. The position includes instruction within both a professional undergraduate program in architecture and a graduate program in the History of Architecture and Urban Development. Teaching in a secondary area of architectural history (European, preferably Century) will also be necessary. Tenure track, rank dependent upon qualifications. Submit application and supporting materials by January 15, 1984 to: Jerry A. Wells, Chairman, Department of Architecture, 143 East Sibley Hall, Cornell University, Ithaca, New York 14853. Cornell University is an Equal Opportunity / Affirmative Action Employer.

President: The UCLA School of Architecture and Urban Planning has an opening for the position of President of the Urban Innovations Group, the practice arm of the School. Candidates must have an academic background in architecture or urban planning, preferably both, as well as professional experience including direction and management of design and research projects in architecture / urban design or planning. Must be knowledgeable about business development in public and private sectors including government research organizations. Administrative duties include organization and direction of the firm and business development. Teaching responsibilities include one class per quarter as well as a clinical teaching role. Candidates should apply to Acting Dean Samuel Aroni, Graduate School of Architecture and Urban Planning, UCLA, Los Angeles, CA. 90024. Applicants are asked to submit letters of inquiry, including curriculum vitae and the names and addresses of at least three references, by January 31, 1984. UCLA Is An Equal Opportunity / Affirmative Action Employer.

POSITIONS VACANT

UNIVERSITY OF PETROLEUM & MINERALS - DHAHRAN, SAUDI ARABIA COLLEGE OF ENVIRONMENTAL DESIGN ARCHITECTURE AND CITY PLANNING

The Architecture and City Planning Programs are seeking applications for faculty positions beginning the Fall of 1984.

Applicants should possess at least a Master Degree in their area of specialization and have professional and academic experience. Positions are available in the following areas:

Architectural Design Studios
City Planning Studios with emphasis on Physical Design
Architectural History and Theory
Planning Theory, Transportation and Infrastructure Systems
Teaching/Research position in Computer Graphics

LANGUAGE OF INSTRUCTION IS ENGLISH

Minimum regular contract for two years, renewable. Competitive salaries and allowances. Air conditioned and furnished housing provided. Free air transportation to and from Dhahran each year. Attractive Educational Assistance Grants for school age dependent children. All earned income without Saudi taxes. Ten months duty each year with two months vacation with salary. There is also possibility of selection for the University's on-going Summer Program with good additional compensation.

Apply with complete resume on academic, professional and personal data, list of references, publications and research details, and with copies of transcripts and degrees, including home and office addresses and telephone numbers:

University of Petroleum & Minerals
Houston Office (Dept. 127)
5718 Westheimer, Suite 1550
Houston, TX 77057



Architectural Design Position — The Department of Architecture at Cornell University has both non-tenure track and tenure track faculty positions available beginning Fall 1984 in Architectural Design. For individuals qualified to teach architectural design, as well as courses in another area of curriculum, such as technology, architectural theory, profession of architecture, design communications, etc. Appointment criteria: teaching experience, scholarly preparation, creative work in design or research, developed theoretical orientation in areas of teaching specialty. Academic scholarship and administration are obligations of these positions. Rank and salary commensurate with experience. Submit applications and curriculum vitae by December 15, 1983 to: Jerry A. Wells, Chairman, Department of Architecture, 143 East Sibley Hall, Cornell University, Ithaca, New York 14853. Cornell University is an Equal Opportunity / Affirmative Action Employer.

The University of Illinois at Urbana-Champaign, The School of Architecture is seeking applications for full-time, nine-month tenure-track / tenured positions at the Assistant Professor and Associate Professor levels to teach undergraduate or graduate Architectural Design studios as well as seminars or related elective courses beginning Fall semester 1984. Qualifications: Advanced professional degree in architecture and professional registration is required. Teaching experience desirable. Salary and rank dependent on qualifications. To receive full consideration, submit resume together with names of three references by January 30, 1984, to Professor R. Alan Forrester, Director, School of Architecture, 608 E. Lorado Taft Drive, Champaign, IL 61820. (217-333-1330). The University of Illinois is an Equal Opportunity / Affirmative Action Employer.

FACULTY POSITIONS VACANT

Architecture Faculty Positions — Department of Architecture, Ball State University is seeking outstanding candidates for full-time tenure track and temporary faculty positions in Architecture, for undergraduate and graduate programs, effective September, 1984. Candidates should be able to teach architectural design and at least in one of the following areas: Structures, Architectural History and / or Theory, Environmental Systems, Graphics, Computer Applications, Building Technology, and Photography, as well as actively pursue practice and / or research and scholarly activities. Most appointments will be at the Assistant Professor (or Associate Professor in exceptional circumstances) level. Registration and terminal degree preferred. Rank and salary dependent upon qualifications. Applicants should send letters of inquiry, curriculum vitae, transcripts, and three letters of references. Applications must be post-marked by December 30, 1983. Apply to: Professor Marvin Rosenman, Chairman, Department of Architecture, College of Architecture and Planning, Ball State University, Muncie, Indiana 47306. Women, minorities, handicapped, and Vietnam veterans are invited to apply. Ball State University Practices Equal Opportunity in Education and Employment.

MATERIALS WANTED

Wanted: Photographs or perspective rendering houses that can be made available for plan sales. 500,000 circulation offers good royalty to architect. Write Country Living Magazine, Box 622, Princeton, New Jersey 08540, 609/ 924-9655.

Check your wall against R-wall.



Other Exterior Insulation and Finish Systems just don't stand up against R-Wall . . .

R-Wall has the colors, finishes and formulation to suit any building.

With 101 colors in five textures plus a natural stone finish in eight colors, R-Wall allows the creation of shapes, forms and dimensions other materials can't accommodate. And since its all-acrylic formulation is factory mixed, both standard and custom colors match up from start to finish.

R-Wall has more than 150,000 installations worldwide.

With a longer than five-year track record, R-Wall has proved its versatility. Whether new construction or retrofit, commercial or residential, interior or exterior, the R-Wall System performs. With insulation values to R-20, it provides better insulation than any other exterior building material.

R-Wall backs its system with a three-year, single-source warranty.

When you manufacture a system as durable and as well made as R-Wall, it's easy to provide such a warranty. And as a member of the Exterior Insulation Manufacturers Association, we're proud to honor it.

R-Wall. It stands up to examination.

Call 1-800-343-1188 (In Mass., 1-617-339-9106).
ISPO INC 792 South Main Street, Mansfield, MA 02048

R-wall™
Exterior Insulation and Finish System

Member:
Exterior
Insulation
Manufacturers
Association

Circle 1137 on inquiry card

Small Wonders

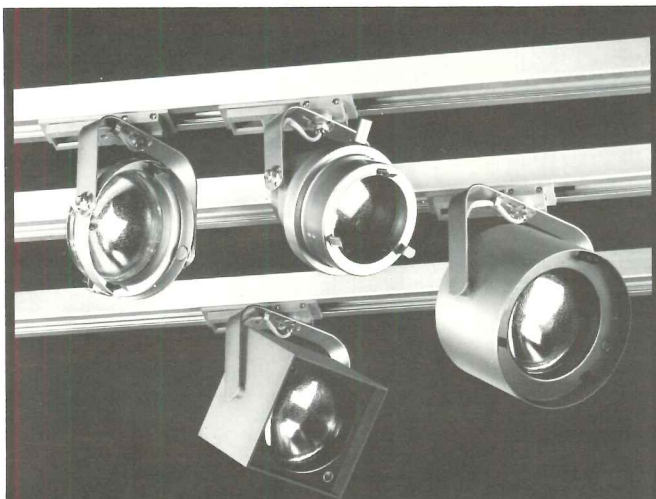

**New Low Voltage
Track & Fixtures**

Manufactured only by

LIGHTING SERVICES INC
150 East 58 Street
New York, NY 10155



dedicated to lighting excellence

212/838-8633

Circle 1138 on inquiry card

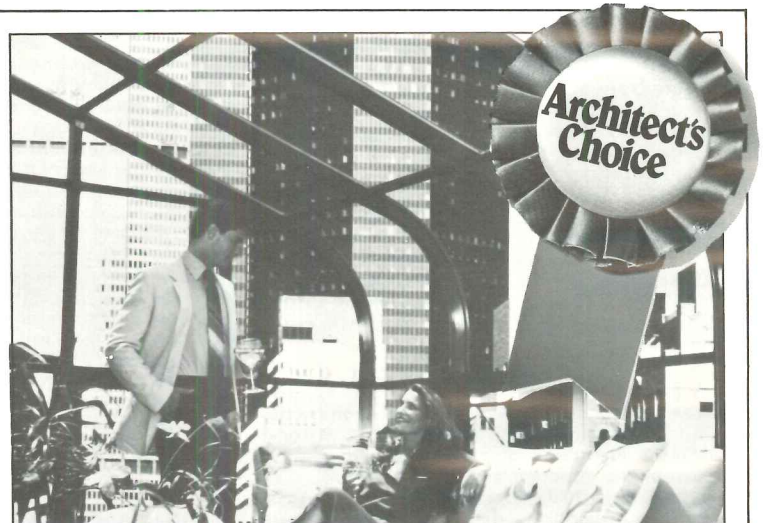

SUN SYSTEM Prefabricated Solar Greenhouses are designed for fast, smooth installations in residential and commercial applications. The only 100% Thermally Broken passive solar greenhouse on the market.

For our new 24 page color catalog and price list write to:



SUN SYSTEM™
**PREFABRICATED
SOLAR GREENHOUSES**
60M Vanderbilt Motor Parkway
Commack, New York 11725
or call toll free 1-800-645-4506
in NY 516-543-7766
Dealer Inquiries Invited

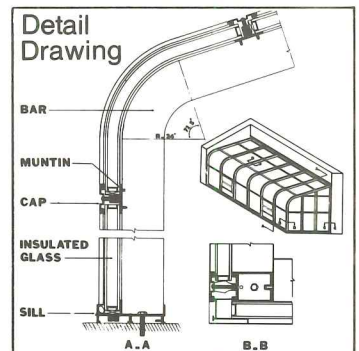

Sweets Catalog, Section 13.2c Sty

Circle 1139 on inquiry card

NEW LIFE FOR OLD BUILDINGS

edited by Mildred F. Schmertz

In view of skyrocketing construction costs: the sizable savings in energy consumption offered by well-insulated, cross-ventilated older structures; and a host of new tax incentives and preservation laws, the recycling of old buildings is, more and more often, the sensible — and profitable — alternative to building anew. This handsome book presents the best recent examples of renovation, remodeling, reuse, and restoration in dozens of case histories drawn from the pages of *Architectural Record*. Urban marketplaces, such as Faneuil Hall in Boston, are spotlighted, along with museums, theaters, offices, restaurants, houses, lofts, apartments, and campus buildings.

200 pgs: over 385 photos, plans and sections: 8 pgs in color
\$34.50

Only \$32.50 if order is received before Jan. 1, 1983

Use the coupon on page 237 to order

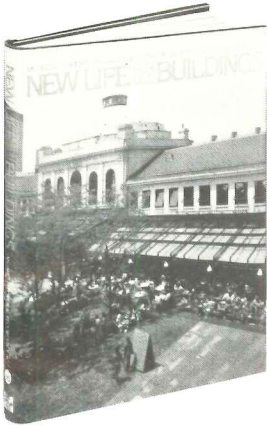

Granite.

To say it stands up underfoot is an understatement.



Nationwide Plaza, Columbus, OH/Architect: Sasaki Associates, Boston, MA.

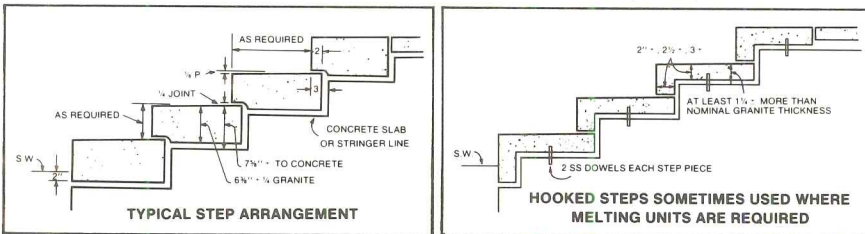

Because what else will be able to withstand decades, even centuries of footsteps and weather without staining, fading, or showing measurable wear? That's why Cold Spring Granite is the ideal choice for steps and paving. For planters, fountains, landscaping, and seating. Plus, all 16 colors of Cold Spring Granite offer the same unique combination of beauty and unsurpassed durability.

For a 20 page, full-color catalog showing all Cold Spring Granite has to offer, just call **800-328-7038**. In Minnesota call (612) 685-3621. Or write to the address below.

Cold Spring Granite Company Dept. AR-12 202 South 3rd Avenue, Cold Spring, MN 56320

Circle 1140 on inquiry card



ICE RINK

Buying and Specifying

GUIDE

& CHECK

LIST

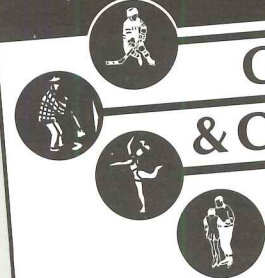

PUBLISHED BY AMERICA'S LARGEST MANUFACTURER AND INSTALLER OF ICE RINKS, DASHER BOARDS AND ACCESSORIES

HOLMSTEN
Rinkmaster
HOLMSTEN ICE RINKS, INC.

FREE FROM AMERICA'S LARGEST MANUFACTURER AND INSTALLER OF ICE RINKS, DASHER BOARDS AND ACCESSORIES

For your free copy, just write or call. This 28 page guide contains essential information for the architect on the following:

- Latest ice rink developments.
- Kinds of rink refrigeration. Initial cost and operating cost data.
- Utilization of waste heat. Subsoil heating and when needed.
- Ice temperature control, ice hardness requirements.
- Ice resurfacing equipment.
- Dasher board types and feature comparisons.
- Dehumidification and where required.

SERVICES PROVIDED TO ARCHITECTS:

1. Typical ice rink plans, specifications, options.
2. Preliminary cost estimate.
3. Customized plans and specifications for your project.
4. Accurate project cost estimate for budget protection.
5. Total BONDED ice rink responsibility including: refrigeration, installation, concrete rink floor, subsoil heating, waste heat recovery, dasher boards, ice resurfacer, nets, scoreboards, etc., etc., etc.

ARCHITECTS DO BETTER WITH HOLMSTEN

HOLMSTEN ICE RINKS, INC.



1802 Como Ave., St. Paul, MN 55108
612-646-8625 TELEX 298-415

Circle 1141 on inquiry card

Something You Can See Through Will Protect Your Investment for Years to Come

Tri-Guards



Contact your nearest Tri-Guards distributor or Tri-Guards, Inc. for further information regarding sizes and ordering.

It's true! Tri-Guards protect interior corners with a clear plastic shield that's almost invisible. Tri-Guards let the beauty of the original decor shine through.

Tri-Guards are practically indestructible. Made from Lexan®, a high impact material developed by General Electric, Tri-Guards won't crack, chip, or dent, even in high traffic areas. Tri-Guards are the thoroughly modern way to protect vulnerable corners.

Tri-Guards are easy to install. Available in a variety of widths and lengths to fit any corner, Tri-Guards can be installed perfectly in minutes. In addition, Tri-Guards can be removed and re-installed just as easily when a room or corridor is ready for redecorating.

Tri-Guards are also available in colors, custom blended to fit your wall treatment exactly.

Check for quantity requirements on color orders.

New, from Tri-Guards . . . WALL GUARDS

Protecting walls in high traffic movement and seating areas is a costly and continuing problem for institutional and commercial buildings. Now, by specifying Wall-Guards, you can control these costs in a handsome and decorative way.

Wallguards are available in 3 inch by 8 foot pre-drilled lengths, mounting hardware furnished. Contact Tri-Guards, Inc., for further information.

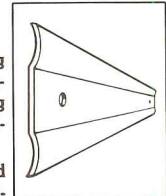

Tri-Guards

CLEAR PROTECTORS

953 Seton Court, Wheeling, Illinois 60090
Telephone (312)537-8444

Circle 1142 on inquiry card

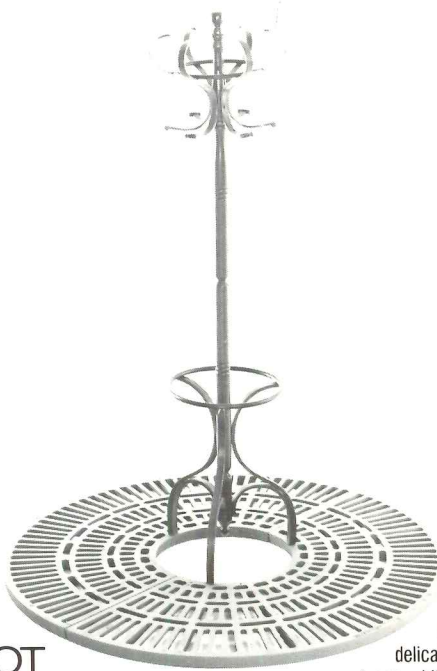

NOT ALL TREES NEED OUR TREE GRATES!

Our tree grates are specifically designed to protect the delicate root systems of living trees while at the same time allowing moisture and fertilizers to reach the necessary areas. We offer over 65 geometric design opportunities for use in malls, sidewalks, parks and shopping areas to fit into your plans. Or, we will work with you to custom design according to your specifications.

NEENAH FOUNDRY COMPANY
Box 729, Neenah, WI 54956 (414) 725-7000

Write Dept. T for our Cat. R., 9th Ed.

Circle 1143 on inquiry card

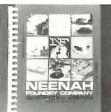

Specify the best

HIDDEN WALL SYSTEMS

YOCA® | STUD-EZE™

YOCA stud is a combination metal wall stud and slotted insert. Accepts dry wall and provides concealed slotted standards to hold brackets for shelves, cornices, hangrail, etc. for stores, commercial and institutional construction.

STUD-EZE is a flanged aluminum housing, with slotted heavy duty steel insert, designed to work with metal studs/dry wall application. Concealed slotting holds brackets for shelves, cornices, hangrail, etc.

TWO UNIQUE HIDDEN STANDARD SHELVING SYSTEMS - CHOOSE THE ONE THAT BEST FITS YOUR NEED!

FOR COMPLETE INFORMATION, WRITE OR PHONE

TELEPHONE 312/873-3833

5925 SOUTH LOWE AVENUE, CHICAGO, ILLINOIS 60621

Crown METAL MFG. CO.

Circle 1144 on inquiry card

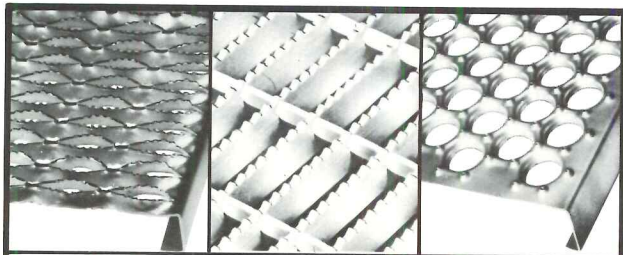

GRIP STRUT

SERRATED
BAR GRATING

OPEN GRIP
GRATING



Safety Gratings

ALL STYLES

Planks — Walkway — Stair Treads
Galvanized — Aluminum
Carbon Steel — Stainless
FAST CUT-TO-SIZE SERVICE
Same Day Shipment From the Largest Stock
in the 'HOLE' Country

GET THE 'HOLE STORY' ON
PERFORATED METAL + EXPANDED METAL
WIRE CLOTH + BAR GRATING
GRIP STRUT + OPEN GRIP
SAFETY GRATINGS

Call or Write for a New Catalog and Stock List

CLEVELAND • CHICAGO • DALLAS • ATLANTA • TAMPA



McNICHOLS CO.
5501 Gray St. / Tampa, Florida 33609 / 813-876-4100
CALL TOLL FREE
800-237-3820 (In Florida) 800-282-6600



Circle 1145 on inquiry card

DRAFTING SUPPLY PROBLEMS? DATAPRINT SUPPLIES SOLUTIONS!

WE SOLVE COST PROBLEMS WITH DISCOUNTS UP TO 40%.

Even small orders are discounted. Call us for quotations on large volume purchases.



WE SOLVE DELIVERY PROBLEMS WITH SAME-DAY SHIPMENT.

Call us by 2 PM; we'll have your order on its way by 5 PM from a distribution center close to you.



WE SOLVE SELECTION PROBLEMS WITH THOUSANDS OF BRAND NAME DRAFTING, PRINT & PLOTTER SUPPLIES IN STOCK.

Mayline, Koh-I-Noor, Vemco, LeRoy, Mars, Plan Hold and many more. Ask for a free catalog.



WE SOLVE SERVICE PROBLEMS WITH A QUICK, EASY PHONE CALL.

Our friendly, knowledgeable customer representatives are ready and want to help you. We guarantee full satisfaction.



DATAPRINT®
DRAFTING, PRINT, & PLOTTER SUPPLIES
(800) 227-6191

In California, call (800) 632-4715

CORPORATE OFFICES: 700 S. CLAREMONT STREET P.O. BOX 5910 SAN MATEO, CA 94402

Circle 1146 on inquiry card

CONCRETE LIGHTED BOLLARD

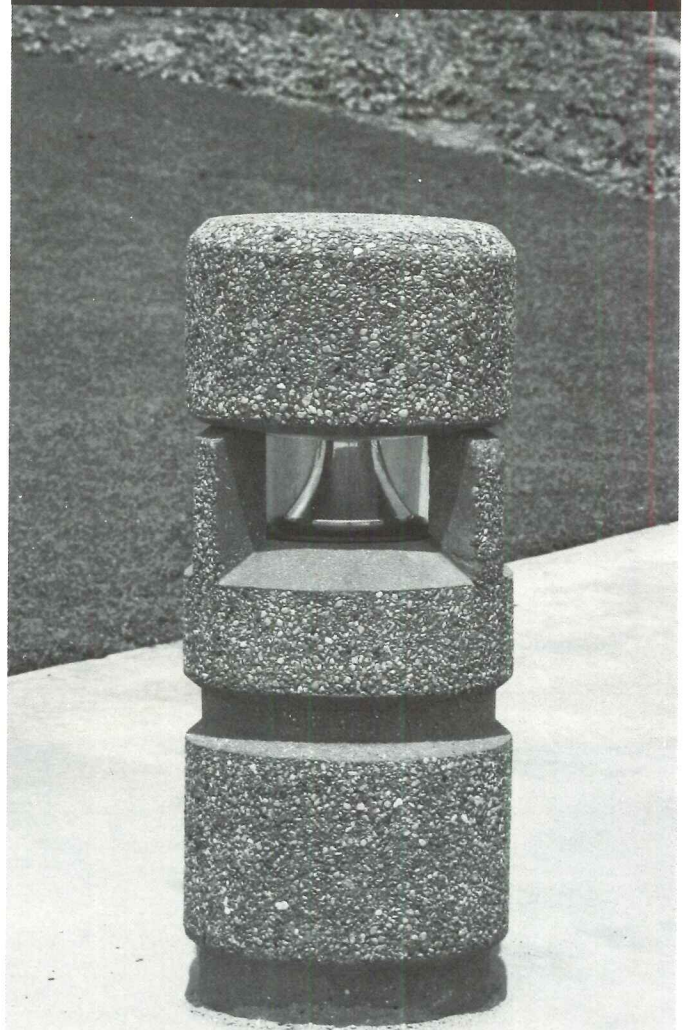

A lighted bollard constructed of precast reinforced concrete that will last. Perfect for vandalism areas and impervious to rusting. Available in a wide selection of colors, aggregate finishes, and efficient H.I.D. light sources. Dim: 36" high—15" dia.

Write on your letterhead for new color brochure.

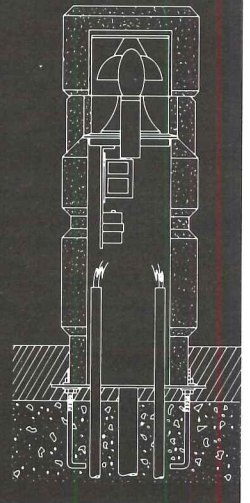

ARCHITECTURAL AREA LIGHTING CO.

Subsidiary of Kidde, Inc.
13901-B South Carmenita Road, Santa Fe Springs, CA 90670



Circle 1147 on inquiry card

PROBLEM WALL? ... FLEXI-WALL®!



PLASTER IN A ROLL™

**ECONOMICALLY COVERS
CONCRETE, BLOCK, TILE,
PLASTER, PANELING, ETC.**



FLEXI-WALL® SYSTEMS
P. O. BOX 88, LIBERTY, SC 29657
(803) 855-0500

- Heavy duty performance
 - Government, hospital, school, public housing approved
 - Attractive colors
 - Class-A flame spread
 - Zero smoke generation
 - Meets N.Y.C. fire toxicity code
 - Eliminates lead paint hazard
 - Ideal passive solar finish
- See Sweet's General Building File 9.13 FL, Spec-Data and Means Cost Data

WRITE
OR CALL (803) 855-0500 FOR
LITERATURE & FREE SWATCHES

**BUY DIRECT FROM FACTORY
AND SAVE**

Circle 1148 on inquiry card

flood barriers

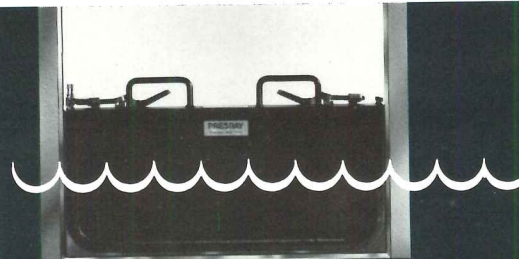

Custom engineered for installation in new or existing construction (block, concrete, steel or brick). Consists of: 1) a permanently installed, inconspicuous conversion frame for the opening to be sealed and 2) a removable rigid panel with an inflatable or compression gasket affixed to the sides and bottom. The panel is stored, then positioned at the time of an anticipated flood. Alternate designs incorporate permanent bottom or side hinged construction. Most Presray Flood Barriers utilize our patented inflatable Pneuma-Seal® system. Once pressurized, the seal conforms to even or uneven surfaces creating a positive, leaktight barrier. Where use of Pneuma-Seal is not practical or possible, we offer customized compression gasketing.

Our flood barriers are applicable to any building where flooding could prove disastrous to equipment, stock, supplies, machinery, etc.

You'll find our literature in Sweet's or contact Ted Hollander at Presray Corporation, 159 Charles Colman Blvd., Pawling, NY 12564 914-855-1220; California Office: 415-321-6002.

PRESRAY

Circle 1149 on inquiry card

this publication is available in microform

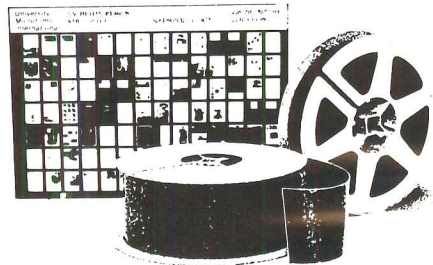

Please send me additional information.

University Microfilms International

300 North Zeeb Road
Dept. P.R.
Ann Arbor, MI 48106
U.S.A.

18 Bedford Row
Dept. P.R.
London, WC1R 4EJ
England

Name _____

Institution _____

Street _____

City _____

State _____ Zip _____



MORE PLACES FOR PEOPLE

edited by Charles K. Hoyt

From its initial spotlight on the exciting theater created by dramatic public spaces in hotels — lobbies that act as magnets to draw guests and passersby alike — to its exploration of stadium and arena design — where increasingly the same space must accommodate not only sports, but theater, dance, concerts, even banquets — the 43 projects in this new sequel to *Places for People* offer hundreds of ideas for designing places where people will gather for leisure events — places that are often breathtaking events in themselves. The case studies include resorts, parks, urban marketplaces, restaurants, and athletic facilities — not only new buildings, but many examples of renovation and adaptive reuse.

200 pgs; over 400 photos, plans and sections; 8 pgs in color
\$39.95

Use the coupon at right to order

Please send the books indicated at left to me for a free examination. At the end of 15 days, I will either remit in full, plus local tax and postage, or return the books.

name _____

street _____

city/state/zip _____

Pay with order and save! Remit in full, plus local tax, and McGraw-Hill pays regular postage and handling. Full return privileges.

The Purrrfect Pair

A table and chair
Made For
Each Other



Write for free catalog

Now you can have a Plan Hold drafting chair and table that not only work well together, they *look great* together! We created just the right chair with a soil and stain resistant Autumn Haze fabric to match our Autumn Haze drafting table. The NEW 402CH Graphic Arts Chair at \$179 list... the 370TA Drafting Tables from \$310 list. See your Plan Hold Dealer for your "Purrrfect Pair."

PLAN HOLD
17421 Von Karman Avenue • Irvine, California 92714-6293

Dealers in all Major U.S. Cities and Canada

Circle 1150 on inquiry card

Send this coupon to
ARCHITECTURAL RECORD
BOOK/REPRINT DEPARTMENT
1221 AVE OF THE AMERICAS
NEW YORK, NEW YORK 10020
Send this coupon to

...the *Architectural Record* books described on this page and on pages 223, 227, and 233...

- MORE HOUSES ARCHITECTS DESIGN FOR THEMSELVES \$34.50
- 25 YEARS OF RECORD HOUSES \$39.95
- NEW LIFE FOR OLD BUILDINGS \$34.50
- MORE PLACES FOR PEOPLE \$39.95

PLEASE
SEND
ME

1983 index

Architectural Record Vol. 171.
January-December 1983.
Published by McGraw-Hill, Inc.,
1221 Avenue of the Americas,
New York, New York 10020.

Copyright 1983.
All rights reserved.

Readers using this index will find buildings entered in at least three ways: by architect's name, by building or owner's name, and by building type (banks, medical facilities, schools, etc.). Projects featured in Building Types Studies are identified by the abbreviation BTS before the page number.

A

Acoustics—Hult Center for the Performing Arts [Acoustics], Eugene, OR; Jaffe Assoc., acoustics, Hardy Holzman Pfeiffer Assoc., archts—May 1983, pp. 130-133 • Steelcase Headquarters Building, Grand Rapids, MI; WBDC, archts, with Steelcase dsgrs—Nov. 1983, pp. 132-135.

Adaptive Use (*see also Additions, Preservation, and Renovations & Restorations*)—Bank of America Plaza [Biltmore Hotel renovation], New York, NY; Environetics Architect P.C., archts—Jan. 1983, pp. 128-133 • Batey & Mack Office, San Francisco, CA; Batey & Mack, archts—Sept-1 1983, pp. 120-121 • Brooklyn Bridge Anchorage Restoration, New York, NY; Smotrich & Platt, archts—Aug. 1983, pp. 124-127 • Church of St. Ann and the Holy Trinity, Brooklyn Heights, NY; Hardy Holzman Pfeiffer Associates, archts—Oct. 1983, BTS, pp. 92-95 • Claffin Park, Newtonville, MA; Sasaki Associates, archts—July 1983, BTS, pp. 100-103 • Federal Archives Building, New York, NY; Warner, Burns, Toan & Lunde, archts—Oct. 1983, BTS, pp. 92-95 • Five 1880s Warehouse Renovations, New York, NY; Stephen B. Jacobs & Associates, archts—Oct. 1983, BTS, pp. 92-95 • Jessica Gunne Sax Headquarters, San Francisco, CA; Hanns Kainz & Associates, archts—Sept-1 1983, pp. 102-107 • Landor Associates Offices, New York, NY; Landor Associates with Penney & Bernstein, archts—Jan. 1983, BTS, pp. 92-94 • Meola Studio and Apartment, New York, NY; Gillis Associates, archts—Nov. 1983, pp. 120-123 • New York University Graduate School of Business Library, New York, NY; Voorsanger & Mills Associates, archts—Aug. 1983, BTS, pp. 80-83 • One Post Office Square, Boston, MA; Jung/Brannen Associates, archts—July 1983, pp. 128-135 • Seagram Museum and Archives, Waterloo, Ontario, Canada; Barton Myers Associates, archts—Feb. 1983, pp. 92-95 • Seattle Garden Center, Seattle, WA; Arne Bystrom, archt—Apr. 1983, pp. 150-151 • Springer Building, Galveston, TX; Taft Architects, archts—Sept-1 1983, p. 144-145 and Oct. 1983, BTS, pp. 102-105 • Station Square, Commerce Court, and The Freighthouse Shops, Pittsburgh History & Landmark Foundation, developers—Oct. 1983, BTS, pp. 96-101 • Town-house Renovation, Boston, MA; Graham Gund Associates, archts—Mid-May 1983, pp. 134-137.

Additions—North Shore Congregation Israel, Glencoe, IL; Hammond Beebe and Babka, archts—June 1983, pp. 104-113 • Russell Sage College, Albany Campus Center, Albany, NY; Architectural Resources Cambridge, archts—Nov. 1983, BTS, pp. 102-103 • Seagram Museum and Archives, Waterloo, Ontario, Canada; Barton Myers Associates, archts—Feb. 1983, pp. 92-95.

Aga Khan Award for Architecture—Azem Palace Reconstruction, Damascus, Syria; Shafiq Imam, archt—Sept-2 1983, BTS, p. 74 • Ca-

kirhan Residence, Akyaka Village, Turkey; Nail Cakirhan, dsgrn—Sept-2 1983, BTS, pp. 82-83 • Darb Qirmiz Revitalization, Cairo, Egypt; Philip Speiser, archt—Sept-2 1983, BTS, p. 75 • Great Mosque of Niono, Niono, Mali; Lassine Minta, master mason—Sept-2 1983, BTS, pp. 72-73 • Hafsia Quarter, Medina of Tunis, Tunisia; Wassim bin Mahmoud with Arno Heinz, archts—Sept-2 1983, BTS, pp. 80-81 • King Abdul-Aziz International Airport, Hajj Terminal, Jeddah, Saudi Arabia; Skidmore, Owings & Merrill, archts—Sept-2 1983, BTS, pp. 84-85 • Residence Andalous, Sousse, Tunisia; Serge Santelli, archt—Sept-2 1983, BTS, pp. 76-79 • Sherefudin's White Mosque, Visoko, Yugoslavia; Zlatko Ugljen, archt—Sept-2 1983, BTS, pp. 68-71 • Tanjong Jara Beach Hotel and Rantau Abang Visitors' Center, Kuala Trenggnau, Malaysia; Whisenand, Allison, Tong and Goo, archts—Sept-2 1983, BTS, p. 75 • Tomb of Shah Rukn-i Alam Restoration, Multan, Pakistan; Muhammad Wali Ullah Khan, archt—Sept-2 1983, BTS, p. 74 • Wissa Wassef Arts Center, Giza-Cairo, Egypt; Ramses Wissa Wassef, archt—Sept-2 1983, BTS, p. 81.

AIA—"The AIA reaches out nationally—to influence the government and the public," by Walter F. Wagner, Jr.—Mar. 1983, p. 9 • "AIA seminar yields sophisticated advice on working abroad," by Peter Hoffman—Jan. 1983, p. 33 • "Bylaw changes and resolutions: No revolutions"—July 1983, p. 35 • "Convention mood: Kind of calm and quiet this year"—July 1983, p. 35 • "It is time to register for the annual AIA Convention"—Apr. 1983, p. 35 • "It's convention time. . . Is it also time to think of conventions as a place to think?", by Walter F. Wagner, Jr.—May 1983, p. 9 • "A nearly 80-year-old architect [Nathaniel Alexander Owings] talks about what seems important now," by Walter F. Wagner, Jr.—July 1983, p. 9 • "Professional development: Seminars on preservation, computers, and business management"—July 1983, p. 37 • "Theme speeches: The role of architecture for the nation, the city and the individual"—July 1983, pp. 39, 52.

Airports—King Abdul-Aziz International Airport, Hajj Terminal, Jeddah, Saudi Arabia; Skidmore, Owings & Merrill, archts—Sept-2 1983, BTS, pp. 84-85.

Ames, Anthony, archt—"Anthony Ames, architect/delineator"—Aug. 1983, pp. 96-103 • Friedrich Stadt, East Berlin, East Germany—Aug. 1983, pp. 102-103 • Garden Pavilion, Atlanta, GA—Aug. 1983, p. 101 • Pickering House, Laurel, MI—Aug. 1983, pp. 98-99 • Villa Augusta, Augusta, GA—Aug. 1983, p. 100 • Villa Chang, Augusta, GA—Aug. 1983, p. 97.

- Amoco Building, Denver CO—Kohn Pederson Fox Associates, archts—Feb. 1983, p. 125.
- Amsler Hagenah MacLean, archts—Phillips Exeter Academy, Frederick R. Mayer Art Center, Exeter, NH—Nov. 1983, BTS, pp. 96-101.
- Anaconda Tower, Denver, CO—Skidmore, Owings & Merrill, archts—Feb. 1983, p. 125.
- Anchorage Headquarters Library Competition Entry, Anchorage, AK—Gunnar Birkerts & Associates, archts—Mar. 1983, pp. 108-109.
- Anspach Grossman Portugal Offices, New York, NY—Samuel J. De Santo & Associates, archts—Sept-1 1983, pp. 116-119.
- Apartments—see *Housing & Apartments*
- Arbour Hospital, Jamaica Plain, MA—Graham/Meus, archts—June 1983, BTS, pp. 94-97.
- Architect/Designer (*portfolios and retrospectives*)—Ames, Anthony; “Anthony Ames, architect/delineator”—Aug. 1983, pp. 96-103 • Birkerts, Gunnar; “Explorations: Four projects by Gunnar Birkerts”—Mar. 1983, pp. 108-113 • Gehry, Frank; “A minimalist architecture of allusion: current projects of Frank Gehry,” by Lindsay Stamm Shapiro—June 1983, pp. 114-125 • Isozaki, Arata; “The recent work of Arata Isozaki: Part I,” by Martin Filler—Oct. 1983, pp. 125-137 • Le Corbusier; “An architecture drawn from life [a review of *Le Corbusier Sketchbooks*],” by Kurt W. Forster—Apr. 1983, pp. 142-145 • Mitchell/Giurgola [with Renato Severino]; “Made in Friuli”—Aug. 1983, pp. 104-117 • Murphy/Jahn; “Toward romantic high-tech”—Jan. 1983, pp. 102-115 • Myers, Barton; “Barton Myers proposes warm, lively indoor towns”—Feb. 1983, pp. 92-101 • Pelli, Cesar; “New layers of meaning: Works in progress by Cesar Pelli”—July 1983, pp. 104-113 • Safdie, Moshe; “Purpose and place”—Nov. 1983, pp. 124-131 • Severino, Renato [with Mitchell/Giurgola]; “Made in Friuli”—Aug. 1983, pp. 104-117 • Solomon, Barbara Stauffacher; “Green architecture”—Sept-2 1983, pp. 98-101.
- Architectural Business (see also *Building Activity, Building Codes, Building Costs & Financing, Computers, Construction Management, Legal Perspectives, Marketing, and Office Management*)—“Federal design commissions tied to increased authority for OFPP,” by Peter Hoffman—Aug. 1983, p. 25 • “Housing affordability index announced”—Sept-2 1983 p. 27.
- Architectural Drawing—Ames, Anthony; “Anthony Ames, architect/delineator”—Aug. 1983, pp. 96-103 • Diniz, Carlos; “Are renderings still important in our electronic age?”—Oct. 1983, pp. 45-51 • Le Corbusier; “An architecture drawn from life [a review of *Le Corbusier Sketchbooks*],” by Kurt W. Forster—Apr. 1983, pp. 142-145 • Solomon, Barbara Stauffacher; “Green architecture”—Sept-2 1983, pp. 98-101.
- Architectural Education—“Architectural education: questions piled upon questions,” by Walter F. Wagner, Jr.—Sept-2 1983, p. 9 • “Educating architects at Berkeley,” by Marcy Li Wang—Feb. 1983, pp. 108-117 • “Round Table: The education of architects in interior design”—Sept-1 1983, pp. 35-47 • “Still planning with the poor: community design centers keep up the good works,” by Paul M. Sachner—June 1983, pp. 126-131.
- Architectural Engineering (see also *Acoustics, Daylighting, Earth-sheltered Buildings, Energy Conservation, HVAC Systems, Lighting, Roofing, Solar Energy, and Structural headings*)—10 & 30 South Wacker Drive, Chicago, IL; Alfred Benesch & Co., engrns, with Fujikawa Johnson, archts; “Unique cantilevers carry 400,000 sq ft of tower”—Nov. 1983, pp. 136-139.
- Architectural Resources Cambridge, archts—Russell Sage College, Albany Campus Center, Albany, NY—Nov. 1983, BTS, pp. 102-103.
- Area 2 Police Center, Chicago, IL—Murphy/Jahn with the Chicago Dept. of Public Works, archts—Jan. 1983, pp. 105-107.
- Argonne National Laboratories Program Support Facility, Joliet, IL—Murphy/Jahn, archts—Jan. 1983, pp. 108-111.
- Arquitectonica, archts—Imperial at Brickell, Miami, FL—July 1983, BTS, pp. 92-95.
- Art Galleries—Phillips Exeter Academy, Frederick R. Mayer Art Center, Exeter, NH; Amsler Hagenah MacLean, archts—Nov. 1983, BTS, pp. 96-101.
- Artemide Show Room, Los Angeles, CA—Vignelli Associates, dsgnrs—Sept-1 1983, p. 138-139.
- Austin Junior High School, Galveston, TX—Ben Templin & Associates with Lloyd Pape, archts—July 1983, pp. 140-141.
- Aviano Elementary School, Aviano, Italy—Mitchell/Giurgola, archts—Aug. 1983, pp. 112-113.
- Azem Palace Reconstruction, Damascus, Syria—Shafiq Imam, archt—Sept-2 1983, BTS, p. 74.
- B**
- Bank of America Plaza [Biltmore Hotel renovation], New York, NY—Environmental Architect P.C., archts—Jan. 1983, pp. 128-133.
- Banks-Bankers Trust Company Trading Room, New York, NY; Interior Facilities Associates, interior dsgnrs—June 1983, pp. 136-137 • First Source Center, South Bend, IN; Murphy/Jahn, archts—Jan. 1983, pp. 112-115.
- Barclays Bank International Offices, Chicago, IL—Landahl Group, archts—Sept-1 1983, pp. 146-149.
- Batey & Mack, archts—Batey & Mack Office, San Francisco, CA—Sept-1 1983, pp. 120-121.
- Beneficial Center, Peapack/Gladstone, NJ—The Hillier Group, archts—Apr. 1983, BTS, pp. 114-117.
- Benesch, Alfred & Co., engrns, with Fujikawa Johnson, archts—10 & 30 South Wacker Drive, Chicago, IL—Nov. 1983, pp. 136-139.
- Bentley/LaRosa/Salasky, dsgnrs—Berkhoff Corporation Executive and Sales Offices, New York, NY—Sept-1 1983, pp. 140-143 • Hog Hill House, East Holden, ME—Mid-May 1983, pp. 70-73.
- Berger, Horst—“The Brooklyn Bridge at 100,”—Aug. 1983, pp. 118-123.
- Berkhoff Corporation Executive and Sales Offices, New York, NY—Bentley/LaRosa/Salasky, dsgnrs—Sept-1 1983, p. 140-143.
- BGS Architects with RS Architects, archts—Gallatin County Detention Center, Bozeman, MT—Mar. 1983, BTS, pp. 96-98.
- Billerica Public Library, Billerica, MA—James C. Hopkins Associates, archts—Aug. 1983, BTS, pp. 84-85.
- bin Mahmoud, Wassim with Arno Heinz, archts—Hafsia Quarter, Medina of Tunis, Tunisia—Sept-2, 1983, BTS, pp. 80-81.
- Birkerts, Gunnar & Associates, archts—Anchorage Headquarters Library Competition Entry, Anchorage, AK—Mar. 1983, pp. 108-109 • “Explorations: Four projects by Gunnar Birkerts”—Mar. 1983, pp. 108-113 • US Corps of Engineers Chapel & Educational Facility [with Giffels Associates], Camp Wildflecken, Germany—Mar. 1983, p. 110 • University of Nebraska, Wick Alumni Center Competition, Lincoln, NE—Mar. 1983, p. 111 • Villa Ginny, Kalamazoo, MI—Mar. 1983, pp. 112-113.
- Bobrow, Michael, and Julia Thomas—“For health-care providers too: an outlook of stressful—but hopeful—change”—June 1983, BTS, pp. 102-103.
- Booth/Hansen & Associates, archts—CF-14 Fire Station [with Joseph Casserly], Chicago, IL—July 1983, pp. 121-123 • Villa Barr, Northville, MI—Mid-May 1983, pp. 116-119.
- Bray-Schaible Design, dsgnrs—Rosen Apartment, New York, NY—Sept-1 1983, pp. 150-151.
- Brooklyn Bridge, New York, NY—John A. Roebing, archt; by Horst Berger—Aug. 1983, pp. 118-123.
- Brooklyn Bridge Anchorage Restoration, New York, NY—Smotrich & Platt, archts—Aug. 1983, pp. 124-127.
- Buchsbaum, Alan & Stephen Tilly, archts—Tenenbaum House, Lexington, SC—Mid-May 1983, pp. 120-123.
- Building Activity—“Administration gives some mild support for preservation with jobs bill”—May 1983, p. 35 • “Commercial rehab shows big upsurge”—Apr. 1983, p. 35 • “Construction-economy update: The dam is starting to break,” by George A. Christie—Apr. 1983, pp. 37, 39, 41 • “Construction-economy update: The outlook continues good, but there are a few more hurdles to overcome,” by George A. Christie—Sept-2 1983, pp. 35, 37, 39 • “Design commissions from the new jobs bill?,” by Peter Hoffman—June 1983, p. 35 • “Dodge/Sweet’s Construction Outlook: Is 1984 the year for nonresidential building?,” by George A. Christie—Nov. 1983, pp. 39-49 • “Economics: The rise and fall of the high-rise,” by John Morawetz—June 1983, pp. 39, 41 • “The infrastructure issue: Congress just can’t seem to decide,” by Peter Hoffman—June 1983, p. 35.
- Building Codes—“Financial incentives may not be the way to go on new-codes compliance”—Sept-2 1983, p. 25 • “Largest group of changes ever proposed for BOCA code”—Feb. 1983, p. 35 • “National research effort on building-fire toxicity called for by NIBS”—Oct. 1983, p. 33 • “NIBS fund drive showing success”—Dec. 1983, p. 15 • “A step backward in building research,” by Peter Hoffman—Apr. 1983, pp. 35, 71.
- Building Costs & Financing—“Cities tighten belts for new economic realities,” by Peter Hoffman—Mar. 1983, p. 33 • Construction costs: Better news than anticipated—except for some housing costs,” by James Stewart—Oct. 1983, p. 43 • “Construction costs: The economic upswing may bring new upward pressures,” by James Stewart—July 1983, p. 49 • “Costs: Are they really coming down?,” by James Stewart—Apr. 1983, p. 47 • “Economics: Interest rates should decline—but then watch out,” by Phillip E. Kidd—Oct. 1983, p. 35 • “Economics: The economy is positioned for a sustained recovery,” by Phillip E. Kidd—July 1983, p. 41 • “Fair Tax Act would eliminate real estate investment incentives”—Aug. 1983, p. 25 • “Fine tuning is needed to spur recovery without more inflation,” by Phillip E. Kidd—Mar. 1983, p. 39 • “Is cheaper money really cheap yet?,” by Phillip E. Kidd—Jan. 1983, p. 39 • “More favorable news on Davis-Bacon,” by Peter Hoffman—Nov. 1983, p. 35 • “Petitions on Davis-Bacon Act hit Congress”—Mar. 1983, p. 53 • “The present period of stability may last a while longer,” by James Stewart—Jan. 1983, p. 45 • “Rehabilitation credits in jeopardy from retroactive bill,” by Peter Hoffman—Sept-2 1983, p. 27.
- Building Type Studies—“Big business preservation,” by Nory Miller—Oct. 1983, pp. 91-109 • “Building for the art of the 20th century,” [Museum]—Feb. 1983, pp. 79-91 • “Conserving a rich architectural heritage,” [Aga Khan Award for Architecture]—Sept-2 1983, pp. 67-85 • “Corporate images,” [Offices]—Jan. 1983, pp. 85-101 • “Growing in,” [University & College Buildings]—Nov. 1983, pp. 89-107 • “Jails and prisons,”—Mar. 1983, pp. 81-99 • “Libraries: the dawn of the information age,”—Aug. 1983, pp. 73-91 • “Offices go to the suburbs for peace and quiet,” [Low-rise Office Buildings]—Apr. 1983, 113-129 • “Product Reports 1984: The manufacturer as part of the team”—Dec. 1983, pp. 39-216 • “Record Houses 1983,”—Mid-May 1983, 69-143 • “Record Interiors 1983,”—Sept-1 1983, pp. 87-159 • “Recreation facilities,”—May

- 1983, pp. 91-105 • "Rx: Environment," [Mental Health Facilities]—June 1983, pp. 85-103 • "A variety of apartments for city, suburb and beach,"—July 1983, pp. 87-103.
- Bumpzoid, archts—Mere House, Flint Hill, VA—Mid-May 1983, pp. 90-93.
- Burden, Ernest—"What are the aggressive firms doing to get their share of design work? An important [1982] survey report..."—Feb. 1983, pp. 47, 49 • "What are the aggressive firms doing to get their share of design work? An important [1983] survey report..."—June 1983, pp. 43, 45, 55.
- Bystrom, Arne, archt—Seattle Garden Center, Seattle, WA—Apr. 1983, pp. 150-151.
- C**
- CAD—see *Computers*
- Cakirhan, Nail, dsgnr—Cakirhan Residence, Akyaka Village, Turkey—Sept-2 1983, BTS, pp. 82-83.
- California Aerospace Museum, Exposition Park, Los Angeles, CA—Frank Gehry, archt—June 1983, pp. 122-123.
- Canada—Harborview at Kil-Cona Park, Winnipeg, Manitoba; IKOY Architects, archts—May 1983, BTS, pp. 102-105 • IKOY Office Building, Winnipeg, Manitoba; IKOY Architects, archts—Apr. 1983, pp. 146-149 • Royal Conservatory of Music, Toronto, Ontario; Barton Myers Associates, archts—Feb. 1983, pp. 100-101 • Seagram Museum and Archives, Waterloo, Ontario; Barton Myers Associates, archts—Feb. 1983, pp. 92-95 • Unionville Library, Town of Markham, Ontario; Barton Myers Associates, archts—Feb. 1983, pp. 96-97 • Wandich House, Peterborough, Ontario; Jim Strassman Architects, archts—Mid-May 1983, pp. 138-143.
- Cassery, Joseph with Booth/Hansen & Associates, archts—CF-14 Fire Station, Chicago, IL—July 1983, pp. 121-123.
- Cavaglieri, Giorgio with Davis, Brody & Associates, archts—New York Public Library Renovation, New York, NY—Aug. 1983, BTS, pp. 74-79.
- Center for the Elderly, Buia, Italy—Renato Severino, archt—Aug. 1983, pp. 108-109.
- CF-14 Fire Station, Chicago, IL—Booth/Hansen & Associates with Joseph Cassery, archts—July 1983, pp. 121-123.
- Chapman, Liane Leach—"Disability insurance protects you from possible disaster [Part 2]"—Nov. 1983, p. 37.
- Charlton Park, Bronx, NY—Leland R. Weintraub, landscape archt—May 1983, BTS, p. 101.
- Chestnut Place Apartments, Chicago, IL—Weese Seegers Hickey Weese, archts—July 1983, BTS, pp. 96-97.
- Chicago Dept. of Public Works with Murphy/Jahn, archts—Area 2 Police Center, Chicago, IL—Jan. 1983, pp. 105-107.
- Chimera, John, Architect, archts—Cooper & Company Offices and Studio, New York, NY—Jan. 1983, BTS, pp. 96-97.
- China—"So you want to do business in China?"—Sept-2 1983, p. 33.
- Christie, George A.—"Construction-economy update: The dam is starting to break"—Apr. 1983, pp. 37, 39, 41 • "Construction-economy update: The outlook continues good, but there are a few more hurdles to overcome—Sept-2 1983, pp. 35, 37, 39 • "Dodge/Sweet's Construction Outlook: Is 1984 the year for non-residential building?"—Nov. 1983, pp. 39-49.
- Chrysalis Corp., archts—Reinhard House, Chicago, IL—Mid-May 1983, pp. 94-97.
- Church of St. Ann and the Holy Trinity, Brooklyn Heights, NY—Hardy Holzman Pfeiffer Associates, archts—Oct. 1983, BTS, pp. 92-95.
- Churches—see *Religious Buildings*
- Cidade de Goa Resort Hotel, Goa, India—C.M. Correa, archt—Apr. 1983, pp. 154-159.
- CIGNA Office Building, Bloomfield, CT—The Architects Collaborative with Interspace Incorporated, archts—Apr. 1983, pp. 160-167.
- Cigolle, Mark, archt—Covington Restaurant, Armonk, NY—June 1983, pp. 132-135.
- Claffin Park, Newtonville, MA—Sasaki Associates, archts—July 1983, BTS, pp. 100-103.
- Cleveland Clinic, Cleveland, OH—Cesar Pelli & Associates, archts—July 1983, p. 107.
- Colleges—see *University & College Buildings*
- Computers—Bankers Trust Company Trading Room, New York, NY; Interior Facilities Associates, interior dsgnrs—June 1983, pp. 136-137 • "Can computer-aided drafting be effective and affordable for the small firm?" by Eric Teicholz—Feb. 1983, pp. 37, 39 • "Computer congress announced"—Mar. 1983, p. 33 • "Computers: The real opportunities are in design," by Douglas F. Stoker and Nicholas H. Weingarten—Dec. 1983, pp. 19, 21 • "How to protect your rights when you buy [a computer]," by John W. Greenfield—Apr. 1983, pp. 43, 45 • "Lighting those visual display terminals—in the cause of the operator's comfort," by Sylvan R. Shemitz, with Gladys Walker—Oct. 1983, pp. 138-143 • "On learning how to think about computers in architecture," by Walter F. Wagner, Jr.—Apr. 1983, p. 9 • "The personal challenge of CAD," by Barry Milliken—Mar. 1983, pp. 41, 43, 45 • "Professional development: Seminars on preservation, computers, and business management"—July 1983, p. 37 • "Round Table on computers in architecture," by Harry Mileaf and Walter Wagner—May 1983, pp. 39-53 • "Selecting the right CAD system for your office," by Eric Teicholz—July 1983, pp. 45, 47 • "The single-user workstation—A new concept that promises to benefit the design profession," by John C. Dill and Jon H. Pittman—Aug. 1983, pp. 27, 29, 31 • "Systems '83 to be held in Dallas"—Apr. 1983, p. 35 • "Using CAD effectively with reprographics," by Bradley Meade—Sept-2 1983, pp. 29, 31 • "Using reprographics effectively with CAD," by Bradley Meade—Oct. 1983, pp. 37-39 • "Where is your firm to get software?" by Harry Mileaf—Jan. 1983, pp. 41, 43 • "The wonderland of computer language," by Harry Mileaf—Apr. 1983, pp. 51, 73.
- Concrete—see *Structural, Concrete*
- Consolidated Edison Customer Service Facility, Bronx, NY—Richard Dattner, archt—July 1983, pp. 124-125.
- Construction Costs—see *Building Costs & Financing*
- Construction Management—"Construction management: A useful service—if you know how to work with it," by Bradford Perkins—Mar. 1983, pp. 35, 37.
- Construction Outlook—see *Building Activity*
- Contra Costa County Detention Facility, Martinez, CA—Correction Facility Architects, archts—Mar. 1983, BTS, pp. 82-85.
- Cooper & Company Offices and Studio, New York, NY—John Chimera Architect, archts—Jan. 1983, BTS, pp. 96-97.
- Correa, C.M., archt—Cidade de Goa Resort Hotel, Goa, India—Apr. 1983, pp. 154-159.
- Correction Facility Architects, archts—Contra Costa County Detention Facility, Martinez, CA—Mar. 1983, BTS, pp. 82-85.
- Cossuta & Associates, archts—Long Wharf Marriott Hotel, Boston, MA—Mar. 1983, pp. 100-107.
- Covington Restaurant, Armonk, NY—Mark Cigolle, archt—June 1983, pp. 132-135.
- Credit du Nord Offices, New York, NY—Rivkin/Weisman, archts—Sept-1 1983, pp. 96-99.
- Crissman & Solomon, archts—Dattelbaum House, Kezar Lake/Center Lovell, ME—Mid-May 1983, pp. 98-101.
- Croxton Collaborative, archts—Reynolds Tobacco Company Building [lobby restoration], Winston-Salem, NC—Jan. 1983, BTS, pp. 98-101.
- Custom House Renovation, New York, NY—James Stewart Polshek & Partners with MBA/Architects, archts—Oct. 1983, BTS, pp. 92-95.
- D**
- Darb Qirmiz Revitalization, Cairo, Egypt—Philip Speiser, archt—Sept-2 1983, BTS, p. 75.
- Dattelbaum House, Kezar Lake/Center Lovell, ME—Crissman & Solomon, archts—Mid-May 1983, pp. 98-101.
- Dattner, Richard, archt—Consolidated Edison Customer Service Facility, Bronx, NY—July 1983, pp. 124-125.
- Davidow House, Kauai, HI—MLTW/Turnbull Associates, archts—Mid-May 1983, pp. 112-115.
- Davis, Brody & Associates, archts—New York Public Library Renovation [with Giorgio Cavaglieri], New York, NY—Aug. 1983, BTS, pp. 74-79 • Philip Morris Operations Center, Richmond, VA—Mar. 1983, pp. 114-121.
- Davis, Sam, archt—"Educating architects at Berkeley," by Marcy Li Wang—Feb. 1983, pp. 110-111.
- Day Care Centers—see *Schools*
- Daylighting—Anchorage Headquarters Library Competition Entry, Anchorage, AK; Gunnar Birkerts & Associates, archts—Mar. 1983, pp. 108-109 • Phillips Exeter Academy, Frederick R. Mayer Art Center, Exeter, NH; Amsler Hagenah MacLean, archts—Nov. 1983, BTS, pp. 96-101.
- De Santo, Samuel J. & Associates, archts—Anspach Grossman Portugal Offices, New York, NY—Sept-1 1983, pp. 116-119.
- Deer Valley Resort, Park City, UT—Esherick Homsey Dodge and Davis, archts—May 1983, BTS, pp. 92-97.
- Dianne B., New York, NY—Voorsanger & Mills Associates, archts—Mar. 1983, pp. 126-127.
- Dill, John C., and Jon H. Pittman—"The single-user workstation—A new concept that promises to benefit the design profession"—Aug. 1983, pp. 27, 29, 31.
- Diniz, Carlos, illustrator—"Are renderings still important in our electronic age?"—Oct. 1983, pp. 45-51.
- District Court of Appeal, First District, Tallahassee, FL—William Morgan Architects, archts—Jan. 1983, pp. 116-121.
- Duany, Andres and Elizabeth Plater-Zyberk, archts—Hibiscus House, Coconut Grove, FL—Mid-May 1983, pp. 102-105.
- Dubai Bank Limited Offices, New York, NY—Rivkin/Weisman, archts—Jan. 1983, BTS, pp. 86-91.
- D'Urso Design, dsgnr—Swid Powell Design Offices, New York, NY—Sept-1 1983, pp. 132-133.
- E**
- Earth-sheltered Buildings—Private Residence, AL; Moshe Safdie and Associates, archts—Nov. 1983, pp. 128-131.
- East Germany—Friedrich Stadt, East Berlin; Anthony Ames, archt—Aug. 1983, pp. 102-103.
- Economic Outlook—see *Building Activity, Building Costs & Financing*
- Editorials [by Walter F. Wagner, Jr.]—"The AIA reaches out nationally—to influence the government and the public"—Mar. 1983, p. 9 • "Architectural education: questions piled upon questions"—Sept-2 1983, p. 9 • "It's convention time... Is it also time to think of conventions as a place to think?"—May 1983, p. 9 • "A little anniversary, a little more evolution"—June 1983, p. 9 • "A nearly-80-year-old architect [Nathaniel Alexander Owings] talks about what seems important now"—July 1983, p. 9 • "On learning how to think about computers in architecture"—Apr. 1983, p. 9 • "On readers, research, and readership"—Feb. 1983, p. 9 • "On Record Houses and Record Interiors, skyscrapers—and design ideas"—Aug. 1983, p. 9 • "On talking to the public about architecture"—Nov. 1983, p. 9 • "On understanding changing marketplaces and changing tactics for getting things built"—Oct. 1983,

- p. 9 • "Some thoughts at the start of the New Year"—Jan. 1983, p. 9.
- Egypt—Darb Qirmiz Revitalization, Cairo; Philip Speiser, archt—Sept-2 1983, BTS, p. 75 • Wissa Wassef Arts Center, Giza-Cairo; Ramses Wissa Wassef, archt—Sept-2 1983, BTS, p. 81.
- Elliott House, PA—Jefferson B. Riley of Moore Grover Harper, archt—Mid-May 1983, pp. 106-111.
- Energy Conservation (see also *Daylighting, Solar Energy*)—Argonne National Laboratories Program Support Facility, Joliet, IL; Murphy/Jahn, archts—Jan. 1983, pp. 108-111 • "Engineers urge clear national energy policy"—June 1983, p. 35 • Flack + Kurtz, engnrs, "Energy conservation in office buildings—a maturing art"—Feb. 1983, pp. 124-131 • Middletown Public Library, Middletown, OH; Lorenz & Williams, archts—July 1983, pp. 138-139 • One Champion Plaza, Stamford, CT; Ulrich Franzen & Associates, archts—Feb. 1983, pp. 102-107 • "Round Table: Conserving energy in the rehabilitated or retro-fitted building"—Dec. 1983, pp. 30-37 • St. Enoch Square, Glasgow, Scotland; G.M.W. Partnership with Reiach and Hall, archts—June 1983, pp. 138-143.
- Enerplex, South Building, Princeton, NJ—Skidmore, Owings & Merrill, archts—Feb. 1983, pp. 130-131.
- Engineering—see *Architectural Engineering*
- Environetics Architect P.C., archts—Bank of America Plaza [Biltmore Hotel renovation], New York, NY—Jan. 1983, pp. 128-133.
- EPR, archts—Georgetown University, Riggs Memorial Library, Washington, DC—Sept-1 1983, pp. 134-137.
- Esherick Homsey Dodge and Davis, archts—Deer Valley Resort, Park City, UT—May 1983, BTS, pp. 92-97.
- Exposition Buildings—Exposition Multicultural Center, Los Angeles, CA; Barton Myers Associates, archts—Feb. 1983, pp. 98-99 • Louisiana World Exposition 1984 Amphitheater, New Orleans, LA; Frank Gehry, archt—June 1983, pp. 124-125.
- F**
- Facility Programming—"Designing tomorrow's libraries"—Aug. 1983, BTS, p. 91 • "For health-care providers too: an outlook of stressful—but hopeful—change," by Michael Bobrow and Julia Thomas—June 1983, BTS, pp. 102-103 • "Strategies for corrections programming," by Kenneth Ricci—Mar. 1983, BTS, p. 99.
- Farm Credit Banks of Spokane Building, Spokane, WA—Walker McGough Foltz Lyerla, archts—Feb. 1983, pp. 128-129.
- Federal Archives Building, New York, NY—Warner, Burns, Toan & Lunde, archts—Oct. 1983, BTS, pp. 92-95.
- Filler, Martin—"The recent work of Arata Isozaki: Part I"—Oct. 1983, pp. 125-137.
- Finance—see *Building Costs & Financing*
- Fire Safety—see *Building Codes*
- Fire Stations—CF-14 Fire Station, Chicago, IL; Booth/Hansen & Associates with Joseph Casserly, archts—July 1983, pp. 121-123.
- First Source Center, South Bend, IN—Murphy/Jahn, archts—Jan. 1983, pp. 112-115.
- Five 1880s Warehouse Renovations, New York, NY—Stephen B. Jacobs & Associates, archts—Oct. 1983, BTS, pp. 92-95.
- Flack + Kurtz, engnrs—"Energy conservation in office buildings—a maturing art"—Feb. 1983, pp. 124-131.
- Forbes, Peter and Associates, archts—Wharton House, Seal Cove, Mt. Desert Island, ME—Mid-May 1983, pp. 124-127.
- Forster, Kurt W.—"An architecture drawn from life [a review of *Le Corbusier Sketchbooks*]"—Apr. 1983, pp. 142-145.
- Franzen, Ulrich & Associates, archts—One Champion Plaza, Stamford, CT—Feb. 1983, pp. 102-107.
- Friedrich Stadt, East Berlin, East Germany—Anthony Ames, archt—Aug. 1983, pp. 102-103.
- Fujikawa Johnson & Assoc., archts, with Alfred Benesch & Co., engnrs—10 & 30 South Wacker Drive, Chicago, IL—Nov. 1983, pp. 136-139.
- Funerary Architecture—Tomb of Shah Rukn-i Alam Restoration, Multan, Pakistan; Muhammad Wali Ullah Khan, archt—Sept-2 1983, BTS, p. 74.
- G**
- Gallatin County Detention Center, Bozeman, MT—BGS Architects with RS Architects, archts—Mar. 1983, BTS, pp. 96-98.
- Galveston Historic Foundation, preservationists—"Big business preservation—Galveston: In-town turnaround," by Nory Miller—Oct. 1983, BTS, pp. 102-105.
- Garden Pavilion, Atlanta, GA—Anthony Ames, archt—Aug. 1983, p. 101.
- Gehry, Frank, archt—California Aerospace Museum, Exposition Park, Los Angeles, CA—June 1983, pp. 122-123 • Louisiana World Exposition 1984 Amphitheater, New Orleans, LA—June 1983, pp. 124-125 • Loyola Law School, Los Angeles, CA—June 1983, pp. 120-121 • "A minimalist architecture of allusion: current projects of Frank Gehry," by Lindsay Stamm Shapiro—June 1983, pp. 114-125 • Norton House, Venice, CA—June 1983, p. 117 • Private Residence, Beverly Hills, CA—June 1983, p. 116 • Smith House, Los Angeles, CA—June 1983, pp. 118-119 • Spiller Houses, Venice, CA—Mid-May 1983, pp. 84-89.
- Gensler & Associates, archts—Harlequin Plaza, Englewood, CO—Apr. 1983, BTS, pp. 118-121.
- Georgetown University, Riggs Memorial Library, Washington, DC—EPR, archts—Sept-1 1983, pp. 134-137.
- Germany—US Corps of Engineers Chapel & Educational Facility, Camp Wildflecken; Gunnar Birkerts & Associates with Giffels Associates, archts—Mar. 1983, p. 110.
- Giffels Associates with Gunnar Birkerts & Associates, archts—US Corps of Engineers Chapel & Educational Facility, Camp Wildflecken, Germany—Mar. 1983, p. 110.
- Gillis Associates, archts—Meola Studio and Apartment, New York, NY—Nov. 1983, pp. 120-123.
- G.M.W. Partnership with Reiach and Hall, archts—St. Enoch Square, Glasgow, Scotland—June 1983, pp. 138-143.
- Goodkind & O'dea, archts—Pier 76 Garage, New York, NY—July 1983, pp. 142-143.
- Goody, Joan E.—"A rare and rich response to context"; Keio University Library, Tokyo, Japan—May 1983, pp. 106-113.
- Government Buildings—see *Public Buildings*
- Grad Partnership, The, with The Gruzen Partnership, archts—Trenton State Prison Rehabilitation, Trenton, NJ—Mar. 1983, BTS, pp. 88-91.
- Graham/Meus, archts—Arbour Hospital, Jamaica Plain, MA—June 1983, BTS, pp. 94-97.
- Grakal, Stamler, Blackman [Law] Offices, Santa Monica, CA—Eugene Kupper, archt—Sept-1 1983, pp. 122-127.
- Great Mosque of Niono, Niono, Mali—Lassine Minta, master mason—Sept-2 1983, BTS, pp. 72-73.
- Greenfield, John W.—"How to protect your rights when you buy [a computer]"—Apr. 1983, pp. 43, 45.
- Gruzen Partnership, The, archts—Manhattan House of Detention for Men, New York, NY—Mar. 1983, BTS, pp. 86-87 • Trenton State Prison Rehabilitation [with The Grad Partnership], Trenton, NJ—Mar. 1983, BTS, pp. 88-91.
- Gully, The, New England—Timothy D. Smith & Associates, archts—Feb. 1983, pp. 118-123.
- Gund, Graham Associates, archts—Town-house Renovation, Boston, MA—Mid-May 1983, pp. 134-137.
- H**
- Hafsia Quarter, Medina of Tunis, Tunisia—Wassim bin Mahmoud with Arno Heinz, archts—Sept-2 1983, BTS, pp. 80-81.
- Hammond Beebe and Babka, archts—North Shore Congregation Israel, Glencoe, IL—June 1983, pp. 104-113.
- Hanlon, John J., Jr.—"Disability insurance protects you from possible disaster [Part 1]"—July 1983, p. 43.
- Harbor Plaza, Stamford, CT—Yankee Planning/Do H. Chung, archts; by Mary Woods—Sept-2 1983, pp. 108-111.
- Harborview at Kil-Cona Park, Winnipeg, Manitoba, Canada—IKOY Architects, archts—May 1983, BTS, pp. 102-105.
- Hardy Holzman Pfeiffer Associates, archts—Church of St. Ann and the Holy Trinity, Brooklyn Heights, NY—Oct. 1983, BTS, pp. 92-95 • Hult Center for the Performing Arts, Eugene, OR—May 1983, pp. 120-129.
- Harlequin Plaza, Englewood, CO—Gensler & Associates, archts—Apr. 1983, BTS, pp. 118-121.
- Harry Winston "Petit Salon," New York, NY—Adam Tihany, archt—Sept-1 1983, pp. 114-115.
- Heery & Heery, archts—Herman Miller Roswell Facility, Roswell, GA—Jan. 1983, pp. 122-127.
- Hellmuth, Obata & Kassabaum with TRA Associates, archts—Washington State Medium Security Prison, Monroe, WA—Mar. 1983, BTS, pp. 94-95.
- Henderson House Restoration/Fair Oaks Cottages Remodeling, Selma, AL—James Seay with Nicholas H. Holmes, archts—May 1983, pp. 114-119.
- Herman Miller Roswell Facility, Roswell, GA—Heery & Heery, archts—Jan. 1983, pp. 122-127.
- Hibiscus House, Coconut Grove, FL—Andres Duany and Elizabeth Plater-Zyberk, archts—Mid-May 1983, pp. 102-105.
- Hillier Group, The, archts—Beneficial Center, Peapack/Gladstone, NJ—Apr. 1983, BTS, pp. 114-117.
- Himmel, Bonner, archts—Himmel, Bonner Architects Offices, Chicago, IL—Apr. 1983, pp. 152-153.
- Hog Hill House, East Holden, ME—Bentley/LaRosa/Salasky, dsgnrs—Mid-May 1983, pp. 70-73.
- Holabird & Root, archts—Saenger Theater, Pensacola, FL—Aug. 1983, pp. 92-95.
- Hollein, Hans, archt—Municipal Museum Abteiberg Monchengladbach, Monchengladbach, West Germany—Feb. 1983, BTS, pp. 79-91.
- Holmes, Nicholas H. with James Seay, archts—Henderson House Restoration/Fair Oaks Cottages Remodeling, Selma, AL—May 1983, pp. 114-119.
- Hopkins, James C. Associates, archts—Billerica Public Library, Billerica, MA—Aug. 1983, BTS, pp. 84-85.
- Hospitals—Arbour Hospital, Jamaica Plain, MA; Graham/Meus, archts—June 1983, BTS, pp. 94-97 • Ingalls Memorial Hospital, Wyman-Gordon Pavilion, Harvey, IL; Perkins & Will, archts—June 1983, BTS, pp. 98-101.
- Hotels & Motels—Cidade de Goa Resort Hotel, Goa, India; C.M. Correa, archt—Apr. 1983, pp. 154-159 • First Source Center, South Bend, IN; Murphy/Jahn, archts—Jan. 1983, pp. 112-115 • Long Wharf Marriott Hotel, Boston, MA; Cossutta & Associates, archts—Mar. 1983, pp. 100-107 • One Post Office Square, Boston, MA; Jung/Brannen Associates, archts—July 1983, pp. 128-135 • Pin Oak Commercial Center, Houston, TX; Cesar Pelli & Associates, archts—July 1983, p. 109 • Residence Andalous, Sousse, Tunisia; Serge Santelli, archt—Sept-2 1983, BTS, pp. 76-79 • Tanjong Jara Beach Hotel and Rantau Abang Visitors' Center, Kuala Trenggnau, Malaysia; Whisenand, Allison, Tong and Goo, archts—Sept-2 1983, BTS, p. 75 • Tsukuba Civic Center/Dai Ichi Hotel, Tsukuba New Town, Ibaragi Prefecture, Japan; Arata Isozaki & Associates, archts; by Martin Filler—Oct. 1983, pp. 126-137.

Hough, Reginald—"The secret to quality in architectural concrete: knowing construction"—Mar. 1983, pp. 128-135.

Houses-Cakirhan Residence, Akyaka Village, Turkey; Nail Cakirhan, dsgnr—Sept-2 1983, BTS, pp. 82-83 • Dattelbaum House, Kezar Lake/Center Lovell, ME; Crissman & Solomon, archts—Mid-May 1983, pp. 98-101 • Davidow House, Kauai, HI; MLTW/Turnbull Associates, archts—Mid-May 1983, pp. 112-115 • Elliott House, PA; Jefferson B. Riley of Moore Grover Harper, archt—Mid-May 1983, pp. 106-111 • Garden Pavilion, Atlanta, GA; Anthony Ames, archt—Aug. 1983, p. 101 • Gully, The, New England; Timothy D. Smith & Associates, archts—Feb. 1983, pp. 118-123 • Henderson House Restoration/Fair Oaks Cottages Remodeling, Selma, AL; James Seay with Nicholas H. Holmes, archts—May 1983, pp. 114-119 • Hibiscus House, Coconut Grove, FL; Andres Duany and Elizabeth Plater-Zyberk, archts—Mid-May 1983, pp. 102-105 • Hog Hill House, East Holden, ME; Bentley/LaRosa/Salasky, dsgnrs—Mid-May 1983, pp. 70-73 • Johnson Study/Library, New Canaan, CT; Philip Johnson, archt—July 1983, pp. 114-119 • Mere House, Flint Hill, VA; Bumpzoid, archts—Mid-May 1983, pp. 90-93 • No.ton House, Venice, CA; Frank Gehry, archt—June 1983, p. 117 • Pickering House, Laurel, MI; Anthony Ames, archt—August 1983, pp. 98-99 • Potatoe Hill Residential District Renovations, Winchester, VA; Preservation of Historic Winchester, preservationists—Oct. 1983, BTS, pp. 106-109 • Private Residence, AL; Moshe Safdie and Associates, archts—Nov. 1983, pp. 128-131 • Private Residence, Beverly Hills, CA; Frank Gehry, archt—June 1983, p. 116 • Private Residence, Fire Island, NY; Rivkin/Weisman, archts—Mid-May 1983, pp. 80-83 • Private Residence, New Buffalo, MI; Veronda Associates, archts—Mid-May 1983, pp. 74-79 • Private Residence, San Juan Islands, WA; Morgan and Lindstrom, archts—Mid-May 1983, pp. 128-133 • Raikes House, Roxbury, CT; Redroof Design, archts—Oct. 1983, pp. 118-124 • Reinhard House, Chicago, IL; Chrysalis Corp., archts—Mid-May 1983, pp. 94-97 • Smith House, Los Angeles, CA; Frank Gehry, archt—June 1983, pp. 118-119 • Spiller Houses, Venice, CA; Frank O. Gehry & Associates, archts—Mid-May 1983, pp. 84-89 • Tenenbaum House, Lexington, SC; Alan Buchsbaum & Stephen Tilly, archts—Mid-May 1983, pp. 120-123 • Town-house Renovation, Boston, MA; Graham Gund Associates, archts—Mid-May 1983, pp. 134-137 • Van Leer Residence, Jerusalem, Israel; Moshe Safdie and Associates, archts—Nov. 1983, pp. 124-127 • Venturi, Scott Brown Residence, Philadelphia, PA; Venturi, Rauch and Scott Brown, archts—Sept-1 1983, pp. 108-113 • Villa Augusta, Augusta, GA; Anthony Ames, archt—Aug. 1983, p. 100 • Villa

Barr, Northville, MI; Booth/Hansen & Associates, archts—Mid-May 1983, pp. 116-119 • Villa Chang, Augusta, GA; Anthony Ames, archt—Aug. 1983, p. 97 • Villa Ginny, Kalamazoo, MI; Gunnar Birkerts & Associates, archts—Mar. 1983, pp. 112-113 • Wandich House, Peterborough, Ontario, Canada; Jim Strassman Architects, archts—Mid-May 1983, pp. 138-143 • Wharton House, Seal Cove, Mt. Desert Island, ME; Peter Forbes and Associates, archts—Mid-May 1983, pp. 124-127.

Housing & Apartments (see also *Mixed-use Buildings*)—Chestnut Place Apartments, Chicago, IL; Weese Seegers Hickey Weese, archts—July 1983, BTS, pp. 96-97 • Claffin Park, Newtonville, MA; Sasaki Associates, archts—July 1983, BTS, pp. 100-103 • Federal Archives Building, New York, NY; Warner, Burns, Toan & Lunde, archts—Oct. 1983, BTS, pp. 92-95 • Friedrich Stadt, East Berlin, East Germany; Anthony Ames, archt—Aug. 1983, pp. 102-103 • "Housing affordability index announced"—Sept-2 1983, p. 27 • Imperial at Brickell, Miami, FL; Arquitectonica, archts—July 1983, BTS, pp. 92-95 • Marriott Residence, Chicago, IL; Krueck & Olsen, archts—Sept-1 1983, pp. 88-95 • "NAHB plans convention and issues warnings"—Oct. 1983, p. 33 • Pensacola Place, Chicago, IL; Tigerman Fugman McCurry, archts—July 1983, BTS, pp. 98-99 • Pin Oak Commercial Center, Houston, TX; Cesar Pelli & Associates, archts—July 1983, p. 109 • Potatoe Hill Residential District Renovation, Winchester, VA; Preservation of Historic Winchester, preservationists—Oct. 1983, BTS, pp. 106-109 • Rosen Apartment, New York, NY; Bray-Schaible Design, dsgnrs—Sept-1 1983, pp. 150-151 • "Round Table: The architect's role in built-for-sale housing"—Mid-May 1983, pp. 33-47 • San Pietro al Natisono Student Housing, San Pietro al Natisono, Italy; Mitchell/Giurgola, archts—Aug. 1983, pp. 116-117 • Tsao Apartment, New York, NY; Calvin Tsao with Zack McKown, dsgnrs—Sept-1 1983, pp. 152-159 • Windswept, Kiawah Island, SC; Sandy & Babcock, archts—July 1983, BTS, pp. 88-91.

Housing for the Elderly—Center for the Elderly, Buia, Italy; Renato Severino, archt—Aug. 1983, pp. 108-109.

Hult Center for the Performing Arts, Eugene, OR—Hardy Holzman Pfeiffer Associates, archts—May 1983, pp. 120-129 • Hult Center Acoustics; Jaffe Associates, acoustics—May 1983, pp. 130-133.

HVAC Systems—Amoco Building, Denver, CO; Kohn Pederson Fox Associates, archts—Feb. 1983, p. 125 • Anaconda Tower, Denver, CO; Skidmore, Owings & Merrill, archts—Feb. 1983, p. 125 • Enerplex, South Building, Princeton, NJ; Skidmore, Owings & Merrill, archts—Feb. 1983, pp. 130-131 •

Farm Credit Banks of Spokane Building, Spokane, WA; Walker McGough Foltz Lyerla, archts—Feb. 1983, pp. 128-129 • Rocky Mountain Energy Company Headquarters, Bloomfield, CO; Kohn Pederson Fox Associates, archts—Feb. 1983, p. 127 • St. Paul Town Square Complex, St. Paul, MN; Skidmore, Owings & Merrill, archts—Feb. 1983, p. 126 • World Financial Center, New York, NY; Cesar Pelli & Associates, archts—Feb. 1983, p. 126.

I

IKOY Architects, archts—Harborview at Kil-Cona Park, Winnipeg, Manitoba, Canada—May 1983, BTS, pp. 102-105 • IKOY Office Building, Winnipeg, Manitoba, Canada—Apr. 1983, pp. 146-149.

Imam, Shafiq, archt—Azem Palace Reconstruction, Damascus, Syria—Sept-2 1983, BTS, p. 74.

Imperial at Brickell, Miami, FL—Arquitectonica, archts—July 1983, BTS, pp. 92-95.

Independence National Historical Park Maintenance Facility, Philadelphia, PA—Mitchell/Giurgola, archts—July 1983, pp. 126-127.

India—Cidade de Goa Resort Hotel, Goa; C.M. Correa, archt—Apr. 1983, pp. 154-159.

Indiana Tower, White Rock Park, Indianapolis, IN—Cesar Pelli & Associates, archts—July 1983, p. 106.

Industrial Buildings—"Blue-collar buildings"—July 1983, pp. 120-127 • Consolidated Edison Customer Service Facility, Bronx, NY; Richard Dattner, archt—July 1983, pp. 124-125 • Independence National Historical Park Maintenance Facility, Philadelphia, PA; Mitchell/Giurgola, archts—July 1983, pp. 126-127 • Wissa Wassef Arts Center, Giza-Cairo, Egypt; Ramses Wissa Wassef, archt—Sept-2 1983, BTS, p. 81.

Ingalls Memorial Hospital, Wyman-Gordon Pavilion, Harvey, IL—Perkins & Will, archts—June 1983, BTS, pp. 98-101.

Interior Facilities Associates, interior dsgnrs—Bankers Trust Company Trading Room, New York, NY—June 1983, pp. 136-137.

Interiors (see also *Offices, Showrooms*)—Dianne B., New York, NY; Voorsanger & Mills Associates, archts—Mar. 1983, pp. 126-127 • Georgetown University, Riggs Memorial Library, Washington, DC; EPR, archts—Sept-1 1983, pp. 134-137 • Harry Winston "Petit Salon," New York, NY; Adam Tihany, archt—Sept-1 1983, pp. 114-115 • Janovic Plaza, New York, NY; Voorsanger & Mills Associates, archts—Mar. 1983, pp. 122-125 • Jessica Gunne Sax Headquarters, San Francisco, CA; Hanns Kainz & Associates, archts—Sept-1 1983, pp. 102-107 • Marriott Residence, Chicago, IL; Krueck & Olsen, archts—Sept-1 1983, pp. 88-95 • New York University Graduate School of Business Library, New York, NY; Voorsanger & Mills Associates, archts—Aug. 1983, BTS, pp. 80-83 • Piano, Barcelona, Spain; Riart/Cortes/Gubern/Ordeig/Perez Sanchez, dsgnrs—Sept-1 1983, pp. 128-

131 • Private Screening Room, New York, NY; G. Michael Mostoller, archt—Sept-1 1983, pp. 100-101 • Rosen Apartment, New York, NY; Bray-Schaible Design, dsgnrs—Sept-1 1983, pp. 150-151 • "Round Table: The education of architects in interior design"—Sept-1 1983, pp. 35-47 • Springer Building, Galveston, TX; Taft Architects, archts—Sept-1 1983, p. 144-145 • Tsao Apartment, New York, NY; Calvin Tsao with Zack McKown, dsgnrs—Sept-1 1983, pp. 152-159 • Venturi, Scott Brown Residence, Philadelphia, PA; Venturi, Rauch and Scott Brown, archts—Sept-1 1983, pp. 108-113.

Interspace Incorporated with The Architects Collaborative, archts—CIGNA Office Building, Bloomfield, CT—Apr. 1983, pp. 160-167.

Islamic Architecture—see *Aga Khan Award for Architecture*

Isozaki, Arata, archt—"The recent work of Arata Isozaki: Part I," by Martin Filler—Oct. 1983, pp. 125-137 • Tsukuba Civic Center/Dai Ichi Hotel, Tsukuba New Town, Ibaragi Prefecture, Japan; by Martin Filler—Oct. 1983, pp. 126-137.

Israel—Van Leer Residence, Jerusalem; Moshe Safdie and Associates, archts—Nov. 1983, pp. 124-127.

Italy—Aviano Elementary School, Aviano; Mitchell/Giurgola, archts—Aug. 1983, pp. 112-113 • Center for the Elderly, Buia; Renato Severino, archt—Aug. 1983, pp. 108-109 • Maniago Technical High School, Maniago; Mitchell/Giurgola, archts—Aug. 1983, pp. 114-115 • Pordenone School of Architecture, Spilimbergo; Renato Severino, archt—Aug. 1983, pp. 110-111 • San Pietro al Natisono Student Housing, San Pietro al Natisono; Mitchell/Giurgola, archts—Aug. 1983, pp. 116-117.

J

Jacobs, Stephen B. & Associates, archts—Five 1880s Warehouse Renovations, New York, NY—Oct. 1983, BTS, pp. 92-95.

Jacobsen, Hugh Newell, archt—University of Michigan Alumni Center, Ann Arbor, MI—Apr. 1983, pp. 130-137.

Jaffe Associates, acoustics, Hardy Holzman Pfeiffer Associates archts—Hult Center for the Performing Arts [Acoustics], Eugene, OR—May 1983, pp. 130-133.

Jails—see *Penal Institutions*

Janovic Plaza, New York, NY—Voorsanger & Mills Associates, archts—Mar. 1983, pp. 122-125.

Japan—Keio University Library, Tokyo; Maki and Associates, archts; by Joan E. Goody—May 1983, pp. 106-113 • Tsukuba Civic Center/Dai Ichi Hotel, Tsukuba New Town, Ibaragi Prefecture; Arata Isozaki & Associates, archts, by Martin Filler—Oct. 1983, pp. 126-137.

Jessica Gunne Sax Headquarters, San Francisco, CA—Hanns Kainz & Associates, archts—Sept-1 1983, pp. 102-107.
Johnson, Philip, archt—Johnson Study/Library, New Canaan, CT—July 1983, pp. 114-119.
Jung/Brannen Associates, archts—One Post Office Square, Boston, MA—July 1983, pp. 128-135.

K

Kainz, Hanns & Associates, archts—Jessica Gunne Sax Headquarters, San Francisco, CA—Sept-1 1983, pp. 102-107.
Karson, Michael, and Michael Silchuck—“Coping with insured liability claims”—June 1983, pp. 37, 53, 78.
Keio University Library, Tokyo, Japan—Maki and Associates, archts; by Joan E. Goody—May 1983, pp. 106-113.
Kiene & Bradley Design Group with Skidmore, Owings & Merrill, archts—Menninger Foundation, Topeka, KS—June 1983, BTS, pp. 86-93.
King Abdul-Aziz International Airport, Hajj Terminal, Jeddah, Saudi Arabia—Skidmore, Owings & Merrill, archts—Sept-2 1983, BTS, pp. 84-85.
Kohn Pederson Fox Associates, archts—Amoco Building, Denver, CO—Feb. 1983, p. 125 • Rocky Mountain Energy Company Headquarters, Bloomfield, CO—Feb. 1983, p. 127 and Apr. 1983, BTS, pp. 126-129.
Kornblut, Arthur, Esq.—“How responsible are you for shop drawings?”—May 1983, p. 37 • “Mostly good news on statute-of-limitations rulings”—Aug. 1983, p. 33 • “Proprietary specifications and the antitrust law”—Feb. 1983, p. 41 • “Who is responsible for construction safety?”—Oct. 1983, p. 41.
Krueck & Olsen, archts—Marriott Residence, Chicago, IL—Sept-1 1983, pp. 88-95.
Kupper, Eugene, archt—Grakal, Stampler, Blackman [Law] Offices, Santa Monica, CA—Sept-1 1983, pp. 122-127.

L

Landahl Group, archts—Barclays Bank International Offices, Chicago, IL—Sept-1 1983, pp. 146-149.
Londor Associates with Penney & Bernstein, archts—Londor Associates Offices, New York, NY—Jan. 1983, BTS, pp. 92-94.
Le Corbusier—“An architecture drawn from life [a review of *Le Corbusier Sketchbooks*],” by Kurt W. Forster—Apr. 1983, pp. 142-145.
Legal Perspectives (see also *Building Codes, Office Management*)—“Arbitrations to be speeded”—May 1983, p. 35 • “Architects and engineers getting part of what they want on antitrust laws,” by Peter Hoffman and Daniel B. Moskowitz—Feb. 1983, p. 35 • “How responsible are you for shop drawings?” by Arthur Kornblut, Esq.—May 1983, p. 37 • “Mostly good news on statute-of-limitations rulings,” by Arthur Kornblut, Esq.—Aug. 1983, p. 33 •

“Proprietary specifications and the antitrust law,” by Arthur Kornblut, Esq.—Feb. 1983, p. 41 • “Who is responsible for construction safety?” by Arthur Kornblut, Esq.—Oct. 1983, p. 41.

LePatner, Barry B., Esq.—“The profitable professional: Protecting ownership and use of plans”—Jan. 1983, pp. 47, 49 • “The profitable professional: Target your goals and priorities”—June 1983, pp. 47, 57.

Libraries—Anchorage Headquarters Library Competition Entry, Anchorage, AK; Gunnar Birkerts & Associates, archts—Mar. 1983, pp. 108-109 • Billerica Public Library, Billerica, MA; James C. Hopkins Associates, archts—Aug. 1983, BTS, pp. 84-85 • “Designing tomorrow’s libraries”—Aug. 1983, BTS, p. 91 • Georgetown University, Riggs Memorial Library, Washington, DC; EPR, archts—Sept-1 1983, pp. 134-137 • Keio University Library, Tokyo, Japan; Maki and Associates, archts; by Joan E. Goody—May 1983, pp. 106-113 • Middletown Public Library, Middletown, OH; Lorenz & Williams, archts—July 1983, pp. 138-139 • New York Public Library Renovation, New York, NY; Giorgio Cavaglieri with Davis, Brody & Associates, archts—Aug. 1983, BTS, pp. 74-79 • New York University Graduate School of Business Library, New York, NY; Voorsanger & Mills Associates, archts—Aug. 1983, BTS, pp. 80-83 • Unionville Library, Town of Markham, Ontario, Canada; Barton Myers Associates, archts—Feb. 1983, pp. 96-97 • Yale University, Seeley G. Mudd Library, New Haven, CT; Roth and Moore, archts—Aug. 1983, BTS, pp. 86-90.

Lighting (see also *Daylighting*)—CIGNA Office Building, Bloomfield, CT; The Architects Collaborative with Interspace Incorporated, archts—Apr. 1983, pp. 160-167 • “Lighting those visual display terminals—in the cause of the operator’s comfort,” by Sylvan R. Shemitz, with Gladys Walker—Oct. 1983, pp. 138-143 • Steelcase Headquarters Building, Grand Rapids, MI; WBDC, archts, with Steelcase dsgrns—Nov. 1983, pp. 132-135.

L.L. Evan Restaurant, Warwick, RI—Warren Platner Associates, archts—Apr. 1983, pp. 138-141.

Loftis Bell Downing & Partners, archts—Marion Corporation, Daphne, AL—Apr. 1983, BTS, pp. 122-125.

Logan, Donn, archt—“Educating architects at Berkeley,” by Marcy Li Wang—Feb. 1983, pp. 112-113.

Long Wharf Marriott Hotel, Boston, MA—Cossuta & Associates, archts—Mar. 1983, pp. 100-107.

Lorenz & Williams, archts—Middletown Public Library, Middletown, OH—July 1983, pp. 138-139.

Louisiana World Exposition 1984 Amphitheater, New Orleans, LA—Frank Gehry, archt—June 1983, pp. 124-125.

Loyola Law School, Los Angeles, CA—Frank Gehry, archt—June 1983, pp. 120-121.

Lyndon, Donlyn, archt—“Educating architects at Berkeley,” by Marcy Li Wang—Feb. 1983, pp. 114-115.

Lynn, Dorothy A.—“Some useful tips on how to be effective and confident in presentations”—Mar. 1983, p. 47.

M

Maki and Associates, archts—Keio University Library, Tokyo, Japan; by Joan E. Goody—May 1983, pp. 106-113.

Malaysia—Tanjong Jara Beach Hotel and Rantau Abang Visitors’ Center, Kuala Trengganu; Wihsenand, Allison, Tong and Goo, archts—Sept-2 1983, BTS, p. 75.

Mali—Great Mosque of Niono, Niono; Lassine Minta, master mason—Sept-2 1983, BTS, pp. 72-73.

Manhattan House of Detention for Men, New York, NY—The Gruzen partnership, archts—Mar. 1983, BTS, pp. 86-87.

Maniago Technical High School, Maniago, Italy—Mitchell/Giurgola, archts—Aug. 1983, pp. 114-115.

Marion Corporation, Daphne, AL—Loftis Bell Downing & Partners, archts—Apr. 1983, BTS, pp. 122-125.

Marketing—“Are renderings still important in our electronic age?”—Oct. 1983, pp. 45-51 • “The market-segmentation approach,” by Kenneth Rohde and Michael Noble—Aug. 1983, pp. 37-45 • “Some useful tips on how to be effective and confident in presentations,” by Dorothy A. Lynn—Mar. 1983, p. 47 • “What are the aggressive firms doing to get their share of design work? An important [1982] survey report...”, by Ernest Burden—June 1983, pp. 43, 45, 55.

Marketplaces—see *Shopping Centers & Marketplaces*

Marriott Residence, Chicago, IL—Krueck & Olsen, archts—Sept-1 1983, pp. 88-95.

MBA/Architects & Planners, archts—Custom House Renovation [with James Stewart Polshek & Partners], New York, NY—Oct. 1983, BTS, pp. 92-95 • Merck, Sharp & Dohme Divisional Headquarters, West Point, PA—Sept-2 1983, pp. 102-107.

McFarlane, Robert E., and Robert J. Nissen—“Two-way teleconferencing: room design comes first”—Sept-2 1983, pp. 112-119.

McKown, Zack with Calvin Tsao, dsgrns—Tsao Apartment, New York, NY—Sept-1 1983, pp. 152-159.

Meade, Bradley—“Using CAD effectively with reprographics”—Sept-2 1983, pp. 29, 31 • “Using reprographics effectively with CAD”—Oct. 1983, pp. 37, 39.

Medical Facilities (see also *Hospitals*)—Cleveland Clinic, Cleveland, OH; Cesar Pelli & Associates, archts—July 1983, p. 107 • “For

health-care providers too: an outlook of stressful—but hopeful—change,” by Michael Bobrow and Julia Thomas—June 1983, BTS, pp. 102-103 • Menninger Foundation, Topeka, KS; Skidmore, Owings & Merrill with Kiene & Bradley Design Group, archts—June 1983, BTS, pp. 86-93.

Mental Health Facilities—see *Hospitals, Medical Facilities*

Meola Studio and Apartment, New York, NY—Gillis Associates, archts—Nov. 1983, pp. 120-123.

Merck, Sharp & Dohme Divisional Headquarters, West Point, PA—MBA/Architects & Planners, archts—Sept-2 1983, pp. 102-107.

Mere House, Flint Hill, VA—Bump-Zoid, archts—Mid-May 1983, pp. 90-93.

Middletown Public Library, Middletown, OH—Lorenz & Williams, archts—July 1983, pp. 138-139.

Mileaf, Harry—“Round Table on computers in architecture” [with Walter Wagner]—May 1983, pp. 39-53 • “Where is your firm to get software?”—Jan. 1983, pp. 41, 43 • “The wonderland of computer language”—Apr. 1983, pp. 51, 73.

Miller, Nory—“Big business preservation”—Oct. 1983, BTS, pp. 91-109.

Milliken, Barry—“The personal challenge of CAD”—Mar. 1983, pp. 41, 43, 45.

Minta, Lassine, master mason—Great Mosque of Niono, Niono, Mali—Sept-2 1983, BTS, pp. 72-73.

Mitchell/Giurgola, archts—Aviano Elementary School, Aviano, Italy—Aug. 1983, pp. 112-113 • Independence National Historical Park Maintenance Facility, Philadelphia, PA—July 1983, pp. 126-127 • “Made in Friuli” [with Renato Severino]—Aug. 1983, pp. 104-117 • Maniago Technical High School, Maniago, Italy—Aug. 1983, pp. 114-115 • San Pietro al Natisone Student Housing, San Pietro al Natisone, Italy—Aug. 1983, pp. 116-117.

Mixed-use Buildings—Five 1880s Warehouse Renovations, New York, NY; Stephen B. Jacobs & Associates, archts—Oct. 1983, BTS, pp. 92-95 • Meola Studio and Apartment, New York, NY; Gillis Associates, archts—Nov. 1983, pp. 120-123 • Royal Conservatory of Music, Toronto, Ontario, Canada; Barton Myers Associates, archts—Feb. 1983, pp. 100-101 • Springer Building, Galveston, TX; Taft Architects, archts—Sept-1 1983, p. 144-145 and Oct. 1983, BTS, pp. 102-105.

MLTW/Turnbull Associates, archts—Davidow House, Kauai, HI—Mid-May 1983, pp. 112-115.

Morawetz, John—“Economics: The rise and fall of the high-rise”—June 1983, pp. 39, 41.

Morgan and Lindstrom, archts—Private Residence, San Juan Islands, WA—Mid-May 1983, pp. 128-133.

Morgan, William Architects, archts—District Court of Appeal, First District, Tallahassee, FL—Jan. 1983, pp. 116-121.

Mostoller, G. Michael, archt—Private Screening Room, New York, NY—Sept-1 1983, pp. 100-101.

Motels—see *Hotels & Motels*

Municipal Museum Abteiberg Monchengladbach, Monchengladbach, West Germany—Hans Hollein, archt—Feb. 1983, BTS, pp. 79-91.
 Murphy/Jahn, archts—Area 2 Police Center [with the Chicago Dept. of Public Works], Chicago, IL—Jan. 1983, pp. 105-107 • Argonne National Laboratories Program Support Facility, Joliet, IL—Jan. 1983, pp. 108-111 • First Source Center, South Bend, IN—Jan. 1983, pp. 112-115 • "Toward romantic high-tech"—Jan. 1983, pp. 102-115.
 Museums—California Aerospace Museum, Exposition Park, Los Angeles, CA; Frank Gehry, archt—June 1983, pp. 122-123 • Municipal Museum Abteiberg Monchengladbach, Monchengladbach, West Germany; Hans Hollein, archt—Feb. 1983, BTS, pp. 79-91 • Portland Museum of Art, Charles Shipman Payson Building, Portland, ME; I.M. Pei & Partners, archts—Nov. 1983, pp. 108-119 • Seagram Museum and Archives, Waterloo, Ontario, Canada; Barton Myers Associates, archts—Feb. 1983, pp. 92-95.
 Myers, Barton Associates, archts—"Barton Myers proposes warm, lively indoor towns"—Feb. 1983, pp. 92-101 • Exposition Multicultural Center, Los Angeles, CA—Feb. 1983, pp. 98-99 • Royal Conservatory of Music, Toronto, Ontario, Canada—Feb. 1983, pp. 100-101 • Seagram Museum and Archives, Waterloo, Ontario, Canada—Feb. 1983, pp. 92-95 • Unionville Library, Town of Markham, Ontario, Canada—Feb. 1983, pp. 96-97.

N

NEOCON—"It's convention time... Is it also time to think of conventions as a place to think?", by Walter F. Wagner, Jr.—May 1983, p. 9.
 New York Landmarks Conservancy, preservationists—"Big business preservation—New York: Wheeling and dealing," by Nory Miller—Oct. 1983, BTS, pp. 92-95.
 New York Public Library Renovation, New York, NY - Giorgio Cavaglieri with Davis, Brody & Associates, archts—Aug. 1983, BTS, pp. 74-79.
 New York University Graduate School of Business Library, New York, NY - Voorsanger & Mills Associates, archts—Aug. 1983, BTS, pp. 80-83.
 Newman, Herbert S. Associates, archts - Northeastern University, Kariotis Hall, Boston, MA—Nov. 1983, BTS, pp. 104-107.
 Nissen, Robert J., and Robert E. McFarlane - "Two-way teleconferencing: room design comes first"—Sept-2 1983, pp. 112-119.
 Noble, Michael, and Kenneth Rohde - "The market-segmentation approach"—Aug. 1983, pp. 37-45.
 North Shore Congregation Israel, Glencoe, IL - Hammond Beebe and Babka, archts—June 1983, pp. 104-113.

Northeastern University, Kariotis Hall, Boston, MA—Herbert S. Newman Associates, archts—Nov. 1983, BTS, pp. 104-107.
 Norton House, Venice, CA—Frank Gehry, archt—June 1983, p. 117.

O

Office Buildings, High-rise (see also *Office Buildings, Low-rise; Mixed-use Buildings*)—Amoco Building, Denver, CO; Kohn Pederson Fox Associates, archts—Feb. 1983, p. 125 • Anaconda Tower, Denver, CO; Skidmore, Owings & Merrill, archts—Feb. 1983, p. 125 • Bank of America Plaza [Biltmore Hotel renovation], New York, NY; Environmental Architect P.C., archts—Jan. 1983, pp. 128-133 • "Economics: The rise and fall of the high-rise," by John Morawetz—June 1983, pp. 39, 41 • Farm Credit Banks of Spokane Building, Spokane, WA; Walker McGough Foltz Lyerla, archts—Feb. 1983, pp. 128-129 • First Source Center, South Bend, IN; Murphy/Jahn, archts—Jan. 1983, pp. 112-115 • "Energy conservation in office buildings—a maturing art," Flack + Kurtz, engns—Feb. 1983, pp. 124-131 • One Champion Plaza, Stamford, CT; Ulrich Franzen & Associates, archts—Feb. 1983, pp. 102-107 • One Post Office Square, Boston, MA; Jung/Brannen Associates, archts—July 1983, pp. 128-135 • Pin Oak Commercial Center, Houston, TX; Cesar Pelli & Associates, archts—July 1983, p. 109 • St. Paul Town Square Complex, St. Paul, MN; Skidmore, Owings & Merrill, archts—Feb. 1983, p. 126 • 10 & 30 South Wacker Drive, Chicago, IL; Fujikawa Johnson & Assoc., archts, with Alfred Benesch & Co., engns—Nov. 1983, pp. 136-139 • World Financial Center, New York, NY; Cesar Pelli & Associates, archts—Feb. 1983, p. 126 and July 1983, pp. 110-113.
 Office Buildings, Low-rise (see also *Office Buildings, High-rise; Mixed-use Buildings*)—Argonne National Laboratories Program Support Facility, Joliet, IL; Murphy/Jahn, archts—Jan. 1983, pp. 108-111 • Beneficial Center, Peapack/Gladstone, NJ; The Hillier Group, archts—Apr. 1983, BTS, pp. 114-117 • Consolidated Edison Customer Service Facility, Bronx, NY; Richard Dattner, archt—July 1983, pp. 124-125 • "Energy conservation in office buildings—a maturing art," Flack + Kurtz, engns—Feb. 1983, pp. 124-131 • Enerplex, South Building, Princeton, NJ; Skidmore, Owings & Merrill, archts—Feb. 1983, pp. 130-131 • Harbor Plaza, Stamford, CT; Yankee Planning/Do H. Chung, archts; by Mary Woods—Sept-2 1983, pp. 108-111 • Harlequin Plaza, Englewood, CO; Gensler & Associates, archts—Apr. 1983, BTS, pp. 118-121 • Herman Miller Roswell Facility, Roswell, GA; Heery & Heery, archts—Jan. 1983, pp. 122-127 • IKOY Office Building, Winnipeg, Manitoba, Canada; IKOY Architects, archts—Apr. 1983, pp. 146-149 • Marion Corporation, Daphne, AL; Loftis Bell Downing & Partners, archts—Apr. 1983, BTS, pp. 122-125 • Merck, Sharp & Dohme

Divisional Headquarters, West Point, PA; MBA/Architects & Planners, archts—Sept-2 1983, pp. 102-107 • Philip Morris Operations Center, Richmond, VA; Davis, Brody & Associates, archts—Mar. 1983, pp. 114-121 • Rocky Mountain Energy Company Headquarters, Bloomfield, CO; Kohn Pederson Fox Associates, archts—Feb. 1983, p. 127 and Apr. 1983, BTS, pp. 126-129 • Seattle Garden Center, Seattle, WA; Arne Bystrom, archt—Apr. 1983, pp. 150-151 • Station Square, Commerce Court, and The Freighthouse Shops, Pittsburgh, PA; Pittsburgh History & Landmark Foundation, developers—Oct. 1983, BTS, pp. 96-101 • Union Carbide Corporation World Headquarters, Danbury, CT; Kevin Roche John Dinkeloo Associates, archts—Oct. 1983, pp. 110-117.

Office Management (see also *Computers, Construction Management, Legal Perspectives, and Marketing*)—"AIA seminar yields sophisticated advice on working abroad," by Peter Hoffman—Jan. 1983, p. 33 • "Assessing your liability insurance," by Sara Paretsky and Michael Silchuck—Jan. 1983, pp. 35, 37 • "Calling yourself an interior designer in Connecticut could bring problems"—Oct. 1983, p. 33 • "Coping with insured liability claims," by Michael Silchuck and Michael Karson—June 1983, pp. 37, 53, 78 • "Disability insurance protects you from possible disaster [Part 1]," by John J. Hanlon, Jr.—July 1983, p. 43 • "Disability insurance protects you from possible disaster [Part 2]," by Liane Leach Chapman—Nov. 1983, p. 37 • "Good news for architects—but not engineers," by Herbert Cheshire—Aug. 1983, p. 25 • "Insurance: Reducing your chances of a liability claim," by Michael Silchuck—Aug. 1983, pp. 39, 47 • "Mergers may not work for every firm—but here's why two big ones got together"—Aug. 1983, p. 35 • "On understanding changing marketplaces and changing tactics for getting things built," by Walter F. Wagner, Jr.—Oct. 1983, p. 9 • "Professional development: Seminars on preservation, computers, and business management"—July 1983, p. 37 • "The profitable professional: Protecting ownership and use of plans," by Barry B. LePatner, Esq.—Jan. 1983, pp. 47, 49 • "The profitable professional: Target your goals and priorities," by Barry B. LePatner, Esq.—June 1983, pp. 47, 57 • "PSMA plots new course"—Jan. 1983, p. 33 • "So you want to do business in China?"—Sept-2 1983, p. 33 • "Strategies for survival"—Feb. 1983, pp. 43, 45.

Offices—Anspach Grossman Portugal Offices, New York, NY; Samuel J. De Santo & Associates, archts—Sept-1 1983, pp. 116-119 • Barclays Bank International Offices, Chicago, IL; Landahl Group, archts—Sept-1 1983, pp. 146-149 • Batey & Mack Office, San Francisco, CA; Batey & Mack, archts—Sept-1 1983,

pp. 120-121 • Berkliff Corporation Executive and Sales Offices, New York, NY; Bentley/LaRosa/Salasky, dsgrns—Sept-1 1983, p. 140-143 • CIGNA Office Building, Bloomfield, CT; The Architects Collaborative with Interspace Incorporated, archts—Apr. 1983, pp. 160-167 • Cooper & Company Offices and Studio, New York, NY; John Chimera Architect, archts—Jan. 1983, BTS, pp. 96-97 • Credit du Nord Offices, New York, NY; Rivkin/Weisman, archts—Sept-1 1983, pp. 96-99 • Dubai Bank Limited Offices, New York, NY; Rivkin/Weisman, archts—Jan. 1983, BTS, pp. 86-91 • Grakal, Stamler, Blackman [Law] Offices, Santa Monica, CA; Eugene Kupper, archt—Sept-1 1983, pp. 122-127 • Himmel, Bonner Architects Offices, Chicago, IL; Himmel, Bonner, archts—Apr. 1983, pp. 152-153 • Landor Associates Offices, New York, NY; Landor Associates with Penney & Bernstein, archts—Jan. 1983, BTS, pp. 92-94 • Reynolds Tobacco Company Building [lobby restoration], Winston-Salem, NC; Croxton Collaborative, archts—Jan. 1983, BTS, pp. 98-101 • Steelcase Headquarters Building, Grand Rapids, MI; WBDC, archts, with Steelcase dsgrns—Nov. 1983, pp. 132-135 • Swid Powell Design Offices, New York, NY; D'Urso Design, dsgrn—Sept-1 1983, pp. 132-133 • "Two-way teleconferencing: room design comes first," by Robert E. McFarlane and Robert J. Nissen—Sept-2 1983, pp. 112-119.
 One Champion Plaza, Stamford, CT—Ulrich Franzen & Associates, archts—Feb. 1983, pp. 102-107.
 One Post Office Square, Boston, MA—July 1983, pp. 128-135.
 Owings, Nathaniel Alexander—"A nearly-80-year-old architect talks about what seems important now," by Walter F. Wagner, Jr.—July 1983, p. 9.

P

Pakistan—Tomb of Shah Rukn-i Alam Restoration, Multan; Muhammad Wali Ullah Khan, archt—Sept-2 1983, BTS, p. 74.
 Pape, Lloyd with Ben Templin & Associates, archts—Austin Junior High School, Galveston, TX—July 1983, pp. 140-141.
 Paretsky, Sara, and Michael Silchuck—"Assessing your liability insurance"—Jan. 1983, pp. 35, 37.
 Parking, Garage—Pier 76 Garage, New York, NY; Goodkind & O'dea, archts—July 1983, pp. 142-143.
 Parks (see also *Recreation Facilities*)—Charlton Park, Bronx, NY; Leland R. Weintraub, landscape archt—May 1983, BTS, p. 101 • Independence National Historical Park Maintenance Facility, Philadelphia, PA; Mitchell/Giurgola, archts—July 1983, pp. 126-127 • Tiffany Plaza, Bronx, NY; Leland R. Weintraub, landscape archt—May 1983, BTS, pp. 98-99 • Washington Market Park, New York, NY; Leland R. Weintraub, landscape archt—May 1983, BTS, p. 100.
 Pavilions—see *Exposition Buildings*
 Pei, I.M. & Partners, archts—Portland Museum of Art, Charles Shipman

- Payson Building, Portland, ME—Nov. 1983, pp. 108-119.
- Pelli, Cesar & Associates, archts—Cleveland Clinic, Cleveland, OH—July 1983, p. 107 • Indiana Tower, White Rock Park, Indianapolis, IN—July 1983, p. 106 • “New layers of meaning: Works in progress by Cesar Pelli”—July 1983, pp. 104-113 • Pin Oak Commercial Center, Houston, TX—July 1983, p. 109 • Rice University, Herring Hall, Houston, TX—July 1983, p. 108 • World Financial Center, New York, NY—Feb. 1983, p. 126 and July 1983, pp. 110-113.
- Penal Institutions—Contra Costa County Detention Facility, Martinez, CA; Correction Facility Architects, archts—Mar. 1983, BTS, pp. 82-85 • Gallatin County Detention Center, Bozeman, MT; BGS Architects with RS Architects, archts—Mar. 1983, BTS, pp. 96-98 • Manhattan House of Detention for Men, New York, NY; The Gruzen Partnership, archts—Mar. 1983, BTS, pp. 86-87 • Spokane County Correction/Detention Facility, Spokane, WA; Walker McGough Foltz Lyerla, archts—Mar. 1983, BTS, pp. 92-93 • “Strategies for corrections programming,” by Kenneth Ricci—Mar. 1983, BTS, p. 99 • Trenton State Prison Rehabilitation, Trenton, NJ; The Grad Partnership with The Gruzen Partnership, archts—Mar. 1983, BTS, pp. 88-91 • Washington State Medium Security Prison, Monroe, WA; Hellmuth, Obata & Kassabaum with TRA Associates, archts—Mar. 1983, BTS, pp. 94-95.
- Penney & Bernstein with Landor Associates, archts—Landor Associates Offices, New York, NY—Jan. 1983, BTS, pp. 92-94.
- Pensacola Place, Chicago, IL—Tigerman Fugman McCurry, archts—July 1983, BTS, pp. 98-99.
- Performing Arts Buildings—Brooklyn Bridge Anchorage Restoration, New York, NY; Smotrich & Platt, archts—Aug. 1983, pp. 124-127 • Church of St. Ann and the Holy Trinity, Brooklyn Heights, NY; Hardy Holzman Pfeiffer Associates, archts—Oct. 1983, BTS, pp. 92-95 • Exposition Multicultural Center, Los Angeles, CA; Barton Myers Associates, archts—Feb. 1983, pp. 98-99 • Hult Center for the Performing Arts, Eugene, OR; Hardy Holzman Pfeiffer Associates, archts, Jaffe Associates, acoustics—May 1983, pp. 120-133 • Louisiana World Exposition 1984 Amphitheater, New Orleans, LA; Frank Gehry, archt—June 1983, pp. 124-125 • Royal Conservatory of Music, Toronto, Ontario, Canada; Barton Myers Associates, archts—Feb. 1983, pp. 100-101 • Saenger Theater, Pensacola, FL; Holabird & Root, archts—Aug. 1983, pp. 92-95 • Tsukuba Civic Center/Dai Ichi Hotel, Tsukuba New Town, Ibaragi Prefecture, Japan; Arata Isozaki & Associates, archts; by Martin Filler—Oct. 1983, pp. 126-137.
- Perkins & Will, archts—Ingalls Memorial Hospital, Wyman-Gordon Pavilion, Harvey, IL—June 1983, BTS, pp. 98-101.
- Perkins, Bradford—“Construction management: A useful service—if you know how to work with it”—Mar. 1983, pp. 35, 37 • “Form & Purpose, by Moshe Safdie” [review]—Jan. 1983, pp. 77-79.
- Philip Morris Operations Center, Richmond, VA—Davis, Brody & Associates, archts—Mar. 1983, pp. 114-121.
- Phillips Exeter Academy, Frederick R. Mayer Art Center, Exeter, NH—Amsler Hagenah MacLean, archts—Nov. 1983, BTS, pp. 96-101.
- Piano, Barcelona, Spain—Riart/Cortes/Gubern/Ordeig/Perez Sanchez, dsgrs—Sept-1 1983, pp. 128-131.
- Pickering House, Laurel, MI—Anthony Ames, archt—Aug. 1983, pp. 98-99.
- Pier 76 Garage, New York, NY—Goodkind & O’dea, archts—July 1983, pp. 142-143.
- Pin Oak Commercial Center, Houston, TX—Cesar Pelli & Associates, archts—July 1983, p. 109.
- Pittman, Jon H., and John C. Dill—“The single-user workstation—A new concept that promises to benefit the design profession”—Aug. 1983, pp. 27, 29, 31.
- Pittsburgh History & Landmark Foundation, preservationists—“Big business preservation—Pittsburgh: Virtuoso preservationists,” by Nory Miller—Oct. 1983, BTS, pp. 96-101.
- Planning (see also *Urban Design*)—“Still planning with the poor: community design centers keep up the good works,” by Paul M. Sachner—June 1983, pp. 126-131.
- Platner, Warren Associates, archts—L.L. Evan Restaurant, Warwick, RI—Apr. 1983, pp. 138-141.
- Polshek, James Stewart & Partners, archts—Custom House Renovation [with MBA/Architects & Planners], New York, NY—Oct. 1983, BTS, pp. 92-95.
- Pordenone School of Architecture, Spilimbergo, Italy—Renato Severino, archt—Aug. 1983, pp. 110-111.
- Portland Museum of Art, Charles Shipman Payson Building, Portland, ME—I.M. Pei & Partners, archts—Nov. 1983, pp. 108-119.
- Potatoe Hill Residential District Renovations, Winchester, VA—Preservation of Historic Winchester, preservationists—Oct. 1983, BTS, pp. 106-109.
- Preservation (see also *Adaptive Use, Additions, Renovations & Restorations*)—“Administration gives some mild support for preservation with jobs bill”—May 1983, p. 35 • “Big business preservation—Galveston: In-town turnaround [Galveston Historic Foundation],” by Nory Miller—Oct. 1983, BTS, pp. 102-105 • “Big business preservation—New York: Wheeling and dealing [New York Landmarks Conservancy],” by Nory Miller—Oct. 1983, BTS, pp. 92-95 • “Big business preservation—Pittsburgh: Virtuoso preservationists [Pittsburgh History & Landmark Foundation],” by Nory Miller—Oct. 1983, BTS, pp. 96-101 • “Big business preservation—Winchester, VA.: No-frills preservation [Preservation of Historic Winchester],” by Nory Miller—Oct. 1983, BTS, pp. 106-109 • “Churches challenge landmark designation”—Sept-2 1983, p. 25 • “Design commissions from the new jobs bill?,” by Peter Hoffman—June 1983, p. 35 • “Louisiana legislation sets new preservation models”—Dec. 1983, p. 15 • “Professional development: Seminars on preservation, computers, and business management”—July 1983, p. 37 • “Rehabilitation credits in jeopardy from retroactive bill,” by Peter Hoffman—Sept-2 1983, p. 27 • “Setback for preservation tax incentives”—Nov. 1983, p. 35.
- Preservation of Historic Winchester, preservationists—“Big business preservation—Winchester, VA: No-frills preservation,” by Nory Miller—Oct. 1983, BTS, pp. 106-109.
- Princeton University, Gordon Wu Hall, Princeton, NJ—Venturi, Rauch and Scott Brown, archts—Sept-2 1983, pp. 86-97.
- Prisons—see *Penal Institutions*
- Products (see also *Specifications*)—“Innovative customer guarantees announced by Manville”—Mar. 1983, p. 33 • “NIBS fund drive showing success”—Dec. 1983, p. 15 • “Product Reports 1984: The manufacturer as part of the team”—Dec. 1983, pp. 39-216 • “A step backward in building research,” by Peter Hoffman—Apr. 1983, pp. 35, 71.
- Public Buildings (see also *Exposition Buildings, Fire Stations, Libraries, Parks, Penal Institutions, and Recreation Facilities*)—Area 2 Police Center, Chicago, IL; Murphy/Jahn with the Chicago Dept. of Public Works, archts—Jan. 1983, pp. 105-107 • Azem Palace Reconstruction, Damascus, Syria; Shafiq Imam, archt—Sept-2 1983, BTS, p. 74 • District Court of Appeal, First District, Tallahassee, FL; William Morgan Architects, archts—Jan. 1983, pp. 116-121 • Tsukuba Civic Center/Dai Ichi Hotel, Tsukuba New Town, Ibaragi Prefecture, Japan; Arata Isozaki & Associates, archts; by Martin Filler—Oct. 1983, pp. 126-137.
- R**
- Raikes House, Roxbury, CT—Redroof Design, archts—Oct. 1983, pp. 118-124.
- Recreation Facilities (see also *Parks*)—Deer Valley Resort, Park City, UT; Esherick Homsey Dodge and Davis, archts—May 1983, BTS, pp. 92-97 • Harborview at Kil-Cona Park, Winnipeg, Manitoba, Canada; IKOY Architects, archts—May 1983, BTS, pp. 102-105 • Indiana Tower, White Rock Park, Indianapolis, IN; Cesar Pelli & Associates, archts—July 1983, p. 106.
- Redroof Design, archts—Raikes House, Roxbury, CT—Oct. 1983, pp. 118-124.
- Reiach and Hall with G.M.W. Partnership, archts—St. Enoch Square, Glasgow, Scotland—June 1983, pp. 138-143.
- Reinhard House, Chicago, IL—Chrysalis Corp., archts—Mid-May 1983, pp. 94-97.
- Religious Buildings—“Churches challenge landmark designation”—Sept-2 1983, p. 25 • Great Mosque of Niono, Niono, Mali; Lassine Minta, master mason—Sept-2 1983, BTS, pp. 72-73 • North Shore Congregation Israel, Glencoe, IL; Hammond Beebe and Babka, archts—June 1983, pp. 104-113 • Sherefudin’s White Mosque, Visoko, Yugoslavia; Zlatko Ugljen, archt—Sept-2 1983, BTS, pp. 68-71 • US Corps of Engineers Chapel & Educational Facility, Camp Wildflecken, Germany; Gunnar Birkerts & Associates with Giffels Associates, archts—Mar. 1983, p. 110.
- Renovations & Restorations (see also *Adaptive Use, Additions, Preservation*)—Austin Junior High School, Galveston, TX; Ben Templin & Associates with Lloyd Pape, archts—July 1983, pp. 140-141 • Azem Palace Reconstruction, Damascus, Syria; Shafiq Imam, archt—Sept-2 1983, BTS, p. 74 • “Commercial rehab shows big upsurge”—Apr. 1983, p. 35 • Covington Restaurant, Armonk, NY; Mark Cigolle, archt—June 1983, pp. 132-135 • Custom House Renovation, New York, NY; James Stewart Polshek & Partners with MBA/Architects, archts—Oct. 1983, BTS, pp. 92-95 • Darb Qirmiz Revitalization, Cairo, Egypt; Philip Speiser, archt—Sept-2 1983, BTS, p. 75 • Georgetown University, Riggs Memorial Library, Washington, DC; EPR, archts—Sept-1 1983, pp. 134-137 • Gully, The, New England; Timothy D. Smith & Associates, archts—Feb. 1983, pp. 118-123 • Henderson House Restoration/Fair Oaks Cottages Remodeling, Selma, AL; James Seay with Nicholas H. Holmes, archts—May 1983, pp. 114-119 • Manhattan House of Detention for Men, New York, NY; The Gruzen Partnership, archts—Mar. 1983, BTS, pp. 86-87 • New York Public Library Renovation, New York, NY; Giorgio Cavaglieri with Davis, Brody & Associates, archts—Aug. 1983, BTS, pp. 74-79 • Phillips Exeter Academy, Frederick R. Mayer Art Center, Exeter, NH; Amsler Hagenah MacLean, archts—Nov. 1983, BS, pp. 96-101 • Pier 76 Garage, New York, NY; Goodkind & O’dea, archts—July 1983, pp. 142-143 • Potatoe Hill Residential District Renovations, Winchester, VA; Preservation of Historic Winchester, preservationists—Oct. 1983, BTS, pp. 106-109 • Reinhard House, Chicago, IL; Chrysalis Corp., archts—Mid-May 1983, pp. 94-97 • Reynolds Tobacco Company Building [lobby restoration], Winston-Salem, NC; Croxton Collaborative, archts—Jan. 1983, BTS, pp. 98-101 • “Round Table: Conserving energy in the rehabilitated or retrofitted building”—Dec. 1983, pp. 30-37 • Royal Conservatory of Music, Toronto, Ontario, Canada; Barton Myers Associates, archts—Feb. 1983, pp. 100-101 • Saenger Theater, Pensacola, FL; Holabird & Root, archts—Aug. 1983, pp. 92-95 • Tomb of Shah Rukn-i Alam Restoration, Multan, Pakistan; Muhammad Wali Ullah Khan, archt—Sept-2 1983, BTS, p. 74 • Trenton State

- Prison Rehabilitation, Trenton, NJ; The Grad Partnership with The Gruzen Partnership, archts—Mar. 1983, BTS, pp. 88-91 • Van Leer Residence, Jerusalem, Israel; Moshe Safdie and Associates, archts—Nov. 1983, pp. 124-127.
- Research Buildings—Philip Morris Operations Center, Richmond, VA; Davis, Brody & Associates, archts—Mar. 1983, pp. 114-121.
- Residence Andalous, Sousse, Tunisia—Serge Santelli, archt—Sept-2, 1983, BTS, pp. 76-79.
- Restaurants—Covington Restaurant, Armonk, NY; Mark Cigolle, archt—June 1983, pp. 132-135 • L.L. Evan Restaurant, Warwick, RI; Warren Platner Associates, archts—Apr. 1983, pp. 138-141 • Station Square, Commerce Court, and The Freight-house Shops, Pittsburgh, PA; Pittsburgh History & Landmark Foundation, developers—Oct. 1983, BTS, pp. 96-101.
- Reynolds Tobacco Company Building [lobby restoration], Winston-Salem, NC—Croton Collaborative, archts—Jan. 1983, BTS, pp. 98-101.
- Riart/Cortes/Gubern/Ordeig/Perez Sanchez, dsgnrs—Piano, Barcelona, Spain—Sept-1 1983, pp. 128-131.
- Ricci, Kenneth—“Strategies for corrections programming”—Mar. 1983, BTS, p. 99.
- Rice University, Houston, TX—Herring Hall; Cesar Pelli & Associates, archts—July 1983, p. 108 • Seeley G. Mudd Computer Science Library, Charles Tapley Associates, archts—Nov. 1983, BTS, pp. 90-95.
- Riley, Jefferson B. of Moore Grover Harper, archt—Elliott House, PA—Mid-May 1983, pp. 106-111.
- Rivkin/Weisman, archts—Credit du Nord Offices, New York, NY—Sept-1 1983, pp. 96-99 • Dubai Bank Limited Offices, New York, NY—Jan. 1983, BTS, pp. 86-91 • Private Residence, Fire Island, NY—Mid-May 1983, pp. 80-83.
- Roche, Kevin, John Dinkeloo Associates, archts—Union Carbide Corporation World Headquarters, Danbury, CT—Oct. 1983, pp. 110-117.
- Rocky Mountain Energy Company Headquarters, Bloomfield, CO—Kohn Pederson Fox Associates, archts—Feb. 1983, p. 127 and Apr. 1983, BTS, pp. 126-129.
- Roebbing, John A., archt—Brooklyn Bridge, New York, NY; by Horst Berger—Aug. 1983, pp. 118-123.
- Rohde, Kenneth, and Michael Noble—“The market-segmentation approach”—Aug. 1983, pp. 37-45.
- Roofing—“Roofing in transition: Implications of a new technology”—May 1983, pp. 134-141 • “Roofs that work: when everybody observes the rules”—July 1983, pp. 136-143.
- Rosen Apartment, New York, NY—Bray-Schaible Design, dsgnrs—Sept-1 1983, pp. 150-151.
- Roth and Moore, archts—Yale University, Seeley G. Mudd Library, New Haven, CT—Aug. 1983, BTS, pp. 86-90.
- Round Table Discussions—“The architect's role is built-for-sale housing”—Mid-May 1983, pp. 33-47 • “Conserving energy in the rehabilitated or retrofitted building”—Dec. 1983, pp. 30-37 • “The education of architects in interior design”—Sept-1 1983, pp. 35-47 • “Round Table on computers in architecture”—May 1983, pp. 39-53.
- Royal Conservatory of Music, Toronto, Ontario, Canada—Barton Myers Associates, archts—Feb. 1983, pp. 100-101.
- RS Architects with BSG Architects, archts—Gallatin County Detention Center, Bozeman, MT—Mar. 1983, BTS, pp. 96-98.
- Russell Sage College, Albany Campus Center, Albany, NY—Architectural Resources Cambridge, archts—Nov. 1983, BTS, pp. 102-103.
- S**
- Sachner, Paul M.—“Still planning with the poor: community design centers keep up the good works”—June 1983, pp. 126-131.
- Saenger Theater, Pensacola, FL—Holabird & Root, archts—Aug. 1983, pp. 92-95.
- Safdie, Moshe—*Form & Purpose* [book reviewed]; by Bradford Perkins—Jan. 1983, pp. 77, 79.
- Safdie, Moshe and Associates, archts—Private Residence, AL—Nov. 1983, pp. 128-131 • “Purpose and place”—Nov. 1983, pp. 124-131 • Van Leer Residence, Jerusalem, Israel—Nov. 1983, pp. 124-127.
- St. Enoch Square, Glasgow, Scotland—G.M.W. Partnership with Reiach and Hall, archts—June 1983, pp. 138-143.
- St. Paul Town Square Complex, St. Paul, MN—Skidmore, Owings & Merrill, archts—Feb. 1983, p. 126.
- San Pietro al Natisone Student Housing, San Pietro al Natisone, Italy—Mitchell/Giurgola, archts—Aug. 1983, pp. 116-117.
- Sandy & Babcock, archts—Windswept, Kiawah Island, SC—July 1983, BTS, pp. 88-91.
- Santelli, Serge, archt—Residence Andalous, Sousse, Tunisia—Sept-2 1983, BTS, pp. 76-79.
- Sasaki Associates, archts—Clafin Park, Newtonville, MA—July 1983, BTS, pp. 100-103.
- Saudi Arabia—King Abdul-Aziz International Airport, Hajj Terminal, Jeddah; Skidmore, Owings & Merrill, archts—Sept-2 1983, BTS, pp. 84-85.
- Schools—Austin Junior High School, Galveston, TX; Ben Templin & Associates with Lloyd Pape, archts—July 1983, pp. 140-141 • Aviano Elementary School, Aviano, Italy; Mitchell/Giurgola, archts—Aug. 1983, pp. 112-113 • Maniago Technical High School, Maniago, Italy; Mitchell/Giurgola, archts—Aug. 1983, pp. 114-115 • Pordenone School of Architecture, Spilimbergo, Italy; Renato Severino, archt—Aug. 1983, pp. 110-111 • Royal Conservatory of Music, Toronto, Ontario, Canada; Barton Myers Associates, archts—Feb. 1983, pp. 100-101 • San Pietro al Natisone Student Housing, San Pietro al Natisone, Italy; Mitchell/Giurgola, archts—Aug. 1983, pp. 116-117 • Wissa Wassef Arts Center, Giza-Cairo, Egypt; Ramses Wissa Wassef, archt—Sept-2 1983, BTS, p. 81.
- Scotland—St. Enoch Square, Glasgow, G.M.W. Partnership with Reiach and Hall, archts—June 1983, pp. 138-143.
- Seagram Museum and Archives, Waterloo, Ontario, Canada—Barton Myers Associates, archts—Feb. 1983, pp. 92-95.
- Seattle Garden Center, Seattle, WA—Arne Bystrom, archt—Apr. 1983, pp. 150-151.
- Seay, James with Nicholas H. Holmes, archts—Henderson House Restoration/Fair Oaks Cottages Remodeling, Selma, AL—May 1983, pp. 114-119.
- Severino, Renato, archt—Center for the Elderly, Buia, Italy—Aug. 1983, pp. 108-109 • “Made in Friuli” [with Mitchell/Giurgola]—Aug. 1983, pp. 104-117 • Pordenone School of Architecture, Spilimbergo, Italy—Aug. 1983, pp. 110-111.
- Shapiro, Lindsay Stamm—“A minimalist architecture of allusion: current projects of Frank Gehry”—June 1983, pp. 114-125.
- Shemitz, Sylvan R., with Gladys Walker—“Lighting those visual display terminals—in the cause of the operator's comfort”—Oct. 1983, pp. 138-143.
- Sherefudin's White Mosque, Visoko, Yugoslavia—Zlatko Ugljen, archt—Sept-2 1983, BTS, pp. 68-71.
- Shopping Centers & Marketplaces (see also *Stores & Shops*)—Station Square, Commerce Court, and The Freight-house Shops, Pittsburgh, PA; Pittsburgh History & Landmark Foundation, developers—Oct. 1983, BTS, pp. 96-101.
- Showrooms—Artemide Show Room, Los Angeles, CA; Vignelli Associates, dsgnrs—Sept-1 1983, p. 138-138 • Berkkliff Corporation Executive and Sales Offices, New York, NY; Bentley/LaRosa/Salasky, dsgnrs—Sept-1 1983, p. 140-143 • Jessica Gunne Sax Headquarters, San Francisco, CA; Hanns Kainz & Associates, archts—Sept-1 1983, pp. 102-107.
- Silchuck, Michael—“Assessing your liability insurance” [with Sara Par-etsky]—Jan. 1983, pp. 35, 37 • “Coping with insured liability claims” [with Michael Karson]—June 1983, pp. 37, 53, 78 • “Insurance: Reducing your chances of a liability claim”—Aug. 1983, pp. 39, 47.
- Skidmore, Owings & Merrill, archts—Anaconda Tower, Denver, CO—Feb. 1983, p. 125 • Enerplex, South Building, Princeton, NJ—Feb. 1983, pp. 130-131 • King Abdul-Aziz International Airport, Hajj Terminal, Jeddah, Saudi Arabia—Sept-2 1983, BTS, pp. 84-85 • Menninger Foundation [with Kiene & Bradley Design Group], Topeka, KS—June 1983, BTS, pp. 86-93 • St. Paul Town Square Complex, St. Paul, MN—Feb. 1983, p. 126.
- Smith House, Los Angeles, CA—Frank Gehry, archt—June 1983, pp. 118-119.
- Smith, Timothy D. & Associates, archts—Gully, The, New England—Feb. 1983, pp. 118-123.
- Smotrich & Platt, archts—Brooklyn Bridge Anchorage Restoration, New York, NY—Aug. 1983, pp. 124-127.
- Solar Energy (see also *Daylighting, Energy Conservation*)—Tenenbaum House, Lexington, SC; Alan Buchsbaum & Stephen Tilly, archts—Mid-May 1983, pp. 120-123.
- Solomon, Barbara Stauffacher, archt—“Green architecture”—Sept-2 1983, pp. 98-101.
- Solomon, Daniel, archt—“Educating architects at Berkeley,” by Marcy Li Wang—Feb. 1983, pp. 116-117.
- Spain—Piano, Barcelona; Riart/Cortes/Gubern/Ordeig/Perez Sanchez, dsgnrs—Sept-1 1983, pp. 128-131.
- Specifications (see also *Building Codes, Products*)—“Proprietary specifications and the antitrust law,” by Arthur Kornblut, Esq.—Feb. 1983, p. 41.
- Speiser, Philip, archt—Darb Qirmiz Revitalization, Cairo, Egypt—Sept-2 1983, BTS, p. 75.
- Spiller Houses, Venice, CA—Frank O. Gehry & Associates, archts—Mid-May 1983, pp. 84-89.
- Spokane County Correction/Detention Facility, Spokane, WA—Walker McGough Foltz Lyerla, archts—Mar. 1983, BTS, pp. 92-93.
- Sports Facilities—see *Recreation Facilities*
- Springer Building, Galveston, TX—Taft Architects, archts—Sept-1 1983, p. 144-145 and Oct. 1983, BTS, pp. 102-105.
- Station Square, Commerce Court, and The Freight-house Shops, Pittsburgh, PA—Pittsburgh History & Landmark Foundation, developers—Oct. 1983, BTS, pp. 96-101.
- Steelcase Headquarters Building, Grand Rapids, MI—WBDC, archts, with Steelcase dsgnrs—Nov. 1983, pp. 132-135.
- Stoker, Douglas F., and Nicholas Weingarten—“Computers: The real opportunities are in design”—Dec. 1983, pp. 19, 21.
- Stores & Shops (see also *Shopping Centers & Marketplaces*)—Dianne B., New York, NY; Voorsanger & Mills Associates, archts—Mar. 1983, pp. 126-127 • Harry Winston “Petit Salon,” New York, NY; Adam Tihany, archt—Sept-1 1983, pp. 114-115 • Janovic Plaza, New York, NY; Voorsanger & Mills Associates, archts—Mar. 1983, pp. 122-125 • Piano, Barcelona, Spain; Riart/Cortes/Gubern/Ordeig/Perez Sanchez, dsgnrs—Sept-1 1983, pp. 128-131.
- Strasman, Jim Architects, archts—Wandich House, Peterborough, Ontario, Canada—Mid-May 1983, pp. 138-143.
- Structural, Concrete—“The secret to quality in architectural concrete: knowing construction,” by Reginald Hough—Mar. 1983, pp. 128-135.
- Suid Powell Design Offices, New York, NY—D'Urso Design, dsgnr—Sept-1 1983, pp. 132-133.
- Synagogues—see *Religious Buildings*
- Syria—Azem Palace Reconstruction, Damascus; Shafiq Imam, archt—Sept-2 1983, BTS, p. 74.
- T**
- Taft Architects, archts—Springer Building, Galveston, TX—Sept-1 1983, p. 144-145 and Oct. 1983, BTS, pp. 102-105.

- Tanjong Jara Beach Hotel and Rantau Abang Visitors' Center, Kuala Trengganu, Malaysia—Wihensand, Allison, Tong and Goo, archts—Sept-2 1983, BTS, p. 75.
- Tapley, Charles Associates, archts—Rice University, Seeley G. Mudd Computer Science Library, Houston, TX—Nov. 1983, BTS, pp. 90-95.
- Teicholz, Eric—"Can computer-aided drafting be effective and affordable for the small firm?"—Feb. 1983, pp. 37, 39 • "Selecting the right CAD system for your office"—July 1983, pp. 45, 47.
- Templin, Ben & Associates with Lloyd Pape, archts—Austin Junior High School, Galveston, TX—July 1983, pp. 140-141.
- 10 & 30 South Wacker Drive, Chicago, IL—Fujikawa Johnson & Assoc., archts, with Alfred Benesch & Co., engns—Nov. 1983, pp. 136-139.
- Tenenbaum House, Lexington, SC—Alan Buchsbaum & Stephen Tilly, archts—Mid-May 1983, pp. 120-123.
- The Architects Collaborative with Interspace Incorporated, archts—CIGNA Office Building, Bloomfield, CT—Apr. 1983, pp. 160-167.
- Theaters—see *Performing Arts Buildings*
- Thomas, Julia, and Michael Bobrow—"For health-care providers too: an outlook of stressful—but hopeful—change"—June 1983, BTS, pp. 102-103.
- Tiffany Plaza, Bronx, NY—Leland R. Weintraub, landscape archt—May 1983, BTS, pp. 98-99.
- Tigerman Fugman McCurry, archts—Pensacola Place, Chicago, IL—July 1983, BTS, pp. 98-99.
- Tihany, Adam, archt—Harry Winston "Petit Salon," New York, NY—Sept-1 1983, pp. 114-115.
- Tilly, Stephen & Alan Buchsbaum, archts—Tenenbaum House, Lexington, SC—Mid-May 1983, pp. 120-123.
- Tomb of Shah Rukn-i Alam Restoration, Multan, Pakistan—Muhammad Wali Ullah Khan, archt—Sept-2 1983, BTS, p. 74.
- Town-house Renovation, Boston, MA—Graham Gund Associates, archts—Mid-May 1983, pp. 134-137.
- TRA Associates with Hellmuth, Obata & Kassabaum, archts—Washington State Medium Security Prison, Monroe, WA—Mar. 1983, BTS, pp. 94-95.
- Transportation—Brooklyn Bridge, New York, NY; John A. Roebling, archt; by Horst Berger—Aug. 1983, pp. 118-123.
- Trenton State Prison Rehabilitation, Trenton, NJ—The Grad Partnership with The Gruzen Partnership, archts—Mar. 1983, BTS, pp. 88-91.
- Tsao, Calvin with Zack McKown, dsgrs—Tsao Apartment, New York, NY—Sept-1 1983, pp. 152-159.
- Tsukuba Civic Center/Dai Ichi Hotel, Tsukuba New Town, Ibaragi Prefecture, Japan—Arata Isozaki & Associates, archts; by Martin Filler—Oct. 1983, pp. 126-137.
- Tunisia—Hafsia Quarter, Medina of Tunis; Wassim bin Mahmoud with Arno Heinz, archts—Sept-2 1983, BTS, pp. 80-81 • Residence Andalous, Sousse; Serge Santelli, archt—Sept-2 1983, BTS, pp. 76-79.
- Turkey—Cakirhan Residence, Akyaka Village; Nail Cakirhan, dsgrn—Sept-2 1983, BTS pp. 82-83.
- U**
- Ugljen, Zlatko, archt—Sherefudin's White Mosque, Visoko, Yugoslavia—Sept-2 1983, BTS, pp. 68-71.
- Underground Buildings—see *Earth-sheltered Buildings*
- Union Carbide Corporation World Headquarters, Danbury, CT—Kevin Roche John Dinkeloo Associates, archts—Oct. 1983, pp. 110-117.
- Unionville Library, Town of Markham, Ontario, Canada—Barton Myers Associates, archts—Feb. 1983, pp. 96-97.
- US Corps of Engineers Chapel & Educational Facility, Camp Wildflecken, Germany—Gunnar Birkerts & Associates with Giffels Associates, archts—Mar. 1983, p. 110.
- University & College Buildings—Georgetown University, Riggs Memorial Library, Washington, DC; EPR, archts—Sept-1 1983, pp. 134-137 • Keio University Library, Tokyo, Japan; Maki and Associates, archts; by Joan E. Goody—May 1983, pp. 106-113 • Loyola Law School, Los Angeles, CA; Frank Gehry, archt—June 1983, pp. 120-121 • Northeastern University, Kariotis Hall, Boston, MA; Herbert S. Newman Associates, archts—Nov. 1983, BTS, pp. 104-107 • Phillips Exeter Academy, Frederick R. Mayer Art Center, Exeter, NH; Amsler Hagenah MacLean, archts—Nov. 1983, BTS, pp. 96-101 • Princeton University, Gordon Wu Hall, Princeton, NJ; Venturi, Rauch and Scott Brown, archts—Sept-2 1983, pp. 86-97 • Rice University, Herring Hall, Houston, TX; Cesar Pelli & Associates, archts—July 1983, p. 108 • Rice University, Seeley G. Mudd Computer Science Library, Houston, TX; Charles Tapley Associates, archts—Nov. 1983, BTS, pp. 90-95 • Russell Sage College, Albany Campus Center, Albany, NY; Architectural Resources Cambridge, archts—Nov. 1983, BTS, pp. 102-103 • University of Michigan Alumni Center, Ann Arbor, MI; Hugh Newell Jacobsen, archt—Apr. 1983, pp. 130-137 • University of Nebraska, Wick Alumni Center Competition, Lincoln, NE; Gunnar Birkerts & Associates, archts—Mar. 1983, p. 111 • Yale University, Seeley G. Mudd Library, New Haven, CT; Roth and Moore, archts—Aug. 1983, BTS, pp. 86-90.
- University of Michigan Alumni Center, Ann Arbor, MI—Hugh Newell Jacobsen, archt—Apr. 1983, pp. 130-137.
- University of Nebraska, Wick Alumni Center Competition, Lincoln, NE—Gunnar Birkerts & Associates, archts—Mar. 1983, p. 111.
- Urban Design (see also *Planning*)—Hafsia Quarter, Medina of Tunis, Tunisia; Wassim bin Mahmoud with Arno Heinz, archts—Sept-2 1983, BTS, pp. 80-81 • Pin Oak Commercial Center, Houston, TX; Cesar Pelli & Associates, archts—July 1983, p. 109 • "Theme speeches: The role of architecture for the nation, the city and the individual"—July 1983, pp. 39, 52.
- V**
- Van Leer Residence, Jerusalem, Israel—Moshe Safdie and Associates, archts—Nov. 1983, pp. 124-127.
- Venturi, Rauch and Scott Brown, archts—Princeton University, Gordon Wu Hall, Princeton, NJ—Sept-2 1983, pp. 86-97 • Venturi, Scott Brown Residence, Philadelphia, PA—Sept-1 1983, pp. 108-113.
- Vernacular Architecture—Great Mosque of Niono, Niono, Mali; Lassine Minta, master mason—Sept-2 1983, BTS, pp. 72-73.
- Veronda Associates, archts—Private Residence, New Buffalo, MI—Mid-May 1983, pp. 74-79.
- Vignelli Associates, dsgrns—Artemide Show Room, Los Angeles, CA—Sept-1 1983, p. 138-139.
- Villa Augusta, Augusta, GA—Anthony Ames, archt—Aug. 1983, p. 100.
- Villa Barr, Northville, MI—Booth/Hansen & Associates, archts—Mid-May 1983, pp. 116-119.
- Villa Chang, Augusta, GA—Anthony Ames, archt—Aug. 1983, p. 97.
- Villa Ginny, Kalamazoo, MI—Gunnar Birkerts & Associates, archts—Mar. 1983, pp. 112-113.
- Voorsanger & Mills Associates, archts—Dianne B., New York, NY—Mar. 1983, pp. 126-127 • Janovic Plaza, New York, NY—Mar. 1983, pp. 122-125 • New York University Graduate School of Business Library, New York, NY—Aug. 1983, BTS, pp. 80-83.
- W**
- Wagner, Walter F., Jr.—"The AIA reaches out nationally—to influence the government and the public"—Mar. 1983, p. 9 • "Architectural education: questions piled upon questions"—Sept-2 1983, p. 9 • "It's convention time, . . . Is it also time to think of conventions as a place to think?"—May 1983, p. 9 • "A little anniversary, a little more evolution"—June 1983, p. 9 • "A nearly-80-year-old architect [Nathaniel Alexander Owings] talks about what seems important now"—July 1983, p. 9 • "On learning how to think about computers in architecture"—Apr. 1983, p. 9 • "On readers, research, and readership"—Feb. 1983, p. 9 • "On Record Houses and Record Interiors, skyscrapers—and design ideas"—Aug. 1983, p. 9 • "On talking to the public about architecture"—Nov. 1983, p. 9 • "On understanding changing market-places and changing tactics for getting things built"—Oct. 1983, p. 9 • "Some thoughts at the start of the New Year"—Jan. 1983, p. 9.
- Wali Ullah Khan, Muhammad, archt—Tomb of Shah Rukn-i Alam Restoration, Multan, Pakistan—Sept-2 1983, BTS, p. 74.
- Walker McGough Foltz Lyerla, archts—Farm Credit Banks of Spokane Building, Spokane, WA—Feb. 1983, pp. 128-129 • Spokane County Correction/Detention Facility, Spokane, WA—Mar. 1983, BTS, pp. 92-93.
- Wandich House, Peterborough, Ontario, Canada—Jim Strasman Architects, archts—Mid-May 1983, pp. 138-143.
- Wang, Marcy Li—"Educating architects at Berkeley"—Feb. 1983, pp. 108-117.
- Warner, Burns, Toan & Lunde, archts—Federal Archives Building, New York, NY—Oct. 1983, BTS, pp. 92-95.
- Washington Market Park, New York, NY—Leland R. Weintraub, landscape archt—May 1983, BTS, p. 100.
- Washington State Medium Security Prison, Monroe, WA—Hellmuth, Obata & Kassabaum with TRA Associates, archts—Mar. 1983, BTS, pp. 94-95.
- WBDC, archts, with Steelcase dsgrns—Steelcase Headquarters Building, Grand Rapids, MI—Nov. 1983, pp. 132-135.
- Weese Seegers Hickey Weese, archts—Chestnut Place Apartments, Chicago, IL—July 1983, BTS, pp. 96-97.
- Weingarten, Nicholas, and Douglas F. Stoker—"Computers: The real opportunities are in design"—Dec. 1983, pp. 19, 21.
- Weintraub, Leland R., landscape archt—Charlton Park, Bronx, NY—May 1983, BTS, p. 101 • Tiffany Plaza, Bronx, NY—May 1983, BTS, pp. 98-99 • Washington Market Park, New York, NY—May 1983, BTS, p. 100.
- West Germany—Municipal Museum Abteiberg Monchengladbach, Monchengladbach; Hans Hollein, archt—Feb. 1983, BTS, pp. 79-91.
- Wharton House, Seal Cove, Mt. Desert Island, ME—Peter Forbes and Associates, archts—Mid-May 1983, pp. 124-127.
- Wihensand, Allison, Tong and Goo, archts—Tanjong Jara Beach Hotel and Rantau Abang Visitors' Center, Kuala Trengganu, Malaysia—Sept-2 1983, BTS, p. 75.
- Windswept, Kiawah Island, SC—Sandy & Babcock, archts—July 1983, BTS, pp. 88-91.
- Wissa Wassef, Ramses, archt—Wissa Wassef Arts Center, Giza-Cairo, Egypt—Sept-2 1983, BTS, p. 81.
- Woods, Mary—Harbor Plaza, Stamford, CT—Sept-2 1983, pp. 108-11.
- World Financial Center, New York, NY—Cesar Pelli & Associates, archts—Feb. 1983, p. 126 and July 1983, pp. 110-113.
- Y**
- Yale University, Seeley G. Mudd Library, New Haven, CT—Roth and Moore, archts—Aug. 1983, BTS, pp. 86-90.
- Yankee Planning/Do H. Chung, archts—Harbor Plaza, Stamford, CT; by Mary Woods—Sept-2 1983, pp. 108-111.
- Yugoslavia—Sherefudin's White Mosque, Visoko; Zlatko Ugljen, archt—Sept-2 1983, BTS, pp. 68-71.

**We'd like to complement
your building . . .** *while we're cooling it.*

**Masonry shell
water
cooling towers by**



Circle 1151 on inquiry card



The Marley Cooling Tower Company 5800 Foxridge Drive Mission, Kansas 66202 (Kansas City, Mo) 913/362-1818 CT-2

KETCHAM BATHROOM EQUIPMENT

An extensive selection of Shower Doors and Shower Enclosures — including Steam-Proof models — that are

- Custom Designed
- Custom Finished: Chrome Plated Brass, Polished or Satin Brass, Gold Plated, Anodized Aluminum or Gold Anodized Aluminum.
- Custom Measured and Installed

The ultimate in quality.
"Clean" trim styling.

A complete line of Bathroom Accessories is also available . . . Medicine Cabinets, Hampers, Shelves, Towel Bars, Paper Holders, Soap and Tumbler Holders, Custom Grab Bars, etc. as well as Public Washroom Equipment, Hotel-Motel Specialties and Janitorial Accessories.

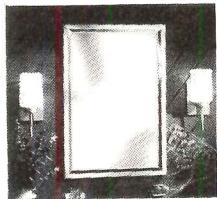
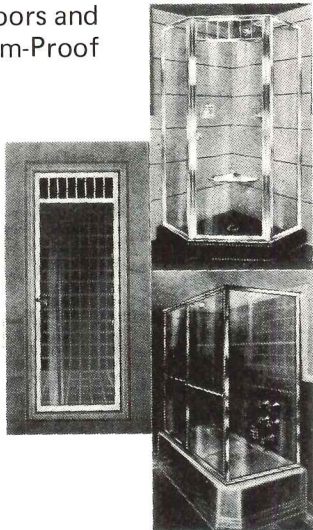

*Custom Size Framed Mirrors and
Medicine Cabinets Our Specialty.*

COMPLETE CATALOG SENT ON REQUEST

G.M. KETCHAM COMPANY INC.
132-06 89th AVENUE, RICHMOND HILL, N.Y. 11418 • 212-847-9316

Circle 1152 on inquiry card

THE (UN)HIDDEN ADVANTAGE

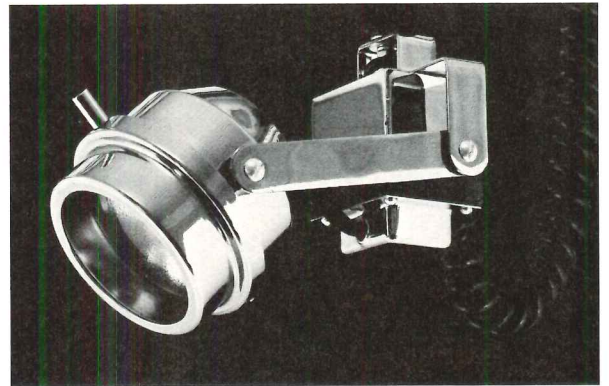

(Shown: LPB-9A)

Because flexibility, precision and ease of installation are pre-requisites for effective lighting design, LINE AND LOW VOLTAGE SURFACE-MOUNT FIXTURES have a clear advantage over recessed.

Directional flexibility without cut-off and a variety of interchangeable beamspreads allow surface mount fixtures to provide a greater range of design possibilities, upon installation and as user requirements change.

Let your local Rep show you the solutions Litelab has to offer for your creative lighting project.

Litelab
corp.

NEW YORK (212) 675-4357
LOS ANGELES (213) 936-6206

Circle 1153 on inquiry card

Go
With A
Winner!



*
Quality You
Can Stand On

*
Economy You
Can Bank On

- *
• Fire Control
• Sound Control
• High Strength
• Lightweight Economy
• Sets in 90 Minutes
• No Shrinkage Cracks
• Eliminates Double-Plating
• No Urea Formaldehyde
• Radiant Heat Systems

GYP-CRETE CORPORATION

900 HAMEL ROAD • P.O. BOX 253 • HAMEL, MINNESOTA 55340 • (612) 478-6072

See Us At Booth #2145, NAHB Show
January 21-24, 1984, Houston, Texas

Engineering the world's most critical barriers:

CLIMATE

To control an atmosphere at a testing facility is difficult enough. To control a variable atmosphere – and preserve the integrity of shifting interrelationships of temperature and humidity, is infinitely more so. That's why the specialized door of choice is so often a Jamison.

With forty years experience in the design and manufacturing of such doors, we bring the same high-level technological and manufacturing expertise to single-swinging personnel doors as we do to large/multi-leaf doors for highly complex experimental testing facilities. For sound, temperature, chemical reaction and atmospheric control, when you can't just allow nature to take its course, we can help you control it.



To learn how, contact us with your requirements. And we'll engineer the solution to *your* most critical barrier.

For Shell Testing chassis lubricants requires controlled atmospheric conditions with ambient temperatures ranging from +125°F to -40°F and humidity from 20% to 100%. To preserve the integrity of these environments, Shell Oil Company installed personnel size and vehicle size freezer doors custom built by Jamison Door Company.

SPECIALY ENGINEERED DOORS BY
JAMISON

Jamison Door Co. P.O. Box 70, Hagerstown, MD 21740
Telephone (301) 733-3100, Telex #292336 JMSN UR

Any other door is second best

Circle 1155 on inquiry card

Advertising index

For detailed data, prefilled catalogs of the manufacturers listed below are available in your 1983 Sweet's Catalog File as follows:

- (G) General Building (green)
- (E) Engineering (brown)
- (I) Industrial Construction and Renovation (blue)
- (L) Light Residential Construction (yellow)
- (D) Interiors (white)

A

AllianceWall Corp., 149 (G)
All-Metal, Inc., 140
Aluminum Association, 24
Amchem Products, Inc., 153
American Express Co., 22
American Gas Association, 5, 26-27
American Plywood Association, 71
American Stair Glide Corporation, 226 (G)
AMP/ASI Division, 218-219 (G-D)
Andersen Corp., 118, 130-131 (G-L)
Architectural Area Lighting, 235
Architectural Complements, 57, 205 (G)
Armor Elevator Co., Inc., Cov III
Armstrong, Cov II-1 (G-I-D-E)
Atlas Door Co., 224 (G-I)
Aurora Steel Products, 164 (G-D)

B

Baumann, Inc., 168 (G)
Bausch & Lomb, 49
Blasing Granite, 16-17
Bonsal Co., W.R., 99 (G)
Bradley Corporation, 207 (G-I-E)
Bruce Engineering, 134 (G)
Buchta USA (G-D)

C

California Glass Bending Corp., 132
Carlisle Syntec Systems, Div.
Carlisle Corp., 86 (G-E-I)
Certainteed, 100 (G-L-E-I)
Certification Board of Colorado, 22Sa
Clearprint Paper Co., 45
CNA Insurance, 48
Cold Spring Granite Co., 233 (G)
Columbia Lighting, Inc., Subs. US Industries, 222
Computervision, 46-47
Conoco Chemicals Co., 135
Crown Metal Mfg. Co., 234

D

Dataprint, 235
DeSoto, Inc., 65
Donn Corporation, 150 (G)
Dover Corp., Elevator Div., 199 (G)
Dryvit Systems, Inc., 87 (G)
Dupont Co., Hypalon, 96
Dupont-Textile Fibers, 154-155 (G-L-D-E-I)

E

Eagle Manufacturing Co., 227
Ebc Co. Mfg. Co., 204 (G-I-E)

F

Firestone Industrial Products, 92 (G-I)
Flax, 229
Flexiwall Systems, 236 (G)
Follansbee Steel Corp., 66 (G)
Fuller, H.B., 102 (G)

G

General Electric Co., Air Conditioner Div., (G-L-I)
General Elevator, 22Eb, 22Ed
General Products Co., 113 (G)
Georgia Marble Co., 61 (G)
Grace & Co., W.R., 84-85, 94-95 (G-I)
Gyp-Crete Corp., 249 (G-L)

H

Hartco, 151 (G-L-D)
Haworth, Inc., 181, 186
Haws Drinking Faucet Co., 206 (G)
Helios Industries, Inc., 194 (G)
Hiebert, Inc., 183
Holmsten Ice Rinks, Inc., 233
Hopes Windows, 125 (G)
Howe Furniture Corporation, 187
Hunter Douglas Architectural Products, 190-191 (G-D)
Huntington/Pacific Ceramics, Inc., 62 (G)
Hydrozo Coatings Co., 225 (G-E)

I

Innocerte Systems, Inc., 161
Inryco, Inc., 80-81, 117 (G-I)
Iron-a-Way, Inc., 224 (G-L)
Iron Craft, Inc., 22Wb
Ispo, Inc., 232 (G-I)

J

Jamison Door Co., 249 (G)
Jason Industrial, Inc., 226 (G)

K

Kawneer Company, Inc., 138-139 (G)
Kenall Mfg., 223
Ketchum, G.M., 248
Keystone Group, 82 (G-E-L)
Kleidon & Associates, Inc., 252
Koch & Lowy, 221
Koh-I-Noor Rapidograph, Inc., 50-51
Kroin, 57, 205 (G)

L

LCN Closers Div. of Schlage Lock Co., 119 (G-E-I)
Levolor Lorentzen, Inc., 193 (G)
Lighting Services, Inc., 232
Lite-Lab Graphics Div., 248

M

Manville Corp., Building Materials Marketing Div., 83, 101 (G-E-I-L)
Marley Cooling Tower, 248
Marvin Windows, 11 to 14 (G)
Mayline Co., Inc., 55
McNichols Company, 235 (G-I)
Milco Div., Wausau Metals, 133 (G)
Miller Redwood, 22Wa
Modernfold Div. of American Standard, Inc., 163 (G)
Monsanto Co., 112 (G-E)
Morrow & Co., William, 223

N

Naturalite, Inc., 109 (G-L-I)
NBM, Inc., 110 (G)
Nenah Foundry Co., 234 (G-E-I)
Neo-Ray Products, Inc., 224
Nixalite Company, 225
Norco Windows, 128

O

ODC, Inc., 189

P

Panasonic, 38
Panelfold, Inc., 165 (G-L)
Pawling Rubber Corp., 227 (G-I-E)
Peerless Electric Co., 217
Pella Rolcreen Co., 136-137 (G-L-D)
Phillips Eindhoven, 14B-14C
Phillips Fiber Corp., 22Sb-2Sc (E)
Pittsburgh Corning Corp., 93, 126-127 (G-I-E)
Plan Hold Corp., 237
PPG Industries, Inc., Fiberglass, 182
PPG Industries, Inc., Glass, 114-115 (G)
Presray Corporation, 236

R

Rambusch, 252
Raynor Mfg. Co., 120 (I)
Robertson Co., H.H., 67, 89 (G-E-I)
Ryther Purdy Lumber Co., 229 (G)

S

Sanders Associates, Inc., 54
Sargent & Co., 111 (G)
Schindler Haughton Elevator Corp., 12 (G)
Schlage Lock Co., 124 (G-L)
Shakertown Corp., 72 (G-L)
Simplex Ceiling Corp., 228 (G-E)
Smith, Elwin G. Div. Cyclops Corp., 64 (G-I)
Southwall Corp., 129 (G)
Southwestern Bell Telephone Co., 22We, 22Cb
Spacesaver Corp., 167 (G)
Stark Ceramics, Inc., 22Ea, 22Ca (G-I-E)
Stevens & Co., Inc., J.P., 91 (G-I)
Sto Industries, 79 (G-I)
Summitville Tiles, Inc., 152 (G)
Sunar/Hauserman, 184
Sun System Prefabricated Solar Greenhouses, 232 (G)
Symmons Industries, Inc., 209

T

Tectum, Inc., 226 (G)
Telautograph Corp., 251
Texas Instruments, 20
Thermal Concepts, Inc., 208
Thiokol Corp., 98 (G)
Thoro System Products, 148 (G)
3M Scanamurals, 166
Tri-Guards, Inc., 234 (G-D-I)
Tubular Specialties Mfg., Inc., 228 (G)
TWA-Cargo, 2

U

United States Gypsum Co., 90, 156 (G-L-I)
United States Steel Corp., 68-69 (G-E-I)
U.S. Elevator Subs. Cubic Corp., 196 (E-I-D)

V

Velux-America, Inc., 121 (L-G)
Ventarama Skylight Corp., 252 (G-L)
Vermont Structural Slate, Co., 229
Vinyl Plastics, Inc., 162 (G)
VIP Enterprises, Inc., 88 (G)

W

Watercolors, Inc., 228
Wausau Metals Corp., 97 (G)
Western Electric Co., 52-53
Wiley & Sons, Inc., John, 18
Won-Door Corp., 122-123 (G)

Z

Zeluck, Inc., J., 22Ec

Sales offices

Main Office

McGraw-Hill, Inc.
1221 Avenue of the Americas
New York, New York 10020

Publisher
Paul B. Beatty (212) 512-4685

Director of National Advertising
Harrington A. Rose (212) 512-2838

Business Manager
Joseph R. Wunk (212) 512-2793

Marketing Services Manager
Camille Padula (212) 512-2858

Classified Advertising
(212) 512-2556

District Offices

Atlanta
4170 Ashford-Dunwoody Road
Atlanta, Georgia 30319
Terry G. Blackwood (404) 252-0626

Boston
607 Boylston St.
Boston, Massachusetts 02116
Louis F. Kutscher (617) 262-1160

Chicago
645 N. Michigan Ave. (312) 751-3771
Chicago, Illinois 60611
Anthony Arnone, (312) 751-3765
Cheryl L. Shores, (312) 751-3705

Edward R. Novak, (312) 658-7133
ER&J Associates, Inc.
P.O. Box 348,
Algonquin, IL 60102

Cleveland
55 Public Square
Cleveland, Ohio 44113
Michael F. Charlton (216) 781-7000

Denver
655 Broadway, Suite 325
Denver, Colorado 80203
John W. Maisel (303) 825-6731

Detroit
4000 Town Center, Suite 770
Southfield, Michigan 48075
John W. Maisel
(313) 352-9760

Houston
1 Northwind Plaza, 7600 W. Tidwell
Houston, Texas 77040
Lockwood Seegar (713) 462-0757

Los Angeles
3333 Wilshire Blvd., South Tower
Los Angeles, California 90010
Stanley J. Kasson (213) 487-1160

New York
1221 Avenue of the Americas
New York, New York 10020
Theodore C. Rzempoluch
(212) 512-3603

Philadelphia
Three Parkway
Philadelphia, Pennsylvania 19102
Blair McClenachan (215) 496-3829

Pittsburgh
6 Gateway Center, Suite 215
Pittsburgh, Pennsylvania 15222
Michael F. Charlton (412) 227-3640

San Francisco
425 Battery Street
San Francisco, California 94111
Stanley J. Kasson (415) 362-4600

Stamford
300 Broad St.
Stamford, Connecticut 06901
Louis F. Kutscher
(203) 359-2860

Overseas Offices

Frankfurt/Main
Elsa-Brandstroem Str. 2
Frankfurt/Main, Germany

London
34 Dover Street
London W.1, England

Milan
Via Baracchini No. 1
Milan, Italy

Paris
17, rue Georges Bizet
75 Paris 16e, France

Tokyo
2-5, 3-chome
Kasumigaseki, Chiyoda-ku
Tokyo, Japan

South America
Empresa Internacional de
Comunicacoes Ltda.
Rua da Consolacao, 222
Conjunto 103
01302 Sao Paulo, S.P. Brasil

DO YOU OFTEN WISH THAT THE SMITH COMPANY WAS THE SMITH & SMITH & SMITH & SMITH COMPANY?



Business people often find themselves doing so many things that just one of them isn't enough.

So hire some of the needy and disadvantaged young people of America this summer to help you.

Hiring them can also help you in another very important way. Because a business that hires economically disadvantaged youth during the summer may get as much as an 85% tax credit on the first \$3,000 of wages you pay them. Write the National Alliance of Business at P.O. Box 7207, Washington D.C. 20044. And support your local summer-jobs-for-youth programs.

You'll be doing something for yourself, for your business, for your community, and for the needy youth of America, too.

LET'S GET ALL OF AMERICA WORKING AGAIN.

A PUBLIC SERVICE
OF THIS PUBLICATION &
THE ADVERTISING COUNCIL **Ad Council**

OMNIFAX®

The facsimile for people with small spaces, modest budgets and great expectations.

Never before have so many sophisticated features been condensed into less than three square feet of lightweight desktop facsimile.

Our new Omnifax G39 digital facsimile delivers documents in seconds without mail delays or the cost of couriers. Best of all, it requires a minimum of operator time and performs

most functions automatically.

Sold and serviced by Telautograph's own facsimile experts nationwide and Canada. For brochure or demonstration, call toll free, ask for operator 553,

800-824-7888



Omnifax is a registered trademark of Telautograph Corp.

Circle 1156 on inquiry card

Skylighting with

VENTARAMA®

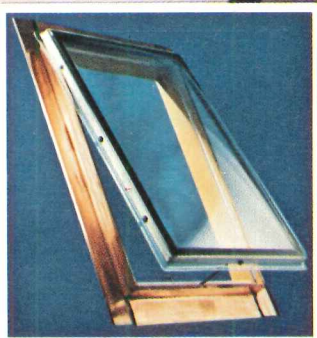

Skylights give interiors an effect which no regular window can offer. Now with Ventarama's new low-profile dome, homes of any style are graciously complemented.

Our extensive experience manufacturing ventilating skylights which can be conveniently opened from any distance has kept us in builders' and architects' favor for over 33 years.

FEATURES:

- All copper flashing
- Thermoformed molded dome — clear, bronze or white
- Manual, pole or motorized operator.



VENTARAMA®

SKYLIGHT CORPORATION

140 Cantiague Rock Road, Hicksville, NY 11801 (516) 931-0202

Circle 1157 on inquiry card

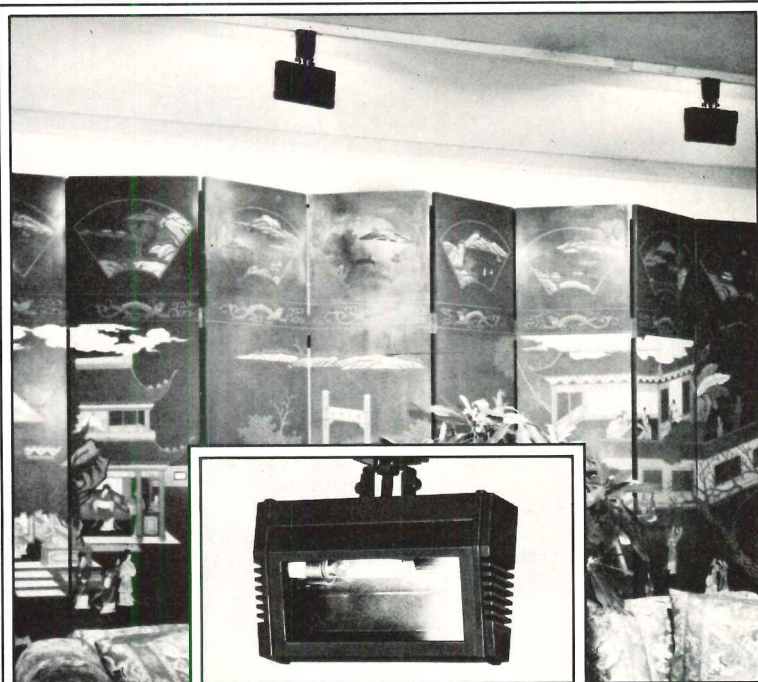

A mini quartz lighting fixture engineered for maximum performance.

LITE-PAK by Rambusch. Attractive, innovative, compact. (App. 4" x 6 1/2"). Wall wash, indirect and accent lighting. 150W TH lamp with reflector provide high utilization and accurate color. Available: track mount, picture arm, pedestal, and canopy mount. Single or multiple use. Die cast and extruded aluminum. UL label. For information: RAMBUSCH, 40 W. 13th St., NY NY 10011. (212) 675-0400.

LITE-PAK by RAMBUSCH

Circle 1158 on inquiry card

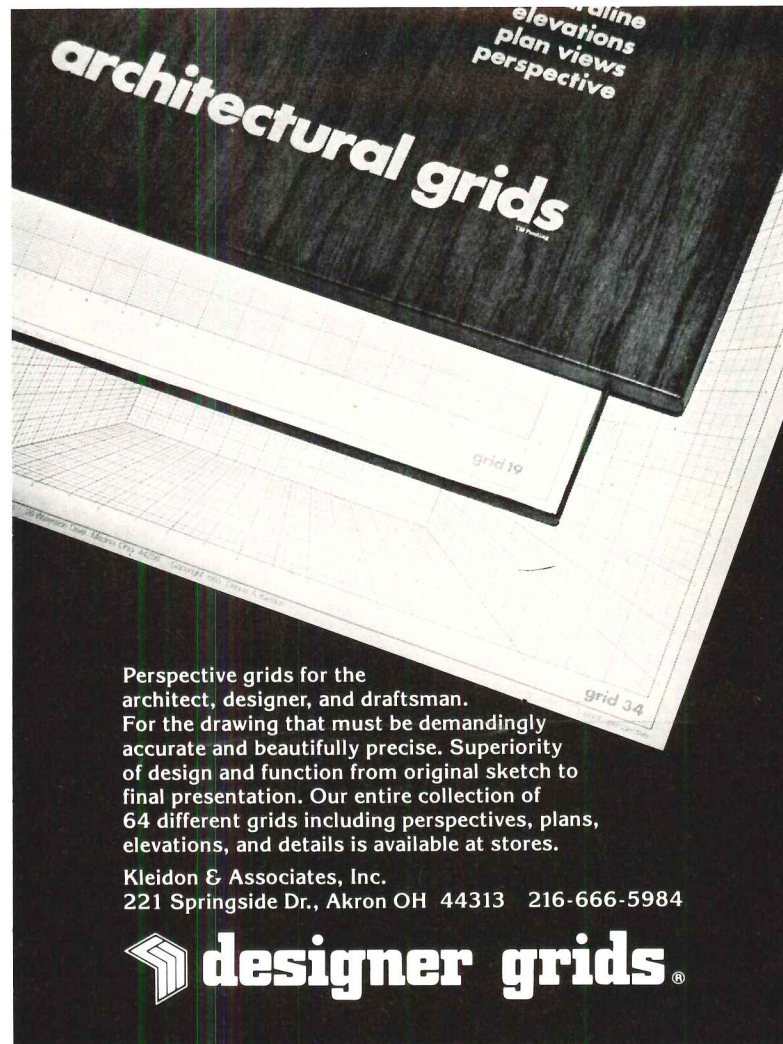

Perspective grids for the architect, designer, and draftsman. For the drawing that must be demandingly accurate and beautifully precise. Superiority of design and function from original sketch to final presentation. Our entire collection of 64 different grids including perspectives, plans, elevations, and details is available at stores.

Kleidon & Associates, Inc.
221 Springside Dr., Akron OH 44313 216-666-5984

designer grids®

Circle 1159 on inquiry card



Buildings. Whether a masterpiece of function or an idea that touches the limits of architectural imagination, Armor salutes the unique blending of art and engineering that goes into today's building design and construction.

We believe it's the finest art of all.

And we're proud to be able to offer an advanced, microprocessor-based elevator system worthy of it — Traffic Master (TMS).

No elevator system in the world is designed to provide greater comfort, smoothness, efficiency or reliability.

The energy-saving characteristics available with TMS are unsurpassed in the industry.

THE FINEST ART OF ALL

And the flexibility of TMS's unique modular concept has made the high performance and advanced technology of computer-controlled elevator systems available to just about any size or type of building — new or modernized.

It's one of the world's finest elevator systems.

And we're honored to showcase TMS in four of our city's finest buildings: (above left to right) the historic Brown Hotel, the 40-story First National Tower, the Commonwealth Building and the 27-story Humana Building.

Armor
ARMOR ELEVATOR COMPANY, INC.

A **KONIG** Company

Circle 1160 on inquiry card

And on the eighth day Schindler re-created the elevator: Miconic.

The ultimate in advanced micro-electronic elevator technology.

Schindler presents Miconic V, an elevator control system so technologically advanced, it redefines the very concept of vertical transportation.

Miconic V offers immediate response and unsurpassed precision in a control so brilliantly conceived it continuously monitors its own performance to adjust to distinct traffic patterns in your building. So sophisticated it senses and compensates for subtle changes in the building itself. With an advanced speed control system providing smoother, faster trips with extremely accurate stops.

All in a "user-friendly" format so simple to use you can easily create your own special elevator service whenever the need arises. And of course Miconic V will talk to passengers, too.

Best of all, Miconic V is designed and engineered with Schindler's legendary tradition for quality, precision and long-term reliability.

Ask your Schindler representative for full details on the Miconic V elevator control system. You'll find that at Schindler there's more to talk about in high-tech elevating than elevators that talk.

Schindler Haughton

ELEVATOR CORPORATION

Toledo, Ohio 43695



The World's Elevator Company

© 1983, Schindler Haughton Elevator Corporation

Circle 1161 on inquiry card

