

ASID AWARD WINNER

## CREATING A NEW PATH IN VINYL

Possibilities™ vinyl sheet flooring features three fabric-like visuals designed to work together. Heathered pattern in 2' width serves as a border or accent for dot or weave visuals.

All available in 10 contract colors.

For more information, call 1 800 233-3823 and ask for Possibilities.



© 2011 Armstrong Ceiling designs copyrighted by Armstrong

# ARMSTRONG CONTRACT INTERIORS

SHOWROOMS  
NEW YORK  
CHICAGO  
LOS ANGELES

**Armstrong**

Circle 2 on inquiry card



ARCHITECTURAL RECORD (Combined with AMERICAN ARCHITECT, and WESTERN ARCHITECT AND ENGINEER) (ISSN0003-858X/92) May 1992, Vol. 180, No. 5, Title © reg. in U.S. Patent Office, copyright ©1992 by McGraw-Hill, Inc. All rights reserved. Indexed in Reader's Guide to Periodical Literature, Art Index, Applied Science and Technology Index, Engineering Index, The Architectural Index, the Architectural Periodicals Index, and the Construction Index.

Every possible effort will be made to return material submitted for possible publication (if accompanied by stamped, addressed envelope), but the editors and the corporation will not be responsible for loss or damage.

*Executive, Editorial, Circulation and Advertising Offices:* 1221 Avenue of the Americas, New York, NY 10020.

*Officers of McGraw-Hill, Inc.:* Chairman, President and Chief Executive Officer: Joseph L. Dionne. Executive Vice President, General Counsel and Secretary: Robert N. Landes. Executive Vice President: Harold W. McGraw III. Senior Vice President, Treasury Operations: Frank D. Penglase. Senior Vice President, Editorial: Ralph R. Schulz.

*Associated Services:* Sweet's Catalog Files (General Building, Engineering, Industrial Construction and Renovation, Light Residential Construction, Interiors), Dodge Reports and Bulletins, Dodge/SCAN Microfilm Systems, Dodge Construction Statistics, Dodge regional construction newspapers (Chicago, Denver, Los Angeles, San Francisco).

Subscription rates are as follows: U.S. Possessions and Canada \$49.00; Europe: \$150.00; Japan: \$160.00 (including Air); all other Foreign: \$125.00. Single copy price for \$7.00; For Foreign: \$10.00. For Subscriber Services: 609/426-7070.

*Change of Address:* Forward changes of address or service letters to Fulfillment Manager, ARCHITECTURAL RECORD, P. O. 566, Hightstown, NJ 08520. Provide both old and new address; include zip code; if possible attach issue address label.

*Guarantee:* Publisher agrees to refund that part of subscription price applying to unfilled part of subscription if service is unsatisfactory. Publisher reserves right to accept or reject any subscription.

*Copyright and Reprinting:* Title © reg. in U.S. Patent Office. Copyright ©1992 by McGraw-Hill, Inc. All rights reserved. Where necessary, permission is granted by the copyright owner for libraries and others registered with the Copyright Clearance Center (CCC) to photocopy any article herein for personal or internal reference use only for the base fee of \$1.50 per copy of the article plus ten cents per page. Payment should be sent directly to the CCC, 27 Congress Street, Salem, MA 01970. Include code with request: ISSN0003-858X/92 (\$1.50 + .10). Written permission must be secured for any other copying. Write Reprint Manager for such permission at address below, or to obtain quotations on bulk orders.

*Subscription List Usage:* Advertisers may use our list to mail information to readers. To be excluded from such mailings, send a request to ARCHITECTURAL RECORD, Mailing List Mgr., P. O. Box 555, Hightstown, NJ 08520.

ARCHITECTURAL RECORD (ISSN0003-858X/92) published monthly by McGraw-Hill, Inc. Second-class postage paid at New York, NY and additional mailing offices. Postage paid at Montreal, Quebec, Canada. Registration Number 9617. Registered for GST as McGraw-Hill, Inc. GST Number R123075673

*Postmaster:* Please send address changes to: ARCHITECTURAL RECORD, Attn: Fulfillment Manager, P. O. Box 566, Hightstown, NJ 08520. THIS ISSUE is published in national and separate editions. Additional pages or separate editions numbered or allowed for as follows: Western Section 61W.

### Recession resistant

Having just read Nancy Levinson's "Working Through the Recession" [Practice News, RECORD, March 1992, pages 34-35], I felt akin to the residents of Johnstown, Pennsylvania, who, after surviving the devastating flood of 1889, were told that "at least they wouldn't have to worry about a drought for a while." Feeble attempts to put a positive spin on the general malaise affecting our profession trivialize the fact that many small firms are just not going to weather the storm. [Statements by] mainstream corporate architects like David Childs of SOM, who stated that "this is a time to take of advantage of" simply underline the profession's old-guard commitment to myopic drawbridge philosophies and lifeboat ethics. Unlike other professions, particularly law and medicine, which have formidable organizations that lobby effectively for reform, architects are told by the venerable AIA (please note this author's non-membership) that one must simply wait for times to get better. As a principal of a small design office who has had to lay off up to 75 percent of my staff and compete with other architects out walking the streets, you could say I've had enough. Until architects as a group commit to a system that discourages cut-rate operations and establishes parameters to both fees and services, the bad times will continue to roll regardless of the direction the economy moves. *Christopher Restak, Architect Santa Monica, California*

The article "Working Through the Recession" spoke, I am sure, to just about all of us. We need to approach each task and responsibility, no matter how small or mundane, with the

same vigor, rigor, and delight that we could bring to the biggest or most challenging project we could ever imagine having. That, to my mind, is being professional. It is having "grace under pressure," and hanging onto control of our situations. That is what I hope we can all do with the megaprojects and with the bathroom renovations.

*Frank Orr, Architect Nashville, Tennessee*

### No commercial potential?

As I read another article about the splendor of new suburbs based on 19th-century America ["Accidental Cities," RECORD, February 1992, pages 94-101], I wondered how many times we would read such things without considering that they basically don't work. They may be good design, but no retailer is going to rent in them because they ignore the reality that even a small retailer needs more accessible parking. This is incompatible with the intimate scale that is much loved these days by all. The press is reaching a point of irresponsibility in its urge to jump on this look-back-with-longing bandwagon, because too many cities will make too many unsuccessful plans. There are some very positive things that can be proposed that will do more for lessening the "deadly grip of outmoded zoning" than the utopian drawings you printed. The real trouble with zoning is that it is a police action rather than a creative concept.

*John L. Field, Architect San Francisco*

### Correction

Credits for the Allied Health Facility at Hostos Community College ["Street Life," RECORD, February 1992, pages 88-93] should have listed Corey C. Delany, Director of Interiors.

### May 1-June 6

"Future Systems," Storefront for Art and Architecture, 97 Kenmare Street, New York City. 212/431-5795.

### May 17-20

"International Contemporary Furniture Fair," Jacob Javits Convention Center, New York City. 212/686-6070.

### June 8-10

"NeoCon '92," The Merchandise Mart, Chicago. 800/677-6278. With "Found Futures," an exhibit sponsored by Formica Corp of eight Chicago architects; USG Interiors, 222 West Hubbard. 212/459-9182.

### June 8-11

"A/E/C Systems '92," annual conference and exhibition, Dallas Convention Center, P. O. Box 310318, Newington, Conn. 06111. 800/451-1196.

### June 15 et al.

"The Building Envelope," Washington, D. C. The first of nine one-day seminars conducted by engineering firm Simpson, Gumpertz and Heger. For other dates and locations: 617/951-2199.

### June 19-22

"Explorations '92: Engaging Society in Vital Ways," annual AIA convention. Hynes Convention Center, Boston. 202/626-7395.

### Through June 21

"John Hejduk: The Lancaster/Hanover Masque," Canadian Center for Architecture, 1920 rue Baile, Montreal, Quebec. 514/939-7000.

### June 26-28

Construction Specifications Institute's 36th annual convention and exhibit. Georgia World Congress Center, the Conference Center, Atlanta. 703/684-0300.

### June-August

Professional Development Architecture Courses, Harvard University Graduate School of Design. Gund Hall, 48 Quincy Street, Cambridge, Mass. 02138. 617/496-4315.

## The Best Customer

A commercial beamed to New York television and radio by a local purveyor of suits, boots, and haberdashery proclaims: "An Educated Consumer Is Our Best Customer." Whatever the truth of this in the retail clothing industry, there's no doubt as to its message to the architect. A client who can recognize good architecture, who participates vigorously but wisely in its development, who recognizes a good plan, and what makes for a viable community, is of infinite value in helping the architect attain goals, perhaps even in restraining excesses at both ends of the stylistic spectrum.

One can in fact make a strong case for historical parallels between the knowledge level of the client and the quality of the architecture. The merchant princes of Venice, the aristocrats of the 18th century, this nation's founding fathers, the rulers of 17th-century Japan, the ranking prelates in the middle ages—all learned about architecture, as it were, at their mother's knee. Without it you could no more call yourself educated than if you lacked French or arithmetic. The results were buildings and surroundings of surpassing quality and consistency. The elitism often charged to architects comes perhaps as much from practitioners' doubt in their clients' ability to contribute to the dialog as from any innate arrogance.

It's therefore good to be able to report advances in making architectural literacy (or "environmental education," as it is now less euphoniously but more accurately known) an intrinsic part of every student's education. For example:

- A program sponsored by the Newhouse Architecture Foundation has for the past nine years introduced Chicago public school students to architecture and related fields and helped talented students into professional careers. A competition comprises modelmaking and rendering. This year's subjects are buildings by Hammond Beeby and Babka, Kohn Pedersen Fox, Perkins & Will, and Decker and Kemp.
- In New York, the local AIA chapter, working with the city's public and some independent schools and the Cooper-Hewitt Museum, has under way a program called "Using Architecture in the Classroom: Buildings, Maps and Neighborhoods" that puts on weekend lectures and workshops for selected teachers. The workshops consist of urban walks, drawing and mapping, and help them uncover ways to see the city through new eyes. Next, teachers pair with architects to bring the experience into the classroom.
- The American Architectural Foundation (AAF) operates a *Learning by Design* program. It helps schoolteachers "develop an enhanced perception of their surroundings and to translate this into practical activities for their students." AAF has just published its 1992 *Pocket Guide to Architectural Learning*, and a host of other practical materials. For example, a handy 8-page pamphlet, "Why Do Buildings Stand Up?" shows how students can use common materials such as paper, bricks, and even their own bodies to see what holds a building up. Another uses simple techniques to explain such concepts as space, shape, pattern, and rhythm.

Here are the clients of the future, the selection panels, the review board members, the politicians. They should understand what they are buying. So make a start. Contact AAF's Alan Sandler at (202) 626-7500 and ask him for the information kit and pocket guide. Contact your local school board and help start a program. Tap into AIA's environmental education regional network. An engaged client brings out the best in the architect. It's a worthy labor. *Stephen A. Kliment*

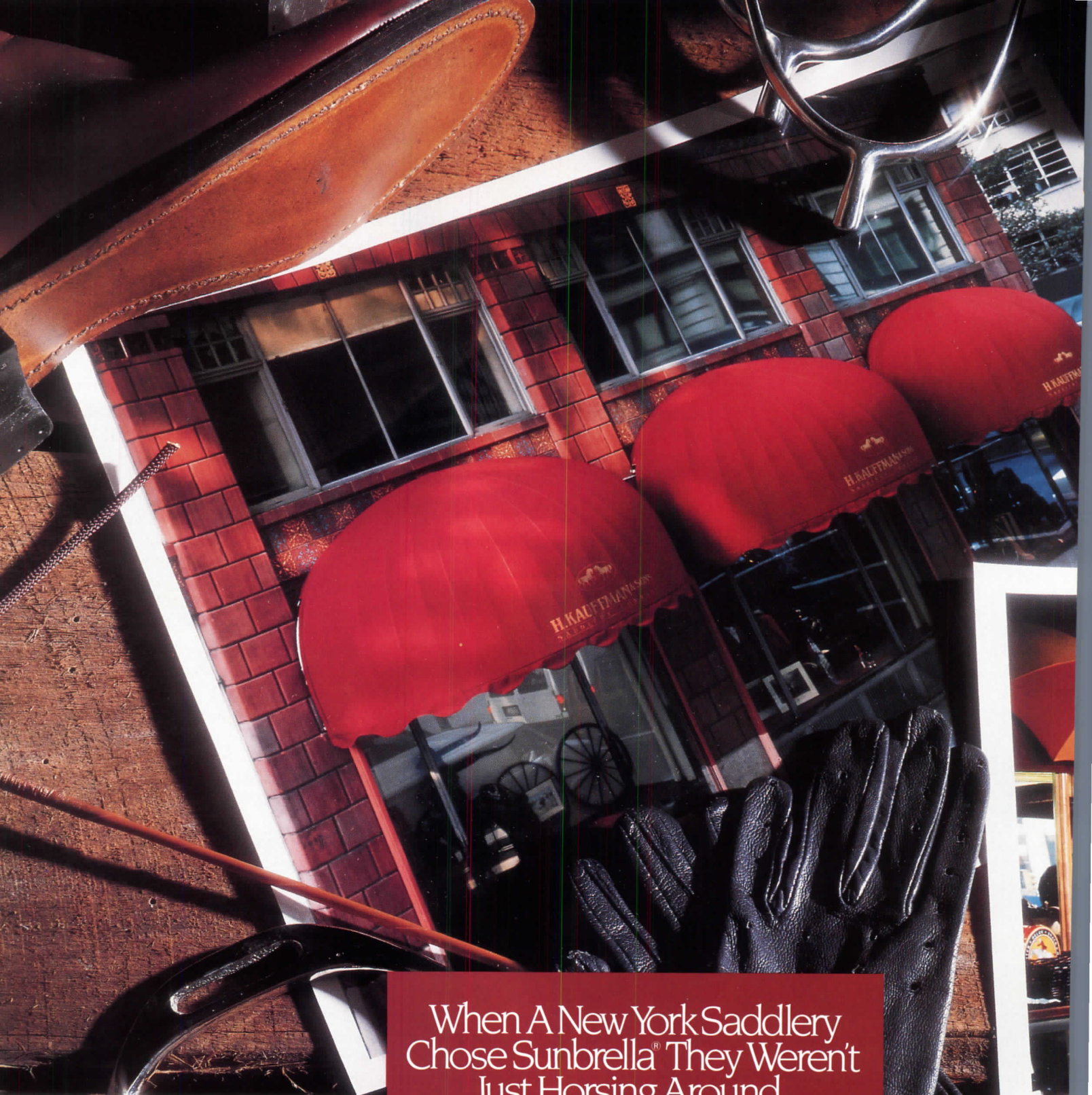

## When A New York Saddlery Chose Sunbrella® They Weren't Just Horsing Around.

Not just any fabric would do

for H. Kauffman & S

Saddlery Company. They needed something that was versatile, beautiful and durable. Sunbrella solution-dyed acrylic fabric and Sunbrella Firesist® fabric are all those things.

The versatility of our fabric is evident all over the store. Inside and out creative uses of the fabric abound: in the beautiful awnings that grace the outside, in the canopies hanging over the showroom, in the door and window treatments, in the many accent pieces.

The beauty of Sunbrella shines through in every Sunbrella fabric we offer. Regular Sunbrella is available in over 90 colors and styles.

Designer: Jane Victor Associates, New York, Fabricator: ABC Awning, New York, Location Photography: © 1991 Norman McGrath, Studio Photography: Gerin Choiniere

## Chicago

### Alvaro Siza Wins 1992 Pritzker Prize



Teresa Siza

The 1992 Pritzker Prize for Architecture has been awarded to Portuguese architect Alvaro Siza, whose work is well known in Europe but relatively unfamiliar in the U. S. Siza received the \$100,000 award from Hyatt Foundation president Jay A. Pritzker in a recent ceremony at the Harold Washington Library in Chicago. In honoring Siza for his 40-year practice in Porto, Portugal, the jury—J. Carter Brown, Giovanni Agnelli, Ada Louise Huxtable, Ricardo Legorreta, Toshio Nakamura, and Lord Rothschild—celebrated the “subtle mastery underlying what appear to be natural creations.” The panel noted the consistent freshness of his design, in work from a 1966 pair of ocean-side swimming pools to low-cost housing such as the 1,200-unit Malagueira complex in Evora, Portugal (sketch and photo below), designed in 1977 and still expanding. ■

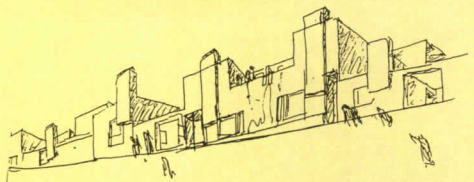

## New York City

### Style and Substance in Reprise of 1932 MoMA Show



“This exhibition has style,” wrote Catherine K. Bauer in the March 1932 issue of *Creative Art* about “The International Style,” a Museum of Modern Art exhibit put together by Philip Johnson and Henry-Russell Hitchcock. That was the problem: the show may have had style, but the buildings represented and the movement they embodied were thought by many to be beyond such a shallow rendering. Tempers flared over who was included and who was not, and confusion was compounded by a concurrently released Johnson-Hitchcock book—also called *The International Style*—and by the exhibition catalog, both of which left out many of the works in the show and included others. In an effort “to encourage a more thoughtful review” of this influential event, Terence Riley, now curator of architecture at MoMA, recently mounted a reprise of the 1932

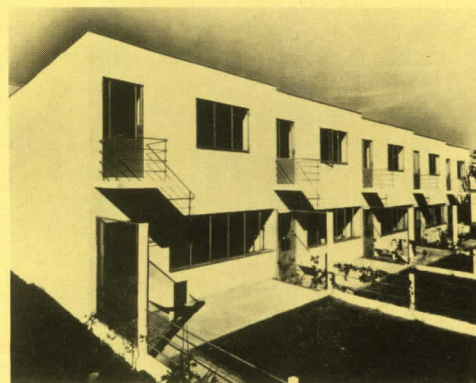
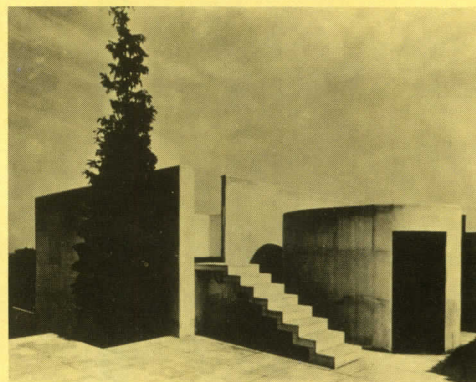

exhibition at Columbia University, where he was previously gallery director at the School of Architecture. Combining archival material from MoMA with carefully built models by Columbia graduate students, Riley repeated the original show’s three sections—“Modern Architects,” focusing on nine architects, including Le Corbusier (De Bestegui penthouse roof terrace, top), J. J. P. Oud (row of small houses, bottom), and Raymond Hood (McGraw-Hill Building, left); “The Extent of Modern Architecture,” photographs of 40 works by 37 architects from 15 countries; and “Housing,” curated by Lewis Mumford with associates Bauer, Henry Wright, and Clarence Stein. Unlike its predecessor, the new catalog reproduces every work in the show. “It’s very important that if people are going to keep referring to this show they know what was in it,” says Riley. *P. D. S.*

## Predock Science Museum Rises in Arizona Desert

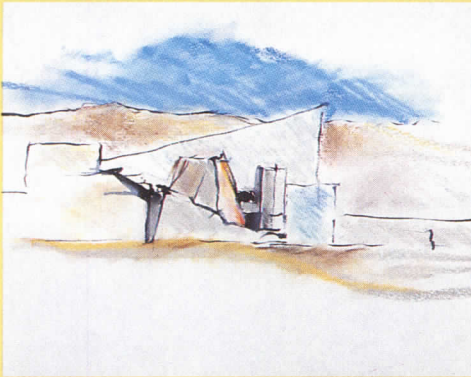

© Robert Reck

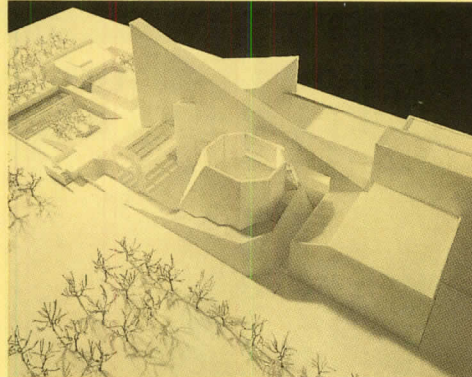

In a promising union of architect, project, and location, Antoine Predock is designing the new Arizona Museum of Science and Technology for a desert site at the edge of downtown Phoenix. Adjacent to Heritage Square Park, with its Victorian rowhouses, the main entry to the 120,000-sq-ft concrete, stucco, and stainless-steel complex descends eight feet below grade. Visitors move through a series of shaded courtyards and oases toward a 110-foot peak that mirrors mountains to the south. Completion of the \$15-million project is expected in 1994. ■

## RISD Art Museum Addition Unclogs Circulation

Steady growth has clogged circulation and storage at the Rhode Island School of Design's Museum of Art, a mix of Romanesque, Colonial Revival, and Queen Anne buildings constructed between 1893 and 1926 on a hillside site in Providence. After preparing a master plan for the complex, Philadelphia-based Tony Atkins Architects was asked to design an 8,000-sq-ft addition. The new link clears the interrupted circulation path, expands storage, and provides a large contemporary art gallery and a new main entrance. Construction began in April. ■

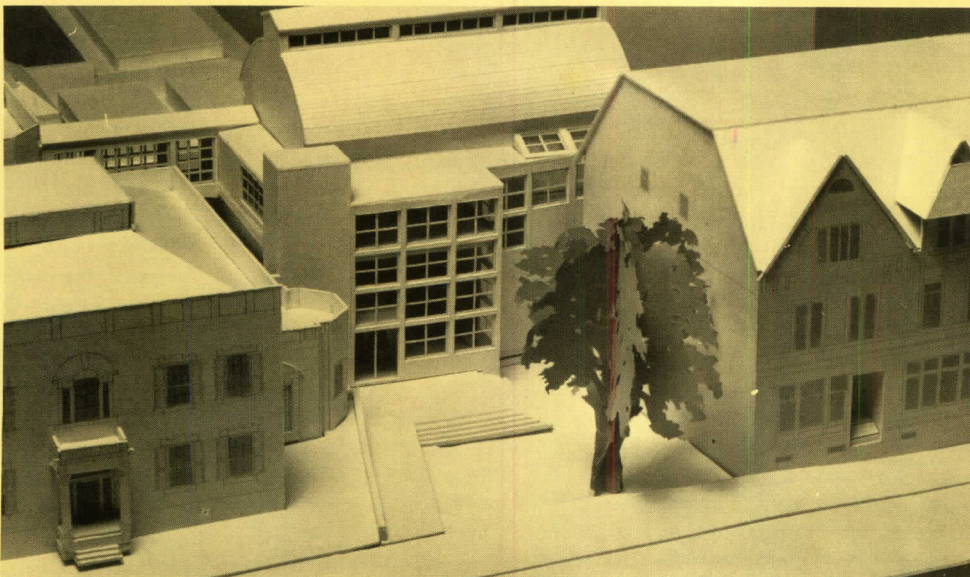

## Mile-High Visitors Center Planned

Using native timber and stone, photovoltaic power, and composting toilets in two small buildings, Norwegian student Einar Jarmund's design for the Washington Pass Visitors Center, in North Cascades National Park, fits into a remote but spectacular mile-high setting. Jarmund won a design contest while at the University of Washington, and helped a faculty team led by architect Douglas Kelbaugh flesh out the design for the north- and south-facing buildings. Kelbaugh hopes construction will begin in 1993 if funds are raised. *Charles Linn*

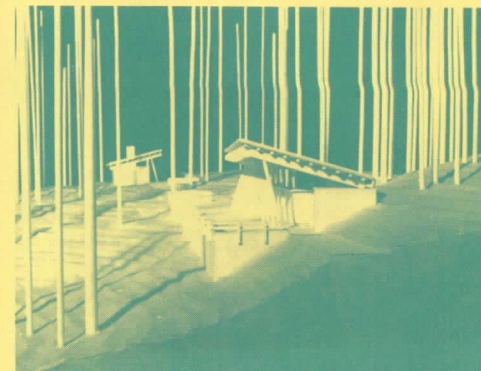
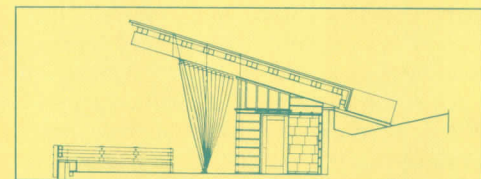



## Briefs

## Realpolitik

After months of saying it couldn't afford to build Daniel Libeskind's Jewish Museum extension of the Berlin Museum, the German government has reversed itself. A *Grundstein*—combination groundbreaking and cornerstone-laying—is scheduled for November 9, the anniversary of Kristallnacht. This month Libeskind receives the St. Gaudens Award from Cooper Union in New York City.

## Projects

- Spanish architect Rafael Moneo is designing a \$50-million building for Houston's Museum of Fine Arts, on a city block next to the existing Mies-designed museum. At 150,000 sq ft, the new facility will double current gallery space in accordance with the 1990 master plan prepared by Venturi, Scott Brown and Associates.

- In what may be one of the last major building projects in Portland, Oregon, for some time, the General Services Administration tapped local architects BOOR/A with Kohn Pederson Fox to design a new \$130-million, 600,000-sq-ft federal courthouse, to be completed by 1997.

- The Battery Park City Authority in New York City has scrapped existing plans by Cooper Robertson & Partners with artist Jennifer Bartlett [Design News, RECORD, August 1991, page 25] for its 3.5-acre South Park garden. Instead, the authority has picked a team led by landscape architects Hanna/Olin, and including architects Machado and Silvetti, city horticulturist Lynda Miller, and three local public artists, to come up with a new scheme.

## Competitions

- Nominations are being accepted for the 1992 American Express Preservation Awards for the Caribbean, sponsored by American Express and the Caribbean Tourism Organization and administered by U. S. /ICOMOS. Deadline for entries is June 22. Write Russell V. Keune, U. S. /ICOMOS, 1600 H Street N. W., Washington, D. C. 20006; tel. 202/842-1866.

- "Design Diaspora: Black Architects," an international traveling exhibit scheduled for spring 1993 at the Chicago Athenaeum, is seeking submissions by licensed architects of projects completed between 1970-90. Carolyn Armenta Davis, 313/266-0269; Chicago Athenaeum, 312/829-9650. ■

## New Contemporary Museum Scheme Bows to Mies

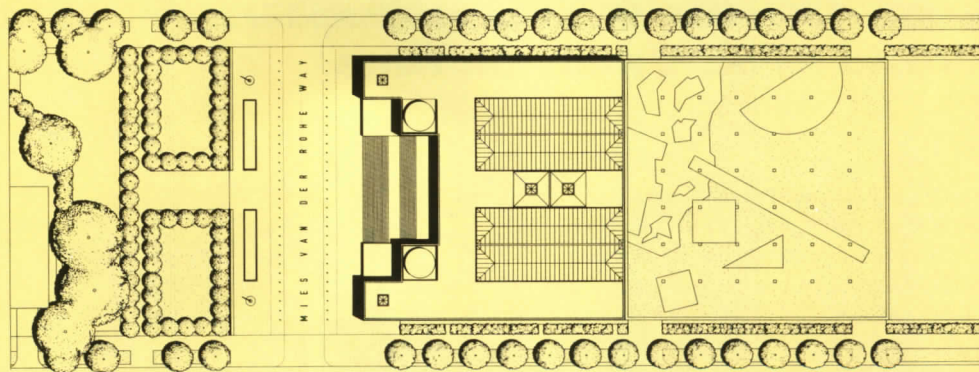
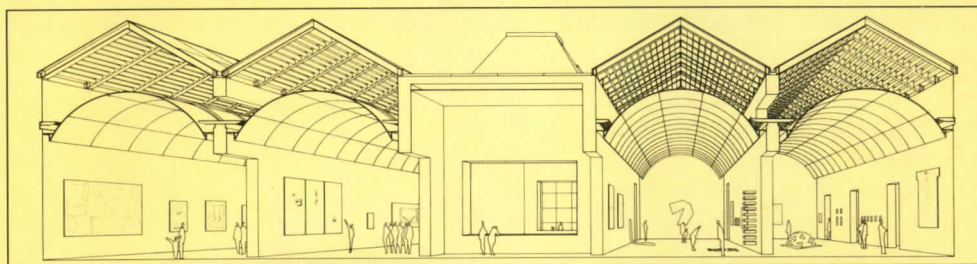
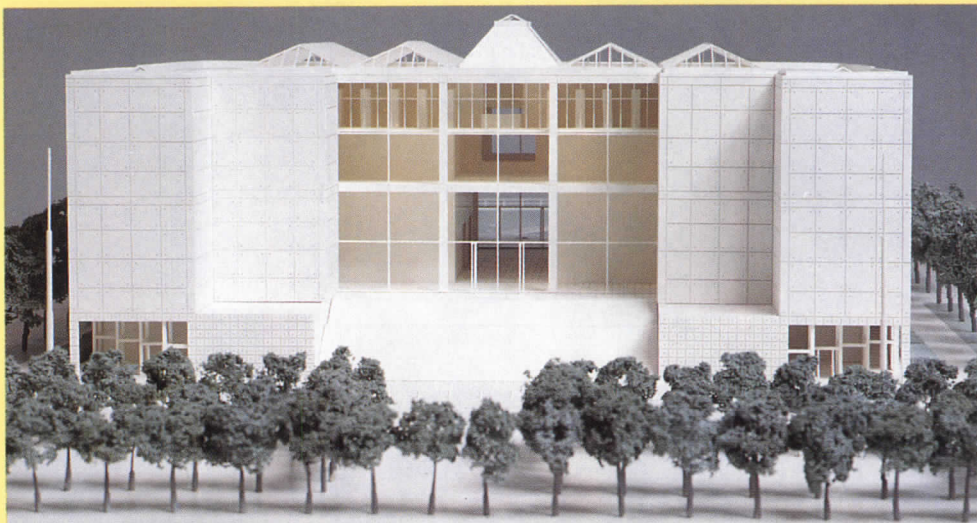

Plans for Chicago's new Museum of Contemporary Art were unveiled in April by Berlin-based architect Josef Paul Kleihues, a self-professed Chicago-cum-Mies devotee and the controversial choice in an involved selection process last year. On the site of an existing armory and scheduled to open in 1995, the \$50-million museum and sculpture garden sits midway in a three-block high-rise canyon, flanked by public parks that stretch from North Michigan Avenue and its iconic Water Tower to Lake Michigan (site plan, bottom). A Modernist building that is utterly

Classical in symmetry and spirit, the museum is wrapped in a relentless grid of seven-foot-square cast-aluminum panels rising from a 16-foot-high white Indiana limestone base that also supports the sculpture garden. The lake, another Chicago icon, is revealed through 56-foot-high glass curtain walls to those who mount the grand stair from Mies Van der Rohe Way. Within, Kleihues puts his own experience as a major collector of contemporary German painting to use in elegantly proportioned galleries with adjustable skylights. *James Krohe Jr.*

## New Finnish Embassy Planned for Massachusetts Avenue

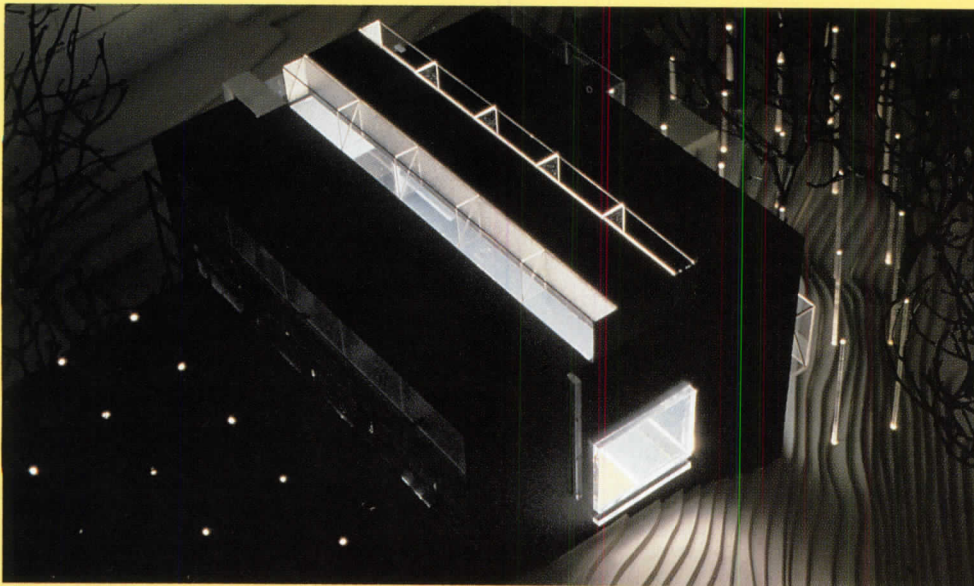

Split by a large skylit central hall dubbed the Grand Canyon, the new Finnish embassy designed by architects Mikko Heikinen and Markku Komonen occupies a prominent Washington site on Massachusetts Avenue, flanked by the Vatican, Belgian, and Norwe-

gian embassies and across the street from the Vice President's residence. The exterior, which consolidates embassy functions now scattered in three locations, is clad in green granite (polished and matte), glass block, and bronze. A metal grid for creepers climbs

the street-facing south elevation. Ramps, stairs, and bridges cross the deep, narrow interior in perhaps an unintended reference to the convoluted paths of diplomacy. Construction begins this summer for late 1993 completion. *P. D. S.*

## World's Fair Opens on Time

Seville's Universal Exposition (to be covered extensively, along with Barcelona Olympics architecture, in a forthcoming RECORD) opened April 20 for a six-month run. Some \$8 billion has been lavished on the 250-acre site and surrounding city. Already Santiago Calatrava's cable-stayed Guadalquivir River bridge and Antonio Cruz's and Antonio Ortiz's new high-speed-rail terminal have become landmarks. The fair itself, celebrating the 500th anniversary of Columbus's voyage to America, was master-planned by Oriol Bohigas as a series of gardens and avenues (one designed by SITE). Pavilions likely to become favorites: Japan (Tadao Ando, right), Great Britain (Nicholas Grimshaw, far right), Pabellón de Navegación (Guillermo Vázquez Consuegra), and the restored 15th-century Monastery of Santa Maria de las Cuevas. *J. S. R.*



James S. Russell photos

## The Temporary American Center in Paris

© Jean-Marie Monthier



To keep operating while Frank Gehry's American Center is being built in the Bercy quarter of Paris, the performing-arts and cultural institution held a competition for a temporary headquarters on a small triangle in front of the construction site. Inspired by



childhood Mechno toys, Nasrin Seraji, an Iranian-born, British-trained architect in Paris, won with a scheme—erected last November—that stacked 32 chipboard boxes horizontally and vertically, bound by a steel frame. The boxes weave around trees on the

north and incorporate those in the center (the program called for preserving them). The building fits neatly into its low residential neighborhood, and there is talk of finding a permanent home for it. But, says Seraji, "It was meant to disappear." *P. D. S.*

### Napa Valley

## Barcelona Architect Takes Winemaking Underground

The idea of architecture as earth art is taking hold in Napa Valley. In addition to Johnson Fain Pereira's mound for Opus One [see "Rare Vintage," pages 94-107 this issue], and an earlier cave excavation for Story Book Vineyards by Stanley Saitowitz, Barcelona architect Domingo Triay has just completed a shaped hill that contains the champagne operation of Codorniu Napa Winery. The 120,000 sq ft of production, storage, administration, and tasting spaces for this independent offshoot of the Spanish wine producer are buried in a stepped hill that exactly mirrors the surrounding hills of the Carneros district. Smooth public spaces and inner court round out the interior. As a piece of industrial agriculture, the massive hill cools the champagne and offers an environmentally sound and sculptural version of the traditional vineyard. *Aaron Betsky*



Lori J. P. Stocker

**Rulings**

**Arbitration Binds Burgee**

Partnership agreements, binding arbitration, and money are the defining elements in a nearly four-year legal battle that led in April to Chapter 11 professional and personal bankruptcy filings by John Burgee. The filings came after a recent unanimous ruling by an American Arbitration Association panel of lawyers, which awarded \$13.7 million plus interest to Raj Ahuja, an architect who had been a 25-percent partner in John Burgee Architects. Burgee, the 75-percent partner, says he asked Ahuja to leave the partnership in late 1988 because "we just disagreed on the general operation of the office." Ahuja, who joined the firm in 1971 and became a partner in 1984, claims he was offered much less than he was entitled to under the partnership agreement. Burgee requested arbitration as stipulated in that agreement (arbitration is a common requirement). In arbitration, Ahuja claimed \$21 million in fees and damages, but all parties agree that the eventual award was "several times" what Ahuja had been willing to settle for early on. The award factors in fees from projects in progress during Ahuja's tenure, but these include what Burgee calls many "maybes and ifs"—projects that may never be built—or billed. According to Ahuja's attorney, Donald L. Kreindler of Kreindler and Relkin, the award also includes damages for misappropriation of Ahuja's assets in the firm. Says one New York architect: "This is another bad rap for architects' fees. If a minority partner's profits from four years of practice were anything like \$13.7 million, it would be an extremely unusual firm." Ahuja, explaining why he decided to press his case, says his "fight is based on establishing the principles of partnership agreements and of relationships between partners." Would Burgee have had a chance with a subsequent court case? "Only if he could have proved misconduct by the arbitrators," says attorney Arthur Kornblut, a task he called extremely difficult. But, says Burgee, "I thought arbitration was quicker, easier, and cheaper." *P. D. S.*

**Interior Design**

**Single Trade Group for Designers Can Be a "Win-Win"—for Whom?**

Tougher competition in the interior-design marketplace is forcing designers and trade groups to increase their efforts to create a unified trade organization. Program initiatives that include legislative regulation of interior designers, greater recognition of the validity of the National Council for Interior Design Qualification (NCIDQ) examination, and continuing improvement of interior-design education indicate the profession is forging a more powerful, cohesive voice.

Behind the move to merge is the Unified Voice Task Force (UVTF), including representatives of the American Society of Interior Designers (ASID), the Institute of Business Designers (IBD), the International Society of Interior Designers of Canada (IDC), the Institute of Store Planners (ISP), and the Interior Design Educators Council (IDEC). The combined total membership of the seven organizations is about 49,000 and growing yearly. (The AIA has 56,900 members.) By July, the governing boards of each organization should complete their reviews of the proposed unification plan. No date has been set for unification, although an original goal is 1995. Robert Angle, executive director of ASID, calls unification a "win-win situation" for both the profession and the consumer.

Architectural and interior-design offices are merging as well, attempting to get a larger slice of the interior-design pie in a tough economy. Besides a host of smaller mergers, notable examples include HOK's purchase of PHH Environments, the association of ISD and A. Epstein & Sons and, most recently, the merger of the MacDonald Design Group with Gensler. Furniture manufacturers and dealers are also closing ranks. In the past several years the four largest manufacturers—Steelcase, Herman Miller, The Knoll Group, and The Haworth Portfolio—have acquired more than 20 smaller companies and now control about 50 percent of the total office furniture market. Smaller firms are

competing by forming their own alliances and carving out niche markets to supply what the giants cannot.

Interior-design education and qualification testing are almost prerequisites as the industry consolidates. The Foundation for Interior Design Education Research (FIDER) has so far accredited 96 interior-design programs in the United States. Passing the NCIDQ exam is required by most jurisdictions with legislative requirements (12 states and the District of Columbia now have some type of legislation governing interior design). Successful completion of the exam is also a condition of professional membership in the UVTF organizations. This development is likely to impinge on architects' ability to compete for lucrative interior-design work.

*David Kent Ballast*

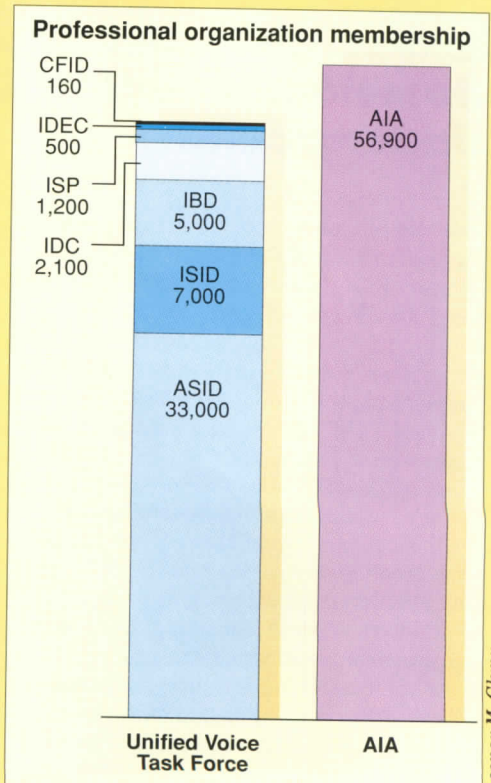

## Social Science

# Looking at the '60s to See the '90s

"Rethinking Designs of the '60s" was the provocative title of a recent one-day conference co-sponsored by the New York City chapter of Architects, Designers, and Planners for Social Responsibility (ADPSR), *Perspecta*, and the Parsons School of Design. Actually, much more than design was on the program. Led by several well-known architects, planners, educators, and artists, the day's discussions ranged through a virtual catalog—or primer, for the students in the audience—of those issues that shaped the '60s and, as a number of speakers emphasized, continue to demand our attention.

Ronald Shiffman, director of the Pratt Institute Center for Community and Environmental Development, recalled the emergence two decades ago of a still-active network of community-based design centers [Practice News, RECORD, August 1991, page 27]. He described how architects and planners, spurred by the decade's various movements for social justice, began to work with low-income communities to revitalize neighborhoods decimated by building abandonment or upscale development.

Richard Dozier, a professor of architecture at Florida A&M University, and architect Sharon Sutton, a professor at the University of Michigan, told how their efforts to mature professionally have been bound up with the larger struggle of African-Americans for racial equality both within and outside the profession, and of the continuing challenge to motivate students. Sutton, who studied architecture at Columbia in the incendiary days of the late 1960s, deplored the recent direction of the profession. "We've moved from a concern with how, why, and for whom we build," she said, "to being concerned simply with craft."

Another alumna of the Columbia of 1968, Susana Torre (now dean of architecture at Parsons), examined the resurgence of feminism in the '60s and the backlash against it.

Torre remarked that, while women have entered the profession in large numbers, "it is still necessary to clear a space for women to work and obtain recognition."

Ecological planner/designer Pliny Fisk remembered his student days 20 years ago, and the career-defining influence of Ian McHarg's theories of ecological land-planning. He traced a direct line from that experience to his current work as cofounder of the Center for Maximum Potential Building Systems in Austin, Texas, which explores and analyzes the increasing sophistication of architects in using green materials. Previously, Fisk noted, energy-conscious design focused mainly on the operating costs of buildings; it now encompasses the larger concept of the sustainability of natural resources.

Given the political atmosphere of the past decade, it was perhaps inevitable that an exploration of the '60s would inspire a rueful awareness of unfinished business. Fortunately, speakers and audience alike were as interested in looking forward. Indeed, to judge from their questions, the younger members of the audience are seeking ways to pick up where the '60s left off. Several panelists offered ample encouragement. Shiffman urged architects to once again become advocates for a "humane domestic agenda" that would effectively address our troubled cities. Architect Robert Goodman, a professor at the University of Massachusetts, took up this theme. "[Architects] tend to look for solutions too narrowly, within our profession," he said. "But if we wish to participate [in movements for social change], we'll need to develop political as well as design skills." And, invoking the words of the late pacifist A. J. Muste—"There is no way to peace. Peace is the way"—Denise Scott Brown encouraged designers to think of social, racial, and economic justice not simply as a goal to be achieved but as a process to be lived. *Nancy Levinson*

## Contributions

# Architects and AIDS

Perhaps as a reflection of the serious impact of AIDS on the design professions, one out of every \$30 donated by private foundations for research, prevention, and treatment has been given by Design Industries Foundation for AIDS (DIFFA). Now DIFFA would like to step up its contributions and is seeking increased donations. Any amount is welcome and \$1,000 will get you or your organization on DIFFA's Leadership Council. Contact DIFFA, Suite 602, 150 West 26th Street, New York, N. Y., 10001 (212/727-3100; fax, 727-2574). ■

## Markets

# On the Road to Recovery

### Top 20 States in Health-care Construction

Percentage of total United States

STATE	1991	1990
1. California	11.58 %	10.84 %
2. Florida	8.02	6.14
3. Pennsylvania	6.74	4.69
4. Texas	4.87	4.45
5. New Jersey	4.62	3.11
6. Georgia	4.47	2.00
7. New York	4.19	7.77
8. Ohio	3.55	6.75
9. Michigan	3.54	1.94
10. Virginia	3.52	2.76
11. North Carolina	3.19	4.24
12. Connecticut	2.60	2.48
13. Massachusetts	2.49	1.83
14. Illinois	2.34	3.68
15. Maryland	2.28	2.91
16. Wisconsin	2.16	2.21
17. South Carolina	2.11	1.97
18. Indiana	2.10	3.05
19. Missouri	1.85	1.99
20. Minnesota	1.77	1.97
<b>All other</b>	<b>21.99</b>	<b>23.19</b>
<b>TOTAL</b>	<b>100.00</b>	<b>100.00</b>

Source: F.W. Dodge Group

Leonor M. Glynn

NEOCON 92: Product Preview



300



302

**300. Individualistic.** Although they're all variations on a similar theme, William Schacht feels each of his Cleo occasional chairs has its own viewpoint. The maple-framed chair comes in open, slat, and closed/upholstered versions. Mueller, A Haworth Portfolio Co., Kalamazoo, Mich.

**301. Swiss concept.** Designed by Dieter Stierli, the 91 cross bow chair has a cantilever frame of chromed steel and beech wood that provides both comfort and stability. Suggested applications include conference



303

seating and as a pull-up chair in the executive office. Girsberger Industries, Inc., Smithfield, N. C.

**302. Presidential.** A replica of the Rustic Gothic original designed by Stanford White for the dining room at Newport, R. I.'s Kingscote mansion, Trouvailles' new sidechair is called the W. H. Taft for its generous proportions. The frame and turned legs are maple; overall dimensions are 22 in. wide by 21 in. deep by 36 in. high. Trouvailles, Watertown, Mass.



301

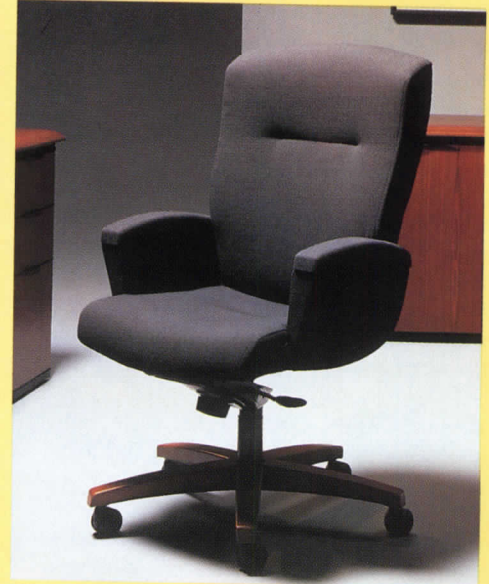

304

**303. Italo-Scot.** Andrea Branzi's Lubekka chair interprets the minimalism of Charles Rennie Mackintosh with a Mediterranean flair: and it's surprisingly comfortable. The ashwood screens are joined only at the base, allowing them flex as the sitter moves. Finish options are blue or ebony. Atelier International, Ltd., Long Island City, N. Y.

**304. Active ergonomic.** Gentry, a new mid-price line of desk seating designed to work with contemporary wood office furniture, provides a spectrum of user-

A revised, more focused format promises to rejuvenate this year's NEOCON, the granddaddy of contract shows that takes place June 8 to 10 in Chicago. RECORD's preview focuses on seating.

For more information circle item numbers on Reader Service Cards.



305



307

adjustment functions such as swivel-tilt and low front rise knee-tilt. The contoured seat-back configuration offers built-in lumbar support. The collection is available in a full product range including manager, professional, and guest models. Steelcase, Inc., Grand Rapids, Mich.

**305. Pull up.** Harden's Slatted Guest chair incorporates the scroll detail, on arms and back, that characterizes other seating in their new 1400 line. Back, arms, and tapered legs are made of solid black cherry; the seat



306



308

can be ordered in leather, as shown, or fabric. Harden Contract, McConnellsville, N. Y.

**306. Details.** Brian Cox allowed himself only the most discreet Deco touch for his Architektur lounge: a wood pinstripe reveal under the arm cap. Bernhardt, Lenoir, N. C.

**307. Plush Salon.** Based on a 1912 Josef Hoffmann design for Dr. Koller's music room, the Musikzimmer offers audience comfort in a chair as wide as it is high. ICF, New York City.

**308. Nonhierarchical.** 4 O'Clock chairs match adjustability to the reality of the task: the supportive, OSHA-compliant chair needed by the VDT operator can be just as useful to the computer-literate CEO. Reflecting today's more collegial corporate style, the line offers an egalitarian choice of sophisticated active or passive ergonomic functions within a uniform esthetic. Chairs come in three sizes to best fit different body types, and status options are confined to a choice of upholstery or metal finish. Vecta, Grand Prairie, Tex. ■

**This Month**

**1992 Dodge/Sweet's Construction Volume Update**

**Construction Outlook Update. Page 30.** Dodge Sweet's takes a fresh look at its annual October predictions on the volume of construction activity and finds, for many types of construction, a recovery is on schedule.

**True or False: Model Photography is High Art. Page 34.** A rundown on the latest techniques in model photography raises a question on what constitutes a true picture of buildings that have yet to be built.

**Mandatory Continuing Education Is Back. Page 36.** With some sort of action at next month's AIA convention almost certain, it pays to examine what mandatory continuing education may and may not accomplish.

**Specification Series: Glazed Metal Curtain Walls/Structural Performance. Page 38.** Performance standards in your specifications will allow a choice of many more systems, open up competition on bidding, and achieve better bottom-line results.

**Computers: Keeping It Simple. Page 40.** A small architectural firm takes on big projects while buying only what it needs as it goes along, thereby keeping its computing costs low. ■

*By George A. Christie*  
When the original *1992 Outlook* went to press last October, the construction market was in a state of transition. The leading indicator of construction and building-materials demand, the Dodge Index of construction contracting, was making a tenuous recovery from a decline that lasted six consecutive quarters. Its turnaround promised the start of a new building cycle.

The industry's coincident indicator, Construction Put in Place, which measures expenditures for work being brought to completion, had yet to show improvement, but it seemed to be stabilizing after an extended decline that paralleled the index of contracting. While these were signs that forces within the construction sector were coming together to launch a new period of expansion, recovery was by no means certain.

During the fall and winter months, some positive events, as well as a few negative ones, have modified some of the details of the *1992 Outlook* for construction contracting without altering its basic message of recovery.

With the 1990 budget resolution neutralizing fiscal policy, monetary policy has become more aggressive as indicated by the significant lowering of interest rates last December. That month also brought passage of the new federal transportation program, which provides for a substantial escalation of funding for highway and bridge construction. But it was also during this period that consumer confidence plummeted as the economy's fragile recovery stalled for two anxiety-filled quarters.

**Out of the tunnel**  
On balance, developments since last October's edition of the *1992 Construction Outlook* appear to have favored the construction industry more than others. The evidence:

- Expenditures for construction put in place did, in fact, turn up in 1991's final quarter, confirming the earlier improvement in the Dodge Index.
- Contracting for new construction contin-

ued to advance through 1991's second half and into the first quarter of 1992. Preliminary data for the first quarter of 1992 show the Dodge Index averaging 96 (1987 now replaces 1982 as the 100 base), nearly 15 percent above its year-earlier low of 84. Most of this recent improvement in newly started projects has yet to be realized in spending for materials and wages on the job site.

This update of the *1992 Outlook* examines the prospects for construction contracting in the year ahead under two broad groupings: those categories of construction that are cyclically sensitive, and those that are inherently stable.

**THE CYCLICALS**  
**Single-family housing**

Recovery of the Dodge Index from early 1991 to the present has been due principally to the revival of housebuilding. Largely in response to falling mortgage rates, single-family housing starts increased in each quarter of 1991, from a low starting rate of 700,000 units (F. W. Dodge basis) to finish comfortably above 850,000 units. The early 1992 rate of building, by then on the high side of 900,000 units, was as yet an incomplete recovery to the pre-recession/pre-credit crunch volume of the late 1980s, and it is reasonable to expect that further improve-





*Call 1991 the turn-around year; recovery, which is already several quarters along, will start to show in annual data in 1992.*

ment can be sustained through 1992. For more than one reason, single-family-house construction could overshoot its potential and then settle back. After two years (1990 and 1991) when starts averaged only slightly over 800,000 units—compared with the previously demonstrated demand for a million homes annually—there exists a backlog of demand to be met over and above current needs. The powerful combination of low interest rates, solid demographics, and a temporary tax incentive will sustain the single-family market's recovery through 1992 and beyond. It is now estimated that the rate of starts, currently in the range of 950,000 to 975,000 units, will cross the one-million-unit threshold before mid-1992 and continue to rise to a peak rate of 1.050 to 1.075 million units by mid-1993. This pattern would bring the 1992 total to 985,000 new homes—a gain

*On balance, developments since last October's annual Outlook appear to have favored the construction industry more than others. That forecast's details have changed without altering the basic message of recovery.*

of just under 25 percent from the 1991 total—with room for a further advance of about 10 percent in 1993.

#### **Income properties**

The most that can be said for the building industry's hardship cases—offices, hotels, shopping centers, condos, and apartments—is that after five years of “adjusting” to the mid-1980s over-development, downside risk for this group is now negligible. That's not saying much.

The succession of tax reform (1986/87), credit crunch (1989/90), and recession (1990/91) has taken its toll in reducing the outpouring of unwanted buildings, and little, if any, further cutback seems necessary. At a combined total of approximately 650 million square feet of new construction last year—less than half the average of the mid-1980s—this depressed level of building is no

more appropriate than was the exaggerated volume generated during the tax-sheltered boom years. Yet, while the risk of further decline is minimal, there is little justification for near-term improvement. Two impediments to recovery are formidable:

- The banking system is gradually working its way out of near-collapse in 1990, but it will be a long time before chastened lenders will again be eager to back commercial real-estate development. And even when they are ready, a far stricter set of standards will apply.
- Before developers are willing to re-enter this depressed market, the tedious process of assimilating the vast surplus of empty space left over from the “Irresponsible Eighties” must be completed. So far, five years of diminished building have done little to reduce vacancy rates from their late-1980

highs. Consequently, the value of existing properties continues to decline, discouraging investment in new facilities.

It remains for a slowly recovering economy and gradually rising employment to reduce oppressive vacancy rates so that higher levels of building can again become profitable. Meanwhile, stability of contracting at close to the 1991 volume is the best bet.

A fine-tuning of last October's estimates for the income-properties group now leaves a slightly lower volume of building in both 1991 and 1992 but, as before, little change from last year to this one.

#### **THE STABILIZERS** **Institutional buildings**

While contracting for commercial buildings was soaring through the first half of the 1980s and crashing in the second half, insti-

tutional building kept plodding ahead—slowly but steadily. From the beginning to the end of the decade, contracting for schools, healthcare facilities, and various other public buildings expanded from an annual value of \$20 billion in 1980 to just over \$40 billion by 1990, and at present constitutes more than half the total of all nonresidential building.

This remarkable record of growth, which was based on solid demographics and dependable funding, is subject to a temporary interruption in 1992. The demographics have not changed, but the funding has.

The biggest share of institutional building (roughly half the total) is educational facilities, and schools owe much of their financial support to state and local government budgets, which are in a severe squeeze. The situation is summarized in a statement from the latest “Fiscal Survey of the States” by the National Governors' Association: “. . . a conflict between slow revenue growth and rapidly escalating costs [requires] a shift toward healthcare and corrections, a trade-off against states' long-run investment in schools, infrastructure, and the environment.”

Although the full-year 1991 total of educational building brought the decade-long upward trend to a new high, the rate of contracting for schools leveled off in last year's second half. That was when most states had to adjust to austere fiscal 1992 budgets. The lost momentum can be viewed as the transition to a temporary setback in calendar year 1992. Data for the early months of this year appear to support this interpretation.

An expected 5-percent decline of educational-construction contracting in 1992 will leave total institutional building short of 1991's record value by 2 or 3 percent, interrupting the long string of yearly increases. Once the pressure on state and local budgets is relieved, the upward trend of educational, healthcare, and other institutional building will resume in response to demographics.

#### **Public-works construction**

Although the usually reliable institutional building market will not be playing its sup-

## Practice

## True or False: Model Photography Is High Art

*Architectural-model photography claims to show how buildings will appear when built. But that effect may not always be the true one.*

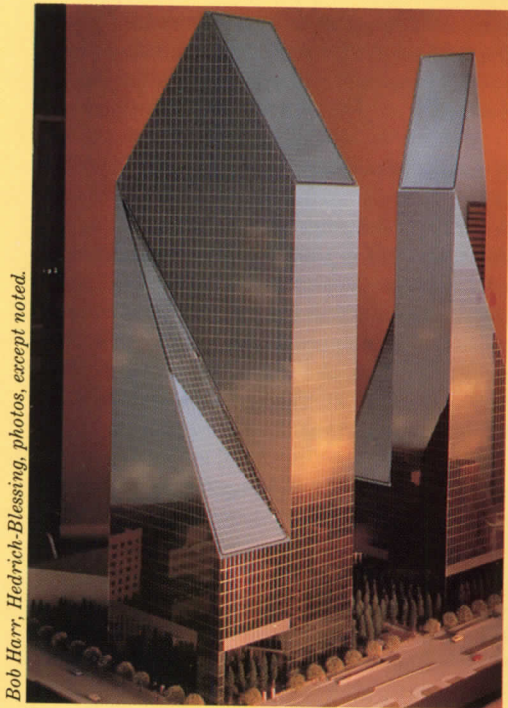

Bob Harr, Hedrich-Blessing, photos, except noted.



By Akiko Busch

Composite or montage photography, which puts a proposed building in an existing landscape, is the most sophisticated brand of model photography. And with the growing capabilities of computer imaging, montage photography has achieved a new level of accuracy. Such photographs give views not only of the building before it is built, but where it will sit. With emulsion stripping and computer retouching for color, lighting, and the blending of images, such photographs can indeed be persuasive portraits of the unbuilt world.

They may also be the most practical way to show a model once it is built. Models are fragile and transporting them is often hazardous when you have to display them to developers, design partners, contractors, and prospective tenants in locations outside your office.

*Ms. Busch often writes on architecture and design. Among her books are The Photography of Architecture: Twelve Views, published by Van Nostrand Reinhold, New York, New York, 1987, and The Art of the Architectural Model, Design Press, New York, New York, 1991.*

### How composite images are made

The old-fashioned and simplest method has been simply to patch together two prints. The photographer uses the same perspective in the views of model and site, and the lab makes them the same scale. A technician cuts the model image out with a matte knife and pastes it on the site. The problem with patching prints this way is that the thickness of the paper may make the patching visible, reducing realism.

Today, emulsion stripping is more efficient and common. A lab lifts the emulsion of one image and superimposes it on a second piece of film, on which the area to be replaced has been masked out. Emulsion stripping is relatively simple and reliable when the outline of the image to be stripped is not too complex or detailed.

For images that are more complex, emulsion stripping can be carried a step further. Once these first steps have been taken, the lab shoots a negative and makes prints from the new film. It then enlarges the prints to a workable size and retouches by hand, adding trees, clouds, parking meters, and curbs and deleting construction debris. The final print is then reshot. The problem with this tech-

nique is that the final print is several generations removed from the original image, and thereby may lose clarity.

### Making computer composites

The "generation" problem makes computer graphics seem very appealing. The Shima Seiki and Quantel Paintbox are two systems that are, in essence, computer-operated photo labs. Transparencies both of the model and of its site are scanned into a computer, which digitizes them or translates them into pixels. On the computer screen, an operator corrects perspective, size, details, and color in seconds, then transfers the new image onto a magnetic tape, which is, in turn, recorded onto film. The film is then processed, like any other film, into a transparency, producing a third, and final, transparency.

Raphael Digital Transparencies Inc. in Houston uses its own system of lasers to digitize original transparencies. After the lab modifies images on a screen, it converts them back to a final high-resolution image. The resolution is so high, in fact, that the scanning lines are not visible even when the image is enlarged. (See Hedrich-Blessing photos above.) Not surprisingly, the cost of assembling such images is high. Architec-

*A model of I. M. Pei & Partners' First Interstate Bank (1) is placed on an aerial view of its proposed Dallas site (2) to appear as it will be built including*

*reflections of adjacent buildings (3). Fox & Fowle and Frank Williams' proposed South Ferry Plaza (4) hides behind existing buildings in lower Manhattan.*



3 tural photographer Bob Harr of Hedrich-Blessing in Chicago gives a ballpark figure of \$20,000 for a single transparency, a cost that includes travel to and from the site; travel to and from the location of the model; all equipment and processing fees; a black-and-white "patched" print (not unlike primitive composite shots) used as a prototype for the final computerized image; and all the computer-graphics fees. The costs, he points out, can be justified if the image helps lease a single floor of a proposed building earlier than anticipated.

#### **Authentic or artificial?**

Although manipulated photographs have been around since photography began in the mid-19th century, the accuracy of recent computer graphics has made such manipulations undetectable, leading to questions about the integrity of the process. In the eyes of some critics, montage photography—and its intrinsic deceptions—is the architectural equivalent of lip-synching.

Originally, montage photographs simply helped architects visualize the "fit" of a proposed building into its existing environment. They were made to create a realistic vision of the proposed building within its landscape

and lighting. While such photographs continue to serve this purpose, they now do more. Often, they glamorize a building by accentuating specific features to market it to planning boards, leasing agents, and potential tenants.

#### **Case 1: Minimizing the surroundings**

Well-done composites can invent their own truths. Raphaelae observes that ethical questions on what precisely constitutes reality come up constantly; however, she states emphatically: "I do see composites as documentary. There are limits to our graphics invention at the monitor. If we are given an architectural model that has trees growing around it, we know that these trees have not yet been planted. But we'll put them into the photograph on good faith. Likewise, it can be assumed that construction debris appearing in the photograph will, eventually, be removed; therefore, its removal from the photograph stretches the truth only slightly."

Trees and construction debris are the least of it. If a client's proposed building is adjacent to another building that is itself a prominent monument likely to draw the viewer's attention, the client may well ask to

4 have it downplayed. Raphaelae admits she might modify lighting to do that. "But changing its configuration or modifying its bulk is something we would never do."

#### **Case 2: Minimizing the building**

A composite photograph that neutralizes the visual impact of a new building can also be an asset to its developers. Bob Harr recalls a composite of a model built for a proposed building—of contested height—in San Francisco's financial district. The site was photographed from different surrounding hills at angles that invariably diminished the perception of the proposed building's height. But as the building would be seen from the city's many hilltops, such representation was fair.

Harr observes that, thus far, developers and architects have governed themselves. "No one wants to be responsible for misrepresenting the building, which is obvious ground for later legal action. Sure, there are times it would help the client a lot to make his building more dramatic by removing three floors from the building across the street. But we wouldn't do that and we haven't been confronted by clients who want  
*Continued on next page*

© Dan Cornish/Esto

## Mandatory Continuing Education Is Back

*Continued from previous page*

us to do that. When people talk about these computer-generated images, you assume that there will be a lot of ethical problems and questions about who will police its use, but we haven't come across any clients interested in misrepresenting their buildings."

Harr adds that his preliminary work with the client may include suggestions on angles, views, and quality of light that will most enhance a proposed building. Often he recommends that composites include dramatic sunrises or sunsets.

### Know what you are seeing

Erica Stoller of Esto is slightly less sanguine, observing that, if visual deceptions do occur, they are more likely at the hands of a PR agency or graphic-design firm assembling marketing brochures than from architects or developers. "I have seen whole buildings disappear," she says, "although it wasn't our doing. It wasn't the building being proposed, of course, but a background building that detracted from the overall view. You don't see this often, but it does happen."

Stoller posits that the photography of architecture incorporated theatrics long before the advent of computer-generated images: "Using a wide-angle lens is its own kind of deceit. And so, for that matter, is composite photography. Isn't it misrepresenting the building from the start by making it look built—when it's not?" she asks. And as she accurately points out, even in straightforward model photography, rarely is studio lighting composed to duplicate the way actual sunlight might strike—or completely miss—the facade of the proposed building. Stoller concludes that "We all just have to be savvier about what we're looking at. We have to make more of an effort to understand the language of the thing."

While computer-generated composite photography of models may give us intriguing glimpses into the unbuilt world, the viewer must also keep in mind that this is a hybrid landscape, composed of actual and imagined objects. Here is the architecture of fact and fiction. ■

*By Donald Levy*

Once again, architects are seriously considering mandatory continuing education for their profession. There has been activity in some states and Resolution K-1 at the 1991 AIA convention called for a year-long study of the subject and action at the convention next month.

How would enacting continuing-education requirements effectively address the problem? Indeed, what is the problem?

Having a license does not imply competency; it simply implies that an individual has met certain qualifications, which, by consensual agreement among professionals, reduce the likelihood of deficient practice. "Society relies on a standard of care established by the profession and interpreted by courts," says Dale Ellickson, senior director of the AIA's Documents Department, "and we find that licensure does not guarantee competency, but rather acts to reduce quackery."

The licensing examination ends only an architect's *preparation* to practice. Notes

*A study found substantial differences between what architects really needed to know and what they thought they needed to know. How will architects know which courses to take?*

NCARB executive vice president Samuel Balen: "The content of the exam is based on what architects do on a daily basis and tests for certain knowledge, skills, and ability that predict adequate performance of minimal services." From his view, we can see competency as a judgment about performance after the fact, which should not be confused with capacity, which is potential to perform.

*Mr. Levy is a principal of the Rochelle Organization, Inc. in Washington, D. C., consultants to design, education, and professional organizations. He is former director, professional development, for the AIA.*

### Continuing-education trends

When asked why practitioners are licensed, most architects instinctively respond: "To protect the public health, safety, and welfare." Protection of the public is a laudable goal. In an effort to achieve this, ongoing regulatory requirements are common to many vocational groups—physicians, nursing-home administrators, pharmacists, social workers, and beauticians, among others. Mandatory continuing education for 16 professions under certain circumstances has increased from 31 percent in 1979 to almost 57 percent in 1991 (see graph). Increasing litigiousness and consumer advocacy creates an aggressive "watchfulness" by the public, which rightly wants to receive competent service. One has only to turn to newspapers for disquieting stories of professional practice artlessly provided or even fatally flawed.

### Measuring performance

The crux, therefore—the ability of a practitioner to keep a license—depends less on preparation for that license than on competent performance; it is what one does, not

what one knows. Accepting that competent performance is the goal of licensure, we must define it. Here the discussion begins to fracture. How is performance measured? How can the many varied types of practitioners be measured by one analytical test?

Academics have struggled with this issue for years. Solutions include case-study simulations, measuring responses to typical situations, a wide variety of skill tests, peer review of actual practice, and knowledge-based examinations. The general conclusion is that the effective practice of most contemporary professions is so situation-dependent that a single unified test will never ade-

## Sure to be a hot topic at this year's AIA convention, continuing education offers benefits and drawbacks.

quately mimic actual practice. Moreover, if it could, it would be too unwieldy, expensive, time-consuming, and politically insupportable to survive.

Regulatory boards of most professions consist of senior practitioners, although the lay public is increasingly part of the "team." When charged with asserting continued competence of licensed professionals, these boards typically take two approaches: re-examination and mandatory continuing education. Each approach has its problems:

### Problems with re-examination

Examinations are exhausting and fraught with anxiety, especially for those who have been out of school for many years. Some practitioners feel that, as their careers progress, they become increasingly specialized to the point that unrelated base-level knowledge has atrophied; they "don't use it, so they lose it."

The process of writing, promoting, administering, scoring, and posting re-examination would impossibly burden most licensing boards. Costs would have to be passed along to the examinee or the taxpayer. Costs to firms would include lost billable hours spent in preparing for and taking the examination. The price of failing the exam could be drastic (especially for the sole practitioner). And, in the end, there is still no real assurance of competent performance, but only the knowledge that an individual has passed a test. And failure to pass that test does not mean that the individual cannot perform competently.

### Problems with continuing education

Mandatory continuing education is not a particularly better solution than re-examination. A study by Pennsylvania State University (underwritten in part by the AIA) concluded that there were substantial differences between what architects really needed to know and what they thought they did.

If architects are forced to take continuing-education courses, how will they know which to take? How will the public know architects have learned anything that will improve their performance? How can anyone know that an individual's inadequate performance does not

come from causes other than education? How will the profession assure the competence of education providers? Who will police the process, keep records, accredit courses, and insure that the learner has met objectives? In short, how will we know that continuing education means competent performance?

Not to say that continuing education does not work. There is a growing body of scholarly research that suggests it does improve knowledge. A study of accountants by the State of New York found a positive correlation between continuing education and professional knowledge. The study further found mandatory education meant that more people took courses.

The study determined that there were significant increases in knowledge, but only after 40 hours. Less time produced an unacceptable gain.

The research committee therefore concluded that accountants should be required to undertake a minimum of 40 hours per year in specified areas of study or 24 hours per year concentrated in one of three specialized subject areas. But neither the study nor the recommendations addressed what this would do for practice. In other words, continuing education may indeed increase knowledge, but no one has proven that improved knowledge means improved application.

Additional perspective is provided by author Thomas Gilbert in *Human Competence: Engineering Worthy Performance* (1978). Gilbert asserts that the delivery of competent services depends on two equally important elements:

- An appropriate "repertory of behavior"—knowledge, skill, capacity (requisite physical and mental abilities), and motivation.
  - The "supporting environment" comprising (1) adequate and appropriate information and data, (2) tools and materials, and (3) incentives for appropriate performance.
- Education or training will only have a positive impact if the problem is within an individual's "repertory of behavior;" problems within the "supporting environment" cannot be corrected by continuing education.
- Continued on next page*

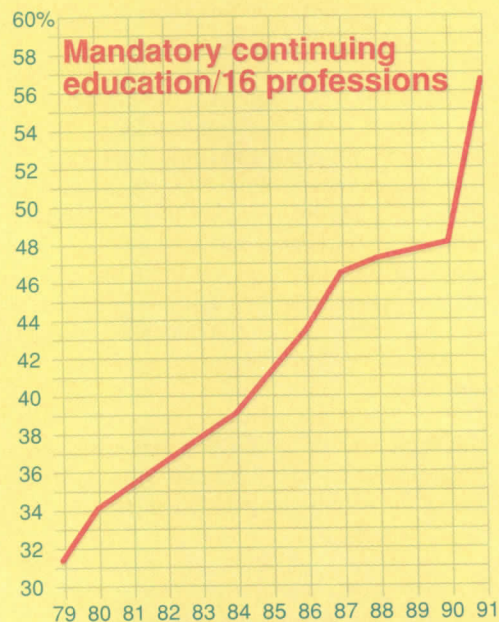

*"Mandatory continuing education is increasingly the major means of relicensure," reports Dr. Louis E. Phillips, a consultant on education and training. He foresees more emphasis on relicensing, tracking of licenses, assurance of competence, assessment, and disciplinary action, but not re-examination. He has tracked regulations for 16 professions in 50 states and the District of Columbia since 1977 (graph). The professions include architects, certified public accountants, dentists, engineers, lawyers, licensed practical nurses, nursing-home administrators, optometrists, psychologists, pharmacists, physical therapists, physicians, real-estate personnel, social workers, and veterinarians.*

## Specification Series: Glazed Metal Curtain Walls/Structural Performance

*Continued from previous page*

### The most recent AIA resolution

AIA Resolution K-1 (revised), sponsored by the Minnesota Society/AIA, the Region of the Virginias, and the Minneapolis, St. Paul, Northern Minnesota and Iowa chapters, AIA, was adopted by the AIA's membership at the May 1991 convention. The resolution calls for a study by the AIA's Lifelong Learning Committee to "evaluate the AIA's current policy regarding continuing education for architects, [and] to analyze benefits of mandatory vs. voluntary continuing education."

The study was presented to the membership for comment in early 1992 and will be presented for membership action at the '92 convention.

The resolution calls for the AIA's study committee to "specifically evaluate an AIA policy for mandatory continuing education for its members" (emphasis added). The intent of this resolution is clear—study the issue (once again), and evaluate whether or not the AIA should require continuing education for membership.

The institute's examination of mandatory continuing education for membership in the AIA offers both encouragement and the potential for argument. The results of the study will interest many, including the registration boards. There may be several right answers or no right answers. But development of a good answer depends on the statement of question, and to date the question has not been made clear. ■

*By Duane Sohl, Bruce Kaskel, and Susan Greenwald*

To develop curtain-wall structural-performance documents, architects must understand design criteria and available products more thoroughly than they would for a prescriptive specification. To create performance documents, they must first evaluate the different systems, detailing them in sketch form at full or half-scale, and then prepare drawings and specifications that create an "envelope" within which appropriate systems can fit.

Structural criteria dictate much about their performance. Structurally, curtain walls generally fall into one of two categories—stick systems and unitized systems, both with variations. Loads are transferred to horizontal and vertical framing members and through anchors to the building structure. Typically, vertical members span floor to floor and are the primary supports.

### Gravity loads

Because the curtain wall is a nonloadbearing assembly, the only gravity loads that it supports are its own weight and possibly the weight of interior finishes. Since glazed metal curtain-wall systems weigh about 10 to 15 pounds per square foot, their weight usually has little impact on the building structure. For special conditions, you may have to restrict the weight of the wall or the locations of gravity anchors.

### Wind loads

Wind creates positive (inward) and negative (outward) pressures on curtain walls. Governing building codes usually specify minimum required design wind pressures.

*Mr. Sohl is a senior principal of DeStefano + Partners, a Chicago architectural, interiors, and planning firm. Mr. Kaskel is senior architect and engineer in Wiss, Janney, & Elstner, architects, engineers, and material scientists who specialize in investigating and repairing existing buildings, and consult on the design of new buildings. Ms. Greenwald is principal of ArchiText, specifications and technical-information consultants. The authors are currently producing a CSI monograph on glazed curtain-wall systems.*

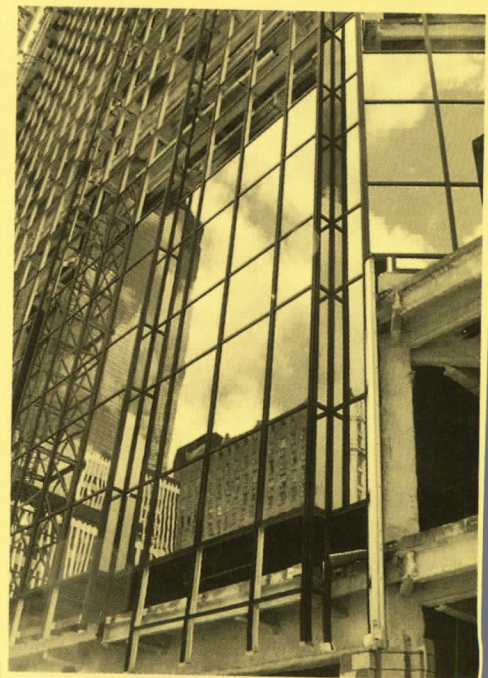

*Photo top: A typical lateral anchor at the edge of a slab. Vertical slots allow for movement of the structure. Teflon washers are used to eliminate binding. Gravity anchors for this system are similar, without the vertical slots. Photo bottom: An aluminum curtain wall in place.*

*Developing structural-performance documents lets contractors adapt various systems to your project and thereby opens up competition on bids.*

## **Abbreviated Structural Performance Requirements: Glazed Metal Curtain Walls**

### **SYSTEM DESCRIPTION**

**A. Structural Requirements:** System shall meet or exceed the following as demonstrated by calculations and mock-up testing.

1. Gravity loads: In addition to supporting its own weight, curtain-wall system shall support [note items such as interior finish].
2. Wind loads: Engineer systems to withstand design wind loads of [fill in number] psf positive, and [fill in number] psf negative.

Add provisions for special conditions such as those described in text.

3. Seismic forces: Engineer curtain wall to accommodate seismic forces identified in [code] for seismic zone [insert zone].
4. Transferred Loads: [Insert requirements for loads transferred to curtain wall by window-washing tiebacks, stone-veneer systems, or other related systems.]
5. Factors of safety: Systems shall be designed to incorporate factors of safety in accordance with the following standards: [insert standards] and shall sustain without damage a proof load of [1.5 or other] times design wind loads when tested in accordance with ASTM E330.

Add factors of safety for individual components, such as anchors, as required.

6. Deflection limits: For metal members supporting glass:

- a. At design loads:
  - 1) Perpendicular to plane of wall: [insert limit]
  - 2) In plane of wall: [insert limit]
  - 3) At connection points of framing members to anchors: [insert limit]
  - 4) [insert other limits]

Insert deflection requirements where needed for requirements of glass, if glass is in this section, and for other components such as anchors.

7. Movement provisions: Allow for the following:

- a. Deflections: [fill in number] differential movement at mid-point bay for floor slab deflection.
- b. Creep and elastic shortening: [fill in number] per floor long term column shortening.
- c. Interstory drift: [fill in number].
- d. Settlement: [include if needed].

8. Tolerances: Accommodate all tolerances of the surrounding conditions, including the support structure.

9. Thermal movement: Provide for expansion and contraction of component materials caused by an exterior ambient temperature ranging from [temperature] to maximum metal-surface temperature of [temperature]. Add interior range if needed.

### **SUBMITTALS**

**A. Product Data:** [For standard systems, and for manufactured components of custom systems]

**B. Shop Drawings and Calculations:** Submit shop drawings, signed and sealed by a structural engineer licensed in [state]. Submit calculations verifying conformance with specified structural requirements.

### **QUALITY ASSURANCE**

**A. Laboratory Testing:** [Insert requirements for standard or custom systems as required.]

Codes, however, may not provide an accurate indication of wind pressures on unusually shaped or complex buildings.

Boundary-layer wind-tunnel testing is sometimes used to gain a more accurate indication of wind loads on curtain walls. This test exposes a scale building model fitted with pressure taps to wind forces in a laboratory wind tunnel. Models of adjacent buildings and terrain create representative air flows around the building. These tests provide reliable data about wind loads on the building; however, wind-tunnel testing may be justified only for large highrise buildings, special building shapes, or peculiar site conditions.

Factors that influence wind loads include:

- Height of the building. Wind loads increase at higher elevations.
- Location. Topographical conditions such as open flat areas or a location surrounded by buildings affect wind forces.
- Building configuration. Corners of the building have higher negative wind loads. Setbacks create local turbulence, which varies wind force on localized areas of a facade.
- Other considerations such as stack effects, internal pressures created by mechanical systems, and wall openings, can amplify or reduce the effect of wind loads.

### **Seismic forces**

Earthquakes cause shear and racking forces. In high-seismic areas, you must produce criteria for adequate ductility and strength of members and anchors.

### **Factors of safety**

Structural design of curtain-wall members and anchors includes factors of safety to provide more reliable performance in design conditions. Factors of safety vary depending on the reliability of the component and the consequences of its failure. These factors range from about 1.7 to 2 for aluminum framing members and can vary widely for anchors and fasteners. American Architectural Manufacturers Association guidelines suggest a proof loading of 1.5 times the design wind load for mock-up test conditions. Industry standards provide factors of safety for infill materials and proprietary anchors.

*Continued on next page*

*Continued from previous page*

### **Deflection limits**

Consider deflections of all members and glazing materials for the serviceability of the component. The American Architectural Manufacturers Association suggests limiting out-of-plane deflection of glass-supporting members to  $L/175$  although some designers reduce permitted deflection to  $L/240$ . Framing for infill stone requires much more stringent limits.

### **Isolating building movements**

Make sure that the building structure's movement does not put loads on the curtain wall. Identify the following movement criteria in specifications. You may also want to show anticipated movements on drawings:

- Isolate deflections of the building structure from the curtain wall by the design of curtain wall anchors and joints. Typically, vertical supports are anchored to a building at edges of floors. Two types of designs allow for differential movements: gravity and lateral or tieback anchors. Gravity anchors carry both vertical and horizontal loads, while lateral anchors carry only horizontal loads and permit independent vertical movements of the wall when it or the building moves. Each vertical structural component is attached with a gravity anchor at one floor and lateral anchors at the other (s).
- Account for creep and shrinkage of concrete, and elastic shortening of both steel and concrete structures, especially on taller buildings. The structural engineer should determine the magnitude of potential movements.
- Interstory drift is the relative horizontal displacement of two adjacent floors caused when the building receives a lateral load. Drift is most pronounced on highrise buildings. Structural design should specify the magnitude of interstory drift.
- Building settlement rarely impacts curtain walls, except in long buildings or those with two structures on different foundations.

### **Tolerances**

Because curtain-wall tolerances are typically much tighter than those of building struc-

tures, it is not only important to specify these tolerances, but to anticipate them realistically in the design. Generally structural tolerances are accommodated by slotted anchors and/or temporary erection connections, which can later be permanently fixed. The combination of tolerances of structural and curtain-wall materials is complicated; therefore, coordinate early to assure that the allowances are sufficient.

### **Temperature**

Design joints and anchors for expansion and contraction of the curtain wall due to temperature changes in combination with other movement criteria. Base temperature ranges on surface temperatures of the curtain wall, which can be much higher than the ambient air temperature, especially for dark-colored curtain walls.

### **Submittals**

Through submittals, contractors demonstrate their intent to meet performance requirements. Specify submittal requirements, which may include shop drawings, structural calculations, samples, mockups, test reports and sample installations. While a structural engineer should calculate and design the load-carrying components of the curtain wall, including framing members and anchors, material suppliers sometimes do engineering design of infill materials. Calculations should also verify the capability of the curtain wall to accommodate movements, including those of sealant joints, which should be designed for the movement capability of the selected sealant product.

Testing is often warranted to confirm the structural performance of the curtain-wall assembly. Many manufacturers have tested their standard assemblies. Modifications to a standard system or use of a custom system may make a project mockup test advisable. Structural tests of curtain-wall mock-ups are usually performed in accordance with ASTM E-330 or ASTM E-1233, which replicate single or repetitive cycles of positive and negative wind loads on the building. ■

## **Computers: Keeping It Simple**

*By John Hughes*

There is a widespread belief that CAD only benefits large firms, which can afford the high cost of the most sophisticated systems. The fact is any firm that understands the reason for using a word processor instead of a typewriter should be able to afford the leap from manual design to CAD.

Co-partner Ralph Gillis describes New York-based Gillis Associates Architects as "an old-fashioned, traditional firm." But, despite its five-member size, the firm designs large-scale corporate projects as well as individual houses. It credits CAD with allowing it to capture the big commissions, citing production speed and efficiency, and more time left over for design and client services.

### **Looking for a simple system**

Before it bought, the firm spent two years looking at CAD demonstrations and listening to salespeople discuss features of power and speed, and what they cost. "We began to think we were shopping for a stereo," says Gillis. The firm was then looking for simple technological solutions to common drafting problems while salespeople touted such endless CAD features as networking, drawing databases, and repetitive-work aids and standards, calling them "essentials." The superfluity of information and products was daunting. Gillis recalls: "I had to talk CAD with everyone and anyone, everywhere and anytime, until I found someone who offered a package that was compatible with our way of working."

The search ended in 1988, when Gillis contacted Tony Wildrick, a CAD instructor at the Ringling School of Art and Design in Sarasota, Florida. Said Wildrick: "If you can't draw more quickly, and make more money using CAD, then forget it." He seemed to be talking Gillis's language.

With 20 years' experience as a design architect behind him, Wildrick had developed Design Options, a tablet-and-menu system, which is one of the products on the market that allow architects to work close to the

*Mr. Hughes is a freelance writer based in Fort Collins, Colorado.*



## *A small architectural firm takes on big projects while keeping its computer costs low.*

way they did with traditional methods. In addition, Gillis says, makes better design. Wildrick used AutoCAD as the base program for his package because it is popular, flexible, and works on PCs.

Wildrick believes that CAD economics are justifiable only when the hardware is affordable. "One high-priced, high-powered workstation cannot possibly be faster than two or three people working on separate, slower machines," he says, noting that most firms are able to afford his goal of replacing all drafting boards with PCs."

Gillis Associates was able to make the complete transition to CAD with common mailorder 386 PCs and readily available AutoCAD software. The cost was minimal for the initial equipment needed. Convinced of Wildrick's common-sense approach, Gillis hired him for one week of on-site training. "After two days, we could draw," says Marcia Previti, the firm's other partner. "And we still felt like architects in the bargain." Once the decision was made, the commitment to CAD was 100 percent. The firm invested the time and energy to get all its architects started on the new system, train new staff members, and keep up with software upgrades.

### **The CAD acid test**

Gillis Associates' reward came shortly after its transition to CAD when the firm landed a commission to design six floors of interiors in the Pan Am Building for the law firm of Rogers & Wells. Client partner James Ringer notes: "One compelling argument to choose Gillis was having experienced architects working on the job instead of para-architects or junior staff." This confidence paid off. "We are proud to say," adds Ringer, "that we've somehow managed to finish, so far, two floors on budget and on schedule, which I was told when we went into this was a total impossibility."

The Rogers & Wells experience was a testing ground for Gillis Associates' CAD implementation. The first good thing the architects found was easy access to needed information and the ability to explore options. In design, they could quickly explore alternate plans—so many, in fact, that they

produced 26 fully developed schematic options in two days for the lawyers to evaluate. They found translating conceptual sketches into preliminary drawings no faster than by hand, but no slower either. As the architects worked on the schematic designs, they found that even on PCs they could form a base for the final construction drawings, eliminating the need for much re-drawing. Drawings of similar areas were produced by duplicating one of them and simply moving the parts around or editing them to get the others. Gillis notes that the drawings could even be adapted to suit other projects and that, in fact, every part of every drawing has the potential to be reused. The potential for time savings will grow dramatically over time. "Nothing you ever draw in CAD is obsolete," says Previti.

CAD also helped keep the project team accurate and current. In response to Rogers & Wells' specific requirements, libraries of standardized elements such as filing cabinets were developed early in the project and brought into the schematic drawings to test how well each plan worked. This saved time pursuing unworkable ideas. "It was like having infinitely flexible templates to place anywhere on a drawing," says Gillis.

While trying to keep things simple, none of the architects disputes the benefits of external database programs and other sophisticated applications for automating specific complex procedures. For instance, a database gives any member of the team working on a CAD file complete access to all decisions made to date. The design information is intrinsic in the drawing file, which in the law-firm case meant that, when Gillis decided to make the corridors six-feet wide and give them a complex plan (photo), this information was embedded in the drawing files without having to redraw each plan.

### **A look ahead**

Gillis Associates' CAD implementation continues to become more advanced. The firm has installed a local area network, which allows each architect to access data on any machine or to reference work on any project immediately. A Lantastic peer-to-peer network operating system connects all PCs without requiring a separate central server.

*For lawyers Rogers & Wells, the architects designed corridors with complicated intersections on a 3-D system and showed clients the results with overlay sketches.*



The firm is also looking at new developments, such as 3-D modeling. A computer model offers infinite perspectives for an animated walk-through or fade-dissolve slides that can be made with no more effort than a conventional cardboard study model. "We are trying to verify 3-D modeling's cost-effectiveness," says Wildrick. "The same guidelines will apply: If it can't make money, it's just an expensive toy."

One justification for the cost of 3-D, of course, is ease in showing clients what a design looks like. With such issues as the number of steps from one space to another quickly resolved by computers, Gillis feels 3-D would be able to focus clients' attention on the quality of the spaces created, lighting, proportions and other aspects that will make design better.

Gillis is so committed to computers now that he feels any indecision on using them by the architects in his office will completely undermine the effort. He appreciates that CAD gives his office a significant competitive edge—at least for now. But, he thinks that it will not be long before most clients will insist on CAD, for the tight scheduling and cost monitoring it makes possible. The design process will be shorter because architects will be able to communicate design ideas easily. And better communication, Gillis says, makes better design. ■

## AutoCAD 11 for Windows

For more information circle item number on Reader Service Cards.

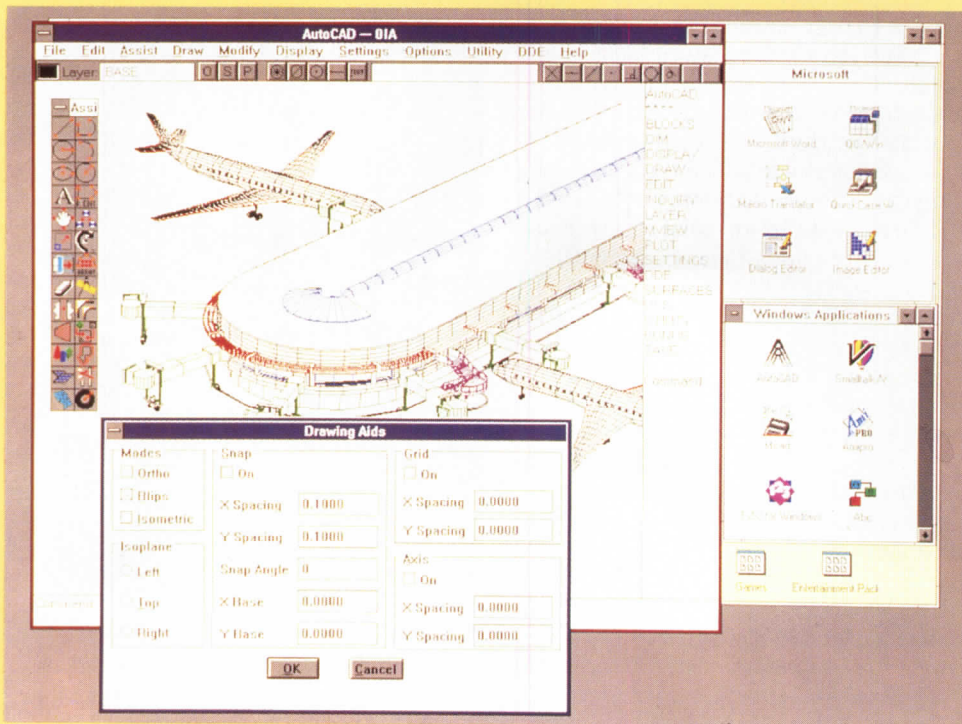

The diagram of an airport terminal shows the flexibility of AutoCAD 11 running in the Windows environment. Customers are able to resize and reposition the AutoCAD window at will, thereby taking full advantage of the friendly AutoCAD for Windows graphical user interface.

With this "extension," owners of AutoCAD Release 11 for MS-DOS and PC-DOS computers can add the ability to work in Windows as well. The price in the United States is only \$99, on top of the cost of AutoCAD 11 itself. Autodesk calls it an "extension" because you need the personalized installation disk from the DOS version of AutoCAD to install it. You cannot use the extension unless you have the original program.

Aside from the Windows interface itself, the Windows extension adds access to the Windows clipboard. The clipboard can transfer the on-screen image to a Windows metafile (WMF) or Windows bit map (BMP) file. From there, the image can easily be included in a word-processed or desktop-published document, or in a graphical presentation.

The Windows extension also supports DDE—dynamic data exchange. Thus, you can use Windows to link AutoCAD and an external database, perhaps one stored in an

Excel spreadsheet. Change the spreadsheet and you can change the data in the drawing—great for bills of materials. DDE also can be customized in more specialized ways, using a programming language such as C, or any one of many more graphical programming tools.

Some other Windows features, such as the ability to load multiple versions of an application into multiple windows, will not work. Nor will the Windows extension support the Multiple Document Interface.

Your old AutoLISP scripts should work. But ADS applications and ADI drivers must be replaced with Windows-specific versions.

Finally, the on-line help is terrific. And the menu system allows you to easily get away with a mouse instead of digitizer in most architectural applications.

On the downside, the Windows version is much slower. This is mainly due to the fact

that current versions of Windows are 16-bit (that is, they process data 16 bits at a time); the DOS version is 32-bit. How much slower? Our estimate is about half the speed of the DOS version. Note, however, that there are graphics-accelerator cards available for Windows for as little as \$400.

This release of the extension does not allow concurrent-use network licensing, even if your office is set up that way now under DOS.

Make sure you get the Windows extension in the same disk size as your AutoCAD 11 for DOS. To install, you will need to temporarily place the personalized installation disk from the older program into the drive from which you are installing the Windows version. **Circle number 309**

### AutoCAD 11 summary

**Equipment required:** A computer capable of running Windows 3.0 or 3.1 in enhanced mode (80386SX or newer CPU chip), 4 MB of random-access memory (6 MB or more strongly recommended), and 7 MB of free disk space—19 MB if you want to use the extensive on-line help and reference manual. That's on top of the disk space needed for AutoCAD 11 itself if you want to continue using it in DOS as well as Windows.

**Vendor:** Autodesk, 2320 Marinship Way, Sausalito, CA 94965. Phone 415/332-2344, fax 415/331-8093. \$99. Free if you purchased your AutoCAD between November 15, 1991, and April 30, 1992, or if you upgrade to Release 11 from earlier versions between February 1, 1992, and May 31, 1992.

**Manual:** A 185-page installation and performance guide. It is assumed that you already understand AutoCAD—and Windows. The on-line manual is excellent.

**Ease-of-use:** It is easier to use. The Windows standard interface is followed fairly well.

**Error-trapping:** As good as Windows itself, which means not perfect (we tested the software with Windows 3.0; Windows 3.1, just appearing, promises to be more stable).

# Architron II PC/MS

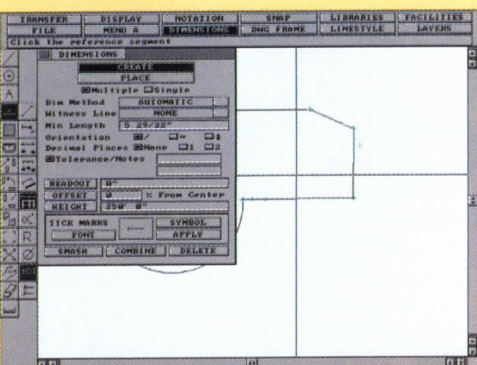

When you draw in 2-D, you set the third axis dimensions with dialog boxes.

Over the past half dozen years Architron has become one of the most popular modeling and drafting programs available for the Macintosh. Now it is available for computers running MS-DOS or PC-DOS as well. Although the menu structure is a bit different, the drawing tools are quite similar. So is the "modular" feel of the software—separate modules for 3-D designing and 2-D drawing, and for creating a bill of materials. There's also a font editor. Within each module there are submodules with separate menus.

The modular approach is probably the biggest drawback of Architron—you cannot move seamlessly from 2-D to 3-D and back. But in exchange, the software rewards you with very fast on-screen response while actually drawing.

Shapes that are irregular in the Z direction are still a bit tricky—detailed sloping roofs with dormers, for instance—but can be managed more easily than with versions 4.0 and earlier on the Macintosh.

You can set and reset views of your 3-D model, write macros for repetitive tasks, check solar effects and shadows.

Why the DOS version instead of the Mac version? Base your choice mainly on the availability of equipment. Files can be transferred between the two platforms in Architron's own "text" format. Files can also be imported and exported in DXF format, to and from AutoCAD and other CAD software.

Circle number 310

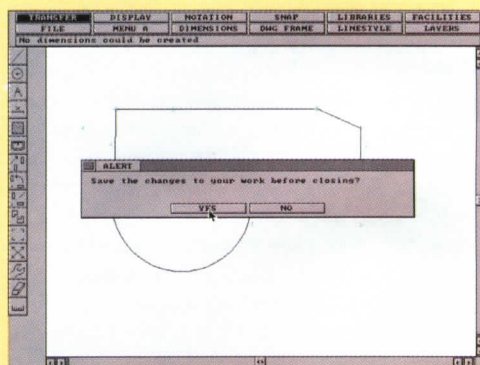

Moving between modules requires saving your work. Architron tells you to do so.

## Architron II summary

**Equipment required:** Computer running DOS 3.3 or higher, 2 MB of random-access memory, fixed disk, high-density floppy drive, and compatible display (not all VGA cards will accept display list management, for instance). A computer equipped with a 386SX or better CPU is recommended.

**Vendor:** UNIC, 1330 Beacon Street, Suite 320, Brookline, MA 02146. Phone 617/731-1766, fax 617/731-8089. Single copy: \$3,950; a service contract is \$800 per year for unlimited calls to a toll-free 800 number. The discount is 50 percent off on a second copy, 60 percent off on additional copies. Until June 30, if you have any other CAD package, its cost will be rebated, up to \$1,000.

**Manuals:** Good. There are two "user" manuals with tutorials for each module, and a reference manual. Aside from the inevitable learning curve for the software itself, you will need to know a few things about DOS, such as directory and path names, and how to modify your CONFIG.SYS file.

**Ease-of-use:** There are lots of terms to learn before you can use the software to full effectiveness. Most users tend to work in 2-D and then move to 3-D, rather than roughly modeling in 3-D and going to 2-D.

**Error-trapping:** Good. It is difficult to lose files. The DXF translator is quite robust, but not perfect. Some warnings are not only printed on screen, but accompanied with sound effects.

# JetPro Series Model V100

The Houston Instrument side of Summagraphics is introducing an interesting new printer-plotter this month (May 15). The ink-jet device can produce a complex 360-dot-per-inch C-size drawing in under five minutes. The trick: The computer sends a relatively compact vector file to the printer, and the printer then turns the vector file into a raster image, so that it can guide the sweep of the print head.

The device can handle HP-GL/2 plotter files, or the less compact HP-GL standard along with Houston Instruments' own DM/PL. It can also handle PCX files (from fax boards or paint programs such as PC Paintbrush), TIFF, RLC, and CALS Group 4 images. The printer itself scales drawings to B or A size sheets. It can also emulate an IBM ProPrinter.

A demonstration in early April showed the JetPro to be quiet as well.

Circle number 311

## JetPro summary

JetPro V100, \$2,995 with 2 MB of random-access memory; 2 MB more can be added with standard SIP boards; Summagraphics will also sell the memory upgrade. Large ink cartridges, good for up to 500 C-size plots, cost under \$30 each. The device accepts serial or parallel input, roll-feed or sheet-feed paper. Summagraphics, 60 Silvermine Rd., Seymour, CT 06483-3907. Phone 203/881-5400, fax 203/881-5367. ■

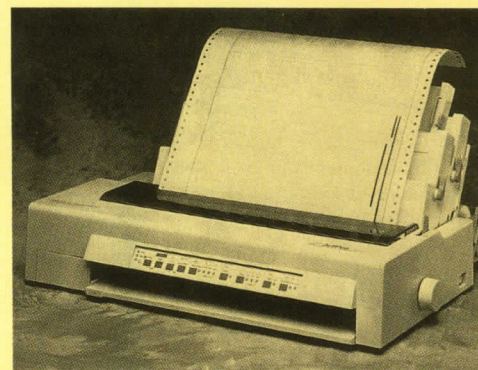

Detail of V100 sample output.

## Beyond Writing on the Wall

By Donald J. Canty

Building signage, or "signing," the current term, used to be a simpler process. The architect looked in a typebook for an appropriate letterform and applied it to the building. As often as not the letterform was Helvetica, that crisp and versatile (and bland) sans serif typeface. (In the 1970s a critical article on building signing was titled "The Tyranny of Helvetica.")

No more. Today, a bewildering variety of signing techniques is in use, many involving symbols and sculptural forms to augment or even displace language. New technologies are being introduced constantly. The typebook itself is all but obsolete: letterforms can be invented or modified at will.

### Enter environmental graphics

A new discipline has emerged called environmental graphic design, and its practitioners

*Mr. Canty is architecture critic for the Seattle Post-Intelligencer.*

are claiming a larger role than just directing traffic. Traditional sign systems have been "concerned with routes rather than places," wrote Jock Kinneir in his book *Words and Buildings*. But, he cautioned, "labeling a place is not the same thing as giving it character." Many environmental graphic designers see the imparting of character as their true role. One designer traces her art to "the Egyptians, the Zuni Indians, the cave paintings at Lascaux." Closer to home, another designer points to Boston's Faneuil Hall and other festival marketplaces as having opened the door to new techniques in signing. "They brought historicism to graphics just as Postmodernism brought it to architecture. They revived the use of symbols and showed that signs themselves could be varied and lighthearted instead of just pristine and tasteful."

Further narrowing the target, one designer points to the demands of the healthcare industry. Signing has always had an especially critical role in health facilities, where getting

to the right place fast can be a matter of life and death, and where patients encounter the environment when they are especially vulnerable. As health care has become more privatized and hence more competitive, signing has become a marketing tool. "The impact of signing on the consumer often has been underrated," Ritch K. Eich, client for the Butterworth Hospital program described on page 48, wrote in an article for his fellow hospital administrators. "The result, especially for the elderly, hurried, or extremely worried, is often disorientation, stress, and sometimes even embarrassment. All of which doesn't make for a very positive first impression of a place that is supposed to help make people feel better." Healthcare has joined retailing as a generator of ever more sophisticated graphic systems. At their best these systems are efficient, even eloquent, conveyors of information about where people are, where they want to go, and how to get there. But sometimes this basic wayfinding function is lost in displays of graphic technique used for its own sake.

### The Louvre Carbone Smolan Associates

Museums are among the most prestigious and difficult signing commissions, requiring a sense of permanence and stature despite constant flux. The Louvre challenged designers Carbone Smolan Associates, chosen in an international competition, to redo its signing as part of ongoing renovations that include the I. M. Pei-designed pyramid. Plans call for its entire collection to be moved over the next 10 years, so the signing had to both identify an array of spaces and circulation paths for extremely heavy (multi-lingual) traffic, and remain flexible for future changes.

The pyramid itself raised a dilemma: the signing had to be at home both with the sharply Modernist pyramid and with buildings dating back to the 16th century, erected for the Louvre's first use as a palace. The designers decided to treat the great museum like a city. Each of its three wings (Sully,

Denon, and Richelieu) was divided into 10 "arrondissements." The task of signaling the locations of individual collections and works, which would have required constant changes in signs, was left to hand-held paper guides distributed to visitors. A simplified version of the museum's plan was developed both for the guide and signs.

Locations within the museum are identified by *letter* for wing and *number* for arrondissement. Emile J. Biasini, in charge of the project for the French government, noted that the system was "just like a city, in which the buildings on a street may be replaced but the street numbers remain the same." Wings are identified by large metal letters on hanging glass signs, whereas other signs are carved in marble. Pictographs are on frosted glass and directional signs are sandblasted steel, aluminum, and glass displayed on posts and pedestals. The type face throughout is Granjon, a 17th-century design chosen because it is elegant, delicate—and French.

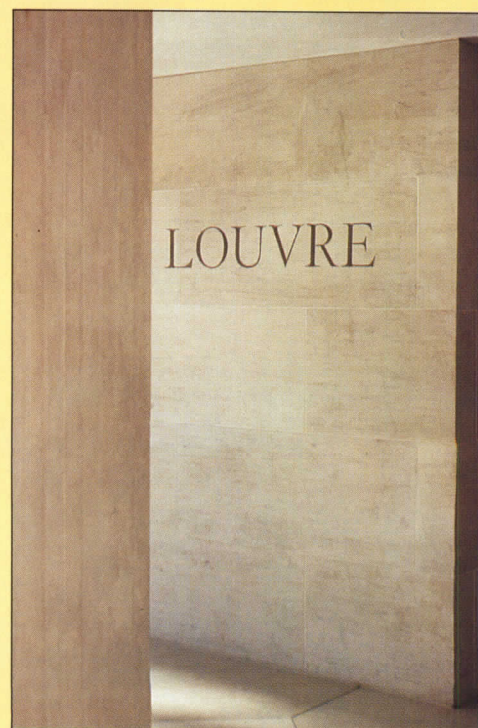

*Not just signs and symbols, environmental graphic design is expanding the ways architecture and signing work together. Six case studies show how.*

### Design mission

Environmental graphics is indeed fulfilling a design mission. Architect Richard Orne of The Jerde Partnership sees it as a field that can help attain "more intelligent urban forms." It is "beginning to address the issues of the spaces between buildings—those elements that are larger than a sign but smaller than a building." He sees the designer as an "urban scriptwriter" whose messages help shape the uses of the urban environment.

The most dramatic urban-scale application of environmental graphic design, and the event that gave it prominence, came with the 1984 Los Angeles Olympic Games. The organizers decided against a major building program. Instead The Jerde Partnership, architects, and Sussman/Prejza, designers, festooned 28 athletic sites, 42 cultural venues, and three athletes' villages with vivid graphic elements, fusing bright colors with fabrics and papers to establish a highly visible signature.

### Collaboration with architects

Collaboration between architects and environmental graphic designers has grown since then. Interested architects can seek information through the Society of Environmental Graphic Designers, a national organization based in Cambridge, Massachusetts. Designers interviewed for this article agreed on one point: their services are most valuable if they are brought into a project early on. Said one, "Only if we come in at the beginning can our work and the architecture really complement each other." Consensus is that building signing should be integral to the architecture, not something "tacked onto it," in the words of one designer. In purest form, this synthesis is achieved by carving signs into the walls, but it is also possible with the choice of appropriate sign materials, finishes, and colors. Similar coordination is important between lighting and graphic design.

### New technologies applied

The growth of techniques and media is

straining the supply of craftspeople who work with such materials as decorative metals and stone. Signing technology is also changing rapidly, especially with computers, which can process interactive graphics and animation with increasing speed. Laser engraving has been used to impart pictorial images to wood, but is now being studied for commercial uses in combination with other materials. Fiber-optics are being employed with gels to produce signs of unusual brilliance, a process that may displace neon. New methods are being investigated for television and video, already widely used in signing. One method is tele-optics, which allows viewers at various locations to receive different messages at the same time from a single source.

Below, RECORD examines six large-scale projects—Disney World, the Louvre, Rockefeller Center, a huge office park outside Dallas, a Michigan hospital, and a Seattle retail center—in which environmental graphic design strikes a unifying chord.

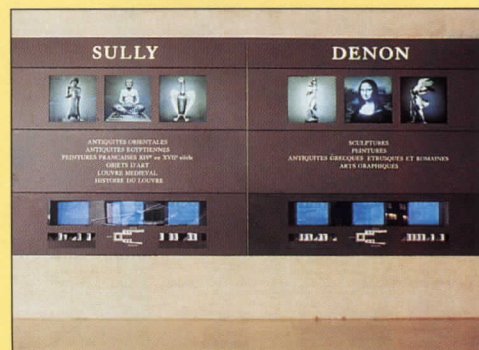
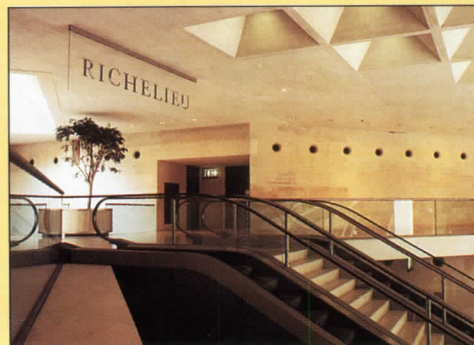
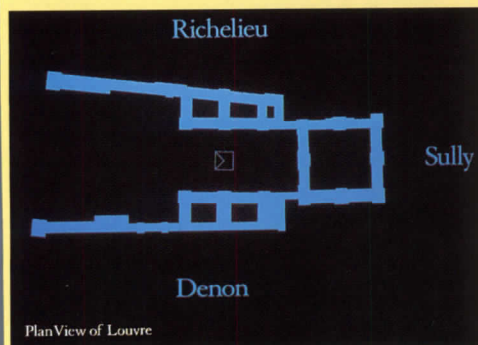
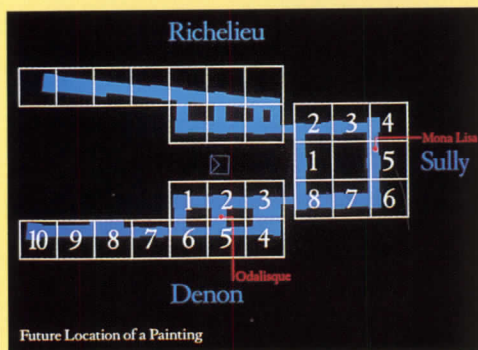

**Solana  
Skidmore, Owings & Merrill/  
San Francisco; Debra Nichols**

Solana announces itself from a distance, not by its buildings or signs but by a set of landmarks: pylons in vivid tones of purple, magenta, and yellow. Similarly, the most striking elements of the graphics program are landmarks rather than directional signs. Despite the project's vastness and the involvement of several architects—Ricardo Legorreta, Mitchell/Giurgola, and Barton Myers—this 900-acre office park near Dallas/Fort Worth Airport is surprisingly well-knit, thanks in part to a consistent graphics program by SOM's San Francisco office (Debra Nichols, team leader).

The large graphic elements had to be interesting as well as attractive, rather than merely transmitting detailed information to the thousands of workers who come to Solana every day and vastly outnumber visitors. Nichols, who has since started her own

office in San Francisco, turned for inspiration to Southwestern folk art. Major intersections are marked by brightly colored images of a wolf, a steer, or a horse; secondary intersections have a blue jay or an owl perched on posts. All are animals found on the nearby prairie; they are made of painted cut steel and oxidized bronze.

The Solana buildings are set back from the road by means of individual driveways. So Nichols used another Southwestern precedent in identifying them. "On a hacienda," Nichols explains, "the family's name is on the front gate," rather than on the dwelling. At Solana, building signs are displayed at the entry drive, not on the walls. Interior signs make use of Southwestern colors and materials, including much tile and metal grillework.

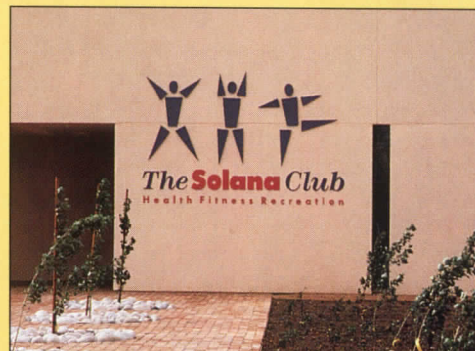

© Wes Thompson photos

**Pacific First Centre  
Rees-Thompson**

Pacific First Centre is in the retail core of Seattle and was designed to be more than an office tower with shops at the base. From the start it was conceived as a true multiuse project as varied in function as an enclosed downtown neighborhood. To this end, the Callison Partnership, architects, put the building's public spaces inside rather than out, partly due to Seattle's damp climate. One enters these spaces via three 72-foot rotundas. The public areas occupy three levels apart from the office lobby and cut diagonally through the building to link other downtown activity nodes. Within this space the firm of Rees-Thompson—which once described its services as graphic design, then environmental graphics, and now environmental design—has created a sparkling series of visual "special effects."

Rather than do a conventional marquee announcing the presence of cinemas, a neon

artist was commissioned to do a sculpture. Other large sculptural pieces signal the entrances to the retail space in the rotundas. Directories are framed by stone fragments from an old theater demolished on the site. Through such devices the designers influence movement of people by other means than simply pointing the way. "We try to slow them down and get them interested in what is going on," says principal Paul Rees. "Another way to put it is that we place greater emphasis on creating destinations than in giving directions."

This approach depends on small touches as well as large objects. Colorful tiles mark the floor levels with both images and numerals. And even the code-required warning against using elevators in case of fire is made a spirited graphic.

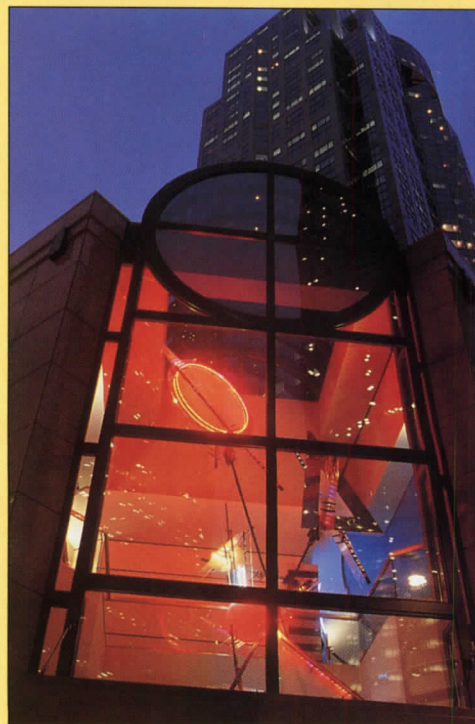

Fred Housel photos

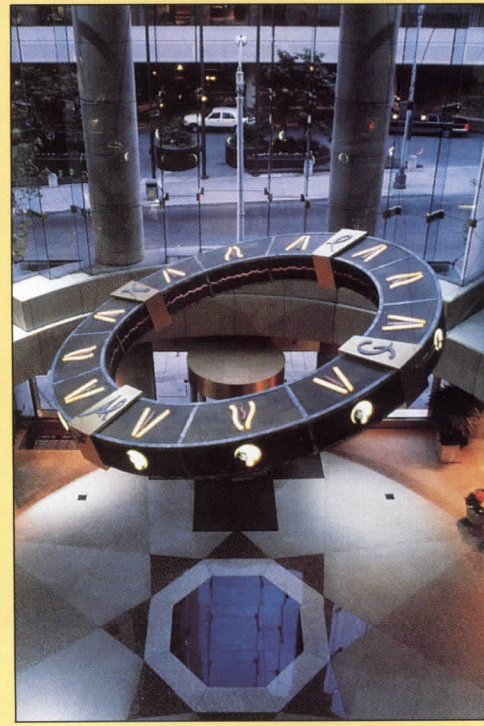
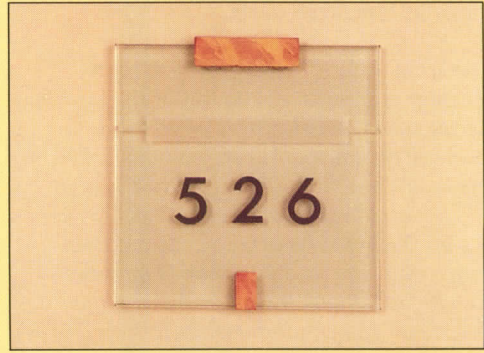
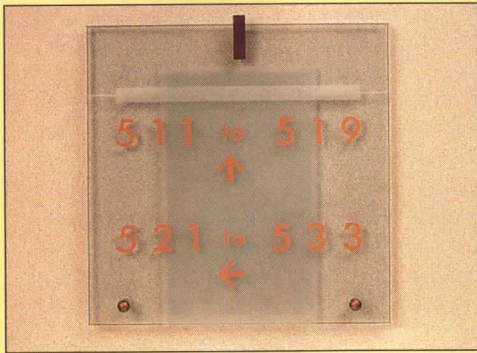
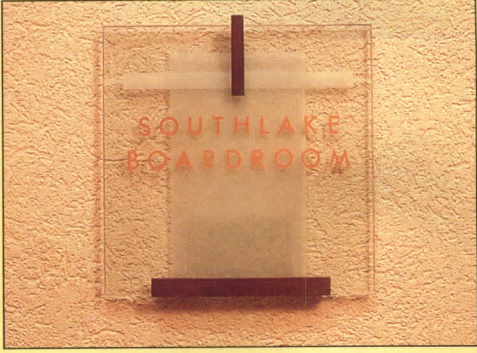

**Butterworth Hospital  
Corbin Design**

Butterworth Hospital in Grand Rapids, Michigan, like many such institutions, is a collection of buildings accreted over time. Directional signing was never standardized and tended to refer to the buildings by name, which meant little to patients or visitors since the buildings were hard to distinguish from one another. Even more confusing, some floor levels were noncontiguous; the fourth level, for example, had three unconnected parts.

Designer Jeffrey Corbin, charged with forging order and clarity out of the informational chaos, decided first to treat the hospital complex as a single building for purposes of circulation. His approach was to move people horizontally as much as possible on the lower, contiguous floors, then move them vertically to their destinations. To this end, lobby directories depict only the first floor. Maps, produced on film strips for

ease of change, illustrate parking, points of entry, major corridors, and elevator banks. Below the maps are listings of all hospital facilities, first by elevator bank and then by floor. These also are on film strips.

In each elevator lobby a 24-in.-square glass fiber sign tells the floor number and building location. Banks are designated by the letters N, S, and W (there are, for examples, 4W, 4S, and 4N banks). These signs are hung from the ceiling to be visible from as far as possible, and are illuminated by the ceiling fixtures shining through them. Each elevator bank also has a directory containing a map of its floor, a listing of all facilities on it, and a listing of all other destinations in the hospital that can be reached from those particular elevators. Facility listings are on easily moved strips. Throughout Corbin sought to use "clear and simple language, conventional and courteous, and graphics that are direct and to the point," especially important in a place where users are under the most stress.

© D. Floeter

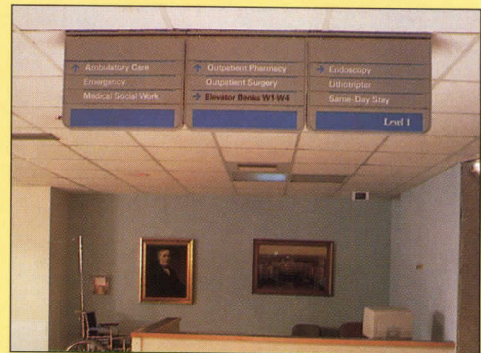

**Rockefeller Center  
Heery International**

Rockefeller Center's monumental buildings are unmistakable from a distance, or even from across the street. But deteriorated sidewalks and entrances in the six-block complex marred its Depression-era public face, prompting management to hire Heery International to develop a comprehensive renovation program. A team from Heery led by Scott Drees made an exhaustive study, noting identifying features at each building that also unify the entire complex at ground level. The first addition comprised some 130 new trees spaced along the Center's side streets, set in diamond-shaped tree surrounds derived from existing elements. New entrance canopies and address plaques using familiar materials, such as bronze and polished granite detailing, also had to blend with the sidewalks and landmark buildings yet stand out enough to inform the crowds of tourists and office workers that pass through Rockefeller Center daily. *P.D.S.*



Richard Gore

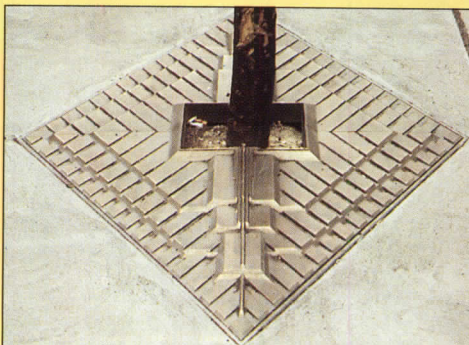

Bo Parker



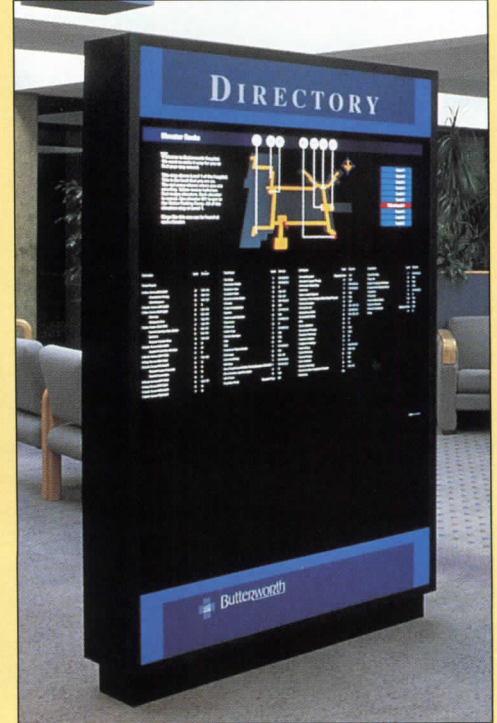
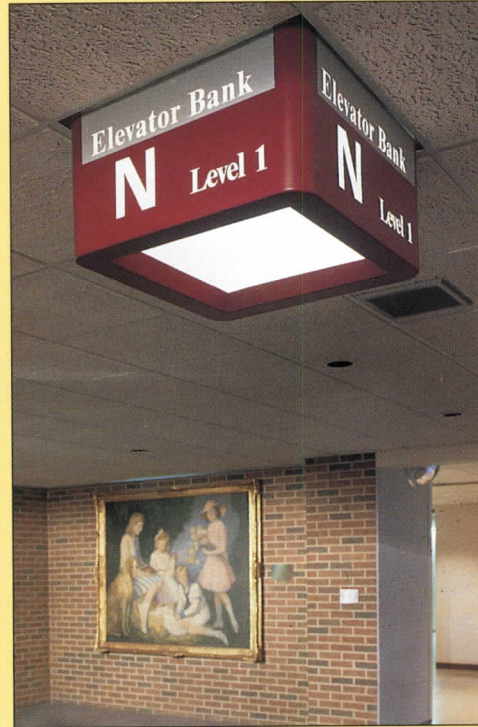
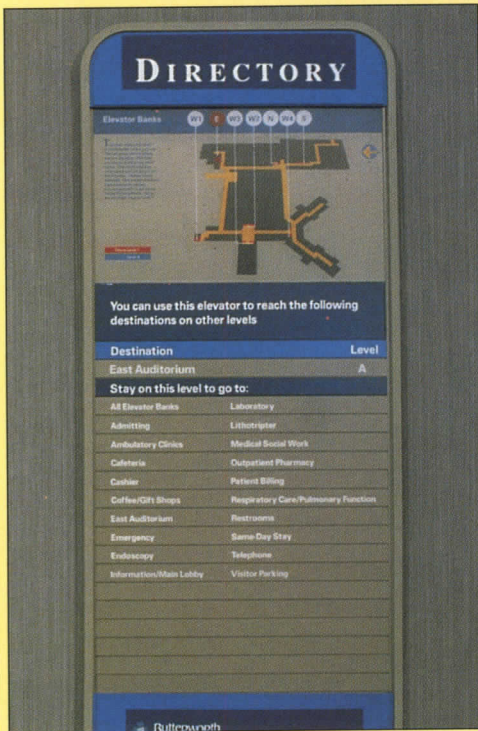

## Disney World Sussman/Prejza

Beginning with the premise that “there is the world and there is Disney World,” Deborah Sussman of Sussman/Prejza, in her signing scheme for the roads that lead into and connect the elements of Disney World, used the common threads of entertainment and escape embodied in Disney World’s most prominent resident. On the way into the complex, pudgy fingers reach over the highway signs; next, round black ears appear, followed by a pair of wide eyes. To organize the project’s 700-plus elements, Sussman/Prejza divided Disney World into districts, then established sign categories for each before developing specific physical elements. Univers, the dominant typeface, was chosen because it allows a wide range of variations in size and weight. The designers have now been asked to do a visual identity program for the entire Disney organization, a reverse of the usual process, in which signing is derived from an existing identity. ■

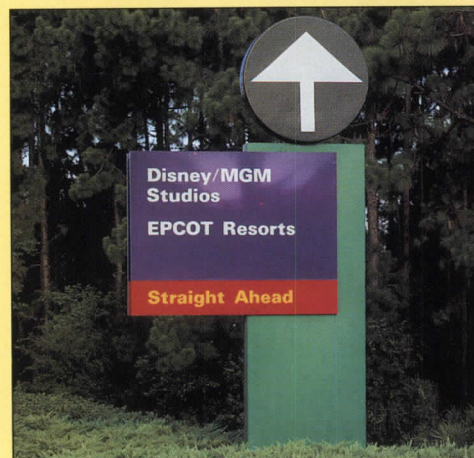

© Timothy Hursley

## The '80s as Spectacle

**Exquisite Corpse: Writings on Buildings,** by Michael Sorkin. New York: Verso, 1991, 365 pages, \$35.

*Reviewed by Kurt Andersen*

It is now fashionable to repudiate and decry the 1980s. Yet as pure spectacle, the decade is hard to beat: the rise and fall of Postmodernism, the rise and fall of Deconstructivism, the rise and fall of Donald Trump, the emergence of Disney as the great patron of the age and, as ever, Philip Johnson. Nobody provided a more entertaining and intelligent play-by-play than the critic Michael Sorkin, whose 55 pieces from *The Village Voice*, *RECORD*, and elsewhere have been collected in *Exquisite Corpse: Writings on Buildings*. Rereading Sorkin—nervy, wisecracking, manic, eloquent—is enough to make one nostalgic for the go-go era he so loathed, if only to experience his joyful, passionate loathing in real time.

Especially during Postmodernism's ascent, it was good to have such a sharp, with-it naysayer regularly in print. His critique was consistent, coherent, early, and unequivocal. "It is the architecture of appliqué," he wrote of the AT&T Building in 1978, "a building of words with no syntax. Not to put too fine a point on it, the building sucks." Writing about one of Michael Graves's proposals for an addition to Marcel Breuer's Whitney Museum, Sorkin sounded personally wounded, as if it were 1930 all over again: "There are major axes and minor axes, chambers and antechambers, portals and vestibules, the whole. . . Beaux-Arts apparatus against which modernism rebelled."

Not that Sorkin forgives the rebels' descendants their own smugness and neuroses. Richard Rogers's high-tech institutional buildings "represent the apogee of some kind of Victorian optimism," Sorkin points out, and he doesn't mean it as a compliment. About the exposed, color-coded pipes and ducts in a new Rogers office building, Sorkin is merciless and astute: "[W]hat a fine moral for the modern age it is! Useless information marshaled with bone-headed rigor signify-

ing nothing beyond the act of signification."

His ridicule isn't indiscriminate: in fact, Sorkin is downright reverent toward almost any Modernism that's perverse or visionary, dark or grandiose—Paul Rudolph and John Hejduk and *Archigram* are his heroes, Coop Himmelblau his good pals. What is consistent is his reflexive rebelliousness; the idea of a powerful architectural establishment keeps him almost perpetually, giddily angry. And so for Sorkin, Paul Goldberger and Philip Johnson are demons, and denouncing them something like an ecstatic religious ritual.

Nobody is a better troublemaker than Michael Sorkin. But when he writes about architects he admires, he can stumble, sounding like some credulous undergraduate, brimming with naive enthusiasm and mushy prose. On a Coop Himmelblau bar: "The (self-) exterminating angel has (roll over Beethoven. . . ) become the angel of sound. While the wing has not exactly become domesticated, interiorizing the angel both constrains and frees it."

The lapses, minor and forgivable, are evidently a function of fatigue. "Writing this column gets harder and harder for me," he confessed in the *Voice* in 1987. "While my dismay at the current course of events is undimmed, my passion to denounce is ebbing; I'm enervated by irony." A year later, Sorkin abandoned journalism and returned fulltime to the practice of architecture. His writing was terrific, nearly perfect for its time. May his buildings be as good.

© Wolfgang Hoyt



Two of Sorkin's favorite targets: Philip Johnson and John Burgee

**Aldo Rossi: Architecture, 1981-1991,** edited by Morris Adjmi. New York: Princeton Architectural Press, 1991, 300 pages, \$60.

*Reviewed by Scott Gutterman*

This splendid monograph charts the progress of Italy's premier architect since he "went international" with a winning design for the Friedrichstadt complex in Berlin. The projects presented here are rendered in Rossi's now famous Neo-rationalist style and this clear-eyed, timeless approach often yields memorable results. In particular, the architect's trademark use of the tower, as in the Town Hall (1983) for the Italian city of Borgoriccio, crosses the campanile with the smokestack to create a mysterious and engaging poetic-industrial archetype.

Rossi can work large- or small-scale with equal aplomb. The Via Croce Rossa Monument (1991) is a great work of Modern sculpture, bridging an ancient past and an uncertain future. At the other end of the spectrum, a low-cost housing project for Venice (1985) is elegantly plain in a way that so many blank-faced endeavors are not.

Rossi's most experimental work is in Japan, where he mixes styles freely and to good effect. Less successful are his attempts at regional architecture in the United States, including his labored School of Architecture at the University of Miami (1986), an awkward Pocono Pines House (1988), and the dour Disney Office Complex (1991). Only in a proposed art academy for the South Bronx is his gift apparent.

In the book's essays, Diane Ghirardo discusses Rossi's complex relationship with theater and memory, and Karen Stein elaborates on Rossi's use of architecture as a script for an austere drama. Both essays help explain his relative lack of success in America. Despite claims to internationalism, Rossi is a profoundly *Italian* architect. His buildings work best in a landscape filled with long memories. They play beautifully against the tragic pull of history, less well in the land of new beginnings.

*Scott Gutterman is a freelance writer specializing in art and architecture.*

*Kurt Andersen is the editor of Spy and the architecture critic for Time.*

**Archigram**, edited by Peter Cook, with Warren Chalk, Dennis Crompton, David Greene, Ron Herron, Mike Webb. Boston: Birkhauser Verlag, 1991, 144 pages, \$40.

Reviewed by Felix Drury

If you have forgotten or were not around to feel the explosive energies of the 1960s, the re-emergence of *Archigram*, one of the era's principal detonations, brings it all back.

It began with a small group of fledgling architects in London, working against the established attitudes and styles of 1950s architecture and publishing their criticism and proposals in occasional broadsheets they called *Archigram*. Although many participated in *Archigram*'s brainstorming and drawings, six men—Warren Chalk, Dennis Crompton, David Greene, Ron Herron, Mike Webb, and Peter Cook—formed the group's nucleus. Breaking open the architect's traditional relationship to society, this merry band of designers responded to life as they saw it being lived on and off the streets. The result was a series of architectural notions such as Plug-In City, Instant City, the Capsule, the Suitaloon, the Cushicle, and Manzak and the Electric Tomato.

The original broadsheets were assembled as a book in 1972. The current volume is a reprint of that book with an update by Cook, comments by Arata Isozaki, the late Reyner Banham, Hans Hollein, and Peter Blake, and short biographies of the original six.

Reading as a series of very loose, far-reaching and playful architecture-school master's theses, these projects relate to each other in attitude and tone more than as interconnected schemes. From personal environments modeled after space suits to housing units plugged into giant grids, the projects looked forward to a day when mechanization and individual choice would join forces. *Archigram* members saw the "space capsule" approach to architecture as both more accommodating and more sophisticated than traditional buildings. Such ideas might have become a heavy manifesto, had it not been

*Felix Drury is an architect practicing in New Haven.*

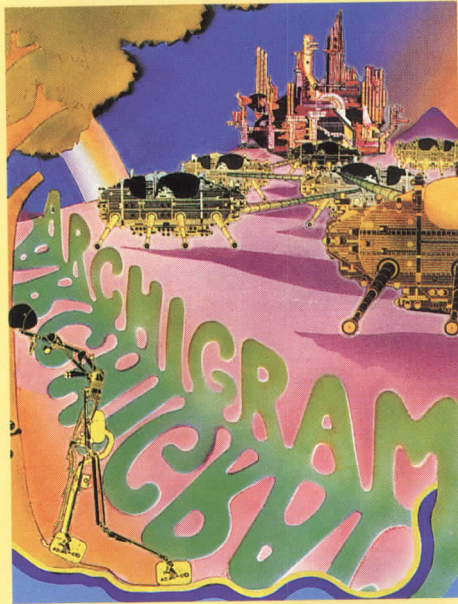

for the constant thread of humor and the bold comic-book graphics running through all of the group's work.

Like watching old home movies, reading *Archigram* now reveals a considerable novice behind the group's enthusiastic generalizations. By replacing everything familiar with a brand-new mechano-scientific environment, the architects certainly misunderstood the real desires and habits of the average person. While the lessons of the '60s may have gotten lost in the ensuing decades, *Archigram* reminds us of their promise.

**The Built, the Unbuilt, and the Unbuildable**, by Robert Harbison. Cambridge: MIT Press, 1991, 192 pages, \$25.

Reviewed by Nancy Levinson

In this era of ubiquitous mass media, when today's catchword is tomorrow's cliché, Robert Harbison has produced that rarity, a thoroughly personal and original book. *The Built, the Unbuilt, and the Unbuildable* is a lucid, provocative meditation on architectural meaning, on "some of the witting and unwitting means by which buildings evade functional necessities, or surpass them even while satisfying them." The writer of three previous books on architecture, Harbison pursues his theme "almost wholly through the extremest instances [of architecture] I

could find, those which violate ordinary logic and ordinary need, from a belief that the edges of a field are the best guide to the centre." These extreme instances, each discussed in its own chapter, are gardens, monuments, fortifications and ideal cities, ruins, paintings, and unbuildable buildings.

Harbison's examples belong mostly to the Western tradition, and range from such well-known places as Hampton Court, Versailles, the Statue of Liberty, and the Lincoln Memorial, to more obscure works like Thomas Tresham's Triangular Lodge and Hermann Finsterlin's expressionist fantasies. An intrepid interdisciplinary, he makes connections between Stonehenge and Claes Oldenburg's giant popsicle for Park Avenue, and between Mount Rushmore and the new Mississauga town center. He compares the "aqueous and transparent effects" of Philip Johnson's glass house with Monet's waterlilies, links the rationality of Ledoux with that of the Shakers, and imagines the fascination Piranesi would feel for the "landscape-ruin" of industrial New Jersey.

The work is concerned throughout with the impermanence of meaning. "If stones are not, meanings are perishable and mistakable, local to cultures which fade or undergo convulsive change." In the chapter on monuments, Harbison reflects that even so stirring a work as the Vietnam Veterans' Memorial will inevitably lose its original power "as the event it commemorates becomes less embarrassing and as survivors disappear who remember the people whose names it is made of." Someday "it too will become inert, commemorating something truly forgotten, except by historians or the historian in us."

This book offers no comprehensive theory or set of critical categories; nor do we miss them. Packed with historical details and fresh insights, it is more discussion than argument. Harbison's approach to architecture, his focus on the nonfunctional, is both Romantic and poetic. It may thus, he concedes, rub against the grain of a profession with strong practical tendencies. Perhaps, however, it won't; as this fine book suggests, such distinctions do not much matter.

## Briefly Noted

**100 Contemporary Architects: Drawings and Sketches**, selected by Bill Lacy. New York: Abrams, 1991, 272 pages, \$50.

As head of an architectural consulting firm and secretary to the jury of the Pritzker Prize, Bill Lacy casts a wide net, or network, boosted by past posts as head of Cooper Union and of the design arts program at the National Endowment for the Arts. Lacy's 100, starting with Raimund Abraham and ending with Lebbeus Woods, include those who, in Lacy's words, have "distinguished themselves by word, deed or building," and those whose drawings he loves. Drawings range from squiggles and smudges to grandiose presentations. In a foreword, Lacy supports accepted wisdom that conceptual sketches happen on backs of envelopes and napkins. (It is perhaps premature to expect them to be done between dinner courses on pocket computers loaded with 3D CADD modeling software.) Lacy's essays promise to convey the flavor of each architect's philosophy, but they end up describing each architect's career and don't say enough about links between the drawings and the buildings they portray. *S. A.K.*

**Weissenhof 1927 and the Modern Movement in Architecture**, by Richard Pommer and Christian F. Otto. Chicago: University of Chicago Press, 1991, 305 pages, \$65.

A thoroughly researched account of the landmark housing development and exhibit organized by Mies van der Rohe in Stuttgart, this book offers new insights into the artistic, political, and social issues raised by the project. Other recent books have focused on the Weissenhof *Siedlung*, but this one is the best.

**The Good, the Bad, and the Ugly: Cities in Crisis**, by Rod Hackney. North Pomfret, Vermont: Trafalgar Square, 1991, 225 pages, \$40.

A past president of the Royal Institute of British Architects and unofficial adviser to Prince Charles, Rod Hackney has strong opinions on Modernism's urban legacy. A practitioner of so-called community architecture, Hackney criticizes Modern architects' insensitivity to the needs and wants of those who live in their glass, steel, and concrete creations. While sometimes simplistic, Hackney's arguments often ring true.

**Styles and Types of North American Architecture: Social Function and Cultural Expression**, by Alan Gowans. New York: HarperCollins, 1992, 396 pages, \$50.

A survey of American architectural history from early colonial settlements to Postmodern condo developments, this book falls into the popular trap of analysis by style. Although Gowans writes well and makes some useful comments on the cultural baggage that buildings carry with them, the book's focus on style emphasizes the superficial aspects of architecture.

**Houses for Science: A Pictorial History of Cold Spring Harbor Laboratory**, by Elizabeth L. Watson. Cold Spring Harbor: Cold Spring Harbor Laboratory Press, 1991, 354 pages, \$75.

A shade more than 100 years old, the Cold Spring Harbor Laboratory inhabits a special set of buildings—including 19th-century residences, a Mott B. Schmidt mansion, and a host of structures by Moore Grover Harper and Centerbrook. The book is a strange and sometimes awkward hybrid of local facts, architecture history, and scientific essays. ■



Drawn for ARCHITECTURAL RECORD  
by Sidney Harris.

What do a winery in California's Napa Valley, a Roman Catholic church in North Carolina, a golf club in Japan, a branch library near Atlanta, and an office tower in downtown Los Angeles have in common? Seemingly little, aside from the fact that they are completed buildings featured on the following pages. But when RECORD elects to publish articles in what we call a "design portfolio"—i. e., an issue that does not focus on any single building type—it is with the deliberate intent to show how all works of architecture, despite wide variations in budget, usage, and style, somehow respect and even enhance the existing environment. For example, the members of St. Therese Church in Wilson, North Carolina, told architect Gerald Allen that "we don't want a spaceship." Allen listened and responded with a traditional buff brick structure that respects its residential surroundings (page 112). Halfway around the world Don Hisaka avoided tradition and created a striking sense of place for a new golf club 100 miles from Tokyo (page 118). In suburban Atlanta, Scogin Elam and Bray's distinctive brand of architecture gives special character to a branch public library and its charmless surroundings (page 86). Though it would seem impossible to improve on the natural environment of California's Napa Valley, Johnson Fain and Pereira did just that with its Opus One winery (page 94). And in Los Angeles, the meticulously detailed Gas Tower (cover and page 102) almost single-handedly makes the Southern California metropolis a better place as it restores the tarnished image of American corporate Modernism. *P. M. S.*

# Hands-on Architecture

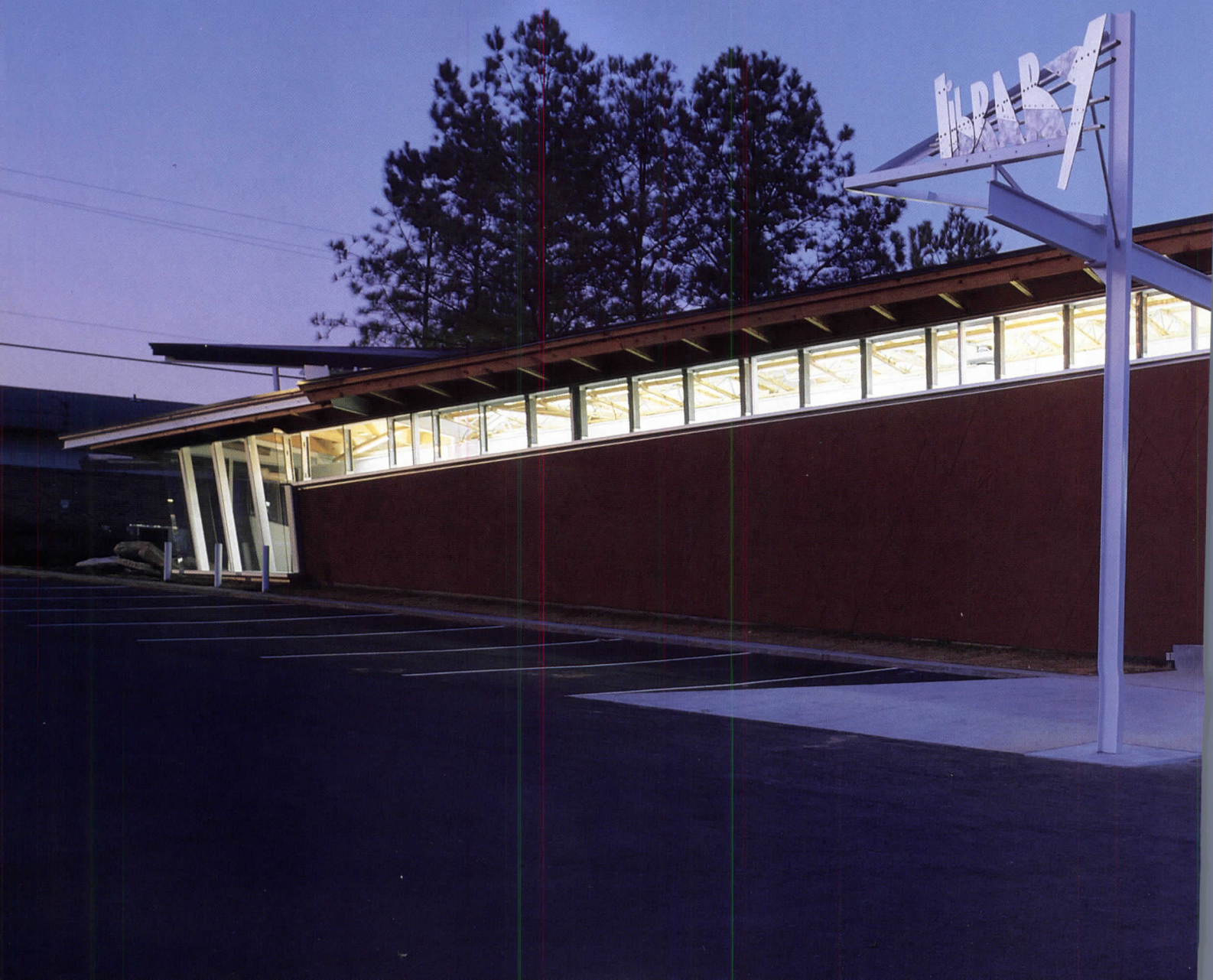

*An imaginative architect and a community's willingness to experiment have produced an unusual branch library near Atlanta.*

*Carol Cobb Turner Branch Library  
Morrow, Georgia  
Scogin Elam and Bray Architects*



To the untrained eye, the one-acre site designated for Clayton County's branch library had little to offer. The parcel is located in the city of Morrow, where there is "no main street, no downtown, no obvious hierarchy—urbanistically it's Jackson Pollock's abstract expressionism," according to Mack Scogin. Its neighbors included a florist turned caterer, a gas station, a fried-chicken outlet, and what Merrill Elam calls "your basic assortment of 'American Dream homes.'" The site's lack of distinction was heightened by its location in a septic no-man's-land: situated in between two active sewer lines, the property required any future occupant to provide, at considerable cost, its own pumping system. But the schizophrenic country road/town strip character of the area held considerable appeal for architects Scogin, Elam, and partner Lloyd Bray, who have built their Atlanta-based practice on being able to integrate the prosaic and the poetic with the technical finesse of skilled engineers.

Though Clayton County is small in area (at 148 square miles, the fourth smallest county in Georgia), its population has swelled from 98,000 in 1970 to 190,000 in 1990, an increase that, among other things, has overburdened its public libraries. Although Carol Stewart, director of the county library system, concedes that Scogin Elam and Bray's bold, idiosyncratic brand of Modernism might initially shock constituents comfortable in more countrified settings, she adds that "libraries are exciting places, and they should be in exciting buildings." Stewart and the library board have been promoting this idea for several years, and a crucial step in its public acceptance was the completion in 1988 of the library system's Scogin Elam and Bray-designed headquarters in Jonesboro some five miles away. While the earlier building's corrugated metal exterior stenciled with a black-and-white notebook-cover pattern did at first cause a local stir, the structure's desirable combination of durable, inexpensive materials and bright study areas in the end satisfied its users.

In Morrow, the smaller site and the reduced program of a branch library—10,000 square feet of lending and reference collections, staff offices, and public meeting rooms—led the architects to a simple parti of long walls along lot lines to screen unwanted views and clerestories beneath the roof to light what is in effect a giant, easy-to-supervise reading room (photos and plan page 92). The architects integrated their client's vision of libraries as communal gathering places, likening their scheme to a giant umbrella with a center pole (a two-story tower) that structurally supports its "ribs" (roof trusses), which extend toward such community landmarks as Morrow's public schools to the west and the Jonesboro library headquarters to the southeast. After building adjustable cardboard models to study the complex angles of the three-part roof (section page 90), the architects used computers to generate truss drawings for the steel fabricator. Technical considerations aside, they sought a hand-hewn effect on the exterior: under their guidance, construction workers swept the synthetic stucco surface with homemade brushes of bundled pine branches culled from the area, and, before the surface dried, they invited neighborhood children to make hand prints in the Georgia clay-colored surface as a touching symbol of ownership.

"We wanted to build something that is a draw and something that we could afford," Stewart recalls of the library board's intentions. With attendance up 75 percent since the Morrow branch opened last January and cost on budget at \$72 per square foot, it looks like Scogin Elam and Bray gave the county exactly what it sought.

*Karen D. Stein*

© Timothy Hursley photos

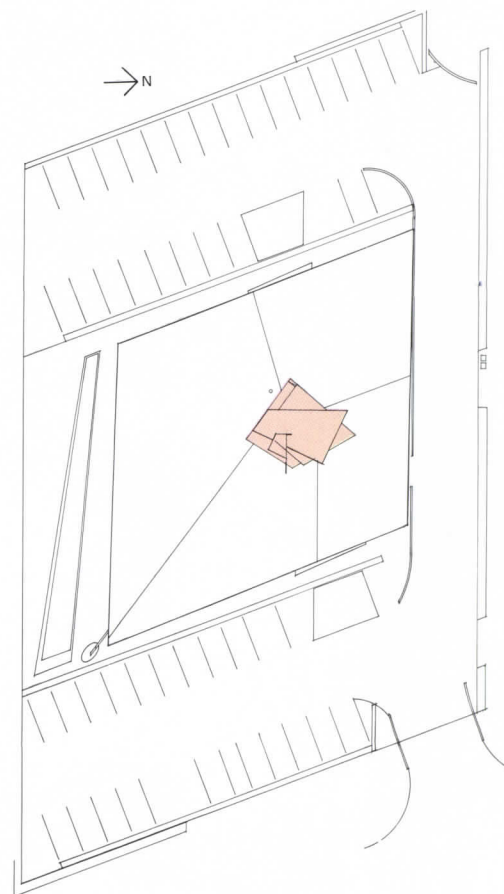

*The one-acre site that Clayton County purchased for its new branch library was barely able to accommodate the 10,000-square-foot program and necessary parking (plan, photo above) in a handicap-accessible one-story structure. The architects used the tight constraints to advantage. By pushing long, stuccoed walls to lot lines, and placing in the site's center a canopied steel tower (opposite) that appears to burst from boxy confines, they gave the building a much-needed presence within its jumbled urban/suburban setting.*







Since sites adjacent to the library's east, west (middle left) and north (bottom left) facades contain a variety of undistinguished structures, or are slated for future development, the architects placed most windows on those sides high enough to block unwanted views yet still admit light. They opened up the south facade, however, where a canopy screens the main entrance and the glass wall of the story area (opposite). The architects used cardboard models with movable wood dowels to study the inclination of the three-part roof (section below). This architectural "puppet" became a useful tool not only to achieve the desired sculptural effect but also to demonstrate to the Clayton County library board how light would enter the tower and permeate the interior. (The tower also acts as a return plenum.) Rough measurements from the final model were refined on computers for working drawings.

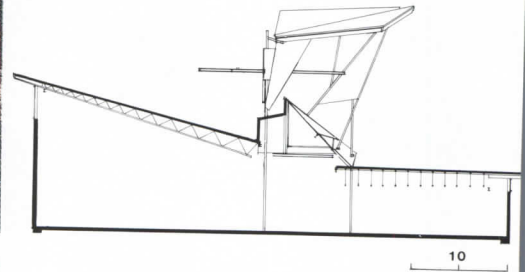





An oval entry foyer of aqua fiberglass extends into the parallelogram form of the library (top left). Aware that budget cuts could leave the library short of staff, the architects integrated adult and children's collections and the reference area into one easy-to-supervise reading room (middle and bottom left). Behind a curved circulation desk are offices and a public meeting room (opposite). Ducts to electric heat pumps are woven between trusses, creating an active ceiling that fulfills the client's premise of a lively library as vital to a culturally thriving community.

**Credits**

Carol Cobb Turner  
Branch Library  
Morrow, Georgia  
**Owner:** Clayton County Library Board of Trustees  
**Architect:** Scogin Elam and Bray Architects—Merrill Elam, Mack Scogin, Lloyd Bray, principals-in-charge; Carlos Tardio, Jeff Atwood, Susan Desko, Richard Ashworth, Julie Sanford, and Criss Mills, project team  
**Engineers:** Pruitt Eberly, Inc. (structural); Engineering Design Concepts, Inc. (electrical); Sunbelt, An Engineering Group (mechanical); Williamson & Associates, Inc. (specifications); Roger S. Lingerfelt, PE (civil)  
**Consultants:** Costing Services Group (costing); Ramon Luminance Design (lighting); Charles J. Schmidt (library programming)  
**General Contractor:** Lusk & Associates, Inc.

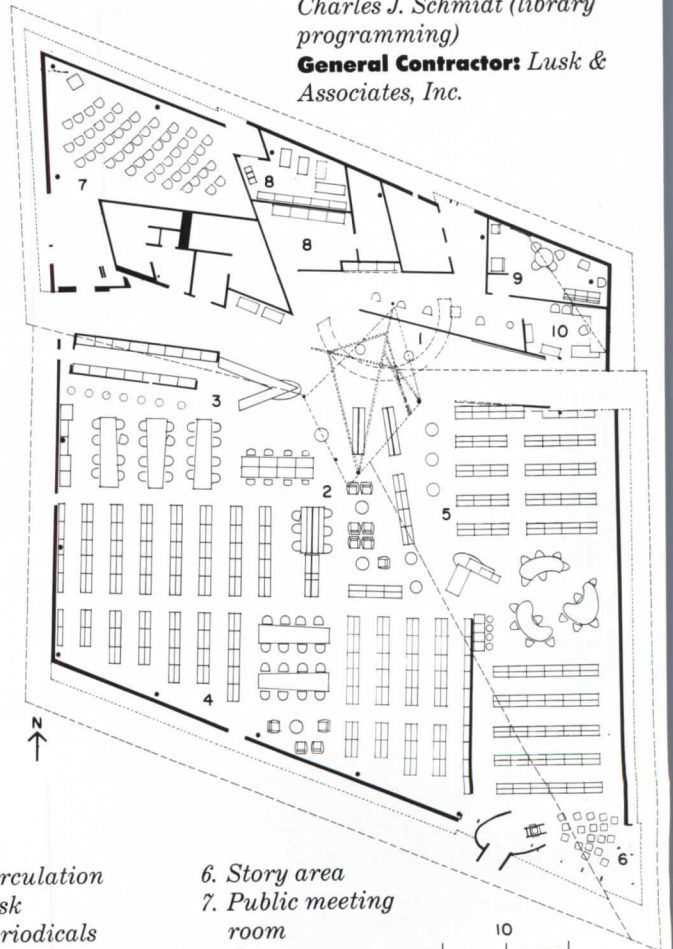

- 1. Circulation desk
- 2. Periodicals
- 3. Reference
- 4. Adult collection
- 5. Children's collection
- 6. Story area
- 7. Public meeting room
- 8. Storage
- 9. Staff breakroom
- 10. Librarian's office



# Rare Vintage

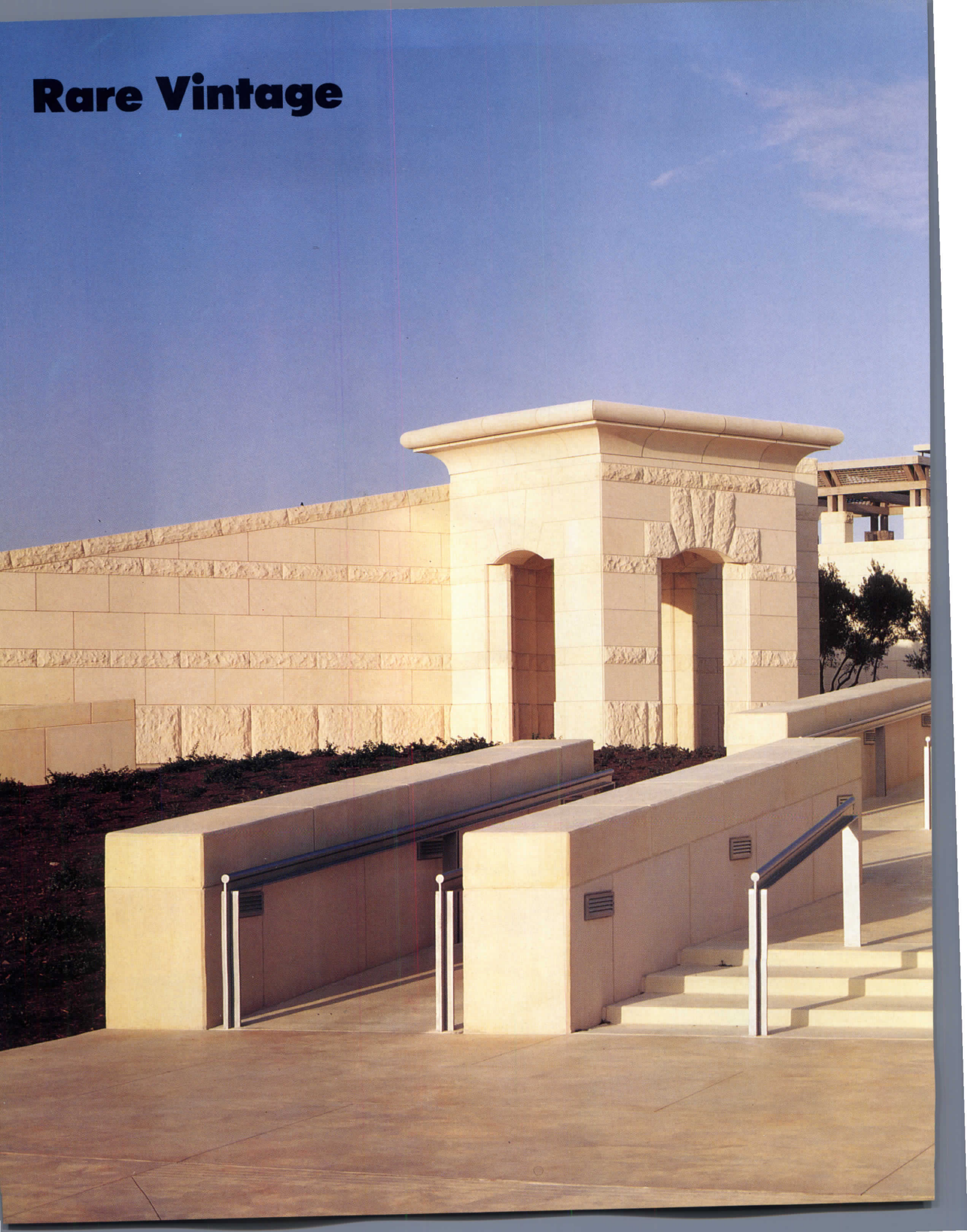

*A winery tucked into an earthen  
berm brings a touch of class to  
California's Napa Valley.*

*Opus One Winery  
Oakville, California  
Johnson Fain and Pereira Associates,  
Architect*



**N**ext to Disneyland, the Napa Valley is California's most popular tourist destination. Though the 100-year-old, native stone winery buildings that rise out of the rolling valley floor are still the most imposing structures in the area, their facades today mark tasting rooms for bumper-to-bumper traffic cruising Highway 29. So much emphasis is put on tasting and buying wine, in fact, that many forget that wineries are places where the vintners' art is practiced, not just charming country gift shops dotting the roadside.

Opus One Winery is different. This small private winery, inaccessible to the general public, produces a limited number of ultra-premium Cabernets every year. As one drives up an allée of native olive trees, the building ahead rises gently out of a 100-acre field of trellised grapes. The earthen berm that lifts the building above the trellises is anchored to the valley floor by a carpet of seasonal wildflowers and native grasses. The berm is not a gimmick: it covers and insulates an underground chamber, called the grand chai, where barrels of first-year Cabernet are stored.

Scott Johnson of Johnson Fain and Pereira Associates uses several metaphors to describe Opus One. He views the form of the building as an erupting volcano, its crater expressed by the building's interior. The clients are two winemaking families, one French, the other Californian. It is easy to see that the cloister of limestone encircling the entry courtyard, and the wooden elements of redwood and oak, both borrow from the building traditions of the families' cultures.

Johnson likens the cylinder expressed by the reception room and gallery below to a barrel. This is apt: all of the visitor activity in the building radiates from this point and sooner or later returns to it. Above this space a redwood pergola affords the only views of the valley once one is inside the winery. Its debt to the trellis work in the fields below will become increasingly apparent as the wisteria planted around it begins to fill in. The reception room is supported by columns that alternate with openings and niches. Subtle barrel allusions are everywhere, from the barrel-vaulted ceiling in the tasting room to the radial concrete beams in the grand chai.

The centerpiece of the reception area is a helical stair of cast-in-place concrete. It is hand-finished to a low polish, its Palladian balusters molded in negative space by the real balusters. As one descends below grade, the light begins to fade, and the air grows moister, cooler, and darker. The faint hiss of humidification equipment and the astringent aroma of new wine in oak barrels fill the air. Just visible at the end of a dark concrete-block corridor is the lower tasting room, separated from the barrels in the grand chai by walls of triple-paned insulating glass. The light level is low here, like candlelight, but brighter over a custom oak table and wrought-iron chairs.

The grand chai is a climate-controlled room where wines are aged for their first year. Here barrels are laid side by side, rather than stacked in racks as is the norm. This arrangement makes it easy to add wine to each barrel several times a week, not once a month in the customary way. The all-encompassing effect of barrels extending as far as the eye can see is reinforced by the radial concrete beams overhead, punctuated by dots of incandescent downlighting.

Like all things vintage, the design and construction of Opus One took time—seven years to be exact. Johnson says that the clients were patient people willing to keep working at all the details until they were completely resolved. "I think that patience comes from working in agriculture. Things cannot be rushed." *Charles Linn*

© Charles Callister, Jr., photos

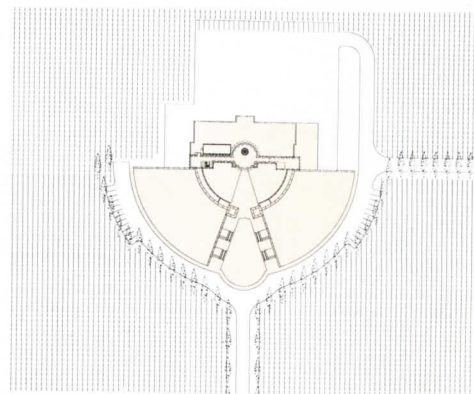

*Opus One Winery rises gently out of the Napa Valley floor, supported by a berm (top photos) covered with native grasses and wildflowers. The winery's main entrance borrows elements from the architectural traditions of both the French and the Napa Valley winemaking regions. Walls of rusticated Texas limestone enclose a reception hall, and a pergola is done in unfinished redwood (previous pages and opposite).*



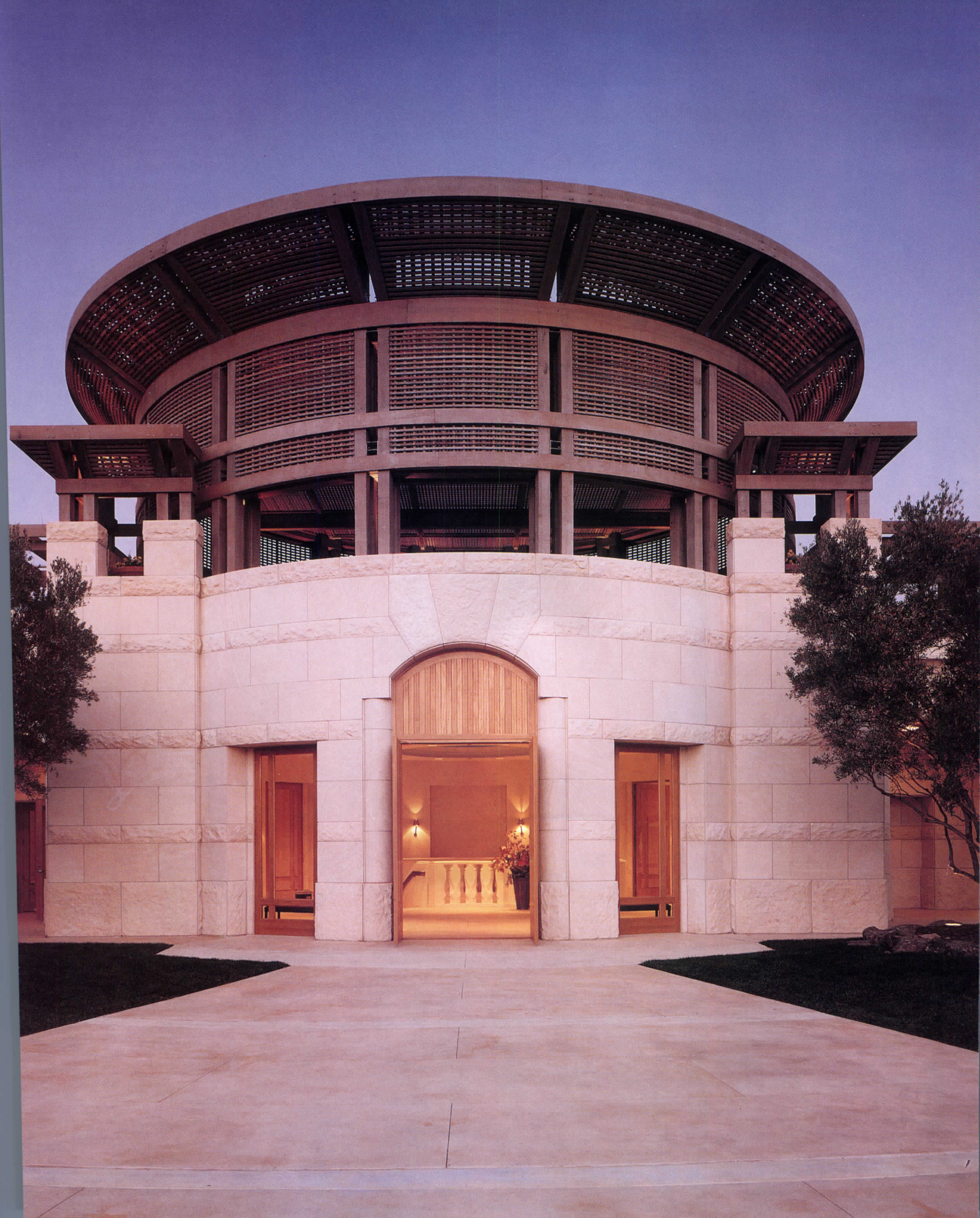

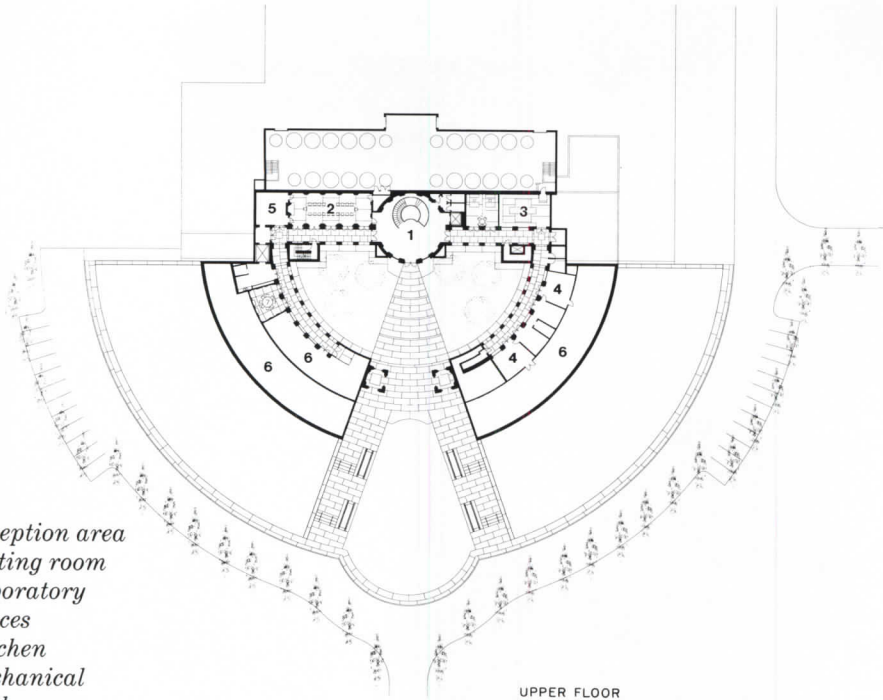

UPPER FLOOR

1. Reception area
2. Tasting room
3. Laboratory
4. Offices
5. Kitchen
6. Mechanical
7. Gallery
8. Grand chai
9. Back room A
10. Back room B
11. Bottling
12. Fan room
13. Storage
14. Barrel storage
15. Loading dock
16. Fermenting

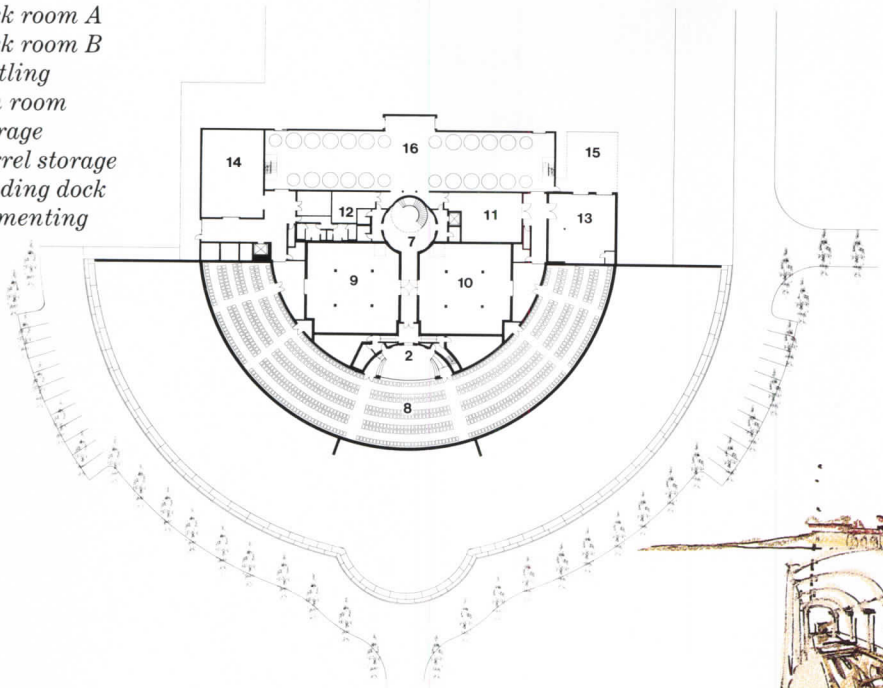

For visitors all activities originate from and return to a cylindrical reception room on the upper level and a gallery below (plans left). Twin semi-circular cloisters of limestone (opposite) enclose the court, shielding office windows from the sun.

A group of preliminary sketches by Johnson Fain and Pereira shows (below, clockwise from upper left) an elevation of the winery from afar, a perspective of the entry, pergola, and courtyard; the gate and the allée of olive trees behind; and the barrel-vaulted tasting room on the upper level.

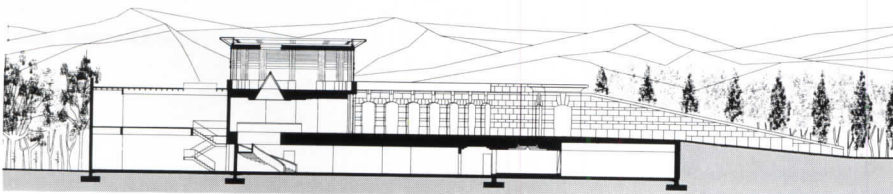
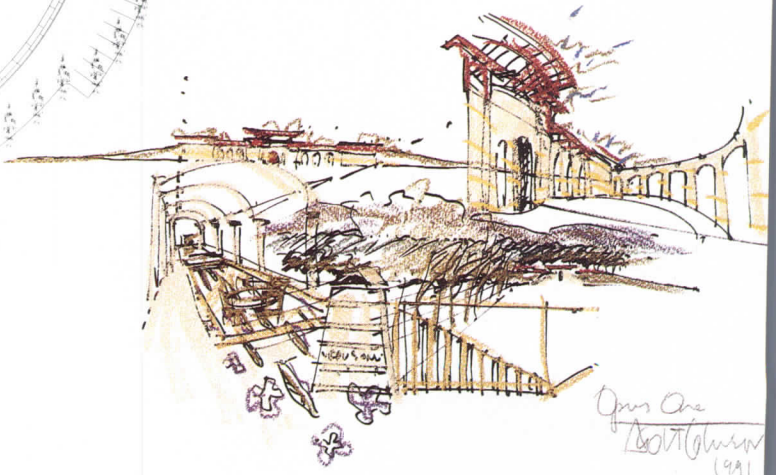



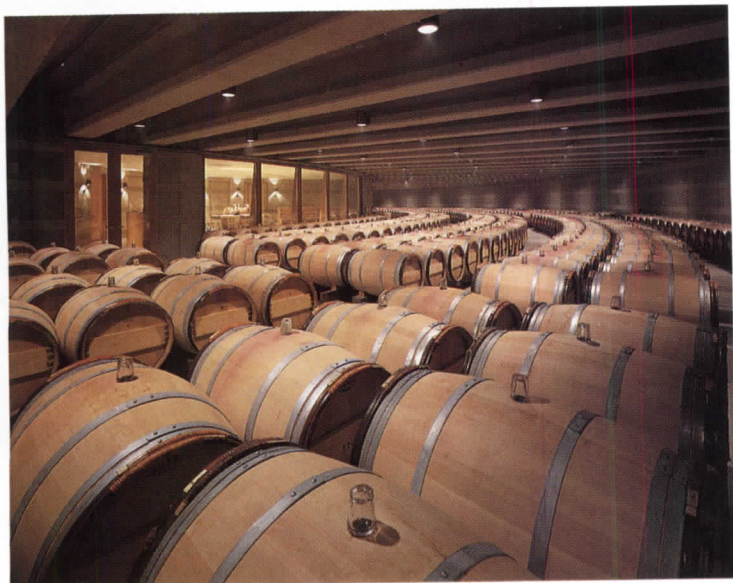

The corridor from the gallery to the lower tasting room has a ceiling of clear redwood planks (top left.) Dark-gray walls of smooth and split concrete-block bands echo the pattern of the limestone walls upstairs. The lower tasting room (middle left) is encircled by the grand chai (bottom left), where barrels of new wine are aged during the first year. A radiant cooling system embedded in the concrete slab helps lower 72-degree soil temperature, which is caused by nearby geothermal activity. In the grand chai a virtual-zero ventilating system slowly moves humidified air over the barrels, minimizing evaporation.

A helical staircase (opposite) of hand-finished cast-in-place concrete is the centerpiece of the reception room. Architect-designed custom sconces are adapted from sconces in the grand chai of Mouton-Rothschild in Pauillac, France.

#### **Credits**

*Opus One Winery  
Oakville, California*

**Owner:** *Opus One, a joint venture between Baron Philippe de Rothschild, S. A., and the Robert Mondavi Winery*

**Architect:** *Johnson Fain and Pereira Associates—R. Scott Johnson, design partner; William H. Fain, Jr., managing partner; Ralph Stanislaw, project architect; Margot Alofsin, Jan Szupinski, Rudy Abrio, design team*

**Engineers:** *Bentley Engineering Company (structural, mechanical, electrical); Summit Engineering, Inc. (civil); Roger Foot Associates, Inc. (soils)*

**Consultants:** *Royston Hanamoto Alley & Abey (landscape); Daniel Kiener (interior design); Horton-Lees Lighting Design (lighting); Rosenberg McGinnis (insulation/waterproofing)*

**Construction Manager:**  
*L. E. Wentz Company*



# Fire and Ice

*The Gas Company Tower  
Los Angeles, California  
Skidmore, Owings & Merrill (Los Angeles),  
Architect*





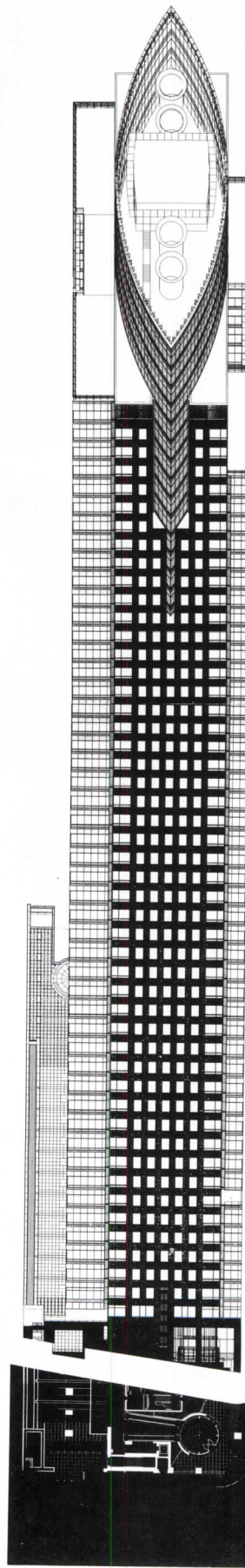

*Skidmore, Owings & Merrill's wizardry with glass grids and the innovative structural designs of CBM Engineers led to an elegant, seemingly complex curtain wall. A middle layer of dark stone is visually strengthened by thick mullions in corner windows, while mullions in lighter-colored "saddlebags" are thin bands.*

*The central "boat" slices through both layers with a knife's edge of glass and extruded aluminum moldings (opposite). By using a panel system assembled off-site, the architects were able to create a Miesian "negative" corner detail that further dematerializes the structure. Together, the three-part massing of the tower and the detailing of the skin makes the structure appear more slender than its 1.44-million-square-foot bulk, an effect client Robert Maguire describes as "pretty graceful for a building with 27,000-square-foot floor plates." The tower stands out among the more somber masonry that predominates in downtown Los Angeles (left). "It was a bit of a shock to the client," admits David Epstein of the easy-to-assemble skin's high-tech imagery, "but we convinced them it was the only way to get it built." Richard Keating agrees: "If we had the luxury of time, we never could have gone this far."*







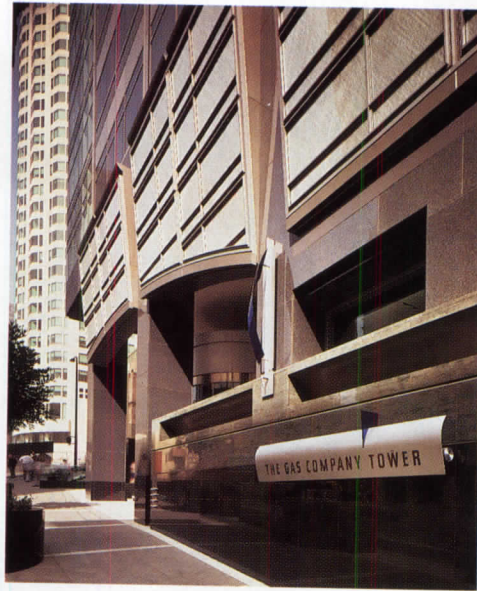

*The tower is carved out at the base for pedestrian access via stairs, escalators, or handicap ramps, creating an active circulation route that threads its way through Vierendeel trusses and a garage exhaust system. Sussman/Prejza's sign (top) and flamelike sconces remind passersby of the principal tenant. Tilted "shoji-screens" (rice paper laminated between glass) signal a branch of a Japanese bank on the mezzanine and block views of a recent addition to the Biltmore Hotel across the street (above and opposite).*

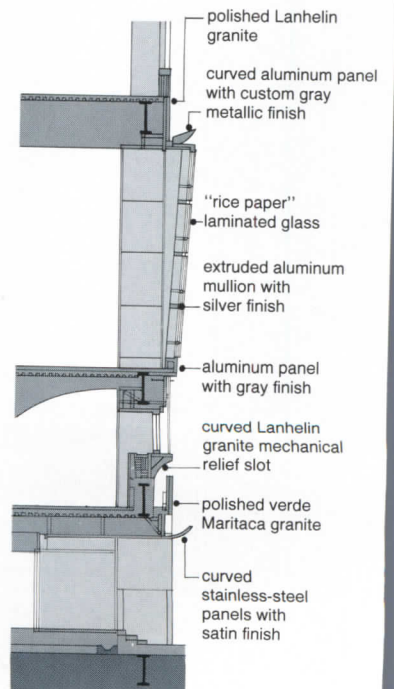
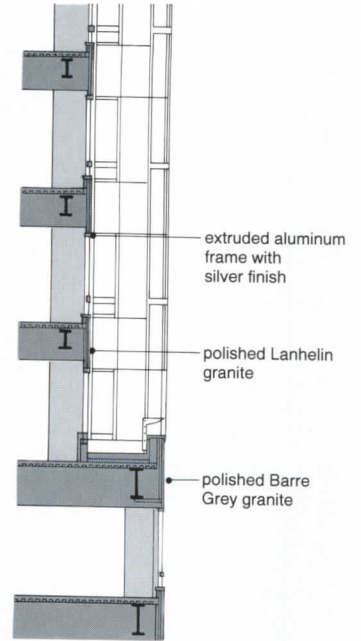
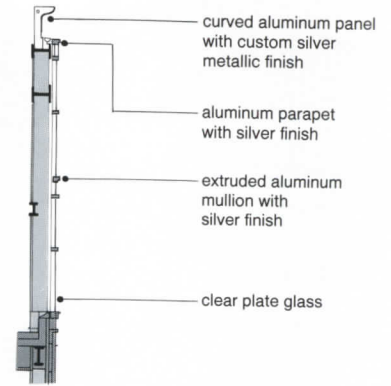

PARTIAL SOUTH WALL SECTION







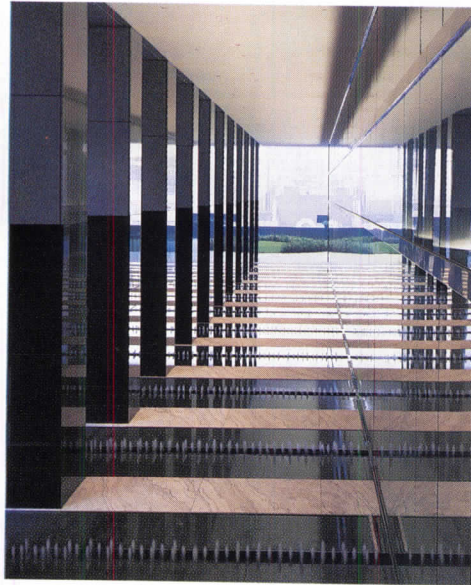

Because of a 60-foot drop in grade, the tower has three lobbies (plan). In the main lobby elevator shafts appear as seamless columns (top right), whose limestone panels are hung from a steel framework that allows them to move individually in an earthquake. The panels are separated by wood toboggans that disperse uplighting. Wet Design's fountains stitching inside to outside, while a Frank Stella mural adds color to the grays of the architecture.

**Credits**

*The Gas Company Tower*  
Los Angeles

**Owner:** Maguire Thomas Partners

**Architect:** Skidmore, Owings & Merrill (Los Angeles)—Richard Keating, design partner-in-charge; David W. Epstein, senior designer; C. Keith Boswell, project manager/technical coordinator; Satoru Kato, job captain; Richard Kosheluk, Joseph Smooke, Chung-Yi Sun, William White, assistant job captains; Duane Chung, Carlos Del'Aqua, Kurt Erlbeck, Mark Flory, Sam Holloway, Kathryn Millan, Eric Randolph, April Sheldon, Ursula Spitz, David Swartz, Sarah Zimmerman

**Engineers:** CBM Engineers (structural); James A. Knowles & Associates (mechanical); Levine/Seegel Associates (electrical)

**Consultants:** Fisher/Marantz (lighting); Sussman/Prejza (graphics/signing); Wet Designs (fountains); Cerami & Associates (acoustical); Lerch, Bates & Associates (elevators); Rolf Jensen & Associates (fire codes) Hanna Olin (landscape)

**General Contractor:** Turner Construction Company

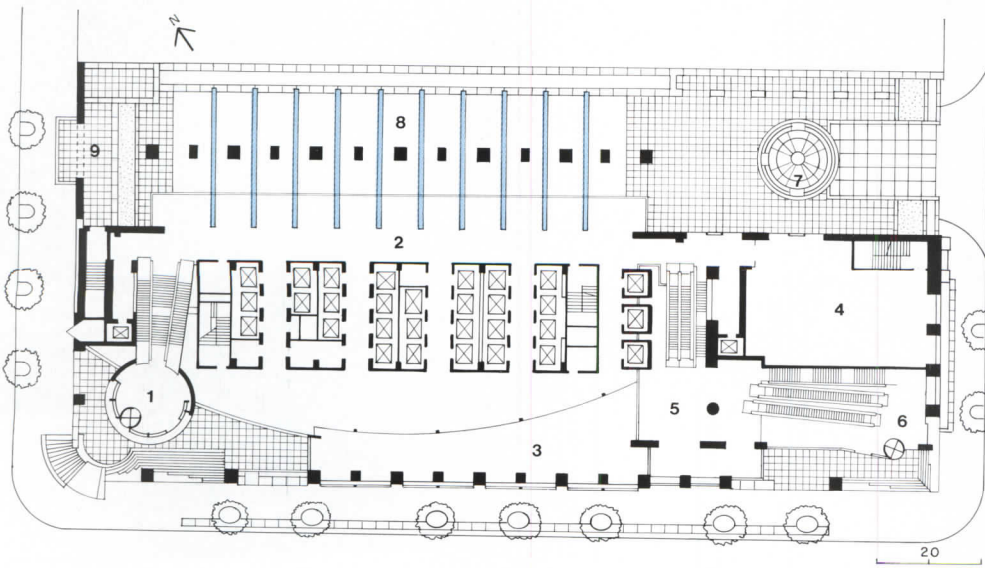

1. Rotunda
2. Elevator lobby
3. Retail
4. Restaurant
5. Intermediate lobby
6. Lower lobby
7. Garden trellis
8. Water garden
9. Garden overlook

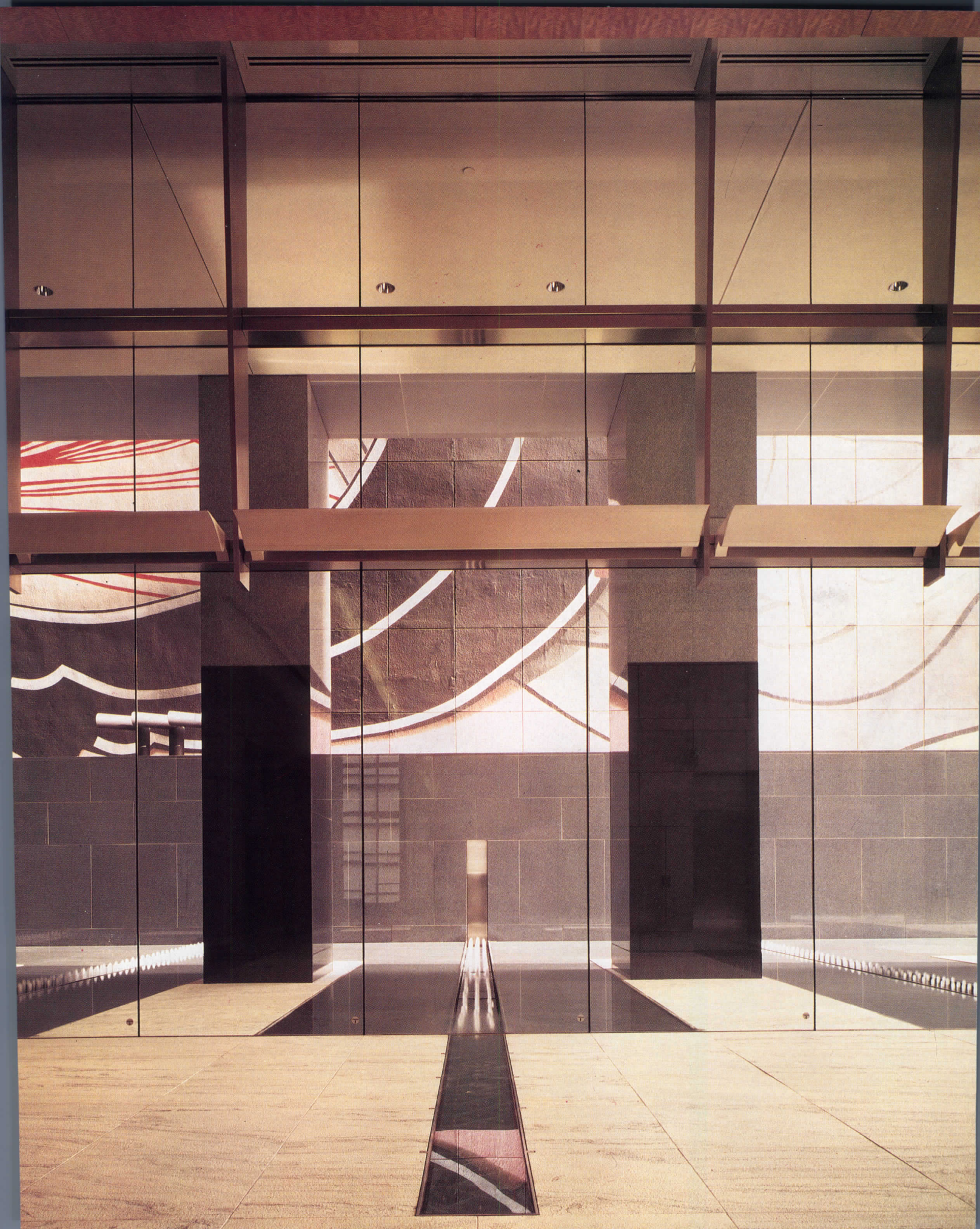

# First Church

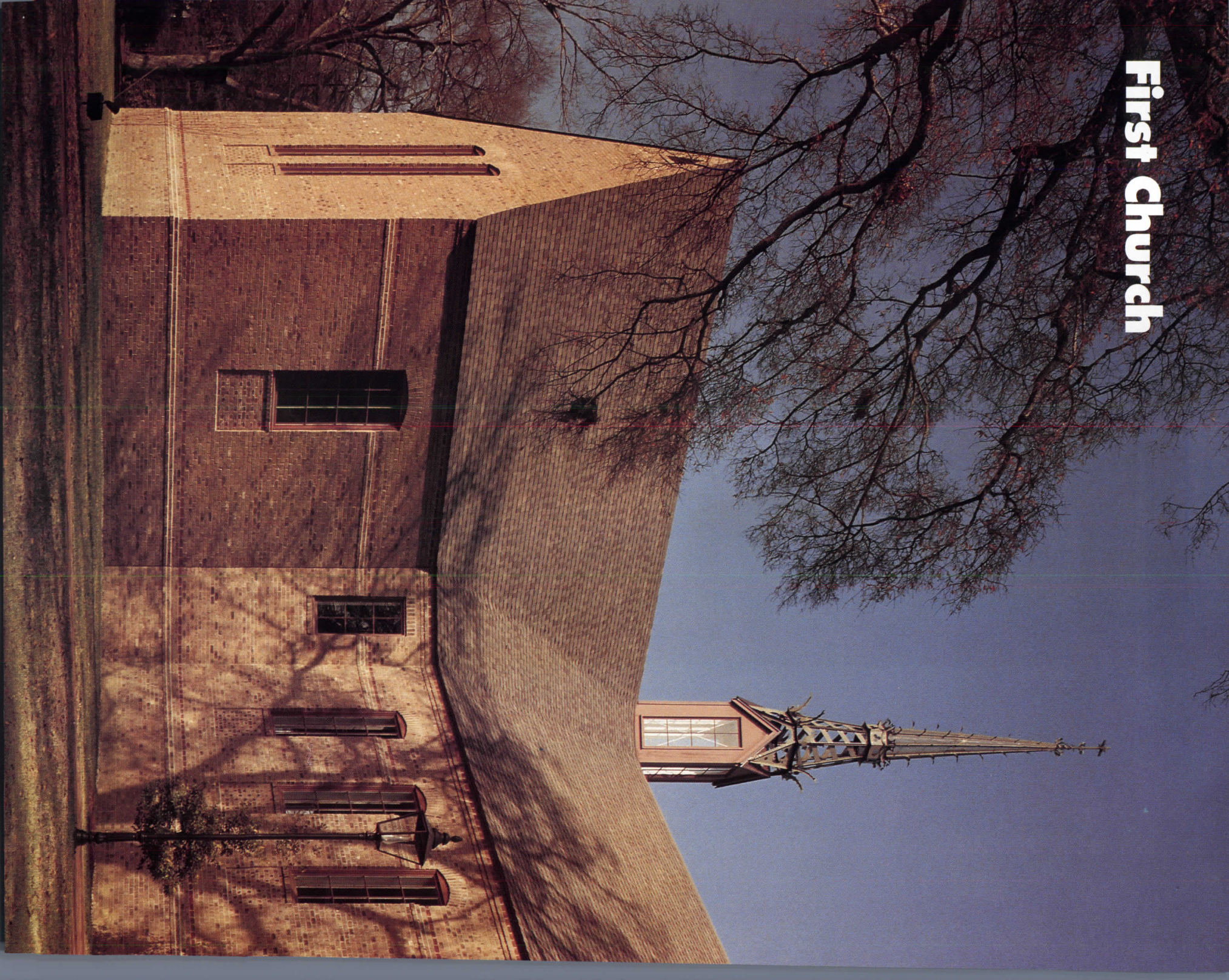



*Sensitive design, teamwork, and attention to detail deliver high vernacular on a low budget.*

*The Church of St. Therese  
Wilson, North Carolina  
Allen, Harbinson & Associates,  
Architects*







**W**e want a church that looks like a church," said the members of this Roman Catholic parish, who had been holding mass for 30 years in their school's gymnasium. "We're tired of buildings that look like that." What they got could not be mistaken for anything but what it is—a church reminiscent of both those in the English countryside from the Middle Ages and those from a New England village green—all on a tight budget and with many innovations along the way.

According to Allen, Harbinson principal Gerald Allen, the church also harkens back to 18th- and early-19th-century churches in Virginia and the Albermarle area of North Carolina, which he remembers fondly from childhood. To achieve this for a basic-building cost of \$99 per square foot, his team used a structural system often seen in economical commercial buildings—a concrete slab on grade, concrete-block walls, and prefabricated wood scissor trusses. Then they worked with a highly cooperative contractor in the field to reduce the costs of many finish details (a job that often fell to construction administrator Ann Ketterer), including the slight, but visually significant, splay of the roof, subtly variegated colors of the machine-distressed oversized brick, V-shaped masonry joints that give strong shadow lines, and angled brick in lintels.

Inside, floors are brick, walls sheetrock, and windows clear glass—all creating an unusually open and welcoming effect favored by the current pastor, who resisted some parishioners' suggestions of carpets and stained glass. The hard surfaces also create "one of the finest acoustic spaces in North America," says concert organist Carlo Curley. The 9,300-square-foot building seats up to 450 people in its main room, which is in the form of a traditional Latin cross, while the altar is in the crossing according to new liturgy. Even old functions have new names (e.g., "reconciliation" instead of confession"). Indeed, the whole building is turned from usual orientation so that its carefully composed side faces Wilson's main street (left in site plan) and the major door faces parking areas, from which most parishioners enter. Allen is not so happy with all innovations here; he points to the "bus-station-size" restrooms taking up valuable building area, but required by codes. Still, the architects' economic resourcefulness permitted details, which, in the end, contribute to the interior's churchly character. *Charles K. Hoyt*

#### Credits

*The Church of St. Therese, Wilson, North Carolina*

**Owner:** The Most Reverend F. Joseph Gossman, Bishop of the Roman Catholic Diocese of Raleigh. Former and current pastors: the Rev. Chan R. Chase and the Very Rev. James M. Labosky, V.F.

**Architect:** Allen, Harbinson & Associates—Gerald Allen, Henry C. Clark, Jon Alexander Dick, Jeffrey Harbinson, David Holowka, Ann Bayard Ketterer, Kevin L. Mason, R. Timothy Middleton, Laurence K. Qamar, Steven A. Schenker, Roxanne C. Valdez, Robert C. Wilkanowski, project team

**Engineers:** Lysaght & Associates (structural); Progressive Design Collaborative (mechanical); Froehling & Robertson (soils)

**Consultants:** Kent Bloomer and Kimo Griggs (designers and builders: crossing spire, in collaboration with architects); Josephine M. Brown (landscape); The Century Guild (builders: altar, president's chair, ambry, tabernacle, all designed by architects); Don Jordan (builder: other sanctuary chairs, baptismal font, ambry, all designed by architects); Marilee Keys and Bruce Lindsay (designers, painters, builders: processional cross, torches, stations of the cross); Klepper Marshall King (acoustics); Patrick Stewart (designer, painter: sanctuary icon)

**General Contractor:** Robert Williams Construction Company

*Opposite, clockwise from top left: processional crucifix and torches made from all natural materials with gilding and painting; one of 14 stations of the cross with building carpenter as model; mahogany ambry containing baptismal oils in blue glass vials; fleur de lis for the Virgin Mary and roses for St. Therese at top of reredos. Site plan shows pre-existing school to right.*

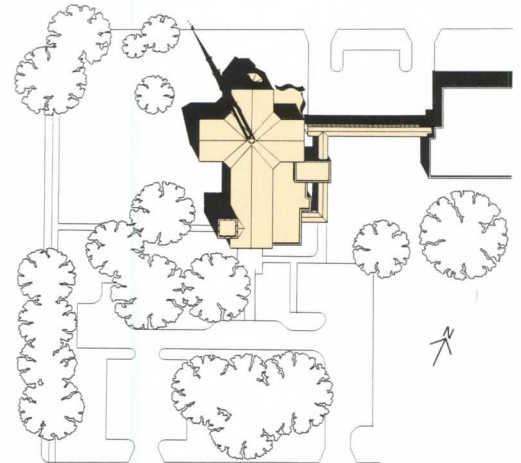

1. Gathering area
2. Daily mass chapel
3. Reconciliation
4. Working sacristy
5. Acolytes' sacristy
6. Priests' sacristy
7. Reception
8. Pastor
9. Conference

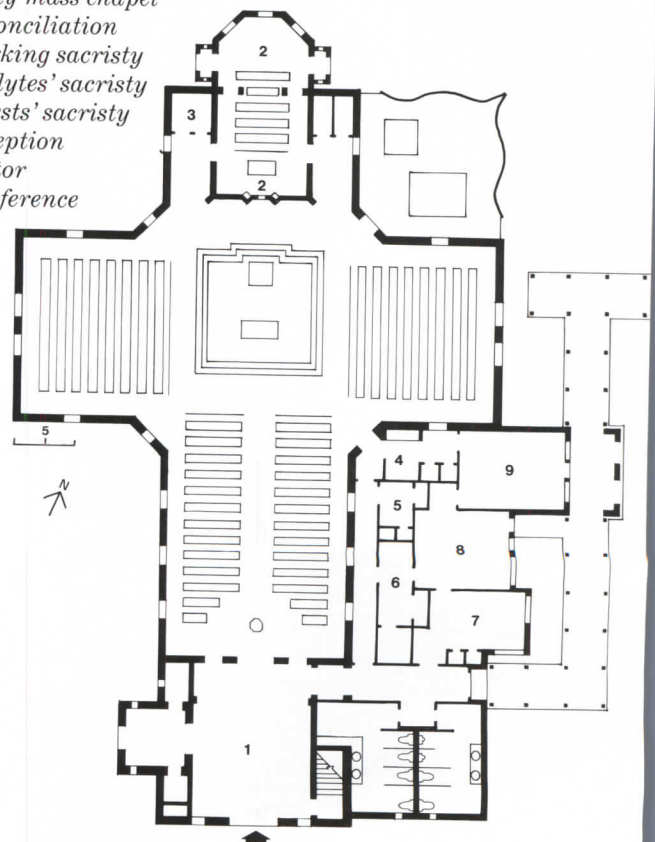

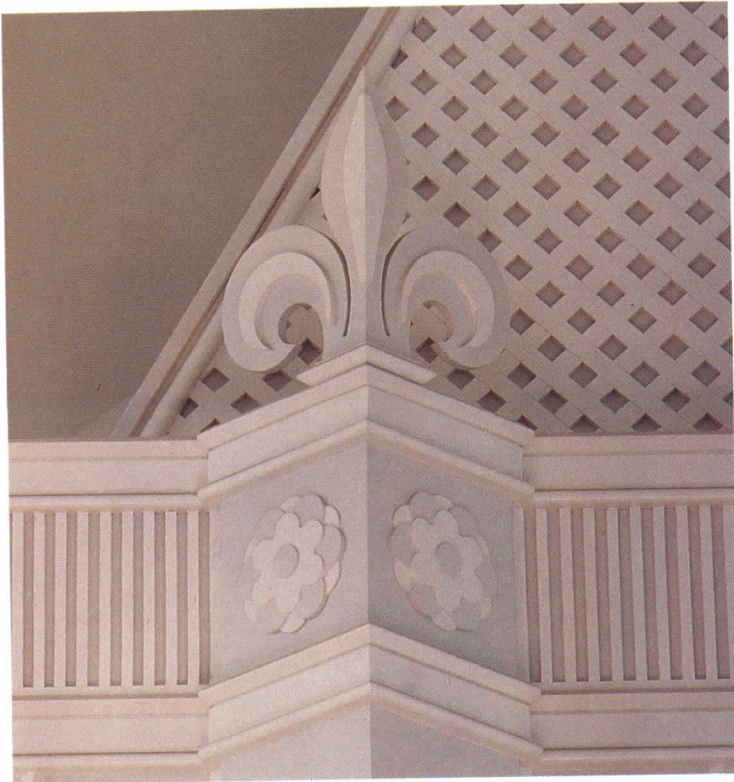
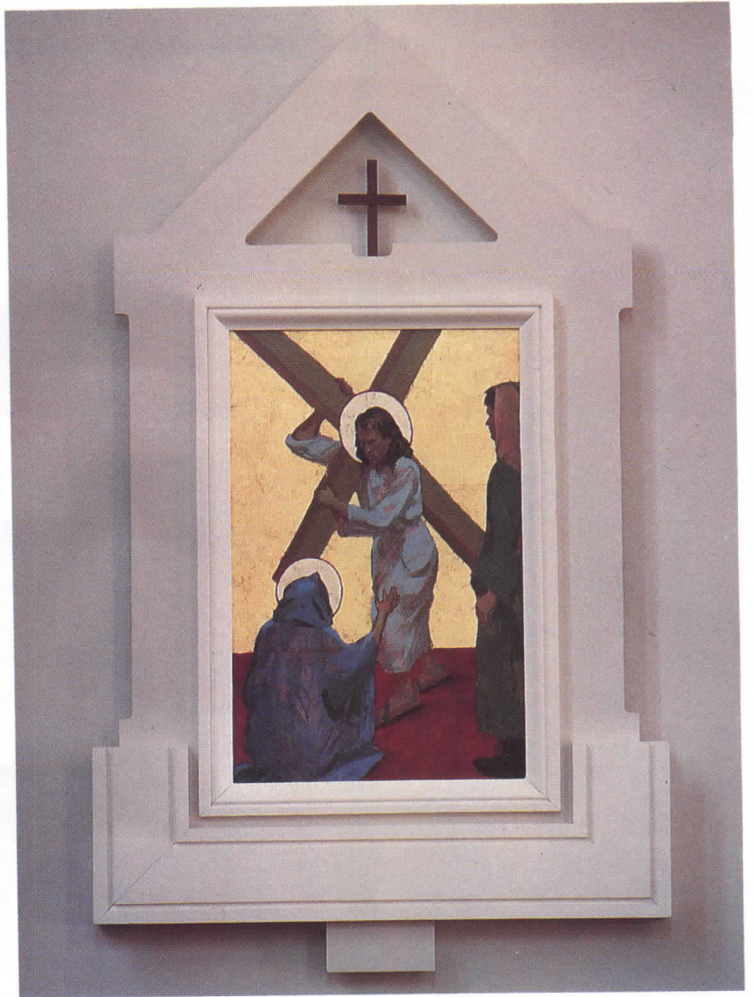

# The Right Club



*Ancient forms rendered in  
modern materials wed a  
golf-course clubhouse to the  
Japanese countryside.*

*Old Orchard Golf Club  
Ibaraki, Japan  
Hisaka & Associates, Design Architect  
A & A (Tobishima Corporation),  
Executive Architect*

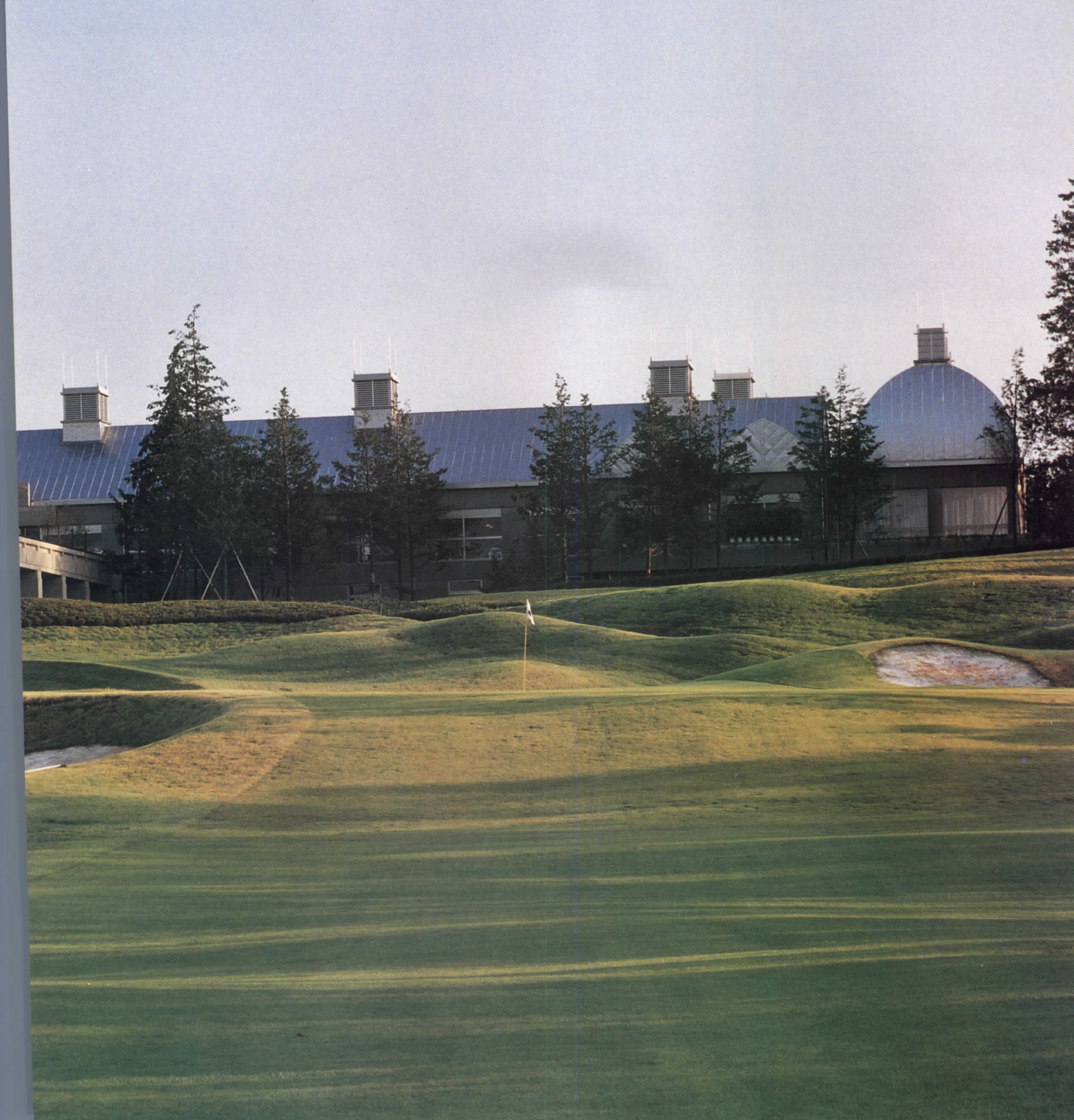

The chairman of the Tobishima Corporation, a Japanese development/construction firm specializing in resorts and hotels, is an avid golfer who plays the finest courses in the United States and Europe. When the firm decided to develop a golf club in the prefecture of Ibaraki, a two-and-a-half-hour drive from Tokyo, he envisioned a clubhouse reminiscent of rural New England. Commissioned to realize the vision, New England-based architect Don Hisaka added his own concern that the building fit gracefully into the landscape of rural Japan.

In the ensuing rapid-fire cross-Pacific exchange of oversized volumes filled with photographs depicting Japanese villas and New England farmsteads, architect and client distilled the proposed American prototype by going beyond mere images of Georgian brick or Cape Cod clapboard and into their core values: simple form, intimate scale, uncontrived clarity, modest demeanor. The same qualities, Hisaka observes—and persuaded the client—imbue the traditional architecture of Japan, which directly inspired a clubhouse that is both wholly original and unmistakably Japanese.

Although the building program called for little more than baths and locker rooms plus facilities for drinking and dining, Hisaka resisted the more efficient course of massing the required 60,000 square feet in a single monolith. Instead, the various spaces are dispersed informally in wings that reach out to the surrounding landscape. An integral part of the complex, the resulting gardens and courts compose a relaxed but engaging sequence of experiences as members move through the clubhouse.

A westerner's mental image of Japan tends to focus on Tokyo's Ginza at one extreme and cloistered garden temples at the other, but the Old Orchard club lies in an open countryside of rice paddies and cypress groves. The approach to the club winds through woodland to a large paved auto court where a porte cochere introduces the reception building and the main dining hall beyond. On the cross axis a series of private dining rooms, balanced by the kitchen and service areas, are stretched along a natural ridge facing north to the fairways and the broadest views. A second glass-enclosed passageway runs west from reception to locker rooms housed in a similar wing set slightly off-kilter to hug the edge of the surrounding woods. Structures throughout are site-cast concrete with sturdy columns and lintels framing infill panels of glass or concrete.

To reconcile the modest scale of these low gable-roofed buildings with the panoramic sweep of the golf course—and heighten the experience of arrival to a level in keeping with the cost of membership—Hisaka pulled such discrete spaces as the dining hall and its adjoining bar, the reception building, VIP suites, and a bathhouse away from the L-shaped wings and crowned them with emphatic helmetlike roofs. While claiming as his model the thatched roofs of traditional Japanese houses and outbuildings, he has not only exaggerated their steep pitch and gentle curvature, he has snapped them into the 21st century with his unexpected choice of modern materials. Lightweight steel framing is elaborated to recall the intricacy of indigenous timber construction and exposed to create distinctive, well-scaled interiors. Outside sheathing is closely seamed stainless steel light enough in gauge to dimple at the connectors in an “oil-canning” effect that suggests the softness of aging and diffracts sunlight to an evanescent shimmer. To disguise smoke vents and skylights, rooftops erupt in metal pinnacles and parapets bristling with lightning rods, reinforcing the illusion of feudal imagery given space-age substance. *Margaret Gaskie*

Masuda photos except as noted

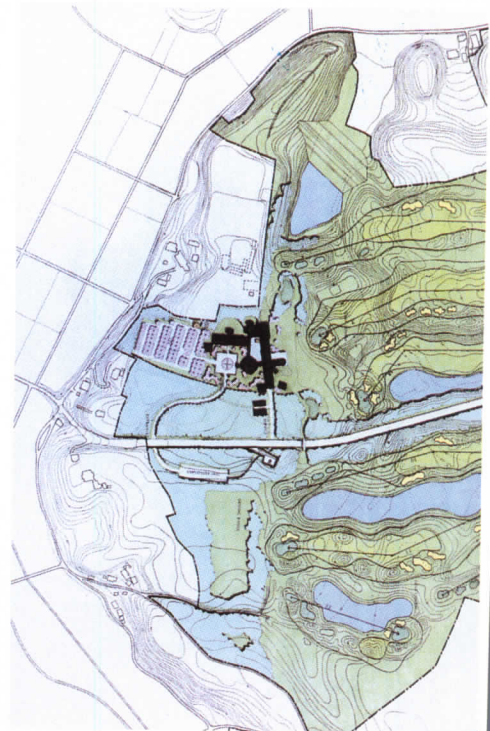

*Approached through woodland, the Old Orchard clubhouse is further veiled by mist (or plumes) rising from a multispout fountain at the center of the auto turn-around (top photo), while cars are tucked away in an oversized carport on the south. Within the complex, domelike stainless-steel roofs designate such special areas as the dining hall (top opposite), whose terrace roofs an open ground-level pavilion from which golfers and their carts sally forth. Ground-hugging gable-roofed wings of concrete patterned in bush-hammered and as-cast finishes turn glass curtains to courts and gardens; in the terraced court shown below opposite, granite defines the grid and “contour lines.”*



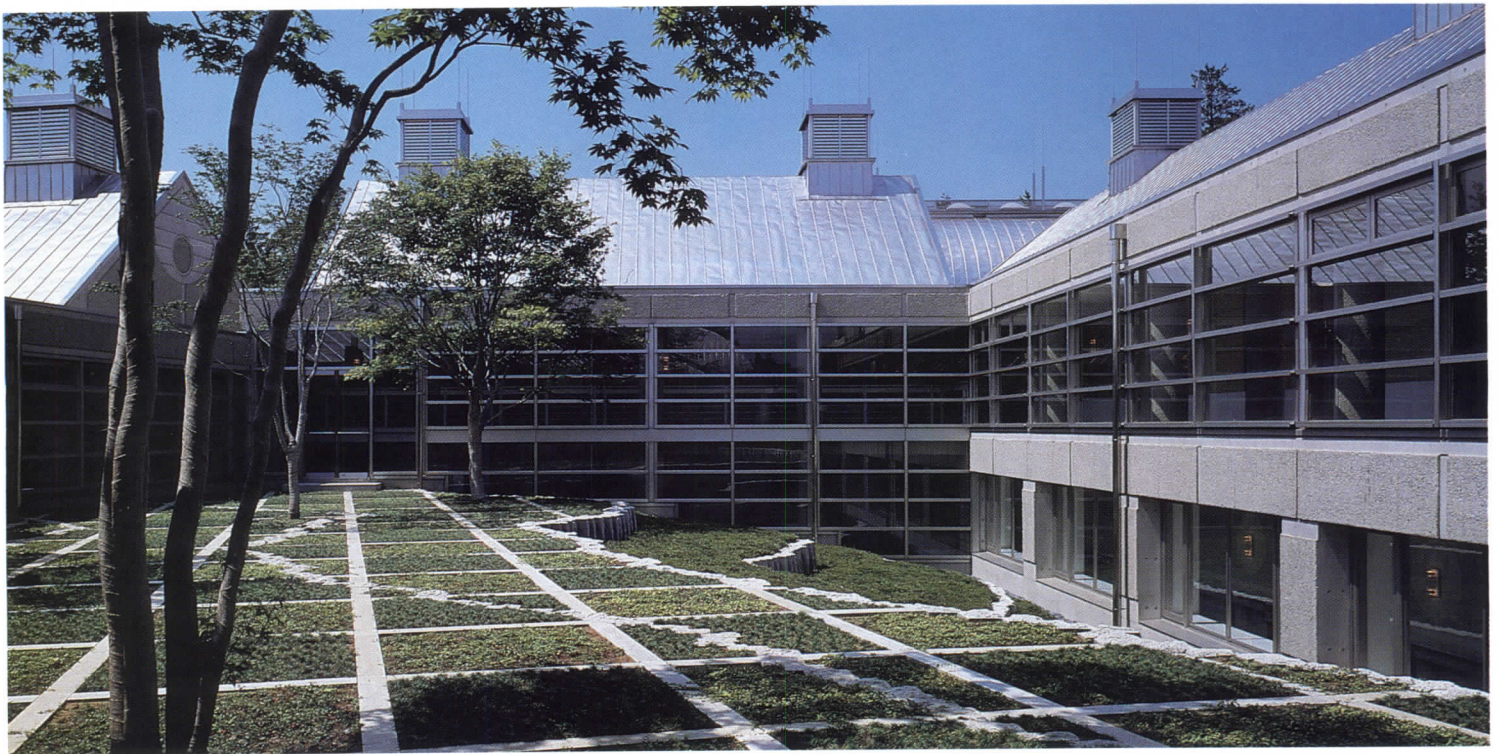



*From the registration and lounge areas in the reception building (right in top photo) glass-enclosed galleries extend to an L formed by long narrow wings. The east-west wing houses food-service areas, including a row of private dining rooms; the north-south wing contains locker facilities (bottom photo) served by a large separate bathhouse. Aluminum-framed glass walls along single-loaded corridors throughout the linked buildings (middle photo) open interiors to the landscape and negotiate changes in level as the site declines toward the golf course on the north. In addition to the main dining room and reception building, smaller single-purpose spaces—a gatehouse, the bathhouse, private suites in the knuckle between the two wings, servants' quarters at the ends of the wings—are helmeted by distinctive metal roofs.*

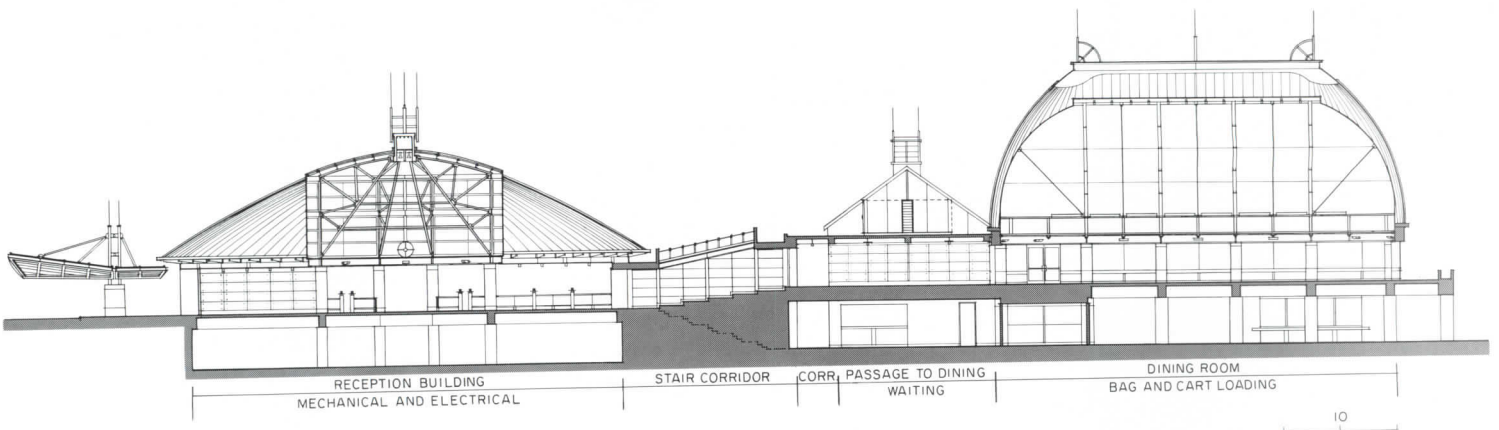
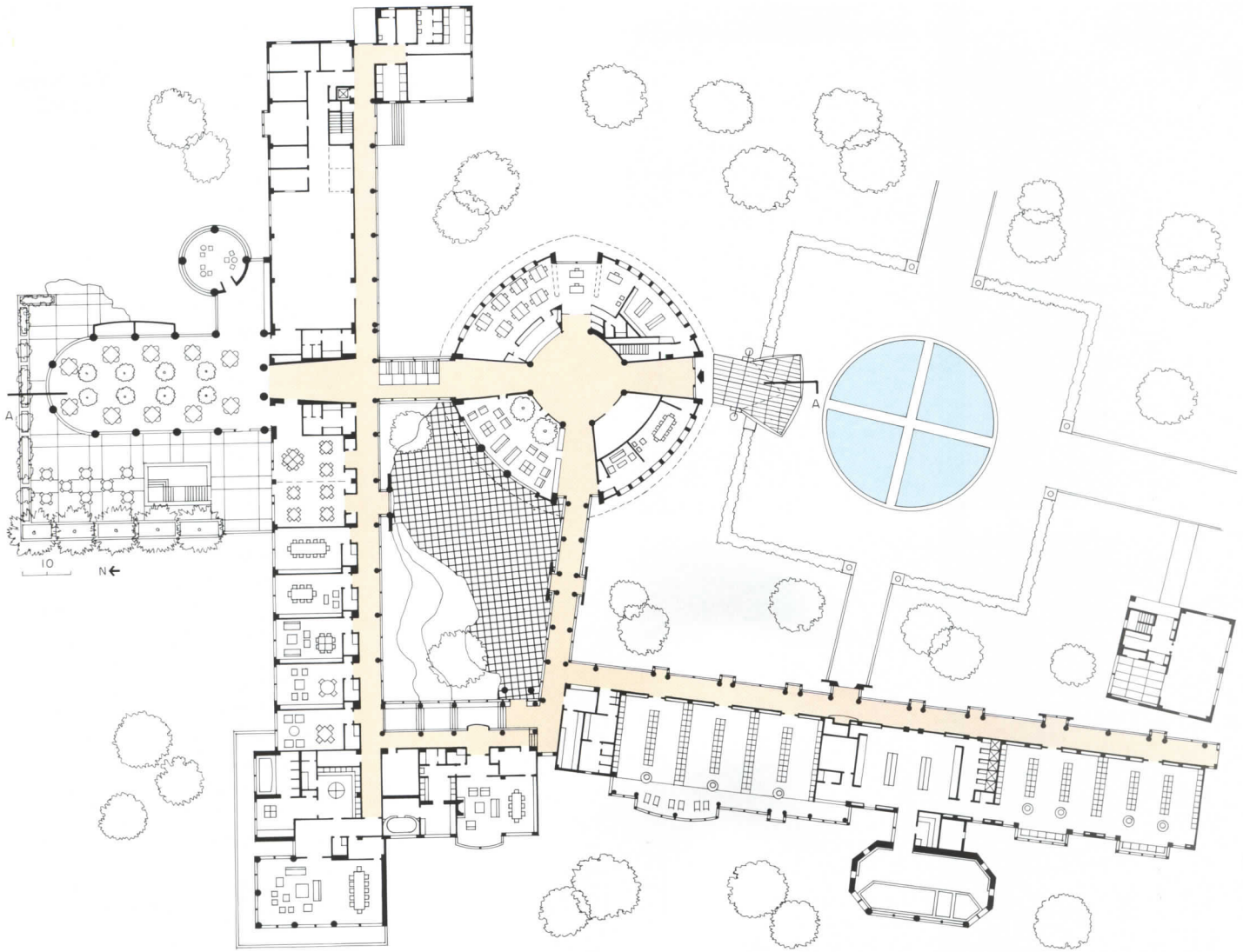

SECTION A-A



The dramatic roof forms that punctuate the clubhouse's low-lying structures also create dynamic interior spaces. Though varied in size and shape, the "domes" share fine-grained light steel frames of rolled channels set about 16 inches apart at the base, where members tie into large beams that top a concrete perimeter ring. Outer sheathing is light-gauge stainless steel; inner ceilings are dry wall; interstitial spaces carry hvac and other service runs. In the reception building (opposite), where registration and lounge areas ring a central atrium, a second frame of trusses braced by pipe columns atop the concrete columns supports a skylight and compression ring. In the dining hall and small round bar adjoining it (photos left), soaring spaces overhead complement sweeping views bounded by relatively narrow bands of glass. A steel grid suspended from the dining room's steep ovoid vault lends scale with a suggested ceiling plane that holds lighting fixtures.

**Credits**

*Old Orchard Golf Club  
Ibaraki, Japan*

**Owner/Developer:**  
*Tobishima Corporation*

**Design Architect:**  
*Hisaka & Associates,  
Architects, Inc.—Don Hisaka,  
John McDonald, Joseph Chong,  
designers*

**Executive Architect:**  
*A & A (Tobishima  
Corporation)—Takashi  
Nagiyama, Kazuyuki Okada,  
project architects; Hiroshi  
Amemiya, designer*

**Engineers:**  
*Tobishima Corporation  
(structural/mechanical/  
electrical)*

**Consultants:**  
*Jim Fazio (golf course); Peter  
Lukacic (landscape)*

**Project Coordinator:**  
*Tobishima Associates—Tony  
Yamada, architect*

**General Contractor:**  
*Tobishima Corporation*



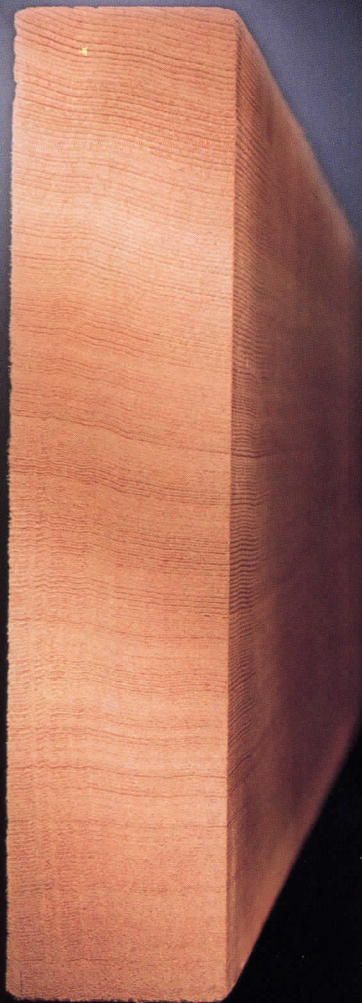

# WHICH IS A STEAL?

Hopefully, you picked the one on the left. Because the fact is, Western wood is the real "steal" in multi-story construction up to four stories.

Designers everywhere are discovering they can lower costs framing with naturally resilient wood. And we're not just talking lower material costs. Western woods are easily modified on-site, making wood-frame construction quicker in all types of weather.



*Wood-frame construction delivers cost-effectiveness in high density areas and difficult terrain.*

The move from steel to wood is only natural. After all, no other material can match wood's warmth and beauty or wood-frame construction's design flexibility and lower costs.

But don't just take our word for it, look around. Award-winning wood-frame buildings are popping up all over the country in multi-story projects like office buildings, senior care centers and hotels. In fact, virtually any low-rise structure up to four stories can be framed in versatile Western wood.

So send for our free packet on wood-frame construction, chock-full of design specs, code provisions and revealing case studies. Simply mark the reader service card or fax us your name and address at the number below. And start stealing our ideas on wood-frame construction.



*Perpetuating America's Forests for Products and the Environment®*

**WESTERN WOOD PRODUCTS ASSOCIATION**



Dept. AR/5-92, Yeon Building, 522 S. W. 5th Ave., Portland, OR 97204-2122 Fax: (503) 224-3934

Circle 31 on inquiry card



## **“FLY-THRUS, ASSOCIATIVE DIMENSIONING, GLOBAL EDITING . . . ALL I KNEW WAS THIS HAD BETTER WORK.”**

Our search for CAD software was intense. Being a small architectural firm, we *couldn't* afford to make a mistake.

### **By Architects, For Architects**

Fortunately, we discovered DataCAD<sup>®</sup>, a versatile, easy to learn, easy to use PC-based design and drafting tool. DataCAD was developed *by* architects, *for* architects, (unlike the “name brand” we almost bought).

### **Works Like An Architect**

DataCAD allows us to do 2-D and 3-D designs faster and more easily than we ever thought possible. Create with built-in wall, door, window and column commands. Easy editing, symbol libraries and “live views” are also standard.

We now spend more time designing, while we've reduced our costs. And in this tough market, we can use all the help we can get.

### **Even The Price Is Easy**

Not only was DataCAD simple to learn (and a pleasure to use), even the price was easy. We got everything we needed in one basic package with *no* costly add-ons.

If you could design CAD software for your firm, this is what you'd invent. Ask for a live demonstration and see for yourself. You've got nothing to lose except the drudgery.



*Render option available.*

Courtesy William Riseman Associates, Inc.

**DataCAD<sup>®</sup>**

Cadkey, Inc.  
4 Griffin Road North, Windsor, CT 06095-1511  
For a Free PC Demo Disk call today!  
Toll Free: 800-654-3413

\*DataCAD is a registered trademark of Cadkey, Inc.

**Circle 116 on inquiry card**

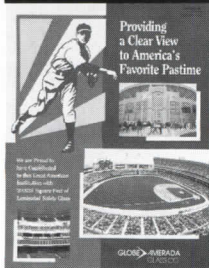

#### 400. Specialty glass

A colorful architectural guide illustrates recent applications of laminated and other glass in zoos, sports stadiums (Comiskey Park is featured), and institutions. Includes wind-load and other technical data; charts list decorative and color options. Globe Amerada Glass Co., Elk Grove Village, Ill.

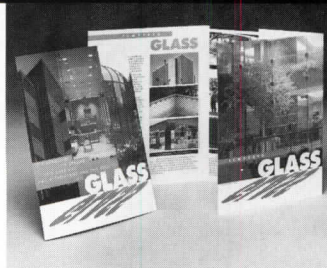

#### 401. Glass tempering

Brochure explains the tempering process that makes glass resist thermal and impact stresses four times better than the standard annealed product, and highlights architectural applications of tempered safety glass. Glass Tempering Association, Topeka, Kan.

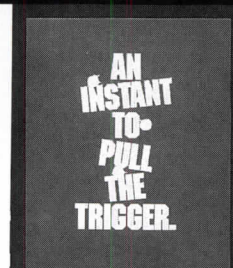

#### 402. Bullet-resistant framing

A new reinforced-aluminum framing system that meets UL Level III ballistic ratings, Armorline accepts BR glazing but has the same esthetics as standard storefronts. Bulletin describes its benefits in convenience stores, prisons, and other high-security applications. Kawneer Co., Inc., Norcross, Ga.

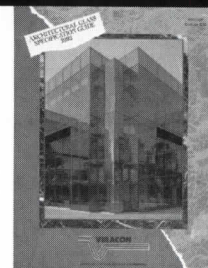

#### 403. Architectural glass

Fabrication manual illustrates applications of clear, tinted, reflective, and graphic glass in laminated, monolithic, insulating, and other configurations. Charts match architectural requirements with appropriate glass product. Viracon, Inc., Owatonna, Minn.

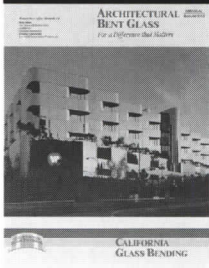

#### 404. Bent-glass guide

A color brochure shows some of the architectural uses for bent glass in curtain walls, spandrels, corner and transition areas, railing systems, entrances, and canopies. Custom-fabrication and laminating options described. California Glass Bending, Inc., Wilmington, Calif.

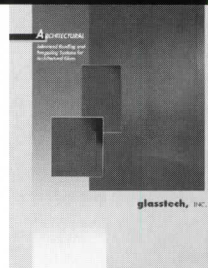

#### 405. Large curves

A new technology, the Advanced Bending and Tempering System, both bends and tempers architectural glass without tong or gripper marks, in sizes up to 7 by 12 ft., to minimum radii of 20 in. Process does not create distortion in safety glass. Glasstech, Inc., Perrysburg, Ohio.

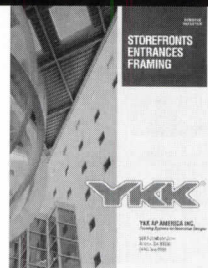

#### 406. Storefronts

A design brochure describes aluminum framing and entrance systems produced at a new facility in Dublin, Ga. In-plant finish options include Anodized Plus with a protective, clear-composite coating, fluoropolymer resins, acrylic enamels, and polyester paints. YKK AP America, Inc., Atlanta.

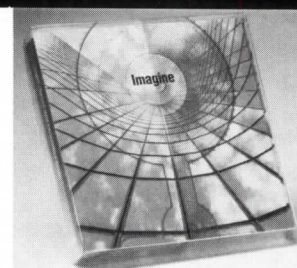

#### 407. Architectural video

"Light, Space, and Laminated Glass" is a 15-minute film featuring dramatic projects such as La Defense in Paris, London's Lloyds building, and Australia's new Parliament House. Architects' kit includes updated design values and tech data on structural glass. Du Pont Co., Wilmington, Del.

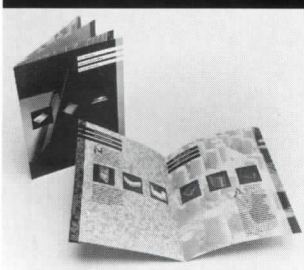

#### 408. Complex shapes

A color brochure demonstrates standard and custom fabrications in multiple-shape single-pane and insulating glass, as well as TemperBent glass, silk-screened graphics, and to-order drilling and hinging of glass components. Arco, Inc., Advanced Glass Products Div., Chicago.



#### 409. Decorative glass

Technical literature describes architectural-glass products and custom fabrication services including glass bending to sharp angles (up to 90 degrees), photo-etched and custom-laminate decorations, and no-hole Solderbond connections. Dlubak Corp., Freeport, Pa.



#### 410. Glazing systems

Technical catalog covers storefront, curtain wall, and window systems with a wide range of applications. Introduces the 960 Wall, a new product that is stronger than a curtain wall but cheaper than a storefront. EFCO Corp., Monett, Mo.

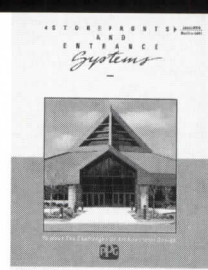

#### 411. Storefronts

Design guide includes performance data, such as uniform load deflection and air- and water-infiltration ratings, for 18 different storefront systems. Single- and tall-span installations are detailed. PPG Industries, Inc., Glass Group, Twinsburg, Ohio.



Pigments of the imagination

Benjamin Moore paint

comes in more than

2,000 standard and custom colors.

More colors perhaps,  
than one might even imagine.



A Stroke Of Brilliance.

Circle 33 on inquiry card

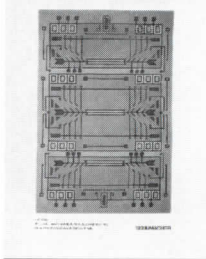

#### 412. Wright rug

Color catalog illustrates a floorcovering collection woven to original Frank Lloyd Wright designs. Reproduction and adapted motifs can be incorporated in custom-made wool carpets of any size over 50 sq ft. Schumacher, New York City.

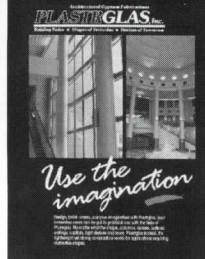

#### 413. Gypsum fabrications

Technical brochure illustrates custom architectural elements made of fiberglass-reinforced gypsum, including columns, domes, coffered ceilings, and light shelves. The material can be molded in almost any special shape, and comes in formulations for interior and exterior work. Plastrglas, Omaha, Neb.

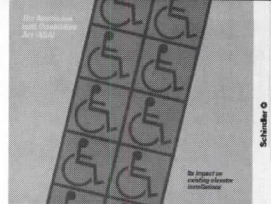

#### 414. Elevator accessibility

Concise guide explains ADA terms, such as "readily achievable," in the context of elevator and escalator control panels, cab performance and dimensions, door-protective devices, and emergency communications. Schindler Elevator Corp., Morristown, N. J.

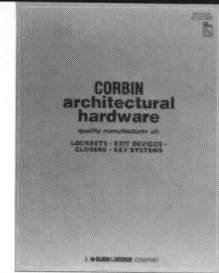

#### 415. Builders hardware

Designed as a quick-summary reference to the full line of Corbin locksets, exit devices, door closers, and key systems, a 16-page catalog highlights all disabled-code-compliant products. Corbin Architectural Hardware, Berlin, Conn.



#### 416. Fire-rated cabinets

Binder insert introduces the Fire-FX, a double-wall insulated cabinet said to be the only extinguisher housing that can be recessed into a wall without compromising the one- or two-hour fire rating of the partition itself. J. L. Industries, Bloomington, Minn.

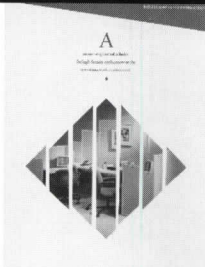

#### 417. Computer intensive

Workstation elements and wiring chases offer more space, flexibility, and lower cost to multiple-shift operations such as airlines reservation centers, travel agencies, and telemarketing companies. Separate ventilation units dissipate PC-generated heat. Structural Concepts Corp., Spring Lake, Mich.

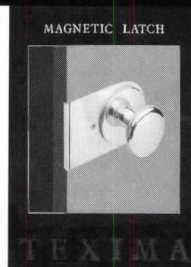

#### 418. Magnetic latch

A new design that can replace standard passage sets, the Texima latch holds an interior door closed by magnetic force: you push or pull the door open without turning a handle. Magnetic pull can be adjusted; only a simple cutout is needed for installation. Texim, Irvine, Calif.

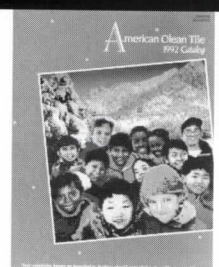

#### 419. Architectural tile

A 60-page catalog summarizes data on size, color, availability, suggested use, and test ratings for all American Olean tile. Color photos illustrate over 50 tile installations, from city-block-scale murals to powder rooms. American Olean Tile Co., Lansdale, Pa.

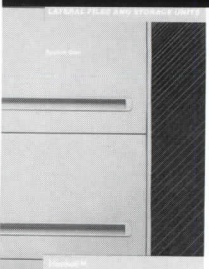

#### 420. Storage options

System One lateral files, wardrobes, and cases offer many space and storage configurations, from open fixed-shelf units for libraries to pull-out drawers for computer tapes. A 12-page brochure suggests layouts, and illustrates all 33 standard color choices. Haskell, Oakmont, Pa.

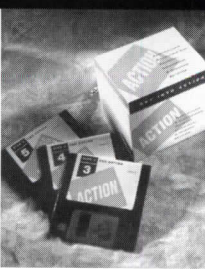

#### 421. Product-data tools

USG Action provides computer-based technical and design help for the architect on five Windows-format floppy disks. Interactive CD-ROM disks, formatted by Eclat, provide full product descriptions. United States Gypsum Co., Chicago. \*



#### 422. Metal-curving service

An eight-page brochure illustrates some of the dramatic effects possible with crimp-curved metal roofs, walls, mansards, canopies, and other architectural elements. Radius dimensions for various shapes are diagrammed. Curveline, Inc., Ontario, Calif.

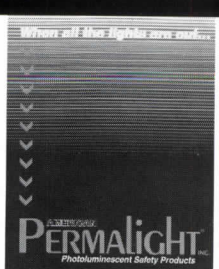

#### 423. Photoluminescent path

Developed in Germany to DIN standards, Permalight escape-route marking products include paints, strips, and cast-resin materials that cause stairs, handrails, or obstructions to glow in the dark, facilitating fast and safe emergency evacuations in dark, smoky conditions. Permalight, Compton, Calif.

\* Product data also offered on CAD disk

## Manufacturer Sources

For your convenience in locating building materials and other products shown in this month's feature articles, RECORD has asked the architects to identify the products specified.

### Pages 86-93

Carol Cobb Turner Branch Library  
Scogin Elam and Bray Architects, Inc.

**Pages 86-91**—Steel-truss framing: Truss Joist. Synthetic-stucco finish: Sto Industries, Inc. Aluminum-framed curtain wall, windows, aluminum and glass entrances, and glazing: PPG Industries, Inc., Glass Group. Locksets: Schlage Lock Co. Exit devices: Von Duprin. Closers: LCN Closers. EPDM membrane roofing: Firestone Building Products Co.

### Pages 92-93

Hollow-metal doors: Amweld. Seating: ICF (Bertoia and Eames Chair). Fluorescent fixtures: Lithonia. Metal-halide lighting: Lightolier. HPS lighting: Icon; Kidde. Custom casework: DeKalb Cabinets. Paints: Duron. Slate-texture laminate: Ralph Wilson Plastics Co. (Wilson Art). Custom chairs: Curry and Company.

### Pages 94-101

Opus One Winery  
Johnson Fain and Pereira Associates,  
Architect

**Pages 94-99**—Limestone: Wisman Masonry; Texas Quarries. Redwood trellis: Andrews and Thornley. White-oak windows and doors: Dor-Tec. Stainless-steel locksets and hinges: Yale Hardware. Thermal insulation: Dow Chemical Co. (Styrofoam). Concrete patterning: Bomanite Corp. Concrete colorants: L. M. Scofield Co.

**Pages 100-101**—Integrally colored plaster: J. W. Whittaker Co. Special lighting: custom fixtures by Johnson Fain and Pereira Associates; Horton-Lees Lighting Design, Inc. Downlighting: Kurt Versen. Oak tables: custom by Johnson Fain and Pereira Associates, fabricated by Wavell Huber. Elevator: Dover. Bronze table and chairs: Philippe Antonioz.

### Pages 102-111

The Gas Company Tower  
Skidmore Owings & Merrill, Los Angeles,  
Architects  
Stone cladding: Campolonghi Italia, SpA  
(Barre Gray and Lanoline granite). Aluminum curtain wall: Harmon Contract. Glass: Viracon, Inc. Structural sealants: General Electric Co., G. E. Silicones. Downlighting: Edison Price, Inc. Special lobby fixtures: custom by architects and Jules Fisher

& Paul Marantz, Inc. Elevators and escalators: Otis.

### Pages 112-117

The Church of St. Therese  
Allen, Harbinson & Associates Architect  
Face brick: Cherokee Sanford Group, Inc. (Cape Hatteras). Wood trusses: Carolina Components Corp. Roof shingles: Elk Roofing Corp. (Prestique Plus). Wood windows, entrance, and molding: custom by architect, fabricated by Stephenson Millwork. Locksets and hinges: Baldwin Hardware

Mfg. Co. Closers: Rixon-Firemark. Drywall: United States Gypsum Co. Paints: Benjamin Moore & Co. Pavers: Boren Clay Products. Lighting: Halo. Pews: A&O Church Furniture. Altar and liturgical furniture: custom by architect, fabricated by Century Guild, Ltd. Processional cross; Stations of the Cross: Marilee Keys and Bruce Lindsay. ■

© 1990 Raynor Garage Doors



6 years, 36 months of darkness,

45 snowstorms, 500 inches of snow,

92,000 cups of coffee (24,000 creams),

two polar bears,

one Raynor™ Tri-Core™ Door,

one Raynor Distributor.

**RAYNOR GARAGE DOORS**

You can't imagine what a garage door goes through over the years. But you don't have to when you specify a Raynor Tri-Core Door, because the only thing more reliable than a Raynor Door is a Raynor Distributor. To locate the one nearest you, call 1-800-545-0455.

Circle 36 on inquiry card

# A sense of permanence, a touch of fantasy...with MBCI's preformed metal roofing systems.

Two recently completed facilities at Vistana Resort illustrate the magic that can happen when good creative people and good clients get together.

The Reception Center in this unique timeshare resort features patterned stucco walls in sunset hues, topped with MBCI's Craftsman SB-12 architectural panels in Natural

Patina. The Recreation Center features peach/orange stucco walls, topped with MBCI's Craftsman SB-12 architectural panels in Copper Metallic.

To find out more about the distinctive character and long term durability that preformed metal roofing systems can add to *your* next

project, just call any one of our nine convenient facilities.



Houston 713/445-8555

Lubbock 806/747-4291

Atlanta 404/948-7568

Oklahoma City 405/672-7676

Tampa 813/752-3474

San Antonio 512/661-2409

Richmond 804/526-3375

Dallas 214/988-3300

Indianapolis 317/398-4400

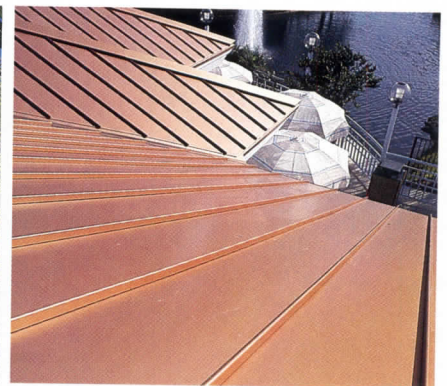

Project: Vistana Reception Center Architect: Hedman Hurley Charvat and Peacock Architects Roofing Contractor: Quality Metals, Inc.  
Project: Vistana Recreation Center Architect: Barry Sugerman, AIA Roofing Contractor: Quality Metals, Inc.

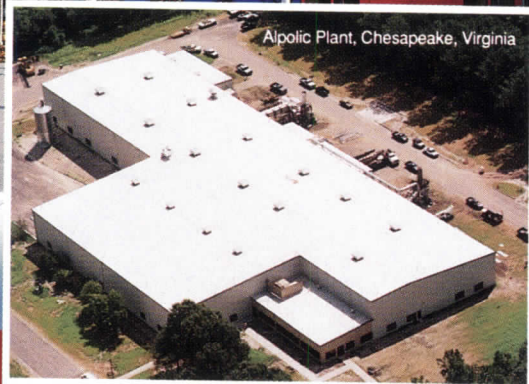

Alpolic Plant, Chesapeake, Virginia

# ALPOLIC®

**The Lightweight, Rigid, Bendable  
Composite Material**

How many times have you developed a concept for a design only to discover that the products available could not be fabricated in the way you had envisioned? How many times have you developed a specific company design only to discover that products available cannot be produced in the desired colors? Now, you can make your design fantasies come true.

A-LOOK supplies a high quality mirror like finish which will enhance any design without the possibility of shattering or breaking. A-LOOK can be easily fabricated to fit almost any design you require. For those exterior applications, A-LOOKEX is available.

ALPOLIC can be produced in almost any color and gloss you can imagine and can be used both on interior and exterior designs. ALPOLIC can be bent, cut, drilled and routed to help create your vision.

ALPOLIC and A-LOOK are both a lightweight aluminum composite material. Their superior flatness and workability make them the perfect addition to your designs. The next time you sit down to create an image let your imagination go wild. ALPOLIC and A-LOOK are available to help make your dreams reality.

# A-LOOK®

**The Lightweight, Flexible,  
Unbreakable Mirror**

**MITSUBISHI  
KASEI**

**MITSUBISHI KASEI AMERICA INC. (MKA)** Circle 65 on inquiry card  
1214 Progressive Drive, Suite 101, Chesapeake, VA 23320 • Phone: 804-548-3000/800-422-7270/FAX: 804-548-3551



## **ACROVYN PATTERNS: BECAUSE WALL PROTECTION SHOULDN'T BE BORING**

Now there's no need to settle for plain, drab, institutional looking Handrails, Crash Rails, Bumper Guards and Corner Guards.

Acrovyn's exclusive, new collection of seven dramatic patterns is available in 53 distinctive colorways. Acrovyn also offers 63 up-to-the-minute solid colors, 27 of which are prematched to Formica® brand laminates.

And, Acrovyn still has the industry's best fit and finish; computer controlled color consistency; comprehensive code compliance including ADA; and U.L.® Classified, Class I Fire Rating.

For colorful, free literature, call The C/S Group 800-233-8493.

**ACROVYN® INTERIORS**

Circle 66 on inquiry card



We Can Help Make Beautiful Lighting Ea

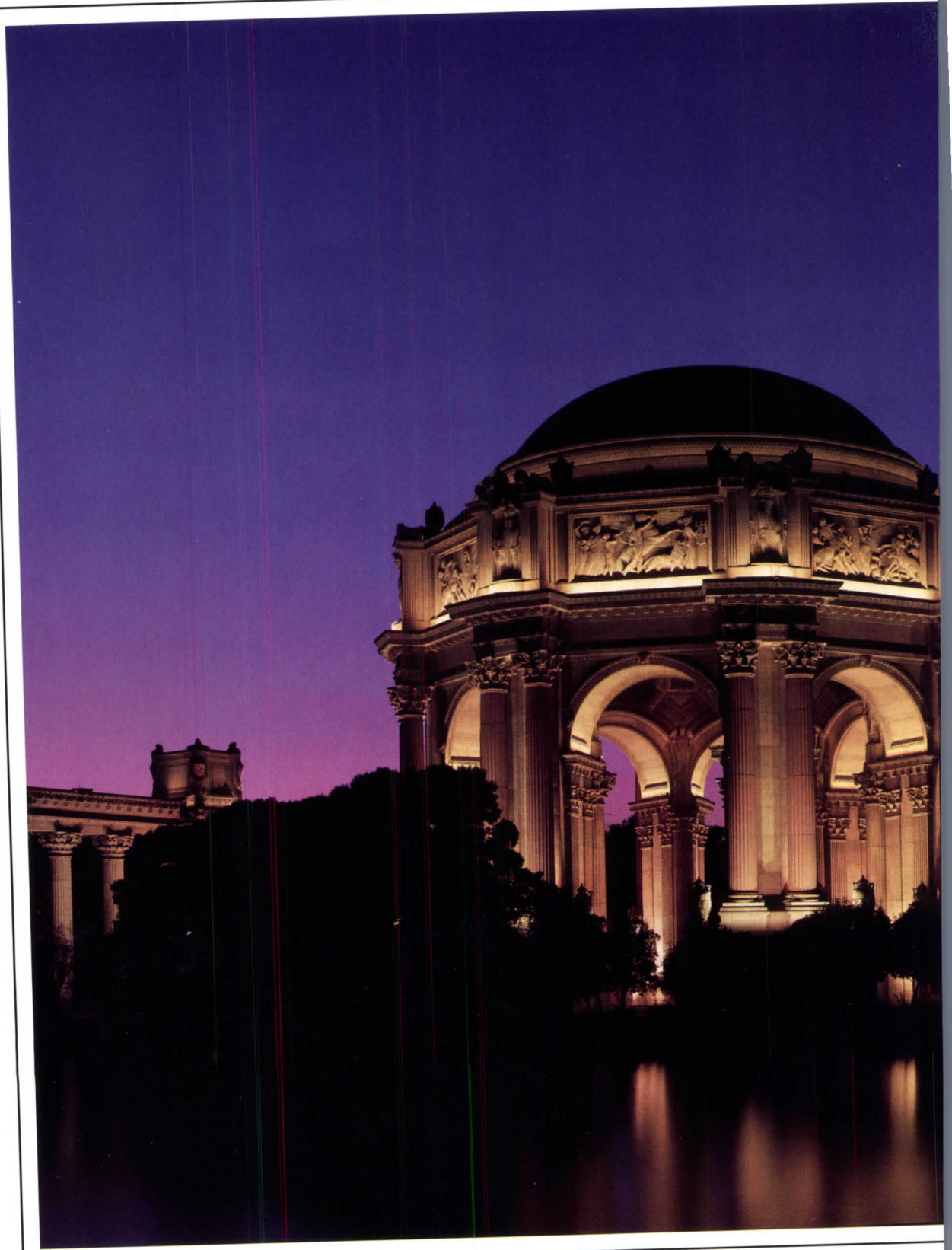

C-935



---

**Hotel Macklowe, New York City 42**

William Derman, Architect  
Cosentini Lighting Design, Lighting Designer

---

**Interstate Tower, Charlotte, North Carolina 46**

Kohn Pedersen Fox Architects  
Craig A. Roeder Associates, Lighting Designer

---

**Eugenio Maria de Hostos Community College, Bronx, New York 48**

Voorsanger & Associates, Architects  
H. M. Brandston & Partners, Inc., Lighting Designer

---

**Seven projects by Haverson-Rockwell Architects 52**

Le Bar Bat, New York City/Tatou, New York City/La Galleria, Norfolk, Virginia/Tomy  
Toys Showroom, New York City/The Museum Club at Bridgewater, New York City/  
Caffe Roma, New York City/Residence, Pound Ridge, New York

---

**HealthPark Medical Center, Lee County, Florida 56**

HKS Inc., Architect  
Craig A. Roeder Associates, Lighting Designer

---

**Redwood Grove, East Bay, California 62**

Jan Moyer, Lighting Designer

---

**Boogies Diner, New York City 64**

Himmel/Bonner Architects  
Mark Kruger Associates, Lighting Designer

---

**Lighting Design News 17**

Pacific Energy Center Features Lighting Classroom, Laboratories  
Après Lightfair, Go Take a Hike

---

**Lighting Product News 20**

Lightfair International Product Preview

---

**Lighting Technology and Design 24**

Avoiding Pitfalls When Installing Specular Reflectors, *by Lindsay Audin*  
Landscape Lighting, *by Jan Moyer*  
Lumen-Micro 5.03, *by Sam Mills*  
Efficient Fixtures: Beyond Troffers, *by James R. Benya*  
Energy-Code Alert, *by Robert Davis*

---

**Editorial 41**  
**Product Literature 69**  
**Manufacturers' Sources 74**

**Advertising Index 80**  
**Reader Service Card 81,82**

Cover: *La Galleria, Norfolk, Virginia, Haverson-Rockwell Architects*  
©Paul Warchol Studio, photo

# Louis Poulsen introduces new technology for lighting the intelligent building.

*About the Author.*

*Willard L. Warren, P.E., Electrical Engineer is a graduate and trustee of Cooper Union in New York City, and practices as an independent Lighting and Energy Consultant.*

**T**wo years ago, Howard G. Cohen, President and CEO of Poulsen Lighting, Inc., asked his top marketing people this question, "If you could describe the 'ideal' lighting fixture for the 90's, what would it be like?" After canvassing lighting consultants and their field sales agencies all over the United States, this was the specification presented to Mr. Cohen several months later.

The 'ideal' Poulsen lighting fixture for the 1990's:

1. Large lumen package.
2. Attractive design.
3. Good glare control.
4. Efficient.
5. Comes in a small package.
6. Versatile, Recessed, Surface and Pendant Mountable.
7. Uses standard, long life, instant start lamps.
8. Symmetrical and Asymmetrical light distributions.
9. Modular.
10. Easy to install.
11. Easy to maintain.
12. Saves Energy, Dimmable, Occupant and Daylight sensing.
13. Emergency light capability.
14. Electrically clean.
15. (But not least) Low life cycle cost.

At the next gathering of the Poulsen sales team, Howard Cohen unveiled the design for the newest Poulsen fixture, the Direkta™. "This fixture will be ready in late 1991", he said confidently, "and incorporates every one of your 15 requirements. It represents a breakthrough in design and technology, and will be the first of a new generation of 'intelligent' luminaires. Welcome to the 1990's."

True to this word, Howard Cohen delivered the Direkta™ late in 1991 and the results were indeed impressive. In meeting every one of the 15 objectives, Poulsen has to its credit several unique features.

These features start with a unique three part basic construction.

First, a mounting assembly with an in-built terminal block for simplified electrical connections. The installer merely strips the insulation from the supply wires and inserts them into the proper port of the terminal block. Since each port has two separate entries, there's no need to ever splice two wires. The electrician just inserts the two wires into both entries of the same port in the terminal block and they're joined electrically and safely, in seconds.

Second, there's the PSM™ power service module which contains one, two or three compact fluorescent ballasts, sockets and lamps. The unit is pre-wired at the factory and connected to the other half of the terminal block. The PSM™ power service module just slides into place in the mounting frame assembly, joining the two halves of the terminal block, and the fixture's wired for dual switching and ready to go.

The third and most critical part of Direkta™ luminaire is the optical package, which consists of a concentric ring parabolic reflector system with radial louvers. The reflector-louver system is supplied either mirror specular or matte white, but the specular version is so optically precise that there is no brightness in the 60 to 90 degree zone which makes it ideally suited for VDT viewing.

With 15 out of 15 desired features accomplished in the design of the unit it is not surprising how versatile the Direkta™ can be.



*Conference room using lens suspended below Direkta™ for widest possible spread of light.*



*Conference room using wall wash Direkta™ units to light paintings on wall and symmetrical units in middle of room.*

Consider its applicability in a corporate office. With 3-26 watt quad tube lamps the unit has a lumen package of 5400 lumens. That's the equivalent of a two-lamp 1'x4' or a two-lamp 2'x2' fixture, and the recessed Direkta™ is only 11 inches in diameter. So it's certainly suitable for general lighting. Depending on room size, units on 6' by 6' centers will provide 50 to 60 ftc. maintained. For prolonged VDT viewing, one lamp can be switched off for proper balance. To highlight one of the walls, the asymmetric distribution can be used.

For audio-visual presentations, two lamps can be shut off, or dimmed. This makes every office a conference room. In the corridor or lobby the unit can be used as a wall wash, and near perimeter glass walls can be provided with a daylight compensating dimming ballast. Every unit can be wired with one ballast on the night light circuit, and some can be equipped with emergency battery packs. The beauty of it all is that all units will look alike. For the purpose of variety, the Direkta™ is available with a suspended glass lens below the inner reflector, or the unit can be surface attached or suspended on aircraft cable. It is not an exaggeration to call it the first of a line of 'ideal' fixtures. There could be nothing more suited to a conference room, or executive office. Because of the Direkta's small diameter and shallow depth, it's ideally suited to any combination room such as conference/dining in a hotel, or classroom/conference in an executive training area, or in any room that has dividers so that partitions could be placed anywhere and lights would never be too close to walls.

There's probably never been a unit with so much appeal to the interior designer, so versatile for the lighting consultant and so cleverly designed for the electrical engineer.

*Fixture whip entering via knock out.*

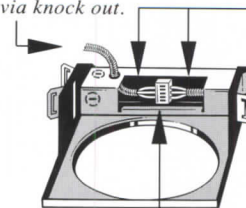

*Terminal block (female) Mounted on inside rear wall of mounting frame assembly.*

*Circuit wires and neutral entering one side of terminal block, and leaving (if necessary) out the other side, after being spliced.*

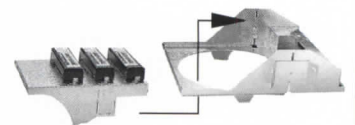

*Pre-wired power service module (PSM) slides over mounting frame assembly joining both halves of terminal block and energizing ballasts and lamps.*

San Francisco

## Pacific Energy Center Features Lighting Classroom, Laboratories

Douglas Salin photos



Pacific Gas and Electric, a utility company serving the San Francisco region, recently opened the Pacific Energy Center, a 25,000-sq. ft facility aimed at teaching design professionals and the public about energy efficiency. The center is part of PG&E's \$2-billion customer energy-efficiency program. PG&E hopes to reduce growth in electrical demand by 75 percent, or 2,500 megawatts over the next 10 years through customer education and energy-saving technologies. Architects for the center were Robinson Mills + Williams of San Francisco.

The center features interactive displays that demonstrate energy-efficient appliances, insulation and glazings, lighting and hvac technologies in operation. For the design professional, the center offers a large lighting classroom fitted with a comprehensive array of lighting demonstrations and fixture displays. A separate laboratory for electric-lighting mock-ups features a ceiling that can be lowered to install different lighting systems. The daylighting laboratory includes a heliodon and a model-building shop.

The building itself functions as a lighting-efficiency demonstration project. The lighting-design firm Luminae Souter of San Francisco used 66 types of energy-efficient fixtures, achieving a total connected lighting power load of 0.95W per sq ft. Lighting controls, including ultrasonic occupancy sensors, daylight sensors, and a building-wide computer-control system, lower the connected lighting-power load to the equivalent of 0.76W per sq ft. Plaques located throughout the building identify and explain the technology used to light specific areas.

*Charles Linn*

*The lighting classroom at the Pacific Energy Center uses many different types of lighting systems to educate design professionals. The daylighting lab features model testing and a heliodon.*

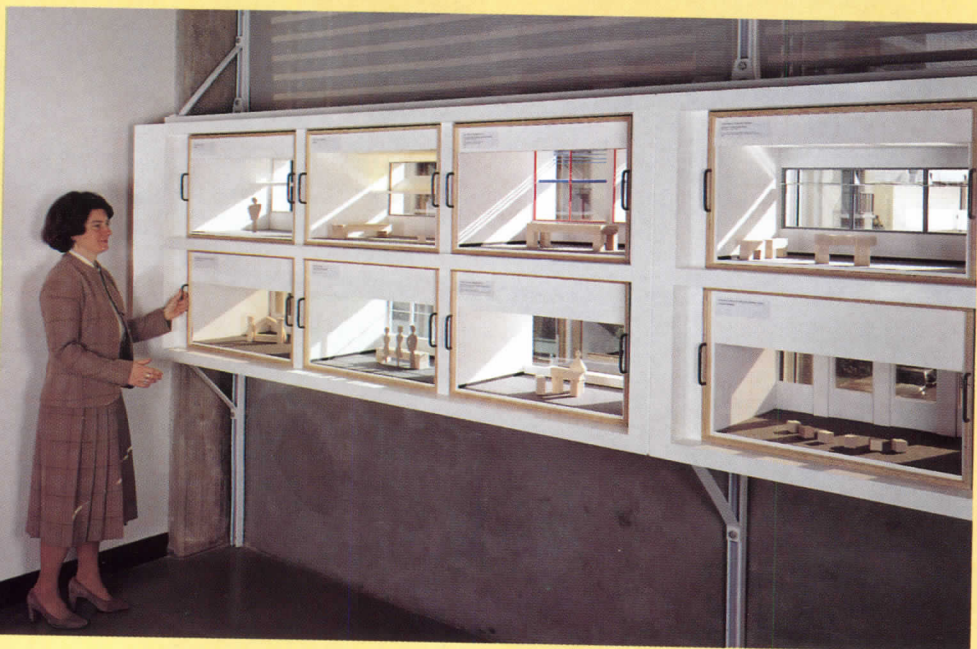

## Après Lightfair, Go Take a Hike

### Coca-Cola

**711 Fifth Avenue between  
55th & 56th Streets**  
**Lighting design: Ronnette Riley  
Architect/Johnson Schwinghammer  
Lighting**  
**Interior: Ronnette Riley Architect**  
**Hours: Mon.-Sat. 10 AM to 8 PM;**  
**Sun. Noon to 6 PM**

A wave of light draws strollers into and through this retail outlet cum museum of the history of Coca-Cola's advertising imagery, where everything from trays to necklaces made of mini-Coke bottles can be purchased. White by day and red by night, the wave is a stainless-steel-framed double layer of polycarbonate sheet lens suspended beneath a layer of cold cathode and neon tubes on sequenced dimmers. Low-voltage lamps illuminate the display cases.



© Otto Baitz

### Planet Hollywood

**140 West 57th Street  
between 6th & 7th Avenues**  
**Lighting Design: Charles Daboub  
Design, Inc.**  
**Interiors: Anton Furst**  
**Hours: Mon.-Sun. 11:30 AM to 1:45 AM**

Film designer Anton Furst's memorabilia-packed homage to Hollywood is the kind of club where a lighting designer may never be able to get enough control, but Charles Daboub is particularly satisfied with cove-hidden low-voltage track lighting that permits new wires to be fished through to any point in the ceiling when more light-hungry memorabilia turns up. A trolley system downlights tables in one room without compromising a dramatic starlit sky.



© M. J. G. / M. J. G.

### Gianni Versace—Donna

**819 Madison Avenue  
between 67th & 68th Streets**  
**Lighting design and interior:  
Laboratorio Associati, Milan**  
**Hours: Mon.-Sat. 10:30 AM to 6 PM**  
**closed Sun.**

Opaline acrylic glazing and a fluorescent ladder of light reinforces the dramatic simplicity of this shop by climbing up the stairwell in an echo of the risers, crossing the ceiling, and descending to meet the front entrance, where the motif continues in horizontally banded doors in a vertically columned facade. Low-voltage down spots in the riser reverses pick out the austere curve of the bottom steps, one of the few rounded forms in the space.



Grace Giaccone/Reggiani

### Rockefeller Center

**48th to 51st Streets  
between 5th & 6th Avenues**  
**Lighting design: Abe Feder**  
**Architect: Raymond Hood**  
**Hours: exterior lighting  
from Dusk to 1 AM**

Start on Fifth Avenue between 49th and 50th streets and saunter through the Channel Gardens, gazing up at the first New York skyscraper to be illuminated from bottom to top on all four sides (near right)—by Abe Feder, who theorized that since the entire 70-story RCA (now GE) Building had been designed as the focal point of the 19-building limestone ensemble, the entire building deserved to be illuminated. He used 50-million lumens from 342 tightly focused

lamps atop nine neighboring buildings; wherever the building's planes block a beam of light, another beam takes over so that the soaring lines and delicate setbacks are not only sharp but also shadowless. Feder worked with GE in developing the high-intensity lamps that throw immense light up to 800 ft. At the foot of the Gardens, the stroller discovers the Prometheus fountain (far right) in a hollow that holds an ice rink in winter and a café in warm months. Feder,

*Fifth and Madison Avenues in the 50s and the 60s contain some of the most interesting lighting designs New York has to offer. Here are just a few examples...*

**Fila**

**831 Madison Avenue  
between 69th & 70th Streets  
Lighting design and interior:  
Sergio Bernardini 7 Associates,  
New York and Rome/Pierluigi Cerri,  
Gregotti Associati, Milan.  
Hours: Mon.-Sat. 10 AM to 6 PM  
closed Sun.**

Upscale Italian sportswear glows beneath rows of adjustable chrome-hooded downspots flanking a perforated, brushed-aluminum ceiling that admits air conditioning and low-voltage halogen light. A single line of recessed light slots with crystal drops extends the ceiling gleam out the front door, past deep display windows, to meet the street. Transformer-modified lamps and color filters permit a wide variety of lighting in the street windows.



Grace Giacomone/Reggiani

**Aquavit Atrium**

**13 West 54th Street, off Fifth Avenue  
Lighting design: Horton Lees  
Architect: Emery Roth  
Hours: Mon.-Fri. Lunch: Noon to 2:30 PM;  
Dinner: 5:30 PM to 10:30 PM  
Sat. dinner only: 5:30 to 10:30 PM  
closed Sun.**

Stephen Lees was invited to use light to liven up this restaurant's atrium extension. He suggested first installing something that could be lighted—which landed him the task of locating art consultants and then serving on a MOMA panel interviewing artists. He says the lighting itself is an almost retrofit installation, illuminating Richard Smith's suspended canvases, and protecting diners from the spill, without disturbing the built space.



Barbara Horton

**Bulgari**

**730 Fifth Avenue at 57th Street  
Lighting design: H. M. Brandston  
& Partners  
Interiors: Piero Sartogo, Rome/  
Soo Kim Associates, New York  
Hours: Mon.-Sat. 10 AM to 5 PM  
closed Sun.**

This is an elegant jewelry shop lit by Howard Brandston, Robert Prouse, and Randy Sabedra. Incandescent uplights imbedded in beams and A-lamps in vertical fascia niches wash the walls; the intensity of MR-16s flooding the vitrines counteracts veiling reflections on the glass and makes it appear that glowing displays alone light the space. Adjacent salesrooms contain dual-lensed MR16s to make jewels sparkle while casting a soft glow on clients' faces.



© Norman McGrath

who has lit numerous Broadway hits, designed a 26-minute computerized dramatization in light and water, climaxing in a storm of gray, yellow, and red jets from which the 18-foot mythical hero emerges carrying the gift of fire. Color filters of split glass guard against breakage. Feder has been lighting Rockefeller Center since 1948, including the Channel Gardens, interior murals, sidewalks, and Atlas (center right) on Fifth Avenue between 50th and 51st streets.

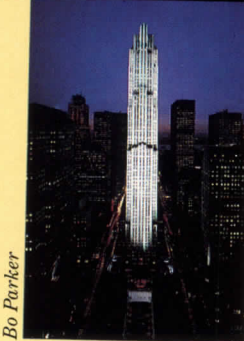

Bo Parker



Bart Barlow



© Elliot Kaufman

## Lightfair International Product Preview

*This year's Lightfair, sponsored by IESNA and IALD, takes place May 6-8 at the Javits Center in New York City. Here's a look at some new fixtures and sources culled from information ready at press time. The booths where they can be seen are noted in italics. J. F. B.*

**320. Outdoor lighting.** New designs in the Eurocast line of cast-aluminum fixtures include four wall brackets for exterior use. Lights take PL and PLC compact-fluorescent lamps; two models will also accept HID sources. Quality Lighting, Franklin Park, Ill. *Booth 514/516*

**321. Half-cone luminaire.** Bega's wall-mount fixture, labeled for wet locations, has a textured surface on a cast-aluminum housing; diffuser is heavy pressed glass. For incandescent and compact-fluorescent sources, the light comes in black, white, and a choice of custom colors. Bega/FS, Carpinteria, Calif. *Booth 624*

**322. Commercial fixture.** A new line, the Designer Collection includes this contemporary-style sconce. Made with rugged materials for commercial and institutional settings, the series offers a variety of size, color, and lamping options. R. A. Manning Co., Sheboygan, Wis. *Booth 938*

**323. Halogen sconce.** From Artemide's moderate-price Sidecar Collection, the Warrior is made with chromed-steel hardware, coated-glass diffuser, and black backplate. A 150W halogen bulb sparkles through the slit in the helmetlike shade and provides wall-wash illumination. Artemide, Inc., Farmingdale, N. Y. *Booth 659*

**324. Contact rail system.** The Galaxis low-voltage track uses uninsulated conductors and a dedicated power supply that has Recognized Component Status from UL. The MR11 and MR16 lamp heads can be positioned anywhere along the rigid monorail track; a clip can attach the track in turn directly to display-lighting truss systems, as shown. Translite Systems, Redwood City, Calif. *Booth 925*

**325. Floating heads.** Suspension fixtures Cairo and Mona are two of several halogen

lights that can be clipped anyplace along the UL-listed Kable Lite low-voltage power/suspension system. Translucent shades are frosted white glass. Tech Lighting, Inc., Chicago. *Booth 619*

**326. Suspended indirect.** Introduced in 1991, the Series 67 Flatlite uses specular-aluminum reflectors said to produce uniform ceiling illumination and wide distribution yields. Lamping options include 1 or 2 T8, T12, or biaxial lamps. Extruded-aluminum housing is finished in any color powder paint; all hardware is concealed. NeoRay Lighting, Brooklyn, N. Y. *Booth 402*

**327. Decorative globe.** A compact (4-in. diameter by 5-in. high) medium-base bulb, the Dulux EL has a CRI of 82, a rated life of 10,000 hours, and a universal burning position. The electronic ballast is said to start without flicker, even outdoors. Osram Corp., Trenton, N. J. *Booth 718*

**328. Task light.** LucePlan's BAP is said cure the ills of VDT-intensive workspace lighting: "reflex, dazzling, and mirror effects." The head of the lamp tilts to accommodate the user's preferred angle while staying parallel to the worksurface, and the diffusing light-filter can be specified in amber, blue, or green to match the computer screen. Light source is a PL13 fluorescent. Artemide, Inc. Farmingdale, N. Y. *Booth 659*

**329. Articulated halogen task.** A new armature for Luxo's System-2 has two hinges: one where the arm connects to the base, and another at the mid-point of the arm extension that permits a range of vertical motion, and a left or right swing of 180 degrees. Mounting options allow the unit to attach to panel systems, worksurface or shelf edges, directly to walls, or to sit on weighted bases. Luxo Corp., Port Chester, N. Y. *Booth 336*

**330. Table top.** Resembling a scoop of vanilla ice cream set on a colorful cone, Ron Rezek's Gelato lamp has a shade of white mouthblown cased glass supported on a stem of either emerald green or cobalt blue matte-finish glass. A 75W A bulb provides both ambient and task light. Artemide, Inc., Farmingdale, N. Y. *Booth 659*

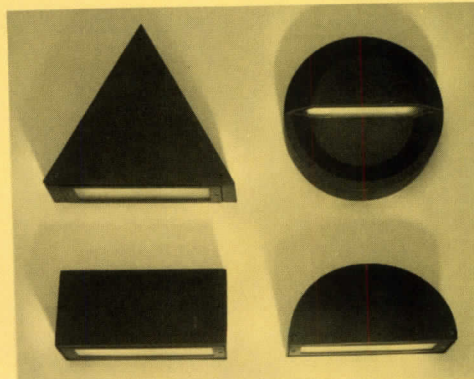

320

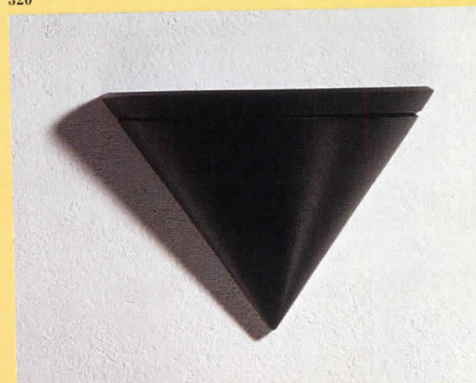

321



322

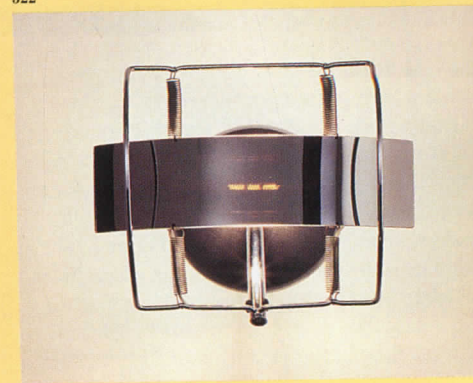

323

For more information circle item numbers on Reader Service Cards.

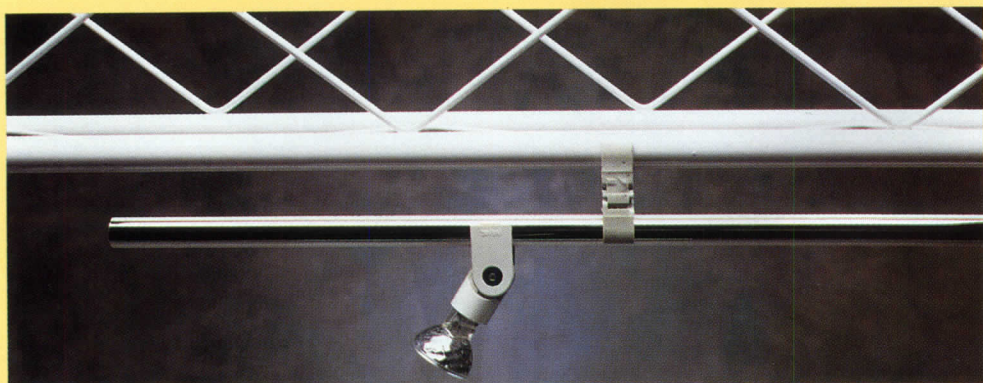

324

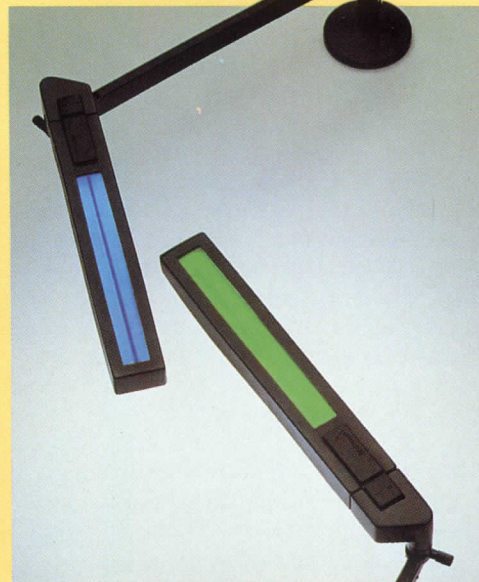

328



325

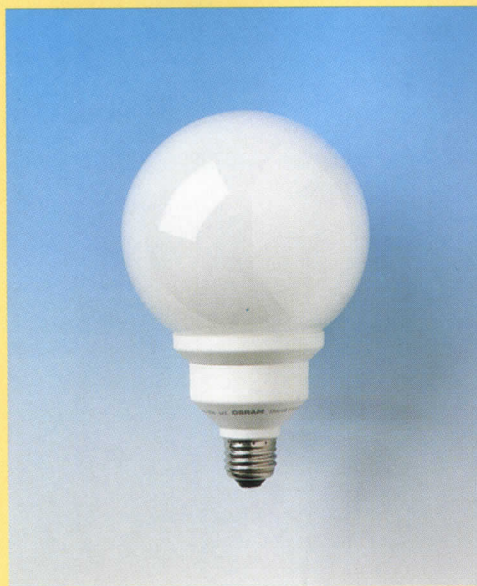

327



329



326



330

**331. Snap shot.** The Sunlight spotlight lets the designer use the most suitable light source and color temperature to illuminate projects, while maintaining continuity in the shape of the lampholders throughout the installation. Fixtures accept single-ended metal halide, HPS, linear halogen tubes, and low-voltage halogen bulbs. Ballast and lamp head are connected by a mechanical swivel that permits 130 degrees of vertical adjustment; the entire fixture can be rotated 350 degrees on its mounting plate. Slots and fins promote air flow; a snap-on ring holds anti-glare lens, louvers, and UV filters. Reggiani USA, Inc., New Windsor, N. Y. *Booth 108*

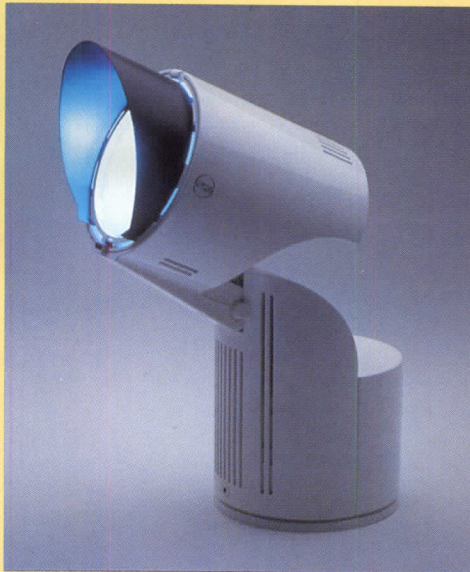

331

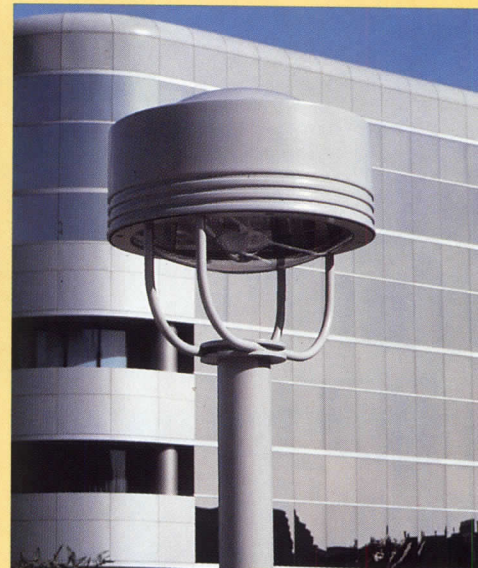

334

**332. Quick fit.** A lightweight mounting frame of heat-resistant Noryl plastic can replace conventional recessed housings with metal plaster frames. This Quicklight housing can be used in four types of downlighting applications, including insulated ceilings. A self-aligning integral ledge positions the housing against the ceiling joist at the correct level and spacing. The UL-listed component meets NEC flammability and firestop requirements for recessed lighting and will accommodate over 70 different fixture and trim styles. Capri Lighting, Los Angeles. *Booth 1000*

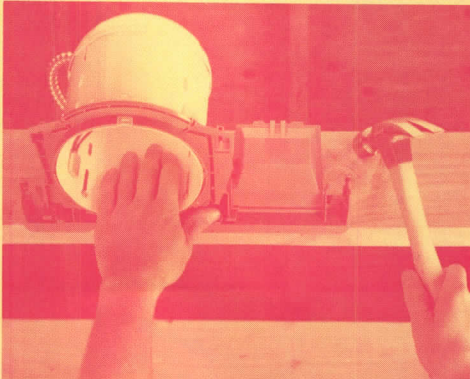

332

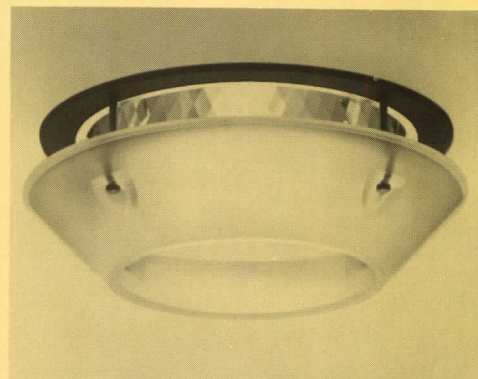

335

**333. Asymmetric quads.** Elliptipar has introduced a line of small-scale fluorescent fixtures that echo the shape of the firm's HID luminaires. For interior spaces, the wall- or ceiling-mount lights accept 26W quads, 2 ft Biax, or T8 lamps, projecting the light its maximum distance in a precisely cutoff pattern. Elliptipar, Inc., West Haven, Conn. *Booth 545*

**334. HID area light.** The VL luminaire incorporates very-wide-distribution optics said to get the most lumens from vertical-burning HID sources without redirecting light through the arc tube. Spun-metal housings were designed to reduce wind loading, with horizontal ribbing that is both decorative and structural. A side-shield option eliminates light trespass. Kim Lighting, Inc., City of Industry, Calif. *Booth 931*

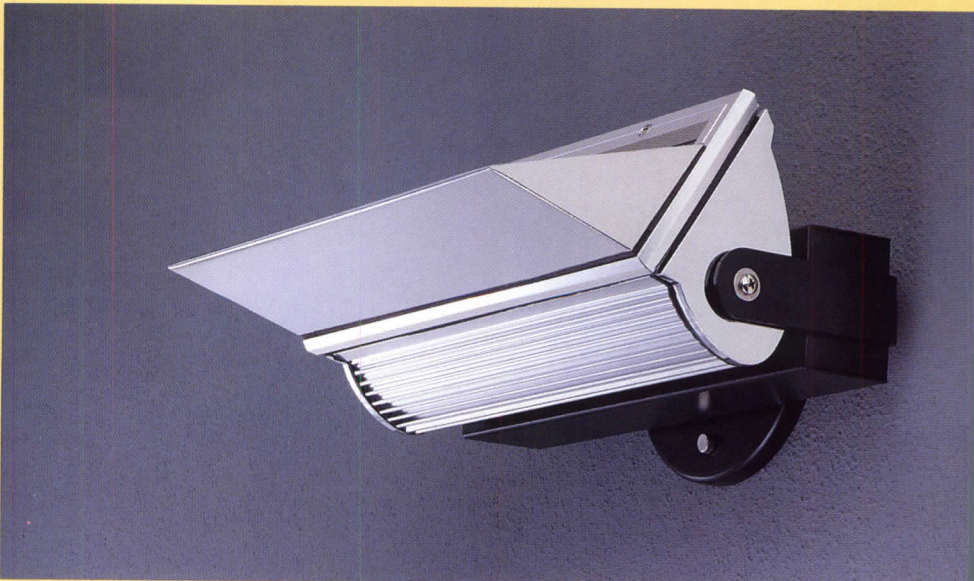

333

**335. Modular downlighting.** Designed by Ettore Sottsass, Optos is a system of interchangeable rings, faceted or specular



For more information circle item numbers on Reader Service Cards.



336

reflectors, and matte-glass accessories that alter both the appearance and the optics of recessed downlights. Glass rings can be suspended either side up. Zumtobel Lighting, Inc., Garfield, N. J. *Booth 616*

**336. Almost wireless.** A new MR-11 display light is especially useful on glass shelves, because its very thin, very flat conductor ribbon adheres almost invisibly along an edge of the glass. Compact rotatable lampholders can be clamped anywhere along this strip. ETL listing pending. Lucifer Lighting Co., San Antonio. *Booth 506*

**337. Field flexible.** Described as the first field-curvable compact-fluorescent light strip, a new cove-lighting fixture can conform to radii as tight as three feet and accommodate reverse curves. A flexible lighting option for contoured coves, units can be ordered without specifying a predetermined radius dimension and for less cost than cold cathode. Norbert Belfer Lighting, Ocean, N. J. *Booth 730*

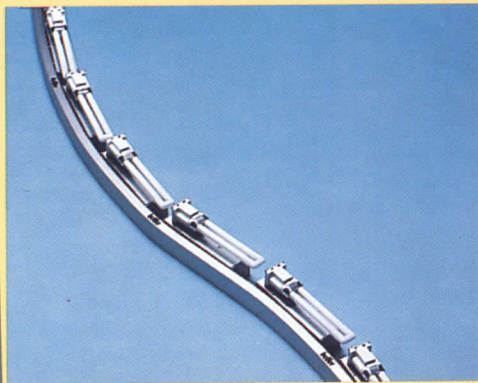

337

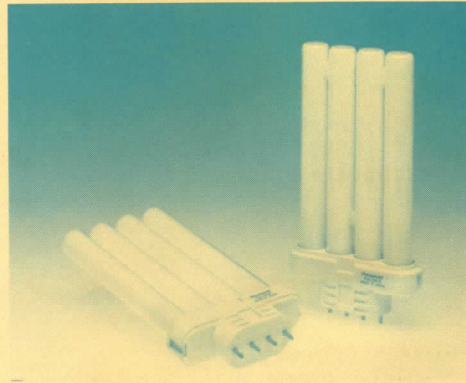

339

**338. Fiber-optic illumination.** Large-diameter, solid-core fiber optics are now available in unspliced lengths of 100 feet (72 feet was the old maximum), which makes the lighting easier to install in architectural applications. Lumenyte International Corp., Costa Mesa, Calif. *Booth 1034*

**339. Linear quad.** Initially offered in this 28W version, Panasonic's LiteWise compact fluorescent has its four tubes placed in a row, a configuration said to minimize the shadow effect of adjoining tubes and provide a slim profile that fits into flatter fixtures. Panasonic Lighting Products, Secaucus, N. J. *Booth 850*

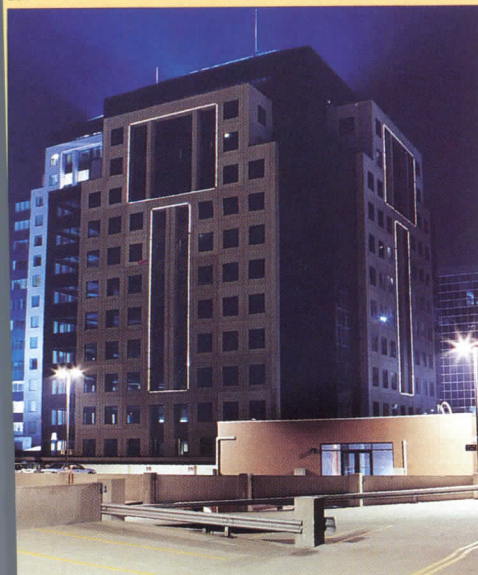

338



340

**340. Multifunctional.** Representative of this firm's custom work, the Edina standard was designed to perform several tasks in the streetscape of a Minnesota city. Roadway and area lighting is provided by 250W HPS lamps set in prismatic acrylic globes; two PAR 38 downlights inside the smaller top sphere highlight seasonal banners that hang from the narrow crossbar. And there's a 120v outlet to plug in Christmas lights. Appleton Lamplighter, Appleton, Wis. *Booth 1024*

## Avoiding Pitfalls When Installing Specular Reflectors

*Two previous articles took up the pros and cons of specular reflectors. This article gives some valuable tips on how to do a proper installation.*

*Courtesy of Metal Optics*

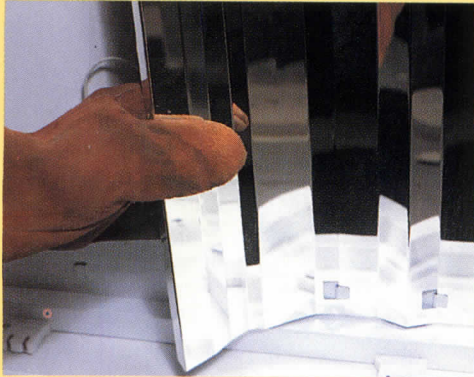

*By Lindsay Audin*

Every vendor should review the existing lighting and submit a room-by-room design document for approval, detailing the reflectors, lamps, and ballasts to be installed. Don't use an audit from any other source; doing so negates the vendor's responsibility for supplying and installing the right equipment. When only a few fixture types exist (and no changes are to be made in fixture location or height), the vendor may simply submit plans and specs on the retrofits by fixture type. Efficiency-based retrofits are notorious for worsening existing lighting problems, so review the design against the following checklist to avoid problems.

- If a utility rebate is involved, does the design comply with its requirements? Failure to comply with utility-company specifications and definitions could cost a lot more.
- The vendor's audit should include sample light levels and surface reflectances where they vary significantly from a stated norm; spot-check various rooms to verify this data. Dark wall and floor coverings (e. g., wood paneling, black tabletops) may severely reduce the expected light levels; the design should account for them.
- Properly retrofitted lighting in typical office, classroom, or merchandising spaces consumes between 1 and 1.5W per square foot, assuming use of electronic ballasts. If the design in any room is much above or below that range, light levels may be unacceptable because the existing

lighting layout may be designed to an excessively high or low light level. Properly designed corridors and lobbies consuming less than half that amount are usually considered acceptably bright.

- If existing fixtures are too far apart, too high or low, or poorly grouped, putting reflectorized lighting in those same positions may result in glare, or major variations in light levels, making some spaces appear too dark. Here's a good rule of thumb: if the ratio of the distance between fixture centers to the height above the task exceeds 1.25, ask the vendor how his or her design will avoid these problems.
- Tasks performed in some spaces may have changed since the existing lighting was installed; for example personal computers may have been added. How does the design account for these variations? Does it comply with IES recommendations for luminance ratios? If a reduction in light level is proposed, could it result in the use of incandescent task lights, eliminating most of the savings? If the vendor doesn't understand these terms and concepts, eject this person—and the design—from your office.
- How high is the present lighting above the task? High-efficiency lighting often reduces or eliminates sidelight, uplight (if fixtures are pendant-mounted), and light out of the end of a fixture, creating a dark ceiling and upper walls. This may be acceptable if the ceiling is high (over 9 ft) or those surfaces are very light-colored, but the loss of light at the end of a fixture row may darken perimeter workspaces. Pay special attention to shelves, blackboards, racks, and bulletin boards. A poor design may later require extra fixtures in these areas.
- Does the design pose any maintenance problems by using nonstandard (e. g., T-10) lamps or ballasts? The building's purchasing and maintenance divisions may resist stocking them due to price or technical concerns, resulting in short-lived savings when they are replaced by standard (i. e., less-efficient) varieties.
- Are new ballasts reduced through tandeming and use of 3- or 4-lamp ballasts?

Doing so helps maximize energy savings.

- Are the lenses/louvers to be changed? If so, how will the new shielding affect light distribution? If parabolic "eggcrates" are specified, ask to see them in a demonstration room be set up with them before proceeding.

### **Project methodology/documentation**

All flows of product and information related to the job should be coordinated through procedures set up prior to installation.

The vendor should supply a comprehensive audit-design-installation document to avoid duplication and mistakes, minimize paperwork, and guide the electricians.

Meet with a utility representative to ensure the proper rebate. Discuss application filing, pre- and post-implementation inspections, back-up paperwork (e. g., invoices), ballast-disposal verification, etc. Never assign this task, or the rebate, to the vendor. Doing so limits your control of the job if it's not acceptable at completion.

Set up a work-order system to handle in-field variations to the design. It should specify the condition (e. g., code violation), the accepted remedy, responsibility for any charges, and sign-off after inspection. Discuss future cleaning, maintenance, and replacement for the new equipment.

Establish clear warranty-fulfillment mechanisms, both for the reflectors and ballasts (as well as overall system performance) prior to starting construction.

Create job closeout procedures that address all of the following items:

- utility inspections (e. g., does using the vendor's electrician involve an extra person?)
- material-disposal documentation (proof of hazardous-waste disposal)
- verification and documentation of: code compliance, design performance, client/occupant acceptance, energy savings
- cataloging of design and shop drawings
- resolution of lost or damaged inventory
- disbursement of utility rebates
- invoicing procedures, if shared-savings or leasing is involved. ■

*Lindsay Audin is energy manager for Columbia University.*

# Landscape Lighting

*Which to choose: Line- or low-voltage light sources? How to decide between the two.*



Doug Salm

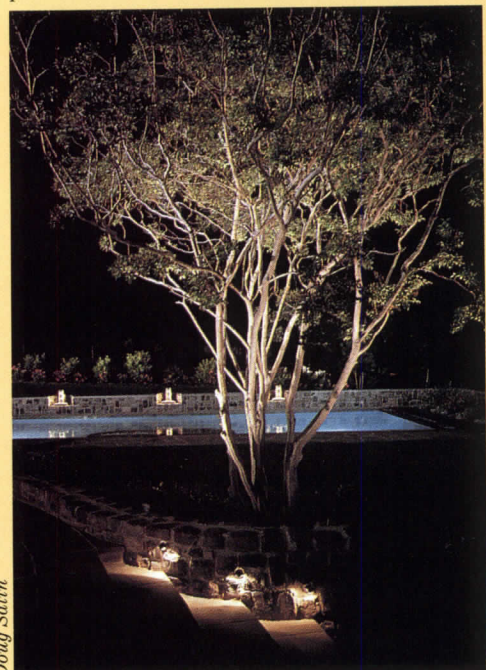

Doug Salm

By Jan Moyer

One of the first things a landscape lighting designer must do is decide between line- and low-voltage light sources. The characteristics of these two sources vary, making it a complex choice.

What doesn't vary is the kind of effect that can be created. The same effects can be created using either source, within some limits. In photos (1) and (2), the effect of the tree uplighting is similar but the source differs. The tree at the top left (1) is lit by 120V lamps in junction box-mounted uplights. The tree above is lit by 2V

*Janet Lennox Moyer, IES, ASID, is principal of Jan Moyer Design, a Berkeley firm specializing in landscape lighting.*



3



Ken Rice

lamps in stake-mounted uplight fixtures.

The similarity between line- and low-voltage sources ends with the similar effects they may produce. One difference between the lamp types is the amount of light they produce. If a project requires lower light levels, the voltage choice will often be swayed toward low-voltage. When higher light levels are needed, in public areas or for very large trees, line-voltage sources may be preferable because they are available in higher wattages.

## Low and behold

Remember that landscape-lighting levels need to be much lower than interior-lighting levels, so the vast range of low-voltage lamps available in the range of 20W to 35W

often gives low-voltage light sources the edge over line-voltage sources. A quick count shows over 25 different R, PAR, and MR lamp types in this wattage range! There are only a few line voltage R lamps in the same range, and no PAR lamps. Watt for watt, the low-voltage lamps in both incandescent and halogen have the ability to produce more light than their line-voltage counterparts in most spot to medium flood distributions, and even in some flood distributions.

The physical dimensions of the lamps and fixtures is another factor that will determine whether to change line- or low-voltage equipment. Low-voltage equipment is generally smaller than line-voltage equipment. When lamps are mounted in tight spots, or beneath beams or trellises as in photos (3) and (4), low-voltage equipment may be the best way to create the desired effect unobtrusively. Small equipment can be slipped into beds of low-growing ground cover with less evidence of intrusion, and their light weight allows them to be attached to tree limbs with minimal stress to the tree.

## How does your garden grow?

Installation conditions should also be considered. Wiring for line-voltage equipment must be installed in conduit a certain distance below grade, according to the National Electrical Code. If the garden is mature and tightly planted with specimen plants, installation of the wiring may be difficult, if not impossible. The trenching and conduit required for line-voltage installation makes more sense if a garden is new or undergoing a major renovation. Trenching for the lighting can often be coordinated with trenching for the irrigation system to hold down costs.

Low-voltage wiring may be installed close to the surface of the ground, with no conduit protection. If a garden is replanted during the year to provide seasonal color variation, the low-voltage wiring may be cut accidentally, or the light fixtures may be disturbed. Where routine garden work is likely to dislocate wiring, a deep, in-conduit wiring installation may be indicated.

A future column will discuss waterproofing and electrical distribution. ■

## Lumen-Micro 5.03

For more information circle item numbers on Reader Service Cards.

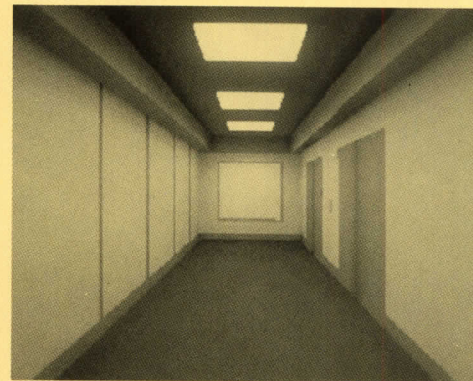
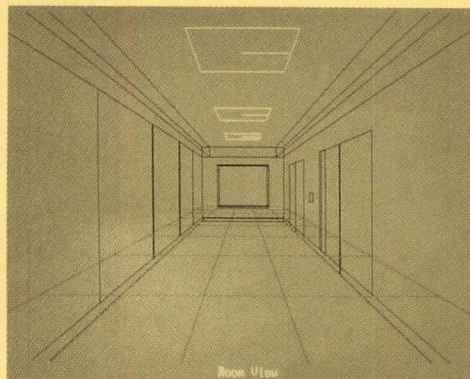
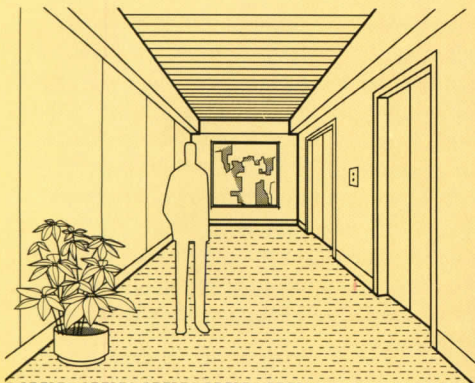

By Sam Mills

When the box with the Lumen-Micro software arrived, I opened it immediately, motivated by years of curiosity. As an architect involved in lighting for most of my professional career, I had heard about this amazing program and seen examples of its near-photographic capabilities. As a Macintosh user (only recently introduced to the world of MS-DOS), I envisioned slipping a diskette into the appropriate drive, clicking the mouse a few times, and exploring the world of Lumen-Micro. Little did I know that two days would pass before I could solve the syntax puzzle of the MS-DOS operating system—in particular, getting my `autoexec.bat` and `config.sys` files in order. The wait, however, proved to be more than worthwhile.

To be honest, half of the delay was because my 286-12MHz computer didn't have a math coprocessor. I had one shipped in overnight from one of those incredible mail-order houses, for far less than retail price, and plugged it in. A coprocessor is not optional; in fact, you can't get beyond the DOS prompt without it. Even though the 286 is the minimum system recommended, the program ran without any problems, and at reasonable speeds. A monochrome or EGA monitor will work, but a VGA monitor is required for the high-resolution gray-scale graphics.

The Lumen-Micro package (in a plain-paper wrapper) seemed somehow inappropriate for the sophisticated contents—particularly

*Sam Mills is an architect specializing in lighting design and a freelance writer in Oklahoma City.*

when compared to the four-color, shrink-wrapped packaging we've become accustomed to. The contents included two master diskettes, a spiral-bound user's guide, and a registration form. The user's guide has clear and descriptive headings, large type, lots of white space, and an organized, unhurried approach to learning how to use this software. One important item was missing however—an index. With a sizable number of program options and special features, this proved to be a handicap. The seven-page table of contents helped to compensate a little, but only a little.

### Getting started

If your system has less than 545K of memory available, a message tells you that you cannot run the program. The instructions for resolving this, by freeing up memory, are confusing and divided between the standard text and two appendixes. After carefully reading all of it a number of times, I'm still hazy on the distinctions between conventional memory, extended memory, expanded memory, and virtual memory. A call to Lighting Technologies resulted in my removing items from my `autoexec.bat` and `config.sys` files to free some conventional memory. After a few tries, I found that removal of Win, the line which automatically opens windows on startup, from the `autoexec.bat` file enabled me to finally open the program. A future option to use extended or expanded memory to run the basic program would be desirable.

The program opens with a blank sky-blue screen with pulldown menus across the top. The menus can be selected three ways: with arrow keys, keyboard characters, or a

mouse. As a Mac user, I chose the familiar mouse option, although for straightforward data entry the keyboard is very fast and convenient. Before proceeding you must furnish the usual system configuration data, such as monitor screen size, desired dimensional units, printer port, and printer type.

### Entering data

Selecting the Input menu gives a choice of two submenus, Design Tools and Worksheet. Data can be entered in either one, or both, with a screen format that requires racketed spaces to be filled in. Design Tools (this is a confusing name) calculates average illuminance values and gives layout suggestions and luminaire quantities for specific illuminance values. The Worksheet is for input of more-detailed room configurations and point-by-point illumination of analysis grids and room surfaces. Working through the included lesson files provides a good introduction to the reasonably complicated data-entry process. A completed or blank worksheet can be printed for inclusion in reports or more detailed review.

To test the program's proficiency at generating alternate lighting schemes, I entered data to simulate the space shown on the architectural sketch above. With a little practice, it is easy to generate three-dimensional spaces using polar coordinates (x, y and z distances). Up to 10 inserts can also be added (surface areas of different reflectance) on each room surface and up to 50 north-south or east-west partitions of varying height, length, and reflectance. Then, magically, with two keystrokes the screen turns into a 3-D wireframe representation of the space—endless amusement may be had

*Lumen-Micro lets the designer evaluate the luminous characteristics of alternate lighting schemes with 3-D wireframe and high-resolution gray-scale graphics. In the*

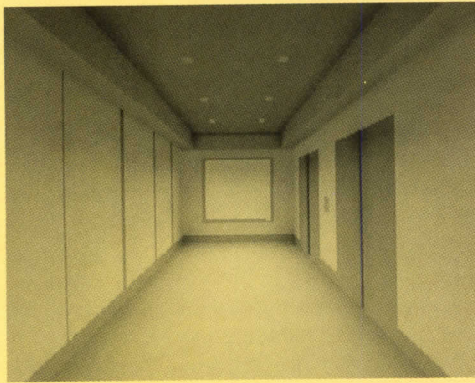

*wireframe format, the viewing point can be moved anywhere inside or outside the room for a "walk-through" of the space.*

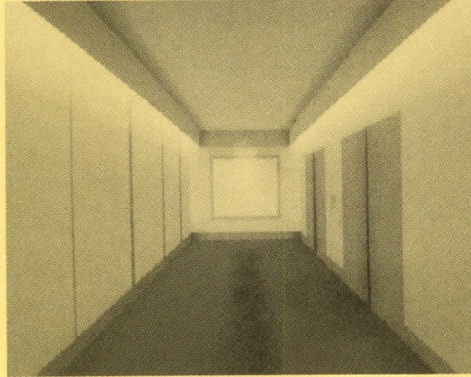

by moving the viewing position to any point inside or outside the room.

The next step is to enter the desired luminaire type and photometric data. The procedure for doing this is needlessly complicated and time-consuming—using the DOS path name method to search for files. And the choice of sample luminaires is quite meager. The program will, however, access any fixture manufacturer's data (if IES formatted), and Lighting Technologies plans to release a complete electronic library of luminaires early in 1992.

#### **Calculation and output**

After completing the entry of data, you can take advantage of the unique data-checking function to assure accurate program results. You then save the file, return to the main menu, and instruct the program to calculate the requested illuminance values. The choice is very complete, including horizontal and vertical illuminance, equivalent sphere illumination (ESI), visual comfort probability (VCP), and surface exitances (brightness). Calculations on my 286-12MHz equipment took from 20 to 40 minutes. Calculations made after changing an existing file were a little faster.

Selecting either Report or Contour under the Output menu produces written reports of engineering data associated with the calculation process and isofotcandle curves of elected room surfaces and work planes. Selecting the Graphics option brings the same 3-D wireframe room view on screen that was available during the entering of data. Curiously, the image is not exactly the same—due to two different methods of calculation,

according to Lighting Technologies. This should present no problem for the typical user.

After selecting a viewing position and pressing two designated keys, the perspective room view begins slowly building on the screen. After some time it produces a near-photo-quality rendering of the space in 64 shades of gray. Pressing the keys again starts the rendering over with only 16 shades of gray, but this time, with the "jaggies" gone from the room boundaries and surface intersections. The piece-by-piece construction compels your full attention—at least the first few times.

The screen image can be printed on most printers and future options promise graphic-transfer functions to export the image to draw and paint programs. Color slides taken of the screen also offer an excellent option for comparative analysis by the designer or presentation to a client. The screen images make some designs look significantly darker than others—because the program attempts to accurately represent relative visual perception. I feel most observers would find the modification too exaggerated and "unnatural." Keyboard controls can be used to lighten or darken the image or increase or decrease contrast—although the instructions are missing from the manual and fail to tell the user to use only the keyboard numerical pad plus and minus—not the usual typing symbols. In spite of this, the overall quality and accuracy of individual screen images greatly helps lighting designers in visualizing early lighting concepts and documenting final lighting solutions.

*Circle number 341*

## **Bits and bytes summary**

**Pros:** Outstanding design tool for analysis of interior illumination systems; good 3-D wireframe functions; excellent ray-scale graphics; extensive report capabilities; easily accessible on-screen help; reasonably priced.

**Cons:** Slow and complex file management; inoperative "remove hidden lines" function; meager sample luminaire data; lack of "busy" notification during data processing; missing instructions for gray-scale image control.

**Vendor:** Lighting Technologies, Inc., 2540 Frontier Ave, Suite 107, Boulder, CO 80301, 303/449-5791, Fax 303/449-5864.

**Equipment required:** IBM 286 PC-compatible computer with math coprocessor (386 or 486 recommended); 545K memory, 2MB extended or expanded memory recommended, high-density floppy drive; hard disk with 5MB available; monochrome, EGA or VGA graphics adapter (VGA needed for perspective graphics).

**Cost:** \$595 (demo disk available).

Other on-screen and printed output options include isofotcandle curves, point-by-point horizontal and vertical illuminance, room-surface exitance, equivalent sphere illumination, visual-comfort probability, luminaire quantities, DXF files, and daylight modeling.

## Efficient Fixtures: Beyond Troffers

By James R. Benya

Much of what has been written recently about energy-efficient lighting has covered troffer components: T8 lamps, electronic ballasts, and reflectors. After troffers, the second-most-popular energy-efficient lighting solution is the medium-base, self-ballasted compact fluorescent lamp. It is installed in millions of luminaires—including many where it doesn't belong. Such installations are often made where it is important to improve energy efficiency without sacrificing lighting quality. These situations demand sophisticated luminaires that use advanced lighting technologies.

### Traditional architectural downlights

Recessed and surface-mounted downlight cans are found in most building types. Although metal halide and HPS downlights have been used for years, the color quality, warmup, and recycle times of these sources made them impractical for most applications. Incandescent and halogen lamps remained the source of choice by default.

In 1982, the first compact-fluorescent downlights came on the market. At first, apertures were too large and luminaires too shallow, but by 1984 horizontal twin-tube downlights with 7-in. apertures were available. As the higher-quality downlight companies entered the field, other good products were developed. Now designers can choose from whole families of downlights with lamps oriented either horizontally or vertically.

Solutions for the huge downlight retrofit market have also become more sophisticated. Originally, medium-based fluorescent adaptors were simply screwed into existing cans with no consideration for luminaire efficiency or glare control. This improvised solution has been replaced by permanent remodel kits that have built-in reflectors, properly placed and shielded lamps, and in some cases, electronic ballasts [RECORD LIGHTING May 1991, pages 22-23]. Another new option is the white sodium downlight. A 95W or 100W white sodium lamp produces

*James Benya is the chairman and CEO of Luminae Souter Lighting Design, San Francisco.*

about the amount of light as a 250W quartz lamp with nearly the same color quality, and can be used in architecturally demanding spaces, such as hotel lobbies, where infrequent switching makes warmup and restrike times moot.

Keep in mind that fluorescent downlights can be used in residential as well as commercial lighting. Most common residential fixture types, including shower lights, closet lights, and lensed lights for kitchens and eaves are readily available in compact fluorescent. There are even insulated ceiling (IC) fluorescent downlight housings to readily address the demands of this market.

### Wallwashers

Wallwashers have also long been available in HID, but like downlights, the preferred sources have still been incandescent or halogen. However, consider the new, round recessed spread-lens wallwashers in compact fluorescent, and the recessed linear wallwashers that use biaxial fluorescent lamps. The linear wallwashers are tremendously efficient and produce a high-quality wash. The surface and semirecessed asymmetric wallwashers, which have been on the market for quite a while, are now available with white sodium, T8, and biaxial fluorescent lamps, and with electronic ballasts.

### Know Your Source Behavior

White high-pressure sodium, metal halide, and compact or full-size fluorescent sources are not as easy to use as incandescent sources, making it a real challenge to incorporate efficient sources into every design. The limitations of these modern sources need to be remembered:

- Preheat fluorescent lamps have an annoying starting sequence, including flicker, and they hum.
- Magnetic ballasts operating fluorescent or high-intensity discharge lamps can also introduce hum.
- The proper incandescent-to-fluorescent wattage-replacement ratio is about 3.5 to 1. Be wary of outlandish claims. A 13W compact fluorescent is not an equal replacement for a 60W incandescent lamp, for example.
- Incandescent dimmers cannot be used to dim either compact fluorescent or high-in-

Compact fluorescent conversion kits are also available for traditional eyelid wallwashers and downlight-wallwashers.

### Architectural fluorescent lighting

High-quality fluorescent lighting is usually performed with suspended luminaires having various direct, direct/indirect, and indirect distributions. Significant improvements in efficiency in luminaires in this market have resulted in some of the most efficient, well-shielded luminaires yet developed, including extremely wide distribution and efficient uplights, ultra-efficient direct-indirect luminaires, and asymmetric, efficient cove and slot luminaires.

With these new fixtures, specifiers can achieve familiar effects, such as indirect lighting, with substantially less energy than was needed only a decade ago. While much of the improvement is due to the T8 or biaxial fluorescent lamps and electronic ballasts, substantial optical improvements have also been made.

### Sconces, chandeliers, and pendants

Without question, much of the evolution of decorative lighting in recent years has been influenced by wall-sconce design. The sconce can easily house the compact-fluorescent lamp and create the illusion of incandescent

tensity discharge sources. When remodeling, be certain to remove existing incandescent dimmers from the circuit.

- Compact-fluorescent lamps do not start well when the temperature is below freezing, making their use outdoors questionable in colder climates.
- High-intensity discharge lamps all require time to warm up and restrike once they have been turned off, making them unsuitable for frequent switching.
- Dimming high-intensity discharge sources is extremely costly and often not recommended.
- The color of the light produced by metal-halide lamps shifts throughout the entire life of the lamp.
- The color of light produced by white high-pressure sodium lamps only begins shifting toward the end of the lamp life.

*New luminaires combine fluorescent and HID sources with custom-engineered hardware to produce high-quality, efficient lighting.*

lighting in the process. The latest designs for wall sconces have gone beyond the retro-fit and are done expressly for the compact fluorescent lamp.

Energy-efficient chandelier and pendant fixtures are less common, but this situation should not last long. Many lighting designers have custom-designed chandeliers for projects using fluorescent and high-intensity discharge lamps, and high-end fixture manufacturers have picked up many of them as standard offerings. At present, fluorescent pendants and chandeliers are still a bit of a rarity in the residential and hospitality market.

**Stand-alone fixtures**

Millions of incandescent lamps could be replaced with fluorescent in table, floor, and desk lamps. Some of these conversions are temporary, made by screwing a compact fluorescent self-ballasted lamp into the socket. However, permanent conversions can be made in which the lamp socket is fitted with a nonremovable socket insert, and the line is cut to install a ballast. New lamps, including desk, table, and floor lamps, can be ordered with permanent fluorescent fittings.

**Other residential lighting**

The radically improved color rendering of modern fluorescent lamps makes fluorescent bath and kitchen lighting an optimal solution. Excellent new designs in bath-mirror luminaires, good-looking ceiling fixtures, and high-quality undercabinet lights support the notion that kitchens and baths can—and perhaps should—have their general illumination provided mostly by fluorescent lighting. Compact fluorescent sources can also be chosen in outdoor wall brackets, lanterns, and garden and landscape lighting.

Don't be afraid to design efficient modern lighting. But make certain you are prepared for the challenge. Keeping up with what is available on the market is one of the most exciting aspects of lighting design. And without a doubt, the best opportunity of the year to see the fixtures I've written about here—and many others—is at Lightfair, May 6, 7, and 8, at the Jacob Javits Convention Center, New York City. I hope to see you there. ■



1

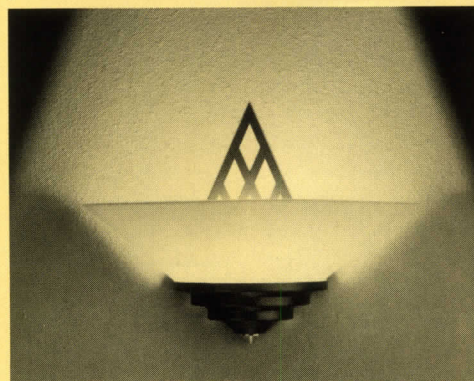

2

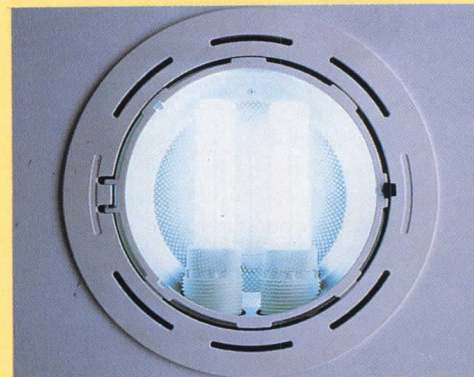

3

1. Lightolier's Helios bath lighting uses a 39W single-ended compact fluorescent.
2. Veda fluorescent sconce from Appleton Lamplighter.
3. Techne downlight with compact fluorescents; Reggiani USA, Inc.

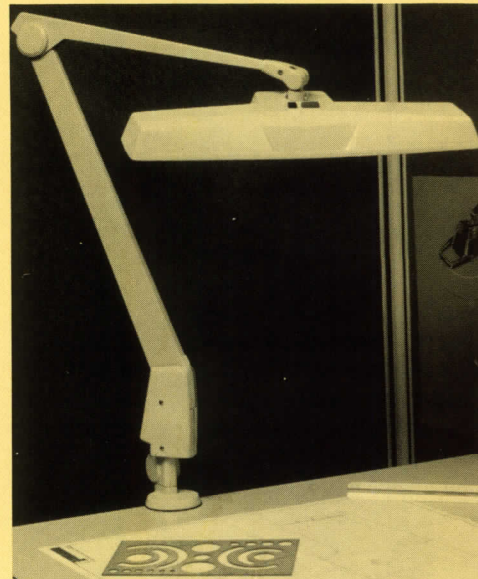

4



5

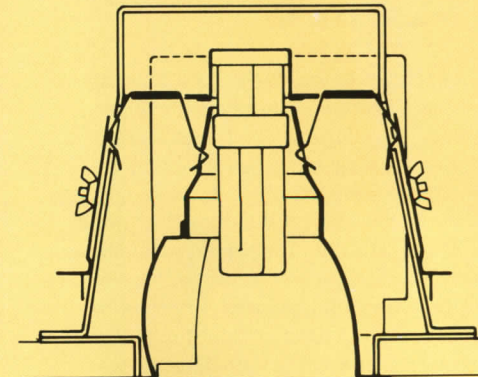

6

4. Task light from Dazor uses two 13W compact fluorescents.
5. LDX suspended fixtures take T8, T12, or biaxial lamps. Peerless Lighting Corp.
6. DTT9/4 downlight/wallwasher takes 9W twin-tube fluorescents. Edison Price.

## Energy-Code Alert

*Lighting laws must not ignore occupancy, worker productivity, and lighting-system performance.*

*By Robert Davis*

The debate over how lighting should be regulated has heated up recently. Historically, energy use for lighting has been regulated using power-density limits. These establish a maximum allowable watts per square foot for lighting. For years, ASHRAE/IES Standard 90 has been the basic technical reference for most code agencies who take a power-density approach to lighting regulation.

Standard 90 has been challenged on several fronts. The most recent version was rejected by the American National Standards Institute (ANSI) as a national standard, due to flaws in the consensus and peer-review processes. Environmental-advocacy groups say the power-density limits are unnecessarily high and blame lighting manufacturers for perpetuating high illuminance levels and power-density limits. Other argue that power-density-based designs are difficult to evaluate for compliance and that proper installation cannot be assured.

### Component-efficiency path

Regulation of component efficiency is another approach to assuring efficient lighting systems. Just as inefficient appliances were eliminated by regulation, so would inefficient lighting components. The National Appliance Energy Conservation Amendments of 1988, which eliminated high-loss magnetic ballasts, is the most widely enacted standard so far.

Massachusetts and New York have actively pursued a component-efficiency approach to lighting regulation. The latest Massachusetts state code has a power-density procedure similar to Standard 90, but also recommends the establishment of minimum efficacy standards for some types of incandescent and fluorescent lamps. These have not yet been implemented, but they have become an important model for federal legislation now under consideration.

The New York State Building Code, which

*Robert Davis heads research and development for the Lighting Research Center's Efficient Lighting Program, Rensselaer Polytechnic Institute, Troy, New York.*

went into effect in April 1991, is the most-comprehensive component-efficiency standard now in use. It establishes minimum lumen-per-watt efficacies for various incandescent and fluorescent lamp types and, for the first time, uses controversial Total Luminaire Efficiency (TLE) values for general lighting.

### TLE spells trouble

TLE is defined as a percentage of the rated lamp lumens that actually leave the luminaire—it represents the light losses within the luminaire itself. TLE requirements reflect the belief that, of the efficient and inefficient models of a given luminaire type, the code should allow only the efficient ones on the market. For certain luminaires, minimum TLE values are specified, based on the luminaire's distribution characteristics. Lighting designers and manufacturers object strongly to component-efficiency laws, and to New York's law in particular.

California's Title 24 is often cited as an example of a code that ensures energy efficiency without unduly restricting design. This code uses a watts-per-square-foot procedure similar to Standard 90, but uses illuminance requirements as the basis for the power-density levels. Thus, spaces with visually demanding tasks are allowed higher power-density limits than those with less visually demanding tasks.

### What's next?

There is fear in the industry that other states have been waiting for the New York code to evolve and will now follow suit in implementing TLE standards. A survey of each state conducted by the Lighting Research Center and partially funded by Litecontrol Corporation and GTE's Sylvania Lighting Division, indicates that no other state is seriously considering component standards. Most are continuing to use either the latest version of the ASHRAE/IES Standard or the Council of American Building Officials' (CABO) Model Energy Code, which is based on an earlier version of Standard 90.

It now appears power-density standards will be preempted by federal legislation currently in committee in both houses of

Congress. Although the outcome of the legislative process is impossible to predict, it seems quite likely that federally mandated lamp efficacy standards will be adopted in 1992.

Lighting legislation is obviously, and rightly, concerned with energy, but the debate over it seems to ignore three important elements—worker productivity and satisfaction, occupancy controls, and measuring results. The easiest way to reduce lighting energy is to decrease the illuminance level and thus the amount of lighting equipment required. This strategy for saving energy flies in the face of research that indicates visual task performance will be reduced if illuminance levels are dropped below a certain point. California's Title 24, which bases its power-density limits on the Illuminating Engineering Society's illuminance selection procedure, is a start toward addressing this issue.

### Lights out, too!

Lighting regulations should also address the way occupants use lighting energy as well as the efficiency of the lighting system itself. Most codes today provide some sort of incentive for the use of automatic lighting controls, which shut off lights when spaces are unoccupied. But this incentive usually takes the form of increased allowable power densities. That makes it questionable whether any additional savings are realized by installing the controls. Future codes should stress both system efficiency and turning lights off when spaces are unoccupied.

Part of the problem in linking power-density and component-efficiency standards to productivity and occupancy is the lack of simplified field-measurement techniques and tools for benchmark comparisons. These would help us evaluate the success of lighting systems and, thus, lighting legislation. Unfortunately, the lighting legislation debate is often framed in philosophical and political terms, rather than in technical terms. As a result, measured performance data are sometimes seen as unimportant or even undesirable. But without these data, the debate will likely continue to generate more heat than light. ■



## Growing Pains

My last few columns have chronicled movements in lighting education, and the certification of lighting designers. These are two indications that the architectural lighting-design profession continues to define itself, and is starting to come of age. Here's another: Recent work accomplished by the Business Standards Committee of the International Association of Lighting Designers (IALD) to develop standard forms of agreement between lighting designer and owner, and lighting designer and prime professional, i.e., the architect, engineer, or interior designer on a given project.

Committee chair Al Borden of the Lighting Practice, Philadelphia, says the documents have already undergone legal review by the IALD's legal counsel, and been through an informal review by the International Facility Management Association. They may be reviewed by other professional organizations soon. Because the Scope of Work—among other articles in such documents—spells out the responsibilities of the lighting designer to the client, in a sense the documents define what the lighting designer is and does every bit as much as a lighting-design certificate will.

Maybe more. Once such standard forms of agreement are accepted, courts often employ them in determining whether or not two parties have performed their duties, even if the standard form of agreement was not used by the parties. For parties to a lighting-design project, this standard form of agreement may one day act as the basis on which they may sue or be sued. This important project deserves the attention of the lighting community.

Meanwhile, in late February the National Council on Qualifications for the Lighting Professions met with representatives from other professional organizations who have an interest in this arena. This was a long anticipated meeting for the NCQLP board, and from what I have heard, no shots were fired. In fact, several of the organizations were positive enough about the Council that they have pledged support beyond mere kind words once incorporation paperwork is complete.

On the subject of another type of standard, I can't resist repeating a story I heard recently. A large quantity of preheat fluorescent lamps made by one manufacturer was almost mistakenly substituted for the specified and unavailable rapid-start lamps made by another. Both lamp types had identical shapes and bases, and the substitution was actually suggested by one of the manufacturers' reps!

I'm sure no harm was intended. It was a mistake. But maybe it's time for lamp manufacturers to standardize lamp bases for fluorescent lamps. How about standard fluorescent lamp colors, too?

Ah yes, we always must keep in mind that these kinds of growing pains are standard for a growing profession. On a final note, we welcome Lightfair to its premiere appearance at Jacob Javits Convention Center in New York City, May 6-8.  
*Charles Linn*

# Putting Deco To Work



*A layered lighting system  
emphasizes elegance in a new  
hotel lobby and practicality in an  
upstairs conference center.*

*Hotel Macklowe  
New York City  
William Derman, Architect  
Cosentini Lighting Design  
Lighting Designer*



In the case of the Hotel Macklowe, a diagnosis of "split personality" is a sign of smart design rather than emotional imbalance. Faced with lighting the hotel's rich Deco-inspired public spaces on the ground floor and a corporate conference center on four upper floors, lighting designer Stephen Margulies from Cosentini Associates and William Derman, in-house architect for the Macklowe Organization, stamped each component with its own identity. Although clearly parts of a single complex, the hotel and conference center work on their own terms, making few compromises in the name of conformity. As a result, the hotel's lobby, bar, and restaurant resonate with the sultry elegance of a '30s vamp, while the conference center blends a concern for comfort with a roll-up-your-sleeves practicality.

Located just east of Times Square on a midblock site, the Hotel Macklowe draws attention to itself with an etched-glass mural lit by small capsule lights ringing the perimeter of a metal canopy (right). Flanking the entrance are flags lit by tungsten halogen spots at their base and stainless-steel torchères equipped with glass shades and incandescent T-lamps. Because the block was already well lit, Margulies and Derman saw no reason to flood the hotel exterior with light. Instead, they highlighted a few select elements: the mural, the canopy, the torchères, and the flags.

Dressed in black-absolute and leopard-green marbles, African-mahogany and lacewood-veneer paneling, and polished and brushed stainless-steel detailing, the hotel's lobby has the dark, smoky, slightly decadent feeling of the best Art Deco interiors (preceding pages). To illuminate such a rich environment, Margulies and Derman established three layers of light: wall washers for ambience, surface-mounted half-globe chandeliers for general decoration, and sconces for particular attention. "We didn't want too many layers competing with the interiors for attention," explains Margulies, "so we kept it relatively simple." The key, though, he adds, "was getting the proper balance."

In the hotel's bar the designers used hanging pendant fixtures with quartz uplights and diffusers for downlighting (opposite top right). Low-voltage MR-16s illuminate the backbar from above. Next door in the restaurant, "we wanted to use the 16-foot ceiling height to our advantage," says Derman. To do so, the designers supplemented the usual mix of wall washers, sconces, and pendants with uplights behind dining banquettes, accent lights aimed at food displays, and MR-16s in soffits to highlight frosted-glass mirrors.

The conference center, which occupies four upper floors, presents a different face to the public. Although some of the same rich materials (such as black marble and wood paneling) are continued here, the architecture is less assertive. The lighting follows suit. "The idea was to create a background vanilla scheme," states Margulies. To help maintain a sophisticated setting in the conference center's lounge areas and provide better readability for closed-circuit video monitors, the designers kept lighting levels low. In dining rooms on the second floor, incandescent feature lighting works together with fluorescent cove lighting to establish a no-nonsense setting for business lunches. Upstairs, conference rooms equipped with front- and rear-projection video technology take advantage of multiple-scene lighting controls. Fluorescent uplights provide general lighting, while deeply recessed ellipsoidal downlights illuminate desks for notetaking during video presentations.

The result is a comfortable space that offers flexibility in lighting levels without calling attention to itself. *Clifford A. Pearson*

*Elliott Kaufman photos*



The main entrance to the hotel on West 44th Street (above) features flanking torchères and an etched-glass mural lit with capsule lights set on the building's canopy. A three-layered lighting scheme in the lobby (preceding pages and opposite top left) complements a rich palette of materials including black marble, mahogany-veneer paneling, and polished and brushed stainless steel. Pendants, sconces, and MR-16s provide elegant touches to the bar (opposite top right). Fluorescent uplights and ellipsoidal downlights are the major lighting elements in conference rooms (opposite bottom).

#### **Credits**

*Hotel Macklowe  
New York City*

**Owner:** *The Macklowe  
Organization*

**Design Architect:**  
*William Derman*

**Lighting Designer:** *Cosentini  
Lighting Design—Stephen  
Margulies, Phyllis Eckstein,  
designers*

**General Contractor:** *McGraw  
Hudson Construction*



# Rocket Ship

*Interstate Tower  
Charlotte, North Carolina  
Kohn Pedersen Fox Architects  
Craig A. Roeder Associates,  
Lighting Designer*





Halogen, metal halide, and neon sources illuminate the intricate details of the tower top. In the lobby (above), indirect cold cathode lighting operates at a boosted current of 150 milliamperes. The result, says lighting designer Craig Roeder, is 20 percent more light output than the standard 120-milliamp system.

By Gareth Fenley

**T**he new Interstate Tower shoulders into the skyline of Charlotte, North Carolina, visible from the city's approaching and encircling highways. Like the tip of a rocket emerging from its gantry, the tower's intricate crown suggests vast potential energy. And on some nights, the building moves.

While the architect was originally "not terribly interested" in the animation concept suggested by lighting designer Craig Roeder, the developer liked it. For about \$2,500, a programmable controller was included in the budget to set the top in motion, enabling three rings of chasing strip lights to flash in patterns.

Roeder, who entered the project at the design-development phase, praises architects at Kohn Pedersen Fox for the successful result. "It's a complicated building, a very interesting piece of architecture," he says. "It took a lot of ingenuity in detailing. Because of the great coordination by the architect, the design was built and it works." The tower's facade sweeps upward in clean planes from the street, terminating in complex setbacks where a cylinder emerges. At this level, the architect placed four decorative metal hemispheres that Roeder used to hold lighting fixtures. He at first recommended energy-efficient, long-life metal-halide fixtures costing about \$1,500 apiece. The final specification, however, was 500W halogen spot fixtures at \$250 each. The crown has several other types and wattages of halogen fixtures, including the chasing PAR 38 strips.

"Burning five hours a night, they'll last a year," says Roeder. "Sometimes you either light a building and make sure you have a window nearby that opens for maintenance access—which is what we did here—or you quadruple the price and you don't get the building lit."

Long-life sources were affordable only for mounting atop the conical roof, where Roeder used 10,000-hour metal-halide lamps. Washing the slope are 70W fixtures; the quirky pinnacle beacon is illuminated by a single 250W lamp behind acid-frosted glass; and the topmost spire is lit by two recently introduced PAR 56 lamps. Neon was used, too, in rings around the cylinder and inside the toothed rails that surmount the roof. All neon and metal-halide lamps have a 3000K color temperature to match the halogen light lower on the crown.

Gareth Fenley is an Atlanta-based freelance writer and a frequent contributor to *RECORD LIGHTING*.

#### Credits

*Interstate Tower*

*Charlotte, North Carolina*

**Architect:** Kohn Pedersen Fox—Gary Handel, senior associate partner-in-charge

**Associate Architect:** Odell Associates, Inc.—Steve Thomas and Mike Grabman

**Lighting Designer:** Craig A. Roeder Associates—Craig Roeder

**Engineering:** King/Guinn Associates—Randy Ruggles and Dennis Ferguson (structural); Benner & Fields—Irvin Angel and Virginia Johnson (mechanical); Bullard Associates—Connor Builard and Jim Safrit (electrical)

**Developer:** Faison Associates

# A Touch of Class





*A welcoming glow tells students  
that school is not just an  
endurance test – it's an experience  
to be enjoyed to its fullest.*

*Eugenio Maria de Hostos  
Community College  
Bronx, New York  
Voorsanger & Associates, Architects  
H. M. Brandston & Partners, Inc.  
Lighting Design*

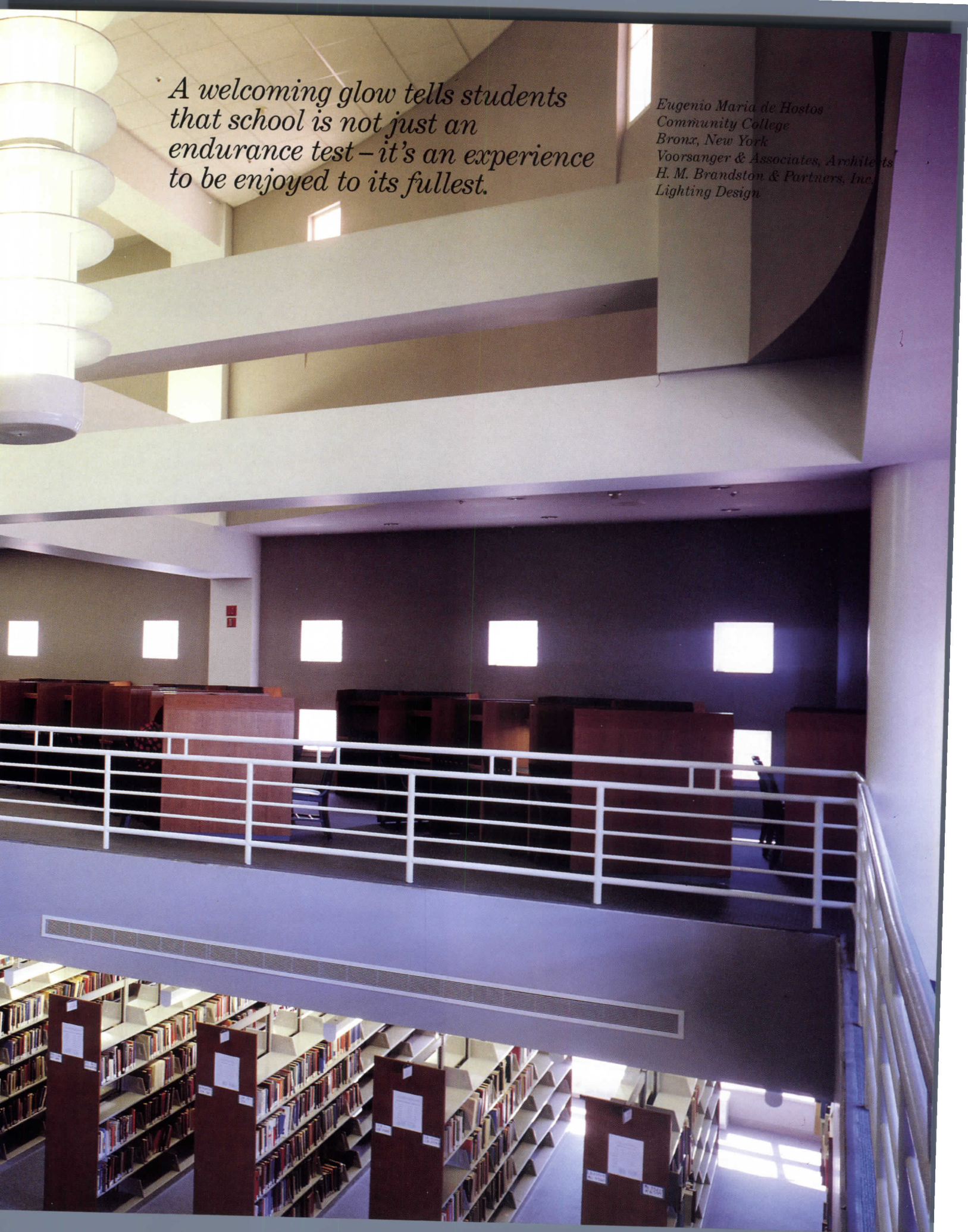

By Judith Davidsen

According to Howard Brandston, coming to a project with a fixed idea about building types is a sure-fire recipe for failure. "If you go in with an idea based on 'school,' for instance," says the founder of H. M. Brandston & Partners, Inc., "you already have a prejudice. I like what Abraham Maslow said: 'If the only tool you have is a hammer, you will approach every problem as though it was a nail.'"

The New York City-based lighting-design firm instead went into the Eugenio Maria de Hostos Community College project with some ideas about the struggling South Bronx community where the school is located, and decided a major role that lighting could play there lay in broadcasting the message, "You are entitled to a good place for your kids. This is not a place that one has to endure but that one can enjoy." Given the financial constraints on New York's public university system, however, the lighting at Hostos had to achieve top-of-the-line quality without being, or looking, particularly expensive. "It's all done with simple stuff artfully put together," says Brandston. "It's about fixtures custom designed from standard products to look like they belong. And it's about how the light recognizes the composition of materials and their glows and brightnesses. Light is not light until it interacts with space."

The central symbolic space at the Voorsanger Associates-designed campus is a cylindrical library of significant proportions, with laboratories, classrooms, administration, and day-care lined up on a tangent [see RECORD, February 1992, pages 88-93]. A sense of grandeur is injected through the use of ceremonial-scaled stairways, gracious atriums, a generous use of balconies, and floods of natural light. The interior finishes, however, involve the serviceable block walls, brickwork, acoustical ceiling tile, terrazzo floor tile, and pipe handrails that could, in the wrong hands and without sensitive lighting approaches, conjure up jailhouse images. Brandston believes that people are more comfortable when they can locate sources for at least some of the light in a space. For the triple-height library (preceding pages), the HMB team devised simple but dramatic 12-foot pendants of fluorescent tubes surrounded by perforated metal blades and smaller versions to match. Daylight enters through a series of windows on the second-level balcony while fluorescent tubes tucked into the open beam work above emphasize soaring structural detail.

The lighting team created skylight effects in the corridors (not shown) by tilting panels of acoustical ceiling tile at an angle and inserting shielded fluorescents that bounce illumination off the now broken ceiling plane. The glass-walled stairwell (opposite), which marks Hostos as the southern gateway to the historic—and slowly resurrecting—Grand Concourse, uses simple overhead pickle jars with radial disk baffles to create just enough brightness at each level to say, in Brandston's words, "It's okay to come up."

At the opposite end of the bar-shaped portion of the project, a three-story glass atrium (upper right) shines out over the community, with the help of prism-lensed fluorescent tubes lined up along its interior balconies, and oversized torchères that take on a residential, almost candle-in-the-window, cast.

*Judith Davidsen is a freelance writer based in New York City.*

© Paul Warchol photos



*The Hostos library (preceding pages) features 12-foot pendants created from blades of perforated metal surrounding vertical-hung 3500K fluorescent tubes. Fluorescents tucked behind upper beams highlight architectural details. Above, prism-lensed fluorescents edging the balconies create a glow in the triple-height atrium that opens northward into the community. The 12-foot torchères in the window illuminate ceiling detail while shielding glare from the balcony levels. At the opposite end of the building, a prowlike glass stairwell (opposite), illuminated simply by overhead pickle jars with radial baffle disks at each landing, announces the college entrance as well as the southern gateway to the historic Grand Concourse.*

#### **Credits**

*Eugenio Maria de Hostos  
Community College  
Bronx, New York*

**Owner:** *City University of  
New York*

**Architect:** *Voorsanger &  
Associates*

**Associate Architect:** *Hirsch/  
Danois*

**Lighting Design:** *H. M.  
Brandston & Partners, Inc.  
Howard Brandston and the  
late Gene Stival, principals-in-  
charge; Randy Sabedra and  
Cindy Turner, project  
managers*

**Master Plan:** *Gwathmey Siegel  
& Associates, Architects, in  
association with Sanchez &  
Figuerora Architects*



# That Extra Edge

*Architects like Haverson-Rockwell of New York City who design their own lighting add to the creativity and value of their services.*

By Gareth Fenley

**A**rchitects David Rockwell and Jay Haverson refuse to design with solid materials alone. By using light as a primary element, they create spaces that burn brightly in memory. "Our inspiration comes from many different sources—fashion, movies, theater—and we have a lot of confidence in our ability to render an emotional portrait of that style," Rockwell says. "Without lighting, you can't really do that; you're dealing only with surfaces and edges."

While partner Haverson describes his lighting background as "I met David," partner Rockwell contributes his experience as a theatrical and architectural lighting designer. Their nine-year-old New York-based firm, Haverson-Rockwell Architects, is one of the nation's elite in restaurant design. "Lighting is a great selling point for us," says Haverson. "Clients like the idea of being able to work with lighting as a conceptual idea. They think it's terrific to find architects who can provide conventional services and also bring lighting design to the table, to incorporate it convincingly into the overall concept." Rather than viewing lighting as purely functional or even as an enhancement, the partners use lighting in almost every project as a key element. Sometimes the lighting concept actually drives the spatial design. Explains Haverson, "We may think of how to create the lighting, and then figure out how the architecture is going to accommodate it."

To create the fantastic interior of Le Bar Bat, a club restaurant in a former church, the architects drew inspiration from an opera production by Franco Zeffirelli. The idea was to suggest a Western building taken over by an Asian culturé, then abandoned and inhabited by bats. Eighteen of the creatures glow with a body of hand-blown cobalt glass enclosing a 25W MR16 lamp; miniature incandescent lamps light their copper wings. An array of

pipe-mounted PAR fixtures and metal-halide framing projectors light the humans below and teasingly reveal certain architectural features, leaving others in gloom. Custom parchment sconces drip with crystals, suggesting strange plants. Intimate lighting at each table is provided by a candle nested in glass and bamboo. The assemblage of light sources is as technically precise as a theatrical set, yet even more complex because the effects work in three dimensions for people anywhere inside the space. "If we were trying to do something like this as architects with a lighting consultant, it would be very, very difficult," comments Rockwell. "It would take a lot of energy to try to translate ideas, particularly because everything is custom-made and integrated."

At Tatou, a club restaurant featuring live blues music, lighting more conventionally reinforces the interior concept of a Southern opera house. Layers of ambient, task, and decorative lighting create a comfortably welcoming room enlivened by sparkle. The ceiling's warm colors reflect flattering light from coves housing two circuits of 100W A-lamps, one peach and one white. A preset-dimming-control system subtly changes the color balance and intensity over the course of the day; maximum output is 70 percent for extended life. The chandelier originally in the room was cleaned and relit as an apparent source. While it holds a few candelabra-based lamps, most of its sparkle comes from crosslighting with four theatrical fixtures. The other decorative fixtures are all custom-made, including statues holding stanchions cast from an old floor lamp found in the Bowery. "We like to decorate with artifacts, real or invented," says Rockwell. "These quirky fixtures look like they were held over from a previous period." In contrast, the restaurants Caffe Roma and La Galleria have no artifacts. Here a lighted wall provides the main interior concept, inspired by another opera set in which colored light on paint created vibrant radiance. The wall works to open up the narrow Caffe Roma and to unify the interior of La Galleria, which occupies three previously separate buildings. A theatrical strip holding four

*Gareth Fenley is a frequent contributor to RECORD LIGHTING.*

## **1, 2. Le Bar Bat New York City**

*Handcrafted glowing bats are suspended from the ceiling of a church turned nightclub. No less than eight different light sources, from metal-halide lamps to candles, are orchestrated in an interior inspired by an opera set. Maintenance*

*of this complex project requires the vigilance of a thoroughly versed staff member—and a tall ladder.*

**Owners:** Minerva West, Joyce Steins

**Engineer:** Paul Gregory (focus lighting)

**Contractor:** Zardesco Construction

## **3, 4. Tatou New York City**

*Cove lighting on a colored ceiling provides flattering ambient light, while a sparkling restored chandelier is only an apparent source. Colored beams on a velour curtain bring drama to the stage where a pianist plays the*

*blues. Quirky decorative fixtures with stained lampshades were custom-made to look like historic artifacts.*

**Owners:** Tatou, Inc.

**Managers:** Mark and Alan Fleischman

**Engineer:** Paul Gregory (focus lighting)

**Contractor:** Wave Dancer



1

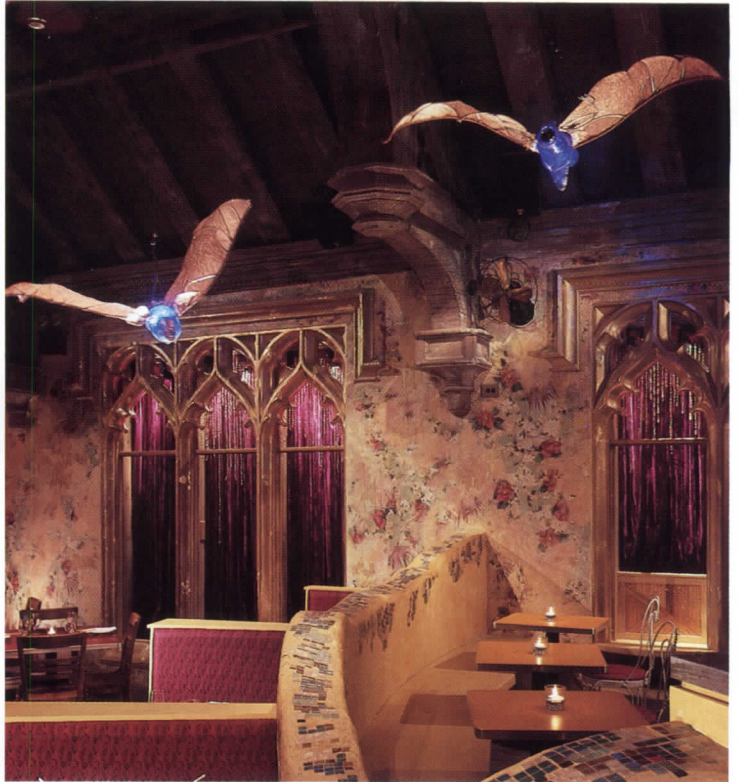

2



3



4

circuits of R lamps with glass gels is electronically programmed with a light painting system; lunch, dinner, and late night have very different moods. La Galleria adds circuits of red and blue neon in a cove, making the wall's color mix even more vivid.

At the Museum Club at Bridgewater, lighting helped solve the problem of how to attract customers to a cavernous upper-level space where previous restaurants had failed. "Our principal idea," recalls Haverson, "was to create intimacy, direction, and focus by establishing a separation of a fantasy world above 8 feet and a real seafood house from 8 feet down." A framework of pipe holds the light fixtures that make it happen. Technically, it was challenging to achieve the effect of a blue sea of light above while accurately rendering colors of food and people below. To uplight the ceiling, the architects chose powerful 500W quartz floodlights, then added double blue-glass filters to each. The resulting vibrant blue must not be allowed to give seafood a sickly tint; thus, two PAR track lights filtered with pale peach glass are aimed at every table to achieve correct color rendering.

### **Restaurant techniques**

In the course of their work, Haverson and Rockwell have mastered the special requirements of restaurant lighting. They avoid putting downlights directly over tables, for example. "People need fill light in order to look good, and the bounce light coming off the table is the best kind of light people can get," Rockwell explains. "Grazing a table at a 15- or 20-degree angle from both sides gives a beautiful bounce light that makes people look terrific. You also can use the lighting on the food to create intimacy at the table. If you're spotlighting tables without using ambient light, though, it's important to communicate to the client that the look means keeping the table in the right place. If a lamp burns out or a table moves, it doesn't look good." As a result, projects such as La Galleria and the Museum Club require especially diligent maintenance.

Light on food should always be incandescent for color rendering, but the quantity varies depending on the style of service. For a four-star French restaurant in which presentation is vitally important, the plate needs 30 to 40 footcandles of shadowless illumination. A bar or romantic spot can do with much less light on the plate. Overall light levels in the room will affect turnover; to discourage lingering, room surfaces generally should be bright, with low contrast between diners and their surroundings. Haverson and Rockwell prefer light-colored, dull-finished table surfaces to reflect light without glare. "We rarely use the high-gloss lacquer tables that are popular," says Rockwell. Very early in design, the architects ask a client to decide whether to use table linen—a major financial decision, because cleaning can cost \$100,000 a year. "If it's to be a tablecloth restaurant, we definitely get involved in picking the linen, which affects the lighting," Rockwell says. "We tend to avoid cool gray colors and move to either white or pale peach."

As clients, high-budget restaurateurs are unusual in their keen appreciation of lighting as a vital element. They know lighting establishes mood, and that it can make or break their business. But Haverson and Rockwell don't believe that architectural lighting expertise is a niche specialty. They point to their own growing volume of residential and retail projects, as well as to work by others. "I think that thoroughness in the search for a strong image should apply to all public spaces." Haverson-Rockwell's success suggests that architects who know lighting well can strengthen the market for their services. ■

### **5. La Galleria Norfolk, Virginia**

*A wall saturated with a changing balance of six colors unifies a large dining area. Here, the main architectural concept actually drives the design of the space.*

**Owners:** Richard Taves, Tony Gargiulo

**Contractor:** Charles Wright Construction

### **6. Tomy Toys Showroom New York City**

*Track fixtures pinpoint the product; there is no ambient lighting.*

**Owner:** Tomy Toys

**Contractor:** Piper Construction, Inc.

### **7. The Museum Club at Bridgewater New York City**

*A sea of blue light turns overhead space into a fantasy realm. To balance color rendering in the space below, PAR lamps are tinted with peach filters.*

**Owner:** Delta Dallas Restaurants

**Engineer:** Paul Gregory (lighting)

**Contractor:** G. P. Winter and Associates

### **8. Caffe Roma New York City**

*A sponge-painted wall picks up color from a light painting system.*

**Owner:** Reto Cantone

**Contractor:** Tiger Construction

### **9. Residence, Pound Ridge, New York**

*Cove-lit residential loggia.*

**Owners:** George and Maria Roach

**Contractor:** Ranneklev Brothers



© Paul Warchol Studio



# Kindly Light

*Lighting for a new hospital  
contributes to both the image of  
hospitality and the real thing.*







*HealthPark Medical Center  
Lee County, Florida  
HKS Inc., Architect  
Craig A. Roeder Associates,  
Lighting Designer*

**A**mong the ironies of a healthcare system beset by costs fast spiraling out of control is the competition engendered among hospitals, which vie with one another for paying patients and referring physicians. The HealthPark Medical Center uses two common strategies: to strike a balance between economic winners and losers in the services offered, and to make the facilities housing them attractive to patients able to choose. The center was first conceived as a satellite hospital to receive 100 licensed beds transferred from obsolete wings of an existing facility. But it soon became the "anchor tenant" of a 402-acre "medical mall" encompassing a wide range of health-related enterprises whose development is expected to generate income to offset rising hospital costs. A nursing home and a medical office building will open this year.

The hospital itself illustrates the idea of comprehensive one-stop health services, albeit in microcosm. A five-story, 485,000-square-foot building centered on a four-story atrium, it contains 220 beds, including a heart center (open-heart surgery, angioplasty, cardiac rehabilitation), a women and children's center (obstetrics, gynecology, pediatrics), and a 24-hour emergency center in addition to general medical and surgical beds. Sixty doctors' offices dispersed among easy-to-reach locations within the building complement extensive outpatient facilities, while the atrium is ringed by such retail offerings as a restaurant and fast-food kiosks, a florist, and a gift shop and newsstand.

The 12,000-square-foot atrium at the core of the roughly U-shaped hospital is not only its public circulation hub and main lobby but its threshold, the source of patients' and visitors' first impressions of a building that tries hard to dispel the antiseptic image long associated with healthcare facilities. Borrowing freely from the hospitality industry, architect HKS Inc. deploys forms and materials, furnishings and landscaping, to convey an atmosphere of comfort and warmth—a goal that could easily be undercut by what project manager Noel Barrick calls "industrial-strength" lighting. Instead, architect and interior designer worked closely with lighting designer Craig Roeder to develop a scheme that not only enhances the space visually but meets the parallel criteria of economy, energy efficiency, and easy maintenance.

Roeder credits to new technology, and especially to lamps that combine warmth and true color rendering with low wattage, his success in achieving varied effects—some subtle, some almost theatrical—by simple means. Except in back-of-the-house applications, incandescents dominate, as do indirect sources. Throughout such key areas as waiting rooms and lounges, the dining area, and the walls around the atrium, cove lighting with 3100K cold-cathode tubing is used to define the spaces as well as illuminate them. The melding of brightness and visual comfort is particularly welcome in corridors, which are illuminated to 32 footcandles (1W per square foot) with single-wall coves that shield patients on gurneys from ceiling glare.

Drama is reserved for the atrium, a lavishly landscaped garden complete with glass-caged elevators and a waterfall cascading from the third floor to a stream across the lobby. During the day the space is flooded with tempered natural light from a skylight roof of four barrel vaults clad with transparent glazing panels. Ambient and night lighting approximate this flow with theater pockets holding banks of semirecessed metal-halide fixtures. Ellipsoidal projectors throw adjustable beams to spotlight palm trees four stories below, while color-filtered spots fling across the garden luminous rainbows of light—a fitting symbol of life and hope. *Margaret Gaskie*



*A beacon by night (top), the hospital's four-story skylit atrium (above and opposite) is a garden where natural light is complemented by 250W, 15-degree PAR64 metal-halide spots combined with custom dichroic color filters projecting rainbows of light. Ellipsoidal projectors (250W-HQI) spotlight palms with an 8- to 15-degree adjustable beam pattern producing 400 footcandles at the center. Although landscaping appears informal, casual pathways through the atrium are sturdy enough to support 75-foot lifts for relamping. Perimeter cove lighting at 50 percent power plus 100W metal-halide uplights provide 0.9W per square foot for late-night illumination.*



*The simple but efficient lighting system used throughout the hospital interior is based on cold-cathode cove lighting with two-stage ballasts timed to dim automatically to half power late at night. In the cafeteria dining room (right), cove-lit coffers that define seating areas are tuned to match the day and night settings of the adjoining atrium. Waiting rooms (above opposite) are similarly lit with space-shaping coves augmented by compact-fluorescent downlights and residential-style lamps as accents.*

*In corridors indirect lighting from coves on one side combines brightness with visual comfort for patients. Compact-fluorescent downlights and task lighting that intensify the general illumination mark nursing stations (below right). "Birthday Suites" (below opposite) offer obstetrics patients and their families comfortable living rooms comfortably lighted with 60ma indirect cathode, 25W low-voltage accents. Stronger light, including indirect cove lighting and trof-fers with parabolic baffles for examinations, are provided at the bed.*





**Credits**

*HealthPark Medical Center  
Lee County, Florida*

**Owner:** *Lee Memorial Hospital*

**Architect:** *HKS Inc.—Noel  
Barrick, project manager;  
Robert Martineck, project  
architect; Jonathan Bakey,  
project designer*

**Lighting:** *Craig A. Roeder  
Associates*

**Interiors:** *HKS Designcare/  
Medical Space Design*

**Landscape:** *Herbert-Halback*

**Graphics:** *Tom Graboski  
Associates*

**General Contractor:** *Centex-  
Rogers Construction Co.*



# Garden Spots

*Redwood Grove  
East Bay, California  
Jan Moyet, Lighting Designer*



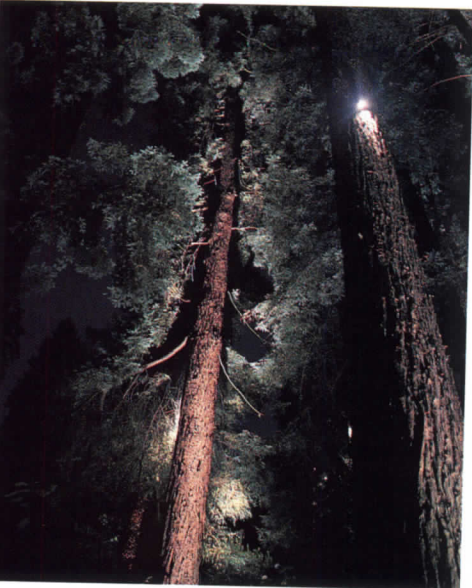

Carefully placed lighting gives human scale to giant redwoods, while soft spots lead visitors along a stone path through an ancient grove to the front door (opposite). Uplights wash through a canopy of leaves that begins 200 feet overhead (top), while a selection of well-lighted trees brings out the depth and breadth of this front-yard grove.

It's a simple yet impressive front-yard setting: a gate, a stone path, a front door—and a grove of stately California redwood trees. Beautiful and lush by day, at night harsh lighting made the scene confusing. The path itself was poorly lit because bare-lensed uplights, although focused on the trees, drew the eye and were blindingly bright. "You really don't want the fixture to be the brightest spot in the composition," says lighting designer Jan Moyer, whose task it was to redraw the picture. In addition, the unshielded lenses "threw light everywhere," especially on the white house next door, further obscuring the path and misleading the eye.

Moyer's goal, then, was to direct the viewer along the path to the front door, meanwhile creating "a wonderful visual experience" out of the garden. First, she masked out the house next door, restricting light in that quadrant of the grove. Next, and perhaps most important, was selecting specific trees and areas for illumination; lighting the entire grove would only continue the present confusion. The challenge was to maintain interest using a restricted palette: the trees, some of which are four feet thick, shoot straight up for 200 feet before spreading their branches.

Moyer seized on this "sculpture of vertical trunks" as the best means of giving a sense of the grove's depth and breadth. In all, she says, only about 10 percent of the grove is illuminated. "Making a visually pleasing scene at night is one of the hardest design problems in lighting. You're starting with such blackness," she explains, "yet you don't want to create huge contrasting areas." To uplight the redwoods, Moyer placed 90W PAR 38 quartz spots in 120V adjustable fixtures, bringing out the three-dimensional texture of the tree trunks and giving them "human scale" (Moyer calls them "individuals"). The light softens as it travels up the trunks to wash the high canopy of leaves, creating a garden roof. Thirty feet up the trunks, Moyer placed low-voltage downlights to softly light the ground plantings between the redwood trunks. For the path lighting, she made use of existing power locations, moving them forward slightly and choosing subtle fixtures. These cast intermittent circles along the 90-foot path to the house. "I would have rather had more-even lighting on the path," says Moyer, "but given the budget, it was a worthwhile compromise." One crucial element was changed after months of searching for alternate solutions by landscape architect Valerie Matzger and the owners: two redwoods were removed, clearing the view to the door. "It was tough, but it was the right decision," Moyer declares.

At the entry, Moyer had to frame the front door, pulling the viewer forward without distracting from the surrounding grove. An existing sconce and hanging light by the door were changed to "balance the site," and accent uplighting was directed onto the brick foundation, creating a backdrop of patterns for the tall redwoods.

Peter D. Slatin

#### Credits

Redwood Grove

East Bay, California

Owners: Name withheld by request

Lighting Designer: Jan Moyer Design

Landscape Architect: Valerie Matzger

Contractor: A. Robbins

**Let the Good Light Roll**





*Boogies Diner, a New York boutique  
and eatery, borrows heavily  
from the lighting vocabulary of  
the rock 'n' roll show.*

*Boogies Diner  
New York City  
Himmel/Bonner Architects  
Mark Kruger Associates Lighting Design*



By Les Dennis

Lighting designer Mark Kruger saw lighting Boogies Diner as an opportunity to wed dramatic theatrical techniques and the latest energy-efficient technology. Architects Himmel/Bonner designed the futuristic clothing boutique cum restaurant. The front of the two-story building is a curtain wall with an atrium topping the entrance, giving the second-floor restaurant an airy ambience. The boutique is on the ground floor and in the basement.

Rock music provides a constant beat and sets a tone that Kruger wanted to reinforce, and his experience designing lighting for several major rock acts gave him direction. "Creating the Boogies image was a great deal of fun," Kruger says. "I settled quickly on three basic pieces of hardware to allude to the rock-and-roll experience. The first was pure rock-show material: a fixture with a 700W MSR lamp, and a programmable effects head, which produces dynamic beam patterns, using rich dichroic color filters and motorized templates. The next was a 2000W projector, used in theatrical productions to create very bright moving images on backdrops. And the third was a custom clamp-on PAR 64 lampholder and filters to project colored light throughout the atrium."

The idea was to attract customers from outside on Lexington Avenue. Four of the programmable-head projectors are mounted on the slab break of the second floor. Controlled by a computer, they paint a mural of light on the ceiling of the atrium, which can be viewed from the street through the glass facade. A fifth projector's beam is directed down on the patrons as they enter, on diners in the front booths on the second floor, and on the primary display windows. The animated and colored light establishes the psychological mood for a potential sale.

The large projector uses an "oil and water" accessory head to project a constantly moving lava-lamplike image onto the back of the large translucent Boogies Diner sign mounted on the curtain wall. It's a dramatic nighttime attention-getter that makes even blasé New Yorkers look twice. The custom PAR 64 lamp holders project color directly through stripped glass color filters. They're assigned to dimmer channels which slowly cycle from fading to full intensity. "Nobody," explains Kruger, "wants to see their hamburger turn a different color every two seconds."

The entry lighting at Boogies was planned to dazzle the customers, to draw them in. The boutique portion of the store called for another approach: even, energy-efficient lighting with high color rendering. Boogies has, in Kruger's words, "a sea of merchandise," and he decided it should be lit evenly so customers could decide if they truly liked the color of an article of clothing. "I tried to create a full spectrum of white light by additive mixing of two distinct variations, the warm-toned 50W white high-pressure sodium, and the cooler-toned 70W metal halide mounted in track fixtures," says Kruger. Besides being more energy-efficient, these high-intensity discharge lamps last up to four times longer than their 75W and 150W PAR cousins. These days, the choice merits a standing ovation.

*Les Dennis is a freelance writer in New York City.*

#### Credits

*Boogies Diner, New York City*

**Owner:** Merry-Go-Round Enterprises

**Architect:** Himmel/Bonner Associates

**Lighting Designer:** Mark Kruger, IALD

**Mechanical/Electrical Engineer:** A. Epstein and Sons

© Scott Frances/Esto

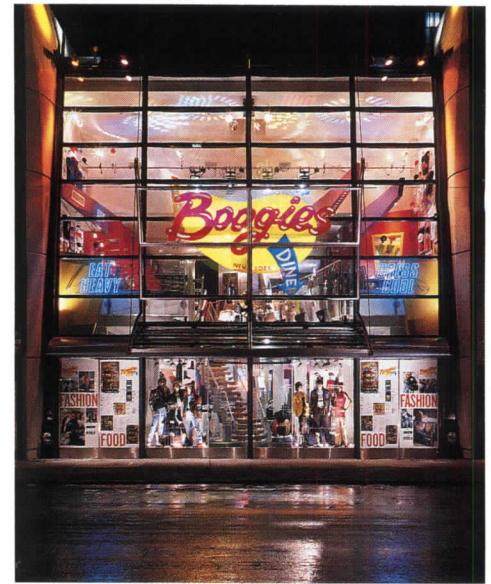

*A mural of light sweeps through Boogies curtain wall, filling the sidewalk with colored light. Custom clamp-on PAR 64 lampholders (top drawing) use Q1000 lamps and dichroic glass filters to place color throughout the boutique. Custom modular wall washers (bottom) fitted with a pair of 75W 12V lamps plug into transformer-powered ceiling outlets.*

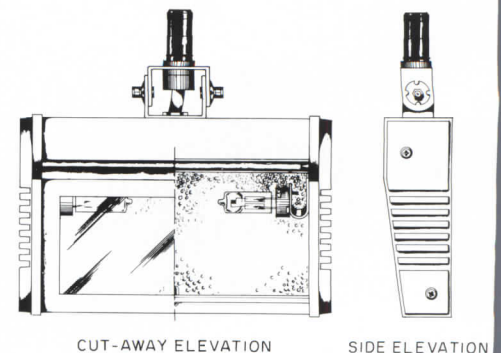
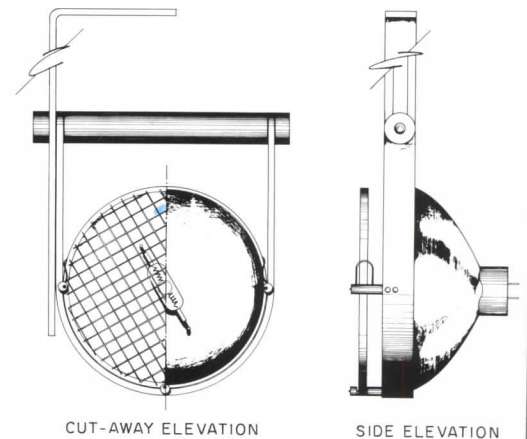





## Zumtobel. Destined For Exposure.

Progressing beyond the limits of light as merely a functional necessity, Zumtobel creates Optos,<sup>™</sup> the architectural downlight series designed to be seen. A modular system of interchangeable components that offers the lighting specifier freedom to control the ambience as well as the final aesthetic.

Zumtobel. Innovative lighting solutions. Uncompromising quality and performance. State-of-the-art manufacturing facilities. A worldwide commitment to excellence in lighting.

**ZUMTOBEL** 

**Circle 92 on inquiry card**

The Optos<sup>™</sup> Luminaire Series by Zumtobel. For further information and the name of your local Zumtobel Sales Representative, please contact us at: Zumtobel Lighting, 141 Lanza Ave., Bldg. 16D, Garfield, NJ 07026. 201 340-8900. Fax 201 340-9898.

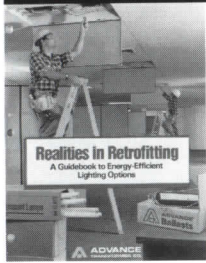

### 424. Lighting upgrade

An 18-page guidebook to energy-efficient lighting options covers all retrofit phases: assessment, ballast/lamp evaluation and comparison, and product selection. Discusses light output, input power conditions, and utility rebate requirements. Advance Transformer Co., Rosemont, Ill.

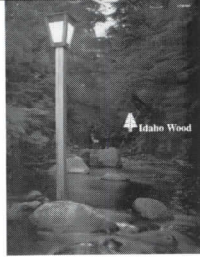

### 425. Cedar luminaires

Catalog illustrates bollards, post lights, sconces, lanterns, and other residential and commercial designs made of Western cedar. Custom work is a specialty, from a rustic chandelier to street lighting for an office park. Idaho Wood, Sandpoint, Idaho.

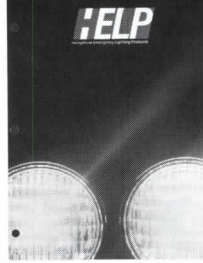

### 426. Emergency lighting

Holophane Emergency Lighting Products (HELP) line includes unit-device incandescent and fluorescent fixtures with integrated battery power and recharging capabilities. Catalog shows fixtures for commercial and industrial applications. Holophane, Newark, Ohio.

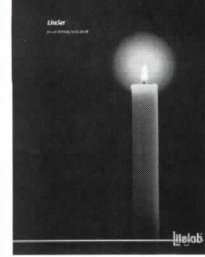

### 427. Pre-set dimmers

Catalog introduces LiteSet dimming systems, which operate with the newer light sources such as compact-twin, quad, and biaxial fluorescents, and linear T8, T10, and T12 lamps. Dimmer packs can be combined for different loads, and dim down to 5 percent of full brightness. Litelab Corp., Buffalo, N. Y.

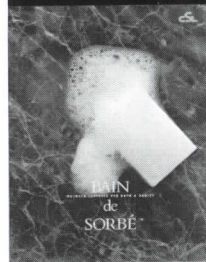

### 428. Bath illumination

An eight-page brochure illustrates the dramatic color range offered in Bain de Sorbé line-voltage halogen lighting for bath and vanity. There are 15 different but interchangeable Murano-glass shade options, mounted on rods available in six metal finishes. Dimmable. CSL Lighting Mfg., Valencia, Calif.



### 429. Rugged lamp

Fact sheet on the Nightingale lamp explains its built-to-last features, including a polycarbonate diffuser, fire-retardant translucent shade, and finial and base locks. Suggested for day rooms, lounges, and resident living areas. Adjustable Fixture Co., Milwaukee.

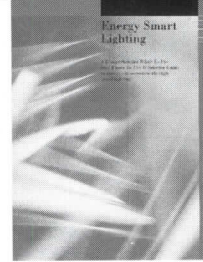

### 430. Lighting efficacy

A thoughtful 70-page booklet highlights fixtures and lighting systems designed specifically for the newest, energy-efficient lamps and ballasts. Applications include recessed, commercial fluorescent, decorative fixtures, and track lighting. Lightolier, Secaucus, N. J.



### 431. Compact dimmers

Brochure explains how new Hi-Lume electronic dimming ballasts dim a 26W or 18W T4 quad down to 5 percent with blink-free start up and no flicker. Ballasts can be controlled by standard wallbox fluorescent dimmers. Lutron Electronics Co., Inc., Coopersburg, Pa.

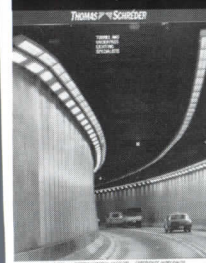

### 432. Tunnel lighting

New-product bulletins describe application-specific luminaires for tunnels, underpasses, and other adverse environments, as well as system controllers that can adjust entrance lighting levels to reflect physiological eyesight adaptation and ambient lighting changes. Thomas/Schreder Lighting, Milan, Ill.

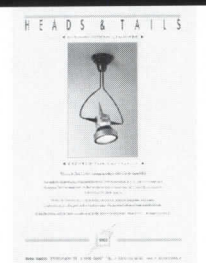

### 433. Plug-jack halogens

The Waco Sidekick and Heads & Tails spotlights get their low-voltage power from a plug-in system. Once mounted, the high-styled lamp heads can be rotated 360 degrees along any axis. Ardee Lighting/USA, Miami.

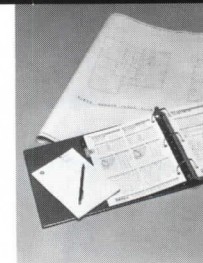

### 434. Recessed architectural

Technical-literature package includes a full-color catalog, specification binder, and product-specific data sheets on an entire line of recessed fixtures, with information on design and color characteristics of various light sources for each. Omega Lighting, Los Angeles.

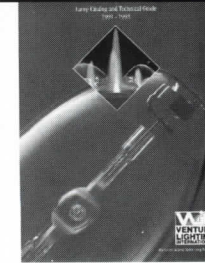

### 435. Metal-halide lamps

A 50-page technical guide stresses the positive environmental impact of metal-halide sources, and lists design parameters for energy-saving lamps. On-site photography illustrates color temperatures and applications for all lamps; charts present lumen values. Venture Lighting, Solon, Ohio. ■

# Looks great in the light . . .



No single element can enhance the appearance of an environment as significantly as correct lighting. At Beta, we define correct lighting as the combination of exceptional daytime appearance, superb nighttime performance and quality design that you can appreciate 24 hours a day.

Our entire line of indoor and outdoor HID luminaires is engineered for maximum efficiency, quick installation and easy maintenance. A unique five stage acrylic powder coat paint system further enhances and brings attention to the fine craftsmanship of the Beta line.

When you need a wide range of outdoor, industrial and commercial lighting products, backed by expert technical and application support, specify Beta Lighting.



l i g h t i n g

1200 92nd Street, Sturtevant, WI 53177

(414) 886-2800

Circle 93 on inquiry card

# . . . Lights great in the dark.

## New Products



**342. Incandescent lamp.** Hybec says its new incandescent lamps have the color temperature of a halogen source, but burn twice as long with less heat generated. And the light output of the 60W source approaches that of a 100W halogen. Available in 20W, 40W, and 60W with an MC base, and a 60W reflector with an E27 base. Hybec, Div. Miyakawa Corp., Cary, Ill.

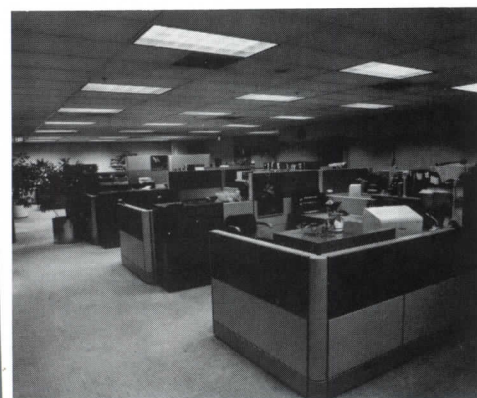

**343. Blackout lighting.** The Multinet interruptible-power inverter uses high-frequency sine wave power to operate all rapid-start fluorescent fixtures in a building at an even, lower level of illumination (bottom photo) during utility power failures. Exit signs remain at near-full light levels. Siltron Illumination, Inc., Cucamonga, Calif.

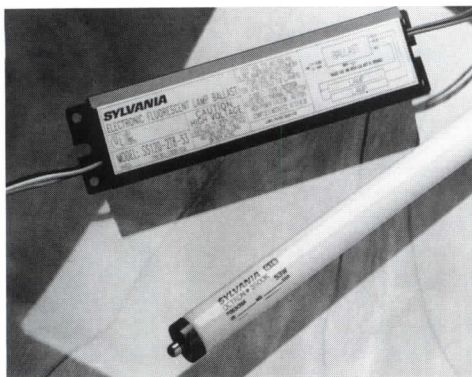

**344. Lamp/ballast match.** Sylvania now offers an electronic ballast designed specifically for the 8-ft Octron lamp, a combination said to provide additional energy efficiencies and better lamp performance. The system is a direct replacement for standard 8-ft T12s, and is said to represent a 38 percent savings (108W vs 175W) at 25 percent longer life (15,000 vs 12,000 hours). The Octron lamp comes in temperatures of 3,100K, 3,500K, and 4,100K. Sylvania Lighting/GTE, Danvers, Mass.

*Continued on page 72*

## Lighting the outdoors...



- elliptipar's unique asymmetric reflector projects light evenly without scallops, striations or hot spots.
- durable, quality constructed, compact fixtures lend style to any application.
- tungsten halogen, metal halide, HPS, and fluorescent sources meet specific lighting needs.

Excellent for illuminating facades, canopies, paths, parking lots....

Write for technical and application information.

### elliptipar, inc.

145 Orange Avenue, West Haven,  
Connecticut 06516 (203) 932-2266

Sylvan R. Shemitz® Designs ©Copyright 1991

Circle 94 on inquiry card

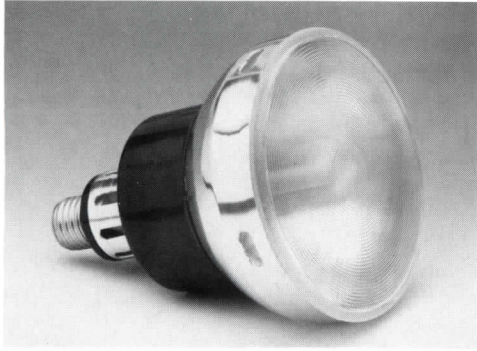

345

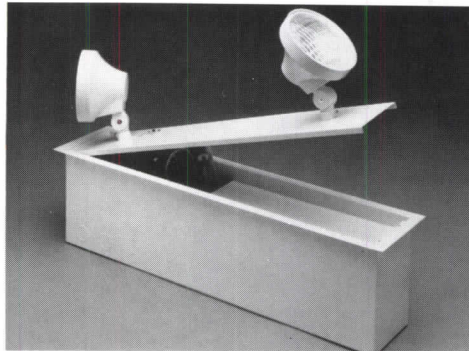

347

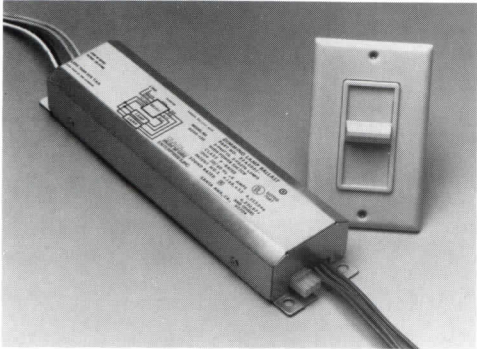

346

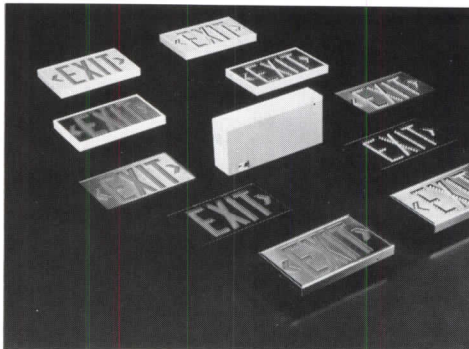

348

**345. Retro floodlights.** A new venting system and specular reflector for 13W compact-fluorescent floodlamps is said to ensure performance at the full specified lumen output over the 50,000-hr rated ballast life. Intended for use in existing incandescent fixtures. Eastrock Technology, Hackettstown, N. J.

**346. Dimmable fluorescents.** A new ballast incorporates dimming capabilities (manual, automatic, remote, and multi-function) within the ballast housing. Dimming is described as full range, from zero to 100 percent, and over 1,000 fluorescents can be controlled with one 600W incandescent dimmer. Tek-Tron, Santa Ana, Calif.

**347. Recessed emergency.** Series T lights have a 5/8-in.-wide edge flange that permits installation in both T-grid and nonaccessible ceilings. Only the light heads, mounted on a hinged access plate, extend below the ceiling plane. Pathway, Clinton, Conn.

**348. LED exits.** Up to 10 2W lights can operate from a single remotely mounted control, connected by pairs of low-voltage wires. Hubbell, Christiansburg, Va.



**Barneys New York**  
Owner: Barneys New York  
Architect: Peter Marino  
International Ltd.

LIGHTFAIR  
BOOTH #136

## CUSTOM FIT LIGHTING

National/Horlbeck Lighting is dedicated to assisting the lighting consultant and architect in the evolution of the fixture, from inspiration and design through fabrication to finished product. Our decorative fixtures range from incandescent wall washers to architectural specification grade fixtures, including premium parabolic fluorescent lighting.

Uncompromising attention to detail has been the hallmark of National/Horlbeck lighting fixtures for over half a century.

Represented by Lighting Dynamics of New York, Inc.  
212-268-9222 Fax# 212-268-9240

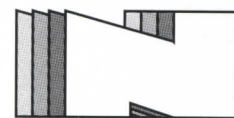

**NATIONAL/HORLBECK  
LIGHTING COMPANY INC.**

National/Horlbeck Lighting Company, Inc.  
522 Cortlandt Street, Belleville, New Jersey 07109  
NJ 201-267-4400 NJ 201-751-1600 Fax# 201-751-4391

Circle 95 on inquiry card



For more information, circle item numbers on Reader Service Cards.

**349. Restful illumination.** The BioLite lamp converts AC to DC, eliminating the subtle flicker said to contribute to eyestrain, and letting a standard 60W A bulb emit light "like early-morning sunlight." Biovation Products, Westport, Conn.



349

**350. Special effects.** Weatherproof luminaire casts beams of light for exterior nighttime illumination. Templates shape the light into logos, pictures, or custom forms, projecting the light clearly onto surfaces with no spill. Comes with a long- or short-throw lens, zoom/shutter adjustments, and quartz or HQI lamps. Phoenix Products, Milwaukee.

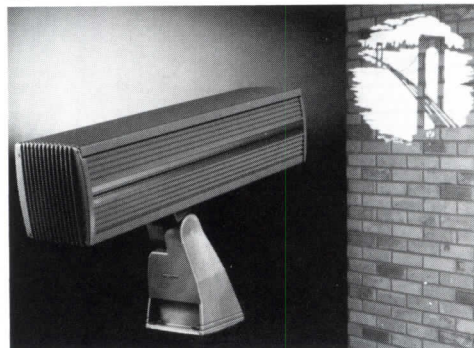

350

**351. Color-balanced metal halide.** Compact double-ended lamps use metal-halide chemistry said to be less sensitive to in-use variables—supply voltage, ballast/control configurations, burn position, and ambient temperature—that can cause color shift. Light is a balance of blue, red, and green output. Ushio America, Inc., Torrance, Calif.

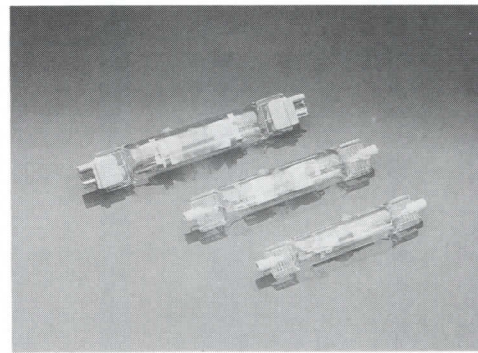

351

**352. Low-profile switch.** Occupancy-sensing light control has a new, sleeker design that fits a standard decorator wall plate. The Watt Stopper, Inc., Santa Clara, Calif. ■

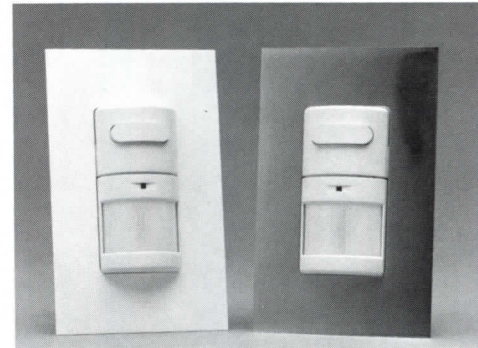

352

## Uncommon Style And Performance Are Standard

Winona Lighting presents the Pyramis series. A selection of chandeliers and wall sconces designed with a unique pyramid shape lens. Another example of Winona Lighting's commitment to energy efficient decorative lighting.

### TRIANTA

Catalog #4100. Available in 26 & 39" width, polished brass or chrome finish. Standard lamping incandescent, fluorescent, and HID (Metal Halide).



LIGHTFAIR  
INTERNATIONAL  
Booth #908

**winona**  
lighting  
3760 West Fourth Street  
Winona, MN 55987  
1-800-328-5291 USA  
507-454-5113

Circle 96 on inquiry card

“LIGHT SEEKING  
LIGHT DOETH  
LIGHT OF LIGHT  
BEGUILE”

SHAKESPEARE



**V**iew Craftsman,  
Victorian and

Art Deco lamps and fixtures in a whole new light. Request our catalog of fine, solid brass reproductions.



REJUVENATION LAMP & FIXTURE CO.

1100 S.E. GRAND AVENUE  
PORTLAND, OREGON 97214  
(503) 231-1900

Circle 97 on inquiry card

## Manufacturer Sources

### Pages 42-45

Hotel Macklowe, New York City  
William Derman, Architect  
Cosentini Lighting Design, Lighting Designer  
HID downlights: Edison Price. Custom decorative fixtures: Winona. Indirect fluorescents: Linear Lighting. Flag and canopy lights: Lightolier.

### Pages 46-47

Interstate Tower  
Kohn Pederson Fox Architects  
Craig A. Roeder Associates, Lighting Designer  
Exterior uplights: Sterner. Chasing lights and controller: Litelab. Metal-halide PAR lamps: Venture Lighting. Neon: Neotek. Recessed lighting: Edison Price. Plaza uplights: Hydrel.

### Pages 48-51

Eugenio Maria de Hostos Community College  
Voorsanger & Associates, Architects  
H. M. Brandston & Partners, Inc., Lighting Design  
Library pendants, atrium torchères: Sterner Lighting Systems. Fluorescent troffers: Lightolier. Stairwell fixtures: Louis Poulsen.

### Pages 52-55

Haverson/Rockwell Architects, P. C.  
**Le Bar Bat**—Pipe-mounted PAR fixtures: Litelab. Metal-halide framing projectors: Arc Lighting. Silk basket lights: custom by architects, fabricated by John Savittieri. Handblown “bat” fixtures: custom by architects, fabricated by Exciting Lighting.  
**Tatou, Inc.**—Decorative fixtures: Karen Atta, Inc.; New York Gas Lighting. Theatrical lights: Altman. Chandelier restoration: Focus Lighting.

**La Galleria**—Overhead PAR track fixtures: Litelab. Lighting troughs: Lighting and Electric.

**The Museum Club at Bridgewater**—Quartz uplights: Daybright. Track fixtures: Litelab. Framing projectors: Times Square. Sconces: Stonco.

**Caffe Roma**—Downlights: Lightolier. Mural lighting: Lighting and Electric. Overhead track: Litelab.

**Residence, Pound Ridge**—Pin spots: Lightolier. Cove lights: Litelab.

### Pages 56-61

HealthPark Medical Center  
HKS Inc., Architects  
Craig A. Roeder Associates, Lighting Designer  
Cold-cathode coves: Neotek. PL downlights: Omega. Metal-halide spots: Litelab. Fountain uplighting: Hydrel. Translucent glazing: Kalwall. Compact-fluorescent downlights in corridors: Omega. Low-voltage accents: Halo. Parabolics: H. E. Williams.

### Pages 62-63

Redwood Grove  
Jan Moyer Design, Lighting Design  
Path lights: Casella. Uplighting: Hadco. Downlights: Lumière.

### Pages 64-67

Boogies Diner  
Himmel/Bonner Associates, Architect  
Mark Kruger, Lighting Designer  
Indirect uplights: SPI Lighting. HPS and metal-halide track: Amerlux. Wall-washers: Modular International. PAR 64 lampholders: Lazin Lighting. LV downlights: CSL Lighting. Projectors: Ludwig Pani GmbH. Programmable lighting: High End Systems. Wall-washers: Rambusch Lighting. Exterior floods: Kim Lighting. Custom modifications: Harry Gitlin Co. Controls: Lutron.

1	Exxon
2	General Motors
3	Mobil
4	Ford Motor
5	IBM
6	Texaco
7	E.I. du Pont
8	Standard Oil (Ind.)
9	Standard Oil of Cal.
10	General Electric
11	Gulf Oil
12	Atlantic Richfield
13	Shell Oil
14	Occidental Petroleum
15	U.S. Steel
16	Phillips Petroleum
17	Sun

**27**  
**million**  
**Americans**  
**can't read.**  
**And guess**  
**who pays**  
**the price.**

Every year, functional illiteracy costs American business billions.

But your company can fight back...by joining your local community's fight against illiteracy. Call the Coalition for Literacy at toll-free **1-800-228-8813** and find out how.

You may find it's the greatest cost-saving measure your company has ever taken.

**A literate**  
**America is a**  
**good investment.**



Coalition for Literacy

# SWEET'S LIGHT SOURCE

A New Link to Your Hottest Lighting Prospects

**COMING SOON!**  
**Sweet's Light Source**



In 1993, Sweet's will present Sweet's Light Source, the first single-source reference of lighting product information. Specifically targeted for buyers and specifiers of lighting products, Sweet's Light Source will only include lighting manufacturers.

Sweet's Light Source guarantees your products are seen by professionals with proven purchasing power – right at the moment they are actively seeking lighting products. To insure this, Sweet's Light Source will be distributed to the 21,000 Architectural, Engineering, Electrical Contracting, Interior Design, and Space Planning Offices, Lighting Design Consultants, Landscape Architects, Lighting Maintenance Firms, and Distributors who account for the majority of construction dollars spent in this market.

Fully endorsed by the IALD and IESNA, Sweet's Light Source promises to be an invaluable tool for buyers and specifiers of lighting equipment, providing you with an excellent showcase for your lighting products.

To include your product information in Sweet's Light Source, call **1-800-421-9330**.  
To qualify to receive Sweet's Light Source, call **1-800-442-2258**.



**Sweet's Group**

McGraw-Hill, Inc.  
1221 Avenue of the Americas, 20th Floor  
New York, NY 10020

LSRLC

# Product & Literature Spotlight

## Trouble - Free Sports Lighting

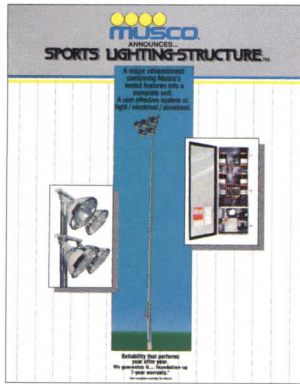

Faster, easier to install; Costs less to operate; Responsible energy-efficient lighting. Complete lighting system includes precast concrete base, galvanized steel pole, factory-aimed fixtures, factory-wired electrical enclosure, & factory-built wire harness. Entire system guaranteed for seven years. UL listed. Comprehensive package of support services. Send for 10-page brochure or call 1-800-825-6030.

**Musco Sports-Lighting, Inc.**  
Circle 98 on the inquiry card.

## Tech Lighting introduces "Kable Lite"

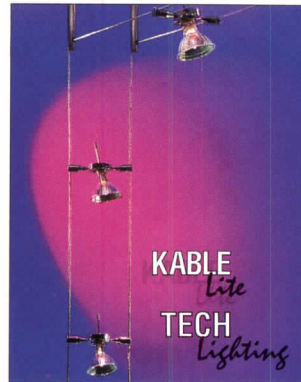

the UL approved barewire system. Comprised of uninsulated parallel cables tensioned between 2 rigid surfaces & powered by transformer. Each system accommodates 250 watts on a cable distance of 20 feet. Types of fixtures include suspension, track heads, wall sconce, etc. A fabulous alternative to track. Sleek "free air" suspension gives the illusion of floating light. Design is versatile, & the sleek geometric spots are easily mounted & remounted. (312) 486-6464 or Fax (312) 252-4264.

**Tech Lighting**  
Circle 99 on the inquiry card.

## Lighting that's Professional

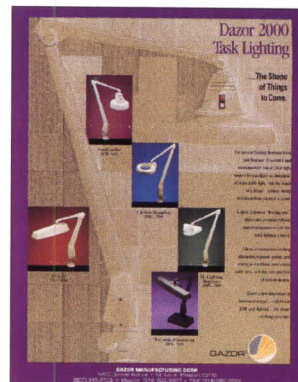

Dazor Mfg. Corp., manufactures a full range of adjustable-arm task lighting designed for applications that include: offices, workstations, computer terminals, drafting/engineering/art & graphics tables, examination/inspection, & for a variety of professional & commercial uses. Light sources include: fluorescent, compact fluorescent, incandescent, halogen & high intensity. Arm movement is easy & there are no exposed springs or wires.

**Dazor Manufacturing Corp.**  
Circle 100 on the inquiry card.

## Metrolite puts other emergency lighting designs in the dark

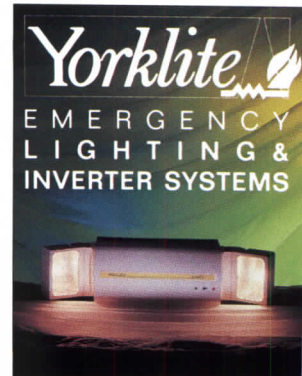

An emergency lighting system that achieves new standards of performance & reliability, but is designed to complement any interior. 12 watt halogen lampheads provide even, high intensity illumination. Sealed batteries & precision charge ensure maintenance-free operation. Twin lampheads are individually adjustable after mounting to accommodate any location. Send for your **FREE** Metrolite color brochure today! (215) 244-4201.

**Yorklite**  
Circle 101 on the inquiry card.

## Nostalgic Post-Top Ornamental Luminaire

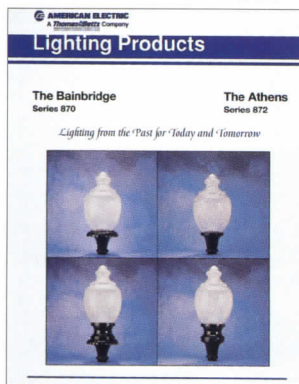

AMERICAN ELECTRIC is introducing a new luminaire to the ornamental/nostalgic lighting market. The ATHENS/BAINBRIDGE luminaire features old-fashioned style & grace with modern performance & materials. These luminaires are available with a variety of globe styles, ornamental accessories, colors, and a range of wattages of High Pressure Sodium, Mercury Vapor, & Metal Halide light sources.

**American Electric**  
Circle 102 on the inquiry card.

## Eclipse Model # 5112



Introducing the ECLIPSE model #5112 in 24 carat gold finish from Inlite's European Epique collection. 100 watt halogen capacity for use with Inlite 3000 series duo track.

For more information please contact:  
**Inlite Corporation**  
939 Grayson Street  
Berkeley, CA 94710  
(510) 849-1067  
1-800-346-5932

**Inlite Corporation**  
Circle 103 on the inquiry card.

## 1992 Catalog of Indoor & Outdoor Fixtures



**Prisma Illuminazione . . .** a Lightning Bug, Ltd. exclusive, is a fixture line offering recessed low voltage, ceiling, wall, & landscape lighting. Applicable for residential & commercial specification, Prisma offers UL and/or ETL damp & wet listed fixtures. Incandescent, compact fluorescent, 2D fluorescent, high power factor & many high intensity discharge applications are available.

**Lightning Bug, Ltd.**  
Circle 104 on the inquiry card.

## The Wave

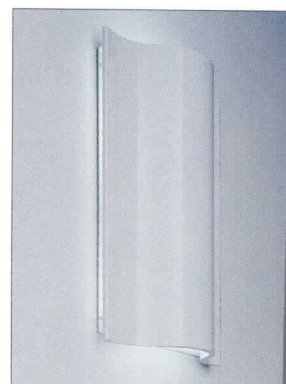

Creating a sensation of the fluidity of light, the **Wave** is a up & down light using edge lighted acrylic. The vertical edges of the fixture glow, creating a halo effect. The **Wave** is formed of one-quarter inch aluminum that is fastened one piece of one-half inch thick laser-cut acrylic. The edges of the aluminum are machined & the fixture is finished in white enamel. Special finishes are available on request. UL listed.

**Perry Pratt Lighting**  
Circle 105 on the inquiry card.

### Kirlin High Efficiency Metal Halide Downlights

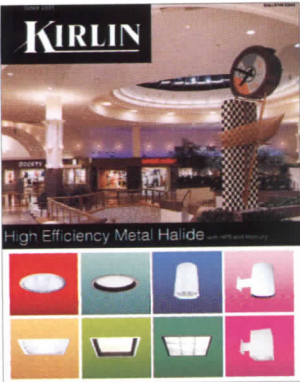

Green Lights Manufacturer Ally introduces 78 new high efficiency metal halide luminaires for indoor and outdoor use. Broad product line includes new open fixture-rated metal halide, ellipsoidal, parabolic louver, recessed lens, wall wash, directional and direct/indirect fixtures. Extensive options include HPS, Mercury, electronic ballasts, relays, lenses, reflector/housing colors, and all mountings.

#### The Kirlin Company

Circle 106 on the inquiry card.

### LIGHT To Specifications. Custom or Standard.



A unique Illumination Concept: Over 200 Luminaires & Systems. Modular Engineering allows Myriad of Combinations, Variations & Mounting Methods. Linear Lighting: Artlighting, Wallwashers, Up/Downlighting, Cove/Cabinet/Shelflighting, Fluorescents. "Lightpoints". Spots. Recessed's. Pendants. Sconces. Bracket. Display. Chandeliers & Pendants. 246 East 58th St., New York, NY 10022, 212-371-0336, FAX 212-371-0335.

#### Modulighting

Circle 107 on the inquiry card.

### Recessed Architectural Edgelit Series by Sure-Lites



The crystal clear wedge shape panel allows aesthetic design details while providing illumination uniformity. New Edgelit Series engineered with molded letters & NFPA directional chevrons for increase exit visibility, uses two energy efficient 8 watt fluorescent lamps & long life Nickel Cadmium batteries. The recessed steel housing is obtainable for wall, end or ceiling mount & includes adjustable hanging bars. Available in brushed aluminum, brass, chrome, white, black & bronze.

#### Sure-Lites

Circle 108 on the inquiry card.

### Hanover Lantern Commercial Lighting



Hanover Lantern designs & manufactures high quality heavy duty cast titanium/aluminum commercial grade decorative lighting fixtures, poles & accessories. A selection of design styles, light source options, light distribution systems, mounting options, computer generated photometric data plus a custom design service are available to the architect or engineer. 470 High St., Hanover PA 17331. Phone (717) 632-6464, Fax (717) 632-5039.

#### Hanover Lantern

Circle 109 on the inquiry card.

### Vandal Resistant



Vandal resistant lighting has been our only business for over twenty-five years. All of our products use polycarbonate lenses, zinc coated steel, and powder polyester finishes. We use only HPF ballasts, specialize on the GE 2D lamp and offer cold weather starting to -25F.

#### Designplan Lighting, Inc.

Circle 110 on the inquiry card.

### Bodine Offers More Emergency Lighting Options

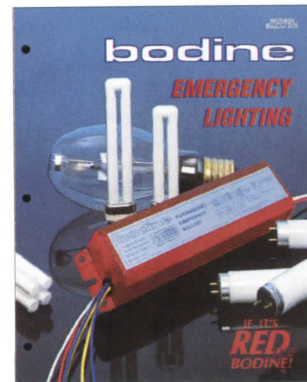

Free brochure tells how to convert HID, standard, twin- or quad-tube and specialty fluorescent lamps into emergency fixtures. Concealed in or near a fixture, Bodine's dependable equipment won't affect normal operation and meets UL, NFPA-LSC and NEC requirements. Explains application, operation & installation to ensure your emergency illumination never detracts from the interior design. (901) 853-7211.

#### Bodine

Circle 111 on the inquiry card.

### Contemporary Lighting



The WoodForm collection California redwood outdoor lighting features wall sconces, post, bollard, and garden fixtures in incandescent, fluorescent, high intensity discharge, and low-voltage modes. Each design utilizes hand-jointery and advanced lamination techniques to create unique, sculptural light forms of solid wood. All are U.L. approved for wet locations. (800) 624-5091.

#### WoodForm, Inc.

Circle 112 on the inquiry card.

### Tech Light introduces the Compact Series

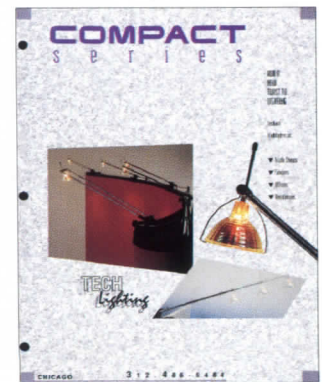

This system was specially designed for exhibit booths, or any display setting. This unique design places the plug directly at the end of the lighting fixture. The fixture plugs or unplugs for easy storage & mobility, available in clamp or canopy mount. The low-profile canopy covers an electrical box that houses the 50-watt transformer. MR16 halogen bulb included. Also available, a specially designed, compact, single handled traveling case.

#### Tech Lighting

Circle 113 on the inquiry card.

# Advertising index

For detailed data, prefiled catalogs of the manufacturers listed below are available in your 1992 Sweet's Catalog File as follows:

Bold face—page number  
Italics—Reader Service number

## A

Art Directions, Inc., **33**; *82*  
(314) 863-1895

## B

Baldinger Architectural Lighting, Inc., **37**; *86*  
(718) 204-5700  
BEGA/FS, **9**; *71*  
(805) 684-0533  
Beta Lighting, **70**; *93*  
(414) 886-2800

## C

Con-Tech Lighting, **38**; *89*  
(708) 945-0303  
CSL Lighting Mfg., Inc., **Cov. IV**; *115*  
(805) 257-4155

## E

Edison Price, Inc., **33**; *81*  
(212) 838-5212  
Elliptipar, Inc., **71**; *94*  
(203) 932-2266

## G

General Electric - C&I Lamps, **Cov. II-1**; *67* [G-E-I]  
(800) 523-5520

## H

Hydrel, **Cov. III**; *114*  
(818) 362-9465

## I

ITL, Inc., **36**; *85*  
(303) 442-1255

## K

Kim Lighting, **2**; *68*  
(818) 968-5666

## L

Leviton Mfg. Co., **31**; *79*  
(800) 323-8920  
Lighting Services, Inc., **33**; *83*  
Litecontrol, **35**; *50*  
(800) 852-3455  
Lutron, **40**; *91*  
(800) 523-9466

## N

National/Horlbeck Lighting Co., Inc., **72**; *95*  
(212) 268-9222

**(G) General Building & Renovation**  
**(E) Engineering & Retrofit**  
**(I) Industrial Construction & Renovation**  
**(L) Homebuilding & Remodeling**  
**(D) Contract Interiors**

Neo-Ray Lighting, **38**; *88*  
(718) 445-5492  
Noral Lighting, Inc., **12**; *74*  
(800) 676-3945  
Norbert Belfer Lighting, **32**; *80*  
(908) 493-2666

## O

OSRAM, **6-7**  
(800) 338-2542

## P

Peerless Lighting, **11**; *73*  
(415) 845-2760  
Philips Lighting, **10**; *72* [E]  
(800) 631-1259  
Phoenix Prods. Co., **39**; *90*  
(414) 438-0213  
Poulsen Lighting, Inc., **4-5**; *69*, *15*; *77*  
(800) 342-2310

## Q

Quality Lighting, **8**; *70*  
(800) 375-7632

## R

Reggiani USA, **16**; *78*  
(914) 565-8500  
Rejuvenation Lamp & Fixture Co., **74**; *97* [G]  
(503) 231-1900

## S

SPI Lighting, Inc., **38**; *87*  
(414) 242-1420

## T

Targetti, Inc., **14**; *76*  
(800) 526-6990

## V

Visa Lighting Corp., **13**; *75*  
(800) 788-VISA

## W

Waldmann Lighting Co., **36**; *84*  
(708) 520-1060  
Winona Lighting, **73**; *96*  
(800) 328-5291

## Z

Zumtobel Lighting, **68**; *92*  
(201) 340-8900

# Sales offices

## Main Office

McGraw-Hill, Inc.  
1221 Avenue of the Americas  
New York, New York 10020

Publisher  
*Roscoe C. Smith III (212) 512-2841*

Administrative Assistant  
*Anne Mullen (212) 512-4686*

Director of Business and Production  
*Joseph R. Wunk (212) 512-2793*  
*Fax: (212) 512-4256*

Classified Advertising  
*(801) 972-4400*

## District Offices

### Atlanta

4170 Ashford-Dunwoody Road  
Atlanta, Georgia 30319  
*Gregory Bowerman (404) 843-4781*  
*Fax: (404) 252-4056*

### Chicago

2 Prudential Plaza  
180 N. Stetson Ave.  
Chicago, Illinois 60601  
*Anthony Arnone, (312) 616-3339*  
*Thomas P. Kavooras, Jr., (312) 616-3338*  
*Fax: (312) 616-3323*

### Cleveland/Philadelphia/Pittsburgh

1221 Avenue of the Americas  
New York, New York 10020  
*Frank Rose (212) 512-2409*  
*Fax: (212) 512-4256*

### Dallas/Houston

2 Prudential Plaza  
180 N. Stetson Ave.  
Chicago, Illinois 60601  
*Thomas P. Kavooras, Jr., (312) 616-3338*  
*Fax: (312) 616-3323*

## The Marketplace/Product Literature Showcase

*Kevin Beatty*  
*John Haddock*  
*1-800-544-7929*  
*Fax: (212) 512-4256*

### Denver

*John J. Hernan (415) 882-2825*  
*Fax: (415) 882-2826*

### Los Angeles

Media Sales Associates  
1493 Temple Hills Drive  
Laguna Beach, Calif. 92651  
*William Hague (714) 494-8419*  
*Sherylen Young*  
*Fax: (714) 497-7261*

### New England/New York

1221 Avenue of the Americas  
New York, New York 10020  
*Louis Kutscher (212) 512-2814*  
*Frank Rose (212) 512-2409*  
*Fax: (212) 512-4256*

### New York

1221 Avenue of the Americas  
New York, New York 10020  
*Laura Viscusi (212) 512-3603*  
*Fax: (212) 512-4256*

### San Francisco/Seattle

Media Sales Associates  
9017 Peacock Hill  
Gig Harbor, WA 98332  
*William Hague (206) 858-7575*  
*Fax: (206) 858-7576*



# 9000 NIGHTWASH

Wide, even light finds new shapes in the night time landscape

**Hydrel's 9000 Series ingrade up lights illuminate the walls at the new Citadel retail and office complex in Los Angeles. These new hi-tech ingrade fixtures were chosen especially for their high performance and low installation cost.**

Chip Israel of Grenald talks about the project:

*"The lighting on the front had to unify the whole project, as well as provide a soft inviting feeling."*

*"The solution included 175 watt metal halide 9000 Series from Hydrel, set back six feet from 30 to 40 foot walls as a wash."*

*"We ended up further back and with a softer approach... we wanted the building to have a friendly feel, not to eerie."*

*"The lighting was also aimed up and outward from the entrance along the walls to accentuate architectural detail and shadows and to prevent the lighting from becoming too flat."*

*"These lights have the benefits of being concealed in-grade fixtures which reduce both aesthetic objections and installation costs, as well as new high performance E-17 lamps."*

*"We were fortunate to be able to work very well with some manufacturers such as Hydrel and Western Lighting Industries... They were able to supply us with some great and efficient lighting at a price that enabled the job to get done in the way we wanted."*

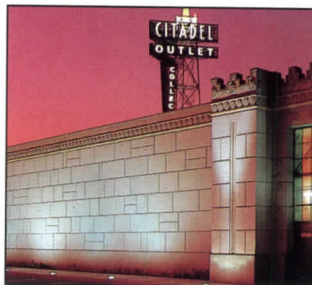

Hydrel's 9000 Series in grade fixtures provide wide uniform performance for wall wash and sign lighting applications.



# It took to make the Lamp... It took CSL to Turn It On!

...and on!

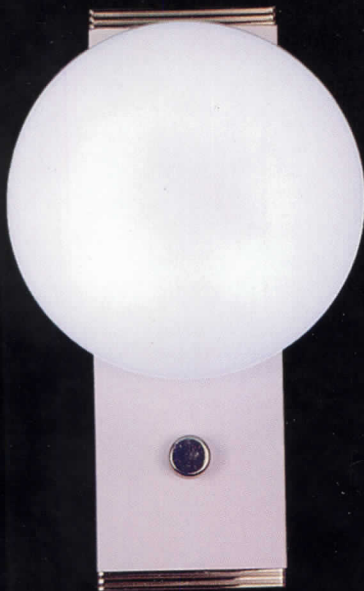

...and on!

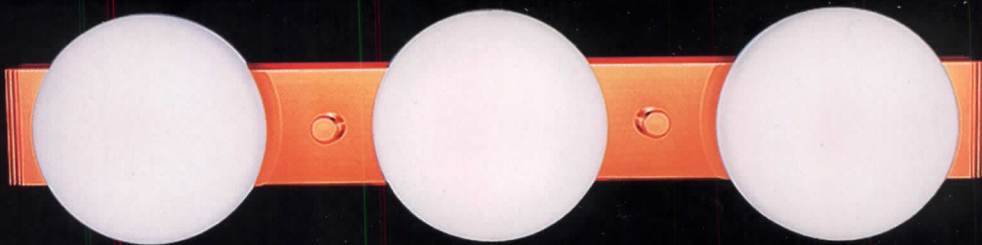

...and on!



Meeting the lighting challenges of the nineties...  
a bold new concept in Corridor, Room Entry, Bath/Vanity,  
and Recessed fluorescent illumination.

- Corridor / Room Entry fixture meets all requirements of Americans With Disability Act. (3-1/2" Projection)
- All surface mounted fixtures are available in Polished Brass, Polished Chrome, or White, and utilize either 10 watt or 21 watt 2D lamp(s).
- High power factor electronic 'instant-on' ballast.
- Triplex Glass or Acrylic Diffuser
- 8,000 hr. lamp life - 15,000 hr. with continuous burn.

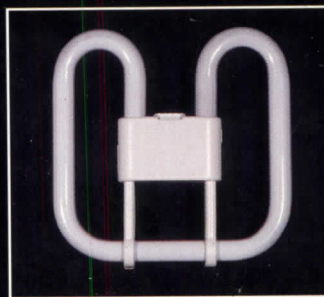

- 10 Watt 2D = 50 Watt Incandescent
- 21 Watt 2D = 100 Watt Incandescent
- 2700° Kelvin Same as Incandescent!
- 82 CRI - 65 Lumens per Watt

**CSL LIGHTING MFG.®**

25070 Avenue Tibbetts, Valencia, California 91355-3447  
Telephone: (805) 257-4155 • FAX: (805) 257-1554  
Circle 115 on inquiry card

See us at Light Fair, May 6-8, 1992, Booth #712