



NEW DEFINITIONS™ WILL CHANGE THE WAY YOU LOOK AT CEILING GRID.

Finally, grid can work as a totally integrated element of design. The crisp detail of Definitions opens avenues of expression never explored before in ceilings. Available in five distinct profiles, Definitions performs like conventional grid while revolutionizing the face of ceiling design. For a free color catalog, call 1 800 233-3823 and ask for Definitions.



Preservation of artifacts like the huge Duquesne Works, near Pittsburgh, is among the challenges of a new, regional form of historic preservation. Page 24.

Next month

Building Types Study 714 Laboratories

Marine science, pharmaceutical, and plant genetics research laboratories are covered.

Also in March

- Two new buildings by Charles Moore with collaborators.
- Fumihiko Maki's Center for the Arts, San Francisco.
- A Queens, N. Y., police station by Perkins Eastman.
- The Architecture Institute in Rotterdam by Jo Coenen.
- *The Profession* includes an in-depth look at architectural salaries.

Introduction 85

More than Preservation 86

Adaptive Reuse's New Rules

Old Bird House Renovation and Rehabilitation International Wildlife Conservation Park Bronx, New York City 88

Davis, Brody & Associates, Architect

Stuyvesant Hotel Conversion Kingston, New York 94

David Smotrich & Partners, Architect

The Brooke Russell Astor Rare Books and Manuscripts Reading Room New York Public Library 98

Davis, Brody & Associates, Architects

Adelbert Hall Restoration Case Western Reserve University Cleveland, Ohio 102

R. M. Kliment & Frances Halsband Architects

Industria Superstudio, New York City 108

Deborah Berke and Carey McWhorter Architects

Tobacco Dock Wapping, London 112

Terry Farrell and Company, Architect

Primary Care Clinic, Oakland Children's Hospital Oakland, California 118

The Ratcliff Architects

Focus on: A Rich Range of Recycled Buildings 122

Projects include architects' own offices, a whole urban block, a church, and a clinic in a former supermarket.

THE PROFESSION 23

Preservation's Vast New Horizons (Agenda). Landmark Dilemma: How Much Upgrading Is Enough? (Seismic & Preservation). Microstation 5 (Software Reviews). Through the Roof—Skylights and Scuttles (Products).

Editorial 9

On The Urban Front:
A Look at the Bright Side

Letters/Calendar 4 Design News 11 Observations 16 Manufacturers' Sources 137

Classified Advertising 146
Editorial Index 149
Advertising Index 156
Reader Service Card 157

Cover: Old Bird House Renovation and Rehabilitation International Wildlife Conservation Park, New York City
©Peter Aaron/Esto photo

SUPPLEMENT ON LIGHTING IS INCLUDED WITH THIS ISSUE
(with U. S. and Canadian copies only)

**WHY YOU
SHOULD BE SURE
OF THE FINISH
EVEN BEFORE
THE START.**

LONG BEFORE PEN HITS PAPER, YOU KNOW WHAT IT LOOKS LIKE. EVERY ROOM. EVERY ANGLE. EVERY DETAIL. AND YOUR VISION WILL NOT BE COMPROMISED. WHICH IS WHY YOU SHOULD HAVE SHERWIN-WILLIAMS ALONG FROM THE VERY START. OUR ARCHITECTURAL CONSULTANTS AND CORROSION ENGINEERS CAN PROVIDE THE MOST UP-TO-DATE TECHNICAL ADVICE AND FINISHING TECHNIQUES. AND SHOULD YOU EVER HAVE A QUESTION, OUR PAINT DATABANK® NUMBER OFFERS ASSISTANCE. BECAUSE HELPING YOU DO YOUR BEST WORK IS SOME OF THE BEST WORK WE DO. CALL 1-800-321-8194, MONDAY THROUGH FRIDAY, 8:30 A.M. TO 5:00 P.M. EST.

THE PROS KNOW. ASK SHERWIN-WILLIAMS.®

©1994 The Sherwin-Williams Company



New York City

Art Commission Confers Excellence-in-Design Awards



The Art Commission of the City of New York has conferred “Excellence in Design” architecture and landscape architecture awards on Scott Mahaffey’s Inwood Hill Urban Ecology Center; Brooklyn Army Terminal renovations by Beyer Blinder Belle and Arthur L. Spaet & Associates; Diffendale & Kubeck’s restoration of Staten Island’s P. S. 20 (left) for senior housing; DCI International’s Morrisania Branch Library rehabilitation; Hardy Holtzman Pfeiffer’s renovated and expanded Dance Theater of Harlem School; Samuel Karneal Thomas’s Brizzi Playground reconstruction; Striver’s Center streetscape reconstruction and site improvements by Johansson and Walcavage, and Daniel Frankfurt; and a special recognition award for sidewalk newsstands by Benjamin Thompson & Associates, Frances Halsband and Patsy Norvell, and James Garretson Architects. ■

Singapore

International Symposium Charges Architects to Embrace Ecology Through Technology



Some 800 architects, engineers, contractors, consultants, and construction-industry officials from around the world celebrated innovative technology in architecture at Quaternario '93, a symposium/awards program sponsored by Italian curtain-wall specialty contractor Permasteelisa Group and French cladding manufacturer Structal Europe. The International Award for Innovative Technology in Architecture (IAITA) went to Nicholas Grimshaw & Partners for Waterloo International Terminal, London (left); Maki and Associates for the Nippon Convention Center, Tokyo; Behnisch & Partners for the German Federal Parliament Building, Bonn; Forbes & Fitzhardinge for the CRA Advanced Technical Development Complex, Victoria, Australia; and Valode et Pistre & Associés for the L'Oréal Factory outside Paris. Tay Kheng Soon, partner in the Singa-

pore firm of Akitek Tenggara II, called for “a new design culture based on ecological responsibility” using the latest technology. He illustrated his talk with drawings from a conceptual project called Tropical City, in which a team of Singapore architects explored ways to link ecology, architecture, and urban planning. Richard Rogers noted that buildings consume nearly 50 percent of all the energy used in the world, twice as much as transportation systems. In the future, he expects the skins of buildings will respond to environmental changes in much the same way as the skins of animals do, making buildings more efficient users of energy. Asked why no North American won an IAITA this year, Rogers, an IAITA juror, said, “Perhaps it is due to the clients and the economics in America, which don’t allow the same kind of innovative approach to technology.” C. A. P.

Photo courtesy of Quaternario Foundation

Jewel-Box Addition, New Circulation Routes—and More to Come—for State's Only Law School

© Bruce T. Martin photo

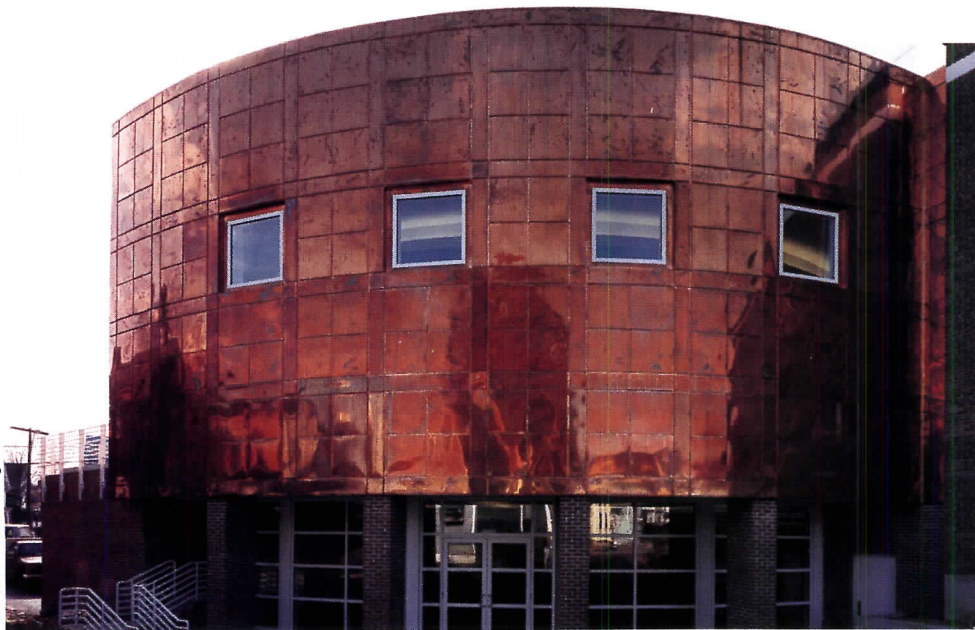

The first phase of Elkus/Manfredi's renovation and expansion of New Hampshire's only law school, the Franklin Law Center, which specializes in the study of intellectual properties, includes a new curved copper-clad 15,000-sq-ft addition containing lecture hall, cafeteria, lounge, three classrooms, two seminar rooms, and a glassed-in atrium entry (not shown; the rear elevation, left, is the view from neighboring residences). "We studied all kinds of ways to preserve the copper color," says David Manfredi, "but became convinced it should weather." The first phase also involves a reconfigured circulation route between the existing building and the new entrance. Work to come will tackle 64,000-sq-ft of renovations in the older building, which had never been intended to serve as an educational facility. ■

Pennsylvania

Arts Center in 1920s Variety Hall

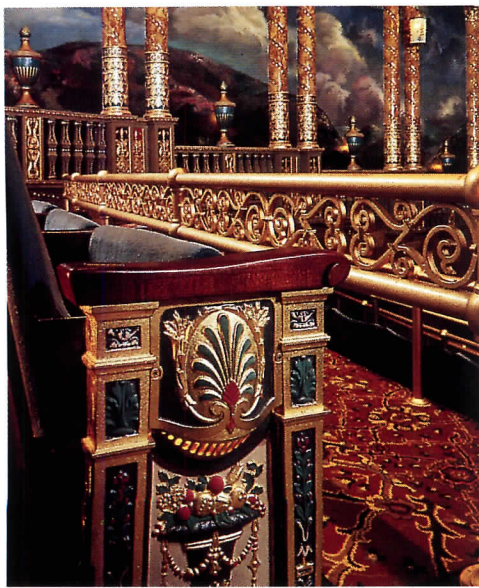

A town-and-gown campaign spearheaded by the Pennsylvania College of Technology has succeeded in turning Williamsport's Capitol Theater into a community-arts center with an \$8.6-million restoration, technical upgrade, and expansion by Hayes Large Architects. ■

California

Down to the Sea in Redwood and Glass

The geophysics and planetary physics staff at the Scripps Institution of Oceanography was so enamored of its 1963 Lloyd Ruocco building that it selected Frederick Liebhardt, then of Liebhardt and Botton and a former apprentice to Ruocco and Frank Lloyd Wright, to design its new laboratory across the road in La Jolla. The multi-level complex, which features exposed redwood post-and-beam framing, flat roofs, full-height sliding windows in all east- and west-facing offices, and glass elevator shafts, opens up previously restricted ocean vistas. Resembling a well-bred vacation resort, it travels a 40-ft change of elevation, using circulation routes composed of open stairs, decks, and patios for convenient access between the pier level of the campus and the original hillside laboratories east of La Jolla Shores Drive. Robert Botton, who formed Robert Botton and Associates after Liebhardt's retirement, handled user-group contacts after the conceptual design, detailed project programming, project management, and detailing. But, he says, "There is no question: this is clearly a Fred Liebhardt building." ■

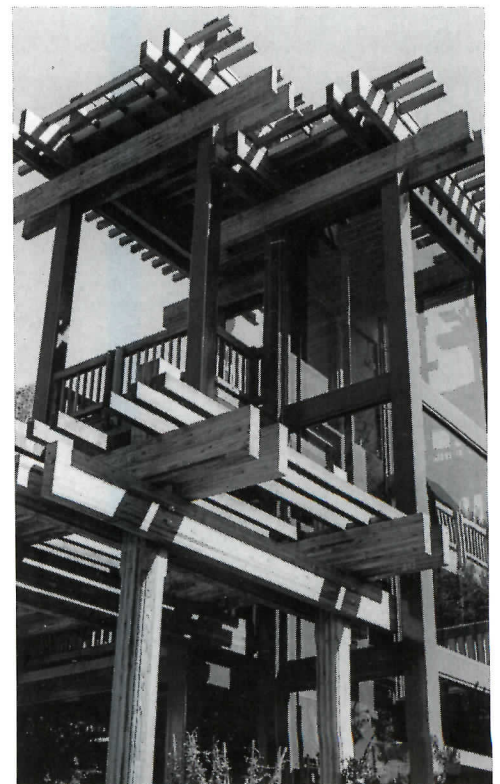

Briefs

Quitting Time

Claiming he “strongly disagrees ethically and morally,” Oswald Mathias Ungers has pulled out of Renzo Piano’s Daimler-Benz project in Berlin’s Potsdamer Platz [RECORD, November 1992, page 23]. Ungers calls his senior housing site on a narrow traffic-heavy route “irresponsible,” and pans an enclosed shopping street he says will close at 7 p.m., shutting off Berlin’s famed street life. He blames investor pressure for breaking with Berlin’s “house-street-block-plaza” layout.

Alternative School

Stanley Tigerman and Eva Maddox’s Archeworks Design Laboratory, an education and retraining facility with an admitted social agenda of improving society through work on projects that resist conventional market solutions, opens in Chicago in September. Archeworks will use R&D teams on projects initiated by community groups, commerce, government, and through competitions, and work toward satisfying NCARB/NCIDQ internship requirements. Semester tuition is \$3,500. Applications, from students and professionals in transition, are due March 2; fax 312/644-3750.

Winners

Society of American Registered Architects Gold Ribbons have been awarded to Bermello, Ajamil for Miami’s Riverside School; Carlson Associates for the Charles Schwab center in Phoenix; and Zivkovic Associates for the St. Mark’s Bookstore interior in New York City.

Memorial

Moore/Andersson is starting a fund to maintain the home of the late Charles W. Moore as a memorial and lodging for young architects working on area projects 512/476-5780.

Remembered

Arthur Holden died in Washington, Conn., Dec. 18, aged 103. Holden, a principal of several architecture firms since he first went into practice in 1920, had focused his long career on two areas of effort—housing, where his social, financial, and technical ideas were well ahead of their time—and housing finance. He had been the subject of a profile in RECORD’s centennial issue [July 1991, page 174], and at the time attributed his longevity to “having something to do that’s interesting.” He had gone to his 81st Princeton reunion in June, and died of no particular ailment but old age. *S. A. K.*

Move Over, Sears Tower

John Back photo

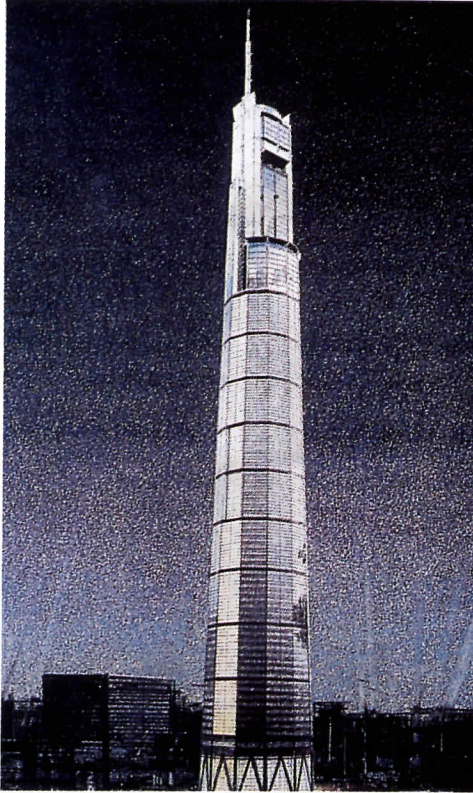

Within the next four years, downtown Chongqing will become home to the tallest building in the world, a 1,500-ft office and hotel tower designed by Haines Lundberg Waehler to exceed the Sears Tower by 46 feet (excluding their antenna masts). Much of the design rhythm is expressed in increments of eight elements, the number being an invitation to prosperity in Chinese numerology: an eight-story public lobby; nine layers of eight-floor office segments punctuated by eight-story atria; a residential hotel with an eight-story lobby and observation deck, and, soaring above all that, 24 floors of single and duplex hotel units. The predominantly glass top section makes a deliberate reference to the temple forms that traditionally crown mountains in Chinese landscape paintings. In one of the best zoning stories heard in some time, the site carried a requirement that construction could not be under 100 stories (which HLW topped by another 14). Chongqing, with a metropolitan population of 12 million, is the capital of Sichuan Province, where the government plans to build the largest hydroelectric project in the world. ■

Massachusetts

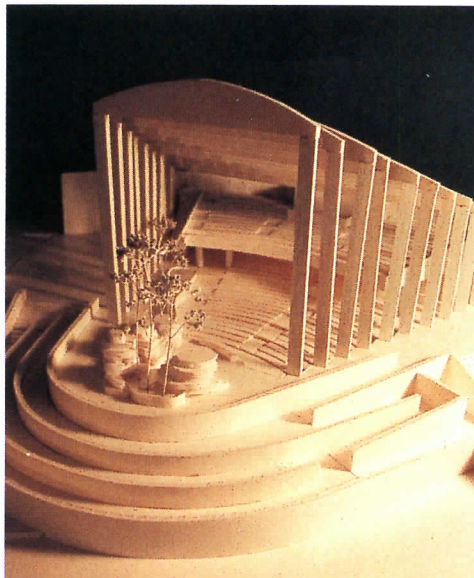
Church Provides Sanctuary for Nature

The Duo Dickinson design for Christ Lutheran Church in Southwick uses the site’s existing slope to launch upward a projecting mass to remarkable views. The worship space, with a 450-seat main area and a 450-seat balcony, will focus on a most untraditional sanctuary: instead of an altar, there’s an interior rock berm and tree cluster representing the Garden of Gethsemane and giving rise to a stream of water that will cascade down a side aisle for the length of the church. An 18-foot cross will hang in the apex of the progressively ascending roof. The entry will form a natural amphitheater for outdoor services, festivals, and performances. Plans include renovation of the existing church and construction of a multimedia “Magic Chapel” for children. Construction, to begin in 1998, is expected to culminate in Easter services in the year 2000. ■

FEED POWER HUNGRY WORKSTATIONS

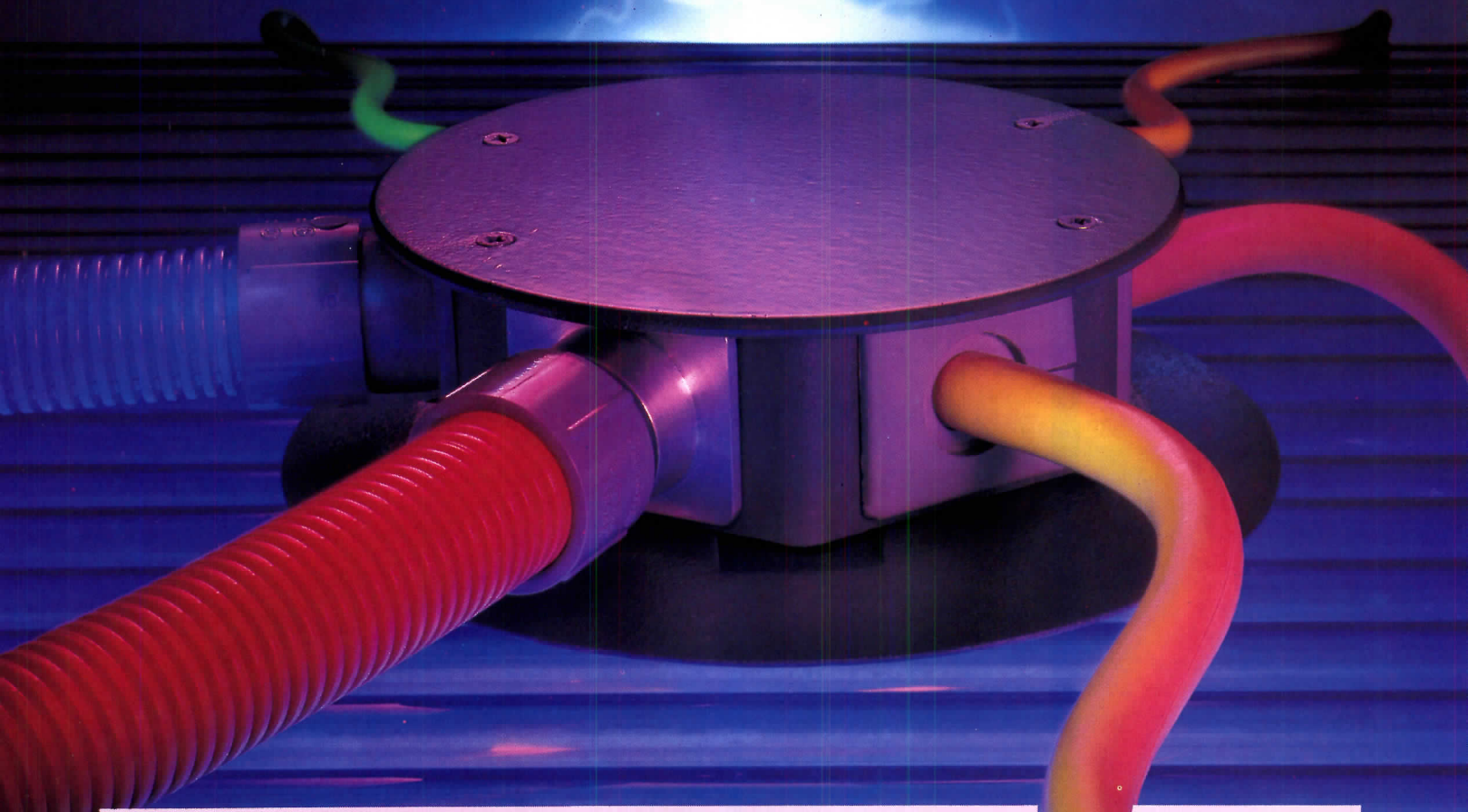

From the innovator in thru-floor electrification there's now a Furniture Feed that transforms the others into discards of history.

One glance at the Raceway RC-900-FF "Station Master" tells you this is something different. The unobtrusive low silhouette disguises the largest capacity of any Furniture/Partition Feed fitting; ten #12 power, five 4 pair communication and five IBM class II data cables. With a total of 0.1014 square inches of copper tested in a single fitting, the Raceway "Station Master" far exceeds the present UL limitations of any of the others.

LOW AND ROUND

The roundish, semi-flush design contains impressive function within its fabulous form. Its omnidirectional hexagon provides as many as six opportunities for a variety of power and low tension. It meets the demand for more and more protected data and communications by being the first to permit more than one

flexible conduit connection. Each facet permits interchangeable "drop-in" power plates or communications grommets. Disciplines are isolated as needed or the entire fitting can be dedicated.

The RC-900-FF "Station Master" is a true departure from the past, both esthetically and functionally. So, give those workstations an energizing "Power Lunch". For further information, contact Raceway Components, Inc. 208 19th Avenue, Paterson, N.J. 07504 (201) 279-1116.



**RACEWAY
COMPONENTS, INC.**

Circle 7 on inquiry card



"NOW THE OUTSIDE
MAY COME INSIDE,
AND THE INSIDE
MAY, AND DOES,
GO OUTSIDE.

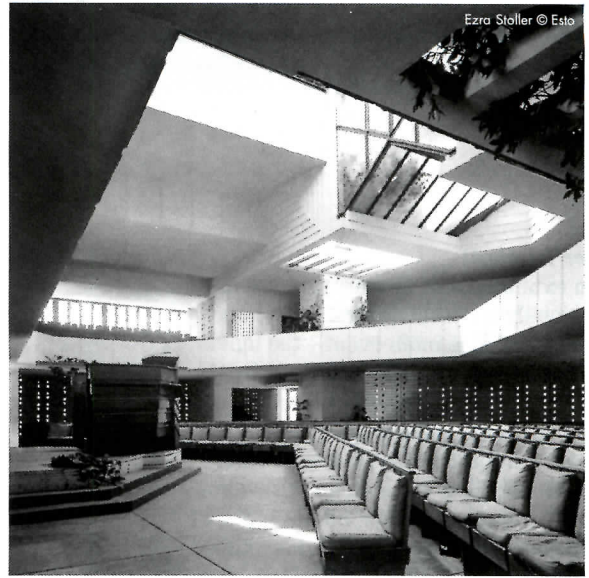

PFEIFFER CHAPEL, FLORIDA SOUTHERN COLLEGE, LAKELAND, FL. 1938-41

THEY ARE OF EACH OTHER."

FRANK LLOYD WRIGHT

IN HONOR OF THE POWER OF ARCHITECTURE
TO ENHANCE OUR LIVES, ANDERSEN WINDOWS
IS PLEASED TO SPONSOR

F R A N K L L O Y D W R I G H T
A R C H I T E C T

T H E M U S E U M O F M O D E R N A R T

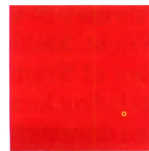

N E W Y O R K
F E B R U A R Y 2 0 - M A Y 1 0

1 9 9 4

A N D E R S E N W I N D O W S

FRANK LLOYD WRIGHT: ARCHITECT WAS ORGANIZED BY THE MUSEUM OF MODERN ART, NEW YORK, IN COOPERATION WITH THE FRANK LLOYD WRIGHT FOUNDATION, SCOTTSDALE, ARIZONA. THE EXHIBITION IS MADE POSSIBLE BY ANDERSEN WINDOWS, INC., AND BY GENEROUS GRANTS FROM THE DAVID H. COGAN FOUNDATION AND THE NATIONAL ENDOWMENT FOR THE HUMANITIES. RED SQUARE IS A TRADEMARK OF THE FRANK LLOYD WRIGHT FOUNDATION. USED WITH THEIR PERMISSION. 4308 COPYRIGHT © ANDERSEN CORPORATION 1994. ALL RIGHTS RESERVED.

Circle 8 on inquiry card

Letters

Continued from page 4

surprised by the comments of Nancy Levinson, who seems to have reacted to, rather than reviewed, the monograph. Apparently antagonized by the word "theory," her points are haphazard. First, she suggests that the book's essays are not written in "clear English prose" and then—quoting me in her very next sentence—she chides me for my "disarming matter-of-factness." Unfortunately, my matter-of-factness did not prevent her from taking the quotation (from the first paragraph of the first essay) out of context and thus misconstruing the very premise of the book: contrary to what is implied in the review, the monograph proposes a distinction between "theory" and "criticism", the latter being a practice that involves practitioners and *evades* what I called "the present theory club." Perhaps her presumption that access to a chapter of theory requires "the linguistic equivalent of a secret handshake" dissuaded her from proceeding further into the book.

Admittedly, the monograph's design, like the work of Scogin, Elam and Bray and the essays on their work, is intended to be challenging, but there is no desire to be obscure

or to exclude. In fact, the opposite is the case. I invite her to read further.

Mark Linder
Philadelphia

Nancy Levinson replies:

My comment about Mr. Linder's matter-of-factness refers not generally to his prose style but specifically to his description of contemporary academic theoreticians as constituting "the present theory club," of which, he continues, "I am a junior member." Regarding his distinction between theory and criticism, I would like to suggest, respectfully, that this kind of concern with nomenclature and classification is usually far more interesting to academics than to practitioners. In any case, I should note that the author's introductory essay, discussing this distinction, did not discourage me from "proceeding further." My review, or "reaction," was based upon reading the entire book.

Calendar

Continued from page 4

Architecture Students offers cash awards to students and interns in its Copper Technology Center Design Competition. Deadline: Spring, 1994. Call 202/626-7472.

- The Architectural League of New York announces its thirteenth annual Young Architects Competition. Participants must be not more than ten years out of architectural school. Deadline for entries is February 14, 1994. The Architectural League of New York, 457 Madison Avenue, New York, NY, 10022. (212) 753-1722.
- The American Hardboard Association is holding its "Home of the Year" competition. Deadline: February 14, 1994. For submission information, call 708/934-8800.
- International ideas competition for the reconstruction of the Souks of Beirut has been launched. First prize is \$75,000 U. S. Deadline: February 15, 1994. Fax 212/444-8165 or call 212/478-3914.
- A November 1994 public housing forum to be held at the University of Cincinnati is now accepting abstracts for papers on this topic.

Power.

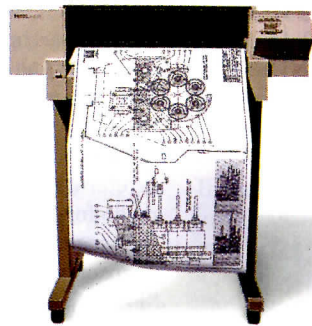

5 minute plots

The new HP DesignJet 200 monochrome inkjet plotter makes fast plotting affordable for everyone.

It's true. For about the price of the average pen plotter, the HP DesignJet 200 gives you crisp, 300-dpi, D-size plots in under five minutes.

Of course, HP's proven inkjet technology means more than just fast plotting. It means no more pen-related problems. No more skipped lines. No more pen clogging. And our smooth, quiet writing

for inclusion. Deadline: February 15, 1994. Contact: School of Architecture, University of Cincinnati, 45221-0016. Call 513/556-6743. Fax 513/556-3288.

- The National Institute for Architectural Education sponsors an essay contest. Five copies of an essay of 800-1,000 words is due Feb. 18. Call NIAE 212/924-7000 or fax 212/366-5836 for topic.

- A year of study and a two-year academic fellowship are to be awarded in a design competition being held by the Ove Arup Partnership. Deadline: Feb. 28. For more information contact "The Peter Rice Prize," 13 Fitzroy Street, London W1P 6BQ. Phone: 071-465-3553. Fax: 071-465-3666.

- Affordable Utah housing competition. \$3,000 first prize; \$2,000 second prize. Submit infill housing design appropriate to established Utah communities. Register by March 4. Deadline: May 13. ■

Observations

Continued from page 17

poetically in the surrounding landscape. These are Wright's most lasting contributions to architecture. They are also the things that Wright's students and followers have sought most assiduously to emulate.

But such things can not be emulated by imitating their outward forms. Friedrich Nietzsche wrote that a pupil repays a teacher poorly if he always remains nothing but a pupil. Wright's egomania required that his pupils remain in perpetual tutelage or suffer ostracism, which is why most of Wright's self-declared followers are little more than embarrassing epigones of the master. In his catalog essay, Cronon notes that for Wright, architecture should strive to imitate the principles of nature without imitating its forms. Wright took this advice when he assimilated the lessons of Sullivan and other influences without copying them.

This is something that few architects have managed. It is one thing to make a building that "looks like" or reminds one of a Frank Lloyd Wright building. It is quite another to design a building that exhibits the spatial ingenuity that Wright perfected. One of

Wright's most distinguished heirs is Paul Rudolph (born in 1918), who coincidentally had exhibitions of his work at the Cooper-Hewitt Museum and the National Institute for Architectural Education in New York this winter. Anyone familiar with Rudolph's work—the Interdenominational Chapel in Tuskegee, Alabama, the Orange County Government Center in California, the Endo Laboratories in Garden City, New York, and the Art and Architecture Building at Yale University—knows that his buildings do not look like Wright's buildings any more than Wright's looked like those of Louis Sullivan.

Yet the critic who called Wright Paul Rudolph's "earliest and most lasting inspiration" was correct. Consider the complex arrangement of spaces in the Concourse, Rudolph's recently completed project in Singapore. With its swirling concrete forms the building is pure Rudolph, but the inspiration is quintessential Wright. If the ambitious retrospective at the Museum of Modern Art helps us to look at Wright with fresh eyes, the example of architects like Rudolph reminds us that his legacy continues to live on in contemporary architectural practice. ■

To the people.

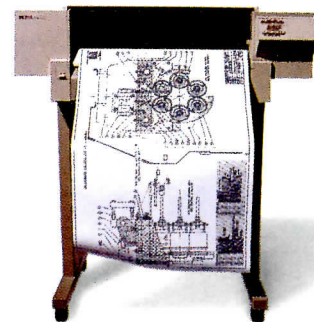

\$3,695*

system makes the HP DesignJet 200 ideal for any office environment. And with the addition of legs, the DesignJet 200 converts from a desktop to a free-standing plotter.

So get the plotter that saves you as much time as it does money. Call 1-800-851-1170, Ext. 7720 for the location of your local HP demo dealer.†

 **HEWLETT®
PACKARD**

©1993 Hewlett-Packard Company *E-size model priced at just \$4,695. Suggested U.S. list prices. Price does not include optional legs and bin. Plot images courtesy of Autodesk, Inc. †In Canada, call 1-800-387-3867, Ext. 7720. PE12316

Circle 9 on inquiry card

THE ATLANTA AIR TO ANNOUNCE A RA



Arched chord joists top the Arrivals Hall, International Concourse, Hartsfield Atlanta International Airport

Indicators

More small projects on the boards

The total dollar value of projects entering F. W. Dodge's reporting system continues to decline, though at a much lower rate than two years ago. Dodge, with architects' cooperation, is increasingly tracking projects at inception as a measure of the construction climate. The *number* of projects, however, rose 33 percent, suggesting that many more owners are commissioning work, even if in a tentative way: alterations outpaced new construction in many types. ■

Projects in Planning, September 1993

	\$Value (in millions)			Number of Projects	
	1992	1993	% CHANGE	NEW	ADDS/ALTS.
NON-RESIDENTIAL					
Commercial	\$102,873	\$79,349	22.8% ▼	7,775	4,430
Schools	57,447	55,368	3.6% ▼	4,861	8,535
Health Facilities	39,685	38,947	1.9% ▼	2,788	3,927
Leisure	36,785	38,275	4.0% ▲	3,496	2,332
Industrial	30,101	30,153	0.2% ▲	2,676	1,361
Transportation	23,057	22,822	1.0% ▼	2,007	993
Public Service Facilities	17,568	18,056	2.3% ▲	2,092	1,849
Religious Facilities	2,880	3,105	7.9% ▲	478	692
Military/Space Facilities	2,510	3,318	32.0% ▲	1,677	1,449
Animal/Fish/Plant Fac.	2,210	2,460	11.2% ▲	367	171
TOTAL NON-RESIDENTIAL	\$315,116	\$291,854	7.5% ▼	28,217	25,739
MULTI-RESIDENTIAL	62,378	49,897	20.0% ▼	4,384	2,537
GRAND TOTAL	377,494	341,751	9.5% ▼	32,601	28,276

Source: F.W. Dodge

Improved outlook for design firms

Two recent surveys suggest generally improved—though mixed—economic conditions for design firms. Compared to the previous year, the AIA's October 1993 poll shows lower confidence in business conditions and a slightly lower percent who feel that the recession has either ended or at least bottomed out. Still, most firms had either maintained staffing levels or added staff. Almost half the firms had increased billings over 1992; the increase for most was above 10 percent. The strongest regions were the West North Central, West South Central, and Mountain states. The Professional Services Management Journal's October/November survey also shows increased revenues, but it covers a broader spectrum of design firms. Though some sectors don't yet represent the strongest markets, they seem to be improving faster than others, said respondents, e. g., commercial work, housing, and light industry. ■

PSMJ Survey

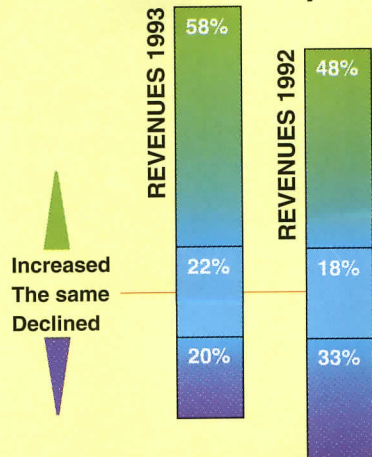

Best Building Types:

Education
Healthcare
Housing
Light Industry
Commercial
Government

AIA Economic Survey

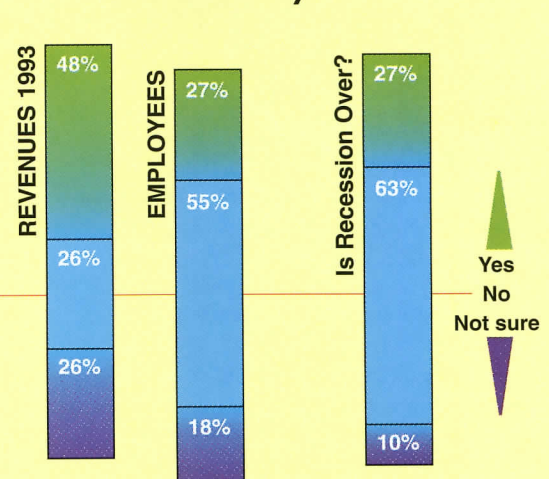

Best Building Types:

Education
Healthcare
Commercial
S.F. Residential
Government
Institutional

The Profession This Month

- **Preservation's Vast New Horizons:** Industrial Heritage Corridors are a new way of looking at preservation and conservation. Architects can be key players. *Page 24*
- **Seismic and Landmarks:** Southern California's January earthquake gave renewed urgency to the search for earthquake-resisting improvements for older buildings. Preservationists hoped base isolation would prove less invasive. Does it live up to its billing? *Page 28*

- **Made For Multiple Platforms:** Intergraph's Microstation 5 is not only a powerful 2D/3D CAD package; it's ready for the multi-platform future. Software review, *Page 32*
- **Roof Accessories:** Our product report focuses on advanced roof scuttles and a versatile new roof window/door. *Page 34*

Preservation's Vast New Horizons

© Timothy Hursley photos

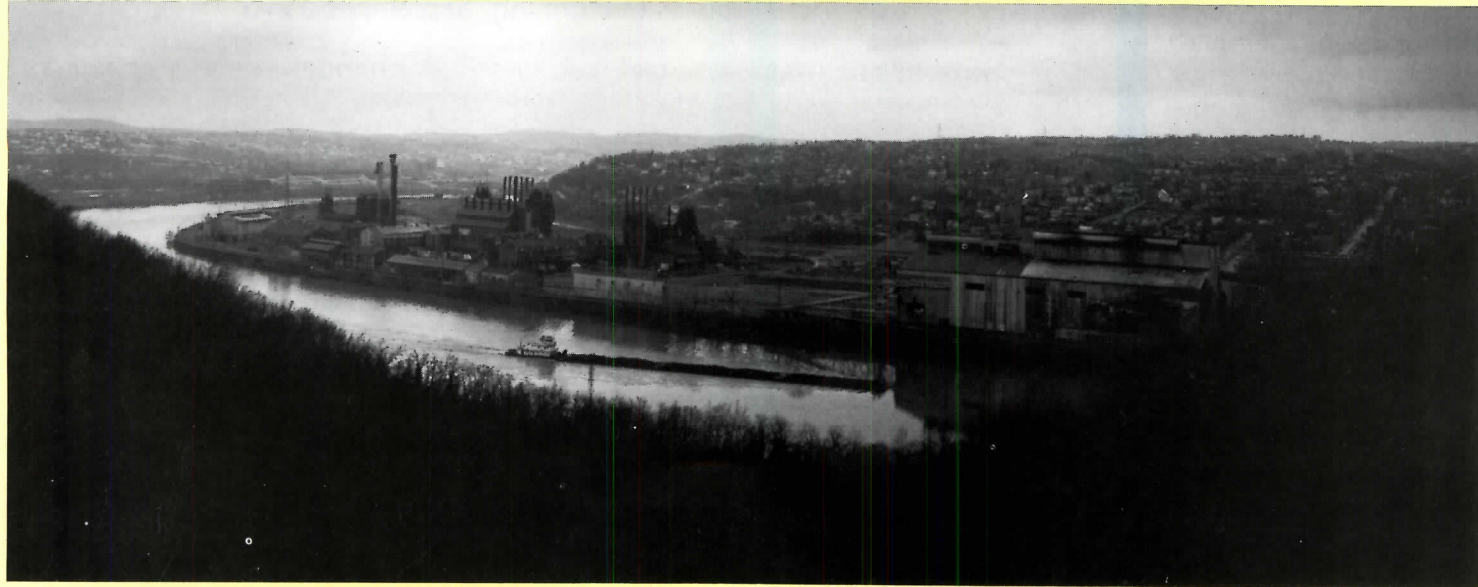

Typical of the Mon valley, the hulking Duquesne Works divides river and town.

By Nora Richter Greer and
James S. Russell

Along the rivers of southwestern Pennsylvania—the Allegheny, Youghiogheny, Monongahela, and Ohio—America's vast, once-mighty steelmaking complex pulsed. Now it has shrunk or moved to other places, taking economic vitality with it, and leaving behind hulking remains marooned on vast stretches of vacant, bulldozed lands. These massive ruins seem almost geologic: more in scale with the river and the hills than the neighborhoods of the valley towns whose views they block.

Now a broad coalition sees in these haunting remains the seeds of the steel towns' renewal, as well as an important heritage that merits preservation. Considering the enormity of southwestern Pennsylvania's steel-making, coal-extracting, and transportation complex, preservation here is, oddly, a race against time. The relentless wrecking ball has patiently eaten away at mills and foundries so vast they were once described in terms of football fields, even miles.

This is no ordinary preservation task. "Adaptive reuse" seems a feeble term when

Nora Richter Greer is a freelance writer based in Washington, D. C.

applied to these haunting and desolate, often mangled steel structures, let alone of the vast landscapes of which they are a part. Pennsylvania, however, has been the most successful state in marshaling federal and local resources to interpret these areas as industrial-heritage corridors, which seek to protect cultural, natural, and recreational resources of national significance that extend over a wide area.

A regional approach to preservation

The heritage corridor concept exemplifies a significant, if not fully realized, shift toward regional conservation and planning, one that looks beyond individual artifacts or districts to an entire area's special sense of place. Architects have a role in assessing the historical value of artifacts, and designing interpretive sites and structures. And architects can do much more by entering the unfolding debate about what large-scale heritage areas can and cannot accomplish.

A good place to start is southwestern Pennsylvania, which has both a federally designated and a state-chartered heritage corridor. As the accompanying photographs show, it has artifacts of uncommon emotive power, but ones that don't easily lend themselves to conventional "park" or "museum" models. Heritage corridors are not new. The

first was established by Congress in 1984 for the Illinois & Michigan Canal, which stretches some 150 miles southeast from Chicago. Currently there are only three other designated national heritage corridors: the Blackstone River Valley (Massachusetts and Rhode Island, which documents early industrial development), the Delaware & Lehigh Canal (eastern Pennsylvania) and the American Industrial Heritage Area (which covers nine counties east of Pittsburgh and focuses on a variety of industrial topics). "There must be 20 or 30 others in various stages of development," says Mary Means, a planner who is a board member of the National Coalition for Heritage Areas. "There's rampant interest at the grassroots level."

Overdoing "partnership"?

Legislation must be passed in the U. S. Congress to establish each corridor under the auspices of the National Park Service. Three states also have heritage-park systems. NPS provides funding to both state and federal entities for start-up and feasibility studies.

The federal government may also fund specific projects in a heritage area, most often in the form of a grant matching state, local, and private moneys. Legal protection for sites comes through local zoning and planning initiatives and designation of historic

Industrial Heritage Corridors combine untraditional artifacts and enormous natural and created landscapes. Architects' vision can help this new conception of preservation realize its great promise.

Steel-industry conservation efforts began in the early 1980s. The NPS's Historic American Engineering Record (HAER) produced hundreds of measured drawings and determined, with the help of industrial archaeologists, what remnants of steel mills were most in need of preservation. The vast old industrial structures had been seen as a brake to redevelopment, and were targeted for wide-scale demolition. The Corporation's efforts encompass a multi-county area (concept plan right) but focus on the overlooked boroughs of the Monongahela valley, particularly Homestead, Duquesne, Braddock, and McKeesport. It has secured land in Homestead for the Steel Heritage Center museum on the site of a famous July 1892 strike that was a critical event in union history. It will become the starting point for a self-guided tour of the region. The Corporation is also saving parts of the Carrie blast furnaces and parts of the Homestead mill.

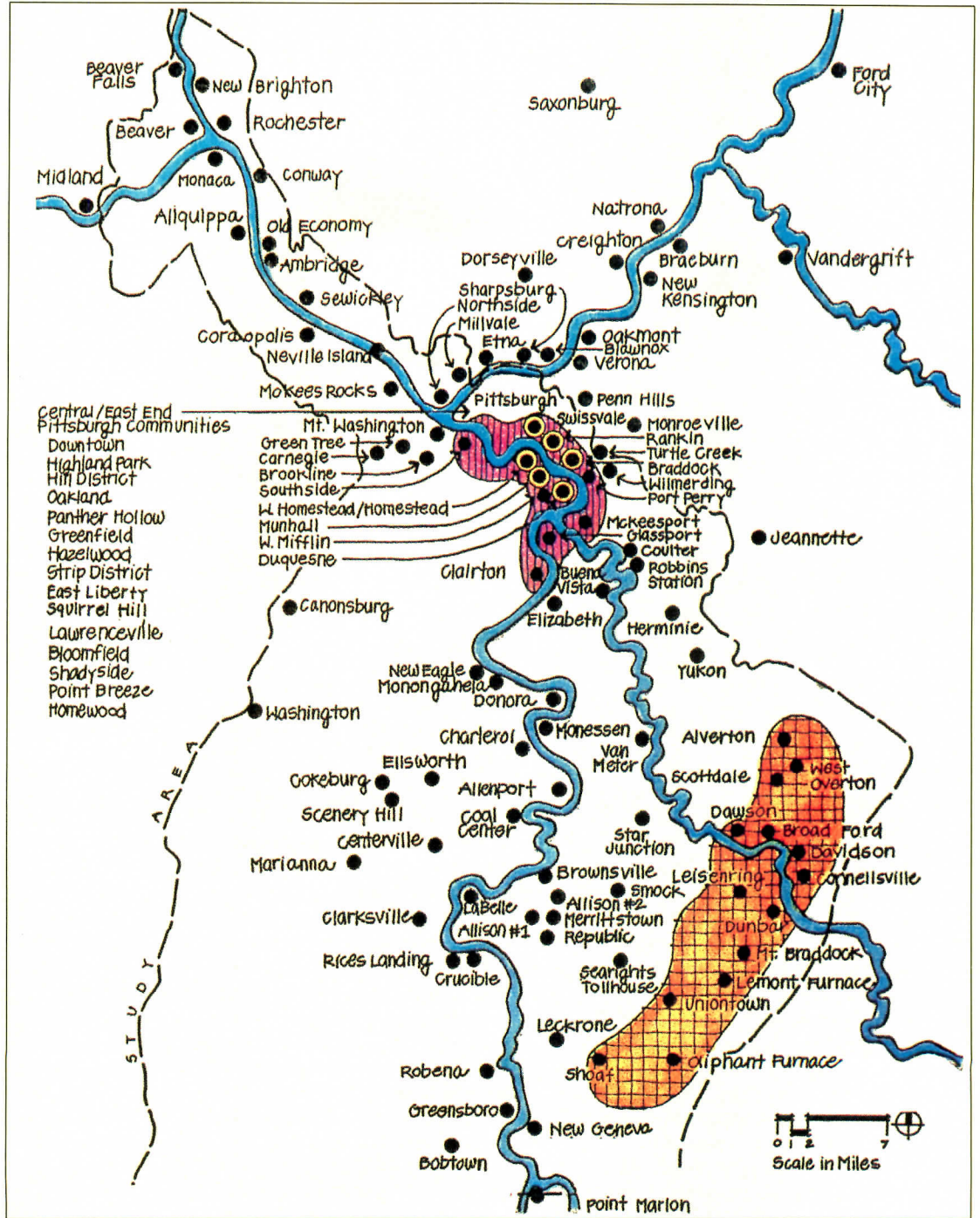

A typical Duquesne street.

Undeniably powerful, the size, scale, and expense of preserving industrial artifacts offer unique challenges of conservation and interpretation. Below and opposite: blast furnaces at the Duquesne Works.

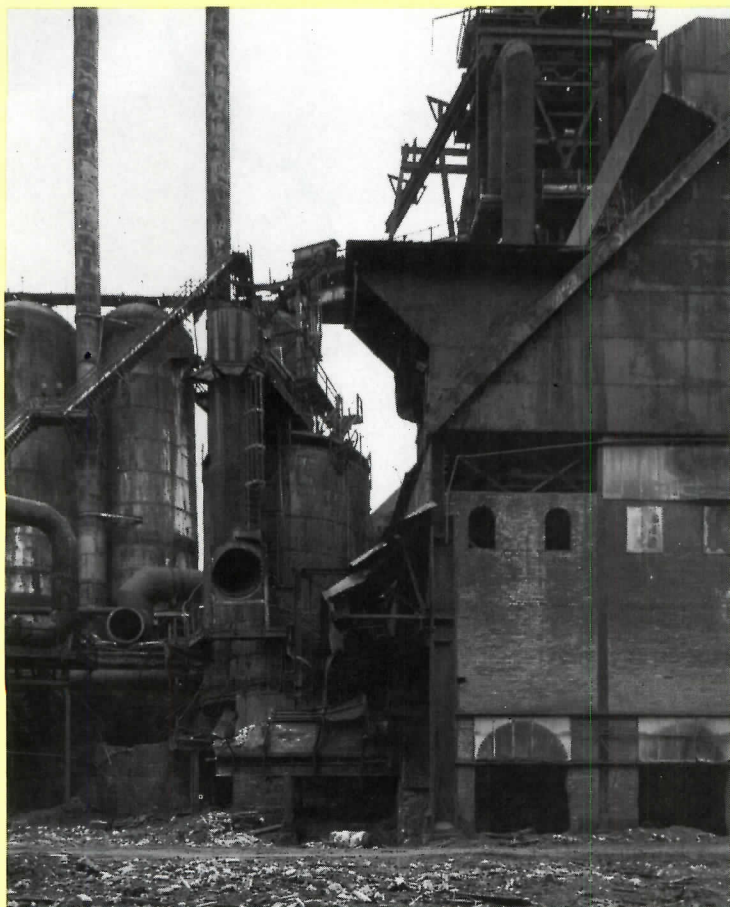

landmarks and districts. The euphemism for these management juggernauts is “partnership parks,” according to Eric DeLony, of NPS’s Historic American Engineering Record. Can a structure this complex work? “The designation of the corridors that exist has been officially opposed by the Park Service,” says Means, “because the only standard used is that under which land is added to the [pristine] ‘crown jewels’ park system. Under these criteria, all the heritage corridors fail.” Congressional clout has figured prominently in those areas designated to date. The National Coalition for Heritage Areas is seeking federal legislation to create appropriate designation criteria.

The Mon Valley’s steel heritage

Federally designated or not, the steelmaking towns near Pittsburgh and along the Monongahela river are aggressively pursuing both the historic-preservation, natural resource-conservation, and economic-development

tracks envisioned in the heritage corridor idea. In 1990, 14 federal, state, and local conservation and economic-development organizations agreed to jointly develop a working strategy. The Steel Industry Heritage Corporation, based in Homestead, leads the effort, working with communities and government agencies. UDA, a Pittsburgh-based urban-design firm, has begun a Management Action Plan that will suggest interpretive themes, rank key artifacts for conservation, and, says UDA’s Don Carter, “figure out how to link them figurally and literally over this vast area.”

Jump-starting economic development

August Carlino, executive director of the Steel Industry Heritage Corporation, sees an integration of economic development and conservation, explaining that “many of these communities have lost their economic base. What we’re doing is working with community organizations to implement projects

and programs such as Main Street [preservation] programs and historic tax credits for restored buildings.” According to Means, “No one is under the illusion you’ll create the job base that the steel industry provided. Tourism is not an end game, but a very important transitional phase.” UDA’s Carter looks to Lowell, Mass., which has been successfully transformed into an industrial heritage park and working town center: “Because the heritage park and historic preservation acted as a catalyst, developers could take that leap of faith and put offices and apartments in the old mills.”

Pittsburgh is a closer model. It has successfully recast itself as a center of high-tech medicine, research, and metallurgy. With the support of the quasi-governmental Mon Valley Initiative, the first phase of a new technology center has risen on the former J&L Pittsburgh works. It’s a lab designed by Bohlin Cywinski Jackson. *Out in the Mon*

302. Hatchwork

A hatch is not a smoke vent, this 88-year-old firm points out to architects. Whereas a fire vent opens automatically at elevated temperatures, releasing superheated gasses to prevent flashover and clearing smoke for firefighters, the powerful springs, cables, and shock absorbers that help it work can make it hazardous as a personnel hatch. A scuttle or hatch is designed to give building personnel routine access to rooftop equipment without compromising security, energy-efficiency, or moisture resistance.

Recent advances in roof-hatch design have focused on improved weathertightness, and on creating a standard access-hatch line for special uses. These include high-security prison scuttles (photo (a) and section, lower right) constructed with heavy, 3/16-in.-thick steel plate. They can have a bullet-resistant view window, gunports, and detention-level locks. Hatches for metal roofs can be ordered with base-flange configurations that match specific roof-panel profiles (c). Installations in single-ply membrane roofs are made easier by what the company calls the Bilclip, an "easy-flashing" design that secures the roof membrane under the capflashing (shown (b) and detail below). Custom-use hatches remain a specialty. In addition to site-specific sizes, finishes, and materials (a copper hatch for a copper roof, say), hatches can meet unique functional requirements, such as a 42-in.-high louvered unit that houses laser canons for nightly light shows at Disney World's Epcot (d). Covers can hold heating cables that prevent snow buildup at ski resorts. And banks install radio-controlled scuttles that open on command to receive cash drops by helicopter. The Bilco Company, New Haven, Conn.

A further note on smoke vents: recently completed research by the Center for Fire Research (NIST), using computer simulations of fire conditions, has found that proper smoke venting enhances the performance of sprinkler systems by releasing smoke and gases and improving visibility. The NFPA 204M standard (smoke and heat venting) will incorporate this data, plus supporting full-scale fire tests that validate the computer model, as completed, in its next revision cycle.—J. F. B.

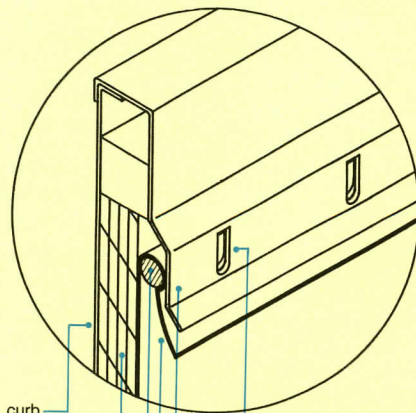
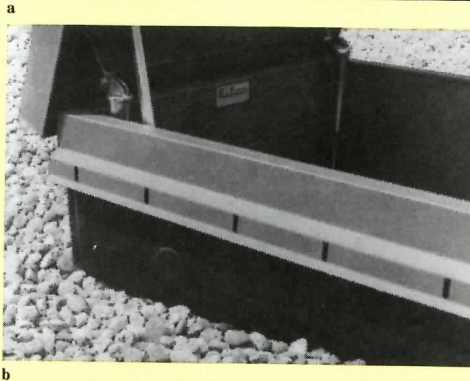
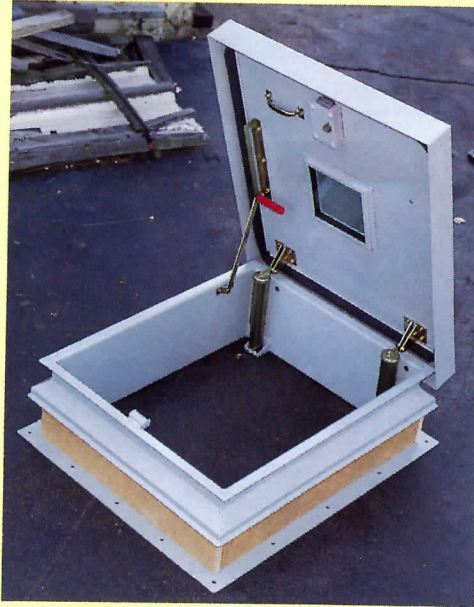

curb
fiberboard insulation
pack-in rope
MEMBRANE-ROOF FLASHING
press-in fasteners
capflashing
single-ply roof membrane

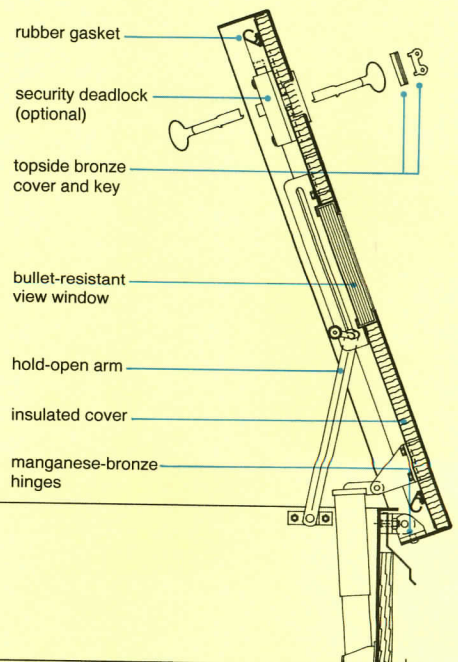
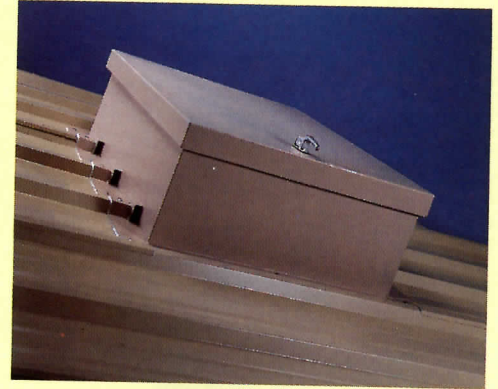



303. Finnish seating

A new source for furniture and accessories from Finland, located in the Pacific Design Center, showcases pieces like Kaarle Holmberg's Paletti chairs, sofas, and stools. Awarded a first prize by Finland's Interior Architects, the stackable, aluminum-framed side chair provides lumbar support for comfortable long-term seating. Design Finland, Inc., Los Angeles.



304. Concrete stains

Architectural-concrete paving can be chemically etched in any of eight mottled colors. The professionally applied solution of metallic salts reacts with old or new cement to form permanent, insoluble precipitates on the surface. For interior and exterior floors, stains can also be used on other cementitious and masonry surfaces such as porous tile. Bomanite Corp., Madera, Calif.

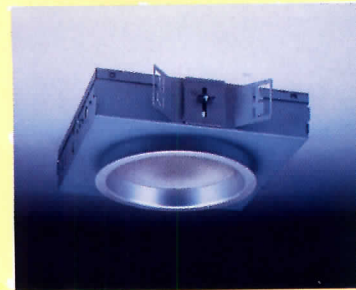

305. Lensed CFL downlight

Lenslux is said to be the first lensed compact-fluorescent downlight for the U. S. market, combining the wide light distribution and reduced contrast of a prismatic or milk-white diffuser with the energy savings of CFL sources. Features include regressed trim in six colors; wattages from 18 to 52; and housings as shallow as 3 1/16-in. Edison Price Lighting, New York City.

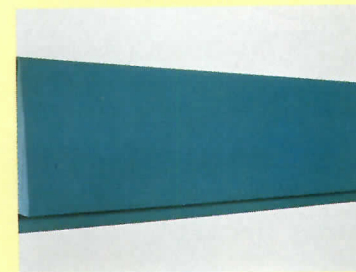

306. Wedge-profile base

A totally redesigned flooring accessory, TightLock pre-hung wall base has a recessed notch that hides the trimmed edges of carpeting. Available in rubber or vinyl, its wedge shape has the look of a toeless base and conceals gaps between drywall and subfloor. Base comes with a spacer that holds it off the floor for quick, professional-looking installation. Johnsonite, Chagrin Falls, Ohio.



307. Tight-radius wallboard

At only 1/4-in. thick, High-Flex gypsum board is flexible enough to accommodate the tight curves of stairways, arches, and columns without needing to be wetted or scored. Suitable for both inside or outside radii, the board has a tapered edge for quicker and neater joint finishing. Initial availability restricted to the West Coast. National Gypsum Co., Charlotte, N. C.



308. Modular coffer system

Hardwood ceilings can be furnished at only 20 percent of the installed cost of custom millwork, say the makers of a new system of snap-together prefinished components. The ceiling hangs on a standard suspended grid; options include laser-cut grilles (shown), custom sizes and woods, and a Class A rating. Free video demonstrates layouts. Wood Ceilings, Maryland Heights, Mo.



309. For porch or patio

Made of solid hardwood suitable for contract use indoors or out, the SunSled lounge can be ordered in a range of UV-shielding oil finishes or white enamel. A proprietary inking technology permits custom-print designs on the weather-resistant Sunbrella fabric upholstery of the cushions. Coordinating footrest, sofa, and dining furniture. Sloan & Associates, Lincoln, Neb.



310. Asymmetrical pedestals

Axel Enthoven basins come in two heights: standard 31 1/2-in., and a 35-in. height suited to taller users. Left- and right-hand basins can be set next to each other to create a matched suite, as shown, or placed on opposite walls. White only; countertop lav, bidet, and toilet offered in this design. Absolute, a Division of American Standard, Piscataway, N. J.

Short takes

• **Spare that tree.** Pella Corporation is sponsoring a nationwide series of day-long workshops intended to help architects and builders take advantage of existing tree stands on their project sites. Write for information to Building with Trees, 102 Main St., Pella, Iowa 50219.

• **Steel-frame initiative.** Aiming to capture a bigger share of the residential construction market at the expense of wood studs and framing members (whose prices have been squeezed upward by supply pressures), the American Iron and Steel

Institute showcased two steel-frame homes at January's National Association of Home Builders convention. A 5,191-sq-ft home was built for sale; a 1,350-sq-ft demonstration project was constructed in the Convention Center's parking lot.

• **Roofing-business swap.** Schuller International, maker of Manville roofing materials, has bought Owens-Corning's commercial and industrial roofing business. At the same time, the Denver-based firm is selling its residential-shingle product line to Owens-Corning.

• **Firestop empire.** A new marketing alliance unites 3M Corporation, a manufacturer of intumescent and endothermic through-penetration firestop materials, with Dow Corning. Under the contract terms, as of February 1 3M will market and sell Dow Corning's silicone-based firestopping sealants and foams exclusively in the U. S., creating a single vendor for a broad range of product for specific fire-safety code and performance requirements.



ACCENT
ON
ARCHITECTURE

THE AIA
GOLD MEDAL

THE AIA GOLD MEDAL
HONORING A LIFETIME
OF CREATIVITY AND EXCEL-
LENCE IN ARCHITECTURE

THE AIA
TWENTY-FIVE
YEAR AWARD

THE TWENTY-FIVE YEAR
AWARD HONORING
ARCHITECTURE THAT HAS
WITHSTOOD THE TEST OF TIME

THE AIA HONOR
AWARDS FOR
ARCHITECTURE

HONOR AWARDS FOR ARCHI-
TECTURE RECOGNIZING
EXCELLENCE IN INDIVIDUAL
BUILDING PROJECTS BY
AMERICAN ARCHITECTS

THE AIA HONOR
AWARDS FOR
URBAN DESIGN

HONOR AWARDS FOR URBAN
DESIGN HONORING PROJECTS
AND PROGRAMS THAT
CONTRIBUTE TO THE QUALITY
OF URBAN ENVIRONMENTS

A CELEBRATION
OF DESIGN EXCELLENCE

THE AMERICAN
INSTITUTE OF ARCHITECTS
THE AMERICAN
ARCHITECTURAL FOUNDATION

This awards section was developed as a public service to the building industry. Sponsors are listed on the next page. The awards section was distributed at the Accent on Architecture celebration held 1 February 1994 in Washington, D.C.

NORMAN FOSTER

AIA 1994 GOLD MEDAL

Sir Norman Foster, Hon. FAIA, RIBA, winner of the 1994 AIA Gold Medal, has made a career of exposing the humane and open-hearted side of Modernism. "High technology is not an end in itself," he has written, "but rather a means to social goals and wider possibilities. Handcrafted care is the factor that makes a building loved by its users and by those who look at it." It is his belief that "at any point in time things that have endured have been on the cutting edge." Or, in the words of AIA president L. William Chapin II, FAIA, "his work transcends the inherent coldness of modern materials to show that high-tech design can be sympathetic and hospitable to people."

Typically, Sir Norman's work has pushed services and vertical support to the outer extremities, where they boldly express structure and anchor the large, free-flowing interiors that stem from his fascination with the aircraft industry (he is a pilot) and space technology. At the same time, his use of glass, as in the mullion-free curved facade of his Willis Faber & Dumas Building, Ipswich (2) (Britain's only post-World War II building to achieve "listed" status), has the effect of virtually eliminating any visual boundary between inside and outside.

Educated at Manchester University and Yale, Sir Norman has won 15 international design competitions, 114 awards and citations, Britain's 1983 Royal Gold Medal for Architecture, and the 1991 Gold Medal of the French Academy of Architecture. He was knighted in 1991.

1. Factory for Reliance Controls, Swindon
2. Willis Faber & Dumas Building, Ipswich.
3. Sainsbury Center for the Visual Arts, Norwich
4. Renault Distribution Center, Swindon
5. Hong Kong and Shanghai Banking Corporation Headquarters, Hong Kong
6. Stansted Airport Terminal, Stanstad, Essex
7. Sackler Galleries, The Royal Academy, London
8. Century Tower Building, Tokyo
9. Barcelona Telecommunication Tower
10. Hong Kong Airport
11. Commerzbank Headquarters, Frankfurt
12. Reichstag (New Parliament Building), Berlin.
13. American Air Museum in Britain, Imperial War Museum, Duxford.

60s—70s

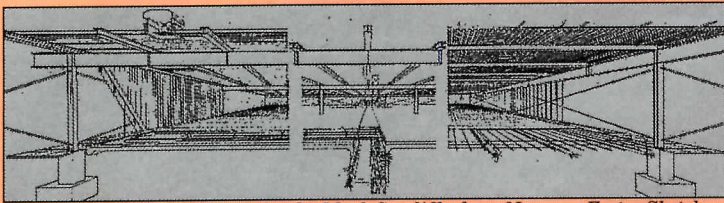

1 © Drawing by Mark Sutcliffe, from Norman Foster Sketches, Birkhauser Verlag, 1992 1



2 © Ken Kirkwood

70s—80s

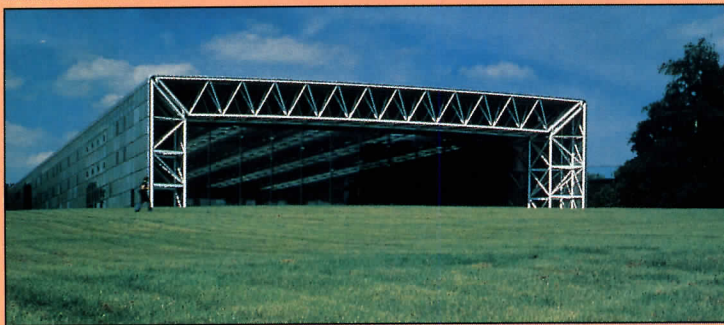

3 © Ken Kirkwood 4



© Richard Davies



5 © Ian Lambot

90s



6 © Ken Kirkwood



7 © Dennis Gilbert



8 © Ian Lambot



9 © Ben Johnson

FUTURE



10 © Richard Davies



11 © Richard Davies



12 © Richard Davies



13 © Richard Davies

Haystack Mountain School of Crafts

Edward Larrabee Barnes's 1962 Haystack Mountain School of Crafts is a villagelike collection of simple geometric forms tucked into the vegetation that tumbles down the side of Deer Isle, Maine, to the Jericho Bay. Rising on piers, the summer school's workshops, dormitories, and communal buildings appear to hover above, rather than conquer, the landscape.

Designed at a time when many architects were moving toward elaborate sculptural forms, the unheated, uninsulated structures, which cost \$5 a square foot to build, resemble modest farm outbuildings. "I've always been drawn to making things as simple as possible," Barnes told *Architecture* magazine in 1989, "if you can do that without making them inhuman or dull or oppressive."

After 32 years, Haystack's shingles have weathered to gray and collected a coating of lichen, making the architecture appear more at one with the site than ever. The school offers graphics, weaving, metal, wood, and clay studios and a "hot shop" for metal and glass blowing. From time to time, teachers may orient a course to investigate their craft's architectural ramifications.

"For architects who have studied the complex, it has provided an early and profound example of the fruitful and liberating fusion of vernacular building traditions with the rationality and discipline of Modern architecture," says Donlyn Lyndon, chairman of the AIA Honor Award jury that selected Haystack for the 1994 Twenty-Five Year Award.

Boston Globe architecture critic Robert Campbell, who nominated Haystack for the award, recalls that the sharp rise-and-fall profile of the monopitch-shed buildings "was instantly accepted as a classic and became a major influence on the architecture of the 1960s, including such more-celebrated works as Sea Ranch."

Barnes, who studied under Gropius and Breuer at Harvard, has had his own office in New York since 1949.

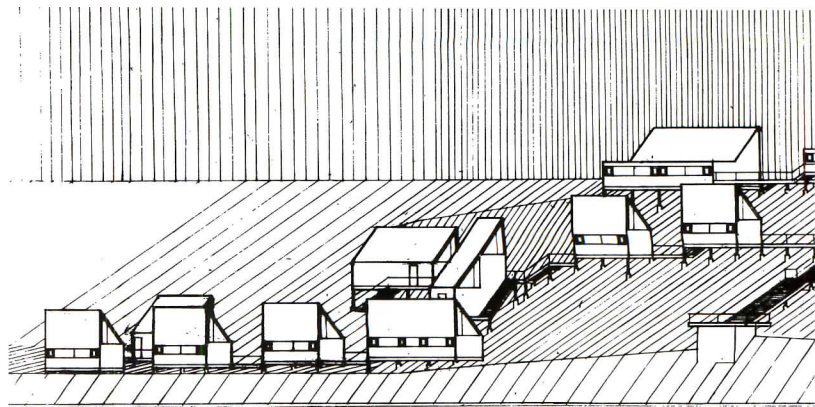
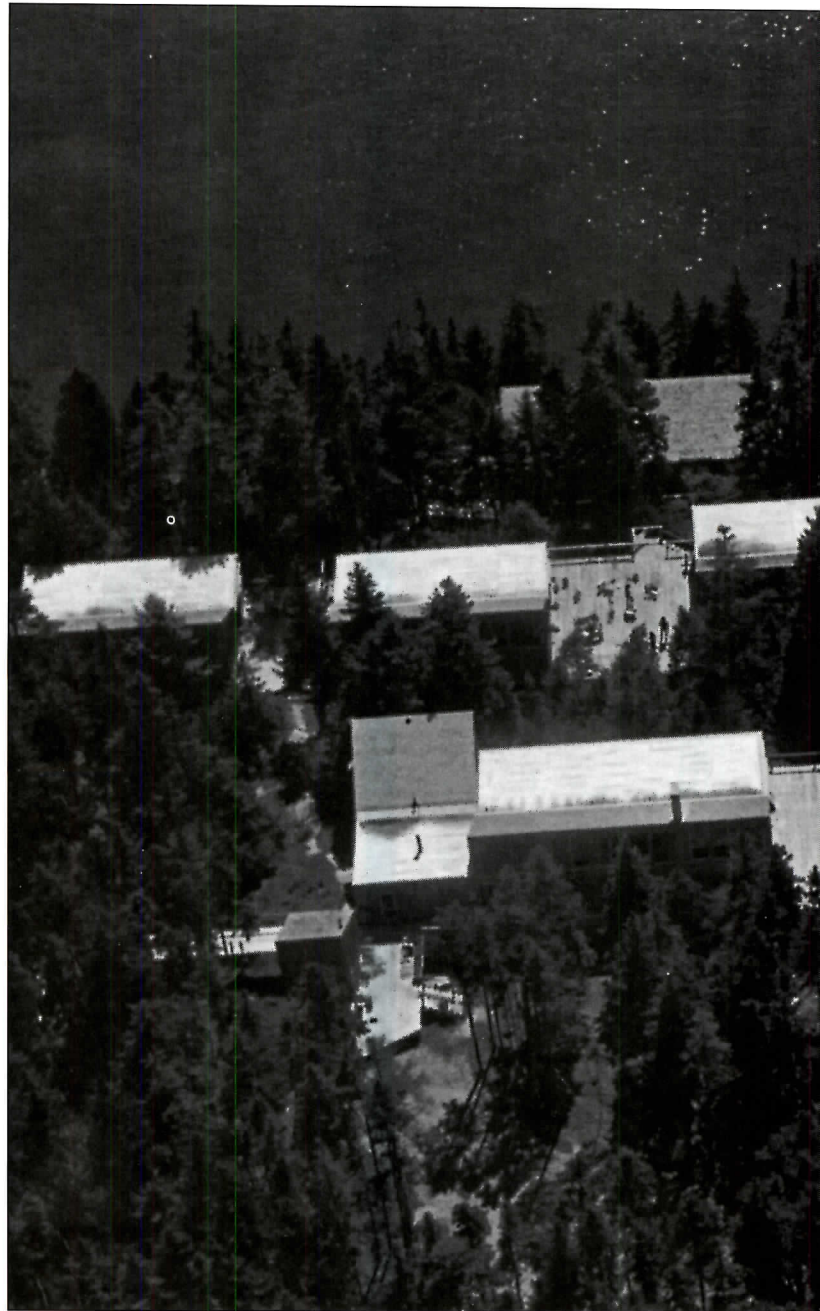

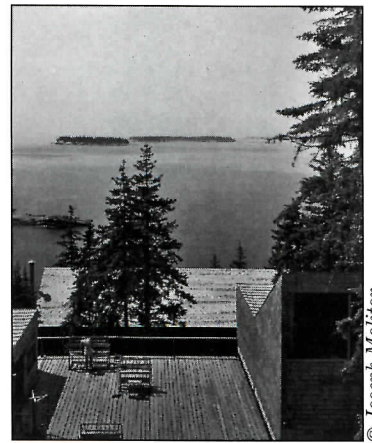

© Joseph Molitor

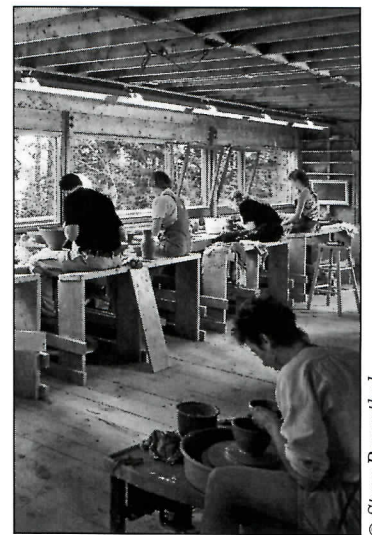

© Steve Rosenthal

All decks and walkways lead to Haystack Mountain's central organizing feature, a long, wide staircase that plunges 90 feet to the water (left). Decks offer views over the tops of adjacent buildings (top). Ribbon windows and the proximity of the landscape lend a tree-house air to workshops (above).

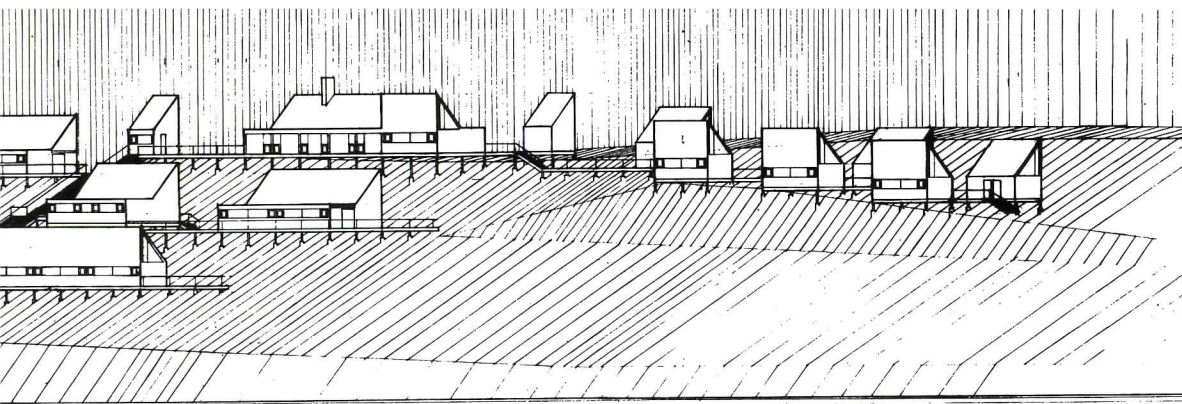

**“A LIVELY CIVIC SPACE THAT, ALTHOUGH PRIVATELY DEVELOPED,
IS SUPREMELY PUBLIC IN SPIRIT.”**

ROWES WHARF

Boston

Architect

Skidmore, Owings & Merrill

Owner

The Beacon Companies and
The Equitable Life Assurance
Society of the U. S.

The jury declared that Rowes Wharf “sets a standard for waterside development, demonstrating the power of architecture to capture the public imagination and restore life to neglected parts of the urban landscape. On the city side, the curving wall of the building frames a great domed space whose enormous arch serves as a spectacular gateway to the water, while on the harbor side, wharf-like buildings reach out like welcoming arms for those entering the city from Boston Harbor. The combination of harborside forms, high-quality materials, and working water plaza makes this complex, mixed-use project a genuine and integral setting for city life. By carrying the urbane vocabulary of downtown Boston right to the water, Rowes Wharf has helped create a lively civic space that, although privately developed, is supremely public in spirit.”

To link the project to its surroundings, “we employed various contextual strategies,” explained SOM. A visual corridor is maintained through the site connecting the project to the city’s historic center, and the peninsulas extend a welcome to those approaching the city by boat.”

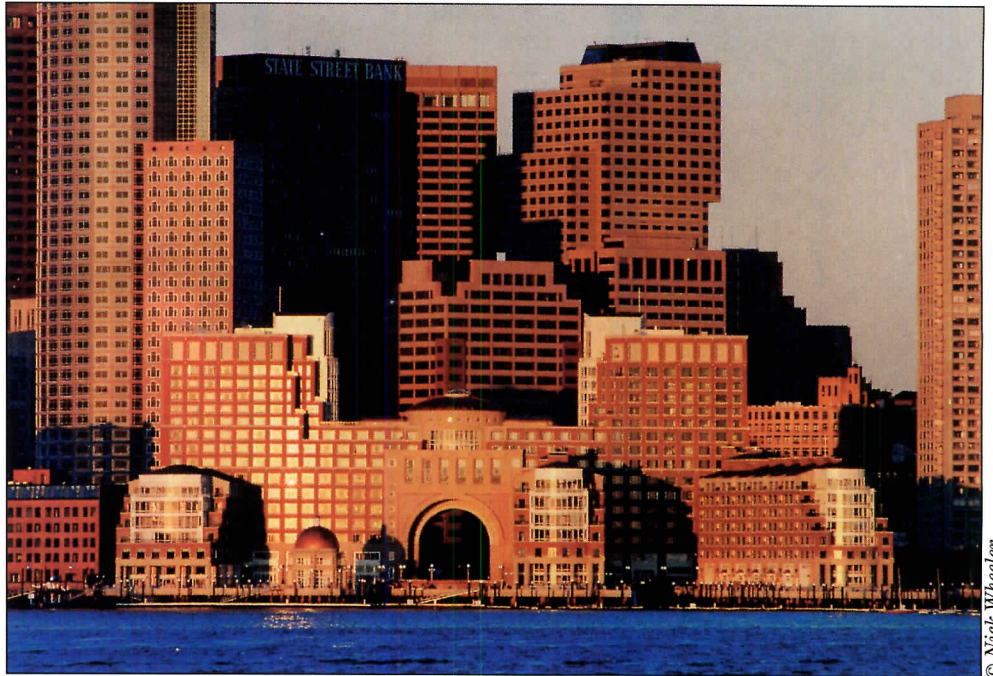

© Nick Wheeler



© Nick Wheeler



© Steve Rosenthal

"A HANDSOMELY DETAILED HIGH SCHOOL PROVIDING A FOCUS FOR COMMUNITY ACTIVITY AND PRIDE."

TROY HIGH SCHOOL

Troy, Mich.
Architect
 Perkins & Will
Owner
 Troy Public Schools

Commented the jury, "From the signature stair tower at the main entrance to the library's rotunda, to the subtle use of three colors of brick, Troy High School is handsomely detailed and well planned. The public and communal areas like the library, hallways, and pool are flooded with daylight through the skillful use of skylights and clerestories, while generous windows in the classrooms bring in views of the courtyards and woods. Though it's quite large, its insistent horizontality allows it to be simultaneously monumental yet unimpos-

© Nick Merrick/Hedrich-Blessing photos



ing in its suburban site—a robust civic presence. Its elegant, villagelike plan is created by extending classroom wings rearward toward a grove of trees that helps isolate the school from its neighbors, while another wing, culminating in the theater, faces the town as a gesture of connection to the community. Through superb siting, strong



forms, and a functional yet engaging floor plan, the architects have created not only an admirable school, but a focus for community activity, identity, and pride."

"UNPRETENTIOUS STUDENT HOUSING MAKING THE MOST OF A LIMITED BUDGET AND DIFFICULT SITE."

THE COOPER UNION RESIDENCE HALL

New York City
Architect
 Prentice & Chan, Ohlhausen
Owner
 The Cooper Union

Familiar without being old fashioned, this skillfully executed student housing complex draws its forms from the school's cluttered New York neighborhood. "The architects bring order to a high-rise tower that carefully marks its place without overwhelming its neighbors," complimented the jury. "Immaculate, well-ordered interior spaces offer comfortable apartments as well as communal areas for socializing and working. The architects' generous use of windows provides ample natural light and gives residents interesting views of the city, constantly connecting them and this residence to the larger urban context."

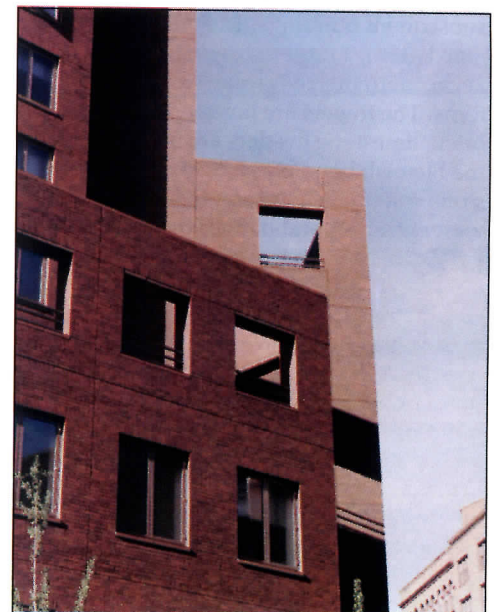

© Brian Rose photos

of modern technologies and...
 Every aspect of the design of Camden Yards, from the smallest graphic touches to the largest structural elements, is lively and good natured."



"A PRECISELY CONTROLLED MUSEUM/MEMORIAL THAT EVOKES THE RAW EMOTIONS OF UNSPEAKABLE HUMAN TRAGEDY."

UNITED STATES HOLOCAUST MEMORIAL MUSEUM

Washington, D. C.

Architect

Pei Cobb Freed & Partners

James Ingo Freed, Design Partner

Associate Architect

Notter Finegold & Alexander

Owner

United States Holocaust Memorial Museum

Precisely controlled and often deliberately unsettling, the U. S. Holocaust Memorial Museum "masterfully employs the power of architecture to evoke the raw emotion of unspeakable human tragedy," said the jury. "The brick walls and archways and industrial steel detailing recall the efficiency and precision of the machinery of

death. Hauntingly beautiful and sculptural, yet often laden with anguish, sorrow, and remembrance, the building constantly engages all of the senses. The architecture itself reinforces the profound messages of the exhibits, careful not to upstage them while quietly telling its own story. Just a few blocks from America's most significant monuments to freedom and set amid the structures of bureaucracy, this memorial stands as an unflinching witness to the horrors that can be unleashed in the absence of democratic ideals and as a reminder of the necessity of vigilance."

Commented Freed, "This building is not simply a museum, but a living institution dedicated to research, teaching, and the performing arts as well as to contemplation and commemoration. The partial Neoclassical facade is a screen that aims not for synthesis but for spatial and emotional dis-

engagement from the city. The container has been made to merge with its contents so that the building itself engages in a visceral dialogue with the Holocaust exhibitions it contains.

"Internal organization around a three-story, skylit arrival, distribution, and circulation space prepares visitors for the museum experience ahead. There are no literal references to particular places or occurrences from the historic event. Instead, architectural form is abstract and open-ended so that the museum becomes a resonator of memory, providing a stage for introspection rather than a series of specific architectural metaphors. It is a place of remembrance where the past is made a living part of the present in order to protect the future."

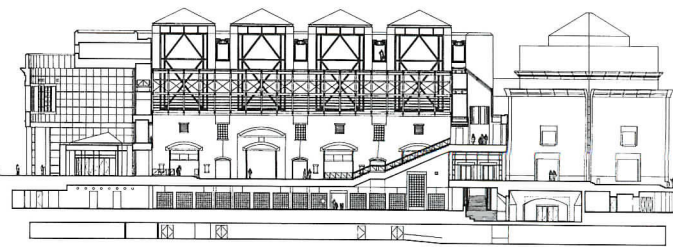
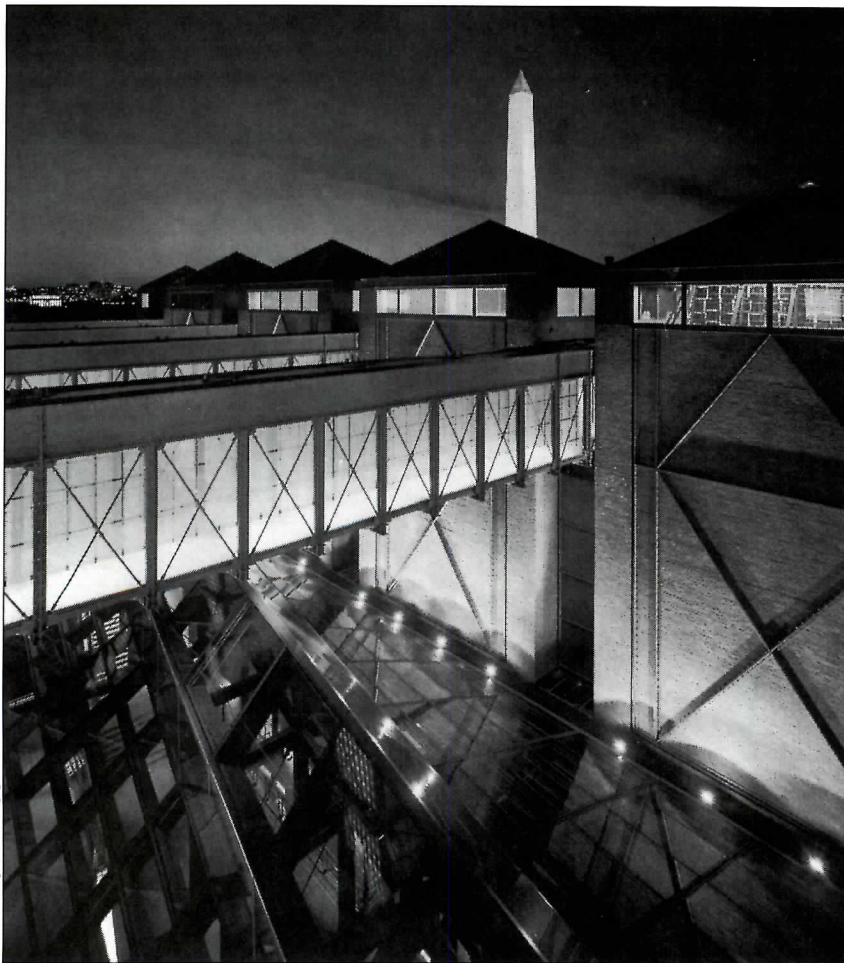

“THE PLAN RETAINS THE INTEGRITY AND SCALE OF THE EXISTING ENVIRONMENT WHILE ADDING SUCCESSFUL NEW USES.”

THE CHARLESTOWN NAVY YARD

Boston

Urban Designer

Boston Redevelopment Authority
(for the Charlestown Navy Yard
Master Plan)

Owner

Boston Redevelopment Authority

A successful reuse of a historic naval shipyard and a notable answer to the problem of reusing military installations—a challenge that many more communities are facing or will face in the future,” declared the jury. “The Boston Redevelopment Authority took on the long-term management of the shipyard so that it could be redeveloped with a coordinated plan, a plan

that preserves historic buildings and maintains the geometry of streets and piers. At the same time, it created housing for a wide range of income levels. The naval yard is still a work in progress, but it is already a substantial accomplishment.”

“This 135-acre maritime industrial site is sandwiched between downtown Boston and the residential neighborhood of Charlestown. A strong existing street grid is obscured by years of haphazard construction and seemingly random building additions. Several large empty spaces provide new development opportunities, along with 20 acres of vacant and underused land at Yard’s End. One section remains a national park where the U. S. S. Constitution is berthed,” said the authority.

Among the urban-design goals and

objectives of the authority were:

- Maximize public access from Charlestown to the west and along piers.
- Design a comprehensive open-space system to connect public attractions and take advantage of views and sunlight.
- Develop a street network that can accommodate the demands of tourists, workers, and residents.
- Create a mix of residential, commercial, cultural, and recreational uses.
- Preserve significant structures.
- Stimulate long-term investment.
- Ensure a participatory planning process.



“THE NEW PLAN INTEGRATES MODERN, LARGE-FLOOR OFFICE BUILDINGS INTO A SCENOGRAPHIC URBAN PRECINCT THAT WILL BE A MAJOR IMPROVEMENT OVER THE NONDESCRIPT COMMERCIAL DISTRICT.”

PATERNOSTER SQUARE REDEVELOPMENT MASTER PLAN

London
Architect
 Hammond Beeby and Babka Inc.
Owner
 Paternoster Associates
Associated Master Planners and Building Architects
 John Simpson & Partners
 Terry Farrell & Company
Building Design Architects
 Erith and Terry
 Sidell Gibson Partnership
 Allan Greenberg Associates
 Demetri Porphyrios Associates.
 RHWL
 Winchester Design Ltd.

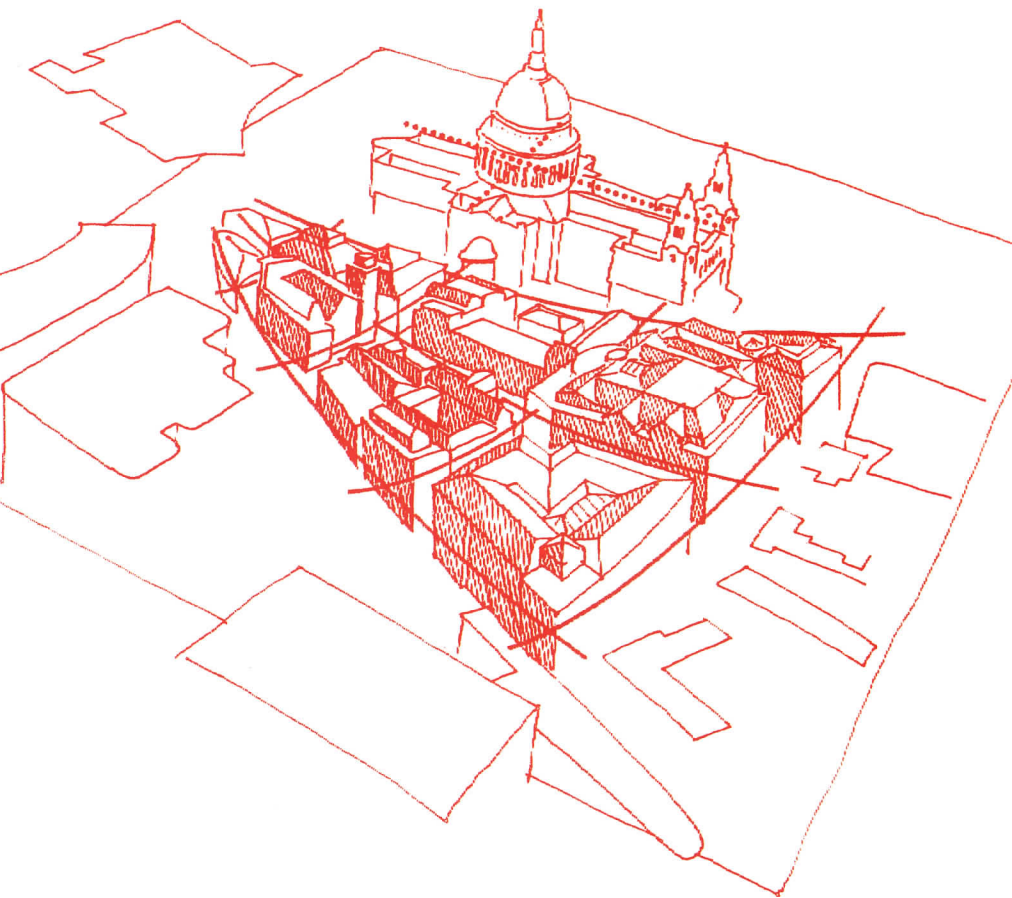
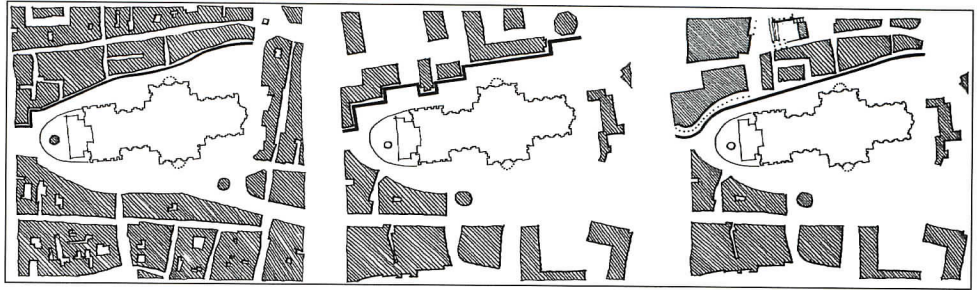

The jury commented, “The new plan for Paternoster Square integrates modern, large-floor office buildings into a scenographic urban precinct that will be a major improvement over the nondescript commercial district built after World War II. The new plan responds to the presence of St. Paul’s Cathedral and creates a pleasing variety of streets and public spaces. The buildings have been planned to revive some traditional architectural ideas at a new scale in ways that will create a sense of identity for the whole district.”

Stated the architects, “The Paternoster Square Redevelopment Master Plan addresses a seven-acre district of London in the shadow of St. Paul’s Cathedral. The plan reinstates a traditional pattern of streets and a pedestrian scale and density of building characteristic of Paternoster Square for centuries before wartime devastation in 1940. A rigid planning grid imposed on Paternoster Square during reconstruction in the 1960s is replaced by a more harmonious network of streets and lanes and a variety of buildings appropriate to London’s historic center. Also reinstated is a fitting context for Wren’s cathedral, which had lost its scenographic and hierarchical importance with postwar development. The primacy of the cathedral is reestablished with all the amenities of the development arranged to enhance the sacred precinct. “

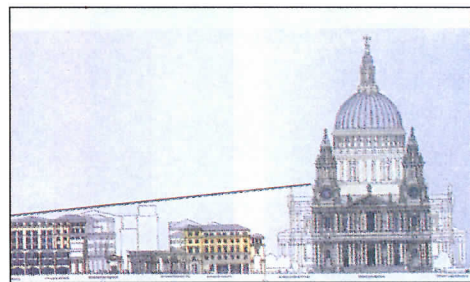

Drawings by Paternoster Associates

erection; it had to function first as a social system. Therefore, the planning process stressed security, maintenance, and events programming. A means to provide ongoing public and private funding was secured by organizing a private corporation to manage the park and imposing a special business tax—11 cents a year on each square foot of business space.”



"THIS URBAN OASIS TRANSFORMS AN UNFRIENDLY SPACE INTO AN INVITING PLACE ATTRACTING CONTINUOUS ACTIVITY AND PEOPLE."

POST OFFICE SQUARE PARK AND GARAGE

Boston

Urban Design Team

Ellenzweig Associates Inc. Architects



SPONSORS

ACCENT ON ARCHITECTURE

Each year, The American Institute of Architects and The American Architectural Foundation sponsor Accent on Architecture, a public celebration of design excellence created to increase understanding of the role architecture plays in shaping the quality of life. Through an awards gala, education programs, exhibitions, lectures, television programs, and other national and local efforts, Accent on Architecture focuses public attention on design excellence and on critical design issues.

ACCENT ON ARCHITECTURE 1994 IS SUPPORTED BY GENEROUS CONTRIBUTIONS FROM THE FOLLOWING CORPORATIONS, ORGANIZATIONS, AND INDIVIDUALS:

PRINCIPAL BENEFACTOR

The Construction Information Group of McGraw-Hill, Inc.
Architectural Record
Construction News Publishing Network
F. W. Dodge
Engineering News-Record
Sweet's Group

BENEFACTORS

CNA Insurance Companies
Victor O. Schinnerer & Company, Inc.
Herman Miller Inc.

PRINCIPAL CORPORATE PATRONS

Southam Construction Information Network
Architects' First Source
Construction Market Data
R. S. Means
MBNA America Bank, N.A.

CORPORATE PATRONS

CNA Insurance Companies
Kirke-Van Orsdel Inc.
State Mutual Companies

PATRONS

AIA Press
American Consulting Engineers Council
Associated General Contractors of America
Brede Exposition Services
HKS Architects

DONORS

Amana Refrigeration, Inc.
American Society of Interior Designers
American Standard Inc.
Architecture Magazine
Armstrong World Industries, Inc.
Autodesk, Inc.
Bethlehem Steel Corporation
W. R. Bonsal Company
Carlisle SynTec Systems
Carrier Corporation
Collins & Aikman Floor Coverings
Concrete Steel Reinforcing Institute
Coopers & Lybrand
Dover Elevator Company
DPIC Companies, Inc.
Electro-Voice, Inc.
W. R. Grace & Company
Harman Consumer Group
Institute of Business Designers
Mannington Commercial
National Concrete Masonry Association
North American Insulation Manufacturers Association
Otis Elevator Company
Owens Corning
Pella Corporation
Portland Cement Association
Schuller International Inc.
Steelcase Inc.
The Trane Company
Trocal Roofing Systems
Unistrut Corporation
Wilsonart

Building Types Study 713/Adaptive Reuse

Three issues affect successful conversion of existing buildings to new uses:

- Compatibility of the building with a new program.
- The economic feasibility of making a conversion versus new construction.
- The commitment of an owner even when total replacement might cost less.

The first issue is crucial to any reuse project. A new auditorium will probably not fit easily into a building designed for apartments. Nor will a massive corporation's headquarters fit into most houses. Whether the other two issues can be resolved depends on the reasons for launching the project. If profit is the motive, conversion costs are as crucial as fit. If a building's existing construction type or structural system requires total alteration to support a new use, there may not be enough original building left to save. If preservation is the motive, the issue becomes more complex. The promise of success is best when suitability, feasibility, and preservation converge in one project.

On the following pages are examples of successes of all kinds. An aviary becomes offices with surprising ease. The conversion of a hotel into assisted housing shows the cost benefits of a compatible program. A burned-out university classroom building offers an opportunity to redesign the inside to fit the requirements of offices. A garage becomes a photo studio with minimum change and cost. A former tobacco warehouse now houses a shopping complex. And a once-derelict office building becomes a cheerful clinic for children. *C. K. H.*

*Manufacturers' Sources
listed on page 137*

More Than Preservation

Preservation's back on track," says *Preservation News* executive editor Arnold Berke, referring to the Pennsylvania Supreme Court's recent reversal of its 1991 ruling that Philadelphia's landmark designation of the Boyd Theater constituted a taking of property [RECORD, January 1992, page 33]. But these days preservation of landmarks is just the tip of the iceberg. Though not *every* distinguished building in the U. S. will survive indefinitely, it is becoming increasingly likely that most will. That no longer seems the pressing issue. The real issue is the effective recycling of built resources—a vast stock of underutilized buildings that, distinguished or plain, is increasingly seen as having more potential than new development sites.

The evidence is in the healthy statistics (see F. W. Dodge's projections, opposite page). But even these figures may undercount renovation's real value by some 25 percent, says Dodge's Robert Murray, vice president, economic affairs. Not included are countless projects that cost less than \$1 million, ranging from commercial fix-ups to major single-family renovations. He does not, however, back the AIA's prediction there will be more rebuilding than building by the year 2000. "The market for new construction will be too strong by then," he says. Nonetheless, the projected growth for rebuilding is impressive.

Why renovation is popular

• The psychological ingredient.

Building rehabilitation has entered the national vocabulary as a user-friendly word, "rehab." Surrounded by accelerating change, both in technology and society, people find comfort in familiar touchstones. Advances in national and local preservation policy during the past three decades, despite setbacks, testify to the public's desire to slow change, and preserve the past. The growing activism of community-based organizations (recently including minority ones) that resist wholesale neighborhood change and sometimes—to developers' and planners' dismay—any change at all, is another indicator.

• The conservation ingredient.

Environmentalists like recycling buildings. Just as reusing paper and bottles makes new use of finite resources, buildings also contain "embodied energy" [RECORD, January 1993, page 72]—the energy expended in their construction now "stored" within them.

• The economic ingredient.

Developers and other building owners are finding that saving a building through reuse is far more likely to get the approval of neighborhood groups and conservationists than new construction. Reuse can also make economic sense—as much as a 16 percent savings in construction costs for a gut rehab and an 18 percent savings in construction time over tearing a building down and building a new one of similar size, says Donovan Rypkema, a principal of The Real

Estate Services Group in Washington, D. C. Some architects have found even larger savings (see *Perfect Union*, page 94). Federal tax incentives offered first by the Tax Reform Act of 1976 and later by the Economic Recovery Tax Act of 1981 also sweetened the pot for developers. While the Tax Reform Act of 1986 reduced these benefits, they are still available [RECORD, January 1992, page 29].

Facing new facts

Why would an owner want to tear down a building and rebuild one of similar size? In this overbuilt decade, especially in office and multi-family construction, owners often want reduced financial exposure even while they seek improved income or quality of use instead of simply more floor space. Does rehab meet these ends as effectively as new construction? It depends on the match of existing building to new program. If the shoe fits and reconditioning doesn't cost too much, it's probably wearable. Theodore Prudon, a principal of Swanke Hayden Connell Architects, points out that real problems may be found in the structure (including seismic safety), fire and life safety, and accessibility. If these issues can be resolved economically, other popular arguments against rehab are easily overcome:

- Most older buildings' systems *are* obsolete. "In any major project, they are usually replaced," points out Prudon. They are a minor investment relative to the value of solid construction.
- Despite assertions that floor layouts of older buildings are inefficient, "studies show that there is little, if any, difference in net-to-gross ratios between new buildings and those over 50 years old," reports Rypkema. While floor areas may be limited in size and unsuitable for the offices of large corporations, the average office tenant leases only 10,000 square feet.
- Rents in older buildings may indeed be lower, but not much, says Rypkema. "Retail rents will range from 95 to 100 percent of those for competitive new space," he observes.

From fix-up to virtual reconstruction

Those who apply for federal-tax relief in return for conforming to National Park Service guidelines for restoration report much greater savings over new construction than those for gut rehab—up to 50 percent. But they are talking about much less intrusive changes and using far more of the original fabric. Indeed, municipalities set limits on how much of a building's value can be replaced before owners must fully comply with codes for new construction—often 50 percent. This limit, of course, is the point at which—unless the building is a landmark requiring careful concealment of new exiting, mechanical, and structural features—a gut rehab will usually occur. Then, it will usually be more economical to reuse structure and exterior walls and replace the interior with new construction. "Officials are then looking for full compliance," reminds Prudon. "No longer will they accept mitigation."

As the preservation of landmarks moves into the mainstream, the focus is shifting to conserving the vast stock of under-utilized buildings of every stripe. Finding new uses and converting such buildings is often a complex process.

To qualify for federal-tax preservation incentives, owners originally had to preserve 75 percent of original exterior walls. The only change to Park Service guidelines since they were written is the removal of this requirement when applied to "certified historic structures," reports department chief of technical services, Ward Jandl. Indeed, the rule has been difficult to interpret because of the large number of buildings, such as party-wall lofts, that do not fit the freestanding model the guideline's drafters had in mind.

Will the original, far more generous tax incentives ever be restored? Jandl remains hopeful, and points to bills introduced almost every year to accomplish that purpose. Berke is more pragmatic: "Preservationists are realizing that, in a tight fiscal climate, the original tax credits won't be restored," he says. "Those applying for credits will have to take what they can get." Prudon sees a silver lining in this: "Before the reduced incentives in the 1986 Tax Act, developers were going around like maniacs converting buildings to all sorts of marginal uses, which meant, at the end of the day, those buildings were not saved. How many upscale cutesy boutiques do we need?" he asks, referring to the retail-complex conversions of factories and warehouses that were once the rage. The current overbuilt market will demand much sounder feasibility analysis in the future. Concludes Prudon: "Buildings can only be saved by the same spirit that built them," which, in the case of commercial buildings, means "desire for profit."

Reuse's special problems

Conventional wisdom holds that reuse makes the most sense when the new use is closest to the original one. Berke says this isn't always true: "Sometimes the most successful reuses are the most radical." He points to the ongoing conversion of such buildings as factories and schools to housing, buildings that were never intended for domesticity, but that were built with such flexible structures as to produce unusual, characterful apartments. He is more dubious of conversions that seem inappropriate in symbolism (a church into a nightclub) or in character (a theater into offices by inserting many floors), but observes that, when a building has no other users, such conversions can be better than destruction.

Prudon is more strict in his standards, despite his firm's seemingly startling project in London (see *Stretching the Limits*, right). To him, appropriateness is a paramount issue. "How far do you go in intervening in the original structure before you have removed the parts that made it interesting in the first place?" he asks. "The criterion should be that the new use is not the *end* use"—that the building is not so altered that it cannot go on to another useful life in the future. Prudon commends the European practice in which new uses evolve over centuries. *Charles K. Hoyt*

Rehab's projected growth

1993: \$23.1 billion
1994: \$24.9 billion
1995: \$26.9 billion
1996: \$28.3 billion
1997: \$30.1 billion
1998: \$31.1 billion

F. W. Dodge

© Richard Bryant

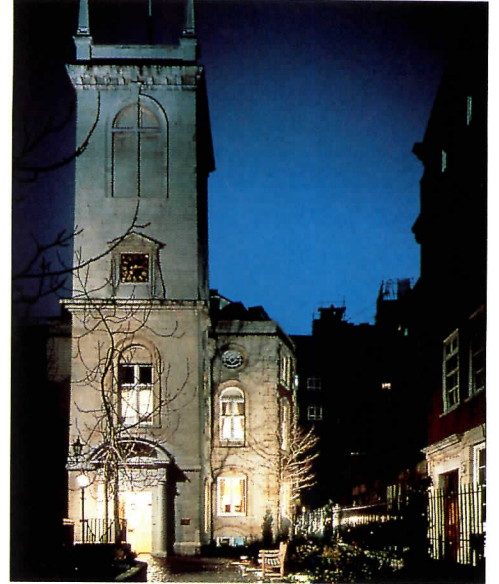

Stretching the limits. *Swanke Hayden Connell Architects' conversion of Christopher Wren's Grade I listed St. Olave's Church into London offices for U. S. lawyers Sullivan & Cromwell may seem radical. But the building had been divided into floors in the 1880s. Conversion paid for extensive exterior restoration.*

Catherine Bogert



Keeping it basic. *A garage becomes photo studios with only the sparest of changes (see story, page 108).*

Re-feathering the Nest

This building might have been built for any use," says project architect Helen Cohen of Davis, Brody & Associates, pointing out that the Old Bird House, at the since renamed Bronx Zoo, contained long-span, full-height spaces. Such flexible interiors characterize many utilitarian turn-of-the-century Beaux-Arts buildings designed by architects who focused their formal-compositional efforts on exterior elevations. These buildings were also usually built to last. Indeed, so sturdy was the masonry and steel-truss construction of the Old Bird House, as it is still called, the steel-beam and metal-pan floor needed for additional office space was inserted between the original floor and roof with the addition of only minor added reinforcement to basement piers under the new steel columns. At the perimeter, the architects supported the new beams directly on the exterior masonry-bearing walls.

When building functions change as much as they did here, deciding which architectural elements to retain can become complex. The new program called for 24,000 square feet for zoo offices to house public affairs, accounting, personnel, and other administrative functions. The existing building provided less than half the required area, so the lofty spaces where viewers once walked around towering central exhibition cages had to go to accommodate a new second floor. Davis, Brody found more space outside the masonry walls, constructing low office wings where outdoor cages were once located. They retained the Bird House's original appearance by adding an aviary-exhibition cage (foreground of photo opposite, below) parallel to one exterior wall, with a domed structure at one end. The dome replaces a similar original cage and shares an attribute of all new animal enclosures in the park: greater visibility of exhibits through "zoo-mesh," an almost invisible stainless-steel netting stretched on thin frames.

Davis, Brody retained many original elements of the interiors, including the exposed steel trusses. These, after sandblasting and painting, afford the new upper floor a sense of the original space—both in construction and open character. Office partitions are topped with glass privacy walls so that the trusses' full spans can be appreciated. Drywall was applied over the original exposed brick walls to cover mechanical and electrical lines and improve insulation; it stops short of window edges to reveal the original finish. The second-floor windows were originally clerestories at the top of the tall exhibition spaces and initially seemed too short to provide a view. However, this low position provides fine eye-level views to those seated at desks. Details such as the specially designed metal-halide light fixtures add to the building's Neoclassical character without aping it. So, too, does custom-made interior trim, including stair railings, made of painted poplar and mahogany-stained oak. Both client and architect opted to use only natural *and* unendangered materials.

Without question, the exterior needed restoration. Although not an officially designated landmark, the Bird House is part of a six-building complex designed around a formal courtyard by Heins & LaFarge in 1895. All buildings are or will be undergoing renovation and adaptation as the park realizes new exhibition concepts, expands its educational role, and becomes involved with animal conservation worldwide. Nonetheless, the architects' original report states: "It would be a mistake to disregard the history and integrity of the court in favor of more contemporary design." The clients have wisely taken this recommendation to heart. *Charles K. Hoyt*

Up Close

More than just cleaning. Despite the building's basic sturdy masonry-wall construction, cast-stone and terra-cotta decorative elements had succumbed to the typical cycle of water penetration, freezing, cracking, and deterioration of these materials. The copper roofs and skylight framing had corroded beyond repair. The terra-cotta frieze of birds was removed to aid replacement of the deteriorated concealed gutters behind it that had caused many water-seepage problems. Artisans from Building Conservation Associates provided new frieze anchors, repaired and recast damaged and missing wings, beaks, and whole bodies so skillfully that it is now difficult to tell old from new. They also integrated the original copper peacock over the side entrance (photo opposite, bottom) into a new copper pediment so that the whole assembly of elements appears original. The architects saved the cast-stone balustrades along the north and east terraces when possible and interspersed them with matching ones to avoid a jarring contrast between whole sections of old and new. "The zoo's maintenance department keeps a whole storehouse of these balustrades," explains project architect Helen Cohen, pointing out that such replacements are a constant safety challenge even on those buildings not now under restoration.



© Peter Aaron/Esto photos

So skillfully did the architects design the new curved handicapped ramp on the main entrance (preceding page) that, despite its small scale, it appears to be a carriage drive. While they copied original railings for another ramp (photo opposite, top), code requirements restricting the rail diameter to 1 1/2 inches for gripping ease meant they could not possess the original's hefty profile.



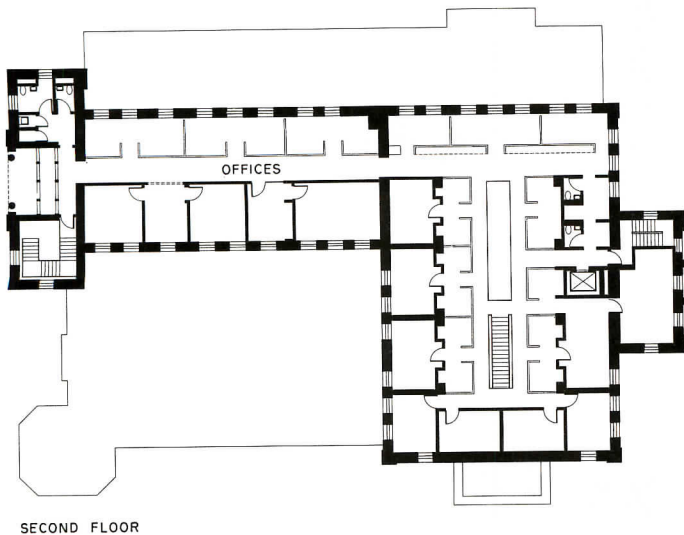

SECOND FLOOR

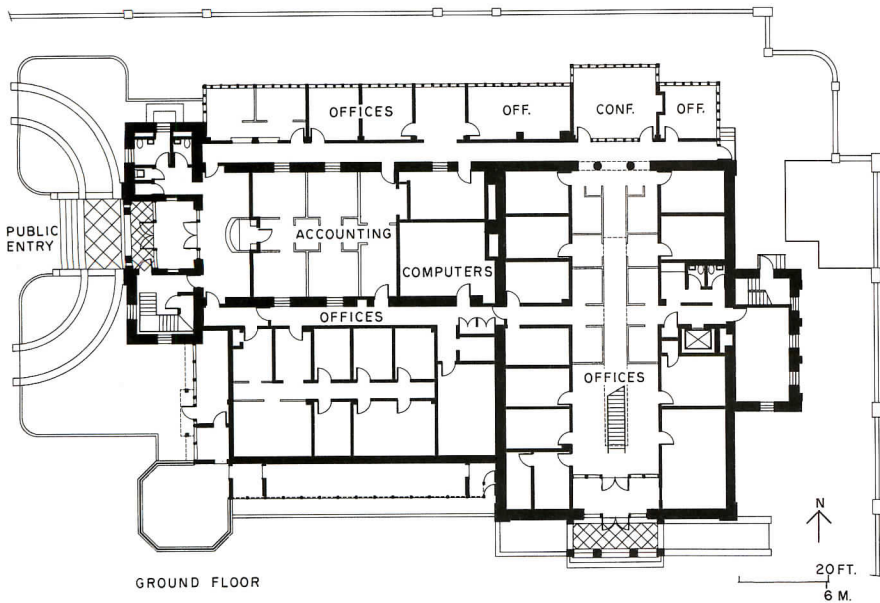

GROUND FLOOR



A conference room replaces original cages (top photo, this page). The character and structure of the original space are best understood on the second floor (photo opposite) where the original steel trusses are exposed full length.

Credits

*Old Bird House Renovation and Rehabilitation
Bronx, New York*

Owner: *International Wildlife Conservation Park (formerly the Bronx Zoo)*

Architect: *Davis, Brody & Associates—Sam Brody,*

partner-in-charge; Michael DeCandia, project manager; Gerald Olanoff and Helen Cohen, project architects; Nat Hoyt, John Torborg, Peggy Tasker, Brian Sweny, Paul Carr, project team

Engineers: *Goldreich, Page & Thropp (structural); Cosentini Associates (mechanical)*

Consultants: *Hanna/Olin, (landscape); Building Conservation Associates, Inc. (exterior restoration); Cosentini Lighting (lighting); Gleyen Hardward (hardware)*

General Contractor: *CM-AJ Contracting*





The oldest building on campus and seat of the school's administration, Adelbert Hall lies at the heart of Case Western Reserve's identity. So when a fire swept through the building in June 1991—pulling down the old slate roof, toppling the belltower, and gutting the interior—the university was in danger of losing a precious link with its past and a vital piece of its working capital. But thanks to an “interpretive reconstruction” designed by R. M. Kliment & Frances Halsband Architects, the landmark structure has been given a second life and outfitted to take the university into the next century.

In its new incarnation Adelbert Hall is not the building it once was. But change has been a constant in the building's history. Designed by Joseph Ireland and completed in 1882, Adelbert Hall was originally a classroom building. Subsequent alterations added a chapel, a bookstore, and administrative space to the building. In the process, the building's Romanesque Revival architecture was compromised by Italianate roof brackets, a reconfigured central tower, and ad-hoc changes in interior spaces. “We were asked to design the reconstruction of Adelbert as an administration building,” says partner-in-charge Robert Kliment, “adding generic office space, meeting rooms, and support spaces and preserving the ceremonial qualities and communal spirit of the original.” In so doing, the architects designed new construction to be consistent with the original Romanesque Revival vocabulary.

After the fire, all that remained were the sandstone exterior walls and the steel-joist and brick-vault-floor structure. Whatever interior masonry walls remained were below code, so they were removed and a new steel frame was inserted. Because the most pressing task after the fire was to seal the building from the elements, a new fourth floor was poured first and construction progressed from the top down. While the pre-fire building had an attic with a roof sitting somewhat awkwardly atop bracketed eaves, the reconfigured structure now has a full fourth floor with a slate roof resting firmly on a new stone cornice. To reinforce the building's prominence on campus, the architects increased the mass and ornament of the tower; using stone from the original quarry. The new aluminum double-glazed windows have the same profiles and divisions as the originals. On the east side of the building, facing Adelbert Road, the grade was lowered to accommodate a new handicap-accessible entrance.

Inside, the major goal was to preserve the spirit of the central stairhall as a grand space for casual encounters, while adding state-of-the-art flexible offices all around it. However, the new entrance on the east side of the building and the addition of new mezzanine levels within the 16-foot floor-to-floor heights required some reconfiguring of the stairs. The most dramatic change in the stairhall is the new skylight, larger than the old one with clear rather than opaque glazing. To underscore the transformation from a dark oak-paneled hall to a light-filled vertical-circulation core, the architects painted the walls in a gentle gradation of hues—from pumpkin on the first floor to off-white on the top floor. The new mechanical system includes two air-handling units in the attic and a cooling tower and chiller in a neighboring building.

“We told the architects to preserve the character of the old building,” explains Frank Borchert, Jr., Case Western Reserve's vice president for budget and planning, “but if they could find ways to improve it, we'd listen.” “That objective was met,” says the owner.
Clifford A. Pearson

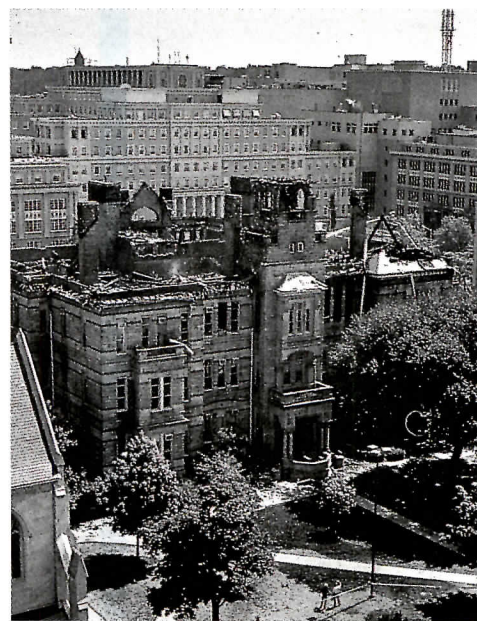

Case Western Reserve University photos except as noted

Up Close

Building from the top down. The original Adelbert Hall (seen shortly after completion in 1882 in top photo) was ravaged by fire in 1991 (above). To protect the damaged building from the elements, the architects' first sealed it with a new fourth floor, leaving openings in strategic locations through which building materials could be lowered. This top floor was initially placed on existing bearing walls, which had been temporarily shored up. Once the new steel columns reached the top floor, the old bearing walls (which didn't meet code) were removed down to the third floor. The existing third-floor beams were then shored, while new girders were run between columns. With these members in place, the old third-floor walls could be removed. This procedure was followed until all of the old bearing walls were eliminated and a new steel-frame had been erected within an enclosed building. On the campus-facing (western) side of the building (opposite), a new stone cornice replaces the bracketed eaves dating from 1902.





Although reconfigured to accommodate a new entrance on the east side of the building as well as new mezzanines, the central stairhall (photos this page and section) retains the footprint of its pre-fire predecessor (left). It also serves the same function as an important social gathering area. The stair has a different character, though, due to an enlarged skylight with clear rather than opaque glazing (top left, opposite).

The dark Victorian feeling of the old stairhall's furnishings has been relieved by combining red-oak-veneer paneling with paint colors that grow lighter as the floors get higher. The architects organized office spaces around the stairhall and added new restrooms and kitchenettes. They also renovated areas to the east and west of the stair to serve as major ceremonial spaces, such as a conference room (right

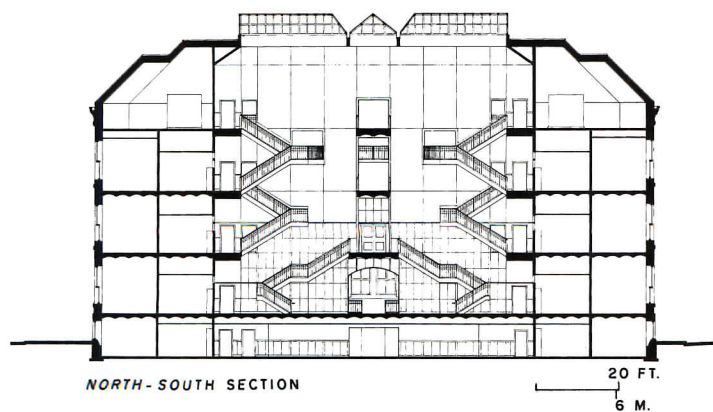

below) fitted into the tower.
Pendant lighting with fluorescent up-lights and incandescent down-lights was designed by the architects.

Credits

*Adelbert Hall
Cleveland, Ohio*

Owner: Case Western Reserve University

Architect: R. M. Kliment & Frances Halsband Architects—
R. M. Kliment, partner-in-charge; Frances Halsband, collaborating partner; Richard L. McElhiney, associate-in-charge; Christopher R. Borchardt, George D. Hallowell,

Michael A. Nieminen, Joseph Singer, Mark H. Wright, design team

Engineers: Barber & Hoffman (structural); Byers Engineering (mechanical/electrical)

Consultants: Robert Schwartz & Associates (specifications); H. M. Brandston & Partners (lighting); Robert A. Hansen Associates (acoustics)

Construction Manager: The Krill Company

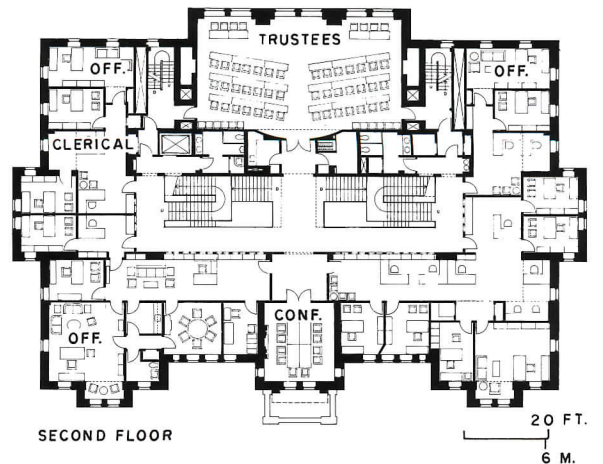
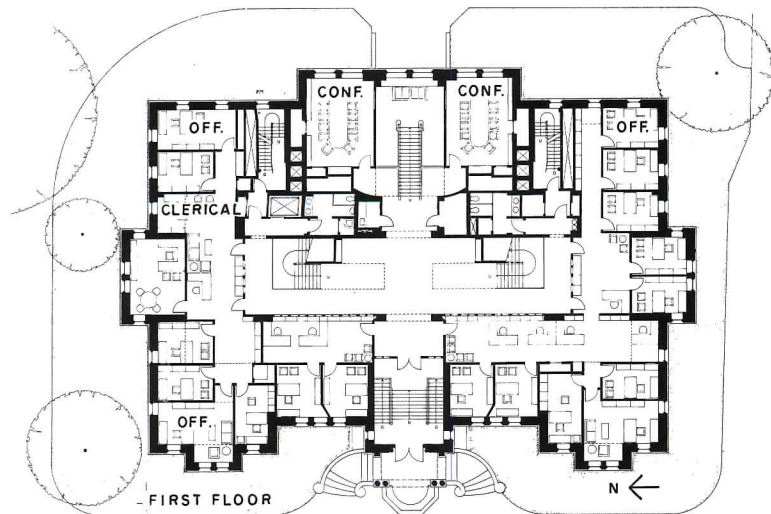

Industrial Strength

*Industria Superstudio
New York City
Deborah Berke and Carey McWhorter
Architects*

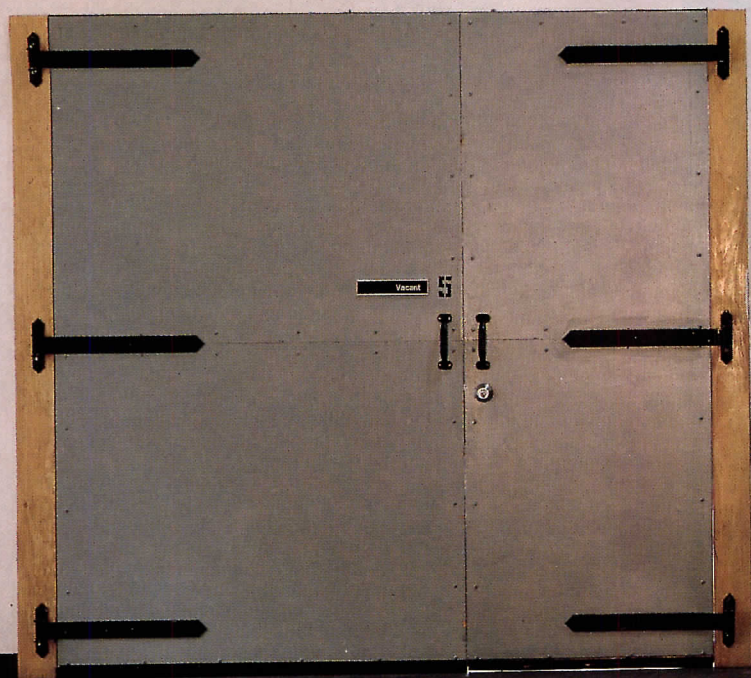

To outsiders, the world of high-fashion photography is nothing if not glamorous. Photographer and entrepreneur Fabrizio Ferri sees it otherwise. "It's work," says Ferri. To transform a 1930s building located on the fringe of New York City's meatpacking district into high-priced all-equipped rental space for fashion shoots and related social events, Ferri turned to architects Deborah Berke and Carey McWhorter. In addition to the duo's interest in industrial vernacular, Berke, a former model, displayed what Ferri considered a fitting indifference to the fashion world's glossy veneer. "She knows the reality of the business," he explains. "It's about utility," offers Berke.

The former auto garage's reputation as a specialist in Rolls Royce repairs had an allure not lost on Ferri, a Rolls Royce owner. In addition to its cosmopolitan past, the structure boasts the wide open spaces and high ceilings ideal for customizing photo shoots. Ferri was also attracted by the building's westerly orientation—"the best light for shooting"—and its proximity to the Hudson River—"it gives the energy of commerce." After repairing exterior brickwork and existing steel-sash windows in accordance with the New York City Landmarks Preservation Commission's regulations, Berke and McWhorter reconfigured the 20,000-square-foot interior space into different-size studios, each with its own spatial and lighting amenities. On the ground floor, the architects made smaller studios, inserting walls among a 24-foot grid of columns. On the second floor, two giant studios share the uninterrupted open space of 90-foot wood bow trusses and skylights (which can be covered depending on each photographer's requirements). An existing internal automobile ramp also makes the second floor accessible to large props and heavy equipment—in fact, an elephant was recently led upstairs to have his picture taken.

Separating the studios are asymmetrical mossy-green painted double doors with three-foot- and five-foot-wide panels that can be opened to admit people and props. In between studios, the architects carved out spaces for dressing rooms and makeup tables, adapting used scaffolding as furniture. Berke and McWhorter replaced gas furnaces suspended from ceilings with a conventional forced-air heating system, leaving ducts exposed. The building had 400 amps of power, but to accommodate the enormous power draw of strobe lighting, the facility was completely rewired for 800 amps. "The building was intended for heavy-duty use," explains McWhorter, "And that still applies." "Industrial and clean," says Berke of the overall effect, noting that frequent post-shoot paint jobs keep Industria looking new. The work is often charged to clients as a clean-up service, part of a business strategy that has proven successful enough to allow Ferri to expand his operation down the street. *Karen D. Stein*



© Catherine Bogert photos

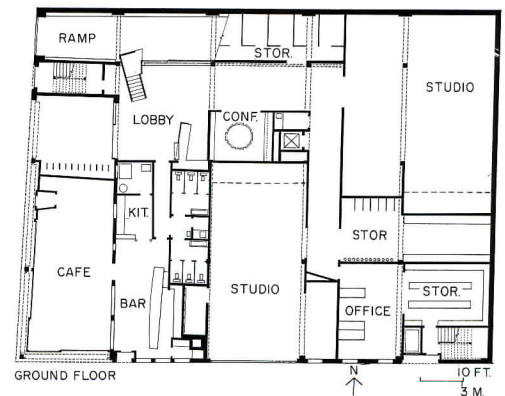
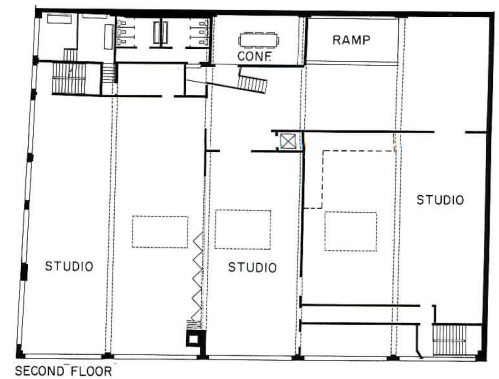

Industria Superstudio occupies a former auto-repair garage on Manhattan's Lower West Side. For \$38 per square foot, the architects had exterior brick repointed and divided the 20,000-square-foot interior into different-size studios that rent for between \$550 to \$1,200 per day (plans above). An Industria-owned restaurant in the southwest corner of the building caters to the facility and can be rented for private parties (photo left). A reception desk overlooks a new glass and steel storefront (top).

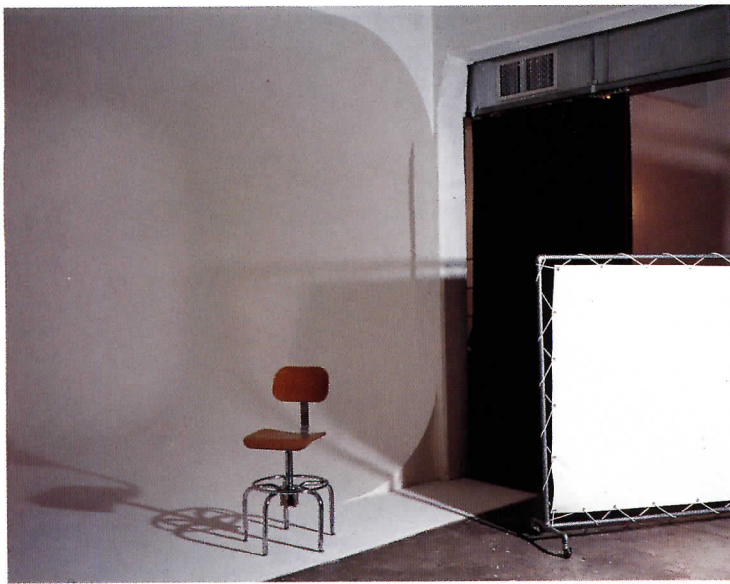

The architects recycled used scaffolding into furniture, including make-up desks and prop tables topped with stainless-steel commercial kitchen counters (top) and privacy screens (opposite). Curved cement and plaster "cycloramas" (middle and bottom left) create seamless backdrops. Second floor studios have west and southerly exposures and repaired skylights, but can be blacked out if necessary. The architects called for a new concrete slab on the ground floor and had the concrete second floor painted.

Credits

*Industria Superstudio
New York City*

Owner: *Industria Superstudio
Overseas, Inc.*

Architect: *Deborah Berke and
Carey McWhorter Architects—
Deborah Berke and Carey
McWhorter, principals-in-
charge*

Engineers: *Ross Dalland
(structural); IP Group—Ivan
Pollak, principal (electrical)*

General Contractor: *GP
Winter*



New Leaf

Converting a tobacco warehouse into a shopping complex illustrates the dilemmas of adaptive reuse vs. true restoration.



*Tobacco Dock
Wapping, London
Terry Farrell and Company
Architect*



TBy Hugh Aldersey-Williams

he massive brick Tobacco Dock lies between tall ships recently anchored to its narrower south, and the castellated tower of Nicholas Hawksmoor's Saint-George-in-the-East church to the north. Through the last century, it was a warehouse, for tobacco and sheepskins on the airy, top-lit upper floor, and for wines in the cool vaults below. Conversion of this dignified structure into a shopping complex required both restoration of the decaying Georgian industrial architecture and intervention to adapt it to a new purpose. The program called for the 150,000 square feet of space to be divided into 100 stores of between 350 and 6,000 square feet each; in all, some three times the area of London's well-known Covent Garden.

The original design incorporated a number of innovative features both worthy of preservation and helpful to that process. The vaulted lower hall of low stone parabolic arches is entirely self-supporting. Above it rises a forest of elegant cast-iron stanchions that support a series of wooden roof trusses. The stanchion branches stay in place without bolts thanks solely to the load they support. Every sixth stanchion is hollow, allowing rainwater to run down and keep the pine pilings wet.

The architects retained the wooden structure, replacing some members with forthright new carpentry and strengthening the whole by adding steel trusses boxed to look like wood. Two bays of the building to the west were threatened with demolition because they were outside of the developer's site. The prefabricated nature of their upper structures, however, made it practical to relocate them to the developer's land on the east by simple dismantling and reassembly.

Real alteration came with the need to pierce the solid masonry walls with low brick arches to make the building appear inviting. The architects brought daylight to the lower level by gutting large openings in the crowns of several brick vaults, and supported them with poured-in-place reinforced concrete rings—a technique mimicking existing steel rings around several earlier openings.

An adaptive-reuse issue is always how to strike the balance between restoration, renovation, and new ideas. Farrell has answered this question in all ways. Purists in either the restoration or modernist camp may take offense. But the result here was intended to be eclectic, and is lacking only in that, partially through the pressures of program, the architects could not save more of the spirit of an elegant original structure.

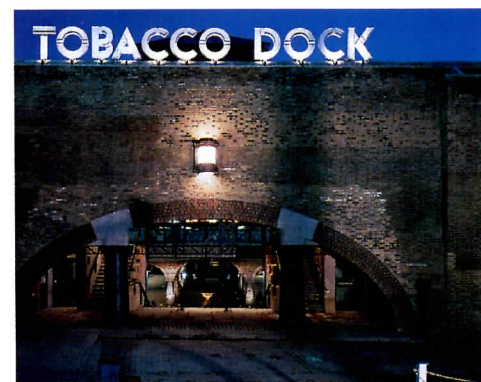

Tobacco Dock spreads out in the Docklands landscape where Nicholas Hawksmoor's Saint-George-in-the-East dominates (top). The dock's former fort-like appearance had to be altered to make it appear inviting. Industrial-style lettering advertises the mall's presence, while new low arches of reinforced concrete clad in granite and brick open the walls to the outside past giant non-structural cast-iron columns. At its completion during the Napoleonic Wars, Tobacco Dock had an upper floor that was a huge single space (photo, previous page). Slim cast-iron tree-like stanchions supported a wooden roof—now partially removed—and glazed clerestories so the room was both well lit and well ventilated. The building fell into decay during the present century until conversion to its current use.

*Dennis Gilbert photos, except as noted
Photos previous pages: ©Richard Bryant*





Up Close

Storefronts. The arches of the vaulted lower floor vary by several inches. To fit storefronts within them, the architects created a standard rectangular unit and a surrounding frame that could accommodate variation. The glass can be covered by metal shutters, while the surrounding frames are securely fastened to the brickwork. These measures provide fire protection to meet fire regulations for the largely wood and iron structure. Retailers are free to arrange their stores according to their own requirements, but must conform to a thick style manual prepared by developer and architect.

Detailing drew from storefronts of the early 19th century, but the architects rescaled individual elements to suit an industrial aesthetic (above). Some parts were specially designed and cast. Others were assembled from standard steel components in a way that accentuated their industrial qualities. On the upper level, for example, painted standard steel beams with contrasting exposed-metal bolts form glazed freestanding boxes for individual stores.

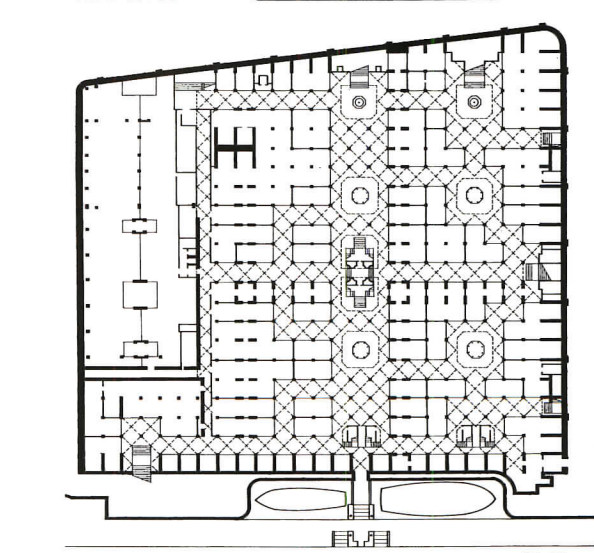
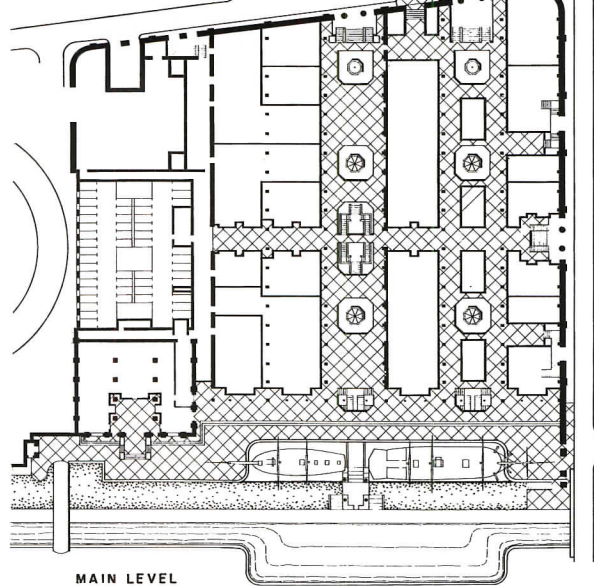
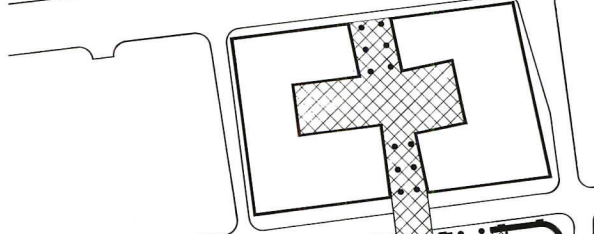
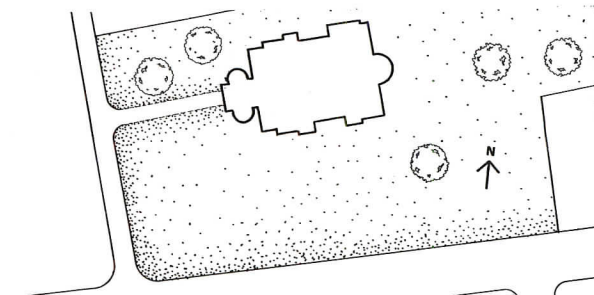

Tobacco Dock occupies an unusual site between the attractions of the Thames River to the south and Nicholas Hawksmoor's church, St.-George-in-the-East (plans, top), across a forecourt and a busy road to the north. The plans show how the circulation and retail spaces follow the north-south alignment of the clerestory-lit bays. Visitors enter from the north and are drawn through the complex by the daylight and sight of tall ships moored alongside a cobbled quay at the south end. One clothing-shop interior (right) designed by Rasshied Din took inspiration from the surrounding industrial aesthetic. Recession followed hard on Tobacco Dock's completion for upscale shopping and the development is due to reopen this year as an American-style factory-outlet complex.

Credits

- Tobacco Dock*
London, England
- Owner:** Tobacco Dock Development, Ltd.
- Architect:** Terry Farrell & Company, Ltd.
- Engineers:** Ove Arup & Partners (structural); H. L. Dawson & Partners (mechanical)
- Consultants:** Burrell Hayward & Budd, construction estimators
- General Contractor:** Harry Neal, Ltd.



Updated Duckling

*Primary Care Clinic,
Oakland Children's Hospital
Oakland, California
The Rateliff Architects*

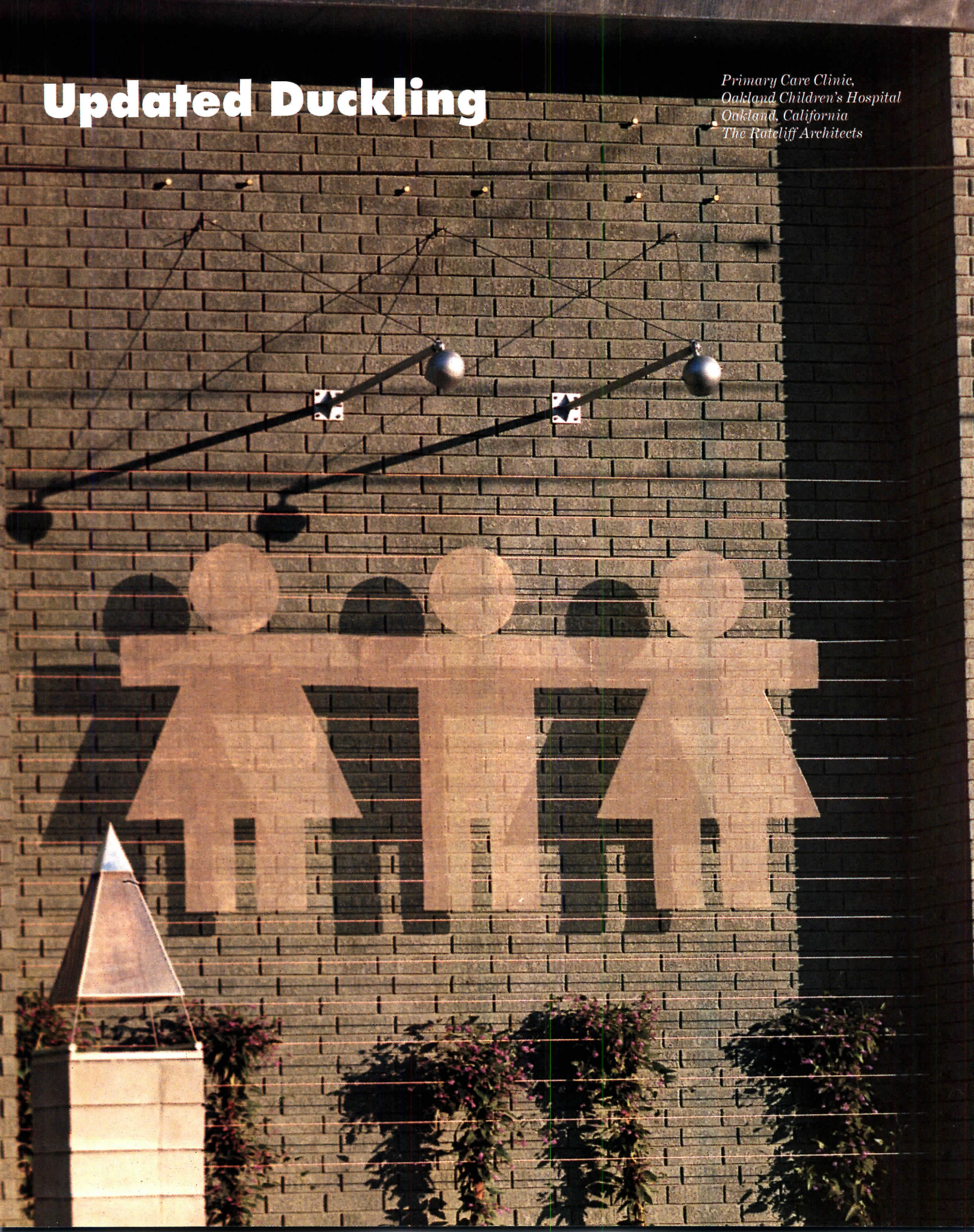

The Primary Care Clinic marks a successful, adaptive reuse that never would have happened without creative vision. It is in one of two long unoccupied buildings located diagonally across the street from each other; both were in advanced stages of deterioration. They are located in a marginal neighborhood plagued by theft and vandalism, the sort of evils that fester when buildings close and normal sidewalk traffic disappears. Yet, it was the idea of remodeling not one but both buildings and its impact on this location, which is less than half a mile from the main Children's Hospital campus, that attracted the client to the project.

The Primary Care Clinic's interior was a warren of offices with a clearly dated facade (top photo, right), an unpromising host to a program that called for clear visual order and a bright, inviting atmosphere. A first floor raised above grade made creating access for the disabled problematic. The load-bearing-masonry walls surrounding steel column-and-beam construction all required connectors and stiffening to meet current California seismic requirements. The wood floors and roof would not meet fire-safety requirements for the anticipated large numbers of people and heavy traffic. Nor would existing passages and fire exits. To install a needed hydraulic elevator, a 30-foot-deep pit would have to be dug below the water level of a nearby underground creek. Mechanical and electrical supply was woefully inadequate for a clinic.

Given these challenges, it may seem surprising that the architects would go to such lengths to remodel instead of starting anew. But the basic components did offer several pluses. The structure and exterior walls could be repaired economically. The floor heights were right, and the square footage met requirements.

Except for the steel structure, the building was gutted to its exterior walls. New concrete slabs were poured on the first and second floors, and a hole was cut in the roof to allow for a skylight over the open, central stairs, which wrap around the new elevator shaft. The skylight saves energy by cutting down on the need for electric-light sources. More importantly, it contributes a bright atmosphere to the interior, calls out the vertical circulation and provides a clear sense of orientation on each floor. (The architects point out that easily understood circulation is important to any building with many first-time visitors, whereas office floor plans, as in the original building, are set up for people who know their way around.) Four medical units on the first floor surround a central waiting area (plans, next page). Each contains a nurses' station and five exam rooms. Each unit has its own color of wood casework (see Up Close). Non-English-speaking visitors use color cards to find the corresponding unit. The second floor contains smaller rooms for psychiatric care as well as doctors' offices. On the outside, the architects have used stainless-steel mesh as protection for windows while enlivening it with paper-doll-like cut-outs. These and other playful elements are designed to entice reluctant young patients through the doors. A wheelchair ramp is concealed behind a sidewalk planter.

Was the effort worth it? For \$119 per square foot, including special casework, Ratcliff produced a 17,000-square foot building that is both an efficient workplace for the medical staff, and a pleasant place for children. And the architects reinforced the turnaround of a neighborhood that was once on its way downhill. *Charles K. Hoyt*

© Andrew McKinney photos



In converting this building to a children's clinic, the architects have made a remarkable change to the facade of a dated former office building, while allowing its original form to show through. The purpose was twofold: to put potentially reluctant young patients at ease and help revive a deteriorated neighborhood.

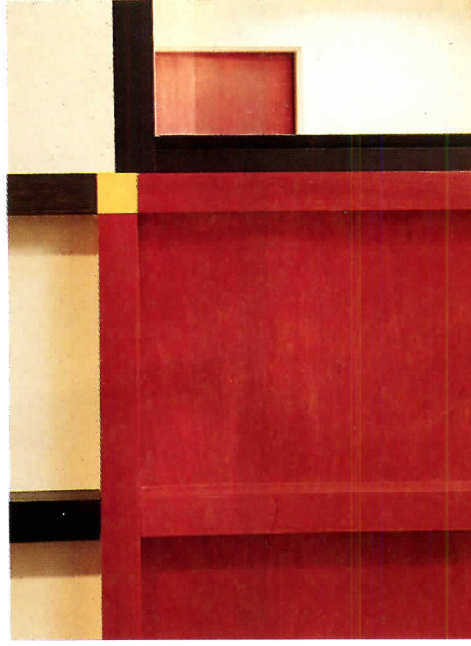

Up Close

Original solutions. To meet the need for durable and economic furniture and partitions, the architects used natural wood with an aniline-dye finish that allows the natural grain to show through. Colors were chosen to brighten the spaces and emphasize a building-block character designed to appeal to young patients. To further this appeal, the architects reduced the furniture's scale to childlike proportions. Casework was executed by Rod Hoffmann. A play area (opposite below) is located immediately inside the front door and is supervised by parents who sit around it, and by workers in offices that ring this central space. The low budget also covered such custom elements as the paper-doll-like cutouts on the facade, executed by craftsman Ken Draizen of Interactive Construction. Glass in many partitions is designed to enhance transparency and make a friendly open impression.

1. Examination
2. Office
3. Charting
4. Conference
5. Discharge
6. Interview
7. Staff lounge
8. Screening

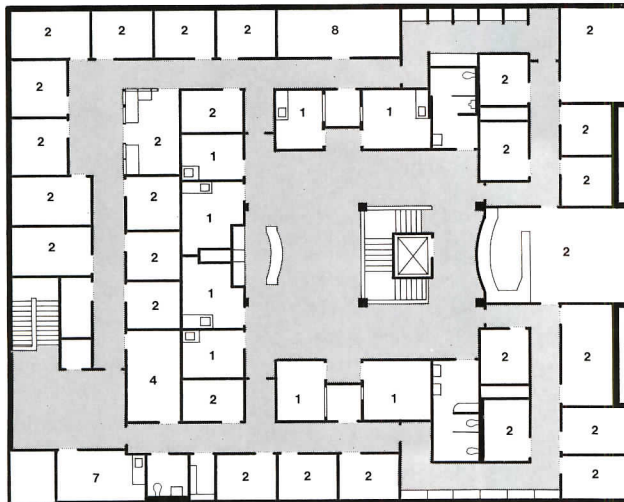

SECOND FLOOR

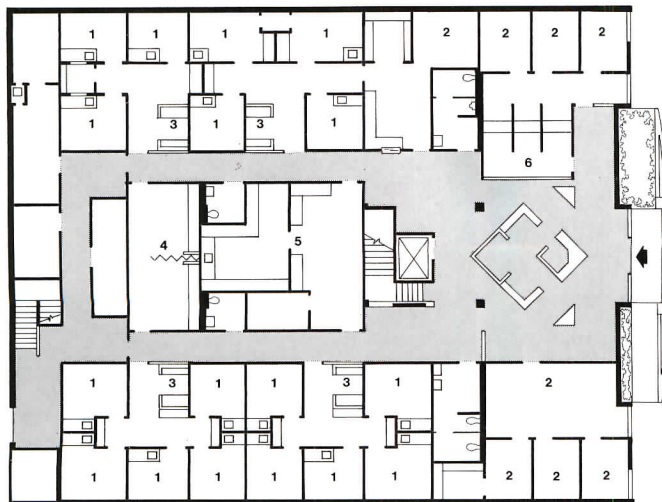

FIRST FLOOR

10 FT.
3 M.

Credits:

*Primary Care Clinic
Children's Hospital Oakland
Oakland, California*

Owner:

Children's Hospital Oakland, California

Architect: *The Ratcliff Architects—Don Kasamoto, principal; Jerry Mastora, project manager; Kava Massih, project designer; Ross Bogen, Stepannie Bartos, Leslie Arnold, project team*

Engineers: *Graham & Kellam (structural); Montgomery & Robert (mechanical); Silverman & Light (electrical)*

Consultant: *Dillingham Associates (landscape)*

General Contractors: *Scott Anderson
Scott Anderson Construction*



Focus on: A Rich Range of Recycled Buildings

A glance at the projects on these pages reveals diverse types of buildings being put to new uses and the reasons their conversions were successful. In Bridge Harbor Heights, buildings that had gone from residential to industrial uses revert to housing and extend an adjacent upscale historic district. The resulting élan has produced above-market rents that may well be ahead of those for an all-new project. Fisher-Friedman's conversion of a warehouse into offices provides affordable space for the architects and income from tenants besides. Gallery Frau was once office space that, due to the nature of a former redesign, was transformed to a gallery with surprising ease. The Fashion Center lobby is more a change of attitude

Bridge Harbor Heights Condominium Apartments

*Brooklyn, New York City
Kweller, Dubin, Baumgarten, Architects
Platt & Byard, Consulting Architects for
Design and Historic Architecture*



333 Bryant Street

*San Francisco
Fisher-Friedman Associates, Architects*

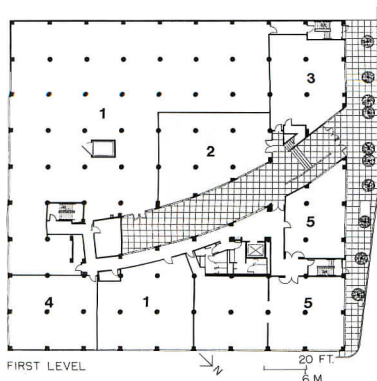

- 1 Fabric design
- 2 Art gallery
- 3 Architectural show room
- 4 Graphic design
- 5 Furniture show room



Charles Callison photo

than use. Typical of many such projects these days, it means to attract tenants by recapturing the elegance of the building's period character. Medical offices in a former supermarket by Gran Sultan create new space at a rock-bottom price. At the Church of the Covenant, the architects face up to problems of an inner-city religious building's survival. National Hall became a hotel after many previous reincarnations. And Burnstudio fits right into a former union hall. C. K. H.



Bill Konitzias

From down-and-out to up-and-coming

This mixture of new and rehabbed housing was made possible by adaptive reuse. The site was a block of vacant lots and derelict light-industrial buildings. The buildings were built in the 19th century as an orphanage (dormered roof in photo this page), apartments, and private houses and later converted to factory use. The site was too valuable to ignore, but presented a problem most developers did not want to tackle: it was adjacent to the intersection of two busy elevated highways. Yet, it was also part of the Brooklyn Heights Historic District, an otherwise prestigious residential neighborhood. One developer finally saw that market-rate housing would be economically feasible, had plans prepared, and started foundations—but then had trouble getting the planned combination of new low-rise buildings and renovated existing structures past the watchful eye of the city's landmarks commission. Enter architects Platt & Byard. They discovered that the commission expected stricter restoration standards for the existing structures, and more distinction between them and the new ones (photo, opposite). “*Façade accomplie*,” jokes Charles Platt after the architects had helped the client express the true spirit of the recycled buildings. C. K. H.



Phil Harvey photo

Architects convert warehouse to offices

Located in San Francisco just off I80, 333 Bryant Street is a five-story former warehouse converted to offices by Fisher-Friedman Associates. The building functions as a “design house” for the south of Market Street community: the firm’s own offices are located there, as well as the offices of graphic-design and textile-design firms, engineers, landscape architects, a reprographics company, and a furniture showroom. The 1920s building was originally built around a curving railroad spur which terminated at loading docks between two wings of the building. When the building was remodeled, the heavy timber trestle that supported the tracks was replaced by a concrete floor, and the area it once occupied was left as an open entry court for the building (photo opposite). Fisher-Friedman’s own offices include a generously sized waiting area where presentation boards are displayed, and a second room featuring architectural models that doubles as a photo studio (photo left) and a photo archive. The original concrete columns and ceiling were left exposed. Because the structure was concrete, the firm avoided many of the problems and costs associated with rehabilitating masonry structures, which must be extensively stabilized in this earthquake-prone area. C. D. L

Galleria Frau

New York City
Vignelli Associates, Architect

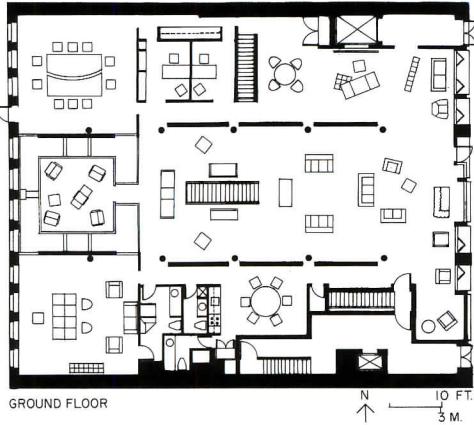

Fashion Center Building Lobby

New York City
George Ranalli, Architect

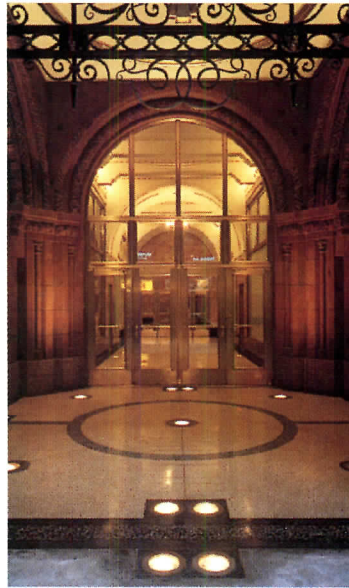
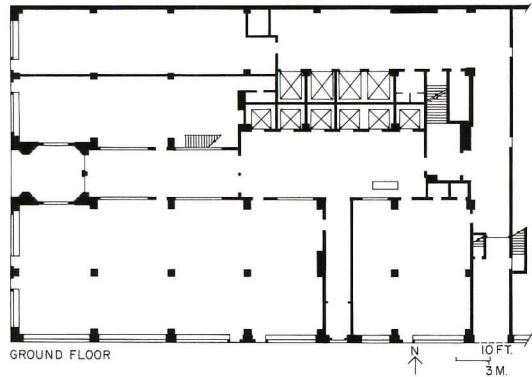

Valley Medical Associates Offices

Hudson, New York
Gran Sultan Associates

1. Waiting
2. Reception
3. Business
4. Exam
5. Office
6. Lab

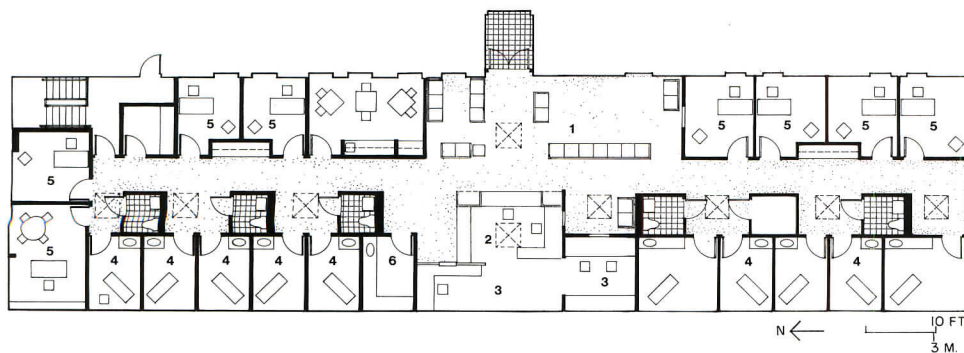



Renovating a renovation

Asked to remake a 10,500 square-foot loft space in New York City's SoHo district, Vignelli Associates developed a dual strategy of addition and subtraction. Built in 1897 by Louis Korn, the space's previous incarnation was as an art gallery and publishing offices designed by New York architects Henry Smith-Miller and Laurie Hawkinson. New tenant, Galleria Frau asked Lella Vignelli and her team to provide for furniture display and related activities. The architects removed steel and glass screens and office partitions to open up views in the front and core of the space. They retained two parallel concrete block walls that run the length, but cut out slots around the columns so they stand unencumbered. The columns were stripped of white paint to reveal their original cast-iron finish and block walls were laminated with gypsum board to make a backdrop for brightly colored furnishings. Downstairs, offices were dismantled and combined with storage space to create a theater for lectures. Alterations to the exterior were minimal since the building is located within a historic district overseen by the New York City Landmarks Preservation Commission. Sandblasted glass panels were replaced by clear glass and a new logo was added. *K. D. S.*



Catherine Bogert, photos

Returning a great public room to its former glory

In restoring a series of public spaces leading from a bustling avenue to an inner lobby, architect George Ranalli found himself playing both detective and interpreter. The focus of his attention was one of the later works of Henry Ives Cobb, the architect responsible for the Gothic campus of the University of Chicago. Designed as a high-rise Romanesque Revival fortress in 1923, the Fashion Center Building blends historical decoration with a Modern approach to massing and transparency. Most of this work was covered by renovations made in the 1950s and '60s, requiring Ranalli to peel away hung ceilings and plaster walls. Fortunately, much of the original decorative plaster and terracotta was still in place and could be repaired. Where pieces were missing or damaged, Ranalli fabricated new ones using the original casting process. Where no documentation of the original elements was left, Ranalli created Modern designs that sit comfortably next to Cobb's work. Such new pieces include a terrazzo floor embedded with 15 lamps in the outdoor vestibule off Seventh Avenue (left opposite), gold-leafed plaster vaults in a side vestibule off 38th Street (right opposite), and a sheet-bronze reception desk in the main lobby (left). *C. A. P.*



Kathleen Vernier, photos

Check aisle two for oncology

After six months of shopping for new space for its expanding medical practice, Valley Medical Associates finally found what it sought—at the supermarket. Located downtown and close to Columbia County Memorial Hospital, the brick supermarket offered the kind of low-budget, flexible space, and possibilities for future expansion perfect for a multi-discipline group medical practice. Architect Warren Gran took full advantage of the 16-foot-high ceilings to create an airy setting with exposed trusses and vents. By punching a few windows into the existing brick shell and cutting nine 4-foot-square skylights into the roof, Gran brought in plenty of daylight. The basic design concept was to insert offices, exam rooms, and treatment rooms as individual containers within the general volume of the clinic. Because doctors and nurses spend more time moving between exam rooms than they do within their offices, circulation and the spaces between rooms were critical to the overall design. By creating a sense of openness and using a palette of soft grays, blues, greens, and whites, Gran gave the clients what they asked for: a facility that would be positive and hopeful, without being frivolous. *C. A. P.*

The Church of the Covenant

Boston
Ann Beha Associates, Architect

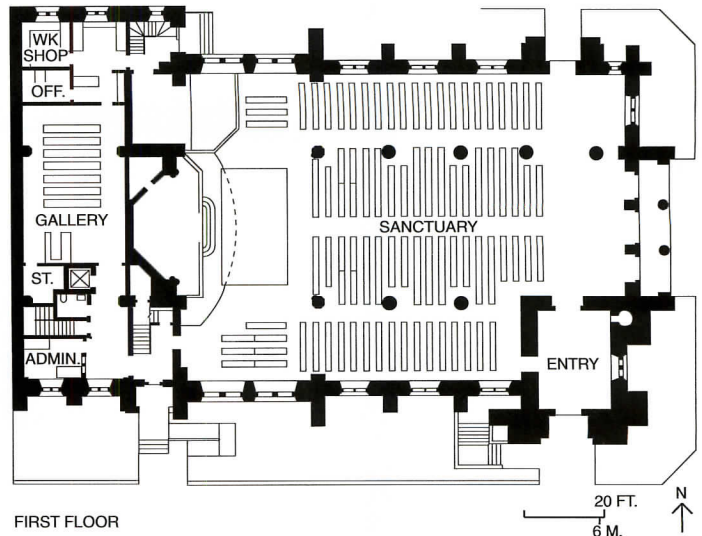

National Hall

Westport, Connecticut
Ferris Architects



Burnstudio Building and Offices

Raleigh, North Carolina
Burnstudio Architects



1. Conference
2. Slide booth
3. Product/print
4. Kitchen
5. Reception
6. Waiting
7. Gallery
8. Darkroom
9. Skylight above
10. Office module
11. Principal
12. Courtyard balcony

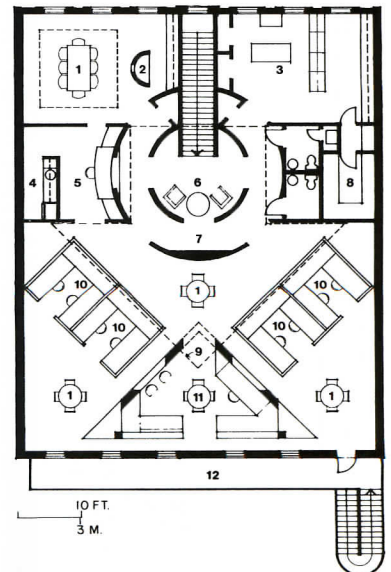

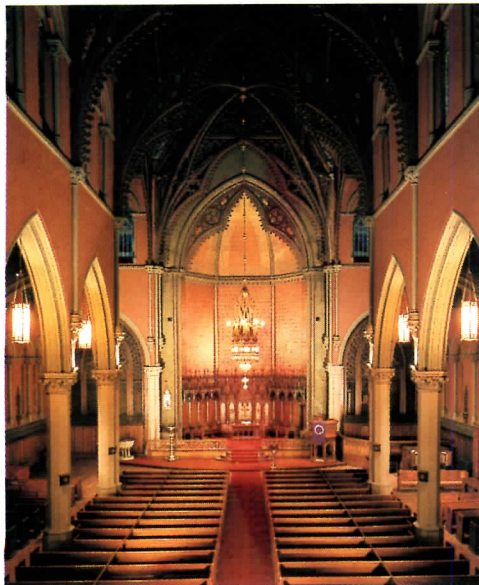

Saved from the wrecker's ball

The years from 1875 to roughly 1920 yielded in what we now call inner cities hundreds of substantial churches erected to accommodate the great population surges of those years, and often built at great sacrifice by modestly endowed congregations. Their descendants have now largely moved to the suburbs, leaving behind structures costly to operate and maintain. A fine example of enterprise triggered by these challenges is the Church of the Covenant, which renovated its Parish House to twice the original square feet (plan, opposite), giving over 80 percent of its space to such uses as a soup kitchen for homeless women, a social-services center for the elderly, and an income-producing commercial-art gallery. A second part of the \$1.35-million project, of which 55 percent came from donations by the congregation, with the rest raised (with the architect's help) from corporate and foundation grants, was adaptation of the Sanctuary (left, and plan) to added use for dramatic performances. Restoration included stabilizing Louis Comfort Tiffany's magnificent 1884 stained glass windows and chandelier. The outcome shows how a determined congregation is able, with counsel from its architect, to turn an urban landmark, once threatened with demolition, into a vital force. *S. A. K.*



Against all odds

Architects can prove their worth by reconciling the often-conflicting demands of today's society, according to Roger Ferris. He refers to the maze of some 47 federal, state, and local regulatory agencies that his firm went through to bring Westport, Conn., a facility now praised by users and local citizens. The project is the conversion of an 1873 municipal building into a restaurant and hotel, which has brought new life to a previously ignored part of town. It was the building's intended use, waterside site, and National Register status that required so many approvals. But the architects faced structural problems as well. Foundations had sunk. The masonry bearing wall and heavy-timber construction was tired, and the brick and cast-iron front wall had never even been attached to the sides. Ferris wove in a new steel frame to bolster the existing structure, managing to preserve, in the process, such spaces as the stairwell (photo, left). Another major problem was functional: the need for entry to the new hotel and restaurant where cars could pull off the street—from the previous rear facade, which had never been finished. The architects solved this with a small compatible addition with a ground-floor colonnade replacing the typical hotel canopy. *C. K. H.*



From labor union hall to architect's offices

The recycling of this 7,800 square-foot commercial building, erected around 1900, has become a milestone in the revitalization of downtown Raleigh's historic Moore Square district. Cleaning, restoring, and painting the Italianate street facade (opposite, far left) helped bring back a sense of dignity to the street. Inside, Burnstudio principal Norma DeCamp Burns took advantage of the openness and daylight of the old union hall by setting up a hierarchy of spaces that radiate from the central entry at the top of the long stair (floor plan, opposite). The large central skylight, partial-height screen walls, and custom-designed work stations create a progression from public to private spaces. The wood and plastic-laminate workstations combine surfaces for drawing, layout, and display with general and flat-file storage within a single vocabulary. The insulated skylight (left) offers generous daylight. The work includes a new mechanical system. Fans distribute the heat, windows are operable, and heat pumps provide efficient zoned heating or cooling. The simple forms and bold color preserve the feeling of the union hall's original open floor, and, for a modest \$61 per square foot, express the architect/landlord's commitment to preserving a part of Raleigh's inner city. *S. A. K.*

ZINC

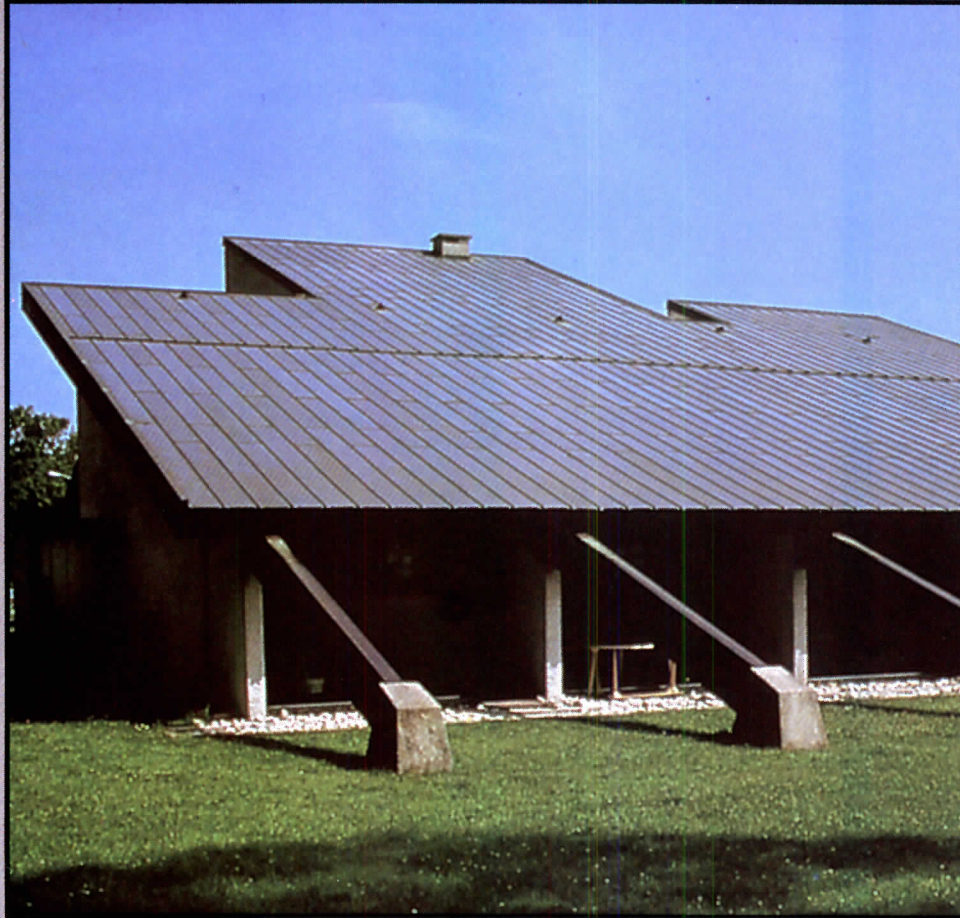

LASTING ELEGANCE WITH ZINC SHEET

Pure zinc sheet is known for both its aesthetic and technical qualities. Architectural zinc has unique natural colors and patinas that complement other building materials, a maintenance-free and self-healing surface, and an extremely long lifespan of over sixty years.

Zinc has a long, proven history in Europe, where over 250,000 tons are specified every year for architectural applications. Since 1812, zinc sheet has graced such prestigious buildings as the Berlin Royal Palace and the Jeu de Paume Art Museum in Paris.

For exterior or interior applications, roofing or wall cladding, natural zinc sheet is an elegant choice for both modern and traditional designs

Cominco Ltd.

2380 Speakman Drive, Mississauga, Ontario L5K 1B4

Tel.: (905) 822-2022 Fax: (905) 822-2882



RESOURCEFUL - WORLDWIDE

Circle 31 on inquiry card

When you're reaching for the stars, you can't risk static at ground level.

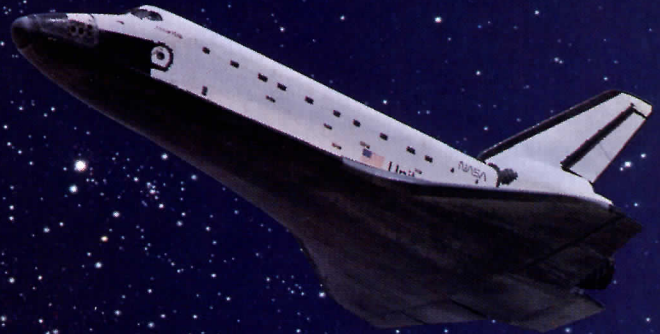

Time-tested VPI flooring was chosen for critical operations at Cape Canaveral.

Conductile® is the leading choice wherever the need for static control is uncompromising. That's because Conductile is a permanent answer. It is highly resistant to abrasion. Conductive elements do not slough or bleed out. Conductile provides continuous, unflinching static protection for process systems, computer installations, electronics manufacturing and assembly operations, clean rooms and other highly sensitive requirements. Conductile – from the leading manufacturer of static-control flooring. Proven since 1950, it's the most time-tested static-control flooring on earth. Why risk protection of vital equipment with anything less?

For information on Conductile static-control flooring as it applies

to your needs, call 1-800-874-4240.

WE DO THINGS DIFFERENTLY AT VPI

vpi®

Circle 78 on inquiry card

Sandrift™

CEILING PANELS

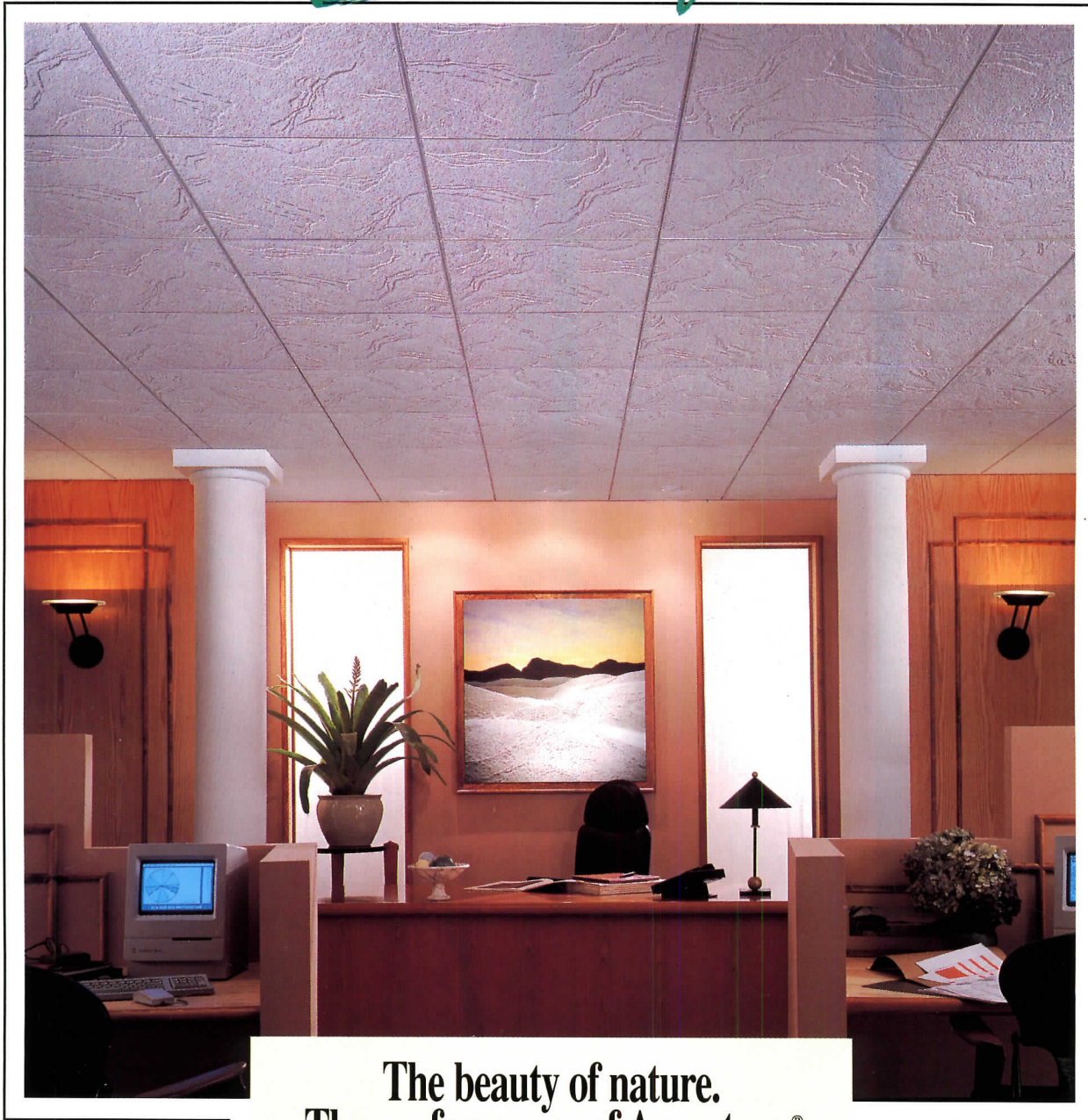

**The beauty of nature.
The performance of Acoustone.®**

Windswept sands. Textured. Tactile. Etched by the breeze. ■ Sparking your imagination. ■ Sandrift™ ceiling panels bring you the infinite variety you expect to find only in nature. Just as no two snowflakes are alike, no two Sandrift ceilings will ever be the same. ■ One-of-a-kind. Random. Non-repetitive. And strikingly beautiful. Bringing to mind the shifting patterns of sand. ■ Move the ambience of nature indoors with Acoustone Sandrift ceiling panels from USG Interiors, Inc. To see the depth and diversity a Sandrift ceiling can bring to any room, ask your USG Interiors distributor, or call 1-800-950-3859.



©1991, USG Interiors, Inc. Acoustone® and Sandrift™ are trademarks of USG Interiors, Inc.

USG Interiors, Inc.

Circle 79 on inquiry card