



# ARCHITECTURAL RECORD

## DESIGN VANGUARD 2006

10 Architects Build for the Future

PRODUCT REPORTS

Presenting this year's  
outstanding new products

[Between us, ideas become reality.]®



Before

# no commercial interruptions

Now you can zone out the random clutter of technical services. The TechZone™ Ceiling System organizes lighting, air diffusers and sprinklers into compact 6" technical zones. This innovative integration of function and design provides a custom, monolithic, uncluttered ceiling visual using large-size Optima™ ceiling panels to create the field. And because it's a system of standard components that have been pre-qualified for fit and finish, you avoid design incompatibilities, long lead times and other hassles associated with custom ceiling systems. With TechZone, reality won't interfere with your design.

[armstrong.com/techzone](http://armstrong.com/techzone)

1-877-ARMSTRONG



CIRCLE 1 ON READER SERVICE CARD OR GO TO [ARCHRECORD.CONSTRUCTION.COM/PRODUCTS/](http://ARCHRECORD.CONSTRUCTION.COM/PRODUCTS/)

TechZone Partners:





# The Case for Design Excellence

## Editorial

By Robert Ivy, FAIA

**A** note of cautious optimism hovered about the group of design professionals convened by the General Services Administration in San Francisco last month. These newly designated GSA peers would face the heady task of helping to select—or to challenge, urge, or encourage—their fellow practitioners through the GSA Design Excellence Program.

They met in the shadow of the program's progenitor, the late Senator Daniel Patrick Moynihan, who had earlier penned a simple set of guiding principles for federal design and construction that included a remarkable assertion: "The advice of distinguished architects ought to, as a rule, be sought prior to the award of important design contracts." As elaborated through the subsequent leadership in the General Services Administration—through former commissioners Robert Peck and Joseph Morevic, GSA Chief Architect Ed Feiner, Director of Design Excellence Marilyn Farley, and carried forward by today's Commissioner of Public Buildings Thomas Winstead and Director of Design Excellence and the Arts Thomas Grooms—the Design Excellence Program has literally turned our expectations of mediocrity in federal design on its head.

As a result of the Design Excellence process, we now enjoy an array of distinguished public buildings that represent high ideals, particularly in the construction of federal courthouses from Boston to the Pacific Northwest. Thanks to a carefully considered evaluative process, the roster of noteworthy architects with significant completed federal projects who might never have submitted a proposal for government work in a more politicized climate now includes the likes of Richard Meier, Cesar Pelli, KPF, Pei Cobb Freed, Perkins+Will, and Leers and Weinzapfel. Thom Mayne, FAIA, and his firm Morphosis have completed one major project (NOAA), with two more noteworthy and imaginative commissions soon to open (the GSA office building in San Francisco and the Eugene, Oregon, courthouse).

The nation would be poorer without them, thanks to the program and to the peers. Unlike most contemporary design and construction programs, which are based on pragmatic concerns, Design Excellence evolved from principles that comprise a value system. While acknowledging that public architecture should be "efficient and economical," Moynihan stated that design be contemporary and regionally appropriate yet "reflect the dignity, enterprise, vigor, and stability of the American government." We are not accustomed to such language today, yet the search for its implications seems to encourage a quest for quality in each project.

The peers must also grapple with issues facing each public building in the 21st century that broaden the original principles. Among them are the following: Iconography—defining who we are in a global world; Security—asking if, in a terrorist-threatened world, we simply move out of town and abandon the urban experiment; Transparency—government of and by the people, strongly advocated by Moynihan and others; Access—for all citizens, young and old, completely barrier free; Context/Siting and Urban Relationship—unique characteristics, from geography to an intended structure's place within a community; Sustainability—determining if a building will serve as a beacon of contemporary energy usage; Historic Preservation, Productivity, and Comfort—for all inhabitants, visitors, and workers.

Although they will not design the future projects themselves, by serving on evaluative juries and ranking submissions, by suggesting participants, by helping to frame the arguments, the peers will help lead the federal government toward informed choices of the best architects for significant projects. Additionally, by meeting with the future occupants and community groups (whether they be judges, managers of federal programs, customs officers, or clerical workers), they can act as knowledgeable ambassadors, expanding public awareness and appreciation for architecture.

Moynihan articulated the role at the outset: "Design must flow from the architectural profession to the government, and not vice versa." Ultimately, the Design Excellence peers, together with the GSA leadership that chooses and supports them, and the professionals that execute the work, will help define the public face of 21st-century American architecture. The program has become invaluable in elevating the role of architects and architecture in public life and deserves our vigilant and continued support.

As promised, McGraw-Hill Construction has launched an interactive forum on sustainability. We welcome your opinions. To gain access, go to [forums.construction.com](http://forums.construction.com).

## Record News

### New York's toniest residents clash over Norman Foster design

A proposed residential tower by Foster and Partners for New York's Upper East Side has sparked conflict between neighbors, pitting preservationists against the local artists, designers, and gallery owners who hope to see the building constructed.

The Foster design would see a 30-story pair of intersecting, elliptical glass towers built on top of the existing 1950 Parke-Bernet Gallery building at 980 Madison Avenue, opposite the famed Carlyle Hotel. It would also restore the Parke-Bernet building to its original four-story design by Walker & Poor, which would involve removing a fifth story that was

added in the 1960s, converting two floors to gallery space, and adding a public roof garden below the towers.

During a presentation at an October 24 New York City Landmarks Preservation Commission hearing, Foster argued that such ambitious architecture isn't out of place in the neighborhood, and pointed to the Carlyle, the Guggenheim Museum, and the Whitney Museum as examples. "The nature of the Upper East Side, interestingly, is that constant of change and renewal," he said. "It's a kind of a tradition of radicalism."

Tradition or not, many residents aren't keen on the development, say-



ing the scale and style of the building isn't appropriate for the neighborhood. At the recent hearing, Teri Slater, cochair of Defenders of the Historic Upper East Side, called the building an "oversized, ovoid, glazed conceit of a project." She added developer Aby Rosen was merely trying to distract preservationists by hiring an internationally famous architect to come up with the design. Ward Blum, another resident of the area, said, "Approving this design proposal would be like the philhar-

monic inviting a heavy-metal punk rocker to join the orchestra," concluding, "Our district should not be a petri dish for design experiments."

But the list of those supporting the project is just as long, and includes many high-profile names. Richard Meier, FAIA, has offered public testimony before the Landmarks Preservation Commission in support of the project, while artist Jeff Koons framed the debate as one of "segregation, discrimination," saying that opponents are sending the message, "If you like Modernism, don't live in the Upper East Side."

The project is presently under consideration by the commission, and a decision is expected early next year. *Tim McKeough*

### In Beirut, the show pauses, then goes on

"Beirut: a thousand times destroyed, a thousand times reborn" is a saying popular enough to have once graced the posters of Lebanon's national airline. Except for the bombing of Beirut airport and important infrastructural arteries, however, forthcoming architecture projects in the capital city have emerged unscathed from the recent tension between Lebanon and Israel.

Prior to the Lebanon-Israel conflict, Beirut's most comprehensive rebirth was begun under a reconstruction campaign spearheaded by the country's late prime minister, al-Hariri, through Solidere, The Lebanese Company for Development and Reconstruction of the Beirut City Center. Established in 1994 following a 15-year-long civil war, Solidere commissioned leading architects to give a new face to the city.

The plethora of Solidere-sponsored projects includes the city's new marina, designed by Steven Holl Architects and L.E.F.T. and for which excavation just began; completion is expected by 2009. The project is of major significance for a nation of seafaring merchants. It

is conceived as an urban beach of public spaces; its centerpiece building, which will include apartments, a yacht club, shops, and restaurants, comprises staggered volumes to recall the lapping of waves.

The London-based landscape-design firm Gustafson-Porter is also playing a large role in the Solidere operation with Shoreside Walk, a redesign for a stretch of former shoreline, and the Garden of Forgiveness, a green space emphasizing the common ties of people seeking reconciliation after civil strife. Neil Porter, a director at Gustafson-Porter, speaks with passion about working in the city: "While it may be an environment where money is not so easily found, awareness of essential principles such as design integrity and ecological sustainability make working in Beirut a challenging and rewarding experience." The Garden may take on new meaning as cross-border tolerance is debated; the recent spate of violence has delayed realization, perhaps to 2009.

Jean Nouvel, acclaimed in the region for his Arab World Institute (IMA) building in Paris, designed a



Excavation has just begun on Beirut's new marina, by Steven Holl and L.E.F.T.

cutting-edge, multipurpose development currently being built downtown. The \$200 million complex, due to be completed in 2008, will feature a 40-story, campanilelike tower soaring above the city center. The limestone-colored tower will be sheathed in perforated aluminum shutters, recalling the latticework of the traditional Arab house, which also inspired the IMA entrance facade.

Not all design-luminary-linked projects have been commissioned by investors like Solidere. Vincent James Associates Architects (VJAA) has designed a soon-to-be completed student center for the American University in Beirut, a century-old institution that is also the patron of a building by Zaha Hadid that will open in 2008. "It's an opportunity to deal with critical environmental and energy-saving-related issues, while catering to the needs of a really dynamic society and reflecting the

lifestyles generated by the Mediterranean climate," VJAA principal Jennifer Yoos says of the project. The VJAA design features carefully articulated masses interspersed with open courtyards to capture hillside breezes, and it provides students with a mix of common spaces, including the rooftop terraces that define the local quality of life.

Many of the heavyweight architect-planners working in Beirut, such as Boston-based Hashim Sarkis, who has completed a variety of projects in the city, and L.E.F.T. founders Makram el-Kadi, Ziad Jamaeddine, and Naji Moujaes, have ancestral ties to Lebanon. And although their designs have weathered the recent storm, like the rest of their resilient compatriots they're holding their breath for fear of renewed political instability—while engaging in that quintessentially Lebanese tradition of awakening the phoenix. *Seif El Rashidi*

Feels great  
at home and at the office.



*Look Beyond®*



Comfort Ti AC23™ from AFG.  
The energy savings deserve a look.



To learn more, visit [www.afglass.com](http://www.afglass.com) or call 800-251-0441  
AFG Glass • P.O. Box 929 • Kingsport, TN 37662 • [www.afglass.com](http://www.afglass.com)

CIRCLE 14 ON READER SERVICE CARD OR GO TO [ARCHRECORD.CONSTRUCTION.COM/PRODUCTS/](http://ARCHRECORD.CONSTRUCTION.COM/PRODUCTS/)

### The Glass House to open to public this spring

Two years after Philip Johnson's death, his Glass House will open to the public for the first time this spring. The New Canaan, Connecticut, estate, run by the National Trust for Historic Preservation, promises to serve as a living landmark while it houses a progressive cultural institution.

Occupying over 47 acres and totaling a dozen structures including galleries, sculptures, follies, and the Glass House itself, the estate stands as a timeline of sorts for Johnson's life and influences. "In its day, the Glass House was a nexus for architects, artists, and writers," explains Christy MacLear, the site's executive director. "We want to recreate that through the opening."

To realize that goal, the Glass House will sponsor high-profile programs and publications, as well as residential fellowships beginning in

2008. MacLear particularly hopes the residency can revive the cooperative atmosphere the estate fostered in years past, when cultural heavyweights such as Andy Warhol, Fran Lebowitz, and Vincent Scully were frequent guests. Works on the site were inspired by the camaraderie and input of Johnson's contemporaries—such as his Ghost House, a faux edifice built entirely from chain-link fence in 1985, which stands as a tribute to his friend Frank Gehry. In that spirit, fellowship participants will range from artists to industrial designers, and will work for six to eight months on individual projects.

Before fans and fellows can visit, major repairs of the Glass House must be completed on areas such as the roof and brick foundation, which fell into disrepair during Johnson's final years. Eight



Starting in April, once repairs are done on the Glass House and other areas, much of Philip Johnson's New Canaan estate will open to the public.

of the structures will be open to the public, with the first tours starting in April to select donors. The estate will be open annually from April through October.

This is the second Modern masterpiece to enter the trust's portfolio, after the Farnsworth House, allowing for more of the

general public to appreciate the work of the era. The imprimatur of the popular National Trust also secures midcentury architecture's place as history deserving to be saved. "It's exciting," MacLear says. "We get to introduce the importance of preservation to a whole new audience." *Dan Rubinstein*

### Beloved L.A. landmark reopens

Talk about Hollywood facelifts. The flamboyant, John C. Austin–designed Griffith Observatory reopened on November 3. The beloved Angeleno, which has appeared in the films *Rebel Without a Cause*, *The Terminator*, and *Charlie's Angels: Full Throttle*, is finally ready for its closeup after a four-year, \$93 million overhaul.

Local executive architects Pfeiffer Partners and associate

architects Levin & Associates, and New York–based exhibition designers C&G Partners, restored the building's facade and existing facilities, upgraded technical infrastructure, and added 40,000 square feet of new exhibition, learning, and public space. Stephen Johnson, FAIA, a Pfeiffer partner, says the goal was not to disturb the observatory's legendary white concrete facade and four copper domes, so the firms

built most additions under the north-facing front lawn of the existing building, lifting much of the museum on hydraulic jacks to accommodate excavations.

New facilities include a multi-level exhibition gallery and a 200-seat cylindrical presentation theater; the existing planetarium has been completely updated with an acoustical dome and new projectors, sound, and lighting. On the western edge of the hilltop site, a new "transit corridor" terrace is clad with bronze-colored aluminum and glass and contains a new café as well as large instruments that allow visitors to track the movements of Earth in relation to the Sun.

On the building's main level, its Art Deco architecture is maintained, while underground visitors get the feeling of being in space. Rubber-floor patterns emulate gases in the cosmos, and planetarium-seat fabrics are printed with phases of the

moon. C&G Partners' exhibits include the *Big Picture*, the largest astronomical picture ever created, a scale model of the solar system, a heliostat, and a giant moon rock displayed in a large glass case.

Levin & Associates headed the restoration of the existing building, a massive task that included removing and replacing lead-based paint, filling cracks and holes in the building's surface, repairing and waterproofing copper domes, replacing the planetarium's dome, cleaning interior murals and sculptures, and restoring the walls, ceilings, and travertine marble and rubber-tile floors. The firm also opened alcoves, windows, and large rooms that had been filled in over time.

The renovation was paid for by a partnership between the City of Los Angeles, the Department of Recreation and Parks, and the nonprofit *Friends Of The Observatory*. *Sam Lubell*





## Comfort Ti AC23™ from AFG. The energy savings deserve a look.

Comfort Ti-AC23™ is a new low emissivity glass designed to maximize solar control and air conditioning efficiency in Sun Belt regions while maintaining a very attractive appearance. This next-generation low-emissivity product is the newest product innovation from industry leader AFG Glass.

With a solar heat gain coefficient of 0.23—among the lowest in the industry—the newest member of AFG's Comfort Ti™ family of low-emissivity (low-e) sputter-coated glasses is ideal for climates where air conditioning is the primary year-round energy concern. Comfort Ti-AC23, with its combination of low reflectivity, excellent light absorbing properties, and its ability to block the sun's most warming wavelengths of energy, provides one of the highest light-to-solar-gain ratios of 1.74 when deposited on clear glass. The product is ideal for coastal regions as it meets Turtle Code specifications. (<0.45 Visible Transmittance). Its unique combination of powerful solar control with a "neutral look" makes Comfort Ti-AC23 an ideal solution for a range of residential and commercial applications where heat-gain, glare, and aesthetics are a concern.

### AFG Comfort Ti-AC23 Performance Data

Glass Thickness	Air Space	Winter U-value		Summer U-value		% Transmittance			% Reflectance			Shading Coefficient	SHGC	RHG	
		Air	Argon	Air	Argon	Visible	Solar	UV	Vis out	Vis in	Solar			Air	Argon
SGL	1/2"	0.30	0.24	0.28	0.22	41	20	20	11	11	34	0.27	0.24	59	56
1/8"	1/2"	0.30	0.24	0.28	0.22	40	19	19	12	11	33	0.27	0.23	58	55
5/32"	1/2"	0.29	0.24	0.28	0.22	40	19	17	12	11	31	0.27	0.23	58	55
3/16"	1/2"	0.29	0.24	0.28	0.22	39	18	16	13	11	29	0.27	0.24	58	56
1/4"	1/2"	0.29	0.24	0.28	0.22	38	18	16	13	11	27	0.27	0.23	58	55

All values are for center of glass and were obtained using LBNL's Window 5.2 software  
All make-ups are Comfort Ti-AC23 outboard (coating on surface #2), 1/2" air space, and Clear inboard



To learn more, visit [www.afglass.com](http://www.afglass.com) or call 800-251-0441  
AFG Glass • P.O. Box 929 • Kingsport, TN 37662 • [www.afglass.com](http://www.afglass.com)  
CIRCLE 15 ON READER SERVICE CARD OR GO TO [ARCHRECORD.CONSTRUCTION.COM/PRODUCTS/](http://ARCHRECORD.CONSTRUCTION.COM/PRODUCTS/)

### An Amazonian capital rediscovers the Amazon

Manaus is Brazil's great Amazonian metropolis, a 1.5-million-person industrial city isolated in the middle of the rain forest, readily accessible only by airplane or riverboat. Rapid development over recent decades has nearly erased the presence of the rain forest itself; within the city, it's hard to find a single tree. Now, with a \$200 million infrastructural makeover, local authorities are attempting to recover some of Manaus's natural past.

The targeted areas are the stagnant, sewage-strewn *igarapés*, waterways that lace through the cen-

tury-old port facilities, shopping centers, and densely packed residential neighborhoods of Manaus and feed directly into the Rio Negro. Thousands of hand-built wood and brick *barracos* have encrusted the swampy areas, sharing space with small alligators, legions of rats, and piles of waste. Whole elevated shantytowns, housing some 7,500 families, perch precariously on stilts and link to solid land by a network of planks. During the months-long flooding season, polluted water inundates the shacks.

Financed largely by the Inter-American Development Bank, the

local government is relocating the *igarapés'* inhabitants to new housing developments on the city outskirts and demolishing the water-bound villages. The waterways are to be fitted with drainage and sewage treatment systems, filtered for pollutants, and then reshaped into landscaped parks or seeded with native tree species. Some of the streams will be culverted and some will become canals. Those in charge of the project say it will have a wide-ranging impact on sanitation, social welfare, and the environment.

Whatever the project's promised benefits, *igarapé* dwellers feel

ambivalent. Terezinha Souza, is a 62-year-old hairdresser who has lived along the *igarapés* for 40 years. When she first moved there, people simply lived on floating shacks. "It's a tradition of the people to live here," she says. The principal option for those forced to leave is a 580-square-foot government tract home located far from downtown.

Work on the *igarapés* began last year. As of late August, about 3,700 families had relocated, according to the local housing agency. The project is expected to take approximately 12 years. *David S. Morton*

### Students fashion new home for Lower Ninth Ward landmark

During the spring and summer of 2006, Project Locus, a nonprofit corporation dedicated to addressing underserved communities, rounded up architecture students from the University of Montana, Kansas State, Tulane, and a host of other schools to rebuild a New Orleans gem that had been lost to Hurricane Katrina. Housed in the detached garage of Ronald Lewis's home in the Lower Ninth Ward, the House of Dance and Feathers contained his extensive collection of

relics of New Orleans' black culture.

Second Line Parade and Mardi Gras Indians' costumes, Social Aid and Pleasure Clubs photographic histories, and other artifacts were central to New Orleans's historically disenfranchised black community. Until the mid-1950s, for example, African-Americans were prohibited from participating in the official "main line" Mardi Gras celebrations. In response, they created their own Second Line Parades, where community members donned intricate

beaded costumes incorporating African and Native American aesthetics and danced down the street. Lewis's museum amasses needlework from the festivals and holds classes in the craft.

The house was only 65 percent intact after the hurricane; Lewis was able to spirit away most of his collection before Katrina made landfall, although the storm destroyed everything left behind. He was on-site during the 2006 spring break when students cleared debris from the site

and researched the Lower Ninth, and again this summer when they came back to rebuild. Project Locus executive director Patrick Rhodes led the \$40,000 rebuilding project. Many members of his 35-student construction team, representing schools from throughout the country, traveled to the site at their own expense—and for no college credit.

Reopened this fall, the 384-square-foot building features a rectangular footprint rotated on the original foundation; for additional space, a deck wraps the museum and travels across the yard. It is also marked by two separate roof structures: The primary, corrugated-metal roof hovers on metal struts over a secondary, corrugated-plastic roof, serving as an umbrella and as a chimney for radiant heat. The interior is also a dedicated multitasker, because displays are actually hinged exterior panels that open and close for natural ventilation. Lewis now looks upon his reborn neighborhood beacon through a new sliding glass door, one new feature of the \$50,000 home renovation also donated by Project Locus and the students. *Leigh Batnick*





# UNCONTROLLED, WATER SHAPES NATURE.

Controlled,  
it can shape  
our future.

## The Sloan Water Conservation Division

was established to identify and develop the most advanced plumbing conservation systems — products which control water and contribute toward LEED® credits. Sloan is **THE** Water Conservation Company.

- Solis™ Solar-Powered Faucet
- Waterfree Urinals
- FLUSHMATE® 1.0 gpf Pressure-Assist Units
- Crown® HET Flushometers
- Dual-Flush Flushometer
- XLerator® Hand Dryers

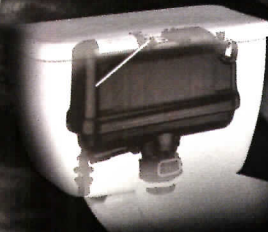

For more information call  
800-9-VALVE-9 (800-982-5839) ext. 5609  
[www.sloanvalve.com](http://www.sloanvalve.com)

In China: Sloan Valve Water Technologies (Suzhou) Co. Ltd.  
Suzhou New District, China • [www.sloan.com.cn](http://www.sloan.com.cn)

CIRCLE 16 ON READER SERVICE CARD OR GO  
TO [ARCHRECORD.CONSTRUCTION.COM/PRODUCTS/](http://ARCHRECORD.CONSTRUCTION.COM/PRODUCTS/)

## A conservative outlook for Toronto offices

Much has changed about Toronto since Paul Goldberger, as architecture critic for *The New York Times*, noted in a 1992 column that the city "hasn't been much of a place for architecture."

Since then, an uncharacteristically adventurous agenda initiated C\$1 billion of cultural facilities, including a Frank Gehry remake of the Art Gallery of Ontario and a Daniel Libeskind addition to the Royal Ontario Museum, which are under way. Yet Toronto will not quite retreat to its more subdued status quo next year when work begins on 3.1 million square feet in three office towers. Tall, sleek, and sedate, they are the first to be built in the downtown core since the early 1990s, when a recession froze office construction.

Brookfield Properties Corporation is resurrecting Bay-Adelaide Centre, a 1.1-million-square-foot, 50-story office tower with adjacent hotel and condo whose clock stopped 13 years ago; local architects WZMH designed the first

scheme for Trizec Hahn, the original developer, and its subsequent incarnations. The 30-story, 780,000-square-foot tower 25 York, a joint venture of Menkes Developments, Hospitals of Ontario Pension Plan, and Halcyon Partners Fund, is designed by Adamson Associates in association with Sweeney Sterling Finlayson & Company. And the Cadillac Fairview Corporation will build the 43-story, 1.2-million-square-foot RBC Centre while also co-developing an adjacent 53-story Ritz-Carlton Hotel and Residences; Kohn Pederson Fox Architects designed both buildings. All three projects will be completed by 2009.

Bruce Kuwabara, a founding partner of Toronto's Kuwabara Payne McKenna Blumberg Architects and one of Canada's most prominent architects, says the three towers do not challenge the city's architectural fabric because "after a long drought in office buildings, neither Toronto developers nor the market can make a big statement about design."



Office towers are rising again in Toronto, with (from left to right) RBC Centre, 25 York, and Bay-Adelaide Centre, all due for completion in 2009.

The city's entrenched conservatism is compounded by memory of the early 1990s, when downtown Toronto's office vacancy rate shot past 20 percent. While the developers landed the anchor tenants they needed to warrant new construction, they are by no means heading into an unstoppable market that would fill the rest of the space.

In September, a CB Richard Ellis Limited report noted that growth in the office sector had stopped nationwide, except for Calgary. Toronto's vacancy rates during the second quarter rose from 8.7 to 9 percent, and CB Richard Ellis expects that rate to increase to 10.2 percent when the three towers are completed.

Even though neither the current crop of office buildings nor market forces promise to give

Toronto office developments an architectural jolt, the three forthcoming projects do set a higher urban-design standard among the mainly undistinguished structures on the city's skyline.

James Parakh, an architect and senior urban designer in the City of Toronto's planning department, is enthusiastic about their contributions to the public realm, which include new plazas and extensions to the downtown's underground PATH shopping complex. Kuwabara concurs, adding that the three towers will rebalance the mix of uses in the wake of a condo boom downtown: "It's the vibrant mixed-use downtown that Toronto should be about, connected to the commuter line, with an urban design that emphasizes pedestrian connections." *Albert Warson*

## B&B Italia enters contract furniture market

Ay, there's the rub—45,000 Martindale rubs, to be exact. The Modern home furniture manufacturer B&B Italia is subjecting itself to higher durability standards with a first foray into the contract market. Its nine-piece Project Collection was previewed at the Milan and NeoCon

furniture fairs, and was officially launched at the October trade show Orgatec, in Cologne, Germany.

While the boom in nonresidential construction has encouraged B&B's branching out, Project Collection manager Paul Statham also attributes the move to interior-design trends: "We've seen a general increase in the amount of home furniture being specified for

the contract market," he says, also noting that "the office landscape has changed: The amount of space being dedicated to collaboration, meeting, lounge, and other front-of-house areas has doubled, and we reckon it's going to be 50 percent of a building. Usually that means you're looking at soft seating, tables, and chairs, and B&B is strong in those areas."

The company has reengineered some domestic favorites for the collection, such as the Uwe Fischer-designed Sina chair. It also features innovative new products. A new co-molding technique made it possible to realize Antonio Citterio and Toan Nguyen's Ottochairs:

Two different plastics are injected and fused in the same mold to give the chair a firm seat and a softer, more flexible splat. Hollow, an armchair and two-seat sofa by design superstar Patricia Urquiola, also features a unique combination of materials. Its arms and backrest comprise concave plastic panels lined in upholstery or leather. The pairing tops delicate varnished or chromed legs. All products' dimensions and finishes coordinate so that architects and designers can "mix and match within and across families," Statham says.

Although Statham won't decide on a North American distribution plan until next year, specifiers in the States can order Project Collection items through B&B's two New York stores now. *David Sokol*



 imagePROGRAF®

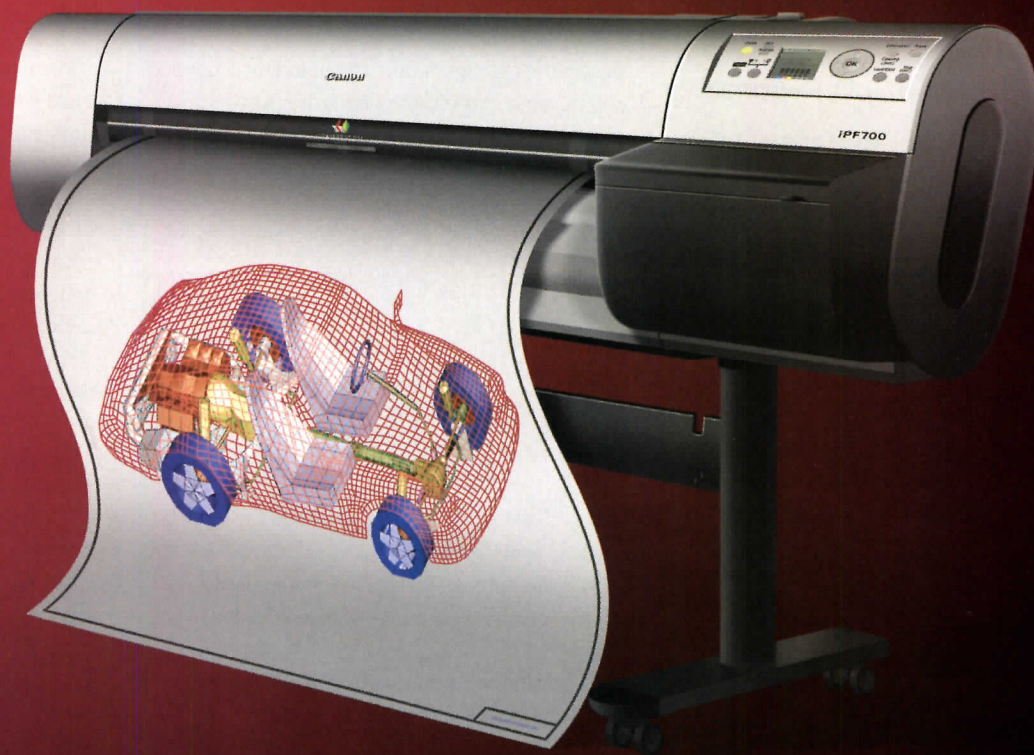

## What's next for technical drawings. Canon technology.

Introducing the 36" Canon imagePROGRAF® iPF700. D-size output in 40 seconds at 1200 x 1200 dpi.

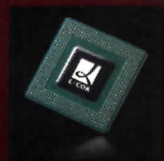

Here it is: the perfect choice for technical design professionals. It all starts with our exclusive L-COA controller chip, which intelligently performs multiple tasks with great quality and speed. This allows for advanced, rapid output of CAD drawings, maps and other renderings requiring fine lines and text, all with remarkable accuracy and incredible consistency. Canon L-COA technology is present in our entire line of Corporate and CAD printers, such as the 17" iPF500 and 24" iPF600. Then there's our proprietary reactive ink technology, which combines matte black ink with cyan ink, to prevent ink bleed between color and black text. The results: clear text, smooth curves and sharp lines, regardless of media. All of which makes for the perfect blend of speed and quality for technical applications.

**The new Canon imagePROGRAF Corporate and CAD Series.  
It's what's next for color.**

[www.usa.canon.com/isg/whatsnextforcolor](http://www.usa.canon.com/isg/whatsnextforcolor) 1-800-OK-CANON

**Canon**  
image*ANYWARE*

The Door With A Split Personality



Automatic Operation  
When You Need It,  
-and-

Balanced Door Operation  
When You Don't.

Balanced doors will never be the same thanks to this completely unobtrusive, ingenious, automatic door operator. It's perfect for ADA applications and excellent for smoke evacuation. And, like all Ellison products, it's built to last.

**ellison**

BALANCED DOORS  
& CUSTOM ENTRANCE SOLUTIONS

www.ellisonbronze.com

800.665.6445

CIRCLE 18 ON READER SERVICE CARD OR GO  
TO ARCHRECORD.CONSTRUCTION.COM/PRODUCTS/

Record News On the Boards

Hyatt Regency expansion by Gensler

During the Chicago winter, the notoriously bone-cutting wind chill often renders the riverfront desolate. A Gensler-designed expansion to the Hyatt Regency, which will give the hotel a presence on the Chicago River, might make this part of the city's landscape hospitable year-round.

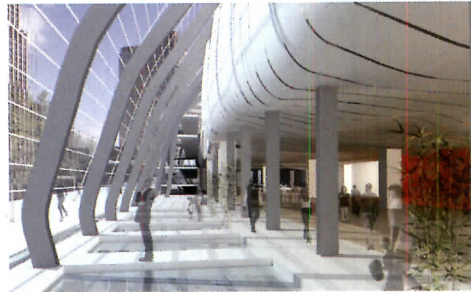

Expansion will take place under the roadway (below) and a glassy front will appear at the river.

Still in the early stages of planning, the 150,000-square-foot addition, housing a hotel exhibition hall, retail space, and concert venues, would occupy a closed stretch of roadway beneath Lower Wacker Drive, emerging at the riverfront as a triple-glazed, faceted-glass curtain wall. Besides making a new architectural statement, the project should reinvigorate the abandoned thoroughfare and invite Michigan Avenue pedestrians to access the riverfront.

In addition to the energy savings afforded by triple glazing, the wall's integrated turbines will harvest the Windy City's namesake renewable energy to generate electricity for the hotel, and a geothermal system will heat and cool the building. The slightly curved form of the wall will help capture rainwater, and act as a light scoop to bring natural daylight beneath the multilevel Wacker Drive structure.

Soon after Gensler was hired by Hyatt to plan the expansion, city officials tapped the firm to remake the riverfront, spanning from the hotel to Lake Michigan's Navy Pier. Tentative plans call for a multiuse promenade and space for a farmers' market. The exhibition hall will be finished by summer 2009, although the broadened scope of work will likely postpone completion of other aspects of the Hyatt project. When it is finished, the architects will seek LEED Platinum certification. *Violet Law*



City of Capitals by NBBJ



While five- and six-story buildings predominate in Moscow, the city's few high-rises mark different eras of its history. The eclectic Seven Sisters towers were built during the last years of Stalin's rule. Now, the immense City of Capitals, a 3.7 million-square-foot building designed by

NBBJ, is helping to write the latest chapter of the city's tale. NBBJ partner in charge Friedl Bohm says the complex will be Moscow's first mixed-use skyscraper when it is completed in late 2008.

City of Capitals encompasses three of 12 building sites in Moscow City, a giant redevelopment zone first conceived by the local government

more than a decade ago. Located about one and a half miles from the Kremlin, the district is "a town in itself," Bohm says, and a destination for freshly minted wealthy Russians to call home.

Within City of Capitals, apartments are located in the 62-story or 74-story poured-in-place concrete towers that contain several units per floor. (In Russia, residential units are sold raw, so expect the place to be overrun with individual homeowners' contractors for a while.) These towers are subdivided into slightly rotated volumes, suggesting Russian Constructivist artwork. "Moscow City is looking for icon buildings," Bohm says of the historical interpretation, and he notes that "the core is so stiff that we can cantilever those twisting pieces very easily."

The towers share a podium, which is designated for office space, and the third South Building is devoted to offices and retail. All aspects of this new luxe life will be on display in the central atrium, a major circulation feature for all occupants. *D.S.*

Ellison balanced doors.  
Everything an entrance should be



and more.

They're incomparably beautiful, yet ruggedly hand constructed. They're engineered to open easily under heavy wind loads, and they perform dependably decade after decade in the busiest traffic conditions. For many designers they represent the ideal mix of elegance, functionality and old fashioned work ethic. Ellison Doors. Available in bronze, stainless steel, aluminum or wood. And optionally equipped with our unobtrusive patent pending automatic opening system — PowerNow.

ellison<sup>TM</sup>

BALANCED DOORS  
& CUSTOM ENTRANCE SOLUTIONS

[www.ellisonbronze.com](http://www.ellisonbronze.com)

CIRCLE 19 ON READER SERVICE CARD OR GO  
TO [ARCHRECORD.CONSTRUCTION.COM/PRODUCTS/](http://ARCHRECORD.CONSTRUCTION.COM/PRODUCTS/)

## O-14 by Reiser + Umemoto

Zaha Hadid's Dancing Towers may have won the international design competition for an iconic structure in Dubai, the first held by Dubai



Properties, but participating in the contest didn't come to naught for Reiser + Umemoto RUR

Architecture. Developer Shahab Lutfi had organized the event on behalf of Dubai Properties, and well before Hadid was even anointed the victor, RUR had gone into preschematic design on a commission from Creek Side Development Company, where Lutfi is a partner. The 300,000-square-foot O-14 office building breaks ground this month.

Situated on the artificially expanded Dubai Creek in the city's Business Bay district (where Dancing Towers also will rise), O-14's 22-story tower features two intriguing shells. A rounded

cruciform-plan volume sits within a parallel 1.3-foot-thick, steel-reinforced concrete wrapper. Floor plates connect the two forms via "tabs," eliminating the need for interior columns.

That outer shell is perforated with more than 1,000 rounded-diagonal openings. RUR principal Jesse Reiser, AIA, says the structure is a diagrid, "but we didn't want it to be so obvious, so we manipulated the solids and voids to create an almost painterly effect." The voids come in five sizes, measuring from 4 to 25 feet on one side.

Besides freeing the habitable core from wind, lateral, and earthquake forces, and establishing a unique aesthetic, the dotted outer skin exercises several passive solar techniques. It shields the core from brutal Middle Eastern sunlight, with

the assortment of holes, though seemingly random, neatly corresponding with views and sun exposure for building occupants. Further, where tabs aren't present, the 3-foot-long distance between internal and exterior shells creates a chimney for ventilating hot air before it can penetrate the core. The architects expect that, as a result, they can reduce air-conditioning load by 25 percent.

A cunning design, confident developer, almost-full tenant roster, and a breakneck design and construction timetable—was any aspect of this project second-guessed? That would be the name. Try as they might for an alternative, "O-14 is the plot number, it's what we finally came to," Reiser says. Presumably, SpongeBob references didn't hit the target. D.S.

RENDERING: COURTESY RUR



## COR by Oppenheim Architecture + Design

While at first glance, its sexy, Rat Pack surface seems more stylish than practical, Chad Oppenheim, AIA, says the giant polka-dotted shell of the mixed-use COR building in Miami, Florida, follows function. Multiple functions, actually.

The 400-foot-tall structure is stuck on a tough site: cramped for space, oddly shaped, just steps from a highway, and yet zoned to require ample parking. "Our challenge is how to fit the parking, not destroy the street experience, and generate an architecture that cloaks the experience," Oppenheim explains. Deploying a diagonally braced outer shell to carry lateral loads allowed the architecture and engineering team to eliminate shear walls and other structural elements inside, thereby making room for parking within the building.

And, with cars located roughly between levels two to 10, office and condominium occupants in the floors above are comfortably removed from the highway—and given better views of the downtown and Biscayne Bay.

"It's not really a whimsical, 'Here's great, cool-looking architecture,'" Oppenheim says of COR's logo-ready appearance. "It's more about how do we solve this problem, and we solve it by creating an exoskeleton." He also says the choice of circles was inspired by endemic MiMo architecture.

The exoskeleton solves other, equally urgent problems, such as neighborhood and environmental stewardship. At ground level, for instance, the concrete shell peels away from the internal volume, creating an arcade to shelter

pedestrians from the subtropical heat. It also provides thermal insulation and shading for that volume. In combination with Energy Star Appliances, LED lighting, and other measures, Oppenheim estimates 40 percent energy savings for the building. Also, as the shell extends beyond the penthouse level, it becomes an armature for wind turbines, the energy from which will light common areas such as hallways and the lobby. Solar hot-water panels, ringing the circular openings like glittering cuffs, will heat the condo swimming pool. Although ground

breaking won't take place for another eight months, Oppenheim says he is aiming for a LEED Platinum rating. *D.S.*

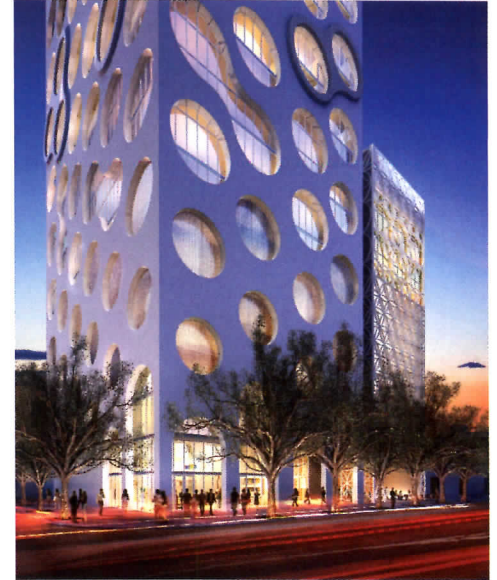

## The LONSEAL Collection

LONSEAL

[www.lonseal.com/ar2](http://www.lonseal.com/ar2)

comfort | brought to you by **Lutron® Shading Solutions**



2:30 pm: Afternoon sun makes it impossible to see your computer screen.



Glare reduced more than 80%.  
SheerNature™ PVC-free solar fabric.

glare | comfort

With a touch of a button, lower Lutron shades to transform harsh glare into useable daylight. Intelligent drive technology coupled with the latest in solar fabrics reduces solar heat gain and saves energy.

Make your space more comfortable and your employees more productive.

For more information on Sivoia QED™ shading solutions, call Lutron at **800.523.9466** or visit us online at **[www.lutron.com/SivoiaQED](http://www.lutron.com/SivoiaQED)**.



CIRCLE 21 ON READER SERVICE CARD OR GO  
TO [ARCHRECORD.CONSTRUCTION.COM/PRODUCTS/](http://ARCHRECORD.CONSTRUCTION.COM/PRODUCTS/)





# For and about the emerging architect

## archrecord2

DEPARTMENTS

In this month's archrecord2, it's all about the brand. For today's young firms, working with branding means more than littering our architectural landscape with logos and billboards. It means innovative architecture that reflects the values of a company—and brings the public into those spaces. Two firms show how it's done properly, one in Los Angeles and one in New York. Tune in online to **Design, Work, Live, and Talk**, where forums now let you speak your mind.

### Design

#### M(Arch): Brands and the built environment



Two architects and a strategic-marketing professional walk into a building. This time, however, it's no joke. Architect Todd Erlandson, AIA, and marketing guru Sherry Hoffman (center and right in photo, left), principals of Los Angeles-based architecture and branding firm (M)Arch, and (M)Arch project

architect Laura Hoad (far left in photo), have structured their firm into what could be a significant niche in the business of architecture. While some architects might scoff at a firm that puts its own star power aside to focus solely on a company or community's identity, these three are happy to concentrate on creating a holistic brand experience for clients that includes good design as part of the strategy, and keeps their egos out of the picture. "Becoming stars is the antithesis of who we are," says Erlandson, who has worked for Richard Meier & Partners and Skidmore, Owings & Merrill, and teaches a course about branding and architecture with Hoffman at the Art Center College of Design in Pasadena, California. "We are focused on creating significant work, not signature work."

To these three, creating significant work means defining a company's values, and maximizing those values into a built environment, whether it be for a corporate headquarters, a preschool, a city, or a dental office. "Our goal is to translate the values of a company or community into architecture," says Hoffman, whose experience includes marketing positions at Young & Rubicam and Universal Studios. "Companies want to communicate their identity, and their physical environment can do that for them."

The 5-to-8 person firm, which began in 1998, has worked for such varied California clients as HBO Films, hip Los Angeles department store Fred Segal, and the City of Santa Monica. The (M)Arch team believes that buildings are important vehicles for

**Clover Park, Santa Monica, Calif., 2002**  
*Landscape and cladding communicate the city's identity and aesthetically blend new and existing office trailers into a lush public park.*

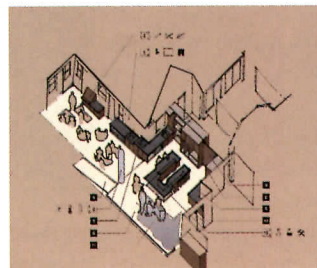
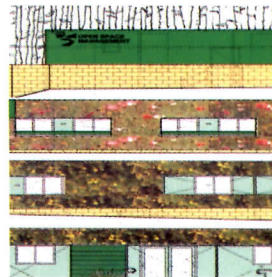
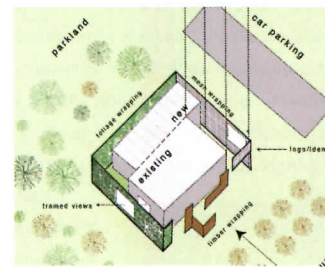

**The Children's Center at CalTech, Pasadena, Calif., 2007**

*A 600-square-foot arts and sciences lab for university preschool that reflects CalTech's culture.*

IMAGES: COURTESY (M)ARCH



Fred Segal Beauty, Santa Monica, Calif., 2007

Six-thousand-square-foot salon, spa, and retail space for L.A. beauty trendsetter.

communicating a message. "We offer a creative business strategy for our clients that encourages them to define who they are," says Erlandson. "The strategy applies to different areas of design, including logos, business cards, Web sites, and more, so we'll collaborate with graphic professionals to create the other material for a client. And context is everything. We pay attention to how this brand fits into the community in a meaningful way. We want to create something that will make a difference, expose the process, and give people a connection to a hot place."

And connecting with the public means designing structures that are more than boxes covered in logos and signage. "Brands are creating the landscapes of our cities," says Erlandson. "If we, as architects, don't step up and get into it, what will happen to our built environment?" *Ingrid Spencer*

For more information on these and other projects by (M)Arch, visit [archrecord.construction.com/archrecord2/](http://archrecord.construction.com/archrecord2/).

## Klingmann Architecture Brand Development



Anna Klingmann, principal of Klingmann Architecture Brand Development, has just finished a book about architecture and branding called *Brandscapes: Architecture in the Experience Economy* (MIT Press, 2007). The architect and educator, who transplanted herself to New York City from Germany many years ago, is raring to bring her expertise to the American marketplace. Having formally started her company in 2004, her clients have been exclusively European—German-based Robinson Resorts;

the City of Halle, Germany; and competitions for clients such as Adidas and the City of Prague. "I'm excited to work where I live," says Klingmann, "and I see the potential here, as real estate developers and corporations in recent years are realizing that good design can enhance the value of their brands."

While Klingmann's firm consists of about 3-to-4 people at any one time, she relies on collaborations with a network of professionals around the globe to accomplish the total package that a branding effort requires for a client. "We do the architecture and the master planning," she says. "We try to see the brand in a conceptual way. Not as a product, but as a catalyst—a strategic tool. We bring logic to the table, and magic."

Klingmann emphasizes that it's the values of the company that need to be shared with the public through architecture, and while that means that the building can help employees "live the brand," it also means that the public should be brought into the culture. "Corporations often close themselves off from the public with their architecture," she says. "That's an opportunity

### Oasis Resort, Agadir, Morocco, 2008

This project for Robinson Resorts contains a center envisioned as a lively souk, with residential communities designed as quiet villages nestled in a vast, sensual, and colorful landscape.

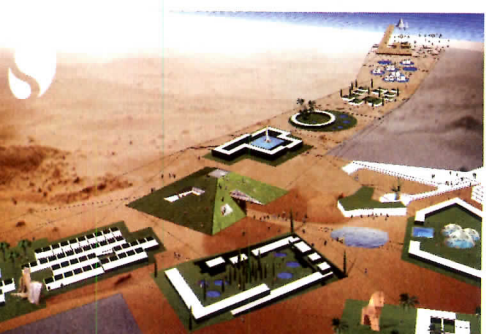

Audi Flyer, various cities, unbuilt

Flexible boutique spaces in urban areas would encourage exposure to the Audi brand.



lost. If clients have public spaces that create a physical experience for people, then architecture can serve a powerful role in communicating. By fencing themselves off, they create a feeling of distrust."

As an educator, Klingmann knows that brandism is still not quite accepted as a viable way to go about the business of architecture. "Academia is so concerned with 'shape making' that it often ignores the relevance of content," she says. "Architecture is more than just creating a cool object. It can make economic impact, improve a depressed area, and communicate a long-term strategy. We visit certain places because they are unique, so as the world becomes smaller, it's important that architects keep it from becoming homogenized." *I.S.*



### Kunsthalle Rebranding Study, Halle, Germany, 2004

To rebrand a derelict district of the city, Klingmann proposed turning it into a living urban sculpture park where a culturally attractive environment would create new economic opportunities.



For more photos and projects by Klingmann Architecture Brand Development, go to [archrecord.construction.com/archrecord2/](http://archrecord.construction.com/archrecord2/).

# Battling for better architecture: The argument for activist criticism

## Critique

By Blair Kamin

Here's one explanation for all the whining you've heard in recent months about the devolution of architecture criticism: Not enough critics today write like Allan Temko, the late, Pulitzer Prize-winning architecture critic of the *San Francisco Chronicle*.

All too often, today's critics play the role of the jet-setting formalist. They happily chase star-architects around the globe, but take a pass on going after hideous buildings in their own backyard. Some even characterize Temko's activist approach as nostalgic and outdated when, in reality, it's more relevant than ever. In the process, they're turning the serious business of evaluating the inescapable art into an aesthetic parlor game. This may fascinate the chattering classes. But it seems ever more disconnected from the lives of everyday people as well as the important but all-too-often ignored work of the profession's rank and file.

How do I know this? I've read a transcript of a critics panel, held last May in New York, that brought together four distinguished critics: Robert Campbell of *The Boston Globe*, Paul Goldberger of *The New Yorker*, John King of the *San Francisco Chronicle*, and Nicolai Ouroussoff of *The New York Times*. The panel was meant to honor Temko. Instead, it consigned his work to a dim, supposedly remote past—the equivalent of love beads and Flower Power.

*Contributing editor Blair Kamin is the Pulitzer Prize-winning architecture critic of the Chicago Tribune.*

Because I was unable to attend the panel, my own thoughts about criticism, based in many ways on Temko's, got more twisted than one of those new torquing skyscrapers. So RECORD editor Bob Ivy, the panel's moderator, has generously given me

Rachel Carson's *Silent Spring* alerted Americans to the environmental and human dangers caused by the indiscriminate use of pesticides, Temko became the *Chronicle's* architecture critic. He quickly began railing against ill-considered

In the early days, Temko fought his battles in a rambunctious, crusading newspaper that was in no way constrained by the ethical guidelines that bind today's journalists. He would write a slash-and-burn critique, slamming a design for a

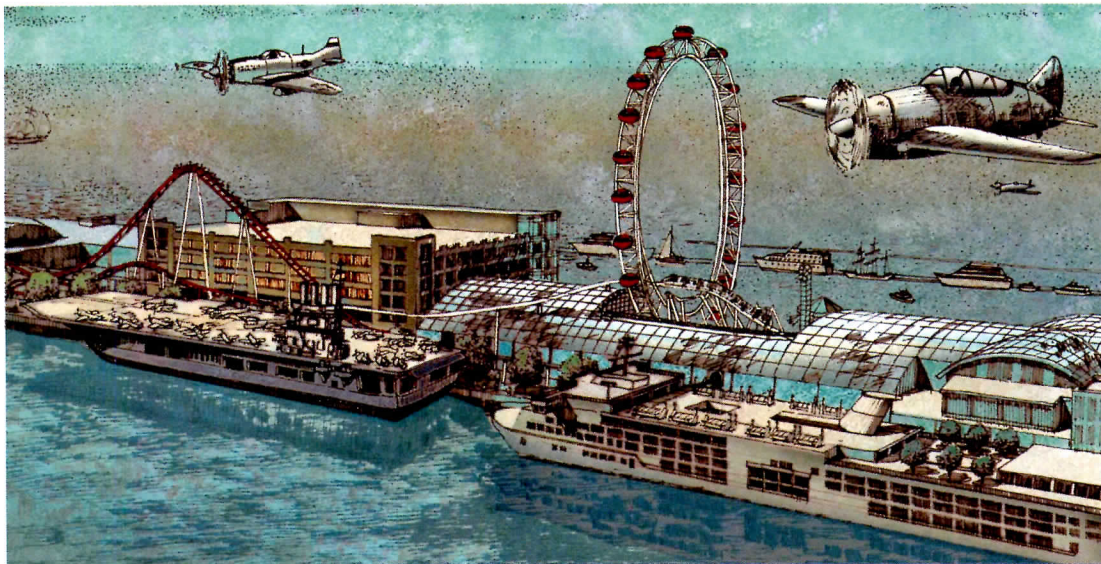

a chance to respond. Thanks, Bob. With a new generation of architecture critics coming to the fore at American newspapers, it's essential for both architectural journalism and architectural culture to put Temko's contribution in proper context.

Temko was a hell-raising humanist who had a piercing eye and a wicked wit. Along with the renowned Ada Louise Huxtable at *The New York Times*, he was one of the pioneers of modern architecture criticism. His take on the field was firmly rooted in the dawning environmental consciousness of the early 1960s.

In 1962, the same year that

plans—and raising his readers' sights.

As Temko wrote in *No Way to Build a Ballpark and Other Irreverent Essays on Architecture*, a collection of his columns published in 1993, “Suddenly the country

was being ruined before our eyes, smashed, raped, poisoned, stunk up and, not least, disfigured by inhumane and even hideous buildings ... A new environmental politics was needed, and with it a new journalism, not [Lewis] Mumford's rarefied jeremiads in *The New Yorker*, but war-in-the-trenches attacks on ugliness.”



**In the fighting spirit of the late critic Allan Temko (left), Blair Kamin attacked a design by Forrec Ltd. for Chicago's Navy Pier (above) before it could become a reality.**

clunky, out-of-date span across San Francisco Bay as a “Rip Van Winkle bridge.” Then he would pen an unsigned editorial praising the brilliant judgment of the architecture critic.

This sort of preemptive strike—not waiting for mistakes to happen, but going after them before it was too late—had an enormous impact. It

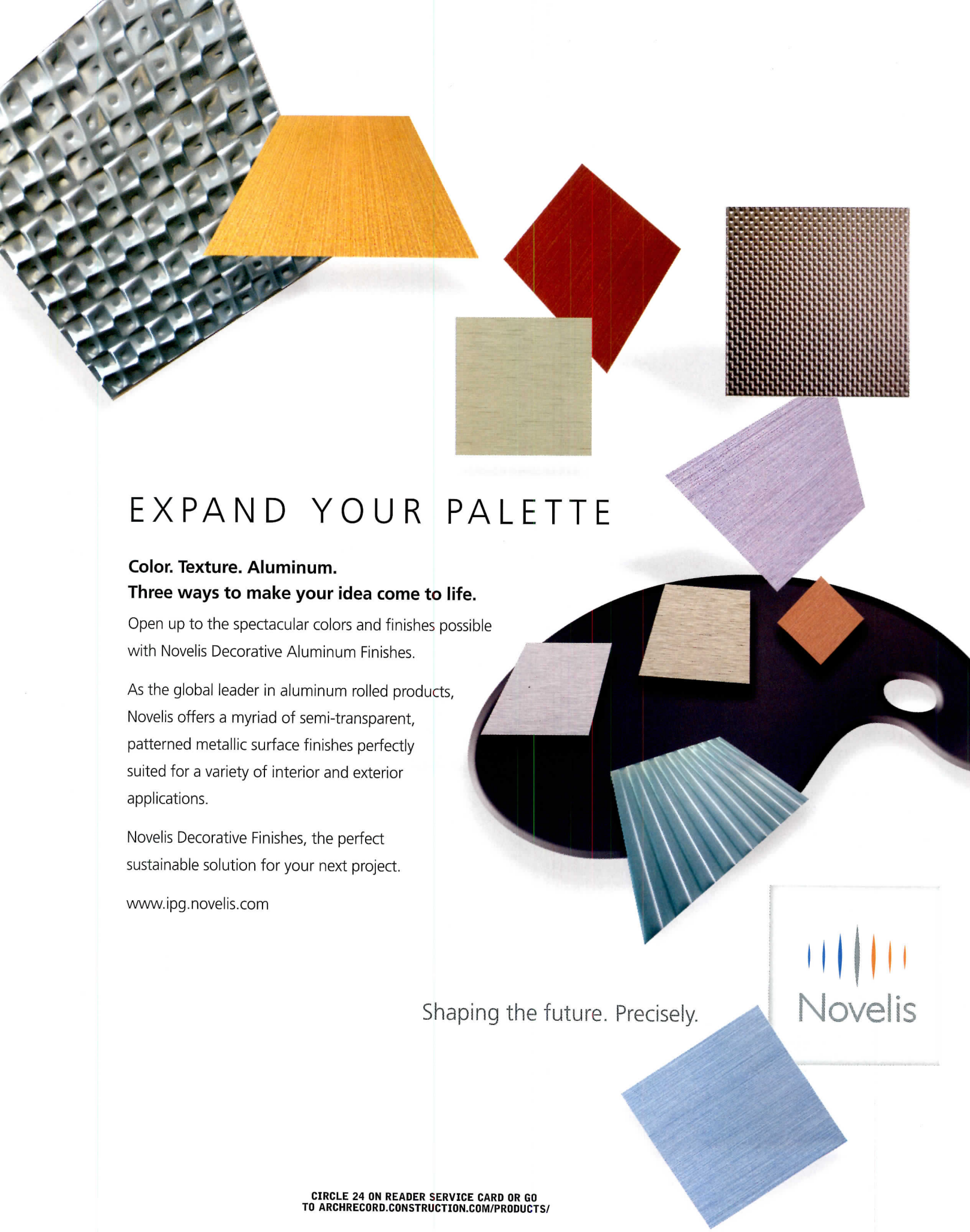

## EXPAND YOUR PALETTE

**Color. Texture. Aluminum.**

**Three ways to make your idea come to life.**

Open up to the spectacular colors and finishes possible with Novelis Decorative Aluminum Finishes.

As the global leader in aluminum rolled products, Novelis offers a myriad of semi-transparent, patterned metallic surface finishes perfectly suited for a variety of interior and exterior applications.

Novelis Decorative Finishes, the perfect sustainable solution for your next project.

[www.ipg.novelis.com](http://www.ipg.novelis.com)

Shaping the future. Precisely.

Novelis

CIRCLE 24 ON READER SERVICE CARD OR GO  
TO [ARCHRECORD.CONSTRUCTION.COM/PRODUCTS/](http://ARCHRECORD.CONSTRUCTION.COM/PRODUCTS/)

# Critique

resulted not simply in better bridges, but in better architecture, better historic preservation, better waterfront and coastal protection. The list could go on and on, as Temko himself, in fits of immodesty, sometimes let it. Once, after he gave himself one too many pats on the back during a lecture at the Illinois Institute of Technology, I watched in astonishment as Franz Schulze, Mies's biographer, simply got up and walked out.

But Schulze, an old newspaper guy himself, still loved Temko. And for good reason. While Temko could play the salon game, having written the definitive book on Notre-Dame of Paris, he was first and foremost a street fighter. He knew that a daily newspaper was a weapon that should be wielded in an entirely different way than a monthly architectural magazine. A daily newspaper isn't supposed to practice criticism by omission, ignoring

what it doesn't like. It's supposed to take on everything and connect with everyone.

And so, Temko cast his critical net beyond glamour buildings and ventured to jails, halfway houses, hospitals and other health-care facilities, such as a former San Francisco convent that was transformed into an AIDS hospice. Consider this sharply observed but remarkably sensitive 1989 piece about the hospice: "The mutual regard between the patients and staff is tactfully enhanced by the design. Little was done to the building, but the interior was reorganized and refurbished almost inch-by-inch to provide maximum comfort ... [I]n what had been a sacristy, a sound-proofed room with heavily padded walls allows for the release of grief."

This was one of the pieces that, in 1990, won Temko journalism's highest honor, the Pulitzer Prize. His deep engagement with his city and

his region undoubtedly explains why Temko's legacy was widely celebrated in the San Francisco Bay Area after he died in January at age 81. Ironically, however, the celebration did not extend to the very event meant to honor Temko.

At the panel, when Ivy asked whether critics should take a proactive (rather than a merely reactive) role, Campbell opined that the distinction is a false one. Even in a reactive story, he argued, you can make a proactive case. Which is true if you're solely interested in upgrading the level of dialogue over the long-term, but meaningless if you intend to change short-term outcomes—and stop stupid proposals.

If I had waited until after the fact earlier this year, Chicago might now be proceeding with a ridiculous plan to convert Navy Pier, the city's 3,000-foot-long waterfront attraction, into a giant theme park, complete with a Coney Island roller coaster. Yet shortly after the plan was unveiled, I wrote that it would inject the already-tacky pier with "lethal doses of future

schlock." Now the powers that be are consulting Helmut Jahn and other top Chicago architects to see if they can come up with something better.

My colleagues are kidding themselves if they think that just because Robert Moses isn't out there tearing up neighborhoods to build highways, other destructive forces haven't replaced him. We may have entered the age of mass good design, thanks to Starbucks and several decades of informed architecture criticism, but there are still decision-makers out there who just don't get it. Exhibit A: Ground Zero. And look at the way the government is surrounding federal buildings with security bollards that project paranoia and suck the vitality out of cities. Besides, they're ugly.

Whoops! I used the word ugly. "Ugly is the wrong word," Campbell said at the panel, with a quick second from Goldberger. Then Ourossoff chimed in about the need to fight for certain ugly buildings, like Frank Gehry's, to exist. Duly noted (and Temko's own too-

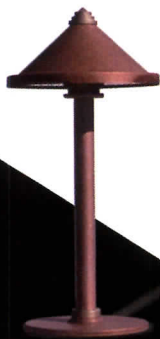

FORM MEETS FUNCTION

**B-K LIGHTING**  **TEKA ILLUMINATION**

www.bklighting.com • 559.438.5800 • www.teka-illumination.com

## Critique

rigid rationalism prevented him from appreciating Gehry's spectacular talent). But for every Frank Gehry head-turner that's ahead of its time, there are hundreds of shoddily built, poorly designed condo towers or apartment buildings trashing the urban fabric. And they're irredeemable blights.

When critics play the global game, they run the risk of missing the unglamorous but significant local design issue that hits readers where they live. I have tremendous admiration for the incisive and elegant writing that Ouroussoff and Christopher Hawthorne of *The Los Angeles Times* bring to national and international stories. Yet I wish they would write more often about the cities on their papers' nameplates.

Clueless cosmopolitanism is as dangerous as ignorant insularity. I'm talking about the critic who covers the world but treats his own back-

yard (or, at least, the non-starchitect buildings in it) as a flyover zone. That's a sure way to guarantee that you'll lose touch with readers. As Temko showed, confronting bad plans head-on—and doing it on your home turf, week after week, year after year—is the ultimate test of a critic's mettle.

So is the other side of the activist coin: The enterprise story or multipart series that focuses public attention on an essential civic issue, such as waterfront development or public housing, and points out best practices to local officials or architects. Those are the kind of impact-generating stories that aren't handed to you by publicists.

Needless to say, you do all this while writing on deadline and trying to articulate a position in today's "anything goes" world of design pluralism. My own approach is to argue for a set of underlying values—qual-

ity, utility, continuity, authenticity, and sustainability all come to mind—rather than a particular aesthetic. I judge the architecture, not the architect. And I ask to be judged not by one piece, but by how well I communicate those values over time—and to what extent they shape public debate and influence its outcome.

Temko retired in 1993, just as the Internet age was gaining steam. He didn't offer any models for the age of the World Wide Web, but I suspect that he'd be intrigued to see what's happening in Chicago today: The development of a small but highly competitive group of newspaper critics, broadcasters, and bloggers.

They are Kevin Nance at the *Chicago Sun-Times* (who splits his time between art and architecture criticism); Lynn Becker at the *Chicago Reader* and his *ArchitectureChicago Plus* Web site ([www.arcchicago.blogspot.com](http://www.arcchicago.blogspot.com)); Edward Lifson at WBEZ Public Radio; Edward Keegan at *Crain's Chicago Business*; and myself. Why are there so many of us? Perhaps

because Chicago is the first city of American architecture. But the real reason, I think, is fear of embarrassment: Architecture is a big story in this town and no one wants to get beat. So we compete ferociously, which keeps everybody on his toes.

Who wins? The readers—and the architects they hire. When it comes to criticism, more is more. More voices mean a higher collective visual IQ. And that invariably means more enlightened clients and better designs. Maybe there's a lesson here for other cities: Foundations and architecture groups should do everything they can to plant the seeds of dialogue in a variety of media outlets—not simply newspapers, but the Web, TV, and radio.

Globalism and the Web can be a positive force for criticism so long as you don't fall into globalism's trap: Going everywhere and writing with true insight and impact about nothing. In contrast, the journalistic debate in Chicago is spirited, fractious, and, most of all, engaging to the public. ■

Awant Modular Lounge | www.brayton.com | 800.627.6770

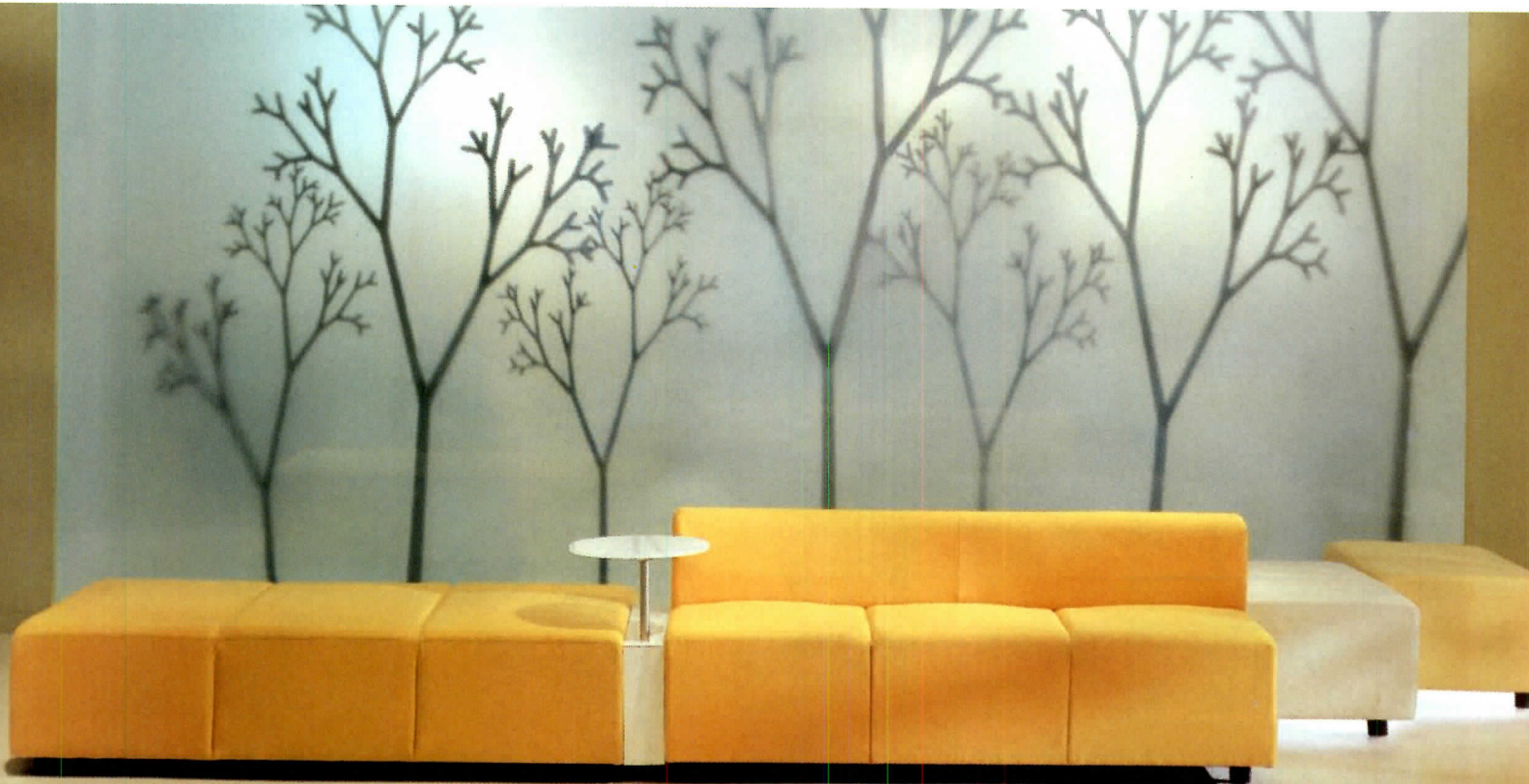

**brayton international®**  
A Steelcase Company

CIRCLE 26 ON READER SERVICE CARD OR GO  
TO [ARCHRECORD.CONSTRUCTION.COM/PRODUCTS/](http://ARCHRECORD.CONSTRUCTION.COM/PRODUCTS/)

# Long ignored, Eero Saarinen makes a grand comeback

## Exhibitions

By Clifford A. Pearson

**Eero Saarinen: Shaping the Future.** Curated by Donald Albrecht. At Kunsthalle Helsinki, October 7–December 6, 2006. Travels to Oslo, Brussels, Detroit, Washington, D.C., Minneapolis, St. Louis, New York, and New Haven.

In death, as in comedy, timing is everything. When it comes to Hollywood stars and politicians, an early death can preserve a romantic image from the corrosive effects of aging and the inevitable missteps of living through changing times. But for architects, passing away prematurely is usually disastrous, since most careers really get going only after a number of years in practice. When Eero Saarinen died in 1961 at the age of 51, though, he was arguably the most important architect in the United States, having designed iconic buildings for some of the most powerful corporations and clients in the land—General Motors, IBM, CBS, Bell Laboratories, the Department of State, and Yale University, to name just a few. And he was lucky enough to have associates in his firm, particularly Kevin Roche and John Dinkeloo, who could see his late works—including the TWA Terminal at JFK Airport, the Gateway Arch in St. Louis, and Dulles International Airport—through to completion after his death.

So you might think Saarinen would have benefited from the James Dean cut-down-at-the-peak-of-his-career halo effect. But Saarinen had the misfortune of dying right as critical opinion of his work was turning increasingly negative. In 1962, when Reyner Banham



At the dawn of the jet age, Saarinen designed the TWA Terminal at JFK (then, Idlewild) Airport, creating an icon that helped define a romantic image of air travel (above). Although best known for his corporate and public commissions, he also designed classic Modern houses, such as one for J. Irwin Miller in Columbus, Indiana (left).

# Exhibitions

saw Morse and Stiles Colleges at Yale, which Saarinen designed in a historicizing mode, he wrote, "Yale is a very sick place!" A few years later, Vincent Scully stated that Saarinen's Yale hockey arena with its swooping roof "embodied a good deal that was wrong with American architecture in the mid-1950s: exhibitionism, structural pretension, self-defeating urbanistic arrogance."

From the grave, Saarinen had no way of rebutting his critics.

Saarinen's reputation also suffered because his office's archives remained out of reach of scholars for more than 40 years. So instead of being rediscovered by new generations of architects and writers, he was relegated to a kind of architectural purgatory and barely mentioned in the standard histories of Modernism.

All that changed in 2002 when Roche (who took over Saarinen's practice) donated his master's archives to Yale and opened the scholarly floodgates. *Eero Saarinen: Shaping the Future*, a major exhibition that opened in October at the Kunsthalle Helsinki and will travel through Europe and the United States until the 100th anniversary of Saarinen's birth in 2010, is the first fruit of this effort to reexamine the architect's life and his body of work. Along with an accompanying book, edited by Eeva-Liisa Pelkonen and

Donald Albrecht, the exhibition strives to do nothing less than restore Saarinen's place at the center of Modern architecture and emphasize his relevance to architects practicing today. That's quite a tall order, and if the exhibition doesn't totally succeed in this glorious mission, it certainly goes far in reminding us why *Time* magazine put Saarinen on its cover in 1956, and how his buildings have continued to wow both the public and architects for so many years.

"Eero Saarinen is back," exclaimed Robert A.M. Stern at the exhibition's opening in Helsinki. As dean of Yale's School of Architecture, Stern helps oversee the Saarinen archives and worked with three other organizations—the Finnish Cultural Institute in New York, the Museum of Finnish Architecture in Helsinki, and the National Building Museum in Washington, D.C.—to mount the exhibition. Amazingly, the show is the first-ever Saarinen retrospective.

But the critical question is, whose Eero do we see in this exhibition? Although he practiced on his own for only 11 years, having worked earlier in the office of his father, Eiel, Saarinen was a master of many identities. Indeed, it was his lack of a signature look that raised suspicions among certain critics that he lacked convictions. Banham saw him as a kind of architectural ad-man, who would whip up a "style for the job." Does the exhibition highlight Saarinen, the favorite of corporate America? Or Saarinen, the shaper of America's international image? (He designed two U.S. embassies—in London and Oslo, respectively.) Or Saarinen, the designer of classic midcentury furniture, whose Womb Chair and Pedestal furniture series, both for Knoll, remain hugely popular today? Or Saarinen, the innovator of structural expressionism and popularizer of new materials? The bold forms of his TWA Terminal, Gateway Arch, and many other projects never failed to delight the public, while his use of new materials, such as Cor-Ten steel and mirrored glass, were seen by some critics as gimmicks to get more attention. *Or is it Saarinen, the proto-Postmodernist? Witness his*

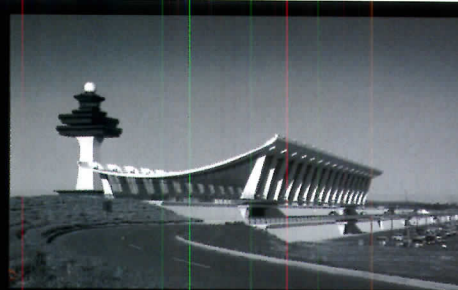

Both the Gateway Arch in St. Louis (left) and Dulles Airport outside of Washington, D.C. (above), were completed after Saarinen's death. The Deere and Company building (below) was one of the first to use Cor-Ten steel.





15 Year  
Fully Transferable  
WARRANTY

*Moonscape.  
World's away from the ordinary.*

Take your designs to a new altitude with LG HI-MACS Acrylic Solid Surfacing. Experience the improved color palette. The surreal color selections are just the thing you need to make your projects out of this world. All LG surfaces are backed by the industry's longest 15-year transferable warranty, offering your clients a superior value and lasting luxury, making them a choice that is very down to earth!

866 / LGHI-MACS  
[www.lgcountertops.com](http://www.lgcountertops.com)  
[www.lgvolcanics.com](http://www.lgvolcanics.com)

CIRCLE 29 ON READER SERVICE CARD OR GO  
TO [ARCHRECORD.CONSTRUCTION.COM/PRODUCTS/](http://ARCHRECORD.CONSTRUCTION.COM/PRODUCTS/)

**LG HI-MACS**  
Acrylic Solid Surface

**LG HI-MACS**  
*Volcanics*

# Exhibitions

Morse and Stiles Colleges at Yale, as well as his embassies in London and Oslo, which respond to their contexts by abstracting the historical styles of their neighbors.

The strength and the weakness of this exhibition lies in its unwillingness to pick one of these Saarinens for special treatment or consideration. While Donald Albrecht, the exhibition's curator,

clearly relishes the multifaceted nature of his subject, his ecumenical approach smacks of trying to have it all ways. The accompanying book (a handsome tome with extremely readable essays by Albrecht, Pelkonen, Scully, Mark Coir, Sandy Isenstadt, Reinhold Martin, and Will Miller) falls into the same trap—finding a Saarinen for almost everyone.

No doubt, future exhibitions and books will focus on particular aspects of Saarinen's architecture, unburdened by the need to cover everything at once. After 40 years of opinion makers neglecting Saarinen, though, I guess it's understandable that his admirers—finally privy to his extensive trove of drawings, private writings, and all kinds of documentation—can't help but sing all of his praises.

The exhibition, indeed, has something for everyone, covering his life, furniture, architecture, planning,

and the collaborative nature of his practice. It features sections on his beginnings at Cranbrook, his residential work—such as the J. Irwin Miller House in Columbus, Indiana, two Case Study Houses, and designs from the early 1940s for preassembled housing—his community-building plans for colleges and churches, and his corporate commissions. There is a final section, entitled "Shaping an American Identity," which looks at his embassy projects, memorials (in St. Louis and Milwaukee), and public projects, such as TWA and Dulles.

As installed in the Kunsthalle Helsinki, the exhibition impresses visitors with large color and black-and-white photographs mounted in the building's high-ceilinged, second-floor rooms, with bands of smaller photographs running below. Albrecht has also assembled a fine collection of models, some original and some created for this show, as well as a few building components (such as a new mock-up of the curtain wall at the IBM Manufacturing and Training Facility in Rochester, Minnesota, which was touted as the "world's thinnest" at just  $\frac{5}{16}$  of an inch thick). Three flat screens present historic videos—one by Charles Guggenheim of the St. Louis arch being constructed, one created by General Motors to show off its good taste in design, and one run on CBS in 1962 to herald the opening of the TWA Terminal. The old videos are wonderful artifacts and help explain the excitement that Saarinen's work created way back when. In addition, Yale students have produced five digital animations of Saarinen buildings, providing a nice touch of modern technology to the task of analyzing his work.

The exhibition may be overly ambitious in its scope and its mission to rehabilitate the lost man of American Modernism, but it's an enjoyable exercise in looking backward and projecting forward. At a time when many people are questioning America's moral authority and its position at the cutting edge of design, *Eero Saarinen: Shaping the Future* provides a *bright-eyed* look at the man who once bestrode American architecture. ■

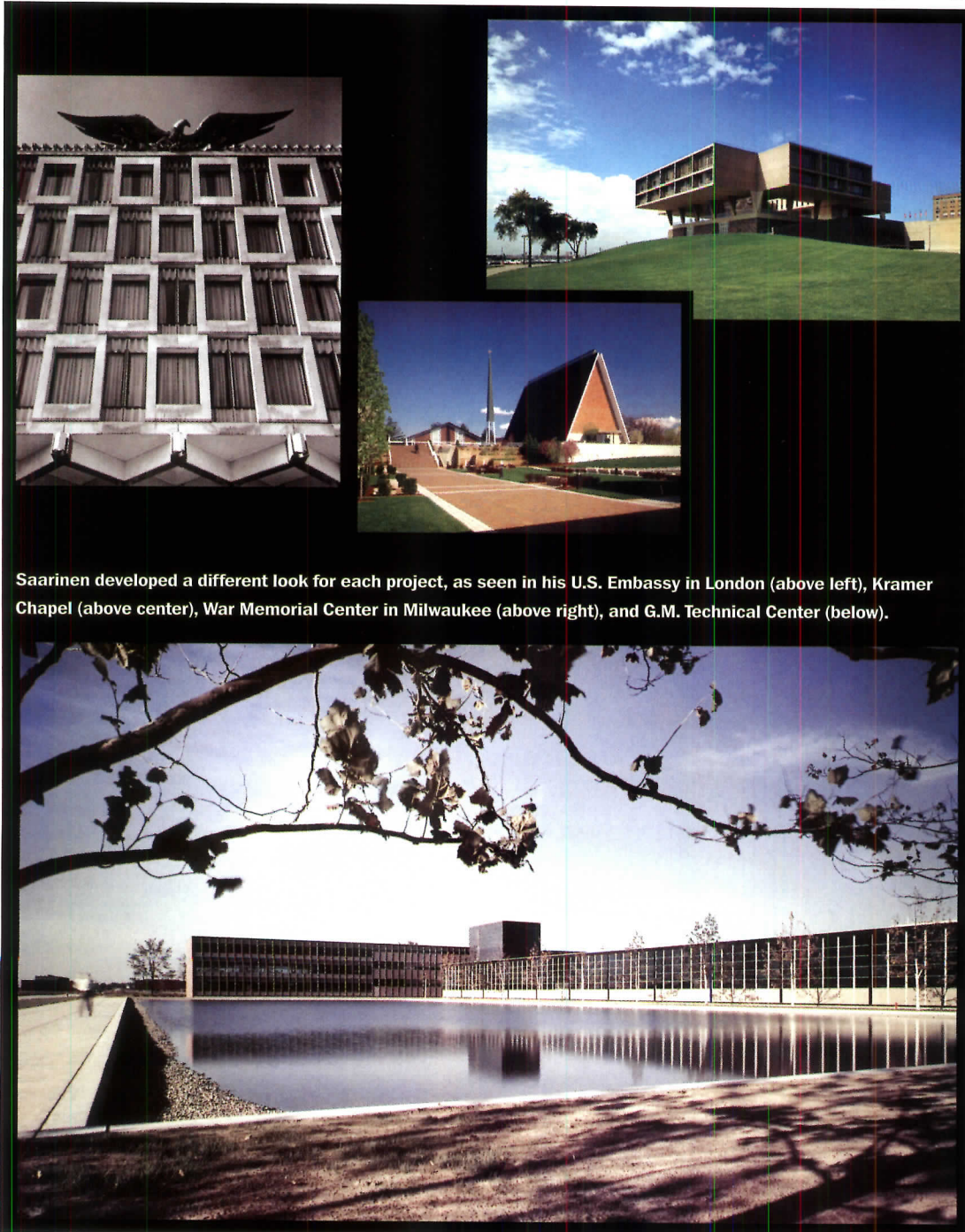

Saarinen developed a different look for each project, as seen in his U.S. Embassy in London (above left), Kramer Chapel (above center), War Memorial Center in Milwaukee (above right), and G.M. Technical Center (below).

# Snapshot



By Beth Broome

At the Broadway Cyberport cineplex in Hong Kong, the show begins before you even take your seat.

One of the anchor tenants of a shopping center in Cyberport, a mixed-use development known as the city's technology hub, the cinema swallows moviegoers whole, bringing them into the belly of a futuristic beast, a double-height, asymmetrically curved foyer defined by a series of curved aluminum ribs.

If it feels like you've just stepped into the Bat Cave or *The Matrix 3*'s last human city of Zion, it is no accident. Project architect and interior designer Michael Tsang, of AGC Design in Hong Kong (which specializes in entertainment and cinema space planning), is a long-time movie buff. When he first visited the raw concrete space, he was transported back to his childhood afternoons spent watching *Batman* on TV. Tsang riffed on this sci-fi aesthetic, which nicely segued into a high-tech focus—a requirement for the cyber-themed mall.

## Special effects that rival the cinema's best



## Snapshot

Aluminum ribbing defines Broadway Cyberport's futuristic, cavelike foyer (opposite). A backlit stair (right and below) leads down from the Cyberport shopping mall to the foyer and four theaters at street level.



Broadway Cyberport, says Tsang, “explores digital application in design.” In this vein, the architect has created what he calls “Easy Cinema,” which facilitates user-friendly navigation through the moviegoing experience. Supergraphics abound, as do automated ticket-vending machines embedded in backlit translucent polycarbonate paneling. Programmable lighting can be altered to complement special events and assists in way-finding. The largest theater features a digital projector, and fiber-optic connections convert it into an auditorium for videoconferencing or for viewing closed-circuit programming.

Increasing the dramatic effect of VIP grand entrances at premieres and the like, an illuminated stair leads from the shopping center and appears to descend from the ribs—each of which was custom produced to fit the wall curvature—down into the street-level foyer. No space is wasted. Voids below the seating are used for circulation purposes and other operational needs, such as ticketing and concession counters.

In keeping with the theme of flexibility that is integral to the “digital age,” Broadway Cyberport is highly adaptable. Glass walls that form a partition for a café, for instance, can be moved to expand the foyer to accommodate different events. “People can go to the cinema for a movie, for a conference, to go to the lounge for a drink, or they can just walk by the space to and from the shopping arcade,” says the architect.

Tsang has extensively studied theater culture, design, and trends and has drawn on his findings with hopes of defining the cinema of the future. Broadway Cyberport’s “[CINE]tecture,” as he calls his silver-screen-inspired architecture, does not just look futuristic, but it also has the higher aspiration of anticipating and responding to future applications and the expanded role of the cinema in our fast-changing digital universe. ■



Blend modern  
architecture within  
a historic setting...

And gird up for  
the big quake?

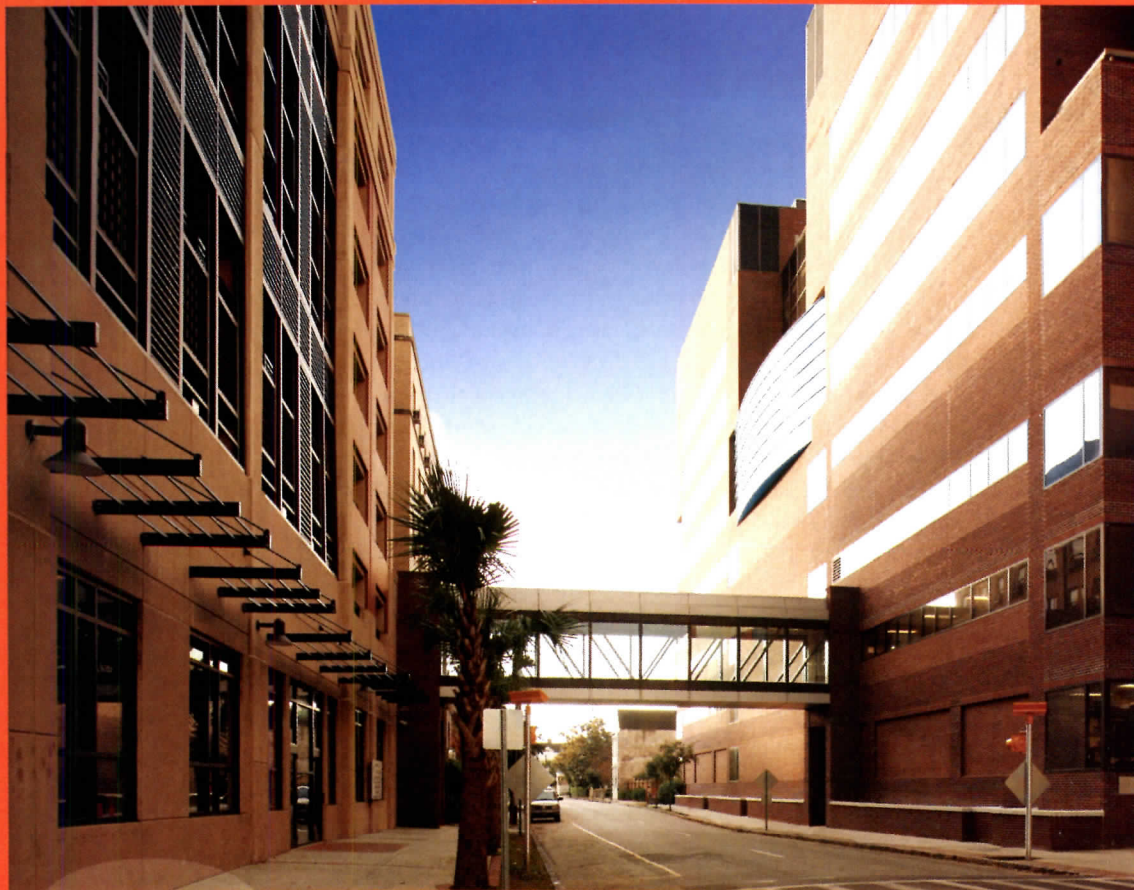

## WHO DOES THAT ?

We do! We're Tindall, and that's precast.

A tight site in historic downtown Charleston created unusual architectural and structural constraints for the Medical University of South Carolina's new mixed-used structure. The solution? Precast wall panels with sandblast finish and inlay brick coordinate with the historic district, while black shutters and balcony grilles blend with the modern hospital. Plus, the structure's 2-ft-thick shear walls meet the high seismic design requirements for the heavily loaded structure.

With precast design flexibility, why let the high costs of conventional construction exhaust your budget? For creative design solutions and engineered structural integrity, call Tindall Corporation today!

*Project: MUSC Parking/Retail/Offices  
Owner: Medical University of South Carolina  
Architect: Jenkins Hancock & Sides  
Engineer: Mabry Engineering  
General Contractor: Mashburn Construction  
Highlights: 700 parking spaces, blend of historic and modern architecture, meets high seismic design requirements*

Check out the entire list of creative precast solutions employed on this project at [www.tindallcorp.com/mixeduse/muschome](http://www.tindallcorp.com/mixeduse/muschome).

Tel.: 800-849-6380  
[www.tindallcorp.com](http://www.tindallcorp.com)  
Email: [sales@tindallcorp.com](mailto:sales@tindallcorp.com)

# Tindall

We put the Wow! in precast.

CIRCLE 34 ON READER SERVICE CARD OR GO  
TO [ARCHRECORD.CONSTRUCTION.COM/PRODUCTS/](http://ARCHRECORD.CONSTRUCTION.COM/PRODUCTS/)

By Suzanne Stephens

If you go by newspapers and monthly consumer magazines, you might think there is only one female architect designing significant buildings today—Zaha Hadid. To be sure, the London-based, Iraqi-born architect deserves acclaim for her inventive assortment of zoomy structures completed in the last few years. But what about the rest? Aren't there other talented women architects out there, who, like Hadid, run their own design practices? RECORD has decided to take a closer look at women who run their own firms in the United States, to see how much gender affects getting ahead. How far have women come since the feminist call-to-arms of the 1970s? In 1977, the landmark exhibition *Women in American Architecture, an Historical and Contemporary Perspective* opened at the Brooklyn Museum of Art in New York. The show, organized by Susana Torre and sponsored by the Architectural League of New York, brought the contributions of scores of unheralded women architects, past and present, to the public's attention. What about today: Are women more prevalent in the profession than they were 30 years ago?

In order to reduce the number of variables in this not-very-scientific investigation, we talked to female architects who have practiced a number of years on their own, by themselves or with other women. We disallowed firms with male partners, unless the female principals had spent a length of time with their own firm before adding (or subtracting) male partners. The goal of this study is not to prove that women practicing alone are better or worse off than women with male partners: We just wanted to find out what it's like. And what

advice would the female architect give female architecture students and graduates who are thinking of starting their own firms?

While we have contacted women architects from various areas in the U.S., most come from New York City. The sample is skewed geographically probably because, with all the architecture schools in the city or nearby, and because of New York's attractiveness to young people looking for jobs, it tends to be a hot bed of female architects with their own firms. And in this highly competitive environment, with serious economic stakes, the women's stories bear scrutiny for others thinking of following the same path.

Today, women make up only 13.3 percent of the American Institute of Architects (AIA), whose members include 62,400 licensed architects. (Altogether, registered architects number 91,000 to 110,000, depending on the source.) The percentage of females may sound mingy, but it indicates serious progress. In 1975, the AIA determined that women composed only 1.2 percent of all registered architects. By 1991, the AIA estimated that 9.59 percent of its members were women, with 4.3 percent owning their own firms. Fifteen years later, women form 13 percent of solely owned practices in the AIA. However, the number of female architecture students, according to the National Architectural Accrediting Board, averages 40 percent for B.Arch. and M.Arch. programs; apparently only a small portion enter the profession.

#### Why do it?

Most women interviewed who decided to go it alone wanted a practice where they made the design decisions, period. Suman Sorg, FAIA, who

What is it like to be a female architect with a solely owned firm in the U.S. today?

Not Only

ZAHA



**Ann Beha Architects**  
*Portland Art Museum,*  
*Portland, Ore., 2005*

**EOA/Elmslie Osler Architects**  
*Anthropologie store project,*  
*Burlingame, Calif.*



**Heather H. McKinney Architects**  
*Robbs Run Residence,*  
*Austin, Tex., 2005*



has a 40-person office, Sorg and Associates, in Washington, D.C., says, "I was obsessive, an achiever, and felt I could do it better. Also, I wanted the freedom." Anne Fougerson, AIA, with a nine-person firm, Fougerson Architecture, based in San Francisco, says, "I want to prove a point about being a female architect with her own office." Some of the women who had male partners for brief stints, often when starting out, agree with Page Ayres Cowley, AIA, whose 11-person New York practice specializes in preservation: "Partnerships don't work out if you have different expectations about the time and income it takes to run your own business." Ann Beha, FAIA, who owns a 30-person, Boston-based firm, finds her partner of 20 years, Pamela Hawkes, FAIA, integral to her design and renovation practice.

Many of the women came out of architecture school just after the 1970s, and did it just because it seemed possible. Others backed into having their own offices by taking on small jobs, sometimes when moonlighting while employed by large offices. Women raising children argue that owning their own firms has given them more flexibility with their time, since it was hard to stay competitive in larger firms while tending to a family (even with helpful husbands).

Katherine McGraw Berry, AIA, who started her own one-person office in New York in 1985 when she had twin boys, came from Kohn Pedersen Fox. But she found the flexibility of her practice meant it stayed small. Heather McKinney, AIA, of Austin, Texas, observes, "By the time children are old enough, the female practitioner may not have enough experience in the variety of building types—especially complex ones—needed for a large practice." About 40 percent of the women interviewed have had children. As Beha, who raised two children, says, "It's just one more hard thing to do."

Most women in this sample come from the generation of women educated in the late 1970s and 1980s, and have been in business for themselves about 10 to 20 years. The size of the offices ranges from one to 40, with a number in the 20-to-30-person range. Most offices, however, average eight to 16 architects and designers. One architect, Sophia Gruzdzys, AIA, who spent her formative years in a large office—at Pei Cobb Freed—where she says principal Harry Cobb "was instrumental in my development," has a one-woman office in New York. Now director of undergraduate studies in the architecture major of Yale College, Gruzdzys explains, "I don't want to work for someone where I have no control." But freedom has its price: To maintain her solvent, solo status, Gruzdzys, who opened up her office in 1988, has taken some architectural jobs she was not that crazy about.

Gisue and Mojgan Hariri, two sisters who have practiced together since 1986, got the idea to join forces after visiting the houses of Greene & Greene in Pasadena, California. "If two brothers could do it, we thought we should give it a try," says Gisue Hariri. Robin Elmslie Osler grew up in an architectural environment—her father, David Osler, had his own firm, and her great uncle, George Elmslie, was a partner in the Prairie School firm of Purcell & Elmslie, in Minneapolis. Although Osler came to architecture after a career as a fashion model, the early exposure to construction sites with her father convinced her to go to Yale's architecture school, where she graduated in 1990. Osler opened her New York office, EOA/Elmslie Osler Architects, in 1996; it now numbers eight people. Not surprisingly, contacts in the fashion business have generated a number of commissions—although one of the earliest, the offices for DNA Model Management, actually came through architect Richard Gluckman, FAIA.



**Wendy Evans Joseph Architecture**  
*Price Family Holocaust Memorial  
 Garden and Exhibition,  
 Salt Lake City, 2002*

**Helfand Architecture**  
*Automated Trading Desk  
 Technology Campus,  
 Mount Pleasant, S.C., 2002*



**Hariri + Hariri Architecture**  
*Sagaponac House,  
 Sagaponac, N.Y., 2004*

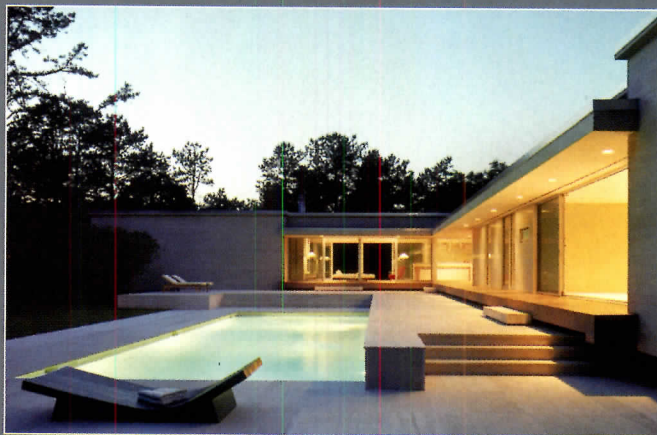

### Getting clients

The time-worn method of depending on referrals operates for women, many of whom met clients while working in others' offices. Some took a more aggressive tack. Wendy Evans Joseph, FAIA, started up her six-person office in 1996, when she designed a pedestrian bridge at Rockefeller University in New York City. One night at a dinner party, the president of the research university had described the economic problem of building the bridge to her. Joseph, who had worked on large commissions, such as the Holocaust Museum in Washington, D.C., while she was at Pei Cobb Freed, submitted an unsolicited proposal, using engineering consultants plus Columbia students working on her dining room table. She got the job.

Andrea Leers, FAIA, and Jane Weinzapfel, FAIA, who opened their Boston-based, 22-person practice in 1982, specialized in infrastructural and technical work, such as the Operations Control Center for the Massachusetts Bay Transportation Authority, from the start—and still do. “We have had a slow, steady growth with low budget, low visibility projects, which insulated us from

**GISUE HARIRI SAYS, “IF THERE ARE NO WOMEN AMONG THE LISTMAKERS, THEN NO WOMEN GET ON THE LIST.”**

economic boom-and-bust cycles,” said Leers. It also has meant that the gender question has been less of an issue, since public-sector programs encourage minority involvement. Karen Bausman AIA, notes that New York City is trying to include women-only architecture firms in its commissions. Both she and Beyhan Karahan, AIA,

each with 11-person and 15-person firms, respectively, in the city, are on the list of architects for New York's design excellence program in its Department of Design and Construction.

One major change that female architects have noticed over the past 20 to 30 years is the increase in women as clients, especially in cultural, institutional, and public-sector work. Leers has noticed, that “being women means we appeal to clients who are risk takers.” But Gisue Hariri notes about selection committees, “If no women are among the listmakers, then no women get on the list.” For her part, Diane Lewis, AIA, who maintains a New York City firm that ranges from one to 11 architects, says, “I attract a special client—one with a particularly intellectual and artistic bent.” Her projects include art galleries, and currently a charter school, and a loft for Mark Wigley, dean of Columbia's Graduate School of Planning and Preservation and his wife, Beatriz Colomina, Princeton architectural historian and theorist.

Developers are often another story. As a rule, jobs with big-time developers remain elusive to most of the female architects interviewed. Deborah Berke, AIA, who has a New York office with 25 architects and designers, observes that the old-fashioned developer can still be dismissive, but then she doesn't run into that sort too often. “The ones who call women are already open; they are a preselected group,” she notes. Julie Snow, FAIA, whose Minneapolis practice varies between 10 and 15 people, comments that some clients aren't going to feel comfortable with a female. “On the other hand, we've gotten jobs because male clients want a female perspective—and not only about the design of the kitchen,” she says. Audrey Matlock, AIA, who has a 12-person office, AM Arch, in Manhattan, notes that if you don't get a job, you are never quite sure whether gender was behind it. Right



now she is designing a sports center and a large (30,000-square-foot) house in Kazakhstan—which she got through a referral from Skidmore, Owings & Merrill (SOM), a former employer.

Ronnette Riley, FAIA, whose New York office opened in 1987 and numbers 14 architects and designers, has found working with developers difficult because they are “conservative and risk-averse. They want to work with people who look like them.” Yet Riley adds she met one developer who became a client because of a car she bought—a BMW 645 CI. “He stopped me and asked me about how the car ran,” says Riley, who, as a native Californian, could talk the guy talk. (She also met another client, a writer, over a similar chat about the car.) Alison Spear, AIA, who has a six-person office in Miami, Florida, loves working with developers—the more intense the better. She just finished her first 12-story condominium building, The Spear, for the developer of Aqua, Craig Robins. Spear, who provides interior design services as well as architectural ones, and used to be based in New York, says many clients like the one-stop-shopping approach.

**The press**

Publicity matters, architects know. But how do you get press when you are starting out? Sometimes it’s the nature of the work, sometimes the sort of client. When Spear lived in New York, she found she got a lot of press with her first job—designing a loft 20 years ago for Jay McInerney, whom she had met through a group of young people at the National Arts Club. Spear, who studied architecture at Cornell University, had decided to take a job as an architect for the interior designer Juan Pablo Molyneux, where she incidentally learned about antiques, color, and fabrics. “The architecture training at Cornell was

very Corbusian, very white,” she says. “I thought a sconce was something you ate.” Now that she has been working on both sides of the design divide, however, she finds that too often the press assumes she is a decorator. “The image is hard to overcome, especially in the shelter magazines,” she says. Jennifer Luce, AIA, of San Diego, who has an interest in landscape and furniture design, as well as architecture, explains that not only her interests, but the fact that her firm, Luce et Studio, is 75 percent female causes people to assume the firm only does interiors. Having just won a *Business Week/Architectural Record* award for 2006 for her Nissan Design America building outside Detroit and a Nissan design studio in La Jolla, California [RECORD, November 2006, page 90], should help Luce dispel this notion, but she says, “It’s hard, because I want to articulate every detail of the job.”

New York-based Annabelle Selldorf, AIA, seems to find little difficulty getting press, much of it stemming from her art-world clients, who commissioned galleries and artists’ lofts, plus the Neue Galerie Museum for German and Austrian Art in Manhattan. “I started alone in 1989 with a kitchen renovation,” she notes. But now Selldorf Architects numbers 33 people, and, as the interior architect for the Urban Glass House, a condominium project in Manhattan designed by Philip Johnson/Alan Ritchie, she is part of a major “branding” campaign. Lindy Roy, who founded her office, ROY, in 2000, and averages about 10 people, was selected in 2001 to design a temporary courtyard installation at P.S. 1 Contemporary Art Center in Long Island City, New York, as part of the MoMA/P.S.1 Young Architects program. “The press coverage had an amazing effect—it triggered attention from clients,” says Roy, a South African-born and Columbia-trained architect, who designed André Balasz’s Hotel QT, a former office building near Times Square, in 2005.

FLOTO + WARNER (RIGHT)



**Toshiko Mori Architect**  
*Addition to the Cohen House,  
 Casey Key, Fla., 2005*



**Winka Dubbeldam/Archi-tectonics**  
*497 Greenwich Street,  
 New York City, 2004*

**Luce et Studio**  
*Nissan Design America,  
 La Jolla, Calif., 2003*





**Julie Snow Architects**  
Great Plains Software  
Development Building,  
Fargo, N.Dak., 2001



**Selldorf Architects**  
Abercrombie & Fitch,  
New York City, 2005



**Leers Weinzapel Assoc.**  
Harvard Science Center  
expansion,  
Cambridge, Mass., 2004

**Ronnette Riley  
Architect**  
Tracey Reese store,  
New York City, 2006



Winka Dubbeldam, who arrived in the New York from the Netherlands in the early 1990s to study at Columbia, previously had an office in Holland. She got jobs working in the high-profile offices of Steven Holl, Bernard Tschumi, and Peter Eisenman here, but her experience in Holland led her to decide to open her own office, Archi-tectonics, in 1994. Now her firm has 15 architects and designers. “I had no press until 1997,” she notes, adding, “I’m kind of shy.” Dubbeldam explains she left it to “luck, and my theory that you keep working slowly, teach, research, and take on jobs you believe in—the slow route.” Having a project in Millbrook, New York, included in the 1999 Museum of Modern Art exhibition *The Un-Private House*, however, didn’t hurt.

Not surprisingly, a number of women architects remark that Zaha Hadid gets all the attention from the press, even while they avow, “More power to her.” Of course the scale and dynamic inventiveness of Hadid’s recent built work—from museums to automobile plants—has helped, along with her larger-than-life persona. As Toshiko Mori, FAIA, who has a New York office of a dozen people while occupying the chair of architecture at Harvard’s Graduate School of Design, notes, “The press wants impact—people who produce an interesting narrative.” Mori points out, however, that Kazuyo Sejima (of SANAA) is also getting attention from the press, and “she’s the opposite of Zaha—very self-effacing and not gregarious.” Still, she notes, the media go for the exotic and the extreme in architectural design: “Some of us deal with ordinary, not glamorous issues.”

Getting publicity is important, but some women, such as Berke, contend that “good press does not specifically lead to new work—and this is not a gender issue. The press attention usually validates your work for your existing clients.” Nevertheless, Berke says that

people tend to keep clips on an architect—for years. When Jerry Adler, was writing *High Rise: How 1,000 Men and Women Worked Round the Clock for Five Years and Lost \$200 Million Building a Skyscraper*, published in 1993, he focused attention on Matlock, then a senior designer at SOM. She easily came across as one of *High Rise*’s liveliest characters: *New York* magazine even prominently displayed a photo of the blond-haired Matlock in a black leather jacket on a red Ducati motorcycle in its May 3, 1993, coverage of the book. By then, Matlock had opened her own storefront office in New York City’s Tribeca—where she and her team of 12 visibly demonstrate to passersby what an architect does.

Related to press coverage is the question of marketing—that is, going after work in a systematic way. Many of the women architects interviewed take a wait-for-the-phone-to-ring approach. Fougerson admits that she “tries to meet new people and have my clients introduce me to other clients.” She also argues that “women architects have to work twice as hard as men to get attention and prove themselves.” Margaret Helfand, FAIA, whose New York office, Helfand Architecture, numbers 10 architects and designers, maintains that marketing is “the most critical piece of daily experience, yet the toughest nut to crack for any architect.” Academic experts concur: Katherine Anthony, professor of architecture at the University of Illinois-Urbana Champaign and author of *Designing for Diversity* (2001), argues that “networking is all the more crucial to women who run their own architectural practice.”

#### How the network works

Networking, of course, helps if you practice architecture near your alma mater, and can make use of all those former colleagues who later turn into potential clients. Some women don’t do this. Helfand grew

# ONE INNOVATIVE MICROWAVE. ENDLESS DESIGN POSSIBILITIES.



## THE WORLD'S FIRST MICROWAVE DRAWER™

Convenience, accessibility and flexible design. The one-of-a-kind Sharp Insight Pro™ Microwave Drawer blends all the ingredients of the perfect kitchen appliance. The 30" and new 24" models open automatically with the touch of a button. Both are ideal under a counter, cooktop or wall oven, in islands and open plan kitchens, even in a wet bar or family room. To learn more about the most innovative idea yet for where to place the microwave, call 1-866-RANGE99 or visit [sharpusa.com/microwavedrawer](http://sharpusa.com/microwavedrawer)



©2006 Sharp Electronics Corporation



Insight Pro™ Microwave Drawer  
Best New Kitchen Product 2005,  
Kitchen and Bath Industry Show

# SHARP®

CIRCLE 35 ON READER SERVICE CARD OR GO  
TO [ARCHRECORD.CONSTRUCTION.COM/PRODUCTS/](http://ARCHRECORD.CONSTRUCTION.COM/PRODUCTS/)

up in California, went east to Swarthmore College, in Pennsylvania, but then headed back west to study architecture at the University of California, Berkeley, before settling in New York, where she started her own office 25 years ago. Jennifer Luce grew up in Canada, and then worked in Virginia before moving to San Diego in 1987, where she could not rely on academic or professional contacts. "It took a long time," she says.

Similarly, McKinney studied architecture at the University of Pennsylvania, in Philadelphia, and then worked in Boston before heading for Austin in 1984, where most of the architects went to the University of Texas. She too had to build up contacts over the years, but cites her involvement with the organization Austin Women in Architecture as crucial in fostering communication among colleagues.

A number of women find meeting architects through architectural organizations leads to jobs. Wendy Evans Joseph, who has served as president of the New York Architectural League, and, like Helfand, was a president of the New York chapter of the AIA, reports that the commission to design The Inn at Price Tower in Frank Lloyd

ing ideas, turns out to be good for networking. "Male teaching colleagues have turned out to be advocates and sponsors of our firm, particularly in situations where they are advising clients, boards of directors, and deans of schools on upcoming buildings," she says.

**Marked women**

In terms of marketing and getting the job, the women are quite aware they are still unusual. Leers accepts that "women are marked," and need to be conscious of that while walking into an interview: "Jane and I see a design challenge; the client sees two women." In going into the client meeting, many women note that the presentation style, including the dress, sends important subliminal signals. Helfand decided early on that "I might as well be a billboard for my architecture." Clients and press have commented (approvingly) that the geometric, simple lines, varied textures, and crafted details of her attire provide a fitting correlative to her Modernist design work.

A number of women notice that clients comment on their working style, as well. According to Cowley, clients remark that women *listen* to them, an observation that a number of other females corroborate. As Luce puts it, "Clients feel we don't have an ego thing." It also makes the job in the office go more smoothly. Sorg says, "I love working with women; they aren't defensive about their mistakes." In the old days, however, there was too little ego demanded of women. At 79, Debora K. Reiser, who graduated from Pratt in 1948, but never got her license, has been in a variety of work situations, ranging from working with George Nemeny, in New York, to having her own firm, in Dobbs Ferry, New York, and forming an association

**LEERS SAYS, "WOMEN ARE MARKED."  
HELFAND DECIDED, "I MIGHT AS WELL BE  
A BILLBOARD FOR MY ARCHITECTURE."**

Wright's landmark structure in Bartlesville, Oklahoma, came through architects in Tulsa whom she met on an AIA committee. "It was too small a job for them and required a fair amount of interior design," she says. Leers notes that teaching, besides providing a way of explor-

PHOTOGRAPHY: COURTESY ALISON SPEAR (TOP LEFT); © ALBERT VECERKA/ESTO (TOP CENTER); COURTESY DIANE LEWIS ARCHITECT (TOP RIGHT); © GUY LAWRENCE/ISTOCKPHOTO.COM (BOTTOM LEFT)



**Alison Spear, AIA**  
*The Spear, Aqua,  
Miami Beach, Fla., 2005*



**Katherine McGraw Berry, AIA**  
*House in Tivoli,  
Tivoli, N.Y., 2000*

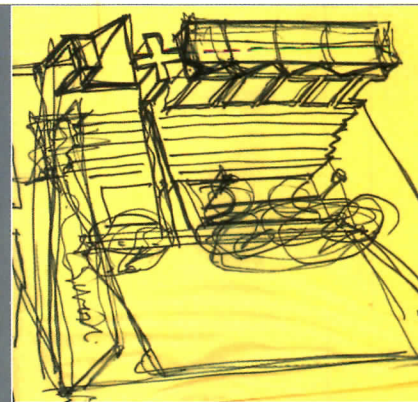

**Diane Lewis Architect**  
*Charter school project,  
New York City*



**Deborah Berke & Partners**  
*Irwin Union Bank,  
Columbus, IN, 2006*

**Page Ayres Cowley, Architects**  
*La Tourette Golf Club House restoration,  
Staten Island, N.Y., 2003*



## Smart energy for a smarter world.

Electricity is everywhere in your daily life. Take baby Joey. When he looks through the window, it's a very lively world he sees. A world where he will feel just as safe as in his daddy's arms. Where, thanks to Schneider Electric, the world leader in the management of electricity and automation, technology becomes so effective that you forget it's even there. Together with its brands: Square D® — the best known name in NEMA type electrical distribution and control products, systems and services — Telemecanique® — one of the world's leading brands of automation and control products, systems and solutions — and TAC® — a leading provider of building automation solutions — Schneider Electric converts electricity into smart energy. Creating processes and solutions today that are simple, efficient and environmentally friendly. So tomorrow's world is a better place to be. Welcome to a new electric world.

1

This is where we control the building's energy usage.

2

This is where we automate the tunnel ventilation network.

5

This is Joey, who's happy to know he's never alone.

This is where we distribute power for the buildings.

3

4

This is where we safely provide electricity for Joey's baby monitor.

GETTY IMAGES



[www.us.schneider-electric.com](http://www.us.schneider-electric.com)

**Schneider**  
 **Electric**  
*Building a New Electric World*

CIRCLE 36 ON READER SERVICE CARD OR GO TO [ARCHRECORD.CONSTRUCTION.COM/PRODUCTS/](http://ARCHRECORD.CONSTRUCTION.COM/PRODUCTS/)

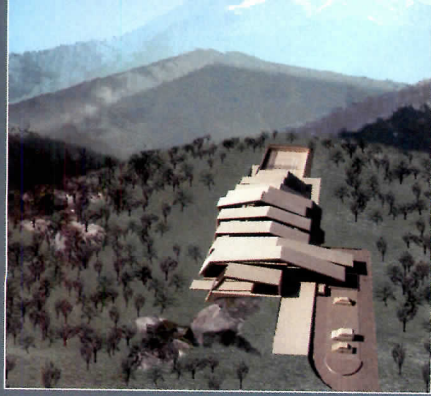

**Audrey Matlock/AM Arch**  
Sport Center project,  
Medeu, Kazakhstan

**Karen Bausman & Associates**  
Hamlin Chapel and Library project,  
Hamlin, Pa.

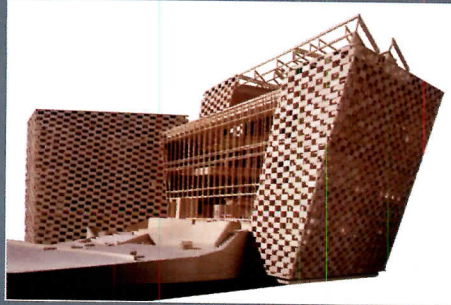

**Sophia Grudzys, AIA**  
Private Residence,  
Begur, Spain, 2006



**ROY**  
The Living Lab for L'Oreal,  
Los Angeles, 2003

**Susana Torre,**  
Housing in Carboneras project,  
Almeria, Spain



with her son, Jesse Reiser, and his partner Naneko Umemoto, based in New York. As she recalls, “When I started, women hid in the back of the room. If the clients thought a woman worked on the project, they wouldn’t respect the design.”

#### On-site

Today, when women go out to the construction sites, they often meet up with contractors long stereotyped as having an adversarial role with architects. Cowley observes that contractors seem to fall into three groups: “One third of them don’t want to be told what to do; one third want to be told, but constantly have to let you know they know what they’re doing; and one third, no matter what, want to pick a fight.” Nevertheless, a number of the women say that after they show they know what they are talking about, the job runs smoothly. Yet Karahan remarks that when she visits a site for publicly sponsored

## CONTRACTORS ARE GETTING USED TO WOMEN ON THE SITE, BUT YOU STILL HAVE TO PROVE YOU KNOW YOUR STUFF.

work, the contractor’s questions are rarely directed to her—always to the project architect, often a man. (Karahana, who teaches design studio and building construction at the New York Institute of Technology [NYIT], obviously knows the answers.) Dubbeldam comments that she usually doesn’t have this problem—“but it helps that I am 6 feet tall,” she says, half-jokingly. Osler also comments that her 6-foot-tall height often catches the men on the construction site off guard. One medium-height woman quipped that at least they can

wear high-heeled boots if they need some extra “stature.” Most female architects say that as they get older, the gender perceptions disappear, although Berry thinks she got her way more often with contractors when she was first starting out in her thirties. “They treat you differently when you’re young. You can play with them. Youth can be tremendously persuasive.” Yet Lewis conjectures contractors trust women more than men, noting, “They know women are going to be straight as an arrow about the payment schedule.”

#### Architecture as a business

In the early days, says Reiser, no one worried about making any money—you just did it “because you could create beautiful work.” Judy DiMaio, AIA, who is the dean of the School of Architecture and Design at NYIT, says that today it’s not just about the passion, and emphasizes that women now are far more aware of the need to know about setting up architecture as a business. Yet the women interviewed did not have business training while studying architecture—nor did they think architecture school was the right place, with so little time to absorb everything else about design, structure, theory, and history. All say they learned the business on the job. Some,

who had had male partners, were surprised to find they were better “businessmen.” Joseph says she retained a good business consultant to come in and train her and her senior staff. Bausman depends on a financial adviser to help with her investment portfolio in order to get over the ups and downs of the economic work cycle. Riley suggests it’s good business to be discerning about the clients—“especially the ones who use up an inordinate amount of the *office energy*, when the projects lead nowhere.”

## Smart energy for a more productive world.

Electricity is everywhere in your daily life. At the office, Paul is so comfortable, he sometimes forgets what time it is. His boss? Delighted. His wife? Less so. Thanks to Schneider Electric, the world leader in the management of electricity and automation, technology becomes so effective that you forget it's even there. Together with its brands: Square D® — the best known name in NEMA type electrical distribution and control products, systems and services — Juno Lighting Group — a leader in the design and manufacturing of recessed, track and decorative lighting fixtures — and TAC® — a leading provider of building automation solutions — Schneider Electric converts electricity into smart energy. Creating processes and solutions today that are simple, efficient and environmentally friendly. So tomorrow's world is a better place to be. Welcome to a new electric world.

1

This is where we provide efficient lighting.

This is where we distribute electrical power and save energy.

2

3

This is where we regulate the lighting and temperature.

4

This is Paul. He feels so good that sometimes he forgets to go home.

Merlin Gerin  
Square D  
Telemecanique

[www.us.schneider-electric.com](http://www.us.schneider-electric.com)

**Schneider**  
 **Electric**  
*Building a New Electric World*

CIRCLE 37 ON READER SERVICE CARD OR GO  
TO [ARCHRECORD.CONSTRUCTION.COM/PRODUCTS/](http://ARCHRECORD.CONSTRUCTION.COM/PRODUCTS/)

**And for the next generation**

Many women architects teach, and say that the best way to encourage women to enter the profession is for them to see women on the faculty of architecture schools. They note that having women deans helps. (Donna Robertson, AIA, is dean of the College of Architecture at IIT, Karen Van Langen is dean of architecture at the University of Virginia, Adele Santos is dean of the School of Architecture and Planning at MIT, and, as noted earlier, Mori is chair of the department of architecture at Harvard's Graduate School of Design, and DiMaio is dean at NYIT.) Beha says students at the various schools where she has taught tell her, "You have changed the way we thought about practice." They reaffirm her role as "an agent for change as well as an agent for design."

Thirty years after her influential exhibition, Susana Torre finds herself as an "accidental developer" designing and constructing a residential complex in Carboneras, Spain. Looking at the current

**DEAMER WORRIES WOMEN ACCEPT A MALE IDEA OF SUCCESS; OTHERS SAY YOU NEED GRIT, PASSION, AND A THICK SKIN.**

state of affairs, she observes that "female architects no longer have the historic burden of credibility with clients and contractors typical 30 or even 10 years ago. But most women seem to be heading small practices, producing small projects that don't capture the public's and the media's attention." Matlock advises women to get experience in large firms to keep from "getting stuck doing tiny projects later."

Some urge rethinking the idea of success. Peggy Deamer, who has been assistant dean and architecture professor at Yale, with her own office, Deamer Studio, in New York since 2002, maintains, "We need to put forth a different image of success in the profession when we choose teachers as role models. There are multiple ways of being a star—this affects how we award prizes to students as well as whom we hire to teach them. The models we have now are oriented to a male idea of success (even Zaha), and it's pretty limited and depressing." Deamer, who is taking over as dean of the School of Architecture and Planning at the University of Auckland in New Zealand in February, will have the opportunity to test her convictions, albeit a bit far from these shores.

In the final analysis, one could argue that definite progress has been made over the past 30 years, in the number of women running their own firms and in the range of commissions they get. More needs to be done for them to crash through the famous glass ceiling, and it should happen first in architecture schools. After school, the decision is up to women. They can have successful, happy lives within larger firms, or as partners with men. Or they can go it alone. But the women interviewed agree that in addition to talent and organization, architects who want to run their own businesses need specific personal qualities: ambition, persistence, grit, determination, passion, and a thick skin. (Charm doesn't hurt.) While they are not Zaha Hadid, her success is helping bring to the public the notion that a lone female architect can indeed create significant, even great architecture. So most of the women can cheer her on, all the while strapping themselves into their own vehicles to enter the race. ■



**Fougeron Architecture**  
*1532 House,*  
*San Francisco, 2005*



**Sorg and Associates**  
*U.S. Embassy,*  
*Kabul, Afghanistan, 2006*



**Judith DiMaio, AIA**  
*Kitchen for a Collector,*  
*New York City, 2005*

**Karahan & Associates**  
*Combined Fire and Emergency*  
*Medical Service Station,*  
*Rockaway, N.Y., 2004*



**Debora K. Reiser**  
*House in the Northeast, 1996*



PHOTOGRAPHY: © RICHARD BARNES (TOP LEFT); COURTESY SORG AND ASSOCIATES



# Design Vanguard 2006

From sensuous skins and vibrant colors to inventive spatial experiences, the works of this year's emerging designers display mature skills

By Clifford A. Pearson

**Y**oung architects seem to be growing up faster these days. (Or maybe I'm just getting older.) Not long ago, cutting-edge firms were in thrall to computer technologies, and much of their work seemed to have been created during heavily caffeinated, all-night sessions playing with their latest digital toys. While computers have hardly disappeared, the firms profiled in this year's Design Vanguard are using them in less showy ways. Instead of hyperactive curves and German Expressionist angles, the architects shown here are designing buildings that get our attention with graceful proportions, elegant details, and inventive use of materials. Yes, they sometimes introduce electric colors that practically vibrate in front of your eyes, and often manipulate building envelopes into forms that wouldn't please Mies. But there's a discipline to the work that makes it feel real, gives it substance. Even when they're cutting loose and having some fun with a competition entry, these firms display a mature approach to design.

This year's Vanguard architects have built more than many of their predecessors, which may help explain their more grounded sensibilities. While the 10 firms featured here exhibit very different perspectives on design, almost all of them are exploring the nature of materials—from Kumiko Inui's elegant essay on glass and transparency for Dior to Studio Luz's theatrical application of common polycarbonate skylights at a restaurant in Boston, from SeARCH's reinterpretation of wood framing on a house in Holland to UnSangDong's folded and perforated metal scrim on a gallery in Seoul. Skin is important in all of these projects, but so are the spaces inside the inventively wrapped packages. All of the architects shown in the following pages express a commitment to the user's experience, creating buildings that elevate the people who live, work, study, shop, dine, and play in them. ■

## THE FIRMS FEATURED ARE:

<b>UnSangDong Architects</b>	p.74
<b>Studio Luz</b>	p.80
<b>BAR</b>	p.86
<b>Studio SUMO</b>	p.92
<b>Kumiko Inui</b>	p.96
<b>Bercy Chen Studio</b>	p.100
<b>BmasC Architects</b>	p.104
<b>Assadi + Pulido</b>	p.110
<b>WORK Architecture Co.</b>	p.116
<b>SeARCH</b>	p.120





# Sculptural projects in Korea by **UnSangDong Architects** sprout from conceptual ideas

By **Fred A. Bernstein**

**Architect:** UnSangDong Architects

**Location:** Seoul, Korea

**Date founded:** 2001

**Design staff:** 10

**Principals:** Yoon Gyoo Jang and Chang Hoon Shin

**Education:** Jang: Seoul National University, M.Arch., 1990, B.S., 1987; Shin: University of Seoul, M.Arch., 2006, Yeungnam University, B.Arch., 1996

**Work history:** Jang: Practice—KACI Architects, 2001–03; HERIM Architects & Engineers, 1997–2001; Artech Architects & Partners, 1995–96; Seoul Architecture Consultants, 1990–94; Academic—Kookmin University, professor, 2001–present; Shin: Architecture studio himma, 2003; M.A.R.U. Architects, 2001; BAUM Architects, 1999; Artech Architects & Partners, 1995

**Key completed projects:** Gallery Yeh, Seoul, 2005; restaurant at Asia Publication Culture & Information Center, Paju, Korea, 2005; University of Seoul College of Law lecture hall and sports complex, 2004; Evervill headquarters, Seongnam, Korea, 2004; Paris Olympic Memorial, 2004; Gwangju Design Center, Gwangju, Korea, 2004; KTNG Culture Complex, Yongsan, Korea, 2004

**Key current projects:** ; Design Center, Hongik University, DeaHak-Ro, Korea, 2006; Gallery of Housing Culture, Chungju, Korea, 2006; Eco Housing, PyungChang, Korea, 2006; Froebel headquarters, Paju Book City, Korea, 2006

**Web site:** www.usdSPACE.com

*Fred A. Bernstein is a writer based in New York City who regularly writes for RECORD.*

To the list of compelling, vertically stacked art venues—including Zaha Hadid's Rosenthal Center in Cincinnati and Brad Cloepfil's Museum of Arts and Design in New York City—add the Gallery Yeh in Seoul. All three buildings rely on dramatic facade treatments to announce their contemporary, not Modernist, intentions. The face of the Yeh is divided into five undulating opaque strips, which fold and buckle as they separate from the building core behind them. The tower is both a memorable urban sculpture and a rebuke to the horizontal banding of the cheaply made structures that surround it.

That a private gallery in Seoul would make such a strong statement is a sign of Korea's affluence and rapid integration of contemporary international culture. The building's designers, UnSangDong Architects, are Korean, part of a generation of architects still in their thirties who are completing major commissions in their home country. Among the firm's built works are the Gwangju Design Center, which, at 170,000 square feet, would be a plum commission for even the most seasoned U.S. firm.

Principals Yoon Gyoo Jang and Chang Hoon Shin studied in Korea and apprenticed at established Korean firms, yet represent the globalization of the profession. Jang, who has been short-listed for competitions in Spain, Israel, and Italy, makes no claims to creating an architecture particular to his home country. "Korean conditions are unavoidable propositions," he says, explaining that much of his work is instead based on research into timeless, placeless "phenomena, like floating." Jung also runs a gallery in Seoul, called Jungmiso, where he shows conceptual art. The firm's architecture, he asserts, is equally conceptual.

As is often the case, however, the trip from concept to construction can be fraught. In the case of the Gallery Yeh, elegant diagrams are meant to demonstrate that programmatic needs produced the bulges in the facade, but with little more than 1 meter (3.3 feet) "in play" in the finished building, the effect is primarily decorative. For the Gwangju Design Center, a school and resource center for product design in a booming industrial region, renderings show a variegated exterior corresponding to a variety of interior functions. As built, though, the main facade is a curtain wall that calls out for relief. Yet its interiors are indeed admirably light-filled and open, fulfilling the goal of local authorities to make design a key part of industrial development on Korea's West Coast.

More successful on the architects' conceptual terms is the Asian Culture Complex in Gwangju, a speculative project with an earthwork covering about 10 acres. Shaped like a hammock, this landscape element rises from a central "plain" into a pair of sloped surfaces. Small buildings housing galleries and theaters float in the hammock. Some rise above the surface like lanterns; others remain underground, evoking ruins. Another project, the Paris Olympic Memorial, is an intriguing assemblage of glass cells that impressively demonstrate how habitable structures can appear to float. And the firm's headquarters for Evervill, a branch of Hyunjin Group (a real estate developer/builder), comprises a beehivelike tower punctured by circular openings. Jang describes his goal as helping to "brand" Evervill, and perhaps the building may do great things for a company that produces generic office and apartment towers across Asia. ■



## Gallery Yeh, Seoul

The architects treated the exposed concrete skin of the seven-story tower as a folded, sculptural “urban canvas.” Rising from a base above two stories set below grade, five vertical bands undulate to reveal glazing as apertures into the gallery spaces. The interiors are finished with exposed-concrete and epoxy-coated panels, which create a Minimalist backdrop for a private collection of sculpture.



## Gwangju Biennale, Gwangju, Korea

Creating a “theatrical topography” was the goal for the temporary exhibition spaces at the 2004 Gwangju Biennale, according to principal Yoon Gyoong Jang. Inspired by the show’s theme, “A Drop of Water, a Grain of Dust,” the architects designed exhibition booths like the cells of a living object, linked by curvaceous walls and pathways that represent the flow of water. In addition to contemporary art exhibition spaces, the interiors incorporated venues for lectures, parties, and performances.

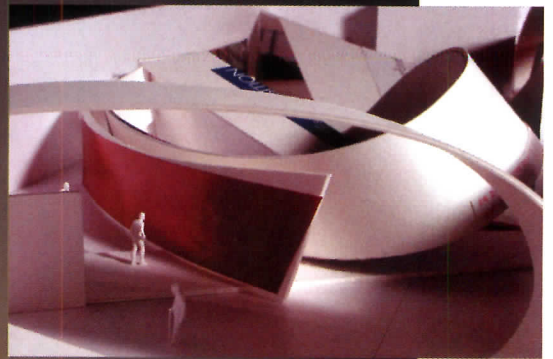

### Evervill Headquarters, Seongnam, Korea

With a curtain-wall facade incorporating aluminum panels and colored glass, the new office tower for Evervill, one of Korea's leading development and construction firms, strikes a distinctive profile intended to support the company's branding. The exterior modular frame screens eight stories of office space, with two additional floors below grade. Interior finishes include exposed-concrete and wood decking.

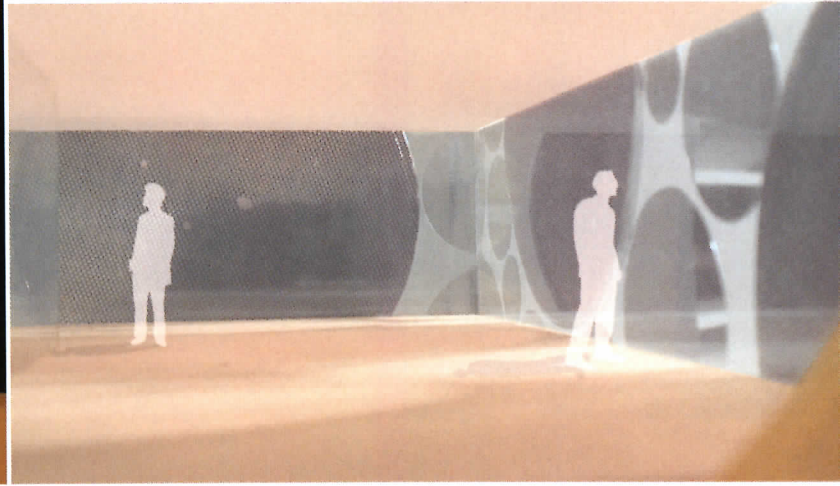

### Asian Culture Complex, Gwangju, Korea

"We proposed that the extruded surface of the earth act as a framework for the Asian Culture Complex," says principal Chang Hoon Shin of the competition entry for a civic project. An earthwork centerpiece morphs into paths, open plazas, and the apexes of underground gallery spaces. "The complex becomes the strata of contours tracing the history of Gwangju while preserving the existing urban fabric."

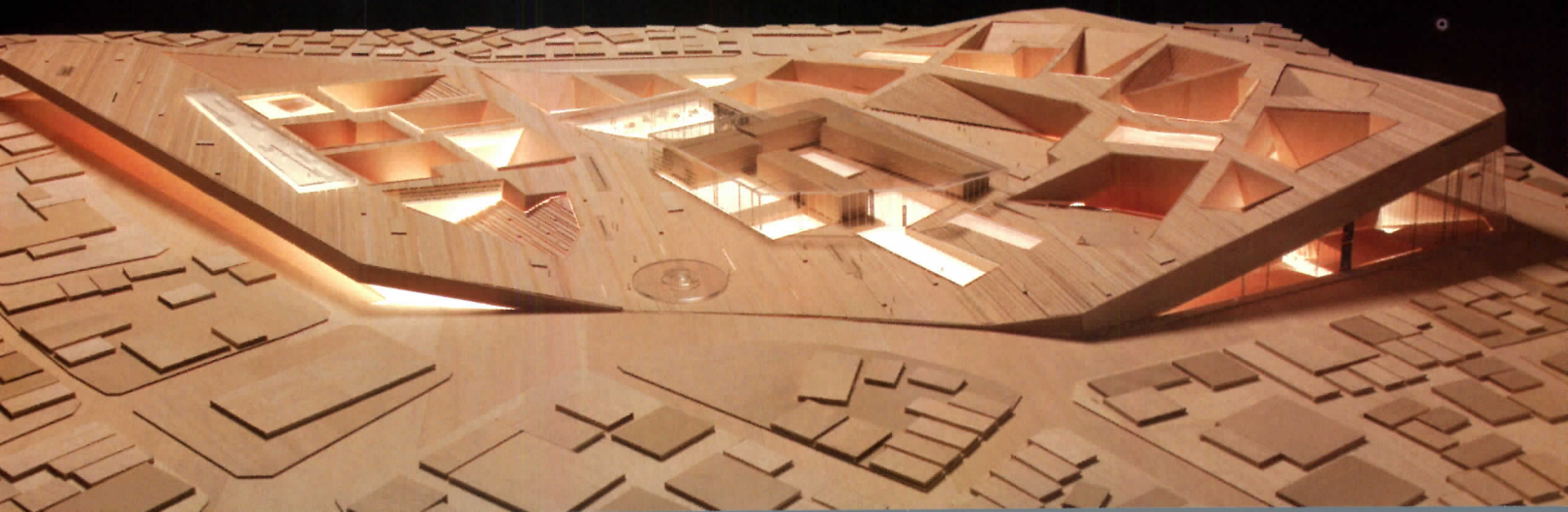
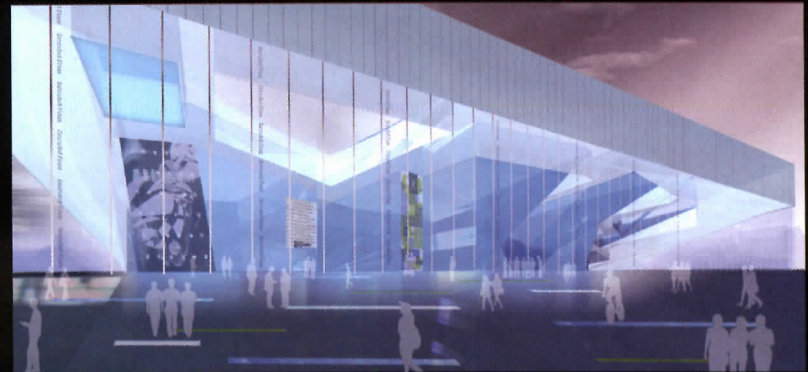



## Gwangju Design Center, Gwangju, Korea

At a school and resource center for product design, angled cutaways in the facade are framed by broad exterior staircases where students gather. The firm's original design featured a variegated facade incorporating panels of glass, stone, aluminum, perforated metal, and CRC plastic. As built, the curtain wall dominates.

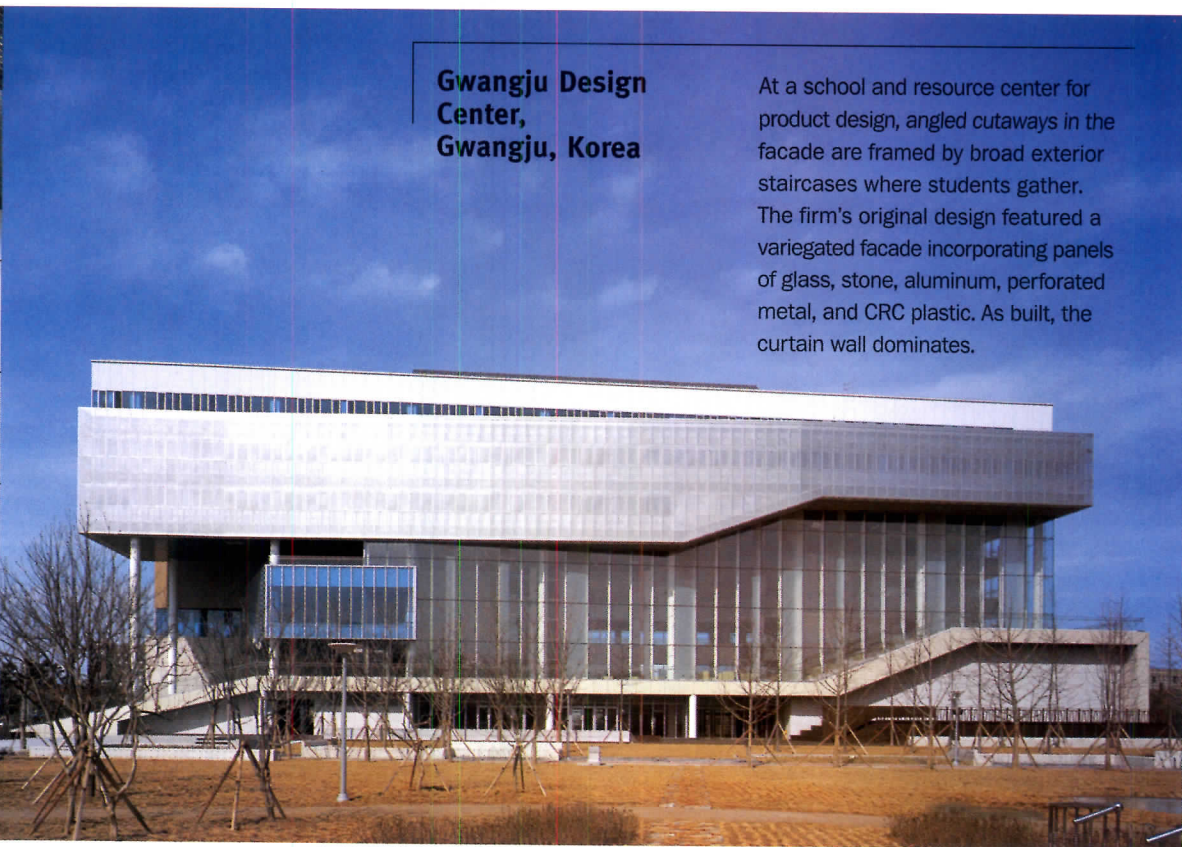

## KTNG Culture Complex, Yongsan, Korea

"A floating city freed from the ground" was the jumping-off point for a new multicultural community center, say the architects. Incorporating retail, theater, clinical, educational, and office spaces, the building sits on a plaza that leads to a grand stairway linking the first three levels. Rooftop gardens accommodating sports and theatrical presentations are layered within the sculptural structure.

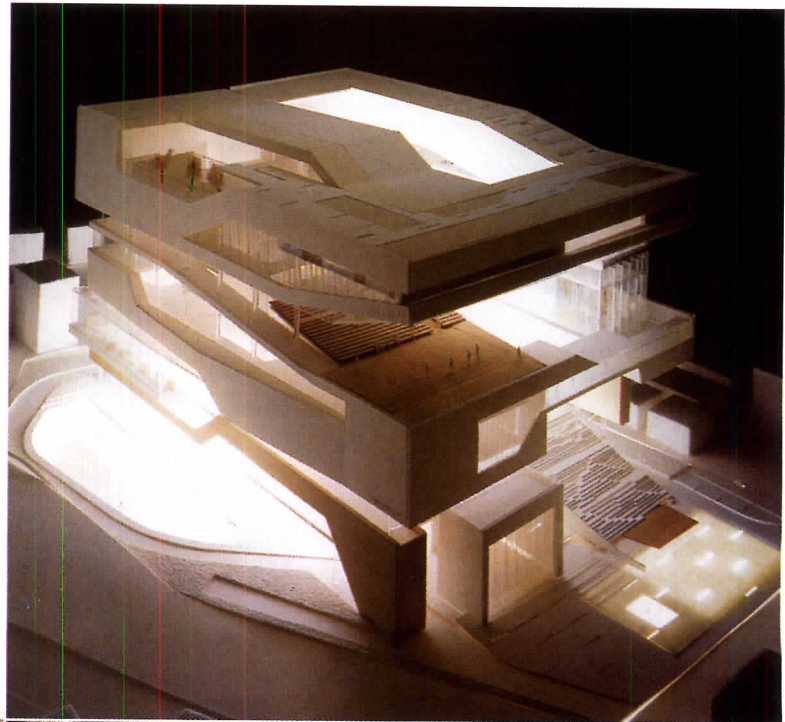

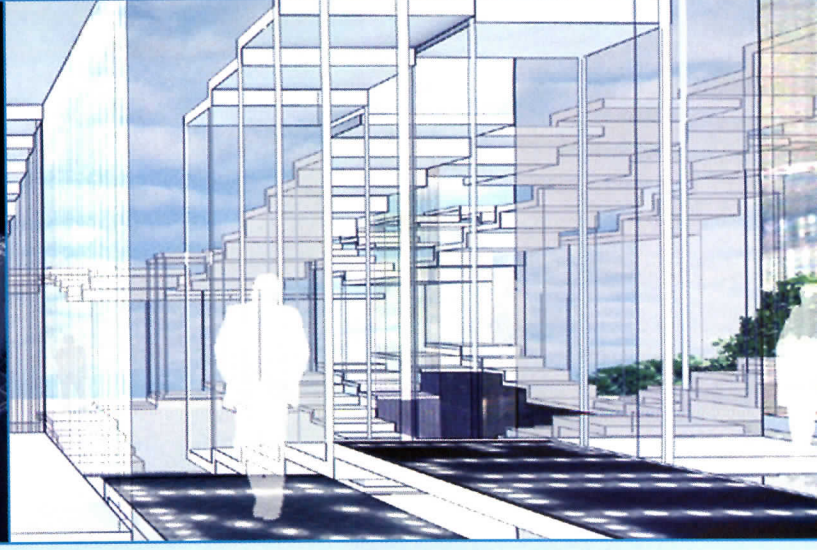
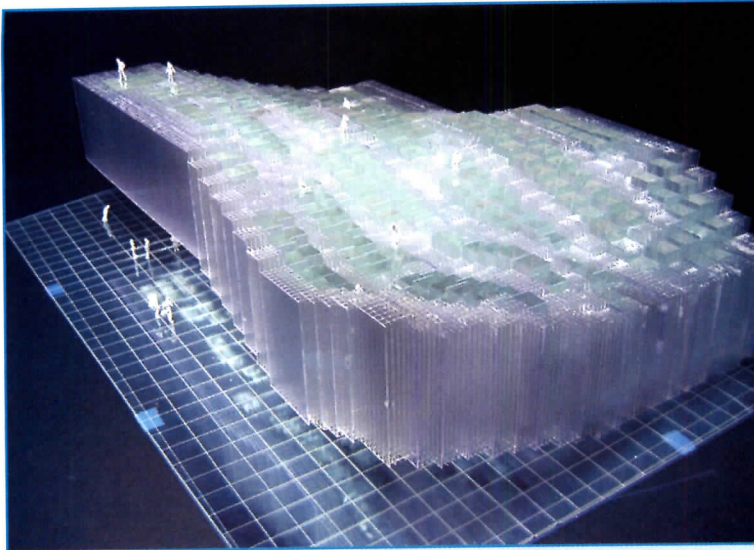

### Olympic Memorial, Paris

Incorporating plastic walls threaded with color LEDs, the proposed design for an Olympic Memorial in a Paris park represents every race and region of the world within a map of abstracted cells. Combining flexible, interchangeable components, the exhibition venue encapsulates the history and contemporary spirit of the Olympic Games through “pixels” of light, color, and graphic elements.



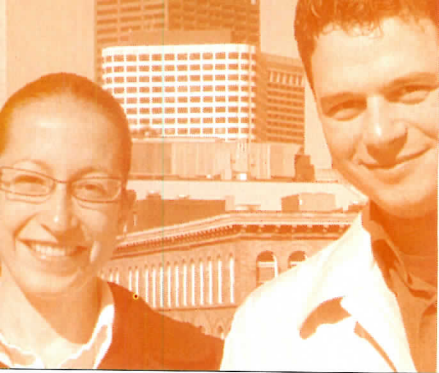

# Studio Luz sheds new, inventive light on the social potential of architecture

By David Sokol

**Architect:** Studio Luz Architects  
**Location:** Boston  
**Founded:** 2002  
**Design Staff:** 5  
**Principals:** Hansy Better Barraza and Anthony J. Piermarini, AIA  
**Education:** Barraza: Harvard Design School, MAUD, 2000; Cornell University, B.Arch., 1997; Piermarini: Harvard Design School, M.Arch. II, 1999; Cornell University, B.Arch., 1997  
**Work history:** Barraza: Practice—Office dA, 2000–02; Habitat for Humanity, 1999; Kennedy & Violich Architecture, 1998; Ricardo Bofill - Taller de Arquitectura, 1997; Academic—Rhode Island School of Design, 2002–present; Piermarini: Kennedy & Violich Architecture, 1998–2003; modA, 1998  
**Key completed projects:** St. Martin Street Residence, Fitchburg, Mass., 2006; Diva Lounge, Somerville, Mass., 2006; Seiyo Sushi & Wine Shop, Boston, 2005; Kashmir Indian Bistro, Boston, 2005; W.O.W. Inc. boutique, Newton Highlands, Mass., 2004; Ombar Lounge, Boston, 2002; Harvard Mailslot System, Cambridge, Mass., 2000  
**Key current projects:** Union Square Performance Space, Somerville, 2006–07; Acôté Salon, Miami Beach, Fla., 2007; Mela, Boston, 2006; Community Hill Development, Leicester, Mass., 2008–12; Hope for the Children of Haiti campus, Port-au-Prince, 2008–14  
**Web site:** www.studioluz.net

It's a Friday night, and Diva Lounge is jumping. Friends converge around the rustic bar made of salvaged Vermont butternut wood and decorated with the random patterns of worm holes. First dates share Indian tapas as they marvel at the walls and ceilings entirely lined with illuminated panels that look like fat pillows. A bouncer checks IDs outside, where the club's exterior features the same glowing, bulging surface as the interior. Welcome to downtown Somerville, Massachusetts, where the Diva crowd is as sexy as the interior.

Steven Holl, Frank Gehry, Office dA: With big-name architects making new icons for the Boston skyline, the New England metropolis is loosening its buttons. But it may be under-the-radar architects like Studio Luz, the designers of Diva Lounge on the city's outskirts, that are changing the ways people interact with their environments and each other.

Indeed, interaction is fuel for Studio Luz principals Hansy Better Barraza and Anthony Piermarini, whose work negotiates experiences of community and introspection. Their Diva Lounge, for example, is a social facilitator. The butternut backrests of the banquettes are incised with the shape of a silhouette. The point, Barraza says, is for visitors literally to “rub shoulders.” The long, narrow lounge terminates in three bathroom pods, the interiors of which are too small to contain anything but the essential plumbing. With surplus space allocated around the pods, queuing up is less annoyance and more friendly, multigender social activity.

Conversely, exhibition installations displaying the architects' work, such as *Terrain: Vulnerable Architecture*, at Drake University in Iowa, and *If... Then*, commissioned as part of The Architectural League's 2004 Young Architects Forum (YAF), foster intensely private moments. At the Drake show, images and collected artifacts were presented inside long chicken-wire cylinders mounted from quicktubes (cardboard forms used for pouring concrete footings), so that contemplating them meant disengaging with the wider gallery setting. For YAF, the architects clipped frosted acrylic elements, looking like toy viewfinders, to a structure of interlinking steel brackets. Of the amorphous shape improvised on-site, Piermarini says, “*If... Then* was an open-ended question, so we wanted to create an open-ended armature.”

These projects also highlight how Studio Luz applies quotidian materials out of context and repeats them to abstraction. Diva Lounge's surfaces, for example, are actually common polycarbonate skylight bubbles. In the firm's fourth-floor workspace in South Boston, visitors glimpse future iterations of this theme. One model, for Boston's Union Square Performance Area, specifies seats made of 6-foot-long granite curb cuts that the city can later dismantle and reuse for sidewalks.

Piermarini notes the gritty circumstances of being a young architect, saying repetition-as-abstraction “is about making the design accessible. The reality is that many of our projects have very limited budgets.” With a long track record of ingeniously responding to budgetary plight, one looks forward to the day when Studio Luz's resources are grander. ■

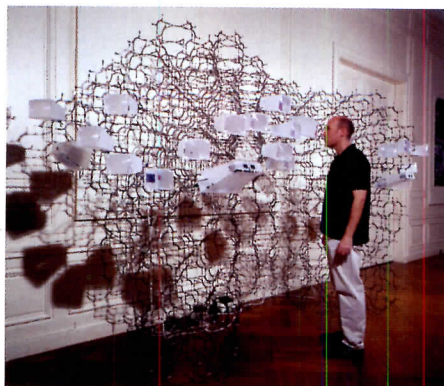

*If... Then* featured a cloudlike exhibition fixture.





**Seiyo Sushi & Wine Shop, Boston**

Echoing its multiple programs, the design for Seiyo comprises a series of quirky vignettes, such as a wall in which lacquered MDF storage units mimic the motion of a waiter holding out a bottle of wine (above right), a screen made of empty bottles extending from steel tubes (below), and dining tables that encourage more intimate seating arrangements (below left).



## W.O.W. Inc., suburban Boston

Commissioned to create a new skin for the clothing store W.O.W. Inc., Studio Luz applied a ribbon of Polygal sheets in aluminum frames, which were varied with any of several predetermined notches. The notches were arranged as cutouts revealing the merchandise behind the windows. To honestly show their work as a second skin for the original Art Deco-era building, the architects pulled it away from the volume, thereby transforming it into a translucent barrier for the parking lot.



## Harvard mailslots, Cambridge, Mass.

For Barraza and Piermarini, transforming everyday things into dynamic elements predates the establishment of Studio Luz in fall 2002. As graduate students at Harvard, the pair, with classmate Michael Cosmas, won a competition to design and fabricate a 40-foot-long wall of mailboxes for Harvard's M.Arch. students. A textured plane of trays cantilevers from a self-supporting waffle panel, all made of 12-gauge, cold-rolled steel—the cheapest variety, Barraza notes with a wink.



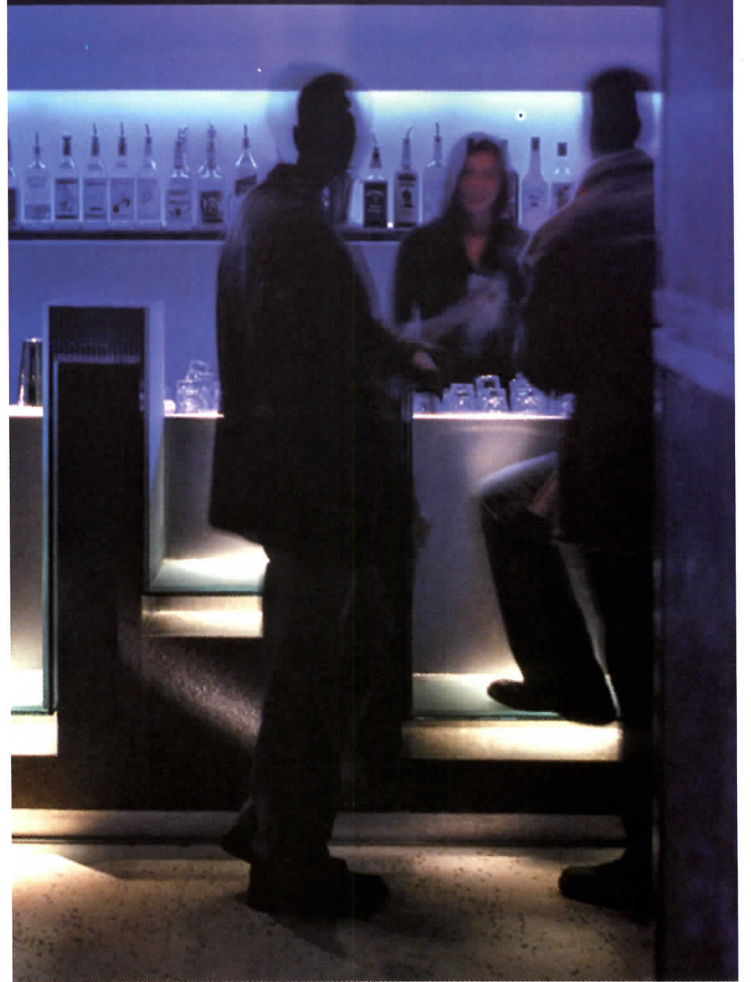

**OmBar lounge at  
Mantra restaurant,  
Boston**

Taking over a space that had also been used as a night spot, the owners of OmBar asked Studio Luz to fashion a reincarnation from the existing materials. Barraza and Piermarini shattered tempered glass from the old space, reusing it to accent terrazzo flooring and laminating it into sheets for the bar. The bar exemplifies the studio's approach to social contact: A monolithic surface was reimagined as podiums to encourage face-to-face contact (above).





## The Dutch firm **BAR**, based in Rotterdam, brings a humanist approach to Modern design

By Tracy Metz

**Architect:** BAR (Bureau voor Architectuur Rotterdam)

**Location:** Rotterdam, the Netherlands

**Founded:** 1999

**Design staff:** 5

**Principals:** Joost Glissenaar and Klaas van der Molen

**Education:** Glissenaar: Academie van Bouwkunst Rotterdam, 1997; Van der Molen: Academie van Bouwkunst Rotterdam, 1996

**Work history:** Glissenaar: MVRDV, 1994–99; Sybrand Fukken, 1989–93; Van der Molen: Akropolis, 1996–99; Kraaijvanger/Urbis, 1995–96

**Key completed projects:** *Just In* exhibition, Netherlands Architecture Institute, Rotterdam, 2005; KEI office space, Rotterdam, 2005; Bridgehouse, Middelburg, 2004; Junky Hotel, Utrecht, 2004; Plantijn Casparie printshop, Utrecht, 2003; BAK center for contemporary arts, Utrecht, 2003

**Key current projects:** Krasinski Pavilion exhibition space, Warsaw, 2006; BNA interiors, Amsterdam, 2007; Kokerloods media center, Utrecht, 2007; Wijkwaard neighborhood center, Alkmaar, 2007; KLPD police stations, Assen and Maasbracht, 2008; Music House, Utrecht, 2008; Glauberweg apartments, Amsterdam, 2008

**Web site:** [www.bararchitects.com](http://www.bararchitects.com)

*Tracy Metz, RECORD's Amsterdam-based correspondent, is currently a Loeb Fellow at Harvard University.*

Can architecture be useless? The question is only half-rhetorical when posed by BAR, the Rotterdam-based architecture firm of Klaas van der Molen and Joost Glissenaar. The pair has repeatedly explored the purpose of architecture, and in particular the interaction between the building and its user. Look at its Bridgehouse for the southern Dutch town of Middelburg: useless! Only six times a year does anyone step inside to open the bridge; the rest of the time it is merely a transformer station. “We call it a folly in the water,” says Glissenaar. But what could have been a boring technical facility has been designed by BAR as a piece of urban sculpture, making it “useful” in a new way to the surrounding city.

Glissenaar and Van der Molen, who have known each other since architecture school, set up shop in 1999 as BAR (Bureau voor Architectuur Rotterdam) after winning first prize in *European*, a European-wide competition for young talent. (Their design has yet to be realized, to their chagrin.) One of their best-known designs so far is a building for the printer Plantijn Casparie on an old industrial waterway. It presents itself to the passerby as a long, crisp wall of double-height glass panes between 18-foot-high wooden supports. Behind this facade, the building extends as a series of three linked boxes, from a transparent front office to a printing shop in the middle and a binding, storage, and shipping facility in the back. Glissenaar says, “The processes that unfold inside are a kind of hidden treasure from which we derive the exterior.”

On one of the most exclusive streets in the historic center of Utrecht, BAR designed a project with a uniquely Dutch social agenda: a hostel for aging junkies. In a landmark building from 1910, the architects created living quarters for 28 homeless, hard-drug addicts, with a communal living room and kitchen. At the core of the deep building, the architects clad walls in formica sheets imprinted with an almost three-dimensional image of juicy green ivy, adding at least the suggestion of a whiff of fresh air.

Contrasting old shell and new interior was a key part of BAR's first commission: a contemporary arts center called BAK, also in Utrecht. Here it inserted a plane of perforated-metal stair treads 6 feet behind an old facade, dating from 1650. “We created a vertical foyer of perforated metal and glass floors that articulates the transition between old and new,” explains Van der Molen. “It is, in fact, one continuous space spread over three stories, containing a library, a reception area, and a gathering space.”

Dutch architecture captured the public's eye in the 1990s with its daring approach to form and program. Now, however, Dutch clients are more inclined to play it safe. This is especially true of housing, long a playground for young architects but now largely market-driven and neotraditional in style. “Young firms have little presence in the developers' world,” says Glissenaar. “We're more at home in the world of government and culture, and we're cheaper and more patient than the big offices.”

With its emphasis on the user's experience, BAR finds itself moving in the direction of postwar Dutch luminaries like Herman Hertzberger and Aldo van Eyck, who took an intensely humanist approach to the built environment. Young though it is, BAR is *grabbing* attention by wrapping its predecessors' social sensibility in unapologetically strong and confident forms. ■

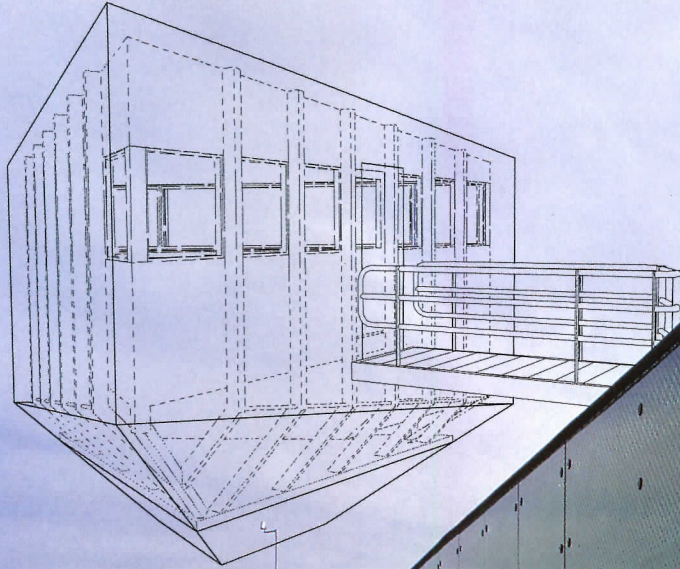
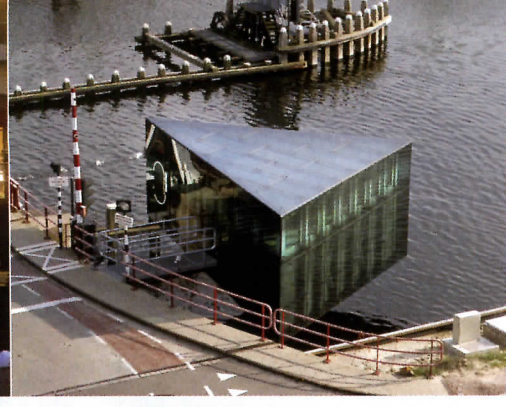

### **Bridgehouse, Middelburg, the Netherlands**

An addition to the existing Station Bridge that connects Middelburg's downtown to its outlying areas, this jewel-like building offers 360-degree views for the bridge attendant during his infrequent visits. The architects say the green glass relates to the copper roof of a nearby abbey and that they saw the project as an urban folly on the Walcheren canal.



## BAK, Utrecht



Set within the shell of a 17th-century building in the historic center of Utrecht, the BAK contemporary arts center initiates a lively dialogue between old and new. The architects inserted a 28-foot-high, glass-and-galvanized-steel element behind the old facade, creating space for service functions. Stairs, toilets, reception area, pantry, library, and storage space are all integrated into the new element. Glass floors allow visitors to appreciate the full height of the modern insertion.

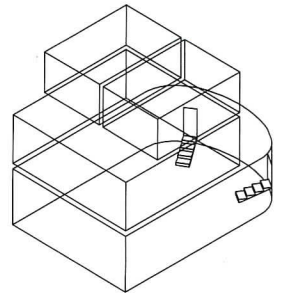
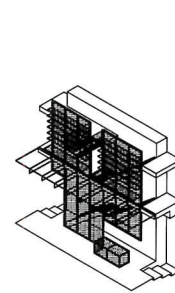
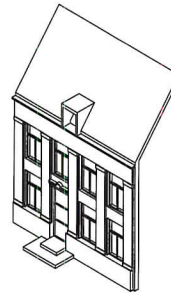

## Royal Theater, Copenhagen, Denmark

In this competition entry, BAR treated the foyer of the theater as a giant public space—wrapped in glass on four sides and flowing out onto a pier at the end of Kvaesthusbroen on Copenhagen's harbor. Stainless-steel boxes house two theaters and are perforated to allow light and air inside and create a lantern effect at night.





**Junky Hotel,  
Utrecht**



This adaptive-reuse project provides housing for 28 homeless hard-drug users while helping them start the process of reintegrating with the rest of society. The residents live in private rooms but share use of a communal living room and dining area. BAR placed reception, administration, meeting rooms, kitchen, and a doctor's office along the front facade, while organizing residents' rooms in two blocks—in the front and back of the building—with service modules in between.

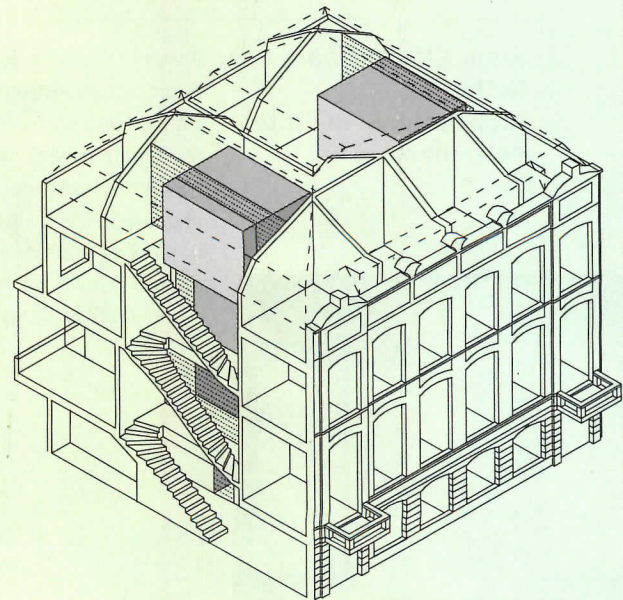

## Plantijn Casparie, Utrecht

BAR designed this facility for a printing company as a series of two-story boxes, one behind the other. On its public front, along a canal, the architects placed offices and studios, then set the print shop in its own box, and finally the binding and distribution area. A row of 80 wooden columns on the canal facade support the roof, act as mullions, and provide sun protection.



## From City to Chair, Netherlands Architecture Institute, Rotterdam

Asked to design “a living room of the future” for an exhibition at the NAI, BAR created an installation with chairs of different heights surrounded by a mirrored skin. The design raises a series of questions: Is it inside or outside? Is it limited or unlimited? Is it a living room or a public square? Is it convivial or abstract? Is it furniture or a city?

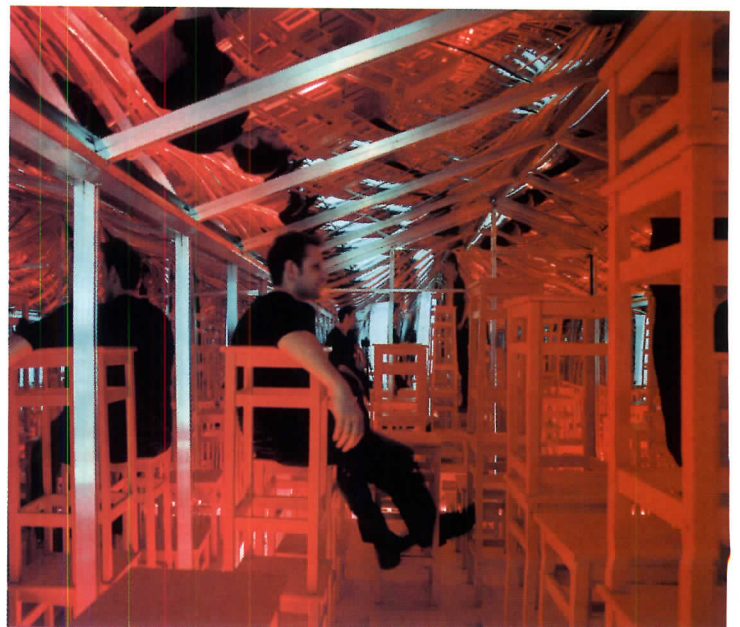





**Mies-Meets-Granpré  
mobile, Utrecht**

This mobile meeting space for the new town of Leidsche Rijn in Utrecht combines irony with practicality. A comment on the struggle between Modernism and traditional design (represented by the Dutch architect Marinus Jan Granpré Molière, who died in 1972), the little structure has a polyester skin decorated with imitation bricks and can be delivered to the site on a standard trailer chassis.

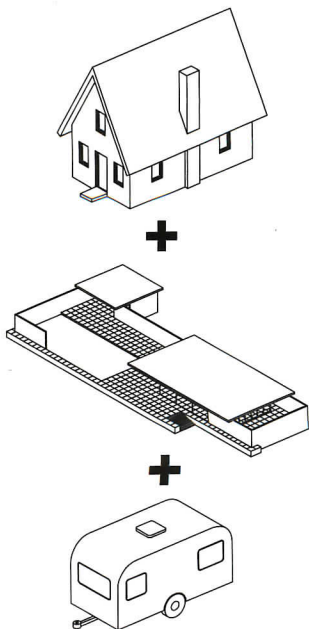



# Studio SUMO eschews signatures by approaching every project inquisitively

By David Sokol

**Architect:** Studio SUMO

**Location:** Long Island City, N.Y.

**Founded:** 1996

**Design Staff:** 5

**Principals:** Sunil Bald and Yolande Daniels

**Education:** Bald: Columbia GSAPP, M.Arch., 1991; University of California Santa Cruz, B.A. biology, 1986; Daniels: Columbia GSAPP, M.Arch., 1990; The City College of New York, CUNY, B.S. Arch., 1987

**Work history:** Bald: Practice—Pasanella + Klein Stolzman + Berg, 1995–96; Gaetano Pesce Ltd., 1994; Antoine Predock Architect, 1991–94; Academic—Yale University, 2006; Parsons The New School of Design, 2000–present; Daniels: Ralph Appelbaum Associates, 1996–98; Selldorf Architects, 1993–95; Smith-Miller + Hawkinson Architects, 1991–93; Gaetano Pesce Ltd., 1991; Academic—Columbia GSAPP, 2000–present

**Key completed projects:** Josai School of Management, Sakado, Japan, 2006; Museum of Contemporary African Diasporan Art, Brooklyn, N.Y., 2006; MiniMax prefabricated housing prototype, 2005; *Urban Life* exhibition design, Urban Center, New York City, 2003; Museum for African Art, Long Island City, N.Y., 2002; *Intimate Landscapes* installation, Project Row Houses, Houston, 2002; *NewNewYork2* exhibition design, Urban Center, 2001; Flip/Flop live/work prototype, New York, 1998; *Femme Pissaire* female urinal prototype, 1997

**Key current projects:** *de facto/de jure* installation, Amtrak Crescent Line, 2006; Mizuta Museum of Art, Sakado, Japan, 2007; Brant Artist Studio, Bennington, Vt., 2007; Mitan Housing, Little Haiti, Miami, 2008

**Web site:** www.studiosumo.com

Names can be deceiving. Studio SUMO, a decade-old practice based in Long Island City, New York, does not represent founders Sunil Bald's and Yolande Daniels's ethnicities, nor an interest in an exotic sport. (Sumo is a combination of Sunil, and Daniels's nickname in grad school, Momo.) But if SUMO were to signify anything related to Japanese wrestling, it would be heft—of the cerebral kind. Bald teaches at Parsons and Yale, and Daniels at Columbia, and as Daniels says, "We begin with a question, searching not necessarily for answers, but for something." Bald adds that projects "don't necessarily have a predestined physical manifestation."

Designs for Josai University in Japan exemplify this tabula rasa approach. In 2000, Bald and Daniels were commissioned to design a pair of information buildings for the university's Togane campus. One, for students, was to be located on a pedestrian route to a nearby train station. The partners devised a program according to the train schedule: A vending machine would occupy the student waiting for just a few minutes, and a magazine stand, laptop stand, and rooftop garden were meant for more patient scholar-commuters. For the second building, a 4,500-square-foot visitors' pavilion planned for the other side of the campus, they drew inspiration from the site's bypass-road location. Referring to the bright lights and quick thrills of nearby used-car dealerships and pachinko parlors, this design included a drive-through component as well as a scrimlike facade that, illuminated internally, acted as an abstract billboard.

Although the so-called Info/Info structures stalled, three years later Josai tapped SUMO for a 70,000-square-foot school of management on its Sakado campus. That project looks nothing like a super-size reiteration of the earlier works. Instead, the designers single-loaded the classrooms into a folded, 600-foot-long structure, and lifted it to allow a public path to run underneath. Besides exercises in individuality, the Josai series shows SUMO's comfort with a range of scales. Indeed, in about the same period the Sakado building was designed and built, so was the Museum of Contemporary African Diasporan Art, an 1,800-square-foot interior in Brooklyn.

Loose connections abound through the portfolio. Formally, the Sakado project hints at a winning design in an affordable-housing competition in Miami—even though the latter's floor plans are based on shotgun and Creole manor houses. And the 2005 MiniMax prefabricated housing prototype hints at the total-design aspirations of Flip/Flop, featuring Murphy-like zones for different live/work functions that Bald and Daniels developed for themselves seven years earlier [RECORD, September 1999, page 105]. The legacies aren't direct, but can be teased out.

In 2001, Bald was invited to present work at a faculty exhibition, for which he and Daniels chose to organize designs not by type or chronology, but by matching projects to descriptive words that feature the abbreviations in the periodic table of elements. "[In] this kind of grid, things relate by their proximity and reference other elements potentially," Bald says. It's a fitting representation for two talents who rigorously investigate architectural solutions, but for whom many streams of consciousness will take them almost anywhere. ■



Seven armature units displayed *NewNewYork2*.

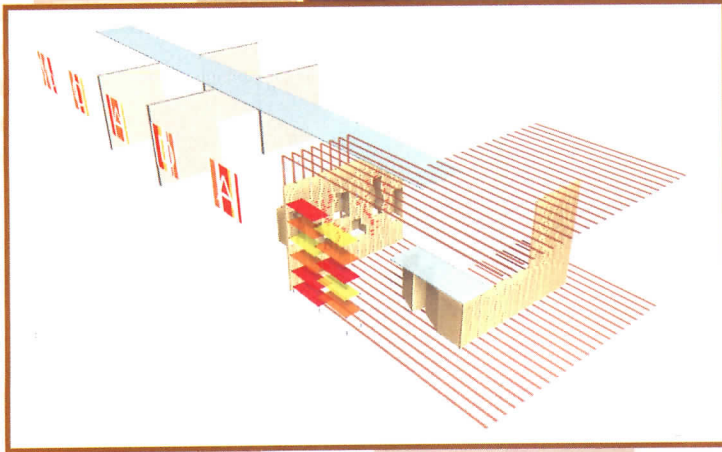

**Museum of Contemporary African Diasporan Art, Brooklyn, N.Y.**

The first public art institution to open in the BAM Cultural District in Brooklyn, this museum dedicated to contemporary African-American and Caribbean artists is housed in the base of a renovated office building. Studio SUMO applied the museum's acronym, MoCADA, to existing windows (right), and transformed the reception area into a giant sculptural map in which stacks of wood represent the world's 24 time zones and text cites places that figured prominently in African migration (above).



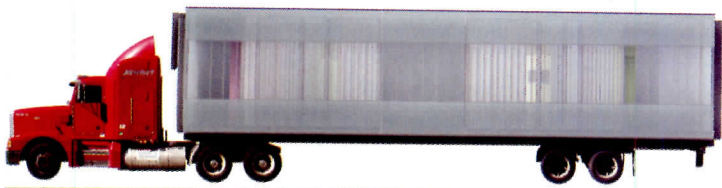

**MiniMax prefab home prototype, City Design Center, Chicago**

Although SUMO developed MiniMax as a concept for a City Design Center exhibition, the team is hoping to bring it to fruition. The prefabricated home is designed to act as a bellows: It arrives in a compressed, shippable form that then expands once it is secured in the site. Two end sections slide out on motorized tracks to form the living area and master bedroom; the middle section moves laterally to form a second bedroom, leaving a courtyard garden in the empty space.

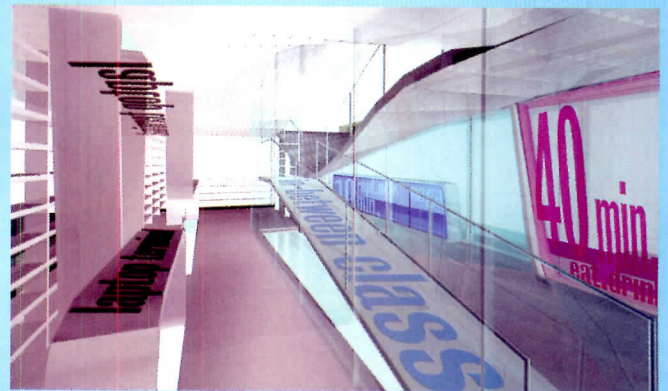
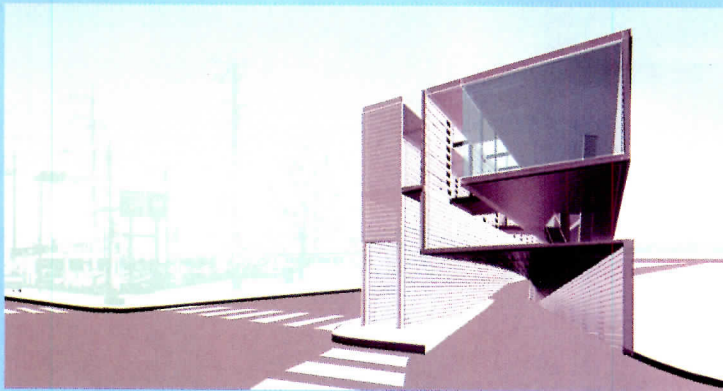
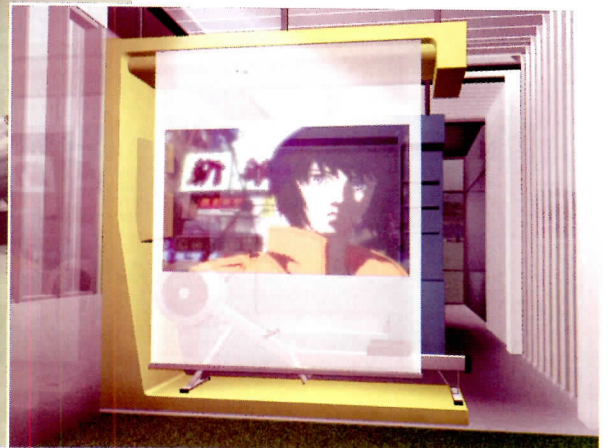
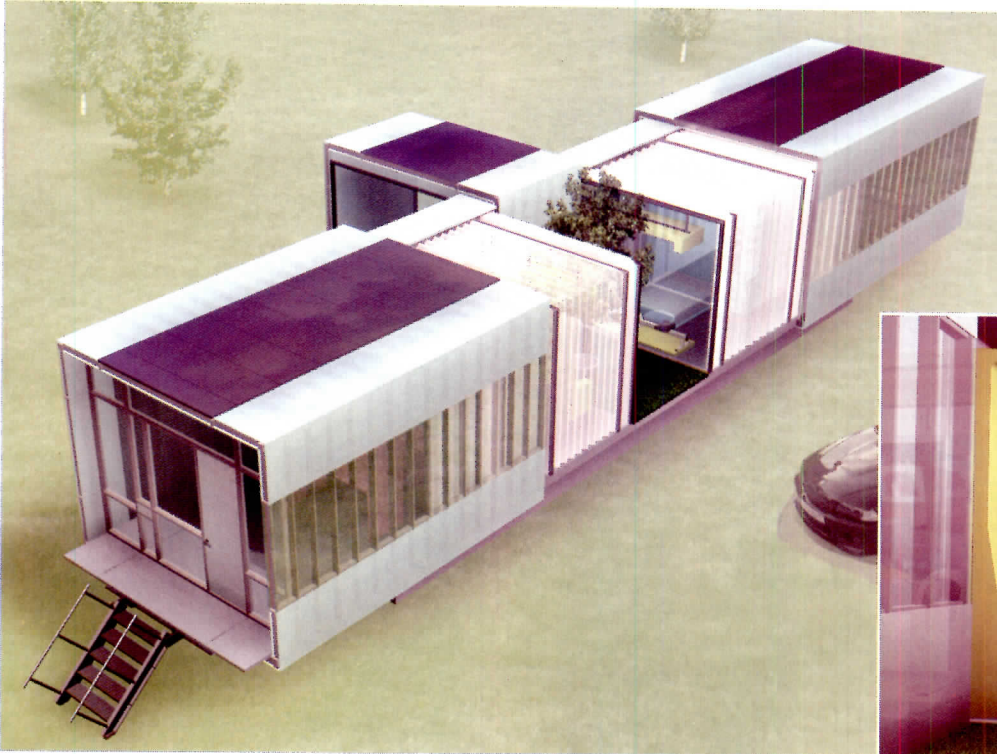

**Info/Info, Josai International University, Togane, Japan**

This pair of information buildings was designed for one of Josai University's three campuses. The larger Bypass Building (above) riffs off its bypass-road location. Canal Building (right and above right) measures one third the size and includes activity zones for students who are waiting for the train. Both feature significant outdoor public space—a drive-through component and rooftop garden, respectively.

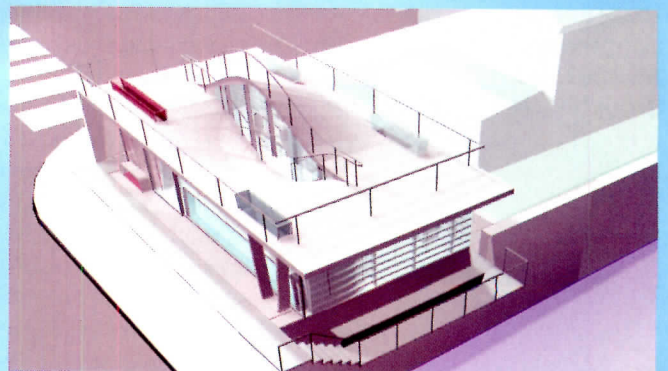

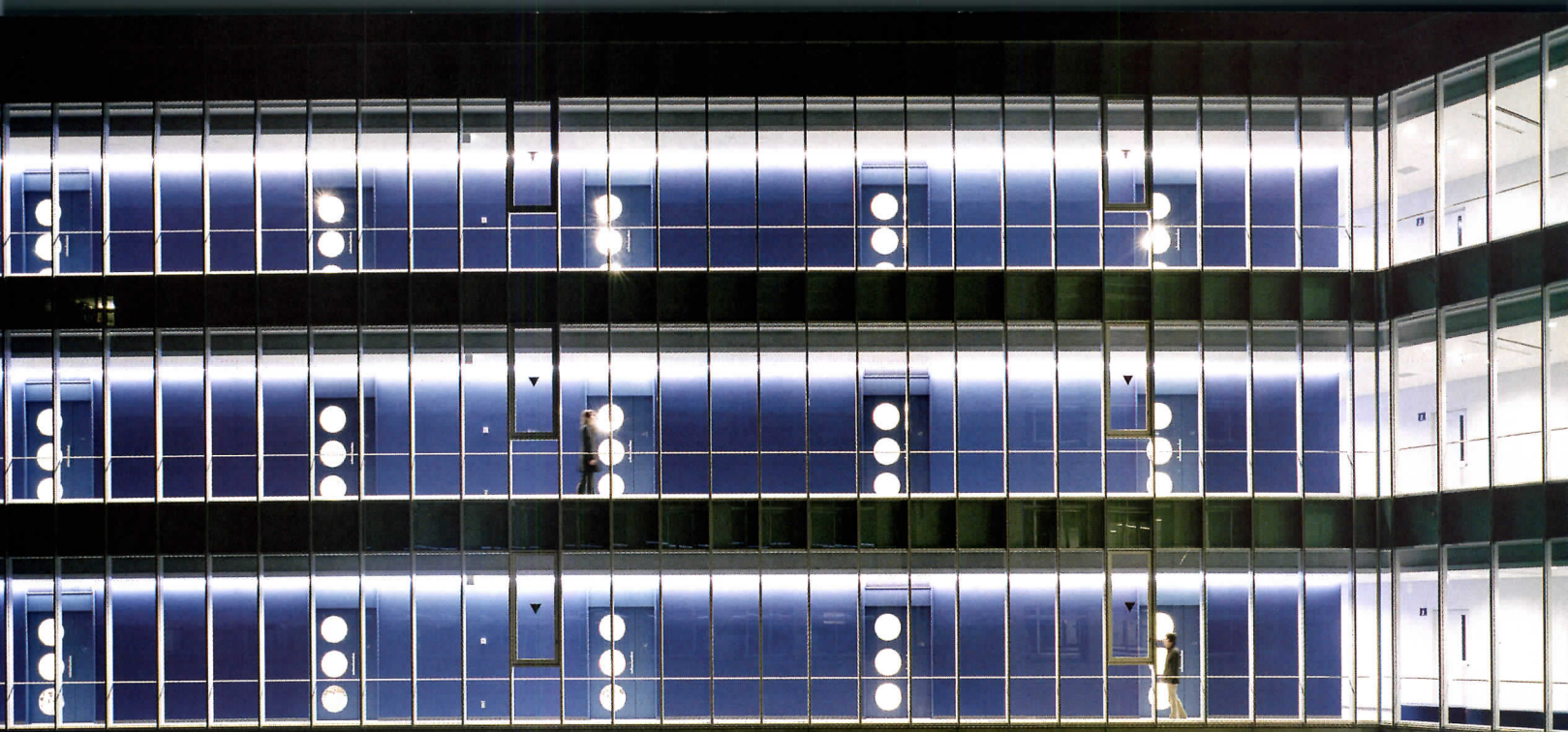

**Josai School of Management, Sakado, Japan**

This new building was SUMO's first opportunity to shoulder landscaping responsibilities. The crossover is evidenced in a pattern of bands that appears in exterior pavers, carpeting, wood decking, and ceilings. While clear glass clads the single-loaded corridor structure (below right), inside, randomly arranged channel glass prevents students from becoming distracted by activity across the atrium (below).

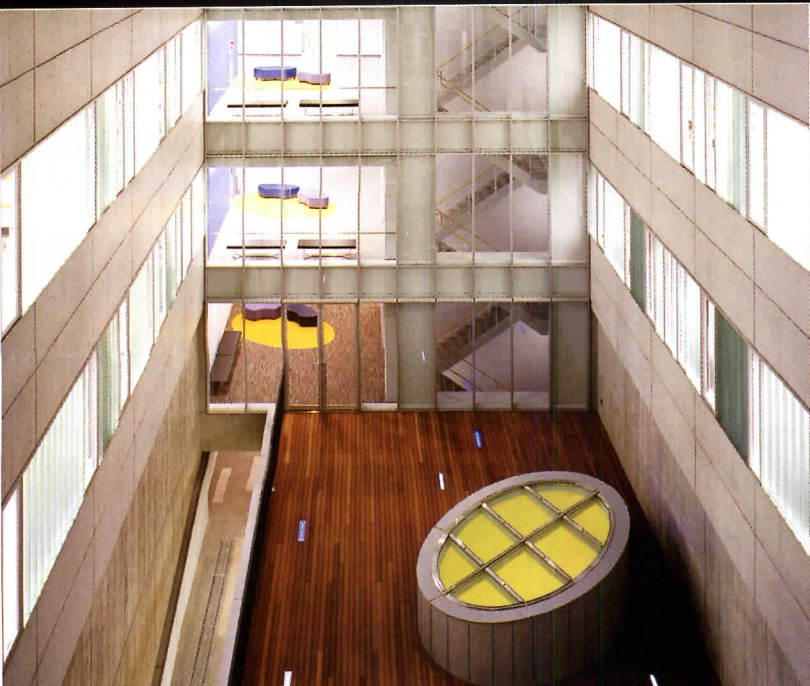



## Kumiko Inui shows that her design talents reach farther than skin deep

By Naomi R. Pollock, AIA

**Architect:** Office of Kumiko Inui

**Location:** Tokyo, Japan

**Founded:** 2000

**Design staff:** 6

**Principal:** Kumiko Inui

**Education:** Yale University, M.A., 1996; Tokyo National University of Fine Arts and Music, B.A., 1992

**Work history:** Practice—Jun Aoki & Associates, 1996–2000; Academic—Showa Women's University, lecturer, 2006–present; Kyoto Zokei University, lecturer, 2001–02; Tokyo National University of Fine Arts and Music, teaching associate, 2000–01

**Key completed projects:** Komatsu Clinique, Osaka, 2006; Louis Vuitton Taipei Building, Taipei, Taiwan, 2006; Jurgen Lehl Shinsaibashi, Osaka, 2005; Louis Vuitton Osaka Hilton, Osaka, 2004; Shin-Yatsushiro Monument, Yatsushiro, 2004; Dior Ginza, Tokyo, 2004; Jurgen Lehl Marunouchi, Tokyo, 2003; Meleze Gotemba, Shizuoka, 2003; Louis Vuitton, Kochi, 2003; Kataokadai Kindergarten, Kitakatsuragi, 2001

**Key current projects:** JLHM House, Tokyo, 2007; Hiroo Apartment, Tokyo, 2007

**Web site:** www.inuiuni.com

*Naomi R. Pollock is RECORD's special international correspondent based in Tokyo and the author of Modern Japanese House, published by Phaidon in 2005.*

Like many young architects, Kumiko Inui launched her career designing bits and pieces of buildings. But instead of churning out bathroom additions and bedroom suites, Inui made her name with eye-catching facades for luxury-brand boutiques. This comes as no great surprise since she apprenticed with Jun Aoki, Japan's king of high-end retail designers, after studying at Yale and Tokyo's National University of Fine Arts and Music. "I didn't really consider going to graduate school in Japan," says Inui. "At most Japanese universities, students study under one professor, but at Yale I had exposure to lots of different teachers."

Similarly, part of the appeal of working for Aoki was the unconventional way he runs his practice. Instead of relying on an office manager to oversee projects, he entrusts his staff architects with every part of the design and construction process. For Inui, this meant supervising the Snow Foundation in Niigata Prefecture and c, a tiny house on the outskirts of Tokyo, among other projects. But Aoki has a strict policy of requiring designers to leave his employ after four years.

"Four years isn't enough time to learn all aspects of architecture, but at the same time, I was ready," says Inui. Fortunately, she had a forgiving first client: a preschool director who happened to be her grandmother. To perk up the school's outdated building, Inui inserted vertical strips of glass into its solid exterior wall and painted horizontal, colored stripes on its interior surfaces. The strips and stripes create a crosshatch pattern that evokes the gingham uniforms sported by many Japanese students.

She used paint again as her medium in a boutique for clothing designer Jurgen Lehl—coating the walls, floors, and ceilings of each of the shop's five rooms with a different one of Lehl's favorite pigments. The soft hues gradually transition from one space to the next, making each one appear filled with tinted light without distorting the products' true colors.

Inui is perhaps best known for her facades—each one a visual pun or optical illusion. She made the elevation for Dior in Ginza out of two overlapping sheets of aluminum, dotting the outer layer with perforations so they replicate the woven pattern of Thonet's famous chair that Christian Dior adapted as his signature motif. Her first stand-alone structure was a pavilion for the town of Shin Yatsushiro in Kumamoto Prefecture. Shaped like a cute, pitched-roof house, it stands in front of a new train station and functions as a waiting area for travelers. Approached from all four sides, the pavilion is an assemblage of flat, semipermeable facades that add up to a

3D composition. Each wall, as well as the roof, is a glass-reinforced concrete plane punctured with square holes. "If it's raining, you still need an umbrella," laughs Inui.

Today Inui has plenty of bona fide buildings on her boards, including an apartment building scaled like a house and a house divided into tiny rooms like an apartment building. So even as her projects grow bigger and more substantial, whimsy and clever artifice—ideas she perfected by designing building parts—remain strong currents in her work. ■



The Meleze Gotemba boutique plays games with light.



**Shin-Yatsushiro  
Monument,  
Yatsushiro, Japan**

Built to celebrate the new bullet-train station in front of which it stands, this pavilion in Kumamoto Prefecture serves as a waiting area for travelers. From a distance, the pavilion recalls a typical house as drawn by a child. But as visitors get closer, the building seems to dematerialize, thanks to a blizzard of openings cut into the glass-reinforced concrete walls and roof.

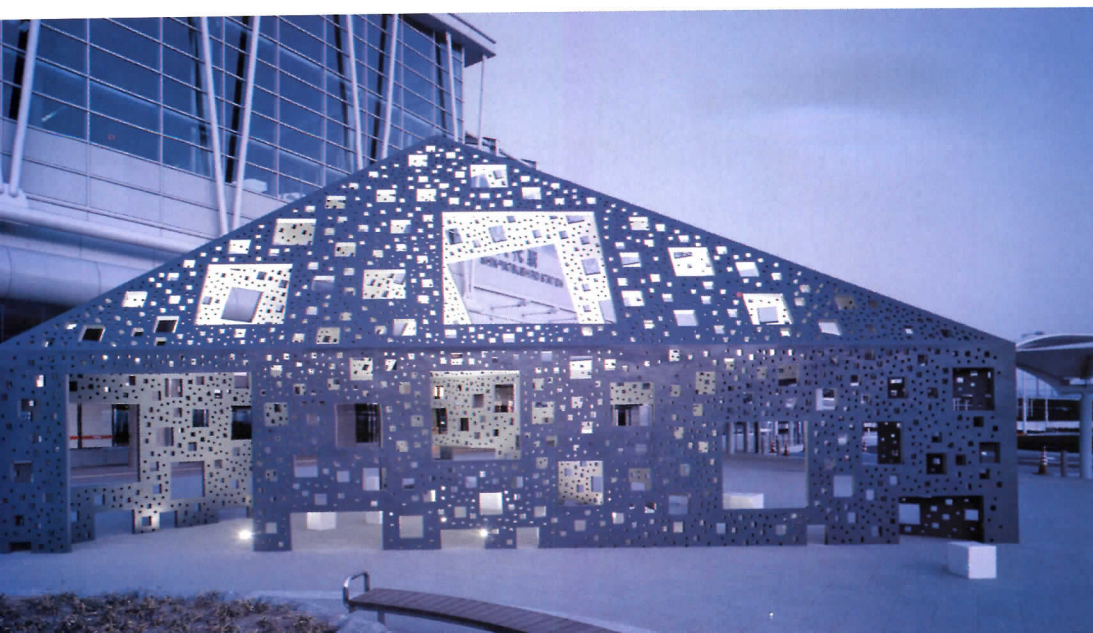



**Louis Vuitton,  
Taipei, Taiwan**

Inui created the building's envelope by inlaying 100,000 clear-resin dots in limestone panels to create Louis Vuitton's iconic *damier* pattern. The size of the dots changes so the pattern merges with the surrounding trees. At night, the dots become luminous and the silhouette of real trees overlaps with the blurred illusion of trees.



**Jurgen Lehl,  
Marunouchi, Tokyo**

In a subtle exercise of light, shadow, and color, Inui painted each of this boutique's five rooms a different color (blue, gray, brown, pink, or purple). By wrapping each room in one color—applying the paint to walls, ceilings, and floors—and blurring the boundaries between the colors, she creates a remarkably fluid environment.





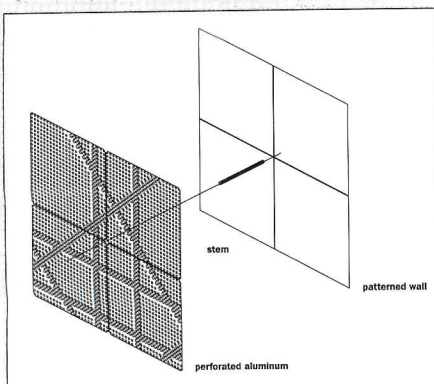
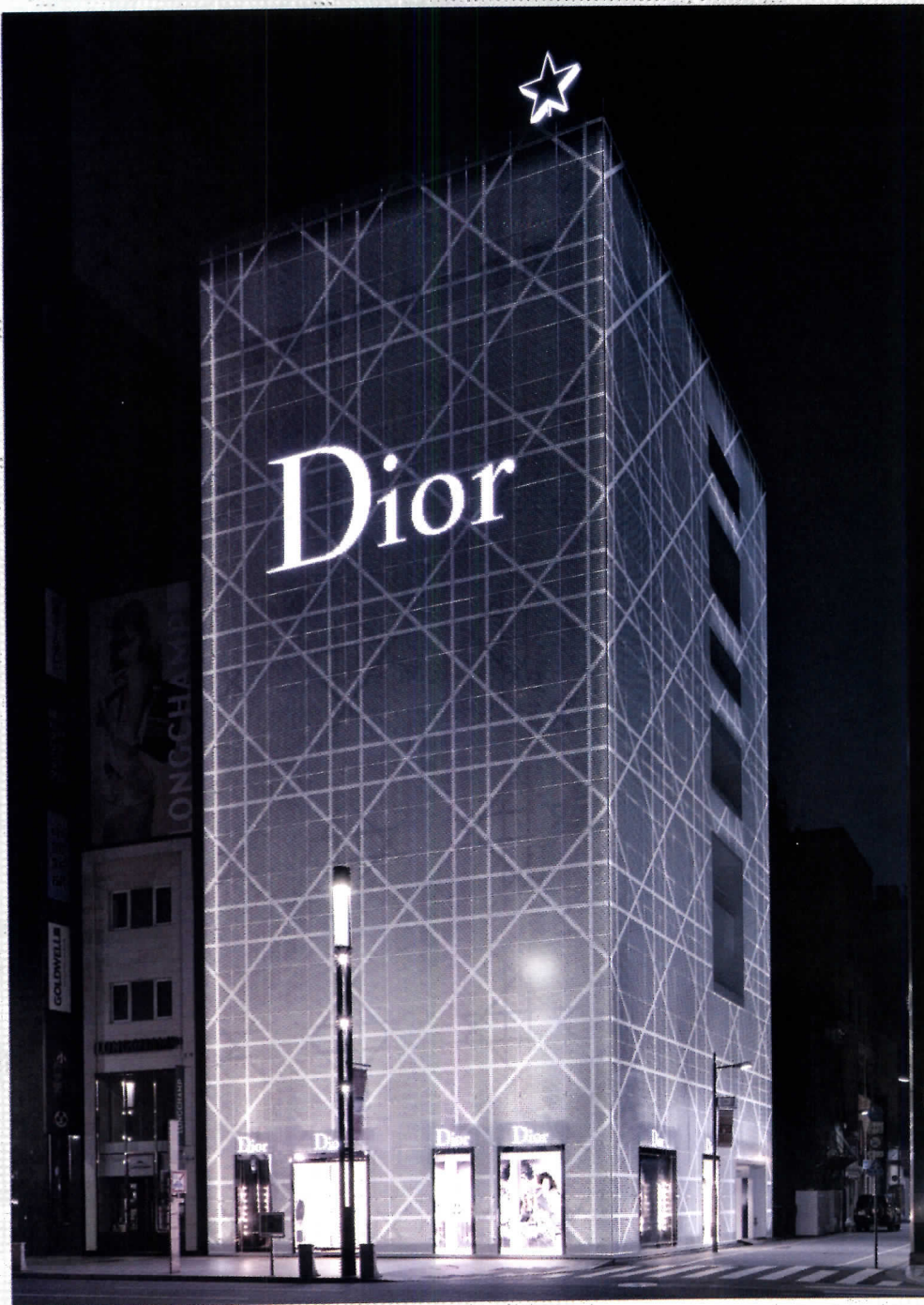

### Dior Ginza, Tokyo, Japan

For the Dior Building in one of Tokyo's famous shopping districts, Inui designed a double-skin facade composed of perforated-aluminum panels and printed-aluminum panels with lighting in between. Both the perforated and the printed panels express Dior's famous *canage* pattern, and at night they create a moiré effect that gives the building a ghostlike appearance.



## Bercy Chen Studio crosses language and cultural barriers from its base in Texas

By Ingrid Spencer

**Firm:** Bercy Chen Studio

**Location:** Austin, Texas

**Founded:** 2001

**Design staff:** 7

**Principals:** Thomas Bercy and Calvin Powei Chen

**Education:** Bercy: University of Texas at Austin, B.Arch., 1999, U.T. Austin, B.Arch. Engineering, 2000; Chen: University of Texas at Austin, B.Arch. 1998

**Work history:** Bercy: MJ Neal Architects, Austin, Tex., 1999–2001; Samyn & Partners, Brussels, Belgium, 1998; Chen: MJ Neal Architects, Austin, 2000–01; STG, Austin, 1998–99; Max Levy Architect, Dallas, 1997

**Key completed projects:** Tortuga Residence, Austin, Phase 1 completed spring 2006; Beverly Skyline Residence, Austin, 2004; Lago Vista Lake House, Austin, 2003; Annie House, Austin, 2002; Factory People, retail space, Austin, 2002

**Key current projects:** Tortuga Residence, Austin, Phase 2 to be completed fall 2006; Asian-American Resource Center master plan, Austin, 2006; Riverview Garden Residences, Austin, 2007; E. 11th multiuse development, Austin, 2007; Volente Residence, Austin, 2007; Skybridge Condominiums, Austin, 2007; Self-sustaining House, 2007; Outdoor amphitheater, Las Vegas, 2007; Florence Oregon Resort Development, Oregon Coast, 2008

**Web site:** [www.bcarc.com](http://www.bcarc.com)

*Contributing editor Ingrid Spencer writes about architecture and design from Austin, Texas.*

Thomas Bercy and Calvin Chen have found Texas the perfect venue for architects from far-flung places to come together and create a powerful design identity. Since 2001, Bercy (from Brussels) and Chen (from Taipei) have used Austin, Texas, as their home base and muse for a growing body of work that combines a sensitivity to local context with an innovative use of materials. Though rooted in a respect for the Texas Hill Country and what they call “borrowed landscapes,” their innovative residential designs and one completed retail project have spread the architects’ reputation beyond central Texas. (New York’s Architectural League featured Bercy Chen in its Emerging Voices program this year.)

The two principals aren’t the only foreign-born designers at work in their design-build firm. “It’s like the U.N. around here,” says Bercy. Indeed, the six-person firm boasts a 50:50 ratio of international-to-U.S.-born members. “You walk in the office and hear me on the phone in French, Calvin chatting away in Chinese, Tom in Danish, Gunter in German—it’s pretty interesting.” With all of the firm’s global contacts, they’ve begun to hear from clients in their home countries. While they are excited by these opportunities, they also hate to let go of the hands-on approach they have taken with their local jobs. “We create buildings that will last,” says Bercy. “They’re not ephemeral, so it helps to control the construction process.” Chen adds, “Because we’ve done all the contracting management as well as the design for our Texas projects, we’ve been able to experiment, and push contractors to break from the norm. We know we can’t be so closely involved with the construction on projects farther away. So, we’re working on improving our document-making abilities to retain as much control as we can.”

And while they learn to let go just a little, and continue entering competitions for projects around the world (the latest is for a library in Stockholm), commissions outside their local time zone have started to come through. The firm is now working on the master plan for an eco-resort on 150 acres outside of Portland, Oregon—a sustainable, mixed-use retreat complete with spa, hotel, and retail components.

The firm is staying busy in Austin, too. Riverview Residences, three 2,800-square-foot, single-family homes in an urban neighborhood near Lake Austin, started construction this year, just as the firm began the master plan for an Asian-American Resource Center on 17 acres in northeast Austin. With a mix of public and private spaces—including restaurants, retail, classrooms, a library, and a 2,000-seat performance hall—the 90,000-square-foot project will be the team’s largest to date. Right now, they’re only involved in the master plan, but they hope to design the actual spaces. “We’re getting a crash course in politics with this one,” says Bercy. Steering the project away from a “Disneyland influence,” Bercy and Chen plan to use elements such as ponds and water features, which are hallmarks of their design aesthetic and help temper the hot climate of Austin. Applying ideas inspired by roof gardens in Marrakesh and Casablanca and other designs from around the world keeps the firm’s perspective “200 percent global,” says Bercy. “Texas has a lot of space,” says Chen, “and when you compare the natural landscape—the limestone formations, the exfoliating, the erosion patterns—to Taiwan, for example, with its miniaturization of landscape, then you gain a fresh perspective of place.” ■



**Tortuga Residence,  
Austin, Texas**

Like a folded plane, massaranduba-wood cladding wraps a dormer-turned-reading-room niche (above and left) in this 5,000-square-foot remodel of and addition to a 1980s tract home on Lake Austin. Reflective red acrylic sheets add to the warmth of the space. Above the garage, a recreation room seems larger than it really is due to its translucent white, acrylic-paneled walls, which are lit from behind with kinetic colored lights, revealing a room of pure color at night.

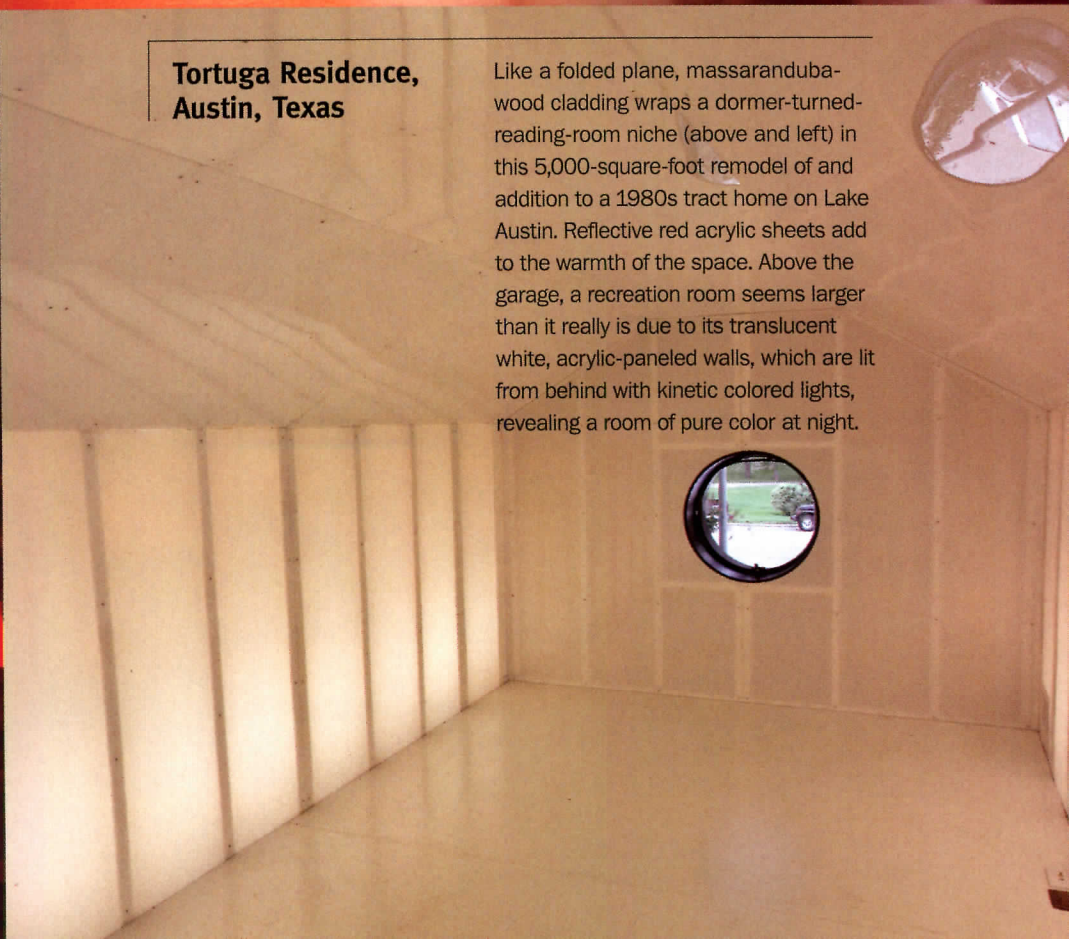



### Beverly Skyline Residence, Austin

Inspired by the 7th-century Kiyomizu Temple in Kyoto, Japan, this 3-story, 3,500-square-foot remodel of a 1970s home has panoramic Hill-Country views. The project took recycling seriously, using 600 glass blocks taken from a demolished hospital to form a translucent, streetside wall, and featuring an extensive rain-collection system that includes cascading pools and reservoirs all around the house. Glass balustrades on the upstairs decks were used to seemingly dissolve corners on the upper level. The downstairs deck clad in massaranduba wood has no barriers separating it from the untamed landscape beyond.

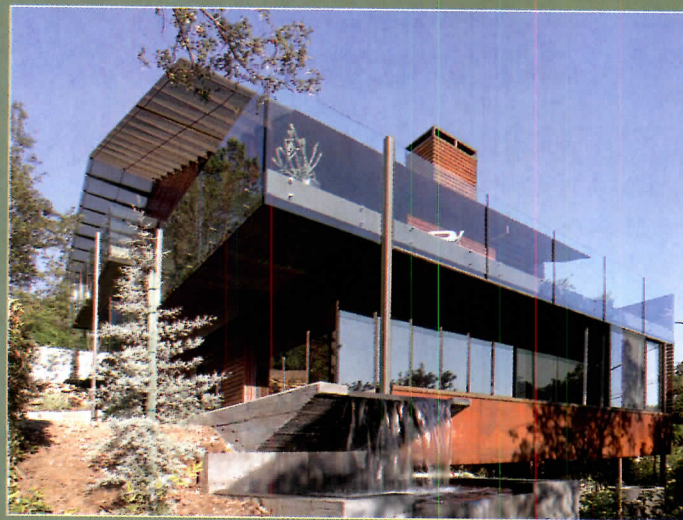

## Annie Residence, Austin

The architects divided one 2,000-square-foot volume into two distinct pavilions for a pair of related households in an urban neighborhood (opposite, left). Connected by a glass corridor (opposite, right) and a reflecting pool, the pavilions feature service cores clad in colored acrylic panels—red on one and blue on the other (left). The house's street facade displays a glowing garage of white acrylic sheeting and a second floor deck covered in stretched canvas (below).



## Lago Vista Residence, Lago Vista, Texas

Basically an open-plan box clad in ipe wood, this 900-square-foot vacation home also has 600 square feet of outdoor porch under its extended shed roof. The roof cantilevers 13 feet over the concrete-slab patio. The patio cantilevers over a concrete foundation, seeming to hover above the site.



## Outside Spain's design capitals, **BmasC Architects** places modernity in context

By David Cohn

**Architect:** BmasC Architects

**Location:** Ávila, Spain

**Founded:** 1998

**Design staff:** 6

**Principals:** Arturo Blanco Herrero and Alegría Colón Mur

**Education:** Blanco: Polytechnic University ETSA, Madrid, Ph.D., 2005; University of Valladolid ETSA, M.Arch., 1997; University of Valladolid ETSA, B.Arch., 1996; Colón: Polytechnic University ETSA, Madrid, Ph.D., 2005; University of Valladolid ETSA, M.Arch., 2000; University of Valladolid ETSA, B.Arch., 1998

**Work history:** Blanco: CJC University ETSA, Madrid, professor, 2005–present; Colón: CJC University ETSA, Madrid, visiting professor, 2005

**Key completed projects:** Jeweler's shop, Ávila, 2005; Municipal Preschool Education Center, Ávila, 2005; Primary Education Center, Sanchidrian, 2005; Mayo House, Las Berlanas, 2003; Eras de Renueva High School, León, 2003; Shoe shop, Ávila, 2002; Shoe shop, Ávila, 2000

**Key current projects:** Municipal Space for Youth, Ávila, 2006; Education Center, Piedralaves, 2006; Preschool Education Center, Sotillo de la Adrada, 2006; Huete House, Muñopepe, 2007; Municipal Cemetery, La Colilla, 2007; Industrial Nursery for Businesses, Ávila, 2007; 63 state-subsidized dwellings, Ávila, 2008; Social Houses, San Esteban del Valle, 2008; French Lyceum, Valladolid, 2008

**Web site:** [www.bmasc.es](http://www.bmasc.es)

**W**hether it's a line of identical glass cases in a jewelry shop, or a row of repeated classrooms at a preschool, the designs of Arturo Blanco and Alegría Colón often involve an elegantly simple unfolding of abstract forms. Based in the small historic capital of Ávila, 70 miles northwest of Madrid, their practice, BmasC Architects, shows how Spain's once-dormant regional centers are becoming motors of contemporary design. Blanco and Colón studied architecture at a small, regional school in nearby Valladolid. Since opening their studio in 1998, they've built eight projects and have nearly a dozen in various stages of development.

Blanco and Colón view abstraction not as their principal goal but a way of developing the potential of each problem, each program, each site. For example, the architects complemented the lines of glass cases in their tiny jewelry shop in Ávila with an illuminated ceiling and dark stone floor so the composition draws the eyes of passing pedestrians deep into the space, a strategy of perspectival recession they also used in two shoe stores in Ávila's historic core. At the preschool, also in Ávila, classrooms alternate with small wings containing service cores to define outdoor play spaces, while the rhythmic spacing of clerestory windows in the classroom's upper volumes provides even daylighting. "We are interested in the pragmatics of architecture, its potential to transform realities," states Blanco.

In their largest work so far, an addition to the Eras de Renueva High School in León, a long block of classrooms two stories high sits atop three perpendicular volumes (containing the gym, library, and cafeteria), with open spaces between them to visually connect the city and the playing fields. The south elevation, facing the city, is a collage of galvanized steel latticework within a metal grid, with screens oriented in different directions to create a range of textures. Seminar rooms and small offices irregularly line the opposite facade, creating an abstract play of wood volumes and voids on the exterior that allows daylight to reach central corridors.

In the Mayo House, a weekend retreat in the village of Las Berlanas, the architects again contrast upper and lower volumes, this time to create two kinds of living space: a relatively enclosed but social space on the ground floor arranged around a chimney and a walled garden; and an upper studio that steals views of the adjoining fields from above the bedrooms. According to Blanco, the juxtaposed volumes recall the sculptural stacks of hay bales the architects had seen in village wheatfields.

In both the preschool in Ávila and a primary school in the village of Sanchidrian, the architects weave together open spaces and built volumes to connect children with the outdoors. Thinking of the cold winters in Sanchidrian, they oriented the classrooms to the south, with fully glazed walls given a Mondrian-like pattern of fenestration.

Referring to the crisp detailing of their work, which regularly features different kinds of glass, zinc cladding, and accents of board-formed concrete and wood, Blanco says, "Although it might sound out of date, we believe in a new beauty based on a recycling of modernity." In its mineral hardness and formal purity, their work claims its place beside the severe granite palaces, convents, churches, and fortified walls of medieval Ávila. At the same time, the light, spacious, and translucent play of their volumes breathes new life into this ancient capital and its rural surroundings. ■



**Preschool,  
Ávila**

Built in the growing suburbs to the southeast of Ávila, this preschool is a recent addition to an existing educational campus. Courtyards separate the six classrooms and serve as play areas for the children. All the classrooms face south and have clerestory windows, so balanced, even daylight animates the interiors. While the architects used monochromatic materials on the exterior, they added color accents inside.

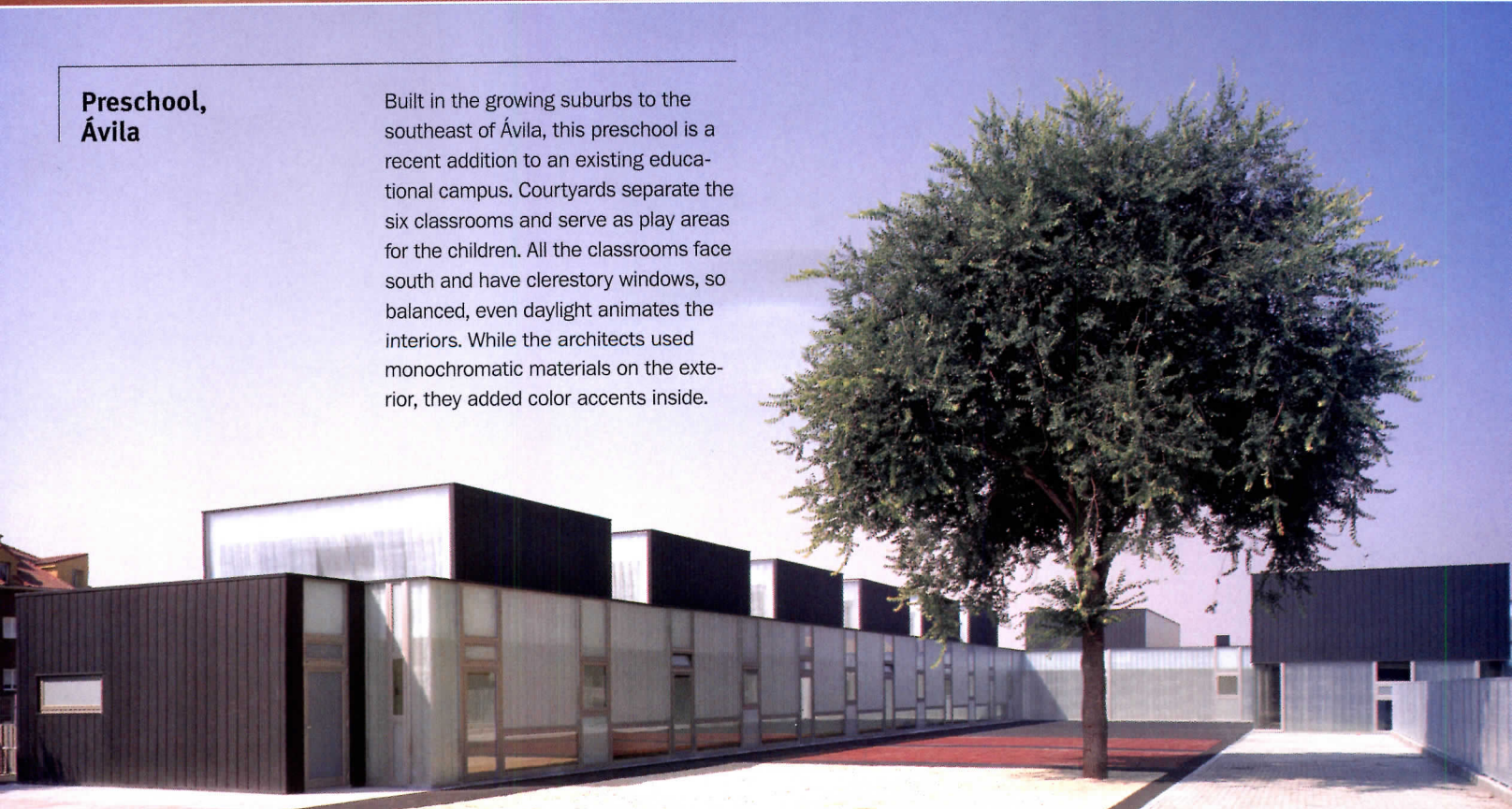

## Shoe Shop, Ávila

Completed in 2000, this boutique in the historic center of Ávila attracts shoppers by appearing almost like a continuation of the sidewalk. Gentle curves in the shelves on one side of the store and in the seating element add subtle notes of asymmetry in the elongated boxlike interior. The architects treated surfaces like skins layered one after another.



## Shoe Shop, Ávila

Floating inside the store's extruded sales space, a floor-to-ceiling glass box works as an enticing display case for shoes. Just as the architects played with skins in the shoe store (above) completed one year earlier, here they create a remarkable sense of layering in such a small space. A simple palette of materials—mostly wood, marble, and glass—enhances the impact of the spatial scheme.







**Mayo House,  
Las Berlanas**

Set on a flat site on the Castilian plains, this weekend home opens up to its rural surroundings at some places and turns away from them at others. According to the architects, it is both a retreat from and a window onto the outdoors. A garden wall sets limits to the owners' domain and creates three outdoor spaces while at the same time taming the land around the house.



ANGEL LUIS BALTANÁS (MAYO HOUSE, TOP LEFT AND BOTTOM LEFT AND RIGHT)

## Jeweler's Shop, Ávila

This store's large glass facade and simple, extruded form emphasize the continuity between indoors and out. A long band of even lighting set in the ceiling helps unify the sales space, while spots set into a series of display cases on one wall highlight the merchandise. The architects' use of repetitive elements, crisp details, and a long band of black marble in the floor pulls shoppers through the space.

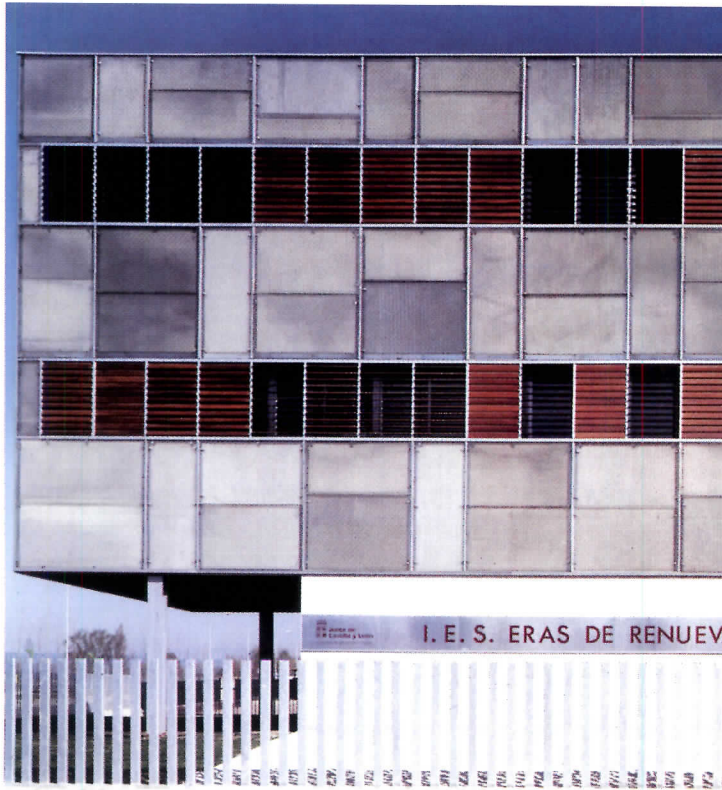

## Eras de Renueva High School, León

A two-story bar containing classrooms and small offices sits above three perpendicular blocks housing a gymnasium, a cafeteria, and a library. On the north side of the upper volume, the architects contrasted solid wood planes with recessed glass surfaces, while on the south they created a flatter composition with slatted shutters and galvanized-steel panels.





**Primary School,  
Sanchidrian**

BmasC oriented two classroom wings and a large multipurpose room to the south to help warm and animate these spaces, since the school is located in an area where it is cold for much of the school year. A combination of clear and translucent glazing on these south elevations creates a lively collage, while some of the wood on the solid elevations was recycled from forms used for the building's poured-concrete walls.





## Assadi + Pulido make an architectural contribution to Chile's evolving identity

By Beth Broome

**Architect:** Assadi + Pulido

**Location:** Santiago, Chile

**Founded:** 1999

**Design staff:** 3

**Principals:** Felipe Assadi and Francisca Pulido

**Education:** Assadi: Universidad Católica de Chile, M.Arch., 2006; Universidad Finis Terrae, Chile, B.A., 1996; Pulido: Universidad Finis Terrae, B.A., 1996

**Work history:** Assadi: Academic—Andrés Bello University, Santiago, 1999–present; Pulido: Academic—Andrés Bello University, 2003–present; Universidad Finis Terrae, Chile, 1997–2003

**Key completed projects:** O2 House, Rancagua, Chile, 2006; Deck House, Maitencillo, Puchuncaví, Chile, 2006; Serrano House, Santiago, 2006; Giovo House, Santiago, 2006; Russo Club, Talca, Chile, 2005; 20 x 20 House, Santiago, 2005; Teatro del Parque, Santiago, 2004; Raveau House, Santiago, 2003; Arauco Express, Santiago, 2001; Schmitz House, Calera de Tango, Santiago, 2001

**Key current projects:** Verbo Divino School, first phase, Santiago, 2006; García House, Santiago, 2006; Lorenzini House, Santiago, 2006; FdR House, Santiago, 2007

**Web site:** www.felipeassadi.com

Chile is like an island in Latin America," says Felipe Assadi, partner with his wife Francisca Pulido in their Santiago-based practice, Assadi + Pulido. Bounded by the Andes to the east, the Atacama Desert to the north, and the Pacific Ocean along its entire western edge, Chile is, indeed, geographically isolated. To many Chileans, the country—despite its long history—also feels "young," like an island, culturally speaking. "The freedom of our practice is based in the fact that we do not have a strong tradition to deal with," says Assadi.

"Chile is a place of opportunity," adds Pulido. For many designers, the two explain, long apprenticeships, like those of European or American architects, are not prerequisites for establishing one's own firm. Indeed, neither partner spent much time working for others. Assadi, who is from Santiago, set out on his own in 1999, just three years after completing his undergraduate studies in architecture at Finis Terrae University in Santiago, where he met Pulido, originally from Punta Arenas in the south. Before officially joining Assadi and forming their partnership earlier this year, Pulido taught and worked part-time for different offices, including Assadi's. "There's a lot to do here," explains Assadi. "The country is in the process of creating an identity, and we are a part of this."

For a young firm, Assadi + Pulido has produced a hefty portfolio of built work, mostly in Chile. "We are more of a geographical country," says Assadi, referring to Chile's great swaths of mountainous, arid, fertile, and coastal terrains. "Our work is always based in the landscape. Everything we make is new, because there are no references." The three concepts that guide the practice, the partners say, are *justeza*, *pertinencia*, and *equilibrio*. A project must be appropriate within its context, relevant to a given moment and environment, and involve a balance between the architect and client.

In its short life, Assadi + Pulido has had ample opportunity to experiment with a variety of programs. Its projects range from a 250-seat theater to a fruit warehouse to a drive-through pick-up facility for items purchased online. However, it is their shared love for residential work that prompted the husband and wife to become working partners after seven years of marriage. With commercial jobs, Assadi explains, the bottom line is the bottom line. Without being bogged down by a house's success as a commodity, the architects can focus on the weighty but rewarding responsibility of determining how design affects those living within it.

The Serrano House, for example, takes full advantage of its dramatic site in the Andean foothills. With part of its lower level built into the slope on which it sits, the house offers privacy from its neighbors. The rest of the lower floor, defined by steel columns and large glass windows, is almost transparent, making the upper level of concrete clad in Amazonian wood appear to levitate over the city below. The 20 x 20 House, on the other hand, quite literally admits and reflects the orchard it sits in.

Assadi + Pulido looks forward to increasing the scale of its work while maintaining a small, intimate office. The firm is currently designing a 25-story apartment building in Santiago and a nine-story office building in Valparaiso. "We have an internal law," says Assadi, "that every project we make has to be an opportunity to do even better things." ■



## Schmitz House, Santiago

Built for a couple on a flat parcel dotted by fruit trees in Santiago's Calera de Tango municipality, the house is elevated from the ground on a concrete foundation wall, which also contains a swimming pool and basement. The public spaces reside within a horizontal volume of glass and alerce wood. Creating a vertical contrast, the second volume, a concrete-and-glass box housing the sleeping quarters, opens onto a broad patio that looks down on the rugged terrain below.





## Russo Club, Talca, Chile

One of this project's challenges was figuring out the program. The clients called for a pool, disco, bar, gift shop, restaurant, and casino, among other things, for the 5,800-square-foot club. Achieving an economy of space, the building integrates itself into the landscape. As well as becoming part of the street's continual facade, it respects the local vernacular of courtyard-focused construction. Because the club consisted of only one two-story building, however, a wall, incorporating color and light, was made to enclose the space and create an interior yard.



## Bar el Tubo, Lima, Peru

Uncharacteristically, the architects' aim was to create a new space completely out of context with its location. "The Tube" bar and art gallery resides within the partly abandoned Neoclassical Puericultorio Pérez Araníbar building, which still houses an orphanage. So as not to interfere with the historic architecture surrounding it, Assadi + Pulido envisioned the bar as a tube suspended in the space. Holes drilled in the wall and ceiling admit a violet light from the exterior, emphasizing the bar's capsulelike quality.

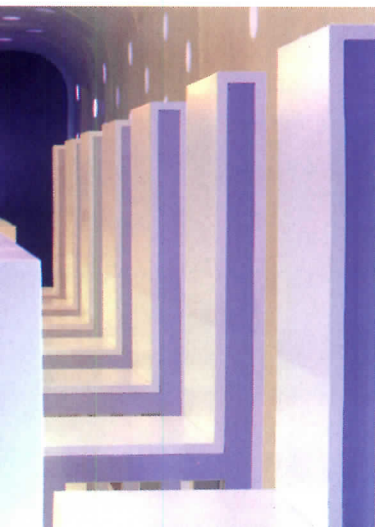



**20 x 20 House,  
Calera de Tango,  
Chile**

A guest-and-game house for the larger Schmitz House, the 20 x 20 House, which sits in an old orchard, explores the squared unit. Divided into units of 20 centimeters, the house is based on the idea of a ceramic box. In fact, the west facade of the predominantly glass pavilion is clad in black tile, resulting in a building that not only admits the natural landscape into the interior, but also reflects it.





**Arauco Express,  
Santiago**

Designed as a drive-through, the interior of this pick-up facility for items purchased online is dedicated primarily to merchandise storage. The gap between a double skin of wood and polycarbonate is illuminated with cobalt-colored fluorescent lighting, making the building a beacon at night, when the facility is most active. The color also gives a sense of speed, an apt association for people too time-pressed to shop at the nearby mall.







## Raveau House, Santiago

Hugging a steep, eroding slope in the foothills of the Andes, this house sits on a grouping of 60 steel piles. Perched several hundred feet over the Mapocho River, the board-formed-concrete and pine house is divided into two horizontal volumes, one for living and one for sleeping, that meet at a partially enclosed deck.





# WORK Architecture Company draws strength from diverse perspectives

By Clifford A. Pearson

**Firm:** WORK Architecture Company

**Location:** New York City

**Founded:** 2002

**Design staff:** 14

**Principals:** Dan Wood, AIA, and  
Amale Andraos

**Education:** Wood: Columbia, M.Arch.,  
1992; University of Pennsylvania, B.A.,  
1989; Andraos: Harvard, M.Arch.,  
1999; McGill, B.Arch., 1996

**Work history:** Wood: Practice—OMA,  
Rotterdam and New York, 1993–2002;  
Keenen/Riley, New York, 1991–92;  
Academic—Ohio State, 2006;  
Princeton, 2004–present; Cooper  
Union, 2004–05; Andraos: Practice—  
OMA, Rotterdam and New York,  
1999–2002; Atelier Big City, Montreal,  
1996–97; Academic—Harvard,  
2005–present; Ohio State, 2006;  
Princeton, 2004–present

**Key completed projects:** *The Good  
Life* exhibition, Van Alen Institute, New  
York City, 2006; D'Amelio Terras  
Gallery, New York City, 2006; 7 Essex  
Street Loft, New York City, 2005; Lee  
Angel offices and showroom, New York  
City, 2004; Creative Edge Parties  
offices and tasting room, New York  
City, 2004; Isaac Mizrahi for Target  
store, New York City, 2003; *Big Love*  
stage set, Dallas Theater Center,  
Dallas, 2002

**Key current projects:** Anthropologie  
stores, Dos Lagos, Calif., Shrewsbury,  
N.J., and Nashville, Tenn., 2006–07;  
Diane von Furstenberg Studio head-  
quarters, New York City, 2007; Eden  
Lun showroom, New York City, 2007;  
Creative Time offices, New York City,  
2007; White Street Residence, New  
York City, 2008; BAM Cultural District  
master plan, 2010

**Web site:** www.work.ac

**H**aving worked on major projects such as the Seattle Public Library, Prada flagship stores, and the master plan for Universal Studios in Los Angeles while at Rem Koolhaas's Office for Metropolitan Architecture (OMA), Dan Wood, AIA, and Amale Andraos knew they would have to downshift scales when they opened their own firm, WORK Architecture Company, in 2002. But they had no idea that their first commission would be a doghouse. Undeterred, they applied their notions of creative programming, intense research, and collaborative design to developing a canine residence that would be auctioned to raise money for an organization called Puppies Behind Bars. Rethinking the function of a doghouse (typically just a place for a pooch to sleep), they designed a high-tech Villa Pup where an urban Fido can run on a treadmill while watching videos of chasing cars and catching Frisbees. They even added an odor machine to provide the lucky dog with all of the smells of such activities.

Since then, the husband-and-wife team of Wood and Andraos has moved up the architectural food chain and is designing a six-story headquarters and retail complex for Diane von Furstenberg in Manhattan's newly hip Meatpacking District, three stores for the Anthropologie retail chain, the master plan for the Brooklyn Academy of Music (BAM) Cultural District, and several lofts for wealthy clients. They have also entered major design competitions, including one for a "green-belt city" in Las Vegas that is not going forward, and one for a cultural complex in the central Chinese city of Xian that should be decided soon. As they did at OMA, Wood and Andraos start every project with an intense examination of program—pulling it apart, reassembling it in different ways, and imagining new components. "We're interested in the world of ideas," says Wood, "but ideas made physical." This emphasis on building, not just theory, generated the firm's name. "We wanted to define ourselves through what we do, through the work itself," explains Andraos.

From their studio on Manhattan's Lower East Side, Wood and Andraos are working mostly locally, but thinking globally. Wood comes from Rhode Island, but has lived in Paris and Rotterdam. Andraos was born in Beirut and has lived in Saudi Arabia, Canada, France, and Holland. Their 12 employees come from places such as Denmark, Germany,

Switzerland, Korea, Spain, and Australia. "We see difference as a strength, as a source of ideas," states Wood. Both of the principals teach and see their academic work as a critical part of their practice. Not only do they use their teaching studios to research topics such as eco-urbanism that they apply in their practice, but they stay connected with other young architects who are also teaching. Comparing themselves to their contemporaries, Wood says with a laugh, "We're boxes, not blobs."

With Andraos's roots in the Middle East, she and Wood have traveled to Beirut and Dubai. "There's a lot at stake in these places—for cities, for cultures coming together," she states. She and Wood hope WORK can contribute to that convergence. ■

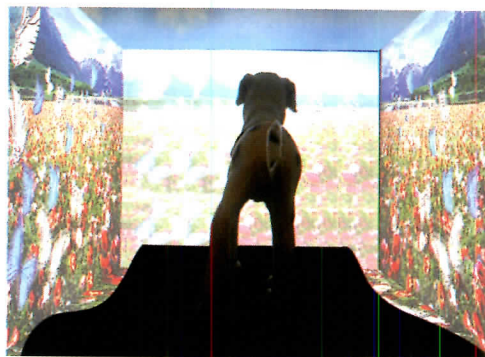

**Auctioned for charity, Villa Pup allowed a lucky city dog to run on a treadmill and watch rural scenes.**



## DvF Headquarters, New York City



Set within a pair of old buildings in the Meatpacking District, this project for Diane von Furstenberg Studio will include offices and design studios for the fashion company, a showroom, a ground-floor store, and a "diamond" penthouse for meetings. A grand stairway acts like a shaft of light from the roof to all of the floors and unifies the diverse program. The stair's guardrail, strung with Swarovski crystals, inspired WORK to dub it a "stairdelier."



## Creative Edge Catering, New York City

Renovating the company's space in a historic building in Greenwich Village, WORK expanded its offices on a mezzanine, but had to reduce the size of its two-story tasting room. To accommodate parties of different sizes, the architects put two of the tasting room's walls on wheels so the space can open onto a circulation area. They also used a silk-screened frit pattern on glass walls that makes the surface opaque at the bottom and transparent above.



## The Good Life, New York City

For an exhibition mounted by the Van Alen Institute at Pier 40 on the Hudson River, WORK designed a 300-foot-long piece of fabric that curved to create five separate areas for display, lounging, and special events. Suspended from the ceiling, this so-called "wiggle" combined bright yellow canvas and printed vinyl panels containing information graphics on 70 urban projects.



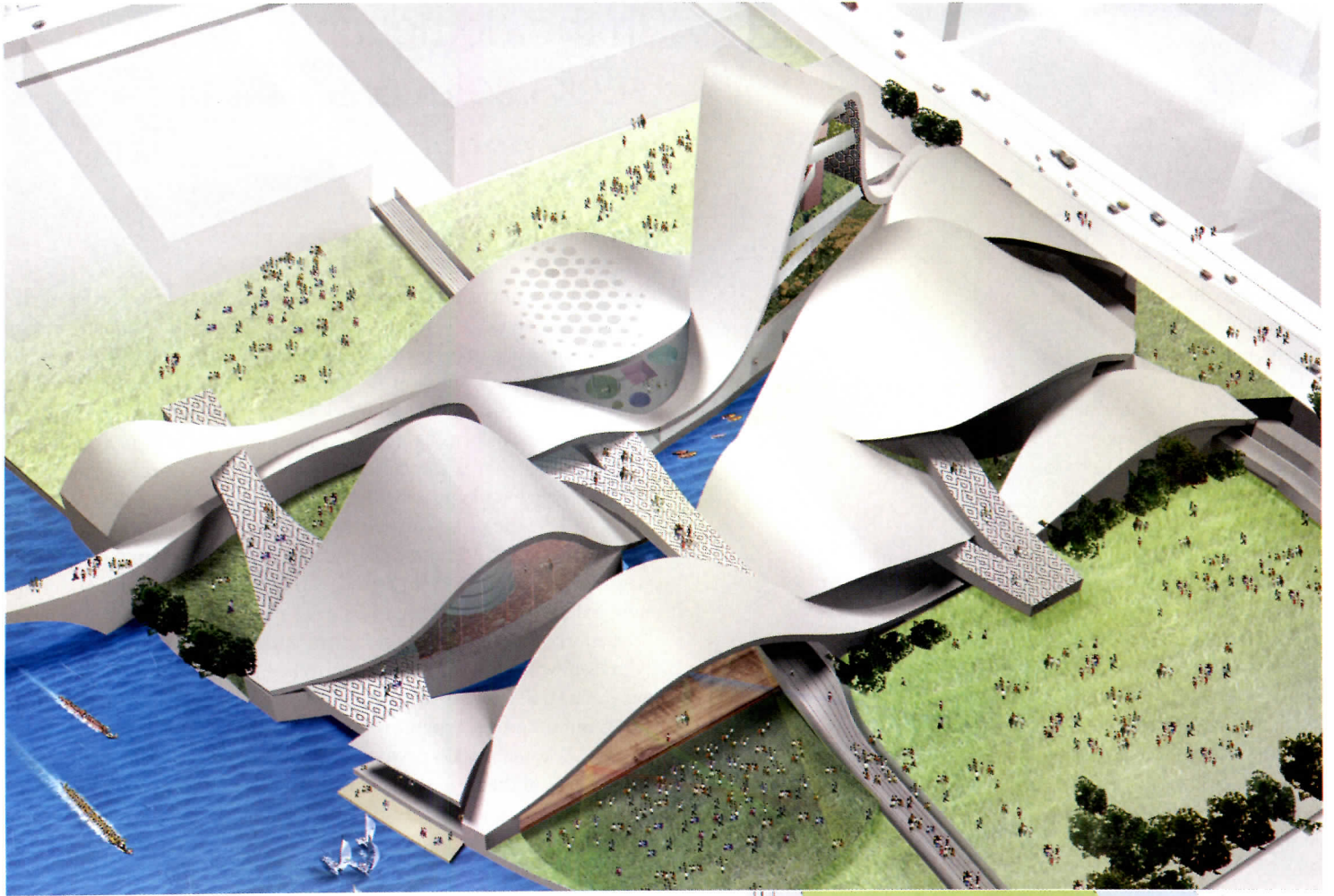

**New Silk Road  
Cultural Center,  
Xian, China**

A competition entry for one of nine cultural centers in a park celebrating the various peoples who traveled along the old Silk Road, this design weaves together space and time. WORK's entry for the Western Turkish facility envisions an unfolding timeline with four bands representing the major epochs in the history of Turkey overlaid with a series of threads marking iconic programs of Turkish culture—the spa, the traveler's hotel, the bazaar, the education center, and the amphitheater.

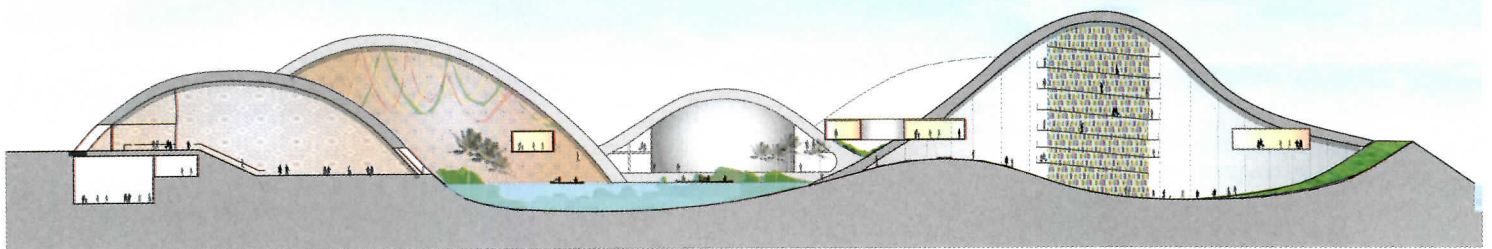
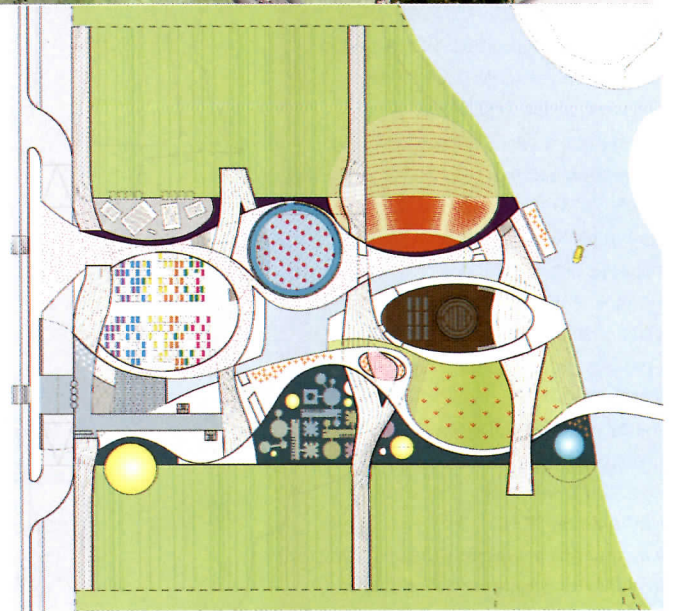



## In the Netherlands, **SeARCH** seeks solutions that are imaginative and muscular

By Tracy Metz

**Architect:** SeARCH

**Location:** Amsterdam

**Date founded:** 2002

**Design staff:** 32

**Principals:** Bjarne Mastenbroek, Uda Visser, and David Gianotten

**Education:** Mastenbroek: Technical University of Delft, M.Arch., 1989; Visser: Technical University of Darmstadt (Germany), M.Arch., 1996; Gianotten: Technical University of Eindhoven, M.Arch., 1998

**Work history:** Mastenbroek: Practice—Architectengroep, 1993–02; Van Gameren Mastenbroek architecten, 1991–93; Enric Miralles & Benedetta Tagliabue, Barcelona, 1990–91; Mecanoo architecten, 1988–90; Academic—Academie of Architecture, Amsterdam, faculty, 1992–93; Technical University of Delft, faculty, 1991–92; Visser: Architectengroep, 2001–02; Mecanoo architecten, 1988–90; Gianotten: Gideon Consult, 2002–05; van Keulen & van Zutphen, 2000–02; Projectbureau Leidsche Rijn, 1998–2000

**Key completed projects:** Scherf 13 housing, Utrecht, 2006; Schijf housing, Utrecht, 2006; Westergasfabriek clubhouse, Amsterdam, 2006; Dutch Embassy, Addis Ababa, Ethiopia, 2005; Wolzak House, Zutphen, the Netherlands, 2004; K-buurt urban planning, Amsterdam, 2003; Posbank Pavilion, Rheden, the Netherlands, 2002

**Key current projects:** Urban planning for office and commercial complex, Leuven, Belgium, 2010; 215-apartment complex, The Hague, 2007; apartment and retail complex, Almere, the Netherlands, 2007; 130 single-family houses, Rotterdam, 2007

**Web site:** [www.searcharchitects.nl](http://www.searcharchitects.nl)

No one-liners, no corporate office buildings, and no single, definable style. When you discuss SeARCH, the 32-person firm founded and led by Dutch architect Bjarne Mastenbroek, you talk as much about what it does not do as what it does do. “Rarely do we work on a tabula rasa,” Mastenbroek says firmly. “Ninety percent of our projects are transforming existing buildings, or new construction on existing sites. That is the Dutch way: We’re good at refurbishing and remodeling what has gone before.”

Like the principals of BAR Architects, the other Dutch firm in this year’s Design Vanguard, Mastenbroek first drew attention with a winning project in 1991 for European, the Europe-wide competition for new talent. With his then-business partner Dick van Gameren, Mastenbroek designed an apartment building for the Dutch city of Nijmegen with rooftop parking, a novel concept at the time. After a few years at a large firm, Architectengroep, Mastenbroek launched SeARCH (Stedenbouw en Architectuur) in 2002.

Mastenbroek is passionate about the need to conserve the country’s cities and the open space around them by building within or at the edge of the existing urban fabric. “Not only bigger cities like Amsterdam and Rotterdam, but middle-size ones are expanding outward,” he says. “Sprawl is great for the individual, but disastrous for the collective.”

No surprise, then, that the firm is focused on several housing projects. “The housing market here has been privatized, and architects who want to build anything out of the ordinary really have to invest an inordinate amount of time and effort in persuasion,” Mastenbroek says. “Many firms have given up courage and begun building 1930s-style villas. The market for neotraditional styles seems to be insatiable, but I feel that housing is too important for Holland to give it up.”

The firm’s biggest housing project to date is in Leidsche Rijn, outside Utrecht. The program called for a traditional apartment building of eight floors with parking behind it. SeARCH shifted the components around, opting for two three-level blocks with all the parking beneath. This plan freed up room for a courtyard between the two boomerang-shaped structures, and doubled the capacity of the garage.

A different take on housing was the renovation and expansion of an old farmyard’s scattered outbuildings into a single-family (non-farming) residence. Here SeARCH shows it has a good feel for adapting historic buildings. The roof of the original house remains thatched, but a livestock barn was replaced with a skewed extension covered with timber lathes from its steeply pitched roof down to the ground. The means are simple and the results legible without seeming banal.

Now under construction are several schools and a museum for regional culture and textiles in Enschede, near the Dutch-German border. The site’s context was literally blown away when a local fireworks factory exploded in 2000. The museum is part of the city’s attempt to recover some of the local culture lost in the accident. Here you see how SeARCH excels—fitting a complex program into a context in a way that is sensitive, imaginative, and nonliteral. The team’s architecture is muscular but compassionate, complex but uncluttered. ■



**Wolzak House,  
Zutphen, the  
Netherlands**

A farmyard with various outbuildings was adapted and expanded as a single-family house. The livestock barn that formed the stem of a traditional T-shaped farmhouse was replaced by a new, skewed volume with a distorted "pulled and dragged perspective," says principal Bjarne Mastenbroek. The new extension abuts the opening left by the removal of the original barn, visually retaining the T shape. The load-bearing construction of the new building consists of prefabricated wood plates.





## Posbank Pavilion, Rheden, the Netherlands

This teahouse set in Veluwezoom National Park is energy-efficient while remaining transparent to its natural surroundings. The building is situated at the end of a range of hills formed in the last Ice Age. From the entrance, the floor rises in a continuous spiral that wraps around a group of trees, culminating in a 45-foot cantilever. The materials include steel, glass, and solid oak, with a large boulder supporting the structure at a pivot point.

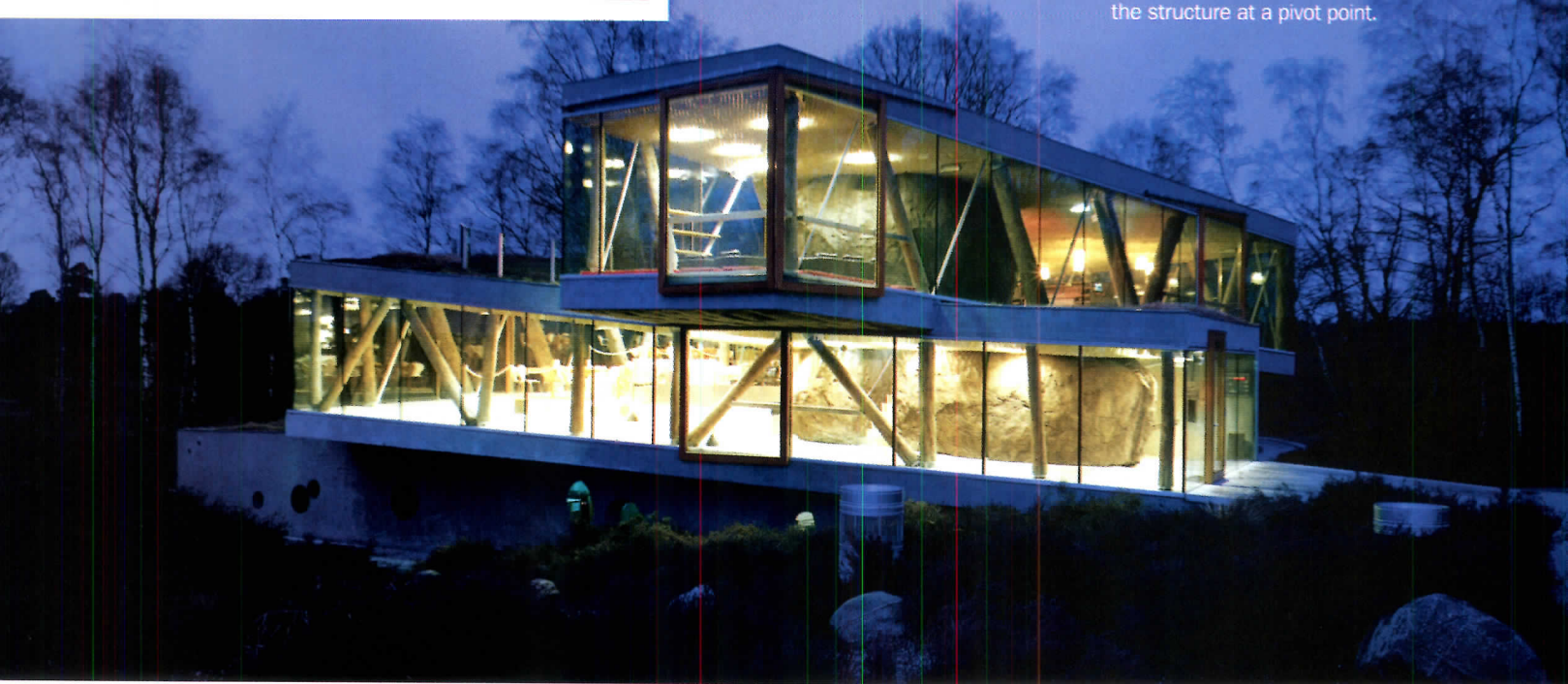





**Dutch Embassy,  
Addis Ababa, Ethiopia**

On a sloped, wooded site, the compound accommodates a chancellery, residences for the ambassador and deputy ambassador, three staff houses, and a school. The horizontal volume of the main building encompasses the ambassador's residence and chancellery. Its roof is constructed as a shallow pool, with reliefs depicting the Ethiopian cross and a model of the Dutch landscape. An interior corridor slopes to follow the natural terrain.





**Schovenhorst  
Observation Platform,  
Putten,  
the Netherlands**

An observation platform overlooks the plantings of the Schovenhorst Estate, a horticultural center showcasing the tallest Sequoias in the Netherlands. The structure features "branches" that offer visitors varying activities and perspectives along the ascent. A tunnel connects two sides of the property bisected by a road. The embankments on either side of the path fold in toward each other underground.



**Residences,  
Floriande, the  
Netherlands**

These multifamily residences are located on the seventh in a series of 12 contiguous islands that form the Dutch community of Floriande, adjacent to the city of Hoofddorp. Housing blocks flank the long sides of a village green planted with 400 maple trees. The prefabricated, timber-framed houses are oriented toward individual gardens and the waterfront. Cars are parked beneath cantilevered bedrooms.



PHOTOGRAPHY: © JEROEN MUSCH (FLORIANDE)

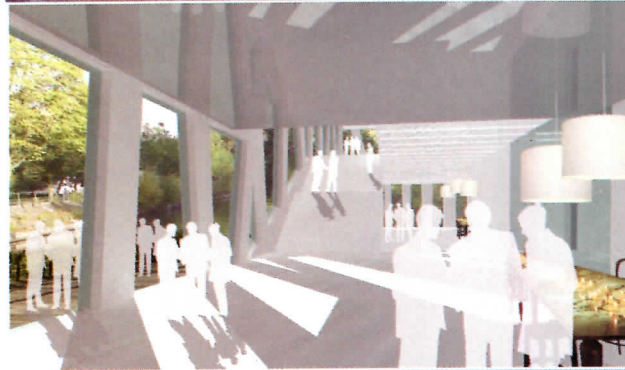
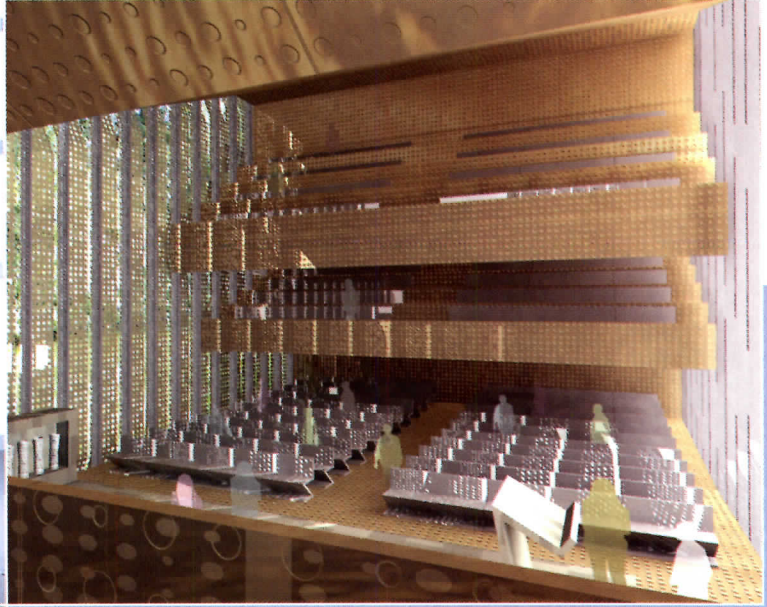

### Synagogue, Amsterdam

A synagogue for one of Amsterdam's Jewish congregations, the first new one built in the city in 43 years, will feature a large central auditorium with low extensions on each side underneath two-tiered balconies. The arrangement of the side spaces, the four balconies, and the central void are meant to suggest the form of a menorah, the seven-armed candelabra.





# BASEMATES™

## THE PERFECT COMPANION TO WALL BASE

It's never been easier to make ordinary wall base into something extraordinary. With BaseMates™ stackable trim molding system from Roppe, designers and installers can choose from a wide selection of components that are specially designed to work together easily and efficiently. BaseMates makes it easy to design and renovate interior spaces without disposing of existing wall base, and without breaking the bank.

Made of a PVC free, 100% rubber compound, BaseMates provides a new option in resilient custom trim molding finishes with 15 different components that can be used with any wall base. So go ahead, mix and match for a true custom look.

WITH ROPPE, THE POSSIBILITIES ARE ENDLESS.  
YOU DESIGN IT AND WE'LL HELP YOU MAKE IT HAPPEN.

**ROPPE**  
Proven. Flooring. Experiences.

1-800-537-9527 [www.roppe.com](http://www.roppe.com)

CIRCLE 43 ON READER SERVICE CARD OR GO  
TO [ARCHRECORD.CONSTRUCTION.COM/PRODUCTS/](http://ARCHRECORD.CONSTRUCTION.COM/PRODUCTS/)

**ECO  
EFFECTS**

**SINGLE  
PRICE POINT**

the  
collaborative  
for high  
performance  
schools



Design  
with Light.

*The West Midtown Intermodal Ferry Terminal, NYC, NY  
Architect: William Nicholas Bodouva & Associates  
50 Monumental Shades: 25' high*

#### A New Vision

- WindowManagement™ Solutions
- Daylighting Controls
- [www.mechoshade.com](http://www.mechoshade.com)
- Mecho®/5 with EcoVeil™ – the first complete window treatment to receive “Cradle to Cradle™” Silver Certification from MBDC
- [www.mechoshade.com](http://www.mechoshade.com)



**MechoShade®**

The Architect's Choice.™

MechoShade Systems, Inc.

718-729-2020 • [www.mechoshade.com](http://www.mechoshade.com)



**MBDC**

**GreenSpec®**

© 2006, MechoShade Systems, Inc. All Rights Reserved.  
Photography: Jim Roof Creative, Inc.

CIRCLE 44 ON READER SERVICE CARD OR GO  
TO [ARCHRECORD.CONSTRUCTION.COM/PRODUCTS/](http://ARCHRECORD.CONSTRUCTION.COM/PRODUCTS/)



Our Family of XP®  
Mold-Resistant Products

FIGHTING MOLD  
RUNS IN THE FAMILY

**Gold Bond® BRAND XP® Wallboard**

The all-purpose wallboard that fights mold, mildew and moisture.

**Gold Bond® BRAND Fire-Shield® Shaftliner XP®**

For mold-resistant fire barriers in cavity shafts and area separation walls.

**Hi-Abuse® BRAND XP® Wallboard**

A tough, mold-resistant board that stands up to surface abuse.

**Hi-Impact® BRAND XP® Wallboard**

The only wallboard that resists abuse, impact, mold and moisture.

**ProForm® BRAND XP® Ready Mix**

The easy-to-use joint compound recommended for finishing XP mold-resistant products.



Technical Info: 1-800-NATIONAL  
nationalgypsum.com  
nationalgypsum.com/espanol

Excellence Across The Board®

CIRCLE 45 ON READER SERVICE CARD OR GO TO ARCHRECORD.CONSTRUCTION.COM/PRODUCTS/

## HOSPITALITY

# Artful Lodgers

Across the globe, in places as varied as the remote reaches of Patagonia and tiny villages in Europe, new hotels are catering more and more to market niches.

By Sarah Amelar

### MARQUÉZ DE RISCAL HOTEL

Elciego, Spain

*With a veritable landscape of colorful titanium streamers, Gehry Partners animates a swath of Spanish vineyards with a hotel geared toward winery and architectural tourism.*

### HOTEL REMOTA

Patagonia, Chile

*Along a sea channel in South America, architect German del Sol's buildings frame a panorama of spectacular terrain, while providing a rustic-luxe base for hikers.*

### THE OUTPOST

Kruger National Park, South Africa

*Enrico Daffonchio builds a lodge that not only offers visitors intense and direct experiences with wildlife, but also returns ancestral lands to a local tribal community.*

### GRAMERCY PARK HOTEL

New York City

*Ian Schrager's team refurbishes a faded and shabby 1920s hotel, targeting a hip clientele with a taste for eclectic, baroque styling.*

**W**ine Therapy," where guests soak in a vintage concoction that promises to curtail the skin's aging process, is one offering at Frank Gehry's new Marqués de Riscal hotel and spa, set amid the vineyards of Elciego, Spain. The wine bath, rich in antioxidants, may be the font of eternal youth (or not), but it's also a sign of a recent hotel trend toward heightened specialization. Sure, the general-interest hotel is still alive and well, especially in major cities endowed with visitors. For such destinations, the motto might as well be: Build it, and they will come. But all sorts of places—especially far-flung, complicated-to-reach, and otherwise challenged or obscure ones—are spawning specialization.

Clearly, Gehry's hotel is targeting winery tourists (reportedly a growing demographic), plus the architectural crowd. After all, the Bilbao effect was born only 68 miles down the road, where Gehry's Guggenheim transformed the exceptionally drab city of Bilbao into a tourist magnet.

Continents away, in South America's southernmost reaches, the aptly named Hotel Remota caters to people who want to trek Patagonia's extraordinary landscape by day, but enjoy rustic-luxe amenities by night. The hotel specializes in hiking packages. Patagonia may be an in-your-wildest-dreams destination, but the hotel, with its remarkable serenity and landscape-embracing forms, could become a destination in its own right.

The Outpost, another lodge whose name epitomizes its location, is tucked into a remote region of a South African national park. With minimal presence in the landscape, the architecture maximizes views out (unmediated by glazing). Here, as guests shower in cantilevered tree-house-like quarters, free of exterior walls, they can simultaneously enjoy privacy and overlook the vast bush, thick with lions, leopards, elephants, and other wild creatures. Unlike "choreographed" safaris with 17-hour days on regimented jeep rides, the more low-key Outpost encourages guests to see the animals and even walk the bush (with guides), but also simply relax. It may be one of the few places where you can, in effect, be naked with the great beasts.

But back in the urban jungle, what about hotels in prime Manhattan territory? You'd think the city's tony allure and reported lodging shortage would quash any call for specialization. But competition for high-paying clients can produce niche players. The new Gramercy is targeting a hipper-than-thou crowd, which, the owners evidently hope, is already dismissing the global Minimalism of boutique hotels as "so yesterday." Banking on the A-list's insatiable craving for a new look, the owners have gone Goth-soft.

Sometimes specialization is only skin deep, but in whatever form, it's cropping up in small European villages, in the wilds of Chile and South Africa, and even in the overheated limelight of downtown New York. ■

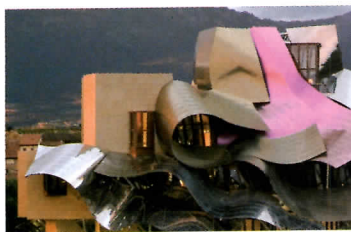

For more information on these projects, go to Building Types Study at [archrecord.construction.com](http://archrecord.construction.com).

# One: MARQUÉS DE RISCAL HOTEL

## Elciego, Spain

Frank Gehry animates a 19th-century vineyard with dynamic forms and great unfurling ribbons of pink-and-gold-hued titanium.

By David Cohn

**Architect:** Gehry Partners—Frank O. Gehry, FAIA, partner; Edwin Chan, design partner; Terry Bell, project partner; Andy Liu, project architect; Richard Barrett, Joejohn McVey, Colby Mayes, Guillermo Angarita, Albert Lee, Chad Dyner, Jonathan Rothstein, Dennis Vermeulen, project team

**Associate architect:** Idiom—Cesar Caicoya, Pilar Mateo, Eva Madariaga, Virginia Cañales, Muguel Angel Frias, project team

**Client:** Marqués de Riscal Winery

**Consultants:** Luis Camino (landscape); AG Licht (schematic lighting design); Javier Muñoz (interior furnishings)

**Size:** 78,580 square feet (total, including annex); 32,185 square feet (main building only)

**Cost:** Withheld

**Completion date:** September 2006

### Sources

**Titanium panels:** Nippon Steel Corporation (metal suppliers); Umaran (fabricator/installer)

**Lighting:** Belux (paper lamps); Van Lux (metal pendant and wall fixtures)

**Plumbing fixtures:** Roca; Volá

Before Frank Gehry's titanium-coated boutique hotel arrived in the village of Elciego, at the heart of Spain's wine-growing La Rioja region, the town already had a landmark: the majestic 16th-century church, presiding over a picturesque valley. But while the church's paired towers shine as local highlights, Gehry's building is more of an international beacon, commissioned by the local Marqués de Riscal Winery to promote the growing international interest in Spanish wine.

### Program

Set beside a stream at the edge of town, Marqués de Riscal is one of the region's oldest and largest wineries, with buildings dating to 1853. According to Edwin Chan, Gehry's design partner on the project, the client was initially interested in a "chateau for the 21st century, a kind of bed-and-breakfast for VIPs," as part of an overall modernization of its facilities. The project eventually grew to 27,000 square feet to include 43 guest rooms (14 junior suites in the main building and 29 rooms or suites in an annex, all managed by an international luxury chain), a wine-therapy spa, and a restaurant run by a local Michelin-starred chef.

### Solution

The hotel's site within the winery's compound was challenging. Set behind the historic stone factories



1. Hotel (main building)
2. Hotel annex/spa
3. Vineyard
4. Parking
5. Access road
6. Plaza

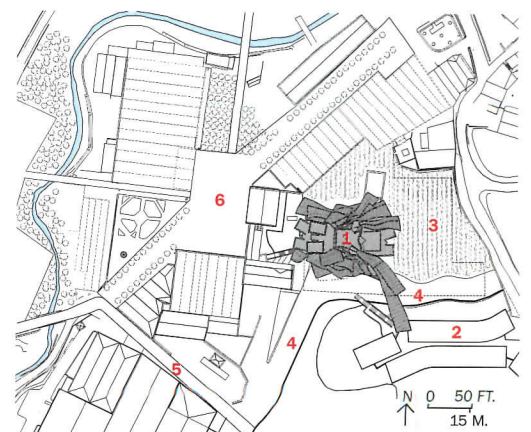

For more information on this project, go to Building Types Study at [archrecord.construction.com](http://archrecord.construction.com).



Tucked beneath ribbons of colored titanium and mirror-finish stainless steel (this page), the hotel's limestone-clad volumes (opposite two) relate to the local architectural vernacular. The modest hotel annex (at far right) sits beside the main building.

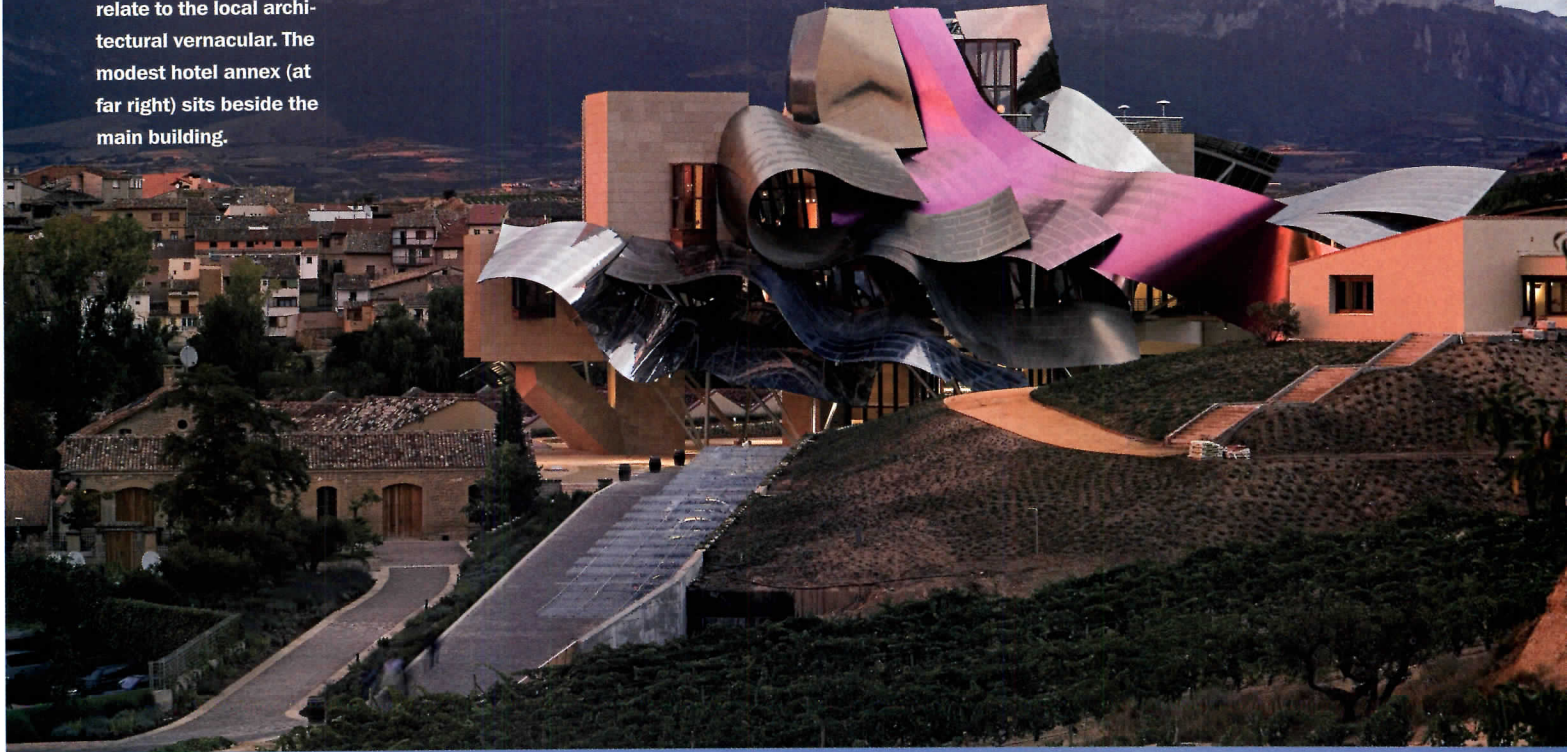



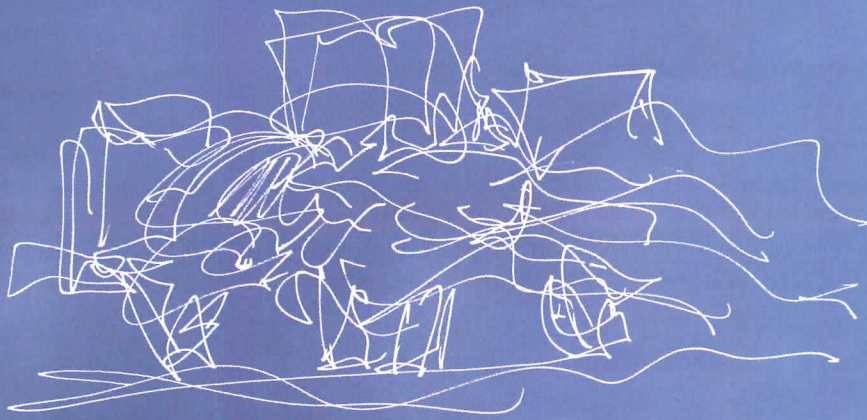

Titanium and steel sheeting forms whimsical, cascading canopies (on exposed steel supports), instead of actual cladding. Inspiration for the colors came from Riscal's wine bottles. A sketch by Gehry (left) conveys the design's uncorked exuberance.

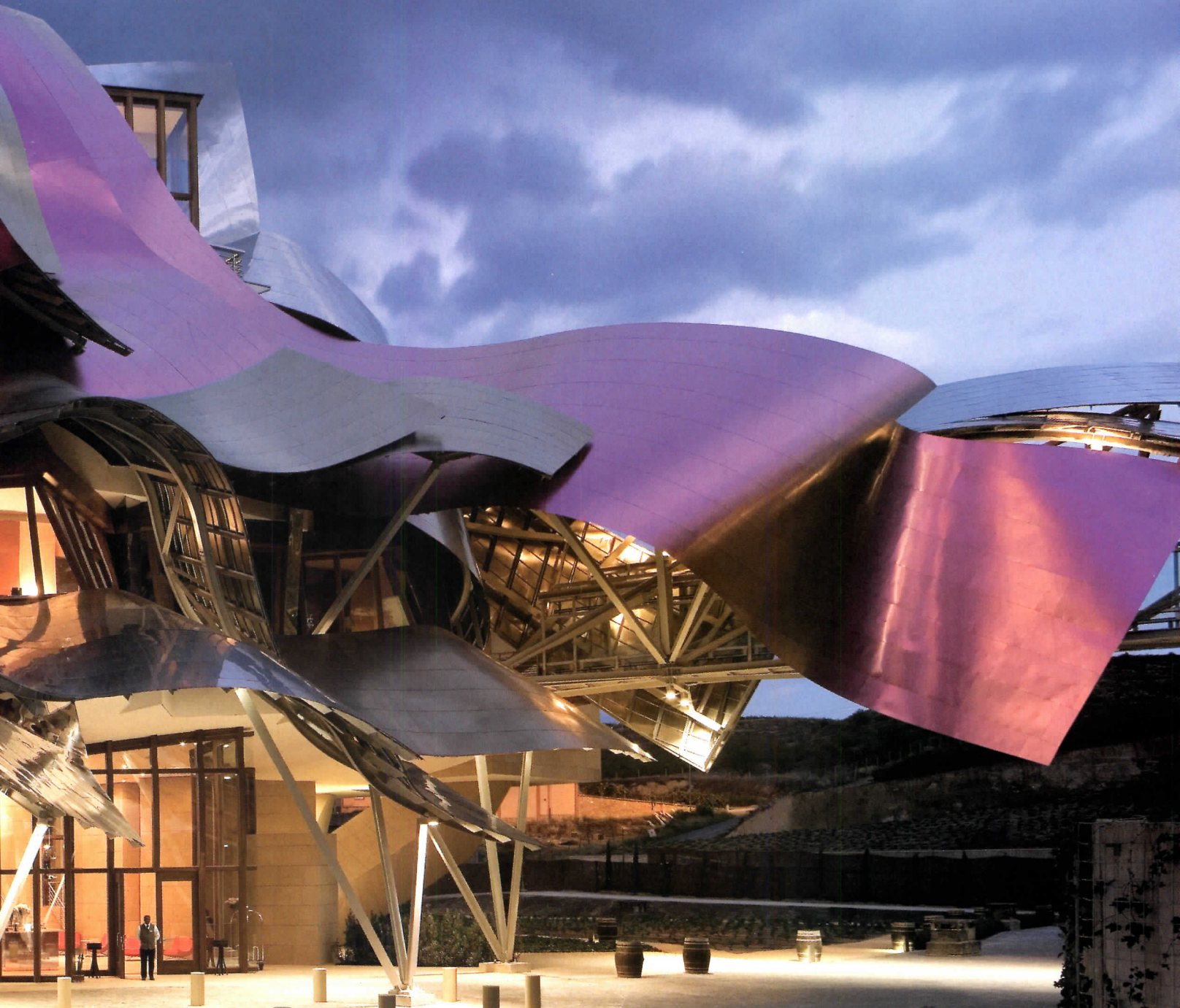

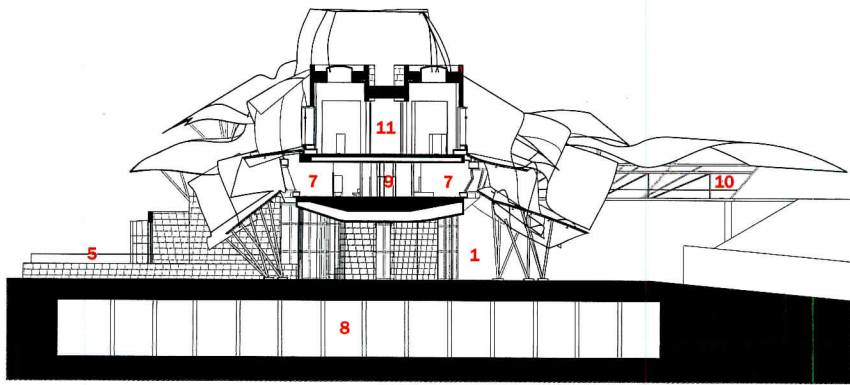

SECTION A-A

0 20 FT.  
6 M.



SECOND FLOOR

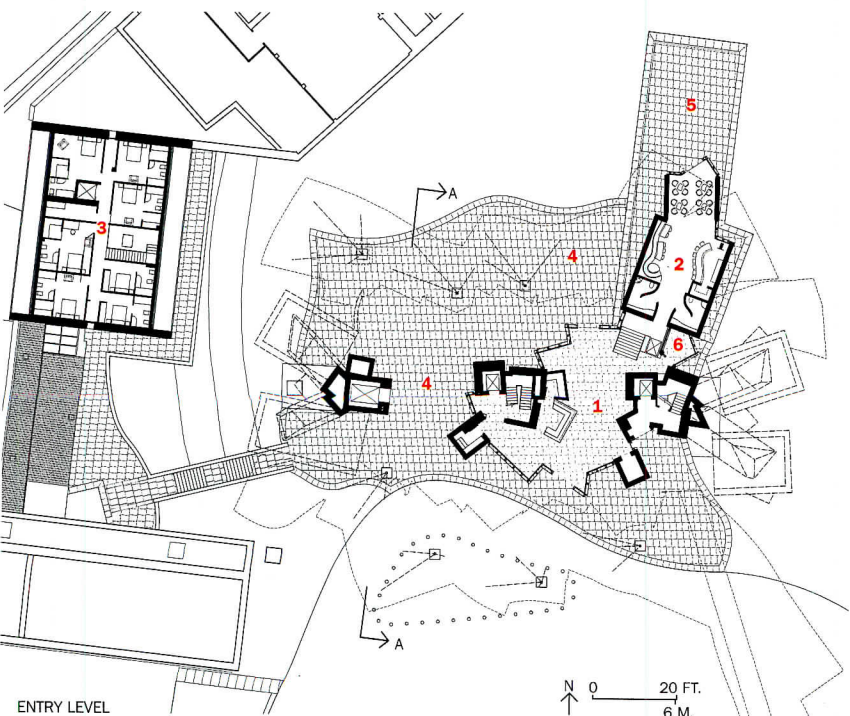

ENTRY LEVEL

N 0 20 FT.  
6 M.

1. Reception/lobby
2. Bar/multipurpose
3. Preexisting winery guesthouse
4. Covered terrace
5. Terrace
6. Manager's office
7. Bedroom
8. Wine cellar
9. Corridor
10. Bridge to annex
11. Dining room

The plans (below two) suggest the playful dynamism of the main building's 3D sculptural forms. A large wine cellar (section, left) lies under this structure, and a bridge, covered by great unfurling metal strips (left) leads to the annex, which houses the spa and most of the guest quarters.

and backed by a steep hill, the new building does not nestle into the vineyards; instead, it stands over a paved plaza that covers a new bottle cave (accessible by direct elevators from the hotel). Gehry's structure rises on three stone piers to capture views and assert its sculptural presence. Chan underscores the "friendly" relationship the architects sought with the church, pointing out that "as you approach the site, the church and winery form a dialogue across the valley." (Connections between old and new are also key to the client's marketing message.)

Views of the town and valley successively unfold as you ascend from the glazed lobby, with its wine bar and terrace, to the 14 junior suites on the next floor, the restaurant with its ample terraces above it, and the guest lounge with more terraces at the top. Seemingly casual stacks of rectangular volumes, clad in pale sandstone like the masonry of the church and village, house the interior spaces. Floor-to-ceiling wood-framed windows, many jutting from the corners of the volumes, peek out amid flowing rolls of mirror-finish stainless steel and pale gold-and-pink-colored titanium (hues inspired, the architects say, by the gold-mesh wrapper, silver cap, and purple contents of the company's bottles, and produced by passing titanium through an electric current in an acid bath). Exposed steel structures support these metal sheets, forming a capricious shading layer—a cascading succession of canopies—over the stone.

On the hilltop beside the main building, larger hotel suites and rooms, along with the spa, occupy

the surprisingly nondescript stucco-clad annex, also designed by Gehry. A spectacular covered glass-and-steel bridge connects this understated building to the titanium-festooned structure. As Chan explains, the annex draws on the “local vernacular” of simple tile-roofed stucco volumes, rather than compete with the main event.

### Commentary

From certain vantage points in the village and along the approach road, the building’s sculptural force appears compromised by site constraints, but the unfurling rolls of light-catching metal are stunning at close range and fascinating from a distance, constantly shifting with changing daylight and seasons. With the titanium acting as a shading canopy rather than cladding (as in previous Gehry work with the material), the sculptural effect becomes free and dynamic; the building appears to unwrap itself with the exuberance of a freshly uncorked wine bottle. Thrillingly photogenic, Gehry’s luminous, fluid, convulsive forms constitute an update of Elciego’s church towers in lighting up La Rioja for a contemporary, media-defined world.

That said, the interiors do not always live up to the expectations raised by the seductive packaging. The spare, white restaurant and guest lounge lack warmth. The hotel corridor, with vinyl baseboards, bleached ash doors, and carpeting over hard concrete floors, seems as austere as a church tower’s stone stair. The junior “suites” are more like high-ceilinged alcoves, with king-size beds plopped in front of bay windows and grand views—though the finishes, including green marble in the bathrooms, red velvet curtains, and several custom light fixtures by Gehry, are fine enough. “Our emphasis is on the spatial experience,” says Chan. “We prefer the architectural details to be more matter-of-fact. It’s a conscious choice.” As in a lighthouse or castle, such sacrifices have their compensations. ■

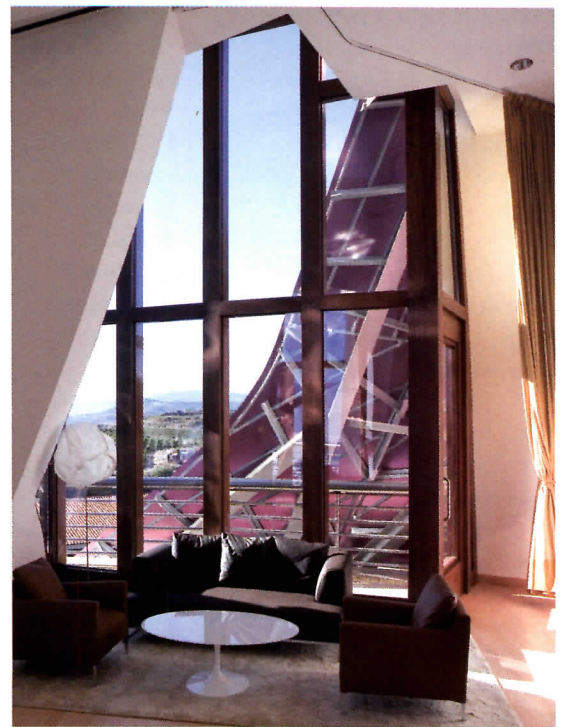

The hotel bar features a gridded display of Riscal wines (top left). In the interior, the exterior’s quirky forms express themselves in curving walls or shifting geometries and windows that curve to a point, pleat

inward, and/or poke out, as in the dining area (top right), the lounges (above two), and the guest rooms (left). Overhangs and projections reveal the outermost layer’s steel understructure (left and above right).

PHOTOGRAPHY: © ROLAND HALBE (TOP TWO, MIDDLE LEFT, AND BOTTOM)

# Two: HOTEL REMOTA

## Puerto Natales, Chile

Germán del Sol captures the folk spirit and isolation of Patagonia, with architecture that envelops both guests and the landscape.

By Russell Fortmeyer

**Architect:** *Germán del Sol Architects—Germán del Sol, principal and project architect; José Luis Ibañez, Francisca Schüller, Rodrigo Arenas, Carlos Venegas*

**Client:** *Daniel and Juan Pablo González Correa Inmobiliaria Fiordos del Sur*

**Consultants:** *Pedro Bartolomé (structural); Germán del Sol Architects (landscape, lighting, acoustics, interiors); Francisca Schüller (interiors); SALFA (general contractor); Guillermo Salinas Engineering; Francisco Arriagada Engineering*

**Size:** *56,000 square feet*

**Cost:** *\$10 million*

**Completion date:** *December 2005*

### Sources

**Exterior asphalt membrane:**

*Asfaltos Chile*

**Slate floors:** *Porcelanato Chile*

**Glass facades and windows:**

*Ventanas de PVC, Antonio Poncell*

**Insulation panels:** *Hechos por Salfa*

**Furniture:** *Germán del Sol Architects*

The Hotel Remota is for people who like their lattes made over a campfire. In a rugged and remote Patagonian landscape, outside Puerto Natales, Chile, the hotel beckons adventurous travelers with equal parts luxury and local folk style.

Germán del Sol, the Santiago-based architect behind Remota, has inadvertently cornered the market on luxe hotels in far-flung Chilean locales. His Hotel Explora in Atacama San Pedro [RECORD, November 1998, page 112] and its earlier sister property in Patagonia offer urbane accommodations in a region better known for sheep barns and rustic lodgings for visitors who prefer sleeping bags to down comforters.

### Program

The 72-room hotel lies at the base of the Patagonian Mountains on a sea channel 125 miles from the Pacific Ocean. Much of the construction material arrived on-site by boat. Remota's 56,000-square-foot complex includes a dining room, bar, and spa. A Santiago family of recreational sailors and outdoorsmen, who also happen to have backgrounds in construction and engineering, developed the hotel. Del Sol's understanding of the area, backed by the four years he spent in the early 1990s trekking the nearby Torres del Paine National Park and environs, helped convince the client to build his formally unconventional, jagged design.



For more information on this project, go to Building Types Study at [archrecord.construction.com](http://archrecord.construction.com).

Three long, partially enclosed wooden corridors embrace a grassy courtyard and connect the two guest-room buildings, the spa, and the main public building. The site's daytime color, set off by black structures, shifts between green and blue.



Erratic boulders from the Patagonia mountain range sprinkle the inner courtyard and

reinforce the mood of peaceful solitude the architects desired for Hotel Remota.

The chimneys' curved flues prevent hard-driving rains and winds from entering the building (opposite, top). Hotel Remota overlooks a mountain range (below left and opposite, bottom) and is only 93 miles from Torres del Paine National Park. Guests of the all-inclusive hotel can choose from a number of day-long trekking options, depending on their skill level.

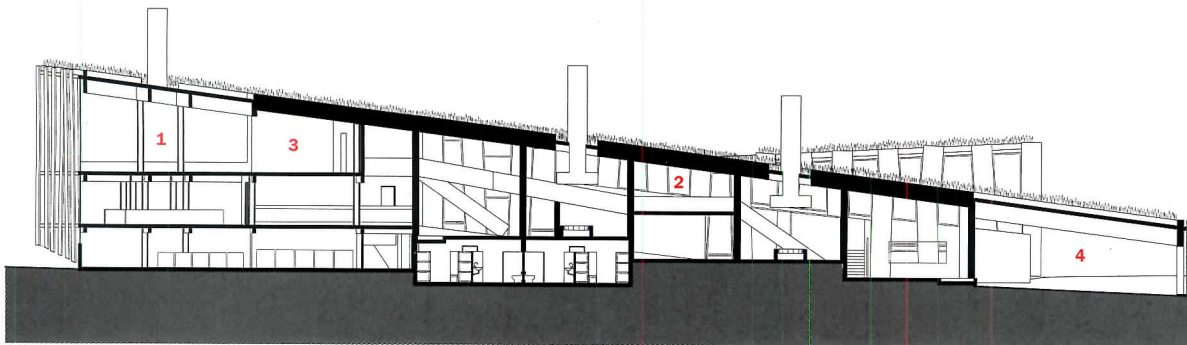

SECTION A-A

0 10 FT.  
3 M.

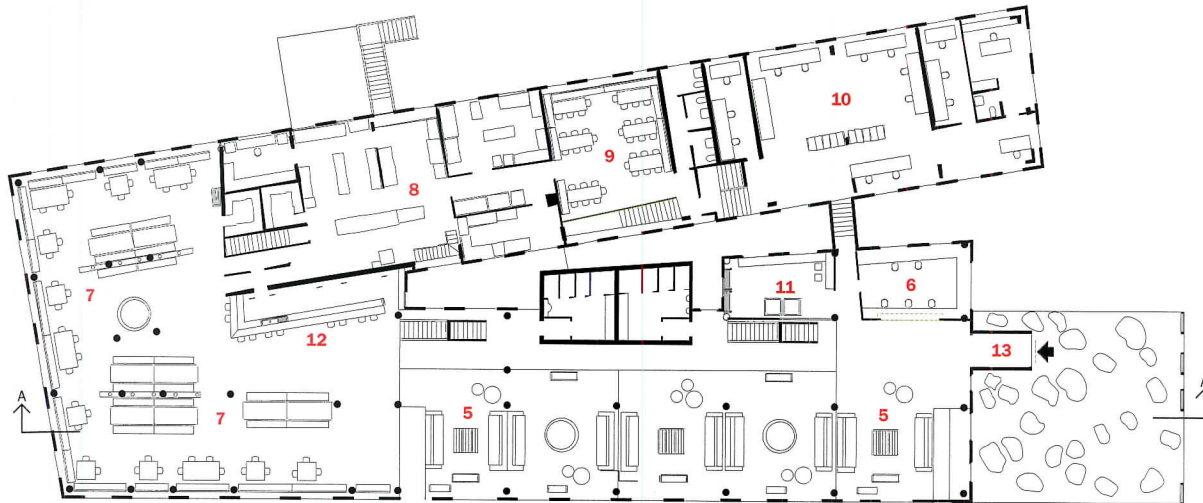

ENTRY LEVEL - MAIN BUILDING

N 0 10 FT.  
3 M.



1. Conservatory
2. Reading room
3. Exhibition area
4. Porte cochere
5. Living room
6. Reception
7. Dining room
8. Kitchen
9. Staff dining
10. Offices
11. Shop
12. Bar
13. Entrance
14. Typical guest room
15. Corridor
16. From main building

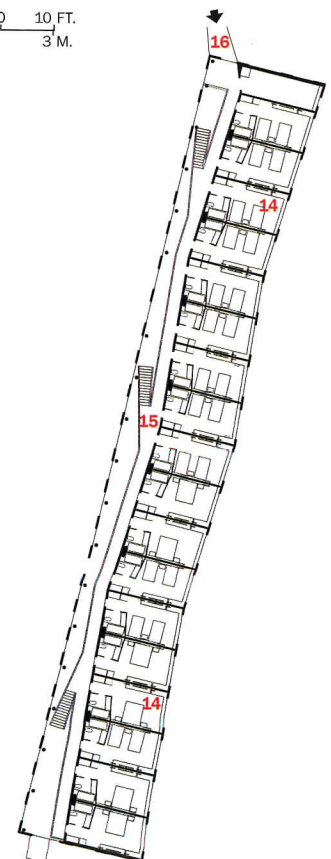

GUESTROOM WING 0 10 FT.  
3 M.



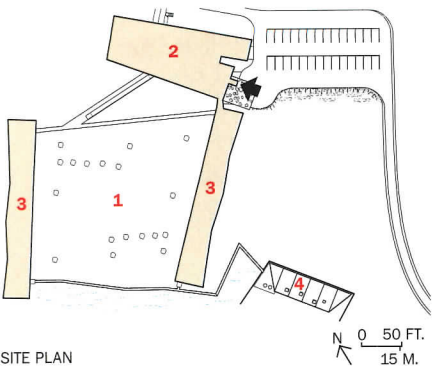

- 1. Plaza
- 2. Main building
- 3. Guest-room building
- 4. Spa





The spa's infinity pool reflects the dissolving colors of the walls (above). Guest rooms provide softly lighted refuges that contrast with the view of the rocky mountain landscape seen from each window (right).



## Solution

Part of Remota's appeal lies in its deferential attitude to the surroundings. Whereas Frank Gehry's Riscal Winery, in Spain (see page 130), redefines the terrain, the low horizontal forms of Remota's totally precast-concrete buildings, like lightning bolts across the ground, frame the landscape. Here, del Sol's exterior vibrates with tall, off-kilter window frames set in wrapped plywood infill panels, an effect the architect likens to both jazz musician Keith Jarrett's improvisational techniques and vernacular building methods that lack the precision of professional designs. As del Sol puts it, "I'm always looking at what the people of the local culture have done in the same situation."

Remota's plan opens up like an interior landscape. Guests thread through a V-shaped public building to extensive understated corridors connecting to the guest-room wings and spa. Outside, the stark super-blocks embrace an irregular field of erratic boulders, brought in from the mountains, conveying the powerful sense of emptiness del Sol finds in the vast peaks beyond. Furthering the landscape conceit, the existing grass, removed to allow for the building footprints, now covers the roofs in a 24-inch insulating layer.

The interiors combine the architect's version of luxurious Minimalism with the faint utilitarian ambience of Patagonian barns. As with those buildings, a single group of carpenters built the hotel and its furniture. Cubic sofas and tables of Lengua wood (harvested locally) populate the native slate floors, with patches of color appearing as sparingly as in the surrounding terrain. Cypress ceilings, installed in an open pattern to dampen sound, reveal painted concrete above and allow lantern-like light fixtures simply to dangle.

"My motivation is to look for new points of view for things that have always been in architecture," says del Sol. With that approach, the slatted wood of sheep barns becomes the mien of the corridors connecting the guest-room wings to the main building; these rough-hewn

The architect intended the living room's muted color scheme to reflect the random spots of color in the landscape (right). Dramatically lit public areas afford vistas of the extraordinary geology outside (below right).

wooden passageways allow some cold wind to pass through them, enhancing the refugelike quality of each 350-square-foot guest room. Perimeter radiators heat each of the rooms, while ventilation spouts maintain fresh airflow. The curved chimneys on the roof protect fireplaces from excessive wind and rain. Large, operable, double-glazed windows in each bedroom allow cool air in during the summer (Patagonia's climate makes air-conditioning unnecessary), and admit ample light in winter. The black synthetic-asphalt membrane over the plywood exterior cladding provides additional free heat in the winter months.

### Commentary

In an era of ambitious global practices, few architects get the chance to develop as intense a relationship with the land and a particular building program as del Sol has with Patagonian hotels. The architect has spent the better part of the past two decades traveling throughout Chile's wild, geologically splendid, and isolated landscapes, developing a confident approach to architecture that doesn't shy away from experimentation with linear and irregular plans, unconventional materials, and distorted forms. At the same time, his work remains anchored in a sensibly straightforward vernacular. As del Sol says, "Remota doesn't take you away from the experience of being in Patagonia." This hotel is not an escapist fantasy or a themed environment, but a choice lesson in how a local building culture can inform design without sacrificing contemporary ambition. ■



# Three: THE OUTPOST

## Kruger National Park, South Africa

Enrico Daffonchio creates an architecture that treads gently in the bush, while giving visitors an intense experience of the wilds.

By Sarah Amelar

**Architect:** Enrico Daffonchio and Associates—Enrico Daffonchio, partner in charge  
**Owner:** Lodges of Manyeleti  
**Engineer:** Rodney van Dam  
**Interior designer:** Peter Aucamp, Christoff van Staden  
**Consultants:** WSP Engineering (lighting); Kruger National Park Management (landscaping); Dave Grossman (environmental impact)

**Size:** 24,757 square feet

**Cost:** \$3.1 million

**Completion date:** February 2003

### Sources

**Steel:** Leita

**Hardware:** Assa-Abloy

**Wall finish:** Cemcrete

**Lighting:** Radiant; Phillips;

Le Grand (controls)

**Plumbing fixtures:** Italtile; Finda

Perched among elephants, lions, leopards, zebras, and giraffes, in the vast bushveld of South Africa's Kruger National Park, The Outpost, a new lodge, needed an environmentally responsive architecture with an atmosphere of relaxed comfort in the wilderness. But the creation of this hotel also involved a far taller order—to help right one of the wrongs committed in the Apartheid era.

In 1969, the Apartheid government had forcibly removed the Makuleke people from their ancestral land, and incorporated that more-than-59,000-acre tract into Kruger National Park.

After the restoration of democracy to South Africa, in the 1990s, the tribal community brought a legal claim, resulting in the return of their land. By the conditions of the agreement, the property would remain in its pristine, undeveloped state—not occupied by the community—except the Makuleke would hold a concession on twelve lodges to be built and operated here in accordance with the park's environmental guidelines. With input from the Makuleke, private developers would commission the hotels. But the labor force engaged to construct, staff, and manage them would come from the tribal community, which would collect concession rental fees for 30 years. At the end of that period, the Makuleke would own the lodges.



### Program

The Outpost, the first of the lodges erected in this northern region of the 6.2-million-acre park, had a modest brief: a dozen freestanding units (each accommodating two adults), and a main building with reception, dining, and lounge areas, as well as an outdoor swimming pool. The idea was to set the architecture subtly into the landscape, providing certain comforts and luxuries, while opening the guests to an intense and direct experience with the natural surroundings.

### Solution

The client engaged Italian-born architect Enrico Daffonchio, who had demonstrated his commitment to sustainability and building minimally in the bush with his small museum at a UNESCO archaeological site near Johannesburg. (The freeing of Nelson Mandela, in

**Raised teak walkways, with the compound's service lines hidden beneath the deck, connect The Outpost's separate buildings (above).**

1990, and Apartheid's dismantlement had inspired Daffonchio, then a recent architecture school graduate, to move to South Africa.)

The site for The Outpost was challenging: Three-quarters-of-a-mile long and a mere 20-feet wide, the land forms a ridge, dropping off at a 60-degree angle toward a plain with a river meandering through it.

Daffonchio used the abrupt topography to dramatic advantage. Visitors, all approaching the lodge by jeep on a sandy road through the bush, suddenly confront a long wall, which they enter through a small opening. There, they discover what the architect calls "an explosion

For more information on this project, go to Building Types Study at [archrecord.construction.com](http://archrecord.construction.com).



Guest units rise on stilts along a ridge high above the riverbank (left). Each nearly wall-less cabin (with sliding screens) has a lounge, bedroom, and bath (bottom). Nestled in the bush, the units offer privacy with panoramic views out (below).

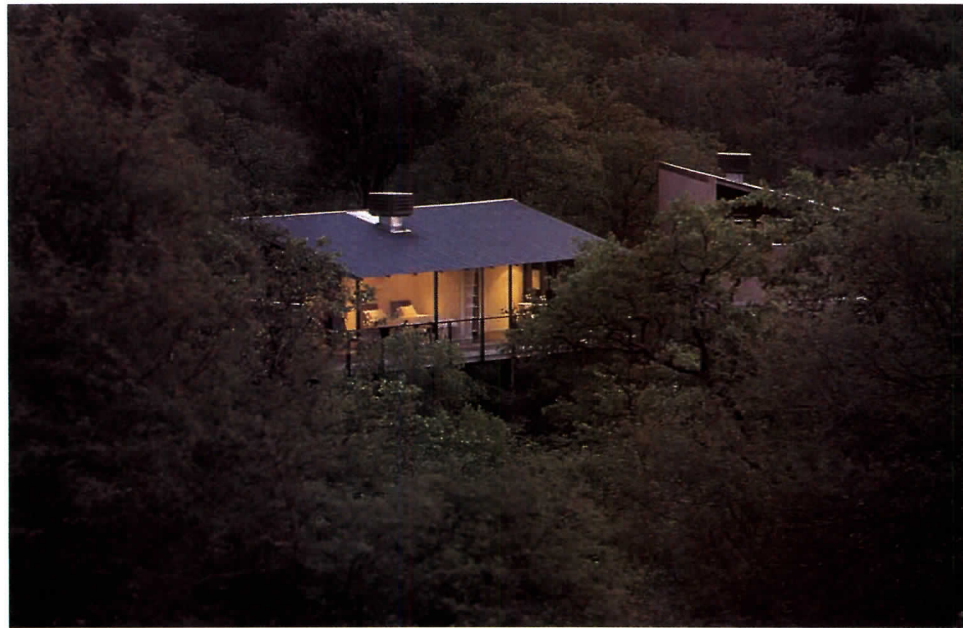
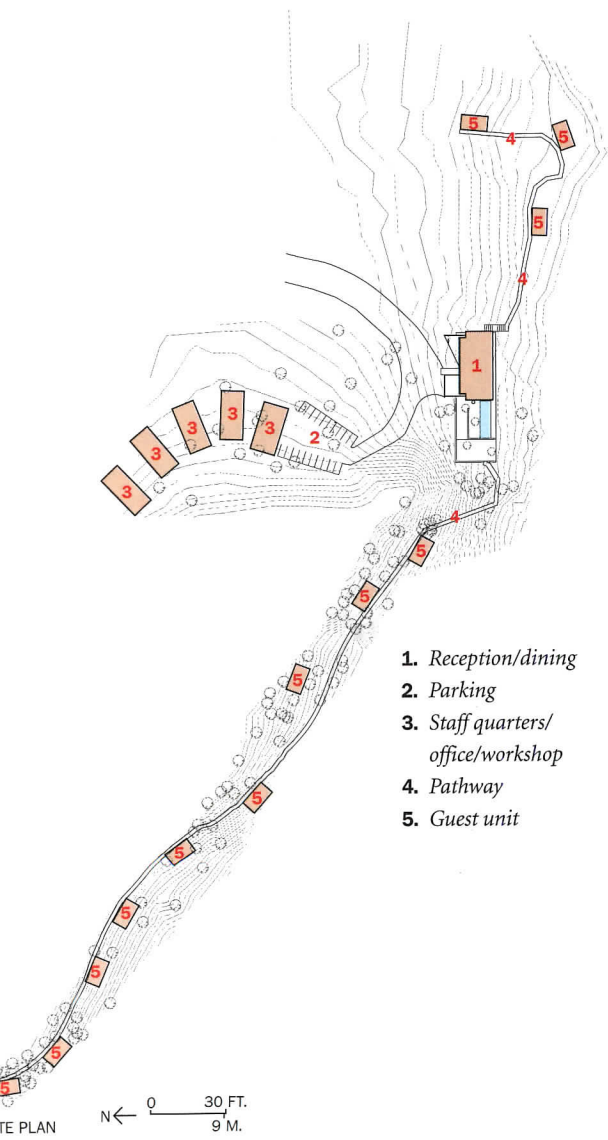



**The pool deck extends from the main structure, which shelters reception, lounge, and dining areas (left). Guest bathrooms open breathtakingly to the dramatic landscape (below).**

of view—300 kilometers of Kruger National Park spreading out beneath them.”

Daffonchio scattered the 12 units along the site, connecting them by raised walkways with teak decking that conceals all the service lines: plumbing, electricity, and telephone. Leaving the terrain equally undisturbed, the buildings also stand on stilts, “like the white African fig trees growing out of the rocks,” as Daffonchio envisioned them. They not only touch the ground lightly, but they can be removed, he says, “without a trace.”

Set above the tree canopy, the individual units—each with a

bedroom, sitting area, and bath—are like tree-house platforms, sheltered overhead but otherwise remarkably open to the great outdoors. Most of the exterior walls are screens that can slide aside; each has separate layers—mosquito netting and canvas, which guests can roll down—but no glass.

Even when the spaces lie wide open, the orientations and siting keep them private and at a very safe distance above the wildlife. So you can relax in the bathtub, muses Daffonchio, “with a glass of ice-cold white wine and a 70-meter [230-foot] drop to one side. You can also hear the jackals at night and see the stars come out.” But you’re not exactly camping out. “It’s very remote,” adds the architect, “but with the finest linen sheets.”

Beyond experiential and aesthetic qualities, the design (and its construction methods) had to suit the previously unskilled Makuleke construction crews, working on a site 200 miles from the nearest hardware store. So Daffonchio created an easy-to-assemble scheme with a limited material palette of wood (local meranti and teak), steel beams, poured-concrete floors (sealed with beeswax), and pre-painted, corrugated-steel roofs. He had all the pieces prefabricated in Johannesburg and shipped in—and allowed for training on the job. The whole process took less than a year.

#### **Commentary**

While many guests already love The Outpost, it’s not for everyone. Daffonchio’s idea of making the units feel “open, but not exposed or threatened” has backfired for the occasional guest, who, he says, has been “traumatized by weather—by lightning or strong winds.” On another level, though, the lodge offers an inspiring model for more to come: Not only informed by a deep respect for the land, it also proposes a creative economic remedy for an injustice committed decades ago. ■



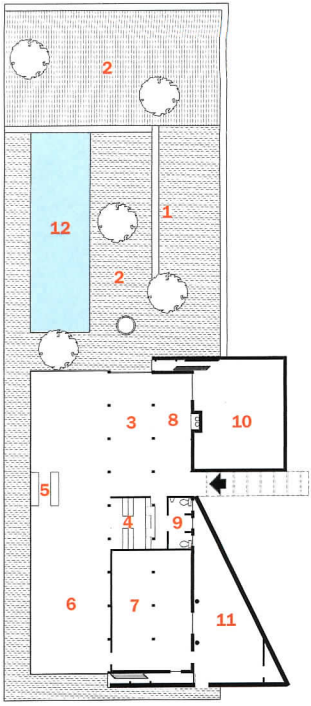

ENTRY LEVEL  
RECEPTION AND RESTAURANT

0 20 FT.  
6 M.

1. Ramp
2. Deck
3. Lounge
4. Wine "cellar"
5. Bar
6. Restaurant
7. Kitchen
8. Library
9. Bathroom
10. Courtyard
11. Service yard
12. Swimming pool

Casual dining (top),  
lounging, and swim-  
ming areas (right) all  
flow together, merging  
with the great out-  
doors. The Makuleke  
crew built masonry  
walls (right, at the  
back) using local  
sandstone and an  
ancient Zimbabwean  
technique, which  
involves no mortar.



# Four: GRAMERCY PARK HOTEL

## New York City

Ian Schrager Company, with theatrical decor, departs energetically from the Modernist aesthetic of its previous projects.

By John Gendall

### Director of architecture and design:

Anda Andrei,  
Ian Schrager Company

Architect of record: Brennan Beer  
Gorman/Architects

Client: Ian Schrager, with Aby Rosen  
and Michael Fuchs

Concept and design direction:  
Julian Schnabel

Design manager: Kirstin Bailey

Consultants: Gilles & Boissier  
(restaurant design); Leslie Simitch  
(photography curator);  
Narciso Rodriguez (clothing design)

Lighting: Arnold Chan and  
Clark Johnson

Size: 150,000 square feet

Cost: Withheld

Completion date: August 2006

### Sources

Paints and stains: Donald Kaufman  
Color by Benjamin Moore

Carpets: Couristan

Plumbing: Custom Corian  
(sinks in rooms); Gerber & Crane  
(toilets in rooms)

Photographs: Magnum Photos  
(in guest rooms)

The curtain rose in August on the second act of the Gramercy Park Hotel in Manhattan. Originally built in 1924, the brick-and-limestone-clad establishment was once a haven for the likes of the Kennedys, Humphrey Bogart, and Babe Ruth. But by the time hotelier Ian Schrager and his longtime business partner, developer Aby Rosen, took it over, the place was a dowdy memory of its former self.

"The hotel was very run-down," explains Anda Andrei, Schrager's director of design and architecture, "with not much left to it—low ceilings, wood paneling, small rooms, and miniscule bathrooms."

Enter Ian Schrager, stage left. Taking advantage of the hotel's storied legacy and its prime location at the edge of New York's only private, lock-and-key park, he set out to retain the aura of the Gramercy's cultural legacy, while giving the place a hipper-than-thou cachet for the jet-set elite and the city's A-list.

### Program

The property Schrager acquired had 600 small guest rooms crammed into two 18-story structures connected by a six-story building. Consolidating the hotel into one of the 18-story volumes, Schrager is now creating 23 condominiums, designed with John Pawson, in the remaining 18 stories, combined with a new building on the site of the original connector.

The Gramercy now boasts a double-height lobby, a spa, a gym, a

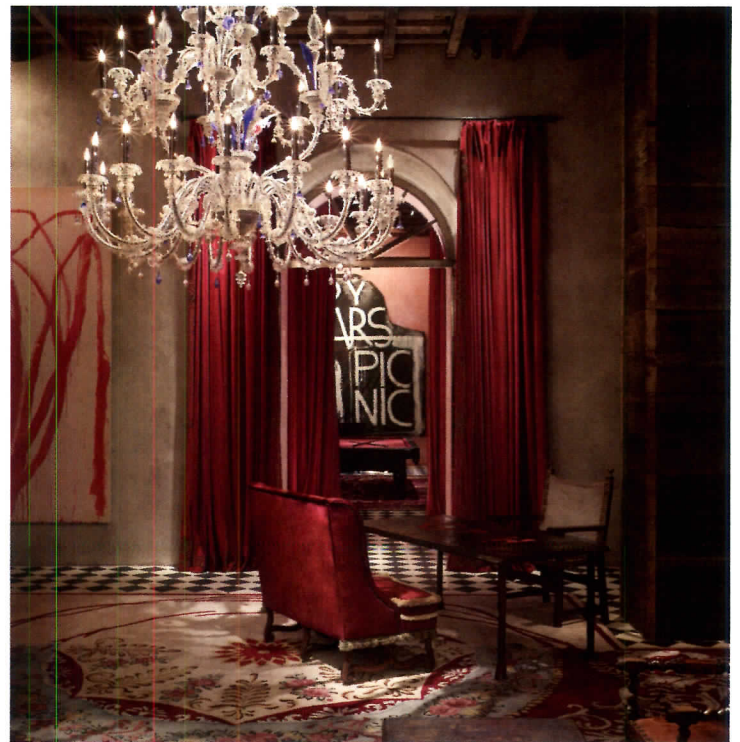

Chandeliers, velvet curtains, and rough-hewn cedar-clad pillars defy the Modernist look of earlier Schrager hotels. But like them, the Gramercy targets a hip, A-list clientele.

chic restaurant, conference facilities, two bars, and in place of the original 600 rooms, 185 more spacious ones. Rather than gut renovate, the developers left two preexisting walls in most of the guest rooms. Plumbing, corridors, and stairs are unchanged.

### Solution

Behind a low-key Minimalist facade,

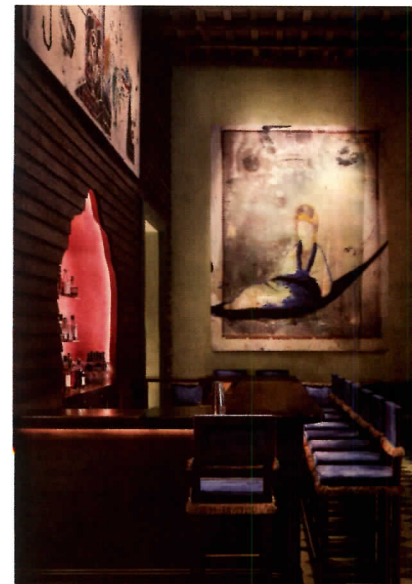

For more information on this project, go to Building Types Study at [archrecord.construction.com](http://archrecord.construction.com).





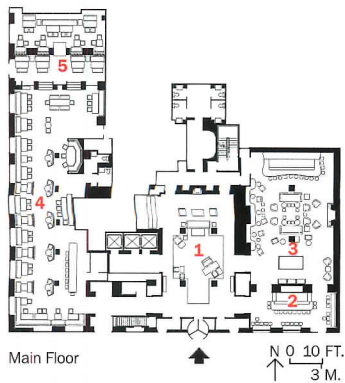

1. Lobby
2. Jade Bar
3. Rose Bar
4. Restaurant
5. Private dining room

Without adhering to any single style, or resorting to a Postmodern *mélange*, the designers aimed for a mercurial atmosphere that evades easy definition. A Renaissance palette of crimson and moss-green velvets complements the modern industrial fixtures and big, bold 20th-century paintings.

created by Schragger on the first two floors, lies an interior that is decidedly un-minimal. Collaborating with Andrei and her associate Kirstin Bailey, along with the artist Julian Schnabel, a friend of Schragger's, the hotel impresario departed from the hypermodern design he had favored in the past.

Under Schnabel's design and concept direction, the new Gramercy borrows freely from across the globe and throughout history. Somewhat whimsically, colors, materials, and motifs inspired by different sources coexist at the hotel. Long, red-velvet drapes; robust, rough-hewn, cedar-clad pillars; and a grand chandelier emphasize the lobby's new double height. Cedar-scented candles contribute to the fabricated atmosphere.

A periodically changing display of bold, large-scale paintings by the likes of Andy Warhol, Cy Twombly, Jean-Michel Basquiat, and Schnabel appears in the lobby. With Schragger's access to New York's art scene (due, in part, to his time running Studio 54 with Steve Rubell), he developed a list of willing friends with collections large enough to make these loans.

Elevators lined with sandblasted, smoked oak lift guests to dimly lit corridors. Each guest room is unique, but all are darkly colorful, with dramatic curtains, velvet bedspreads, and custom-designed rugs over ebonized wood floors.

Andrei acknowledges the delicate balance this approach requires. "Going too far with eclectic design could lead to a Disneyland, but being too conservative lands you in a corporate hotel. There are historical references here, but cleaned up and attached to no particular era."

### Commentary

Whimsical, with a baroque theatricality, the Gramercy seems poised more for a Tony than the Pritzker. Its design may prove as ephemeral as a stage set—merely the beginning of a passing fad. Or it may signal a major new direction, prompted by a serial entrepreneur with a record for redefining hotels. For now, at least, the Gramercy is busy ushering in hip guests—at least, until the final curtain call. ■

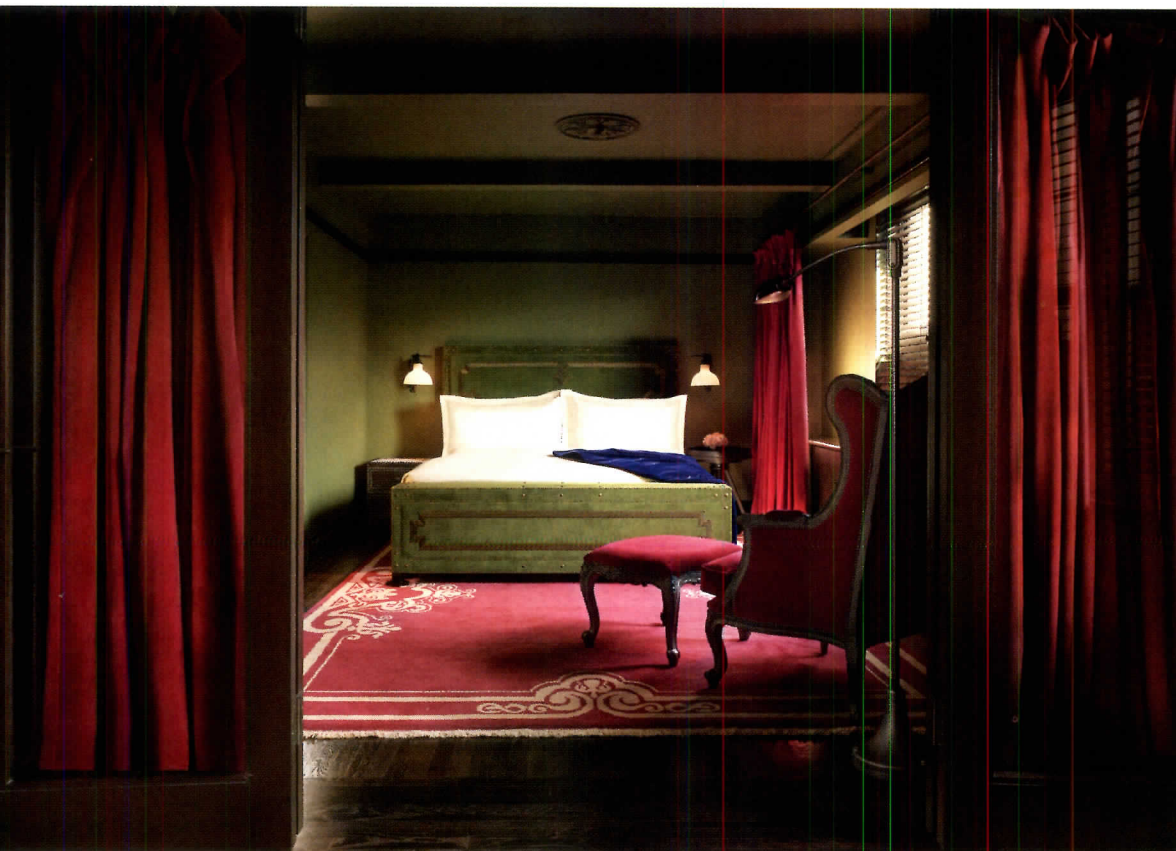

# Architectural Technology

Buildings are the greatest of all energy consumers, which is why architectural innovation lately focuses on efficiency

## CONTENTS

- 155 An Evolving Edifice That Will Improve With Time**
- 164 When Less Powers More**
- 170 Case Study: Arup's Zero-Energy Building**
- 172 Case Study: SOM's Pearl River Tower**

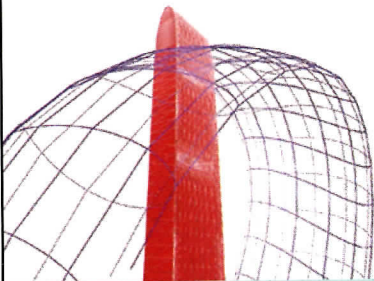

SOM's Pearl River Tower takes full advantage of daylighting (page 172).



Arup's theoretical building attempts efficiency at several scales (page 170).

The term *innovation* traditionally applies to the domain of technology, which perhaps more than other pursuits concerns itself most directly with the idea of the new. Technological development rarely looks back; no one tried in 2006 to invent a better horse carriage. Lately, innovation pops up in business writing to describe this year's version of profit pursuit, as if finding a techie jargon to position the global flow of business somehow qualifies as innovative. While good technology needs an equally good business plan to find widespread use, the plan's success ultimately depends on the innovation of the technology. Apple Computer doesn't sell iPods only because of their celebrity-endorsed sex appeal; the little gadgets actually work quite well at what they do.

The Architectural Technology section for December focuses on innovation in different ways, but all of them were inspired by RECORD's Innovation Conference hosted in New York City in October. We first see the concept at work in a Vancouver university research project that uses its building as a laboratory for experimental energy-saving technologies. Energy-efficiency concerns motivate much innovation, which is explored in a story on the contemporary state of energy policy, technology, and design for architects. Finally, we focus on two case studies that implement such research—a theoretical mixed-use building developed by Arup's New York office and a net-zero-energy skyscraper designed by SOM's Chicago office.

A building will respond to its environment one way or another, but there is increasingly little excuse to allow that response to happen by accident. What we see in the following pages is further evidence of how technological innovation—along with the considerations architects make toward its implementation—is steering the performance of contemporary architecture in the direction of something new. *Russell Fortmeyer*

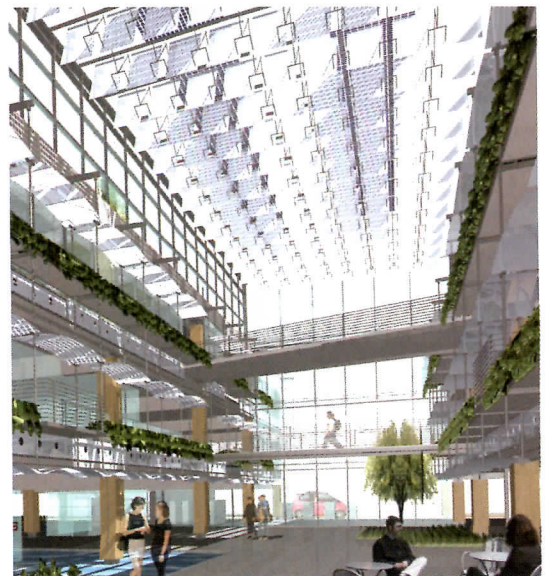

Busby Perkins+Will's Centre for Interactive Research on Sustainability applies new technology (page 155).



## FP OPTICS

High efficiency lamp specific formed optic system for maximum performance. Engineered into all models and sizes of **Advantus**, **Cornice** and **Corona**. Easily adapted into a housing of your own design.



## XP OPTICS

Low maintenance extruded optic system for maximum durability. Engineered into all models and sizes of the **Module** series: **XP-T**, **XP-C** and **XP-F**. Easily adapted into a housing of your own design.



## PERFORMANCE ART

Why choose between performance lighting and architectural lighting when you can have both? Two innovative new optic systems bring performance to a wide selection of Visa Lighting's sconces, ceiling mounts, pendants and chandeliers. Match the optics that meet the needs of your application with the fixture that best complements your vision. Performance without compromise from Visa Lighting.

 **VISA LIGHTING**  
An Oldenburg Group Company

1-800-788-VISA  
[www.visalighting.com](http://www.visalighting.com)

CIRCLE 47 ON READER SERVICE CARD OR GO  
TO [ARCHRECORD.CONSTRUCTION.COM/PRODUCTS/](http://ARCHRECORD.CONSTRUCTION.COM/PRODUCTS/)

# An Evolving Edifice That Will Improve With Time

**FOUR UNIVERSITIES ENVISION THE CENTRE FOR INTERACTIVE RESEARCH ON SUSTAINABILITY AS A LIVING LABORATORY WITH A LOFTY MISSION AND AMBITIOUS PERFORMANCE GOALS**

By Joann Gonchar, AIA

**F**or a former industrial site in downtown Vancouver, four regional educational institutions are collaborating on an unusual experiment. The schools—the University of British Columbia (UBC), Simon Fraser University, Emily Carr, and the British Columbia Institute of Technology (BCIT)—plan to build a 64,500-square-foot “living laboratory” they call the Centre for Interactive Research on Sustainability, or CIRS. It will provide office and research space for the partner institutions and the opportunity to study building products, technologies, and systems in context. Over the lifetime of the building, much of it—including its envelope; the mechanical, energy, and water systems; and the finishes—will be treated as a research test bed. Its components will be modular, allowing them to be replaced or reconfigured in a “plug-and-play” manner as technologies improve.

Designers and center officials have ambitious performance goals. They plan a building that will require few resources from off-site to operate and will create little waste. They say CIRS will use only 17 percent of the energy of an ASHRAE 90.1 base building and will score beyond Platinum in the Canadian Green Building Council’s rating system. They hope to accomplish this for about \$265 per square foot, a budget typical for UBC dry-lab buildings. “If sustainable practices are to become standard operating procedure, we have to find a way to construct [high-performance] buildings at roughly the same cost as those typically built by the development industry,” says UBC geography professor and former director of the school’s Sustainable Development Research Initiative, John Robinson. He is considered one of the chief visionaries behind the CIRS.

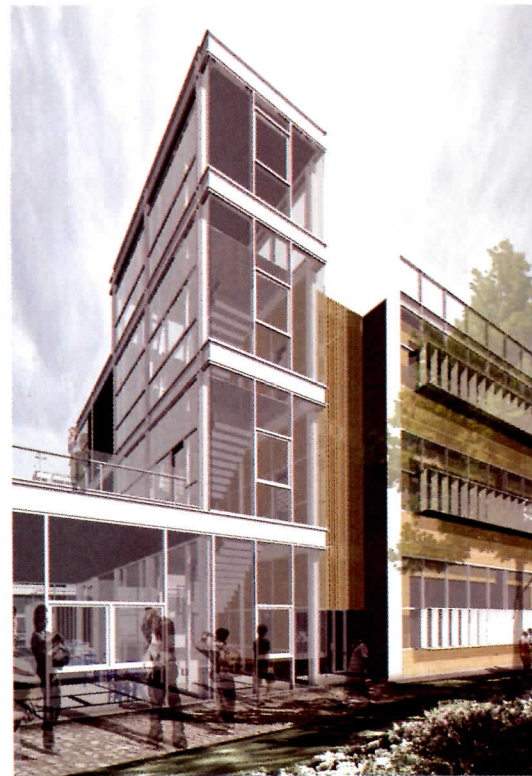

The Centre for Interactive Research on Sustainability will be a flexible building that can adapt to long-term changes in use and technology. The building itself will serve as a “living lab” where the performance of the facility’s components and systems will be the focus of the research conducted by its occupants.

ARCHITECTURAL TECHNOLOGY

The project is within about \$1 million of its \$21 million budget, according to the architect, Busby Perkins+Will, which recently completed design development and has submitted an application for a development permit. The client is now negotiating with the city to allow the facility to provide about a third of the number of parking spaces than would typically be required for a building of its size. CIRS officials say the reduction is justified since tenants will be required to sign a sustainability charter and will encourage users to travel to the center by public transportation, by bicycle, or by other alternative modes. If city officials accept the center’s parking assessment, drilling for the building’s ground source heat pumps and other site work could begin as early as February, with occupancy of the 64,500-square-foot first phase slated for the middle of 2008. Two more phases of construction are planned for an eventual total capacity of 118,000 square feet.

## History as inspiration

The CIRS project is not without precedent. One earlier living lab is the Robert L. Preger Intelligent Workplace (IW), built in Pittsburgh at Carnegie Mellon University in 1997. The \$4 million facility sits atop an early-20th-century building in a penthouse addition designed by architects Bohlin Cywinski Jackson and Pierre Zoelly [RECORD, June 1998, page 148].

## CONTINUING EDUCATION

Use the following learning objectives to focus your study while reading this month’s ARCHITECTURAL RECORD/AIA Continuing Education article. To receive credit, turn to page 162 and follow the instructions. Other opportunities to receive Continuing Education credits in this issue can be found in the sponsored sections beginning on page 175.

## LEARNING OBJECTIVES

After reading this article, you should be able to:

1. Discuss the characteristics of living laboratories.
2. Describe the types of research that will be conducted at the Centre for Interactive Sustainability (CIRS).
3. Describe the CIRS building’s systems and components.

For this story and more continuing education, as well as links to sources, white papers, and products, go to [archrecord.construction.com](http://archrecord.construction.com).

To join a discussion about this story or other sustainability-related topics, go to [forums.construction.com](http://forums.construction.com).

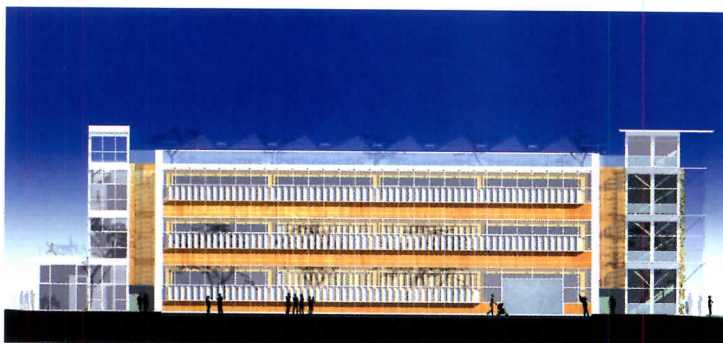

The south facade (top) has a catwalk to facilitate the change-out and testing of components such as photovoltaic panels, shading devices, and glazing. The west

(above) and east facades will be more fixed, but adaptable. They will have internal and external light shelves as well as adjustable vertical shading fins.

The IW serves as offices for the Center for Building Performance and Diagnostics (a division of Carnegie Mellon's school of architecture), and as a reconfigurable facility where the effectiveness of new building products and systems are tested and evaluated. In the nine years since its opening, architecture masters and doctoral candidates have used the IW to perform many kinds of investigations, including lighting and daylighting evaluations, ventilation studies, and acoustics research. For the first seven years, the facility relied on the university's infrastructure for power. However, researchers recently began examining the potential of on-site generated renewable energy, and have installed solar thermal collectors on the penthouse roof [see sidebar, page 160].

The university hopes to further explore distributed energy systems in a project it has dubbed "building as power plant." It plans an approximately 40,000-square-foot academic building that will be a net energy producer. The 7,000-square-foot IW has "only modest heating and cooling loads and is not big enough to support the next generation of power systems," says Vivian Loftness, FAIA, senior researcher for the Center for Building Performance and Diagnostics and former head of the architecture school. Before building this much larger living lab, Carnegie Mellon will have to conduct a national fund-raising campaign, says Loftness.

#### More than an experiment

Unlike Carnegie Mellon's IW, the Vancouver facility will include office space for nonacademic tenants. One of these tenants is the region's elec-

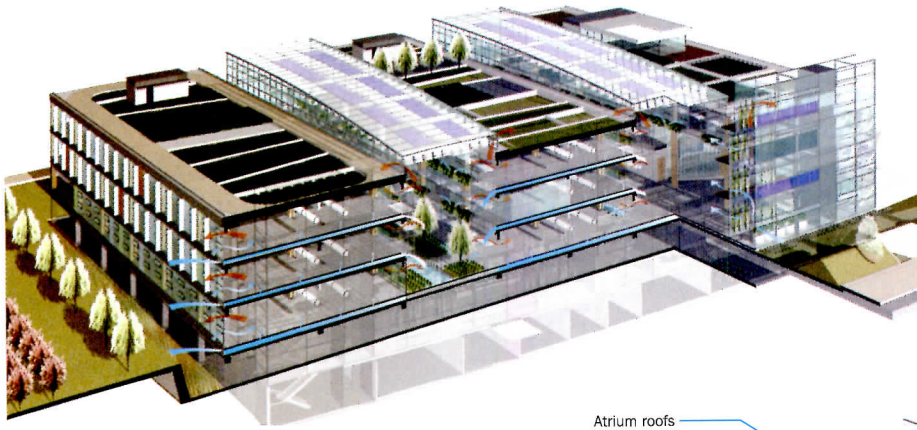

Diagrams showing the center after the third phase of construction illustrate the facility's ventilation and air-supply system (above) and the strategy for rainwater collection and reuse (right).

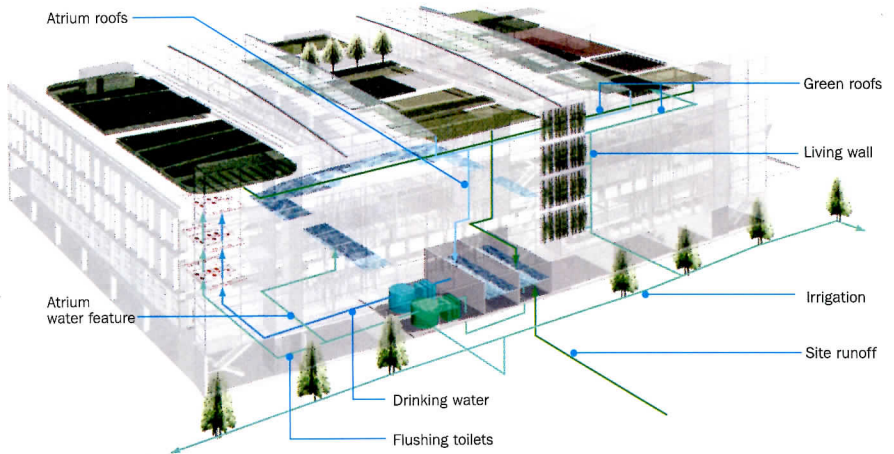

tric utility, BC Hydro. It has signed a 25-year, prepaid lease for about 8,500 square feet of office space. The funds will be used to help finance construction—a way to reap the rewards of CIRS's promised lower operating costs up front. This practice is atypical for developers, and even for long-term institutional owners, who rarely intermingle capital and operating budgets. "One of the biggest barriers to building sustainably is the operating/development cost split," says Robinson.

### Spreading the gospel

The deal is also advantageous for the utility, says Bruce Sampson, BC Hydro's vice president for sustainability, who predicts that rents will rise considerably over the next quarter century. But the utility's interest in CIRS goes beyond the inexpensive rent. It shares the center's mission of community engagement and has had a long-standing program to encourage its customers to conserve electricity.

About 50 employees will occupy BC Hydro's space at the center at any one time, but on a revolving basis, predicts Sampson. "They will be exposed to the leading-edge thinking and then will bring it back to their regional offices," he says.

Part of BC Hydro's approximately \$4.5 million prepayment will go toward sponsorship of a 100-seat visualization theater, where the general public, policy makers, and others will be able to quickly model the environmental ramifications of energy-use decisions at the regional, city, and building scale. "To hit our goals we have to be a catalyst for sustainable urban environments, infrastructure, and buildings," says Sampson.

The CIRS building will be composed of two three-story office blocks connected by a central atrium that features internal light scoops and solar reflectors. The space will be covered by a saw-tooth-shaped skylight with integrated photovoltaic panels. The 36.9 megawatt-hour-per-year array is expected to supply about 20 percent of the facility's electricity needs. Power will also be provided by solar hot-water collectors, fuel cells, and an on-site cogeneration plant. "We are trying to pull the building off the grid," says Blair McCarry, a principal at Stantec, the project's mechanical engineer.

The south side of the building will serve as a "three-dimensional vertical lab" for the testing of such elements as glazing, photovoltaic panels, wall assemblies, and shading devices. On almost every floor, at the

## THE SOUTH FACADE WILL BE CONSTANTLY EVOLVING AND WILL LOOK LIKE A CONTINUOUS CONSTRUCTION SITE.

southwest and southeast corners of the building, labs for building monitoring and assessment will be located in the 13-foot-deep zone directly adjacent to the facade. These rooms will provide a controlled environment for the study of the relationship between the building envelope components and other elements, such as the heating and cooling systems, interior shading devices, or interior finishes and furnishings.

This building monitoring and assessment zone will be constantly evolving. It will have a steel structure with catwalks and a permanent hoist to allow for frequent change-out of components. "It



SECTION A-A

- 1. Atrium
- 2. Biofilter
- 3. Cistern
- 4. Green roof research
- 5. Building monitoring and assessment lab
- 6. Meeting room
- 7. Mechanical room
- 8. Bicycle storage

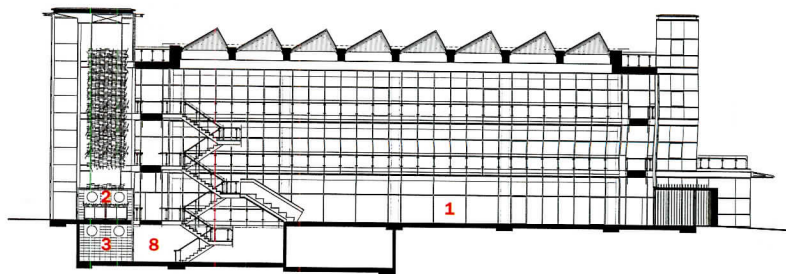

SECTION B-B

The CIRS building will have two office blocks connected by a central atrium, which will be topped by a saw-toothed skylight. Spaces like the visualization theater and policy lab will help the center fulfill its goal of public engagement.

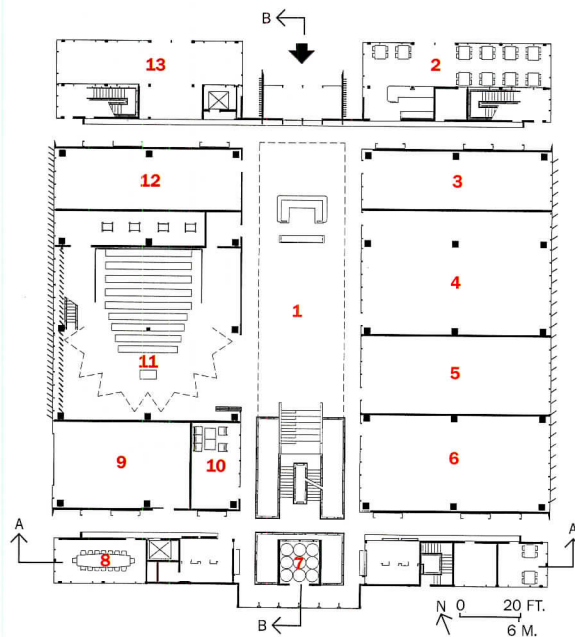

ENTRY LEVEL

- 1. Atrium
- 2. Café
- 3. Operations
- 4. Policy lab
- 5. Lab space
- 6. Project room
- 7. Biofilter
- 8. Meeting room
- 9. Receiving
- 10. Resource library
- 11. Theater
- 12. CIRS offices
- 13. Retail

will never look the same twice and will be a continuous construction site,” predicts Donald Yen, program director for the Centre for Sustainable and Environmental Initiatives at BCIT, the primary research group using these labs.

More limited portions of the north facade will also be changeable, offering another orientation for the testing of building envelope components. The east and west elevations, the facades adjacent to the

## THE BUILDING FRAME IS BOLTED TOGETHER TO FACILITATE RECONFIGURATION AND ULTIMATE DISASSEMBLY.

office portions of the building, will incorporate internal and external light shelves. Vertical fins will act as sunshades. These will have set points appropriate for different seasons but can be repositioned by the occupants for special conditions.

The framing of the main part of the building, which the designers refer to as the “core,” is based on a 26-foot-by-4-inch module. It is to be made of locally sourced engineered wood beams and columns, bolted together to facilitate reconfiguration and ultimately, disassembly, should the building reach the end of its useful life, says Paul Fast, a principal of

Fast + Epp, the project’s structural engineer.

The facility will have many operable windows, but will not be completely naturally ventilated. Because the site is near a rail yard and a fish-processing plant, the design team was concerned about air quality. “There will be times when we might have to button up the building,” says Martin Nielsen, Busby Perkins+Will principal.

A raised floor system over a radiant structural floor will allow for flexibility for wiring and office layouts and will provide a plenum for the displacement air system. Return air from these cavities will be drawn into the atrium space, filtered through a living wall, and recirculated through the building.

In an earlier scheme, the raised floor sat above precast-concrete panels. These have since been replaced by concrete on steel deck because of budget concerns. Although the assembly is likely to be made of poured-in-place concrete, it will nevertheless be panelized to maintain the potential for disassembly, says Nielsen.

The requirement that the building be demountable presented a special seismic design challenge for the structural engineer. He has had to devise a method for the transfer of shear forces across the joints in the radiant-floor assembly. “It’s just one more parameter to think about,” says Fast, who has also designed a steel brace for the building as an alternative



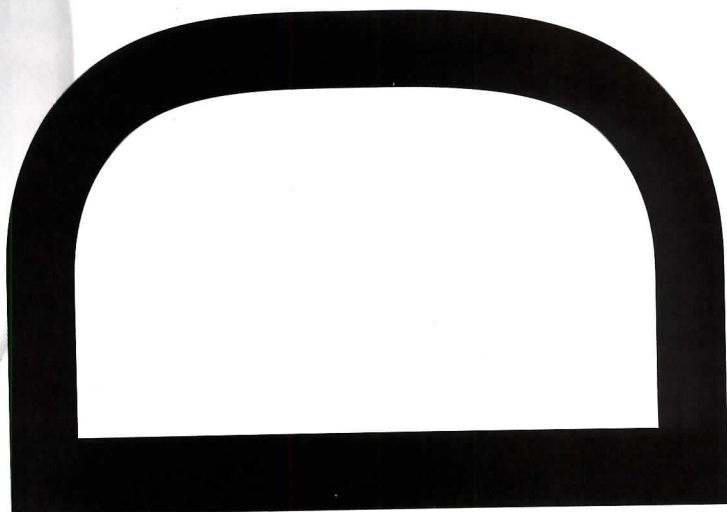
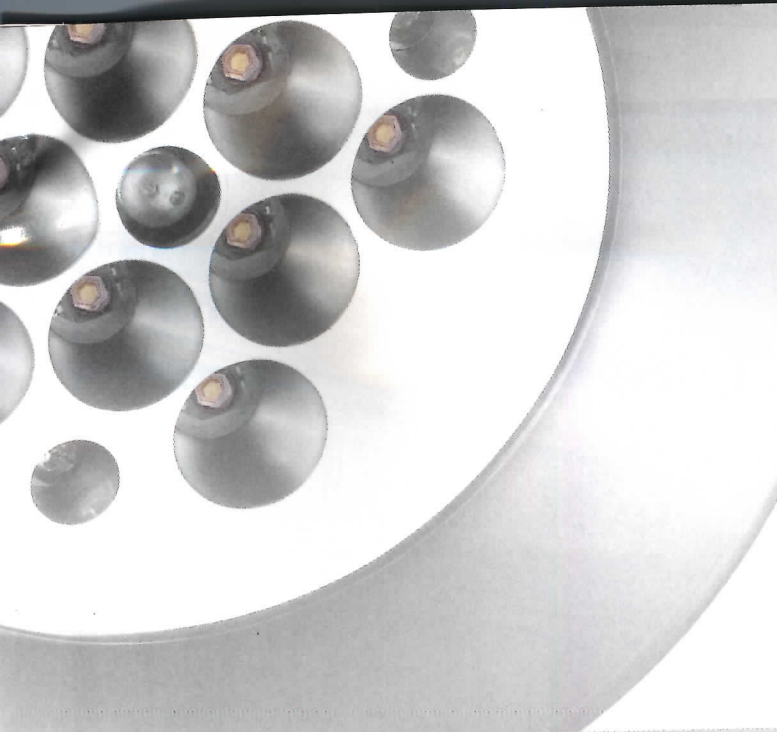

 **prescolite**  
**ABOVE & BEYOND**

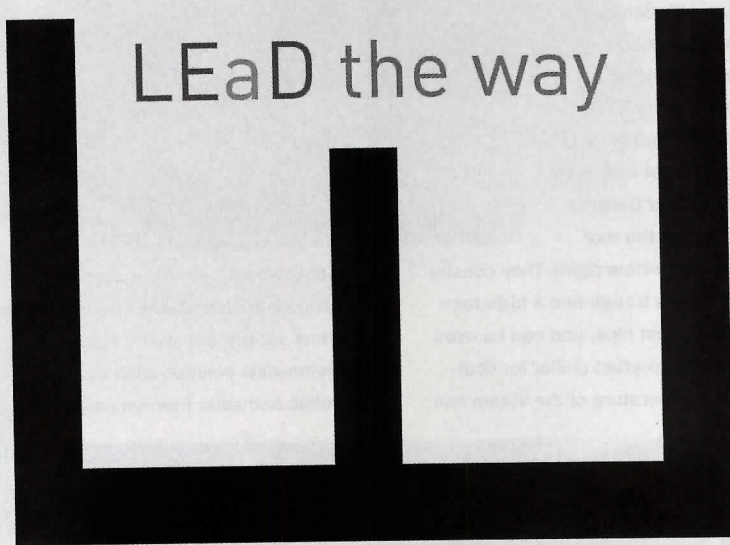
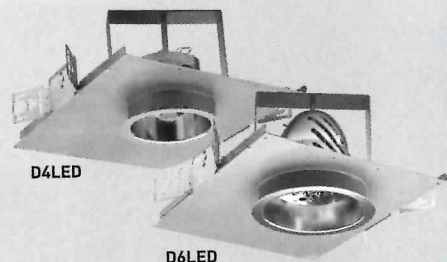

**Why follow when you can LEaD?** Prescolite's new Architektür D6LED and D4LED downlights are the first practical downlighting application of LEDs capable of producing usable illumination. Designed from the ground up around cutting edge Luxeon K2 LEDs from Lumileds and featuring Advance's Xitanium electronic driver, Architektür LED downlights provide the benefits of LED technology to today's general lighting applications. So specify Prescolite's new Architektür LED downlights and LEaD the way.



To learn more about Prescolite's new LED downlights, contact your local Hubbell Lighting representative or visit us at [www.prescolite.com](http://www.prescolite.com) or call 888-PRS-4TEC.

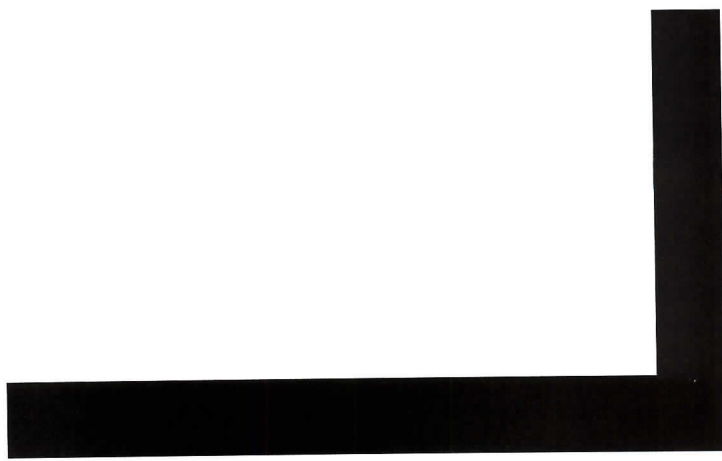

**CIRCLE 48 ON READER SERVICE CARD OR GO TO [ARCHRECORD.CONSTRUCTION.COM/PRODUCTS/](http://ARCHRECORD.CONSTRUCTION.COM/PRODUCTS/)**

**Architektür** ARCHITECTURAL DOWNLIGHTS



CIRCLE 47 ON READER SERVICE CARD OR GO TO [ARCHRECORD.CONSTRUCTION.COM/PRODUCTS/](http://ARCHRECORD.CONSTRUCTION.COM/PRODUCTS/)

areas such as the relationship between green roofs and mechanical-system performance or the therapeutic benefits of rooftop greenspace. The strength of the center's concept is that it brings these academics and their projects together, says Connelly. "At each platform of CIRS, there are many more levels of research," she notes.

The center will be connected to Vancouver's water and sewer systems. However, CIRS officials and its designers say the municipal services will be used rarely, if ever. Rainwater runoff collected from the skylights and other clear roof surfaces will be stored, treated, and distributed for use in showers and sinks, and to supply other potable points. Any water that drains from the building's green roofs will not be suitable for these uses because of organic materials typically found in such runoff, explains Troy Vassos, president of the process engineering firm Novatec. The green roof water will be combined with wastewater from showers, lavatories, and toilets, and treated, possibly using a membrane bioreactor or a solar aquatic system, so that it will be safe for direct human contact, he says. This treated, mixed wastewater will then subsequently be used to flush toilets and to irrigate the green roofs and the site's landscaping.

### Many clients, one project

The center is the first project that Busby Perkins+Will is designing with a three-dimensional, parametric building information model. The model's interference-checking capabilities have been particularly useful for coordinating among the architectural design team and the various con-

sultants, says Nielsen. And the 3D visualization tools have helped explain the building to its many constituents. "With four client institutions, each with its own research clusters, at times there are 30 people at the table during planning meetings," he says.

The center's designers say that the 3D model will also help the industry close the gap between predicted and actual performance. For the life of the building, CIRS's various systems and components will be "super-

## CIRS WILL PROVIDE REAL-WORLD DATA TO HELP CONSTRUCT MORE ACCURATE PREDICTIVE PERFORMANCE MODELS.

monitored," says Stantec's McCarry. Information regarding such factors as energy and water use, indoor air quality, and temperature will be continuously and systematically gathered from nearly 1,500 monitoring points.

Researchers will have the ability to compare this data to the information about the building's predicted performance contained in the 3D model. "Once the building is in operation, we can go back to the original assumptions with real-world feedback," says Nielsen. "Ultimately, we will be able to construct more accurate models," he says.

CIRS officials also plan to evaluate the relationship between the building's environment and the health, productivity, and satisfaction of the occupants, using tools such as postoccupancy surveys. Jokes McCarry, "It's a scary amount of accountability." ■



### AIA/ARCHITECTURAL RECORD CONTINUING EDUCATION

#### INSTRUCTIONS

- ◆ Read the article "An Evolving Edifice That Will Improve With Time" using the learning objectives provided.
- ◆ Complete the questions below, then fill in your answers (page 277).
- ◆ Fill out and submit the AIA/CES education reporting form (page 277) or download the form at [www.archrecord.com](http://www.archrecord.com) to receive one AIA learning unit.

#### QUESTIONS

1. The facility for the Centre for Interactive Research on Sustainability (CIRS) will be all of the following except which?
  - a. a research test bed for building components and systems
  - b. built at the same cost as a University of British Columbia wet-lab building
  - c. an occupied building
  - d. demountable
2. One of the biggest barriers to building sustainably is which, according to University of British Columbia geography professor John Robinson?
  - a. first costs
  - b. operating costs
  - c. the strict separation between development and operating budgets
  - d. permitting
3. The solar thermal collectors on the roof of the Intelligent Workplace at Carnegie Mellon University provide which?
  - a. heating only
  - b. cooling only
  - c. heating and cooling
  - d. hot potable water
4. CIRS will have all of the following features except which?
  - a. a welded-steel structural frame
  - b. two three-story office blocks
  - c. a central atrium
  - d. a saw-tooth-shaped skylight
5. Power for the CIRS facility will be provided by which method?
  - a. fuel cells
  - b. photovoltaic panels
  - c. a cogeneration plant
  - d. all of the above
6. The south facade of the CIRS building will serve as a 3D lab for the testing of all except which?
  - a. steel catwalks
  - b. glazing
  - c. photovoltaic panels
  - d. shading devices
7. The brace designed for the CIRS facility will do all except which?
  - a. absorb the energy of an earthquake
  - b. spare other building components from damage in an earthquake
  - c. be easily replaceable
  - d. not be damaged in a serious earthquake
8. Operable vertical fins will serve as shading devices on which facade of the CIRS building?
  - a. the east facade only
  - b. the west facade only
  - c. the east and west facades
  - d. the north facade
9. Potable water at the CIRS building will come from which source?
  - a. green-roof runoff
  - b. skylight runoff
  - c. site runoff
  - d. the municipal water supply
10. The CIRS facility's architects are using building information modeling to do which of the following?
  - a. coordinate the design among the firm's consultants
  - b. help explain the building to project stakeholders
  - c. develop a database of predicted performance information
  - d. all of the above

SmartGeometry

# WINTER CONFERENCE & RECEPTION

HOSTED BY: ARCHITECTURAL  
RECORD

January 31, 2007  
New York, NY

The SmartGeometry Group is dedicated to educating building professionals in the application of advanced 3D design tools and computational design. The work of its members has resulted in some of the most admired buildings of the 21st century.

Visit [www.SmartGeometry2007.com](http://www.SmartGeometry2007.com) to register.

## SPEAKERS INCLUDE:

Hugh Whitehead,  
*Foster and Partners*  
Lars Hesselgren, *KPF*  
J Parrish, *Arup Sport*  
Rob Woodbury,  
*Simon Fraser University*

Axel Killian, *MIT*  
Shane Burger, *Grimshaw*  
Jalal El Ali, *Buro Happold*  
Chris Williams,  
*Bath University*

## SMARTGEOMETRY CONFERENCE

9:00AM - 6:00PM

The Cooper Union for the  
Advancement of Science and Art  
The Great Hall

7 East Seventh Street at Third  
Avenue Cooper Square  
New York, NY 10003

## SMARTGEOMETRY RECEPTION

7:00 PM

Guggenheim Museum  
1071 Fifth Avenue  
New York, NY 10128

Sponsored By:



CIRCLE 50 ON READER SERVICE CARD OR GO  
TO [ARCHRECORD.CONSTRUCTION.COM/PRODUCTS/](http://ARCHRECORD.CONSTRUCTION.COM/PRODUCTS/)

# When Less Powers More

**WITH ENERGY-MODELING PROGRAMS AND EARLY INPUT, MECHANICAL ENGINEERS ARE INCREASINGLY INVOLVED IN DESIGN DECISIONS THAT ARE SHAPING THE LOOK OF A NEW ARCHITECTURE**

By Russell Fortmeyer

Only a handful of city blocks separate A.C. Martin's 1965 building for the Los Angeles Department of Water and Power and Morphosis's 2004 regional headquarters for the California Department of Transportation, or Caltrans, but the concepts informing their design reflect a much greater divergence.

The DWP and Caltrans arguably rank as the most influential institutions of the city—plentiful water and power enabled the freeway-obsessed birthplace of sprawl to evolve into the de facto financial and cultural capital of the world's seventh-largest economy. And it takes a lot of power to keep it humming (think Hoover Dam). This explains, perhaps more than their 40-year age disparity and different architects, why the DWP and Caltrans buildings look so unrelated. Unlike a Hollywood starlet, the look isn't skin deep: The buildings function radically differently owing to a culture of energy use that has moved from the free-wheeling to the conservative.

David Martin, FAIA, a design partner at his family's firm, fondly remembers when in his youth his late father, A.C. Martin, Jr., FAIA, would discuss the progress of the DWP. "The attitude of the time for the DWP was of tremendous civic pride, so energy was understood not in terms of using the smallest amount, but using it in innovative ways," Martin says. "The building's design was meant to symbolize the use of energy."

The DWP building occupies an artificially constructed promontory surrounded by pools and fountains that feed the building's cooling towers. As the iconic photography of Julius

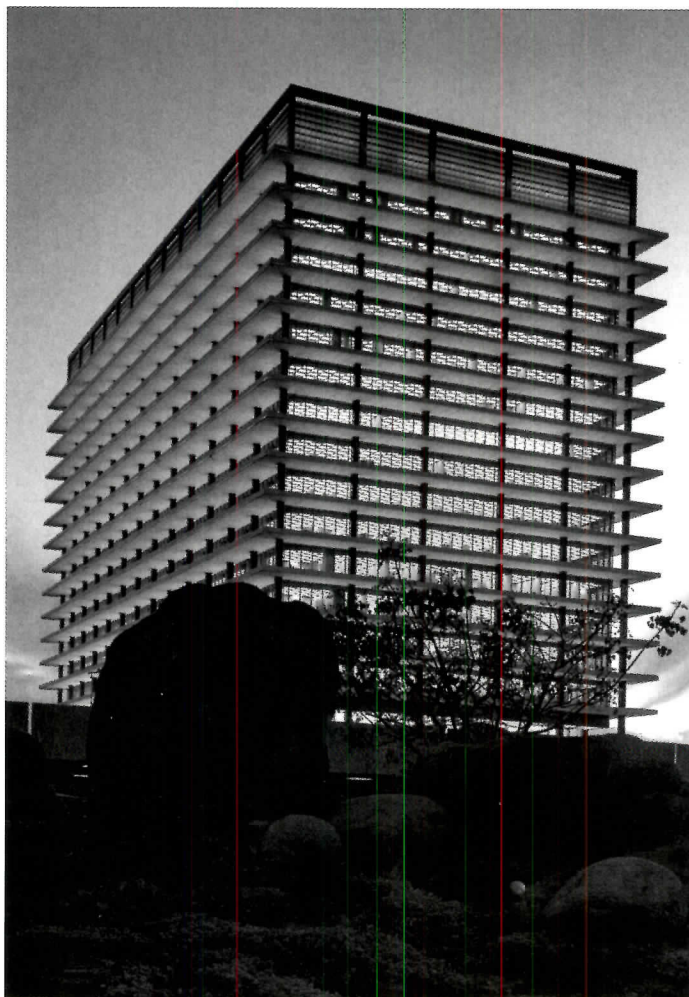

**LOS ANGELES DEPARTMENT OF WATER AND POWER, 1965  
—A.C. MARTIN PARTNERS**

In his 1997 book *The Reluctant Metropolis*, William Fulton calls the DWP building "a far more imposing structure today" than the Welton Becket-designed Los Angeles Music Center located across the street. The DWP's effect on the skyline is enhanced by its canny mix of Modernist design and decorative exhibition of its use of water and power for its (at-the-time) high-tech mechanical systems.

Shulman ably demonstrates, the uniformly lit floors—continuously illuminated around the clock with linear fluorescent T12 lamps—bolster the structure's imposing monumentality. Here, natural resources are a kind of decoration. They are yet another Southern California marketing campaign, like flowers attached to floats in the Rose Parade. That tactic continues, however reversed, with the Caltrans headquarter's advertising of conservation and energy generation, witnessed in the building-integrated solar photovoltaic array on its south side.

DWP's curtain-wall system, with overhangs at each floor to limit sunlight and heat gain, wraps all four building sides. At Caltrans, each face is computer modeled and built to respond to the conditions particular to that side. Where the DWP eschewed boilers, depending instead on its energy-hogging fluorescent lighting for heating, Caltrans's efficient central plant operates through a building control system to target its performance toward shifting environmental conditions. A lighting control system cuts energy use further. These performance improvements are increasingly common in buildings, though few states mandate energy efficiency quite as strictly as California.

## **Crisis as opportunity**

"Designing intelligent structures is mandatory," says Peter Tertzakian, an energy consultant and the author of the book *A Thousand Barrels a Second* (published by

## CALTRANS DISTRICT 7 HEADQUARTERS REPLACEMENT BUILDING, 2004 —MORPHOSIS

The 84-kilowatt solar photovoltaic array on the south side of the Caltrans building consists of 897 panels and is designed to supply 5 percent of the building's energy requirements. The installation was a design collaboration between Morphosis, Arup, and Atlantis Energy and was partially funded by a grant from local utility companies.

McGraw-Hill in 2006). "However, you also have to change people," he adds. Tertzakian, whose book gauges America's addiction to oil, doesn't specifically address buildings as much as a culture of energy use that has avoided developing plentiful alternative energy sources to petroleum and other fossil fuels. He lays out four expectations consumers have toward energy: It must be cheap, clean, secure, and discreet (his version of NIMBYism). The change in today's culture, Tertzakian argues, is we can no longer afford to have all four.

To take one with particular resonance for architecture, the photovoltaics on Caltrans certainly don't qualify as inconspicuous. But photovoltaics are innocuous compared to a coal-fired power plant, and as deployed at Caltrans they represent how architects incorporate energy generation into a building without sacrificing design integrity. (For another example, see the building-integrated wind turbines of SOM's Pearl River Tower, page 172). What PVs aren't, however, is cheap, which explains why they are used only when required or subsidized. This argument is trotted out for every architect contemplating the use of PVs, but as Steven Strong, of Cambridge, Massachusetts-based Solar Design Consultants, says, PVs are among the few materials in buildings where owners stipulate a payback. "No one expects high design to have the payback demanded of an energy-efficient technology," Strong says.

Architects skirt that issue by justifying unconventional design through building information models that demonstrate constructability and performance characteristics in precise, realistic terms. Once the design team sets energy performance criteria—such as beating the American Society of Heating, Refrigerating, and Air-Conditioning Engineers' standards (ASHRAE 90.1) by 20 percent—the engineer and architect could study different curtain-wall designs by modeling them in software programs such as EnergyPlus or DOE2.

Think of the new building modeling as akin to the ergonomic revolution in product design in the 1980s. Auto interiors changed dramatically at that time thanks to ergonomics, with the shape of each button pushed and stretched like dough into gentle pillows of controllability. The tools available



now help to justify design decisions in a way that is clear and economically accountable to clients. Where structural engineers have traditionally enjoyed more creative leeway—as well as architectural influence—in design decisions, mechanical engineers have been held to cost factors associated with conventional marketplace equipment. As any mechanical engineer will tell you, they are usually relegated to the m/e/p “back-of-house” spaces architects love to hate. But as each building has a more performative relationship toward its environment and energy consumption, mechanical engineers have moved outside the realm of mere specifiers and become more aligned with their architects.

At Caltrans, Eugene deSouza, a mechanical engineer in Arup's Los Angeles office, worked with Morphosis in an iterative design collaboration before settling on the custom double-skin curtain-wall system of glass-and-metal mesh. The DOE2 program output helped settle issues such as the width between the two layers, the metal skin's transmissivity, the coatings on the inner glass layer, and the cavity's target ambient temperature. DeSouza says the model showed the metal skin reduced heat gain in the building by 25 percent, which was more than enough to justify its cost. “We try to sell energy modeling with all of our projects, but we do it as an add-service,” he says. “It should be an industry standard.”

### From style to substance

In his essay in the American Institute of Architect's recent *Report on Integrated Practice*, Thom Mayne writes that the work of his firm, Morphosis, has moved away from “styling” to focus instead on “embedding tectonic, constructional, and material design parameters.” This is the key difference in much computer-enabled design and represents, at least for many engineers, the final frontier in working with those architects who generate bloblike forms with no relationship to the site's environmental conditions. “Education across the board is needed,” deSouza says. “It's not being used to its full potential, by architects and engineers.”

Not many firms have invested in the training and technology needed to efficiently implement energy modeling on projects. While DOE2 costs nothing to download, designers proficient in both its use and the productive interpretation of its data are rare and expensive to employ. For the vast majority of buildings, owners seldom know how a building will perform and, since electrical engineers design around projected maximum power use, they don't know how much energy it will consume until the building opens.

Leon Glicksman, director of the Massachusetts Institute of Technology's Building Technology Program, loves to point out that buildings consume more energy than anything else, including automobiles (according to the Department of Energy, buildings account for 70 percent of electricity use). Glicksman is trying to focus attention on building energy use among designers by developing free, simple tools to help architects make quick, informed decisions early in the design process (see <http://designadvisor.mit.edu/design>). "People usually fall back on what they did the last time, even if it's for a totally different climate," Glicksman says. "The architect usually does his thing for a number of reasons, not including energy efficiency, and then throws the drawings over the transom to the engineer. Engineering shouldn't be the only thing that inspires design, but it should be toward the forefront."

Glicksman is trying to focus attention on building energy use among designers by developing free, simple tools to help architects make quick, informed decisions early in the design process (see <http://designadvisor.mit.edu/design>). "People usually fall back on what they did the last time, even if it's for a totally different climate," Glicksman says. "The architect usually does his thing for a number of reasons, not including energy efficiency, and then throws the drawings over the transom to the engineer. Engineering shouldn't be the only thing that inspires design, but it should be toward the forefront."

WITH ENERGY MODELING LEADING THE WAY, IT SEEMS ENGINEERING IS THE NEW ARCHITECTURE.

### Education, like it or not

Like Arup's deSouza, Glicksman points to a lack of education—further impaired by funding shortages for research—as an impediment to widespread implementation of energy-efficient-design strategies. Architects and engineers, however, have had to educate themselves to the issues as some state and local regulations have forced the use of new technologies. For example, two decades ago, incandescent downlights

were standard practice in residential kitchen construction. Today in California, only energy-efficient compact fluorescent downlights meet the state's Title 24 energy code for that use. Title 24 regulates building-envelope ratings, lighting-power densities (watts per square foot), and building-

equipment operating efficiencies, among other things. It is often used as a benchmark, like ASHRAE 90.1, against which designers measure the sustainable performance of projects. The U.S. Green Building Council's LEED rating program relies on such standards for weighting its points system for sustainable design.

The USGBC, ASHRAE, and the Illuminating Engineering Society of North America (IESNA) are collaborating on Standard 189, which would eventually act as an enforceable green building code. In addition, the American Institute of Architects issued a sustainable practice position paper

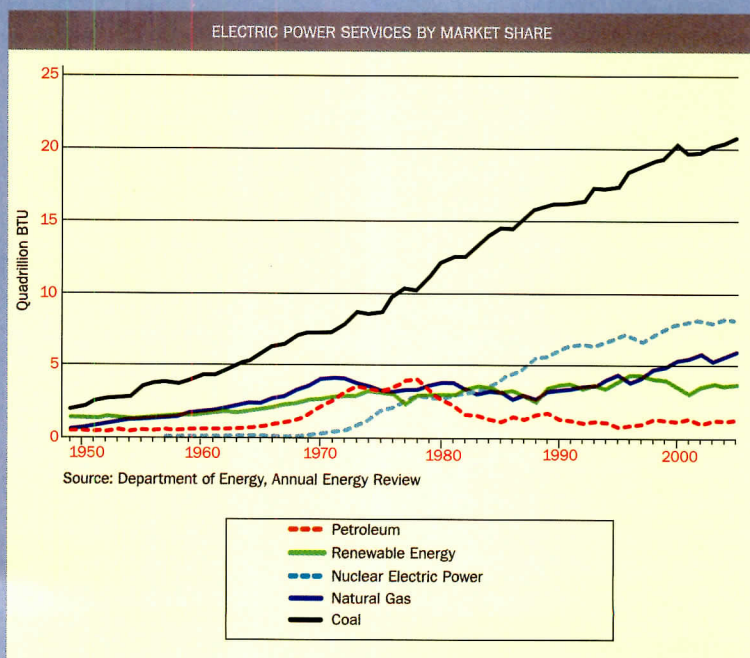
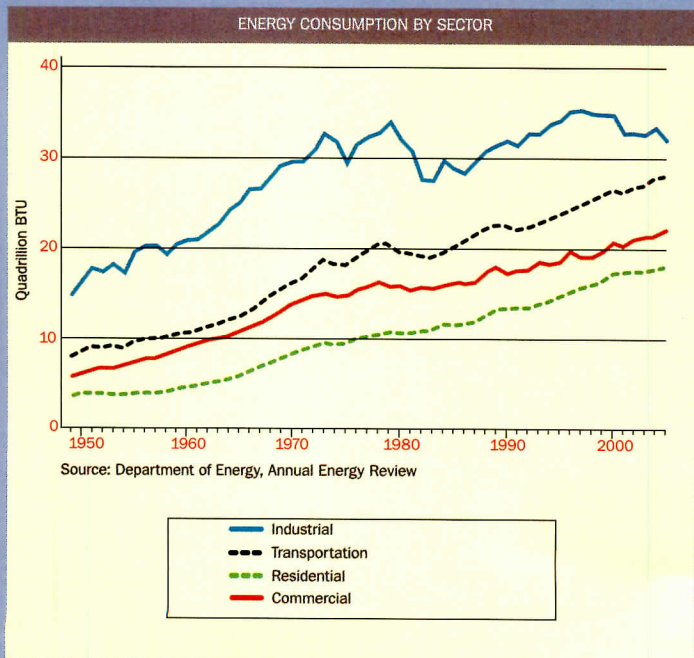

The Department of Energy's 2005 energy-consumption reports illustrate how overall energy use continues to climb, even though on a per capita basis it has leveled off in pro-

gressive states like California and New York. Renewable energy sources for electricity remain in a minority when compared to coal and nuclear power.

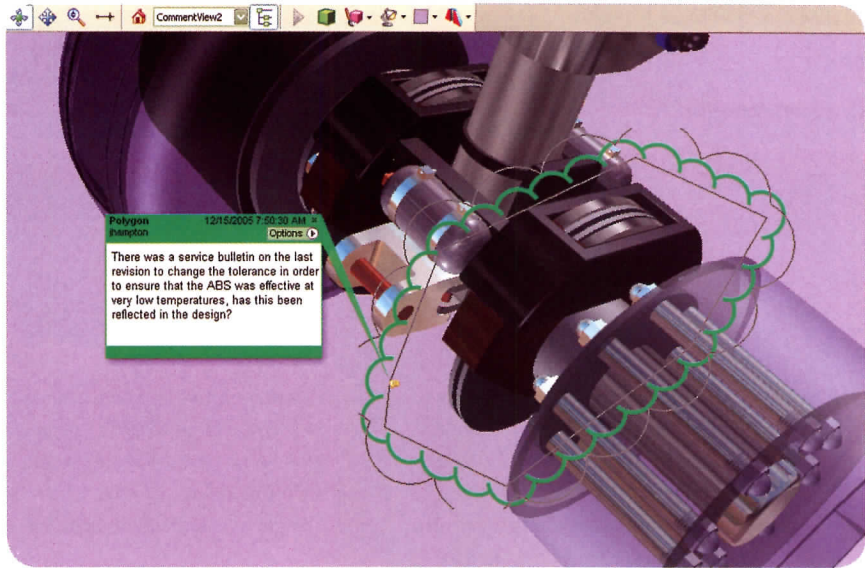
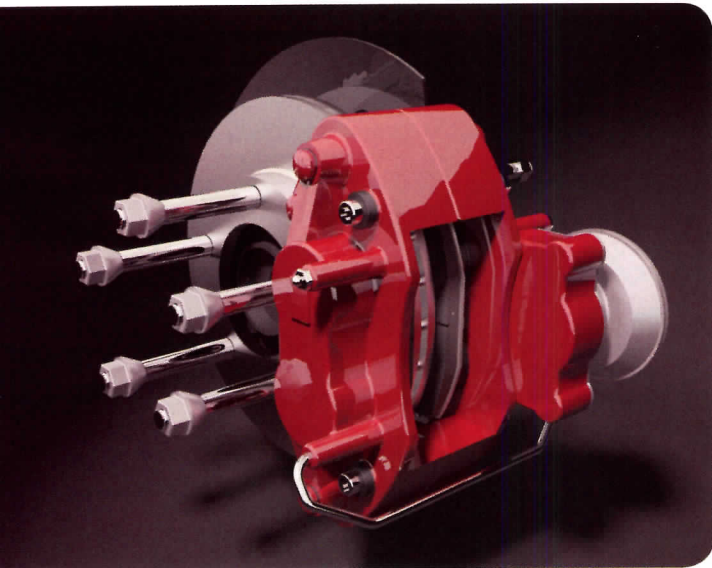

**DELL PRECISION™ 490**  
WORKSTATION  
Starting at **\$1529**

**DELL PRECISION™ M65**  
MOBILE WORKSTATION  
Starting at **\$1849**



Dell 17" 1707FP UltraSharp Flat Panel Display, \$239.



**Adobe Acrobat 3D**  
Software, documentation or packaging may vary from retail version.

# THE POWER TO DESIGN AND COLLABORATE IN THREE DIMENSIONS. THAT'S THE POWER OF DELL.

Dell™ recommends Windows® XP Professional

## ACROBAT 3D SOFTWARE ALLOWS YOU TO EASILY INSERT AND PUBLISH 3D DESIGNS FROM MAJOR CAD APPLICATIONS INTO ADOBE PDF DOCUMENTS.

That way, you can share 3D designs with extended team members who don't have access to expensive CAD programs or specialty viewers. The result is an enriched group collaboration that is designed to let everyone involved in the project to more securely and reliably communicate 3D design intent. And because Adobe Acrobat 3D software can now come preinstalled on Dell high-performance Dell Precision™ Workstations, your team can share and collaborate on their work with the same precision that goes into their designs. After all, every small business is unique. That's why every Dell Solution is purely you.

Dell™ recommends Adobe® software with Dell Precision™ Workstations.

**Adobe® Acrobat® 3D**

- Share 3D designs with extended teams
- Help protect and control sensitive information
- Accelerate and extend design collaboration
- Help reduce errors, design changes, and number of review cycles

Visit link below or call for pricing.

 **0% 24-Month Lease\***  
Available for well-qualified customers.

Elevate your business at [dell.com/share3D12](http://dell.com/share3D12)

**call 888.645.DELL**  
toll free



\*M-F 7a-8p Sat 8a-5p. CT. \*Pricing/Availability: Pricing, specifications, availability, and terms of offer may change without notice. Taxes, fees, shipping, handling and any applicable restocking charges extra, vary and are not subject to discount. Offers may be combined with other select offers or discounts. U.S. Dell Small Business new purchases only. LIMIT 5 DISCOUNTED OR PROMOTIONAL ITEMS PER CUSTOMER. In case of customers leasing under these promotions, please note that items leased will be subject to applicable end-of-lease options and requirements. Dell cannot be responsible for pricing or other errors, and reserves the right to cancel orders arising from such errors. **0% Leasing Offer:** Applicable for 24-month QuickLease with Fair Market Value (FMV) end-of-lease purchase option for hardware products only. \*Implicit lease rate, assuming, at the end of the lease term, lessee does not exercise a fair market value purchase option and timely returns the leased equipment to lessor, and disregarding any charges other than 24 rent payments (such as taxes, fees, shipping or handling charges), all terms subject to credit approval and availability, and can change without notice. QuickLease arranged by Dell Financial Services L.P. ("DFS"), an independent entity, to well-qualified Small Business customers. **Trademark/Copyright Notices:** Dell, the stylized E logo, Dell Precision and Dell Precision are trademarks of Dell Inc. Microsoft and Windows are trademarks or registered trademarks of Microsoft Corporation in the United States and/or other countries. Adobe, the Adobe Logo and Acrobat are either registered trademarks or trademarks of Adobe Systems Incorporated in the United States and/or other countries. ©2006 Dell Inc. All rights reserved.

in late 2005, which became the framework for the U.S. Conference of Mayors' 2030 Challenge. The Challenge calls for a 50 percent reduction in consumption of fossil-fuel energy for all new and renovated buildings, accompanied by a 10 percent reduction in consumption every five years until 2030, when conceivably the country would be carbon neutral. It's an ambitious proposition, but it will have to wind its way through the legislative process before it can be enforced.

### One nation, under green

Until that happens, public and institutional buildings—where local, state, and federal agencies and nongovernmental organizations aren't held to the whims of the commercial building market—will continue to be the main laboratory for high-performance sustainable design in the U.S. These projects combine complicated building programs with generally higher budgets, which allow more study behind each architectural decision. For its design of the LEED Silver-rated United States Courthouse in Seattle, NBBJ Architects depended on energy modeling, as well as computational fluid dynamic (CFD) modeling, to deliver the client's expected level of building transparency (i.e., the glass facade) without producing an energy hog.

A CFD model of the lobby illustrated how air delivered from the floor could pool within the first 8 feet above the finished floor, which eliminated the need to provide enough air-conditioning for the entire space. A conventional design would have dumped air from the ceiling based on the volume of the space; when coupled with the expected heat gain from the glass facade, the demands on the building's chiller *would have been enormous*.

"There seems to me to be an infinite number of choices before

## UNITED STATES COURTHOUSE, SEATTLE, 2005 —NBBJ ARCHITECTS

**The federal government wanted as much daylight as possible in each courtroom, which led NBBJ to rely on complex energy modeling data for implementing a ventilation system that could efficiently accommodate the expanses of glass on the building's 23 stories. Seattle's mild climate and sparse sunshine helped matters greatly.**



the design team and the architect have enormous influence on those decisions," says Steve McConnell, FAIA, NBBJ's design principal. "You have to contemplate an intelligent approach to these decisions—it's not just an aesthetic process." So while energy modeling justified the in-floor ventilation system, it also helped determine the low-E glass coatings, the low-iron glass for greater transparency, and the control of daylighting. McConnell says such modeling was expected from day one on the project. "In a typical project, it takes an extra effort to package these ideas," he says.

### DWP not DOA

It does seem that engineering is the new architecture. It's worth considering, not on the literal level of engineering actually replacing architecture, but in terms of how we've arrived at a place where design and construction technologies are coming together to address a pressing geopolitical issue—energy consumption—in ways unimaginable 40 years ago. Even the Los Angeles DWP has learned from itself, as lights no longer remain on 24 hours a day, a solar photovoltaic array blankets its covered parking lot, and a 250-kilowatt fuel cell was installed in 2000. And David Martin's family firm has changed the way it works, having designed the energy-efficient California EPA Headquarters in 2001, which was certified LEED Platinum in 2003.

Martin says the DWP was built when technology was perceived as the best thing in the world, but given recent evidence, little about that notion seems to have changed. If anything, it has been slightly altered: Technology is now perceived as the best thing as long as it cuts your energy bill. ■





Photo credits: Atrium Skylight at the Gaylord Texan Resort & Convention Center. Architect: Hnedak Bobo Group of Memphis, TN. Courtesy The Vistawall Group.

“We’re committed to the environment. Now we need information on green products and the key trends in sustainable design.”

One name.  
One source.

*GreenSource*  
Your source for green information and intelligence



If you are involved in green design and construction, it is more important than ever to have a source of information that meets your green building needs. *GreenSource* is essential for firms that want to make a difference to a responsibly built environment. Proudly supported by the United States Green Building Council, *GreenSource* is your source for the latest and most comprehensive green information and intelligence.

- Here is what you get inside every issue of *GreenSource*:
- Project case studies, product sources and LEED ratings
  - Green products found in trusted green building programs
  - New policies established by public and private owners
  - Noteworthy trends in green construction
  - Developments in green design legislation

**Subscribe now and connect to one source for all of your green needs.**

**All it takes is one call: 1-866-664-8243**

**Call today and receive one year (four issues) for only \$19.95**

**Go to [www.greensourcemag.com](http://www.greensourcemag.com)**

# In Search of the Zero-Energy Holy Grail

**A REAL-WORLD YET HYPOTHETICAL DESIGN PROBLEM IN A TOUGH CLIMATE CHALLENGES ENGINEERS TO THINK ABOUT THE MEASURES NECESSARY FOR REDUCING A BUILDING'S ENVIRONMENTAL FOOTPRINT**

By Joann Gonchar, AIA

**W**hen ARCHITECTURAL RECORD's editors "commissioned" a team from Arup to design a zero-energy building to present at this year's Innovation Conference, held in New York City in October, we did not specify a site, a client, a program, or a budget. But, even though we left the assignment open for the engineers to define, they set for themselves a very real-world, challenging design problem.

To examine strategies that might be used to reach zero, Arup developed a scheme for a generic mixed-use project in hot and humid Houston. "We decided not to pick a climate that was too easy," said Fiona Cousins, Arup principal and mechanical engineer. It is much

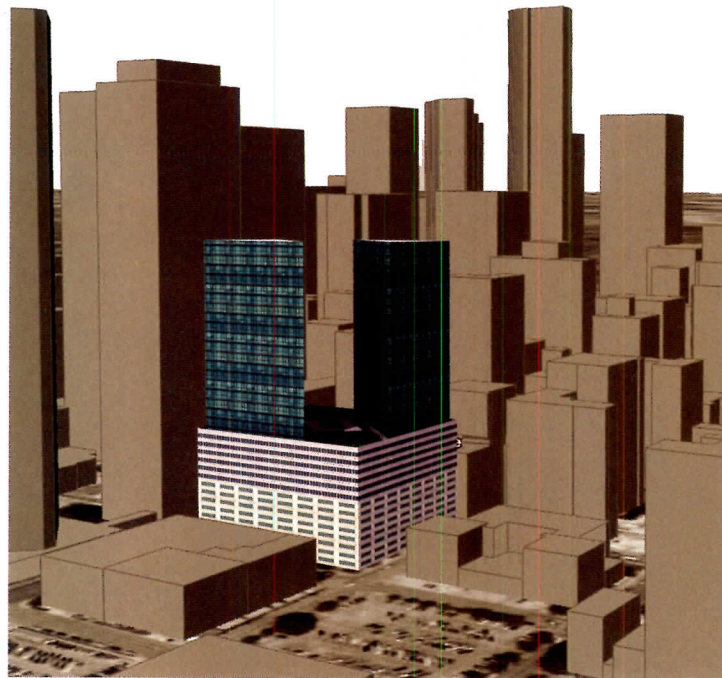

simpler to achieve a building that operates without fossil fuel in a dry climate, "where winters are warm, summers are cool, and nighttime temperatures are moderate," she explained when presenting the hypothetical building at Innovation.

Cousins and her colleagues could have chosen to design a zero-energy hut in a field but instead

developed a scheme for a million-square-foot building that included six stories of parking, eight stories of offices, and 20 stories of residential space. In terms of configuration, they hewed closely to buildings currently under construction or already existing, reasoning that program and financial considerations usually drive building form more strongly than the

desire to conserve energy or to provide views. For example, the building has a deep office floor plate in order to maximize rentable space.

The engineers first analyzed the building's annual energy consumption. Lighting accounted for 35 percent, followed by office equipment at 23 percent, and cooling at 25 percent. Results would have been different if the floor plate was shallow and there was more opportunity for daylighting, said Cousins.

The team modeled the effect of cumulatively adding features such as underfloor air, a high-performance facade, daylighting controls, and occupancy sensors. After tallying the impact of these measures, energy use was significantly reduced but was still at 60 percent of an ASHRAE 90.1 base building. For a structure of

Arup's first step was to analyze the energy consumption of the hypothetical building over the course of a year (right). The team then modeled the cumulative effect of various energy-conservation strategies, including high-performance glazing and an underfloor air system. The reduction in site energy use of all of the measures taken together was only 60 percent over a code-compliant building (opposite, left). To try to reduce energy use further, the design team added cogeneration to the scheme. The cogeneration plant would actually increase the "site" energy used, because fuel use is shifted from the utility to the site. However, because power is generated more efficiently on-site, overall energy, or the building's "source energy," is reduced to 55 percent (opposite, right).

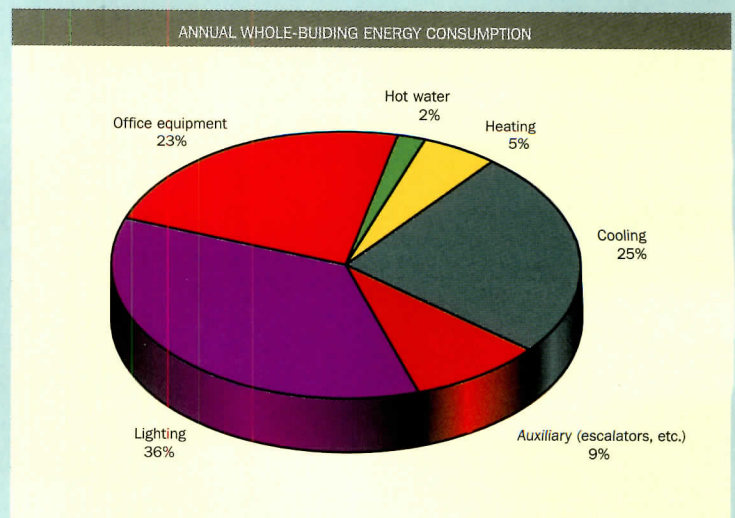



# SOM's Pearl River Tower

THE STORIED DESIGN FIRM HAS SET ITS SIGHTS ON REDEFINING ONE OF ITS BREAD-AND-BUTTER PROJECT TYPES, THE CORPORATE HEADQUARTERS, INTO A MODEL OF HIGH-TECH SUSTAINABILITY

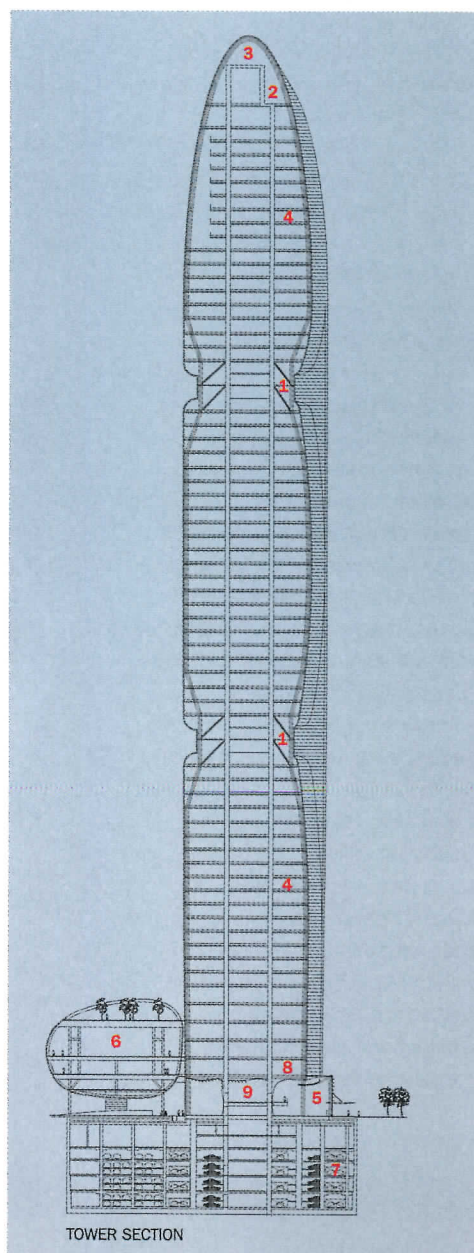
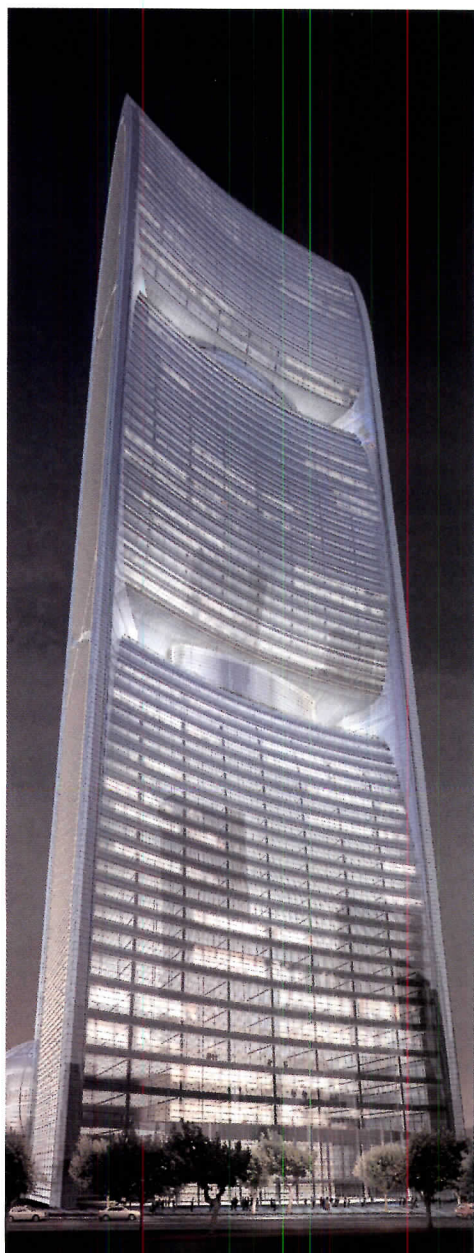
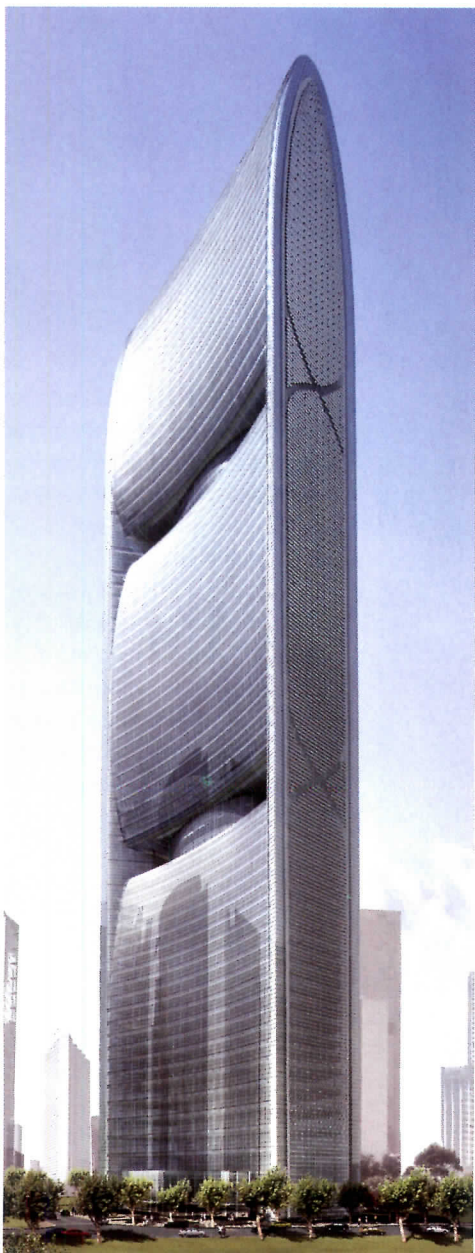

By Russell Fortmeyer

**D**esigning towers for corporate headquarters is something Skidmore, Owings & Merrill (SOM) can do in its sleep. When the firm won a competition for a tobacco company tower in the new city of Guangzhou, China, SOM's Chicago partners decided to approach the commission as a net-zero-energy-skyscraper experiment. "We knew the tower was going to get built with or without us, so we felt we might as well design it and make it as sustainable as possible," says Roger Frechette, director of m/e/p sustainable engineering at SOM.

Frechette distinguishes a "net"-zero-energy building as one that

1. *Integrated wind turbines*
2. *Business club*
3. *Operable skylight*
4. *Typical office floor*
5. *Lobby*
6. *Meeting room*
7. *Parking garage*
8. *Cafeteria*
9. *Double-decker elevator*

The 71-story Pearl River Tower, a headquarters for the CNTC Guangdong Tobacco Company, is scheduled to be completed by October 2009. The tower contains several different exterior envelopes, including a southern double-layer curtain wall that contributes to the HVAC system, and an integrated photovoltaic system (above left and middle). The top-floor business club has an operable skylight for ventilation.

negligibly affects its local environment. In the case of the 71-story, 2.2-million-square-foot Pearl River Tower, this meant it had to conserve and generate enough power to meet its energy demands. “There is no silver bullet,” Frechette says. “What we have is a series of small steps that get you to something that makes a difference.” These divide into four categories: reduction, reclamation, absorption, and generation.

### Reduction

The designers began by reducing the building’s energy consumption through a combination of the building’s site orientation, a high-performance building envelope, daylighting, and building control systems. By rotating to the east, the tower takes advantage of midday sun while the effects of late-day sun on the larger, southern horizontal exposure are minimized. The south facade’s low-E-glass, double-layer curtain-wall system reduces heat gain, which leads to less demand on the HVAC systems.

### Reclamation and absorption

Among other tactics, the tower reclaims its energy by routing each floor’s exhaust air into the south side’s double-layer curtain-wall cavity. This thermal barrier of hot dry air can then be reused on the mechanical floor for passive dehumidification. Many other systems perform double duty, including the chilled slab concrete vaulted ceilings in the typical offices that enhance daylighting, as well as cool the air drifting up from the underfloor ventilation system. The main absorption strategy takes advantage of a geothermal heat sink, so 100 degrees Fahrenheit water in the mechanical system’s return loop can be cooled to 75 degrees Fahrenheit prior to feeding the cooling towers.

### Generation

According to Rob Bolin, SOM’s associate director of sustainable design, the first three strategies reduce the building’s energy use by nearly 65 percent over a baseline of Chinese building codes. To reach the final goal of net zero energy, the design team incorporated three power-generating technologies: wind, integrated photovoltaics, and microturbines.

By far the most innovative of these elements, the wind turbines exploit the prevailing winds from the south, which generate a negative pressure at the rear, or north side, of the building. The tower’s curvilinear structure helps to force air through four turbine inlets in the facade, which SOM’s wind studies have predicted will speed up the wind’s velocity two-and-a-half times. Frechette estimates the turbines will produce nearly 15 times more electricity than a typical stand-alone wind generator.

What’s more, the turbines blend seamlessly into the tower’s architecture as warped cavities at mechanical floors. “The more we can blur lines, the closer we can get to true integration,” Frechette says. ■

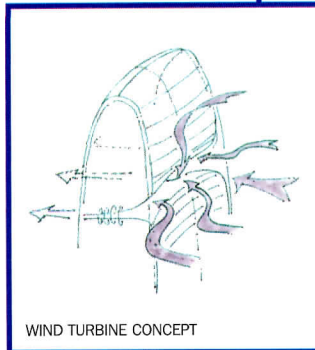

WIND TURBINE CONCEPT

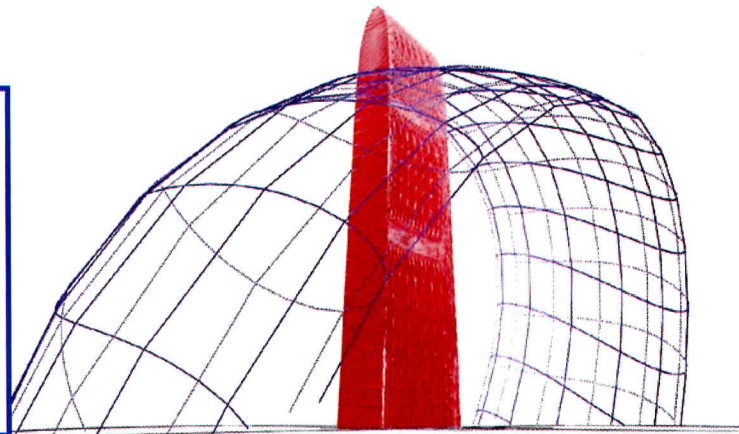

SUN PATH DIAGRAM

**SOM’s concept sketch for the wind turbines (above) illustrates the channeling effect of the curvilinear facade. Sun path diagram studies (top right and right) indicate how daylight is maximized on the building’s south side, while late-day sun is avoided. The chart (bottom right) helped SOM gauge each strategy’s effectiveness in achieving zero energy.**

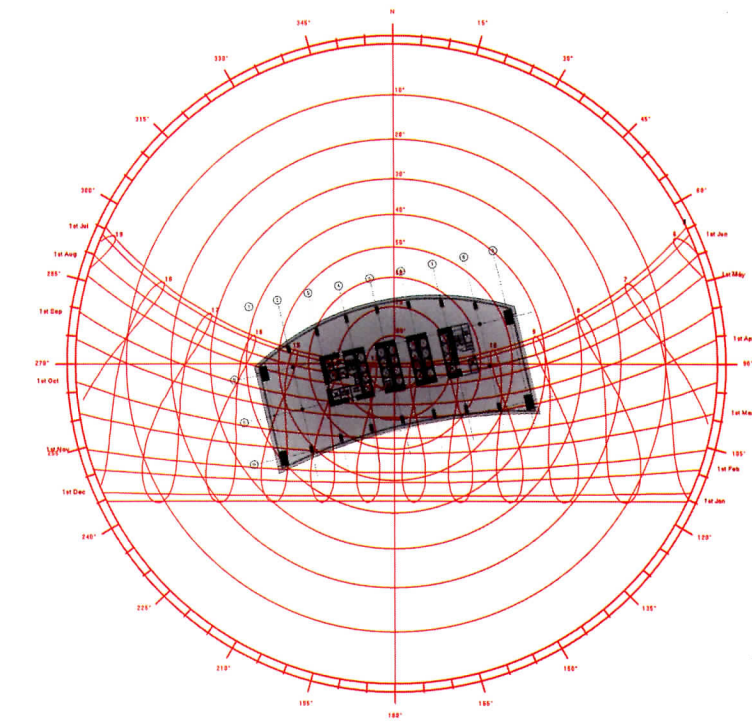

SUN PATH DIAGRAM PLAN

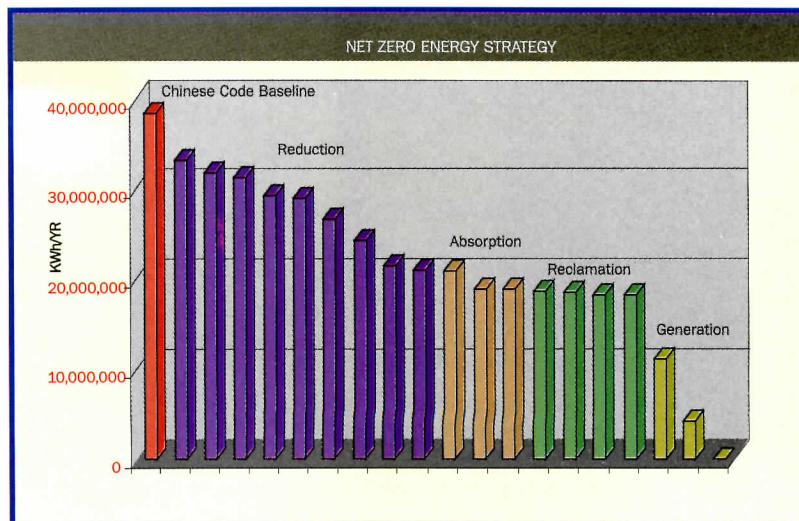



METAL ROOFING

SOFFIT SYSTEMS

WALL SYSTEMS

PERIMETER SYSTEMS

METAL FABRICATION

COLUMN COVERS

## WELCOME TO PETERSEN ALUMINUM

Home

Products

Specifications

Technical Information

AIA/CEP

Green Architecture

Gallery

Company

Petersen Aluminum Corporation was founded in 1965 as a metals service center to the architectural metal industry. At Petersen we strive to provide products of the highest possible quality within reliable and dependable lead-times. Our strong national sales base allows PAC to maintain large inventories and cost economies to our customers.

In addition to our Chicago-based headquarters, we maintain full production facilities in Annapolis Junction, Maryland; Tyler, Texas; and Atlanta, Georgia. In addition to the information found in the catalog, we maintain an extensive web site ([www.pac-clad.com](http://www.pac-clad.com)) and our complete catalog is available in standard 3-ring binder as well as CD-ROM format.

Technical assistance and service are provided by our staff and complimented locally by our national organization of architectural representatives. We are prepared to offer assistance in material finish specification, and budgeting. As the scope of our applications is so wide, we encourage

## HAVE YOU SEEN PAC-CLAD.COM LATELY?

**U**dated. Expanded. Redesigned.

PAC-CLAD.COM has a new look and new features to help make your job easier. A new "Create a Spec" Section which allows you to build your own specification for metal roof or wall panels with an easy-to-use system for entering necessary data. Find the latest on LEED™ and EnergyStar® in our "Green Architecture" Section. New application photos and case studies in the "Gallery" help you decide what panel profile is right for your next project. Earn AIA Learning Units by completing the Metal Roofing Presentation and exam. Visit PAC-CLAD.COM for all these features and more.

For more on our complete line of metal roofing products, please call 1-800-PAC-CLAD or visit [WWW.PAC-CLAD.COM](http://WWW.PAC-CLAD.COM).

# PAC-CLAD

## Petersen Aluminum

1005 Tonne Road • Elk Grove Village, IL 60007  
1-800-PAC-CLAD or 1-847-228-7150  
Fax: 1-800-722-7150 or 1-847-956-7968

**Other Plant Locations:**

Annapolis Junction, MD: 1-800-344-1400

Tyler, TX: 1-800-441-8661

Kennesaw, GA: 1-800-272-4482

<http://www.pac-clad.com>

<b>215</b> Editors' Picks	<b>237</b> Finishes
<b>216</b> Prototypes	<b>243</b> Specialties & Equipment
<b>219</b> Top 10 Green Products	<b>247</b> Furnishings
<b>223</b> Concrete	<b>255</b> Plumbing
<b>225</b> Metal, Woods, Plastics & Composites	<b>259</b> HVAC
<b>231</b> Thermal & Moisture Protection	<b>261</b> Electrical & Communications
<b>233</b> Openings	<b>265</b> Special Construction & Pollution Control

# Product Reports 2006

Our 34th annual review of the year's most interesting and innovative new building products available to architects, designers, and specifiers



**E**ach September, our mission at ARCHITECTURAL RECORD is to present a jury of highly qualified product experts with a collection of the latest and greatest building products, materials, and technologies. The main task facing the jury is to define what are the most “interesting” and “innovative” products from the hundreds of submissions we receive. These terms are highly subjective, but there are a few universal constants: The product responds to a need in the marketplace; it isn't harmful to the end user or the environment; and it displays a certain level of detailing and craftsmanship. An added bonus is when it's produced by a reliable manufacturer interested in establishing a long-term relationship with the specifier.

**2006 Jurors** (Standing, left to right): **Pei-heng Tsai** founded PHT Lighting Design in New York City in 2004 and has over 10 years experience as a project designer and manager for large-scale works in the U.S. and abroad. She is currently teaching lighting design at the Interior Design School of the Fashion Institute of Technology, in New York City. **Brian M. Slocum, AIA**, is a project architect at Polshek Partnership Architects in New York City. His experience includes cultural, educational, institutional, and residential project work. **Matthew C. Petrie, AIA**, has been an associate principal at ADD Inc. in Cambridge, Massachusetts, since 2004. He previously worked for Richard Meier and Partners in New York City and Paris and for Leers Weinzapfel Associates Architects in Boston. **Eileen F. Ragsdale** is a LEED-accredited professional and is the resource librarian for TPG Architecture in New York City. Ragsdale is also president of the Resource Directors Association's New York Chapter. After 23 years of experience in lighting design, **Suzan Tillotson** founded Tillotson Design Associates in 2004. She is a corporate member of the IALD and has been an IES member for 24 years. Her firm's portfolio includes interior and exterior lighting for corporate, education, hospitality, and retail projects. **Herbert Martin Lynn, AIA**, is an associate partner and the director of research and specifications at SOM in New York City. He has over 35 years of experience in architecture, primarily in specification writing. Recently, he wrote specs for the Time Warner Center and Random House projects in New York City. (Seated, left to right): A LEED accredited professional, **Brian Stacy** leads the Arup Lighting office in New York City and has designed lighting and related systems for exterior and interior environments in the cultural, entertainment, and corporate sectors. **Andrew Dent** is vice president for library and materials research at Material ConneXion in New York City. Dent received his Ph.D. in materials science from the University of Cambridge in England. His new book, *Material ConneXion II* (Thames and Hudson), is coming out in 2007.

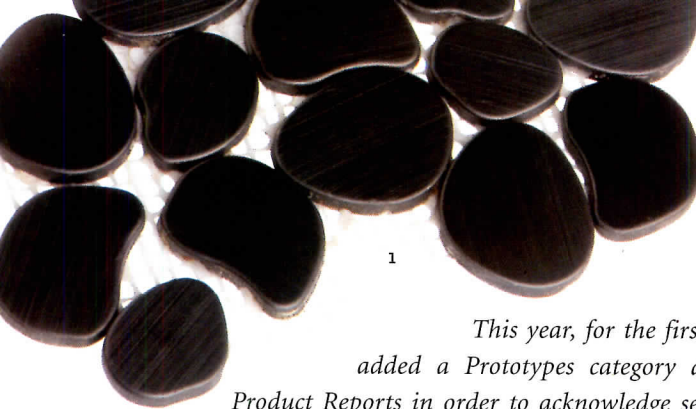

The jury appreciated the chance to review actual samples of the products and materials. Feeling the texture and quality and seeing the detailing of those entries was a great help to the selection process.

1

*This year, for the first time, we added a Prototypes category as part of Product Reports in order to acknowledge several outstanding designs and materials that are not quite ready for production. While it might take some time for these designs to be fully realized, we thought including them would both inspire our readers and encourage the designers and manufacturers who are featured.*

*Our jury often finds a different theme running through the entries, and this year they were intrigued by the integration of LEDs into a variety of unexpected materials and products, including exterior mesh, carpet, and faucets. A few jurors were pleasantly surprised by the breadth of new options in the Concrete category, such as a new bendable concrete and a concrete prototype that reveals hidden patterns upon contact with water. Favorites from other categories included pebble-shaped mosaics made of metal (Finishes), a ridge vent made of natural fibers (Thermal & Moisture Protection), and a new textile that hardens upon impact (Prototypes). As always, the jury appreciated the chance to review actual samples of the products and materials. Feeling the texture and quality and seeing the detailing of those entries was a great help to the selection process.*

*That's not to say our jury found everything they were hoping to see. They would have liked to have reviewed a greater range of options in flooring and seen more of a selection in masonry (none of the latter were selected to appear). Across the board, they preferred designs that avoided looking trendy or easily dated.*

*We hope that you find this year's Reports a helpful resource over the course of the new year. Rita Catinella Orrell, Products Editor*

2

4

3





Refer to the product categories for more information: **1.** Metal Freeform mosaics (Finishes); **2.** Enso health-care cubicle curtains (Furnishings) **3.** GU24 lamp base (Electrical) **4.** Vesale Stone series tile (Finishes) **5.** Ecotextures panels (Finishes) **6.** End-grain Block (Furnishings) **7.** Stones glass (Openings) **8.** Glass-clad Sensitile (Openings) **9.** & **10.** Veritas ResinArt panels (Plastics) **11.** Anigmo touchless dimmer (Electrical) **12.** Cubic Concrete (Concrete) **13.** Case Study ceramic tiles (Finishes) **14.** Fortis Arbor wood mosaics (Finishes) **15.** Silver Collection laminate (Metal)

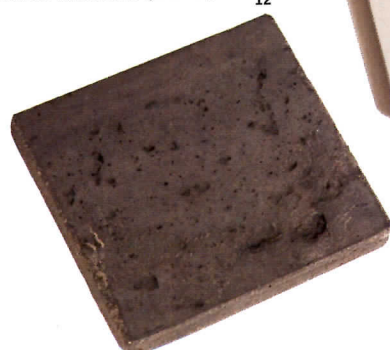
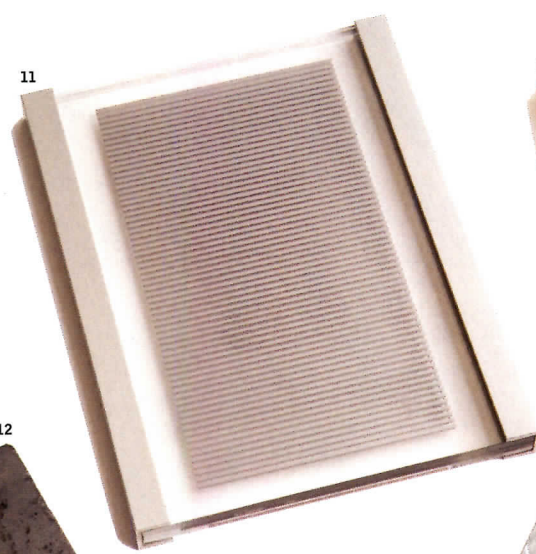

PHOTOGRAPHY: © PAUL GODWIN

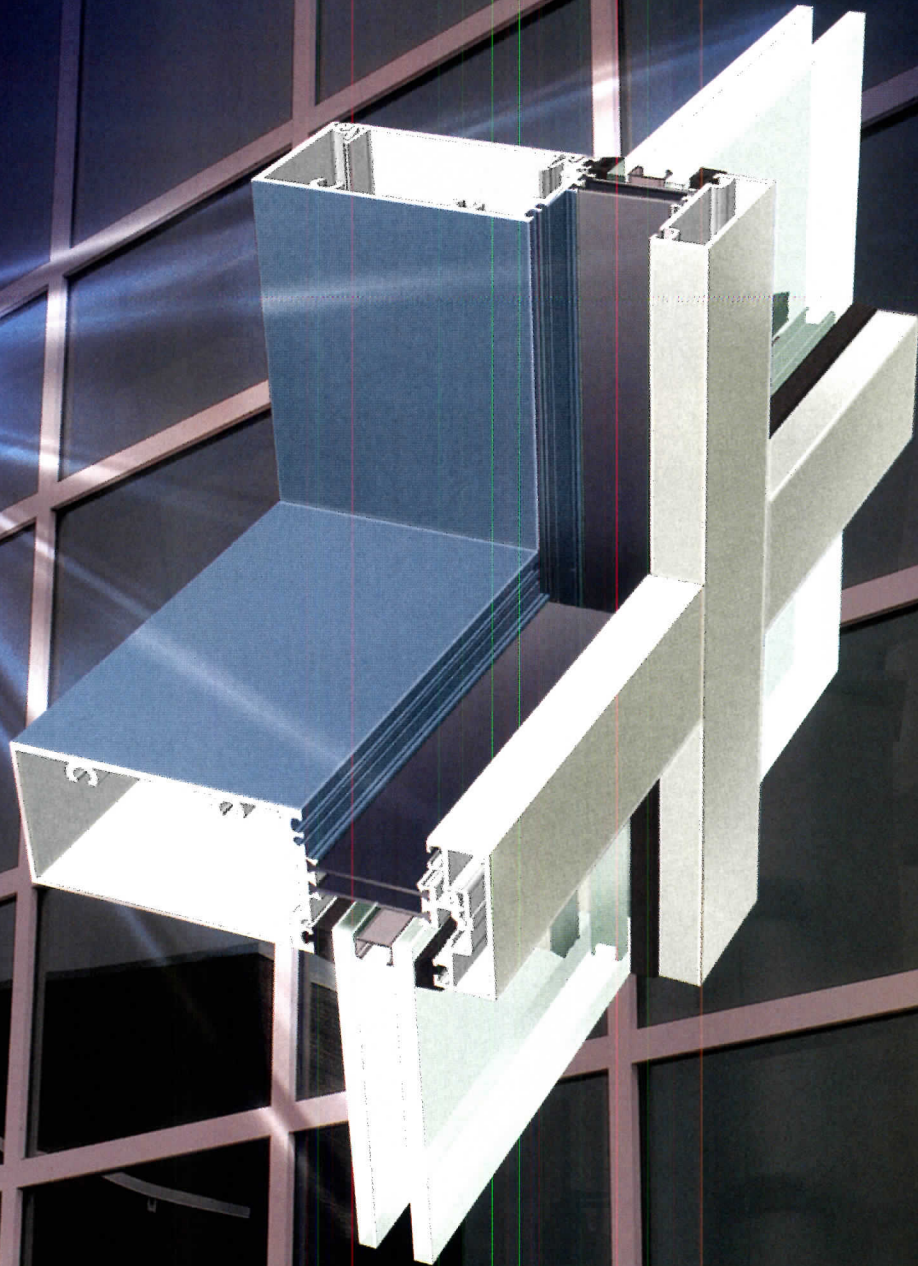

Where windows are just the beginning.

When you specify EFCO's 5500 curtain wall, you get a system that delivers performance and value. 5500 utilizes the E-Strut™ thermal isolator for superior thermal properties and a total composite shape for enhanced structural performance. This design allows the use of different interior and exterior finishes, for enhanced versatility. Since there is no pressure plate or cover to assemble, 5500 offers significant labor savings. With EFCO's 5500 curtain wall system you don't have to choose between performance and value.

For a complete listing of EFCO products, please visit us online at [efcocorp.com](http://efcocorp.com) or call us at 800.221.4169

CIRCLE 61 ON READER SERVICE CARD OR GO  
TO [ARCHRECORD.CONSTRUCTION.COM/PRODUCTS/](http://ARCHRECORD.CONSTRUCTION.COM/PRODUCTS/)



# Editors' Picks

This grouping of memorable introductions from the past year ranges from a breathable wall covering to a hurricane-tough cladding. These thoughtful designs work harder and smarter to help meet multiple project goals with a single product solution. — *R.C.O.*



This Green Seal-certified **Yolo Colorhouse** interior paint line is VOC-free, mold- and mildew-resistant, and features a novel sampling system including poster-size swatches coated with real paint. Yolo Colorhouse, Portland, Ore. [www.yolocolorhouse.com](http://www.yolocolorhouse.com)

**CIRCLE 200**



Designed by Douglas Ball, **My Studio's** high walls on the aisle side and short walls at the back foster conversations between people who work closer together. My Studio consists of 74 percent recyclable components, 28 percent recycled materials, and is GreenGuard certified. A sliding door for privacy is an extra bonus. Herman Miller, Zeeland, Mich. [www.hermanmiller.com](http://www.hermanmiller.com) **CIRCLE 201**

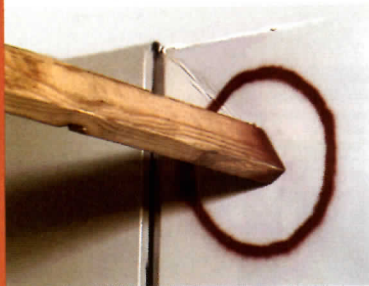

By adding a thin layer of **Kevlar fabric to Reynobond's** polyethylene core, Alcoa has created the only light, flexible, aluminum-composite panel that can withstand hurricane-propelled debris without the use of backer materials. The panel is able to withstand wind speeds up to 130 mph. Alcoa, Eastman, Ga. [www.reynobondwithkevlar.com](http://www.reynobondwithkevlar.com) **CIRCLE 202**



The **180 Walls collection**, developed by Milliken, is a group of antimicrobial, breathable, 100 percent recycled polyester wall coverings that use a pressure-sensitive adhesive in place of paste or water. Five fresh patterns are available from Designtex. Designtex, New York City. [www.designtex.com](http://www.designtex.com) **CIRCLE 203**



Gaggenau entered the U.S. refrigeration market with a **modular column refrigeration and freezer system**. A heavy-load door holds up to 200 pounds of weight (allowing for a range of custom cladding options) and a motorized shelf adjusts at the touch of a button, even fully loaded. Gaggenau USA, Huntington Beach, Calif. [www.gaggenau-usa.com](http://www.gaggenau-usa.com) **CIRCLE 204**

# Prototypes

The following products and technologies, currently in development for the A&D market, impressed and inspired our jury with their innovation, creativity, and potential. —R.C.O.

## Animated lamp

Designed by the Tokyo-based design firm Nendo, the Hanabi lamp was on display at this year's Milan Furniture Fair along with other designs that "resemble natural phenomena." Hanabi is a shape-memory alloy lamp whose thin ribs "bloom" in response to the heat of the incandescent bulb. When the light is turned off, they slowly "wither" and return to a closed position. Nendo is currently negotiating with an Italian manufacturer for production. Nendo, Tokyo. [www.nendo.jp](http://www.nendo.jp) **CIRCLE 205**

I love the organic form of this lamp [Hanabi], its wonderful transformation, and how it occupies space. It would look beautiful used in a field of varying heights. —SUZAN TILLOTSON

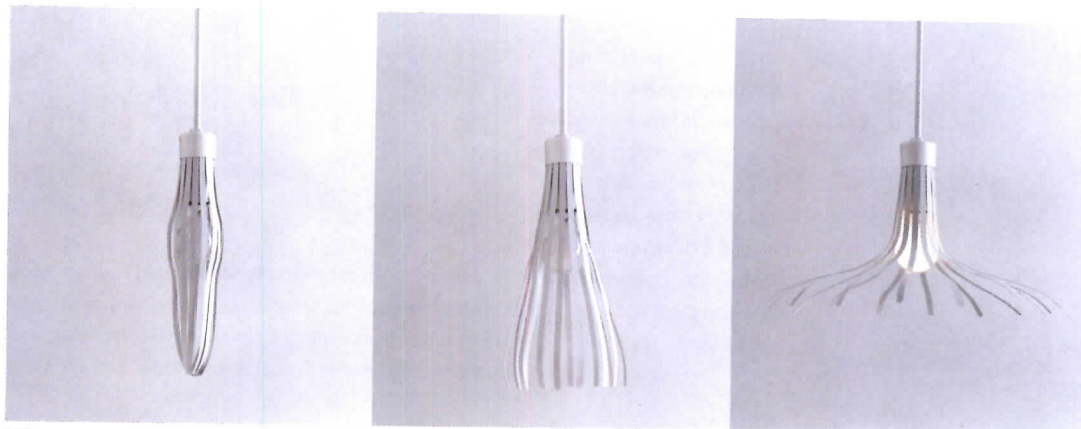

205

## Illuminating rooftops

These LED roof tiles developed by Dutch designer Lambert Kamps have been produced for some small custom projects. The translucent polyester roof tiles have built-in LEDs that work like pixels to create text, logos, and graphics on rooftops. Kamps is currently researching a method to make the tiles run on solar energy. Lambert Kamps, Groningen, The Netherlands. [www.lambertkamps.com](http://www.lambertkamps.com) **CIRCLE 206**

206

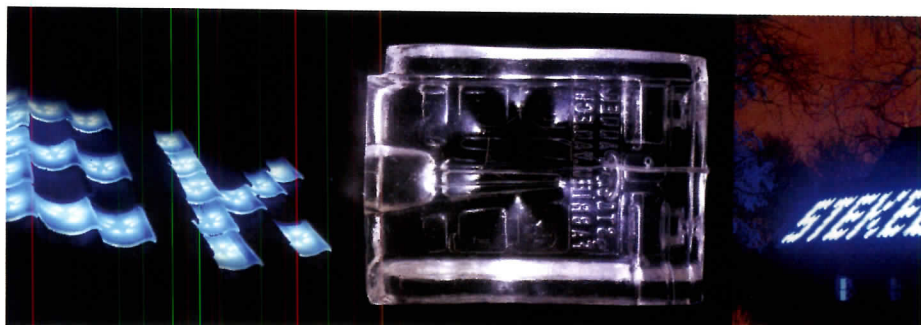

## Poetry in concrete

Inspired by how the weather transforms landscapes, designer Susanne Happle's Solid Poetry concrete reveals a hidden pattern on contact with water. Possible applications include residential bathroom tiles, outdoor garden pavers, or public sidewalks. The patterns will be permanently visible after a period of time. Terratorium, a Dutch-based materials company, hopes to have the patent-pending technology in production by mid-2007. Terratorium, Eindhoven, The Netherlands. [www.terratorium.nl](http://www.terratorium.nl) **CIRCLE 207**

**Gecko-inspired adhesive**  
Synthetic Gecko is an artificial surface that grips incredibly tightly without glue or pressure: A sheet of the material just over 3.3 feet (1 meter) could be used to suspend the weight of an average family car. The surface replicates the hairs on a gecko's feet that ensure the toes are always in close contact with the surface beneath. A number of potential business applications includes new building products. BAE Systems, Farnborough, U.K. [www.baesystems.com](http://www.baesystems.com) **CIRCLE 208**



207



208

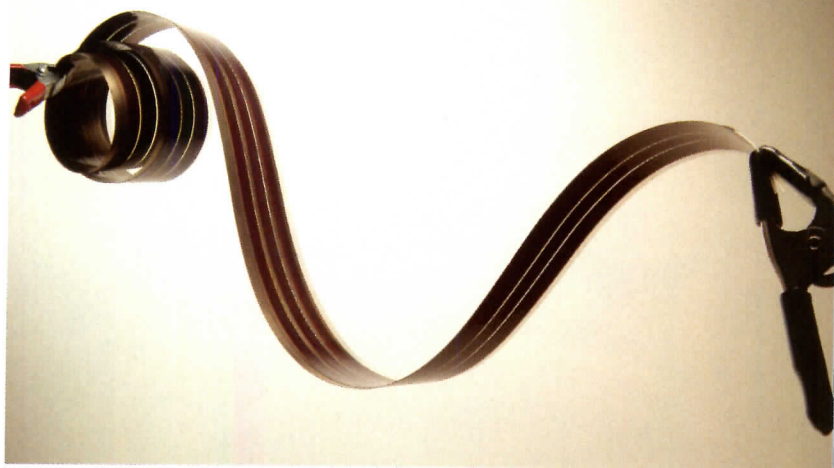
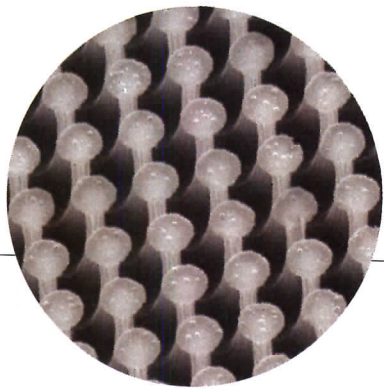

209

**The power of the sun**

Power Plastic is inexpensive (five times less than traditional PV), lightweight (1 to 2 ounces per square foot), and versatile (can be colored, patterned, and cut to fit). The light-activated polymer PV material can be integrated into architectural products such as rooftops, siding, and blinds, although there are no current partnerships in the A&D market. Konarka, Lowell, Mass. [www.konarka.com](http://www.konarka.com) **CIRCLE 209**

**Can take a punch**

The Dow Corning Active Protection System consists of a 3D spacer textile treated with a special coating that remains soft and flexible under normal conditions, but hardens instantly upon impact. When the impact force is removed, the material immediately returns to a flexible state. Dow Corning will initially market the technology to manufacturers of protective motorcycle apparel, but anticipates expansion into other industries, including construction. Dow Corning, Midland, Mich. [www.activeprotectionsystem.com](http://www.activeprotectionsystem.com) **CIRCLE 210**

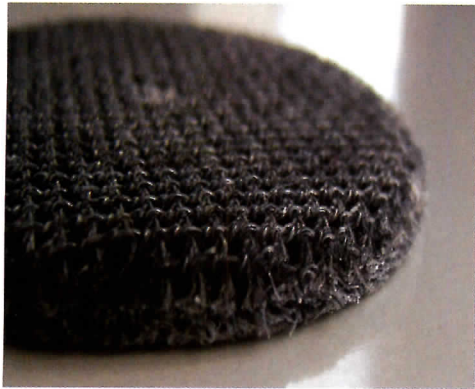

210

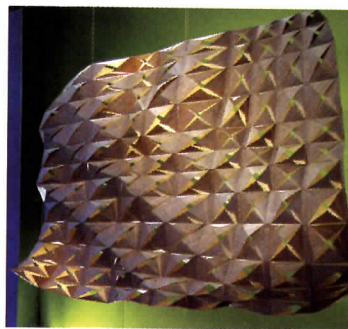

211

**Origami light filter**

Conceived as a hybrid drape/Venetian blind, the In-Out Curtain is an operable screen that combines origami and digital production. Each module of the curtain is designed with internal tensions so it holds both a closed/concave and an open/convex shape, transforming the quality of light. IwamotoScott Architecture, San Francisco. [www.iwamotoscott.com](http://www.iwamotoscott.com) **CIRCLE 211**

**Building in a bag**

Designed by Peter Brewin and William Crawford, Concrete Canvas is a rapidly deployable hardened shelter for disaster victims. The system is delivered folded and sealed in a sack which is then filled with water. After the cement inside is hydrated, the sack is unfolded to form the shelter's footprint. A plastic inner tube is then inflated by activating a small chemical pack. The cement impregnated cloth cures into a dome shape, and is ready to use in 12 hours. Seven trial shelters are planned to be field tested by April 2007 and production should start in April 2008. Crawford Brewin Ltd., Northampton, U.K. [www.concretecanvas.org.uk](http://www.concretecanvas.org.uk) **CIRCLE 212**



212



f a s h i o n   u n d e r   f o o t ™



Amendoim

-  indusparquet® 3/4" solid
-  indusparquet® 7/16" solid
-  indusparquet® 5/16" solid
-  Antiquity™ hand-scraped
-  dolomites engineered
-  triângulo® engineered
-  BR-111™ engineered

800.525.br111 (2711) ■ br111.com

**BR-111**™

exotic hardwood flooring

CIRCLE 62 ON READER SERVICE CARD OR GO

# Top Ten Green Products

The 2006 Top 10 Green Building Products, announced by BuildingGreen at last month's GreenBuild show in Denver, offer a variety of environmental attributes.

## Retrieving sunken treasure

The Sawfish logging submarine harvests standing trees from forests that were submerged decades ago by reservoirs created by hydroelectric dams. Clamping onto the tree, the Sawfish attaches inflatable floats and then cuts the trunk with an electric chain saw: The tree then floats to the surface without disturbing sediments. All of the milled wood is certified as SmartWood Rediscovered by the Rainforest Alliance. Triton Logging, Saanichton, B.C. [www.tritonlogging.com](http://www.tritonlogging.com)

CIRCLE 213

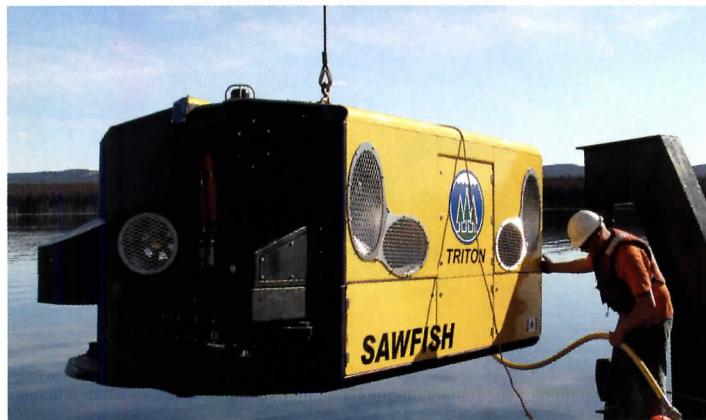

213



## Blowing in the wind

Renewable energy credits (RECs) provide building owners who are unable to install their own renewable energy systems a way to buy conventional grid power while also buying the environmental attributes of electricity produced from renewable energy. Community Energy, a leading North American provider of RECs, owns and develops wind farms that to date have sold over 3 billion kwh of wind energy. Community Energy, Wayne, Pa. [www.communityenergy.biz](http://www.communityenergy.biz)

## Avoid the watering hole

The WeatherTRAK irrigation control system uses local weather conditions to examine evapotranspiration rates and regulate water delivery accordingly, so irrigation will take place in the correct amounts, and not if rainfall is occurring or predicted. The system has been shown to reduce outdoor water use by up to 59 percent. HydroPoint Data Systems, Petaluma, Calif. [www.weathertrak.com](http://www.weathertrak.com)

## Salvaging beauty

Varia (right) is 3form's line of transparent and translucent panels made from its 40 percent preconsumer-recycled-content Ecoresin. Some Varia products include plant materials collected by indigenous peoples using environmentally responsible practices. 100 Percent panels (left) are made entirely of postconsumer-recycled HDPE. (For more info, see page 225.) 3form, Salt Lake City. [www.3-form.com](http://www.3-form.com)

CIRCLE 216



214



215

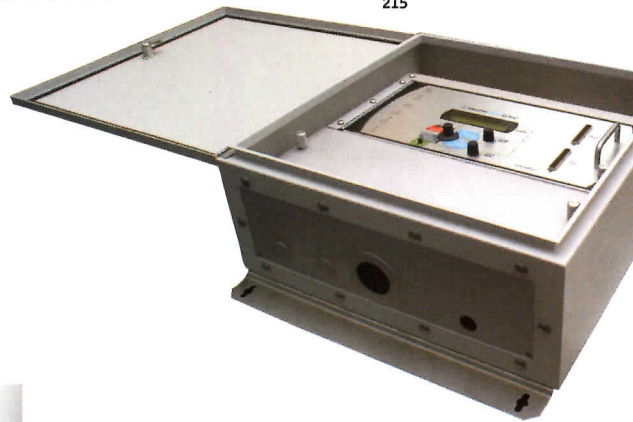

216

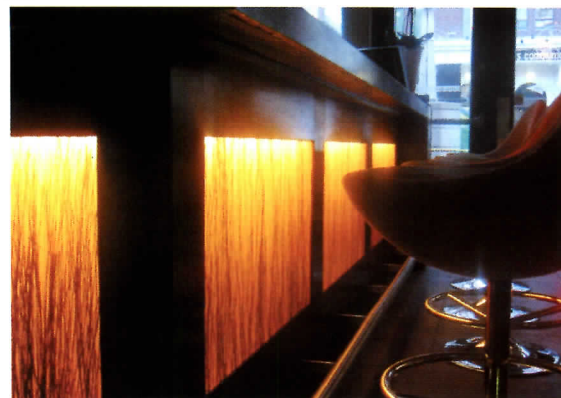

# Top Ten Green Products

Plumbing fixtures • Glass and glazing • Central HVAC equipment • Countertops • Plastic simulated-wood trim • Concrete finishing

## Night and day

SageGlass is an electronically tintable exterior glazing that provides glare control on demand while preserving views. Within minutes, the glass switches from a clear to tinted state, significantly reducing the solar heat gain coefficient. Sage Electrochromics, Faribault, Minn. [www.sage-ec.com](http://www.sage-ec.com) **CIRCLE 217**

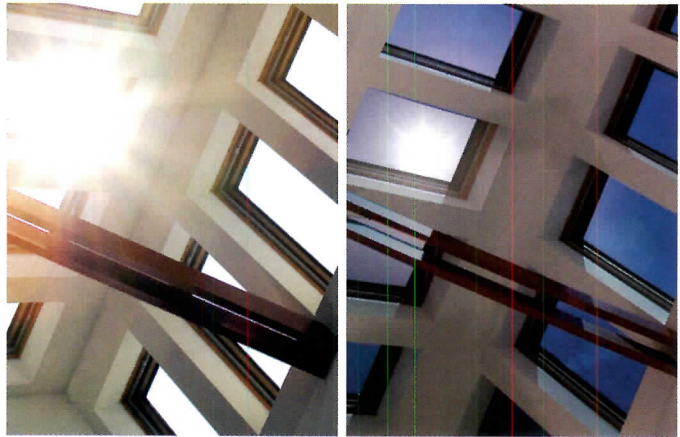

217

## Shower saver

Using just 1.6 gallons of water per minute—a 36 percent savings—Delta's Water-Efficient Showerhead incorporates H<sub>2</sub>OKinetic Technology to produce large droplets at optimal velocity for good heat retention and body drenching. Delta Faucet Company, Indianapolis. [www.deltafaucet.com](http://www.deltafaucet.com) **CIRCLE 218**



218

## Dry cool

Up to three times as efficient as the best compression-cycle air conditioners, the Coolerado Cooler is an all-indirect evaporative air-conditioning system that does not add any moisture. Cooling output is optimal in drier areas in the western United States. Coolerado, Arvada, Colo. [www.coolerado.com](http://www.coolerado.com) **CIRCLE 219**



219

## Wood alternative products

Timbron's interior moldings are made from 90 percent recycled polystyrene. The highly durable, waterproof, termite-proof, paintable surfaces are fully workable with carpentry tools and ideally suited for kitchens, bathrooms, laundry rooms, and basements. Timbron, Walnut Creek, Calif. [www.timbron.com](http://www.timbron.com) **CIRCLE 220**

220



## Rock, paper, countertops

Made from cellulose fiber, PaperStone is a dense, hard, water-resistant material with many applications. Two versions are available, one containing at least 50 percent postconsumer-recycled paper, the other containing 100 percent. KlipTech Composites, Hoquiam, Wash. [www.paperstoneproducts.com](http://www.paperstoneproducts.com) **CIRCLE 221**

221



## From slab to finished floor

RetroPlate's concrete polishing system has been used on more than 100 million square feet of flooring for surfaces that are highly durable, easy to maintain, and free of VOC emissions. RetroPlate, Provo, Utah. [www.retroplatesystem.com](http://www.retroplatesystem.com) **CIRCLE 222**



222



# Concrete

Cast-in-place concrete • Precast concrete • Concrete forming and accessories

## Bendable concrete

Engineered Cement Composites (ECC) is a fiber-reinforced bendable concrete that looks like regular concrete but is 500 times more resistant to cracking and 40 percent lighter in weight. Tiny fibers that make up about 2 percent of the mixture's volume partly account for its performance. The Glorio Roppongi high-rise residential building in Tokyo uses ECC coupling beams in the core for seismic resistance. University of Michigan, Ann Arbor, Mich. [www.umich.edu](http://www.umich.edu) **CIRCLE 223**

## Reinforced furniture

The Company of Arts workshop creates light concrete pieces reinforced with synthetic fibers. Abrasion-, chemical-, and weather-resistant, the concrete can be formed into smooth, lightweight pieces with color throughout the mass. The Company of Arts, Andard, France. [www.beton-lcda.com](http://www.beton-lcda.com) **CIRCLE 224**

## Stainless, but not steel

Made of actual concrete (not an epoxy-covered surface), Nucrete stainless concrete can withstand harsh acids and oils. It is created by modifying concrete's traditional curing and finishing process and introducing some proprietary additives to the batch mix and finish. Sonoma Cast Stone, Petaluma, Calif. [www.sonomastone.com](http://www.sonomastone.com) **CIRCLE 225**

## Concrete sandwich

The Thermomass Building Insulation System for cast-in-place concrete is composed of a core of Dow Styrofoam-brand polystyrene insulation sandwiched between two layers of concrete, all fastened together by high-strength, fiber-composite connectors. Composite Technologies, Boone, Iowa.

[www.thermomass.com](http://www.thermomass.com) **CIRCLE 226**

## Hand-cast and lightweight

The Cubic Concrete Collection includes lightweight concrete furniture elements, wall panels, and cladding with a monolithic feel. Each hand-cast piece weighs up to 70 percent less than standard concrete. Architectural Systems, New York City. [www.archsystems.com](http://www.archsystems.com) **CIRCLE 227**

This was the most interesting category, to my surprise. With nonstaining and lightweight cast versions, as well as new graphic effects, concrete is getting creative. —ANDREW DENT



223



224



225

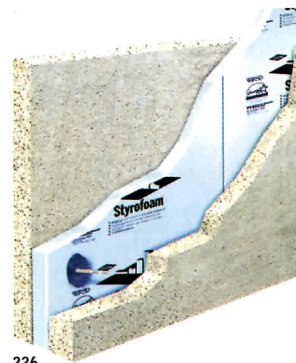

226



227

©2005 DuPont. All rights reserved. The DuPont Oval Logo, DuPont™, The miracles of science™ and Corian® are registered trademarks or trademarks of DuPont or its affiliates.



**VERSATILE HUES THAT  
ADAPT TO ANY ENVIRONMENT.**

When you work with Corian® you can choose from the most extensive **COLOR** palette of any solid surface. See all the potential of DuPont™ Corian® Solid Surfaces in our Possibilities Magazine. Call 800-436-6072 or visit [coriandesign.dupont.com](http://coriandesign.dupont.com) for your copy.

DESIGNER Harry Allen  
TITLE *Core Vase*  
MEDIUM **CORIAN®**



*The miracles of science™*

CIRCLE 64 ON READER SERVICE CARD OR GO  
TO [ARCHRECORD.CONSTRUCTION.COM/PRODUCTS/](http://ARCHRECORD.CONSTRUCTION.COM/PRODUCTS/)

# Metal, Woods, Plastics & Composites

Metal stairs and railings • Cold-formed metal framing • Decorative metal • Metal specialties •  
Rough carpentry • Wood treatment • Plastic and composite fabrications

## Transforming waste

3form was launched in 2001 to provide architectural services and products that offer high-level aesthetics without sacrificing safety, affordability, or environmental responsibility. 100 Percent is a new design-driven material made entirely from postconsumer, high-density polyethylene, including recycled detergent and shampoo bottles. The engineered panels, which are ideally suited for education, science, and health-care environments, are available in four color patterns, including cut grass (left) and orange slice (right). 3form, Salt Lake City.

[www.3-form.com](http://www.3-form.com) **CIRCLE 228**

## Bend it like Beckham

Bendywood is an all natural, solid hardwood that easily bends in a cold and dry state. No chemicals are used in the production process, which involves steaming and then compressing the wood along its length. Bendywood can be bent up to a radius of 10 times its thickness, and thin pieces can readily be bent by hand. Bendywood is commonly used for curved or organically shaped handrails, glazing beads, skirtings, decorative profiles and sculpture, and model making. It is available in beech, ash, oak, and maple.

Decorative Components, High Point, N.C.

[www.bendywood.com](http://www.bendywood.com) **CIRCLE 229**

## Filmic facade treatment

Mediamesh is a stainless-steel fabric interwoven with LED strips. The LEDs, controlled remotely via a Web-based interface, display large-scale imagery from static logos to dynamic action. Unlike LED boards or temporary single-pixel systems, Mediamesh is permanently weather- and temperature-resistant and can even be installed below an ice surface. When the imagery is not in use, the transparent fabric is a striking cladding for a variety of building types, including high-rises, stadiums, and airports. GKD-USA, Cambridge, Md.

[www.gkdmetailfabrics.com](http://www.gkdmetailfabrics.com) **CIRCLE 230**

**Titan Wood [by Accoya] is an interesting process. It does not use toxic chemicals, so it is an improvement on other chemical treatments. —ANDREW DENT**

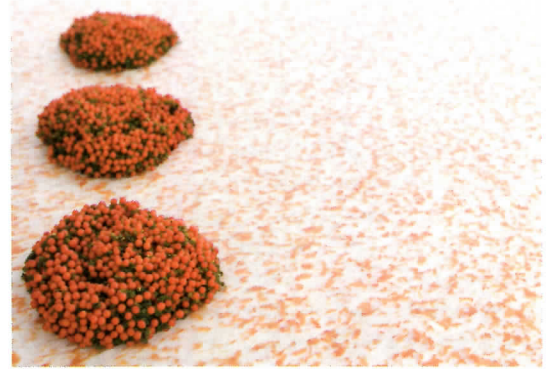

228

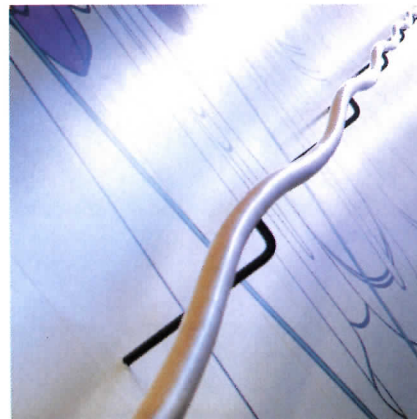

229

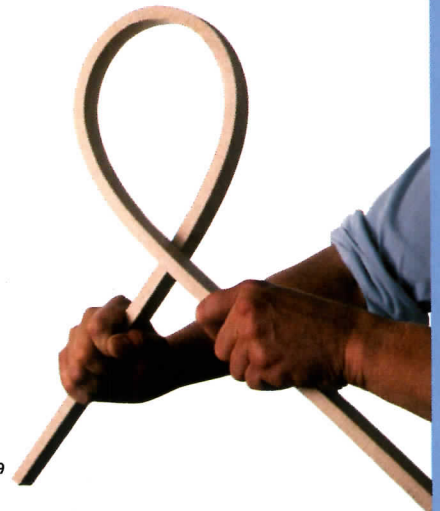

230



# Metal, Woods, Plastics & Composites

Decorative metal • Metal specialties • Rough carpentry • Wood treatment • Plastic fabrications

## The future of fiberboard

Made from 100 percent unbleached soft-wood fibers from sustainably managed forests, Maplex is produced using only water, heat, and pressure. By eliminating binders, formaldehyde, and petroleum-based products, Maplex is both nontoxic and biodegradable. Two types are available: Maplex C, a medium-density, highly flexible version that can be rolled and formed; and Maplex P, a stronger, high-density version with good dimensional stability (twice the bending and tensile strength of birch plywood). Both can be punched, drilled, laminated, stained, or coated, and are suitable for most interior applications. EHV-Weidmann Industries, St. Johnsbury, Vt.

[www.maplexmaterial.com](http://www.maplexmaterial.com) **CIRCLE 231**



231

## True colors

Schneller has added two new collections to its already extensive Veritas ResinArt Panels product line design directed by Marybeth Shaw. The Wood Veneer series (shown left) utilizes laser-cutting technology on paper-thin wood veneers that are illuminated and encapsulated within resin skins. The Piper Shepard series (right), named for the artist, features three printed patterns—Kaleidoscope, Lancet, and Pendant—that are taken directly from the hand-cut canvas technique used in the artist's fine art.

Panels range from 1/8" to 1/2" thick and are available in 4' x 8', 4' x 10', and 5' x 10' dimensions. The lines are made from up to 25 percent recycled plastic and are available through Robin Reigi Inc. Robin Reigi Inc., New York City.

[www.veritasideas.com](http://www.veritasideas.com) **CIRCLE 232**

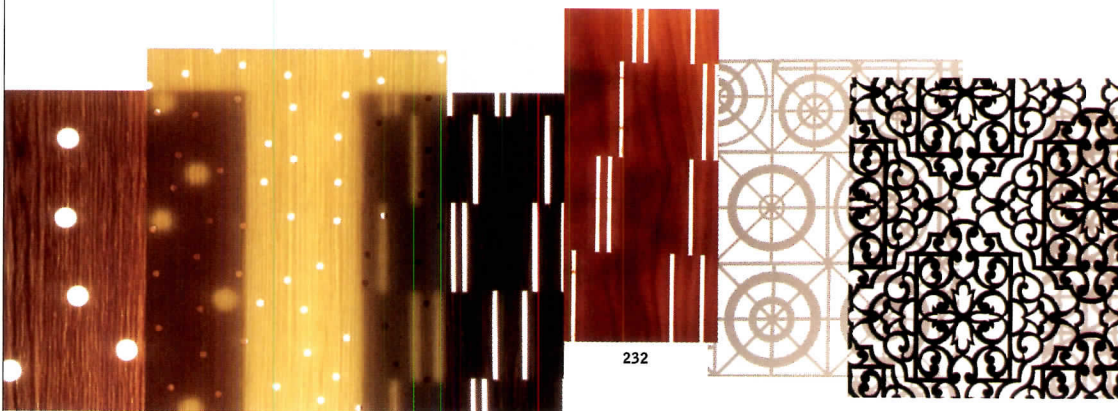

232

## Use your illusion

The Silver Collection by Abet Laminati features high-pressure laminates with a shiny metal finish. The aluminum surface, which is reverse-printed and adhered to the laminate, is protected by a lacquering and anodizing process. Six intricately designed patterns ranging from florals to swirls and dots, appear to be hammered into the laminate to create texture on the flat surface. Sheet sizes are 4' x 10' for use on kitchen cabinets or any vertical surface. Abet Laminati, Englewood, N.J. [www.abetlaminati.com](http://www.abetlaminati.com) **CIRCLE 233**

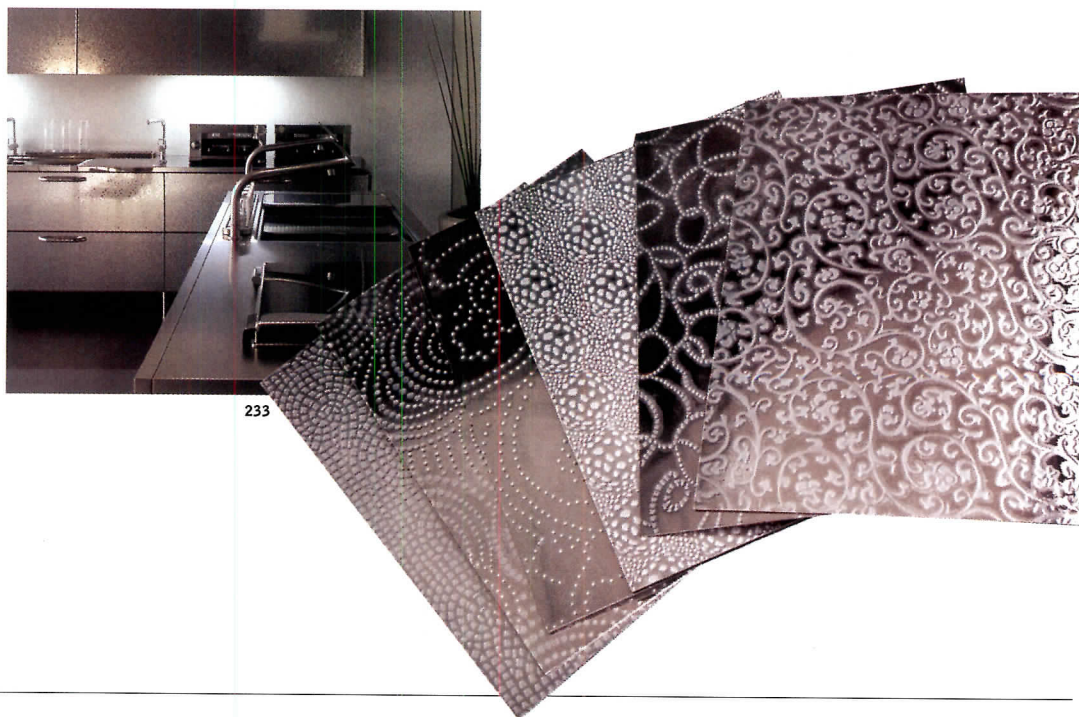

233



Who says a sterile environment needs to  
**LOOK STERILE?**

**healthdesign**  
SOLID VINYL TILE

Antifungal. Antibacterial. It's flooring that can handle the toughest scrutiny of clean rooms or clinics, yet offer a style that's catching on everywhere. That's Health Design. Wherever you need the ultimate in hygiene and cleanliness, Health Design provides the cure to chipping, abrasion, cracking and indentations with a daily dose of substance and style.

Call us today for more information:  
1.800.633.3151 [www.flexcofloors.com](http://www.flexcofloors.com)

AVAILABLE IN THREE TILE SIZES AND 18 COLORS FOR THESE APPLICATIONS AND MORE.  
LABORATORIES > HEALTHCARE FACILITIES > WAITING ROOMS > PATIENT ROOMS > HOSPITALS > CLINICS > HEALTH CLUBS > SCHOOLS >

CIRCLE 65 ON READER SERVICE CARD OR GO  
TO [ARCHRECORD.CONSTRUCTION.COM/PRODUCTS/](http://ARCHRECORD.CONSTRUCTION.COM/PRODUCTS/)

**FLEXCO**<sup>®</sup>  
Flooring to the power of X.

# Metal, Woods, Plastics & Composites

Metals stairs and railings • Cold-formed metal framing • Rough carpentry • Wood treatment • Plastic fabrications

## Tattooed solid surfacing

Dye Sublimation in Corian, manufactured exclusively by R.D. Wing Company, is a new, three-step heating transfer and compression process that allows any image or graphic to be transferred onto Corian. The end result is an image that, like a tattoo on skin, actually becomes a part of the Corian surface. R.D. Wing Company, Kirkland, Wash. [www.blimages.com](http://www.blimages.com) **CIRCLE 234**

## Cold-formed metal framing

The premanufactured Steel Strong Wall features allowable loads that are substantially higher than traditional X-bracing or structural sheathing. Prepunched for wiring, the narrow panels allow designers the flexibility to create structures with larger window and door openings. Simpson Strong-Tie, Pleasanton, Calif. [www.strongtie.com](http://www.strongtie.com) **CIRCLE 235**

## Simplified cable system

Stainless steel Push-Lock simplifies the installation of cables in cable railings by eliminating the need for special crimping equipment at the job site. Cables come with a tensioner on one end and bare cable at the other—installers cut the cable to length, push on the Push-Lock fitting, and tension the cables. The Cable Connection, Carson City, Nev. [www.ultra-tec.com](http://www.ultra-tec.com) **CIRCLE 236**

## Sustainable new species

Accoya, from U.K.-based Titan Wood, is produced using a patented acetylation process that converts sustainably forested softwoods and nondurable hardwoods into a modified wood product that offers durability, dimensional stability, and a nontoxic, 100 percent recyclable alternative to tropical hardwoods, biocide-treated woods, and artificial materials in external applications. Titan Wood, Earlston, U.K. [www.titanwood.com](http://www.titanwood.com) **CIRCLE 237**

## Time-saving wood backers

The Danback wood backing system for steel-framed construction claims to save 90 percent of the time required to install individual backers. Danback units are 48" precut assemblies suitable for 16" or 24" on-center framing. They are intended to help anchor shelves, counters, sinks, and other wall fixtures. Arch Wood Protection, Smyrna, Ga. [www.dricon.com/danback](http://www.dricon.com/danback) **CIRCLE 238**



# Thermal & Moisture Protection

Air barriers and vapor retarders • Sealants, caulking, and seals • Ridge vents • Membrane roofing • Roof accessories

## Batten seam roof look

Sarnafil's Décor Roof Systems are an option for new or existing buildings that call for a metal appearance with the watertight integrity and design flexibility of a thermoplastic roofing membrane. Four new colors meet Energy Star and LEED requirements for solar reflectance and emissivity ratings. Sarnafil, Canton, Mass. [www.sarnafilus.com](http://www.sarnafilus.com) **CIRCLE 239**

## Hurricane proof the roof

The Extruded TerminEdge roof edge fascia is a two-piece system that speeds up fascia installation for single-ply, modified, and built-up roof systems. The product clamps the membrane against the building like a termination bar, preventing leaks and blow-offs. It comes with a 25-year, 155-mph Category 5 warranty. W.P. Hickman Systems, Solon, Ohio. [www.wphickman.com](http://www.wphickman.com) **CIRCLE 240**

## Natural fiber ridge vent

Roof Saver is a continuous ridge-vent system utilizing a patented design of natural fiber materials suitable for asphalt, shakes, tile, and standing-seam metal roofs. It is made of postindustrial coir (coconut fiber) and animal fiber held together with a sprayed latex binder. Roof Saver, Michigan City, Ind. [www.roofsaver.com](http://www.roofsaver.com) **CIRCLE 241**

## Dual-sided flashing tape

DuPont StraightFlash Versatile Flange (VF) is a dual-sided flashing tape designed to reliably provide a durable seal around brick-mold and nonflanged windows and doors. The tape helps guide water safely outside and helps prevent bulk water leaks during a range of temperatures and weather conditions. DuPont, Wilmington, Del. [www.construction.tyvek.com](http://www.construction.tyvek.com) **CIRCLE 242**

## See-through housewrap

Gorilla Wrap housewrap is a non-perforated, nonwoven polymeric polypropylene wrap material that is strong, water-resistant, and energy-efficient. Since the wrap is translucent, builders can see the studs, nails, and windows, improving installation time. Johns Manville, Denver. [www.gorillawrap.com](http://www.gorillawrap.com) **CIRCLE 243**

Décor Batten will allow architects to establish a look that replicates metal-batten roofing with a less expensive single-ply system. —HERBERT MARTIN LYNN, AIA



239



240



241



242



243



Clear Float Glass

Pilkington OptiView™  
Anti-Reflective Glass



Imagine a glass that looks like no glass at all.

### New Pilkington **OptiView™** Anti-Reflective Glass

With two advanced-technology pyrolytic surfaces and a laminated core, Pilkington **OptiView™** Anti-Reflective Glass reduces reflections – both from the outside and inside – to less than 2%, blocks over 99% UV transmittance, and still allows more visible light to pass through than even clear float glass!

The result is a unique fabricated glass that combines the strength, security, safety and sound reduction of laminated glass with the low-reflectivity of a high-end specialty product.

And when you combine that with its large size capability and the fact that it can be tempered and bent like ordinary glass, Pilkington **OptiView™** Glass is not only ideal for museums and displays, but a practical choice for retail storefronts, showrooms, and a host of applications where an anti-reflective product was never possible before.

It's just one more example of Pilkington's advanced technology glass products. To find out more, call us at 800 221 0444, or visit [www.pilkington.com](http://www.pilkington.com).



**PILKINGTON**

*First in Glass™*

Pilkington Building Products North America 811 Madison Ave., P.O. Box 799 • Toledo, OH 43697-0799 • Domestic Sales: 800 221 0444 • International Sales: 419 246 4943  
Main Office: 419 247 3731 • Fax: 419 247 4517 • E-mail: [building.products@us.pilkington.com](mailto:building.products@us.pilkington.com) • Website: [www.pilkington.com](http://www.pilkington.com)

©2005 Pilkington. Actual photo comparing reflectivity of clear float glass and Pilkington **OptiView™** Anti-Reflective Glass. Due to printing and reproduction limitations, photo may not represent actual glass colors. Pilkington **OptiView™** Glass and First in Glass™ are trademarks of Pilkington.

**CIRCLE 68 ON READER SERVICE CARD OR GO  
TO [ARCHRECORD.CONSTRUCTION.COM/PRODUCTS/](http://ARCHRECORD.CONSTRUCTION.COM/PRODUCTS/)**



# Openings

Doors and frames • Windows • Window screens • Roof windows and skylights • Window and door hardware • Security door hardware • Glass and glazing

## Wood grid controls light

Okawood insulating glass offers a way to integrate the warmth of wood into curtain-wall glass. The system is composed of two panes of glass, with a wood grid placed between the panes that provides solar protection yet still allows daylight to enter. The type and width of wood, as well as the intervals within the grid, can be customized.

Schott N.A., Elmsford, N.Y.

[www.us.schott.com](http://www.us.schott.com) **CIRCLE 244**

## Sleek security

The Dialock door terminal offers maximum security with the latest transponder technology in a sleek, stainless-steel package. Touchless key recognition provides LED signals to identify operations. More than 200 keys can be authorized for use at a single terminal, while hotel versions feature a "Do Not Disturb" function. Hafele America, Archdale, N.C. [www.hafele.com](http://www.hafele.com)

**CIRCLE 245**

## Screen saver

Andersen TruScene insect screen (shown on left side of window) is made with a virtually invisible, high-strength stainless-steel material to provide clearer views and greater airflow. Noticeably less visible from outside the home as well, the patented screen material features 40 percent smaller mesh openings than standard Andersen screens to protect against the smallest bugs. Andersen Windows, Bayport, Minn. [www.andersenwindows.com](http://www.andersenwindows.com)

**CIRCLE 246**

## French fold

Jeld-Wen's IWP Exterior Folding Door System combines the style and customization opportunities of a classic French door, with the updated benefits and features of a sliding door. Operating "accordion style," the door sections slide on an overhead track and neatly fold away to allow full access to the indoors or outside. Available in hardwood or fiberglass with low-E-glass options for energy efficiency and UV protection. Jeld-Wen, Klamath Falls, Ore.

[www.jeld-wen.com](http://www.jeld-wen.com) **CIRCLE 247**

I like that window manufacturers are going back to long-lasting hardware rather than cranks that break easily.

—MATTHEW C. PETRIE, AIA



244

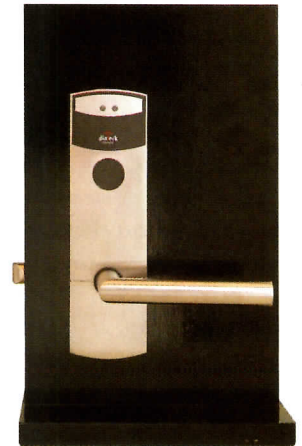

245



246



247

# Openings

Doors and frames • Windows • Window screens • Roof windows and skylights • Window and door hardware • Security door hardware • Glass and glazing

## Clad in metal and wood

The Cyprium Collection by Loewen features copper- and bronze-clad windows and doors with artisanal details including soldered exterior joints. The hand-wrought surfaces develop distinctive patinas. Loewen's 10-Foot Terrace Door, available in clad and natural wood exteriors, caters to the growing trend of large entrance ways. Loewen, Manitoba, Canada. [www.loewen.com](http://www.loewen.com) **CIRCLE 248**

## Glass stones

Created in part using recycled transparent glass reclaimed from job sites or fabricators, Stones is the latest addition to a collection of handcrafted, kiln-cast glass whose theme of abstractions of organic building materials forms the design foundation for multidimensional textured glass. Joel Berman Glass Studios, Vancouver. [www.jbermanglass.com](http://www.jbermanglass.com)

**CIRCLE 249**

## Temperamental tile

Sensitile Scintilla Glass is another PMMA hybrid product in the Scintilla line with the ability to react and respond to surrounding objects and lights, but features the elegance and durability of a glass surface finish. Sensitile Systems, Detroit. [www.sensitile.com](http://www.sensitile.com) **CIRCLE 250**

## Natural light source

Designed to replace electric lights during daylight hours in large commercial and industrial spaces, Huvco's High Performance Daylighting System utilizes a unique dual prismatic top dome. The highly reflective light well channels sunlight from the dome down to the interior diffuser, which is created from a prismatic acrylic to diffuse daylight without harsh glare. Huvco, Rohrsersville, Md. [www.huvco.com](http://www.huvco.com)

**CIRCLE 251**

## A bright future

Solarban 70XL glass combines an exceptional level of solar control with a clear glass aesthetic. Combined with traditional clear glass in a conventional 1" insulating glass unit, Solarban 70XL blocks up to 73 percent of the sun's solar energy while transmitting more than 63 percent of its visible light, creating greater energy savings than other high-performance, nontinted, low-E glass. PPG Industries, Pittsburgh. [www.ppgideasapaces.com](http://www.ppgideasapaces.com) **CIRCLE 252**



248



249

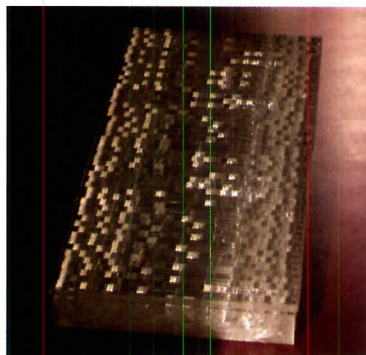

250



251



252



253



254

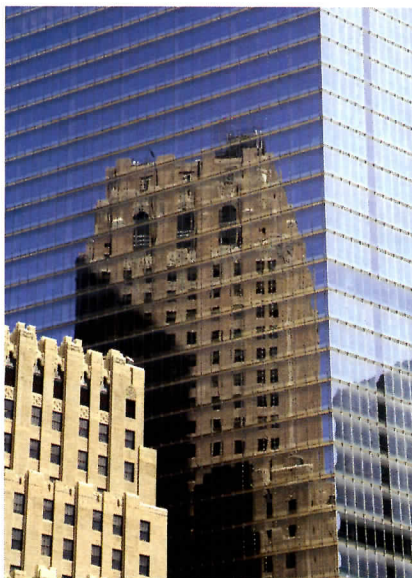

**An open-and-shut casement**

Kolbe's push-out casements and awnings were inspired by the classic simplicity of European windows. The oil-rubbed-finish lever handle (detail shown) operates a single-point lock. Inswing hinged screens or retractable screens are available as options to keep out insects. Kolbe Windows & Doors, Wausau, Wis. [www.kolbe-kolbe.com](http://www.kolbe-kolbe.com) **CIRCLE 253**

**Clear coating**

Viracon's Solarscreen VRE-59 insulating glass combines a crisp, neutral appearance with a light transmittance of 59 percent. The coating made its debut in New York City's new 7 World Trade Center building, delivering a crystal-like appearance while contributing to the overall energy requirements for the building's LEED-CS Gold designation. Viracon, Owatonna, Minn. [www.viracon.com](http://www.viracon.com)

**CIRCLE 254**

**3D glasses**

Convex Glass is shaped so that dimensional viewing can take place from either side of it. The 3D glass can be safety tempered, and is available in clear, low-iron glass, as well as with cast textures and privacy coatings. Nathan Allan Glass Studios, Richmond, British Columbia. [www.nathanallan.com](http://www.nathanallan.com) **CIRCLE 255**



255

**Traditional look**

Weather Shield's Collection's line of all-wood windows and doors is built on a traditional chassis and includes heavy stiles and rails and other features to mimic historic windows. Weather Shield Windows & Doors, Medford, Wis. [www.weathershield.com](http://www.weathershield.com) **CIRCLE 256**

256

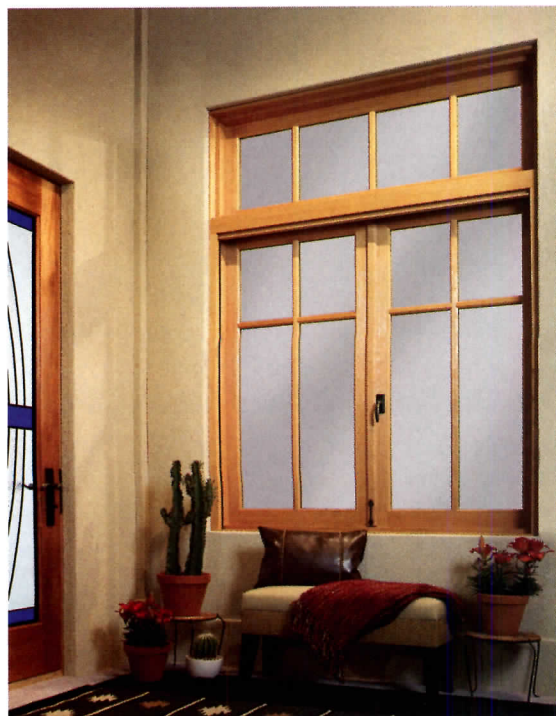

257



**Hinging on design**

The Monti Hinge from Sadev Batiment is a novel approach to hinges for glass interior doors. The organic design of this single-action hinge is manufactured from solid stainless-steel investment casting. Custom Hardware Manufacturing, Keokuk, Iowa. [www.chmi.com](http://www.chmi.com) **CIRCLE 257**

258



**Glass with a sense of motion**

Piccolo was developed in response to architects' demands for greater design choices in structural-glass systems. The vertical fluting creates a gentle sense of motion and interesting degrees of obscurity. Available in tempered or annealed form. Bendheim Wall Systems, Passaic, N.J. [www.bendheim.com](http://www.bendheim.com) **CIRCLE 258**



CERAMIC TILES OF ITALY. THE ART OF LIVING.

A masterpiece begins with the selection of the first building block.

Italy produces the world's largest range of styles, colors, designs and technological innovations in ceramic tile. Before your next residential or commercial project, be sure to visit [www.italiantiles.com](http://www.italiantiles.com) to see the latest trends and find your closest source.

*For more information, please contact:*

Italian Trade Commission – Ceramic Tile Department – 33 East 67<sup>th</sup> Street – New York, NY 10021-5949 – ph (212) 980-1500 – [newyork@newyork.ice.it](mailto:newyork@newyork.ice.it)  
Ceramic Tiles of Italy, promoted by Assopiastrelle (Association of Italian Ceramic Tile and Refractories Manufacturers), is a registered trademark of Edi.Cer. S.p.a., the organizer of CERSAIE, International Exhibition of Ceramic Tile and Bathroom Furnishings – Bologna, Italy, October 2-6, 2007 – [www.cersaie.it](http://www.cersaie.it)



Ceramic Tiles of Italy

# Finishes

Plaster and gypsum board • Prefinished panels • Carpeting • Ceilings • Wood and resilient flooring • Acoustic insulation • Ceramic, metal, and wood tile • Wall coverings

## Architect as artist

From a distance—say, installed on the facade of Media Market in Eindhoven, Belgium—a field of Sculpture tiles looks like shimmering rows of circuitry. Upon much closer inspection, one can almost imagine tiny waves of metallic-glazed porcelain flowing asymmetrically through each tile's seven channels. The Italian architect Massimiliano Fuksas designed the 10" x 16" tile for Cerdomus, which recommends using the product solely on vertical surfaces. Italian Trade Commission, Ceramic Tile Dept., New York City. [www.cerdomus.com](http://www.cerdomus.com) **CIRCLE 259**

## In the zone

Armstrong's TechZone Ceiling System is the first acoustical ceiling system to organize lighting fixtures, air diffusers, and sprinkler heads to reduce clutter overhead. All technical services are housed in a linear 6"-wide "zone" that eliminates the need to penetrate ceiling panels and limits maintenance and potential panel damage to within the zone. The company partnered with lighting, diffuser, and sprinkler-connection manufacturers, including Lightolier, Lithonia Lighting, Neo-Ray/Cooper Lighting, Zumtobel Lighting, Carnes, and FlexHead Industries, to ensure the ceiling product's viability. Armstrong Ceilings, Lancaster, Pa. [www.armstrong.com](http://www.armstrong.com)

**CIRCLE 260**

## Soft cell

Lama Concept presses and cuts industrial felt into strings, then randomly assembles the pieces to form Cell carpet. The multiple flanges are also interspersed with dots—or nuclei—of felt. Since launching the carpet in 2004, designers Yvonne Laurysen and Erik Mantel have introduced this latest version, which replaces several spots with otherworldly pinpricks of LED light. Lama Concept, Amsterdam. [www.lamacconcept.nl](http://www.lamacconcept.nl) **CIRCLE 261**

I like the organic "pebble" design of a metal tile in a typically geometric-metal-tile world. It's a sexy, unexpected interpretation of a natural stone. —EILEEN RAGSDALE

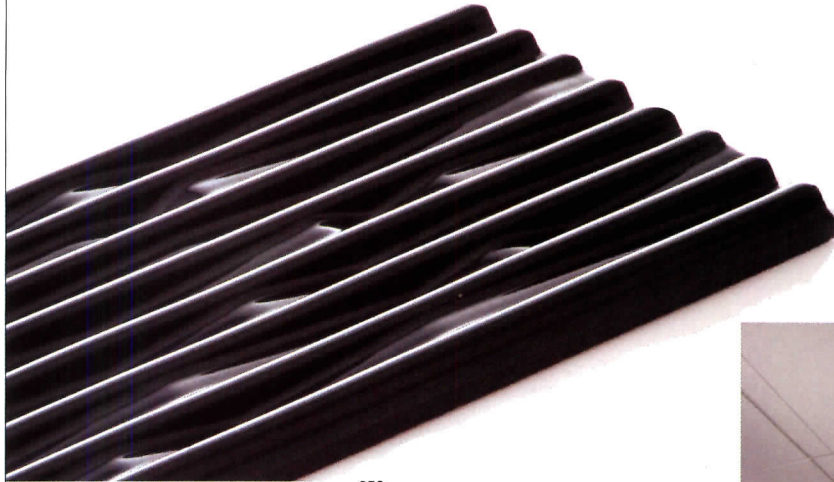

259

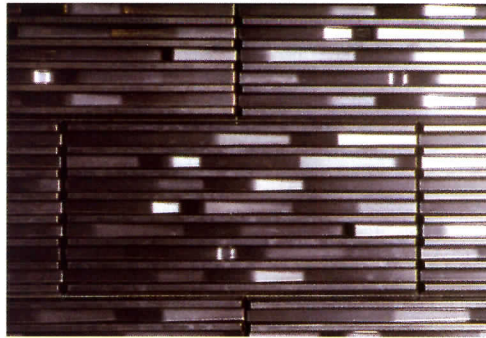

260

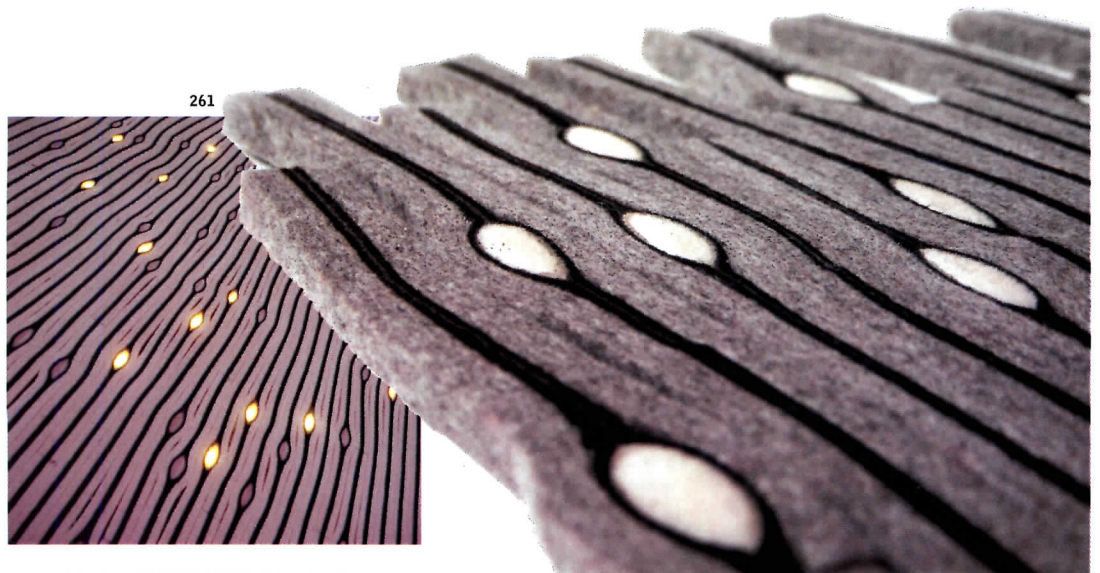

261

# Finishes

Prefinished panels • Carpeting • Ceilings • Wood and resilient flooring • Acoustic insulation • Ceramic, metal, and wood tile • Wall coverings

## Design that rocks

Soli's Metal Freeform Collection is reminiscent of a riverbed of pebbles, although individual porcelain-composite tiles are wrapped with stainless steel in mirror or hairline finishes. Soli, La Puente, Calif. [www.solistone.com](http://www.solistone.com) **CIRCLE 262**

## Mosaics in flux

Flux Studios has searched far and wide to source reclaimed and sustainably harvested solid teak, bamboo, and rosewood for the Fortis Arbor Wood Mosaics line. The company has also gone to great cerebral lengths by developing a flexible grout that accommodates wood's natural expansion and contraction. Flux Studios, Chicago. [www.fluxstudios.com](http://www.fluxstudios.com) **CIRCLE 263**

## First pick for eco-teams

Derived from fast-growing, renewable bamboo, PlybooSport will install over most existing athletic-floor systems and requires less sanding and labor than alternatives. Smith & Fong, San Francisco. [www.plyboo.com](http://www.plyboo.com) **CIRCLE 264**

## In her shoes

The rich, mottled surface of Spinneybeck Recycled Leather wall covering comprises vegetable-tanned scrap leather from the shoe industry and qualifies as both a 100 percent postindustrial and 100 percent postconsumer recyclable product. Spinneybeck, Getzville, N.Y. [www.spinneybeck.com](http://www.spinneybeck.com) **CIRCLE 265**

## Top of the pops

Not your father's wood paneling, POP plywood panels are press-formed into subtle geometric shapes that assemble into a warm, Modern surface. The light birch, cherry, walnut, and cork panels include a concealed aluminum attachment system, and each panel is coated with a transparent film to ease cleaning. Hightower Group, Bellingham, Wash. [www.hightoweraccess.com](http://www.hightoweraccess.com) **CIRCLE 266**

## Screen gems

Erwin Hauer is renowned for bas-relief and perforated partitions whose stylized grids and biomorphic shapes engage with light and shadow as well as tactility, seeming as relevant today as when they were first sculpted in the 1950s. Now, using digital technology, Hauer is offering three reissues, plus the new Design 212. Erwin Hauer Studios, New Haven. [www.erwinhauerstudios.com](http://www.erwinhauerstudios.com) **CIRCLE 267**

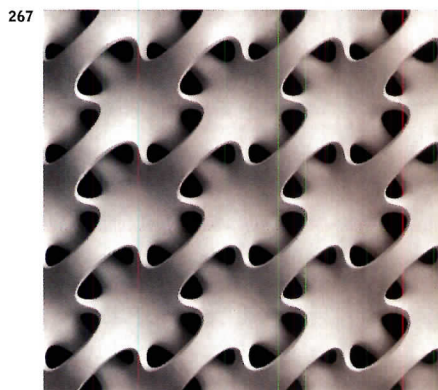
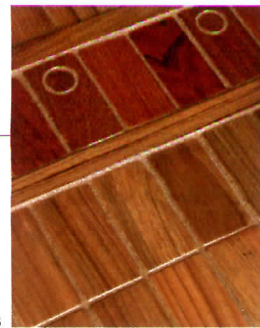
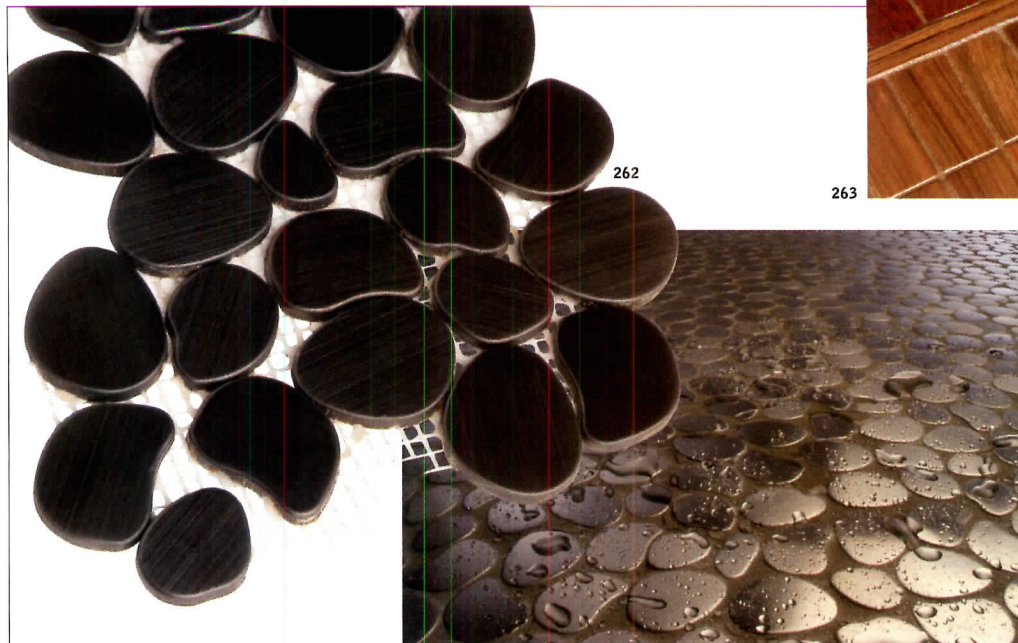



268

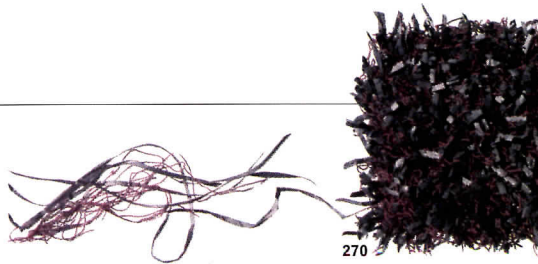

270



269

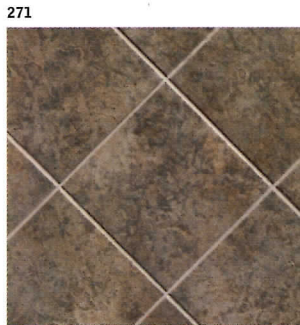

271

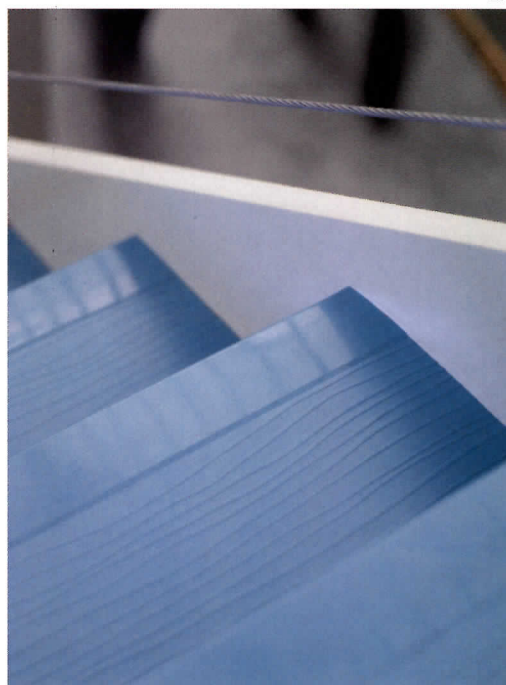

272

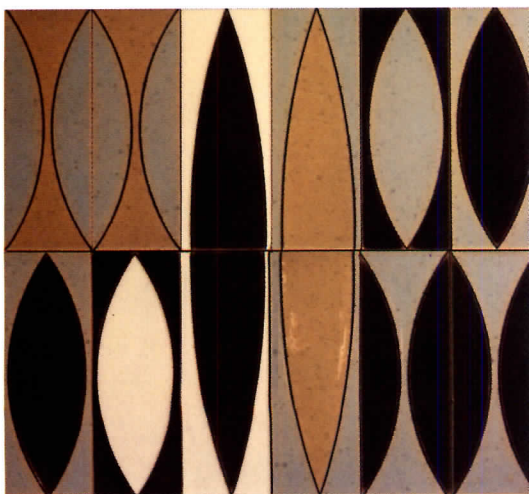

273

**A clean slate**

Painterly dots of color speckle one tile, veining runs through another. Inspired by natural slate, Marazzi's Vesale Stone series deploys asynchronous glaze applications to recreate the stone's many patterns—although these glazed porcelain tiles are flat, slip-resistant, and easy to clean. Marazzi, Sunnyvale, Tex. [www.marazzitile.com](http://www.marazzitile.com) **CIRCLE 268**

**Touchy feely**

Ecotextures interlocking architectural panels are as pleasurable to the senses as they are easy on the conscience: The product is oriented strand board made from rapidly renewable timber. Architectural Systems, New York City. [www.archsystems.com](http://www.archsystems.com) **CIRCLE 269**

**Mixed media**

For Papyra, the celebrated designer Ulf Moritz combines crinkly strands of paper and pure wool, resulting in a festive carpet that is confettilike in its appearance, but which remains soft to the touch. Danskina, Amsterdam. [www.danskina.nl](http://www.danskina.nl) **CIRCLE 270**

**Born again**

Crossville's EcoCycle Series of tiles have that fresh-from-the-quarry look, with a terrestrial color palette and the variety of markings associated with natural stone. But EcoCycle is anything but virgin material. Rather, these porcelain tiles are certified by Scientific Certification Systems as having 40 percent recycled content, giving old ceramic material a second chance. Crossville, Crossville, Tenn. [www.crossvilleinc.com](http://www.crossvilleinc.com) **CIRCLE 271**

**Stairway to style**

Combining safety and aesthetics, Johnsonite has introduced two new rubber stair treads with memorable colors and textures, including the organic lines of Bamboo (shown) and the lineal squares of Cubis. Johnsonite, Chagrin Falls, Ohio. [www.johnsonite.com](http://www.johnsonite.com)

**CIRCLE 272**

**Casing the joint**

With its two-tone surfboard design, the Case Study Collection of ceramic tiles would be perfectly suited to that Lautner-inspired house perched in the Hollywood Hills. Each tile is 34 percent recycled waste collected within 350 miles of the manufacturing plant. Kibak Tile, Sisters, Ore. [www.thetilecounsel.com](http://www.thetilecounsel.com) **CIRCLE 273**

# Finishes

Plaster and gypsum board • Acoustic insulation

## Tiptoes not required

EasyMat weighs as much as 25 times less than the cement backerboard used for setting tile or stone, and considerably reduces impact sounds. Custom Building Products, Seal Beach, Calif. [www.custombuildingproducts.com](http://www.custombuildingproducts.com) **CIRCLE 274**

## Oh so quiet

QuietRock 525's sound-absorbing drywall fabrication is also 1-hour fire-rated. Quiet Solution, Sunnyvale, Calif. [www.quietsolution.com](http://www.quietsolution.com) **CIRCLE 275**

## The sound of silence

One would have to sandwich eight layers of standard drywall to approximate the silencing ability of the Sound-Engineered Drywall from Supress Products.

Supress Products, San Rafael, Calif. [www.supressproducts.com](http://www.supressproducts.com) **CIRCLE 276**

## Clear the air

Sheetrock Brand Lightweight All Purpose Joint Compound PLUS 3 reduces airborne sanding dust with a formula that binds fine residue during sanding, making particles fall to the floor. USG, Chicago. [www.usg.com](http://www.usg.com) **CIRCLE 277**

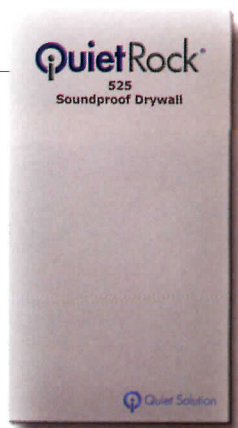

For more information, circle item numbers on Reader Service Card or go to [archrecord.construction.com](http://archrecord.construction.com), under Resources, then Reader Service.

## A floor, or perhaps a canvas.

If you want to turn your next flooring project into a true work of art, choose flooring with capabilities as limitless as your imagination. Anything is possible with General Polymers terrazzo from Sherwin-Williams. Our knowledgeable flooring experts will provide you with the products and support you need to achieve your aesthetic goals and satisfy your customers. To learn more, contact your Sherwin-Williams representative or call 1-800-524-5979 to have a rep contact you.





# Specialties & Equipment

Exterior grilles and screens • Kitchen hoods and ventilation • Residential appliances • Signage

## Techy cooktops

Thermador's induction cooktops in 36", 30", and 15" glass ceramic models, use electromagnetic technology to focus heat on the pan, leaving the surrounding surface cool to the touch. Featuring 17 power levels—the widest range available—the induction-cooking surface's PowerBoost function can concentrate power in a specific zone for rapid heating time. Also from Thermador's parent company BSH is Bosch ceramic electric cooktops (not shown), offering PrecisionSim technology for a wide range of simmering options and PowerBoil for quick boiling with 100 percent of wattage. BSH Home Appliances, Huntington Beach, Calif. [www.thermador.com](http://www.thermador.com), [www.boschappliances.com](http://www.boschappliances.com)

**CIRCLE 278**

## Yoga for your kitchen

The Om mini is a 21"-square vent hood for small kitchen spaces. Designed by Lorenzo Lispi for Zephyr's Elica Collection, the reverse-silk-screened glass square houses a 450 cfm blower, which draws air in through the boundary of the central circle. The ductless venting system with carbon filters as well as adjustable halogen backlighting can be operated from a backlit touch-screen interface or by remote control. Zephyr, San Francisco. [www.zephyronline.com](http://www.zephyronline.com)

**CIRCLE 279**

## Release tension

Cambridge Architectural's Velocity attachment hardware for mesh systems is specialized for hurricane-prone coastal areas. Velocity attaches a mesh system to a surface and is engineered with a tension-release mechanism that operates automatically in high wind conditions up to 176 mph. The installation then re-tensions the mesh when winds subside. Cambridge also manufactures a variety of open metal-fabric patterns that can be applied with Velocity attachment hardware. Cambridge Architectural, Cambridge, Md. [www.cambridgearchitectural.com](http://www.cambridgearchitectural.com)

**CIRCLE 280**

Permalight photoluminescent safety signs are an excellent life safety system. —HERBERT MARTIN LYNN, AIA



278

279



280

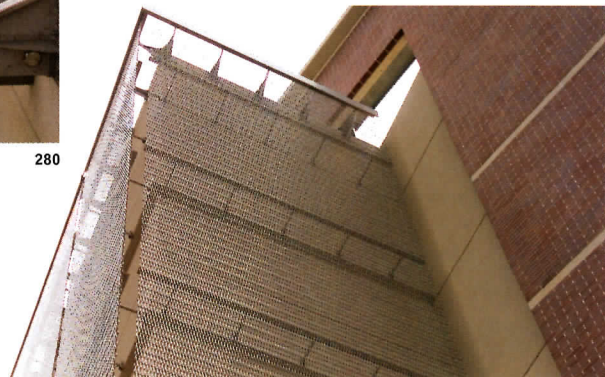

# Specialties & Equipment

Exterior grilles and screens • Kitchen hoods and ventilation • Residential appliances • Signage

## Wine with dinner

The Liebherr SBS 2415 (custom finish) and SBS 245 (stainless) 48" side-by-side refrigerator-freezer-wine combination is Energy Star qualified and features five climate zones including two zones for wine storage. SuperCool and SuperFrost functions offer swift chilling. Liebherr, Burlington, Ontario. [www.liebherr-appliances.com](http://www.liebherr-appliances.com) **CIRCLE 281**

## High-efficiency ventilation

The Halton Capture-Jet is a vent hood system that creates a push-pull effect capturing and extracting grease-laden particulates at exhaust flow levels up to 30 percent lower than conventional systems. Halton Company, Scottsville, Ky. [www.haltoncompany.com](http://www.haltoncompany.com) **CIRCLE 282**

## Nonelectrical safety signs

Permalight photoluminescent safety signs absorb ambient lighting, such as fluorescent light, and produce a bright yellow light in darkness with no electricity. The nontoxic signs come as individual components that can be arranged on-site. American Permalight, Torrance, Calif. [www.americanpermalight.com](http://www.americanpermalight.com) **CIRCLE 283**



281

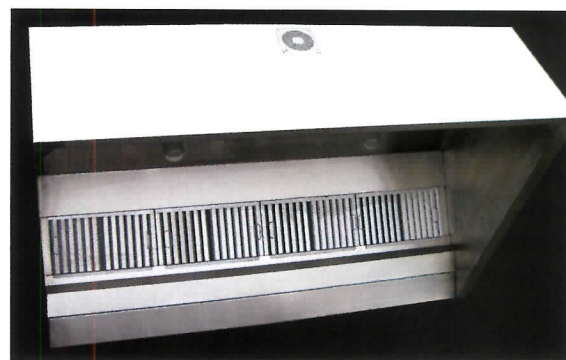

282



283

For more information, circle item numbers on Reader Service Card or go to [archrecord.construction.com](http://archrecord.construction.com), under Resources, then Reader Service.

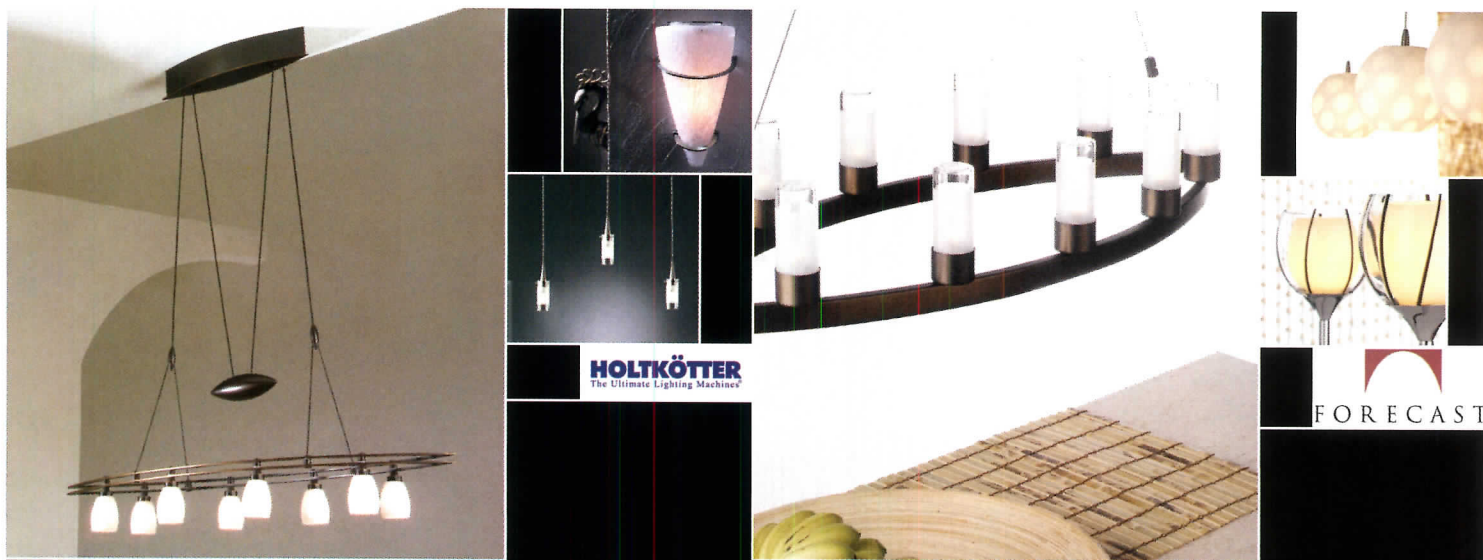

**HOLTKÖTTER**  
The Ultimate Lighting Machines

**FORECAST**

- Special Trade Pricing
- 500,000 Items
- 300 Manufacturers
- Project Management Tools
- Free Shipping

[LightingUniverse.com](http://LightingUniverse.com)



1-800-801-2021

The widest selection of trend-setting lighting fixtures anywhere online.

**ATG ALLIEDTRADEGROUP** Family of Stores

# CERAMIC TILES OF ITALY DESIGN COMPETITION CALL FOR ENTRIES 2007

For the past 13 years, Ceramic Tiles of Italy has recognized outstanding projects featuring Italian ceramic tiles. Entries are judged on their creative attributes as well as how they meet their functional and technical requirements. Domestic and international new construction and renovation projects are eligible.

#### Sponsored by

Ceramic Tiles of Italy  
& The Italian Trade Commission

#### Award

\$5000 presented to winning architects/designers at Coverings, Chicago, IL plus a 5-day trip to Bologna, Italy to attend Cersaie 2007 as part of delegation of design media journalists (Additional \$1000 to be shared by distributor/contractor team)

#### To Apply

Visit [www.italiantiles.com](http://www.italiantiles.com) to download an application or contact us at [info@novitapr.com](mailto:info@novitapr.com)

#### Deadline

February 9, 2007  
(no fee or limit for entries)

#### Categories

Residential, Commercial,  
and Institutional

[www.italiantiles.com](http://www.italiantiles.com)  
[info@novitapr.com](mailto:info@novitapr.com)



FROM TOP TO BOTTOM:  
KA ARCHITECTS  
MICHAEL P. JOHNSON  
HUFFT:PROJECTS  
BERNARD TSCHUMI  
RICHARD FLEISCHMAN  
TVS

CIRCLE 74 ON READER SERVICE CARD OR GO  
TO [ARCHRECORD.CONSTRUCTION.COM/PRODUCTS/](http://ARCHRECORD.CONSTRUCTION.COM/PRODUCTS/)

  
Ceramic Tiles of Italy



SUNBRELLA® GRAPHICS SYSTEM.  
It always adds  
THE PERFECT ACCENT.

Just ask Maggiano's.® They'll tell you canopies and awnings with our custom graphics give patrons a warm, highly recognizable welcome. And now you can easily offer any business beautiful and durable Sunbrella brand fabric with outstanding graphics using 3M® innovative products. With 3M Scotchcal™ ElectroCut™ graphic film and a special heat and vacuum unit, designs bond securely to our fabric, looking crisp and clean for years. Plus you get high-quality, repeatable results every time, along with our five-year limited warranty. For more information, contact Glen Raven Custom Fabrics, LLC at 1-800-788-4413 or visit [sgs.sunbrella.com](http://sgs.sunbrella.com).



Sunbrella® and GLEN RAVEN are registered trademarks of Glen Raven, Inc.  
Location courtesy of Maggiano's, Richmond, VA. 3M, Scotchcal and ElectroCut are trademarks of 3M.

[sgs.sunbrella.com](http://sgs.sunbrella.com)

CIRCLE 75 ON READER SERVICE CARD OR GO  
TO [ARCHRECORD.CONSTRUCTION.COM/PRODUCTS/](http://ARCHRECORD.CONSTRUCTION.COM/PRODUCTS/)

# Furnishings

Curtains and drapes • Countertops • Office accessories • Office furniture • Seating • Systems furniture • Fabric treatments • Bicycle racks • Site furnishings

## Shadow boxing

Venturing into furniture design, Steven Holl continues his investigation of porosity with his new seating and tables for Horm. The sculptural pieces explore the passage of light through matter by using ultrathin, laser-cut wood. The lightweight but sturdy veneer is composed of a sandwich of wood and synthetic materials that eliminates the need for hinges at the various panel folds. The limited-edition pieces are not currently available in the U.S. Horm, Pordenone, Italy.

[www.horm.it](http://www.horm.it) **CIRCLE 284**

## A better bike rack

Created for the urban cyclist with limited storage space, Cycloc affixes to the wall for a stylish and convenient bike perch. The crossbar easily rests within the grooves, which can be rotated to accommodate a wide range of traditional frame shapes, ensuring the bike remains horizontal. Cycloc is available in four colors and in a 100 percent recycled plastic version. Cycloc, London. [www.cycloc.com](http://www.cycloc.com)

**CIRCLE 285**

## Patinated paper

Constructed entirely from unbleached craft paper that has been made fire-retardant, Softseating is a collection of surprisingly strong and durable stools, benches, low tables, and loungers whose flexible honeycomb structure can be compressed like a book for storage. Similar size pieces can be joined in series to create larger and unusual shaped seating topographies. As Softseats are used, the surface crushes down to create a textured patina. Molo Design, Vancouver. [www.molodesign.com](http://www.molodesign.com)

**CIRCLE 286**

## A whale of a tail

Despite its whimsical gesture, Flukes is a stable seat, sculpture, or table base. Entirely handmade and cast from a polished concrete material with a urethane rubber base, Flukes can be used indoors or outdoors. Meld, Raleigh, N.C.

[www.meldusa.com](http://www.meldusa.com) **CIRCLE 287**

I like that [Wellspring by Landscape Forms] is designed for a specific market and encourages time outdoors. The engineering and sustainable wood are a plus. —EILEEN RAGSDALE

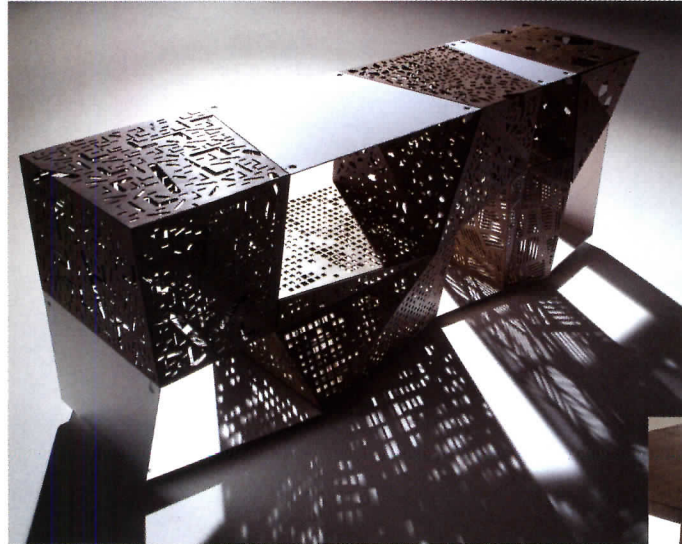

284



285

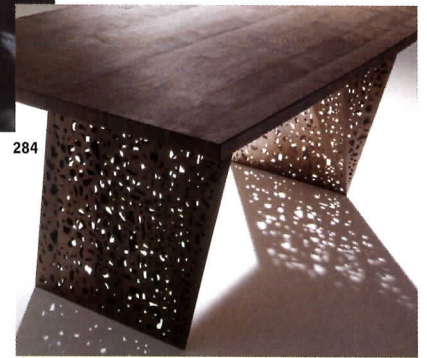

286



287

# Furnishings

Curtains and drapes • Countertops • Office accessories • Office furniture • Seating • Systems furniture • Fabric treatments • Bicycle racks • Site furnishings

## Floral arrangement

Designed by Patricia Urquiola, Antibodi is a lounge chair whose cover, fixed to a painted or chrome-plated metal frame, is created from triangular-shaped petals sewn together in combinations of felt, wool, and leather. The petals can either face down for a quilted look, or up for an unconventional version. Moroso, Milan. [www.moroso.it](http://www.moroso.it) **CIRCLE 288**



288

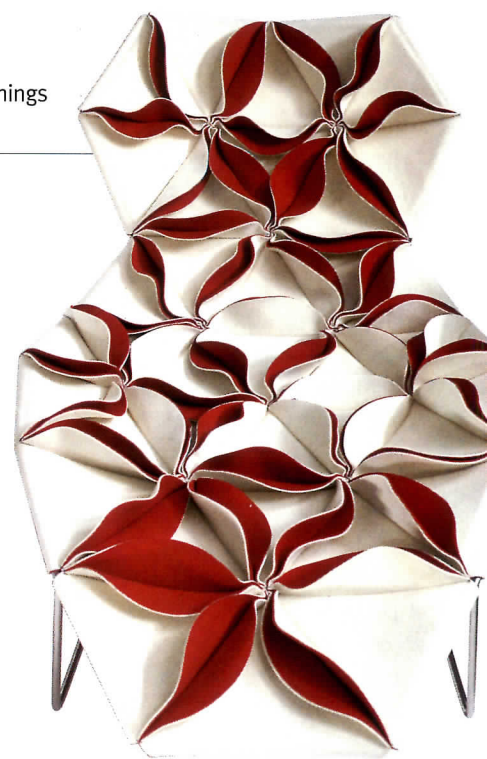

## Food for fabric

Drawing from the most unlikely of sources, Designtex introduced several new fabric lines with sustainability in mind. Ingeo Drapery (right) is composed of a man-made fiber derived from corn kernels. The natural origins of the polymer fiber allow it to be safely biodegradable at the end of its useful life. It is available in three shimmering styles and numerous color ways. Sustainable Home (left) is Designtex's new collection of soft, breathable residential fabrics made from renewable materials such as bamboo and organic cotton. Available in four patterns, the fabric's toxin-free fibers are naturally antibacterial. Designtex, New York City. [www.designtex.com](http://www.designtex.com) **CIRCLE 289**



289

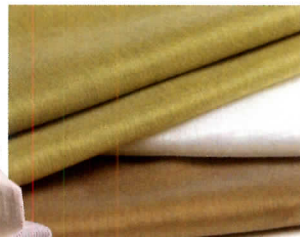

## Tropical flavor

Abacá decorative laminate surface is manufactured using recycled banana fibers and kraft paper and contains approximately 40 percent postindustrial recovered content. Suitable for both horizontal and vertical applications, the line comes in 10 natural hues in 4' x 10' sheets, and a standard thickness of .048". Lamin-Art, Schaumburg, Ill. [www.laminart.com](http://www.laminart.com) **CIRCLE 290**

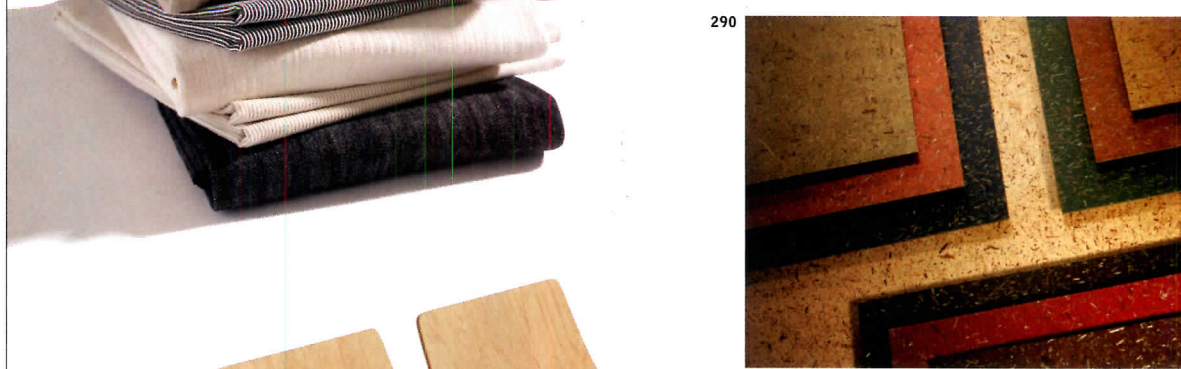

290

## Powered up passengers

Arconas launched two high-performance public seating lines. Bernù Aero (shown) comes in two-to-five-seat linear or curved beam units, with tables, and loop or cantilever arms. The Flyaway line for airport waiting areas features a "Cluster" workstation layout that allows up to six people direct access to a reliable power source to recharge laptops and other electronics from a comfortable seated position with optional footrests. Both collections are constructed of solid, die-cast aluminum components, and are available with fully upholstered seats and backs. Arconas, Ontario. [www.arconas.com](http://www.arconas.com) **CIRCLE 291**



291



292

293



294



295



296

297

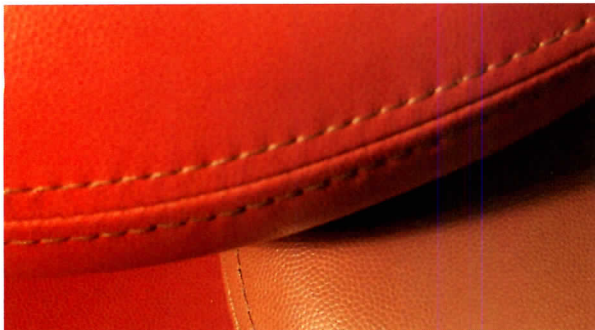

**Well-edited furniture collection**

Suzanne Trocmé's 18-piece collection for Bernhardt Design is an elegant grouping of sofas and lounge pieces, side chairs, occasional tables, and benches. The Egalité bench (shown) features a seat cushion with a "V" cut in the center, allowing a shadow gap to provide an invisible border. Bernhardt Design, Lenoir, N.C. [www.bernhardtdesign.com](http://www.bernhardtdesign.com) **CIRCLE 292**

**Soothing surroundings**

The Enso Collection of health-care cubicle curtains was created using 100 percent Eco Intelligent polyester that is produced, dyed, and recycled using all environmentally safe ingredients and processes. The four patterns feature a neutral-based palette inspired by nature and Japanese motifs. Momentum Textiles, Irvine, Calif. [www.themomgroup.com](http://www.themomgroup.com) **CIRCLE 293**

**Spline curves**

Initially designed by Norway Says for the National Museum of Art, Architecture, and Design in Oslo, Spline is a simple stacking chair composed of a series of narrow metal rods treated with a white rubber surface. For use indoors or out. Offect, Tibro, Sweden. [www.offect.se](http://www.offect.se) **CIRCLE 294**

**Friendly file clerk**

Clerk is a durable mobile cart designed to efficiently transport and neatly hold boxes and project files while keeping them visible and easy to access. When not in use, the shelves can be flipped up and several carts can nest together for compact storage. Allsteel, Muscatine, Iowa. [www.allsteeloffice.com](http://www.allsteeloffice.com) **CIRCLE 295**

**X-treme performance**

The x-Stack chair is made of glass-filled nylon and flexible thermoplastic urethane found in sports equipment. X-stack caters to classroom, meeting, or dining-room applications, with an optional right- or left-handed table and an ambidextrous monopod for laptop use. Vecta, Grand Prairie, Tex. [www.vecta.com](http://www.vecta.com) **CIRCLE 296**

**Silver savior**

Adopting AgION Technologies' silver-based antimicrobial compound for use in its synthetic fabrics, Sommers Plastic Products introduced AgGUARDIAN, a line of bacteria-resistant upholstery and wall coverings. The product will be distributed to the trade by CF Stinson. CF Stinson, Rochester Hills, Mich. [www.cfstinson.com](http://www.cfstinson.com)

**CIRCLE 297**

# Furnishings

Curtains and drapes • Countertops • Office accessories • Office furniture • Seating • Systems furniture • Fabric treatments • Bicycle racks • Site furnishings

## A healthy office environment

Patterns is a flexible office furniture collection that includes workstations, studio tables, benches, and file storage.

A typical Patterns installation is Greenguard certified as a low-emitting furnishing, contains 78 percent recycled content, and can help achieve LEED-CI credits. Haworth, Holland, Mich.

www.haworth.com **CIRCLE 298**

## Bamboo plywood

Not limited to countertops, Smith & Fong Plyboo's End-grain Block is made from 100 percent rapidly renewable bamboo, and uses strong, emissions-free adhesives. Available in a natural or amber tone. Robin Reigi Inc., New York City. www.robin-reigi.com **CIRCLE 299**

## Monitoring your support

Ellipta is a flat screen monitor support system with a spring-tensioned arm for easy movement and rotation. The stainless-steel construction accommodates monitor weights up to 16 pounds. Ellipta can be configured to allow two monitors to be mounted from the same arm for multiscreen use. Hafele America, Archdale, N.C. www.hafele.com **CIRCLE 300**

## A forest of tables

Designed by Norman Diekman, Trees is a collection of sculptural tables in a variety of finishes that include metal, Sensitile terrazzo, recycled and embossed wood, and high-gloss paint. Common tilting edges invite pairing one form with another. Brayton International, High Point, N.C. www.brayton.com **CIRCLE 301**

## Pliable laminate material

Ply is a "pliable laminate" material for interior applications designed by Milan-based Luisa Cevese. The PVC-free polyurethane product is based on a proprietary process Cevese developed to embed textile remnants in a soft, translucent polyurethane. Maharam, New York City.

www.maharam.com **CIRCLE 302**

## Haute hammock

With Loom, Franco Poli's new design for Matteo Grassi, a 2D surface takes on a 3D ergonomic shape thanks to a carefully cut pattern of openings. The thick coach hide is incised using a high-frequency machine, giving the leather elasticity, breathability, and transparency. Matteo Grassi, Milan. www.matteograssi.it

**CIRCLE 303**



298

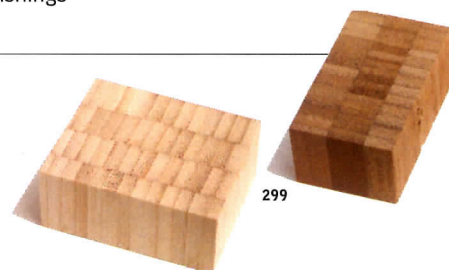

299

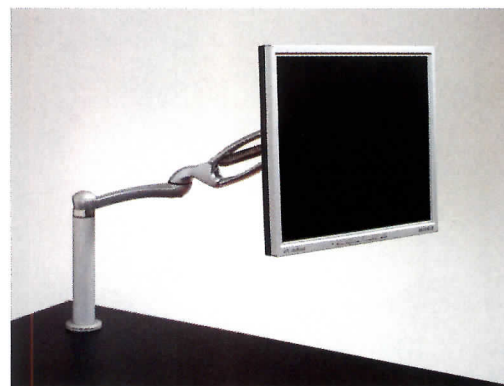

300

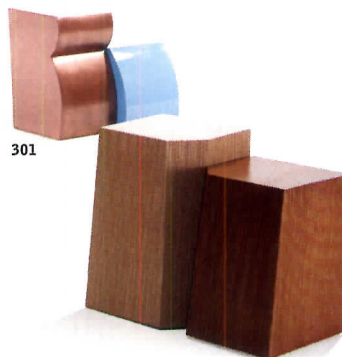
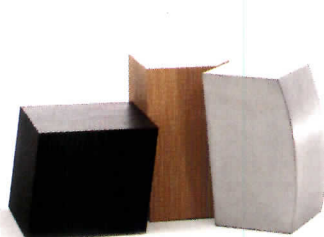

301



303



302



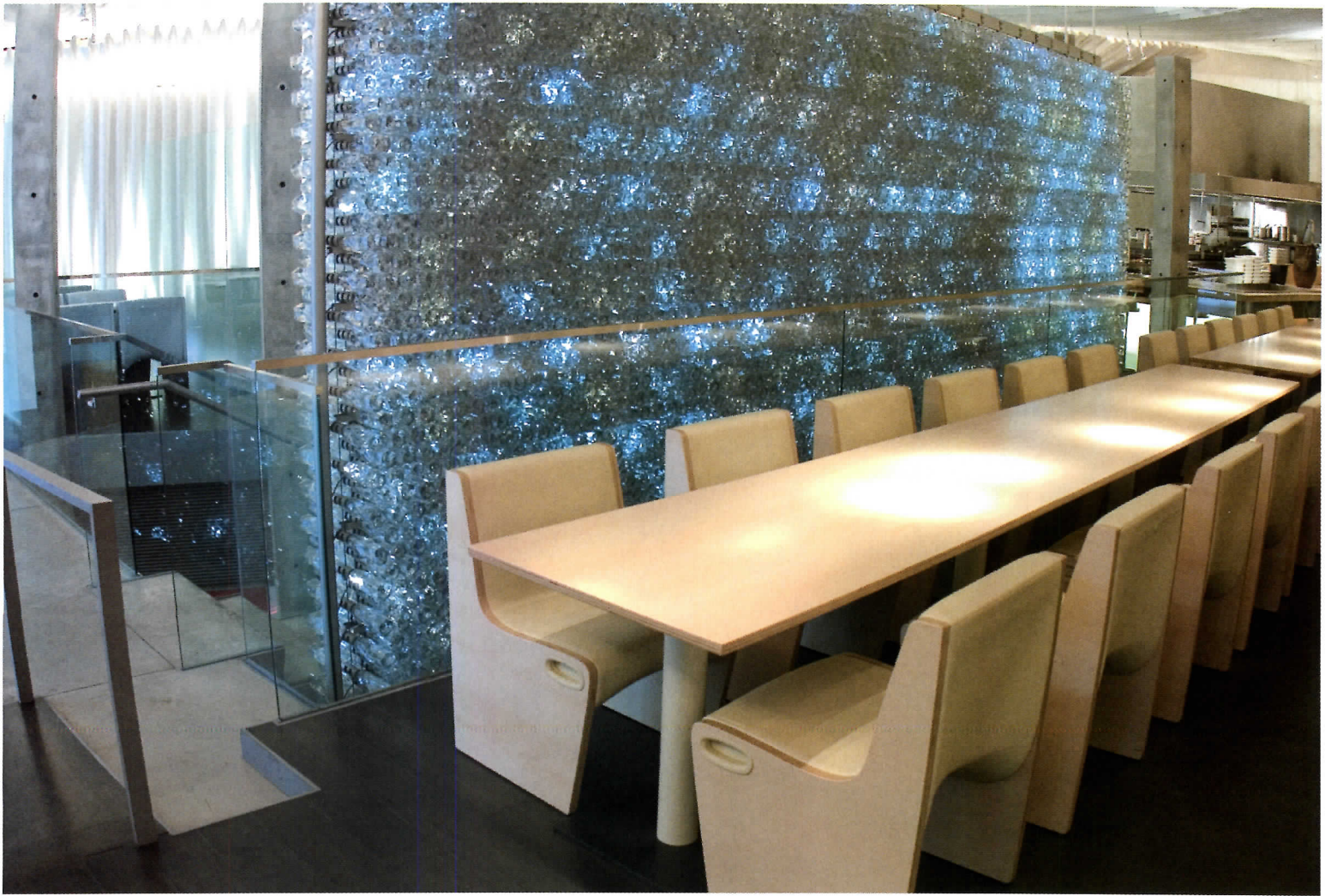

Morimoto Restaurant, New York - Project Tadao Ando  
 Custom products - Design Ross Lovegrove

Poltrona Frau Contract can provide standard and custom variations  
 for auditoriums, theatres, airports, museums, restaurants, hotels and offices

145 Wooster St. New York, NY ph. 212 777 7592 fax 212 777 8481 www.frauusa.com frauusa@frauusa.com



CIRCLE 76 ON READER SERVICE CARD OR GO  
 TO ARCHRECORD.CONSTRUCTION.COM/PRODUCTS/

# Furnishings

Curtains and drapes • Countertops • Office accessories • Office furniture • Seating • Systems furniture • Fabric treatments • Bicycle racks • Site furnishings

## Serpentine seating

Newly produced by Davis for the North American market under license from its original manufacturer, Shin and Tomoko Azumi's ZA bench design has fresh appeal to a wider audience. The bent plywood component pieces are available in one or two seat straight units, and a curved unit for countless wave form or circular configurations. Davis Furniture Industries, High Point, N.C. [www.davisfurniture.com](http://www.davisfurniture.com)

**CIRCLE 304**

## Nature's bounty

PIE is a line of handcrafted furniture made from underutilized natural materials. The Spoon Lounge (top) follows a body's curves. Its thin steel frame is woven with Liana, a rapidly growing Asian vine that is typically cut down and burned. The form of the Sushi Daybed (bottom) was inspired by the traditional art of making sushi. Its wood-and-rattan frame has a handwoven water hyacinth skin. PIE, Miramar, Fla. [www.projectimportexport.com](http://www.projectimportexport.com)

**CIRCLE 305**

## User-friendly furniture

Wellspring is a collection of teakwood garden and courtyard furniture that includes a chair, bench, rocker, table, and sunshade. The collection offers ease of use for people with diminished strength and flexibility while remaining visually appealing and comfortable for all users. Landscape Forms, Kalamazoo, Mich. [www.landscapeforms.com](http://www.landscapeforms.com)

**CIRCLE 306**

## Architect-designed lines

Appoggi has introduced a series of affordably priced chairs, bar stools, ottomans, and tables designed by architectural firms, including Michael Graves & Associates, Gluckman Mayner Architects, and Arquitectonica. The Rockwell Group's Uni-Form chair and ottoman (top) and SHoP Architects' Slice Collection club chair (bottom) are shown. Appoggi, Bedford, Mass. [www.appoggi.com](http://www.appoggi.com)

**CIRCLE 307**

## Hard as paper

Shetkastone is made from 100 percent pre- and postconsumer wastepaper and formed into a hardened product for use as table- or countertop. All by-products can be recycled back into the manufacturing process. Shetkastone can be finished with any wood or stone sealant. All Paper Recycling, LeCenter, Minn. [www.shetkastone.com](http://www.shetkastone.com)

**CIRCLE 308**

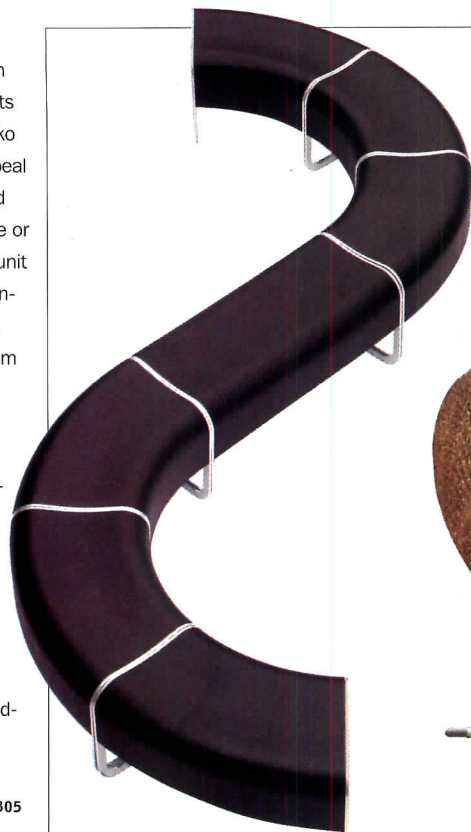

304



305



306



307



308



# Plumbing

Residential plumbing fixtures • Commercial plumbing fixtures

## Bath essentials

Ross Lovegrove's Istanbul Collection of bathroom fittings for Turkish ceramic company Vitra was inspired by the concept of "organic essentialism": Showerheads resemble growing crystals (bottom right) or mushrooms (near right), faucets sprout like branches, and levers are pebble-shaped (both shown on pedestal sink, far right). The line includes 175 products, including plumbing fixtures, wall and floor tiles, bathtubs, shower trays, bathroom furniture, faucets, and accessories. The soft-close toilet and bidet lids come in a translucent option with motion-activated LED lighting. Vitra, Suwanee, Ga. [www.vitra-usa.com](http://www.vitra-usa.com) **CIRCLE 309**

## Seamless tub

Designed by Naoto Fukasawa, the Terra bath tub is made of Cristal Plant solid surfacing. Terra is made without jointing points—the basin is molded and integrated into the entire volume of the bath tub. A lateral water supply gives a waterfall experience to the bather. Boffi, New York City. [www.boffi.com](http://www.boffi.com) **CIRCLE 310**

The fact that product designers are exploring different applications of burgeoning LED technology is timely and should be encouraged. —**BRIAN M. SLOCUM, AIA**

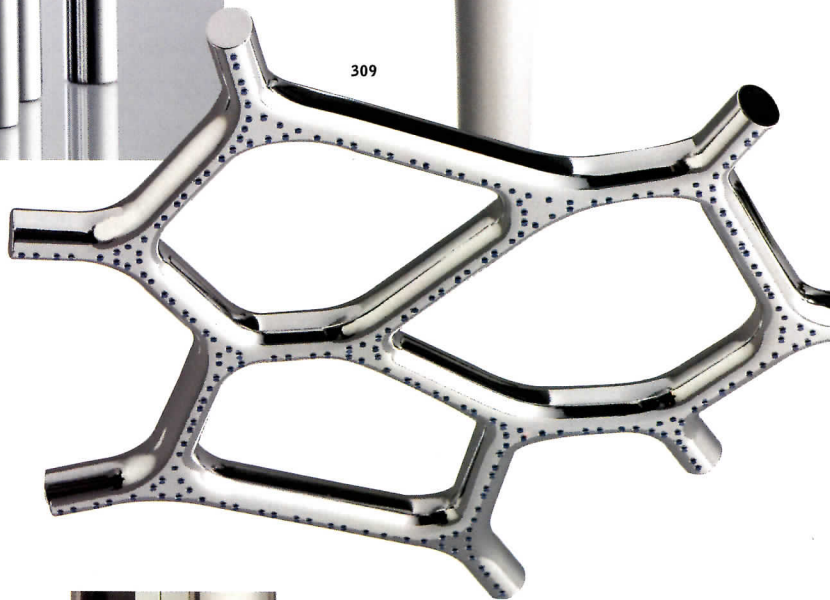
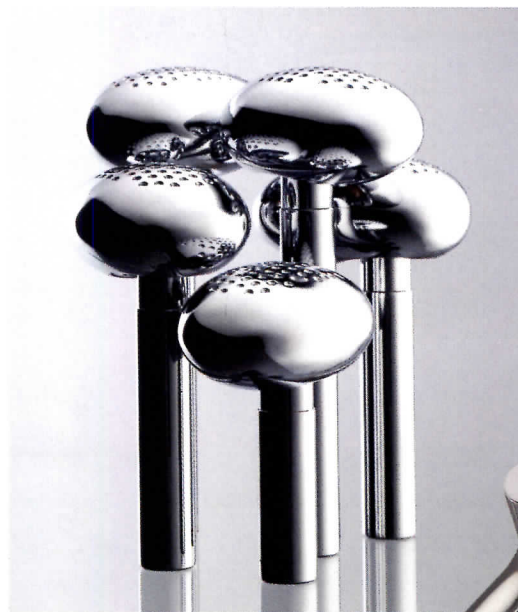

310

# Plumbing

Residential plumbing fixtures • Commercial plumbing fixtures

## In the spotlight

Bringing illumination to the sink area, Eve integrates energy-saving LEDs into a transparent plastic ring within a pull-out faucet that unexpectedly emerges from a slender swivel spout. Pushing a concealed button illuminates the light band, which turns off automatically after 45 minutes. KWC America, Norcross, Ga. [www.kwcamerica.com](http://www.kwcamerica.com) **CIRCLE 311**

## Sexy sink, flashy flushing

Duravit and Sieger Design have collaborated again with the Happy D toilet, the latest offering to the Happy D collection of bathroom fittings. The "D"-shaped toilet includes an overlapping, soft-closing toilet seat and offers low water consumption at 1.6 gallons per flush. A washbasin from the 2nd Floor collection, also designed by Sieger Design, features a "brushed stainless steel" glaze in addition to classic white ceramic. According to the manufacturer, the glaze is tougher than stainless steel and is easy to maintain. Duravit, Duluth, Ga. [www.duravit.com](http://www.duravit.com) **CIRCLE 312**

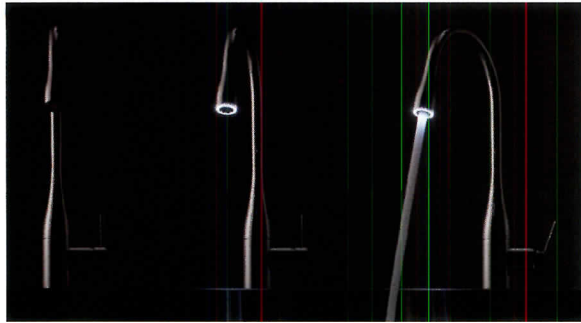

311



312



For more information, circle item numbers on Reader Service Card or go to [archrecord.construction.com](http://archrecord.construction.com), under Resources, then Reader Service.

# Use Our Expertise to Your Advantage.

## International Code Council® Plan Review Services. Experts in Your Field and Ours.

International Code Council (ICC®) technical experts have the best overall experience and expertise in all code disciplines. Architectural firms and other professionals look to ICC as the leading expert in plan reviews.

- Superior, yet competitively priced technical assistance through licensed, highly experienced engineers and architects
- Save time and money: Identify potential issues early
- Free follow up and consultations

**Do it Once, Do it Right!**  
**ICC Publishes the Codes So We Know Them Best!**



For your next Plan Review

Call **1-888-ICC-SAFE (422-7233), x33809** or visit [www.iccsafe.org/ar1](http://www.iccsafe.org/ar1)

CIRCLE 79 ON READER SERVICE CARD OR GO TO [ARCHRECORD.CONSTRUCTION.COM/PRODUCTS/](http://ARCHRECORD.CONSTRUCTION.COM/PRODUCTS/)



People Helping People  
Build a Safer World

## Breathe easier

Trane CleanEffects air-cleaning system removes up to 99.98 percent of airborne particles down to .3 microns in size from the entire airstream. The system's design creates a number of strong electrical fields that charge airborne particles, which then enter the patented collection field, which has eight times the collection surface of conventional electronic air cleaners. Trane, Tyler, Tex. [www.trane.com](http://www.trane.com) **CIRCLE 313**

## One cool customer

IceBank Cool Storage tanks store ice at night that is used to cool buildings the next day. Cooling at night with cheaper off-peak electricity reduces operating costs 10 to 20 percent, conserves resources, and lowers emissions, as nighttime electricity is more efficiently generated and delivered. Calmac Manufacturing, Fair Lawn, N.J. [www.calmac.com](http://www.calmac.com) **CIRCLE 314**

## Self-cleaning diffuser

Available in a range of colors, the LTG linear diffuser system sends out an additional small air curtain along the ceiling, keeping that area around the diffusers clean. The general air pattern of the diffuser can be adjusted at any time. LTG, Spartanburg, S.C. [www.ltg-inc.net](http://www.ltg-inc.net) **CIRCLE 315**

## Fans of ventilation

The jury selected two products from the ventilation experts at Broan-NuTone. The Ultra Silent humidity sensing fan (left) features Sensaire technology, which senses increases in moisture at the ceiling and automatically exhausts the moisture, turning off once the room's normal humidity level is reached. All fans in the SmartSense Intelligent Ventilation system (right) communicate with the "master switch" in the home, which intermittently turns fans on and off to achieve optimal ventilation. Broan-NuTone, Hartford, Wis. [www.broan.com](http://www.broan.com) **CIRCLE 316**

**Trane CleanEffects is a well-designed in-line filtration system for a home central HVAC system. The compact, multilayer filter is a nice feature to improve indoor air quality. —BRIAN STACY**



313



314

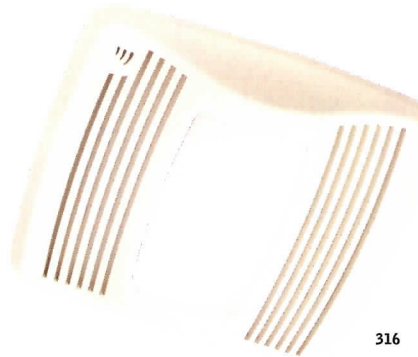

315

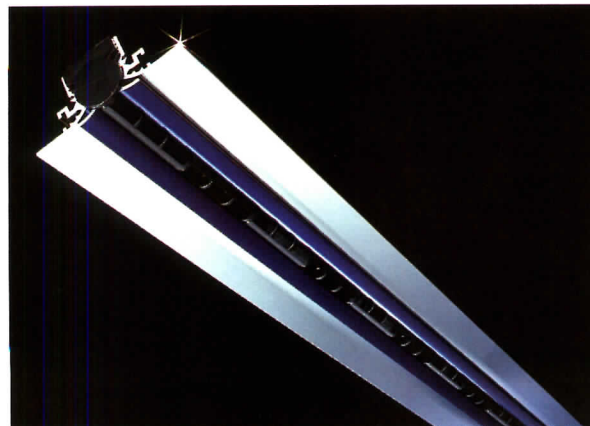

316

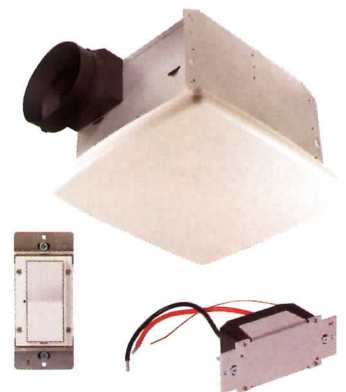

**lighting the  
open plan  
office for...**

the Architect  
an attractive,  
uncluttered  
environment.

the Owner  
lower first  
costs, lower  
energy costs  
and happy  
workers.

the User  
a luminous,  
comfortable  
personal  
workspace.

**Tambient.**  
lighting at work



**and the bottom line ... lowest energy cost, per**

**[www.tambient.com](http://www.tambient.com)**

a division of Sylvan R. Shemitz Designs, Inc., makers of elliptipa

CIRCLE 82 ON READER SERVICE CARD OR GO TO [ARCHRECORD.CONSTRUCTION.COM/PRODUCTS](http://ARCHRECORD.CONSTRUCTION.COM/PRODUCTS)



# Electrical & Communications

Interior lighting fixtures, lamps, and ballasts • Exterior lighting •  
Lighting control devices • Data communications software

## A soft puddle of light

Volcano, designed by London-based David Morgan Associates, is made with a vacuum-formed clear polycarbonate shade. Light emanates from the center of the 1½'-high floor light, striking the reflector and spreading along the bottom portion of the luminaire. Louis Poulsen Lighting, Ft. Lauderdale, Fla. [www.louispoulsen.com](http://www.louispoulsen.com) **CIRCLE 317**

## '60s comeback

Part of Leucos's Historic Collection of reissued lamps from the 1960s and '70s, the Aella table lamp by Renato Toso is constructed of handblown Murano glass complete with a clear crystal glass diffuser and a polished chrome base. Leucos USA, Edison, N.J. [www.leucos.com](http://www.leucos.com) **CIRCLE 318**

## A softer side of control

The Tufted Architect Series Dimmer incorporates a tufted sensor into International Fashion Machines' electronic textile lighting-control line. There are no hidden buttons or switches—electronic yarns and materials are woven directly into the textile, turning the tufted area into a sensor. International Fashion Machines, Seattle. [www.ifmachines.com](http://www.ifmachines.com) **CIRCLE 319**

## A task light with personality

The Leaf LED task light, designed by Yves Béhar, features a thin profile derived from a vertical blade that extends and swivels up to 180 degrees while supporting a matching horizontal blade that can be folded closed for ambient light. An iPod-like control on the base manages both the light intensity and warmth of the LEDs at the stroke of a finger. Herman Miller, Zeeland, Mich. [www.hmleaf.com](http://www.hmleaf.com) **CIRCLE 320**

## Breaking the mold

Described as "breaking the geometric form barrier" by one juror, the Oblivion pendant, designed by Arne Quinze for Dark, has a white body but can change color through the use of a filter. Litecontrol, Hanson, Mass. [www.litecontrol.com](http://www.litecontrol.com) **CIRCLE 321**

The Volcano fixture extends beyond the generic landscape bollard's bulky look. It is elegant, playful, and delivers a soft glow that seems to be Dark Sky-friendly. —PEI-HENG TSAI



317



318



319



320



321

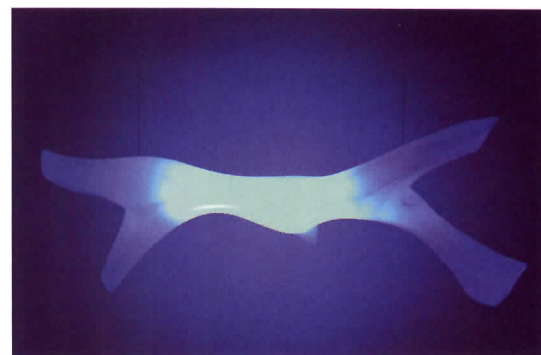

# Electrical & Communications

Interior lighting fixtures, lamps, and ballasts • Exterior lighting • Lighting control devices • Data communications software

## Powerful yet graceful

Noted by the jury for its "clean, graceful form," the LumeLex track-based solid-state lighting fixture integrates controls for both color temperature and dimming. Its 35-watt, 1,000-lumen light output is comparable to a 75-watt PAR lamp. Lighting Services Inc., Stony Point, N.Y. [www.lightingservicesinc.com](http://www.lightingservicesinc.com) **CIRCLE 322**

## Night lighter

Up to three purpose-specific lighting modules may be integrated into a single Night Elements column, resulting in fewer individual fixtures, lower energy consumption, and reduced installation costs. HessAmerica, Gaffney, S.C. [www.hessamerica.com](http://www.hessamerica.com) **CIRCLE 323**

## Shallow, in a good way

The ultra-flat SMD LED semiconductor diodes are cool to the touch and offer a low installation depth. A patented ultra-thin plate in a special alloy cools the SMD LED illuminant, which can operate for up to 50,000 hours. Nimbus, Stuttgart. [www.nimbus-design.com](http://www.nimbus-design.com)

**CIRCLE 324**

## Sleight of hand

Intended either to virtually disappear or stand out like artwork, the Anigmo Touchless Dimmer eliminates all visible controls. A patented proximity sensor detects the user's hand through most materials up to 3/4" thick. Anigmo, New York City. [www.anigmo.com](http://www.anigmo.com) **CIRCLE 325**

## Smarter connections

Acrobat Connect Professional offers a real-time collaboration development environment where users can instantly share computer screens with distant colleagues with integrated video- and audio-conferencing. Adobe Systems, San Jose, Calif. [www.adobe.com](http://www.adobe.com) **CIRCLE 326**

## To illuminate but not be seen

Selected for its minimal scale and simple form, the Nalu landscape fixture offers halogen or LED illumination that has an ecofriendly Dark Sky cutoff. Dreamscape Lighting, Los Angeles. [www.dreamscapelighting.com](http://www.dreamscapelighting.com) **CIRCLE 327**

## Base improvement

While the pin-based socket option has been in the industry for years, TCP has now chosen to use it exclusively for energy-efficient compact fluorescent lamps. TCP, Aurora, Ohio. [www.tcpi.com](http://www.tcpi.com) **CIRCLE 328**







332

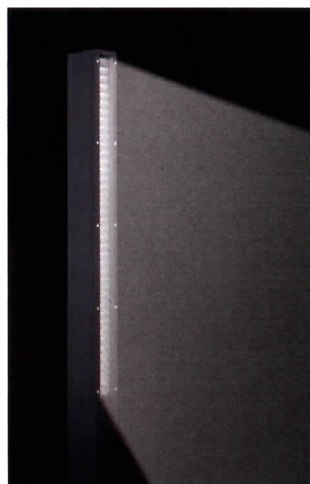

333



334



**Desk lamp on a diet**

The Z-Bar LED desk lamp integrates 66 white LEDs into an ultra-thin body. A 47" reach helps the user easily adjust the lighting angle to eliminate shadows and reflected glare. Koncept Technologies, Monterey Park, Calif. [www.koncepttech.com](http://www.koncepttech.com) **CIRCLE 329**

**Reflection of elegance**

Noted for its "interesting optical effect," the Gé pendant is made of polycarbonate in clear transparent, colored transparent, or solid black or white. A 14"-wide lampshade with a plissé worked surface creates dramatic reflections. Kartell US, New York City. [www.kartellus.com](http://www.kartellus.com) **CIRCLE 330**

**Adding a bit of drama**

The Exterior 1200 features a powerful 1,200-watt lamp and a full range mixing system that achieves a full spectrum of programmable colors that can illuminate tall structures or high-visibility architecture. Martin Architectural, Sunrise, Fla. [www.martin-architectural.com](http://www.martin-architectural.com) **CIRCLE 331**

**Beams of light**

The rectangular Linear Lighting Elements line of fixtures use T5 HO lamps and a precision louver and linear spread lens to shield the lamp and provide wide-spread illumination of interior and exterior spaces. Bega/US, Carpinteria, Calif. [www.bega-us.com](http://www.bega-us.com) **CIRCLE 332**

**Flexible skylight**

Designed to emulate natural light, Sky can be surface-mounted, recessed to walls or ceilings, or suspended as a pendant. Sky uses a combination of fluorescent lamping to evenly illuminate the stretch-fabric diffuser. inter-lux, Columbia, Md. [www.inter-lux.com](http://www.inter-lux.com) **CIRCLE 333**

**Compact lighting control**

The Pharos Lighting Playback Controller offers ultra-compact control for entertainment and LED lighting in architectural settings. It supports DMX or Dali color-mixing fixtures, dimmable ballasts, and automated luminaires. ETC, Middleton, Wis. [www.etcconnect.com](http://www.etcconnect.com) **CIRCLE 334**

# Match This!

## 100 COLORS IN 10 DAYS OR LESS

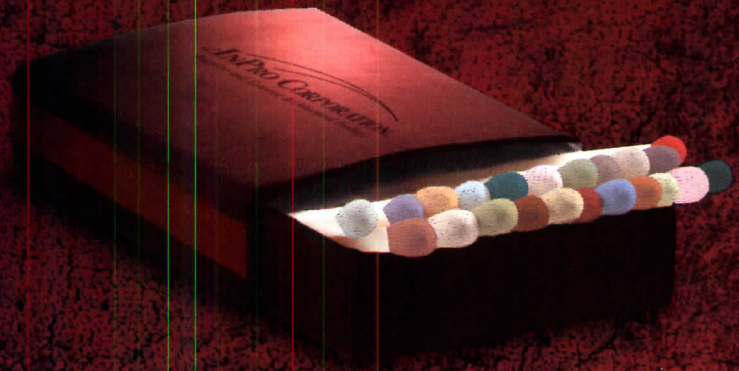

*Arriving*  
January 2007

IPC, the industry leader in door & wall protection, introduces 100 colors in 10 days or less. The largest selection of colors in the least amount of time.

Match your décor with corner guards, wall guards, handrails, Sanparrel rigid vinyl sheet and door protection products, all in 100 colors. Best yet, your products will ship in 10 days or less. By using the same palette of 100 colors, you can also match signs from InPro SignScape with IPC products.

**INPRO**  
**IPC** DOOR and WALL  
PROTECTION SYSTEMS

**INPRO**  
**SIGNSCAPE**  
SIGNAGE and WAYFINDING

*Most Choices. Best Service.*

Visit [inprocorp.com/matchthis](http://inprocorp.com/matchthis) or call 877.780.0034 today to pre-order your new color palette.

CIRCLE 83 ON READER SERVICE CARD OR GO  
TO [ARCHRECORD.CONSTRUCTION.COM/PRODUCTS/](http://ARCHRECORD.CONSTRUCTION.COM/PRODUCTS/)

# Special Construction & Pollution Control

Glazed structures • Whirlpool tubs • Noise-abatement barriers

## Illuminated wall system

The translucent IllumaWall system projects diffused daylighting or programmable LED color at night. Single- or double-glazed, multiwall polycarbonate systems feature aluminum structural framings. In exterior or interior applications, custom design-build systems accommodate optional Nanogel aerogel for enhanced energy efficiency. Duo-Gard Industries, Canton, Mich. [www.duo-gard.com](http://www.duo-gard.com) **CIRCLE 335**

## Whirlpool spa is a speaker

Available in three rectangular-shaped models (undermount, deck mount, or freestanding), the Saphyr whirlpool spa features the Neptuner audio-technology system, which uses acoustic transducers to provide an invisible surround system. Unlike conventional systems, Neptuner completely immerses the body in music, turning the bathtub shell into a giant speaker that is amplified and enhanced by water. Neptune, Quebec. [www.neptuneb.com](http://www.neptuneb.com) **CIRCLE 336**

## Transparent noise control

The Quillite noise barrier system is designed to reduce noise while maintaining maximum light transparency. Corrugated on both sides, the post/panel system of polycarbonate modules are mounted in steel frames providing flexibility for building freestanding structures and wall-height extensions. Quillite, Los Angeles. [www.quillite.com](http://www.quillite.com) **CIRCLE 337**

The ultimate luxury—taking a whirlpool bath in a Minimal tub with a built-in sound system that surrounds your whole body. —MATTHEW C. PETRIE, AIA

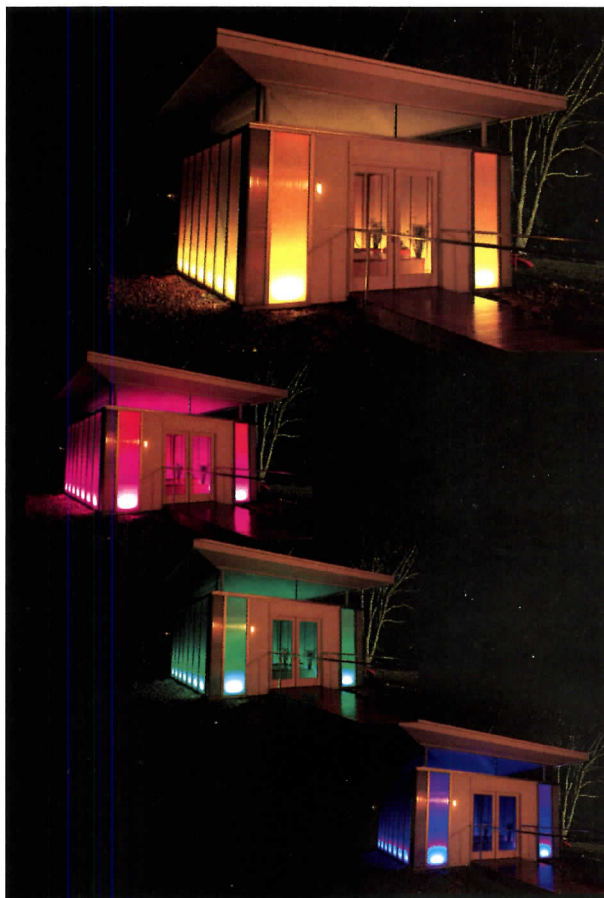

335



336



337

*Not Just Another  
Brick In The Wall.*

*With Belden Brick you get more than just another brick in your wall. You get unrivaled quality and durability. Belden Brick products are available in a variety of colors, textures, sizes and shapes. All in all ... Belden Brick - more than just another brick in the wall.*



**BELDEN**  
THE BELDEN BRICK COMPANY

Canton, Ohio / (330) 456-0031

[www.beldenbrick.com](http://www.beldenbrick.com)

An ISO 9001:2000 Registered  
Quality Management System

CIRCLE 84 ON READER SERVICE CARD OR GO  
TO [ARCHRECORD.CONSTRUCTION.COM/PRODUCTS/](http://ARCHRECORD.CONSTRUCTION.COM/PRODUCTS/)

# Dates & Events

## New and Upcoming Exhibitions

### **Constructing the Swiss Landscape** **Cambridge, Mass.**

December 1, 2006–

January 15, 2007

This exhibition examines the Swiss landscape as both a design and cultural construct. Projects include the mapping of Switzerland as an urban entity, engineered landscapes, and contemporary landscape design. At Harvard University Graduate School of Design. Call 617/495-5453 or visit [www.gsd.harvard.edu/swissla](http://www.gsd.harvard.edu/swissla).

### **Urban America, 1930–1970** **Providence**

December 1, 2006–

February 25, 2007

Between 1930 and 1970, economic and cultural factors contributed to demographic change in America's cities, leading to the diverse, culturally rich, economically stratified urban centers that we know today. This exhibition includes approximately 30 prints, drawings, and photographs by American artists who sought to understand and characterize this new urban scene through their art. At the RISD Museum of Art. Call 401/454-6500 or visit [www.risd.edu](http://www.risd.edu).

### **National Design Triennial: Design Life Now** **New York City**

December 8, 2006–

January 29, 2007

The third Triennial brings together the experimental designs and emerging ideas—including animation, new media, fashion, robotics, architecture, product, medical, and graphic design—at the center of American culture from 2003–2006. At the Cooper-Hewitt National Design Museum. For further information, call 212/849-8400 or visit [www.ndm.si.edu](http://www.ndm.si.edu).

### **Some Assembly Required** **Los Angeles**

February 28–March 13, 2007

For this innovative new show, architects and home buyers unite to support a variety of modern modular dwellings that refute the commonly accepted image of “prefab” homes as cheap, cookie-cutter structures. This exhibition presents various approaches to prefab houses: those built with a kit and an instruction manual or the diminutive one-room version. At the Pacific Design Center. For more information, call 310/657-0800 or visit [www.pacificdesigncenter.com](http://www.pacificdesigncenter.com).

### **Ongoing Exhibitions** **P.A.N. (Progressive Architecture Network)** **New York City**

Through December 2, 2006

Curated by Winka Dubbeldam with Helene Furjan, this exhibition features the work of five “young” international architecture offices whose attitude toward the discipline are similar. The exhibition will contain models, as well as drawings and photographs, exemplifying the work of each office. At the Frederieke Taylor Gallery. To learn more, call 646/230-0992 or visit [www.frederiketaylorgallery.com](http://www.frederiketaylorgallery.com).

### **Architects Fired** **Washington, D.C.**

Through autumn 2006

Some of D.C.'s most innovative and celebrated architects turn their design sensibilities to the medium of clay. This exhibition is on view at Cross Mackenzie Ceramic Arts. Call 202/333-7970 or visit [www.crossmackenzieceramicarts.com](http://www.crossmackenzieceramicarts.com).

### **Project New Orleans** **New Orleans**

Through December 8, 2006

An exhibition of studies, responses, and solutions for rebuilding New



**DORN  
BRACHT**

*the SPIRIT of WATER*

## MEM

With MEM, Dornbracht presents a new sphere of elemental fitting aesthetics. Its conscious understated approach turns the washing experience into a direct encounter with the element of water. Just like the surge of a clear, natural spring. MEM was designed by SIEGER DESIGN. To request a copy of our publication the SPIRIT of WATER / bath, please contact: **Dornbracht USA, Inc.**, 1700 Executive Drive South, Suite 600, Duluth GA 30096, Phone 866-818-3199, E-Mail [literature@dornbracht.com](mailto:literature@dornbracht.com) [www.dornbracht.com](http://www.dornbracht.com)

Chicago: COMMUNITY HOME SUPPLY, Phone (773) 281-7010.

CIRCLE 85 ON READER SERVICE CARD OR GO  
TO [ARCHRECORD.CONSTRUCTION.COM/PRODUCTS/](http://ARCHRECORD.CONSTRUCTION.COM/PRODUCTS/)

# The Older Your Maple Sports Floor Gets, the Smarter You Look.

Over its long lifetime, MFMA maple sports flooring can cost you up to 40% less overall versus synthetic.\* That's value. But maple's true value goes well beyond longevity and lower cost. It offers unrivaled aesthetic beauty, and unmatched playability too. And unlike synthetics, maple is easily and economically restored. So every year your maple sports floor outperforms synthetics, you'll know you made the brightest choice possible. \*Ducker Research Co. Inc.

Visit our redesigned Web site at:  
[www.maplefloor.org](http://www.maplefloor.org)



60 Revere Drive, Suite 500, Northbrook, IL 60062  
phone: 847-480-9138 | e-mail: mfma@maplefloor.org



© 2005 Maple Flooring Manufacturers Association, Inc. All Rights Reserved

CIRCLE 86 ON READER SERVICE CARD OR GO  
TO ARCHRECORD.CONSTRUCTION.COM/PRODUCTS/

## Dates & Events

Orleans from America's schools of architecture. At New Orleans African American Museum. For more information, call 504/566-1136 or visit [www.project-neworleans.org](http://www.project-neworleans.org).

### Glass: Material Matters Los Angeles

*Through December 10, 2006*  
One of the first exhibitions of contemporary glass to explore the artistic use of glass in a diverse range of decorative objects, sculpture, conceptual art, and architecture. At the Los Angeles County Museum of Art. Call 323/857-6522 or visit [www.lacma.org](http://www.lacma.org).

### Time for Design Richmond, Va.

*Through December 10, 2006*  
This exhibition explores the evolution of design solutions and the intersection of various design disciplines through an in-depth look at intention, concept, process, outcome, and client relations. The installation includes graphic, fashion, interior, industrial design, and architecture and also features a series of short video interviews with the participants, Donna and Robert Dunay, professors in Virginia Tech's School of Architecture + Design, College of Architecture and Urban Studies. At the Visual Arts Center of Richmond. Visit [www.vt.edu](http://www.vt.edu).

### The Form of a Lake— Stories of Finnish Design Milan

*Through December 10, 2006*  
Presenting forms inspired by lakes, snow, the northern lights, by light itself and the lack thereof, by wood and fire, and by the sound of skis cutting through the snow. Set up and arranged by Lino Sabattini, who has closely followed Nordic production over the years, the exhibition will feature pieces by Aalto, Heikkilä, Nurmiesniemi, Tapiovaara, Kokko, Wirkkala, Sarpaneva and Puotila, among others. At Tingo Design Gallery. For more informa-

tion, call 02 2906 7239 or visit [www.tingo.it](http://www.tingo.it).

### Seamless New York City

*Through December 15, 2006*  
An exhibition of exclusive works by world-renowned architect Zaha Hadid. At Phillips de Pury and Company's Chelsea headquarters. Call 212/940-1200 or visit [www.phillipsdepur.com](http://www.phillipsdepur.com).

### Toward Substantial Surfaces Los Angeles

*Through December 15, 2006*  
This exhibition of student work documents the research, design scenarios, and models produced for the 2006 spring Advanced Topics Studio led by Heather Roberge in the UCLA Department of Architecture and Urban Design. At Perloff Gallery, UCLA. Call 310/267-4704 or visit [www.aud.ucla.edu](http://www.aud.ucla.edu).

### RoTo Architects: Prairie View Los Angeles

*Through December 17, 2006*  
This exhibition of RoTo Architects' Architecture and Art Building of the Texas Prairie View A&M University features large-scale photographs of the building, a mural-size silk photo print, and a video documenting the construction and project completion in early 2006. At the Southern California Institute of Architecture (SCI-Arc). Call 213/613-2200 or visit [www.sciarc.edu](http://www.sciarc.edu).

### Hostile Terrain: Reflections on Romania's Industrial Landscape Baltimore

*November 1–December 22, 2006*  
An exhibition by photographer Paul Burke reveals how the transformation of Romania's social and political structure is reflected in the physical structures that make up its landscape. On view at the AIA Baltimore Gallery. For additional information, call 410/625-2585 or visit [www.aiabalt.com](http://www.aiabalt.com).

## Dates & Events

### Carlos Garaicoa

#### Toronto

Through December 31, 2006

From a futuristic city made of rice-paper lamps to photographs capturing Havana's deteriorating cityscape, this exhibition features 15 recent works by one of Latin America's most high-profile artists, contemporary Cuban artist Carlos Garaicoa. At the Royal Ontario Museum. Call 416/586-8000 or visit [www.rom.on.ca](http://www.rom.on.ca).

### It's Time...

#### Los Angeles

Through December 31, 2006

The It's time... exhibition, created in conjunction with SCI-Arc architectural students, incorporates the use of biodegradable packing peanuts in a very provocative, sculptural, Gaudí-esque installation. The installation is meant to awaken viewers to the possibility of making green choices with everyday office and business products. At Denizen Design Gallery. For more information, visit [www.denizendesigngallery.com](http://www.denizendesigngallery.com).

### Structure:

#### The Los Angeles Series

#### Los Angeles

Through January 5, 2007

An exhibition of national-award-winning artist Ted VanCleave. A selection of 16 of his new photographic images captures Los Angeles in a bold and colorful way that extends beyond representation to become brilliant, almost surreal abstraction. These highly stylized photographs juxtapose vibrant color and the geometry of L.A.'s architectural landscape. At ChopChop Salon/Gallery. Visit [www.tedvanleave.com](http://www.tedvanleave.com).

### Skin and Bones: Parallel Practices in Fashion and Architecture

#### Los Angeles

Through January 8, 2007

This exhibition explores the common visual and intellectual principles that

underlie both fashion and architecture. Both disciplines start with the body and expand on ideas of space and movement, serving as outward expressions of personal, political, and cultural identity. Presenting the work of international fashion designers and architects, the exhibition examines themes such as shelter, identity, tectonic strategies, creative process, and parallel stylistic tendencies, including deconstruction and minimalism. At the Museum of Contemporary Art. Call 213/621-1749 or visit [www.moca.org](http://www.moca.org).

### The GenHome Project

#### Los Angeles

Through February 18, 2007

An exhibition exploring the integration of recent developments in information technologies and the natural sciences (especially genetics) into cutting-edge architecture. Interacting with one of the 20th-century's most renowned architectural experiments, the Schindler House, exhibition projects offer genetic modifications of the home's structure, interiors, and grounds. Among the many scientific methodologies that are referenced are nanotechnology, climatology, cell physiology, astronomy, robotics, and algorithms. At the MAK Center for Art Architecture. Call 323/651-1510 or visit [www.MAKcenter.org](http://www.MAKcenter.org).

### OMA in Beijing: China Central Television Headquarters by Ole Scheeren and Rem Koolhaas

#### New York City

Through February 26, 2007

Scheduled to open for the Beijing Olympics in 2008, the complex comprises three buildings and a media park situated on a 20-hectare site east of Beijing's Forbidden City. The international partnership Office for Metropolitan Architecture (OMA) won the competition for its design in 2002, and the project broke ground in 2004, with OMA partner Ole Scheeren leading

Are you drowning in a sea of specs from multiple automatic door manufacturers?

## Let Horton Save You With Single Source Convenience.

To keep your projects from becoming a sea of door specs and brands, partner with Horton Automatics. In addition to providing you with the broadest line of automatic access solutions in the industry, we offer professional service through factory-authorized distributors, all highly motivated to deliver a superior brand experience. Developer of the world's first commercial automatic sliding door, Horton Automatics brings you unmatched performance in automatic entrances. Let your Horton distributor prove the benefits of an integrated door solution.

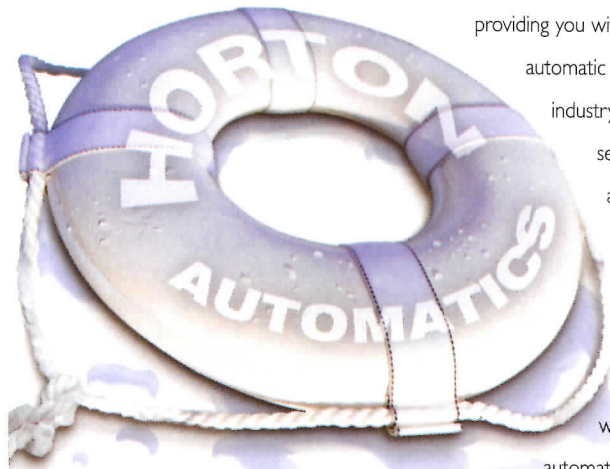

SLIDING



SWINGING



REVOLVING



FOLDING



Horton Automatics  
4242 Baldwin  
Corpus Christi, TX 78405  
800-531-3111 or 361-688-5591  
[www.hortondoors.com](http://www.hortondoors.com)



Exceptional Nationwide Service

AAADM American Association of Automatic Door Manufacturers

By specifying Horton you provide your clients with professional installation per AAADM\* requirements plus ongoing service support that is unparalleled in the industry.



## TAKE DETAIL TO NEW HEIGHTS.



A copper chimney pot by European Copper will take your next project over the top. UL-listed and International Building Code compliant, they are compatible with both masonry and steel fireplace systems.

Call today at 800-391-0014  
for a dealer near you or visit  
[www.europecopperchimney pots.com](http://www.europecopperchimney pots.com)

### FEATURES

- Fine stainless steel and copper
- UL Listed, IBC compliant, patented
- For masonry or metal fireplaces
- Existing or new construction chimneys
- Withstands hurricanes, seismic shifts
- Keeps out pests and water
- Improves draft, reduces spark
- Lightweight, easy to install
- Three styles, seven sizes available

EUROPEAN  
COPPER.  
BY JACK ARNOLD

## Dates & Events

its design and execution from Beijing. The exhibition explores the project through an array of graphics, renderings, and explanatory texts, as well as large- and small-scale models. A selection of architectural drawings from New York's Museum of Modern Art collection will situate the project as one of the most visionary built works in the history of modern architecture. At MoMA. For more information call 212/708-9400 or visit [www.moma.org](http://www.moma.org).

### **Modernism in American Silver: 20th-Century Design Miami Beach, Fla.**

*Through March 25, 2007*

This show charts the stylistic design history of modern American production silver while exploring the economic and cultural factors that influenced silver design, manufacture, and marketing across more than seven decades. At the Wolfsonian-FIU. For more information, call 305/535-1001 or visit [www.wolfsonian.org](http://www.wolfsonian.org).

### **The 2006 National Design Triennial: Design Life Now New York City**

*December 8, 2006–July 29, 2007*

Inaugurated in 2000, the Triennial seeks out and presents the most innovative American designs from the prior three years in a variety of fields, including product design, architecture, furniture, film, graphics, new technologies, animation, science, medicine, and fashion. On view throughout the museum campus will be the work of 87 designers and firms, ranging from established design leaders such as Apple Computer, architect Santiago Calatrava, and Nike to emerging designers like Joshua Davis, Jason Miller, and David Wiseman. At the Cooper-Hewitt National Design Museum. Call 212/849-8400 or visit [www.ndm.si.edu](http://www.ndm.si.edu).

## Lectures, Conferences, and Symposia

### **Lecture: Jorge Silvetti New York City**

*December 5, 2006*

Jorge Silvetti will lecture as part of the Architectural League's fall 2006 program of lectures by eminent architects, engineers, and designers. At the Great Hall, Cooper Union. Call 212/753-1722 or visit [www.archleague.org](http://www.archleague.org).

### **Ecobuild Federal: Sustainable, Green, and High-Performance Solutions for the Built Environment and AEC-ST Federal: Science and Technology for Architecture, Engineering, and Construction**

**Washington, D.C.**

*December 5–7, 2006*

The exhibition is accompanied by a three-day conference for professionals in fields including architecture, construction, and engineering, as well as the federal government. At the Washington Convention Center. For more information, visit [www.ecobuildfederal.com](http://www.ecobuildfederal.com) or [www.aecstfederal.com](http://www.aecstfederal.com).

### **Design Miami Miami, Fla.**

*December 7–10, 2006*

The international design forum brings together influential dealers, designers, collectors, curators, and critics in a weeklong show presented concurrently with the Art Basel fair in Basel, Switzerland. At The Moore Building in the Miami Design District. Call 305/572-0866 or visit [www.designmiami.com](http://www.designmiami.com).

### **ADA: Accessibility Provisions for Multifamily Residential Projects Los Angeles**

*December 8, 2006*

Presented by Isam Hasenin, chief building official for the City of San Diego, this seminar will focus on an update on state accessibility provisions; the latest federal and state accessibility provisions covering multifamily projects; special site accessibility challenges; the application of parking provisions; elevator requirements; many practical examples and case studies, and more. At AIA Los Angeles. Visit [www.aialosangeles.org](http://www.aialosangeles.org).

### **Construction of the World's Longest Tunnel**

**Washington, D.C.**

*December 12, 2006*

Ambros Zgraggen, deputy director of communications at AlpTransit Gotthard, a subsidiary of Swiss Federal Railways, will discuss the project AlpTransit. In particular, he will focus on progress of the Gotthard Base Tunnel, a flat rail link for future travel through the Alps and, at 34 miles, the world's longest tunnel. At the National Building Museum. Call 202/272-2448 or visit [www.nbm.org](http://www.nbm.org).



## Dates & Events

### **Lecture: Eccentricity: Intriguing Characters in Washington's Architectural History Washington, D.C.**

December 14, 2006

In researching and writing the new edition of the *AIA Guide to the Architecture of Washington, D.C.* (Johns Hopkins University Press), Martin Moeller, senior vice president and curator at the National Building Museum, became fascinated by the many colorful characters, "including architects, clients, residents, and politicians," who helped shape the face of the nation's capital. In this lecture, he will talk about the intriguing people closely associated with noteworthy Washington buildings. At the National Building Museum. Call 202/272-2448 or visit [www.nbm.org](http://www.nbm.org).

### **10th Conference of the International Association for the Study of Traditional Environments (IASTE) Bangkok, Thailand**

December 15-18, 2006

"Hyper Traditions" is the theme of this year's conference. It will explore how globalization and new information technologies have contributed to the deterritorialization of tradition, challenging the idea of tradition as an authentic expression of a geographically specific, culturally homogenous, and coherent group of people. At Thammasat University. Call 510/642-6801 or visit [www.arch.ced.berkeley.edu/research/iaste](http://www.arch.ced.berkeley.edu/research/iaste).

### **L.A. Mart Los Angeles**

Through 2006

A resource for gifts, decorative accessories, trend and lifestyle products, and home furnishings in the Western United States, with nearly 300 showrooms encompassing 724,000 square feet of showroom space. In the heart of the Furniture and Decorative Arts District. For a calendar and more information, call 800/526-2784 or visit <http://www.lamart.com/>.

### **Global Place: Practice, Politics, and the Polis Ann Arbor**

January 4-6, 2007

Charles Correa, Shigeru Ban, Kenneth Frampton, Michael Sorkin, Marilyn Taylor, Liane Lefavre, Lars Lerup, Daniel Solomon, Yung Ho Chang, Saskia Sassen, David Orr, Homi Bhabha, Jaime Lerner, Anne Spirn, John Thackara, and others will address intersections and contradictions of the

global and the local, with a focus on the built environment. At the Taubman College of Architecture + Urban Planning, University of Michigan. Call 734/764-1300 or visit [www.tcaup.umich.edu](http://www.tcaup.umich.edu).

### **Lecture and Book Signing: L'Enfant's Legacy: Public Open Spaces in Washington, D.C. Washington, D.C.**

January 9, 2007

Washington is a dual city composed of the monuments and grand spaces of the federal core and the downtown and neighborhoods of the constituent city. Pierre L'Enfant intended them to support each other, relating them through a system of avenues and open spaces. Michael Bednar, senior professor of architecture at the University of Virginia, will discuss the parts of Washington tourists may not visit, the northwest quadrant and Capitol Hill, and how this system of democratic public open spaces has served residents during the two centuries since its inception. At the National Building Museum. Call 202/272-2448 or visit [www.nbm.org](http://www.nbm.org).

### **2007 Vincent J. Scully Prize: Witold Rybczynski Washington, D.C.**

January 17, 2007

Author, scholar, professor, and architect Witold Rybczynski has investigated and chronicled the fields of architecture and urban planning for more than 20 years. Renowned for its lucid prose and ability to translate complex concepts into laymen's terms, Rybczynski's work exposes diverse audiences to the impact of architecture, planning, and more on everyday life. The National Building Museum is recognizing Rybczynski's valued contributions to architecture and urban planning by presenting him with the 2007 Scully Prize. Following the ceremony, Rybczynski will give a lecture on "Demand-Side Urbanism" that will explore four paradigms of 20th-century American urbanism and how the design of American cities has been fundamentally impacted by market demand. At the National Building Museum. Call 202/272-2448 or visit [www.nbm.org](http://www.nbm.org).

### **Spring 2007 Lecture Series: Design Goes Mainstream Houston**

January 17-February 7, 2007

In recent years, "design" has permeated the mainstream. Companies like Target, IKEA, Design

## Design at its most functional.

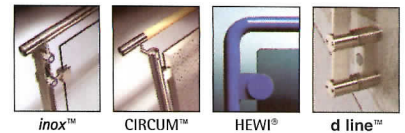

**HDI** Railing Systems

3905 Continental Drive • Columbia, PA 17512 USA  
PH: 717-285-4088 • FAX: 717-285-5083  
Email: [info@hdirailings.com](mailto:info@hdirailings.com)  
[www.hdirailings.com](http://www.hdirailings.com)

CIRCLE 89 ON READER SERVICE CARD OR GO TO [ARCHRECORD.CONSTRUCTION.COM/PRODUCTS/](http://ARCHRECORD.CONSTRUCTION.COM/PRODUCTS/)

# Build With Us

For decades the National Building Museum has inspired children and families to learn more about building, construction, design, and engineering. From our family festivals and our exhibitions, to our school programs and our curriculum kits, we build enthusiasm about skyscrapers and homes, bridges and neighborhoods, and all of the extraordinary things between.



FROM THE TOP:  
Engineering Day  
Careers in Construction  
Bridge Basics Program Kit  
Investigating Where We Live  
Design Apprentice Program



We invite you to join us.

**NATIONAL BUILDING MUSEUM**

401 F Street NW  
Washington, DC 20001  
202.272.2448  
[www.NBM.org](http://www.NBM.org)

## Dates & Events

Within Reach, and Apple have been the harbingers of style to the general public. Magazines like *Wallpaper* and *Dwell* present a design-conscious lifestyle and are read by designers and the general public alike. This lecture series will explore larger issues of design and the products we use in everyday life. Wednesdays at Brown Auditorium, The Museum of Fine Arts, Houston. Call 713/348-4876 or visit [www.rda.rice.edu](http://www.rda.rice.edu).

### Glass Week 2007 Sarasota, Fla.

January 20–24, 2007

Emerging technologies in the Glass Industry featuring Michael Rogers and Don Reynolds, with one day focused on management and the other on industry issues and trends. At the Ritz Carlton Sarasota. Visit [www.glassweek.com](http://www.glassweek.com).

## Competitions

### The Gateway Project Expression of Interest

Deadline: December 6, 2006

University College Dublin, Ireland's largest university, has launched a major international architecture competition for a new landmark development at the university's Belfield campus. The Gateway Project, comprising cultural, academic, leisure, and business facilities, represents the start of the implementation of a 15-year UCD Campus Development Plan. The University is inviting submissions from leading architecture firms from around the world. Visit [www.ucd.ie](http://www.ucd.ie).

### 2007 AIA Housing Awards: Call for Entries

Submission deadline: December 15, 2006

The AIA Housing Awards recognize the best in housing design in the following categories: One and Two Family Custom Residences—custom and remodeled homes for specific clients; One and Two Family Production Homes—homes built for the speculative market; Multifamily Housing—both high- and low-density projects for public and private clients will be considered; and Special Housing—housing that meets the unique needs of other specialized housing types such as single-room-occupancy residences (SROs), independent living for the disabled, residential rehabilitation programs, domestic violence shelters, and other special housing. Call 202/626-7586 or visit [www.aia.org/awp\\_housing](http://www.aia.org/awp_housing).

### The 2006–07 Kenneth F. Brown Asia Pacific Culture and Architecture Design Award

Registration deadline: December 10, 2006

Submission deadline: January 31, 2007

The program recognizes outstanding examples of contemporary architecture in the Asia Pacific region. For more information, call 808/956-3515 or visit [www.arch.hawaii.edu](http://www.arch.hawaii.edu).

### International Design Competition for a Cultural Center in Nicosia, Cyprus

Credential submission deadline:

December 11, 2006

Design proposal submission deadline:

March 5, 2007

The Cultural Center will provide a focal point for the island's performing arts, showcasing national and international performances of music, dance, opera, musical theater, and the spoken word. The competition is open to all qualified architects. For more information, visit [www.ccf.org.cy](http://www.ccf.org.cy).

### Bezalel Academy of Arts and Design, Jerusalem—International Architecture Competition

Registration: December 11, 2006–

January 11, 2007

Architects from around the world are invited to participate in the Bezalel Academy International Architecture competition to design the new campus in the center of Jerusalem. For additional information, visit [www.bezalel-competition.org.il](http://www.bezalel-competition.org.il).

### 2007 Arthur Ross Awards for Excellence in the Classical Tradition

Deadline: December 15, 2006

In May, the Institute of Classical Architecture Classical America will hold its annual Arthur Ross Awards at New York's historic University Club. The ICA is now accepting nominations for consideration by this year's Ross Awards jury, to be chaired by Bunny Williams. For more information, visit [www.classicist.org](http://www.classicist.org).

### 2007 Rudy Bruner Award

Application deadline: December 18, 2006

The Rudy Bruner Award for Urban Excellence seeks to discover special places that have solved urban problems with creative solutions. For more information about the award program, you can call 617/492-8401 or visit [www.brunerfoundation.org](http://www.brunerfoundation.org).

## Dates & Events

### **Rotch Traveling Scholarship**

*Application request deadline:*

*December 27, 2006*

The Rotch Traveling Scholarship was founded in 1883 with sufficient funds to ensure adequate income each year for young architects to pursue studies in foreign countries. For more information, visit [www.rotchscholarship.org](http://www.rotchscholarship.org).

### **2007 International Bamboo Building Design Competition**

*Registration deadline: December 31, 2006*

*Submission deadline: January 15, 2007*

Bamboo Technologies of Maui has launched the first International Design Competition for Structural Bamboo Buildings. Some of the winning entries will be chosen for manufacture by the world's premier builder of international-building-code-approved bamboo homes. The competition is open to architects, builders, designers, and students anywhere in the world. Visit [www.bamboocompetition.com](http://www.bamboocompetition.com).

### **The Loeb Fellowship Call for Nominations and Applications**

*Deadline: January 3, 2007*

Based at the Graduate School of Design, the program offers 10 annual post-professional awards for independent study at Harvard. For more information, visit [www.gsd.harvard.edu/loebfell](http://www.gsd.harvard.edu/loebfell).

### **Living Steel International Architecture Competition**

*Deadline for application: January 12, 2007*

Architectural firms of all sizes, scope, and geographic locations are encouraged to apply for this competition, which was launched to develop innovative approaches to meet sustainable housing needs, addressing the economic, environmental, and social aspirations of a growing world population. Three winning entries will be chosen by an independent jury composed of internationally respected architects Glenn Murcutt, Charles Correa, Andrew Ogorzalek, Jaime Lerner, James Berry, and Nicholas de Monchaux. For more information, visit [www.livingsteel.org](http://www.livingsteel.org).

### **2007 SEGD Design Awards Program**

*Deadline: January 31, 2007*

The Society for Environmental Graphic Design (SEGD) annual design competition honors the best in environmental graphic design. Projects include themed environments, way-finding and signage, place-making projects, mapping, public

art, identity programs, architectural graphics, exhibits, and retail. Visit [www.segd.org](http://www.segd.org).

### **The James Beard Foundation Awards**

*Restaurant and graphics deadline:*

*January 31, 2007*

The James Beard Foundation Awards recognize outstanding achievement within the fine food and beverage industry. The Awards honor professionals including cookbook authors, chefs, restaurateurs, winemakers, journalists, broadcasters, as well as restaurant and graphic designers in the United States. This competition is open to architects and designers in North America for restaurant projects since 2004. For more information, visit [www.jamesbeard.org](http://www.jamesbeard.org).

### **2007 Aurora Awards**

*Deadline: March 9, 2007*

Builders and architects who have demonstrated excellence and creativity when designing hurricane-resistant structures are invited to submit proposals to this design competition recognizing projects in the southeastern United States. Solutia, a manufacturer of polyvinyl butyral (PVB) interlayers for impact-resistant glass, is sponsoring a new category in the competition: The Safe & Secure Award will recognize builders, designers, architects, and other home-building professionals who incorporate—and meet or exceed code requirements for—impact-resistant windows and doors for safety, and who use other design elements that minimize the effects of hurricanes and other disasters on residential structures. Visit [www.theauroras.com](http://www.theauroras.com).

### **Project New Orleans Call for Submissions**

*Ongoing*

Project New Orleans is seeking to compile a record of all architectural and planning proposals created for the post-Katrina rebuilding of New Orleans. Submissions are welcomed, both written and graphic, from the architectural to the regional, and from all engaged in thinking about the future of the city in physical terms. For more information, visit [www.project-neworleans.org](http://www.project-neworleans.org).

*E-mail event and competition information two months in advance to [elisabeth\\_broome@mcgraw-hill.com](mailto:elisabeth_broome@mcgraw-hill.com).*

## Opening doors to new style and design.



Introducing door pulls from HDI. Strong on style, with the same attention to detail that has made us the industry leader in handrail design.

**HDI** Door Hardware

3905 Continental Drive • Columbia, PA 17512 USA  
PH: 717-285-4088 • FAX: 717-285-5083  
Email: [info@hdirailings.com](mailto:info@hdirailings.com)  
[www.hdidoorhardware.com](http://www.hdidoorhardware.com)

CIRCLE 90 ON READER SERVICE CARD OR GO TO [ARCHRECORD.CONSTRUCTION.COM/PRODUCTS/](http://ARCHRECORD.CONSTRUCTION.COM/PRODUCTS/)



# American Institute of Architecture Students

The design studio lies at the core of architectural education. The experiences, habits and patterns found within the studio make up what we have termed, "studio culture." Design studio teaches critical thinking and creates an environment where students are taught to question all things in order to create better designs.

The experience of a design studio has also driven away good people or genuinely and unnecessarily insulted many in the formal process of learning. The AIAS believes we can improve the way students are educated which will lead to better designers.

The efforts of the AIAS to have the entire profession of architecture think critically about the studio model

of education, has recently made remarkable progress. In coordination with our partners (AIA, ACSA, NAAB and NCARB), accredited schools are now expected to demonstrate a positive and respectful learning environment through the encouragement of the fundamental values of optimism, respect, sharing, engagement and innovation between and among the members of its faculty, student body, administration and staff. Nine other initiatives are also being implemented that will create additional positive changes.

Educators and professionals are encouraged to partner with schools on this issue to ensure they graduate well-rounded, prepared and talented emerging professionals. Visit [www.aias.org/studioculture](http://www.aias.org/studioculture) to learn more.

## STUDIO CULTURE RESPECT. INNOVATION. SHARING.



The AIAS is an independent, non-profit, and student-governed organization that is the sole official student voice in the profession. 50 YEARS OF LEADERSHIP: CONNECTING. INTEGRATING. UNITING.



**Good & Looks Integrity**

Handrails  
Wall Guards  
Corner Guards  
Door Protection  
Wall Covering  
Wainscot Paneling



Kwalu offers complete lines of **Virtually Indestructible™** wall protection systems. We offer a 10-year warranty on construction and finish and multiple mix and match options. Call 800.405.3441 or visit [kwalu.com](http://kwalu.com).

**Kwalu**  
Virtually Indestructible™

CIRCLE 91 ON READER SERVICE CARD OR GO TO [ARCHRECORD.CONSTRUCTION.COM/PRODUCTS/](http://ARCHRECORD.CONSTRUCTION.COM/PRODUCTS/)

## Turning Gray Concrete GREEN

These microscopic, glassy spheres are fly ash – and at Headwaters Resources, we sell millions of tons of them every year.

Produced by burning coal at electric power plants, fly ash might be destined for disposal in a landfill. But when added to concrete, fly ash makes concrete easier to work, stronger and more durable.

Fly ash also enhances the environmental performance of concrete. Mining and manufacturing of natural raw materials can be reduced along with decreasing greenhouse gas emissions. In fact, using a ton of fly ash can save almost a ton of CO<sub>2</sub> emissions from being introduced into the atmosphere. In addition to concrete, fly ash is used in mortars, stuccos, paints, artificial stone, carpets, ceiling tiles, soil cement, pervious concrete and a variety of other building materials.

*That's an improvement worth specifying.*

Contact Headwaters Resources for free technical literature and information on how fly ash use benefits the environment.



**HEADWATERS**  
RESOURCES

[www.flyash.com](http://www.flyash.com) • 1-888-236-6236

CIRCLE 92 ON READER SERVICE CARD OR GO TO [ARCHRECORD.CONSTRUCTION.COM/PRODUCTS/](http://ARCHRECORD.CONSTRUCTION.COM/PRODUCTS/)

5	4	Technical Glass Products <i>fireglass.com</i>
55	32	* Thermador <i>thermador.com</i>
209	59	Thermique Technologies <i>thermique technologies.com</i>
46	28	Tile of Spain <i>spaintiles.info</i>
52	31	Timely <i>timelyframes.com</i>
57	34	Tindall Corp <i>tindallcorp.com</i>
254	78	TOTO <i>totousa.com</i>
71	41	Verizon Wireless <i>verizonwireless.com</i>
70	39	VERSA-LOK <i>versa-lok.com</i>
222	63	Victor Oolitic Stone Company <i>victoroolitic.com</i>
154	47	Visa Lighting <i>visalighting.com</i>
40	23	VT Industries <i>vtindustries.com</i>
200-205	56, 57	* Won-Door Corporation <i>wondoors.com</i>
258	81	WSP Group Plc <i>flackandkurtz.com</i>
22	13	* YKK AP America Inc <i>ykkap.com</i>

**EXECUTIVE OFFICES**

Laura Viscusi, VP, Associate Publisher  
(212) 904-2518 Fax: (212) 904-2791  
*lviscusi@mcgraw-hill.com*

Assistant: Pina Del Genio  
(212) 904-6791 Fax: (212) 904-2791  
*pina\_delgenio@mcgraw-hill.com*

**NORTHEAST / MID-ATLANTIC (CT, DE, MA, ME, NH, NJ, NY, RI, VT, EASTERN PA, )**

Joe Sosnowski  
(610) 278-7829 Fax: (610) 278-0936  
*joseph\_sosnowski@mcgraw-hill.com*

**MIDWEST (IL, IN, KS, MI, ND, NE, OH, SD, WI)**

Lisa Nelson  
(312) 233-7402 Fax: (312) 233-7403  
*lisa\_nelson@mcgraw-hill.com*

Bret Ronk (IA, LA, MN, MO, MS, OK, TX)  
(972) 437-7877 Fax: (972) 437-7876  
*bret\_ronk@mcgraw-hill.com*

**SOUTHEAST / MID-ATLANTIC (AL, AR, DC, FL, GA, KY, MD, NC, TN, VA, WV & WESTERN PA)**

Susan Shepherd  
(404) 843-4770 Fax: (404) 252-4056  
*sshepherd@mcgraw-hill.com*

**WEST (AZ, CA, CO, NM, NV)**

Bill Hague  
(253) 858-7575 Fax: (253) 858-7576  
(760) 340-5575 Fax: (760) 340-0439  
*bill\_hague@mcgraw-hill.com*

**WEST (ID, MT, OR, S.CA, UT, WA, WY)**

Bill Madden  
(503) 224-3799 Fax: (503) 224-3899  
*bill\_madden@mcgraw-hill.com*

**INTERNATIONAL**

Dean Pushka (Canada)  
(905) 309-4458 Fax: (905) 309-1737  
*dean\_pushka@mcgraw-hill.com*

Martin Drueke (Germany)  
(49) 202-27169-12 Fax: (49) 202-27169-20  
*drueke@intermediapartners.de*

Ferruccio Silvera (Italy)  
(39) 022-846716 Fax: (39) 022-893849  
*ferruccio@silvera.it*

Katsuhiko Ishii (Japan)  
(03) 5691-3335 Fax: (03) 5691-3336  
*amskatsu@dream.com*

Young-Seoh Chin (Korea)  
(822) 481-3411/3 Fax: (822) 481-3414

**PRODUCT NEWS SPOTLIGHTS / POSTCARD SERVICE**

Deidre Allen  
(212) 904-2010 Fax: (609) 426-7136  
*deidre\_allen@mcgraw-hill.com*

**CLASSIFIEDS**

Diane Soister  
(212) 904-2021 Fax: (212) 904-2074  
*deidre\_allen@mcgraw-hill.com*

**SUBSCRIBER SERVICE**

(888) 867-6395 (USA only)  
(609) 426-7046 Fax: (609) 426-7087  
*p64cs@mcgraw-hill.com*

**BACK ISSUES**

(212) 904-4635  
*phyllis\_moody@mcgraw-hill.com*

**REPRINT MANAGEMENT SERVICES**

(800) 360-5549 x129  
*architecturalrecord@reprintbuyer.com*



# BuildingGreen

Trustworthy • Dependable • Timely

Design professionals who create healthier, greener buildings have relied on the information resources from BuildingGreen, Inc. since 1985.

BuildingGreen Suite™ • GreenSpec® Directory  
Environmental Building News™



**BuildingGreen, Inc.**

Battleboro, VT • 800-861-0954

[www.BuildingGreen.com](http://www.BuildingGreen.com)



Rakks extruded aluminum shelves on "C" standards & brackets | Clicquot, Inc. New York | Design: Traboscia Roiatti Architects

## SUPPORTING THE TOP SHELF



Rakks Bracket



Rakks on Pole



Universal Bracket



Aria Bracket

When the world's top designers are in need of sophisticated shelving, they turn to Rakks. Our display systems are sleek, distinctive and elegant. And they support some of the finest products in the world of retail. To see how Rakks can support you, visit us at [www.rakks.com](http://www.rakks.com) or call for a catalog.

**Rakks®**

In supporting roles everywhere

Rangine Corporation | 330 Reservoir Street | Needham, MA 02494 | 800-826-6006 | [www.rakks.com](http://www.rakks.com)

# AR Past and Present



## A tabula rasa in the Berkshires

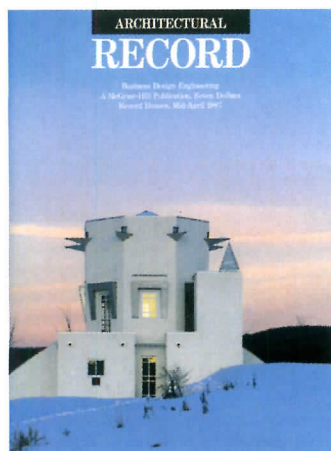

**ARCHITECTURAL RECORD HOUSES**  
Mid-April 1987

A Boston architect razes his own house, which was once on the cover of *RECORD* (above), and plans a new residence (top) with an updated aesthetic.

**O**n the night of October 30, 2006, a Caterpillar excavator turned the Schwartz/Fiekowsky house into one of the great satisfactions of modern architecture—a tabula rasa. The demolition came by order of the architect-owner Warren Schwartz of Schwartz/Silver, whose quirky family getaway in the Berkshires was the cover story for *Record Houses* in 1987 [*RECORD*, Mid-April 1987, page 114]. So why tear down your own award-winning house? After only 20 years, the aluminum “eyebrows” over the windows and doors, the perforated-metal pyramid, and the Lady Liberty-esque rain heads dated the architecture, and rendered it simply unfashionable (read Postmodern).

Inspired by Vincenzo Scamozzi’s 16th-century Villa Pisani, in Vicenza; an elephant; the Statue of Liberty; and transformer toys, by 2006 the house had become an aesthetic white elephant. While most architects would refuse to demolish their work (their houses often double as the chronicle of their creative evolution), Schwartz opted to erase and start anew. He is replacing the house with a 90-foot-long Modernist structure, 45 feet of which cantilever from the sloped site. He intends this glass-and-metal house to be more durable than its predecessor, both physically and aesthetically. Schwartz and his wife, Sheila Fiekowsky, plan to occupy their new getaway by July 4, 2007. *John Gendall*





## Only with engineered wood

"The design goals were to create a place of learning that is warm, welcoming and inspiring. The use of exposed glulam beams and columns plays an important role in helping us achieve these goals."

Paul Akiyama, AIA,  
Principal, BCRA  
Tacoma, Washington

It didn't take long for students at the new Milgard School at Charles Wright to grasp BCRA's impressive new environment. The inspiration is written all over their faces. The faculty and staff are equally engaged by the alluring beauty and complex geometry of the soaring structure.

Consider:

- Cost reductions
- Condensed construction schedules
- Thermal savings
- Sustainable resources
- Wide availability

For more inspiration, see our portfolio of school projects at [www.glulambeams.org](http://www.glulambeams.org)



ENGINEERED WOOD SYSTEMS  
**APA EWS**

**HAWORTH**<sup>®</sup>  
change by design

See the new Compose™  
furniture system – and other  
products and solutions –  
that help make workspaces  
great spaces.

Visit our new Dallas  
showroom or any of the  
other Haworth locations  
around the world.

[www.haworth.com](http://www.haworth.com)  
866.833.4343

**great spaces.**

037C16 84429  
01/30/08 403062 SEL.B Haworth Group

CIRCLE 105 ON READER SERVICE CARD OR GO  
TO [ARCHRECORD.CONSTRUCTION.COM/PRODUCTS/](http://ARCHRECORD.CONSTRUCTION.COM/PRODUCTS/)





**Diva Lounge,  
Somerville,  
Massachusetts**

With Light This!, Studio Luz adapted 500 polycarbonate skylight bubbles into the pillowlike walls and ceiling of Diva Lounge; the bubbles are backlit by 10,000 preprogrammed LEDs. Barraza and Piermarini textured three bathroom pods by placing perforated rug pads on the exteriors before applying the finish coat of plaster. The pads were removed before the final layer of plaster hardened.



## Hope for the Children of Haiti campus, Port-au-Prince, Haiti

Although ground breaking won't take place until 2008, Studio Luz's pro bono master plan for Hope for the Children of Haiti has already been three years in the making. The 16-acre campus will include 100,000 square feet of livable building, with housing for 90 orphans (left), community school facilities (below and below left), and a medical clinic. To match the pace of donations, construction may happen in increments, beginning with infrastructural cores from which rooms are later appended.

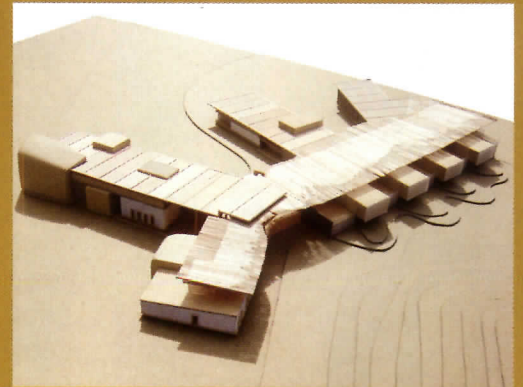
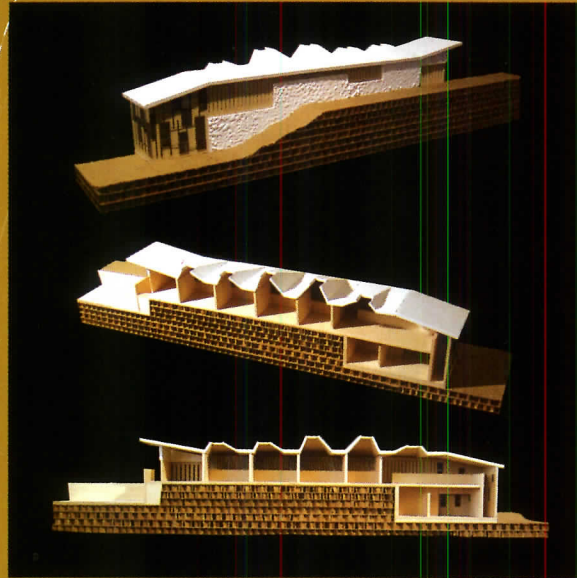

## Terrain: Vulnerable Architecture, Drake University, Iowa

Studio Luz exhibited images of its campus design for the aid organization Hope for the Children of Haiti at the museum show *Terrain: Vulnerable Architecture*, held at Drake University, in Des Moines, in 2005. Displays were mounted inside chicken-wire mini-tunnels projecting from rows of quick-tubes. There are 61 tubes in total, representing the number of orphans currently under the care of the Haitian group, and their lengths correspond with each child's age.

