

ARCHITECTURAL RECORD

MAKING THE GRADE University Buildings

**America's
Top Architecture
Schools 2014**





CEILING SYSTEMS

Between us, ideas become reality™

PRODUCTS: MetalWorks™ Torsion Spring various sized panels with PureWood™ Natural Variations™ Maple on custom aluminum suspension system
BUILDING: College auditorium in Arizona

BRINGING REMARKABLE PERFORMANCE TO THE WINSPEAR OPERA HOUSE.

Designed as a 21st-century reinterpretation of the traditional opera house, the Margot and Bill Winspear Opera House in Dallas presented many unique design and performance challenges. VT was up to the part, manufacturing architectural wood doors that delivered superior acoustics, enhanced fire ratings, and showstopping custom beauty.



Many of the 3-inch-thick doors were fire rated for 90 minutes



2- and 3-inch-thick doors met the theatre's heightened acoustic requirements



**Architectural
Wood Doors**

VTDoors.com 1-800-827-1615 (ext. 512)

©2013 VT Industries, Inc. All rights reserved.

CIRCLE 43



The mark of
responsible forestry

REFLECTING PRESENCE

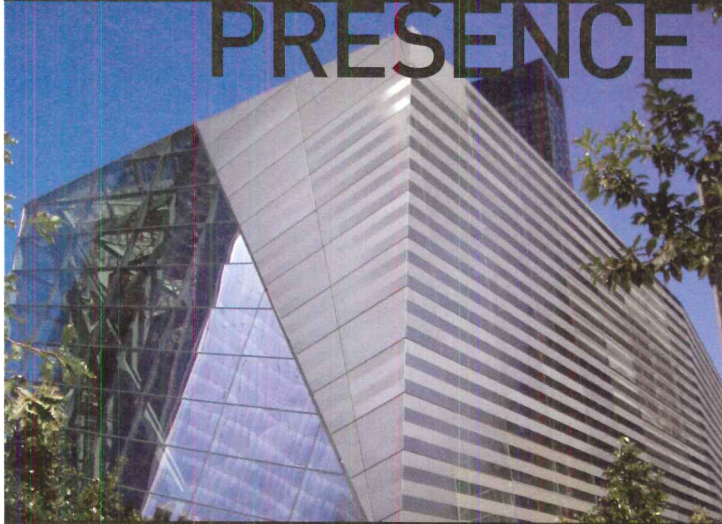

As the only building officially on memorial grounds, the **National September 11 Memorial Museum Pavilion** must echo the somber dignity of its WTC environs while admitting thousands of visitors to its exhibits each day. To achieve these diverse goals, **Snohetta** teamed with consultant **Front Inc.** to design an enclosure that both maximizes the building's security and mirrors its placid surroundings. Through the changing days and seasons, it offers museumgoers a setting for reflection on the past while looking to the future.

Transforming design into reality

For help achieving the goals of your next project, contact the Ornamental Metal Institute of New York.

 **Ornamental Metal Institute of New York**

Publisher of *Metals in Construction*
211 E 43 ST | NY, NY 10017 | 212-697-5554 | www.ominny.org

Architect: Snohetta
Photo: Snohetta

ARCHITECTURAL RECORD

EDITOR IN CHIEF	Cathleen McGuigan, cathleen.mcguigan@mhfi.com
MANAGING EDITOR	Beth Broome, elisabeth.broome@mhfi.com
SENIOR GROUP ART DIRECTOR	Francesca Messina, francesca.messina@mhfi.com
DEPUTY EDITORS	Clifford A. Pearson, pearsonc@mhfi.com Suzanne Stephens, suzanne.stephens@mhfi.com
SENIOR EDITORS	Joann Gonchar, AIA, LEED AP, joann.gonchar@mhfi.com Linda C. Lentz, linda.lentz@mhfi.com
PRODUCTS EDITOR	Sheila Kim, sheila.kim@mhfi.com
SENIOR EDITOR, DIGITAL MEDIA	William Hanley, william.hanley@mhfi.com
NEWS EDITOR	Laura Raskin, laura.raskin@mhfi.com
ASSISTANT EDITOR	Laura Mirviss, laura.mirviss@mhfi.com
EDITORIAL INTERN	Anna Fixsen, anna.fixsen@mhfi.com
ART DIRECTOR	Helene Silverman, helene.silverman@mhfi.com
ASSOCIATE ART DIRECTOR	Gordon Whiteside, gordon.whiteside@mhfi.com
CONTRIBUTING ILLUSTRATORS, PRESENTATION DRAWINGS	I-Ni Chen Peter Coe
EDITORIAL SUPPORT	Monique Francis, monique.francis@mhfi.com
CONTRIBUTING EDITORS	Sarah Amelar, Fred A. Bernstein, Robert Campbell, FAIA, C.J. Hughes, Blair Kamin, Jayne Merkel, Robert Murray, David Sokol, Michael Sorkin, Ingrid Spencer, Clare Jacobson, Lamar Anderson
SPECIAL INTERNATIONAL CORRESPONDENT	Naomi R. Pollock, AIA
INTERNATIONAL CORRESPONDENTS	David Cohn, Tracy Metz, Aric Chen, Chris Foges
CONTRIBUTING PHOTOGRAPHER	Iwan Baan

ARCHITECTURAL RECORD: (ISSN 0003-858X) November 2013. Vol. 201, No. 11. Published monthly by McGraw Hill Financial, 1221 Avenue of the Americas, New York, NY 10020. **FOUNDER:** James H. McGraw (1860-1948). Periodicals postage paid at New York, NY, and additional mailing offices. Canada Post International Publications Mail Product Sales Agreement No. 40012501. E-mail: arhcustserv@cdsfulfillment.com. Registered for GST as McGraw Hill Financial. GST No. R123075673. **POSTMASTER:** Please send address changes to ARCHITECTURAL RECORD, Fulfillment Manager, P.O. Box 5732, Harlan, IA 51593. **SUBSCRIPTION:** Rates are as follows: U.S. and Possessions \$72.00; Canada and Mexico \$79 (payment in U.S. currency, GST included); outside North America \$199 (air freight delivery). Single copy price \$9.95; for foreign \$11. Subscriber Services: 877/876-8093 (U.S. only); 515/237-3681 (outside the U.S.); fax: 712/755-7423. **SUBMISSIONS:** Every effort will be made to return material submitted for possible publication (if accompanied by stamped, self-addressed envelope), but the editors and the corporation will not be responsible for loss or damage. **SUBSCRIPTION LIST USAGE:** Advertisers may use our list to mail information to readers. To be excluded from such mailings, send a request to ARCHITECTURAL RECORD, Mailing List Manager, P.O. Box 555, Hightstown, NJ 08520. **OFFICERS OF MCGRAW HILL FINANCIAL, INC.:** Harold W. McGraw III, Chairman, *President and Chief Executive Officer*; Kenneth M. Vittor, *Executive Vice President and General Counsel*; Robert J. Bahash, *Executive Vice President and Chief Financial Officer*; Elizabeth O'Melia, *Senior Vice President, Treasury Operations*. **COPYRIGHT AND REPRINTING:** Title ® reg. in U.S. Patent Office. Copyright © 2013 by McGraw Hill Financial. All rights reserved. Where necessary, permission is granted by the copyright owner for libraries and others registered with the Copyright Clearance Center (CCC), 222 Rosewood Drive, Danvers, MA 01923. To photocopy any article herein for personal or internal reference use only for the base fee of \$1.80 per copy of the article plus ten cents per page, send payment to CCC, ISSN 0003-858X. Copying for other than personal use or internal reference is prohibited without prior written permission. Write or fax requests (no telephone requests) to Copyright Permission Desk, ARCHITECTURAL RECORD, Two Penn Plaza, New York, NY 10121-2298; fax 212/904-4256. For reprints call 800/360-5549 x168 or e-mail architecturalrecord@theygsgroup.com. Information has been obtained by McGraw Hill Financial from sources believed to be reliable. However, because of the possibility of human or mechanical error by our sources, McGraw Hill Financial and *Architectural Record* do not guarantee the accuracy, adequacy, or completeness of any information and are not responsible for any errors or omissions therein or for the results to be obtained from the use of such information or for any damages resulting therefrom.

EDITORIAL OFFICES: 212/904-6229. Editorial fax: 212/904-4256. E-mail: monique.francis@mhfi.com. Two Penn Plaza, New York, NY 10121-2298. **WEBSITE:** ArchitecturalRecord.com.



OPTIQ™

a smart new window series

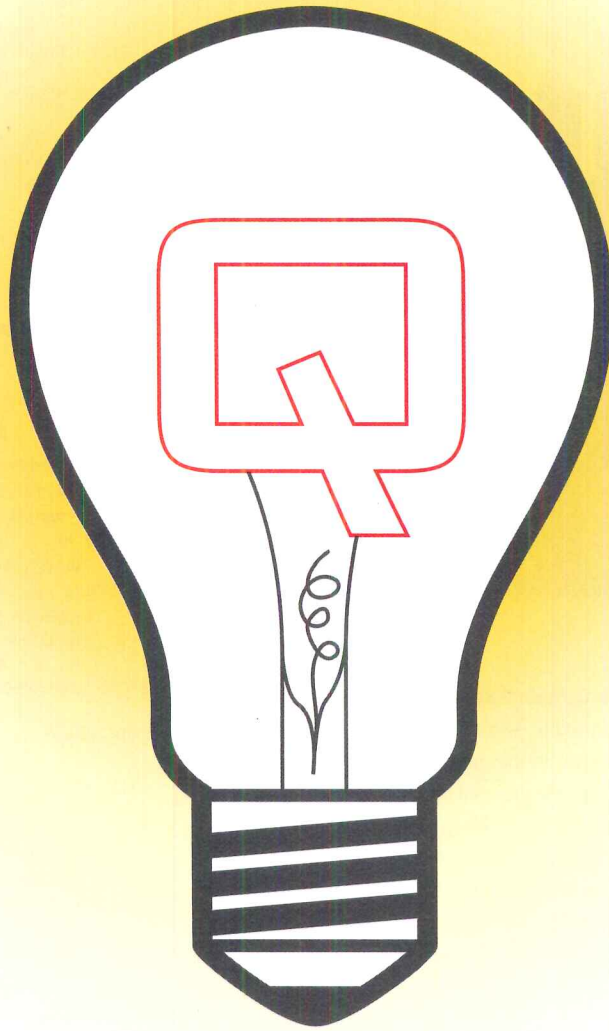

THERMAL INTELLIGENCE JUST GOT BRIGHTER

Introducing the Newest OptiQ™ Ultra Thermal Windows from Traco

The industry's smartest window keeps getting smarter. The new AA®5450 single and double hung windows – the latest in the OptiQ™ Ultra Thermal Window series – continue to set the standard for brilliance in window design. The result of an

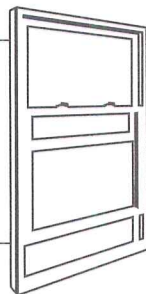

ongoing partnership with the U.S. Department of Energy, the AA5450 series window integrates innovative features to deliver the highest levels of thermal performance. **With the AA5450 series window, thermal intelligence just got brighter.**



kawneer.com

© 2013 Kawneer Company, Inc.

CIRCLE 28

 **TRACO**
A DIVISION OF KAWNEER

SLANT ROUTES

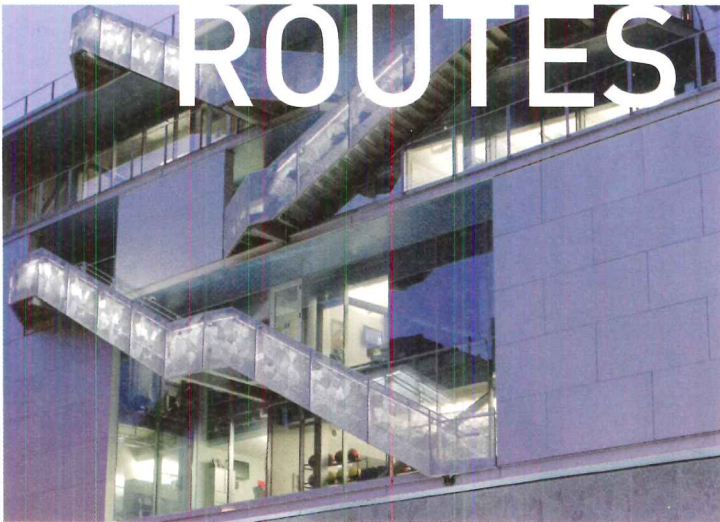

Columbia University's new field house, the **Campbell Sports Center** by **Steven Holl Architects**, is designed to be a team player with facilities that foster balance between the minds and bodies of student athletes in a range of sports. Inspired by the slanting lines of field-play diagrams, the building's design relies on point foundations and a lightweight steel structure to achieve its diverse program on a sloped site. The university's first new athletics building since the mid-1970s, Campbell forms a gateway to the revitalized Baker Athletics Complex, and a new game plan for sports at Columbia.

Structural Steel Right for any application

For help achieving the goals of your next project, contact the Steel Institute of New York.



Publisher of *Metals in Construction*
211 E 43 ST | NY, NY 10017 | 212-697-5553 | www.siny.org

Architect: Steven Holl Architects
Structural Engineer: Robert Silman Associates
Photo: Iwan Baan

CIRCLE 8

ARCHITECTURAL RECORD

VICE PRESIDENT, PUBLISHER

Laura Viscusi, laura.viscusi@mhfi.com

SENIOR DIRECTOR, MEDIA OPERATIONS

Brenda Griffin, brenda.griffin@mhfi.com

DIRECTOR, CREATIVE SERVICES

William Taylor, william.taylor@mhfi.com

PRODUCTION MANAGER

Marilyn DeMilta, marilyn.demilta@mhfi.com

MANAGER, MARKETING COMMUNICATIONS

Michael Nass, michael.nass@mhfi.com

FINANCE DIRECTOR

Ike Chong, ike.chong@mhfi.com

FINANCE MANAGER

Tom Maley, tom.maley@mhfi.com

ASSISTANT TO MEDIA DEPARTMENT

Pina Del Genio, pina.delgenio@mhfi.com

ADVERTISING SALES

NEW ENGLAND AND PA: Joseph Sosnowski

(610) 278-7829 Fax: (610) 278-0936, joseph.sosnowski@mhfi.com

SOUTHEAST/MID-ATLANTIC: Susan Shepherd

(859) 987-9913 Fax: (404) 252-4056, susan.shepherd@mhfi.com

MIDWEST (IA, IL, MN, MO, WI): Martin McClellan

(312) 233-7402 Fax: (312) 233-7430, martin.mcclellan@mhfi.com

MIDWEST (IN, MI, OH, EASTERN CANADA): Lisa Zurick

(513) 345-8210 Fax: (513) 345-8250, lisa.zurick@mhfi.com

NORTHWEST: Bill Madden

(503) 557-9000 Fax: (503) 557-9002, bill.madden@mhfi.com

PACIFIC/TEXAS: Sherylen Yoak

(760) 568-0465 Fax: (720) 559-9818, sherylen.yoak@mhfi.com

KS, NE, ND, NY, SD: Risa Serin

(212) 904-6041 Fax: (212) 904-4652, risa.serin@mhfi.com

SPOTLIGHT SALES: Risa Serin

(212) 904-6041 Fax: (212) 904-4652, risa.serin@mhfi.com

WORKFORCE/RECRUITMENT: Diane Soister

(212) 904-2021 Fax: (212) 904-2074, diane.soister@mhfi.com

INTERNATIONAL

GERMANY: Uwe Riemeyer

(49) 202-27169-0 Fax: (49) 202-27169-20, riemeyer@intermediapartners.de

ITALY: Ferruccio Silvera

(39) 022-846716 Fax: (39) 022-893849, ferruccio@silvera.it

JAPAN: Katsuhiro Ishii

(03) 5691-3335 Fax: (03) 5691-3336, amkatsu@dream.com

KOREA: Young-Seoh Chin

(822) 481-3411/3 Fax: (822) 481-3414

MCGRAW-HILL CONSTRUCTION

PRESIDENT Keith Fox

Linda Brennan, linda.brennan@mhfi.com

VICE PRESIDENT, MHC PRODUCT DEVELOPMENT Kathryn E. Cassino, kate.cassino@mhfi.com

VICE PRESIDENT, TECHNOLOGY Isaac Sacolick, isaac.sacolick@mhfi.com

VICE PRESIDENT, FINANCE John Murphy, john.murphy@mhfi.com

WEBSITE: ArchitecturalRecord.com. SUBSCRIBER SERVICE: 877/876-8093 (U.S. only); 515/237-3681 (outside the U.S.). Subscriber fax: 712/755-7423. E-mail: arhcustserv@cdsfulfillment.com. If the Post Office alerts us that your magazine is undeliverable, we have no further obligation unless we receive a corrected address within one year. INQUIRIES AND SUBMISSIONS: Letters, Beth Broome; Practice, Suzanne Stephens; Books, Clifford A. Pearson; Products, Sheila Kim; Lighting and Interiors, Linda C. Lentz; Residential, Laura Raskin; Architectural Technology, Joann Gonchar; Web Editorial, William Hanley. REPRINT: architecturalrecord@theygroup.com. BACK ISSUES: Call 877/876-8093, or go to archrecord.com/backissues.



PRINTED IN USA

AT ALPOLIC, WE'VE DONE OUR HOMEWORK.

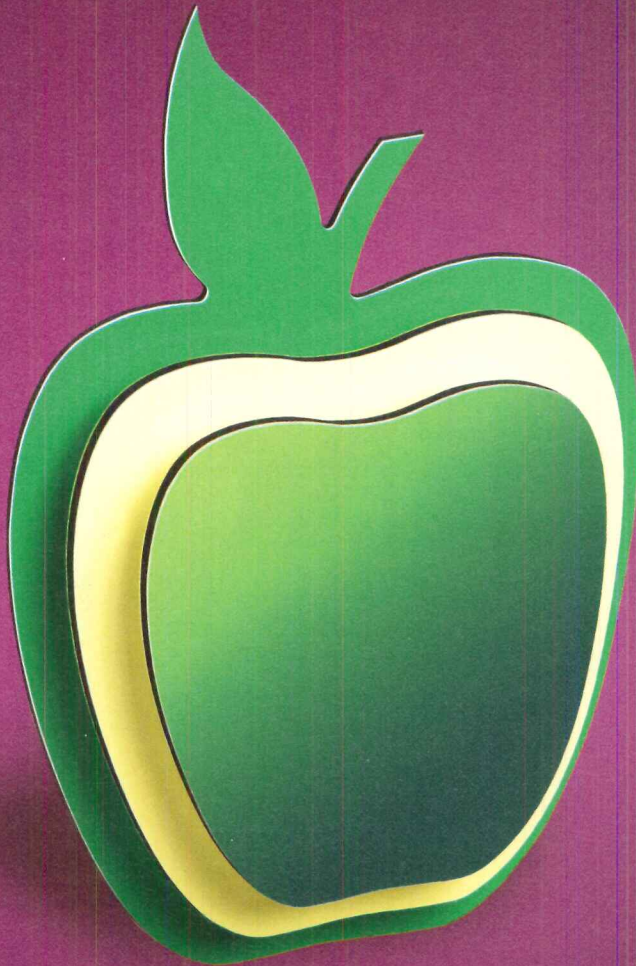

When it comes to meeting the architectural needs of educational institutions, ALPOLIC passes all tests with flying colors. Combining beauty with sustainability, phenomenal strength, lightness, and durability inside and out, ALPOLIC aluminum and metal composite panels provide a wealth of cost-competitive, easily fabricated possibilities to architects and designers of educational facilities. And our large range of innovative finishes, are at the top of the class. **For more information and to access our new Continuing Education course, visit us at www.alpolic-northamerica.com/case-studies.**

ALPOLIC®
ALPOLIC/fr
MATERIALS

MITSUBISHI PLASTICS COMPOSITES AMERICA, INC.



©2013 Mitsubishi Plastics Composites America, Inc. All Rights Reserved. ALPOLIC® is a registered trademark of Mitsubishi Plastics, Inc. LUMIFLON® is a registered trademark of Asahi Glass Co., Ltd.

CIRCLE 52

A large ball of natural fiber twine, possibly made of jute or sisal, is the central focus of the image. It is positioned on the right side, with several strands of the twine extending outwards in a circular pattern across the frame. The background is a dark, textured surface that resembles a wood grain or a similar natural material. In the top left corner, there is a dark red rectangular shape. The overall aesthetic is rustic and natural.

Johnsonite®

Extraordinary inspiration from unexpected places.

A rusted shovel. A seashell. A charred piece of firewood. They may not seem like luxury objects, but their unique textures, patterns and colors inspired the unexpected new designs of I.D. Freedom™ Luxury Planks and Tile.

This collection combines the natural with the naturally unnatural, and allows you to pair abstracts with stones and woods, and all other lines of Johnsonite® flooring. And while the inspiration can come from many places, I.D. Freedom comes only from the U.S.A. To learn more, call 1.888.899.8916 or visit tarkettna.com/whatsyourinspiration.



THE ULTIMATE
FLOORING EXPERIENCE

ARCHITECTURAL RECORD

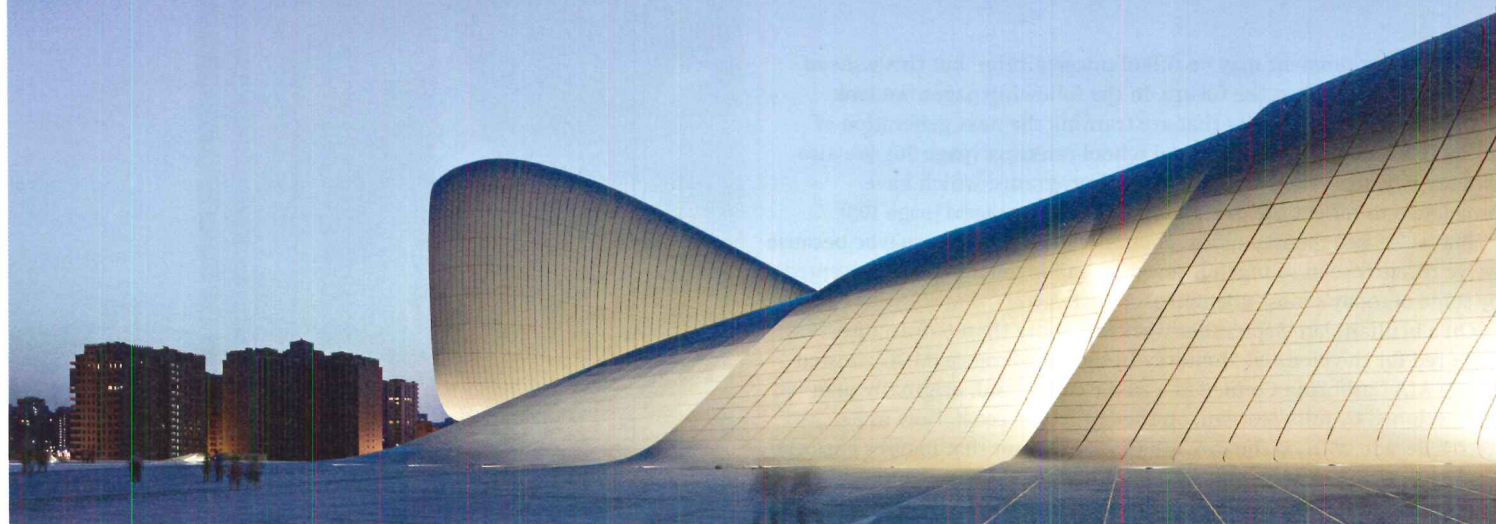

11 2013

ARCHITECTURE EDUCATION **NOW**

NEWS

- 25 WILL TOKYO'S OLYMPICS LEAVE A DESIGN LEGACY? *By Naomi R. Pollock, AIA*
- 30 REIMAGINING EERO SAARINEN'S BELL LABS *By Ronda Kaysen*
- 43 ONE YEAR AFTER SANDY *By James S. Russell*

DEPARTMENTS

- 12 EDITOR'S LETTER: DESIGN, TECHNOLOGY, AND THE CITY
- 46 ARCHITECTURAL ANALYTICS
- 49 HOUSE OF THE MONTH: RYALL PORTER SHERIDAN'S L.I. HOUSE *By Laura Mirviss*
- 54 IN FOCUS: SHIGERU BAN'S CARDBOARD CATHEDRAL *By Naomi R. Pollock, AIA*
- 58 FIRST LOOK: A UNIVERSITY IN VIENNA CREATES A NEW CAMPUS *By Clifford A. Pearson*
- 69 BOOKS: ROWAN MOORE'S *WHY WE BUILD* *Reviewed by Aleksandr Bierig*
- 70 BOOKS: BEN KATCHOR'S *HAND-DRYING IN AMERICA* *Reviewed by Erin McHugh*
- 73 GUESS THE BUILDING
- 77 PRODUCT FOCUS: WOOD *By Sheila Kim*
- 79 PRODUCT BRIEFS: EDUCATION *By Sheila Kim*
- 82 CLOSE-UP: ZAHA HADID'S HEYDAR ALIYEV CULTURAL CENTER *By Iwan Baan*

95 INTRODUCTION

- 96 AMERICA'S TOP ARCHITECTURE SCHOOLS 2014 *By James P. Cramer*
- 100 CROSSING BORDERS *By Sarah Amelar*

BUILDING TYPES STUDY 940 COLLEGES & UNIVERSITIES

- 109 INTRODUCTION
- 110 FOOTBALL PERFORMANCE CENTER, UNIVERSITY OF OREGON, EUGENE ZGF ARCHITECTS *By Laura Raskin*
- 116 CLEMSON UNIVERSITY COLLEGE OF ARCHITECTURE, SOUTH CAROLINA THOMAS PHIFER AND PARTNERS *By Suzanne Stephens*
- 122 UNIVERSITY OF NORTH CAROLINA GENOME SCIENCES BUILDING, CHAPEL HILL SKIDMORE, OWINGS & MERRILL *By Sara Hart*
- 128 FAY JONES SCHOOL OF ARCHITECTURE, UNIVERSITY OF ARKANSAS, FAYETTEVILLE MARLON BLACKWELL ARCHITECT *By William Hanley*
- 134 MARQUEZ HALL, COLORADO SCHOOL OF MINES, GOLDEN BOHLIN CYWINSKI JACKSON *By David Hill*
- 140 KRISHNA P. SINGH CENTER FOR NANOTECHNOLOGY, PHILADELPHIA WEISS/MANFREDI *By Joann Gonchar, AIA*

LIGHTING

- 157 INTRODUCTION
- 158 HEDONISM WINES, LONDON UNIVERSAL DESIGN STUDIO/SPEIRS + MAJOR *By Chris Foges*
- 160 SAISON, SAN FRANCISCO JIUN HO *By Lamar Anderson*
- 167 MAYSVILLE, NEW YORK CITY BERMAN HORN STUDIO *By Linda C. Lentz*
- 171 LIGHTING PRODUCTS *By Sheila Kim*
- 224 READER SERVICE
- 226 DATES & EVENTS
- 232 SNAPSHOT: LAST FOLIO *By Anna Fixsen*

THIS PAGE: HEYDAR ALIYEV CULTURAL CENTER, BY ZAHA HADID. PHOTO BY IWAN BAAN.

ON THE COVER: KRISHNA P. SINGH CENTER FOR NANOTECHNOLOGY, BY WEISS/MANFREDI. PHOTO BY ALBERT VECERKA/ESTO

See expanded coverage of Projects and Building Types Studies as well as web-only features at architecturalrecord.com.

This symbol denotes that enhanced content is available in our iPad edition.

 Visit us at facebook.com/architecturalrecord

 Follow us on Twitter at [@archrecord](https://twitter.com/archrecord)

Design, Technology, and the City

Inspiring work and ideas from the profession's great talents

THE PRESENT moment may be full of uncertainties, but this issue of *RECORD* is really about the future. In the following pages, we look at colleges and universities that are training the next generation of architects and present our annual school rankings [page 96]. We also explore new directions in architectural programs, which have broadened to reflect the demands of a changing world [page 100].

But we're also feeling upbeat about design right now—maybe because we've recently seen so much innovative and inspiring work, presented by some of today's most talented architects.

On a brilliant late-September weekend, more than 600 architects gathered for the biennial Monterey Design Conference (MDC), hosted by the AIA California Council at a rustic compound, originally planned and designed by Julia Morgan, on the California coast. Now in its fourth decade, MDC is the rare architecture event that focuses entirely on design. The stellar roster of speakers included Kengo Kuma of Japan, Odile Decq of France, and Marcio Kogan of Brazil, along with a great American crew—Marlon Blackwell, Anne Fougerson, Thomas Phifer, and Jennifer Yoos, among others—and four emerging West Coast firms. It was a strong showing of beautiful and intelligent work, created by architects deeply engaged in the larger worlds of culture and art, politics and society, nature and cities. Two of the projects presented are included in this issue—architecture schools by Blackwell [page 128] and Phifer [page 116]. Among the many other highlights of the conference: a house by Fougerson that cantilevers off a cliff; the elegant pavilions in a rolling landscape that Phifer is designing for a private art collection; the mirrored lavatories in a museum by Decq that she said, with a Gallic shrug, were inspired by Jacques Tati's *Playtime*; the witty short films Kogan has made to show off the stunning houses designed by his firm, Studio MK27.

"We work between the ideal and the improvised," said Blackwell, a statement that applied not only to his own firm's inventive, tight-budget work—such his post-Katrina Porchdog house in Biloxi, Mississippi—but to others', including Yoos's firm VJAA, which used digital technology to design the twisted roof of a serenely simple boathouse (cost: \$78 per square foot).

A few days after Monterey, *RECORD* held its 11th annual Innovation Conference in New York [page 27], where we looked at design within a larger sphere of evolving digital technology. While most architects would agree with keynoter Liz Diller, of Diller Scofidio + Renfro, that digital technology is merely a tool embedded in the design process, the conference explored newer applications and larger implications. Those included the rapidly growing potential of digital fabrication and the impact of so-called Big Data on shaping the urban realm. Keith

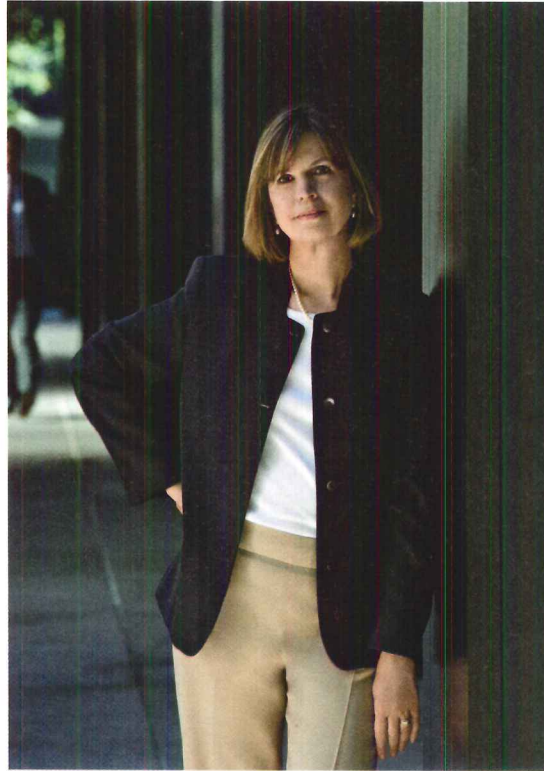

Besserud of Skidmore, Owings & Merrill's Chicago office talked about planning a future community on a 600-acre brownfield site, using computational models developed by the Argonne National Laboratory and the University of Chicago to analyze data about everything from future energy use to water management. As Lise Anne Couture, of the firm Asymptote Architecture, put it, "Innovation is not just about using digital tools but how you creatively solve problems."

One emerging theme of the conference is that architecture continues to move beyond the design of solitary buildings. Thom Mayne, an early master of the singular, digitally designed structure, said in the final keynote, "My work is about relationships and the nature of connection, not the object. I think innovation will be in the urban realm, not in iconic architecture."

Iconic architecture remains a big part of the city—just see Zaha Hadid's latest, a cultural center opening this month in Baku, Azerbaijan [page 82]—but as architects look toward the future, the challenges will be much greater than any single building can address. ■

Cathleen McGuigan

Cathleen McGuigan, Editor in Chief

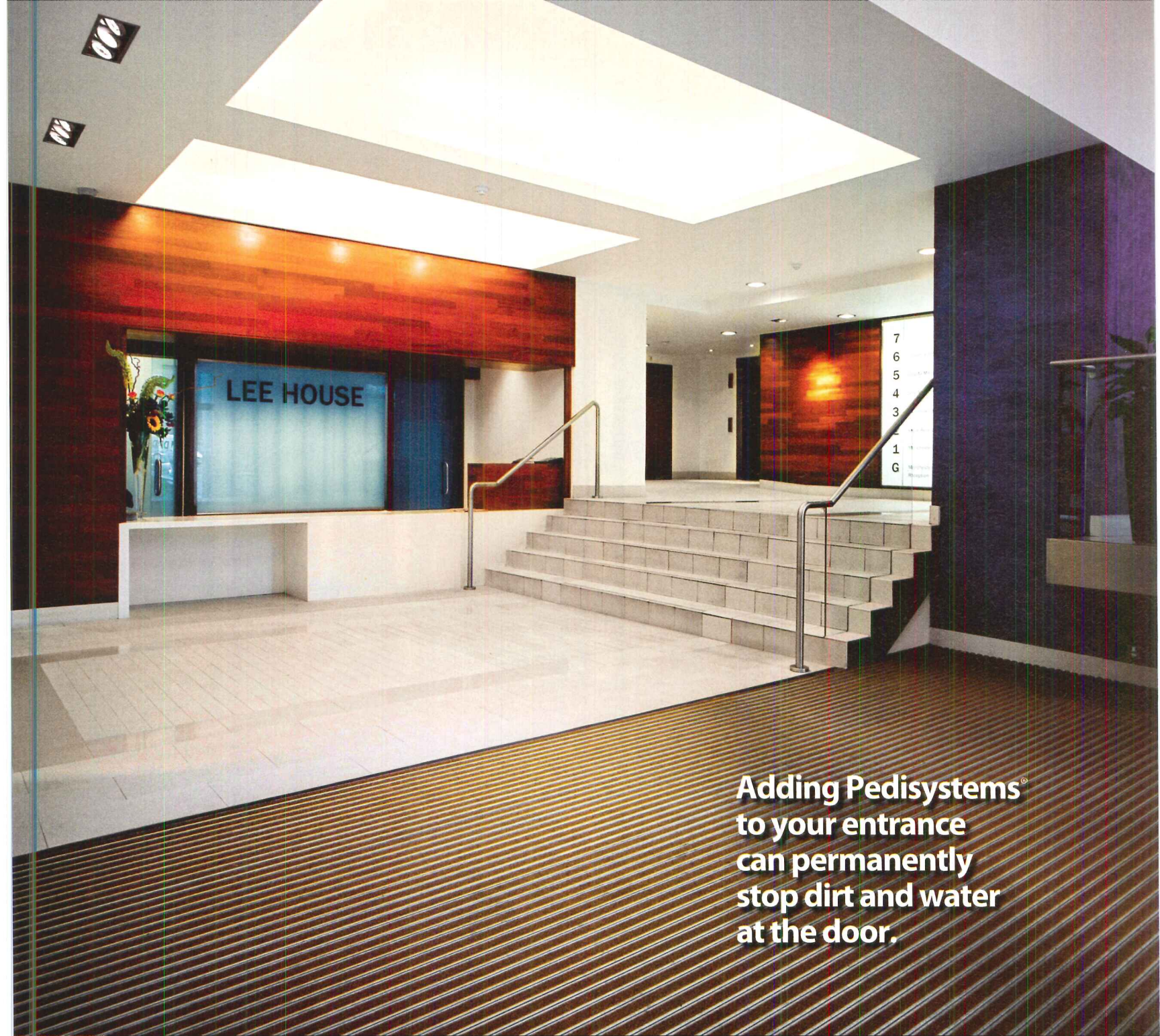

**Adding Pedisystems®
to your entrance
can permanently
stop dirt and water
at the door.**

C/S Pedisystems® entrance grids and mats stop moisture and foreign contaminants from entering your building more effectively than throw down mats ever could—and they look great doing it. Used in tens of thousands of buildings worldwide, Pedisystems can significantly reduce floor cleaning costs in new or retrofitted buildings. Pedisystems mats and grids can easily be retrofitted in your building even if they were not originally designed in your entrance. To learn more, call Construction Specialties at 888-621-3344, or visit www.c-sgroup.com. See us at Greenbuild, booth #2437.

CS™ Pedisystems®

curve your enthusiasm

arboreal®
acoustical wood walls+ceilings



- real wood veneer
- recycled aluminum non-combustible core
- no added formaldehyde



arboreal[®]

SUNY Oswego, Piez Hall. Architect: Cannon Design. © 2013 Ceilings Plus

CIRCLE 39

CEILINGS PLUS[®]
ceilingsplus.com +1 323 724 8166

LEARN & EARN



Earn all your continuing education credits free online or at Architectural Record's Continuing Education App!*

IN THIS ISSUE



Daylight Autonomy 101
Sponsored by Lutron Electronics Co., Inc.
Photo courtesy of Coscia Moos Architecture

Credit: 1 HSW, 1 GBCI HOUR page 186

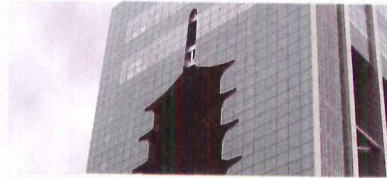

Anodized Aluminum for Architectural Applications
Sponsored by Lorin Industries

Credit: 1 HSW page 199



Paving the Way for Long-Term Stormwater Management
Sponsored by Oldcastle Building Products

Credit: 1 HSW, 1 GBCI HOUR page 213



Class Glass
Sponsored by Hawa

Credit: 1 HSW, 1 GBCI HOUR page 190



EIFS – Performance Beyond Code Compliance
Sponsored by Dryvit Systems, Inc.

Credit: 1 HSW, 1 GBCI HOUR page 204



Designed, Sealed, Delivered—IAQ and the Building Enclosure

Sponsored by UL Environment

Credit: 1 HSW, 1 GBCI HOUR page 218



Dynamic Solar Control with Electrochromic Glazing
Sponsored by SAGE Electrochromics, Inc.

Credit: 1 HSW, 1 GBCI HOUR page 194



Fiberglass Door Systems
Sponsored by Chase Doors

Credit: 1 HSW page 208



Controlling Sound Transmission in Multifamily, Healthcare, and Educational Environments
Sponsored by ECOSilence

Credit: 1 HSW page 222

NEW ONLINE AT ARCHRECORD.COM



Cross Laminated Timber
Sponsored by reThink Wood, American Wood Council, and FPInnovations

Credit: 1 HSW, 1 GBCI CE Hour

ALSO ONLINE AT ARCHRECORD.COM

Light and Truth: Greener Interiors with Glass Partitions
Sponsored by THE SLIDING DOOR COMPANY®

A Guide for Specifying Commercial Lighting
Sponsored by Prudential Lighting

EIFS Update: Pick the Right Substrate
Sponsored by Georgia-Pacific Gypsum

Smart Safety Design to Prevent Slips, Trips and Falls
Sponsored by SlipNOT® Metal Safety Flooring

Specifying Foundation Flood Vents for Building Sustainability, Durability and Performance
Sponsored by Smart Vent Products, Inc.

Floodproofing Non-Residential Buildings
Sponsored by Smart Vent Products, Inc.

Specifying Metal Ceilings
Sponsored by Armstrong Ceiling Systems

Specifying Wood Ceilings and Walls
Sponsored by Armstrong Ceiling Systems

Earn Free Health Safety Welfare (HSW) and Green Building Certification Institute (GBCI) credits with Architectural Record

*All Architectural Record articles and presentations count toward the annual AIA continuing education requirement. All exams are available at no charge and are instantly processed.

Six ways Dodge builds your business

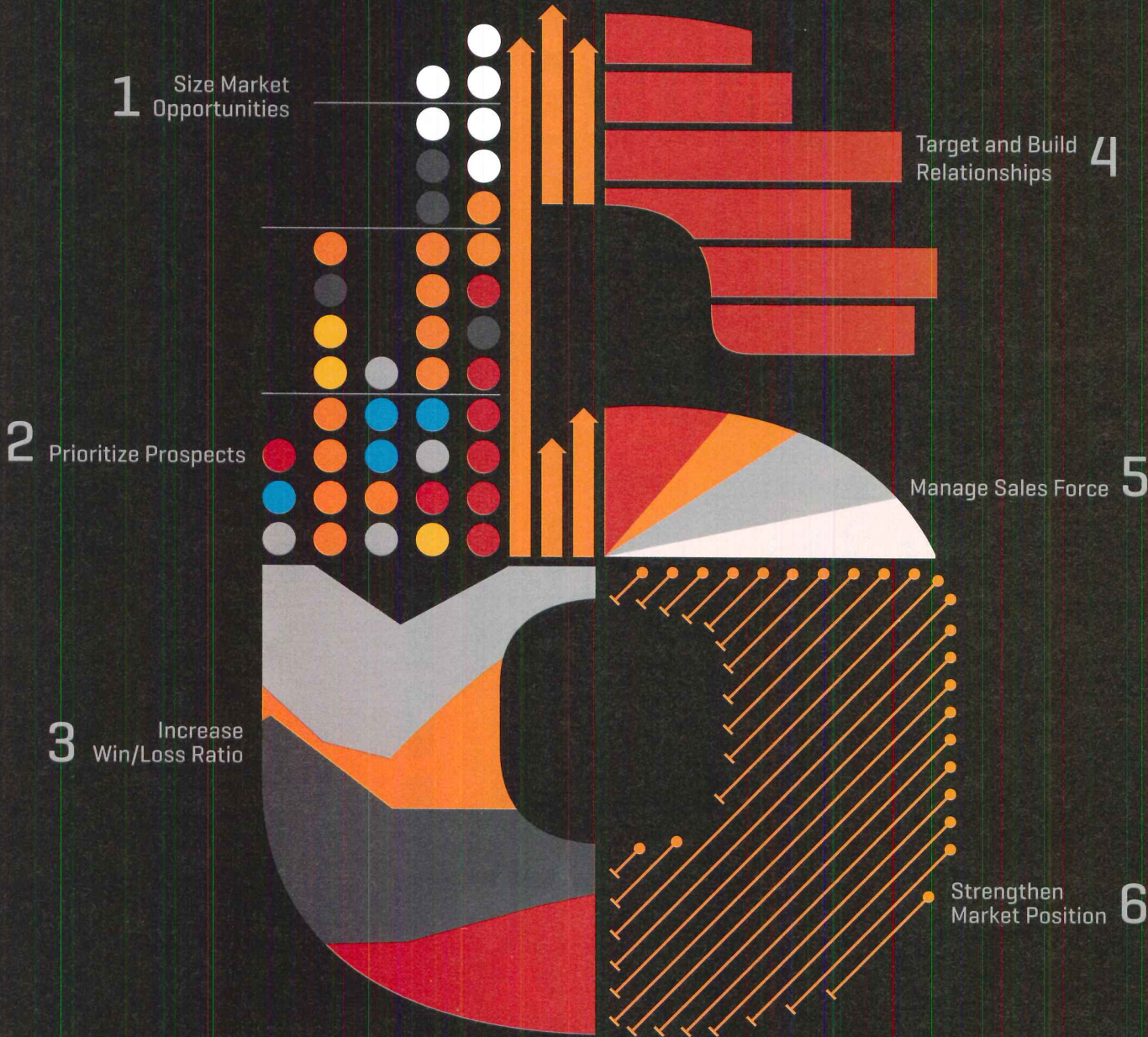

DODGE

Essential intelligence to build on

McGRAW HILL
CONSTRUCTION
McGRAW HILL FINANCIAL

Call 877-958-6836 or visit DodgeBuildsBiz.com

reTHINK
WOOD

WOOD COSTS LESS AND DELIVERS MORE

Explore opportunities
for wood construction—visit
www.rethinkwood.com



MEETS CODE

5 stories of wood-frame construction over 2 and 3 stories of concrete



COSTS LESS

“Cost savings was the major reason of choosing wood for this project.” Andrew McIntyre, Project Engineer



VERSATILE

Design and modification flexibility, time savings



RENEWABLE

North American forests grow back the wood used in these buildings in 12 minutes



ECONOMIC GROWTH

Wood contributes \$100 billion to US gross domestic product

MERCER COURT, UNIVERSITY OF WASHINGTON
SEATTLE, WA

ARCHITECT: ANKROM MOISAN ARCHITECTS
CONTRACTOR & PHOTO CREDIT: WG CLARK CONSTRUCTION

CIRCLE 47

TO LEARN MORE → COME VISIT US AT GREENBUILD: BOOTH 1637 AND 1537

ROCKY MOUNTAIN[®]
H A R D W A R E



ARTFULLY TEXTURED. To create the clean lines of our collection skilled artisans use time-honored casting techniques to turn molten bronze into sculptural works of art.

DOOR WINDOW CABINET LIGHTING
PLUMBING TILE HOSPITALITY CUSTOM

10 patinas to choose from. 90% post-consumer recycled materials. Handmade in the USA.

CIRCLE 49

888 552 9497
rockymountainhardware.com



TOTO®

PeoplePlanetWater™

IF IT BENEFITS PEOPLE, IF IT CARES FOR OUR PLANET, IF IT RESPECTS WATER, IT'S TOTO.

TOTO wants you to know about every eye-opening way we've innovated the bathroom — *from EcoPower® flush valves and faucets, to our SanaGloss glaze that helps your toilet stay cleaner, longer* — but you don't have to remember them all. Instead, just keep three little words in mind: **People. Planet. Water.** They tell you everything we care about and everything we stand for.

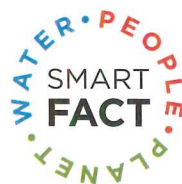

TOTO EcoPower® sensor faucets are ideal for high-traffic commercial spaces, providing an elegant water conservation solution or LEED option. With as few as 10 uses a day, an EcoPower® product's battery can last up to 19 years.

PEOPLE-FIRST INNOVATION™

www.totousa.com | 800-350-TOTO

Reynobond®
with KEVLAR®

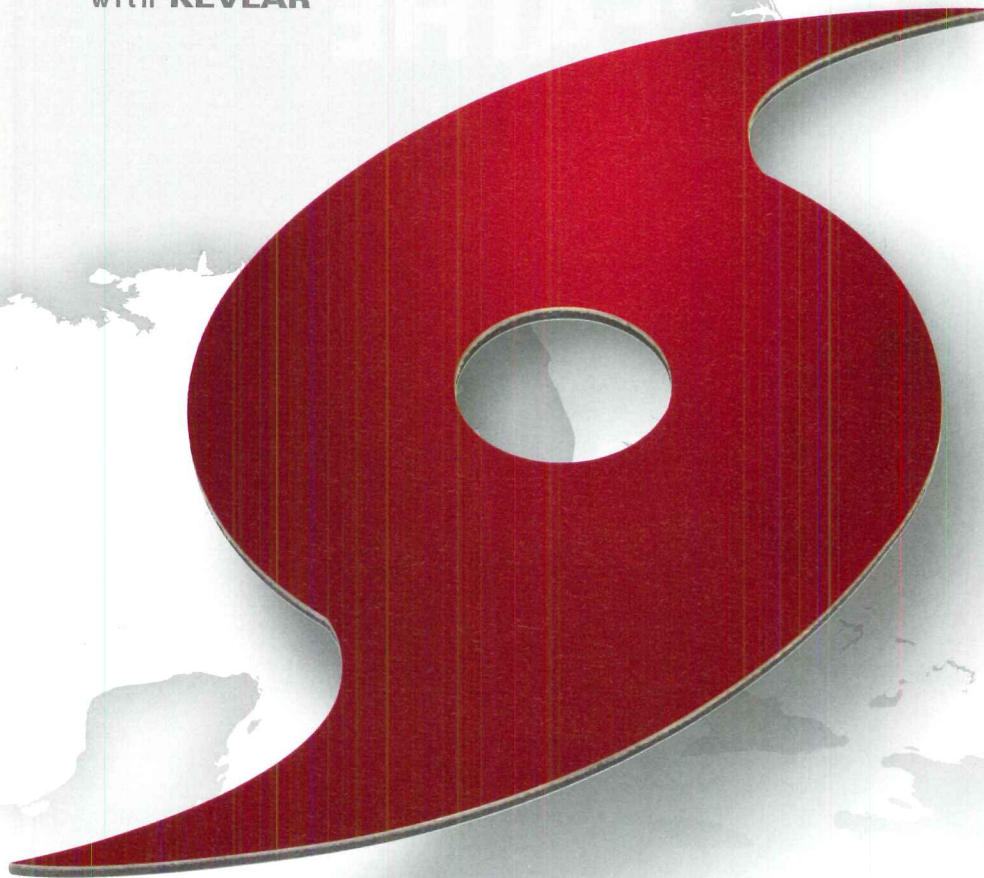

Up To Hurricane Code. And Your Standards.

Reynobond® with KEVLAR® composite material resists hurricane-force impacts with style.

Wind-Borne Debris building code requirements don't have to limit your design options. Now you can get Reynobond® style, flexibility and ease of installation plus the strength of KEVLAR® material. Designed and tested to withstand hurricane-force impacts, Reynobond with KEVLAR® panels meet the Miami-Dade Building Code—the country's highest test standard—without the need for heavy and expensive backer materials.

Learn more and see a demonstration at reynobond.com/KEVLAR.



Alcoa Architectural Products • 50 Industrial Boulevard • Eastman, GA 31023-4129 • Tel. 800 841 7774 • reynobond.com
©2013 Alcoa Architectural Products. Reynobond® is a registered trademark of Alcoa Inc.
KEVLAR® is a registered trademark of E. I. du Pont de Nemours and Company and is used under license by Alcoa Architectural Products.

CIRCLE 73

IMPROVING THE AIR WE BREATHE

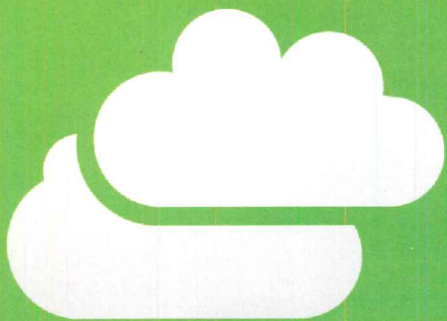

DISCOVER THE NEW SCIENCE OF INDOOR AIR QUALITY

As people encounter more chemicals at home, at school and at work, it is critical to understand potential hazards and minimize adverse health effects. Through New Science, UL is working to mitigate emerging indoor air quality safety risks and safeguard innovation.

JOURNALS. VIDEOS. INFOGRAPHICS. TRENDS.
VISIT UL.COM/NEWSCIENCE

UL and the UL logo are trademarks of UL LLC © 2013



UNIVERSITY LEADER



The PAC App is here!
Full library - no internet needed.

An Academic Center that makes the grade.

Tite-Loc Plus Metal Roofing combines sustainability with weather resistance to earn extra credit in resourcefulness.

The 36,000-square foot Academic Center built for New College of Florida in Sarasota includes ten classrooms, 36 faculty offices, a computer lab, and common spaces. Envisioned as a hub for learning and social interaction, the building focus is on sustainability. Tite-Loc Plus aluminum roofing panels, with high recycled content, helped New College achieve a LEED Gold rating. Tite-Loc Plus is equipped with Florida Product Approvals and Miami Dade NOA, sending this academic center to the head of the class.



WWW.PAC-CLAD.COM | IL: 1 800 PAC CLAD
MD: 1 800 344 1400 | TX: 1 800 441 8661
GA: 1 800 272 4482 | MN: 1 877 571 2025



New College of Florida Academic Building, Sarasota, FL Architect: Moule & Polyzoides Architects, Pasadena, CA
Roofing Contractor: Murton Roofing, a TECTA America Company, Miami, FL Material: Tite-Loc Plus, PAC-850 in Zinc Metallic

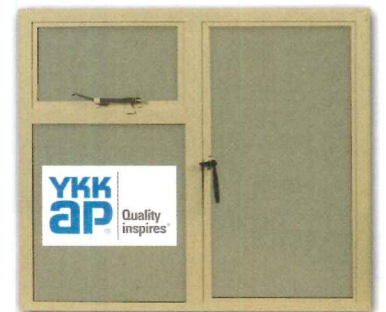

FOR BEST RESULTS, OPEN ANY WINDOW.

CERTIFIED APPLICATORS: YET ANOTHER REASON DURANAR COATINGS HAVE NO EQUAL.



Turn to members of The Certified Applicator Program to make sure you get the unequal performance you expect from Duranar Coatings. Which means you can count on them to find the right

answer to your coating needs. To learn more about Duranar Liquid and Powder coatings available from your local Certified Applicator, call 1-888-PPG-IDEA.

CIRCLE 50

Duranar and PPG are registered trademarks and IdeaScapes is a trademark of PPG Industries Ohio, Inc.



Glass • Coatings • Paint

DAILY UPDATES
archrecord.com/news
twitter.com/archrecord

perspective

If someone asks if this has been done before, I know to answer “no” in China and “yes” in the U.S.

—**Thom Mayne**, at ARCHITECTURAL RECORD's Innovation Conference on October 3, 2013.

Will Tokyo's 2nd Olympics Leave a Design Legacy?

BY NAOMI R. POLLOCK, AIA

ON SEPTEMBER 7, 2013, the International Olympic Committee (IOC) announced the host city for the Games of the XXXII Olympiad in 2020. A town with a good track record, Tokyo beat out Istanbul and Madrid and took the prize for the third time.

The city was first selected for the 1940 summer games, which were canceled due to World War II. Tokyo's second win was for the 1964 summer Olympics. Symbolizing the end of Japan's post-World War II reconstruction, new athletic facilities were built and infrastructure was upgraded, changing the Japanese lifestyle for good. Now many are wondering what kind of legacy the 2020 Olympics will leave.

In preparation for the 1964 Olympics, Tokyo underwent several major changes including the construction of an overhead highway system, the extension of subway lines, the widening of streets, and, just days after the opening of the games, the launch of the Shinkansen bullet train connecting Tokyo and Osaka. “Our urban life, based on a network of underground trains, was a gift of the 1964 Olympics,” says Professor Hiroyuki Suzuki of Aoyama Gakuin University. Most of the new athletic facilities were concentrated within central Tokyo. While a number of the original structures remain in use, Kenzo Tange's Yoyogi National Gymnasium stands out as the event's iconic building. Flexing the country's technological muscles, the building is topped by a spectacular swooping roof and, fittingly, was erected on the site of a former U.S. military base. It showed the world the power of Japan's contemporary architecture culture, which has continued into the present.

This time, the main Olympic venues will be divided between two



The new national stadium of Japan, by Zaha Hadid Architects, will be built for the 2020 summer Olympics in Tokyo.

Finding a Form with a Pile of Sand

After receiving master's of architecture degrees from Princeton University in 2010, Julian Rose and Garrett Ricciardi formed a Brooklyn-based partnership with a name—Formlessfinder—that reflects their shared



The 500-ton pile of sand that forms part of the pavilion, dubbed Tent Pile, will be 70 feet wide at its base.

theoretical bent. Their only built project, expressing their desire to leave materials, whenever possible, in their natural state, was a small addition to a house near Princeton. But a “cold call” from the organizers of Design Miami—to create an entry pavilion for the Design Miami tent, a supermarket-size structure erected in the parking lot of the Miami Beach Convention Center—may change the course of their careers. Realizing their ideas in three dimensions (with the help of consultants like structural engineer Nat Oppenheimer of Robert Silman Associates) will bring them wide attention when Design Miami opens on December 3. Formlessfinder's design consists of an aluminum-truss roof that appears to sit on a large pile of sand, which stabilizes a supporting structure that would otherwise require subterranean bracing. “It works as a ballast, in lieu of a more traditional foundation,” Rose says of the sand. *Fred A. Bernstein*



A range of existing facilities will be used for the 2020 Summer Olympic and Paralympic games: Rafael Viñoly's Tokyo International Forum (above), a civic complex completed in 1996; Fumihiko Maki's Tokyo Metropolitan Gymnasium (top), opened in 1954; Kenzo Tange's Yoyogi National Gymnasium (bottom), completed in 1964, built to house that year's swimming and diving summer Olympic events.

areas reasonably near the Olympic Village, in the middle of the city. To improve Tokyo's already efficient public transportation network, there is talk of adding new subway lines that would facilitate movement to the city's two airports as well as to one of the venue areas, the Tokyo Bay Zone. Largely built on landfill, this area is a relatively recent addition to the city and is still considered a little out of reach. More commercial amenities catering to the 17,000 athletes who will call the Village home are also anticipated. These will make the neighborhood more enticing after the Olympics, when temporary accommodations are converted into permanent residences.

But recasting the Village isn't the only adaptive reuse planned. A whole range of existing facilities will host the new competitions. While the Tange gym will hold handball tournaments, Fumihiko Maki's Tokyo Metropolitan Gymnasium will host table tennis. Other buildings, such as Rafael Viñoly's Tokyo Forum and various stadiums as far afield as Sapporo and Sendai, built for the 2002 FIFA World Cup, will be venues for weightlifting and soccer respectively.

One building not slated for reuse is the 1964 Olympics' main stadium. In preparation for the possibility of winning the bid, the Japan Sports Council held the International Concept Design Competition for a new arena in compli-

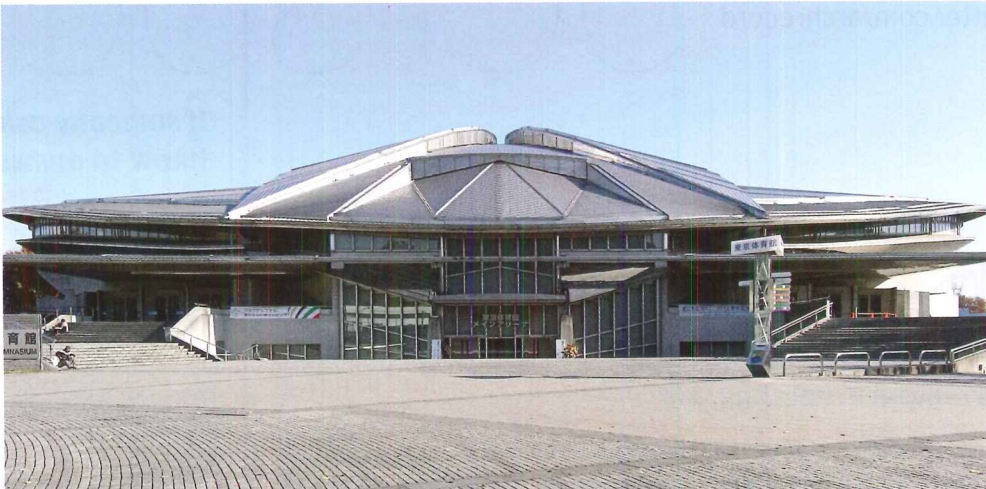

ance with the IOC's current requirements. In November 2012, they awarded the commission to London-based Zaha Hadid Architects, which will serve as the project's design consultant in collaboration with a team of Japanese firms captained by Nihon Sekkei, Nikken Sekkei, and Ove Arup Japan.

"We need a simple, clear image for the main stadium," explains Suzuki, a competition juror. Incorporating the site of the previous stadium (which will be torn down) plus adjacent property, the futuristic scheme has a distinctive, dynamic, helmet-like form, capped by a retractable roof. Since the Olympics will take place in August, when Tokyo's heat and humidity are at their worst, this feature will enable air-conditioning—and, when the Games are all over, provide soundproofing for possible future events, like concerts.

Yet local architects are not uniformly rejoicing about the new building. While they do not oppose the selected scheme or its architectural expression, a number are questioning its size and location. Several times bigger than the previous stadium and situated in a fairly devel-

oped precinct with historic significance, the 80,000-seat structure looms large. Determined to call attention to these and other issues, a symposium was held on October 11, 2013. Though placing the massive building in the less-developed area near Tokyo Bay might have been more logical, that site was deemed too remote when the city bid for the 2016 Olympics. There is also concern that the stadium runs the risk of obsolescence after the Olympic festivities are over and the arena proves just too big for projected uses.

Hopefully, the main stadium in its realized form will become a monument that architects in Japan can rally around. Though the process for deciding who will design the other new buildings for the 2020 games has yet to be announced, it will certainly differ from 1964, when two Tokyo University professors essentially assigned projects to architects. While the changes to the Tokyo landscape and lifestyle are likely to have a less dramatic impact than last time, the 2020 Olympics could become another chance to showcase Japanese architectural talent. ■

RECORD Innovation Conference: Smart Cities

BY FRED A. BERNSTEIN

AT THE start of a day devoted to the connections between architecture and new technology, Elizabeth Diller, of Diller Scofidio + Renfro, urged architects to continue to use “the whole repertoire of old-fashioned tools that are not really getting replaced, just supplemented.” She described the firm’s best-known project, the High Line, designed with James Corner Field Operations, as low-tech, and said the popularity of Blur, in Switzerland—its first building “for a mass audience”—could be explained by the structure’s simplicity. She conceded that one of the firm’s newest projects, a cinch-waisted condo tower in Manhattan’s Hudson Yards, could not have been designed without CATIA (Computer Aided Three-dimensional Interactive Application), the CAD program that has its origins in aircraft fabrication. Still, she argued, technology shouldn’t be seen as itself a generator of architectural forms so much as “an agent” to be



From left: Situ Studio’s Aleksey Lukyanov-Cherny; SHoP Architects’ Chris Sharples; and Ronald Labaco, a curator at New York City’s Museum of Arts and Design.

used “with other, dumber systems.”

The challenge Diller described—finding simplicity in a world of dizzying technological innovation—set the tone for the 11th annual ARCHITECTURAL RECORD Innovation Conference, which drew 400 people to the auditorium of Manhattan’s McGraw-Hill Building on October 3.

True, Ole Scheeren couldn’t describe CCTV, the 5 million-square-foot building he and Rem Koolhaas designed to cantilever over Beijing, as simple, but he did make a strong case that its form grew directly out of its function. And he traced the history of the “service core,” which is part of every skyscraper, to a house designed by “domestic economist” Catharine Beecher in the 1860s. Punning on what he called “core values,” he explained how innovative cores helped generate the startling forms of several of his buildings, includ-

ing a housing development in Singapore made of tower blocks arranged around hexagonal courtyards, and a skyscraper in Bangkok that looks as though parts of it have blown away.

Among architects who spoke during the day-long conference, perhaps the one most clearly indebted to technology was Thom

PHOTOGRAPHY: © STEVE HILL



the Prindle Bench

CIRCLE 30

A sleeker take on site furnishings

Find this product and more at www.huntco.com

Huntco



Elizabeth Diller, founding principal of Diller Scofidio + Renfro, opened with the keynote.

Mayne. The Pritzker Prize winner (who said that outside the office he is techno-challenged, unable to turn on the television) described the arc of his career in terms of what CAD has made possible. Recalling the days when he conceived of buildings as plans, elevations, and sections, he said those drawings are now just digital “outputs” and that the latest soft-

ware is “allowing us to change the direction of architecture aesthetically.” He can now create buildings that are neither drawable nor “preconceivable.” David Rockwell, of Rockwell Group; Lise Anne Couture, of Asymptote Architecture; and Keith Besserud of Skidmore, Owings & Merrill (SOM) spoke of ways they integrate the latest research into their architectural practices. But another representative of SOM, structural engineering partner William F. Baker, described the firm’s intensive research into an initiative that sounds almost retro—creating tall buildings with timber frames—but has strong implications for sustainability. Other speakers commented on the connections between technology and craft. As Chris Sharples of SHoP Architects noted, digital tools are helping to connect innovative

architects with artisans. Aleksey Lukyanov-Cherny of the firm Situ Studio said, “What technology is doing is not removing the hand—it’s actually allowing more hands to participate.”

Among the most provocative presenters of the day were the members of a panel on how “big data,” the vast amount of information available to architects and planners, can shape the physical world. As moderator and author Andrew Blum stated, “Data has spatial consequences.” Anthony Townsend, a researcher and author, spoke of systems that will help control cities of “tens of millions of people,” noting, for example, that cellphone usage data allowed Istanbul to redesign its bus network, matching routes to demand without the need for cumbersome market research. Another panelist, law professor Susan P. Crawford, said the effects of supplying the entire country with fiber optic lines will be as profound as those that resulted from the advent of electricity.

It was Mayne who ended the program, noting that digital tools, by eliminating the need to design in two dimensions, have helped architects rediscover what their profession is about. “As architects, we don’t draw drawings,” he said. “We make buildings.” ■

AVAILABLE THROUGH SPECIALTY DOORS

THE WORLD’S FINEST SLIDING DOOR HARDWARE
AS WELL AS ROLLING LIBRARY LADDERS



HAND CRAFTED IN GERMANY

MWE[®]
Edelstahlmanufaktur GmbH

CIRCLE 19

SPECIALTY DOORS 866-815-8151

WWW.BARNDOORHARDWARE.COM

WWW.MODERNSTAINLESSLADDERS.COM



A moving walk you can roll out like a rug.

iwalk, from ThyssenKrupp Elevator, will fit anywhere and can easily be integrated into existing buildings. It can even be installed on top of the existing floor. All you need are two ramps, one at each end. So install the **iwalk** and remove it just as easily. A flexible option that accomodates crowds or renovation work.

iwalk
the easier way

Learn about the *iwalk* at www.thyssenkruppelevator.com/moving-walks/iwalk

ThyssenKrupp Elevator Americas



ThyssenKrupp

CIRCLE 17

Bell Labs, Reimagined

BY RONDA KAYSEN

EVER SINCE the Eero Saarinen–designed Bell Labs building in central New Jersey closed six years ago, its fate has hung in the balance. Now the iconic edifice that was once the site of enormous technological innovation will re-emerge as a civic center for the surrounding town of Holmdel.

Somerset Development purchased the 1.9-million-square-foot building and the surrounding pastoral grounds from Alcatel-Lucent this summer, securing the future for the vacant structure, which closed in 2007 when the French telecommunications company consolidated its research facilities. At one point, another developer suggested



An aerial view of Bell Labs in Holmdel, New Jersey (left), shows its context within an oval campus, surrounded by seas of parking lots. This was the atrium of the building (above) as it looked when it was completed.

razing the structure, an option that was scrapped after scientists and architects from around the world blasted the idea. And in August, the township of Holmdel approved a redevelopment plan for the site, ensuring the structure's survival. With its future now settled, architects must decide how to transform the vaunted building into a viable mixed-use complex with a health center, hotel, offices, retail, and a library.

The mirrored-glass structure opened in 1962 as a place to foster scientific innovation among AT&T employees at a time when the company had a monopolistic hold on the telecommunications industry. Alcatel-Lucent eventually acquired the property from AT&T. The expansive hallways of the six-story building were designed so scientists might accidentally encounter one another and perhaps stop for a cigarette near one of the built-in ashtrays on the balcony ledges. The design served its purpose: Bell Labs employees contributed to the inventions of touch-tone dialing, lasers, the microwave, and the cell phone. But reimagining this historic structure for a new era is not a

simple task. “You have to think out of the box, and this is a glass box, literally,” says Alexander Gorlin, the architect tapped to lead the redesign effort. NK Architects and Joshua Zinder Architecture + Design, both based in New Jersey, will design interior tenant spaces.

As Somerset begins the task of luring tenants, Gorlin and his team will bring the common spaces back to life. The entryway will be restored, and a heavy awning added later will be removed. Already, Somerset has begun restoring the Sasaki, Walker & Associates–designed landscape to its original glory. The 470-acre grounds include lakes, wetlands, and fields. Although Somerset plans to sell 237 acres to the national homebuilder Toll Brothers, the remaining land will eventually include bike paths, pedestrian walkways, and an outdoor sports center.

But in order for the ambitious \$100 million redevelopment to succeed, Somerset must draw tenants to a property set on a quiet road in a wealthy rural community. Although Bell Labs is close to the Garden State Parkway, most of the town's retail is a 10-minute drive away. Somerset envisions a new center for Holmdel, punctuated by 225 new houses that will rise on the outer edge of the original property.

A health-care developer intends to create a 400,000-square-foot health and wellness center in the building, and the town will move its library there. But so far no other tenants have committed to the project, which will include 50,000 square feet of retail. “We are in a classic chicken-and-egg situation,” says Ralph Zucker,

president of Somerset. “People want to be there because of the restaurants, and the restaurants want to be there because of the offices. So what comes first?”

Meanwhile, Gorlin will set to work restoring the quarter-mile-long atrium that runs the length of the building and acts as an avenue. Daylight pours in through the glass ceiling. Zucker hopes to improve the lighting and acoustics so it can be used for a marketplace and events.

“When Alex walks around the building, you can almost see him relating to every nut and bolt. It really speaks to him, and it's important to us that we have an architect who is not looking to put his imprint on the building but rather to help us complement what is already there,” says Zucker. “He really gets it. He is somebody who understands Midcentury Modern architecture, understands Saarinen, understands the building.” Another immediate challenge: clad in single-pane glass with inoperable windows, it was designed at a time when energy was cheap. The mechanical equipment is aging. Zucker is considering installing a co-generation plant for cooling and heating. The interior, however, was created as four separate buildings contained within a glass curtain wall. So those offices are surprisingly well-insulated. “The single biggest challenge is the role of the skin of the building,” says Michael Calafati, an architect and chairman of the American Institute of Architects' New Jersey Historic Resources Committee. “It's a colossal building without one operable window.”

Recently, Gorlin began sifting through Saarinen's original Mylar and pencil drawings. Although they connect him to the man who designed the Gateway Arch in St. Louis and Lincoln Center's Vivian Beaumont Theater, Gorlin says he is not intimidated by the challenge. In the next two months, he will release renderings of a master plan so that even as pieces of the building are parceled off—like the hotel—the final result will have a single vision. “There won't be a hodgepodge of signage or facades,” says Gorlin. “We're providing a framework for all future development to fit within the box.” ■

Hidden in Plain Sight

Clear fire rated solutions that blend seamlessly



Products: SuperLite II-XL 60 in GPX Framing
Project: CCTC Health Sciences Building (Sumter, SC)
Architect: LS3P Associates Glazier: Charlotte Glass



888.653.3333
www.safti.com/ar

 **SAFTI FIRST**TM
FIRST IN FIRE RATED GLAZING



CIRCLE 79

© 2013 SAFTI FIRST

Solar Decathlon Shines in Its New California Home

BY DEBORAH SNOONIAN GLENN

A **TEAM** from the Vienna Institute of Technology, competing in the U.S. for the first time, took home top honors in the Department of Energy's sixth Solar Decathlon. The University of Nevada, Las Vegas, finished second, and Czech Technical University placed third overall. The event took place from October 3 to 13 in Irvine, California.

The winners were chosen based on cumulative scores from 10 different contests, including architecture, engineering, affordability, and market appeal. Unlike results in years past for this U.S. competition, only a few points separated each of the top six finishers from one another. "The sunny weather was certainly conducive to energy generation, but that's not the only factor that influences the scoring," says Amy Gardner, a juror for the architecture contest who was the faculty advisor to the first-place Decathlon team from the University of Maryland in 2011.

The Decathlon's organizers decided to shake things up a bit this time by moving the event from its former site in Washington, D.C., to Southern California. More than 60,000 visitors toured the 19 houses erected by students at Irvine's Orange County Great Park. The hot, dry climate is a good proving ground for solar energy and water-conservation strategies; the next Decathlon, slated for 2015, will take place at the same venue.



TEAM AUSTRIA, VIENNA INSTITUTE OF TECHNOLOGY Flexible design was the key tenet of the first-place winner—it can be built as a stand-alone residence or as a component in a multifamily design. Triple-glazed walls and an automated screen and awning system keep out heat while letting in plenty of sunlight at the right time of day. In the bath, a shower tray that recovers heat cuts the demand for hot-water heating by roughly a third. A gracious wooden ramp forms a welcoming and accessible entryway.



UNIVERSITY OF NEVADA, LAS VEGAS A generous kitchen is the centerpiece of this house, designed to be a vacation getaway in the southwestern U.S. (it will become an exhibit and education center at the Las Vegas Springs Preserve following the Decathlon). Cooking here actually conserves water: every time the cold water tap is turned on, unused water flows to the house's sprinkler system to ensure that it always has a fresh supply. Resource-saving appliances were used throughout, including a dishwasher that exceeds Energy Star requirements for water savings by 68 percent.



CZECH TECHNICAL UNIVERSITY This house was designed for empty-nesters as a country weekend getaway-turned-permanent-residence. It placed third overall and took first place in the architecture contest. Its primary material is wood sourced near the university, including spruce for its structure and canopy, birch plywood for its finishes and furniture, and wood-fiber insulation. The solar canopy supports photovoltaic panels. Other features include a chilled ceiling system to prevent indoor temperatures from skyrocketing.

STEVENS INSTITUTE OF TECHNOLOGY, HOBOKEN, NEW JERSEY The 980-square-foot house, which placed fourth overall, was the only one in the competition with solar shingles. They are installed on the deeply overhanging roof, which shelters two generous decks. The home also features a unique liquid desiccant system that removes moisture from incoming air using less than a third of the energy needed by traditional dehumidifiers. The student design team was awarded a patent for the technology.

REIMAGINE METAL

EDUCATIONAL IMPACT. ENVIRONMENTAL COMMITMENT.

Universities are committed to advancing knowledge — and by choosing metal for your building envelope enclosure you're committed to advancing sustainability. At CENTRIA sustainability is a cornerstone of our business — from developing environmentally friendly, energy efficient products like Formawall Dimension Series® to reducing the environmental impact of our day-to-day operations. Learn how metal is providing high impact performance and aesthetics, while having a low impact on the environment at

centria.com/reimaginemetal | 800.229.5427

CIRCLE 67



Scan the QR Code with your smart phone to view the University of Nebraska's Mammel Hall College of Business project gallery and learn more about the CENTRIA products selected.



CENTRIA

REIMAGINING THE BUILDING ENVELOPE

Richard Meier's Teachers Village Opens in Newark

BY LINDA C. LENTZ

SEPTEMBER 25 was a festive day on Newark's Halsey Street. There was lots of fanfare—school band included—and brilliant blue skies as New Jersey Governor Chris Christie and then-Mayor Cory Booker cut the ribbon to celebrate the opening of Newark native Richard Meier's first project in his hometown. Embodying phase one of an ambitious 14-block mixed-use development called Teachers Village, for which Richard Meier & Partners Architects (RMPA) developed the master plan, the building houses two charter schools, with interiors designed by the Princeton-based KSS Architects, and includes a gymnasium and fitness center that will eventually be open to the community. A second new school building across the street, designed by KSS, accommodates an additional charter middle school, as well as a spacious day-care center and preschool, which is set to open in the near future.



An aerial rendering of Teachers Village (above), reveals Meier's master plan for the 14-block downtown Newark neighborhood, with the largely brick schools surrounded by yet-to-be-completed residential buildings. Connected by a central stair, the new buildings (below) serve as one and house an elementary school, middle school, and gym.



The brainchild of developer Ron Beit, CEO of the Newark-based RBH Group, Teachers Village is located on a site previously occupied by unused parking lots and dilapidated commercial buildings. It is a short walk from the city's downtown business district, Newark's Penn Station, the Prudential Center, and numerous universities. A unique revitalization program, the project aims to create a nucleus of 24/7 activity around the four educational

and child-care facilities for 1,000 children, supplementing them with 200 units of workforce housing for Newark teachers (under construction) and a lively mix of street-side retail establishments in all eight buildings to be run by local entrepreneurs. It is also one of the first developments in the country to pursue the LEED-Neighborhood Development (ND) designation, meaning that it aims to realize principles of smart growth and urbanism in

addition to green building practices.

Balancing Meier's familiar white metal panels with iron spot brick, the architects were careful to break down the massing of the contemporary buildings, not exceeding a height of 60 feet on the street, in keeping with the Newark Living Downtown Plan. Back-painted white glass panels border transparent windows, as well as spans of milky, light-diffusing, laminated glass that illuminate the school's interiors, while allowing for privacy and minimizing glare. The KSS building, simpler in its material palette and program, adheres to RMPA's brick scheme, adding a set-back fifth story clad in white panels. Layered with texture, the buildings nod to the fabric of the existing neighborhood rather than overwhelm it.

During the festivities, there was a small but noisy contingent of protestors decrying the area's apparent gentrification. But Teachers Village seems to have its heart, and head, in the right place. Beit—having garnered public support and a team of private investors that includes Berggruen Holdings, Frederick Iseman of CI Capital Partners, Goldman Sachs Urban Investment Group, and Prudential—has a realistic vision that embraces the greater Newark population.

"We are not just building buildings," says Beit. "We are building a tool that will serve this city and state in the recruitment and retention of the best teachers in the region. And we are setting an example in school construction for the benefit of the children in the community. In doing so, we are creating a model that cities across the country will want to emulate." Phase two, the residential component, is scheduled to be complete by 2015. ■

PRECISION

TO A T

Even lines
as thin as
0.018MM.

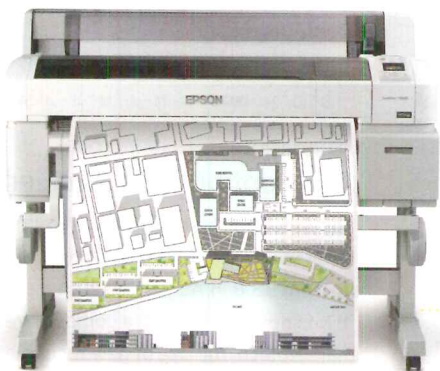

THE NEW EPSON® SURECOLOR® T-SERIES

- Extreme plotting accuracy at resolutions up to 2880 x 1440 dpi
- Produces a presentation quality, color, D-size plot in 25 seconds
- Advanced pigment ink technology for truly durable, full-color plots
- High-capacity ink cartridges up to 700 mL for low printing cost
- Space-saving design with easy access front-loading paper and ink

EPSON SureColor T3000 - 24" | \$2,995

EPSON SureColor T5000 - 36" | \$3,995

EPSON SureColor T7000 - 44" | \$4,995

EPSON®
EXCEED YOUR VISION

Speeds are based upon print engine speed only. Total throughput times depend upon factors such as computer, file size, printer resolution, ink coverage, and networking. For the SC-T3000, fastest print speed for a D-sized plot is 29 seconds. Prices are MSRP, before rebates. Please check with an EPSON Professional Imaging Authorized Reseller for actual price as dealer prices may vary. EPSON and SureColor are registered trademarks and EPSON Exceed Your Vision is a registered logomark of Seiko Epson Corporation. Image courtesy of usgs.gov. Copyright 2013 Epson America, Inc.

EPSON.COM/PLOTTERINFO

CIRCLE 33

[NEWSMAKER]

Charles Jencks

BY DAVID HILL

ARCHITECTURE CAN'T cure cancer, but good design has the power to help heal. That's the philosophy behind Maggie's Cancer Caring Centres, a network of drop-in facilities in Great Britain. The centers—17 and increasing—are named for writer and landscape architect Maggie Keswick Jencks, who died of breast cancer in 1995. Married to the American architecture critic and landscape architect Charles Jencks, Maggie conceived of a warm, inviting place where cancer patients could learn how



Of Snøhetta's design for the new Maggie's Centre in Aberdeen, Scotland, Jencks says: "It has this wonderful mixture of contrasts and moods. The geode that breaks out of the egg is made of dark wood. So immediately it sets up this dialogue between two different scales and two different types of buildings."

to cope with their disease and meet with loved ones. The first Maggie's Centre, designed by Richard Murphy, opened in 1996 in Edinburgh. Since then, some of the world's best-known architects—including Frank Gehry, Zaha Hadid, Richard Rogers, and Rem Koolhaas—have designed Maggie's Centres. The latest, by Snøhetta, opened in Aberdeen, Scotland, on September 23. "It looks kind of like an egg that's cracking open," says Charles Jencks, who cofounded Maggie's Centres with his late wife and continues to serve as a board member. Jencks spoke with RECORD by phone from his home in London.

How do you like the new center in Aberdeen?

I think it works very well. In a few years, it will nestle into the grounds and the landscape that the architects have designed, and it will seem less like a brash piece of sculptural late modernism.

Each Maggie's Centre is different architecturally. Why is that important?

We thought that we might franchise them and have every building be the same, like McDonald's. But we decided against that very early on. An important question for us is how we relate to the local hospital and people,

because we have to raise all the money to build a center. Architecture plays an extremely important role.

What do the centers have in common?

There's an open-door policy, so anyone can come to a center at any time. They all have places to read books and have intimate conversations. And there are semi-open spaces for exercise and group meetings. And a kitchen, where everybody makes tea.

The centers have been designed by well-known architects. How do you select them?

Rem was my student. Zaha, too. And I've known Frank since 1972—he's a close friend. Maybe 70 percent were friends of Maggie's.

So it goes way back. We have high stakes. We're not a religion or a church, but there are spiritual issues that we pose, and architects are challenged by that. A Maggie's Centre has to be friendly, cheerful, and uplifting. And yet it can't just be designed using a simple "architecture of happiness." It's about facing dark times.

What's the connection between architecture and health?

I was born a skeptic about how architecture can change society, having taught in the '60s and seen the pretentious nonsense written by Le Corbusier. I've always thought, "Support good architecture for other cultural reasons, not because it's going to change society." But I was debating a doctor from the National Health Service on the BBC, and when I said architecture can't change society, he said, "You're completely wrong. If it's a bad building, we don't show up for work." I'd never thought of the negative effects of architecture. With Maggie's Centres, I've come to a more nuanced position. I think that if you're talking about hospital design, architecture matters. For us, it matters a great deal, because design supports the carers. One third of the people who come through Maggie's are carers—that is, family members and friends of the patients. ■

noted

World Monuments Fund Releases 2014 Watch List

The WMF released its biennial list of cultural heritage sites at risk of damage or loss. Among this year's 67 sites in 41 countries is the entire country of Syria, furniture-maker George Nakashima's property in Pennsylvania, and the Chinati Foundation in Marfa, Texas.

NYC Design Museum Explores Digital Fabrication

Out of Hand: Materializing the Postdigital, on view until July 6, 2014, at the Museum of Arts and Design, examines the interdisciplinary use of digital fabrication through the pioneering works of more than 80 international artists, architects, and designers, including Ron Arad, Barry X Ball, and Roxy Paine.

World Architecture Festival Awards 29 Projects

Auckland Art Gallery Toi o Tāmaki, by Francis-Jones Morehen Thorp in collaboration with Archimedia, nabbed World Building of the Year, the festival's top honor. Cox Rayner Architects' National Maritime Museum in Tianjin, China, received Future Project of the Year.

Crystal Palace Could Be Rebuilt on Site It Occupied

London Mayor Boris Johnson and Chinese developer Ni Zhaoxing proposed in October a scheme to build a replica of Joseph Paxton's Crystal Palace on the same site it occupied in Sydenham from 1854 until it burned down in 1936. The new palace would be used as a cultural and commercial center if realized.

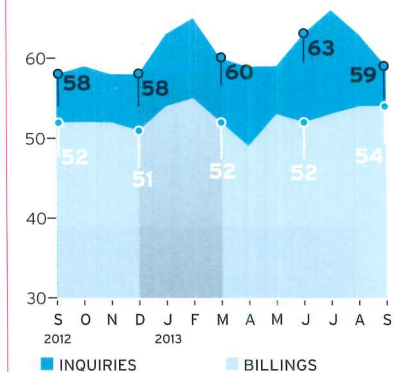

ABI Continues to Accelerate

The American Institute of Architects (AIA) reports the September ABI score was 54.3, up from 53.8 in August. New approaches to business challenges, a competitive marketplace, the use of new technologies, and a renewed focus on efficiency have architecture firms realizing all-time highs in workplace productivity, says the AIA.

Precast Meets Demand for Ageless Aesthetics

Catholic University has a strong campus aesthetic that must be respected. The aesthetic versatility of precast concrete met this challenge efficiently by incorporating thin brick and limestone finishes into large panels, reducing joints and eliminating the risks associated with cavity wall construction. Precast also provided an energy efficient envelope that offers resistance against mold, storms, and fire. Cavity walls couldn't cut it; precast could.

Discover **High Performance** Precast
Versatile | Efficient | Resilient

For more information
and free continuing
education, visit

www.pci.org/hpprecast



CIRCLE 3

RB 500™ Pulls Its Weight

From retail boutiques to extra-large lobbies, the RB 500 roller shade system lifts smoothly and powerfully with options to match every space.

Architectural design in chrome, black and white.

Precision engineering – now available at the window.

HunterDouglasContract.com/RB500





HunterDouglasContract™

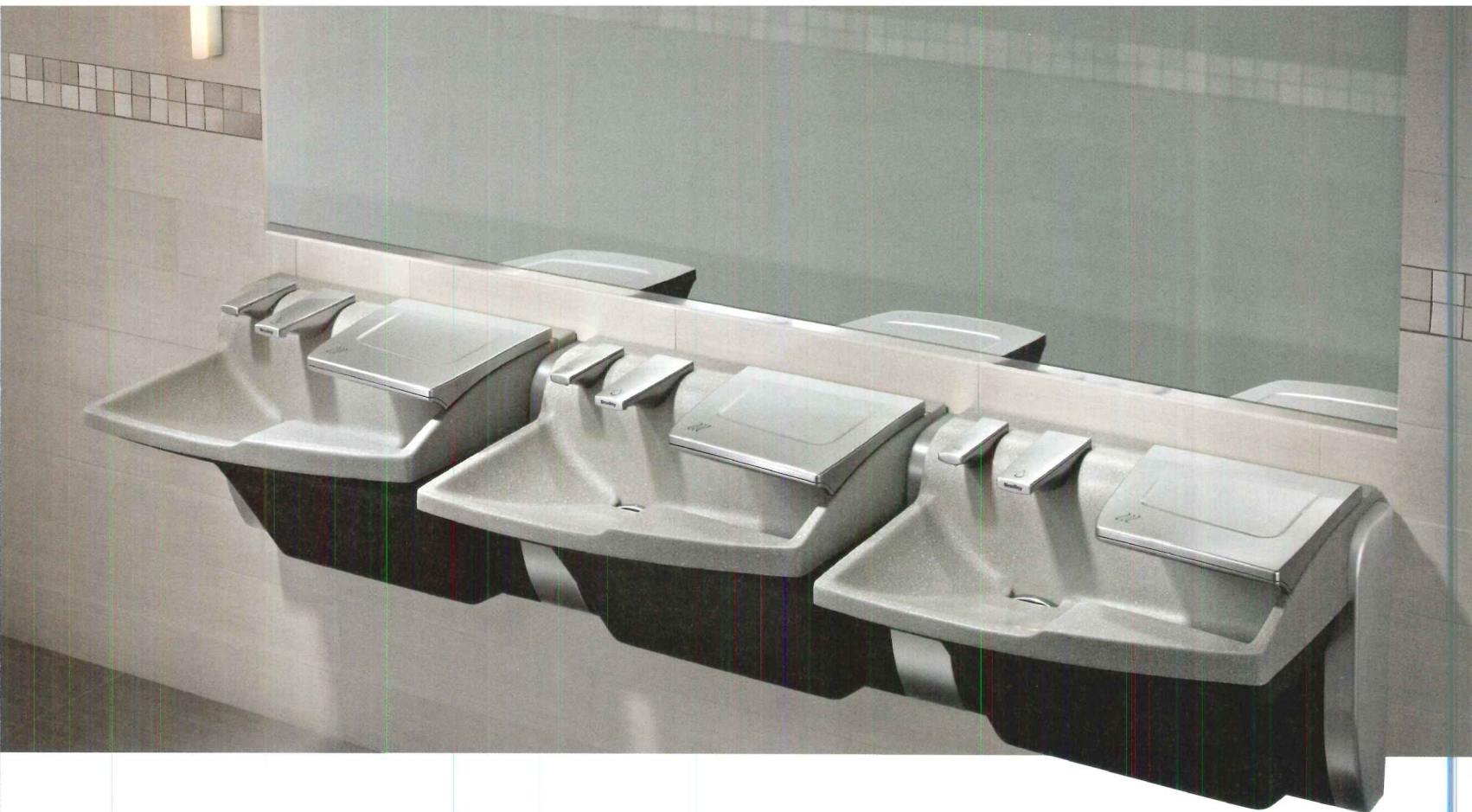

We can't take all the credit for putting the soap, faucet and hand dryer together. Common sense had a lot to do with it.

 Clean + Rinse + Dry = A Sink That Makes Sense

This was a no brainer. By placing a more efficient, completely touchless soap dispenser, sink and hand dryer side by side, we've given users more personal space, while keeping water off the floor. It's simply a better way to wash hands.

Advocate
Exclusively Bradley

clean + simple

Visit us at
Greenbuild
Booth #1141

*If your walls
could talk...*



*They would tell you how
you can improve your
learning environment.*

Students are the most important part of any classroom, which is why their health and comfort are our priority. By making smart choices in your project's building materials, you can provide them with a healthy environment, fewer noise distractions and higher speech intelligibility. Our gypsum products are designed with **indoor air quality, acoustics, and durability** in mind, so that students and teachers can focus on learning. **Listen to your walls. Build a better educational environment and Be Certain™ with CertainTeed Gypsum.**

Visit www.CertainTeed.com/VerticalMarkets to learn more.

800-233-8990 • certainteed.com

ROOFING • SIDING • TRIM • DECKING • RAILING • FENCE
GYPSUM • CEILINGS • INSULATION

CertainTeed
SAINT-GOBAIN

CIRCLE 91



REAL CEDAR

BECAUSE NO ONE EVER BRAGS ABOUT THEIR HOME LOOKING LIKE REAL VINYL.

For natural beauty, subtlety and depth, nothing compares to real western red cedar. Incredibly versatile in its look, Real Cedar also helps keep buildings warm in winter and cool in summer. And its low density means it's an excellent acoustic barrier when used on interior surfaces. To learn more on how this sustainable, renewable and beautiful material can be used on your next project, contact us below.



www.realcedar.com
1 866 778 9096

CIRCLE 15

One Year Later

While victims struggle to rebuild, architects plan for the next Big One.

BY JAMES S. RUSSELL



past, the nonprofit Architecture for Humanity has prepared disaster libraries, with rebuilding guidance organized by building system. For one week in October, the organization cohosted the Sandy Design Help Desk.

The City of New York began long-range planning just months after the storm. Officials used a process called the Special Initiative for Rebuilding and Resilience to figure out what kind of community protections—like higher bulkheads or heftier dunes—should be built along public shorelines. Once that was known, owners would have a clearer picture of how high to rebuild and how sturdy the construction needed to be. Released in June, the Initiative's expedited plan, "A Stronger, More Resilient New York," strikingly rejected such massive civil-engineering silver bullets as a barrier gate extending for miles from Sandy Hook in New Jersey to Coney Island in Brooklyn. Instead it recommended diverse architectural and landscape strategies, like wave-deflecting dunes, water-storing wetlands, and armatures to permit the quick installation of flood walls during emergencies. Tailored to neighborhood conditions, these tactics—

some now in design—are more readily implemented and less costly than civil-engineering works.

New York City's report homed in quickly on natural-system solutions because the groundwork had already been laid by PlaNYC, a 2007 growth plan that substantially focused on climate change. "It was a really brilliant initiative that is the backbone of making resilience possible," says Susannah Drake, principal of the landscape architecture firm Dlandstudio. *Rising Currents*, a 2010 exhibition at New York's Museum of Modern Art of plans and designs for coping with the encroaching ocean, also proved enormously influential.

MORE THAN two months after Hurricane Sandy, Nicole Chati and her neighbors stood in front of a sad collection of aid tents in a beachfront park tangled with downed trees on Staten Island, trying to make rebuilding plans.

A 12-foot-high storm surge had crushed some houses and flooded others up to their eaves. Asked how the 40-year-old homemaker and her neighbors were faring, Chati said at the time, "We've gotten no protection, so we flooded again at Christmas. We have to juggle insurance, FEMA, charities, contractors. It's really stressful."

The predictable chaos and lack of information are the outcome of any disaster, but one year after Sandy (which killed 150 people and damaged or destroyed some 650,000 houses), officials, charities, and disaster experts are concluding that much can be done to smooth the recovery process—and that there's more for architects to do other than drive-by damage assessments and holding empty "ideas" competitions. Now architects are working in neighborhoods to link people like Chati to the resources they need.

Sandy was a much more destructive storm than predicted, and so-called 100-year storms may now arrive much more frequently. Such unprecedented climate violence makes the option of simply rebuilding questionable. Architects must not only assist in raising buildings and strengthening roofs, they are also thinking about how to prepare vulnerable communities for tough future decisions—including moving people away from areas that can't be protected.

Homeowners don't necessarily know what to do. In the

Sage and Coombe Architects' trellised canopies perch in front of restored concession stands in Queens, N.Y. (above). A Coney Island comfort station by Garrison Architects is one of 35 permanent steel-framed modular structures that have been deployed at 15 sites (below).



Appointed by Barry Bergdoll, then the museum's chief curator of architecture, Drake collaborated with Architecture Research Office (ARO) in proposing rebuilt marshes and "sponge parks" to minimize flood damage. Ideas from all the teams with work in the exhibit have come to prominence in the Sandy response.

Architects and related professionals are also refining broad planning ideas to suit specific neighborhood conditions where coastal residents may fear solutions that obliterate the pleasurable experiences of the past. (In New Jersey, some beachfront owners went to court to stop the building of protective dunes that blocked views of the ocean. They lost.) Some things went smoothly. By last Memorial Day, seven months after Sandy, New York City's debris-strewn beaches had been cleaned up in time for the summer season. Visitors returning to the Rockaway beaches in Queens found restored concession stands surrounded by fabric-topped trellises in wave forms by Sage and Coombe Architects, who worked

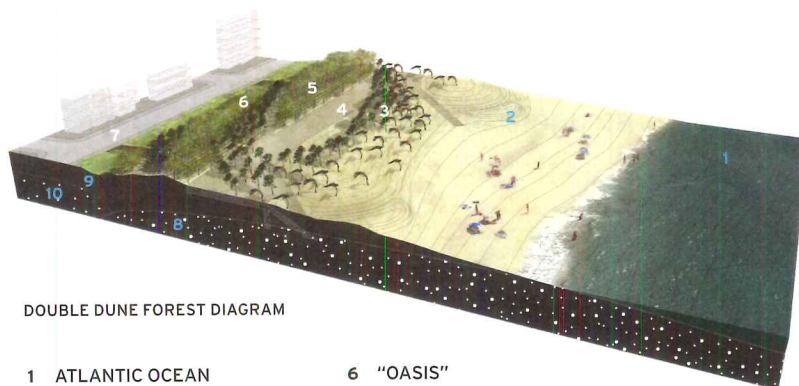

DOUBLE DUNE FOREST DIAGRAM

- | | |
|------------------------|---------------------------|
| 1 ATLANTIC OCEAN | 6 "OASIS" |
| 2 EMBRYO DUNE (12') | 7 SHOREVIEW PARKWAY (10') |
| 3 PRIMARY DUNE (14') | 8 SEAWATER INTRUSION |
| 4 BOARDWALK | 9 DRAIN TILE |
| 5 SECONDARY DUNE (19') | 10 RAINWATER LENS |

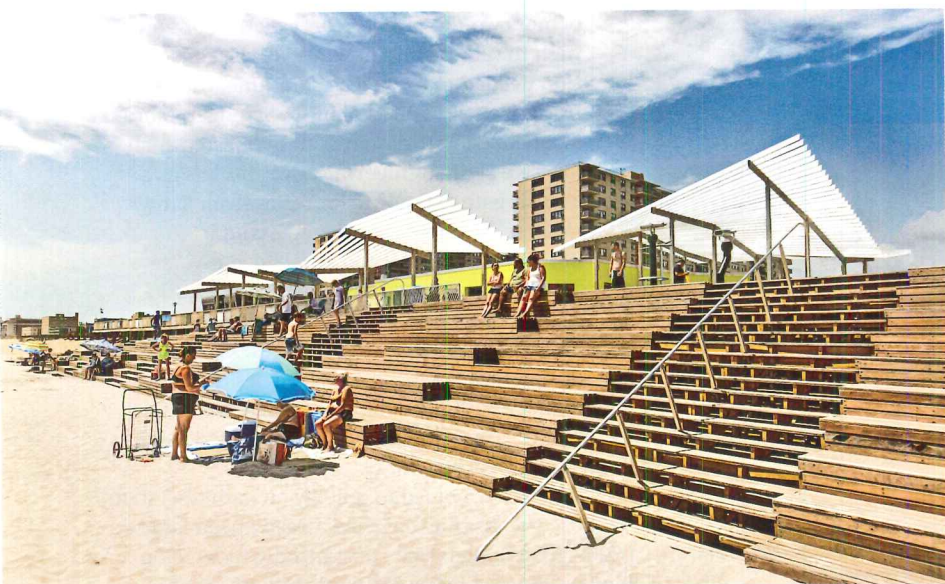

with the landscape architect Signe Nielsen. Prefabricated lifeguard stations by Garrison Architects perched as high as 20 feet above the beach, in anticipation of possible flood levels.

Restored boardwalks must coexist with dunes as high as the lifeguard stations. Walter Meyer and Jennifer Bolstad, of Local Office Landscape Architecture, have designed dunes sculpted to bounce waves back to sea, with patches of trees and shrubs to diffuse high winds. Working with architects at WXY Studio, they propose a public path of hardened cementitious sand that will meander among the hillocks of ordinary sand. As bucolic as this sounds, it's a much larger and less familiar beach intrusion than a classic boardwalk, and Meyer and Bolstad recognize that community approval may not come easily.

Meanwhile, a presidential task force, partnering with private funders like the Rockefeller Foundation, has begun Rebuild by Design, intended to identify innovative rebuilding strategies. Ten interdisciplinary teams totaling 180 professionals are developing "a set of projects and opportunities that can build comprehensive solutions" by next March, says Henk Ovink, senior advisor to the task force.

Local Office Landscape Architecture proposed a coastal dune forest pilot project for Rockaway Beach. It would dissipate wave energy, stabilize the dunes, and protect the beach from damage (top). Sage and Coombe Architects designed beach steps and benches with wood salvaged from the storm (above).

Recovery is a years-long process, which has led people to explore how to take ad hoc groups that arise out of desperate need and turn them into long-term recovery groups (LTRGs) that can plan for a daunting future. FEMA has begun to codify what it has learned from past disasters to help neighborhood groups that sprang up post-Sandy become more robust organizations, engaged in long-term planning.

Nicole Chati's neighbors banded together to form the Yellow Boots Long Term Recovery Group. According to Tina Marquardt, who has advised them as executive director of the New Orleans-based Beacon for Hope, they are now mapping the condition of about 2,300 households to see which still need rebuilding help or other aid. In a more ad hoc manner, architect Deborah Gans has been working in Brooklyn's Sheepshead Bay, apart from FEMA-sanctioned groups, to help raise a neighborhood of bungalows to include shared decks above parking, while fixing a storm-drainage system that invites floods.

Balancing the need for speed and deliberative planning isn't easy. "The approach here has been, rebuild bigger, better, faster, but there's a real danger to that," says Tim McCorry, an architect who lives and works in the hard-hit town of Belmar, New Jersey. Indeed, a fire that roared through blocks of just-rebuilt boardwalk businesses in Seaside Park, New Jersey, on September 12 was blamed on wires corroded in the storm and overlooked during rebuilding.

The most delicate conversations concern whether to rebuild at all in vulnerable locations. Moving communities out of harm's way is called "managed retreat": it is emotionally wrenching and rarely implemented. But rising seas and more violent weather may make retreat a large-scale necessity. It cannot succeed until government aligns monetary, regulatory, and land-use incentives (such as the transfer of development rights) to offer owners a way to recover at least some of the value they give up. "Architects have to lead conversations that are sensitive but say, 'Let's not build in flood zones,'" says McCorry. "And if we build near the ocean, to consider how can we do it in as resilient a way as possible." ■

James S. Russell is the architecture critic for Bloomberg News and the author of *The Agile City: Building Well-being and Wealth in an Era of Climate Change*.

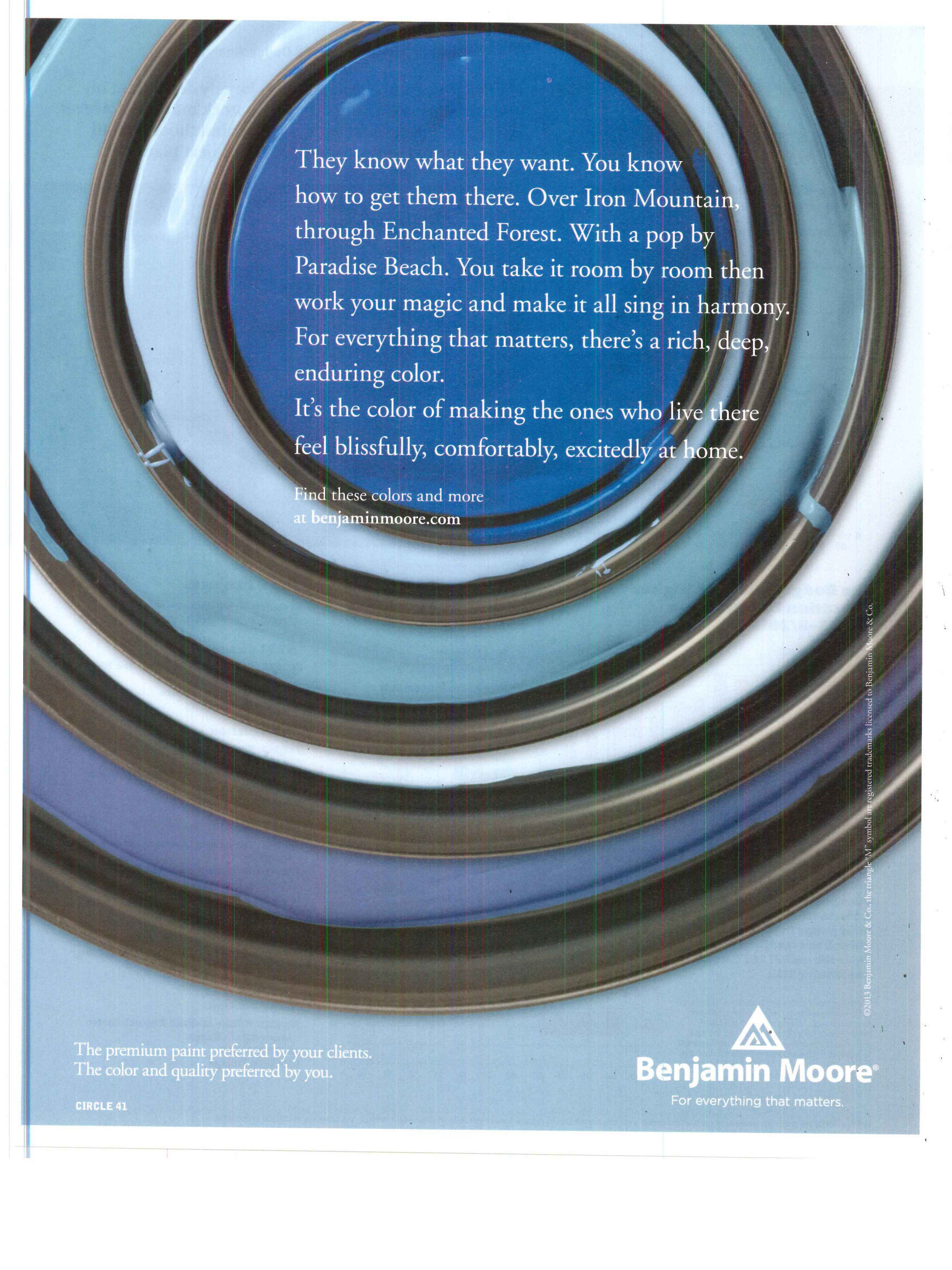

They know what they want. You know
how to get them there. Over Iron Mountain,
through Enchanted Forest. With a pop by
Paradise Beach. You take it room by room then
work your magic and make it all sing in harmony.
For everything that matters, there's a rich, deep,
enduring color.

It's the color of making the ones who live there
feel blissfully, comfortably, excitedly at home.

Find these colors and more
at benjaminmoore.com

©2013 Benjamin Moore & Co. the triangle "M" symbol are registered trademarks licensed to Benjamin Moore & Co.

The premium paint preferred by your clients.
The color and quality preferred by you.

CIRCLE 41



Benjamin Moore®

For everything that matters.

Data from McGraw Hill Dodge Analytics

MARKET FOCUS

HIGHER-EDUCATION CONSTRUCTION

Higher-education construction is largely dependent on endowments and the health of the stock market. However, the sector's peaks and valleys lag behind those of Wall Street, due to the time required for project planning.

Higher-Education Starts by Region

In addition to U.S. total and 2013 forecast figures

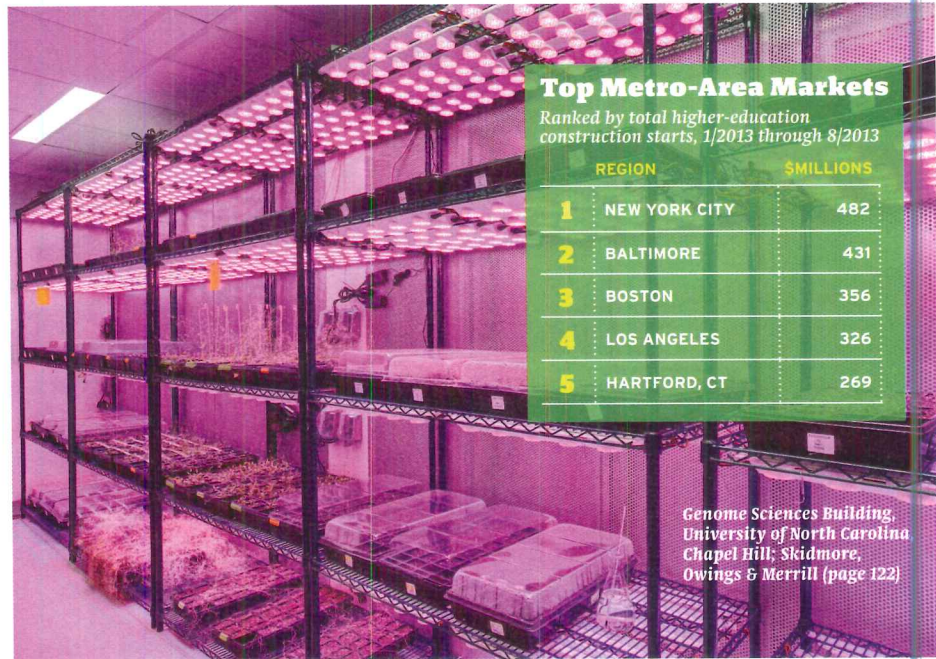
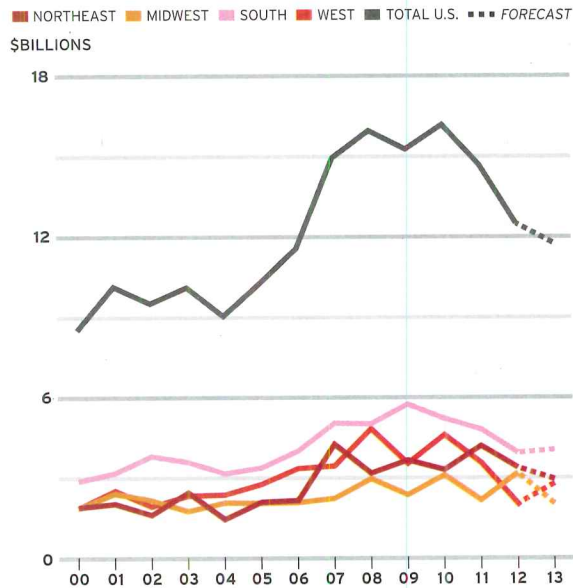

Top Metro-Area Markets

Ranked by total higher-education construction starts, 1/2013 through 8/2013

REGION	\$MILLIONS
1 NEW YORK CITY	482
2 BALTIMORE	431
3 BOSTON	356
4 LOS ANGELES	326
5 HARTFORD, CT	269

Genome Sciences Building, University of North Carolina, Chapel Hill; Skidmore, Owings & Merrill (page 122)

The Dodge Index for Higher-Education Construction 7/2012-8/2013

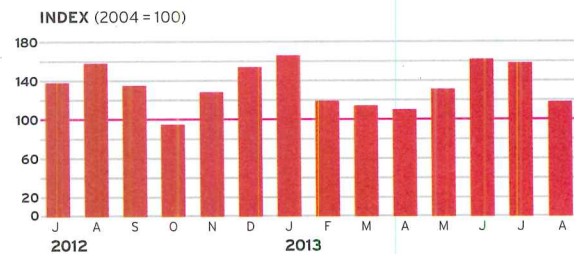

The index is based on data for U.S. higher-education construction starts that have not been seasonally adjusted. The average dollar value of projects in 2004 serves as the index baseline.

Top 5 Design Firms

Ranked by higher-education construction starts, 1/2011 through 8/2013

- 1 Ballinger
- 2 Perkins Eastman
- 3 Perkins+Will
- 4 Skidmore, Owings & Merrill
- 5 Cannon Design

Top 5 Projects

Ranked by higher-education construction starts, 1/2012 through 8/2013

- \$252 MILLION**
PROJECT: New Academic Building, New York City
College of Technology
ARCHITECT: Perkins Eastman
LOCATION: Brooklyn, NY
- \$218 MILLION**
PROJECT: Health Sciences Facility III, University of Maryland
ARCHITECTS: HOK, Design Collective, Melville Thomas Architects
LOCATION: Baltimore
- \$191 MILLION**
PROJECT: The Jackson Laboratory for Genomic Medicine
ARCHITECTS: Centerbrook Architects and Planners, Tsoi/Kobus & Associates
LOCATION: Farmington, CT
- \$180 MILLION**
PROJECT: Clinical Sciences Building, Cincinnati Children's Hospital Medical Center
ARCHITECT: GBBN Architects
LOCATION: Cincinnati
- \$166 MILLION**
PROJECT: William Eckhardt Research Center, University of Chicago
ARCHITECT: HOK
LOCATION: Chicago

MOMENTUM INDEX CONTINUES TO CLIMB

In September, the Dodge Momentum Index advanced 2.9%, to 118.3. Except for a brief pause in June, the index has steadily risen since the end of 2012, up an impressive 31%.

The Dodge Momentum Index is a leading indicator of construction spending. The information is derived from first-issued planning reports in McGraw Hill Construction's Dodge Reports database. The data leads the U.S. Commerce Department's nonresidential spending by a full year. In the graph to the right, the index has been shifted forward 12 months to reflect its relationship to the Commerce data.

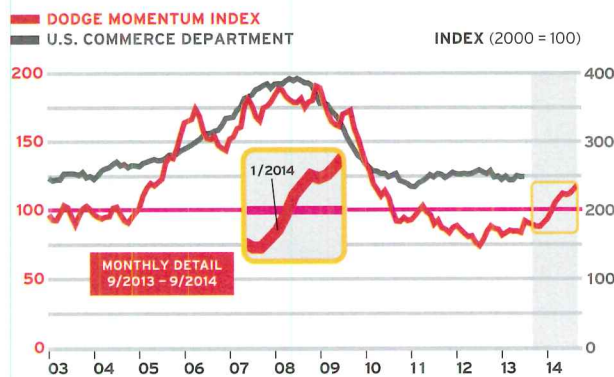



TANGENT
EDGE-LIT LED
LIGHT BOLLARD



FORMS+SURFACES®

www.forms-surfaces.com

CIRCLE 61

Performance Architecture

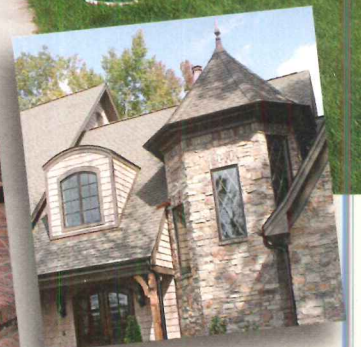
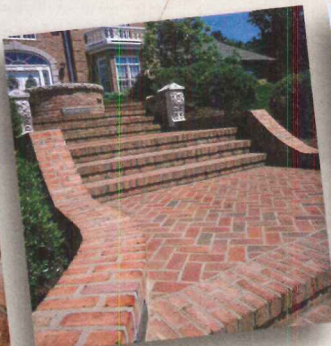
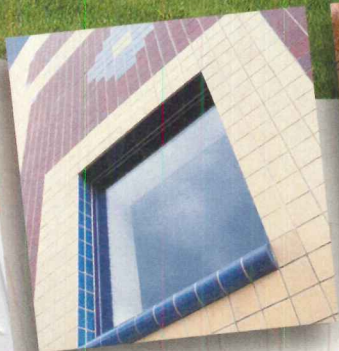

With a tradition of craftsmanship and innovation, Glen-Gery offers style and performance to those who design architecture destined to enrich our environment.

Our extensive line of facebrick, glazed brick, thin brick and paving brick includes a full range of colors, sizes, textures and shapes. Glen-Gery provides high quality data-rich BIM images, including wall assemblies, objects and profiles. We also offer Glen-Gery Landmark Stone and a complete selection of masonry products.

Glen-Gery Brick... Appearing on the finest architecture.

 **Glen-Gery Brick**

An Oldcastle® Company

610.374.4011 • www.glengerybrick.com

perspective house of the month

IN ORIENT, NEW YORK, RYALL PORTER SHERIDAN ARCHITECTS REFINE A RUGGED 1970S BUNGALOW TO MEET THE AMBITIOUS SUSTAINABILITY GOALS OF ITS NEW OWNERS. BY LAURA MIRVISS

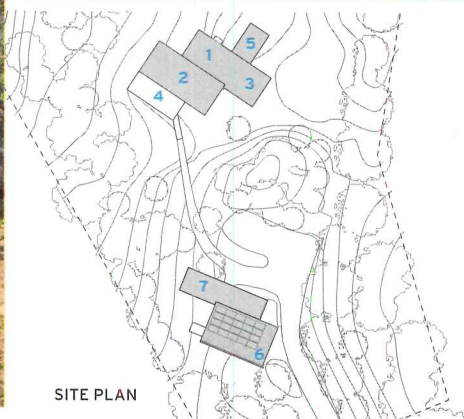

- 1 LIVING/DINING
- 2 OFFICE/KITCHEN/
BEDROOMS
- 3 SCREENED PORCH
- 4 DECK
- 5 PATIO
- 6 STUDIO
- 7 STORAGE

0 50 FT.
15 M.

Located in a remote town of fewer than 1,000 residents on the North Fork of Long Island, the house is entered via a wood platform to the south (above). North-facing living and dining areas (top right, middle right) and a screened porch (top left) frame views of the water. The renovation cost less than \$400 per square foot.

TWO NEW York artists, seeking a respite from city life, had lofty energy-saving goals for the renovation of a modest house, built in 1975, on a jagged bluff overlooking Long Island Sound. Shortly after purchasing the 2.5-acre property on the North Fork of Long Island in 2010, the couple tapped New York City-based Ryall Porter Sheridan Architects, a firm with three previous projects nearby, to update the rectangular volume and design a new stand-alone, net-zero, 1,200-square-foot painting studio.

The architects clad the existing

three-story, 2,100-square-foot wood-frame structure with timber reclaimed from razed buildings in Brooklyn and softened the rugged wood facade with recessed triple-glazed windows set in aluminum panes. “We wanted that rough look on the outside,” says William Ryall, a firm principal. “Our aim was to make it feel like an artist’s cottage in the woods someplace.” The muted interior, containing an open kitchen, dining and living area, an office, and a screened porch, with a master suite above and guest bedroom

below, is finished with white and light-gray plywood floors and walls. Wrapped in a thick layer of insulation, the house offers an array of energy-saving bells and whistles: solar panels, windows imported from Germany with an R-value of 11, and an energy-recovery ventilator (ERV) that recovers 90 percent of heat. “The electric bills have been absurdly low,” says Ryall, adding that the clients were charged the minimum of \$11 last month. “It’s probably the most energy-efficient house on Long Island.” ■

View additional images at architecturalrecord.com.

It's time for **Envolution™**.

Synthesis. Fusion. Innovation. Metl-Span®, experts in insulated metal panels, introduces Envolution, the most comprehensive and most sustainable building envelope solutions yet. Building on the foundation of our insulated metal panels, we bring you a complete platform of building products, featuring sunshades, grilles, louvers, column and beam covers and an extensive offering of custom fabricated products in association with Doralco Architectural Metals. It's time for your tools to match your ambition. **Envolution and Doralco unite customization and quality so that form truly can meet function.**

VISIT US AT GREENBUILD BOOTH 3029



ENVOLUTION
ENVELOPE SOLUTIONS DEFINED BY METL-SPAN

CIRCLE 82

877 585 9969
envolution.com

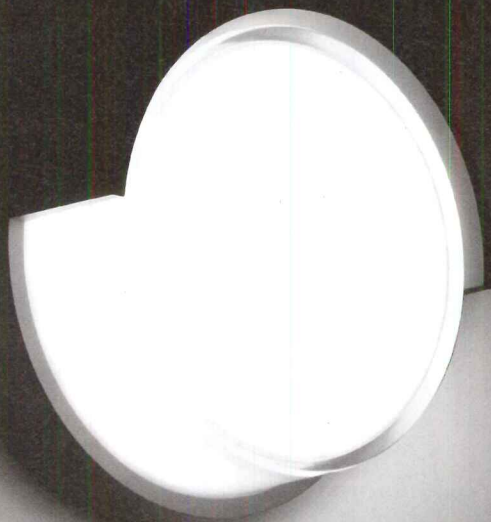

BEGA

Timeless · Classic · LED

Wall mounted interior and exterior
LED luminaires

BEGA sets the standard

BEGA-US
www.bega-us.com
(805) 684-0533
No. 149



CIRCLE 101

SAME POLYISO INSULATION. NEW TESTING METHOD. NEW R-VALUES.

ON JANUARY 1, 2014 R-VALUES FOR POLYISO INSULATION WILL CHANGE IN ACCORDANCE WITH UPDATED ASTM C1289 TESTING METHODS, NOTHING MORE.

Mark your calendars! The new industry-wide ASTM C1289 standard used in determining LTRR values for Polyiso roofing products takes effect on January 1, 2014, and brings with it new testing methods for the determination and calculation of these values. This means all Polyiso manufacturers, including Hunter Panels, will release new R-values effective January 1, 2014. The physical properties of Polyiso will not change, only the way long term thermal performance is calculated. Polyiso will continue to offer the highest R-value per inch of any rigid foam insulation. As a leading manufacturer of Polyiso, Hunter Panels wants to help our customers navigate through this critical change. We invite you to visit www.hpanels.com/index.php/2014-r-values-documents for product-specific charts showing the new LTRR values and to find answers about what the new ASTM standard and revised R-Values will mean to you.

THICKNESS	2010 R VALUE (PER ASTM C 1289)	2014 R VALUE (PER ASTM C 1289-II)
1.5	9.0	8.5
2.0	12.1	11.4
2.5	15.0	14.4
2.6	16.6	15.0 (2 layer system - R 30)
3.0	18.3	17.4

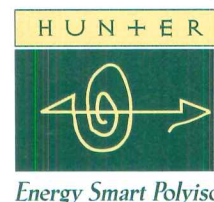

CRL ARCHITECTURAL DOORS

CRL Elephant Doors

Operable storefront sliding door system creates monumental openings!



Typical Applications:

- Mall Fronts • Museums
- Car, Truck, and Boat Dealerships
- Convention Centers • Sports Venues
- Gymnasiums • Performing Arts Facilities

MANUFACTURED BY C.R. LAURENCE COMPANY

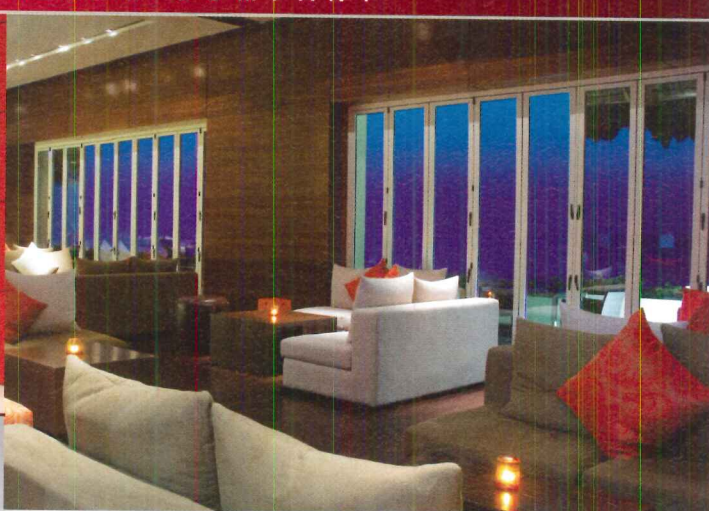

- 'All-Glass' Entrance and Storefront Systems • Balanced Doors • Formed Metal Doors
- Sliding, Bi-Folding and Stacking Doors • Display Case Doors • Screen Doors • Security Doors



C.R. LAURENCE COMPANY

Worldwide Manufacturer and Supplier
crlaurence.com | usalum.com | crl-arch.com
 Phone: (800) 421-6144 ext. 7700 | Fax: (800) 587-7501



NEW! CRL14D DOORS

Showcasing the Largest Selection of Door Systems in One Catalog!

NEW! DC14 DOOR CONTROLS

Features our complete line of door control products.
 Order, View or Download both Catalogs at crlaurence.com.

CIRCLE 40

JAB379-10/13

Cardboard Cathedral

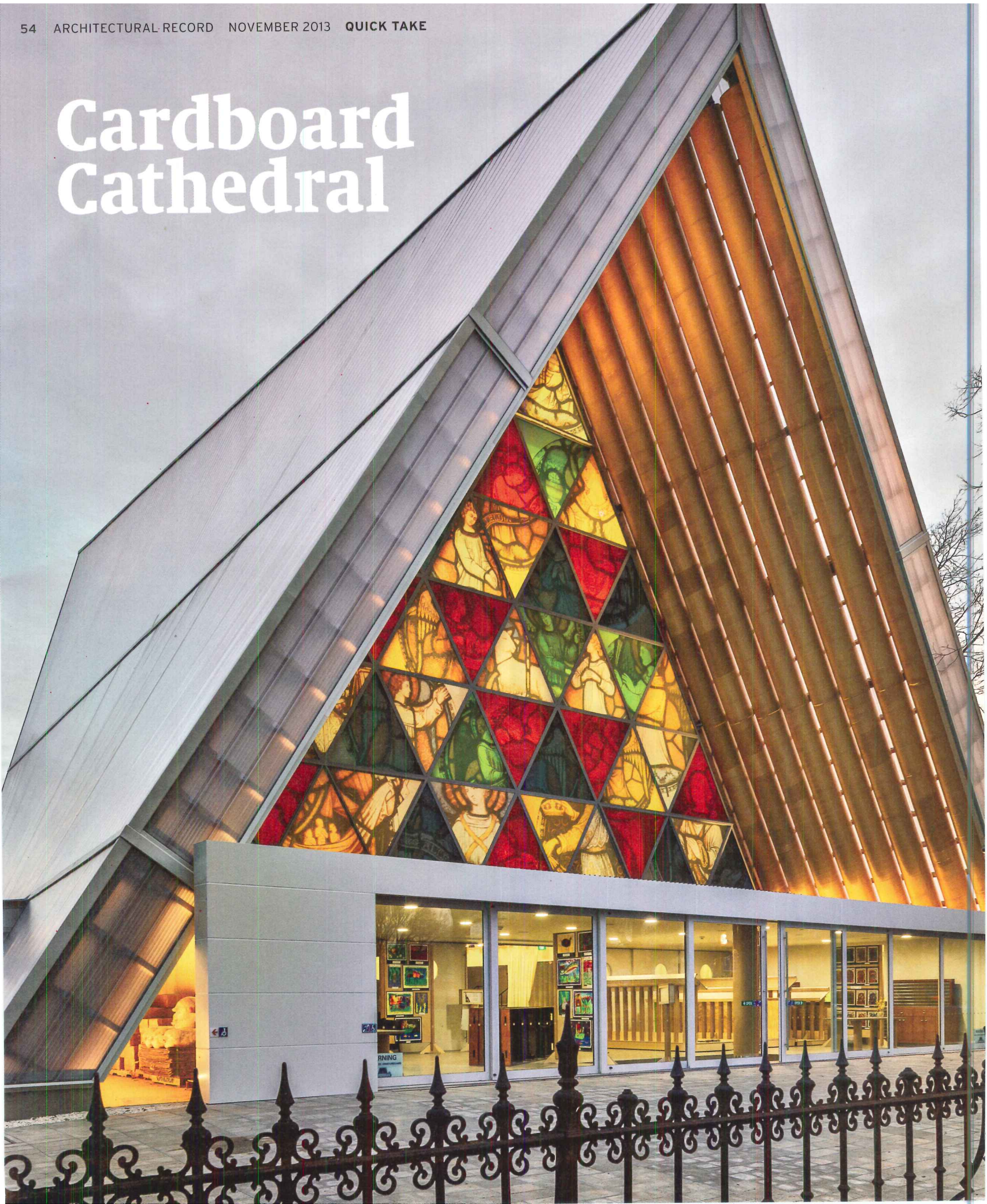

The simple structure of Shigeru Ban's temporary church evokes the resiliency of earthquake-ravaged Christchurch, New Zealand.

BY NAOMI R. POLLOCK, AIA

ON SEPTEMBER 1, the Cardboard Cathedral in Christchurch, New Zealand, had its civic opening. Measuring 8,600 square feet, it is the latest and the largest paper-tube structure designed by the Japanese architect and the world's go-to guy for emergency buildings, Shigeru Ban. Located within the city's decimated central business district, Ban's building is a temporary replacement for Christchurch's Anglican cathedral, a Gothic-style structure built in the 19th century but damaged beyond repair by the 6.3-magnitude earthquake that shook the city in February 2011.

Inspired by the original building, the Cardboard Cathedral is trapezoidal in plan and triangular in section. As the plan narrows, the section soars to its high point of 79 feet near the altar, abstractly evoking the Gothic spirit. Leaning in and up, the architecture's defining elements are the 98 paper tubes that form the A-shaped roof and side walls enclosing the 700-seat nave. In place of pews are rows of a custom version of Ban's L-Unit chair, rendered in locally available lumber and stackable for easy storage. Thanks to polycarbonate sheets shielding the exterior, the interior is filled with soft daylight that filters down between the tubes. While a paper-tube crucifix adorns the opaque end wall, a stained glass window wall crowns the entrance opposite it. Echoing the original church's rose window, Ban's version is composed of triangular primary-colored panes. Each one is etched with a fragmented image borrowed from the historic window.

Though intended for use until the congregation erects its new permanent home, a process that could take as long as 50 years, the Cardboard Cathedral is sturdy enough that it could stand a lot longer. Ban favored local materials: the main building blocks are the 24-inch-diameter paper tubes manufactured in New Zealand. For added stability, each one is filled with LVL laminated-wood inserts, also procured in the country. While pin joints accommodate the church's dynamic geometry and connect the tubes to each other at the top, the tube bottoms are affixed to the 20-foot-long prefabricated shipping containers that comprise the sides of the building. Doubling as storage and other subsidiary functions, the metal crates are anchored to a concrete base, insuring the church's viability even in the event of another quake. ■

PAPER PERMANENCE Triangular panes of stained glass (opposite) echo the original cathedral's rose window. The roof is made of paper tubes, protected from the elements by translucent polycarbonate (top and bottom right).

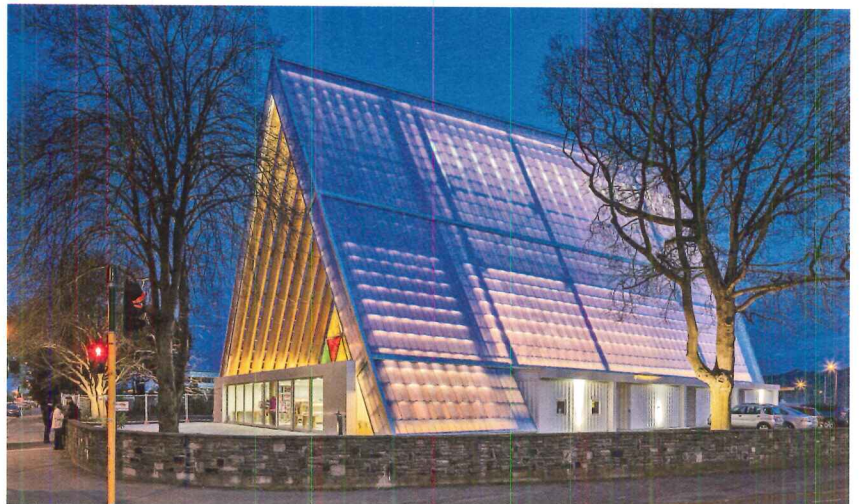
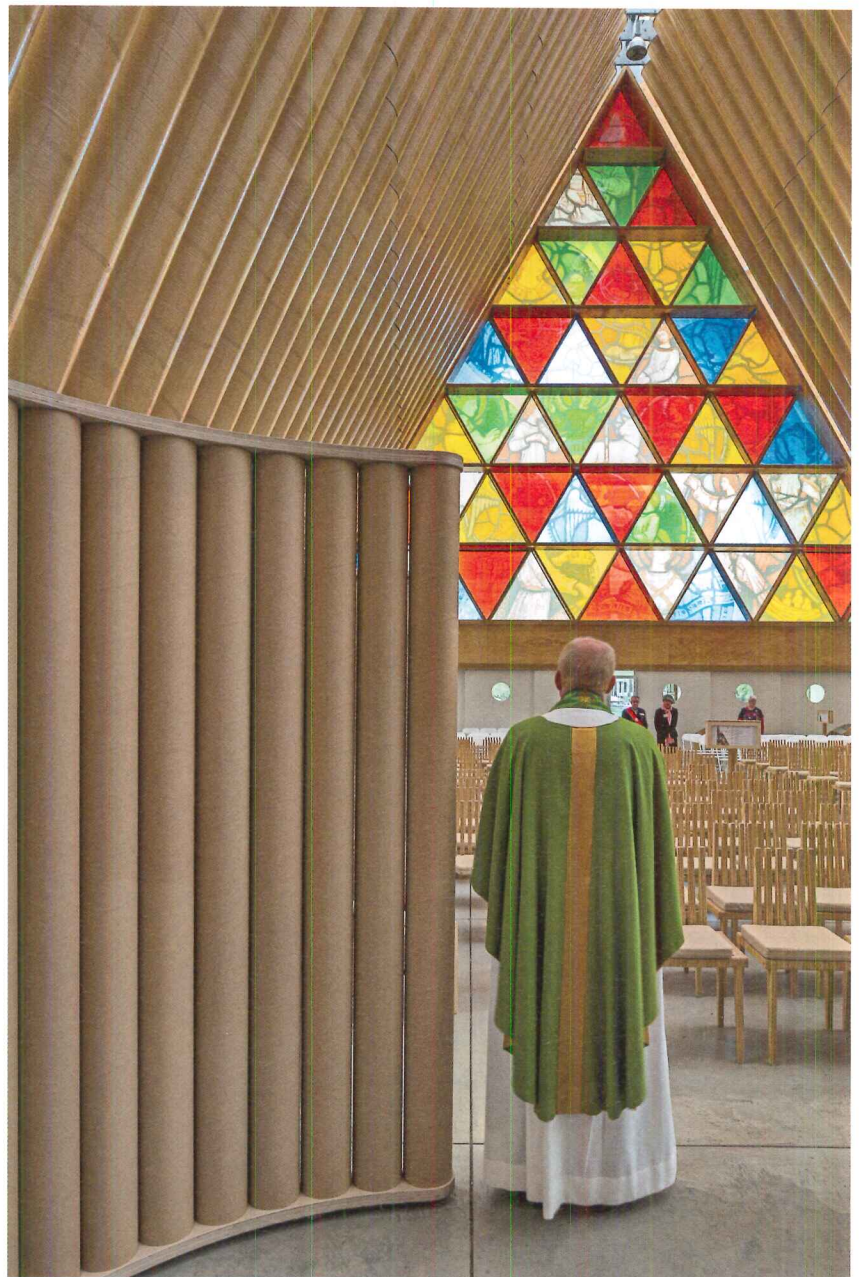



NEW
Architectural Binder
available online!

**Innovative solutions
for commercial interiors.**

www.slidingdoorco.com/tradepro

CIRCLE 45

**THE
SLIDING DOOR
COMPANY PRO®**

Intelligent Design: Perforated Metal Meets Medical Science

UNIVERSITY OF SOUTH FLORIDA

McNICHOLS® DESIGNER METALS

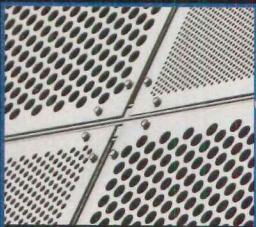

Close up view of the panels attached to the structure

McNICHOLS®

Perforated Metal Panels in alternating panel sizes were selected for the exterior of the USF's Center for Advanced Medical Learning and Simulation (CAMLs) facility in Tampa, Florida. The 0.125-gauge perforated metal panels offered the artistic traits to convey the allusion of health science and the qualities of light diffusion that reduced solar heat gain, especially on the building's western exposure.

Architects and contractors look to **McNICHOLS® Designer Metals** for sustainable, functional and aesthetic solutions for their projects. **McNICHOLS** offers endless design opportunities with our series of Hole Products that include designer metals, perforated metal, wire mesh, gratings and fiberglass in a variety of materials and styles.

For more information on our complete line of Designer Metals or to speak with one of our Architectural Team Members please call 866.754.5144 or visit mcnichols.com/arec. We look forward to serving you!

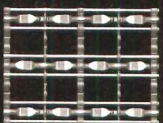

Techna 3156



Ashland 8015



Halo 1162



Halo 2252



Talica 8220

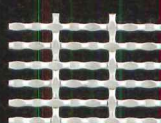

Chateau 3115

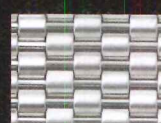

Shire 2134

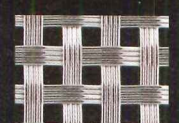

Talica 8158

McNICHOLS CO.
Industrial & Architectural Hole Product Solutions since 1952



866.754.5144 | mcnichols.com/arec

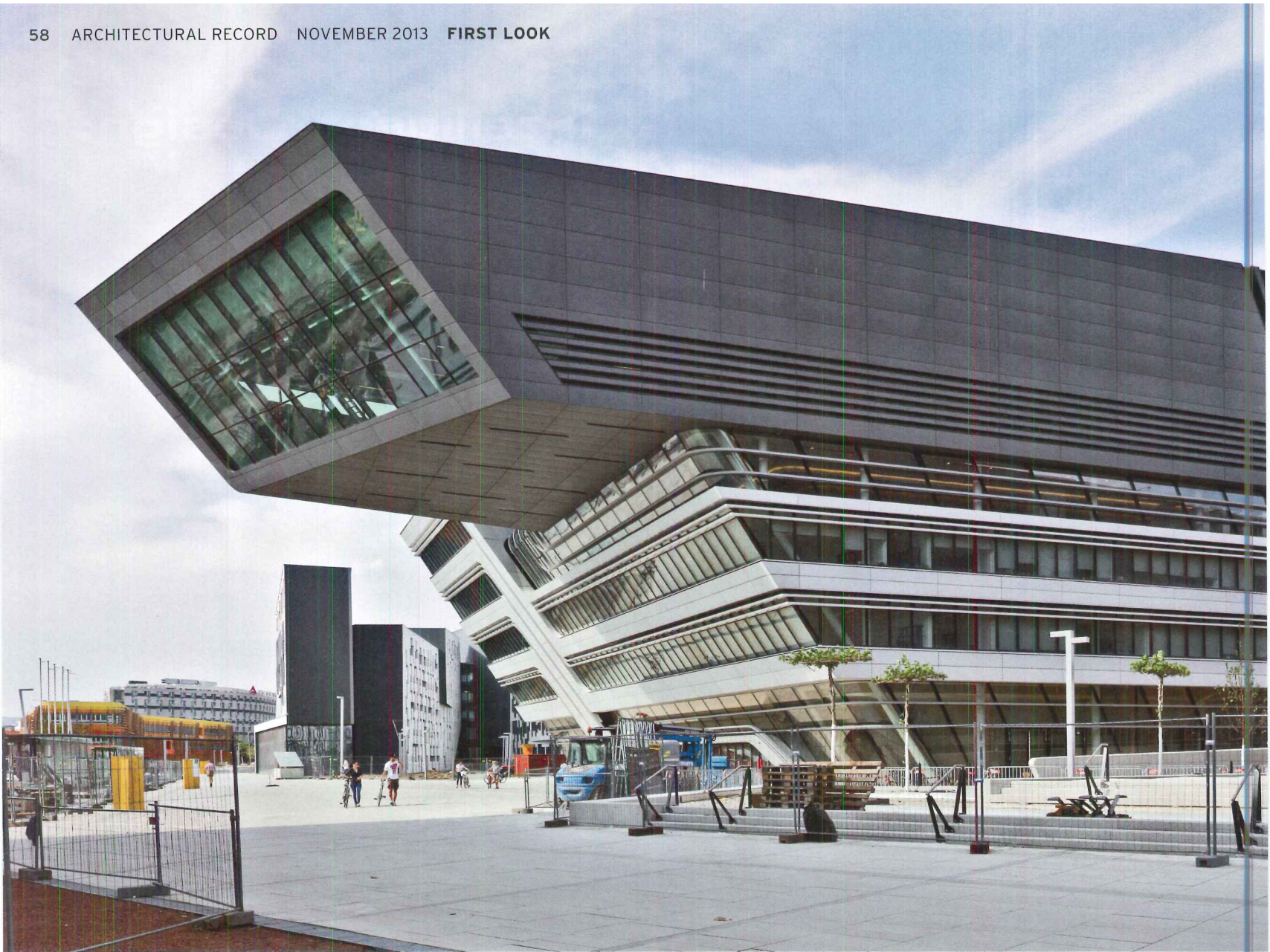

A University Re-brands

For the new campus of a business school in Vienna, six international architects design a series of innovative buildings.

BY CLIFFORD A. PEARSON

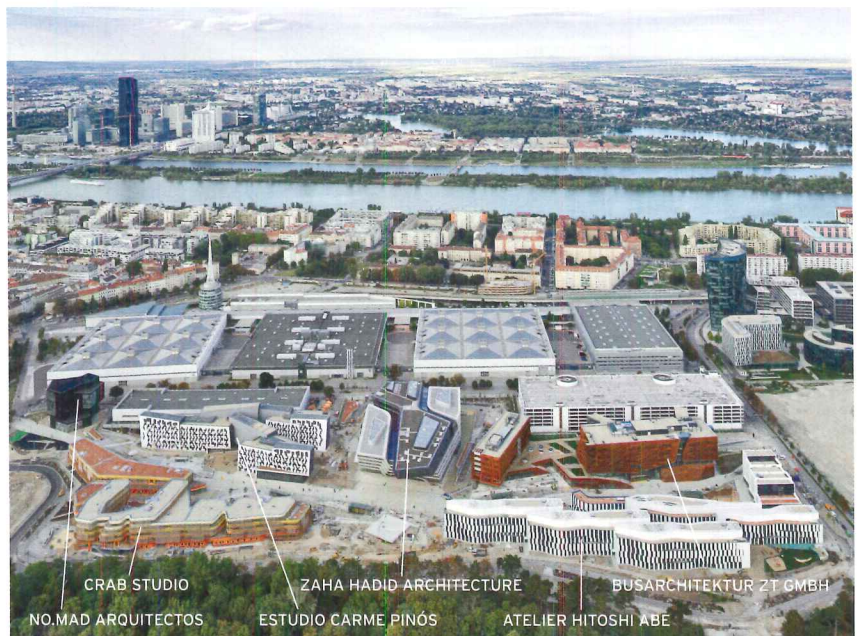

View additional images at architecturalrecord.com.



Angled at 35 degrees, Zaha Hadid's 300,000-square-foot library and Learning Center (above left) asserts itself on the central square. A Cor-Ten-clad building by BUSarchitektur (above right) houses lecture halls and a pair of atria that bring daylight inside. The campus sits between the rectangular buildings of the Messe Exhibition Center and Prater park (opposite bottom).

THE CHALLENGE was daunting: plan, design, and build an entirely new campus for the Vienna University of Economics and Business in just five years. With 25,000 students, the school had outgrown its 30-year-old home in the city's Ninth District and decided to move to a site in the Second District between Prater park and the sprawling new Messe Exhibition Center designed by Austrian architect Gustav Peichl.

The design process started in May 2008 with Vienna-based BUSarchitektur and Vasko + Partner Ingenieure winning the competition to master-plan the 22-acre site and oversee work on the 1 million square feet of facilities on six plots. To express the university's progressive mission of integrating academia and business, the school selected forward-looking architects for those six projects: BUS would design the Lecture Room Center, Zaha Hadid the Learning Center with the university's main library, Atelier Hitoshi Abe the Student Center, Peter Cook's CRAB studio the administration building, NO.MAD from Madrid the Executive Academy, and Estudio Carme Pinós a departmental building. Construction on the site began at the end of 2009, and all the buildings opened in September 2013 at a cost of \$667 million.

"The opportunity here was to create a university as a city," says BUS principal Laura Spinadel. To set an urban tone, Spinadel and her team laid out a main street running diagonally through the nearly 2,000-foot-long site and added a network of paths and plazas between the buildings. The planners also established links to the Messe, so students would have access to the real world of business. And a pair of metro stations—one at each end of the campus—connect the school to mass transit and the rest of the city. Inspired by Vienna's tradition of coffeehouses, many of the buildings have cafés on their ground floor with outdoor seating. "We wanted to create a lot of public places at different scales," says Spinadel. "Face-to-face communication is important, not just texting or e-mailing." At the center of the campus, BUS placed the main library—which stays open 24 hours a day, every day—to serve as the heart of the school.

Since an ecological ethos informs much business in Europe today, the university employs a number of sustainable-design strategies—limiting cars to the periphery of campus, using geothermal energy for 70 percent of its heating and cooling, equipping buildings with daylight- and occupancy-sensing



In Hadid's building, a pair of canted volumes containing the library and the Learning Center shift around and define a central atrium (above). CRAB studio's colorful building (left) snakes around a series of courtyards and outdoor spaces.

A Roof Johns Manville Can't Help You Build Is Unusual. Very Unusual.

Count on the industry's only single-source provider.

For more than 150 years, JM has offered the most comprehensive line of complete roofing systems. We are the only U.S. manufacturer offering an all-inclusive list of low-slope roofing options for the commercial, industrial and institutional roofing markets. From BUR to SBS and APP to single ply—PVC, TPO and EPDM—to photovoltaic and garden or cool roofs—JM truly offers it all.

JM's product innovations deliver high-performance roof systems.

We continually pursue innovative, research-driven solutions. Our recently opened state-of-the-art EPDM production facility demonstrates our ongoing commitment to single ply systems as well as to the highest manufacturing quality. With the addition of this EPDM facility, the roofs that we can't help you with are very few and very far between indeed.

We keep you ahead of the market.

We give you a competitive advantage with the products and systems that meet your customers' needs, the technical support to help you work better and the strongest guarantees in the industry backed by the financial stability of Berkshire Hathaway.

Whether you need a white, reflective roof, a black BUR roof, an environmentally smart "eco" roof, or even a difficult-to-flash roof, JM has the solution. We are dedicated to listening to your needs and meeting any roofing challenge you face.

Today, and into the future, count on JM's full support with an unmatched array of systems and solutions.

Visit us at www.jm.com/roofing.

CIRCLE 85





lighting-control systems, and capturing rainwater from roofs for irrigation. Porous paving materials reduce water runoff, while most roofs are planted, and some have solar panels to generate supplemental energy.

BUS set guidelines for the buildings but didn't dictate an aesthetic. "It's important to have diversity in the architecture," states Spinadel. As a result, BUS's rusting-steel Lecture Room Center strikes a different visual chord from the warped forms of Hadid's sleek Learning Center. The wiggling black-and-white pieces of Abe's Student Center contrast with the colored blocks of CRAB studio's administration building. And the houndstoothlike fenestration on Pinós's building plays off the stacked boxes of NO.MAD's Executive Academy. Is this a true academic village or just an architectural zoo? It's too early to tell. But with this bold move, the school uses design to expose students to a diversity of approaches that work together as a whole. ■



Carme Pinós designed her building (above left) as a set of narrow parallelograms connected at a central point, while Hitoshi Abe created a layered plan for his Student Center (above right). Eduardo Arroyo's firm NO.MAD stacked a group of boxes for its Executive Academy (right) in the northwest corner of the campus.

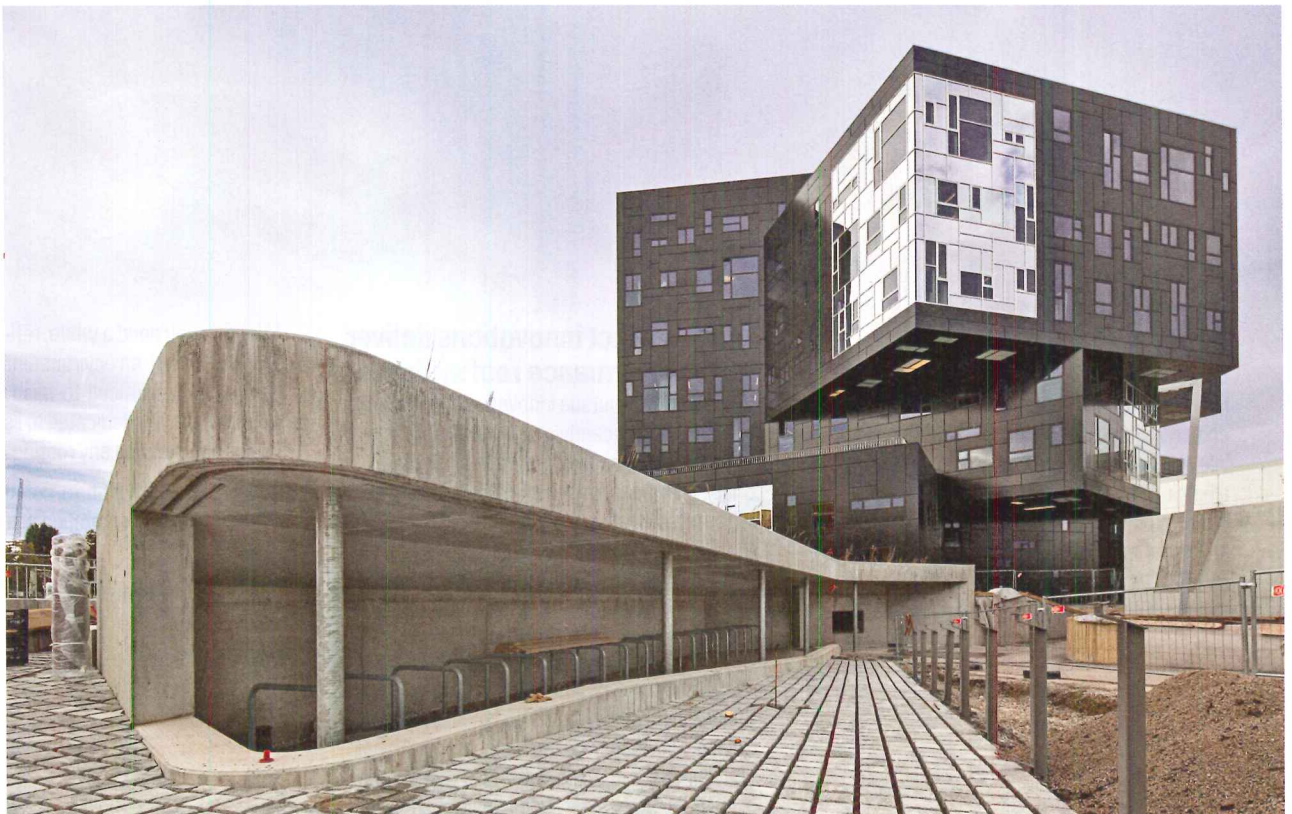

THE PEOPLE BEHIND THE MESH



IRVING CUMBERLAND
40 YEARS

MIKE KENNEDY
27 YEARS

Welcome to the team that makes mesh happen.

We, at Cambridge Architectural, are craftsmen, creative minds, engineers, project managers and expert consultants on a mission to bring your design vision to reality.

Architect: Kee Architecture
Project: University of Wisconsin - Oshkosh Elmwood Center

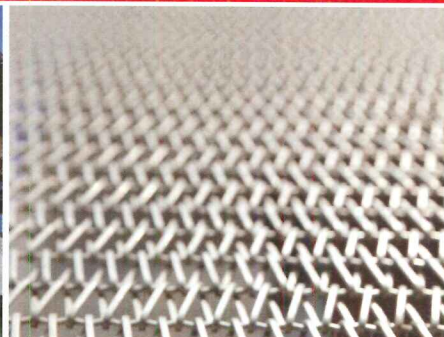
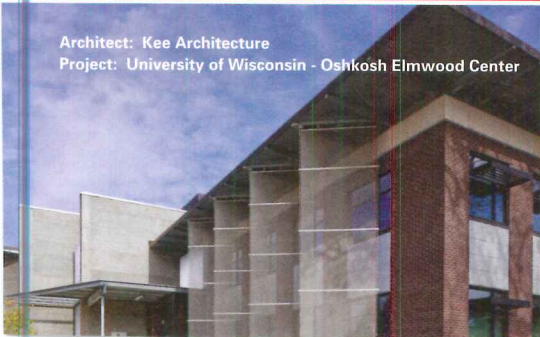

C A M B R I D G E
A R C H I T E C T U R A L

cambridgearchitectural.com

866-806-2385

CIRCLE 92

JuliusBlum&Co.Inc.

JB® Glass Railing

JB® Glass Railing components are available in aluminum, bronze, nickel-silver and stainless. Tested and available from stock, JB® Glass Railing system is designed for use with 1/2" or 3/4" glass. When combined with Carlstadt® self-aligning brackets and JB® glass adapters, the architect and specifier can achieve a wide range of design alternatives, meeting most regulatory requirements.

CATALOG
JuliusBlum&Co.Inc. 19
Stock Components For Architectural Metal Work

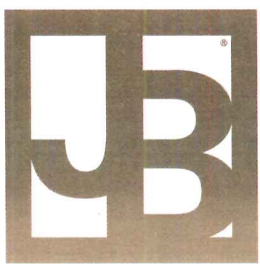

PO Box 816 Carlstadt, NJ 07072 800-526-6293 201-438-6000 Fax 201-438-6003 www.juliusblum.com

To Request your free copy of Catalog 19, email catalog19@juliusblum.com
Julius Blum & Co. Inc. is the nation's largest supplier of architectural metal products.
For complete information on all components, visit juliusblum.com

Julius Blum & Co. Inc.
800.526.6293
P.O. Box 816
Carlstadt, N.J. 07072
fax: 201-438-6003
bluminfo@juliusblum.com



cool by



design

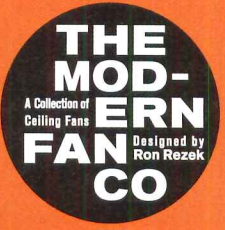

modernfan.com | 888.588.3267 CIRCLE 98

NEW!

INTRODUCING



DURALIFE LOCKERS®

BUILT FOR THE LONG HALL

THE FIRST PLASTIC LOCKER
DESIGNED FOR THE CORRIDOR!

PROUDLY MADE IN THE USA

EXIT

HALLWAY NOISE
REDUCTION

LOW MAINTENANCE

SUSTAINABLE

IMPACT &
DENT RESISTANT

AVAILABLE COLORS:



800.445.5148 CIRCLE 1
scrantonproducts.com



SCRANTON
PRODUCTS
DESIGNED TO BE WORRY-FREE



HDPE

LP

circle pendant

Design: Mikkel Beedholm/KHR arkitekter. LP Circle emits uniform, glare-free light from a high-efficiency acrylic diffuser. Circled by a voluminous blue, white, red, black or white ring, the diffuser is hidden when viewed at low angles, revealing the reflected light from the inside of the ring. LP Circle has been developed for an LED light source and comes in two color temperatures – 3000K and 4000K. Diameter Ø 17.7".

CIRCLE 26

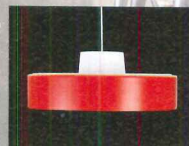

**louis
poulsen**

www.louispoulsen.com

REFLECTIVE SERIES

CHANGING THE WAY YOU THINK ABOUT CONCRETE MASONRY!



For more information on our complete line of architectural concrete masonry or to locate a dealer near you please contact us at (800) 234-8970 or visit our website www.edillon.com

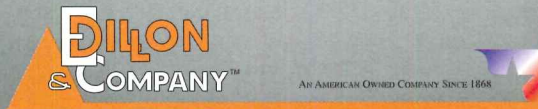

CIRCLE 63

The View From Across the Pond

Why We Build: Power and Desire in Architecture,
by Rowan Moore. Harper Design, August 2013,
400 pages, \$30.

Reviewed by Aleksandr Bierig

AS HE INDICATES in the title of his new book, British architecture critic Rowan Moore sets out to joust with Big Questions. What is the relationship between political and economic power and architectural patronage? How does active human desire translate into the latent desires embedded in architectural space? What is the relationship between the longing for home and the urge to wander?

In addressing these concerns, Moore revels in ambiguities, selecting examples to support widely differing interpretations. Drawing mostly from the 20th century, he finds projects that show how architecture can be both permanent and fleeting, how it can restrict and how it can emancipate, how it works for profit and how it finds ways to be charitable. Moore is a fluid writer and skims the surface of history with ease, but his procession of examples can sometimes feel facile, aligning neatly with his arguments instead of adding complexity.

By contrast, the most engaging sections of the book are those in which he tells longer meandering stories about particular designs and their changing popular reception. These speak to his central point—that buildings should be understood as unstable and uncertain presences, subject to adaptation over time and society's changing priorities. One section recounts the history of Amsterdam's 1957 Bijlmermeer social housing complex, whose forbidding Brutalist design was slowly humanized by immigrant populations in ways its planners could never have imagined.

Elsewhere, he turns to projects and places that have seen their fair share of attention, spending considerable time observing the exuberant development (and recent deflation) of Dubai, and the tangled history of the World Trade Center site in Lower Manhattan. These and other well-worn examples figure prominently, and the book feels more like a compilation of scattered stories than the rousing synthesis its title promises.

Moore's underlying dilemma is the role of architectural criticism in a built environment increasingly overwhelmed (and determined) by economic and political calculation.

"Power and Desire in Architecture," as his subtitle puts it, are shaped less by the visions of the architects that he fixates on than by these larger forces. Moore ably fills the conventional role of the architecture critic—that of the taste-maker, essentially, interpreting architects' longings. But today, with growing inequality and a fragile natural environment, there may be a need for a new criticism. To paraphrase the artist Jenny Holzer, the critic may have to protect us from what we want. ■

Aleksandr Bierig has written for *Log and Clog* and was a recent editor of *Pidgin Magazine*.

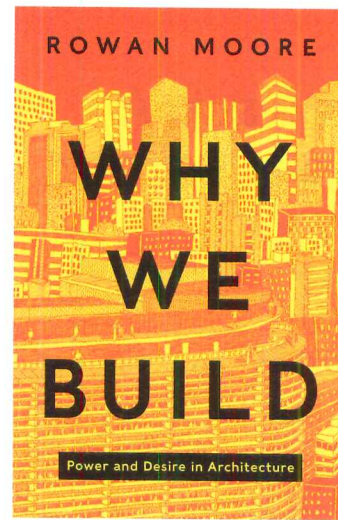

THE ASI GROUP...

BIM
Your Single Source Solution

Partitions

Stainless steel, solid plastic, powder coated steel, phenolic, color-thru phenolic and plastic laminate partitions.



Accessories

Superior design and the most extensive range of products in the industry — hallmarks of our washroom accessories.



Lockers

The best-engineered lockers and shelving in the industry.

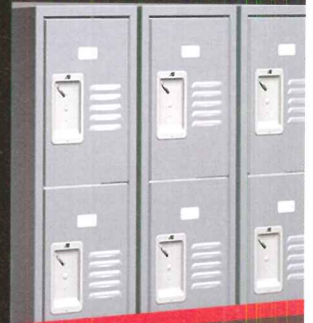

Your single source solution for Washroom Accessories, Toilet Partitions, Lockers and other storage products worldwide offers all products as BIM objects. Over 600 Division 10 products (more than any other Division 10 manufacturer) are now downloadable on our website.

asigroup.us

ASI
GROUP
PARTITIONS
ACCESSORIES
LOCKERS

Out of Whack: A Cartoonist's Vision

Hand-Drying in America: And Other Stories,
by Ben Katchor, Pantheon, 2013, 160 pages, \$30.

Reviewed by Erin McHugh

PICTURE A bizzaro realm where building, construction, architecture, and just plain city living are slightly off-kilter—the stuff that dreams are made of. Welcome to graphic novelist Ben Katchor's world. If you're willing to immerse yourself in it, you may find yourself lying awake at night, worrying about your cellar and bearing walls.

If you haven't crossed paths with Katchor before, *Hand-Drying in America: And Other Stories* is the perfect start. The genius (MacArthur-certified) behind cartoon strips and novels like *Julius Knipl, Real Estate Photographer*, *The Jew of New York*, *The Cardboard Valise*, *Hotel & Farm*, and *Shoehorn Technique* presents an oversize four-color treasury of over 150 Sunday-paper-length strips for anyone who has ever, well, lived or

worked in a building.

Cause and effect are capricious and life-changing under the spell of Katchor's pen, and the results make even the smallest things oddly and thrillingly thought-provoking. It's all in the people the reader meets along the way: the man whose repeated unsuccessful attempts to dry his hands in a restaurant result in a poor impression on an important foreign visitor in the volume's eponymous story; a professional bathroom spy; the entrepreneur who produces a line of perfume and hygiene products for architectural enthusiasts using the scents and debris at demolition sites; the co-op buyer who is sent to a psychologist specializing in architectural incompatibility; the woman who refuses to meet her date in front of a building she abhors (suspiciously reminiscent of Mies van der Rohe's Seagram Building). They all inhabit this crazy, all-too-nearly-real metropolis Katchor has built.

Readers get to visit imaginary architectural wonders like the Maharajah Tower, the Tooth

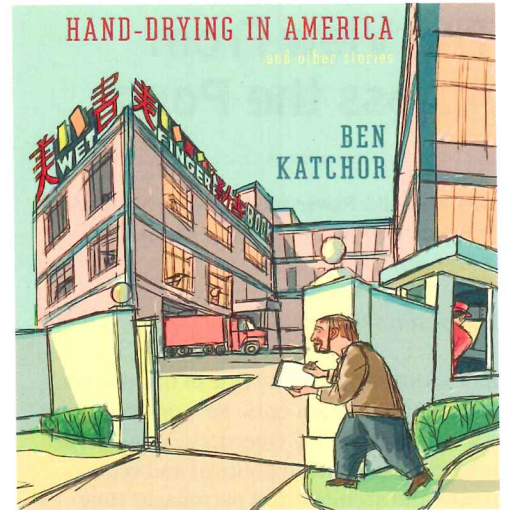

The characters in Katchor's new book inhabit a built environment that's familiar but distorted by their own personality quirks and hang-ups.

& Nail Restaurant, 211 Testes Avenue, and Nadir's Sandwich Grotto. Witness the bitter disappointment every city dweller has suffered from "scaffold shock," when after interminable months of passing under these dank, dark, temporary construction shields, we are horrified when the new, cheesy, unsightly building

INNOVATE WHEN YOU RENOVATE

Use our unique LED luminaires to create exceptionally distinctive spaces.



"Hole In The Wall" Series

Fixtures are cast GRG and, when installed, look like a custom built drywall light niche. **Now with LED options!**



Our New LED LS Series!

The trimless little steplight with a powerful wash of light.

AK Series

Powerful 1', 2' & 4' LED wall washers with 89 efficacy.



Exterior Low-Level Floodlights

Wet Location LED options are available in the CP, HITW-EX, LS-EX, LS-EXS & WLS Series.



Visit elplighting.com
or call us at
(626) 579-0943

is at last unveiled.

Now sit back and ponder: Who is Ben Katchor? Is he an evil genius, part Everyman, part bogeyman, the Bad Boy of Buildings who is the human itch you can't reach, that popcorn you can't stop eating? Or a veritable architectural superhero, protecting and warning those of us intrigued and disappointed, fascinated and undone by the structures built around us? Perhaps the best description of this award-winning graphic novelist is mirrored in his rumination on "taxpayer" buildings, those tiny, rundown pizza joints, cigar stores, dry cleaners, and delis deployed in holding patterns until bigger, fancier, better-bottom-line projects come along. "They offer a pleasant respite from the high-density development around them—a break of light and air—an architectural biding of time," writes Katchor. A few hours with *Hand-Drying in America* will give the reader a similar sense of an odd respite. Then perhaps consider this question: If *MAD* were an architecture magazine, would Ben Katchor be its editor in chief? ■

Erin McHugh is a New York- and Massachusetts-based writer and former publishing executive.



IMAGES: COURTESY PANTHEON

DORMA ACCESS SOLUTIONS

Enabling better buildings

DORMA is a market leader of innovative and inspiring designs and technologies for access solutions. DORMA features a design oriented portfolio of architectural door hardware, specialty hardware for glass door and wall applications, door automation systems, operable wall systems, and electronic access control systems.

For a 360° experience in access technology, visit the **DORMA Design Center** in NYC. | www.dorma.com



Opening & Closing



Securing



Dividing

CIRCLE 36

WINDOWS • CURTAIN WALL • ENTRANCES • STOREFRONT



The best thermal performance. Now with even greater possibilities.

EXACTLY.

EFCO's XTherm® line of high performance thermal products set a new standard for commercial window efficiency. And all the advantages of this innovative technology are available for curtain wall as well. Offering best-in-class U-factors, the XTherm line opens up a whole new world of design possibilities. View the thermal performance video at efcoexactly.com/xtherm. Only from **EFCO. Exactly.**



To learn more, call 1-800-221-4169 or visit efcocorp.com.
© 2013 EFCO Corporation

CIRCLE 34



ARCHITECTURAL RECORD

Guess the Architect Contest

ENTER NOW! A new monthly contest from the editors of RECORD asks you to guess the architect for a building of historical importance.



CLUE: A UNIVERSITY ENGINEERING BUILDING, KNOWN FOR ITS DRAMATIC ARTICULATION OF PROGRAMMATIC ELEMENTS, HELPED LAUNCH THE CAREER OF THIS ARCHITECT.

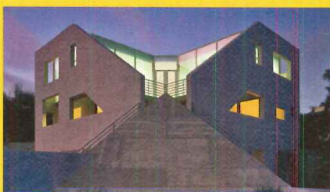

The answer to the October issue's Guess the Architect is **ANTOINE PREDOCK**, who completed the Rosenthal House in Manhattan Beach, California, in 1993. For more details, including the winner, go to archrecord.com.

By entering, you have a chance to win an iPad Mini. See the complete rules and entry form online at archrecord.com.

The World's Finest Water Features



Architects: KOKAISTUDIOS Photo: Charlie Xia

Custom Designed • Precision Crafted in the USA • Available Worldwide
Exclusively from Harmonic Environments®

 Harmonic Environments®
the premier maker of custom waterfalls

www.HarmonicEnvironments.com
800.497.3529

CIRCLE 9

Envision...

...a building that cleans the air and itself. With Parex AquaSol™ enhanced acrylic finish and coating it is all possible.

AquaSol™ is a power-packed acrylic finish and coating with enhanced hydrophobic and photocatalytic technology that creates a water repellent, heat reflective and smog reducing exterior. With exceptional hydrophobicity, AquaSol™ allows surfaces to clean itself repeatedly with rain or any water source. Additionally,

the heat reflective properties of AquaSol™ generate cooler wall surface temperatures. AquaSol™ also utilizes natural sunlight to initiate a photocatalytic process that helps destroy smog. Is your building cleaner, cooler and greener? It's time to envision the possibilities of AquaSol™. To learn more, visit parex.com.

[View Video](#)



ENVISION ANY SHAPE. ANY COLOR. ANY TEXTURE.

CIRCLE 81

PAREX®

TEXAS A&M UNIVERSITY
LIBERAL ARTS & HUMANITIES BUILDING
COLLEGE STATION, TX



Tyvek.

FLUID APPLIED WB

APPROVED & APPLIED FOR TEXAS A&M.

Only the most effective air and water barrier could pass the test to be used on the new Liberal Arts & Humanities Building at Texas A&M. The DuPont™ Tyvek® Fluid Applied System scored high for performance and ease of application to earn high marks from the installers, builders and architects.

Learn more at: www.fluidapplied.tyvek.com/casestudies

CIRCLE 35

Copyright © 2013 DuPont. All rights reserved. The DuPont Oval Logo, DuPont™ and Tyvek® are trademarks or registered trademarks of E.I. du Pont de Nemours and Company or its affiliates. Photo courtesy of BRW Architects.

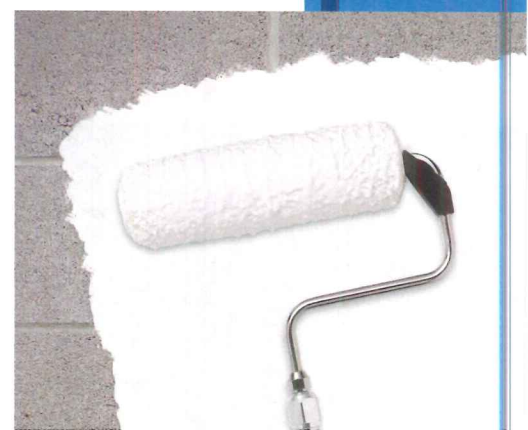

products **wood**

ACROSS THESE FLOOR, WALL, CEILING, AND FURNITURE PRODUCTS, ONE KEY INGREDIENT CONSISTENTLY IMBUES WARMTH AND SOPHISTICATION: JUST ADD WOOD. SHEILA KIM

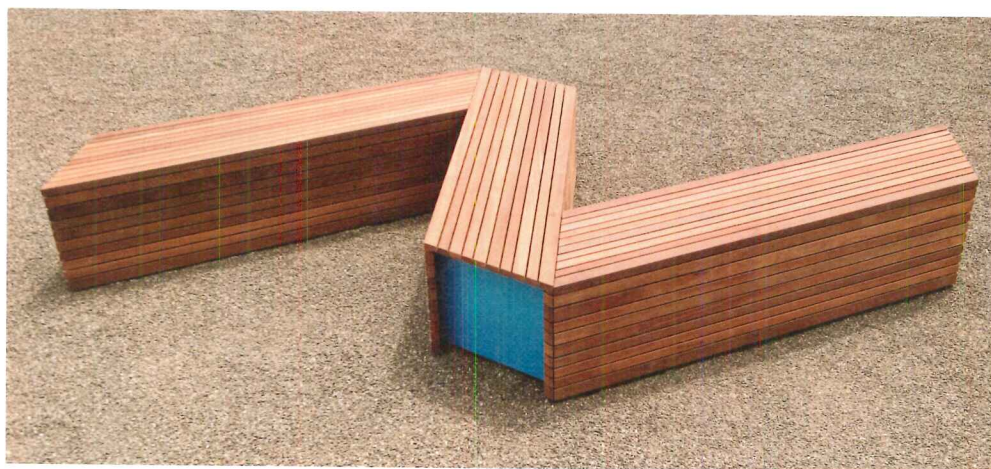

Hy Tek Natural Wood Composite Floors

Parklex parklex.com

Hy Tek is a newly launched floor product that is made using Parklex's Gureprex technology, which impregnates wood with resins to give it wear, scratch, and slip resistance for high-traffic zones. Architects can specify the planks to create desired natural or dramatic looks, thanks to a selection of 26 different finishes that run the gamut from walnut and reconstituted gray oak to deep graphite and silver. Each ½"-thick unit measures 96½" long by 7½" to 23¼" wide. **CIRCLE 200**

Parallel 42 Bench

Landscape Forms landscapeforms.com

Michigan-based Landscape Forms repurposes lumber from its own manufacturing waste to create the slatted modular bench series Parallel 42. The indoor-outdoor units can be specified in isosceles trapezoid or parallelogram formats, which can then be combined to form linear, X, or T shapes, and a number of geometric configurations. The bench is constructed from sanded unfinished Jarrah wood, which weathers naturally to a pewter gray, and steel supports that are powder-coated in the company's proprietary Panguard II, which offers protection against rusting, chipping, peeling, and fading. **CIRCLE 203**

Curvatone Acoustic Panels

Rulon International rulonco.com

Curvatone customizable wood-veneer panels offer high acoustical performance in the guise of sculptural undulating or arc-shaped forms. Suitable for both ceiling and wall applications, the panels come in cherry, maple, anigre, beech, poplar, ash, mahogany, bamboo, white oak, or red oak veneers, and in a choice of perforated or grooved designs. To ensure proper fit, Rulon's engineers consult with clients on special infrastructure needs, from in-grade lighting to sprinklers. **CIRCLE 201**

Shinnoki 2.0 Veneered Panels

Robin Reigi robin-reigi.com

Young European veneer brand Shinnoki has released new styles for its 2.0 prefinished panel product. Recently added are brushed surfaces, a lower-sheen topcoat, and five new oaks in natural and blond tones, though darker finishes such as granite walnut (shown) are also available. Shinnoki 2.0 panels are composed of FSC-certified wood veneers that are bonded to formaldehyde-free MDF substrates, making them more durable than but as easy to install as laminates. The material is ideal for millwork, walls, and other vertical surfaces in both commercial and residential settings. (An HDF-core version can be specified for flooring applications.) The panels measure 4' wide by 9' long by ¾" thick, and are available through Robin Reigi. **CIRCLE 202**



©2013 Samsung Electronics America, Inc. Samsung and Samsung Solve for Tomorrow are trademarks/service marks of Samsung Electronics Co. Ltd.

West Salem High School,
2011 Samsung Solve
for Tomorrow Winners

Nurturing tomorrow's innovators starts today.

As a technology leader, we look constantly towards the future. Through the products and solutions we create, we are dedicated to helping the next generation discover a world of possibilities.

That's why we created Samsung Solve for Tomorrow, a nationwide initiative to promote science, technology, engineering, and math (STEM) education among students in grades 6-12. A successful STEM program creates critical thinkers, increases science literacy, and empowers tomorrow's innovators.

To learn more, please visit
samsung.com/solve

CIRCLE 48



SAMSUNG
SOLVE
FOR TOMORROW



products **education**

THESE FURNISHINGS AND FINISHES—FROM A DRY-ERASE PAINT TO MOBILE DESKS—KEEP PRODUCTIVITY (AND FUN) HIGH IN EDUCATION FACILITIES. BY SHEILA KIM

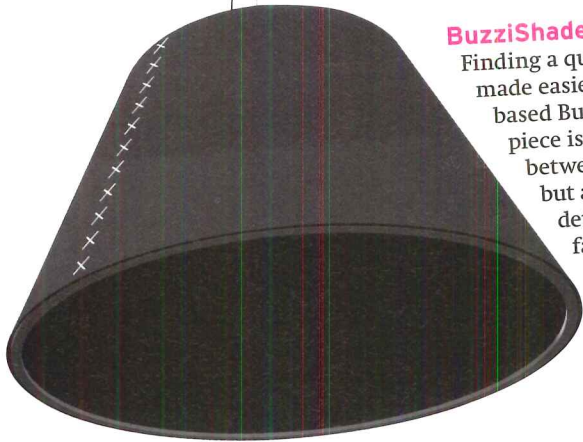

BuzziShade Pendant

Finding a quiet spot to talk within open zones is made easier with the BuzziShade from Belgium-based BuzziSpace. The large drum-pendant piece is covered in felt to isolate conversations between persons or for mobile phone calls, but also acts as a light fixture. Playful X-stitch detailing runs down the edge of the exterior fabric, which is offered in anthracite, lime, red, orange, and off-white, among other vibrant colors. The 43½"-diameter shade is constructed of a recycled-aluminum frame and upcycled-PET felt. buzzispace.com CIRCLE 204

Lily Table

An ergonomic table, Lily possesses a top large enough to accommodate a laptop and writing pad, but overall is compact and light-weight enough to move easily from individual to group work settings. Its top has a round cutout for holding beverages and a subtle groove that keeps pens from rolling off. Lily is available in white, pewter, or black, and measures 24" wide by 15¾" deep by 24½" high. sparkeology.com CIRCLE 209

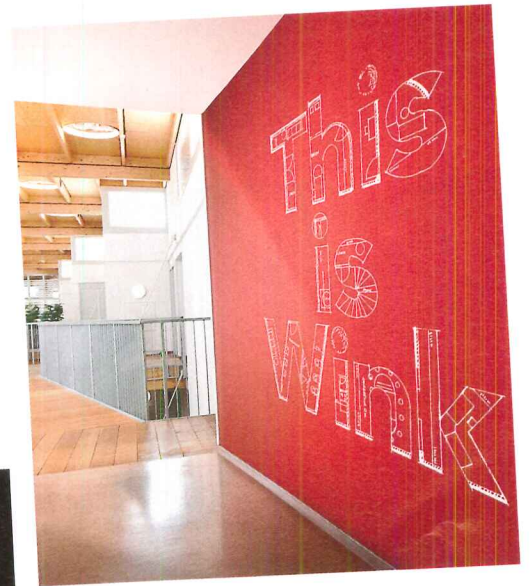

Wink Dry-Erase Paint

In recent years, a spate of paints has been developed to transform any surface into a chalkboard or dry-erase wall. Wolf-Gordon's writable whiteboard rendition, called Wink, dries clear, avoiding interference with a space's original design and color palette. The water-based low-VOC paint is commercial grade and backed by a 10-year guarantee against cracking or peeling. wolfgordon.com CIRCLE 205



Vandal-Resistant EZH2O Bottle Filling Station

To withstand destructive and common wear-and-tear activities, indoors or out, Elkay's EZH2O bottle-filling station has been enhanced with durable and tamper-free features such as an easy-to-use push-button, an inside-mount fountain spout, and a stainless-steel exterior. A monitor displays when the filter needs to be replaced, as well as an estimated count of 20-ounce plastic bottles that have been diverted from landfills through use of the sensor-operated filler station. elkayusa.com CIRCLE 208



Norament Satura Rubber Flooring

Ideal for education and health-care environments, Nora Systems' rubber flooring products are high-performance, easy to maintain, slip-resistant, and noise-reducing coverings. This latest line, Norament Satura, was developed in conjunction with a group of architects seeking new color palettes, resulting in a hammered-texture, flecked product that comes in both neutral and saturated hues. The tiles measure 40" square, though stair-tread formats are also available. nora.com CIRCLE 206

060 Series

Created by Orlandini Design for Sedia Systems, this lecture hall and classroom system consists of a sturdy pedestal that supports one or two swing-out swivel seats and a desktop with integrated wire management. The base features a torsion-spring mechanism for consistent seat return and can be specified with a choice of 10 different chair styles, including mesh-back options from Humanscale. sediastystems.com CIRCLE 207





Heydar Aliyev Cultural Center

Zaha Hadid Architects

Baku, Azerbaijan

Photography by Iwan Baan

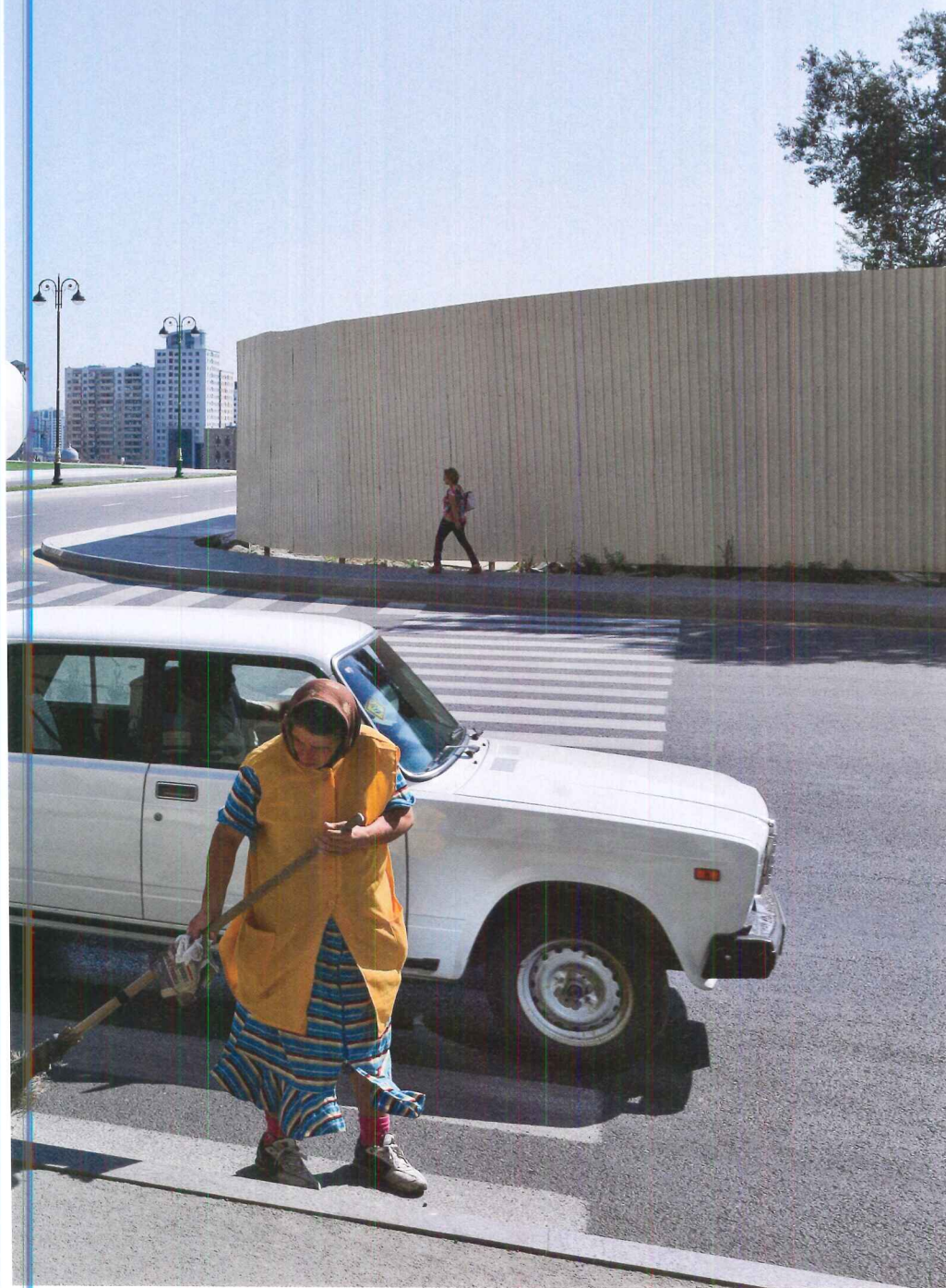

Shooting this project, I wanted to capture how it connects each visitor to the landscape. The cultural center peers up from the earth and wraps around the gardens before disappearing back into the ground again. When visitors aren't resting against the sloping sides, you'll find them inquisitively making their way around the structure, trying to figure out where the building starts and the landscape ends.

To me, what makes Zaha's cultural center remarkable is the fact that, from top to bottom, it expresses one architect's and one client's singular vision—on the scale of a massive public complex. The capital city, Baku, is both captivating and puzzling at the same time. It's the type of place where everything and nothing is possible—so, indeed, photographing there often involves peeling back layers of red tape. When you're inside the building, the all-white, curvy spaces make you feel as if you're wandering through a billowing cloud that is lit by streams of falling stars—it's an atmosphere that perfectly matches my typical jet-lagged state. —Iwan Baan



The unbridled swooping forms and blinding brightness of the glass-fiber-reinforced plastic exterior carry through to the building's interiors, where floors merge into walls, stairs, and ceilings.

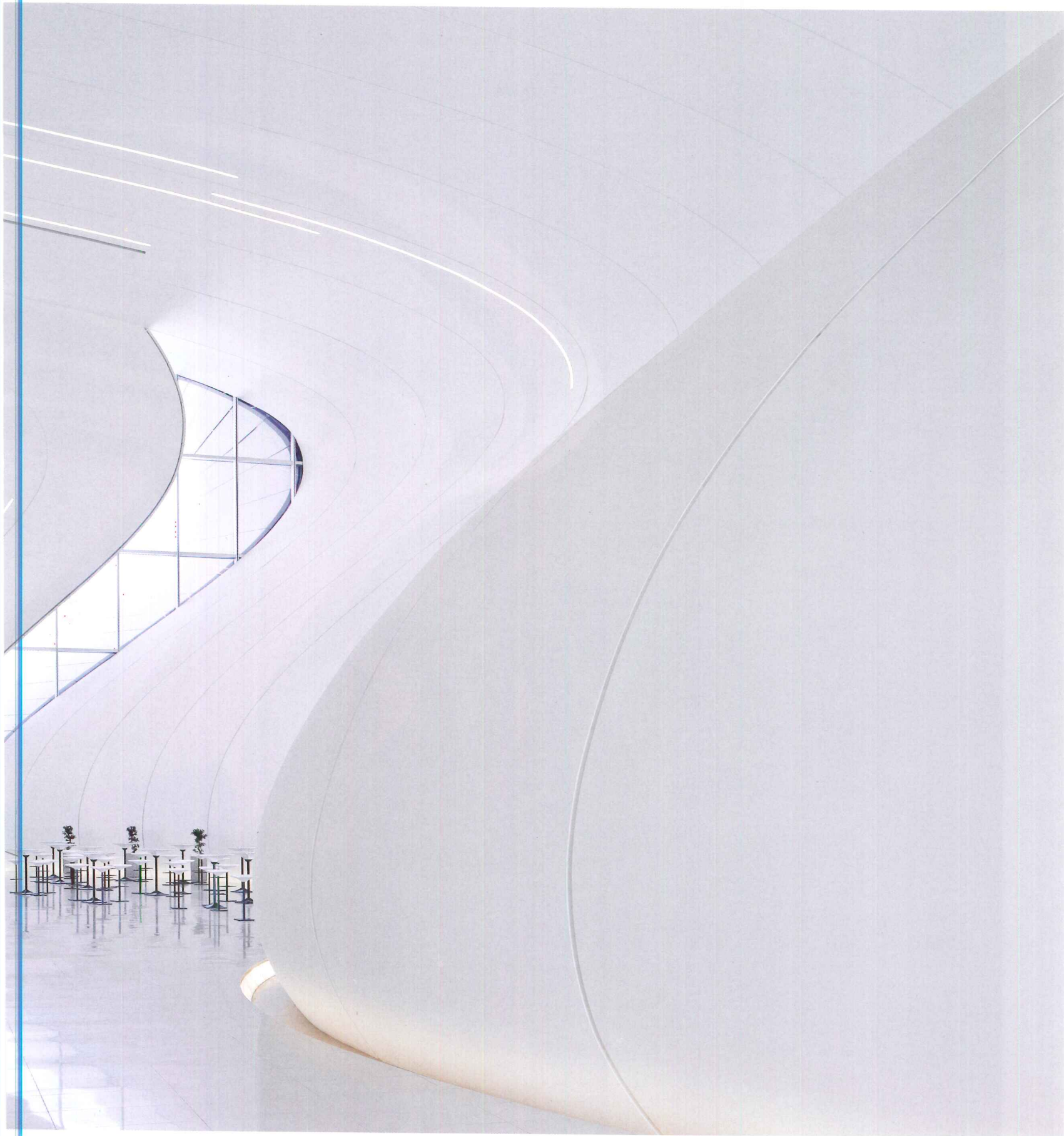

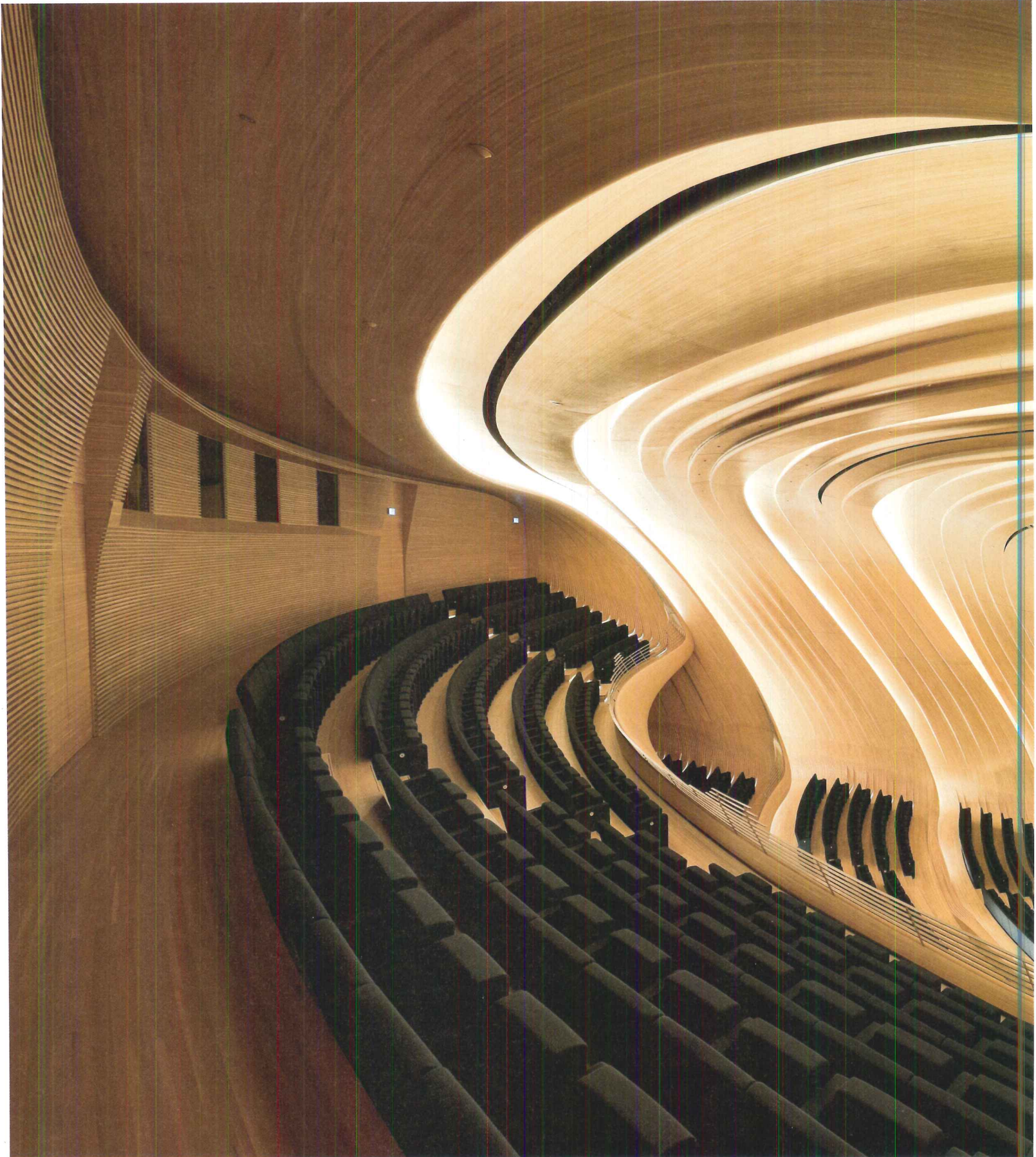

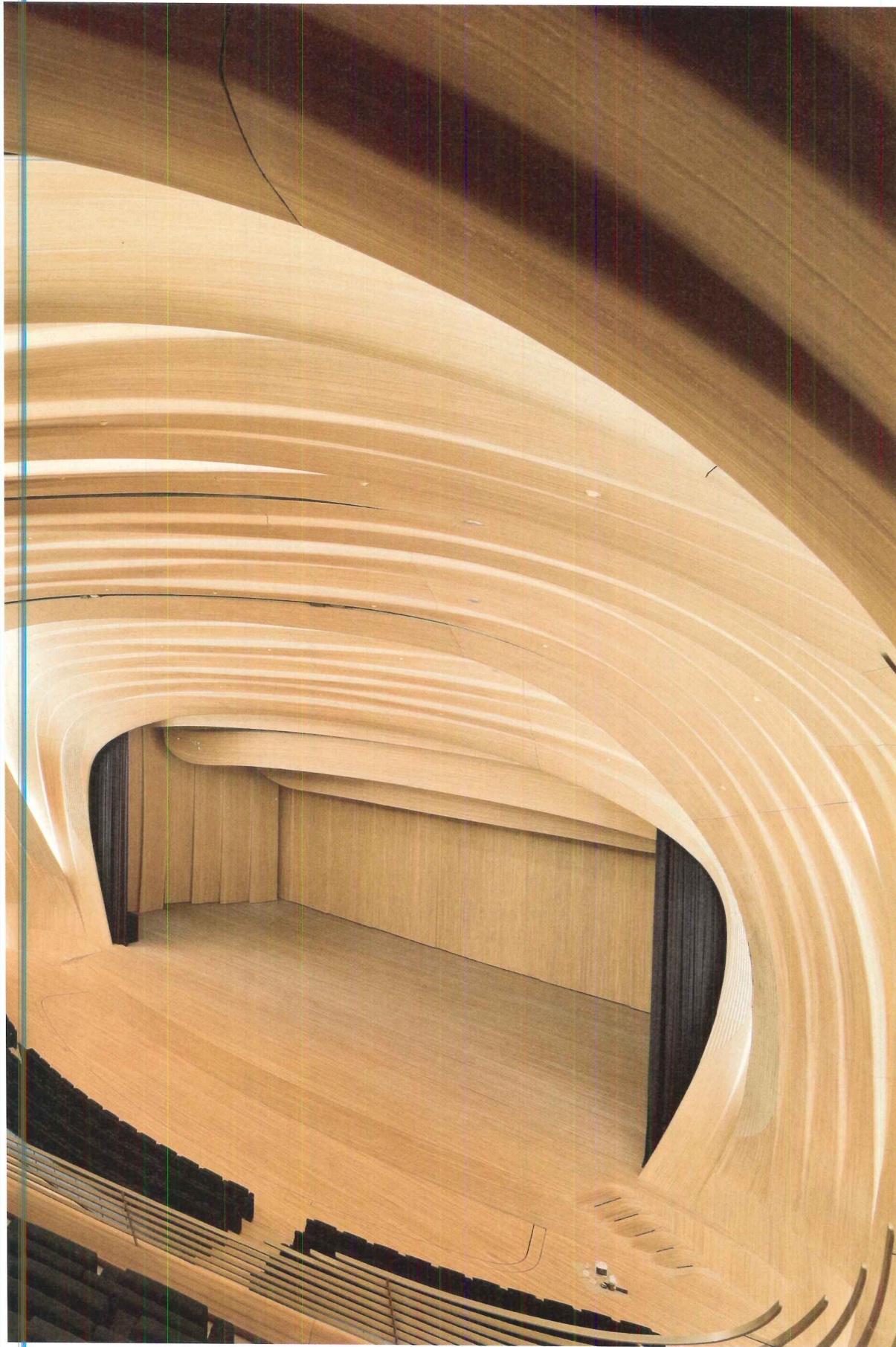

Backlighting emphasizes the dynamism of the 1,000-seat auditorium's pleated oak paneling and underscores the contrast between the materials here and those used in the rest of the building.

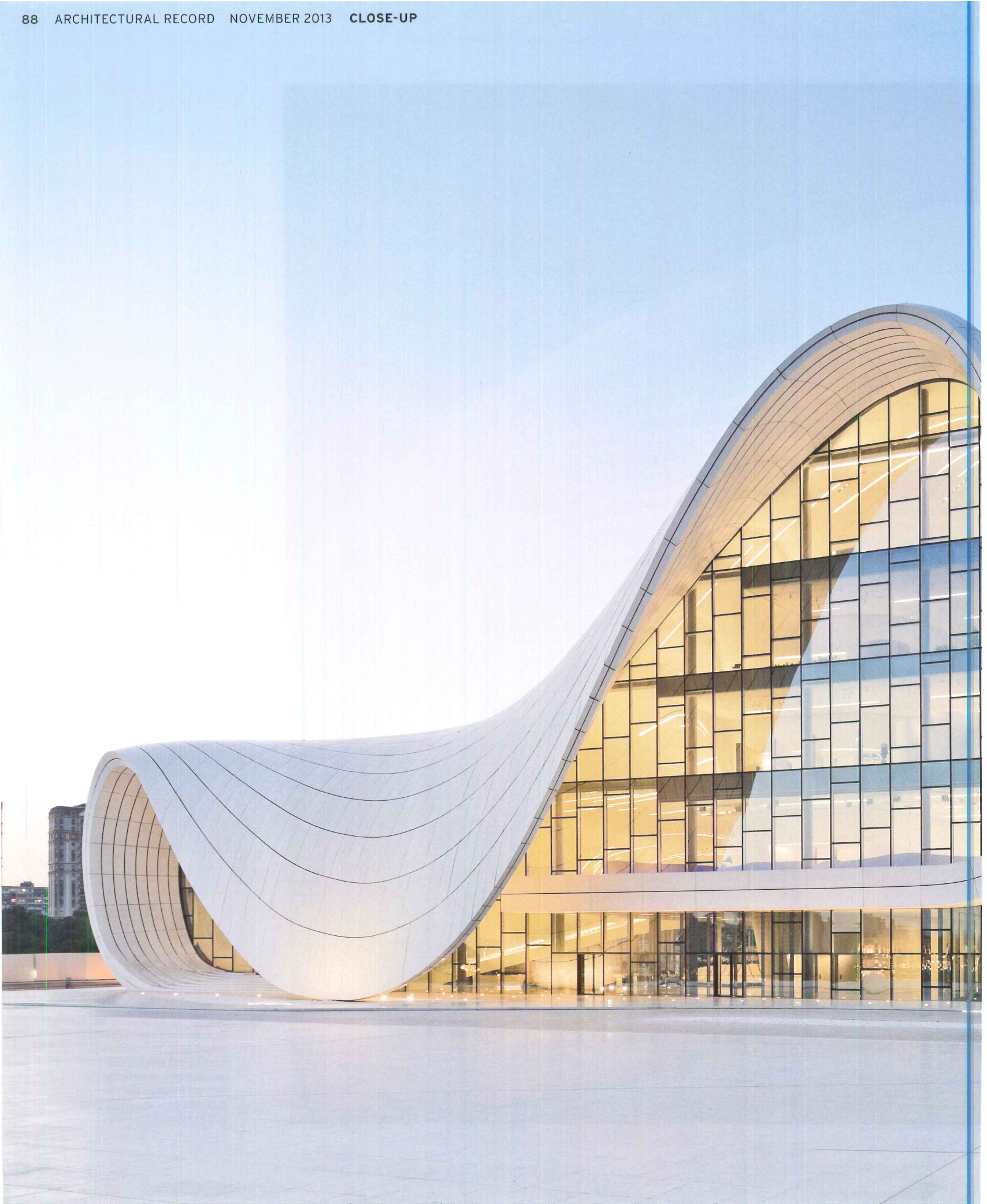



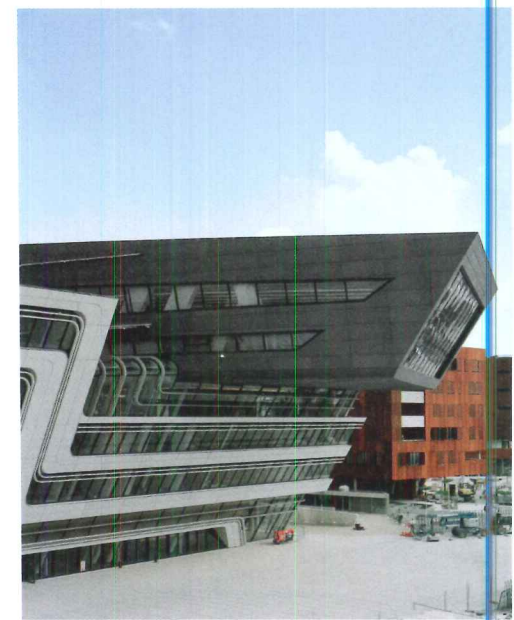
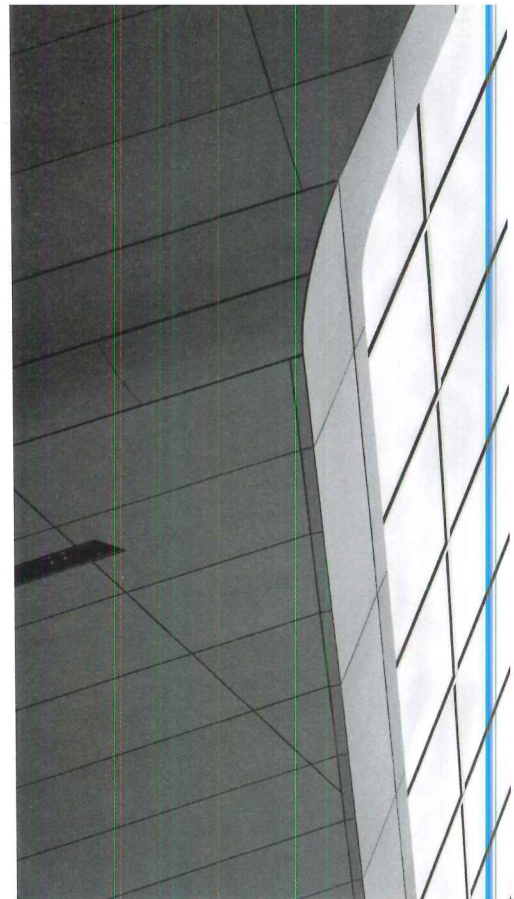

fibreC facade for Library and Learning Center, University of Vienna

Zaha Hadid Architects, London and Hamburg

6,100 m² glassfibre reinforced concrete facade in liquide black and bianco

Large format panels, formed elements and fins

Unique, honest character of material

Distributed by fibreC North America

1-877-740-0303 (toll free) | usa@fibrec.com | www.fibreC.us

CIRCLE 99

[fibre C]^{3D}
BY RIEDER



Mary Bartelme Park & Playground, Chicago, IL

STYLE FLOWS THROUGH

When your vision calls for a permeable paver, there's no better option than Unilock®.

More than twenty years ago, Unilock introduced the first permeable paver to North America and since then we've steadily increased the number of sizes, shapes, colors and architectural finishes available.

Today, our EnduraColor™ Plus technology delivers superior surface durability that can be customized to bring your project vision to life with the natural look of granite, marble, limestone or even sandstone.



Unilock permeable pavers are self-aligning, structural pavers with joint spacing that complies with the Americans with Disabilities Act and will stay true for years to come. Plus, Unilock permeable pavers can help contribute toward achieving your LEED certification goals.

With national distribution and unrivaled product selection, only Unilock truly lets your style flow through.

Visit us at the
2013 ASLA Annual Meeting & Expo
Booth 1813

CIRCLE 75

Contact us to learn more and arrange a "Lunch & Learn". Call 1-800-UNILOCK (864-5625)

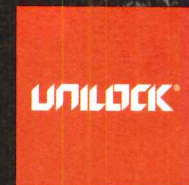

DESIGNED
TO CONNECT.

UNILOCK.COM

UNO GALEWOOD ELEMENTARY SCHOOL (Chicago)
Urban Works Ltd

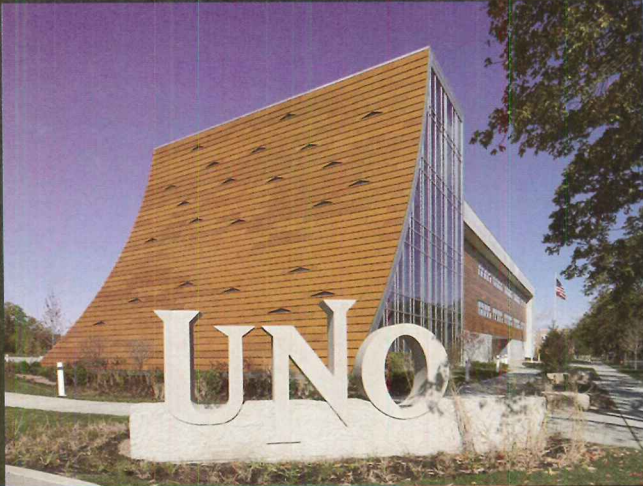

UNIVERSITY OF SOUTH FLORIDA (Tampa)
Alfonso Architects



Natural wood brings your projects to life

Give your buildings the beauty, warmth, and elegance of natural wood with our unique maintenance-free rain screen panel. ProDEX performance results far exceed industry requirements. At Prodema we're all about wood and committed to its sustainability.

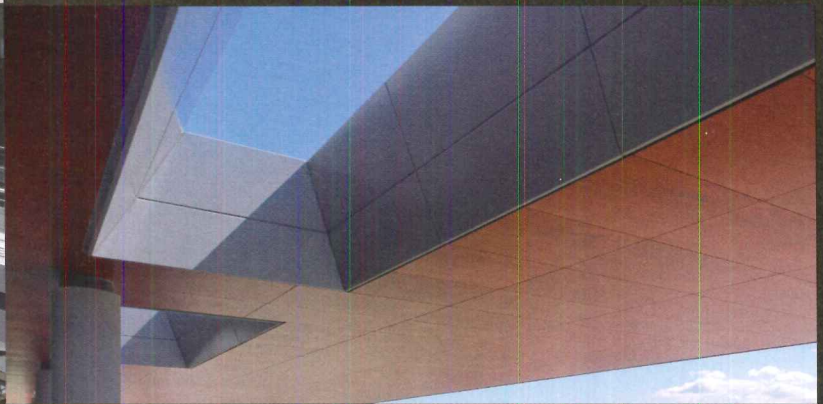

STANFORD UNIVERSITY LCK (Stanford)
NBBJ

STANFORD UNIVERSITY LCK (Stanford)
NBBJ

PRODEMA NORTH AMERICA
5582 N.E. 4th Court, 7B
Miami, FL 33137 • Tel: 305-756-2062
Email: sales@formasinc.com

ProdEX
exteriors by Prodema®

Prodema®
Made to last wooden Products

www.prodema.com

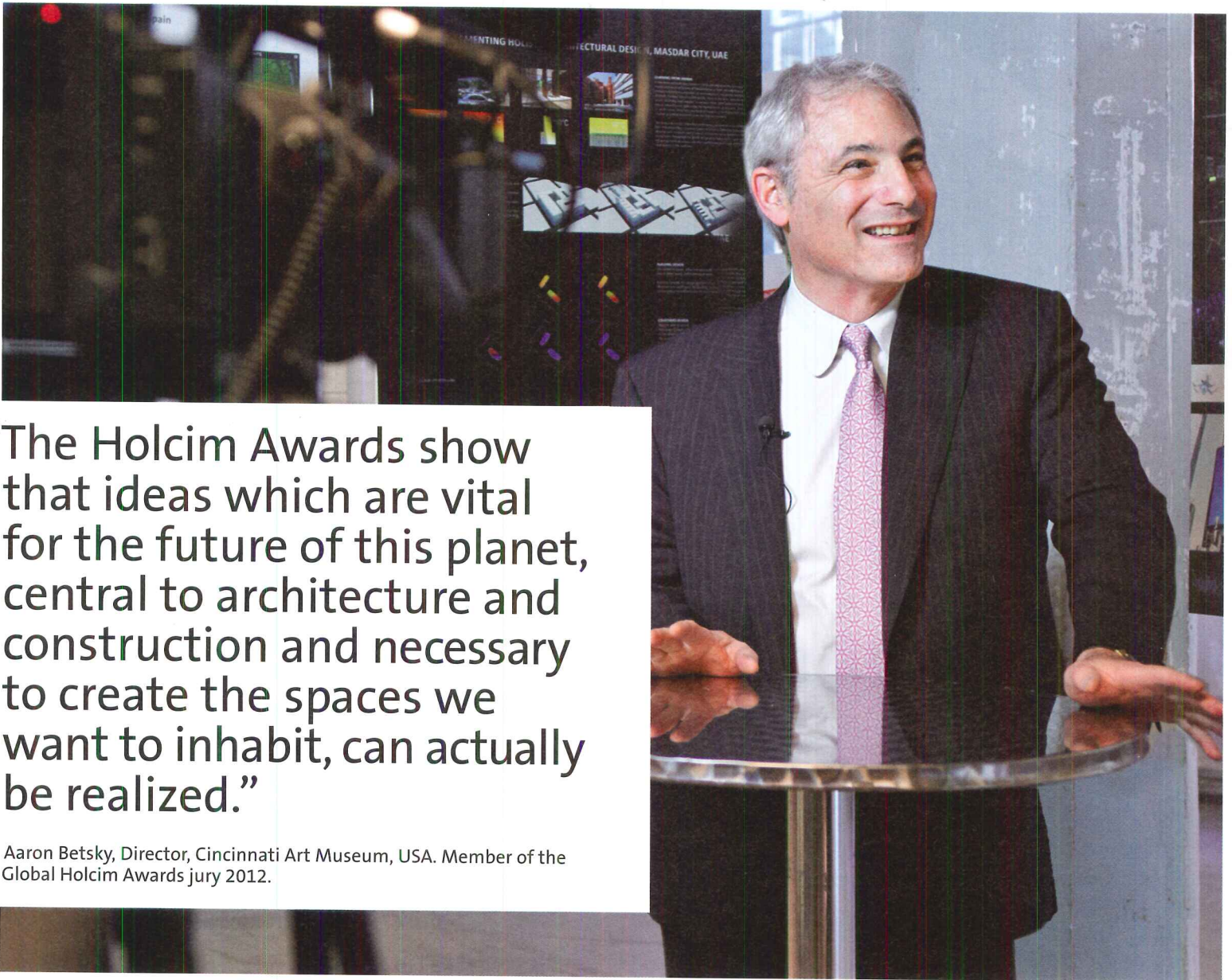

“The Holcim Awards show that ideas which are vital for the future of this planet, central to architecture and construction and necessary to create the spaces we want to inhabit, can actually be realized.”

Aaron Betsky, Director, Cincinnati Art Museum, USA. Member of the Global Holcim Awards jury 2012.

4th International Holcim Awards for sustainable construction projects. Prize money totals USD 2 million.

**OPEN NOW
FOR ENTRIES**
www.holcimawards.org

Renowned technical universities lead the independent juries in five regions of the world. They evaluate projects at an advanced stage of design against the “target issues” for sustainable construction and allocate additional prizes for visionary ideas of young professionals and students. Find out more about the competitions at www.holcimawards.org

The Holcim Awards is an initiative of the Swiss based Holcim Foundation for Sustainable Construction. It is supported by Holcim and its Group companies and affiliates in around 70 countries, including the United States. Holcim Ltd is one of the world’s leading suppliers of cement and aggregates.



 **Holcimawards**
for sustainable construction



FOR THE STILE CONSCIOUS



LaCANTINA DOORS CREATE DRAMATICALLY EXPANDED INTERIORS FILLED WITH NATURAL LIGHT AND OPEN AIR, COMPLETELY TRANSFORMING SPACE AND ENHANCING LIFESTYLE.

CUSTOM MADE IN THE U.S., **LaCANTINA DOORS** FEATURE NARROWER STILES AND MORE GLASS, AND ARE AVAILABLE IN A FULL RANGE OF MATERIALS AND COMMERCIAL OPTIONS INCLUDING THE FIRST TRUE ADA COMPLIANT FOLDING DOOR THRESHOLD.



LaCANTINA DOORS

ARCHITECTURE EDUCATION

NOW

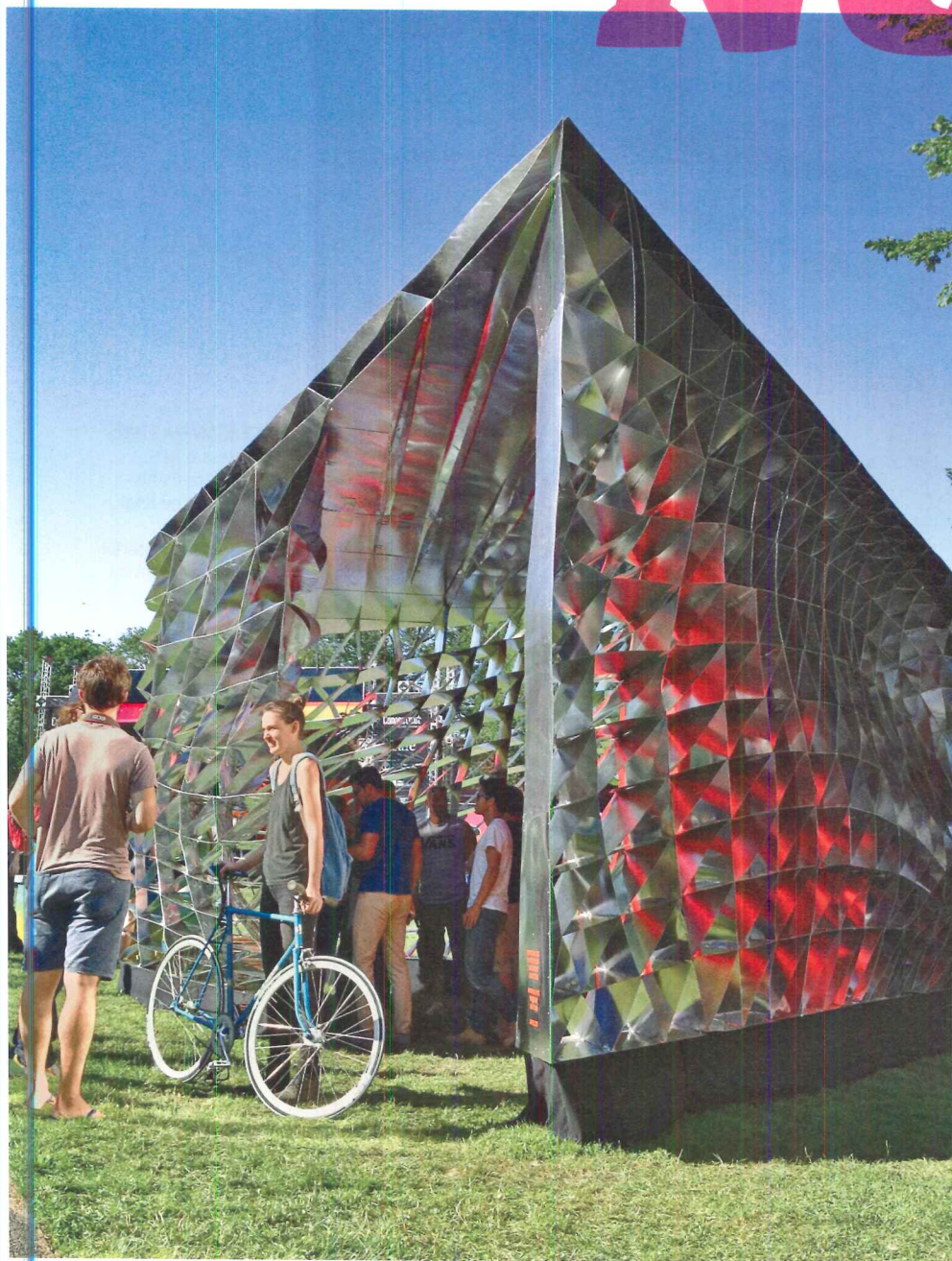

FULL METAL JACKET The School of Architecture students at Yale University designed and built a colorful aluminum-paneled information center for an arts festival in New Haven in 2012.

Once again, it's time for "America's Top Architecture Schools"—RECORD's annual presentation of the top 10 undergraduate and graduate programs, compiled by Greenway Group, a management consultant to the architecture, engineering, and construction industry. Rankings are based on perceptions of leading U.S. practitioners regarding their most valuable hires, and are supplemented by other findings from Greenway, such as key issues facing educators today. Increasingly the data are recognized as crucial to prospective students, who invest substantial time and money to secure an architectural education in today's world.

A separate report, "Crossing Borders" (page 100), highlights the diverse directions architecture educators are taking in meeting the profession's new challenges. Schools are radically expanding their emphasis from form to working with design-build approaches, and extending the reach of architectural problem-solving to the larger community. More architecture programs, both graduate and undergraduate, are initiating studios abroad—not just in Italy or Spain but in China, India, and Cambodia, to mention a few. Some students work with practitioners overseas; others travel to rural communities to help solve social problems through design, planning, and hands-on construction. In this evolving scenario, digital tools are a given: research and experimentation in architecture schools are becoming more sophisticated, with robots and 3-D printing taken for granted. New methods of designing, plus the ability to devise alternate solutions and try unexpected approaches are needed by tomorrow's practitioners. Will they be ready for the rapidly changing demands facing architecture?

America's Top Architecture Schools 2014

RECORD presents this year's rankings compiled by Greenway Group, along with related findings of interest. James P. Cramer, chair of Greenway, offers additional insights and commentary.



MICHIGAN MASTERS
Tom Bessai, M.S. 2013, presents his project for the final review of the Architecture/Material Systems program in June at the University of Michigan's Taubman College of Architecture and Urban Planning.

School rankings can seem mysterious, especially when they change from year to year. The 2014 rankings compiled by Greenway Group are no exception. While certain ones remain the same, others have shifted up or down. Basically, the survey asks architecture firms and corporations which architectural programs—both undergraduate (B.Arch.) and graduate (M.Arch.)—best prepare students for practice. When Greenway compiles its rankings, *RECORD* publishes the top 10 in both categories, while more extensive data appear in the November-December issue of Greenway's publication, *DesignIntelligence*.

Greenway's chair, James P. Cramer, explains that ratings fluctuate because surveys depend on variables such as how many firms participate. For the 2014 top-schools rankings, Greenway gathered data from 693 professional practices and corporations, an almost 250 percent increase from the number of firms (282) responding to the 2013 survey (*RECORD*, November 2013, page 67). To supplement its information, Greenway also asked 89 deans and chairs of architecture schools what they consider to be the significant issues facing architectural educators today and polled 2,760 students about their satisfaction with their architectural education.

Rankings, fluctuations and all, remain important as a measure of performance for an education that is often expensive and must prepare

students for an ever-changing architectural practice. While the economy is still sluggish, the employment rate for these graduates is higher now than in 2009, when unemployment was 13.9 percent for recent college graduates in architecture, and 9.2 percent for those over age 30, according to the Georgetown Center on Education and the Workforce. Currently unemployment is about 5 percent, according to the Department of Labor, although Greenway estimates that the number is sometimes closer to 0, depending on the region.

Enrollment in architecture schools is at a plateau: the National Architectural Accrediting Board reports that 15,187 students were enrolled in 2012 in 57 B.Arch. programs and 11,277 students were in the 95 M.Arch. programs. The numbers of students overall decreased by 2.3 percent from the previous academic year. As Cramer notes, schools need to be concerned about supplying enough well-trained architects to meet the demand. *Suzanne Stephens*

The Top 10 Undergraduate Programs

- 1 California Polytechnic State University, San Luis Obispo
- 2 Cornell University
- 3 Rice University
- 4 University of Texas at Austin
- 5 Virginia Polytechnic Institute and State University
- 6 Syracuse University
- 7 University of Southern California
- 8 Auburn University
- 9 Southern California Institute of Architecture
- 10 Rhode Island School of Design

The Top 10 Graduate Programs

- 1 Harvard University
- 2 Yale University
- 3 Columbia University
- 4 Massachusetts Institute of Technology
- 5 Cornell University
- 5 Rice University
- 7 University of Michigan
- 8 Kansas State University
- 9 University of California, Berkeley
- 10 University of Texas at Austin

COMPARISON OF PREVIOUS RANKINGS: UNDERGRADUATE

	2014	2013	2012	2011	2010	2009	2008	2007
Cal Poly San Luis Obispo	1	5	4	4	3	3	4	6
Cornell	2	1	1	1	1	1	2	1
Rice	3	3	5	3	9	8	11	2
UT Austin	4	6	2	7	5	6	6	9
Virginia Tech	5	7	3	4	4	2	1	4
Syracuse	6	3	7	2	2	4	3	3
USC	7	16	12	9	10	12	12	14
Auburn	8	9	14	18	13	12	18	6
SCI-Arc	9	2	7	6	-	19	-	-
RISD	10	7	6	11	7	4	17	5

COMPARISON OF PREVIOUS RANKINGS: GRADUATE

	2014	2013	2012	2011	2010	2009	2008	2007
Harvard	1	1	1	2	1	1	1	1
Yale	2	3	2	3	2	4	13	3
Columbia	3	2	3	4	4	3	3	9
MIT	4	4	6	5	3	4	2	4
Cornell	5	5	6	6	7	6	3	6
Rice	5	15	14	16	15	16	10	6
U Michigan	7	11	8	1	-	9	8	16
Kansas State	8	13	5	-	16	11	13	-
UC Berkeley	9	7	14	10	9	17	8	-
UT Austin	10	11	11	10	5	9	10	12

Where more than one school receives the same number of votes, the schools are given the same numerical ranking, and the next rank is omitted.

AR: Why did California Polytechnic State University at San Luis Obispo get the top ranking for its B. Arch. program? Cornell University's architecture department often takes that spot.

JC: I really don't know why. I don't see it as an indicator of quality, since they both have great programs and consistently make the list of top 5 undergraduate architecture schools. Let's see if it becomes a trend over the next few years.

What about the general fluctuation in rankings? For example, Rice University is fifth in top 10 graduate programs for 2014, although it ranked 15 last year. The University of Michigan and Kansas State University also landed in the top 10 in graduate programs this year, while both placed lower—in the top 20—in previous years.

Since rankings depend on firms' responses, it might be that the same firms did not participate this year. If firms only respond every other year, it can affect the statistics. Furthermore, a dialogue between the school and the profession, which Rice does well, is important. One mistake schools make is to communicate only

with alumni. You need to let both national and international practitioners—the people who are hiring—know what your school is doing. Most firms don't come to campus to recruit, so you have to reach them. Schools do it through a strong website, or by e-mail, letters, videos, or conferences. It's not a good idea only to communicate with firms when you want to raise money.

Why do the same small coterie of schools remain dominant?

Obviously, a long-standing reputation helps. Schools such as Harvard and Cornell turn out students who will become leading practitioners. Graduates who form global practices create a large international network of foreign clients and practitioners, which continues to boost the rankings at those schools. Harvard, for one, is very responsive to the

profession; it creates an active dialogue among the faculty, students, and professionals through its weekly lectures and frequent symposiums.

Why is a Harvard architectural education so admired?

Deans and chairs from other schools cite its availability of resources, emphasis on theory, focus on global practice and international connections, and its faculty, among other things.

What else improves rankings in schools?

Often a new building helps a school gain visibility. But the curriculum is so important. The differentiation between disciplines is blurring because of the speed of project delivery, which is calling for more integration of abilities and skills. Schools with crossover curricula—and which teach business principles, communication, and leadership—have a better chance to improve their rankings with architecture firms.

Are there particular programs on the horizon that you find commendable?

The University of Minnesota's College of Design includes—besides architecture, landscape architecture, housing studies, graphic design, interior design—apparel design, retail merchandising, and product design. This keeps students from staying in a silo of one discipline, which can be stifling. Other schools are putting construction management and architecture in the same program—California Poly at San Luis Obispo, Texas A&M, Georgia Institute of Technology, to name a few. It creates a new DNA that leads to a design-build orientation. Not only are architects forming design-build practices, but construction companies are bringing architects into their firms. And they recruit at architecture schools, as Skanska has with Georgia Tech. The construction companies want architects as CEOs or owners. We'll be seeing more mergers and shared ownership between the construction industry and the architecture profession.

Another unusual collaboration is between the University of Tennessee's College of Architecture and Design and the Oak Ridge National Laboratory. They are teaming up on a program of research and innovation in energy use and urban design, and plan to bring in an architectural firm.

What about the integration of business and architecture?

Business and design schools are already doing this: Carey Business School at Johns Hopkins, in partnership with Maryland Institute College of Art, offers programs on design leadership. Parsons The New School for Design is rolling out a master's in Strategic Design and Management, and the new Hasso Plattner Institute of Design at Stanford University offers courses in business and management training. Architecture schools need to pay attention to this trend.

In the list of five significant issues that deans and chairs care about, integrated practice and interdisciplinary education is No. 1. But design quality isn't included in the deans' and chairs' top five—although it is top for firm leaders. What's that about?

I suspect that deans and chairs are mentioning the key issues they see emerging. They take design quality for granted. For that same reason, deans and chairs put working with the community on low-income housing or emergency projects in the top five, but you don't see it on practitioners' top five. But so many practitioners take on pro-bono projects,

Architecture Student Survey

This year, 2,760 students responded to *DesignIntelligence's* questions about their satisfaction with their education in 70 schools. Of this group, 28.1 percent is undergraduate (B.Arch.) and 35.4 percent is graduate (M.Arch.); if all undergraduate architecture programs are grouped, including B.Arch., B.S., and B.A., the percentage rises to 57.8 percent. As the sample indicates, the students generally approve of the education they are receiving, and many consider it superlative.



How they grade the quality of their program overall



Believe they will be well prepared for their profession upon graduation

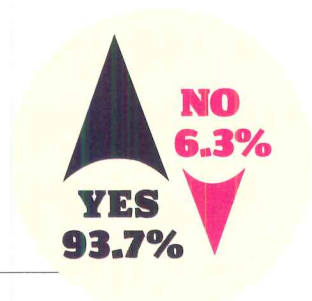

What they'll do after graduation

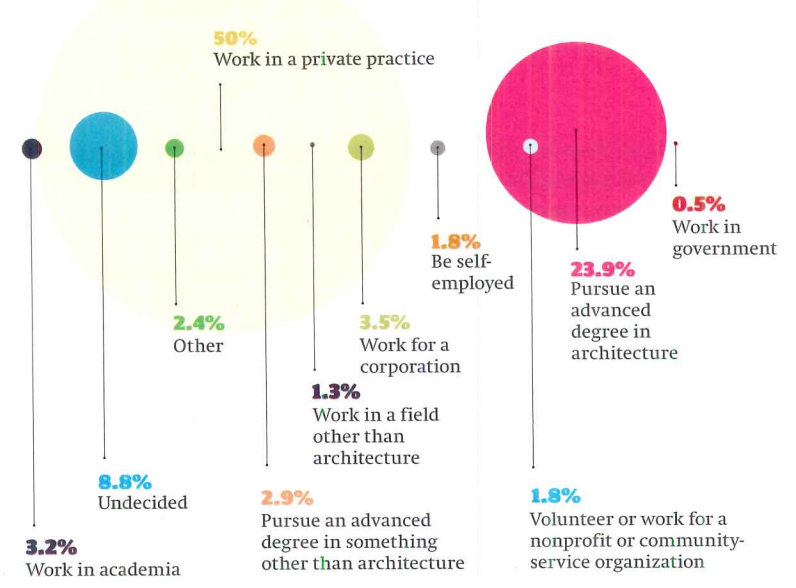

Skills Assessment

The academic programs that practitioners deem strongest for each skill area:

DESIGN

- 1 Harvard
- 2 Yale
- 3 Columbia
- 4 SCI-Arc
- 5 USC

SUSTAINABLE-DESIGN PRACTICES & PRINCIPLES

- 1 Cal Poly San Luis Obispo
- 2 UC Berkeley
- 3 Auburn
- 3 U of Oregon
- 5 USC

COMPUTER APPLICATIONS

- 1 MIT
- 2 SCI-Arc
- 3 Columbia
- 4 Cal Poly San Luis Obispo
- 5 Harvard

perhaps they take it for granted.

What about teaching design per se? Will programs have time to do this if you are focusing on those other skills?

Design and design thinking can be taught as process and product. Design studio is where you teach marketing and business. Design is so important. But if it is not taught well, it can do harm to the environment and the community. To be a good designer, you need to constantly learn and adapt to change. It's a major competitive advantage, for otherwise the profession will be irrelevant. And education must be a continuing process all through life. In fact, we should set up postgraduate programs for the profession on campuses to encourage dialogue and advanced learning with practicing architects.

You mentioned that communication skills need to be taught to architecture students: how so?

Presentation and communication skills are necessary to give more voice to the importance of design. Students need to take courses or be coached.

What is the main challenge for educators in attracting students to architecture programs?

Now that unemployment is down, we are facing a future with an undersupply of talent. We need talented architects. But education is costly, even if it varies widely in accredited schools. For instance, at Cal Poly Obispo, the B.Arch. program is now \$8,724 for an in-state student and \$19,884 for out-of-state. The University of Southern California, a private school, charges an undergraduate tuition of \$46,038. Yale's graduate tuition is \$44,125, while Kansas State is only \$8,870 (in-state) and \$21,815 out-of-state. It gets harder to pay back loans when graduate students only start off earning about \$41,300. While that figure goes up 5 to 9 percent after licensing, it is not much compared to other professions.

How do you advise schools to face the future?

Besides more business education, I would suggest mixing design studios with online education. Stop treating digital and face-to-face settings as two separate learning categories. Architecture skills in design, operations, finance, and marketing can be taught digitally. Technology is the educator's and the architect's friend, and new tools are available every semester. So make it part of continuous learning and adapting to change. Don't be a "desiginosaur." ■

James P. Cramer is founding editor of DesignIntelligence and cochair of the Design Futures Council. He is chairman of Greenway Group, a management consultancy.

Top 5 Significant Issues

This year, *DesignIntelligence* polled 89 deans and chairs, along with 693 professional offices and corporations to assess the top five significant issues from each of their perspectives.

DEANS AND CHAIRS

- 1 Integrated Practice/Interdisciplinary Education
- 2 Sustainable Design/Climate Change
- 3 Technology Integration
- 4 Community Engagement
- 5 Study Abroad/Globalization

FIRM LEADERS

- 1 Design Quality
- 2 Integrated and Interdisciplinary Practice
- 3 Sustainable Design/Climate Change
- 3 Technology Integration
- 5 Talent Acquisition/Quality of Workforce

Methodology

Greenway Group, as it usually does, sent surveys to CEOs, managing partners, and human resource directors asking about their findings in hiring architecture graduates. The respondents could select up to 10 NAAB-certified undergraduate and graduate programs in each category. Each survey response was checked for authenticity and validated by the research staff at Greenway Group. In cases of dubious or unreliable information that could not be confirmed, researchers eliminated the questionable return. Researchers also confirmed that the person responding to the survey was in a hiring capacity. In addition to the architectural component of Greenway Group's research, the study includes rankings and satisfaction surveys for the professions of interior design, landscape architecture, and industrial design. This information is published in *DesignIntelligence* annually, along with a comprehensive list of the firms and employing organizations participating in the research.



UCLA Thom Mayne and graduate students visit an artists' collective in Port-au-Prince, Haiti, as part of a yearlong studio course at the university's Now Institute.

surrounding distressed New Haven neighborhoods. This required M.Arch. I course, now called the Jim Vlock First-Year Building Project, still retains that focus, responding to changing societal, urban, and technological conditions. It has provided single-family homes with income-generating rental units to empower the owners economically; it also has created prototypes for the city's many difficult sliver lots and has advanced prefab techniques through digital modeling and CNC-fabrication.

Design-build within the professional architectural curriculum was literally and figuratively groundbreaking when Yale first introduced it. Now, hands-on construction and community service have become widespread in academia, though they vary in scope and approach. One outstanding example is an institution-wide, ongoing initiative at the University of Cincinnati to create a multi-phase,

net zero energy health complex in rural Tanzania. It engages students and faculty from the colleges of design, architecture, art, and planning, as well as medicine, engineering, nursing, and applied sciences.

The drive for global experience in this age of increasingly international practice has found many channels in architectural education. Dean Mohsen Mostafavi of Harvard's Graduate School of Design (GSD) outlines three major ways its M.Arch. candidates travel afar within the program: a) through upper-level studio-site visits that provide exposure to local context, culture, and expertise (an offering at many architecture schools today); b) with the school's multiyear research projects, such as one focused on emerging cities in China, building on a growing body of student-engaged research; and c) in studios embedded in the workplaces of leading architects abroad.

This last is specific to the GSD. Instead of having architectural luminaries like Rem Koolhaas, Toyo Ito, or Jacques Herzog jet in to teach advanced studios, this program, launched two years ago, brings a dozen students to the architect for the entire semester. With student workspace within or adjacent to the practitioner's office, the Harvard group gets cultural immersion in the foreign city, as well as in the practice itself, and related coursework in what Mostafavi calls a "mini-GSD" abroad. These design studios (not to be confused with paid or unpaid internships) essentially "bring the mountain to Muhammad," giving students more time with the master architect than they'd have with that teacher commuting to them.

Border Crossings by Sarah Amelar

Architecture schools are applying innovative educational models that foster new ways of thinking and challenge the role of the profession.

ARCHITECTURE SCHOOL isn't what it used to be. While core fundamentals, including tectonics and the tools of design, still form the basis of accredited B.Arch. and M.Arch. programs throughout the nation, many schools are broadening and deepening the educational terrain with studios that cross boundaries—geographically, within communities, and into diverse areas of knowledge or investigation.

The general trajectory has shifted decisively in the 21st century from the narrower realm of form-making. As Hitoshi Abe, chair of UCLA's Department of Architecture and Urban Design (AUD), recently put it, "The important question is: 'How can architectural education, with its potential for experimental research, continually challenge the role of the profession so that it remains engaged, energetic, and alive, rather than fixed or stagnant?'"

Many schools have made leaps and also inventively modified features long embedded in their programs. At Yale, for example, community outreach and design-build have been essential in the M.Arch. curriculum at least since the 1960s, when the pioneering Yale Building Project (YBP) was born. Three decades later, YBP reframed its mission, zeroing in on much-needed affordable housing for the



MIT Students build a 50-foot-tall structure out of thousands of waterjet-cut aluminum pieces in a campus stairwell for an arts and science festival.

Even with all the travel, most academic leaders still stress the unwavering importance of education at the home base, with an emphasis on what Yale's dean, Robert A. M. Stern, describes as "actually making things and training the eye and hand." This comes at a time when Yale and many other schools also run active labs, fully equipped with cutting-edge technologies, including robots and 3-D printers.

And while some studios focus on extremely deep rather than broad inquiry (such as those at the GSD investigating the properties and potential of a single material), "border crossings" between disciplines are common. This can happen under one roof, as with the GSD's or MIT's urban planning programs, or across a university, with such entities as Harvard's Wyss Institute for biologically inspired engineering, which explores naturally occurring structures.

Cross-pollination and even joint degrees with, for instance, business schools have long been possible at universities that include Cornell, Harvard, Cincinnati, and Yale (the latter also offering a dual degree in forestry). One of the most intriguing and earliest "crucibles" remains MIT's Media Lab. Founded in 1985, under the auspices of the School of Architecture and Planning, it proposed a paradigm for "anti-disciplinary" research into new technologies, multimedia design, and human experience. Evolving ever since, it has drawn on the university's culture of entrepreneurial and creative research. The many life-changing, real-world applications emerging from it include credit-card security holograms and robotic ankle-foot prostheses. Media Lab's classic "How to Make Almost Anything" has become a standard first-year M.Arch. course, often inspiring interactive, digitally innervated projects (such as a porcupine-like dress that responds to intrusions on personal space). "For one studio, not long ago," dean Adèle Naudé Santos recalls, "every single piece of a building, down to the bricks, had to be 'wired.'"

Other notable academic offerings far from the mother ship include Cornell's required B.Arch. semester at its palazzo in Rome and MIT's ongoing 28-year collaboration with Tsinghua University in China, where students spend a semester on location, rethinking areas of Beijing. Also, at many schools, the shorter summer and winter terms have spawned such opportunities as the University of Michigan's workshop in Jakarta that enabled M.Arch. students to research the ecological issues of rising water, or the groups from MIT that probed the future possibilities for a textile-manufacturing city in India or built a health facility in Cambodia.

Though some schools are endowed for travel (as with Yale's dedicated Henry Hart Rice Fund in Architecture), other models exist. The University of Cincinnati, a public institution, has been resourceful in developing student engagement around the globe. Since 1922, its virtually year-round architectural program has alternated terms of paid work with academic ones. What began as a local cooperative to help students cover tuition has grown into a network of 400 architectural firms, worldwide. "It's a vital program, and placement in offices is competitive, with some even covering airfare and housing," says Cincinnati dean Robert Probst. "The learning opportunities are tremendous and, in the end, 70 percent of our students have jobs lined up before graduation."

HARVARD Toyo Ito's Tokyo office hosted students in 2012, who worked on tsunami relief projects.





As advanced digital tools permeate architectural education, they have become both widely used and been challenged. For a recent University of Michigan studio examining contemporary technology's impact on design, the accompanying history seminar, led partly in Rome, considered how the Baroque period's architectural innovations grew from that era's emerging technologies.

"At SCI-Arc [Southern California Institute of Architecture]," says its director, Eric Owen Moss, "there's simultaneous deployment and questioning of the tools of technology. Here, nothing is sacred. Agents and reagents of contamination, corruption, and provocation are all part of the vigorous and ongoing discourse." While university-based architecture programs draw increasingly from broad offerings within their institutions, Moss sees the stand-alone independence of SCI-Arc, a school proud of its rebellious history, as an asset, affording it nimbleness to veer in or out of radical experiments (those that succeed and those that don't) without a university's bureaucratic structure or red tape.

But like many of its peers, particularly those venturing abroad or into specialized areas of knowledge, SCI-Arc reaches into its larger community to partner with leading experts or fellow institutions. The school did this with the U.S. Department of Energy-sponsored Solar Decathlon—a biennial competition for the design and construction of a prototype net zero energy house. For their entry, an expandable-contractible, climate-adjusting structure, students worked with the California Institute of Technology and Buro

Happold engineers. The SCI-Arc team was responsible for raising and managing the necessary funds, in addition to design and fabrication.

The increasingly powerful convergence of real-world challenges, outside expertise, and speculative research has also contributed to the formation of Suprastudios at UCLA. This immersive program models itself on professional R&D teamwork, enabling M.Arch. II students to collaborate for an entire year on a complex problem they help define. With one master professor and state-of-the-art technologies, the students join forces with experts from a forward-thinking Southern California industry such as aerospace (Boeing) or entertainment (Disney). Similarly, in the Now Institute, UCLA AUD's public service version of the Suprastudio, students partner with policymakers or governmental and community agencies to tackle issues in struggling cities. Both programs are like thesis work in duration and depth, but the team structure more closely resembles scientific post-docs.

These are just a few of the innovative offerings across the nation. "We're working with new educational models, many of them trans-disciplinary," Mostafavi recently said of the GSD, but his comments could apply to enlightened trends in architectural programs more broadly. "Through publications, exhibitions, and ongoing dialogues with experts," he continued, "we're putting the work much more in the public sphere. In speculative and experimental ways, students are researching real problems with unknown answers. And all this provides catalysts for new ways of thinking." ■

SCI-ARC For the 2013 Solar Decathlon, students teamed up with Caltech to build a net zero, 600-square-foot house with an expandable interior.



good state



better state

You've built this business from the ground up. A State Farm® agent can tailor your business insurance to help protect your unique needs. Select the right coverage from a local business owner who understands what it takes to grow. Visit st8.fm/bizinsurance or contact a State Farm agent today.

Get to a better State®. Get State Farm.

 **State Farm®**

State Farm Fire and Casualty Company, State Farm General Insurance Company, Bloomington, IL
State Farm Florida Insurance Company, Winter Haven, FL
State Farm Lloyds, Dallas, TX

CIRCLE 77

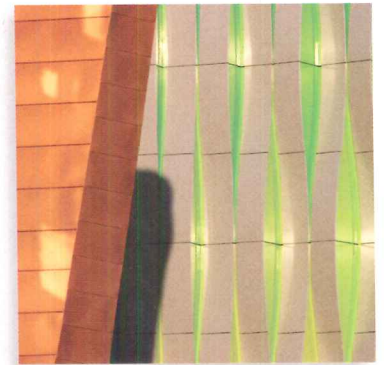
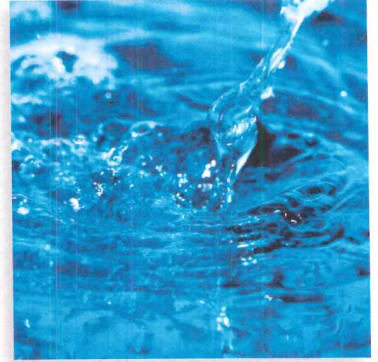

Design with

CONFIDENCE

When facing new or unfamiliar materials, how do you know if they comply with building codes and standards?

- ICC-ES® Evaluation Reports are the most widely accepted and trusted technical reports for code compliance. When you specify products or materials with an ICC-ES report, you avoid delays on project and improve your bottom line.
- ICC-ES is a subsidiary of ICC®, the publisher of the codes used throughout the U.S. and many global markets, so you can be confident in their code expertise.
- ICC-ES provides you with a free online directory of code compliant products at: www.icc-es.org/Evaluation_Reports and CEU courses that help you design with confidence.



Have you **Experienced** the Difference?

Carlisle SynTec Systems offers a dedicated network of Green Roofing Professionals and installers and an industry-leading, single-source warranty for the entire Roof Garden system. Our unique products and specifications provide you with an incredible amount of flexibility, creativity and customizability. Combining the optimal blend of growth media, retention and drainage composites with dependable waterproofing protection, Carlisle is simply without equal. Nowhere else in the industry will you find the same level of service, support and quality for your Roof Garden projects.

**Visit us at the Greenbuild® International
Conference & Expo in booth # 907.**

CIRCLE 68

EXPERIENCE THE CARLISLE DIFFERENCE

800.479.6832 | www.carlisesyntec.com

Carlisle is a trademark of Carlisle. © 2013 Carlisle.

**Financial
Incentives
for
Energy
Efficiency**



Our Energy Bill Got a Lot Smaller

Are you looking for ways to control costs and energy use in your commercial, industrial or government building? Then follow our lead. We turned to *New Jersey's Clean Energy Program*[™] for a FREE Benchmarking Report, which was a big help in understanding what equipment we needed to upgrade first.

That's setting a benchmark for saving energy...and money!

To learn more about benchmarking for buildings in the public and private sectors, visit NJCleanEnergy.com/BENCHMARKING or call 866-NJSMART to speak with a program representative.

Recover, restore, and rebuild after Hurricane Sandy. Visit NJCleanEnergy.com/SANDY to learn about enhanced incentives for homeowners, government officials and business owners.

CIRCLE 16





CHIPMAN

landscapeforms®

Chipman: We believe beauty and elegance create spaces where memorable experiences happen.

Find us at landscapeforms.com or contact us toll free at 800.430.6208.

Designed by
Robert Chipman.

DESIGN. CULTURE. CRAFT.

CIRCLE 54

There's more to the WhisperShade® IQ® than its super-quiet and powerful operation. In fact, the system is designed to maximize daylighting and decrease solar-heat gain, significantly reducing energy demands over time. We would say that's a reason to brag. Quietly, of course.

We're not the same ol' MechoShade.
We're the new MechoSystems.



WhisperShade® IQ®

Not just quiet. Ultra-quiet®



MechoSystems

Design with light.®

T: +1 (800) 437-6360

F: +1 (718) 729-2941

E: marketing@mechosystems.com

W: mechosystems.com

TW: [@mechosystems](https://twitter.com/mechosystems)

CIRCLE 5

The technologically advanced, ultra-quiet WhisperShades don't add to already noisy spaces.

Perfect alignment across multiple shades for a clean appearance.

Customizable intermediate positions.

Motors that marry intelligence with powerful performance.



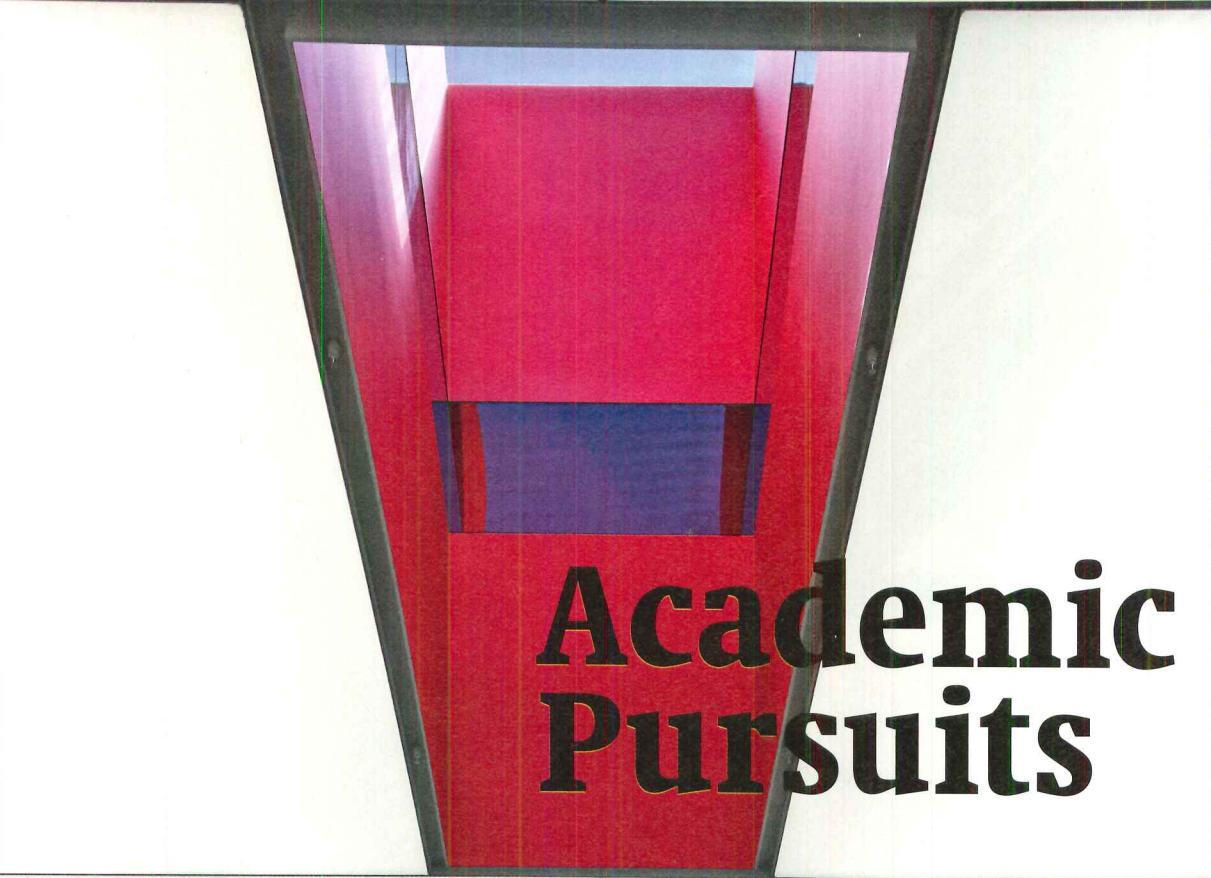

Academic Pursuits

Designing university buildings requires balancing competing interests—for instance, weighing pedagogical needs against the physical constraints of a campus, or creating a showpiece on an institutional budget. The architects of the projects that follow were all challenged to reconcile a disparate set of requirements: from a football training center—a symbol for fans and an unrivaled amenity for players—to a series of laboratories that combine aesthetics with complex mechanical systems. Two architects in this issue, Marlon Blackwell and Thomas Phifer, found themselves designing for particularly tough clients: architecture schools. At the University of Arkansas and Clemson University, respectively, they provided studio and classroom space in facilities that embody and nurture principles of good design.

PHOTOGRAPHY: © TIM HURSLEY



MARLON BLACKWELL ARCHITECT'S RENOVATION AND EXPANSION OF THE FAY JONES SCHOOL OF ARCHITECTURE AT THE UNIVERSITY OF ARKANSAS IN FAYETTEVILLE



Football Performance Center, University of Oregon |
Eugene | ZGF Architects

FANTASY LEAGUE

The University of Oregon's football team is known for an offense that dizzies its opponents. A new building to support these student athletes also blurs the lines between transparency and stealth.

BY LAURA RASKIN

PHOTOGRAPHY BY JEREMY BITTERMAN

In a video that shows the Oregon Ducks football team being introduced this past summer to their new Football Performance Center at the University of Oregon, player after player has the same gobsmacked look on his face. One says, "Are you kidding me, bro? Legit." Their delight in the building, by ZGF Architects with interior architect Firm 151, continues: "Unreal. This place is crazy. I can't even . . . There are no words." "Unbelievable." "Unimaginable."

The Ducks are not only reacting to the architecture—stacked and staggered boxes clad in fritted glass, steel and aluminum plate, and black granite (there is almost no facade that doesn't look three-dimensional)—but also the opulence. This is with good reason, as the luxurious building was paid for by the Phit Foundation, which is run by Nike co-founder Phil Knight and his wife, Penny Knight. They told the architects, "Do it better," according to Gene Sandoval, design partner at ZGF, and flew some of the design team across the country and overseas to look at sports facilities, museums, and halls of fame, as well as to source materials. From custom Nepali rugs to slate showers, to furniture tested to withstand the weight of a dozing 300-pound lineman, no object or surface received standardized treatment. (The cost of the building is confidential. Some stories have reported \$68 million, but ZGF could not confirm the figure, nor speculate on how it was derived.)

The football center, meant to support well-rounded athletes and streamline their diet, strength training, recreation, and game strategy under the watchful eyes of coaches, completes a trilogy of university buildings that ZGF and Firm 151 have designed for the Knights' foundation, the firms' real client—the buildings only get handed over to the school once they are complete. The architects' relationship with the Knights began eight years ago when Sandoval and Firm 151's Randy Stegmeier—who studied architecture at U of O—designed Oregon's athletic-medicine facility and, in 2010, completed an academic center for athletes. Phil Knight is an Oregon alumnus too.

Dreamlike as its luxuries may appear to student athletes, the 145,000-square-foot complex bears down on the earth with its muscular form. It's a meticulously built and elegant fortress, bold enough to grab drivers' attention as they whiz by on their way to Autzen Stadium, the Ducks' home-game turf,

GRACEFUL STRENGTH The architects designed a new outdoor plaza with cascading pools and basalt pavers. The plaza unites the new football center (left) with two existing buildings, the Casanova Athletic Center and Moshofsky Sports Center, and creates an inviting place.

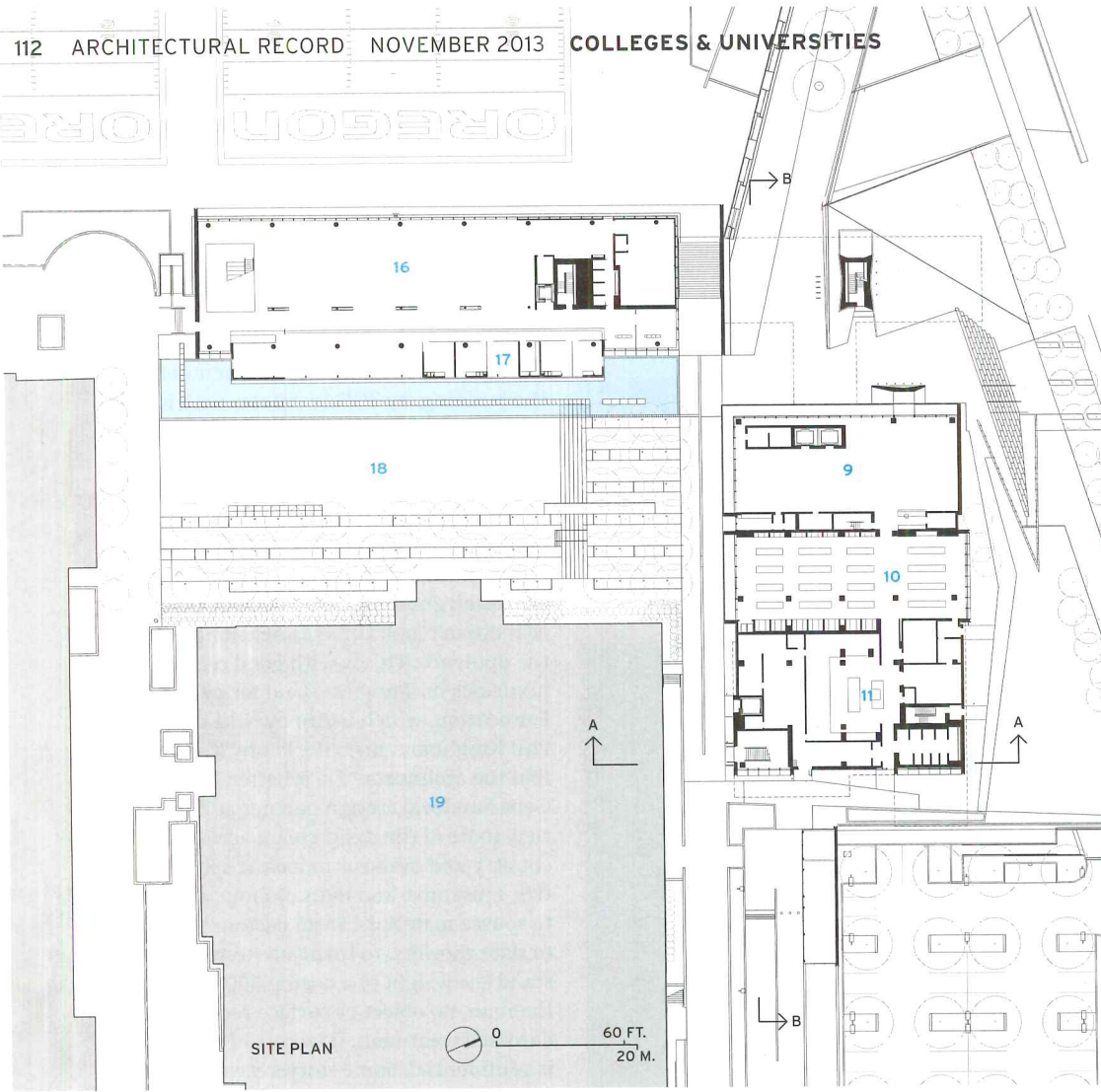

credits

ARCHITECT: ZGF Architects – Gene Sandoval, design partner; Jan Willemse, partner; Bob Packard, partner; Robert Snyder, project manager; Kelvin Ono, project architect

INTERIOR ARCHITECT: Firm 151 – Randy Stegmeier, principal interior designer

ENGINEERS: KPFF (structural, civil); Integral Group (mechanical); Sparling (electrical)

GENERAL CONTRACTOR: Hoffman Construction Company

OWNER: University of Oregon

SIZE: 145,000 square feet

COST: withheld

COMPLETION DATE: August 2013

SOURCES

METAL PANELS: Streimer Sheet Metal Works; Cobra; Metposite

BLACK GRANITE CLADDING: Western Tile & Marble; Best Cheer Stone Group

CURTAIN WALL: Benson Industries

BUILT-UP ROOFING: Johns Manville

INTERIOR AMBIENT LIGHTING: Focal Point; FLOS; Ligman Lighting; Cooper Lighting

CONVEYANCE: KONE

- | | |
|------------------------|-----------------------------|
| 1 PLAYERS' LOUNGE | 11 KITCHEN |
| 2 RECRUITING | 12 PARKING GARAGE |
| 3 COACHES' OFFICES | 13 DEFENSIVE MEETING ROOM |
| 4 SMALL THEATER | 14 OFFENSIVE MEETING ROOM |
| 5 AUDITORIUM | 15 LOCKER ROOM |
| 6 WAR ROOM | 16 WEIGHT ROOM |
| 7 MECHANICAL | 17 OFFICES |
| 8 COACHES' LOCKER ROOM | 18 PLAZA |
| 9 LOBBY | 19 CASANOVA ATHLETIC CENTER |
| 10 DINING ROOM | |

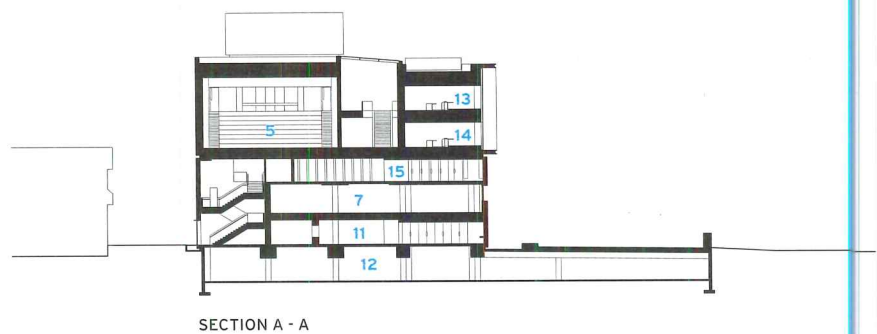

SECTION A - A

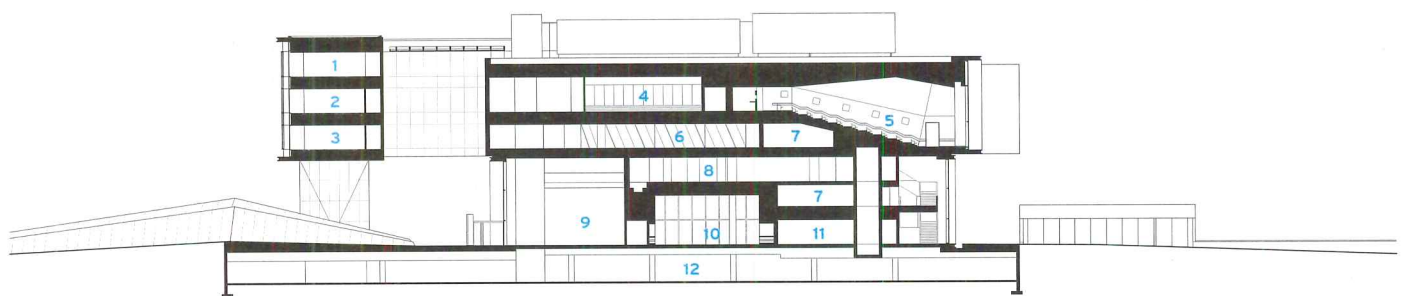

SECTION B - B

0 30 FT.
9 M.



and refined enough to hug a new zenlike plaza, with gurgling pools of water to its east. (The architects also re-skinned two of the center's neighbors in O-punched box-ribbed metal panels and wood composite, visually tying the buildings together.) "The massing of the building was about movement, as when a football player is grabbing a ball and running back," says ZGF's Robert Snyder, project manager, who also studied architecture at Oregon.

The six-story, L-shaped structure is really two buildings connected by a three-level glass sky-bridge. The first building is composed of two long bar volumes, one sliding off the other like a precarious jenga piece. They separate the new plaza from the practice fields. The second is a boxier complex to the north in which the architects placed the more cerebral portions of the program, away from the adrenaline-

SOLAR ARMOR A glass sunscreen on the "office bar" (left and top) shields the volume from solar glare and heat gain. Panes in five different sizes are set about 3-6 feet from the face of the building and are combined in 15 patterns. The center's cantilevering forms make each facade appear as though it is in motion (above).

[View additional images at architecturalrecord.com.](http://architecturalrecord.com)

charged practice fields.

The long bar volumes contain a two-story weight room with custom machines and a mezzanine-level sprinting track; a view of the fields keeps motivation high. The upper bar contains coaches' offices, a players' lounge, and recruitment rooms. Throughout the center, the architects worked with Todd Van Horne, a designer at Nike, and exhibit designer Gallagher & Associates; the interiors are a balance of pop graphics, accents in the Ducks' signature greens and yellows, and a motif best described as Dad's den—if Dad lined his walls in football leather and sourced his recliner from Poltrona Frau.

Sandoval and his team spent months studying the players' schedules and translated that knowledge into the sequence of spaces, the goal being to move players through their day as quickly as possible. Aside from a ground-floor lobby meant for the public and fans, the rest of the other, squarer volume—the “teaching box”—is for athletes. Beyond the lobby are the team's walnut-paneled dining room and the cafeteria. In an aggressive take on classic diner décor, neon letters spell out EAT YOUR ENEMIES AND THE OTHER FOOD GROUPS. The players' locker room on the third floor (the “soul” of the building, according to Jeff Hawkins, the senior associate athletic director of football administration and operations) is fitted out like a spa, with Carrara marble, a barbershop, and solid-surface lockers bearing the silhouettes of uniformed players. The room's air supply is exhausted through the lockers, providing airflow and controlling odors. Climbing farther upstairs, the fourth and fifth floors house lecture-style meeting rooms for the offense and defense connected by a double-story atrium. A two-level walnut-paneled theater spanning these floors has a view to the east and Autzen Stadium.

Since its debut, the football center has elicited a mixture of awe and cynicism in the press, much of it about the professionalization and monetization of student athletics. Heard more than once during a recent tour of the building was the refrain that the Ducks may not see another facility as grand again, even if they go pro. As writer Drew Magary wrote for the sports blog Deadspin, “If I played for Oregon, I would never wanna graduate.” ■

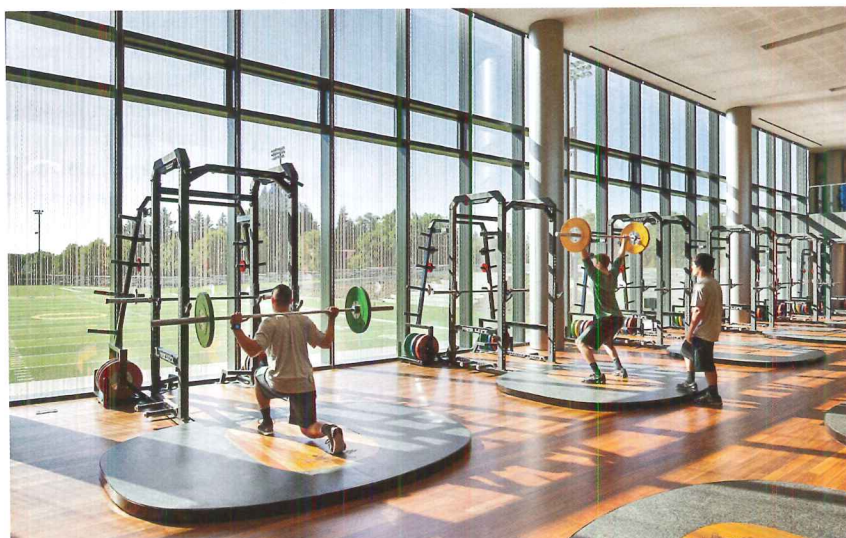
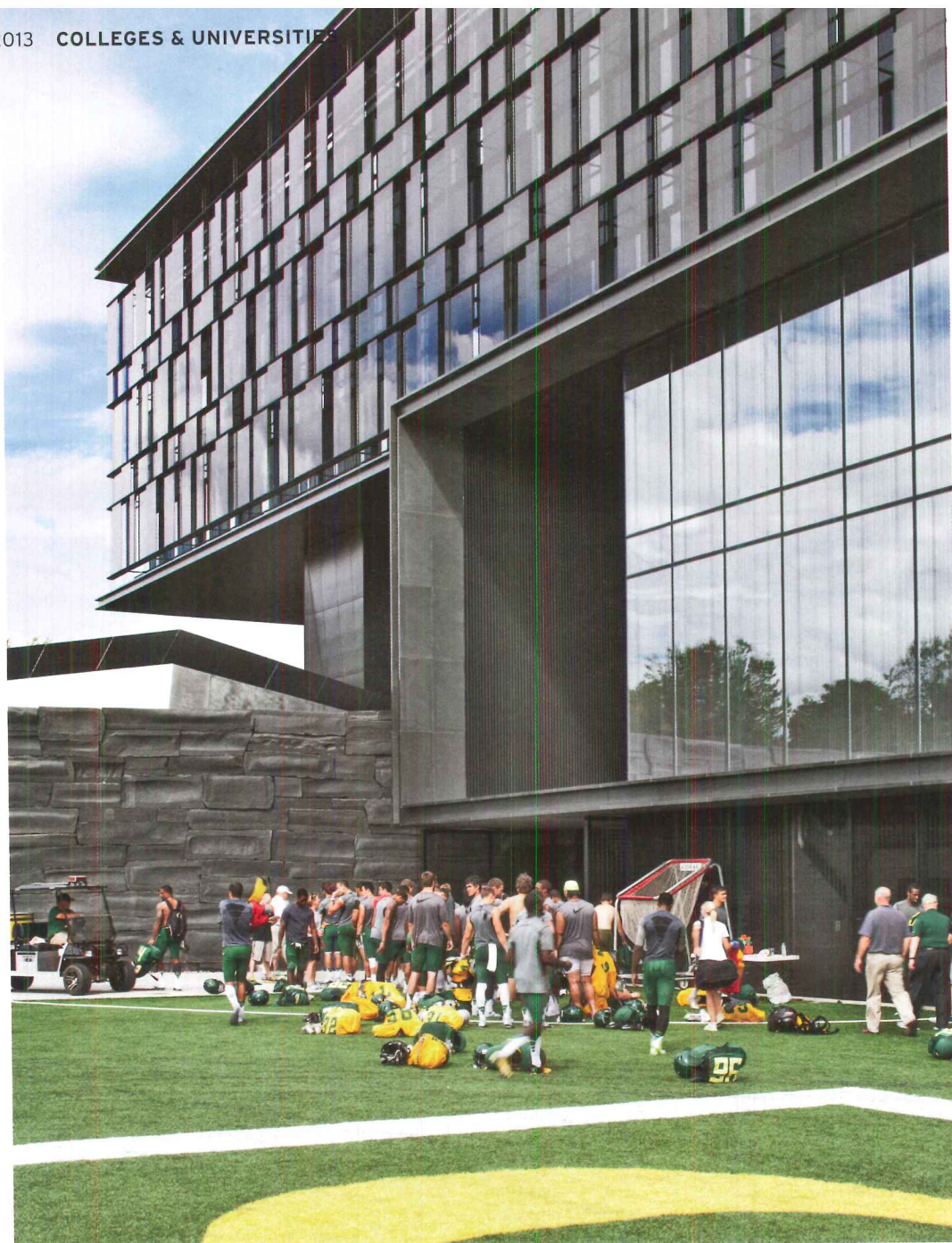

FIELD GOAL

A wall made of columnar basalt pieces, split lengthwise, shields the practice fields from Martin Luther King Jr. Boulevard (above). The weight room (left) looks out on the fields and sits above plunge pools (not pictured), an improvement on the team's former kiddie pools filled with ice.

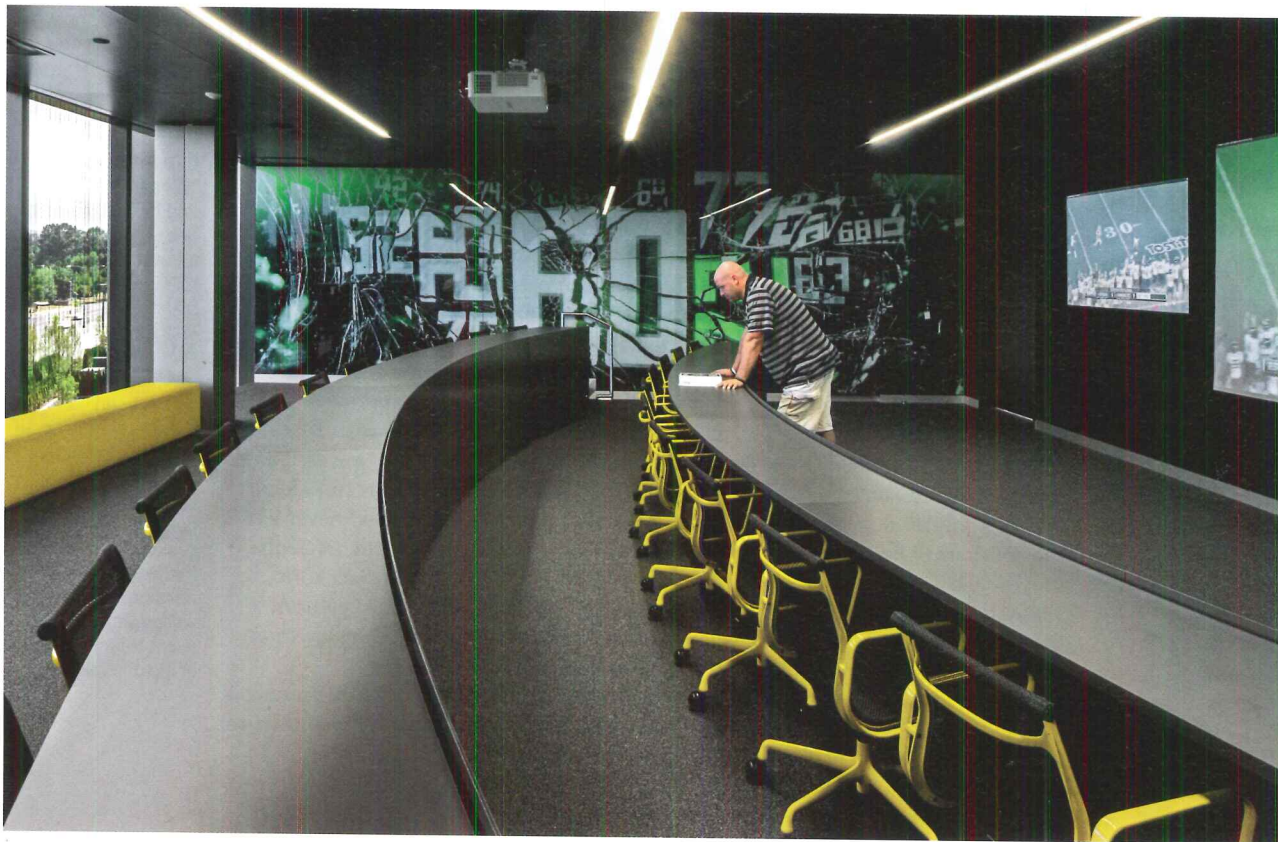

UP THE MIDDLE
Each player has a locker with his name and number on the door. Drop-down shelves provide easy access to uniforms (above). Lecture-style strategy rooms allow coaches to instruct from the front or back of the room and review game and practice footage (left).

Lee Hall Addition, Clemson University | Clemson, South Carolina | Thomas Phifer and Partners

MACHINE FOR LEARNING



An architecture school expands into a steel and glass structure that showcases its structural and energy-efficient features.

BY SUZANNE STEPHENS

PHOTOGRAPHY
BY SCOTT FRANCES

Architects don't often get to design a new building for their alma mater. Yet Thomas Phifer, based in New York City, showed it's possible to go home again—with success. He created an airy 55,000-square-foot addition for the architecture school at Clemson University, in South Carolina, where he got his B.A. in architecture in 1975, and his M.Arch. in 1977. The rural university, founded in 1889 near the Blue Ridge Mountains, is composed of an architectural polyglot of buildings, highlighted by its original Italian Renaissance Revival brick structures. Phifer's evanescent glass-and-steel pavilion definitely introduces a lighter approach.

The well-known alumnus, who has forged a substantive reputation with ethereally refined structures such as the Brochstein Pavilion at Houston's Rice University (RECORD, March 2009, page 84) and the North Carolina Museum of Art in Raleigh (RECORD, July 2010, page 62), grew up in Columbia, South Carolina, and never left the South until he spent a year abroad in Clemson's graduate program, in Genoa, Italy, at age 23. "It was transformative," he says. At 27, he headed for New York, where he worked for Gwathmey Siegel, and then for Richard Meier & Partners. In 1995, Phifer returned to Italy when he won the Rome Prize, spending a year at the American Academy before setting up his own office in New York.

A few years ago, Phifer got a call from a former Clemson professor (and graduate), John Jacques, suggesting he go after the commission for the School of Architecture, and related departments: construction science and management; planning, development, and preservation; landscape architecture; and art. Phifer agreed, but not without anxiety. "Since I knew it so well, the idea was really compelling.

LIGHT TOUCH
Thomas Phifer's addition to Lee Hall, Lee III, faces south (above), framed by a 180-foot-long porch. Slender metal Y-shaped columns support the steel-mesh canopy based on a 7.5-square-foot module. On the north (opposite bottom), the 255-foot-long elevation is divided in half by a pedestrian bridge that links to the older Lee Hall buildings. On the east, a wing wall (far left in photo) follows the angle of a ravine.



[View additional images at architecturalrecord.com.](http://architecturalrecord.com)

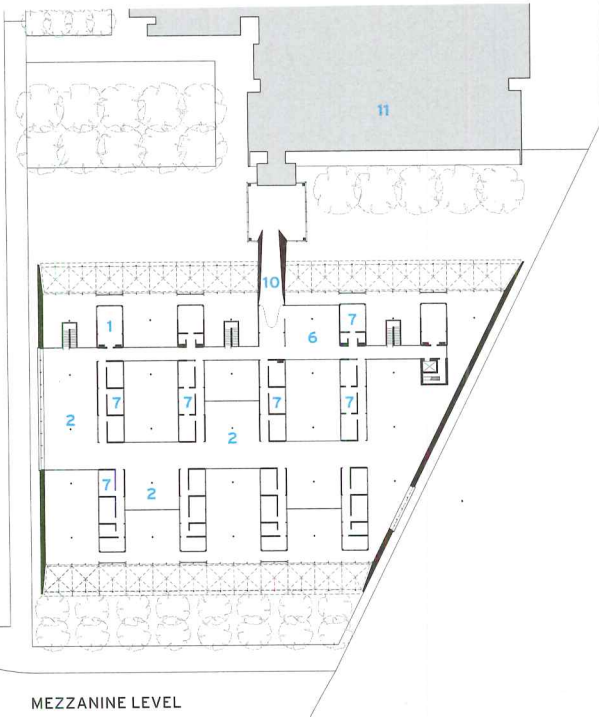

MEZZANINE LEVEL

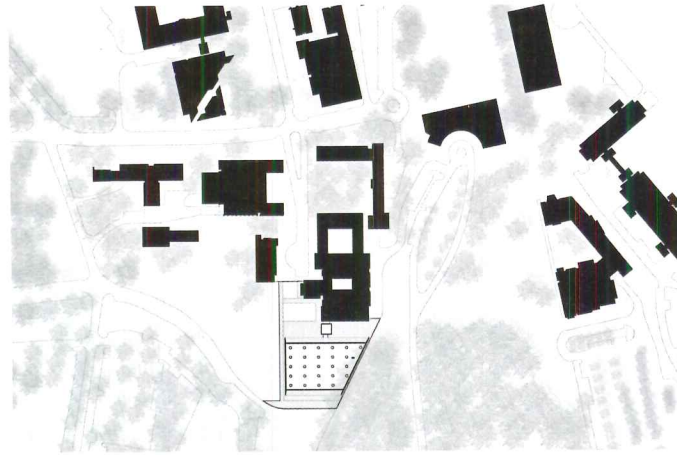

SITE PLAN

- | | |
|------------------|------------------------|
| 1 SEMINAR ROOM | 7 FACULTY OFFICES |
| 2 STUDIO | 8 SOUTH GARDEN |
| 3 PERIPHERAL USE | 9 NORTH GARDEN |
| 4 MEDIA LAB | 10 PEDESTRIAN BRIDGE |
| 5 BATHROOM | 11 LEE HALL (EXISTING) |
| 6 STAFF/FACULTY | |

credits

ARCHITECT: Thomas Phifer and Partners – Thomas Phifer, principal; Eric Richey, project architect

ASSOCIATE ARCHITECTS: McMillan Pazdan Smith Architecture – Brad Smith, principal in charge; John Jacques, design facilitator; Jeff Tiddy, project manager

ENGINEERS: Skidmore Owings & Merrill (structural); Talbot and Associates (m/e/p/f) Transsolar (environmental); Dutton Engineering (civil)

GENERAL CONTRACTOR: Holder Construction

CLIENT: Clemson University

SIZE: 55,000 square feet (gross)

COST: \$24 million (new addition)

COMPLETION DATE: February 2012

SOURCES

CURTAIN WALL, METAL PANELS, SKYLIGHTS: Linel Architectural Glass & Metal Solutions

LOW-E GLASS: Viracon

SKYLIGHT COFFERS: Formglas

SOLID SURFACING: Corian

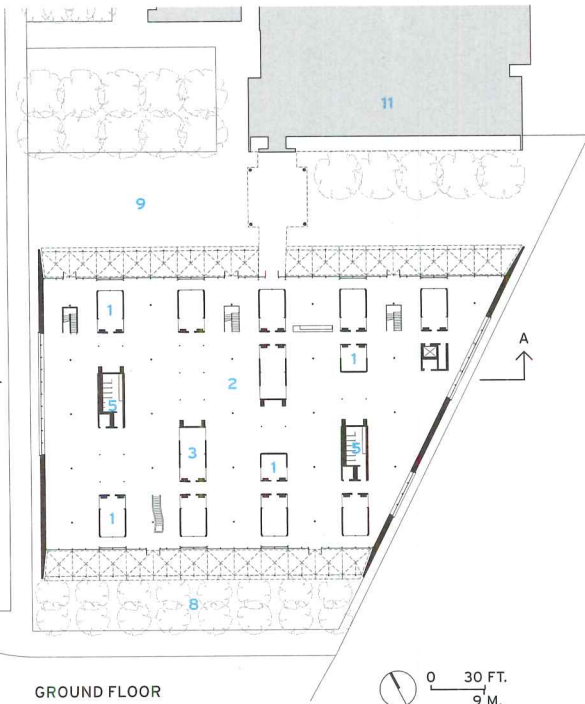

GROUND FLOOR

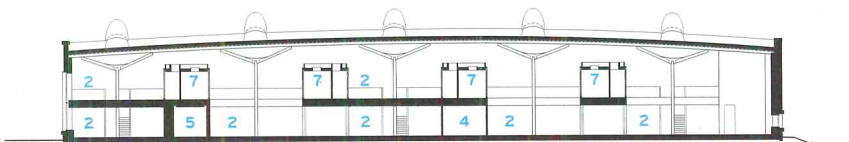
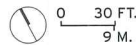

SECTION A - A

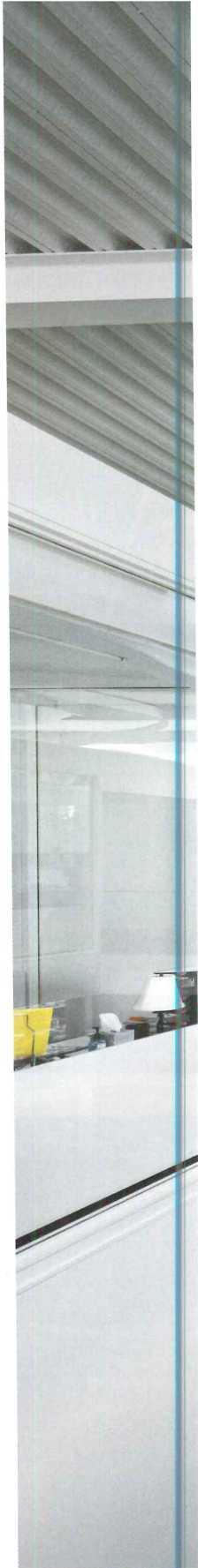
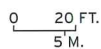

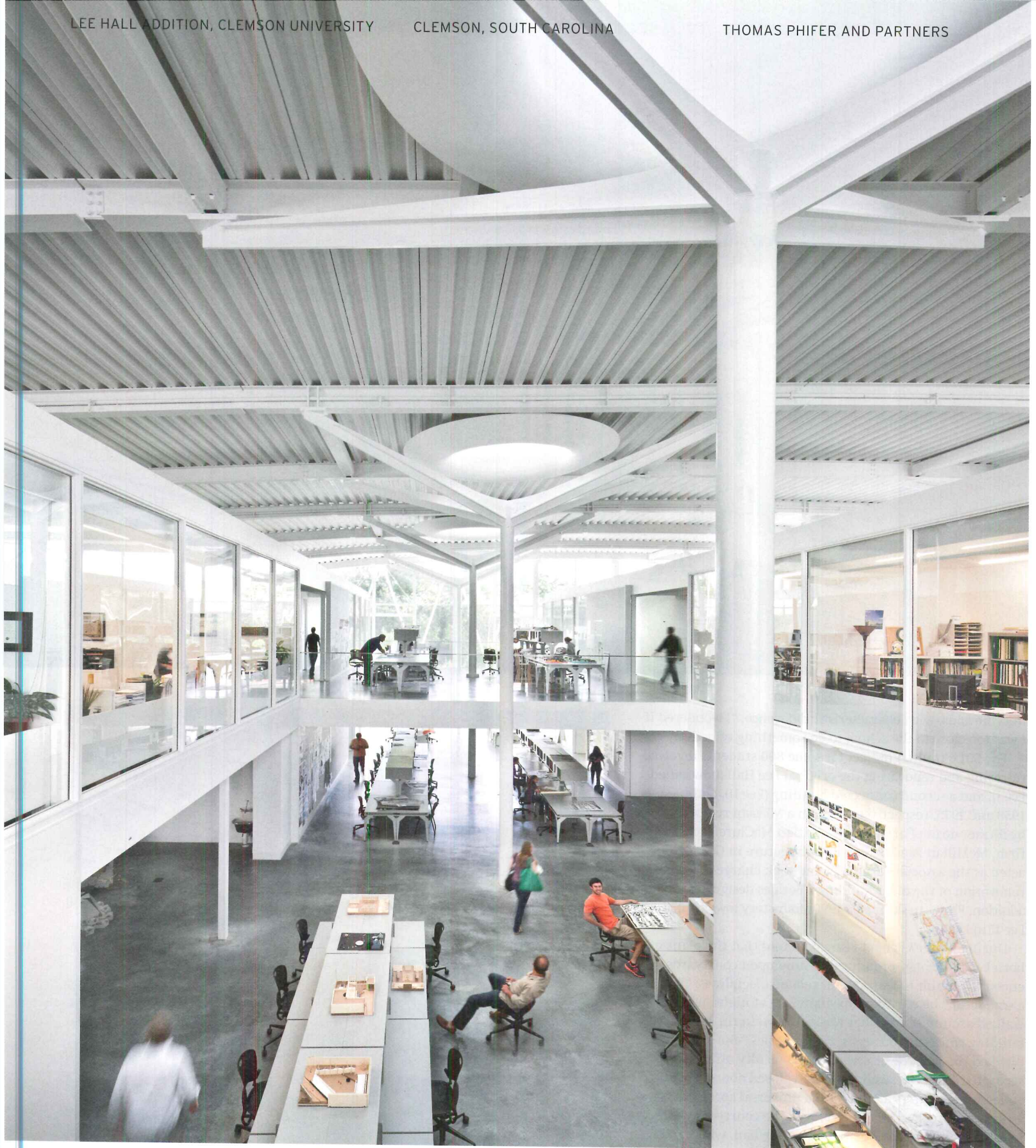

OPEN STUDIO The 55,000-square-foot addition devoted to studios for architecture and related disciplines (above) is subdivided into five sections by four two-story steel-and-glass bars housing faculty offices and seminar rooms. Between these independent structures are treelike columns topped by four branches that seem to grip the rounded fiberglass coffers of the twenty-five vented skylights.

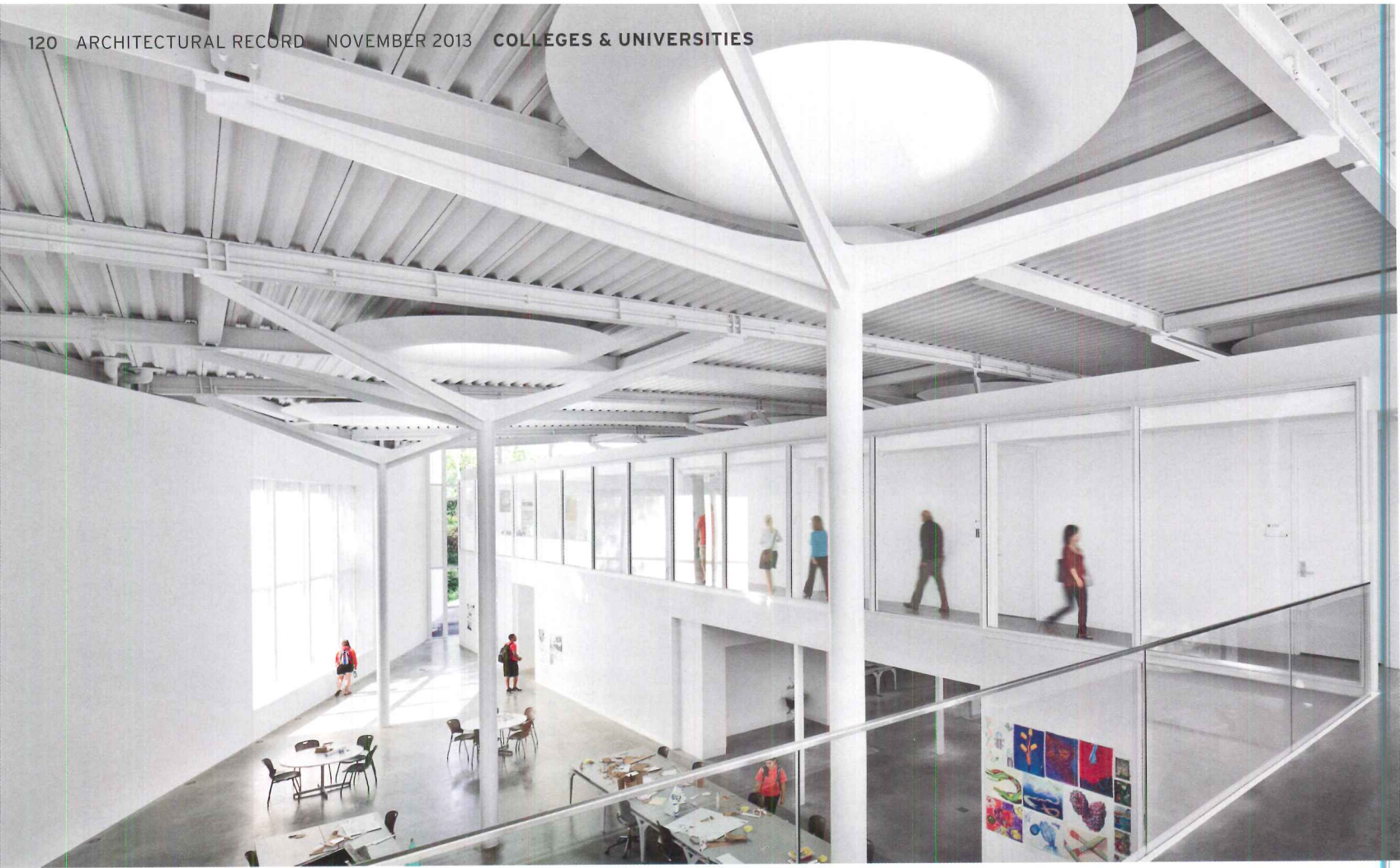

But,” he adds, with characteristic deference, “I wondered if I was too close to the school to do something effective.”

The \$31.6 million project for some 800 students involved restoring and renovating the original Lee Hall (now called Lee I), and a second connected building (Lee II), designed in 1958 and 1975, respectively, each in a Miesian red-brick style by former dean of architecture Harlan McClure. Jacques’s firm, McMillan Pazdan Smith Architecture in Greenville, acted as the associate architect and took charge of the renovation of the older buildings. Besides designing the new addition, Phifer re-skinned a 1990s four-story tower connecting Lee II to Lee III.

During Phifer’s school years he found that the plans of both Lee buildings, organized around open courtyards, encouraged him to learn about related disciplines: “I was a wanderer,” he recalls, “especially late at night, when I walked around to see what was going on in the art studios, building construction areas, and galleries.” But Phifer disliked the way the classrooms and faculty offices were separated from the studios, behind closed doors. “I wanted collective learning—all a mix in a universal space,” he says.

In designing Lee III, Phifer moved the courtyard concept indoors—into the new open, hangar-like hall, which soars to about 31 feet at the center of a gently arcing roof. He divided the indoor area into five bays of studios, partitioned by four double-level glass-and-steel bars for faculty offices and seminar rooms. Additional studios sit on open trays on the mezzanine level, connected by walkways. Entering from a bridge linking Lee II and Lee III, visitors look out and

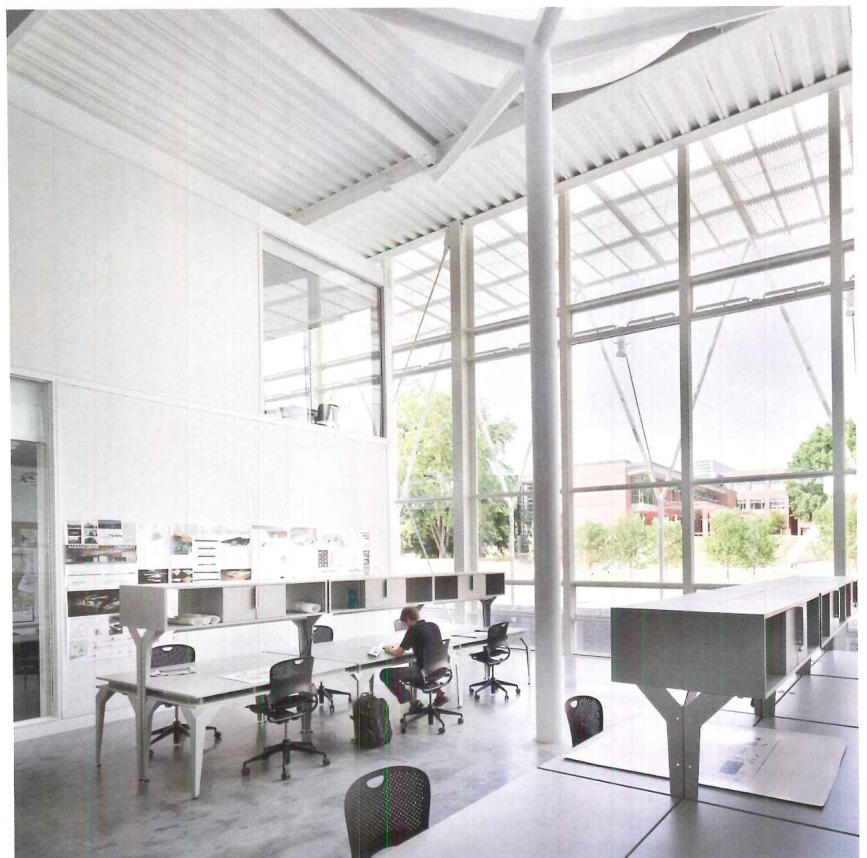

glass. The filigree of structural elements almost appears custom-made. “Yet it’s just all steel—structural deck, plates, and pipes—ordinary elements put together thoughtfully,” says the structural engineer for project, Dmitri Jajich of Skidmore Owings & Merrill (which often works with Phifer on his projects). The interior finishes, including the concrete floors, the roof deck, and the frame, reveal themselves with anatomical precision. “The building functions as a tool for learning,” says Katherine Schwennsen, chair of the architecture school.

The education-by-architecture theme continues to the sloping roof, topped with 30,000 square feet of sedum in 12 inches of engineered soil to mitigate the heat-island effect. Here Phifer protected the skylights with fixed conical “shrouds” that modulate light entering the LEED Gold-certified building—a variation on his skylights at Rice. Geothermal wells (46 in all) provide the energy for radiant heating—and cooling—in the concrete floor and the concrete-over-steel deck of the mezzanine. Passive ventilation brings in fresh air via automated transom windows installed above manually operated ones.

The light-filled, energy-efficient volume, opened in 2012, is just Phifer’s first for Clemson’s 20,000-student campus. In time, he will add a visual arts building bridging the ravine on the east to connect Lee III’s courtyard to an existing performing arts center. When these plans go forward, he’ll go home yet again. ■

CLEAR VIEW The mezzanine’s faculty offices overlook the art studio in the wedge-shaped area on the east end (opposite top), where the wall angles at 64 degrees to follow the edge of a ravine. Studio furniture (opposite bottom) was designed by professors Robert Silance with Dan Harding and students. Trees, porch, and a long hall (below) mitigate the sun load.



down to studios and student-review areas in this thrumming hub of activity.

Owing to the glazed walls and 25 skylights in the roof (along with additional internal skylights and windows), natural illumination permeates the space even on cloudy days. (Rather bald fluorescent fixtures supplement daylight when necessary). The central architectural feature is the grid of slender, treelike steel columns, 10¾ inches in diameter, made from oil-pipe sections. Near the ceiling, four branches extend outward from each column, seemingly to embrace donut-shaped coffers. These fiberglass rings, dematerialized by light filtering down from the glazed oculi, offer a mannerist-modern inversion of the classical notion of solid capitals crowning columns.

Outside, tall porches, shielded by corrugated steel-mesh canopies and supported by slender Y-shaped steel columns, extend 255 feet along the north elevation and 180 feet on the south. For the curtain wall, the design team used 6-inch-square steel elements with pretensioned cables to provide elegant bracing for the fritted double-paned

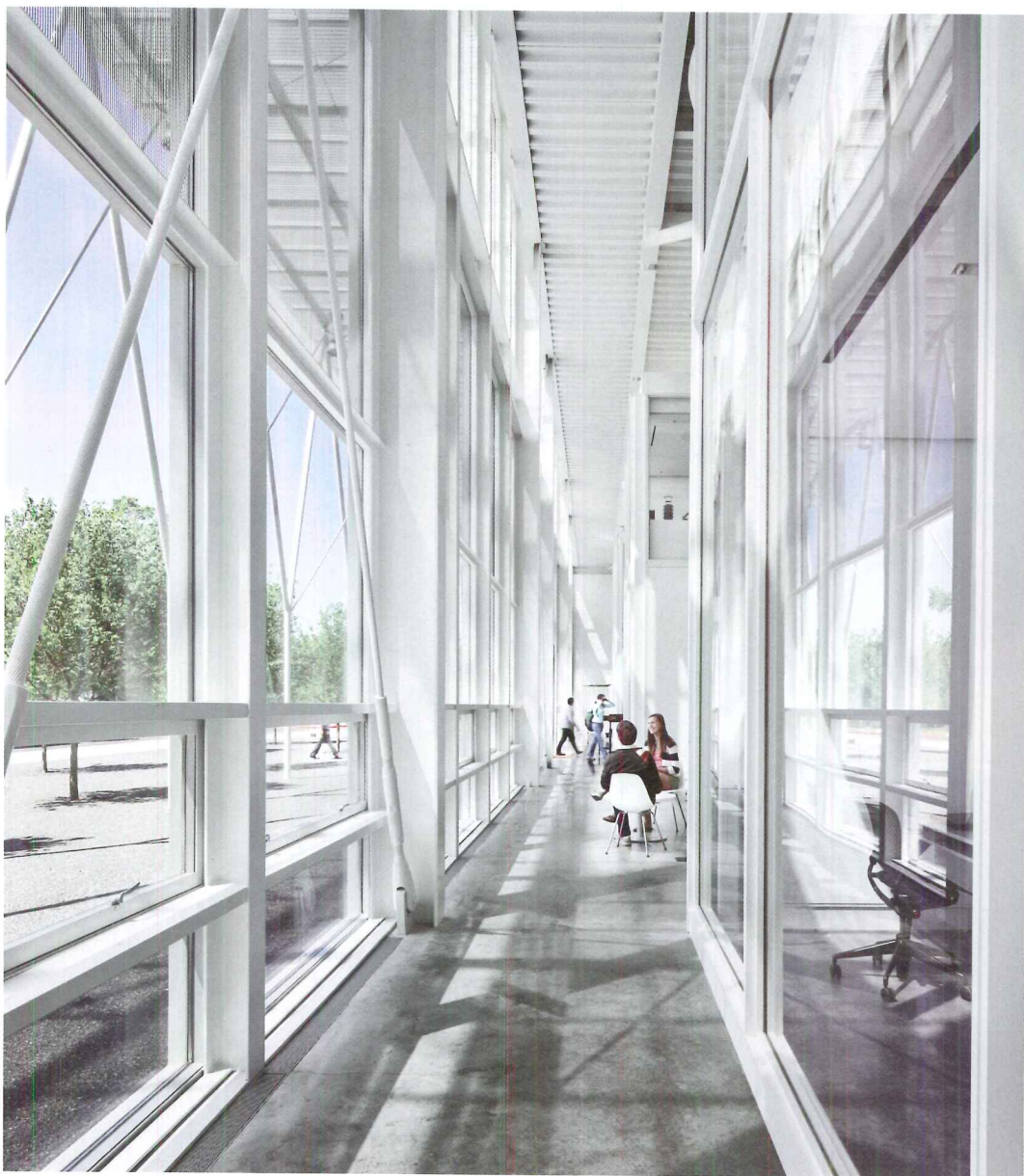

Genome Sciences Building | Chapel Hill, North Carolina | Skidmore, Owings & Merrill

THE DNA OF GOOD DESIGN

A research facility at the University of North Carolina shines the light of day on scientific discovery and collaboration.

BY SARA HART



To attract the best and brightest faculty and students, universities today are asking architects for buildings that not only serve their academic goals but also bring prestige to their campuses through innovative design. The Genome Sciences Building (GSB) at the University of North Carolina (UNC) in Chapel Hill succeeds on both levels. Designed by

the Chicago office of Skidmore, Owings & Merrill (SOM), the GSB is an integral part of the university's Bell Tower District, for which the firm designed the master plan in 2004. "The resulting plan serves as a vital link between the historic north campus and the medical school to the south, forming a series of new quadrangles, a park, and expansion of the existing Coker Woods," explains SOM associate director Peter Van Vechten. "Conceived as an interdisciplinary 'crossroads,' the GSB unites scientific rigor with collaborative flexibility, supporting parallel research and teaching functions."

"Porosity" and "transparency" are the words mentioned most often by the architects and users to describe both the architectural and programmatic goals of the GSB. The center emphasizes a shift from isolated closed-loop research to the open-ended, multidisciplinary collaboration that has become critical to cutting-edge science in the 21st century.

The eight-story 228,000-square-foot GSB rests on a plinth, clad in brick to acknowledge the traditional Georgian structures of the original campus. Students can enter classrooms and lecture halls off pedestrian paths at grade or follow a ramp to a public plaza atop the plinth where they can enjoy landscaped and shaded areas and a café.



BRIGHT IDEAS When lit at night, the Genome Science Building's laboratories and rooftop greenhouse glow, revealing the multidisciplinary activities of students, researchers, and faculty (opposite). The facility is sited at a busy pedestrian intersection near Kenan Memorial Stadium, linking residence halls, the UNC medical campus, and the undergraduate campus (above). The building fronts a simple park, which allows abundant daylight in and provides an informal gathering place in a highly trafficked area (below).



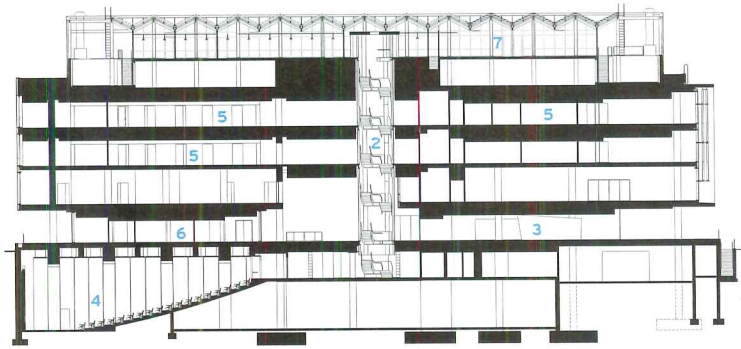

SECTION A - A

0 50 FT.
15 M.

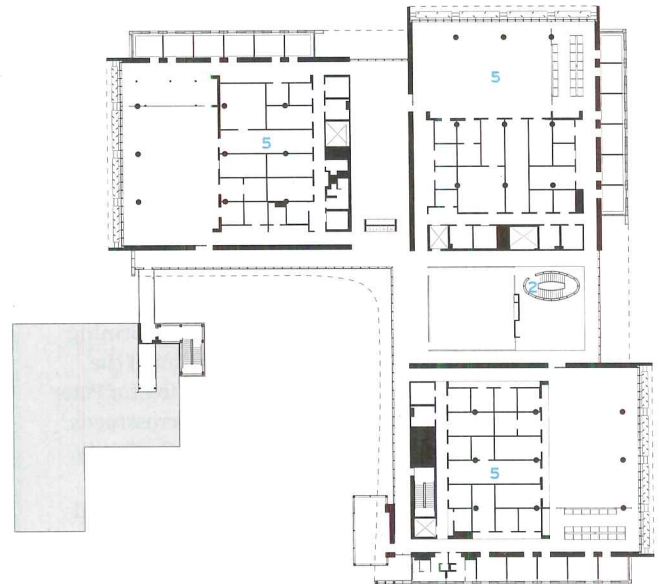

LEVEL 4

- 1 PUBLIC PLAZA
- 2 SPIRAL STAIR
- 3 CAFÉ
- 4 LECTURE HALL
- 5 LAB/SUPPORT
- 6 CLASSROOM/OFFICE
- 7 GREENHOUSE

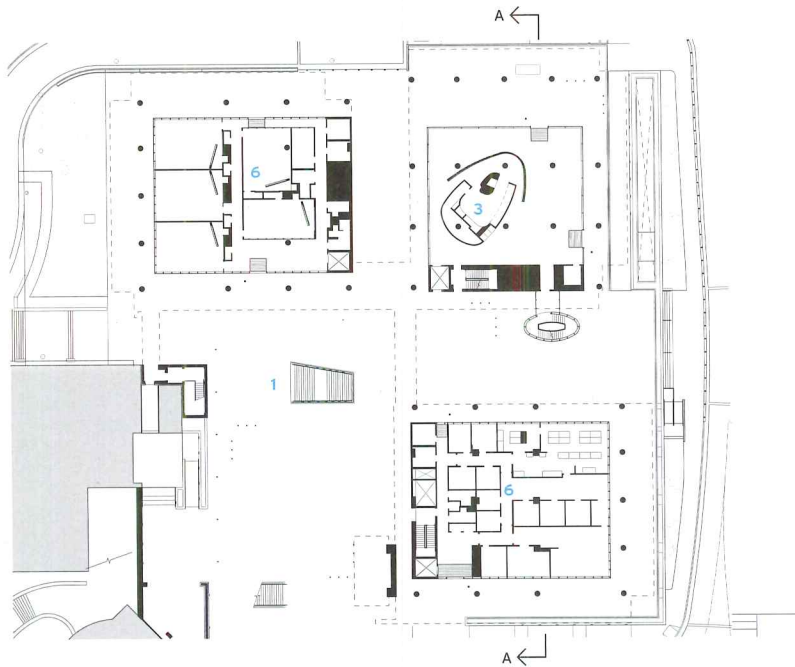

LEVEL 1

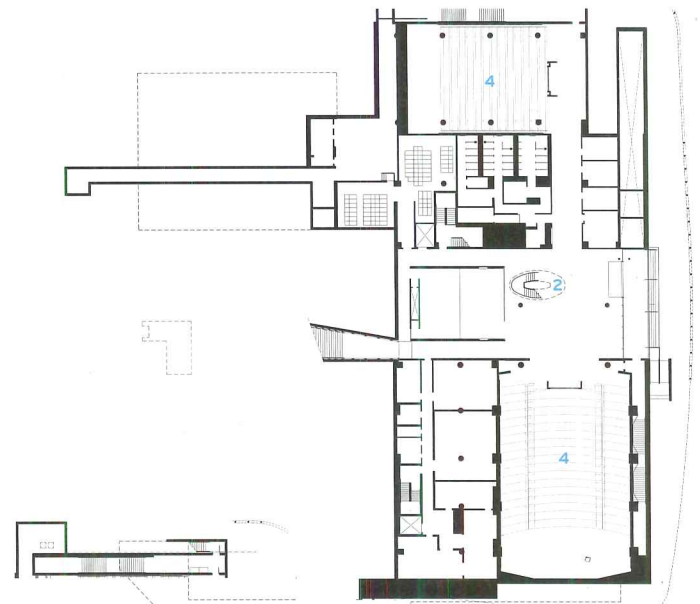

LOWER LEVEL 0 50 FT.
15 M.

credits

ARCHITECT: Skidmore, Owings & Merrill

ENGINEERS: Skidmore, Owings & Merrill (structural/mechanical)

GENERAL CONTRACTOR: Bovis Lend Lease; Clancy & Theys

CLIENT: University of North Carolina at Chapel Hill

SIZE: 210,000 square feet

COST: \$110 million

COMPLETION DATE: September 2012

SOURCES

STAIR: Daniel Metals

GLAZING: Viracom; SAFTI FIRST; Pilkington

MASONRY: Belden Brick Company

CURTAIN WALL: ASI; Juba

Aluminum Products



The plinth and facility rising from it posed significant structural challenges. The GSB is an L-shaped glass-and-concrete box housing wet and dry labs, faculty offices, conference rooms, and an enormous rooftop greenhouse for the study of plant genomics. The L is made of three pods, two of which extend two floors below grade to accommodate the mechanical plant. These pods rest on mat foundations that align with the natural slope of the bedrock. This arrangement minimized excavation and eliminated blasting. The third pod is supported at the plaza level by micropiles, 8 inches in diameter, which are often employed at sites with difficult access such as this one.

The building's upper floors focus on three large wet labs. This organization allows three to five principal investigators to work together in each lab, with benches arranged to accommodate 30 people in the same lab space. Dry labs are adjacent to the wet ones, allowing researchers to go back and forth between different experiments. Faculty offices are next to the dry labs and cantilever from the upper floors.

The major interior-design strategy involves daylighting,

which floods the labs through floor-to-ceiling glazing. Rather than adding drywall or paneling to the interior face of the perimeter walls, the architects saved money and achieved an industrial effect by simply tinting and polishing the concrete. Floors and interior partitions are rendered in sturdy low-maintenance materials. Against this economical backdrop, a dramatic spiral staircase emerges as the centerpiece of the interior. The stair is enclosed in a glass elliptical column, reinforcing the architect's pursuit of transparency at every floor. It terminates at the 80-by-200-foot greenhouse, which, when lit at night, confirms the GSB's status as an icon of innovation in the center of the campus.

"The simple, honest palette of materials—concrete, metal, and high-performance glazing—allows the GSB to maintain UNC's longstanding commitment to sustainability," says Van Vechten. In addition, the facility is fully integrated with the master plan for site development—re-using water for irrigation of the park, which itself is engineered to process stormwater and mitigate peak levels. SOM achieved this feat by installing underground cisterns with a 50,000-cubic-foot

HIGH-MINDED

The labs are enclosed in three distinct yet connected glass-and-concrete pods. These elements hover above a raised brick plaza through which thousands of university members pass each day. A wide stair leads down to three lecture halls located at grade.



capacity. A reservoir tank collects roof drainage water, which silently and invisibly irrigates the gently graded park fronting the building. These water-conservation tactics, along with many energy-saving strategies, contributed to the GSB's LEED Gold certification.

Genomics is a new field within the study of genetics, encompassing a broad range of inquiry from bioinformatics to engineering to medicine. With few precedents for this kind of complex programming, SOM designed a facility that embraces the multidisciplinary nature of 21st-century scientific research, education, and training. Going far beyond the goals of porosity and transparency, SOM delivered a programmatic and architectural model that will allow the university to respond to rapidly evolving technologies and to foresee opportunities for discovery for decades to come. ■

Sara Hart is a New York-based writer and former editor of ARCHITECTURAL RECORD.



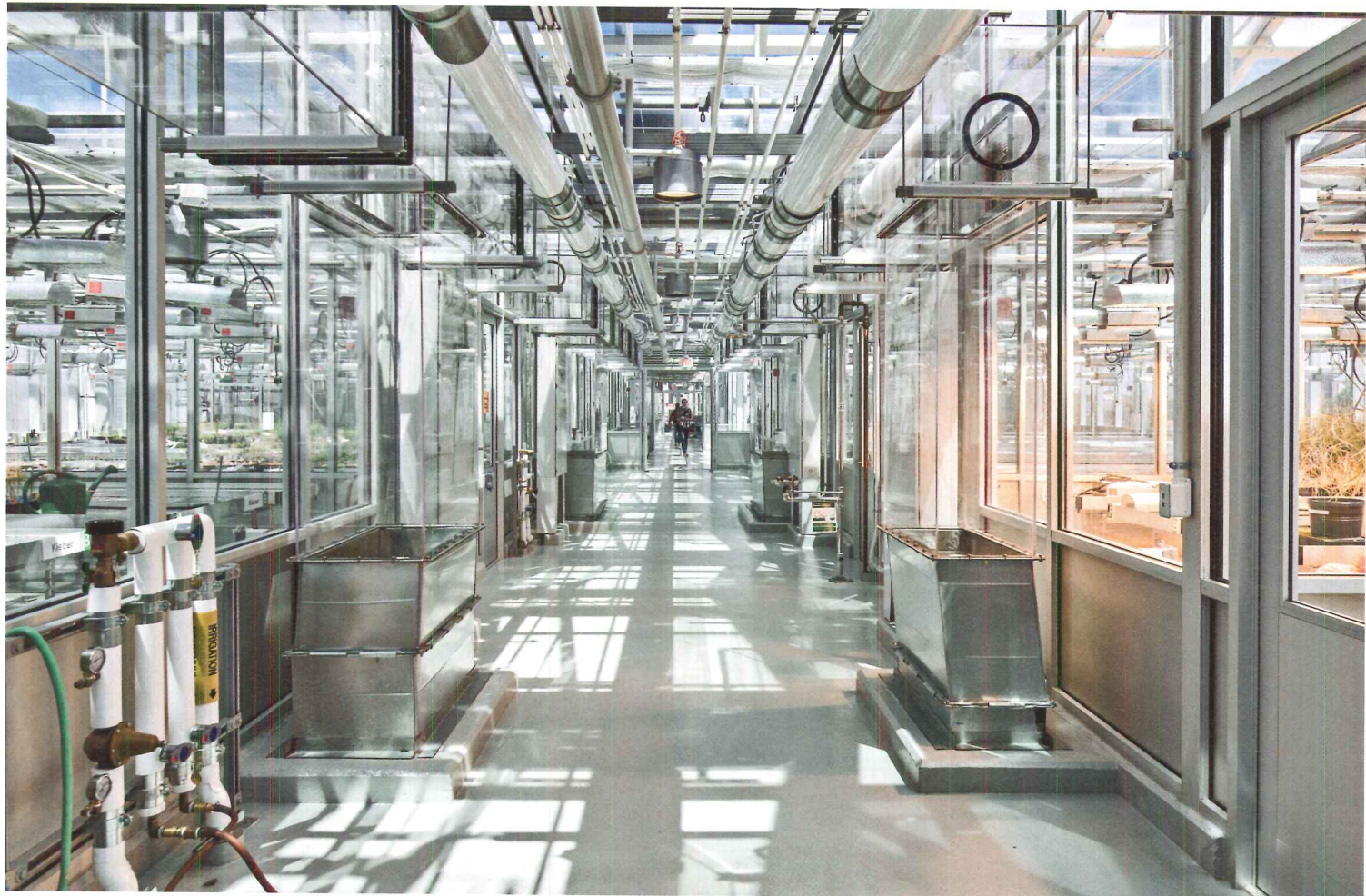

HEART OF GLASS
 A glass-enclosed sky-lit spiral staircase is a major design element of the interior, rising eight floors and bringing additional daylight into the interiors (opposite top and bottom). The state-of-the-art rooftop greenhouse supports research in plant genomics (above). Open labs receive daylight through glazing that has been specifically treated, depending on orientation, to prevent unwanted glare and solar heat gain (right).



Fay Jones School of Architecture | University of Arkansas, Fayetteville | Marlon Blackwell Architect

OBJECT LESSON

A prominent Arkansas designer conceives a study in contrasts for the architecture school where he teaches.

BY WILLIAM HANLEY

PHOTOGRAPHY BY TIM HURSLEY



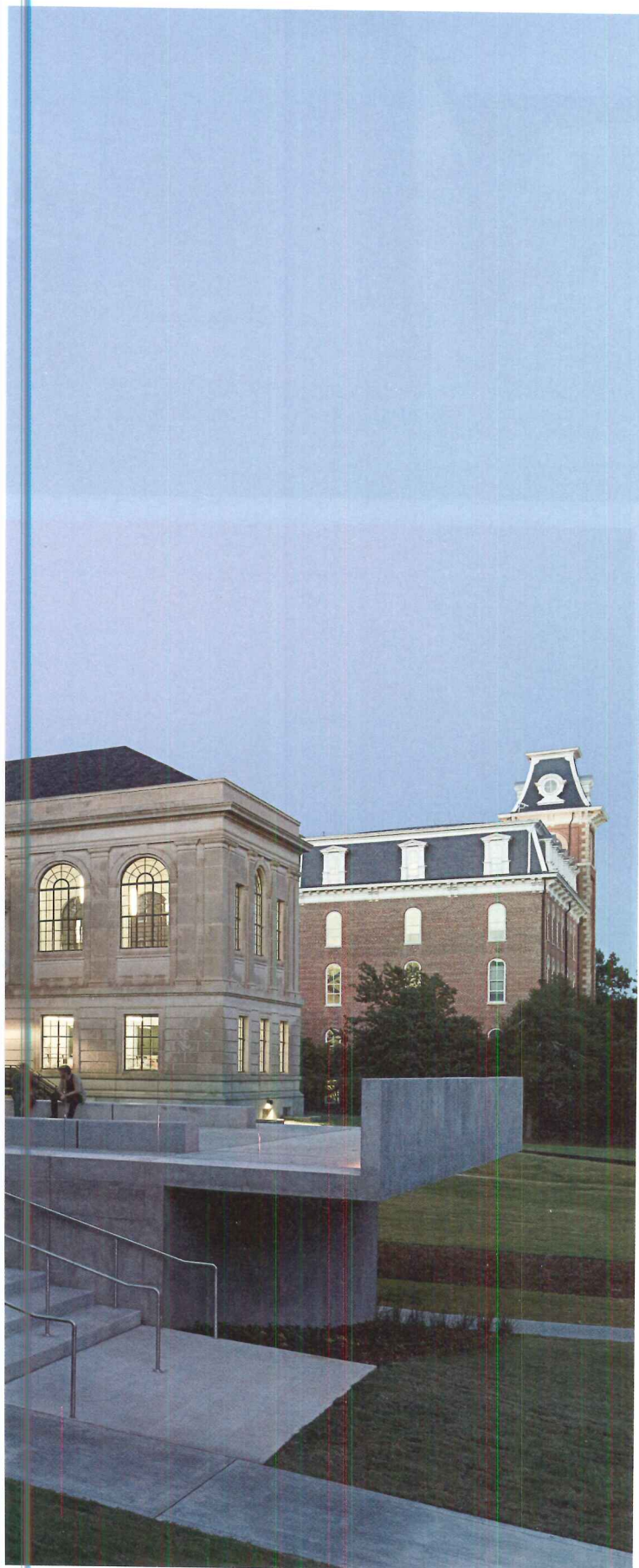

HISTORICAL PROGRESSION
The designers' new addition (foreground) continues a line from Old Main (background) to a former library building (middle) through to two other buildings in the campus's historic heart.

Marlon Blackwell is not afraid to create a little tension. On the second floor of his new renovation and expansion of the architecture school at the University of Arkansas, which opened this fall, students file through a tall, narrow doorway as they make their way between a grand Beaux

Arts-style salon into a contemporary addition. The threshold, lined with razor-thin steel panels, slices through the older interior's wall and decorative molding as if surgically inserted into the room, a move as deft as it is abrupt. Overhead, a light well, painted bright red, terminates in a rectangular oculus, introducing color and a fine-edged geometry into the white, austere classical space. "The new and the old start to infect each other," says Blackwell. "But rather than resolving the two, we wanted the building to resonate, to vibrate like a tuning fork."

Since the 1970s, the Fay Jones School of Architecture—named for the revered regionalist who taught there throughout his career—inhabited the Beaux Arts building, originally constructed in 1934 as a library. It occupies a prominent site along the primary axis through campus, positioned just behind Old Main, an august mansard-roofed 1878 building. But the former library had never been fully fitted out as an architecture school; ad hoc studios were stuffed into reading rooms, and first-year students were banished to flood-prone basement work spaces. Three years ago, the Donald W. Reynolds Foundation offered a \$10 million grant toward a comprehensive upgrade and addition to the building, but it required the school to submit initial plans within weeks. Lacking time to put out a request for proposals, then-dean Jeff Shannon convinced the university's chancellor to hire Blackwell, who has taught at the architecture school for more than two decades and currently chairs the department. The move allowed the school to meet the deadline, but it rankled other Arkansas architects, as well as alums who wanted a shot at the commission.

Unperturbed, Blackwell and his firm delivered a minimalist renovation of the former library building and appended a four-story 35,000-square-foot addition. The new rectangular volume, a post-tensioned concrete structure mostly clad in limestone and zinc panels, with one fully glazed facade, stands behind the Beaux Arts library, turning the older building's T-shaped plan into an H. The combined facility contains new studio, classroom, and administrative spaces, as well as model shops, a gallery, a roof terrace, and a 200-seat auditorium. The project, which currently accommodates 480 students, also consolidates the architecture, landscape, and interior design departments under one roof.

The overall design allows the old building and the new wing to express their distinct architectural languages and building methods, but it stitches them together in key places to create moments of frisson. Blackwell envisions the hybrid structure as a teaching tool. "You have walls, columns, different load-bearing conditions, and cantilevers," he says. "It's not like the Pompidou, where the building just throws up its skirt, but you have this encyclopedia or this whole reference guide to architecture."

The text begins in the former library, where the firm's renovation distills and augments Beaux Arts details. The architects stripped decades of muddied ochre pigment from the walls and repainted the plaster a bright white, which highlights wood doorways and emphasizes the scale of the rooms, an effect heightened by dark cork flooring.

While the circulation through the library building once

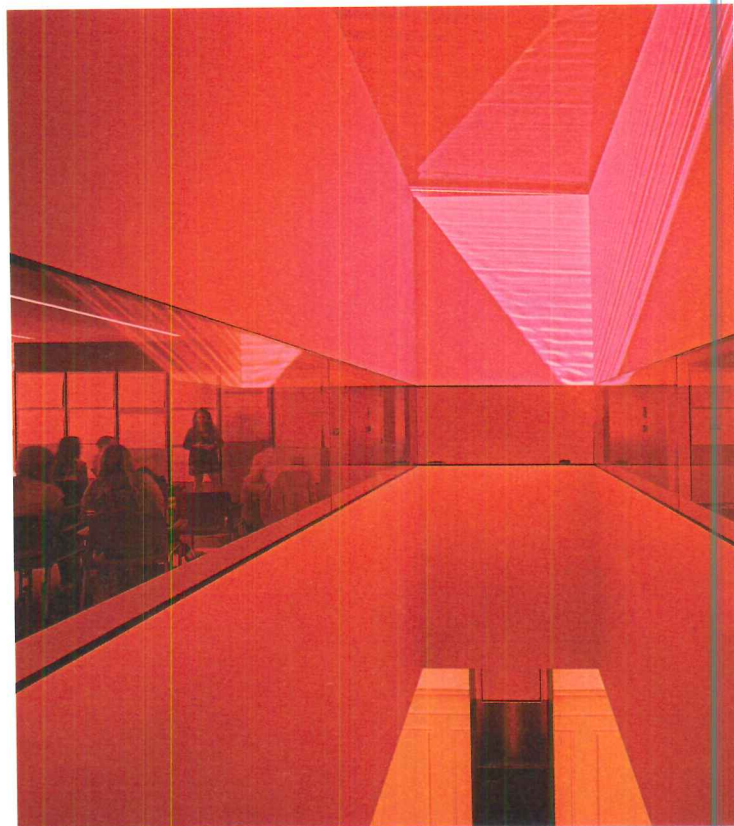
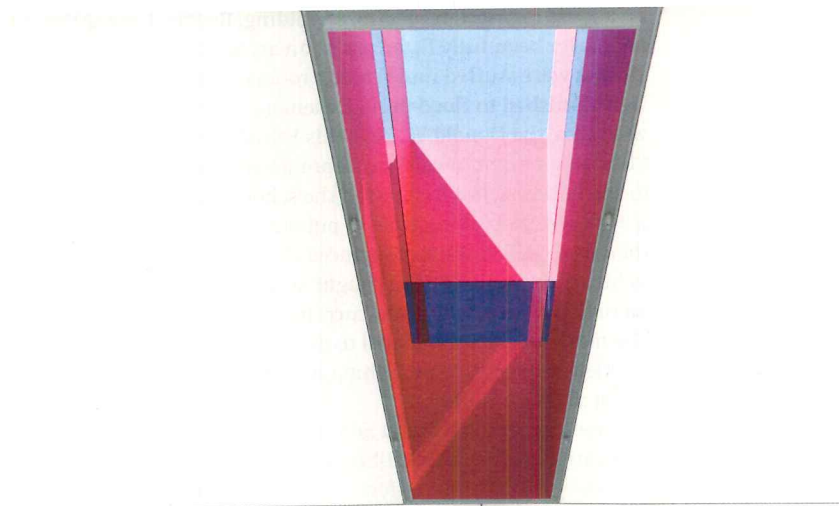
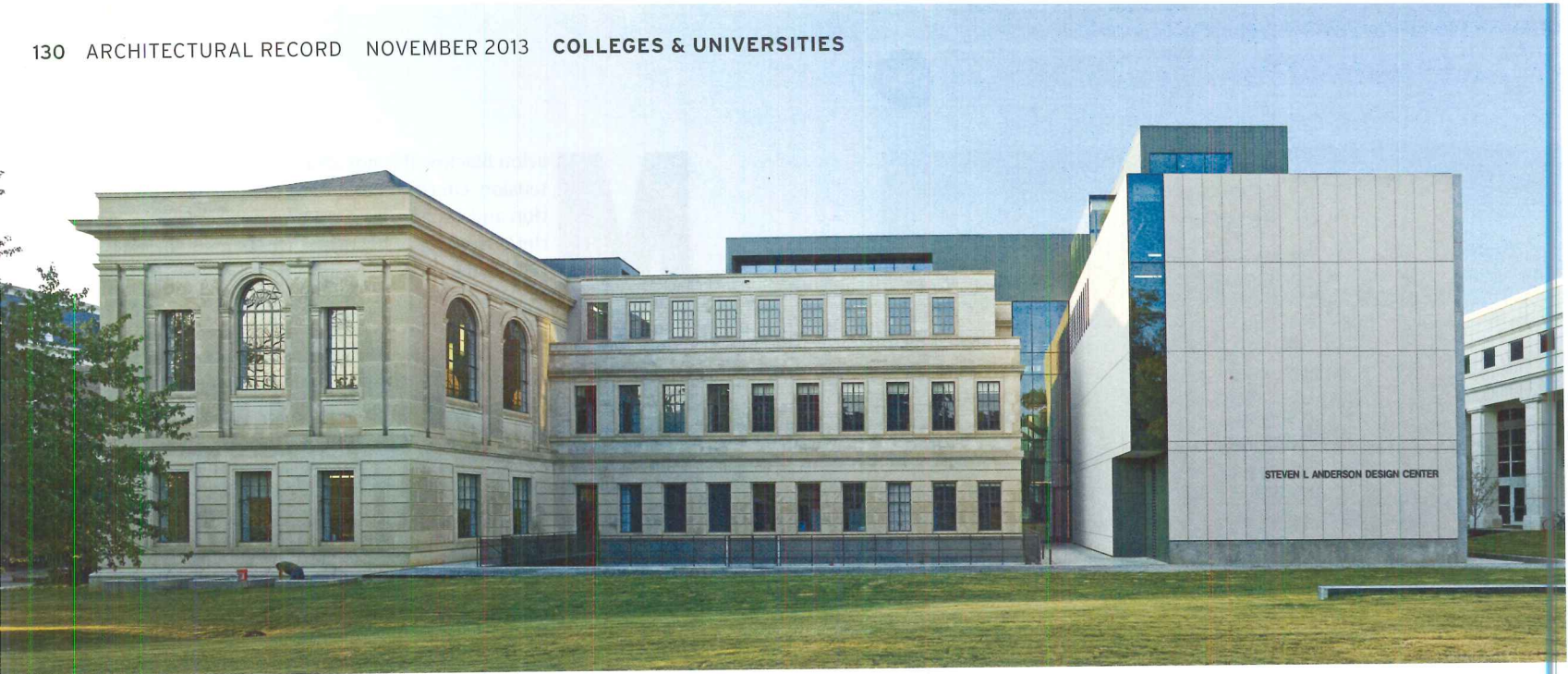

LIGHTING STUDY The top floor of the addition to the architecture school extends over the center of the older building, a former library (top). A light well pierces two new classrooms, admitting daylight through a band of red Plexiglas windows (above). The well brings daylight into a central chamber in the older building through a rectangular oculus set in a backlit fabric ceiling (left). In the former library, the main reading room has been converted into a studio (opposite) with its original iron-framed windows preserved. Task lights built into custom desks—ribs on traditional library reading lamps—supplement pendant lights overhead.

- 1 STUDIO
- 2 SALON
- 3 MATERIALS LIBRARY
- 4 STUDIO
- 5 GREEN ROOF/TERRACE
- 6 LIGHT WELL
- 7 LOBBY

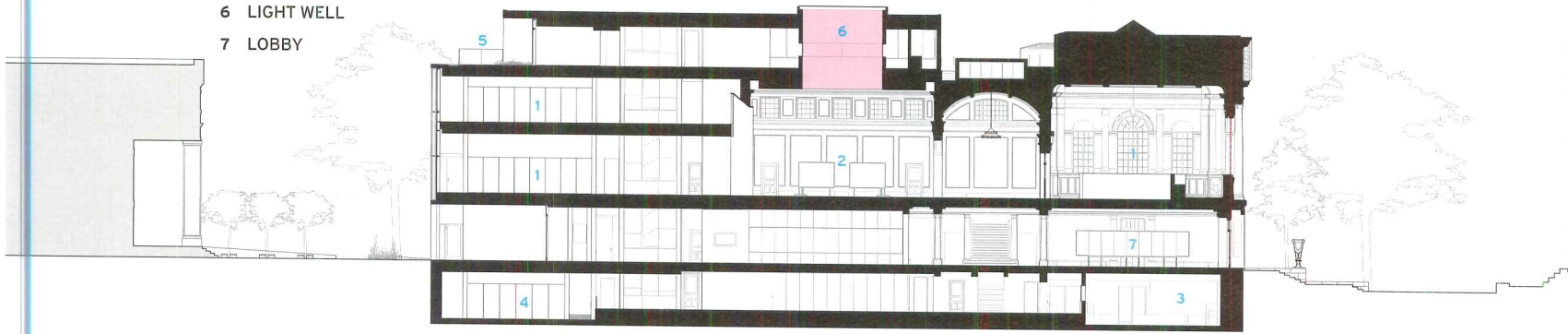

SECTION A - A

0 30 FT.
9 M.



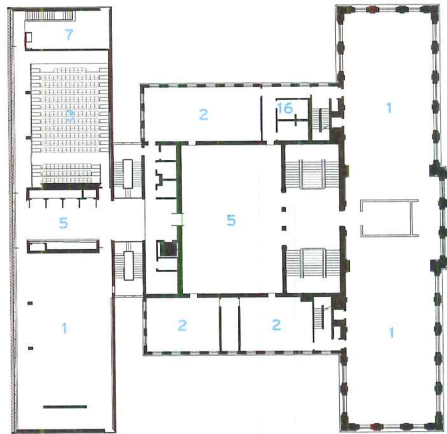

SECOND FLOOR

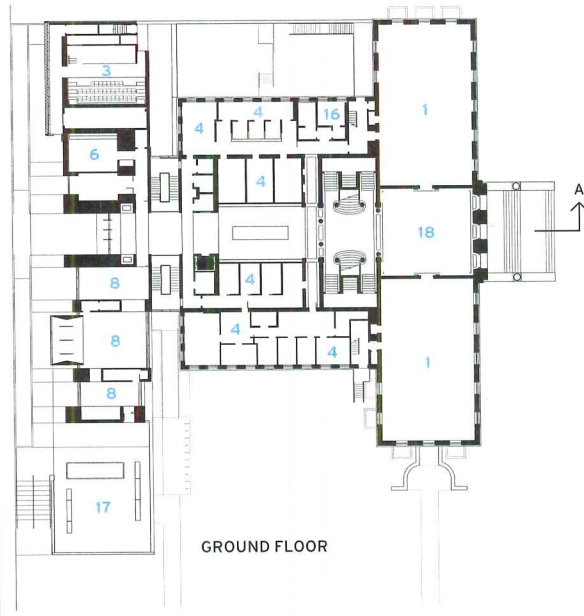

GROUND FLOOR

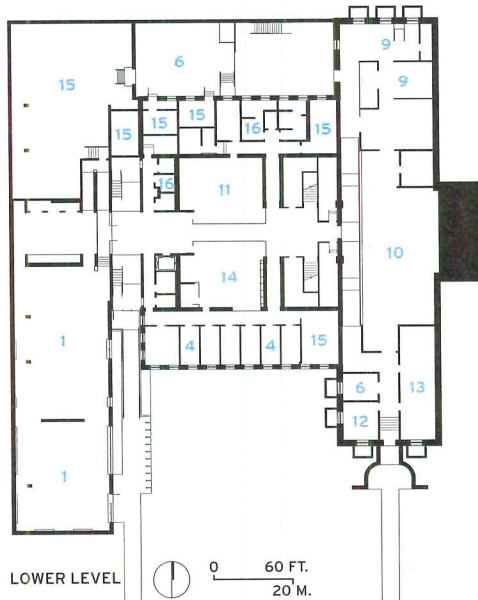

LOWER LEVEL

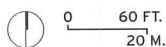

- | | | |
|--------------------------------------|---------------------------------------|----------------------|
| 1 STUDIO | 7 FACULTY LOUNGE | 13 MATERIALS LIBRARY |
| 2 CLASSROOM | 8 GALLERY | 14 MEDIA CENTER |
| 3 AUDITORIUM | 9 VISUALIZATION LAB | 15 MECHANICAL |
| 4 ADMINISTRATION/
FACULTY OFFICES | 10 WOOD SHOP | 16 RESTROOM |
| 5 SALON | 11 COMPUTER LAB | 17 TERRACE |
| 6 STUDENT LOUNGE | 12 SUSTAINABILITY/
DAYLIGHTING LAB | 18 LOBBY |

credits

ARCHITECT: Marlon Blackwell Architect
– Marlon Blackwell, lead architect; David Jaehning, co-project manager

ASSOCIATE ARCHITECTS: Polk Stanley Wilcox Architects – Mark Herrmann, co-project manager/project architect

ENGINEERS: Kenneth Jones & Associates (structural); TME (m/e/p); Development Consultants (civil)

CONSULTANTS: Crafton Tull Sparks (landscape); Clarkson Consulting (concrete)

GENERAL CONTRACTOR: Baldwin & Shell

Construction Company

CLIENT: University of Arkansas

SIZE: 90,955 square feet

COST: \$32.4 million

COMPLETION DATE: August 2013

SOURCES

ROOFING: Johns Manville Roofing

GREEN ROOF: LiveRoof

FRITTED GLASS: Viracon

GLASS DOORS: Oldcastle

BuildingEnvelope

dead-ended in four floors of book stacks, it now continues through the addition, where the architectural vocabulary switches abruptly to emphasize structure and hard-working materials. Twin stairs, enclosed in glass shafts with steel frames that curve into benches, rise along the joint between the old and new sides of the building. They connect basement-level workshops and computer labs to the ground floor—which houses a student lounge, administrative offices, and a gallery—and to the upper levels where studio spaces and classrooms show off the addition’s handsome poured-in-place concrete structure. (One complaint that several students echoed on a recent visit was about the acoustics in some of the new classrooms.)

The addition’s glass facade contrasts dramatically with the inward-looking, temple-like library. “The west side is really one big window,” says Blackwell. The custom double-skin glazing system uses vertical fritted glass fins to filter sunlight. While it provides ample daylighting for classrooms and work spaces, the system also turns the building into a lantern, projecting indoor activities outward to the campus when the sun goes down, and—this being architecture school—the effect typically lasts late into the night.

That presence has given the architecture school a higher profile within the university, or as Kyle Marsh, a fourth-year student, put it on a recent afternoon, “The contemporary building in the old part of campus reflects the kind of work being done inside.” He makes an important point. With an open call for proposals, the administration could have chosen a design architect from anywhere in the world. Instead, they selected someone deeply familiar with the architecture school, who could tailor the addition to both the campus and the teaching program. “I don’t know what the overall grand message to the students is,” says Blackwell, “but I hope the project underscores what it is to build well.” ■

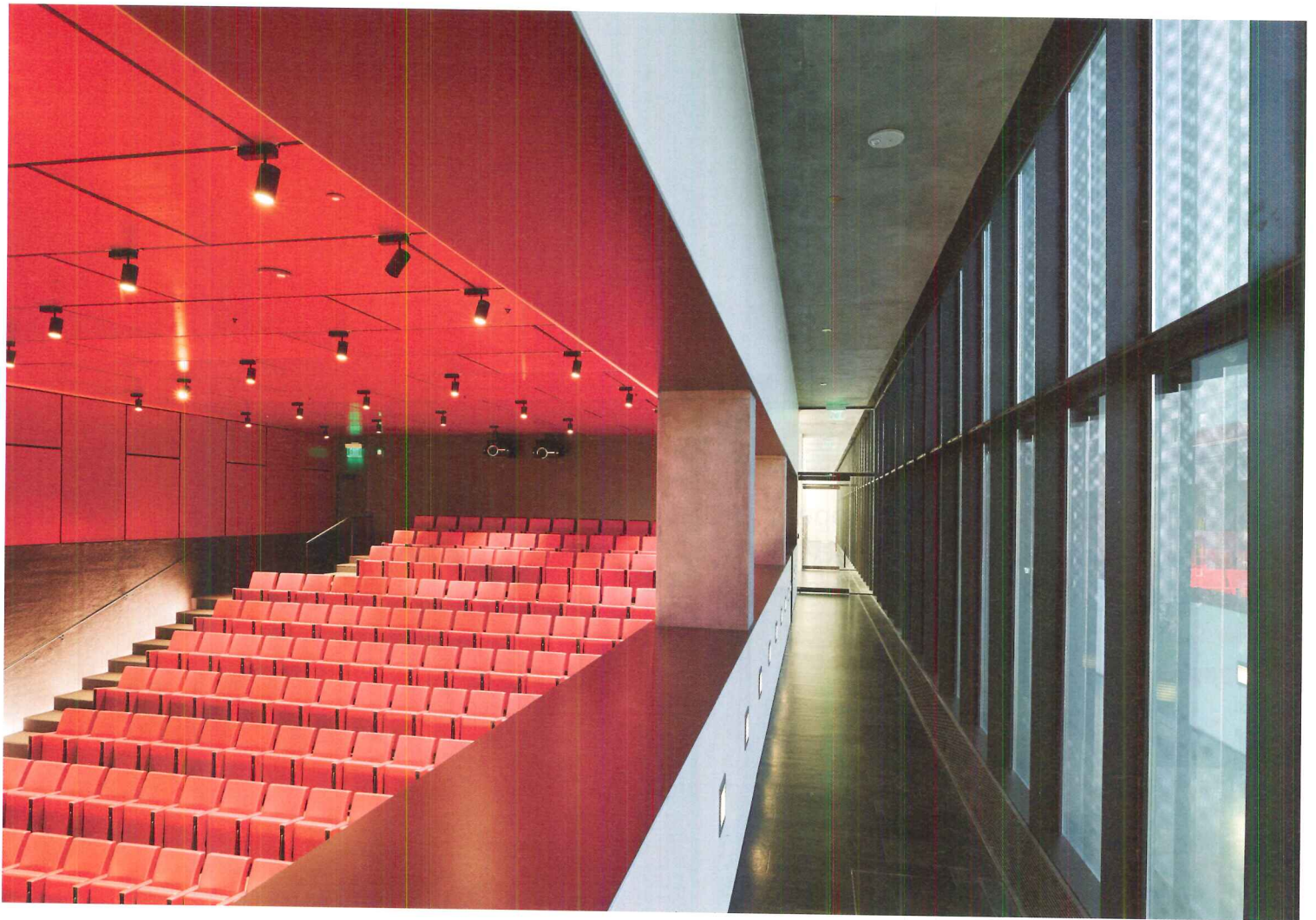

SCHOOL COLORS

Blackwell's firm wrapped the auditorium (above), accessed from the ground and second floors, in plywood acoustical panels painted in the same red as the light well—a nod, says Blackwell, to the university's colors and to Fay Jones, who was heavily influenced by Frank Lloyd Wright. A series of exhibition spaces line the ground floor's main corridor (right).



Marquez Hall, Colorado School of Mines |
Golden, Colorado | Bohlin Cywinski Jackson

FUEL SCHOOL

A team of architects designs an open, inviting new home for a university's petroleum engineering department.

BY DAVID HILL

PHOTOGRAPHY BY NIC LEHOUX

Golden, Colorado, about 20 miles west of Denver, is probably best known for a certain beer brewed in a massive plant on the city's eastern edge. Coors, now part of the MillerCoors conglomerate, was founded here in 1873, before Colorado became a state. One year later, the Colorado School of Mines (CSM) opened its doors to engineering students eager to take part in the territory's booming mining industry.

Today, both institutions are going strong, and they even have a little-known connection: steam from the brewery's cogeneration plant provides heat for the buildings on CSM's small campus. A public university with about 5,500 students, "Mines" still offers classes in mining engineering, but there are programs in chemical engineering, mathematical and computer sciences, and more. Thanks in part to the current domestic oil boom, one of the school's most popular (and competitive) majors is petroleum engineering. And when you look at the numbers, it's no wonder: the program, which serves about 400 undergraduates, has a 97 percent job placement rate for graduates, who earn an average annual starting salary of more than \$100,000.

The department's previous home, Alderson Hall, was built in 1953 and renovated in 1992 by Denver firm RNL. But the growing program needed more classroom and lab space, along with some amenities to help recruit professors, who can earn a lot more working for oil and gas companies. In 2005, Denver oilman (and CSM alum) Tim Marquez and his wife, Bernadette, launched a fundraising campaign with a \$10 million matching donation. Oil companies, individual

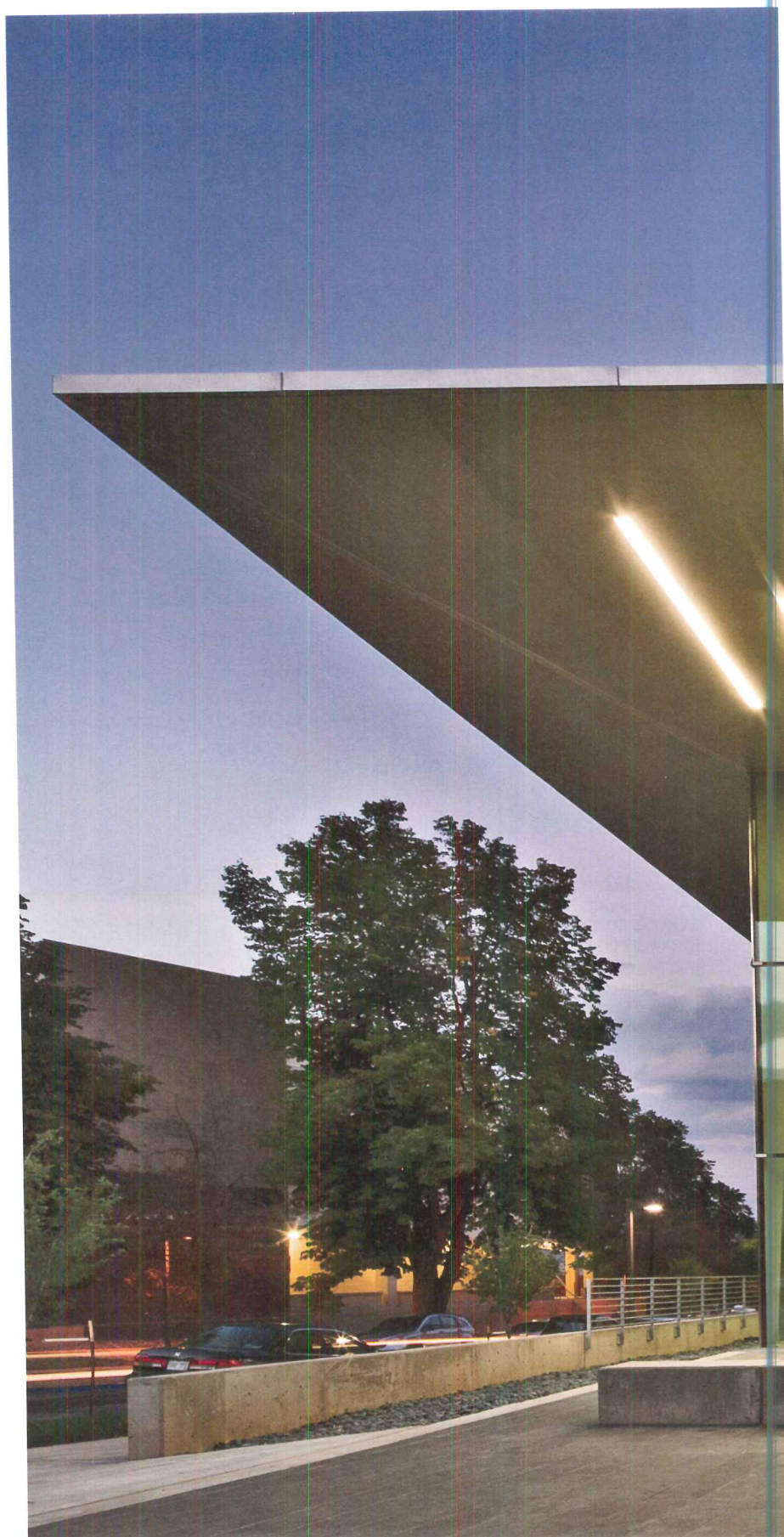



GRAND ENTRANCE A 60-foot cantilevered canopy welcomes visitors to Marquez Hall at the Colorado School of Mines. Classrooms and lab spaces are visible behind the glass entry.

donors, and students pitched in and eventually raised \$25 million for a new building. Designed by Bohlin Cywinski Jackson (BCJ), with architect of record Denver-based Anderson Mason Dale, Marquez Hall opened for the 2012 academic year.

The project is a dazzling light-filled building with spectacular views of Golden and South Table Mountain (the rock-capped mesa that overlooks the city) to the east and the Rocky Mountain Front Range foothills to the west. Sited on the eastern edge of the campus, the L-shaped 85,000-square-foot facility has quickly become a showcase for CSM's petroleum engineering program. "I wanted something that was very modern, very friendly, and very state-of-the-art," says Ramona Graves, former department head and now dean of the College of Earth Resource Sciences and Engineering.

A dramatic 60-foot cantilever canopy extends over a glass-enclosed entrance lobby and exhibition space, which opens onto a plaza. You might think there's a theater behind the glass facade, or maybe an Apple store (BCJ is the longtime designer of the computer company's retail shops). But, no, Marquez Hall contains classrooms, laboratories, computer labs, offices, and study areas, all spread over four floors.

BCJ principal Robert Miller, of the firm's Seattle office, says the building's overall transparency is in part a response to Graves's desire to show that the oil and gas industry is not the big bad wolf. "It's a functional building for the program," Miller says, "but it's also designed to take people through and show them what the program is all about." So there is a window in the lobby allowing visitors to see into a lab with a full-scale drilling rig simulator, and students walking on the

SIGHT LINES
Labs (opposite top) and classrooms have views out to the surrounding mountains, while a new plaza (below) looks into Marquez Hall's teaching spaces. Bohlin Cywinski Jackson clad the exterior with terra-cotta panels (opposite bottom) to echo the blond brick found in other buildings on campus.

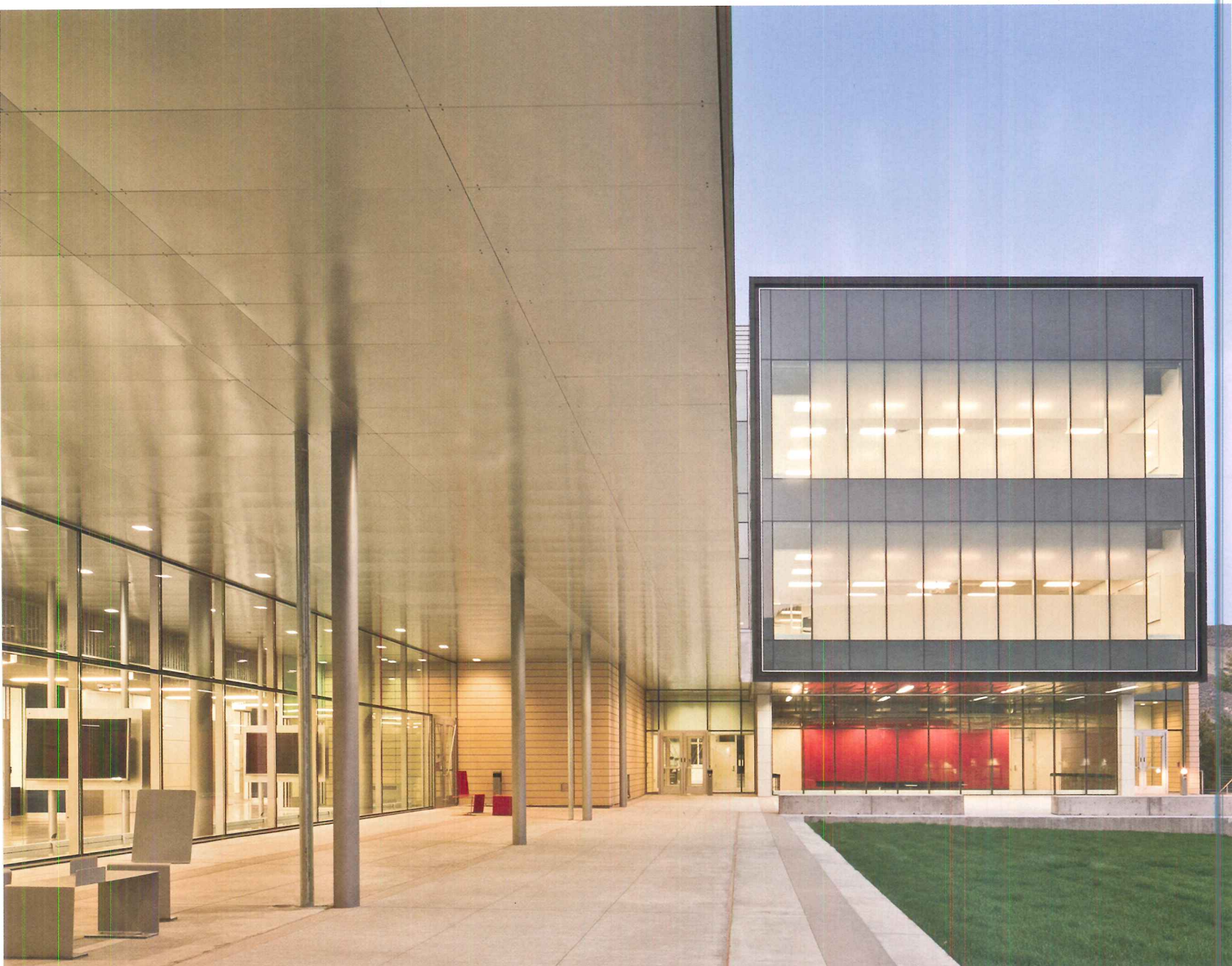

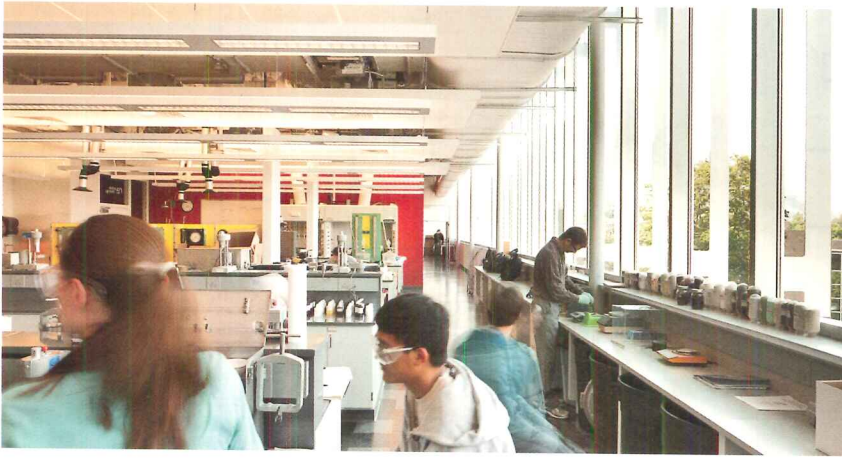

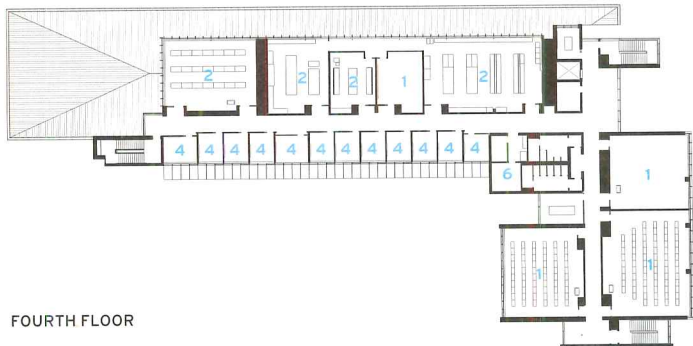

FOURTH FLOOR



THIRD FLOOR

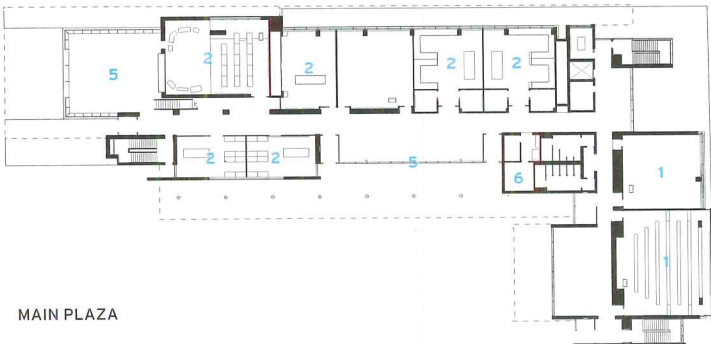

MAIN PLAZA



LOWER LEVEL

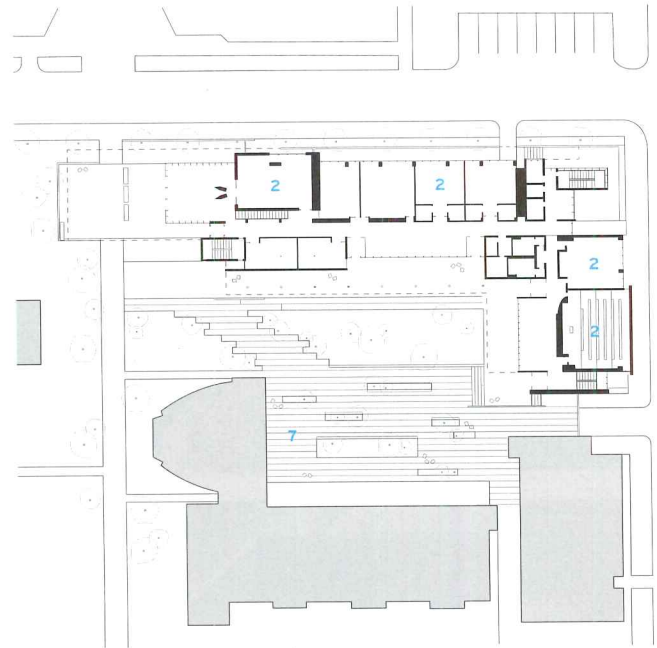

SITE PLAN

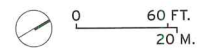

- 1 CLASSROOM
- 2 LAB
- 3 ADMINISTRATION
- 4 FACULTY OFFICE
- 5 LOBBY
- 6 SERVICE/MECHANICAL
- 7 PLAZA

credits

DESIGN ARCHITECT: Bohlin Cywinski Jackson – Peter O. Bohlin, principal for design; Robert Miller, principal in charge; Kirk Hostetter, project manager

ARCHITECT OF RECORD: Anderson Mason Dale Architects – Paul Haack, principal in charge; David Houston, project manager; Gabe Comstock, project architect

ENGINEERS: Shaffer Baucom (m/e/p); Martin/Martin (civil); Studio NYL (structural)

GENERAL CONTRACTOR: Adolfson and Peterson Construction

CLIENT: Colorado School of Mines

SIZE: 85,000 square feet

COST: \$28.2 million

COMPLETION DATE: September 2012

SOURCES

STRUCTURAL SYSTEM: Zimcor

CURTAIN WALL: EFCO

AIR/MOISTURE BARRIER: Carlisle

BUILT-UP ROOFING: Johns Manville

CARPET: Interface FLOR

SOLID SURFACING: Caesarstone

TRANSPARENT RESEARCH To combat the field's reputation for secretiveness, Bohlin Cywinski Jackson opened the petroleum engineering building's classrooms and labs to its public spaces.

sidewalk along the building's north side can peer through windows into research labs. Floor-to-ceiling windows on the south side look onto Jalili Plaza, a new campus quad with outdoor furniture.

Reminders of the strong ties between the department and private industry are everywhere. One room is the Halliburton Visualization Center, another the Hess Corporation Multidisciplinary Classroom. On the first floor, there's a student lounge area sponsored by ConocoPhillips. Several video screens tout the company's world-wide energy exploration, while another highlights the building's sustainable elements, showing energy use in real time. (Marquez Hall is Silver LEED certified.) Surprisingly, one chart reveals just how many barrels of oil have been saved because of all those energy-efficient features.

Many of the buildings at Mines were constructed using blond bricks. Miller and his team wanted Marquez Hall to fit in with the other structures on campus, but they also wanted it to have certain "modern characteristics" that are hard to accomplish with masonry. The solution was terra-cotta cladding, used extensively on the building's exterior. "You can basically tune it to get the pale yellow-brick color that's so prominent on campus," says BCJ associate Christian Kittelson. "But it's a little more 'unexpected' than brick." The terra-cotta extends to much of the interior, which helps connect indoor and outdoor spaces.

Mike Bowker, CSM's associate director for capital planning and construction, says Marquez Hall has effectively raised the bar for future architectural design at the university. Several projects—including a new sports complex, a "welcome" center, and a dorm—are in the works. Pressure is on, Bowker says, to make sure any new buildings "pop."

"The refrain I'm hearing," he says, "is, 'Make it like Marquez.'" ■

Denver writer David Hill is a frequent RECORD contributor.

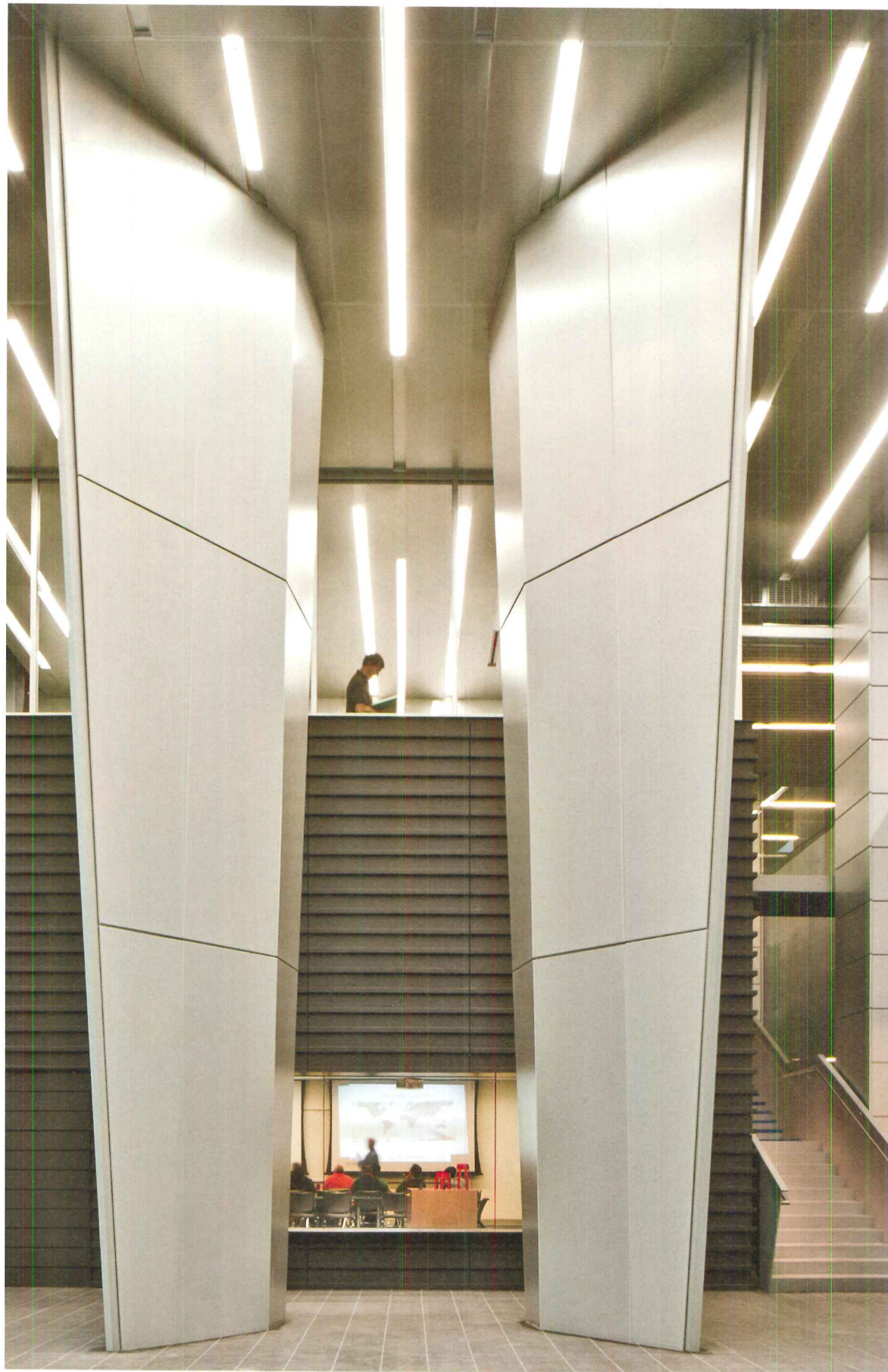

Krishna P. Singh Center for Nanotechnology | Philadelphia |
Weiss/Manfredi Architecture/Landscape/Urbanism

THE ART OF SCIENCE

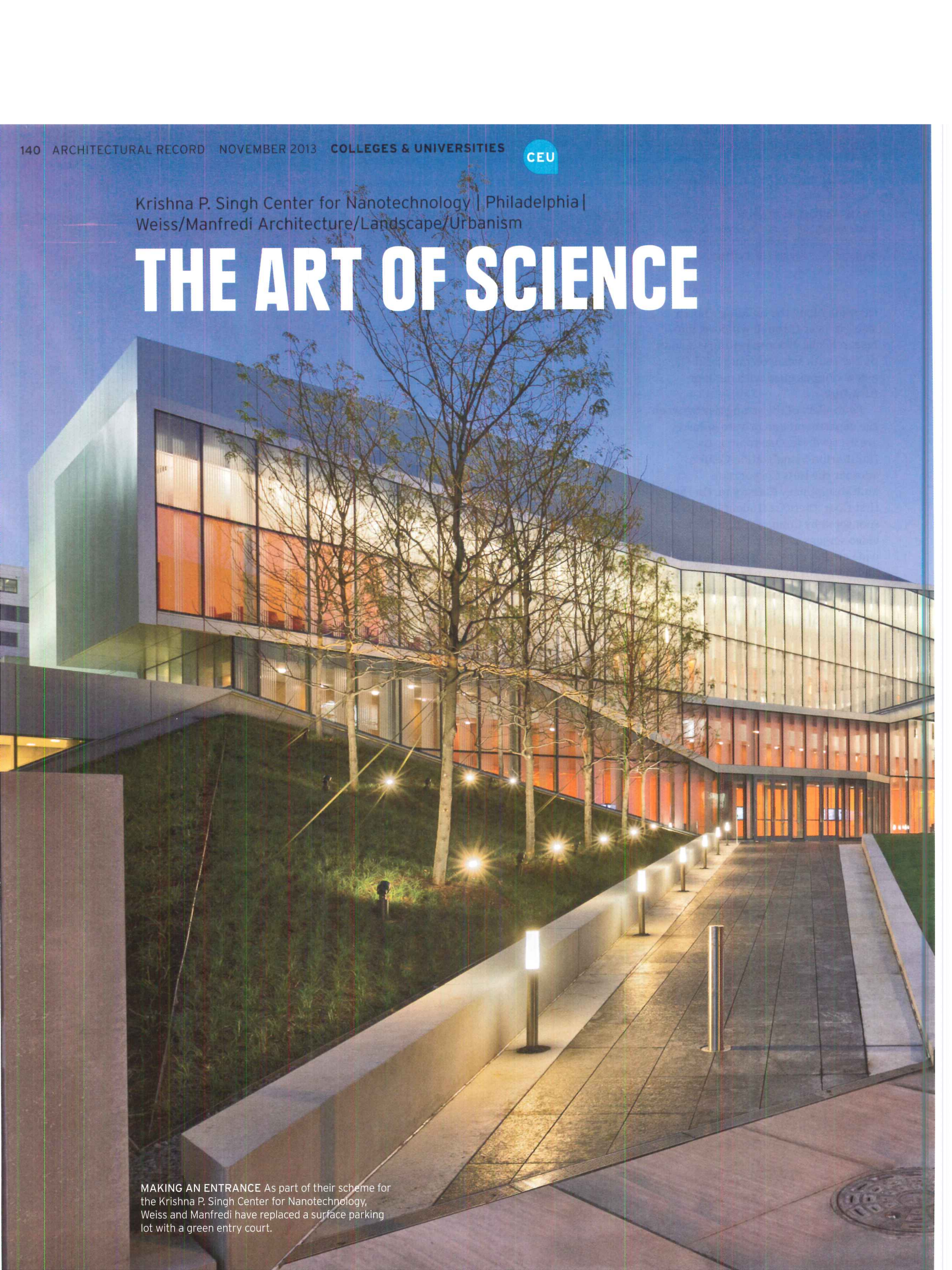

MAKING AN ENTRANCE As part of their scheme for the Krishna P. Singh Center for Nanotechnology, Weiss and Manfredi have replaced a surface parking lot with a green entry court.

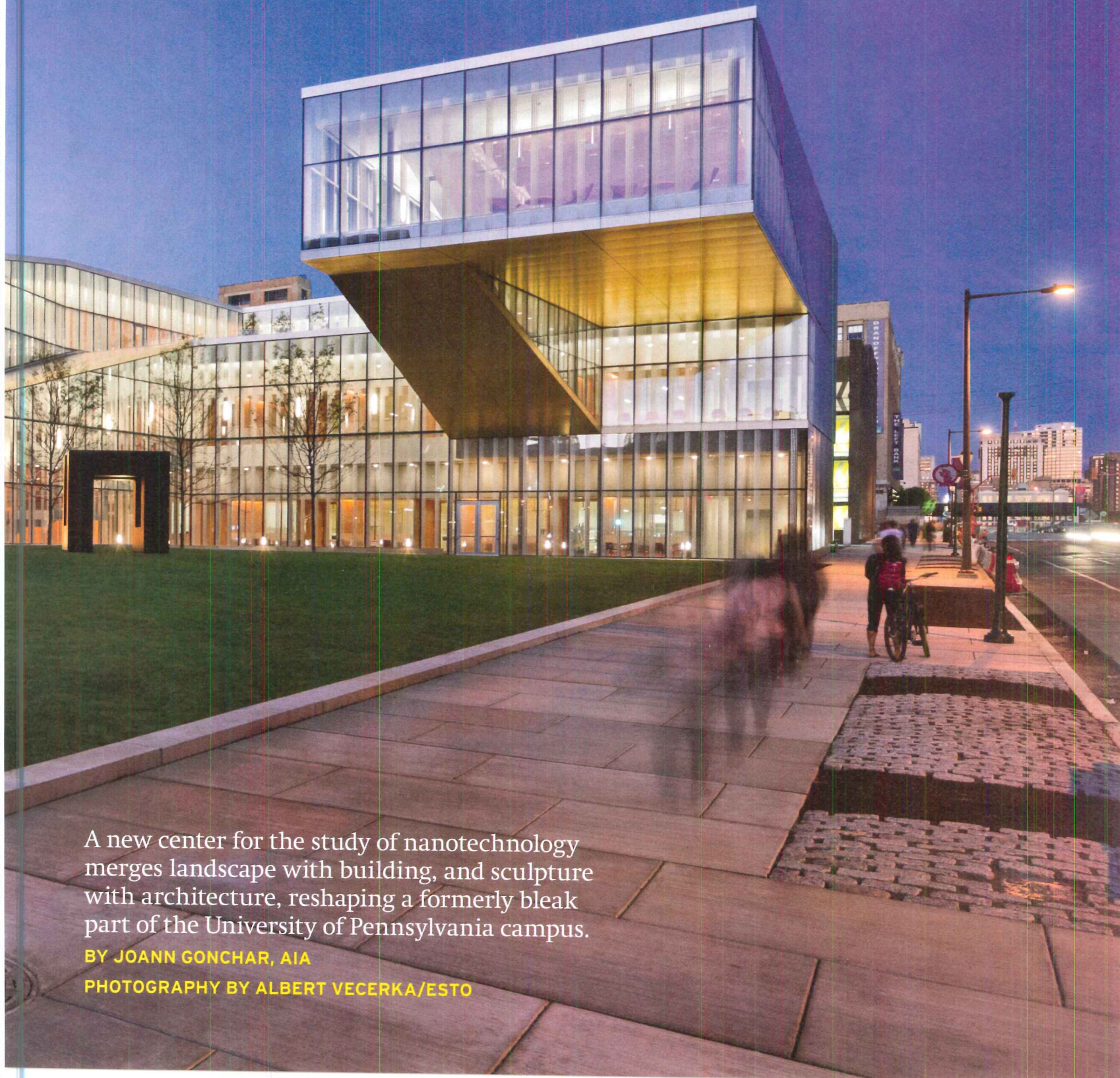

A new center for the study of nanotechnology merges landscape with building, and sculpture with architecture, reshaping a formerly bleak part of the University of Pennsylvania campus.

BY JOANN GONCHAR, AIA

PHOTOGRAPHY BY ALBERT VECERKA/ESTO

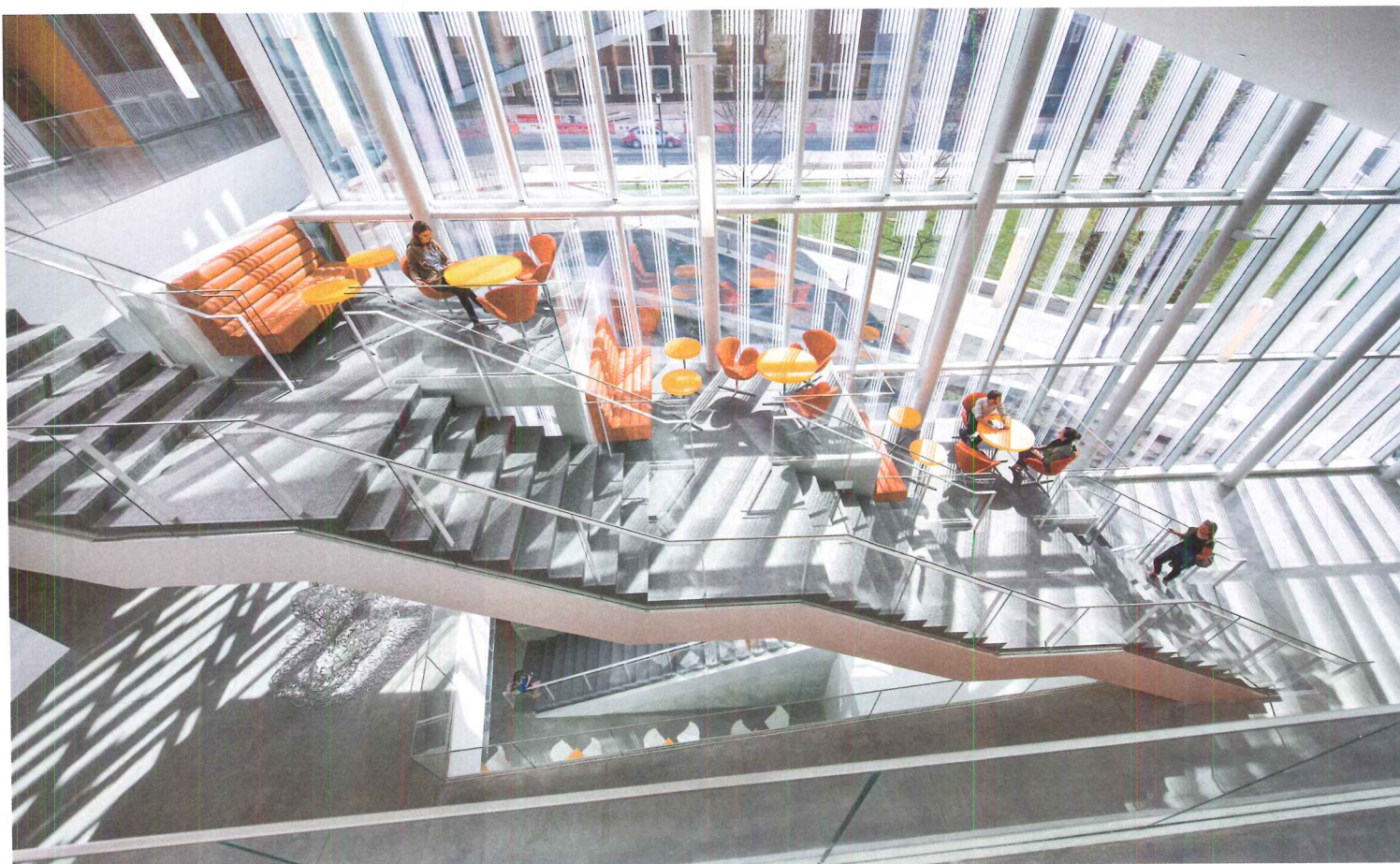

Although located in dense West Philadelphia, the University of Pennsylvania has a genuine campus—one organized around a series of green spaces and landscaped quadrangles carved out of the surrounding urban fabric. But the spot for the school's just-completed Krishna P. Singh Center for Nanotechnology is another story. The site, at the university's northeastern fringe, sits next to a six-story concrete and glass tower for materials research separated from its context by an off-putting brick plinth. And until construction of the new 78,000-square-foot Singh, its 1.7-acres had been home to a surface parking lot and Edison Laboratory—a one-story, nearly windowless box containing high-powered microscopes and other scientific instruments. “It was a part of campus where engineering was central but landscape was not,” says Marion Weiss, founder, with Michael Manfredi, of the New York City–based architecture practice Weiss/Manfredi.

The two architects have completely transformed this previously unappealing part of campus with a three-story steel-framed angular structure cloaked in an origami-like glass and metal skin. The L-shaped Singh wraps two sides of the site and hovers at the street edge with an assertive 68-foot-long cantilever. Together with the adjacent center for materials research, the new building defines an inviting grassy court where there had been only asphalt and brick.

The university has been expanding eastward, toward the Schuylkill River, but for the time being, Singh is the first academic building encountered by anyone approaching the campus from the Walnut Street Bridge—one of the main pedestrian and automobile links to Center City Philadelphia. This prominent position, along with the building's muscular cantilever and the new green space, transforms a typically hermetic building type into something with much more public reach. It also provides visibility for the rapidly developing field of nanotechnology, which involves the study of structure and materials at the molecular level and has a wide array of applications that range from medicine to consumer products.

“The dean wanted the scientists' great work to be seen,” says Weiss, explaining the goals of Eduardo Glandt, head of Penn's engineering school and a key champion of the project. “And he wanted a building with dynamism and buzz.”

The \$91.5-million Singh, named after the founder of the energy-technology company Holtec International, who contributed \$20 million, naturally contains state-of-the-art research facilities. But the building also encompasses a series of vibrant public spaces often lacking in university science centers. The most obvious of these areas is the new lawn, which functions as the building's entry court, drawing people from the street, past a sculpted knoll and a monumental and sober sculpture by Tony Smith that once had a home on Penn's main college green.

When they step inside Singh, visitors and users encounter another public space: a daylight-filled galleria, narrow but three stories tall, around which almost all of the above-ground rooms are arranged. An elegant 60-foot-long stair, with granite treads and glass balustrades and no intermediary supports, leads to second-floor labs and offices. It exerts an almost magnetic pull, enticing people with its gentle slope and expansive landings, which the architects see as indoor extensions of the landscape. These generous landings, which they call “topographical social spaces,” include tables and chairs for relaxing, impromptu meetings, or group study.

The upward spatial sequence spirals around the galleria and the edge of the landscaped court and culminates with the forum—a room contained within the cantilever for

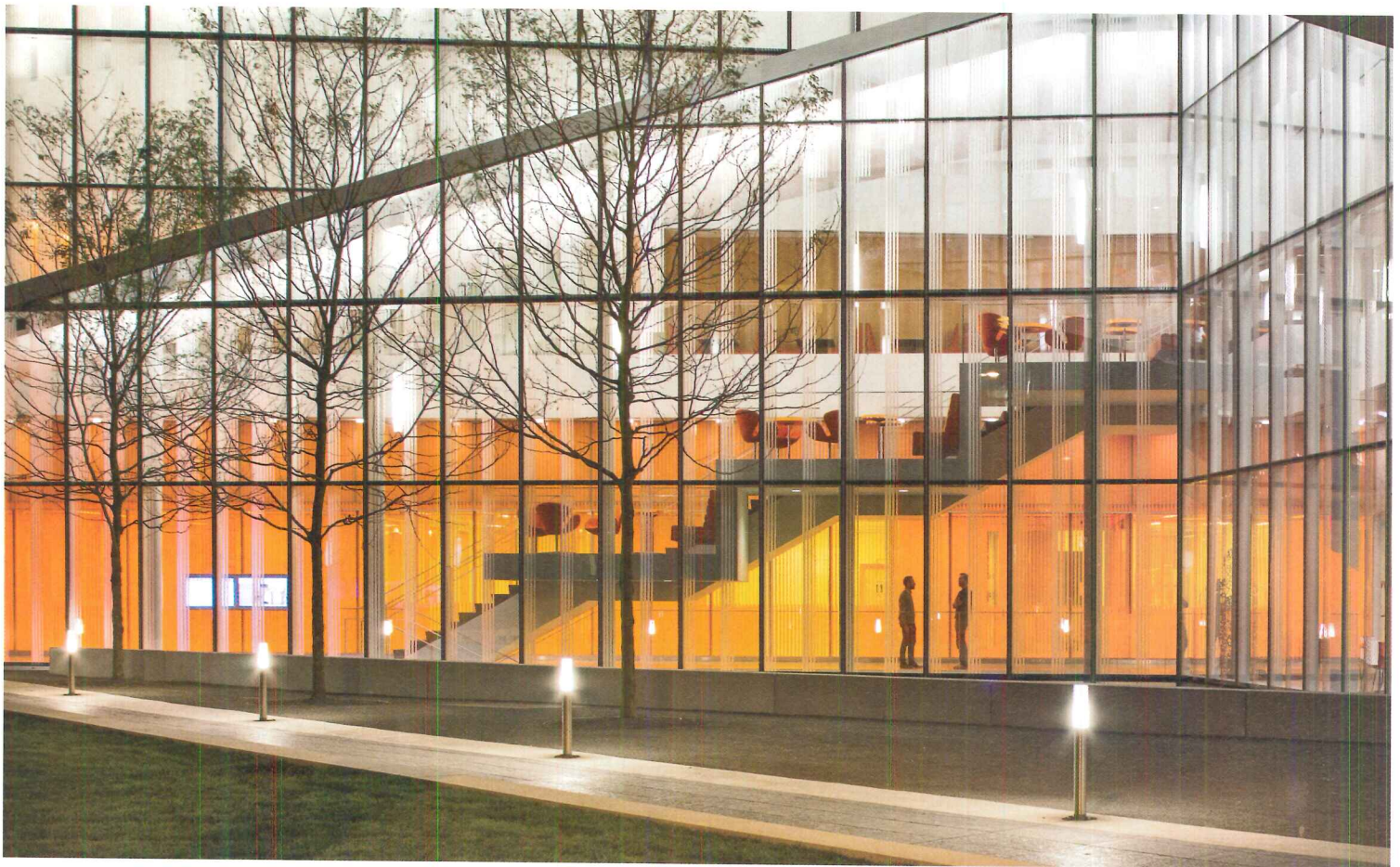

INTERIOR TERRAIN

The architects see the building's grand stair (above left) as an extension of the landscaped courtyard. They refer to its expanded landings as "topographical social spaces" because they provide spots for taking breaks and for informal meetings. The furnishings here are various shades of orange to pick up the saffron tint of the glass shielding the building's first-floor clean room. The wall's vibrant color is visible even from the outside, especially at night (above).

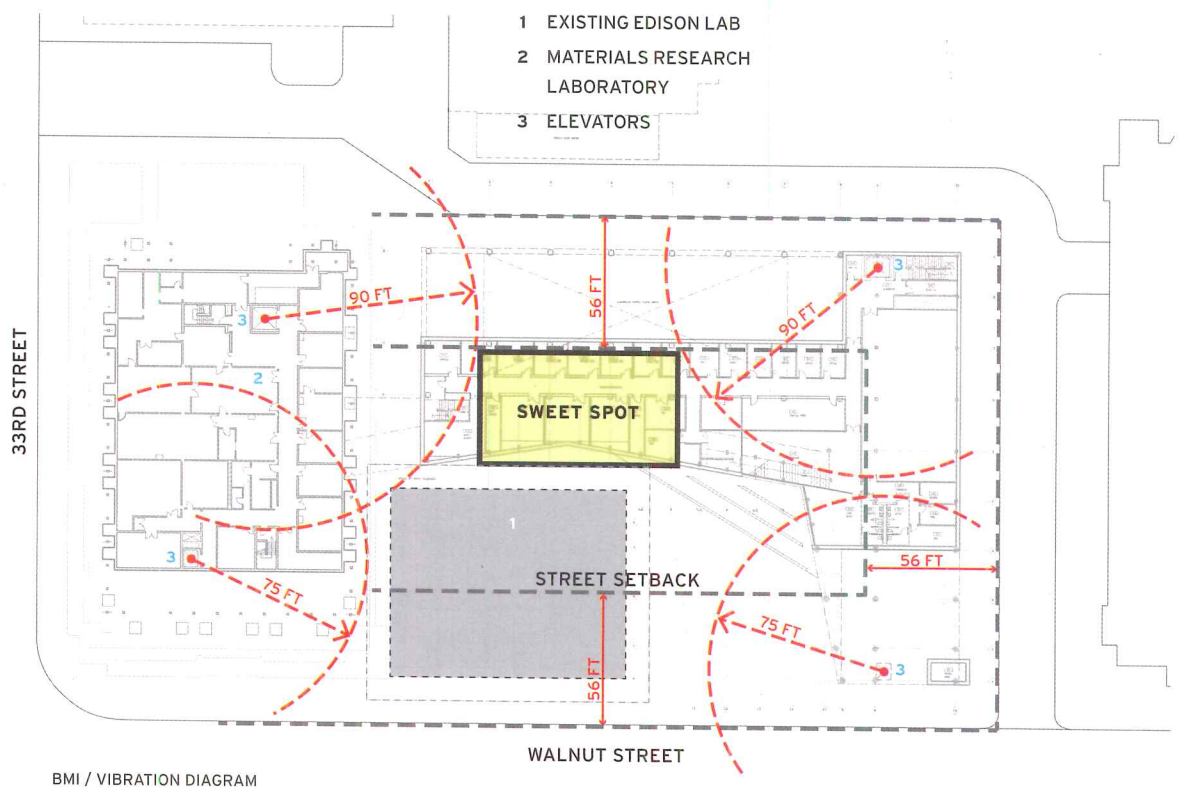



PLEATS AND PINSTRIPES Although Singh reads as a sculptural glass box, much of its exterior is clad in super-insulated metal panels pleated to create a shadow effect and provide structural stability. The rhythm of the panels mimics that of the pinstripe pattern on the glass curtain wall, made by combining ceramic frit and acid etching.

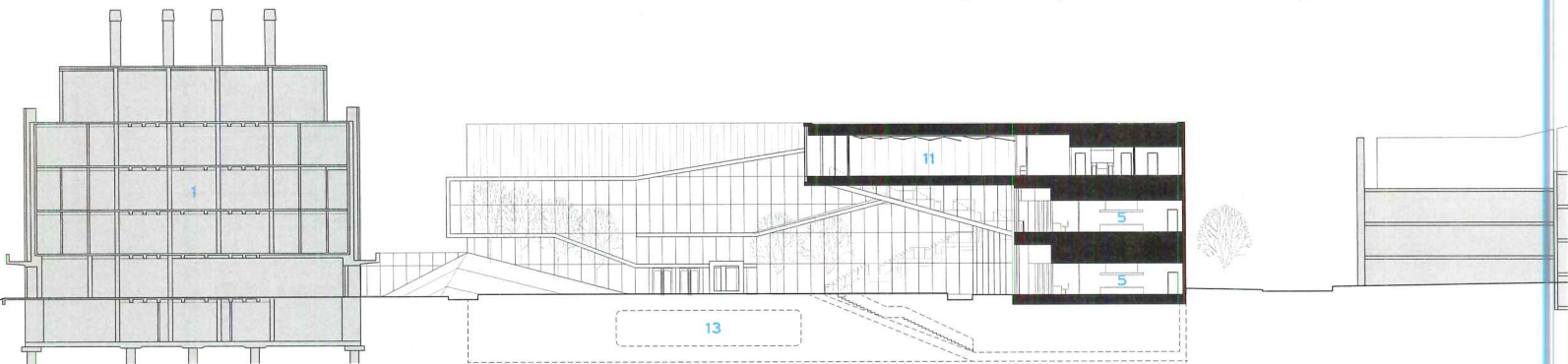

SECTION A - A

0 30 FT.
10 M.

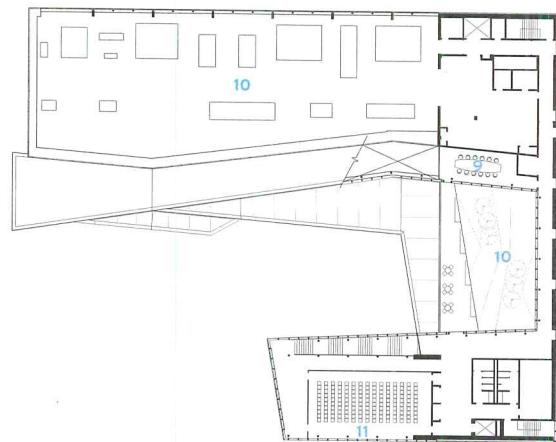

THIRD FLOOR

- 1 MATERIALS RESEARCH LABORATORY
- 2 LOBBY
- 3 CLEAN ROOM BAY
- 4 CLEAN ROOM CHASE
- 5 GENERAL LABORATORY
- 6 CAFÉ
- 7 OFFICE
- 8 MECHANICAL FAN DECK
- 9 CONFERENCE ROOM
- 10 GREEN ROOFS
- 11 FORUM
- 12 CHARACTERIZATION LABORATORY
- 13 STORM-WATER CISTERN



SECOND FLOOR



LOWER FLOOR

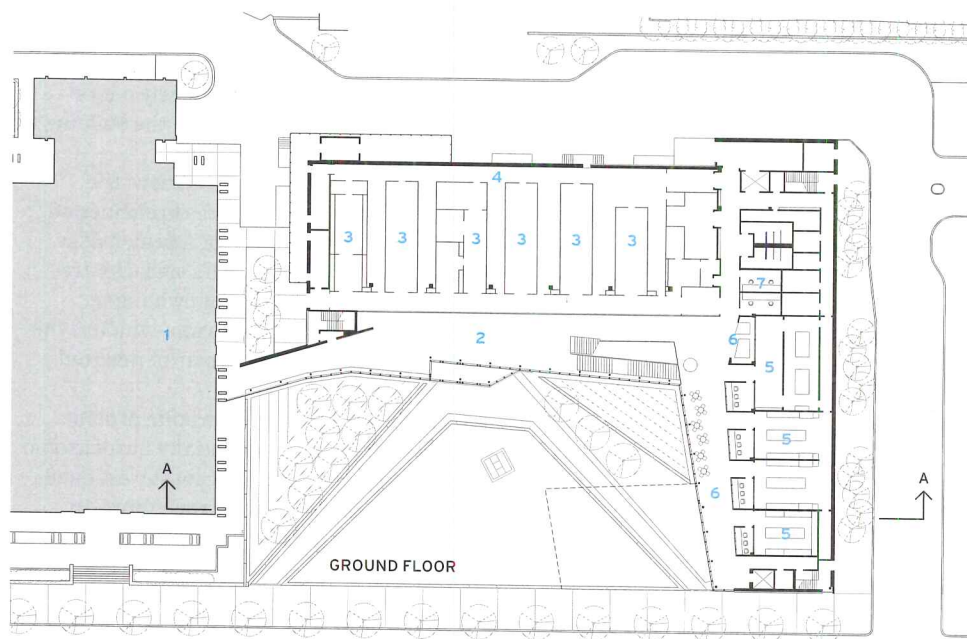
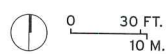

GROUND FLOOR

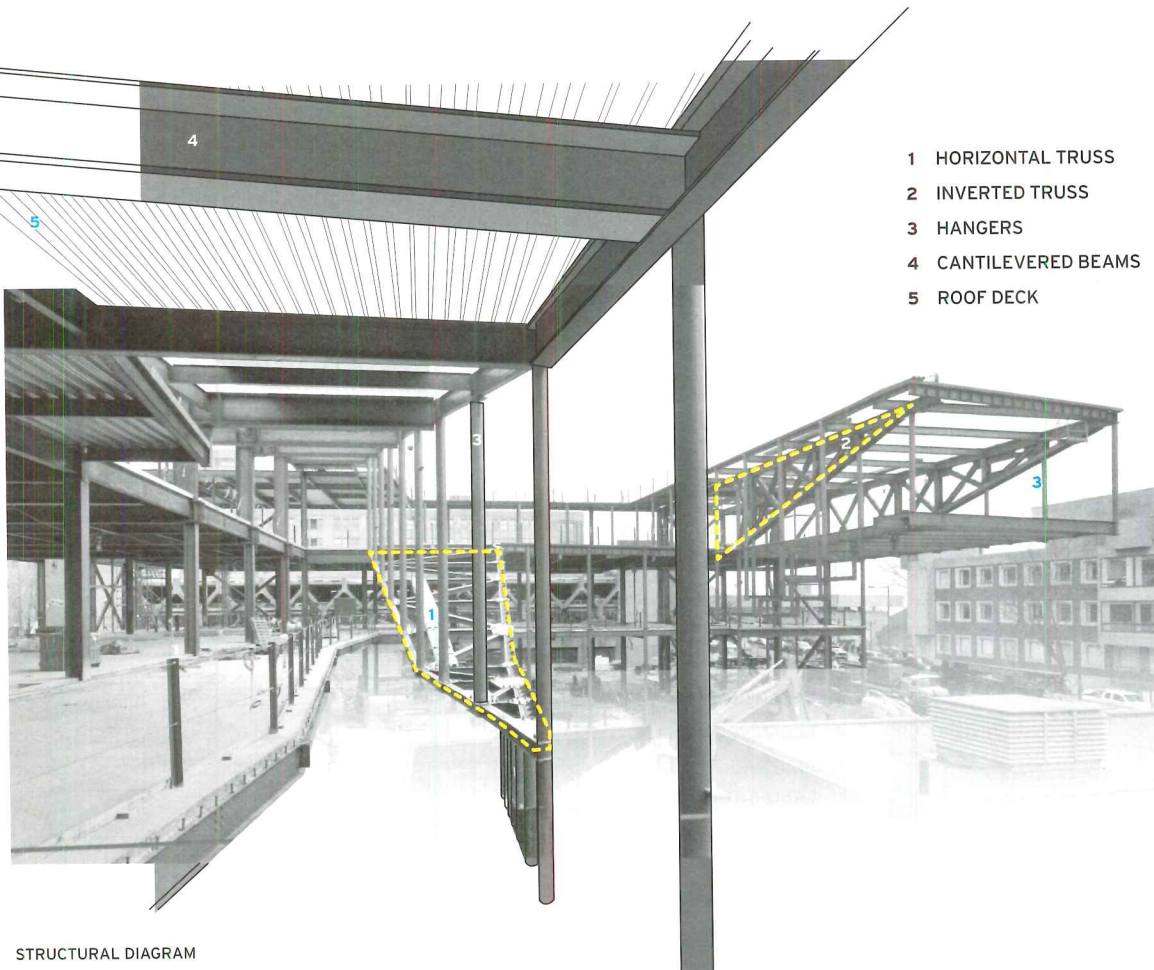

- 1 HORIZONTAL TRUSS
- 2 INVERTED TRUSS
- 3 HANGERS
- 4 CANTILEVERED BEAMS
- 5 ROOF DECK

STRUCTURAL DIAGRAM

credits

ARCHITECT: Weiss/Manfredi Architecture/Landscape/Urbanism – Marion Weiss, Michael A. Manfredi, design partners; Todd Hoehn, project manager; Michael Harshman, senior project architect; Kim Nun, Ina Ko, project architects; Bryan Kelley, Michael Steiner, core team members

CONSULTANTS: M+W Group (lab consultant, m/e/p/fp); Severud Associates (structural); Colin Gordon Associates (vibration isolation)

CLIENT: University of Pennsylvania

GENERAL CONTRACTOR: Gilbane

SIZE: 78,000 square feet

COST: \$91.5 million

COMPLETION DATE: October 2013

SOURCES

CURTAIN WALL: National Glass and Metal Company

EXTERIOR GLASS: Walker Glass Company, J.E. Berkowitz

METAL PANELS: Spectrum Metal Finishing, Wyatt Incorporated

CLEAN ROOM WALL SYSTEM: Plascore

lectures, receptions, and meetings. It has an accordion-like oak ceiling and is surrounded by glass on three sides. Here the prime spot is the room's foyer, at the prow of the cantilever, which offers a perch for taking in the view toward the west and almost the whole Penn campus.

Weiss describes the building's ascending route as one that "unfurls around the crystalline boundary of the courtyard." Key to this crisp and folded effect is the curtain wall's white pinstripes, created by combining an acid-etched pattern on the insulated glazing units' outside lites and a ceramic frit on their inside lites. Along with a low-E coating, the pattern helps reduce heat gain and glare. But because the inside and outside stripes are intentionally ever-so-slightly out of register with each other, they also subtly reinforce the impression that the building's skin is made of layers that can be peeled away.

Some structural gymnastics not so readily apparent also help achieve the effect of overlapping layers on Singh's entry elevation. "There are three lines of vertical structure, but none are continuous," says Brian Falconer, a principal at Severud Associates, the project's structural engineer. The facade's setbacks are horizontal trusses suspended from the cantilevered galleria roof by hangers, which look like columns but are in tension. The cantilevered forum, which is the more obvious example of structural bravura, is supported by a pair of inverted trusses that in turn are tied to concrete shear walls.

This skillful integration of form and structure was realized in spite of some rather severe programmatic constraints. One of the more potentially burdensome project requirements was that Edison, which occupied the site's southwest quadrant, remain standing and accessible to researchers until Singh was complete, forcing the project team to plan around the lab even though it was eventually to be demolished. But the new building's placement also needed to take into account electromagnetic interference (EMI), including that caused by its own elevators, and vibration and noise from sources such as traffic and a nearby subway. These

so-called "environmental contaminants" could hamper the operation of Singh's atomic and electron microscopes.

In order to optimally place the new building, consultants documented the sources of EMI and vibration, took measurements on site and analyzed soil conditions. They eventually identified a slightly off-center "sweet spot"—a roughly 50-foot-by-85-foot below-grade zone where the laboratories with the most sensitive equipment should be located. Most vibration waves are at ground level and become smaller below the surface, explains Michael Gendreau, president of Colin Gordon Associates, the project's vibration-isolation specialist. Many of the rooms containing the powerful microscopes still include shielding, but the equipment's reliability has been improved with good placement, adds John Busch, the director of science and research facilities at M+W Group. The firm served as both the project's lab planning consultant and its mechanical engineer.

Although the characterization labs that depend on sophisticated microscopy are by necessity tucked away in the basement, the designers located the 10,000-square-foot clean room front and center. It sits directly adjacent to the entry galleria, separated from the soaring space by an almost 160-foot-long wall of orange laminated glass. The arrangement allows the building's users and visitors to see scientists clad in their protective caps and suits at work, performing a number of tasks, including the fabrication of wafers and chips used in microelectronic devices.

The tint of the glazed wall prevents ultraviolet light, as

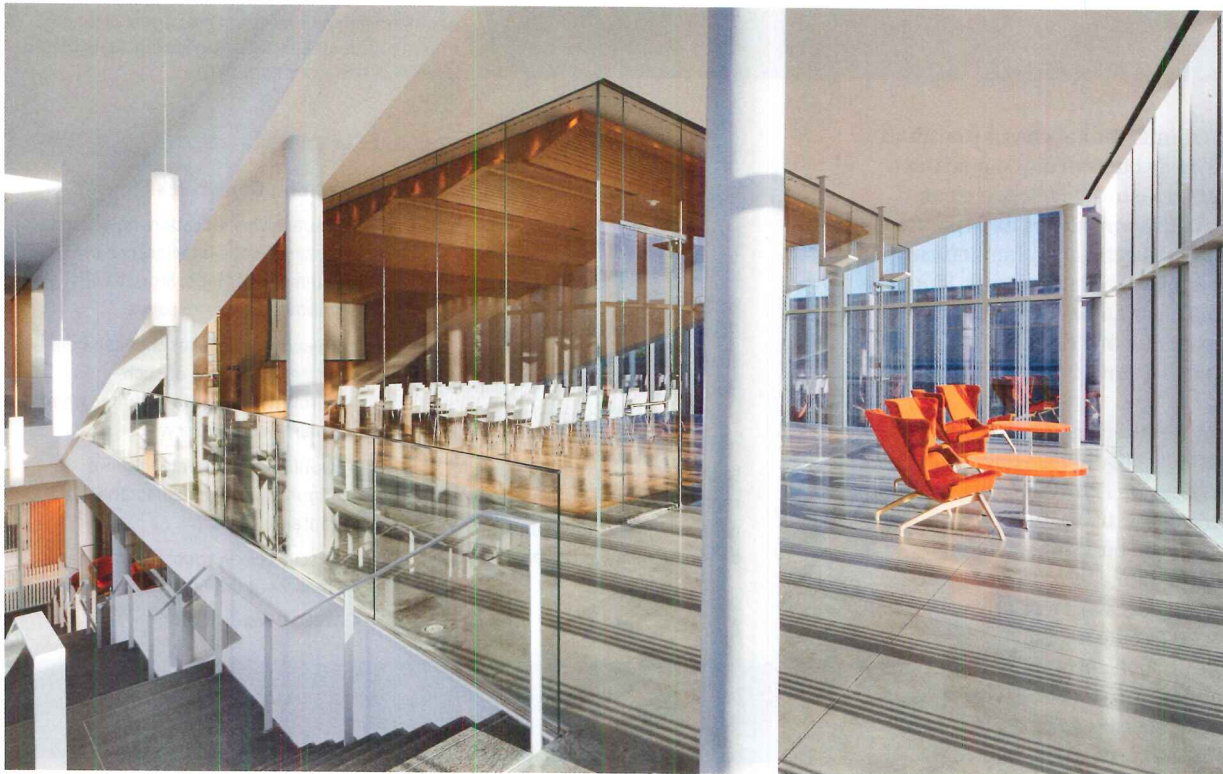
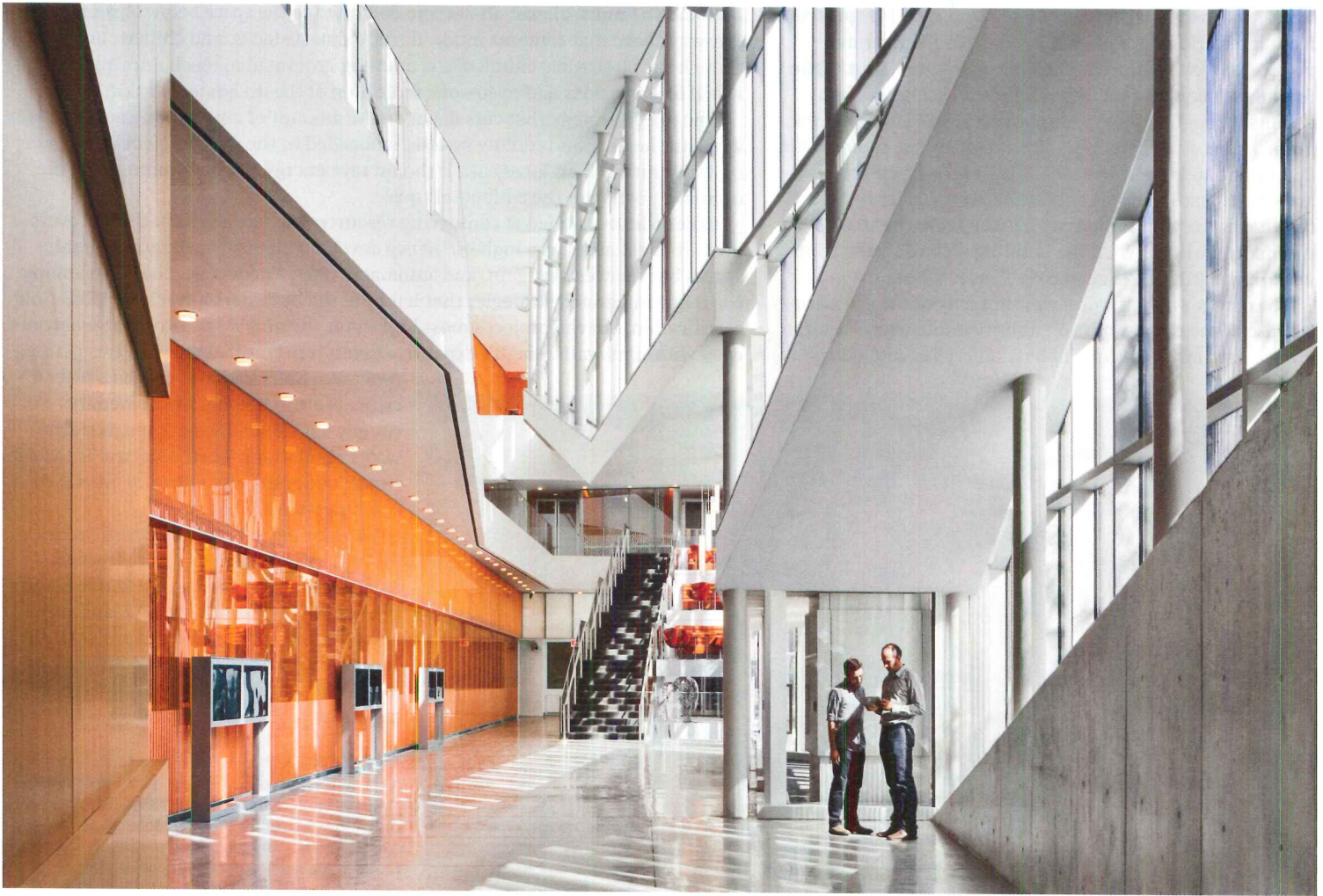

STRUCTURAL GYMNASTICS Singh's cantilever, which contains a forum (left) for a variety of activities including lectures and receptions, is the building's most obvious example of structural bravura. But the entry facade (above), with its three discontinuous lines of vertical structure, required at least as much engineering finesse.

well as some light with wavelengths in the visible spectrum, from interfering with photosensitive nanofabrication processes. Weiss/Manfredi made an opportunity out of the functional requirement by strategically placing saffron accents throughout Singh—in the seating and tables of the grand stair’s study landings, on the conference rooms’ walls and floors, and the upholstery of the two custom-designed armchairs placed in the cantilever’s prow. Under certain conditions the vibrant hue can be seen from the street, especially at night, when the building is illuminated from within. “Luckily, it is a good color,” jokes Weiss.

The orange wall affords a view not only of the scientists, but also of the clean room’s organization into bays (the clean areas where air that is free of dust, microbes, and other

air-handling units, almost all of them dedicated to the space below. A roof areaway above that contains intake ducts, exhaust stacks, and chillers. But even though such a sizeable chunk of the building is devoted to mechanical systems, it still feels spacious and open—one indication of the design team’s skill.

One m/e/p strategy that cuts down on the amount of air-handling equipment is a radiant heating and cooling system, embedded in the galleria floor and relying on water rather than forced air. It should save energy by conditioning only the occupied portion of the 54-foot-tall space.

Other features aimed at conserving resources include a system that recovers heat from exhaust air, a high-efficiency envelope that lets daylight into public spaces but reduces heat gain, and automated lighting controls. These are among the many integrated strategies that have put the building on track for LEED Gold certification. But the project’s most important sustainable feature is arguably not even within its walls. Singh’s expansive green courtyard, along with two planted

roof areas and rainwater cisterns, plays a critical role in helping the university comply with Philadelphia’s tough storm-water regulations. Their objective is to keep runoff out of the city’s already overtaxed combined-sewer system.

The planted courtyard’s significance extends well beyond its environmental benefits, however. At Singh, Manfredi and Weiss have thoroughly melded landscape and building, integrating the project into Penn’s campus, and making it difficult to tell where nature ends and architecture begins. ■

BOXED BOXES The 10,000-square-foot clean room (opposite, both photos) is made up of several chambers known as bays and chases. The orange tint of the glass in the bays’ windows and doors and a 160-foot-long wall separating the clean room from the entry galleria prevents ultraviolet light, as well as some light with wavelengths in the visible spectrum, from interfering with photosensitive nanofabrication processes. One corner of Singh’s entry court is steeply sloped, allowing daylight into a below-grade laboratory (left).

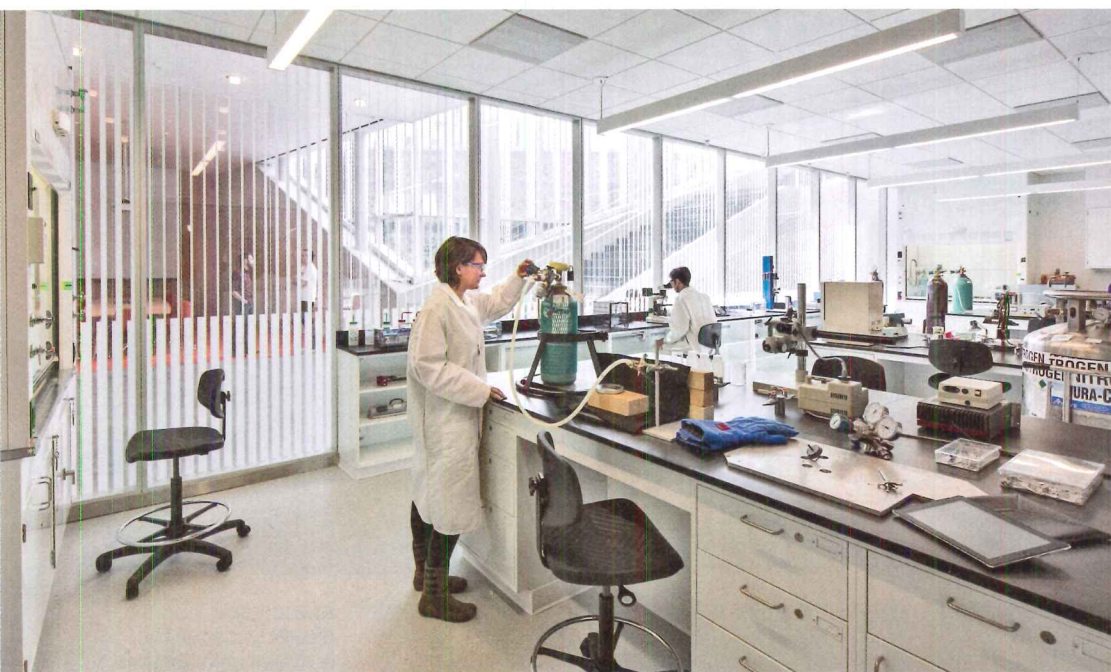

environmental pollutants) and intervening chases (the areas for routing utilities and return-air ducts). This compartmentalized organization, an alternative to a wide-open clean room layout (referred to as a ballroom), allows for separate chambers for various types of research and manufacturing processes that require different levels of cleanliness. Singh has bays rated as class 100 and class 1,000—designations that refer to the number of particles of a certain size permitted in a cubic foot of air. The lower the number, the more highly filtered the air.

In addition to the need for the filtering of particulates, the clean room also has tight humidity and temperature requirements: it is kept at 68 degrees Fahrenheit (plus or minus 2 degrees), with relative humidity between 45 and 50 percent year-round. In contrast, the building’s general laboratory spaces are kept in the range of 70 to 74 degrees Fahrenheit (plus or minus 2 degrees), with a relative humidity that can vary from 20 to 60 percent.

Not surprisingly, maintaining such clean room conditions requires a considerable amount of space for HVAC equipment. Stacked directly above the clean room is a fan deck, roughly the same size and footprint as the clean room, housing



Continuing Education

To earn one AIA learning unit (LU), including one hour of health, safety, and welfare (HSW) credit, read “The Art of Science” and complete the test, at no charge, at architecturalrecord.com. Upon passing the test, you will receive a certificate of completion, and your credit will be automatically reported to the AIA. Additional information regarding credit-reporting and continuing-education requirements can be found online at ce.construction.com.

Learning Objectives

- 1 Explain why vibration, noise, and electromagnetic interference are problematic for laboratories with high-powered microscopes.
- 2 Describe measures that can help mitigate the effects of such “environmental contaminants” when designing a laboratory.
- 3 Outline different clean room configurations and explain the advantages of each.
- 4 Discuss clean room mechanical system requirements.

AIA/CES Course #K1311A

FOR CEU CREDIT, READ “THE ART OF SCIENCE” AND TAKE THE QUIZ AT CE.CONSTRUCTION.COM, OR USE OUR FREE ARCHITECTURAL RECORD CONTINUING-EDUCATION APP, AVAILABLE IN THE ITUNES STORE.





Visions transformed into reality.

Our enhanced online Architect Corner features BIM objects and all the tools you need to specify automatic door systems.

Now more than ever, Horton makes your job just a little bit easier.



hortondoors.com

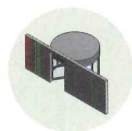

CAD

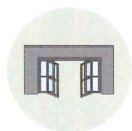

BIM

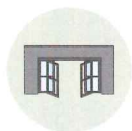

LEED

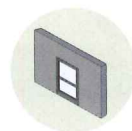

SPECS

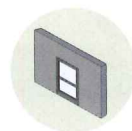

GALLERY



Scan to visit the Architect Corner

MADE IN AMERICA

***"If you can draw it,
we will build it. In steel."***

Dakota Brewer. Dale Brue. Steel Fabricators. "You got to appreciate what you do, and like doing it," Brue says. "Otherwise, what's the purpose? We're tryin' to teach the new guys what we do, and we do it in steel." They lay out beams, holes, cuts, angles and where the plates go on. Fabricate big box beams with three-, four-inch flanges. A 29-ton piece not uncommon. Couldn't even tell you how many tons fabricated since 1976 when Dale started at Zalk Josephs Fabricators. He gets up early. 3 AM. Never been late. Never.

They say compound miters are tough, but they handle them. Steel's forgiving. Weld it up, fill in little gaps. Proud of every one of their jobs. Like Ann & Robert H. Lurie Children's Hospital of Chicago. When the boss sold the project, Zalk came up with an innovative scheme: using cables to support the 14th, 15th and 16th floor. Shaved a couple of months off the duration of the project because of it.

Dakota Brewer. Dale Brue.
Made in America.
Like the steel they fabricate.



There's always a solution in steel.

312.670.2400
www.aisc.org/madeinamerica

CIRCLE 96



What's in a name?

A promise.

“We specialize in custom-made suspended wood ceiling panels, mainly for institutions. The wood has to be clear and beautiful, like **Collins Pacific Albus** hardwood. But for us it also has to come from a company that's the real deal when it comes to forest management. Collins is that company. Walk in their forests like I have and you'll know what I mean. They honestly and transparently, ‘Do the right thing.’”

*Michael Roemen,
Design Solutions Manager 9Wood*

SPECIFY CollinsWood®

Collins Hardwood Lumber

Millwork and dimension, veneer logs

Collins Pacific Albus®

Plantation hardwood lumber

Collins Softwood Lumber

Dimension, common and industrial, slicing flitches

Collins Pine FreeForm®

NAF, CARB Exempt, Declare Product, FSC-certified, and available moisture resistant; MR10, MR50

Collins Pine Particleboard

NAF, CARB Exempt, available moisture resistant

TruWood® Siding & Trim

Engineered wood



Oregon Health & Science University, awarded first LEED health care facility.

Greenbuild 2013 - November 20-22

Philadelphia, PA - Booth #1549



Information and Sales:
800.329.1219
Lee Jimerson ext 2266
ljimerson@collinsco.com

CollinsWood.com **CIRCLE 66**

Collins

The first name in FSC-certified forest products.

AUTOMATES EVERY OCCASION



Show/hide



Rotate



Configure



The chairs can be stored out of sight, fully or partially deployed, and rotated through 360°. The entire process is completely automated.

Rem Koolhaas, the OMA team and Figueras worked hand-in-hand to create a multipurpose auditorium for Milstein Hall at Cornell University. Used primarily as a meeting room for university trustees and as a teaching space, the hall can also be transformed into an open space where a wide range of events can be held.

The Cornell chair, a product that's unique in the world, was created by combining two Figueras systems: Mutasub and the RT System. The result: spacious chairs that can be stored under the floor, deployed as needed, and oriented to the desired position.

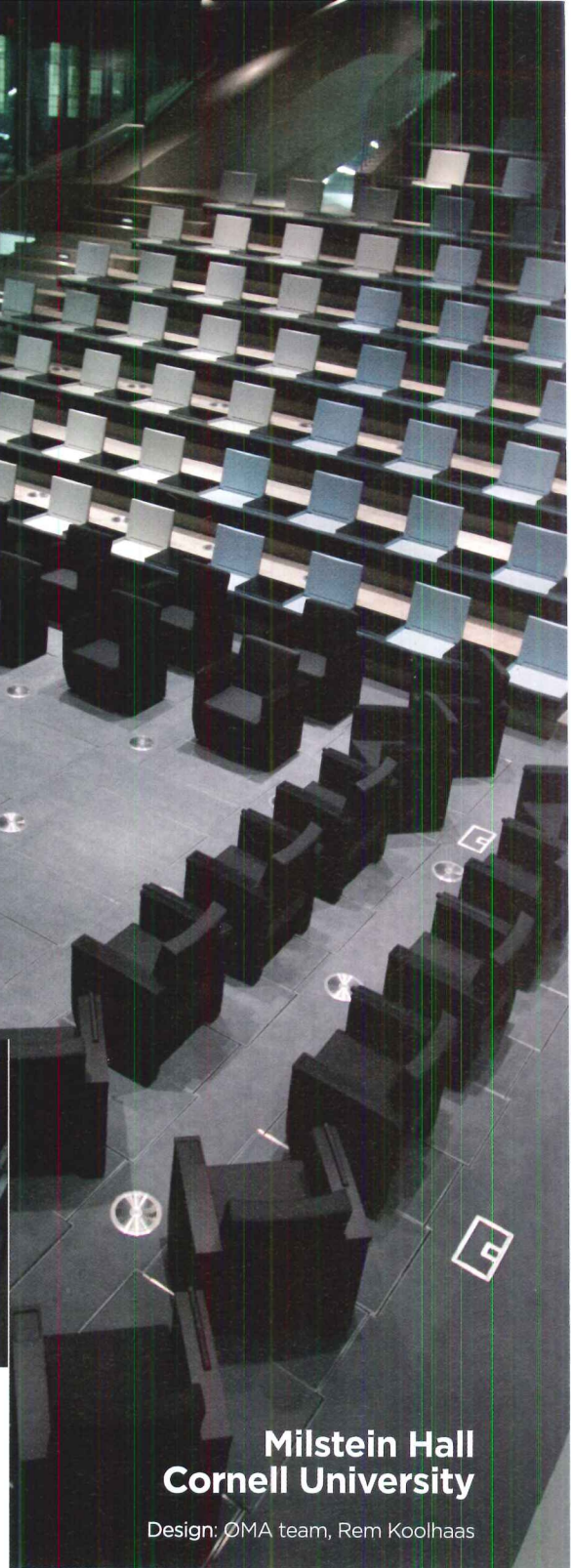

**Milstein Hall
Cornell University**

Design: OMA team, Rem Koolhaas

Figueras International Seating is a global leader in seating for multipurpose halls and public spaces.



Figueras
RT System



TÜVRheinland®
CERT
ISO 9001



TÜVRheinland®
CERT
ISO 14001

CIRCLE 87

 **FIGUERAS**
INTERNATIONAL SEATING

www.figueras-usa.com

Edge-to-Edge & Deck-to-Sky™

Best PVC
Membranes

Custom Prefabricated
Flashings

Duro-Guard®
Insulation

EXCEPTIONAL® Metals
Edge Details
& Accessories

The Industry's Best
Warranties



Duro-Last® is your single-source for complete roofing systems, engineered to provide long-term Edge-to-Edge & Deck-to-Sky™ protection. Installed by authorized contractors, and warranty issued by the industry's largest and best-trained quality assurance team.

 **DURO-LAST®**
THE WORLD'S BEST ROOF®

CONTACT DURO-LAST, INC.
FOR THE "WORLD'S BEST ROOF"®

800-248-0280

www.duro-last.com / Twitter: @durolast

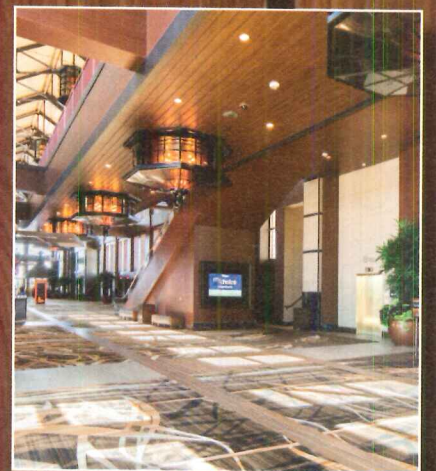
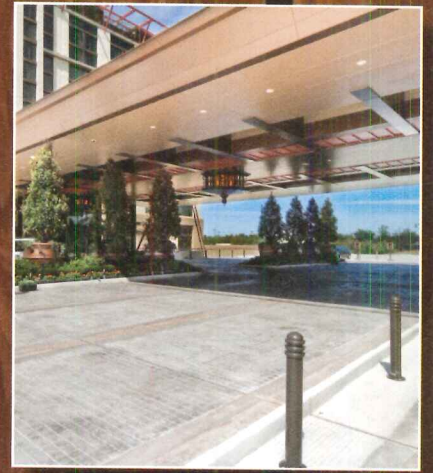
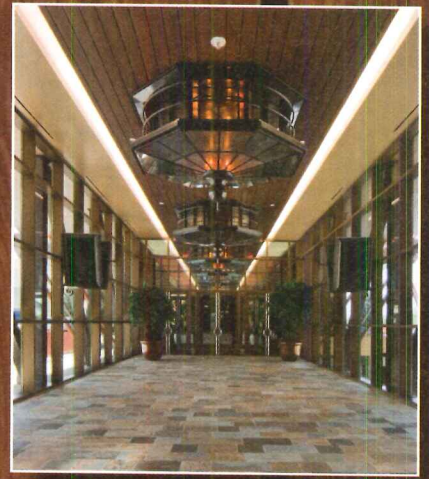

Gordon's Wood and Metal Canopy Ceilings Combine Aesthetics with Performance

Project: L'auberge Casino & Hotel
Baton Rouge, LA

Architect: Marnell Companies, Las Vegas, NV; Manning Architects, New Orleans, LA

Applications: Exterior Metal Canopy Ceilings with Metal and GreenWood™

Finishes; Interior Corrugated GreenWood™ Ceilings

Contributes to LEED®1 Certification

1 LEED is a registered trademark of the USGBC.

CIRCLE 31

GORDON
INCORPORATED



gordon-inc.com
800.747.8954

LED Panels with
uniform light,
edge to edge.

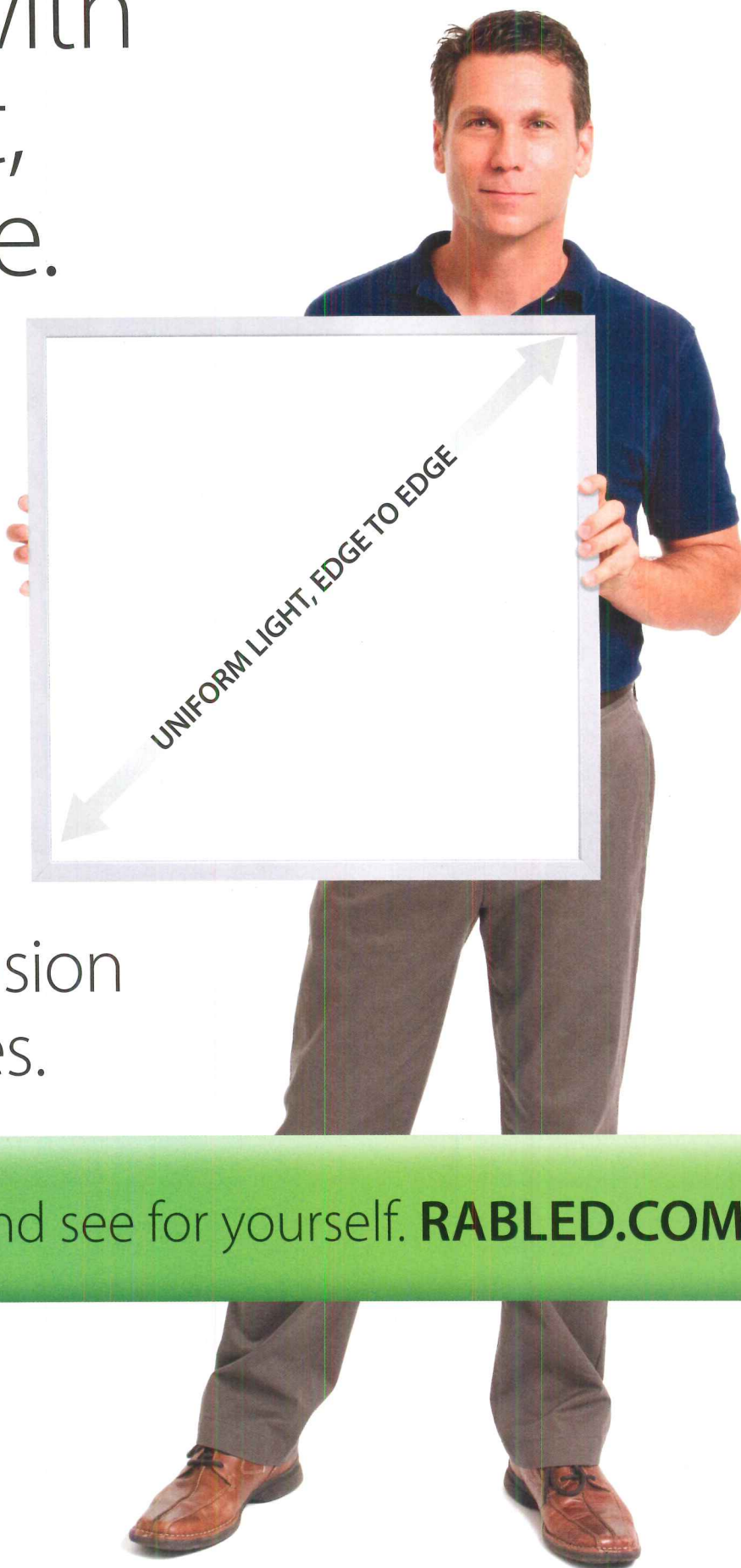

Ultra-smooth diffusion
for evenly lit spaces.

Request a free sample and see for yourself. **RABLED.COM**

RAB[®]
LIGHTING
Designed beyond standards.
Engineered to *perform*.



Food, Wine, & Spirits

Who among us hasn't shunned a restaurant, bar, or specialties shop because the lighting was too bright, too dark—or just lackluster. The designers of the following venues are aware of light's power to attract customers, and each cut to the chase with illuminating schemes that employ LEDs to elevate the ambience, as well as to enhance both the way people look in the space and how they perceive what is being served.

- 158 Hedonism Wines, London
- 160 Saison, San Francisco
- 167 Maysville, New York City

A luminous installation at Hedonism Wines comprises inverted sommelier glasses tipped with LEDs at the base of their stems.

Hedonism Wines

London

Universal Design Studio /
Speirs + Major

By Chris Foges

LONDON'S MAYFAIR district, populated by yacht brokers and art dealers, is a natural home for retailers trading on exclusivity. Hedonism Wines, a vintner with ambitions to be the "best wineshop in the world," is taking a different tack. With single bottles costing as much as \$200,000, many of its 7,000 wines would put a dent in the fattest wallet, but chief executive Tatiana Fokina stresses that the store is aimed equally at ordinary enthusiasts, and prices start at \$20. The design challenge, she explains, was to convey a sense of luxury while welcoming all comers.

From the street, this translates as openness. The corner store occupies the ground and basement floors of a 1950s building. The architecture and interior design firm Universal Design Studio removed dividing walls and fully glazed the two street facades. There are no window displays to impede views inside, where yellow brick walls and reclaimed oak floorboards create a homey, muted backdrop for white wines, champagnes, and spirits.

The lighting, designed by the U.K.-based Speirs + Major, brings to life both the wine and the material palette of pale wood and patinated bronze, amplifying the amber and caramel hues so that the room calls to mind a glass of champagne. The fizz is added by cast-glass pendants, which hang in the space like bubbles, and by an effervescent chandelier over a cast-iron stair leading to the basement. This lustrous installation is formed by 125 mouth-blown sommelier glasses suspended upside down from metal rods of varying lengths. A single LED module at the base of each stem creates a sparkling effect. Lighting designer Keith Bradshaw says that, as with much of Hedonism's feature lighting, this serves to draw the eye away from the ceiling-mounted spotlights that really illuminate the room.

The bones of the scheme reflect principles of good retail. Cross light ensures that customers do not cast shadows over the displays, for example, but the nature of the merchandise adds complexity. Wine must be kept at around 60 degrees Fahrenheit, and conventional incandescent lamps produce a lot of heat, so the lighting team opted for LEDs throughout the store. While previously inconsistent in color and output, LEDs now offer improved control over light quality, says Bradshaw, who

LIGHTING



BOLD & BUBBLY
A fully glazed facade (above) invites passersby to experience Hedonism Wines' glittering effects. Inside the entrance (opposite), a champagne-hued material palette sparkles by the light of delicate, bubblelike glass pendants and the sommelier-glasses "chandelier." The cavelike lower level (left) features a storage unit specially lit to highlight the shop's collection of vintage Château d'Yquem.

used a warm 3,000 Kelvin color temperature, similar to that of halogen lamps, to enhance the vivid labels on the bottles. An exception was made at the tasting table. Here, a cool 4,000 Kelvin, with a higher color rendering, reveals a full range of tones in the wine.

The light is layered: spots provide general illumination, uplights behind freestanding shelves wash the rough brick, and strip lighting integrated into the top of each shelf accentuates the goods. The diverse colors of the wines and bottles required extensive mock-ups to establish the right appearance and avert unwanted reflections.

The lighting designers used the same components to produce a greater contrast between areas of light and shadow downstairs, where a limestone floor, black ceiling, and copper

pendants create a cavelike setting for racks of red wine. They brightened the darkest corner with a glazed cabinet for vintage Château d'Yquem in which the Sauternes are backlit by motion-sensor-controlled LEDs, while individual bottles appear to glow from within due to fiber optic cables concealed in their racks.

At night, the store becomes a vessel for liquid light as 11 synchronized video projectors blanket the interior with an animated tableau intended to intrigue passersby: champagne bubbles play over surfaces, as periodic lighting flashes reveal silhouettes of scudding clouds and flying bats. This quirky, seductive, and subtly spectacular display captures the qualities of a project in which the practical and technical demands of lighting are recast as opportunities for delight. ■



PHOTOGRAPHY: © BRUCE DAMONTE

LIGHTVAULT 8

 **Bluetooth** Wireless Adjustable Aiming & Dimming.
This is Kim Lighting.



<http://www.kimlighting.com/ltv8/>



The **Bluetooth** word mark and logos are registered trademarks owned by Bluetooth SIG, Inc. and any use of such marks by Kim Lighting is under license.



LED MR16 lamps. This system acts as a second ceiling by being physically lower, and creates a contrast between bright light and shadow to keep visitors' attention on one plane, much as a theater's lighting rig does. As Saison's primary source of illumination, the LEDs make the structure above the tracks seem to dissolve into the background. A coat of charcoal paint on the ceiling aids the disappearing act.

If Saison is a performance space, the kitchen is no backstage. To make the room pop against the dark void of the dining area, the designers dropped the ceiling to 12 feet, painted it white, and concealed the HVAC equipment, grease traps, and plumbing above the soffit. They also

brought the cooks into the dining room by lining up refrigerators along tables and pushing a prep station past the soffit's edge. Weaving kitchen functions around the tables gives everyone a view of the action, says Michael Gibson, a New York-based architectural consultant on the project. Without preferential spots like a kitchen bar or chef's table, "there's no hierarchy," he says. And since the prep areas, dining room, and bar are each defined by an overhead steel frame with the same LEDs, there's a spatial balance even as the kitchen's brightness begs for attention.

The lighting turns each table into an island. Waitstaff reconfigure the seating nightly,

WORKFLOW

The designers dropped the ceiling over the kitchen to a height of 12 feet, painted it white, and concealed HVAC, grease traps, and plumbing above the soffit. A narrow concrete loft that houses wine storage and other back-of-house functions recedes from view under a coat of charcoal paint.



based on reservations, and adjust the MR16s to bathe each group in a pool of light. The designers chose full-spectrum LEDs, which render deep reds and violets (hues that have been difficult for manufacturers to perfect) particularly well. “They have a very warm color, and really make the food look fantastic,” says Ho. Each LED is powered by a single chip, which generates a clear, sharp beam. “Wherever you sit, you feel like you’re in your own space within the bigger space,” says Gibson.

In a city where dinner out is a cultural activity, Saison trains its spotlights on the plate and turns eating into a performance. ■

SETTING THE SCENE

Though the bright white kitchen commands attention in the loftlike space (above) the dining tables are also bathed in light to stage a personal experience for guests.

credits

INTERIOR DESIGN: Jiun Ho, principal

CONSULTANTS: Michael Gibson (architectural); Tim Harrison (kitchen)

GENERAL CONTRACTOR: Yanscape Construction

CLIENT: Saison Dining Group – Joshua Skenes, chef

SIZE: 3,712 square feet

COST: withheld

COMPLETION DATE: January 2013

SOURCES

LIGHTING: Soraa (LEDs); Lutron (dimming controls)

APPLIANCES: Molteni (kitchen range)

PAINT: Benjamin Moore

UPHOLSTERY: Maharam



PRODUCER LED

The Superhero of aisle lighting.

10w/ft • 60°/80° Batwing distribution • Replaces Fluorescent

The Producer linear LED makes your grocery section come alive, focusing light on your shelves rather than simply providing general illumination on your aisles.

This new, quality, energy efficient LED delivers crisp white light, providing enhanced clarity, and making it easier for customers to see packaging and read labels. The Producer features consistent LED color, dimming, motion sensing, instant on/off, and energy/maintenance savings.

For more information visit amerlux.com or call us at **973.882.5010**.

10 year limited
warranty
AMERLUX LED

amerlux

CIRCLE 95



Skydro
design Ross Lovegrove

Sparkasse Fulda, Fulda (Germany), 2010
Project: Bredt und Partner
Photo: Linus Lintner

Artemide[®]
design innovation architecture

Contact your local Artemide sales office for more information.
Toll free: 1-877-Art-9111 • contractsales@artemide.net • www.artemide.net

CIRCLE 103

Maysville
 New York City
 Berman Horn Studio

By Linda C. Lentz



MORE THAN 600 miles separate Maysville, Kentucky, from its New York City namesake, a trendy watering hole west of Madison Square Park. Yet the year-old whiskey bar and restaurant evokes the flavor of the old Ohio River port with urbane country fare in a tavernlike setting that celebrates one of the town's first commodities: bourbon.

Maysville owner Sean Josephs opened another homage to the American spirit in Brooklyn five years ago, naming it Char No. 4 for the smokiest level to which oak barrels are charred to age bourbon. Inspired by this process, architects Maria Berman and Bradley Horn, of the New York City-based Berman Horn Studio, suspended large barrel-shaped pendants above the bar (RECORD, August 2009, page 103)—a bold move that helped put the tiny establishment on the map.

Josephs returned to Berman and Horn when he decided to test the waters of the Manhattan dining scene. His new place, in a historic 12-story steel-frame and brick building by Buchman & Fox (circa 1911), is larger. However, the 2,500-square-foot ground-floor space, which had been a wholesale T-shirt shop for years, was devoid of character. It also lacked sufficient daylight for pleasant brunch and lunchtime dining, as the original storefront had been modified and closed off.

BOURBON TRAIL The ceiling matrix (above), designed by the architects, was based on aerial views of Kentucky cornfields. Made of Mylar-backed oiled craft paper on steel frames, the 18-inch-high shades are spaced 4 inches apart to allow for sprinklers and maintenance.

- 1 MAIN DINING ROOM & BAR
- 2 PRIVATE DINING ROOM
- 3 KITCHEN
- 4 OFFICE
- 5 STORAGE



LIGHTING PLAN

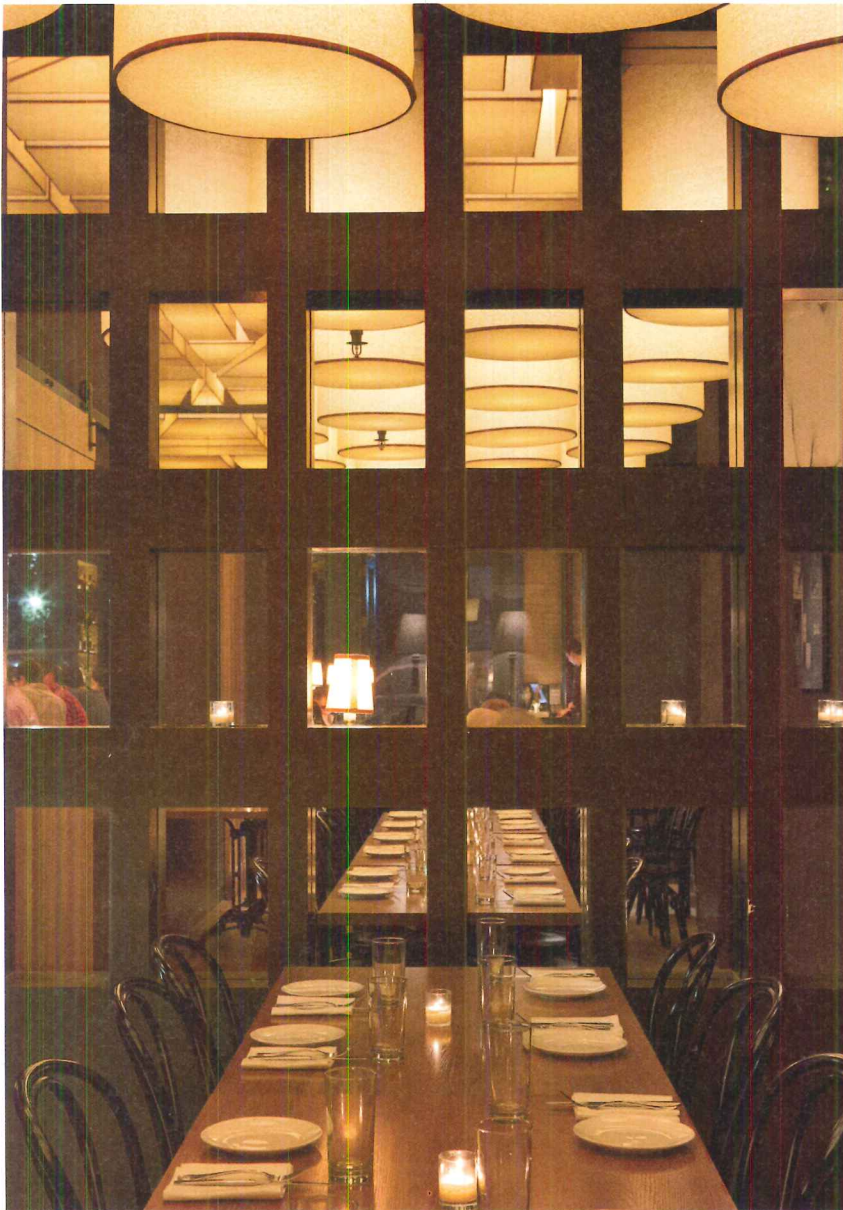

PHOTOGRAPHY: © KRISTINE LARSEN

**LOOK AGAIN**

The private dining area (above) features a wall grid inset with a playful mix of mirrors and windows. These either reflect the barrel shades within the room or provide glimpses of the ceiling grid—and action—in the main dining space next door (right), where a similar peek-a-boo effect is achieved using gilded frames.

The architects worked with the city's Landmarks Preservation Commission, consulting archival photographs to restore the original Neo-Gothic facade. Now generous expanses of glass allow sunlight to stream into the interior and provide views of a landmarked church by Richard Upjohn (circa 1855) across the street. Additionally, the newly installed storefront reveals a convivial dining room wrapped in a rich grass cloth and topped by a luminous ceiling that reflects the firm's evocative approach to lighting.

"We wanted to take what is most successful about Char, which is the beautiful light and ceiling installation," says Berman. Again, bourbon was their muse. But this time the partners developed an overhead lighting system based on the grid formed by the fields of corn used to make the liquor—an idea that came to them on an airplane while looking down at the patterns of Kentucky farmscape below.

Berman and Horn designed ninety steel-framed 18-inch-high shades, in formats drawn from the aerial plan and

made, by a local fabricator, of the same oiled Mylar-backed craft paper they used for the Brooklyn project. Unlike the earlier fixtures, which each house a single incandescent bulb, the new ones conceal dimmable 2,700 Kelvin LED PAR lamps that emit a warm, even glow. For sparkle, the architects perched sconce-like fixtures with traditional candelabra lamps on the banquettes and tucked LED strips under a diffuser along oak shelves behind the bar—a brilliant effect that lets the amber hues of the liquor bottles radiate from their gold-leaf niche.

A treat is in store for anyone observant enough to note the rear wall lined with what look like gilt-framed mirrors. While some do reflect the bar scene out front, others offer peek-a-boo glimpses into the private dining room beyond. Here Berman and Horn recall the origins of their scheme by filling the rustic cork-lined space with replicas of Char No. 4's barrel shades, now lit by LEDs. This quiet yet illuminating gesture, like Maysville, transcends intricacy and state lines. ■

**credits**

ARCHITECT: Berman Horn Studio (BHS) – Maria Berman, Bradley Horn, partners

ENGINEERS: Mottola Rini (m/e/p)

CLIENT: Sean Josephs

CONTRACTOR: Birdrock Construction

CONSULTANTS: Broome Lampshades (fabrication of BHS

ceiling fixtures); O'Lampia Studio (fabrication of BHS sconces)

SIZE: 2,500 square feet

COST: withheld

COMPLETION DATE: November 2012

SOURCES

LIGHTING: Philips (LEDs)

WALLCOVERING: Phillip Jeffries

Lights, Food, Ambiance!

Lighting is the key to ambience in restaurants. Set the mood with Soraa's full visible spectrum LED lamps. Beautiful beams, perfect rendering of colors and whites, full dimming, and high energy efficiency make it the perfect restaurant lighting solution.

Hakkasan Beverly Hills
Interior Design: Gilles & Boissier
Lighting: Firefly Lighting Design

www.soraa.com

CIRCLE 78

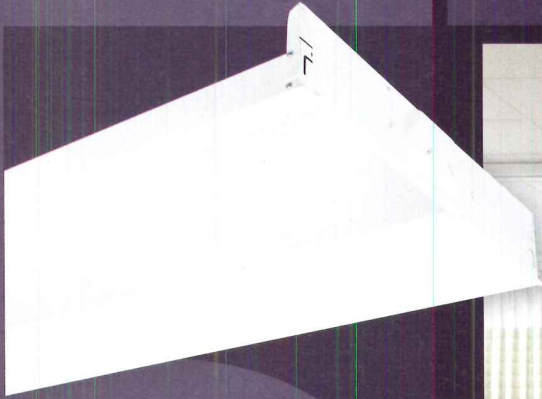

Solid-State Lighting, Excellent Efficacy, Long Life Sustainability.

Columbia Lighting is committed to providing you with energy management products, tools, and energy-efficient lighting solutions. Let us help you reduce energy consumption, lower maintenance costs, and move one step closer to a sustainable future with our growing line of solid-state luminaires.

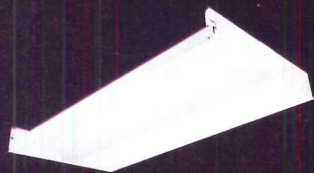

LTRE: Transition® LED Enclosed High Efficiency Architectural Lens

is designed for the flexibility of your needs, the beauty of your design, the health of your occupants and the quality of your installation.

(Featured) LTRE: Transition® LED Enclosed High Efficiency Architectural Lens



LLHP: LED Premium High Bay is a long-life high-efficiency LED high bay that is excellent for demanding applications and meets the most restrictive lighting power density codes.

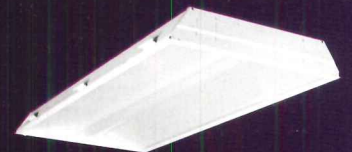

LSER: Serrano® LED Architecturally Styled Luminaire Lens features a modular, upgradeable light engine that delivers a powerful combination of performance and energy savings.



THESE LIGHTING GOODS RANGE FROM LUMINAIRES THAT SHOW OFF MATERIALS AND ENERGY EFFICIENCY TO A LIGHT SOURCE THAT BRINGS OUT VIBRANT COLOR. BY SHEILA KIM

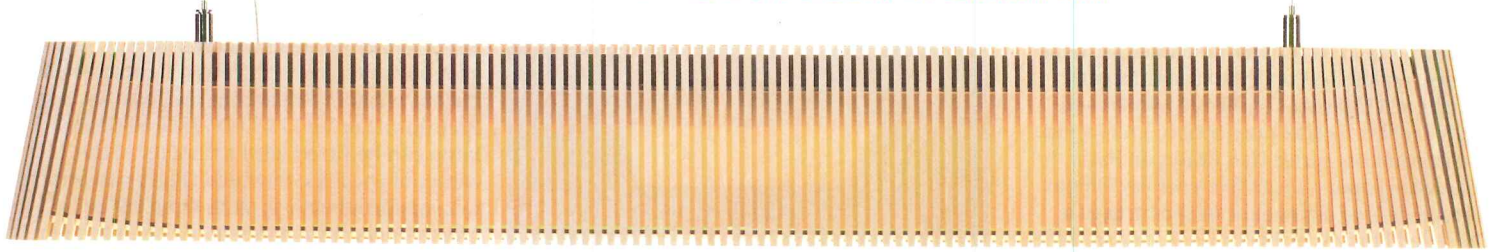

Owalo 7000 Pendant

Finnish architect Seppo Koho draws on his national tree, birch, to design sophisticated wood lamp shades for lighting brand Secto Design Oy. A new offering in the United States, his Owalo 7000 suspension lamp features a slatted oblong form specifiable in natural birch, walnut birch, and black or white laminated birch. The pendant measures 39½" long x 5¼" high x 3½" deep and utilizes LED or fluorescent lamplighting. Available through Global Lighting. globallighting.com CIRCLE 210



Add Pendant

Handcrafted pottery meets lighting design in the Add Pendant from Karboxx. The simple ceramic-vessel shade, which measures 11¾" in diameter and nearly 8" in height, features a hole in the top for slipping the shade over and onto a compact fluorescent lamp. Its interior is white, while the exterior can be specified in a contrasting green, blue, or orange for added punch. The shades are offered in glossy finish (shown) and one matte-clay version. Karboxx lamps are available in the United States through Lepere. karboxx.com CIRCLE 214

XSM Vibrant Series LED Module

Light quality—and not necessarily brighter light—can deeply affect how viewers see color and texture, so Xicato has tuned color gamut areas to create its Vibrant Series, an LED solution that renders cleaner whites, more brilliant reds, pinks, and blues, and greater depth and detail. The 1¾"-diameter module can be used by curators, designers, and retailers to highlight particular displays without affecting the color temperature of the surrounding space.

xicato.com CIRCLE 213



StaxMax LED Flood Light

If three heads are better than one, MaxLite's StaxMax LED Flood Light (above) makes an ideal outdoor luminaire. Its chassis holds one, two, or three 135-watt modules, which can be angled independently of each other for multidirectional illumination from a single mounting point. The fixture is constructed of gray powdercoated die-cast aluminum (which acts as a heat sink), stainless-steel components, and a tempered glass lens. maxlite.com CIRCLE 211

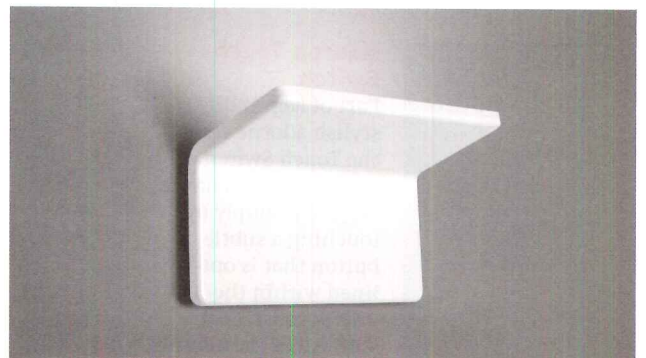

Cuma LED

Designed by Roberto Paoli for Artemide, Cuma is an elegant sculptural form that resembles a folded page against the wall. Composed of two joined planes of die-cast, white-painted polished aluminum, the sconce comes in three sizes: 4" wide x 5" deep x 5¾" high; 7¾" wide x 5½" deep x 5¾" high; and 10¼" wide x 6" deep x 6½" high. The latest version, Cuma LED, is offered in the 4"- and 7¾"-wide versions.

artemide.us CIRCLE 212

products **lighting****Two Pendant**

Durable and easy to clean, 3form's Varia Ecoresin is a logical material choice for lamp shades, which is what led to the company's launch of a lighting division—LightArt—in 2008. LightArt's latest collection, LA2 (right), is a minimalist series that draws on basic geometry. Among LA2's five enclosed-shape fixtures is Two, a pendant in the form of a flattened box. Available in six standard colors, the dimmable LED fixture comes in three sizes—22", 30", or 48" square. 3-form.com CIRCLE 215

**Round 4 I/D**

An indirect-direct LED suspension lamp, Round 4 I/D from Peerless (above) can provide additional energy savings through optional features such as an integrated sensor for daylight dimming and occupancy detection. The die-cast aluminum luminaire—also available with a white finish—comes in 4' or 8' sections, and the cylindrical units can be combined and squared off with L-shaped corner pieces (shown) to create continuous installations. acuitybrands.com CIRCLE 220

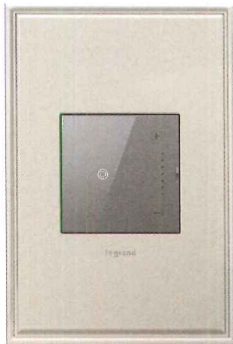
**Adorne Touch Switch**

Part of Legrand's stylish adorne series, the Touch Switch is activated, as its name suggests, simply by touching a subtle button that is outlined within the unit's translucent face. All of the adorne switches are square

pieces that attach onto existing electrical boxes for quick installation, and can be paired with a selection of sleek, flush wall plates that are available in 32 finishes including colors from a neutral antique nickel (shown) to a bold cherry red, natural woods, leather textures, and cast metals. Additional options include a nightlight feature and touch dimmer.

legrand.us CIRCLE 219

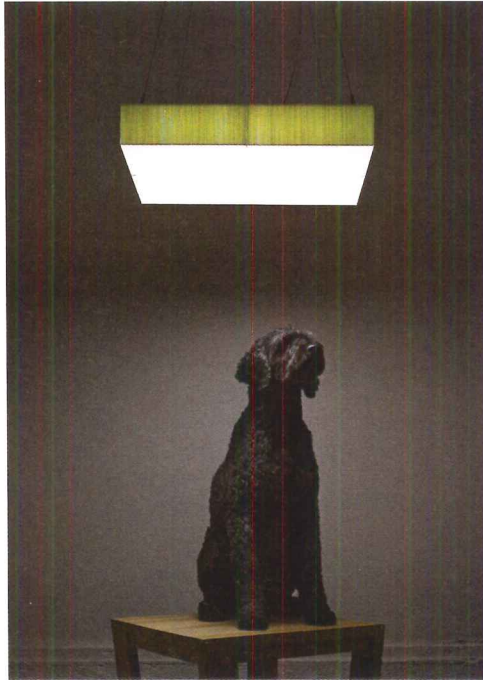
**Snap System**

A magnetic attachment system, Snap from Soraa (below) enables users to swiftly swap accessories to create different lighting configurations without impacting the fixtures. Soraa's Premium 2 or Vivid 2 LED MR16 10-degree lamp can be fitted with a magnet at the center of the lens, to which filters can attach to transform beam spreads from 25° to 60°, create linear light patterns, or change color temperatures and tints. sora.com CIRCLE 216

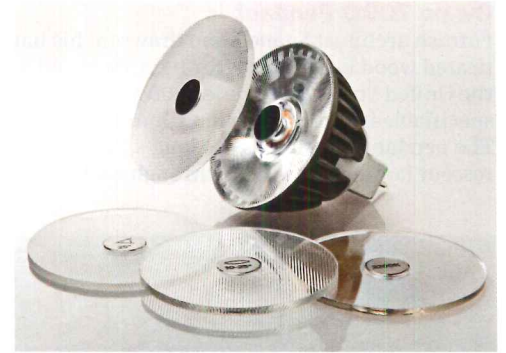
**Monocle Wall Sconce**

Industrial design studio Rich Brilliant Willing likens its Monocle Wall Sconce (left) to an eye that casts a warm beam on wherever it is focused. To direct light, users can both pivot the head and rotate the bracket along the surface-mounted base. The LED-powered, disc-shaped fixture, which can also be used as a ceiling lamp, is constructed of aluminum with a frosted acrylic diffuser that is offered as a dome (shown) or flat lens. The unit measures 5¼" in diameter by 4" deep. An optional cord and plug kit is available. richbrilliantwilling.com CIRCLE 217

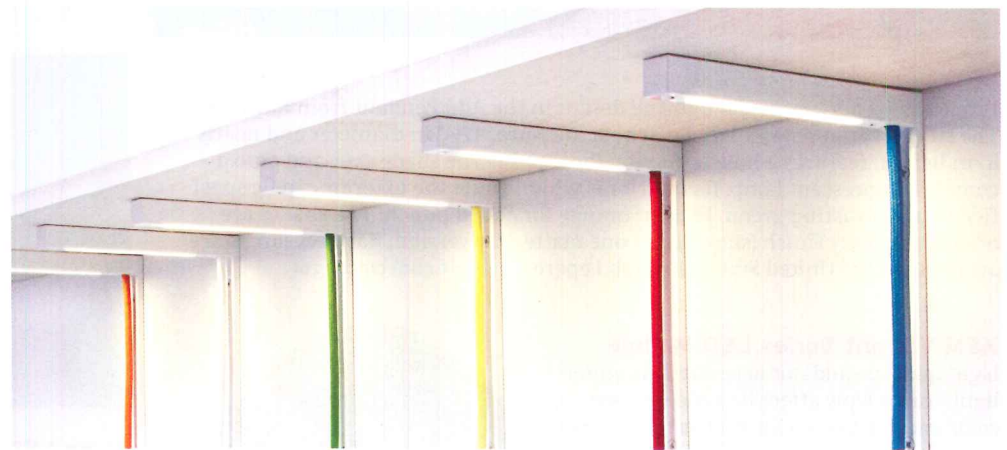
**Lightbracket**

Brooklyn, New York-based AlexAllen Studio conceived Lightbracket as a dual-purpose fixture that illuminates while supporting a shelf. The light consists of an L-shaped powdercoated steel piece enclosing a linear LED strip. The colorful cord—available in orange, white, green, yellow, red, blue, purple, and black—becomes part of the fixture's design, and spans 10' in length. A similar wall-sconce version is also available. The bracket can be alternatively finished in blackened steel or brass, and the cords in custom colors. alexallenstudio.com CIRCLE 218

LARGENT™

Advanced LED Technology
for outdoor lighting

MICROCORE™



CIRCLE 42

The Challenge:

Reduce energy consumption
while maintaining illumination quality.

The Solution:

LITESPANLED®



before
50W MR16 Halogen



after
6W LITESPANLED® MR16 27K



before
150W High Pressure
Sodium Lamps



after
45W LITESPANLED® Post-Top
Replacement Lamps



EiKO Ltd's extensive line of LitespanLED® Fixtures and Replacement Lamps are innovative and practical LED lighting options that feature superior lumen-per-watt efficacy, extended lifetime, precision optics and unrivaled thermal control.



watch



like



follow



23220 W. 84TH STREET, SHAWNEE, KS 66227
1.800.852.2217 • F: 1.800.492.8975

www.eiko.com





SPECIFY CREE LED LIGHTING

innovative LED Light.

Cree's cutting-edge interior and exterior LED luminaires are the perfect way to enhance the learning experience inside the classroom and improve visibility outside for additional campus security. These innovative LED solutions also cut energy use and improve sustainability in a wide range of applications, including new construction and retrofit projects. With a complete line of cost-efficient LED solutions and a vast number of design options, Cree has LED lighting that fits your campus - no matter what your budget or style.

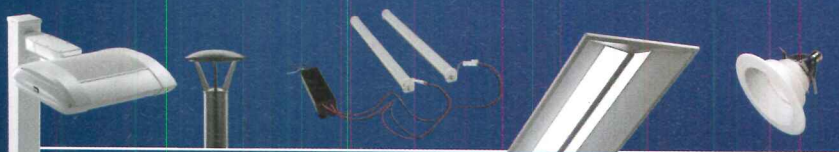

AREA | PARKING | UPGRADE KITS | TROFFERS | DOWNLIGHTS

Cree offers a complete line of high-performance, high-efficiency LED lighting solutions, all backed by our industry-leading warranties.



Visit cree.com/lighting/education to view our LED lighting portfolio.

CIRCLE 65

Stunning Leather Door Pulls!

Simply Stunning!

This is how to have a strikingly elegant door handle! Satin Nickel rod is covered with top quality leather for a really good feeling and grip.

DH401 and DH402 are both 15 3/4" long and project 2 3/8".

Only difference is DH401 is slimmer with 3/4" diameter rod, DH 402 larger at nearly 1" diameter, 31/32".

Available back-to-back as a custom order, please call.

Finishes: Satin Nickel rod, Black, Chestnut Brown or Chocolate Brown leather.



DH401-17S-91H

Satin Nickel with Chocolate Brown leather



DH402-17S-90

Satin Nickel with Black leather

"FINE ARCHITECTURAL HARDWARE FOR YOUR FINE FURNITURE"®

MOCKETT
DOUG MOCKETT & COMPANY, INC.

www.mockett.com • 800-523-1269

CIRCLE 64



BOSTON
ARCHITECTURAL
COLLEGE

Architecture
Interior Design
Landscape Architecture
Design Studies

STUDY IN BOSTON ONSITE AND ONLINE

Architecture and Interior Design programs ranked among top in nation by *DesignIntelligence*.

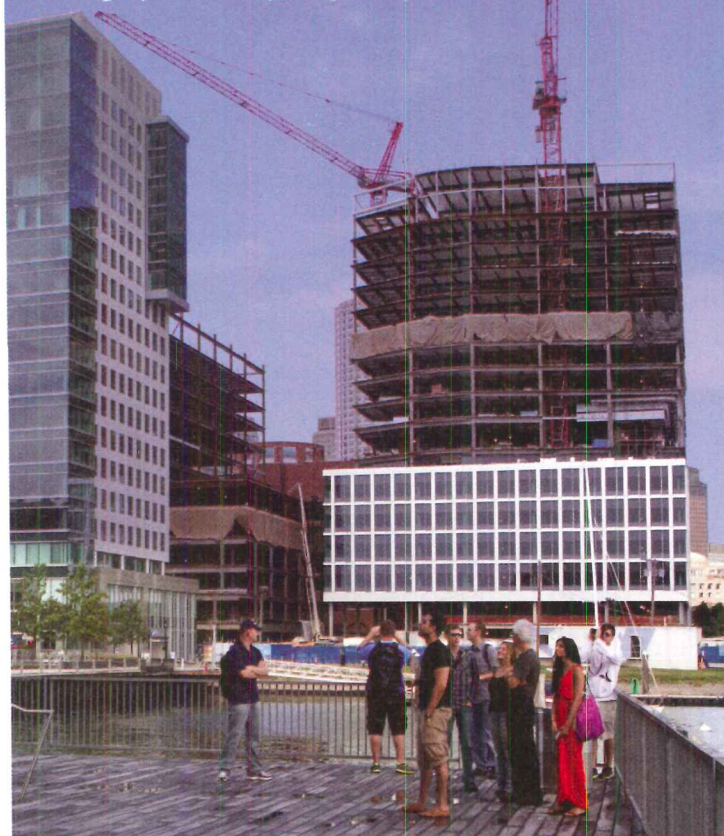

BOSTON ARCHITECTURAL COLLEGE PROGRAMS

ONSITE DEGREE PROGRAMS

- Bachelor and Master of Architecture
- Bachelor and Master of Interior Design
- Bachelor and Master of Landscape Architecture
- Bachelor of Design Studies
- Bachelor of Design Studies—Master of Architecture

LOW-RESIDENCY ONLINE GRADUATE DEGREE PROGRAMS

- Master of Architecture
- Master of Design Studies in Historic Preservation
- Master of Design Studies in Sustainable Design

PROFESSIONAL & CONTINUING EDUCATION

Continuing education credits available

- Online and Onsite Certificates and Courses

THE-BAC.EDU

CIRCLE 69

Loomis

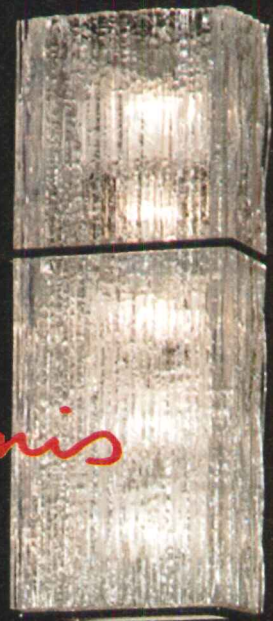

PALISADE S15 LED
PIA '11 Platinum Award

CHARLES LOOMIS, INC.
www.charlesloomis.com
800.755.0471

CIRCLE 38



Woven Wire Fabric

Project: Flour Restaurant, Moreland Hills, Ohio
Photographer: Kevin G. Reeves
Architect: Kordalski Architects Inc.
www.KordalskiArchitects.com

Cascade Coil Drapery's flexible round weave woven wire fabrics are catching the eyes of today's designers. With its versatility, unique texture, variety of colors, flexibility and durability; Cascade Coil Drapery is a long term solution for today's modern style. Besides being durable, fireproof, and virtually maintenance-free, the material diffuses and enhances lighting without blocking views or ventilation. Save energy by reducing heat loss and gain using Cascade Coil's woven wire fabric for interior and exterior window applications. For over 25 years, Cascade Coil has offered round weave woven wire fabrics that have fueled the imagination of architects, designers and other creative people in the design community. Cascade Coil proudly manufactures their products in the USA and distributes them globally.



www.cascadecoil.com | 800-999-2645

CIRCLE 13

Solid Statement.™

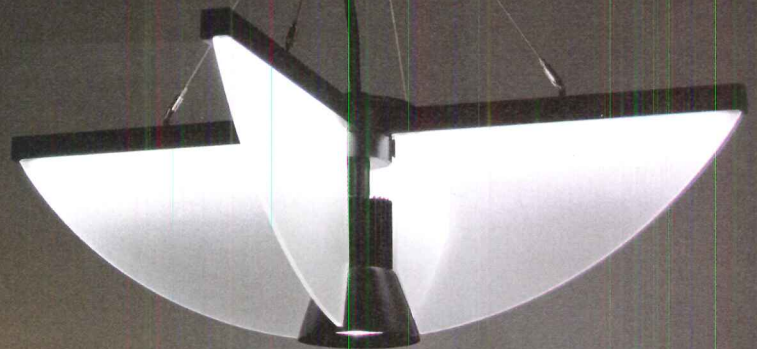

LED lighting with dimensional appeal. Low glare, diode-driven luminaires with precisely engineered performance optical components.

See more at digitalspeck.com.

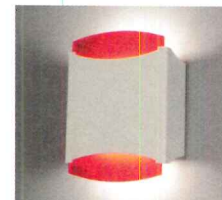
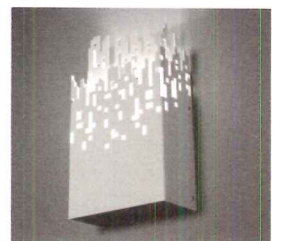
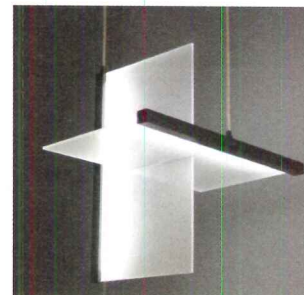
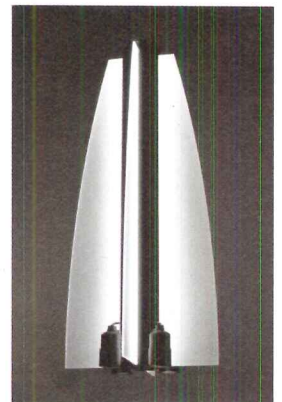

CIRCLE 53

See us at **Lightfair Booth #612**

 **DigitalSpeck™** Lighting
by Manning

©2013 Manning Lighting, Inc. | Sheboygan, Wis. USA

Sustainable Solutions

LINCOLN CENTER BARCLAY CAPITAL GROVE

GROWING AN URBAN FOREST ON A GARAGE ROOFTOP

Nearly five years ago, a bosque of London plane trees was planted on top of an underground parking garage at New York City's Lincoln Center. The design called for a leafy, park-like concert and gathering space; the challenge was to incorporate large trees in tight urban conditions. DeepRoot Silva Cells were used to provide the trees with substantial volumes of soil to create an intensive green roof. Utilities were integrated into the system, and custom metal decks allow lighting below the gravel paving to shine through. Today, the trees at the Barclay Capital Grove are thriving, and the site is a city-wide attraction. To learn more about sustainable solutions, visit <http://bit.ly/18LChbA> to take the DeepRoot Continuing Education course.

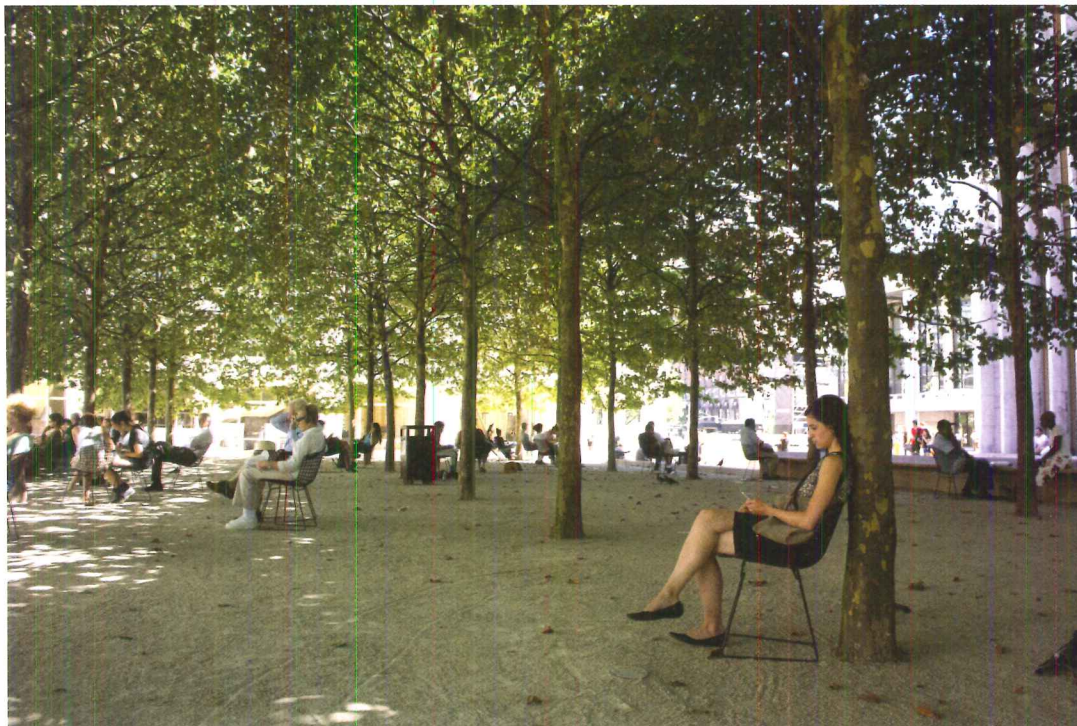

DESIGNERS

- Diller Scofidio + Renfro
- FXFOWLE
- Urban Trees + Soils

OWNER

- Lincoln Center

CONTRACTOR

- Kelco Landscaping
- Turner Construction

PRODUCTS USED

- Silva Cell modular suspended pavement system

PERFORMANCE DATA

- Over 450 cubic feet of soil per tree
- 30 London plane trees
- 970 Silva Cells

OTHER SILVA CELL PROJECTS

- Yankee Stadium (Heritage Field)
- August Wilson Center
- UC-Berkeley Haas School of Business
- Vancouver Olympic Village



www.deeproot.com

Sustainable Solutions

PRUDENTIAL LIGHTING

NORTH FACE HEADQUARTERS, ALAMEDA, CALIFORNIA

The new North Face headquarters is the embodiment of the company's ethos, passion, and commitment to the outdoors. "We wanted lighting to be minimal with little or no ornamentation while accommodating several lighting needs," said the project's design principal, David Galullo. "The Strand was an easy fit into our LEED objectives, our very tight construction budget, and it is appropriate to the design." Prudential's P43, a 4-inch-wide recessed, crisp, sleek linear fixture, is also featured in the design.

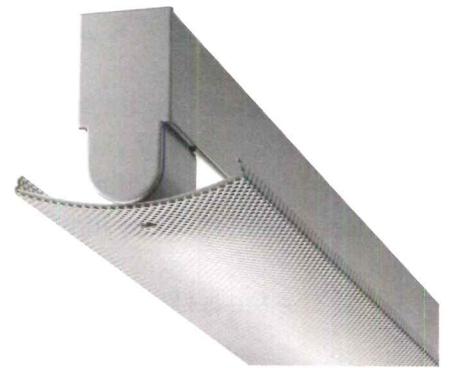
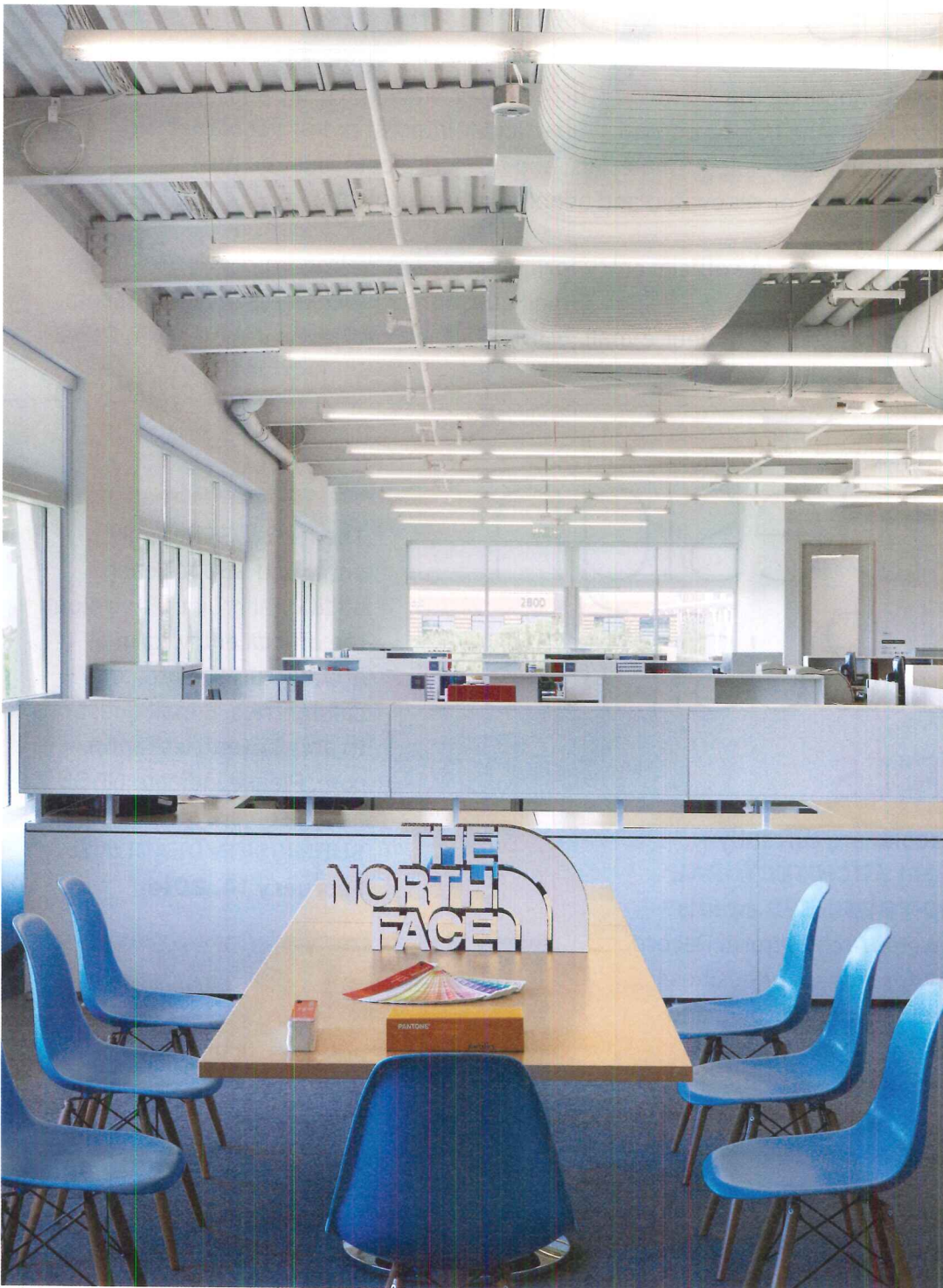

Guided by the explicit goals to create a work environment mirroring the company's dedication to outdoor preservation and environmental responsibility, Rapt Studio created a modern, clean, crisp aesthetic space. The project had strict LEED Gold standards so Rapt Studio selected Prudential Ltg.'s minimalist wrap, the Strand.

ARCHITECT/CONTRACTOR

- Rapt Studio

PRODUCTS USED

- Strand with symmetric perforated fascia
- P43 recessed linear

PERFORMANCE DATA

The project received a LEED Gold designation. Situated on VF Outdoor Campus headquarters' 14-acre campus along with JanSport and Lucy, the campus generates 100 percent of its anticipated electricity needs via wind turbines and solar panels and features electric car charging stations. Rapt Studio designed all 160,000 square feet of the campus's interior space.

PRUDENTIAL LTG.

www.prulite.com



2014 CALL FOR ENTRIES Record Houses

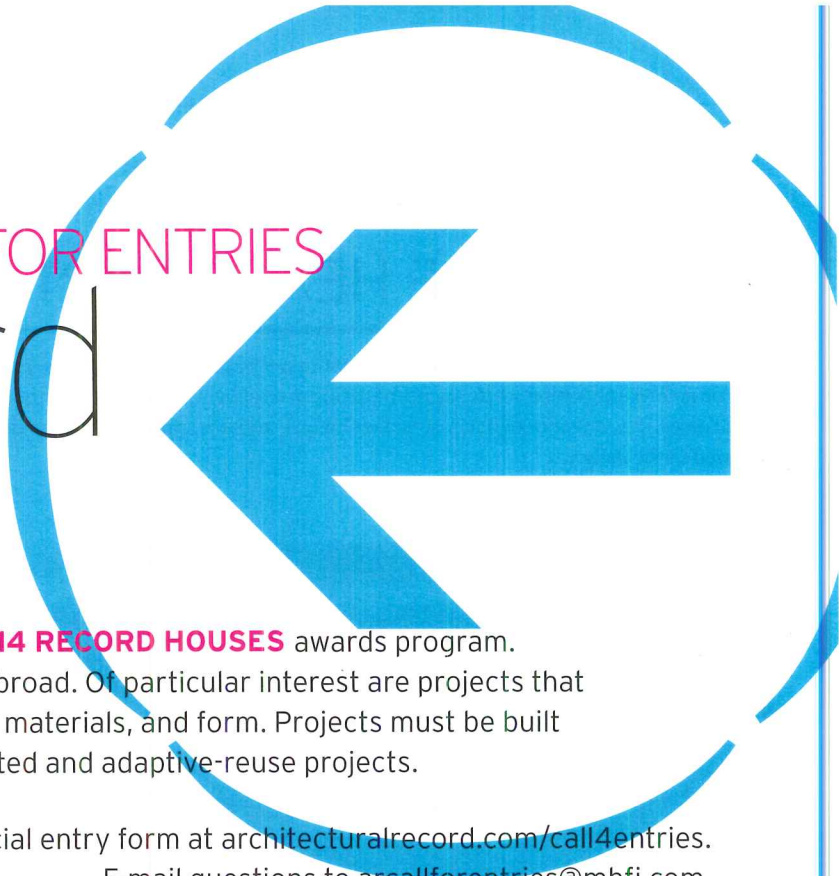

The editors of **ARCHITECTURAL RECORD** announce the **2014 RECORD HOUSES** awards program. Entry is open to any architect registered in the U.S. or abroad. Of particular interest are projects that incorporate innovation in program, building technology, materials, and form. Projects must be built and inhabited. They may be new construction or renovated and adaptive-reuse projects.

The fee is US\$75 per submission. Download the official entry form at architecturalrecord.com/call4entries.

E-mail questions to arcallforentries@mhfi.com.

Please indicate **Record Houses** as the subject of your e-mail. **SUBMISSION DEADLINE: JANUARY 7, 2014**

Good Design Is Good Business

CALL FOR ENTRIES

The editors of **ARCHITECTURAL RECORD** are currently accepting submissions for the **2014 ARCHITECTURAL RECORD GOOD DESIGN IS GOOD BUSINESS** awards program (formerly the BusinessWeek/Architectural Record Awards). **Good design** is a priority for leaders of business and industry looking to boost productivity, rebrand, and attract customers. The Good Design Is Good Business awards honor architects and clients who best utilize design to achieve such strategic objectives. Winners will be published in the June 2014 issue.

The fee is US\$150 per entry and \$50 for each additional project. Download the official entry form at architecturalrecord.com/call4entries. E-mail questions to arcallforentries@mhfi.com. Please indicate **GDGB** as the subject of your e-mail. **SUBMISSION DEADLINE: February 14, 2014.**



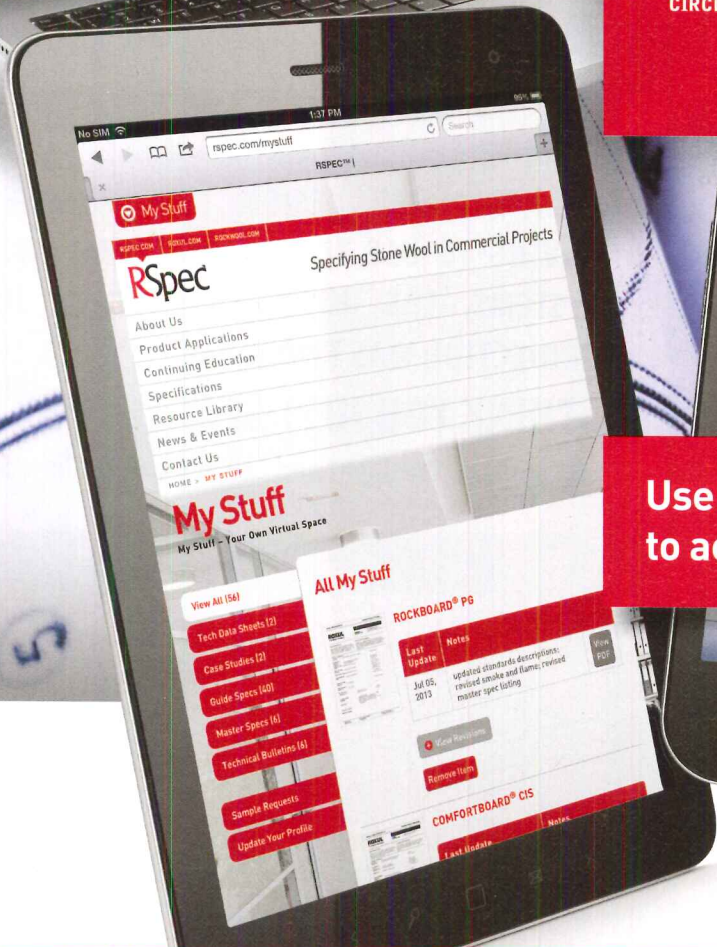
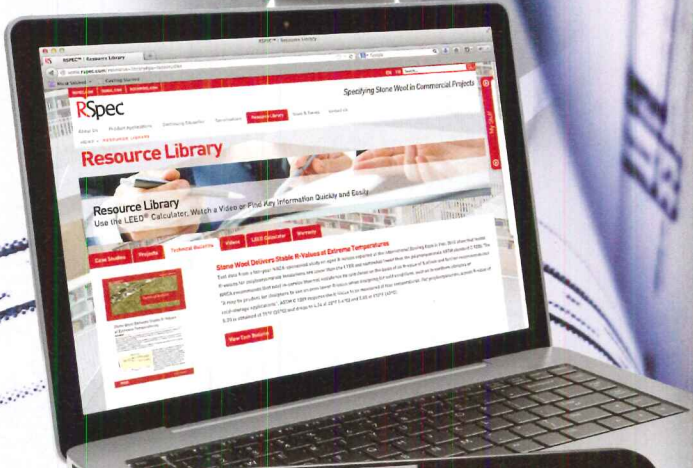

RSpec™ By ROXUL® The Better Insulation™

Specifying Stone Wool just got Easier. Register for My Stuff to Customize your Portfolio.

- ✓ Collect Available Documents from around the site
- ✓ Customize Your Own Virtual Portfolio
- ✓ Technical Data Sheets Automatically Archived and Updated
- ✓ Receive Information Tailored to your Needs

www.rspec.com

CIRCLE 2



Use RSpec™ on your mobile devices to access information on the go!





WITH INSPIRE WALL, WE HAVE BEEN ABLE TO MAINTAIN THE DESIGN TEMPERATURE WITHOUT HAVING TO USE THE NATURAL GAS FIRED BACKUP SYSTEMS. THE INITIAL RETURN ON INVESTMENT PROJECTION WAS TWO YEARS.

I THINK YOU JUST BEAT THAT BY A MILE.

- Craig Cigas, President and CEO of Cigas Machine Shop, Inc.



Find out what all the hype is about at inspirewall.atas.com

ATAS International, Inc.

www.atas.com | 800.468.1441 | Allentown, PA | Mesa, AZ | Maryville, TN

ELIMINATE WATER PENETRATION



Cracks, joint failure and ineffective waterproofing in foundations subject to hydrostatic pressure are major problems that result in leaking and concrete deterioration. Whether for new construction or structural rehabilitation, Xypex Crystalline Technology is a permanent and cost effective solution. Worldwide, in both shallow and deep foundations, Xypex has proven to be highly successful in preventing infiltration even under extreme hydrostatic pressure.

Find a distributor in your region.
www.xypex.com

XYPEX®

CIRCLE 14

LIBRARY.

Introducing the Architectural Record CEU App. The only app that allows you to fulfill credits and track your progress without Internet access.

ARCHITECTURAL RECORD Continuing Education Center

Sculpting the Skyline

FROM ARCHITECTURAL RECORD

By Joann Gonchar, AIA

The article explores the architectural concepts and structural strategies behind Kuwait City's tallest building and discusses the construction methods used to build it.

LEARNING OBJECTIVES

- 1 Explain how evaluation of programmatic requirements and environmental conditions helped designers generate the form of Kuwait City's Al Hamra Firdous Tower.
- 2 Describe the key structural elements of the tower and its foundations.
- 3 Explain the structural and construction challenges presented by the tower's geometry.
- 4 Describe how construction methods were adapted for the harsh desert environment.

Credits: 1.00 HSW

SAVE FOR LATER

TAKE TEST NOW

HOME



COURSE LIBRARY

CREDIT TRACKER

REQUIREMENTS

Download free at iTunes. Sponsored by  **Armstrong**

CEILING & WALL SYSTEMS



CONTINUING EDUCATION

CONTINUING EDUCATION

In this section, you'll find nine compelling courses highlighting creative solutions for tomorrow's buildings—brought to you by industry leaders. Read the courses and then go to our Online Continuing Education Center at archrecord.com to take the tests free of charge to earn AIA/CES Learning Units (LUs).



p.186

Daylight Autonomy 101

Sponsored by Lutron Electronics Co., Inc.

Photo courtesy of Coscia Moos Architecture

EM PM SU

CREDIT: 1 HSW, 1 GBCI HOUR



p.199

Anodized Aluminum for Architectural Applications

Sponsored by Lorin Industries

BE PM SU

CREDIT: 1 HSW



p.213

Paving the Way for Long-Term Stormwater Management

Sponsored by Oldcastle Building Products

PM ST SU

CREDIT: 1 HSW, 1 GBCI HOUR



p.190

Class Glass

Sponsored by Hawa

PM ST SU

CREDIT: 1 HSW, 1 GBCI HOUR

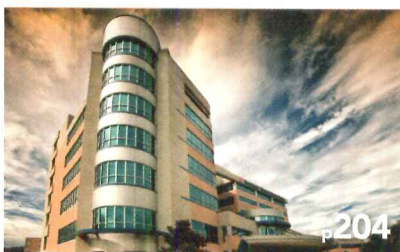

p.204

EIFS – Performance Beyond Code Compliance

Sponsored by Dryvit Systems, Inc.

BE LS PM SU

CREDIT: 1 HSW, 1 GBCI HOUR



p.218

Designed, Sealed, Delivered—IAQ and the Building Enclosure

Sponsored by UL Environment

BE LS PM SU

CREDIT: 1 HSW, 1 GBCI HOUR



p.194

Dynamic Solar Control with Electrochromic Glazing

Sponsored by SAGE Electrochromics, Inc.

BE PM SU

CREDIT: 1 HSW, 1 GBCI HOUR



p.208

Fiberglass Door Systems

Sponsored by Chase Doors

IN PM RR

CREDIT: 1 HSW



p.222

Controlling Sound Transmission in Multifamily, Healthcare, and Educational Environments

Sponsored by ECOSilence

AC PM IN

CREDIT: 1 HSW

CATEGORIES

- AC ACOUSTICS EM ELECTRICAL AND MECHANICAL LS LIFE SAFETY AND CODES RR RENOVATION AND RESTORATION SU SUSTAINABILITY
 BE BUILDING ENVELOPE DESIGN IN INTERIORS PM PRODUCTS AND MATERIALS ST STRUCTURAL

Daylight Autonomy 101

Specifying useful daylight deeper into the interior

Sponsored by Lutron Electronics Co., Inc. | By Jeanette Fitzgerald Pitts

Throughout history, daylight has been considered in the design of the built environment, although the philosophy of its use and the objective of its presence have changed dramatically over the years. Before electric light was invented, in the late 19th century, daylight was the primary light source available to illuminate the interior of buildings, schools, and residences. The houses of Ancient Rome were commonly found to have been planned around a courtyard, with surrounding rooms positioned so that the available daylight could penetrate deeper in the interior space. A guiding principle of the design of Michelangelo's iconic Laurentian Library, built around 1550, was to maximize the presence of daylight from both the northern and southern exposures in the reading room. In the mid-1800s, the one-room schoolhouses that dotted the United States from New England through the prairie and into the western frontier relied on large windows to provide the teacher and students with enough light for their lessons.

Almost 100 years after the invention of electric light, and, subsequently, after fluorescent lighting became more widely used, the philosophy of daylight's role in the interior changed quite dramatically. Instead of relying on large windows and daylight as the primary source of light, the mid-1960s and 1970s saw schools that were designed with few and no windows, citing significant energy losses from windows. The views to the outdoors were even considered a distraction for the students, indicating that a windowless room may be thought to actually improve student performance.

Today, the attitudes toward daylight seem to have come full circle. Study after study has quantified the benefit of daylight exposure to employees and students alike. Daylight exposure has been linked to improved employee productivity, student performance, and even the regulation of a person's circadian rhythm, which drives the all-important wake/sleep cycle. Daylight exposure is considered such a benefit to building occupants that the preeminent green building rating system in the United States, the Leadership in Energy and Environmental Design (LEED®) green building rating system contains credits that are specifically awarded for the project's incorporation of daylight and outdoor views.

Beyond improving the human experience, effectively incorporating daylight in the interior, or daylighting, can dramatically improve the operational performance of the building and create energy savings. In 1997, the Illuminating Engineering Society of North America (IESNA) published a guide entitled *Daylighting Design: Smart and Simple* in which it posited that a building with a 25 percent window-to-wall ratio could realize a lighting energy savings of roughly 30 percent by reducing electric light levels when sufficient daylight levels were available.

Both daylighting know-how and technology have dramatically improved over the past decade, advancing the role and the potential benefits that daylight can now deliver to the built environment. Daylight harvesting, the practice of reducing electric light levels when daylight is present, is becoming more and more commonplace and is now, in fact, required by ANSI/ASHRAE/IESNA Standard

The Vista Center was designed to achieve daylight autonomy and is able to illuminate a significant portion of the interior space exclusively with daylight during working hours.

Photo courtesy of Coscia Moos Architecture

90.1 – 2010 and the California Building Efficiency Standards. Some designers are now interested in taking daylight availability to the next level and using it, when possible, as the exclusive light source for a space, in much the same way it was used in the one-room schoolhouses of the past. The phrase for this new design objective: daylight autonomy.

INTRODUCING DAYLIGHT AUTONOMY

Today, designing a space to meet specific daylight-related objectives is a common practice. The usual daylighting goals include achieving some predefined daylight illuminance level on the workplane or at the floor, incorporating some measure of glare control, or delivering a daylight zone of a certain size. Achieving daylight autonomy essentially requires a project to achieve all of the above and more.

The 10th edition of *The Lighting Handbook*, published by the IES (Illuminating Engineering Society of North America, formerly IESNA), defines daylight autonomy as “the percentage of the operating period (or number of hours) that a particular daylight level is exceeded throughout the year.” It is a dramatically different way to think about and measure the presence of daylight in a building. “One advantage of using daylight autonomy to quantify daylight availability in a building, is that the daylight autonomy calculations take climate into account, an aspect that previous metrics for quantifying daylight had not included,” explained Jack Bailey, Partner at One Lux Studio in New York City. “This metric could benefit architects and owners significantly. Architects can use daylight autonomy analysis to evaluate different design alternatives to determine which concept provides more usable daylight in the interior, and owners will know, definitively, that their building is making good use of daylight. It also provides a consistent metric for comparing the performance of different buildings for building codes and green building initiatives.”

It should be noted that at this moment achieving daylight autonomy in a building is not required by any international, federal, state or local building code. “It was included in the first public draft of the International Green Construction Code (IgCC), but was removed in favor of a simpler metric,” explains Bailey, who served on the committee that wrote the IgCC. “Nor is daylight autonomy analysis required for a project wishing to achieve LEED or any other type of green building certification,” he continues, “however, daylight autonomy is recognized as an option for achieving the daylighting credit in LEED v4.”

Metrics for Measuring Daylight Autonomy

The measurement of daylight autonomy (DA) is the percentage of working hours that a particular daylight level is exceeded throughout the year. The DA value represents the percentage of the workday that a space could be exclusively illuminated with

Photo © Bruce Damonte

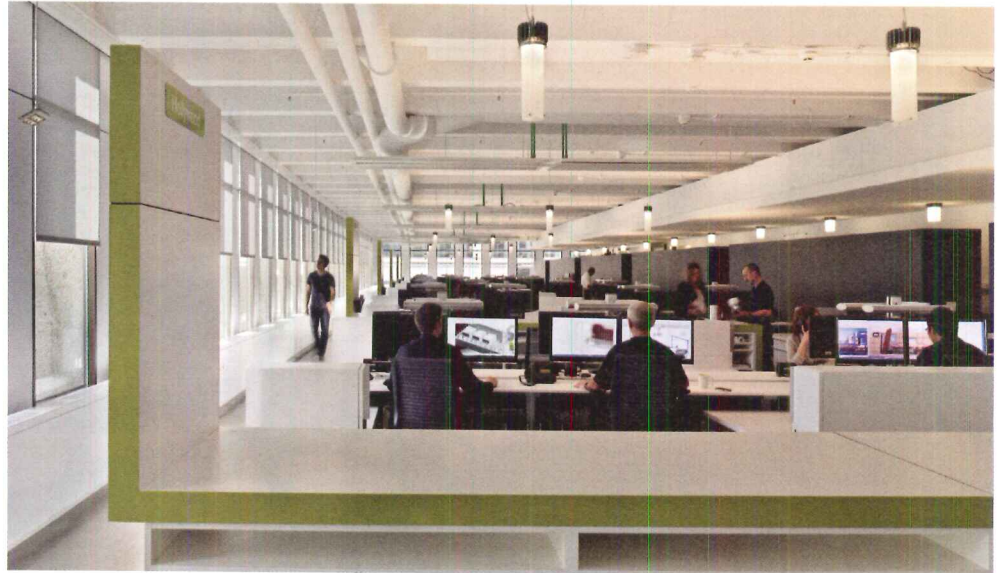

A 2003 study conducted by Heschong Mahone Group linked daylight exposure in the workplace to improved employee productivity and satisfaction.

daylight. There are a few other metrics that can be considered along with the DA value to paint a more complete picture of the presence of daylight in a building throughout the day. Continuous Daylight Autonomy (cDA) gives partial credit to hours where daylight is present, but cannot completely achieve the target illuminance level. Spatial Daylight Autonomy (sDA) refers to the percentage of floor area where 30 footcandles (fc) is achieved for at least 50 percent of the workday.

There is a key term used in the definition of daylight autonomy, and some of the supporting daylight autonomy metrics, that warrants additional attention to ensure that the full concept of daylight autonomy is truly understood.

Defining Useful Daylight

Where daylight autonomy is the goal, it is critical to understand that not all daylight is created equal. As the definition of daylight autonomy implies, there is useful daylight and daylight that is not usable or practical for the interior environment. Useful daylight describes the daylight in the interior space that does not cause glare or discomfort to building occupants.

In an office setting, the range of useful daylight illuminance is generally considered to be between 10 fc and 200 fc at the workplane. This aligns with recommendations developed by the IES that define the optimal light levels for various visual tasks. The IES recommends that office buildings maintain 30 fc at the workplane in private offices, open office spaces, and conference rooms. Lower light levels are recommended for circulation areas and higher levels are recommended in areas where reading and studying will be the primary task. There is even a metric, entitled Useful Daylight Illuminance (UDI), which refers to the percentage of work hours where the illuminance from daylight is between 10 fc and 200 fc.

People can experience visual discomfort when direct sunlight or overly bright sky conditions are present in a workspace due to the intensity and contrast they create. Two metrics that have been developed to help designers identify and protect a space against this potentially destructive and glare-creating daylight are referred to as Max Daylight Autonomy (maxDA) and Annual Sunlight Exposure (aSE). The metric maxDA measures the percentage of work hours where daylight levels provide 10 times the necessary levels of design illuminance. The metric aSE

CONTINUING EDUCATION



EARN ONE AIA/CES HSW
LEARNING UNIT (LU)



EARN ONE GBCI CE HOUR FOR LEED
CREDENTIAL MAINTENANCE

Learning Objectives

After reading this article, you should be able to:

1. Describe daylight autonomy and how it improves the well-being of building occupants and energy efficiency of the electric lighting system.
2. Explain the importance of daylight management in attaining daylight autonomy.
3. Compare the ability of manual shade and automated shade systems to deliver energy savings and usable daylight.
4. Maximize the potential daylight autonomy and energy savings that a space can achieve.

To receive credit, you are required to read the entire article and pass the test. Go to ce.architecturalrecord.com for complete text and to take the test for free.

AIA/CES COURSE #K1311H
GBCI COURSE #0090010656

Photo courtesy of Lutron Electronics



Daylight autonomy can create significant energy savings and improve the quality and comfort of the available views.

measures the number of hours per year where the space receives direct sunlight. This direct or bright, potentially glare-causing sunlight may be considered unusable daylight, whereas the diffuse daylight that fills the sky on a cloudy day is generally considered usable.

The Benefits of Daylight Autonomy

In many instances, energy savings is achieved by sacrificing something else that is deemed valuable, such as occupant comfort. One of the reasons that daylight autonomy is such an attractive design objective is that it manages to deliver significant energy savings, without negatively impacting occupant comfort or the functionality of the space. In fact, it may improve occupant comfort by improving access to outdoor views and ensuring that occupants are exposed to optimal amounts of usable daylight throughout the day, which improves productivity

and satisfaction, while protecting the space from direct or overly bright light that can cause glare and discomfort. Daylight autonomy creates energy savings by being smarter about the inclusion and management of daylight and by eliminating excess lighting energy that is essentially unnecessary.

The Obstacles to Achieving Daylight Autonomy

If there is a down-side to daylight autonomy, it may be that, especially as a relatively new design objective, daylight autonomy can be challenging to achieve. It requires the ongoing, optimal management of a very dynamic light source and, as such, achieving daylight autonomy is very dependent upon selecting the right daylight management technology for the project. Setting a project up to achieve daylight autonomy may also require designers to retool their traditional

approaches to a new project as it relates to the planning of the building envelope and interior. In addition, evaluating the potential DA factors of different concepts requires the use of complex software programs.

The dynamic nature of daylight. At the center of the daylight autonomy challenge is the dynamic and powerful nature of daylight. Daylight levels can range from a few footcandles on an overcast day to over 8,000 footcandles on a clear, sunny day. It can arrive at the window in many forms: streaming directly from the sun, gently diffused through the clouds, or harshly reflected off of a surrounding structure. And it arrives, in some form or another, every day, although its angle and position will vary as the earth orbits the sun.

The potential intensity and daily presence of daylight require that, if daylight is allowed into a building, it must be effectively managed or it can wreak havoc on the visual environment. Some problems commonly experienced as a result of mismanaged or uncontrolled daylight include: glare, hot spots, and thermal heat gain. These problems can cause larger issues of occupant discomfort, loss in productivity, loss of usable interior space, and energy waste.

Selecting the right technology. It is often prudent practice to design a building to be functional in the worst-case scenario. As it relates to the lighting system, the worst-case scenario would be something like blackout or midnight conditions, where zero daylight is available and all of the illumination must be provided by the electric lighting system. In terms of a daylight management system, the worst-case scenario would be that the building was subjected to intense, direct, glare-creating, and unusable daylight all day long, so the daylight management system would need to be deployed to either block or diffuse the daylight all day long. Fortunately,

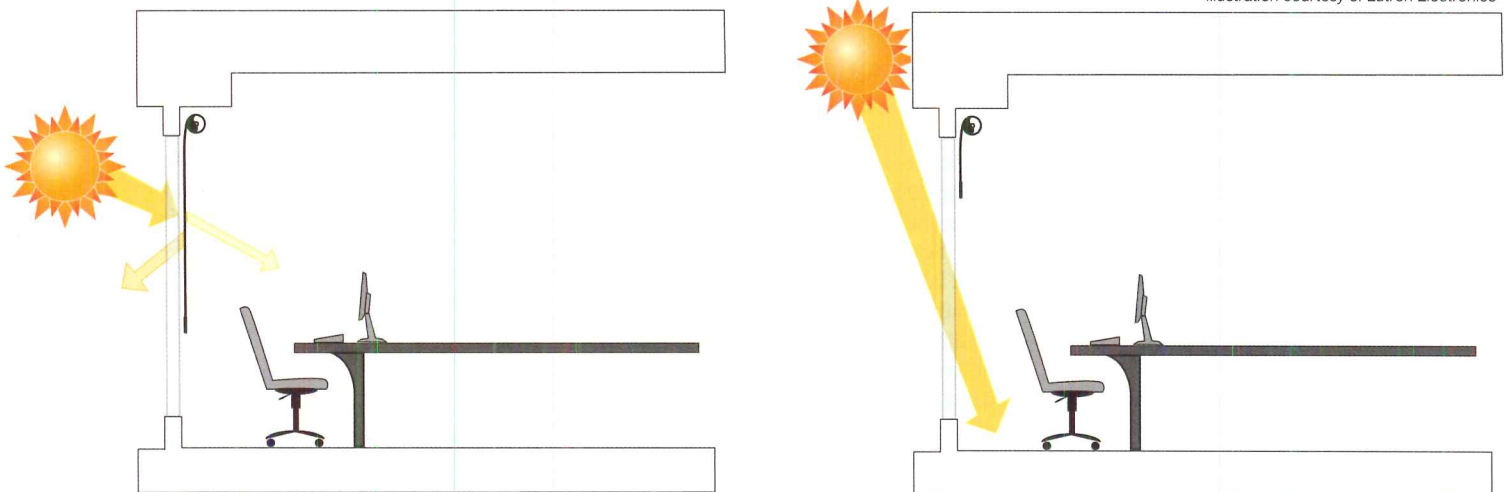

Illustration courtesy of Lutron Electronics

The angle of the sun changes constantly throughout the day, affecting daylight inside a space.

the conditions of an actual day rarely mirror those defined in a worst-case scenario.

It is the technology of the daylight management system that enhances or limits the building's ability to allow useful daylight into the interior when it is available. Automated shading systems automatically raise and lower throughout the day to maximize the useful daylight allowed into the building. A manual shade requires that a person manipulate its position and may not be regularly raised when useful daylight is present. Equipping a building to maximize the presence of useful daylight in a space is a critical step in achieving daylight autonomy.

A new approach to design. The daylight autonomy of a building is affected by variables of the building envelope as well as the interior layout and furnishings. "One of the challenges in achieving daylight autonomy is that it requires the design team to consider how the massing, siting, and orientation of the building impact the availability of daylight in the interior floorplate," explains Bailey. It also requires that many of the elements of the interior space be reconsidered in terms of how it affects daylight penetration and daylight management. This includes the layout of the interior space, the placement and selection of cubicle walls, and even the interior color and finish.

Evaluating alternative designs requires a specialist. Perhaps the greatest challenge for early adopters trying to achieve daylight autonomy is the complexity of the software programs currently available to help designers evaluate the DA factors of their various concepts. "The complex software often requires that a lighting designer with a specialized knowledge of these programs be included in the design team. The need for this specialized expertise is one of the factors currently limiting the inclusion of daylight autonomy in many of the building codes or wider adoption of this metric in green building programs, because it does not seem reasonable to mandate that a professional with this capability be required on every project, regardless of scale," says Bailey. "I'm confident that a more out-of-the-box software solution will be available soon, but it's just not there yet."

DESIGNING TO ACHIEVE DAYLIGHT AUTONOMY

The daylight autonomy a building can achieve is affected by so many variables, it is critically important that the goal of daylight autonomy be identified and actively considered as early in the project as possible. Decisions about the shape and position of the building, interior layout, furnishings, and type of daylight management

Photo courtesy of Coscia Moos Architecture



The massing, siting, and orientation of a building all affect the amount and penetration of usable daylight that will be available in a building throughout a year.

system specified are all critical components in the amount and penetration of usable daylight that is ultimately found in a building throughout a year.

Building Envelope

Many designers begin creating the conceptual design for a building by considering the general shape and mass the building will have, also known as massing, selecting the location on the site that the building will occupy, referred to as siting, and determining how the building will be oriented on the site in relation to the sun.

The initial decisions made with regard to the massing, siting, and orientation of the building all dramatically impact the type of daylight that is available to the project and the potential

access that daylight will have to the interior space. For example, the deeper the floorplate of the building, the more challenging it becomes to achieve target levels of daylight illumination in the more central spaces. In terms of orientation, in the northern hemisphere, it is generally accepted that northern exposures offer the best access to glare-free, ambient light throughout the day, whereas eastern exposures are often subjected to intense and glare-causing daylight as the sun rises, and western exposures experience direct sunlight exposure as the sun sets.

Interior Layout and Furnishings

"Interior space planning is another opportunity to optimize daylight autonomy, especially in office space," explains Bailey. "Designing private offices with solid walls around the perimeter of the building used to be common practice, but that approach blocked daylight from penetrating deeper into the building. To improve the daylight autonomy of an office building, private offices are strategically placed in more central locations and equipped with glass office fronts, to provide occupants with access to daylight and views," he adds. Designing a circulation space around the perimeter of an open office area is another way to improve the potential daylight autonomy of the space, by creating a buffer zone to help limit the potential of glare on the workplane. Lighter colors and lower cubicle walls are two examples of interior furnishings that are often specified to help daylight reach deeper into the space.

The Need for Daylight Management

Achieving daylight autonomy requires more than filling a space with daylight, it must be filled with "usable daylight." As a reminder, usable daylight is defined as daylight within the range of 10 fc and 200 fc that will not disrupt the visual environment or cause glare or hot spots in a space. This range of usable daylight represents a pretty select segment of the daylight that could be available at the window of a building throughout the year, especially considering that daylight can range from a few footcandles on a cloudy day to over 8,000 footcandles on a bright, sunny day. Intense daylight exposure can trim away the usable space in a building by making areas too bright, too glaring, or too hot to use for parts of the day. Avoid the potential pitfalls of daylight exposure by equipping a building to manage the daylight as it enters the space and protect the interior from the bright, direct daylight that can destroy the visual environment and undermine the daylight autonomy of the space.

Continues at ce.architecturalrecord.com



Lutron Electronics, headquartered in Coopersburg, Pennsylvania, designs and manufactures energy-saving light controls, automated window treatments, and appliance modules for both residential and commercial applications. Its innovative, intuitive products can be used to control everything from a single light, to every light and shade in a home or commercial building. www.lutron.com



CONTINUING EDUCATION

**EARN ONE AIA/CES HSW
LEARNING UNIT (LU)**

**EARN ONE GBCI CE HOUR FOR LEED
CREDENTIAL MAINTENANCE**

Learning Objectives

After reading this article, you should be able to:

1. Explain ways in which interior architectural glass contributes to sustainable building goals in the commercial sector.
2. Describe the types of hardware that enable maximum transparency in glass elements.
3. Apply trends in green building, specifically indoor air quality and reduced construction waste, to specification of interior sliding glass doors and partitions.
4. Identify new trends in space planning that promote increased productivity and greater well-being of building occupants.

To receive credit, you are required to read the entire article and pass the test. Go to ce.architecturalrecord.com for complete text and to take the test for free.

AIA/CES COURSE #K1311K
GBCI COURSE #0090010676

Class Glass

Next-generation hardware creates true transparency for commercial spaces

Sponsored by Hawa

The demand for interior architectural glass is on the upswing in the U.S. Sliding glass units for facades and room partitions, long everyday features in Europe, are now hitting North American shores with force. The reasons are compelling: Sliding glass doors are space savers, they are consistent with green building goals, they offer modular interior systems that can be moved to accommodate different office functions and easily demounted for office relocations—and they offer a unique visual that is striking and endlessly modern.

In terms of aesthetics and operation, the effectiveness of a sliding glass door depends on the right hardware. Because glass is about transparency, hardware should be invisible

to the extent possible, and limited, say, to a suspension profile or integrated cover cap. Usability is also a key factor in the strict requirements of the American market, and hardware should be suitable for ceiling mounting, ceiling integration, and wall mounting and capable of maximizing room design options. In projects in the business, hospitality, institutional, and health-care fields, high-end hardware stands out from its technically less sophisticated and inexpensive counterparts. This article will cover the dynamics of quality hardware as well as trending sliding glass solutions and innovative, sustainable options for commercial spaces.

TRANSPARENCY IN DEMAND

Today's businesses and institutions demand transparency, a value that implies openness, communication, and accountability—in short, operating in a way that others can see. Architecturally that concept is increasingly being expressed in glass, on both building exteriors and interiors, meeting philosophical tenets as well as sustainability goals including greater use of green materials, building occupant health and well-being, and energy

All images courtesy of Hawa

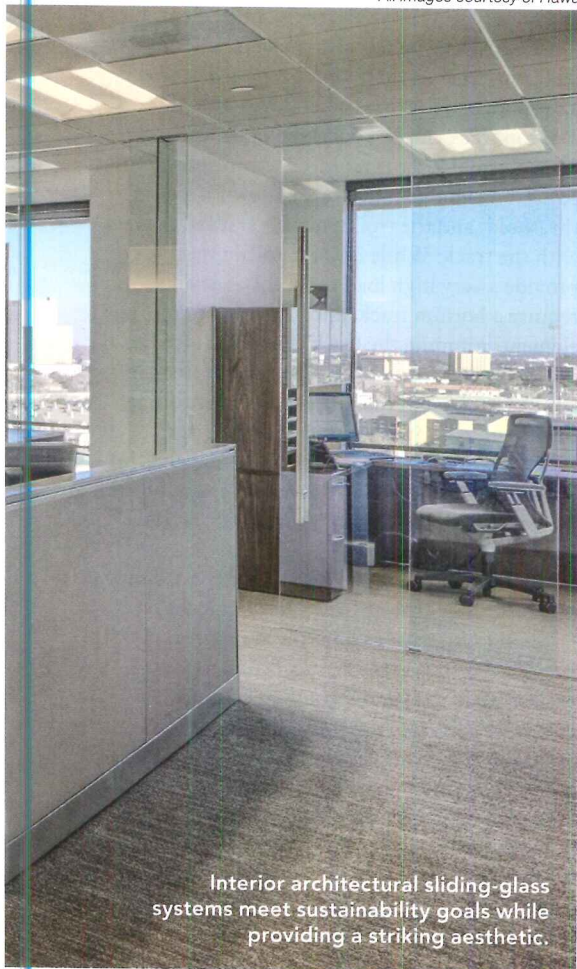

Interior architectural sliding-glass systems meet sustainability goals while providing a striking aesthetic.

efficiency. Over the past decade, these principles have precipitated a change in the amount and location of glass in commercial settings. In building interiors, sliding glass door and wall systems are being used for a number of purposes, among them, connecting interior and exterior spaces, creating striking floor-to-ceiling views, and configuring private enclosures. Not only is less space and clearance needed for sliding versus swinging doors, glass offers sleekness and style that can transform a space, easily merging several smaller spaces into one and vice versa.

Interior glass promotes daylight, and with proper positioning can pull sunlight to the center of the building, minimizing the need to run the lights and often the thermostat—energy savers that effectively decrease energy costs. Increased natural light has been shown to generate salutary effects including greater productivity, higher test scores, and an improved sense of well-being—a phenomenon that has been well documented, particularly in the work of the Heshong Mahone Group and its groundbreaking *Daylighting in Schools: An Investigation Into the Relationship Between Daylighting and Human Performance*. A more recent study about the positive effects of

daylight interviewed more than 260 people in new offices that had achieved LEED Gold or Platinum status. The new green workplace, which featured daylight and views, as well as ergonomic design, safety, and acoustics, correlated with less depression and stress and greater productivity. According to study findings presented in *Commercial Building Products Magazine*, green building occupants who previously experienced stress and depression totaled an additional 202 hours of work, with an overall productivity improvement of 2.6 percent. While a desirable result in itself, an increase in productivity can work to confer additional benefits. In fact, *The Whole Building Design Guide* from the National Institute of Building Sciences states that even a 1 percent savings in productivity can help to offset annual energy costs.

A Range of Options

Sliding glass wall systems and doors bring new possibilities to commercial environments, and as shown in the accompanying figure, come in a variety of solutions.

Sliding glass options include a straight sliding door; a symmetric arrangement, in which two panels slide simultaneously in the opposite direction; and a telescopic version, in which two panels slide simultaneously in the same direction into the recess and park one behind the other, enabling the opening to be twice as wide as the parking solution. This arrangement is particularly suitable for tight environments where transparency makes rooms seem bigger such as kitchens, bathrooms, and offices. Glass sliding solutions can also be curvilinear, or feature accordion walls in which the wall folds.

Glass sliding partitions, which imbue a space with a contemporary look, open up, and can be stacked in a parallel or perpendicular parking area. Adding light, function, and style to any environment, moveable walls are increasingly gaining market share in the interior wall industry. They can be quickly and easily installed offering flexibility in space configuration with minimal structural modifications, and are effective at dispersing natural light. Acoustically, glass partitions can help decrease noise levels, creating a private space in a busy environment.

Types of Glass

Nearly all commercial glasses for architectural use fall into one of several basic categories or types based on chemical composition and/or production process.

TYPES OF GLASS SLIDING SOLUTIONS

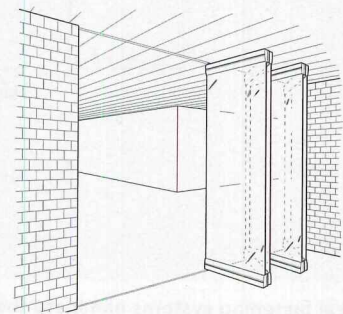
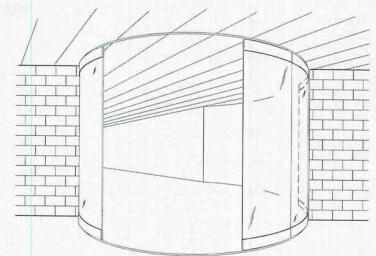
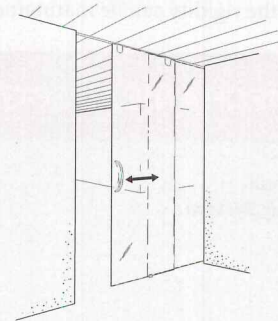
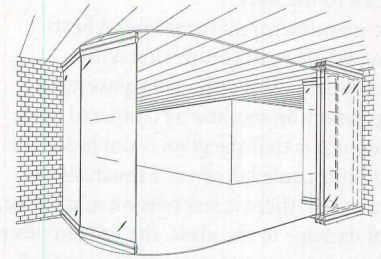
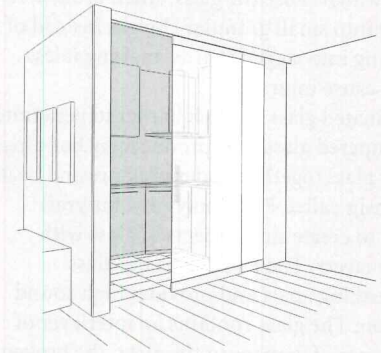

Tempered glass, sometimes known as toughened glass, is a thermally pre-stressed float glass, which is heated to about 1,200 degrees F during production and cooled quickly after heating. Tempering creates imbalanced internal stresses which cause the glass, when broken, to crumble into small granular chunks instead of splintering into jagged shards, making it less likely to cause injury.

Laminated glass is much harder to penetrate than tempered glass. It is produced by bonding layers of glass together under pressure and heat, with a resin called PVB (polyvinyl butyral) in order to create single sheets of glass with multiple layers. The PVB keeps the glass from breaking apart and provides high sound insulation. The glass contains an interlayer of foils. In case of damage to the glass, the broken pieces stick to the foils.

Some manufacturers recommend heat-strengthened glass, in connection with laminated safety glass only. This glass has a similar production method as tempered glass. The difference is that the glass is not heated as much and it is cooled down at a much slower rate. As a result, there is less tension and hence, in case of damage to the glass, the broken pieces remain larger. In connection with laminated safety glass, the rigidity can be maintained.



Hardware that enables full transparency creates a compelling visual effect.

ARCHITECTURAL HARDWARE FOR SLIDING GLASS DOORS—ENABLING MAXIMUM TRANSPARENCY

Hardware systems for sliding glass systems vary widely by manufacturer, but hardware that works with all types of glass and enables full transparency offers architects the greatest design freedom.

An important consideration in hardware selection is top- versus bottom-hung systems. It is widely recognized that compared to bottom-rolling systems, top-hung systems offer smoother movement, more versatility in

accommodating curved panels, and a cleaner look. Top-hung panels also make it easier to deal with uneven floor conditions. There are a number of additional advantages as well. The top track can be concealed in the ceiling, and minimal force is required to move the panel. Top-hung systems also allow for a clear threshold, and the trolley always stays in contact with the track. While bottom-rolling systems provide a very high load capability, they do require a bottom track, and are prone to rolling elements jumping the track. There are also the drawbacks of the mere presence of the track in the threshold, and the difficulty of controlling the leveling of the track on uneven surfaces.

A consistently smooth operation depends on the type of track used in top-hung systems and making the ceiling, rather than the floor, the track foundation.

Another issue is whether to specify a sliding door assembly that utilizes a mechanical fastening system or a clamping system. Some manufacturers use mechanical connections exclusively rather than clamping systems due to safety reasons, maintaining that with mechanical fastening connections the chances of the glass slipping out over time are greatly reduced. Typically mechanical systems can also handle higher weight capacities than a clamping system, with the former accommodating up to 880 pounds with glass thicknesses up to 5/8 inch. Also, mechanical systems can handle laminated glass, which dramatically increases design possibilities. Clamping systems are not recommended for use with laminated glass.

Types of Hardware

A variety of hardware systems exists to promote design flexibility.

Glass sliding doors with concealed suspension.

Sliding glass doors with hidden suspension and a top track that is either surface-mounted or concealed within the ceiling offer optimum transparency. Both systems enable the glass doors to glide through the ceiling with no visible hardware components, for a light and spacious room design. The top track is especially suitable for integrating into concrete ceilings and suspended lightweight ceilings with ceiling connecting angles. The top track can be plain anodized aluminum or specified for a stainless steel effect with matching cover caps. The detachable cover and accessory profiles can be painted to match the ceiling, thus avoiding unsightly transitions. Some designers, however, prefer the unembellished cubic top track, which can be visually striking when not integrated into the ceiling. This top track can be more than 3 inches wide. While some argue that this is too wide, most architects and designers maintain that transparent room design takes priority. The

THE MECHANICAL EDGE

Mechanical Fastening System

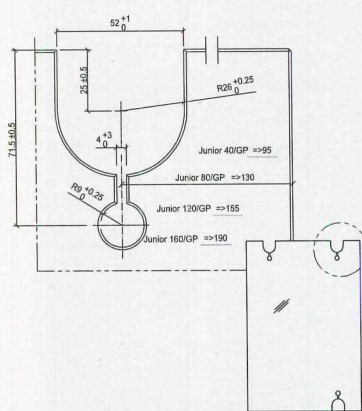

Clamping System

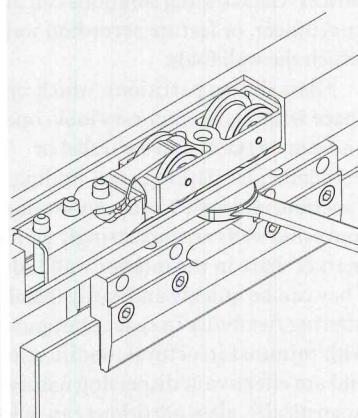
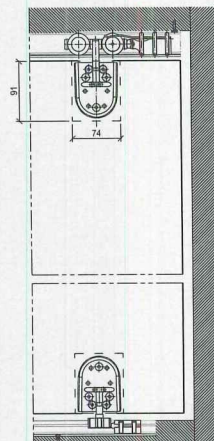

Mechanical fastening systems eliminate the possibility of glass slipping out of the hardware and allow the usage of laminated glass.

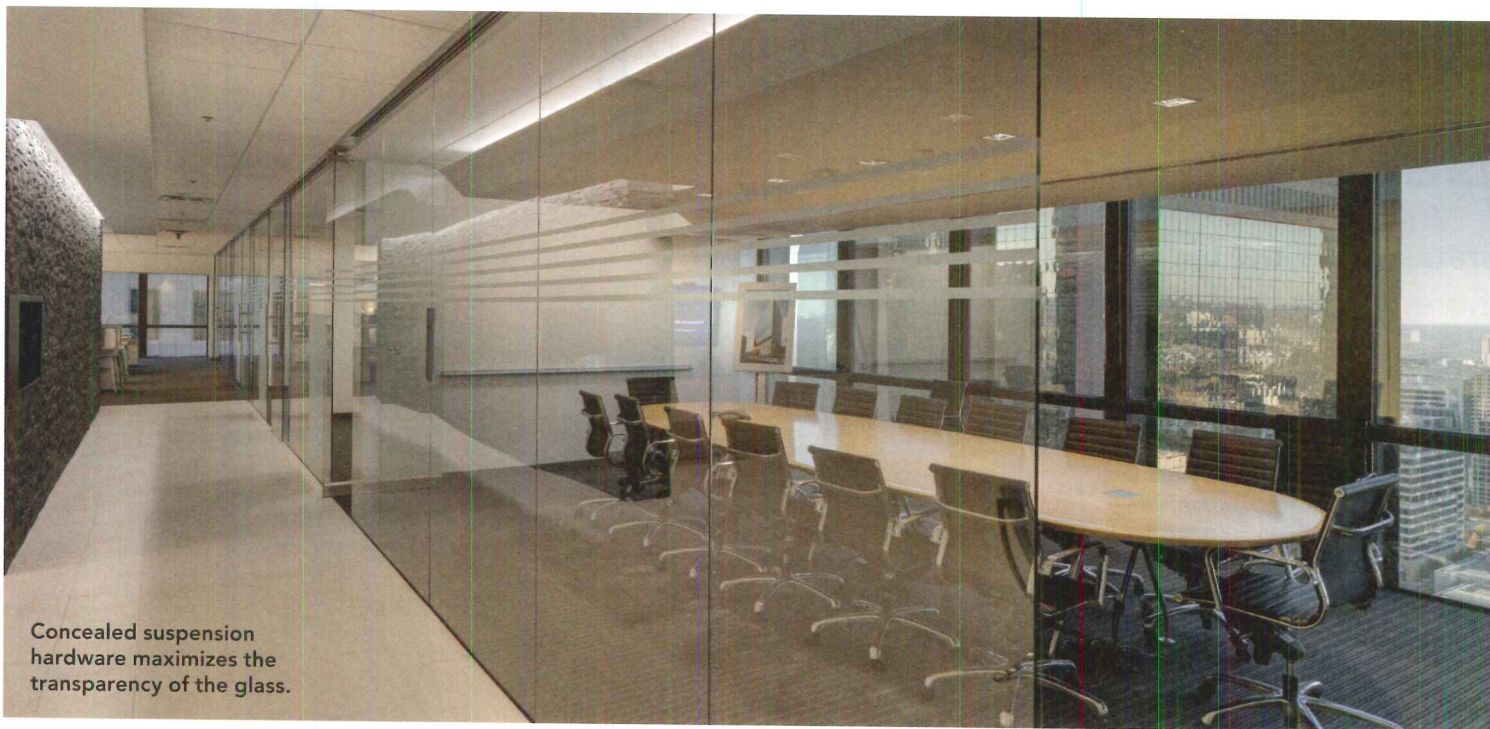

Concealed suspension hardware maximizes the transparency of the glass.

wide track design allows for optimal and simple installation and enables access to components even in ceiling flush installations.

Hardware that incorporates high-quality, hard-wearing ball-bearing technology and plastic-coated roller bearings provides superior running properties, allowing doors to be easily opened and shut with very little operational force. A two-part punctiform and rattle-proof floor guide can also facilitate hanging the sliding glass doors and provide very low roll resistance while preventing rattling noise, such as that from drafts.

Systems with concealed hardware can handle sliding panel weights to approximately 300 pounds. Recently introduced new products offer the option of concealed hardware systems with soft-closing mechanisms for the sliding profile, which enables room partitioning solutions when bolted to the top track. This hardware can handle sliding panel weights up to roughly 175 pounds. With the soft-closing option, a hydraulic damper gently decelerates the door and pulls it in to its final position; progressive damping is designed for the prescribed maximum door weight, optimizing the sliding speed so that the door decelerates and closes very gently, while increasing protection against pinching. A soft-closing mechanism is long-lasting and maintenance-free, and installing the mechanism is consistent for every application.

The hardware can dampen doors on the left, the right, or on both sides. Track stops with adjustable retention springs allow the retention force to be adapted to the door weight for even greater operating convenience. Sliding door locks are optional features.

Both types of concealed suspension offer a form-fitting connection between glass and hardware, resulting in superior safety during use as the potential for glass panes to shift out of place is eliminated. In addition, centric sliding door suspension simplifies installation and prevents lateral pressure on the floor guide. Either toughened safety glass or laminated safety glass can be used, with the latter offering a wide scope of design freedom in conjunction with decorative film. Laminated safety glass is burglary-resistant and provides a high degree of protection against splintering.

In order to simplify logistics, architects should look for product lines in which the same profiles can be used for glass panels of different weights. When the same hardware system can be used for sliding doors with tempered glass thicknesses of 8, 10, 12, and 12.7 mm, and laminated safety glass thicknesses of between 8 to 13 mm, planning and procurement is made easier.

Installation is another consideration and favors hardware systems that utilize the same top track for customized installations with stationary components made of glass or wood,

a feature made possible by top track cover profiles detachable from the underside. With some concealed hardware systems, all relevant components including trolley, height adjustment, track stop, bumper, and soft-closing mechanism are installable and removable from underneath without having to displace any ceiling elements. Because the installer has access to the glass suspension system, glass doors or stationary elements can be easily changed out, or added to, without having to remove parts of the ceiling or make any constructional alterations. In some systems, patent-pending wedge suspension facilitates speed of installation and height adjustment of sliding glass doors.

Other types of accessories can prove valuable in certain situations. A vertical aluminum profile with a rubber seal, for example, closes the gap between the stationary glass element and the sliding door and protects not only the glass edges but also against draft—a scenario that in contrast to conventional brush seals, will still look impeccable after many years. In short, locks, wall connection profiles, and profiles for integration into concrete or suspended ceilings are all useful features as they allow a cost-effective installation of sliding glass doors and stationary elements without requiring any improvisation from the installer during installation and adjustment.

Continues at ce.architecturalrecord.com



Hawa Americas Inc. is the U.S. subsidiary of Hawa AG, a Swiss company renowned internationally as a specialist and leading manufacturer of innovative sliding hardware. Hawa systems can be seen at some of the best addresses in the world. The company has a high-quality solution for virtually any requirement, any material, and any door weight, from sliding doors for furniture and buildings to sliding shutters and highly complex sliding wall systems. Over the past 40 years, Hawa has developed a multitude of technically high-class systems for folding, sliding, or stacking doors and walls made of wood, glass, and metal. www.hawa.com

Dynamic Solar Control with Electrochromic Glazing

State-of-the-art technology performs better and more elegantly than traditional shading or blinds

Sponsored by SAGE Electrochromics, Inc. | *By Peter J. Arsenault, FAIA, NCARB, LEED AP*

Allowing sunlight into buildings has been an important design consideration for centuries. Appropriately controlling that sunlight however has been the focus of many different efforts, particularly in recent times. The attention has been placed on harvesting the desirable characteristics of sunlight in a building while being able to reject or dampen the undesirable characteristics. Achieving that balance has taken on many forms from controlling the orientation of buildings, to using exterior overhangs or interior blinds. It has also included the use of glass and glazing that is treated or coated to have certain light and heat transfer characteristics. All of these solutions have been fixed or static solutions meaning that they have very little or no adjustability beyond their initial installation. But today, electrochromic glazing has changed that and offers a new design solution that is truly variable or dynamic.

ELECTROCHROMIC GLAZING: GLASS AT A NEW LEVEL

Abundant natural daylight has consistently been regarded as a key factor in the design of sustainable buildings. The reason is the powerful impact it has on the occupants of those buildings. People respond positively to natural light, views, and the connection to the outdoors that windows provide. In fact, a 2009 study conducted by Pike Research entitled “Energy Efficiency Retrofits for Commercial and Public Buildings” found that “...office workers, teachers, and students love green buildings... they attend work and school more regularly, are sick less often, and are more productive...” This study and many others have confirmed what most of us know instinctively—people feel better and perform better in spaces where there is abundant daylight.

There is a difference between being in a pleasantly daylit space compared to having direct sunlight shining in your eyes. We put windows in buildings for a reason; however, the intensity of the sun and the potential for bright

spots or glare make the space uncomfortable for occupants. Bright spots and glare are particularly an issue in rooms where computer monitors or similar screens are commonly in use such as office buildings, schools, higher education, and even residences. In addition, regular exposure to direct sunlight causes many materials to wear and fade, thus shortening their life and compromising their inherent qualities such as color, texture, and durability.

From an energy standpoint, sunlight generates solar heat gain. In northern U.S. climates during the heating season, harvesting that sunlight and allowing it to transform into useful solar heat energy can be desirable and sought after. But for the rest of the year and in southern U.S. climates that solar heat energy will still be working during months when cooling is the desired mode. Hence, rejecting that solar gain caused by the sun then becomes more important. So, while glass and glazing may be desirable for daylight and outdoor views, traditionally there has been a distinct tradeoff between daylight and solar heat gain as window to wall ratios increase.

The key to good window design in buildings, then, is to find ways to balance both the amount and characteristics of glazing so the daylight, view, and energy benefits are maximized while the glare, fading, and energy penalties are minimized. Conventional design approaches to find that balance have included some very specific strategies—each with their own pros and cons:

Interior blinds and shades. For most situations, this is probably the most common strategy. Mounting adjustable blinds or shades inside the glazing changes the amount of glare that a person experiences inside the building, but also lowers the amount of light and covers the views. In that case, the benefits of having windows are lost but the energy costs continue. Further, in

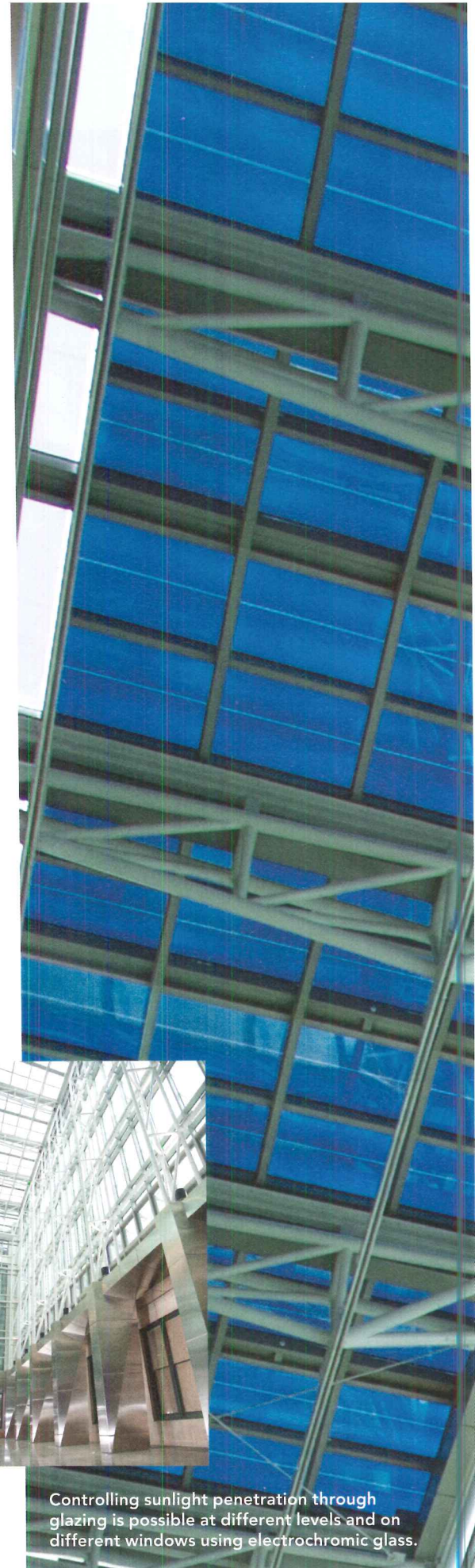

Controlling sunlight penetration through glazing is possible at different levels and on different windows using electrochromic glass.

large settings, it is common that once the blinds or shades are set to a particular position, they are often left there beyond the time intended, further reducing the benefits of the windows. From a cost standpoint, these products often require significant amounts of energy to produce, maintain, replace, and dispose of over the course of their life. And since they are notorious for collecting dust, they require regular cleaning and maintenance which has its own ongoing cost. If the option of automatic controls is added to raise and lower shades for example, that does help with maintaining some of the benefit, but at a notable additional cost.



Fixed exterior shading devices like the ones shown here cannot adjust to changing weather and light conditions.

Exterior shading. Rather than trying to control light from the inside, it has become popular to look at exterior design strategies. These have included things like adding fixed shades, shutters, or awnings to a building façade which can help reduce solar gain, but are very limited based on the angle of the sun in the sky. They can also require considerable design effort and expertise to have them effectively integrated into a building so they perform as intended without blocking views or too much light. They are usually rather expensive items not only for their initial cost, but also in terms of their life-cycle costs of production, maintenance, replacement, and disposal. Since they are usually fixed in place, they do not adjust to changing light conditions from weather or from adjacent buildings/terrain.

High-performance glass. There have been a series of advancements in glazing technology in recent years that allows for the selection of glass that has different thermal and light transmittance properties. These have been important and useful in the design of many buildings, but the reality is that once the particular glass is selected and installed, it is a fixed or “static” solution. Static solutions are permanently clear or tinted or reflective regardless of changing seasons or sunlight conditions—and cannot respond to changing conditions. This static trait means that either interior or exterior shading will likely be desired

in many cases for separate control. It also means that any one window will likely strive for an average condition or a worst case condition and thus not be able to effectively address the range of conditions associated with heat gain, glare, and damage to materials.

Given the need to keep the benefits of glazing and overcome the limitations of conventional control strategies, a number of emerging technologies have been applied to glazing that provide “dynamic” rather than “static” control options. Simply defined, dynamic glass can respond to changing light conditions by clearing or darkening as light levels change. Some examples include photochromic or thermochromic glass that respond to UV light or heat and tint accordingly. This type of dynamic glazing requires no electricity and has been used most commonly in products like eyeglasses, causing them to darken in bright light and clear in less light.

A different type of dynamic glass is privacy glass. Specifically designed for interior applications, privacy glass generally requires 110 volts of AC electricity and is a laminated glass with organic compounds placed between the layers. In either case the glass is made clear when the electricity is turned on and resorts to its natural obscured state when the power is turned off. Privacy glass is for situations that require total privacy and is not typically for solar control.

CONTINUING EDUCATION



**EARN ONE AIA/CES HSW
LEARNING UNIT (LU)**



**EARN ONE GBCI CE HOUR FOR LEED
CREDENTIAL MAINTENANCE**

After reading this article, you should be able to:

1. Explain the impact of glazing on energy consumption in buildings and compare different approaches to sun shading solutions that affect energy use.
2. Analyze the energy and environmental benefits related to the control of electrochromic dynamic glazing.
3. Examine the human factor aspects of using differing zones of electrochromic dynamic glazing in a building façade.
4. Recognize key considerations in designing and specifying electrochromic glazing to achieve maximum performance, including potential contribution to LEED® points.

To receive credit, you are required to read the entire article and pass the test. Go to ce.architecturalrecord.com for complete text and to take the test for free.

AIA/CES COURSE #K1311E
GBCI COURSE #0090010642

The Electrochromic Glazing Breakthrough

The one active dynamic glazing technology specifically designed for building envelope applications is referred to as electrochromic (EC) glazing. This rapidly growing technology uses a series of thin, non-organic ceramic and metallic films deposited onto the surface of glass that are electrically charged to regulate both light and heat through the glass. Unlike SPD or LCD glazing, however, the amount of electricity used is dramatically less, typically at less than 4 volts DC and less than 10 milliamps. Further, the electric charge is only needed to tint the glass, since the natural state of EC glazing is clear. Through variable tint control settings, electrochromic glazing preserves the human benefits of abundant sunlight, views, and connection to the outdoors but without the associated issues and environmental penalties. This makes it one of the most promising forms of dynamic glazing available today for exterior applications.

EC glazing is made from panes of conventional float glass that are sputter coated with ceramic layers of metal oxides. The processes are proprietary to the manufacturers, but are similar to the way low-e glass is produced. In most cases, nanotechnology is used to control layers to a very fine degree. The total thickness of all the layers of an electrochromic coating is commonly less than 1/50th of the thickness of a human hair. When an electronic voltage is applied across the coatings, ions travel between layers, where a reversible solid state change takes place, causing the coating to tint and absorb light. Reversing the polarity of the applied voltage causes the ions to migrate back to their original layer, and the glass returns to its clear state.

The coated panes of glass are fabricated into insulating glass units (IGUs) using another piece of glass (clear, tinted, or laminated) and a stainless steel spacer. These IGUs can be fashioned into windows, skylights, and curtain walls, making advanced electrochromic glazing as easy to specify and install as conventional “static” windows. An electronic control system is integrated with the installed glazing and can be customized depending on the needs of the project. The glazing can be controlled by an automated control system, a Building Management System (BMS), or manually using wall switches, or in various combinations of those methods. Most of the tinting occurs in 7 to 15 minutes, depending on glass size and temperature of the glass. Faster tinting can occur in smaller panes and/or warmer temperatures.

The beauty of the installed system is that since the glass itself is controlling solar light and heat, there is no need for exterior or interior shading or other solar devices to be built, purchased, or installed. Therefore, it integrates easily into any design, and into ordinary construction processes.

ENERGY PERFORMANCE OF EC GLAZING

Using EC glazing means that the glass essentially becomes a “valve” that can be used to meter, regulate, and optimize the use of the solar heat and light coming into the building. It does this by addressing two of the fundamental aspects of all glazing.

Solar Heat Gain Coefficient (SHGC)

This common glazing characteristic is simply the fraction of total solar radiation admitted through glazing. Expressed as a number between 0 and 1, the lower the SHGC, the less solar heat it transmits and the higher the shading ability.

Visible Light Transmission (VLT)

This similarly common trait is the percentage of the visible spectrum transmitted through a glazing and perceived by the human eye.

Commonly, the higher percentage of VLT in glazing, the higher the value of SHGC, or simply put, more light usually means more heat. Conversely, lower VLT reduces solar heat gain, but it also restricts natural daylighting. When using static glazing, the designer needs to determine the most appropriate values for each of these two characteristics and then they stay that way for the life of the glazing.

With dynamic EC glazing, both of the values are variable and adjustable on demand, meaning that the building can respond to different conditions—relieving the designer from having to select only one set of ideal values. As a practical matter, however, it should be pointed out that the variability is commonly controllable at four pre-set points—a low or dark setting at 2 percent VLT, two intermediate settings at approximately 6 percent and 20 percent VLT, and a high point of approximately 60 percent VLT. These settings preserve the view and connection to the outdoors that humans thrive on no matter the time of day or time of year. By adjusting to outdoor conditions, it reduces glare, discomfort, and fading that negate the human benefits of sunlight. It also optimizes energy use in the building by rejecting solar heat gain when it is not wanted, and allowing it in when it is desirable or acceptable.

Although electrochromic glazing is a unique technological innovation, it is a cost-effective solar control system. Installed projects have been shown to generate dramatic reductions

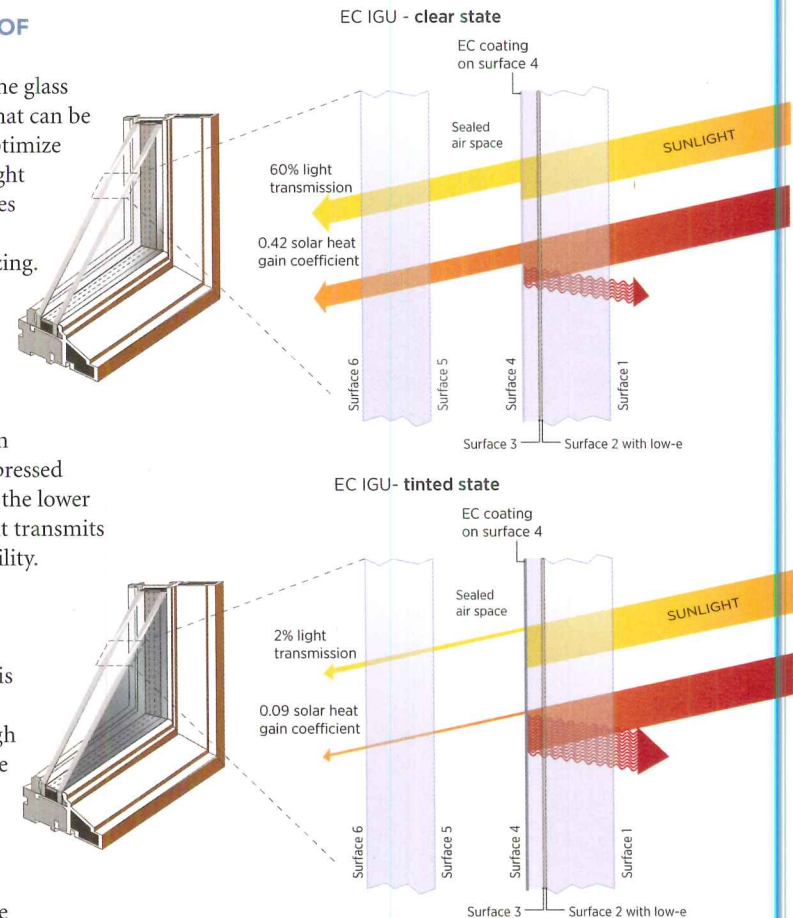

EC glazing in its clear state (top image) allows a certain amount of light and solar heat to pass through. With a small electrical current, it changes to tinted (bottom image) and allows notably less heat and light to pass through.

in operating energy costs since the EC glazing effectively blocks or admits solar heat and light as needed, thus reducing energy demand for heating, cooling, and lighting. Adding to the effectiveness, some advanced electrochromic glazing products have SHGC values of 0.09 in a tinted state, which is approximately three times better than most commercial static glazings. Even in this state, the EC glass transmits 2 percent of visible light. EC is also very cost effective, and can be cost neutral when compared to traditional solar control solutions, such as the combination of low-e glass with blinds and sunshades. This improved performance can also reduce first costs related to energy systems in new construction as smaller HVAC systems can often be used.

Regarding the operation of the EC glazing it should be stressed that due to its electronic nature, it uses minimal electricity. To put things in context, 2,000 square feet of EC glazing (approximately 100 windows) has been shown to be controllable using less power per day than one 60-watt light bulb. Hence, in exchange for a very minimal energy use, much more energy use can

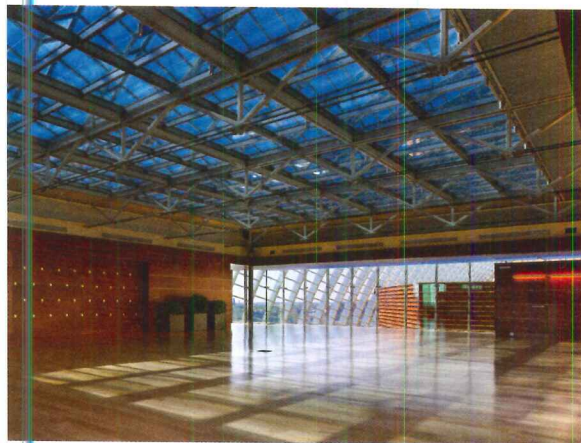
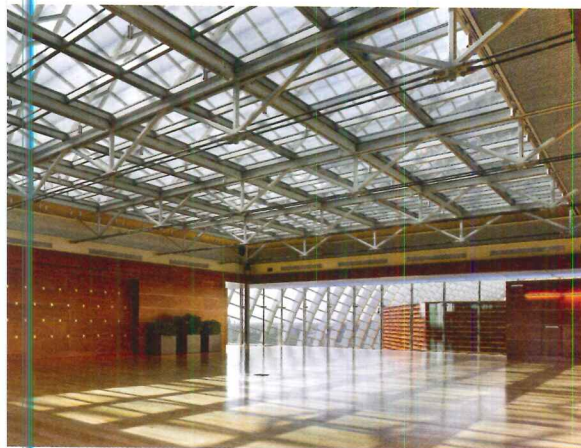

Reducing heat gain and energy use in a public space with a skylight becomes very manageable using EC glazing, which is shown in its normal clear state (top image) and dynamically tinted (bottom image).

be offset and large potential net savings realized. Photovoltaic (PV) solar cells could also be a source of that energy. Because of their low DC voltage and power consumption, and the complementary relationship between the amount of sunlight available and the level of tinting required, EC glazing is an excellent candidate for PV power.

The overall energy results of a properly installed EC glazing system installed in a typical building are realized in several ways. First, it has been demonstrated to reduce overall energy loads (heating, cooling, and lighting) by up to 20 percent by controlling the daylight and solar heat gains of a building. The U.S. Department of Energy (DOE) is even more optimistic in its estimate that electronically tintable window systems are capable of providing up to 40 percent savings on energy bills and 20 percent on operating costs. Secondly, EC glazing can have a ripple effect by lowering peak



The comfort and ambience of this restaurant space with EC glazing can be more desirable than rooms with adjustable interior blinds.

electrical demand power requirements by up to 30 percent, saving some building owners a considerable amount of money beyond pure consumption costs. Thirdly, when used as part of an effective overall daylighting strategy, it can lower electrical lighting costs by up to 60 percent. Finally, all of those load reductions conclude that EC glazing can reduce HVAC equipment sizing by up to 25 percent compared to conventional building designs.

Looking at the bigger picture of energy consumption and CO₂ emissions, utility companies commonly run their most efficient power plants to meet base load demand and slowly bring on less efficient, more CO₂ emitting plants as demand increases. The increased electricity demands are most common during hot weather periods with abundant sunshine. Electrochromic glazing reduces the building loads during these peak utility times, thus directly contributing to reducing power plant emissions. In full building installations, electrochromic glazing can reduce peak load carbon emissions by as much as 35 percent in new construction and 50 percent in renovation projects.

SUSTAINABILITY FACTORS: LIVING WITH EC GLAZING

In addition to energy savings through solar heat gain management, electrochromic glazing contributes to an energy-efficient, sustainable building in several other important ways as discussed further.

Comfort Through Glare Control

The qualities that make EC glazing sustainable also contribute to the comfort and performance of the building's occupants. In human factors evaluations conducted by the Lawrence Berkeley National Laboratory (LBNL), people greatly preferred to be in a room with electrochromic windows versus a room with regular static glass and blinds, because of the level of comfort it brought to the space. This supports what we have already established, namely that controlling glare improves occupant comfort and productivity. But equally important, when glare is removed, occupants can see without closing blinds or shades. With static glass, the only way for an occupant to control glare is to pull the shade or blinds. Most shades are controlled manually but even in automated systems, glare often forces occupants to override the system and close them. So blinds or shades are closed when glare is present, but rarely reopened at the optimized time for energy efficiency. This unhappy situation negates the benefits of the window and decreases the effectiveness of any daylighting strategy. The penalty of glare discomfort is that electric lights get turned on that might otherwise have been kept off.

Continues at ce.architecturalrecord.com

Peter J. Arsenault, FAIA, NCARB, LEED AP, is a nationally known architect, sustainability consultant, technical writer, and continuing education presenter. www.linkedin.com/in/pjaarch



SAGE is the world's leading manufacturer of advanced dynamic glass that can be electronically tinted or cleared to optimize daylight and improve the human experience in buildings. SageGlass® enables you to control sunlight without shades or blinds, maintaining your view and connection to the outdoors and significantly reducing energy consumption. www.sageglass.com

When you have something so beautiful, why cover it up!

Anodizing allows the natural beauty of the aluminum to shine through unlike applied coatings. Anodizing creates a translucent protective layer that is integral to the base aluminum and will not chip, flake, nor peel like paint, nor rust and tarnish like other metals. Anodized aluminum offers architects and designers with an infinite color selection and unique finishes that are durable and easy to clean and maintain.



- ✓ Won't Chip, Flake, or Peel
- ✓ Lightweight and Durable
- ✓ Infinite Color Selection
- ✓ Corrosion Resistant
- ✓ Unlike Paint, No VOC's
- ✓ Easy to Clean
- ✓ 100% Recyclable
- ✓ Metallic Brilliance

 **Lorin**
*Infinite possibilities
in aluminum finishing solutions®*



CIRCLE 6

Call toll free 800.654.1159 | www.Lorin.com

University of Texas Student Apartment Complex, Austin, TX
Lorin's Medium Antique Copper and ClearMatt®

Anodized Aluminum for Architectural Applications

Durable, strong, versatile, and cost effective with extensive color and finish choices, anodized aluminum provides a multitude of applications

Sponsored by Lorin Industries | *By Karin Tetlow*

Nearly a century ago, aluminum revolutionized the world of metals. Since then, coil anodizing technology has allowed remarkable architectural possibilities of designs, textures, and finishes that are functional, versatile, and environmentally responsible. Anodized aluminum can be roll-formed, stamped, laser engraved, laminated, perforated, welded, embossed, and silk-screened. Moreover, recent breakthroughs in coloring techniques provide a range of colors rivaling those of paint. Among the many applications of anodized aluminum are architectural exteriors, interiors, paneling, roofing, windows, doors, ceilings, and lighting.

WHAT IS ANODIZING?

Anodizing is an electrochemical conversion process, not an applied coating. The procedure of anodizing aluminum is a very technical and artistic process involving an electrically

Anodized aluminum cut-out honeycomb panels in the Gyeongju Tower in Gyeongju, South Korea, echo the legendary Hwangnyongsa Temple's wooden pagoda (see case study online).



CONTINUING EDUCATION



EARN ONE AIA/CES HSW
LEARNING UNIT (LU)

Learning Objectives

After reading this article, you should be able to:

1. Describe aluminum anodizing and explain the differences between types of anodizing processes.
2. List the advantages and disadvantages of coil and batch anodized aluminum.
3. Summarize the advantages of coil anodized aluminum compared with other metals and coatings.
4. Identify applications that use coil anodized aluminum products for architectural interior and exterior uses.
5. Discuss the sustainable and environmental characteristics of anodized aluminum.

To receive AIA/CES credit, you are required to read the entire article and pass the test. Go to ce.architecturalrecord.com for complete text and to take the test for free.

AIA/CES COURSE #K1311P

charged solution that works with the natural components of the aluminum substrate. The surface of the aluminum metal is converted to aluminum oxide as a result of reactions occurring at the anode in an acid solution. The process is called “anodizing” because the sheet or part to be treated forms the anode electrode of an electrical circuit. The thickness and properties of the anodic layer will vary with the aluminum alloy, specific anodizing process employed, and electrical current cycle time (ampere-hours).

Anodizing increases corrosion resistance, protects the surface of the aluminum from further oxidization, creates a very hard and durable protective layer, and provides better adhesion for paint primers and glues than bare aluminum. Anodized aluminum can also be used for a number of cosmetic effects because the thick porous oxide layer can absorb dyes, creating an infinite number of colors.

While aluminum anodizing remains the same for all applications, there are two processing methods: batch anodizing of fabricated parts and continuous anodizing of aluminum coils.

Batch Anodizing

Batch anodizing, sometimes known as piece part anodizing, is very labor intensive, requiring racking and un-racking of thousands of parts. Parts are immersed in a series of treatment tanks in the anodizing process. Because not all parts are positioned equally in the process—their distance from the electrical current and from each other in the tank varies—their color will vary. Batch anodizing is primarily used for small run jobs not requiring tight finish and color control.

Continuous Coil Anodizing

The continuous coil anodizing procedure is when coils of wrought aluminum are unwound through a series of tanks where the processing itself takes place. The coils are rewound upon completion ready for shipment and immediate fabrication.

Developed as an alternative to piece part or batch anodizing, continuous coil anodized aluminum is the most useful product for the design and construction industry due to its efficiencies and versatility. Moreover, since the aluminum travels through a series of tanks in a

continuous operation, aluminum coil anodizing has significantly greater color control than a batch process. The result is a very uniform color from start-to-finish and from edge-to-edge of the aluminum coil. The continuous coil anodizing process also maintains a consistent anodic layer, minimizes handling damage since the coil is a single part, reduces manufacturing scrap, and does not come with rack marks like batch anodizing. A typical aluminum coil anodizing line includes three primary treatment processes: pre-treatment, anodizing, and post-treatment processes.

Pre-treatment. Wrought aluminum is received from the aluminum suppliers with contaminants on the rolling surface. In the first step of the pre-treatment stage, mill oils, grease, aluminum oxides, and dirt are “chemically” removed from the wrought aluminum. If these contaminants are left on the surface, the anodic film may become pitted, create a non-uniform anodize thickness, or cause visual imperfections in the surface quality of the finish.

Another step in the pre-treatment process is to prepare the surface for finishing requirements as specified by the design professional. The surface can be etched for a soft, matte appearance or brightened for a mirror-like appearance.

▶ Etching in a chemical solution prepares the aluminum surface for anodizing by removing a thin layer of aluminum. Removing this thin layer will clean up any minor imperfections in the aluminum alloy and at the same time produce a matte surface finish. The tight control in the etching process is also used to maintain and manage the gloss of the aluminum surface, allowing for more consistent panel-to-panel matching. Panel-to-panel matching quality is critical if the architect and designer require uniform color appearance between panels on a flat wall structure. Batch anodizing will not satisfy this type of finish control.

▶ Chemical brightening is a process that smooths the surface roughness of the high-purity wrought aluminum to achieve a non-directional and reflective surface. The brightened surface creates a different dimension in finish quality, allowing design professionals to explore unique reflective and colored finishes. The brightened translucent oxide layer accentuates the rich metallic appearance of the aluminum and does not cover it up like paint or a rolled coating.

▶ Electropolishing is an electrochemical process that also brightens high-purity wrought aluminum alloys that have been specially prepared and polished. Specular reflectivity tests have shown that electropolished aluminum will be 10 percent to 12 percent brighter after anodizing than conventional chemical brightening. Electropolishing will produce a sharper, mirror-like reflective image.

ALUMINUM BATCH ANODIZING LINE

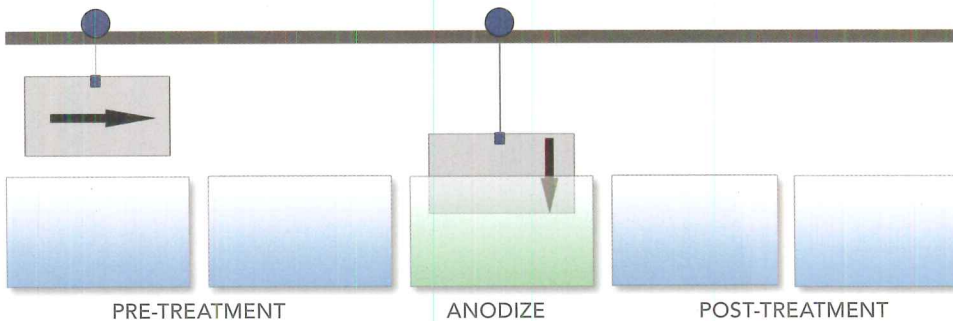

Batch anodizing is sometimes known as piece part anodizing.

ALUMINUM COIL ANODIZING LINE

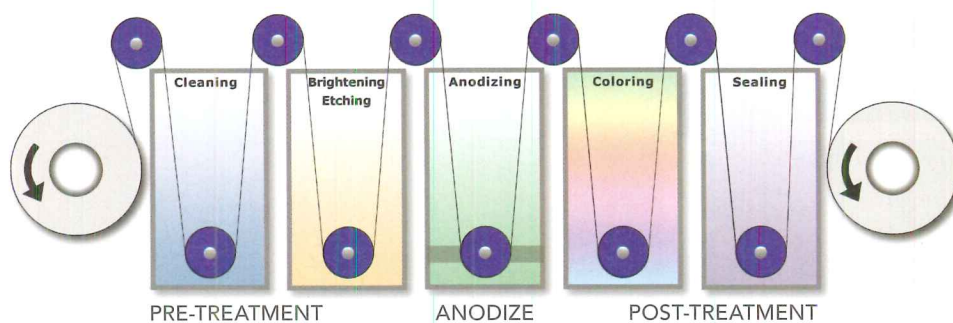

Coil anodizing is a continuous unwinding of aluminum coils through a series of tanks.

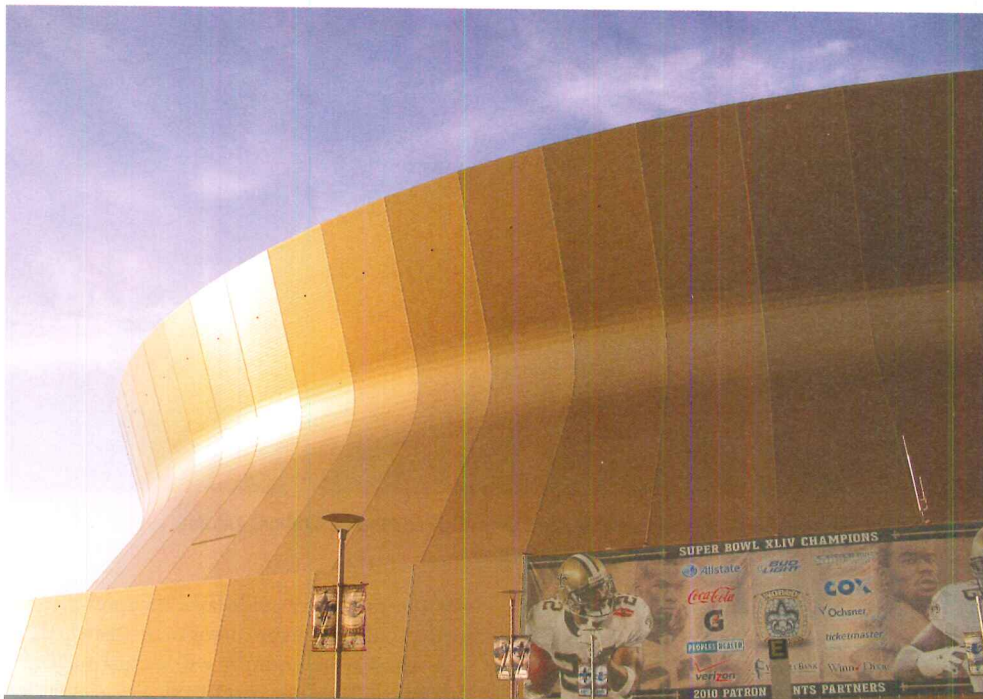

CASE STUDY

ROLL-FORMED COIL ANODIZED ALUMINUM PANELS: MERCEDES-BENZ SUPERDOME, NEW ORLEANS, LA

The Mercedes-Benz Superdome in Louisiana required restoration and resurfacing after Hurricane Katrina caused significant damage to New Orleans. The state-owned building, which was part of the New Orleans skyline for over 40 years, gained negative international attention in the aftermath of the hurricane. This meant that its restoration would be monitored very carefully worldwide.

One of the performance-based criteria for the work to be performed was specifying a 365,000-square-foot cladding system. There were several requirements for the system: It should replicate the New Orleans Saints' gold; it should allow the beauty of the embossed aluminum to show through; its panels be strong enough to pass upgraded wind testing; and it should retain its color for many years to come.

"We were tasked by our client, the state

of Louisiana, to match the original specified custom anodized aluminum color of the Mercedes-Benz Superdome, returning it to its original aesthetic appearance of 1975," says Brad McWhirter, AIA, lead project manager, Trahan Architects. "It was imperative that it be rebuilt to its original design aesthetic, but meet all of the stringent finish and performance standards of modern day exterior building systems."

Requirements for ease of installation, ease of panel replacement, color consistency, panel strength, and rain screen qualities were solved by selecting roll-formed coil anodized aluminum. "Initially, we had reservations about roll forming an anodized finished product due to the surface hardness, but this proved to be a non-issue in terms of cracking or crazing of the formed profile," says Dan Vinet, president, Kalzip, cladding system fabricator.

Electropolishing has been around for a long time but the only chemical solution that originally worked was one requiring several pounds of toxic and costly-to-treat chromic acid or hexavalent chrome which is a known carcinogen. Leading aluminum coil anodizing manufacturers have now developed electropolishing solutions that do not require chromic acid.

Electropolished aluminum finishes are used where applications such as solar concentrators require a reflective surface to capture and

distribute light efficiently. Electropolished brightened aluminum is significantly lower in cost as compared to silver-plated glass mirrors that are commonly used as solar concentrators. Coil anodized aluminum that has been electropolished can also be used for decorative metal panels in architectural design.

Anodizing. Once the surface is prepared for the design professional's finish requirements, an aluminum oxide layer is built from the base aluminum substrate itself. The aluminum

is immersed in a tank containing a sulfuric electrolyte (sulfuric acid electrolyte is most commonly used). Electrical current is then passed through the electrolyte. The aluminum is the anode in this electrolytic cell; the tank is the cathode. Voltage applied across the anode and cathode causes negatively charged anions to migrate to the anode where the oxygen in the anions combines with the aluminum to form aluminum oxide (Al_2O_3).

Raw (not-anodized) aluminum exposed to the outside harsh environment will build its own natural oxide layer and protect itself from further corrosion. However, this oxide layer will be soft, thin, white in color, and non-uniform. The aluminum anodizing process improves upon nature, creating a natural product that accentuates and celebrates the metallic look of aluminum through a uniform translucent protective layer which is very thick and hard with qualities equal to that of a sapphire.

AAMA 611-12, Voluntary Specification for Anodized Architectural Aluminum, published by the American Architectural Manufacturers Association (AAMA), describes the test procedures and requirements for high performance (Architectural Class I Anodic Film Thickness) used primarily for exterior building products and other products that must withstand continuous outdoor exposure, and commercial (Architectural Class II Anodic Film Thickness) architectural quality aluminum oxide layers applied to aluminum extrusions and panels for architectural products. The specification also covers anodized finishes produced in batch or continuous coil.

Post-treatment. The aluminum oxide layer is porous and well suited for coloring using two common methods: absorptive dye coloring and electrolytic two-step coloring.

► Absorptive dye coloring employs both organic and inorganic dye materials. Since the aluminum oxide layer is a very porous structure, it will absorb staining materials. Any colored fabric dyes can be absorbed into the aluminum oxide layer and will deliver vibrant colors that cannot be matched by any painted metal system currently on the market. Inorganic dye materials can also be absorbed into the oxide pores and offer fade-resistant colors.

► Electrolytic two-step coloring is a process that offers color versatility and is the most technically advanced coloring system available today. This coloring technology is used for architectural applications requiring UV stability and exposure in harsh environments. After an oxide layer is built, the metal is immersed in a bath containing an inorganic metal salt. Electrical current is applied which deposits the metal salt into the base of the anodic pores. The resulting color is dependent on the type of metal salt used and specific anodize processing

Photo courtesy of Lorin Industries



Photo courtesy of Wilsonart International



Left: Anodized aluminum in a clear matte finish was specified for sunshade louvers at the Winspear Opera House, Dallas, Texas. **Right:** High-pressure laminate anodized aluminum may be used for interior walls with multiple colors.

conditions applied. This coloring process offers exceptional fade resistance and is very suitable for exterior applications. Design professionals should be aware that color-matching capabilities can vary among manufacturers and it is recommended that a continuous coil anodizing process be requested for tight color control and panel-to-panel matching capabilities.

Sealing is the final step in the anodizing process. Proper sealing of the porous oxide layer is absolutely essential to the satisfactory performance of the anodic layer. The pores must be rendered nonabsorbent to provide maximum resistance to corrosion and stains. The sealing process also locks in colors and helps minimize any color degradation. Sealing is accomplished through a hydrothermal treatment in proprietary chemical baths. Hydrothermal treatments hydrate the anodized pores, stopping the anodization process.

However, in some cases, unsealed products can be effective and offer a viable alternative for an adhesive-friendly surface. For example, an unsealed oxide layer can absorb some printing inks and is used quite readily in identification nameplate applications.

Anodizing may be built on chemistry, but through the skill and artistry of the anodizer, buildings and products can become more alive—celebrating the beauty of the metal instead of covering it up with paints or coatings.

Properties of Anodized Aluminum

Anodized aluminum is well suited for architectural applications for several reasons:

Durability and abrasion resistance.

Having an oxide layer that is very durable and

resistant to abrasion, anodized aluminum is tough enough to withstand both the rigors of spaceflight and adverse climatic conditions.

The thickness of the anodized layer for architectural use should be specified as either an Architectural Class I (minimum of a 0.700 mil or 18 micron thickness) or Architectural Class II (minimum of a 0.400 mil or 10 micron thickness) according to AAMA specifications (see the chart in the online version of this course). Features of the oxide layer include:

- ▶ Three times harder than the aluminum itself and provides a natural abrasion resistance not found in copper, zinc, brass, bronze, or stainless steel.
- ▶ Integral with the aluminum substrate and therefore very durable—it cannot chip, flake, or peel.
- ▶ Protects the underlying metal and self-heals by building its own oxide layer if cut or scratched.

Strength and flexibility. Aluminum's high strength-to-weight ratio has many advantages for architectural applications. It allows design professionals to build lighter structures with more stability and greater design flexibility. This can minimize expenditures on foundations and structural support elements, thereby reducing overall costs. Anodized aluminum will flex or deflect more than steel which lessens the force of impact loads.

Corrosion resistance. The oxide layer is resistant to corrosion and is one of anodized aluminum's greatest strengths.

- ▶ The aluminum oxide layer is tenacious, hard, and instantly self-renewing because aluminum spontaneously forms a thin, but

effective protective oxide layer that prevents further oxidization or corrosion if scratched.

▶ Anodized aluminum will not patina like copper and zinc, nor rust like steel, nor weather like brass. It is an excellent material to use in marine environments and coastal waters. Salt-water exposure will not corrode an anodized aluminum surface because of its neutral pH.

▶ Anodized aluminum is highly resistant to weathering, even in many industrial atmospheres that often corrode other metals. The major pollutants in an urban environment are carbon monoxide and carbon dioxide, which have no effect on an anodized aluminum surface.

Color control and selection. Anodized aluminum may be processed to any color in the visible light spectrum and is able to closely match any custom color requirements specified by architects and designers.

▶ As noted previously, an aluminum oxide layer has a very porous structure and will absorb staining materials such as fabric dyes or inorganic metal salts, depending upon the coloring method applied.

▶ Since the aluminum oxide layer is part of the aluminum itself, the dye is absorbed into the anodic layer and will not chip, flake, or peel.

▶ Anodized aluminum can be colored as a low-cost alternative to match other metals such as stainless steel, brass, muntz (a form of brass), bronze, zinc, gold, and copper.

▶ Continuous coil anodized aluminum has superior color control compared with batch processing.

▶ Continues at ce.architecturalrecord.com

AMERICAN

★ DESIGN ★

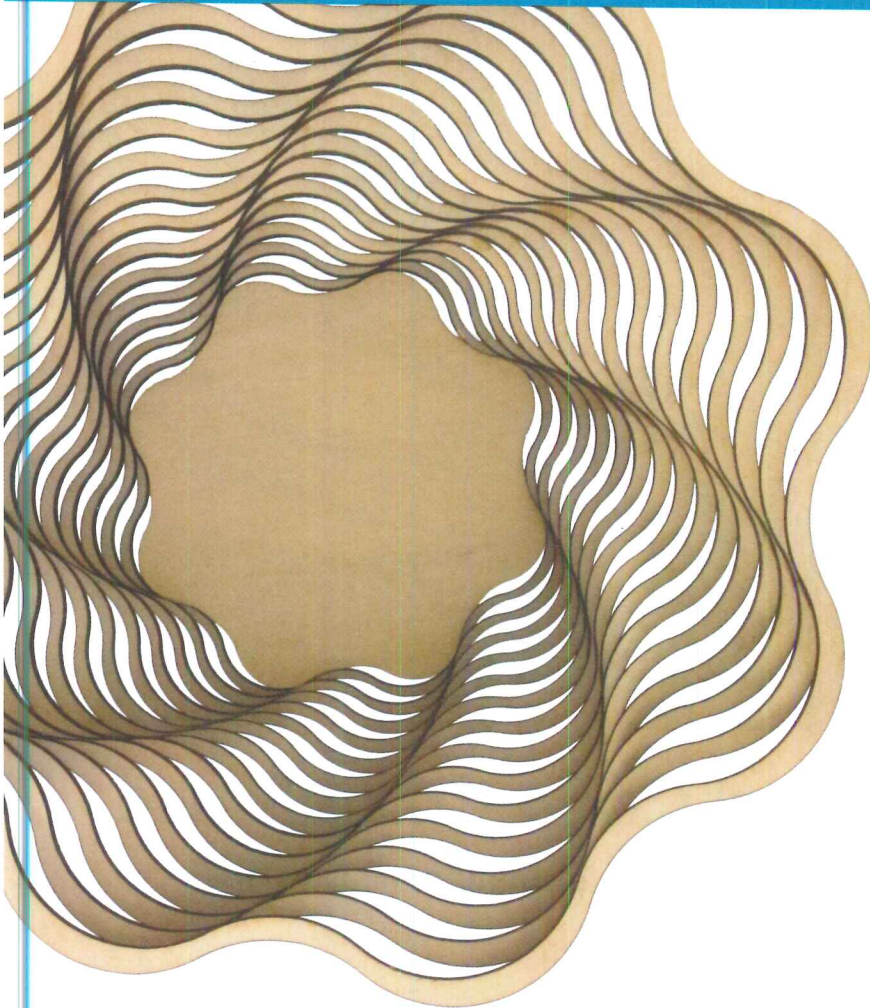

Spiral Wood Bowl, \$55

Star Spangled
Spatula, \$14

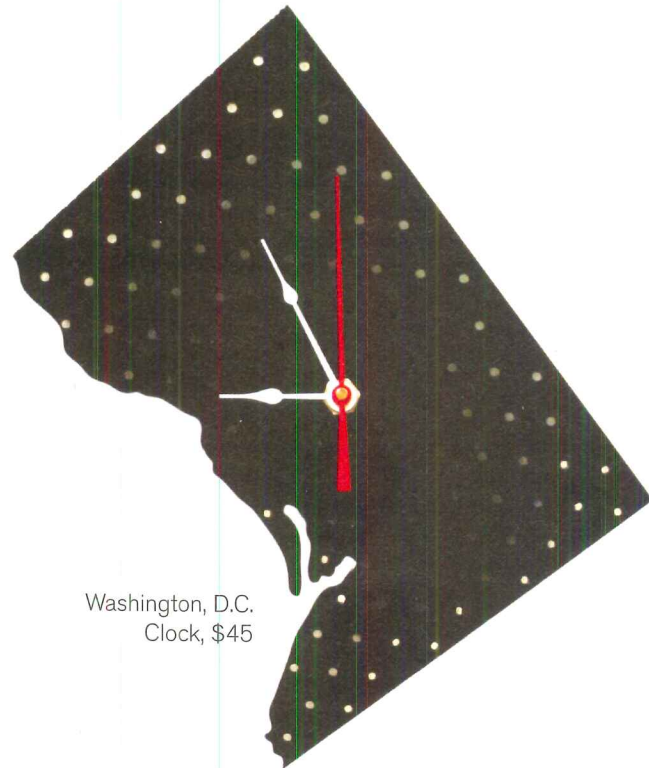

Washington, D.C.
Clock, \$45



nbmshop.org
401 F Street NW Washington, DC

Photo courtesy of Dryvit Systems, Inc.

Exterior Insulation and Finish Systems (EIFS) provide continuous insulation to meet the latest code requirements in a wide variety of architectural finish options.



EIFS – Performance Beyond Code Compliance

Exterior Insulation and Finish Systems provide continuous insulation, air barrier integration, and finish options all in one system

Sponsored by Dryvit Systems, Inc. | *By Peter J. Arsenault, FAIA, NCARB, LEED AP*

The movement to improve energy performance in buildings and lower their environmental impact is dramatically affecting the way new and renovation projects must be designed and built. This is particularly true with recently enacted energy code requirements for continuous insulation and continuous air barrier integration. Architects and building engineers looking for ways to meet or exceed these code requirements are more carefully looking at exterior wall assembly details. Finding ways to achieve the needed performance, maintain a budget, and still address aesthetics are all part of creating a successful design. Toward that end, Exterior Insulation and Finish Systems (EIFS) have been gaining favor as a tested and proven solution to this challenge. The system has always been based on a continuous insulation layer located on the outside of the exterior wall assembly. Compared to many traditional exterior cladding alternatives, it has historically proven to be

very cost competitive. Due to manufacturing advances, performance and aesthetics aren't mutually exclusive since the latest offerings include a wide variety of finishes, textures, and colors providing the aesthetic appearance of brick, granite, stone, metal, and stucco.

THE 2012 CODES: RAISING THE BAR ON PERFORMANCE

The family of International Codes promulgated by the International Codes Council (ICC) has either been adopted directly or used as the basis for building codes in most states and jurisdictions around the country. Throughout this article we will refer to provisions of the 2012 ICC codes but as with all code-related matters the local governing jurisdiction should be consulted for any details of applicability or clarification of locally adopted versions. We will also be discussing only commercial buildings defined as anything that is not a single-family or two-family residential building.

When it comes to the make-up of exterior walls in commercial buildings, the International Building Code (IBC) dedicates an entire chapter to this subject. Specifically Chapter 14 is appropriately titled "Exterior Walls" and provides a considerable level of both prescriptive and performance requirements. Like all code provisions, it does not offer design solutions, rather it indicates functions that must be met in the construction of an exterior commercial wall in rather specific terms.

In discussing the various components of exterior walls, there are several common terms used that are also defined by the code. An "exterior wall" is defined as a load bearing or non-load bearing wall used as an enclosing wall for a building. An "exterior wall assembly" or "wall envelope" is the total collection of components that are assembled to produce the final wall construction including framing, sheathing, and finish materials. An "exterior wall covering" is one or more finish materials

applied to the outermost surfaces of an exterior wall assembly of which it is a part. A “vener,” including masonry, wood, or others, is a facing type of exterior wall covering that does not add any strength to the wall assembly.

IBC Section 1403.2 – Weather Protection

Starting with the basics, the IBC states that “Exterior walls shall provide the building with a weather-resistant exterior wall envelope.” The intent is to protect the wall assembly materials and the building interior from the detrimental effects of the exterior environment. In particular it goes on to require four specific measures to achieve this intent:

Flashing. First is the use of flashing (discussed in detail in 1405.4) that is installed to prevent moisture from entering the wall assembly or to redirect it to the exterior where that happens. The code is rather specific about listing multiple places where flashing is required including door and window perimeters, wall penetrations/rough openings, terminations, and intersections with other elements and projections.

Water-resistive barrier. Second, the IBC requires the prevention of water accumulation in the wall assembly by requiring a water-resistive barrier behind the exterior wall covering. This barrier layer is described in more detail in Section 1404.2 but essentially calls for a minimum one layer of an approved material such as No. 15 asphalt felt complying with ASTM D 226 for Type 1 felt or other approved materials. This barrier can be attached to the exterior side of studs or sheathing but if conventional stucco is used, then the code requires two layers of water barrier. (This barrier will need to be fire tested as part of the testing discussed further for the overall wall as well.)

Drainage. Third, it goes on to require that a means of drainage be provided for any incidental water that does enter behind the exterior wall covering. This can take on the form of properly flashed weepholes detailed into masonry veneer construction or similar appropriate detailing at the bottom of rain screen assemblies where other finish surface options are used.

Condensation prevention. Fourth is protection against condensation forming in the wall assembly (addressed in 1405.3 and the International Energy Conservation Code, IECC). There are somewhat different provisions for different climate zones in the U.S., but code compliance is essentially achieved by providing a Class I or II vapor retarder in the exterior wall. Class I is described as sheet polyethylene film or

non-perforated aluminum (foil) creating a very high level of protection. Class II is described as kraft paper faced batt insulation providing a lesser but acceptable level of condensation protection. Not allowed in this case is a Class III vapor retarder which is defined as latex or enamel paint.

International Energy Conservation Code (IECC) – 2012

One of the benefits of the full family of International Codes developed by the International Code Council is that they have been developed together so they are compatible and complementary with each other. This is the case with the IECC which builds upon the basic building code provisions in the IBC and adds compatible requirements for energy efficiency in buildings. As a comprehensive energy conservation code, it establishes minimum regulations for energy-efficient buildings using prescriptive and performance-related provisions. While the IECC addresses both residential and commercial buildings, Chapter 4 focuses specifically on commercial buildings.

With respect to energy-efficient design, the first fundamental decision that needs to be made is which energy code will be used in the design of a commercial building. The IECC recognizes that there are highly developed national standards in place with the similar intent for energy efficiency and therefore has adopted them by reference. The most significant one is the ASHRAE Standard 90.1, the latest edition of which is 2010. Since this standard addresses all of the same items and issues as the IECC, code compliance can be demonstrated using either the criteria listed solely in the IECC or using the criteria in ASHRAE 90.1. There are some differences between the two in that one may be more stringent or lenient than the other on certain specific items. However the end result for determining overall energy efficiency is regarded as equivalent.

There is a catch here, however. The entire design team must agree on which basis is being used to demonstrate compliance with the code on all aspects. Either all of the IECC provisions or all of the 90.1 provisions must be selected—they cannot be co-mingled. The choice will affect all aspects of energy efficiency including the entire building envelope, fenestration, mechanical systems, lighting design, and electrical loads. Since we are limiting our discussion to exterior walls here, the distinction is slight, since items addressed in both the code and 90.1 are the same, although requirements vary slightly. Familiarity with the actual language in the selected compliance path will obviously be important for specific building projects with specific design teams.

In regards to exterior walls, there are

essentially two significant requirements that have been updated in the IECC and addressed in 90.1. These two items are added in addition to the four listed in the IBC.

Continuous insulation. The energy code and adopted standards have always established minimum insulation and thermal performance levels for exterior walls. The latest versions recognize the limitations of construction and in many cases require not only common wall cavities in stud wall construction to be insulated, but for continuous layers of uninterrupted insulation to be provided as well. The reason behind the requirement comes from extensive study and analysis by ASHRAE and others on the notable inefficiencies of traditional cavity wall insulation, particularly using metal studs. The issue is the numerous interruptions of the insulation by the framing members or studs that act as direct “thermal bridges” between the inside and outside. Many architects and engineers understand that the insulation is compromised in this situation and therefore decide to simply increase the amount of insulation to raise the R-value between the studs. While this sounds logical, ASHRAE studies have shown it doesn’t work. The reality

CONTINUING EDUCATION



EARN ONE AIA/CES HSW
LEARNING UNIT (LU)

EARN ONE GBCI CE HOUR FOR LEED
CREDENTIAL MAINTENANCE

Learning Objectives

After reading this article, you should be able to:

1. Explore the latest energy code and sustainable building design standards for continuous insulation (ci) and air barrier requirements for exterior framed wall assemblies.
2. Assess traditional cavity insulation methods and compare new strategies for higher sustainable building R-values through the use of exterior continuous insulation.
3. Analyze the challenges in framed wall design and detailing associated with the integration of continuous insulation (ci) behind traditional veneer cladding.
4. Investigate the interrelationship between continuous insulation (ci) and improved energy efficiency, reduced energy consumption, and overall improved sustainable building performance.

To receive credit, you are required to read the entire article and pass the test. Go to ce.architecturalrecord.com for complete text and to take the test for free.

AIA/CES COURSE #K1311R
GBCI COURSE #0090010674



PROJECT: Metro Career Academy, Oklahoma City, Oklahoma
ARCHITECT: Quinn & Associates, Oklahoma City, Oklahoma
GENERAL CONTRACTOR: CMS Willowbrook, Oklahoma City, Oklahoma
EIFS APPLICATOR: DMG Masonry, Arlington, Texas
EIFS TYPE & FINISH: Engineered drainage system with specialty brick and limestone finish

METRO CAREER ACADEMY

It is not an overstatement to say that clay brick masonry is the foundation of modern Oklahoma City. The look of brick and stone masonry continues to be very popular with area architects and building owners everywhere. However, the ever-increasing demands of climbing construction costs, energy efficiency, and life-cycle performance led architect Fred Quinn of Quinn & Associates to research different materials to meet the demands of this high-performance facility.

The original design of the Metro Career Academy (MCA) building called for 24,000 square feet of clay brick and 13,000 square feet of cast stone. When Quinn learned that he could use an EIFS with the same look and save nearly 50 percent in construction costs (materials and installation) versus the clay brick and stone, it was an easy decision.

In addition to this dramatic reduction in cladding costs, making the decision to switch to EIFS during the schematic design phase allowed the owners of the Metro Career Academy to harvest the full range of benefits from the lightweight cladding, including less structural support required, a reduced construction schedule, LEED points, projected energy savings, and fewer delivery trucks, i.e. reduced environmental impact. By substituting the 1.5 pound per square foot adhesively attached moisture drainage EIFS for the labor-intensive 40+ pounds per square foot masonry and stone, the designer was able to subtract more than 96 percent of the anticipated weight of the building's skin. Eliminating 1,424,500 pounds from the exterior walls of the building produced additional savings in the concrete and steel support system required to carry that initially designed load. Cris Callins, manager of preconstruction with CMS Willowbrook, estimated that the

reduced demand for structural support and the more rapid installation of the EIFS allowed her project manager to cut a full 15 weeks from the MCA building's construction schedule, lowering manpower, equipment, and insurance costs as well as easily meeting the owner's demanding completion date.

The MCA project utilized 4 inches of exterior continuous insulation (ci) as part of the EIFS, which helped the MCA to achieve its goal of LEED Gold certification for this project. The project earned the full 10 points in the Energy & Atmosphere Credit 1 category available under LEED v2.2. The computer modeled performance anticipates an energy usage savings of 34.8 percent and an energy cost reduction of 42.8 percent annually compared to the baseline. Without taking into consideration rising costs of energy or inflation, it is possible to conservatively estimate the value of these energy savings over a 50-year life cycle of the MCA facility at more than \$1.7 million.

Overall, the EIFS assembly allowed the entire project team to increase the insulation value of the wall, enhance the moisture protection of the building envelope, and lower the cost of the exterior cladding, while retaining the desired look of masonry and stone. The engineered, fully tested system includes:

- ▶ Fluid-applied AWRB
- ▶ Fluid-applied flexible flashings at all transitions and wall penetration rough openings
- ▶ Drainage plane with weep details
- ▶ Exterior ci
- ▶ Continuous air barrier
- ▶ High-impact reinforced assembly
- ▶ Flexible aesthetic finish coat conveying original brick and stone appearance

is that using a minimal R-11 cavity insulation between steel studs has been tested to show that the effective R-value of the wall to be about R-5.5 or 50 percent less than the stated insulation R-value. Increasing the insulation to R-19 doesn't perform much better since its effective R-value tested out at just over R-7 or 63 percent less than its stated value. Even bumping the insulation up to R-25 only creates a modest effective R-value of R-7.75 or 69 percent less than the stated value.

Recognizing this significant practical problem, the IECC and ASHRAE 90.1 allow for two means to demonstrate thermal performance. The first is with prescriptive R-values for walls based on the building's location in one of eight climate zones throughout the U.S. Those prescriptive requirements now include many instances where a minimum amount of continuous insulation (ci) must be used in addition to insulation provided between the studs. The ci reduces the thermal bridging effect of those studs and allows the true effective R-value of the wall to be higher than without it. The R-values listed in the code apply only to the insulation itself and assume cavity stud wall construction to allow for an adequate overall energy performance of the wall.

The second way to demonstrate thermal performance is to show a calculated U-factor for the total wall assembly, not just the insulation. ASHRAE 90.1 includes Appendix A which lists various common wall assemblies and their tested U-factors. If the wall assembly being used in a particular project is not listed, then it will need to be custom calculated. While that is relatively easy for wood frame construction, it is more complicated for metal stud construction or other alternatives. Hence, it is likely that some sophisticated software

Photos courtesy of Dryvit Systems, Inc. and The Dow Chemical Company

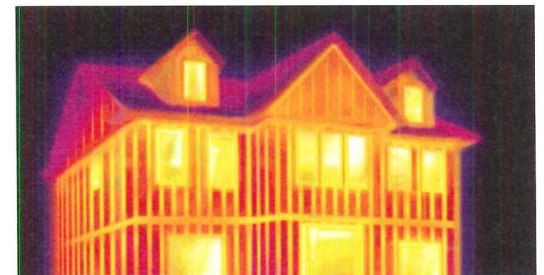

Thermal imaging shows the notable difference in heat loss between an exterior wall that relies on stud walls with cavity insulation (top) and a wall that uses continuous insulation (bottom).

will be needed such as THERM which is publicly available from Lawrence Berkeley National Laboratory (LBNL). Either way, code compliance is demonstrated by comparing the maximum allowable U-factor in the code or 90.1 to the identified U-factor for the wall in the subject building. In many cases, the U-factor analysis will likely be more stringent than basing compliance on the R-value tables in the code. However, for walls that are completely insulated with ci, the difference will likely be less significant since the full R-value of the ci is realized in the assembly and not compromised by thermal bridging.

Air leakage/continuous air barrier requirements. Both the 2012 IECC and ASHRAE 90.1-2010 recognize the significant impact that unwanted air infiltration has on a building's energy performance. It has been well proven that air leaks and drafts that occur around wall openings, penetrations, joints, transitions, and other common building elements add up quickly to become the equivalent of leaving a window or door open in a conditioned space. The code and 90.1 each address this issue and mandate that certain things be done; however they vary in their approach. ASHRAE 90.1 requires the general sealing of joints, seams, and material transitions throughout the building. It identifies exterior sheathing with sealed joints as an approved air barrier "material" in this case. The IECC includes the same air sealing requirements but goes beyond to specifically require a continuous air barrier be included in the exterior wall system in all but the three warmest climate zones. To demonstrate compliance, this air barrier must be tested based on any one of three options:

- A. The material itself can be tested to meet an air permeability rating (≤ 0.004 cfm/ft² @ 75 Pa pressure per ASTM E 2178).
- B. A full wall assembly can be tested to show an average air leakage (≤ 0.04 cfm/ft² per ASTM E 2357, 1677 or 283).
- C. The entire building can be tested after it is constructed and show an average air leakage (≤ 0.40 cfm/ft² per ASTM E 779).

Regardless of the compliance path selected, the intent is the same—reduce air infiltration in buildings to an acceptable level. Further, the means to do so must be designed to withstand positive and negative pressures and stack effect pressures.



Properly designed EIFS meet all of the building code requirements for using foam plastic insulation in exterior walls.

IBC Chapter 26 – Foam Plastic Insulation

Certain types of foam plastic insulation have become popular in recent times because they not only provide thermal insulation, they can also provide water resistance, continuous air barrier qualities, and condensation prevention in some cases. Recognizing the growing use of foam plastic insulation in exterior wall assemblies, the code identifies three specific safety criteria that must be met. Primarily and justifiably so, the intent is to protect the building and people in the event of a fire where combustible plastic materials are present. Therefore all three of these conditions must be met when using them; however it is the third one that is usually the most significant:

- A. Surface-burning characteristics are the first set of criteria including a maximum flame spread index and a maximum smoke developed index based on the standard ASTM E 84 test procedure. (Section 2603.3/2603.5.4)
- B. Second, a 15-minute interior thermal barrier is required in order to separate the interior from

the foam plastic in the event that a fire does occur. (Section 2603.4/2603.5.2). The stated acceptable thermal barrier in this case is ½-inch gypsum board or a demonstrated equivalent that will provide the needed separation.

C. Third and most important the testing of the complete exterior wall assembly is required whenever foam plastic insulation is used. (Section 2603.5.5). Under this part of the code, the specific exterior wall assembly being used must be tested in accordance with and comply with the acceptance criteria of NFPA 285. That means that any given foam plastic product needs to be tested multiple times since it is the total wall assembly, not just the foam plastic that is being tested. This requirement holds regardless of the wall classification type for commercial buildings (type I, II, III, or IV).

Continues at ce.architecturalrecord.com

Peter J. Arsenault, FAIA, NCARB, LEED AP, is a nationally known architect, sustainability consultant, technical writer, and continuing education presenter. www.linkedin.com/in/pjaarch



Outsulation® by Dryvit is a fully tested, code-compliant EIFS, providing an air/water-resistive barrier, exterior CI, and durable finishes to buildings worldwide. Outsulation offers lower construction costs, improved energy efficiency, and long-term sustainability compared to other exterior walls. The final appearance can look like brick, stucco, metal, granite, and limestone. www.dryvit.com

Photo courtesy of Chase Doors



Selecting doors made from materials appropriate to the environment where they are installed is key to the long-term success of a design project.

CONTINUING EDUCATION



EARN ONE AIA/CES HSW
LEARNING UNIT (LU)

Learning Objectives

After reading this article, you should be able to:

1. Compare the construction differences between a typical hollow metal door and a fiberglass door system.
2. Assess the benefits of using fiberglass door systems in terms of durability, cleanliness, and longevity.
3. Identify applications where fiberglass door systems are desirable as compared to traditional hollow metal doors to improve health, safety, and the life-cycle cost of a door system.
4. Specify a fiberglass door system for use in a food, pharmaceutical, or chemical manufacturing facility including hardware and frame system to provide maximum efficiency, performance, and sustainability.

To receive AIA/CES credit, you are required to read the entire article and pass the test. Go to ce.architecturalrecord.com for complete text and to take the test for free.

AIA/CES COURSE #K1311M

Fiberglass Door Systems

Long-term durability and high performance are achieved by specifying the most suitable door materials

Sponsored by Chase Doors | By Peter J. Arsenault, FAIA, NCARB, LEED AP

When selecting or specifying doors, architects commonly have four materials to choose from—namely wood, aluminum, metal, or fiberglass. Wood doors are commonly regarded as suitable for lighter-duty interior or exterior applications where the wood grain appearance is desirable. Aluminum doors are typically found in exterior storefront or interior applications where extensive glass or glazing is used. For many other commercial, industrial, and institutional settings, hollow metal doors and frames are often seen as the default door system. However they have limitations particularly in high-use, heavy-duty, or corrosive environments. In those cases, rust, denting, and deterioration become ongoing maintenance issues that can reduce performance and notably shorten their useful life. In response, fiberglass reinforced polymer (FRP) doors and frames have become widely

used to overcome the limitations of other door systems, thus providing a preferred choice.

DOOR SYSTEMS OVERVIEW: COMPARING CHOICES

One of the keys to a successful building design is the selection and specification of the best material for a particular application. For many buildings that includes the best door material. For purposes of this article we are going to focus on buildings that have high demands either because of high usage or their surrounding interior or exterior environment. In those cases, the choices narrow down to door materials that have been tested and shown to perform well in those situations. Wood and aluminum do not commonly perform well in those situations, so we will focus our comparison on metal and fiberglass door systems.

Metal Doors and Frames

Historically, metal was more commonly used as a cladding for protecting wood doors than an independent door material. In the mid 1800s, for example, contractors began cladding wood doors with steel to protect them from impact by livestock. It wasn't until 1879 that the "hollow metal door" was invented by the Mesker Door Co. in St. Louis, Missouri. It clearly caught on, becoming a popular choice and has evolved dramatically since then.

As the number of metal door manufacturers grew, so did the need for standards for the use of metal doors in buildings. The Chicago-based National Association of Architectural Metal Manufacturers (NAAMM) established in 1938, with roots reaching back to 1907, emerged as a preeminent organization representing members engaged in metal manufacturing. In 1969, they created a separate division known as the Hollow Metal Manufacturers Association (HMMA) which is today its largest division. HMMA is a voluntary, non-profit business association comprised of more than 60 member companies throughout North America that manufacture hollow metal doors and frames. In addition, the Steel Door Institute (SDI) was established in 1954 as a voluntary, unincorporated, non-profit business association whose mission is to promote the use of steel doors and frames in the construction industry. Representatives of SDI member companies create and publish manufacturing, quality, and performance standards and distribute them to licensed architects and construction specifiers at no charge.

With this history and level of development, hollow metal doors are fairly predictable in their types, styles, and elements of their systems. The door panel itself is actually less "hollow" today and typically incorporates an internal framework, reinforcements for hardware, and a core material beneath steel skins on each side. The core material used can vary based on desired door performance criteria and can include honeycomb cardboard spacers, urethane or polystyrene insulating cores, gypsum for fire doors, and even wood. The steel door skins are attached to the internal core and framework, and are most commonly joined together around the perimeter of the door panel creating a visible lock seam. In cases where the aesthetics of that seam are undesirable, it is filled, ground, or welded to cover it.

Similarly, metal door frames have evolved to be fairly simplified and predictable. They are usually manufactured by the same companies that manufacture the doors and are intended as a matched set. There are a variety of profiles possible to accommodate a wide range of wall thicknesses and design conditions in both rigid, welded frames and "knock-down" frames that

assemble on site. These have become fairly standard and relatively easy to incorporate into many building projects.

Based on the aforementioned, hollow metal doors can be evaluated for use in buildings with the following common pros and cons:

METAL DOOR PROS

- ▶ **Ease of manufacture** – Design is friendly to high-volume production.
- ▶ **Cost effectiveness** – Manufacturing technique is streamlined, making them easy and economical to manufacture.
- ▶ **Variety of core materials** – Doors can be created to adapt to many different applications.
- ▶ **Fire rating** – Metal doors can be manufactured and labeled with fire ratings from 20 minutes up to 3 hours, allowing for appropriate installation in fire-rated walls.
- ▶ **Standard hardware options** – Hinges, locks, and closers can fit virtually any manufactured door panel.
- ▶ **Universal acceptance** – Metal doors are used in virtually every commercial facility type in the world.

METAL DOOR CONS

- ▶ **Rust problems** – Moisture is the enemy of every hollow metal door.
- ▶ **Welded design** – Interior trapped moisture means that the door begins rusting from the inside out the day after manufacture.
- ▶ **Seams** – Lock seam design means there are visible seams, gaps, caps, etc.
- ▶ **Limited door sizes** – Metal doors are available in manufacturers' "standard" sizes with custom sizes available for a premium cost.
- ▶ **Maintenance required** – Metal doors must be painted after installation and maintained unless expensive stainless steel is used.
- ▶ **"Hollow panel" core** – Interior cavities of door can harbor dust, dirt, bacteria, etc.

Acknowledging these pros and cons of metal doors helps to determine when it is appropriate to use them and when it may not be.

Fiberglass Doors and Frames

Unlike metal, fiberglass is a newer, although well-proven material for doors. The first

fiberglass doors were manufactured nearly 40 years ago in 1975—almost 100 years after the first hollow metal door. Initially they were developed for the petrochemical industry where the focus was chemical resistance to replace hollow metal doors in highly corrosive environments. The metal doors were not holding up in these locations and an alternative was needed.

Although its history may be shorter, there are indeed organizations and standards that have been developed for them as well. The American Architectural Manufacturers Association (AAMA) has been in existence since 1936 with a goal to develop standard test methods and performance specifications for the fenestration industry in order to protect customers by providing them a basis for an "apples to apples" product comparison. As a material-neutral organization, AAMA brings together window, door, skylight, curtain wall and storefront manufacturers, suppliers, and test labs to represent individual and shared concerns. Their membership is comprised of large and small companies that are both residentially and commercially focused. They have created a Fiberglass Material Council as well as a Door Council, both of which provide relevant information and standards for fiberglass doors. They point out that since fiberglass doors are often mechanically assembled in the factory through chemically welded or bonded assemblies, they provide a high degree of quality, consistency, and reliability.

Functionally speaking, fiberglass doors are conceptually very predictable and similar to hollow metal door systems. They are manufactured with fiberglass door skins that are produced first using a full gel coat finish in a pre-selected color and then laminated to a solid core material. Similar to a metal door, that core material can be selected based on performance needs from lightweight balsa, durable polypropylene, insulating urethane, or fire-resistant gypsum. The perimeter of fiberglass doors are then filled with a fiberglass matrix, giving the door a clean, monolithic finish.

Photo courtesy of Chase Doors

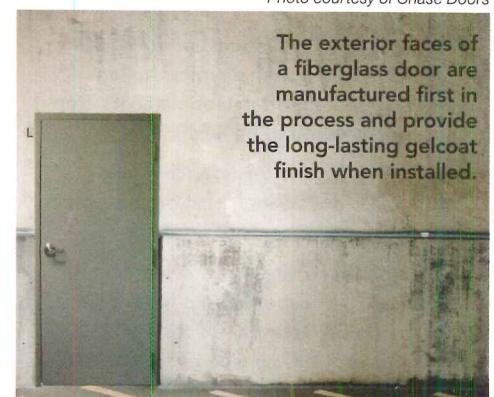

The exterior faces of a fiberglass door are manufactured first in the process and provide the long-lasting gelcoat finish when installed.

FIBERGLASS DOOR PROS

- ▶ **Ease of manufacture** – Design is friendly to high-volume production.
- ▶ **Corrosion resistance** – Fiberglass doors do not rust, corrode, or fail in corrosive environments or locations that require frequent wash-downs.
- ▶ **Maintenance free** – Fiberglass doors are manufactured with a permanent gelcoat finish.
- ▶ **Custom fabrication** – Door panels can be manufactured to virtually any standard or custom size.
- ▶ **Monolithic design** – No seams, gaps, or cavities means that bacteria or dirt have no place to gather.
- ▶ **Variety of solid core materials** – These add strength and the ability to adapt to different usage or performance applications.
- ▶ **Standard hardware options** – Hinges, locks, and closers can fit virtually any fiberglass door panel.
- ▶ **Custom hardware preparation** – The doors can be built to match any metal door manufacturer's standard for hardware locations.
- ▶ **Fire rating** – Fiberglass doors can be manufactured and labeled with fire ratings up to 1-1/2 hours, allowing for appropriate installation in fire-rated walls.
- ▶ **Regulatory approvals** – Fiberglass doors have earned acceptance in regulated facilities under the auspices of the U.S. Department of Agriculture (USDA) and the Food and Drug Administration (FDA) including specific programs such as Good Manufacturing Practices (GMP) and Current Good Manufacturing Practices (cGMP).

FIBERGLASS DOOR CONS

- ▶ **First cost** – The first cost of fiberglass doors is higher than a typical hollow metal door (although lifetime costs are often projected to be lower).
- ▶ **Limits on impact resistance** – The fiberglass door panel must be protected from excessive or sharp impact.
- ▶ **Permanent color** – Once selected, the gelcoat color is permanent for the life of the door. (Door panels can be field painted, but this eliminates the benefits of maintenance-free design.)

FRP frames are made using either FRP pultrusion or RTM (Resin Transfer Method) technology. FRP doors can also be used with existing standard hollow metal frames, although they are not usually recommended since they will corrode in a very short period of time in most applications where fiberglass doors are commonly used. Frames can be installed in a variety of ways either as butt-mount system against a wall assembly or can be sized and selected to wrap around the jamb wall.

Similar to metal doors, fiberglass doors have pros and cons as well. However, when it comes to evaluating them in situations that require durability and corrosion resistance, the pros are more prevalent than the cons. Perhaps the most significant difference is that fiberglass doors are

impervious to dirt, moisture, chemicals, bacteria, salt solutions, sea water, and other contaminants.

The listing of pros and cons makes it clear that fiberglass doors are particularly well suited to locations and environments that are demanding or corrosive. In fact, fiberglass is often used in underground mines for everything from bolts to doors.

FIBERGLASS DOOR MANUFACTURING PROCESS: CREATING LONGEVITY

While the details of manufacturing fiberglass doors may vary a bit between individual manufacturers, the basic process is necessarily the same across all of them. Essentially, the process is rather unique in that it works from the outside in where the outside of the door is manufactured first. This process follows these four basic steps:

1 DOOR SKINS

Fiberglass door skins are created utilizing mold technology. The pre-selected color of gelcoat is then applied uniformly over the mold and allowed to cure. Next, a coat of resin is applied to the "back" surface (inward side of the door) of the gelcoat followed by a layer of fiberglass matting. Additional resin is then applied which saturates the fiberglass matting. The layered material is rolled out, ensuring that the skin is smooth and eliminating any air pockets in the surface. Once the resin cures, the resultant skin is trimmed as needed. The release agent allows it to then be removed from the mold. The result is a very smooth durable fiberglass door skin that is 1/16" to 1/8" thick. The gel coat side has an aesthetically consistent mirror-like colored finish while the resin side is in its natural unfinished state. Note that the skin is commonly sized a little larger than the actual finished door to allow for it to be precisely trimmed to the exact size needed once the door is complete.

2 LAMINATION TO CORE

One skin is placed inside a press with the finished face down. The interior side is coated with resin and the core material is placed on top of the coated skin. The interior side of the second skin is then coated with resin and placed on the opposite side of the core. The resulting combination is a three-layer assembly with the gelcoated skins facing outward and the central core covered by the resin side of the skins. The combined panel (core and skins) is then placed inside a press and allowed to cure. The end result is a solid panel with a smooth finish. Note that the core is deliberately sized to be slightly smaller than the skins so that there is an intentional overhang of the skins all the way around the panel. This creates a recessed edge condition on all four sides that allows for the next steps.

3 EDGE FILLING

Once the panel is laminated and cured, the recessed edges are ready to be filled with fiberglass resin material, thus creating the door's monolithic appearance. First the panels are placed on edge and reinforcements are placed at hardware connection points. Fiberglass matting is then wrapped around the perimeter of the panel to reinforce the edges. Next, resin is poured into the cavity between the skins along the edge of the core, creating a chemical bond with the skins and the core. The end result is a continuous fiberglass perimeter on all sides of the door panel without a seam. The solid reinforced resin around the perimeter provides continuous support for the skin edges while the chemical bond assures that it will remain secure and intact.

4 FINAL DETAILING

The final manufacturing step involves several exacting processes to assure that the panel is finished to the exact dimensions required and prepared for any remaining items. First the panel is machined to its final size and shape, including cutouts and preparations for hardware. When it comes to final detailing for hardware, there are as many options as any other door type. Similarly, preparation and detailing work for locksets, deadbolts, flush bolts, passage hardware, etc. are all undertaken to match a specific manufacturer. In some cases, the door manufacturer may offer complete installation of the hardware, thus saving time in the field with its installation and assuring complete coordination and compatibility.

Photos courtesy of Chase Doors



Exterior door locations that are exposed to salt air or heavy moisture conditions are logical places to use fiberglass doors.

Door Frames

Beyond the manufacture of the door panels, most manufacturers offer both pultruded fiberglass frames and Resin Transfer Molding (RTM) frames for their door systems. Pultruded fiberglass frames can be butt mounted or wrapped for most wall conditions, including insulated panel walls. RTM frames due to their solid profile can only be butt mounted. Frames are commonly available with a variety of mounting systems.

Pultruded fiberglass frames are typically constructed of 1/4-inch-thick material. Fiberglass pultrusions were invented in the late 1940s and 1950s and are commonly in use in buildings of many types around the world. The AAMA describes the specific process as glass strands being pulled through resin baths and then shaped through a die or a mold to create a finished lineal material. The die is the key to the final shape and in this case will form the profile of the door frame. The lineal frame is then cut into sections for the head and jamb pieces and installed in the field.

By design, pultruded frames typically conform to Steel Door Institute and other industry standards for shape and installation methods. The corners of the fiberglass frames are usually mitered with no exposed fasteners, thus creating a desirable “clean” finish. Additional reinforcement can be added if required by the application or to accommodate specialty hardware. Most frames come standard with a satin finish in white, gray, tan, or brown. A variety of configurations and mounting options are also available, allowing products to be installed on concrete, brick, block, foam panel, drywall, and tilt-up wall systems.

When selecting a door, frame, and hardware, be aware that in some cases a manufacturer may offer a “pre-hung” fiberglass door and frame package. In this case, the entire door system (including hardware) can be factory assembled and shipped ready for installation in the opening. Installation time of the door system can be reduced by as much as 70 percent in this manner. Note that double doors are typically pre-hung to ensure a proper fit and that hardware functions properly, then broken down for shipping purposes.

DESIGN CONSIDERATIONS USING FIBERGLASS DOORS

We have been making the point that it is important to match the right door material to the building application where the door is installed. It does not serve anyone well to have an inferior door in a demanding environment any more than it makes sense to have an over-designed door system in a moderate environment. Therefore, it is important to be clear during the design stage about the things that different doors may be exposed to, sometimes varying significantly in the same building.

Door Locations

In medium-duty rooms, building portions, or entire buildings, hollow metal doors may still be the most appropriate design choice. This might be true in general offices, warehouses, dry manufacturing facilities, general industrial buildings, restaurants, retail stores, and dry storage locations. It might also be necessary in locations that require more than a 1-1/2-hour fire rating since metal doors can be rated up to 3 hours.

In both interior and exterior applications where corrosion or damage is a concern, fiberglass doors are usually the more appropriate design choice. As we have seen, fiberglass doors do not break down or corrode the way steel doors do when exposed to water, corrosive materials, or heavy usage. Hence fiberglass doors are logically selected for virtually any building type with exterior doors that are exposed to high moisture or salt levels due to their location near salt water, process water, or particularly rainy locations.

Note that fiberglass door cores are typically electrically non-conductive and therefore eliminate galvanic corrosion, including concerns connected with coastal environments. They can also be appropriate for indoor water exposure in buildings such as car washes or facilities that require regular wash-downs.

Other building types by their nature are corrosive environments that place high demands on doors due to the processes carried out in those buildings. These can include chemical manufacturing plants, pharmaceutical manufacturing facilities, pulp and paper mills, and wastewater treatment plants. Other locations require diligence for compliance with federal regulations regarding health and cleanliness such as USDA and FDA Regulated Facilities including cGMP and GMP Regulated Facilities. Many fiberglass doors are suitable for use in these locations and in fact may be one of the only appropriate choices. The processes being performed in these locations might include food manufacturing and processing including fruit and meat processing.

Finally, fiberglass doors can be the appropriate choice in coastal environments, especially hurricane-prone regions. Fiberglass doors can be manufactured with considerable strength of the skins and core; therefore, can meet and exceed the stringent wind and large missile impact requirements of the Florida Building Code.

Beyond the location, some design options and considerations are rather universal. Obviously the needed door sizes need to be determined either for functional, code, or preferential reasons. Similarly, their operation needs to be determined as swinging, sliding, double acting, etc. In the event that fire ratings are needed, keep in mind that fiberglass doors can achieve up to a 90-minute rating.

Continues at ce.architecturalrecord.com

Peter J. Arsenault, FAIA, NCARB, LEED AP, is a nationally known architect, sustainability consultant, technical writer, and continuing education presenter. www.linkedin.com/in/pjaarch



Founded in 1932, Chase Doors is the global leader and most recognized manufacturer of high-quality, made-to-order specialty door systems including corrosion-resistant doors, fiberglass doors, cold storage doors, sliding fire doors, pharmaceutical doors, and impact traffic doors. Chase Doors' manufacturing capabilities and exceptional customer service have earned them a reputation for premium products that are reliable and durable. www.chasedoors.com

The face of sustainability.



-Project: Scottsdale Fire Station
-Architect: LEA Architects <http://www.lea-architects.com>
-Product: Trenwyth, Trendstone

Trendstone®
Additional colors, sizes & shapes at Trenwyth.com



The face of masonry.

The face of masonry. No matter where you are, chances are we're somewhere close by. In fact, you've probably seen us many times before in the places you shop, work, play, learn and live. We manufacture the brands and products used in the interiors and exteriors of civil, commercial and residential construction projects across the nation. We're Oldcastle Architectural. We are the face of masonry.



For more information about our SmartBIM models and continuing education units, visit oldcastleapg.com/ceubim.html

Brands **TRENWYTH®** | ENDURAMAX™ | ARTISAN MASONRY STONE VENEERS™ | QUIK-BRIK® | AMERIMIX®

For more information on our broad range of products or for free literature call 1-855-346-2766 or visit oldcastleapg.com

CIRCLE 23

All images courtesy of Oldcastle Building Products

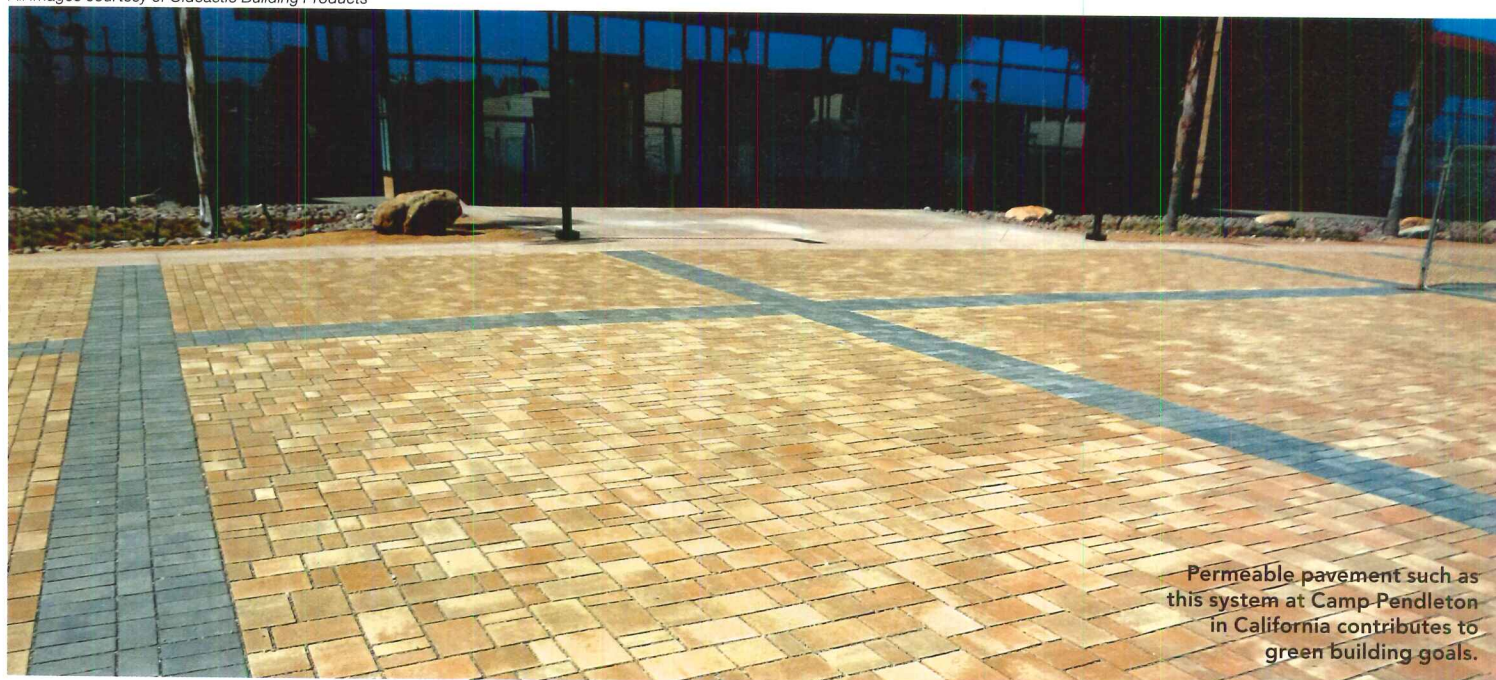

Permeable pavement such as this system at Camp Pendleton in California contributes to green building goals.

Paving the Way for Long-Term Stormwater Management

PICPs offer cost-effective, sustainable solutions for all climates

Sponsored by Oldcastle Building Products

Development brings changes to the hydrologic cycle. With development comes paved surfaces, which may well be the most ubiquitous structures ever built. In the United States alone, paved surfaces cover more than 43,000 square miles—an area nearly the size of Ohio—according to research published in the June 2004 issue of *Eos*, the newsletter of the American Geophysical Union.

But not all pavement is created equal. Impervious pavements can be concrete or asphalt, roofs or parking lots, but they all have at least one thing in common—water runs off of them, not through them. They collect and accumulate pollutants which run directly into water bodies. Because impervious surfaces promote less infiltration, peak flows of stormwater runoff are larger and arrive earlier, increasing the magnitude of urban floods.

By contrast, pervious pavement is designed to allow percolation or infiltration of stormwater through the surface into the soil below where the water is naturally filtered and pollutants are removed. Segmental pavements have been used since the Romans built the

Appian Way over 2,000 years ago. In recent years, flexible segmental paver systems, notably permeable interlocking concrete pavements (PICPs), have provided environmentally sound engineered solutions for municipal, commercial, and industrial applications.

This article will explore the impacts of development on the hydrologic cycle, explaining low-impact development as a way to mitigate negative effects, and assessing the importance of permeable pavement systems in achieving sustainable stormwater control. Also discussed will be the LEED categories to which permeable pavement contributes, and examples of how PICP systems function in real-world applications.

THE HYDROLOGIC CYCLE EXPLAINED

To understand the contribution of permeable segmental pavements to sustainable sites, it is important to understand the dynamics of the hydrologic cycle.

The natural hydrologic cycle involves recycling of water, the continuous circulation of water between the oceans, atmosphere, and land. Precipitation events produce stormwater,

CONTINUING EDUCATION



EARN ONE AIA/CES HSW
LEARNING UNIT (LU)



EARN ONE GBCI CE HOUR FOR LEED
CREDENTIAL MAINTENANCE

Learning Objectives

After reading this article, you should be able to:

1. Discuss the negative effects of development on the hydrologic cycle, and the mitigating effect of low-impact development.
2. Describe the dynamics of permeable pavement as they relate to a structurally and hydrologically focused system.
3. Articulate how PICP contributes to LEED and meets general green building goals.
4. Explain how underground stormwater storage is possible through PICP and can positively affect land planning.

To receive credit, you are required to read the entire article and pass the test. Go to ce.architecturalrecord.com for complete text and to take the test for free.

AIA/CES COURSE #K1311N
GBCI COURSE #0090010641

which can take a number of paths. It can become part of the groundwater, which feeds streams, wetlands, and underground aquifers and supplies much of our drinking water. It can form lakes or enter topsoil and evaporate, or it can be absorbed by plants and eventually evaporate from plant tissues. This cycle is contained to a degree within a watershed, which is naturally bounded by hills or ridges.

Managing stormwater runoff is critical and it constitutes a major part of site design. Nature has always provided a solution to manage stormwater runoff, naturally. Man, on the other hand, does not always get it right. As it was put in *Understanding Stormwater Management: An Introduction to Stormwater Management Planning and Design*, Ontario Ministry of the Environment, ©Queen's Printer for Ontario, 2003, "Humans interact with the hydrologic cycle by extracting water for agricultural, domestic, and industrial uses, and returning it as wastewater which may degrade water quality. Urban development also interferes with the natural transfers of water between storage compartments of the hydrologic cycle. There is decreased infiltration (seepage into the soil) of precipitation and snowmelt which leads to increased stormwater runoff."

When land is developed and covered with impervious surfaces like roads, buildings, and parking lots, the rain no longer infiltrates, or nourishes plant growth. In a post-development scenario, infiltration and evapotranspiration, both drop dramatically and runoff increases by 45 percent. Additionally, the runoff is often picking up pollutants which might include motor oils, gasoline, fertilizers, and pesticides. This type of pollution is called non-point pollution, and according to the U.S. Environmental Protection Agency (EPA), it is the leading remaining cause of water quality problems.

The initial flow of stormwater that runs off a surface or catchment area typically contains a much higher pollutant load than the stormwater that follows. This first flow is called the "first flush." The ability to catch and treat this first flush before releasing it into a stormwater system controls most of the pollution. Cities are particularly concerned with the quantity of urban stormwater discharge and its impact on streams and rivers. Not only does this large volume of water erode stream banks and streambeds, change the shape and dimension of river channels, and alter aquatic habitat and channel stability, in extreme cases it leads to floods and will affect the built environment through washed out roads and bridges.

Stormwater runoff also carries dust, dirt, and debris that can also degrade aquatic habitats. In some climates, collecting stormwater via impervious surfaces will raise the temperature



Retention ponds use valuable surface area.

of the water, which when released to streams and rivers, can harm aquatic species.

The Total Suspended Solids (TSS) measurement calculates the amount of dirt and some pollutants in runoff for a value used by regulating bodies to ensure the cleanliness of stormwater discharge. This is expressed as a percentage of removal where test results of surface removal of TSS were impacted by various sizes of chips in the voids, per a Florida Gulf Coast University study. According to the EPA, a Total Maximum Daily Load, or TMDL, is "a calculation of the maximum amount of a pollutant that a water body can receive and still safely meet water quality standards. The most common pollutants coming from stormwater sources include sediment, pathogens, nutrients, and metals." TMDL levels are set by regulating bodies.

STORMWATER MANAGEMENT

Managing stormwater supports sustainability goals, and municipalities and developers have created strategies to prevent stormwater pollution and designed systems that treat stormwater and route it safely back into the natural environment. Traditional stormwater management techniques have taken a collect, convey, and centralize approach that views water as a waste product. The methodology focuses on collecting stormwater in pipes and transporting it off site as quickly as possible, either directly to a stream or river, to a large stormwater management facility, or combined sewer system linked to a wastewater treatment plant.

Common components of this method are impervious surfaces and retention ponds, both of which have their drawbacks. Traditional retention ponds use valuable surface area and

have proven to be expensive to maintain, usually requiring draining and dredging. Impervious pavements have a high cost of maintenance, they transfer pollutants and sediment to sewers and waterways, and increase winter maintenance expenses, providing a poor life-cycle cost.

Ecological Strategies

A more modern and sustainable view of stormwater management maintains the natural hydrologic cycle, prevents increased risk of flooding and stream erosion, protects water quality and the health of water bodies, and provides human uses of water. Low-impact development (LID) promotes these methods. Working to minimize impacts of development on the hydrological cycle of a watershed, LID addresses stormwater concerns through a variety of techniques, including strategic site design, measures to control the sources of runoff, thoughtful landscape planning, preserving and recreating natural landscape, and minimizing imperviousness to create practical, appealing site drainage systems that treat stormwater as a resource rather than a waste product. Examples of these techniques include bioretention facilities, rain gardens, vegetated rooftops, rain barrels, and permeable pavements.

By implementing LID principles and practices, stormwater can be managed to reduce the impact of built areas and promote the natural movement of water within an ecosystem or watershed. Applied on a broad scale, LID can maintain or restore a watershed's hydrologic and ecological functions. (For more information on LID see: www.lowimpactdevelopment.org/index.html.)

Best Management Practices

Best Management Practices (BMP) have been developed in order to help municipalities and other entities effectively control stormwater runoff. Comprising stormwater management and conservation practices proven to effectively control the movement of pollutants and prevent degradation of soil and water resources, BMPs can be divided into two categories: structural and nonstructural. Performance-based BMP tools allow for monitoring and adjustment to achieve wastewater volume and quality goals that will:

- ▶ Work within the landscape
- ▶ Focus on prevention
- ▶ Micromanage stormwater
- ▶ Keep it simple
- ▶ Allow for multifunctional landscape designs
- ▶ Capture and treat stormwater runoff at its source
- ▶ Maintain and sustain LID tools such as permeable pavement systems

In short, LID involves the three D's of stormwater control: disconnect, distribute, decentralize, that is, disconnect storm sewers, distribute the stormwater on-site, and decentralize this runoff by promoting

groundwater recharge where possible. Central to this system is permeable interlocking concrete pavement (PICP), which is able to capture rainwater for full exfiltration into the soils below or for capture and reuse locally.

PICPs—AN ECOLOGICAL APPROACH

Defined as a system of concrete pavers with joints that allow for infiltration of water through the pavement, PICPs are an engineered ecological system that captures, treats, and stores stormwater. The pavement uses an open-graded base and sub-base for water infiltration and/or storage. These systems can be designed for full exfiltration of the captured water or complete storage. They can stand alone or be used in conjunction with swales, ponds, or storage tanks.

PICP systems can be designed for 100-year hydrological events, with treatment zones that can also be included to encourage the use of naturally occurring enzymes to establish a bacteria colony that will break down the first flush pollutants within the system. In contrast to impervious systems, PICPs have demonstrated ability to provide competitive capitalization costs, reduce winter maintenance costs, and improve long-term savings by providing a 50-year pavement design.

Used in conjunction with bioremediation, PICP is a BMP treatment train used effectively in the U.S. for the past 10 years and in Europe for the past 20 years to mitigate peak flows and improve water quality. A method of removing pollutants using microorganisms in soil, bioremediation can occur naturally or it can be spurred on via biostimulation, which is the addition of fertilizers to increase the bioavailability within the medium. Recently, the addition of microbe strains matched to the medium have successfully enhanced the resident microbe population's ability to break down contaminants. Bio-swales have proven effective in this regard as well.

DESIGNING A PICP SYSTEM

PICP systems are very site-specific, engineered systems, as are all site solutions involving water, soils, and loading conditions. However, generalizations can be made for purposes of discussion. It is important to note that every PICP system requires a set of site parameters and must be designed and reviewed by a design professional—civil engineer, geotechnical engineer, or other qualified land planner/designer. PICP systems are most effective if treated as a first design strategy by engineers or other qualified professionals.

Full Exfiltration System

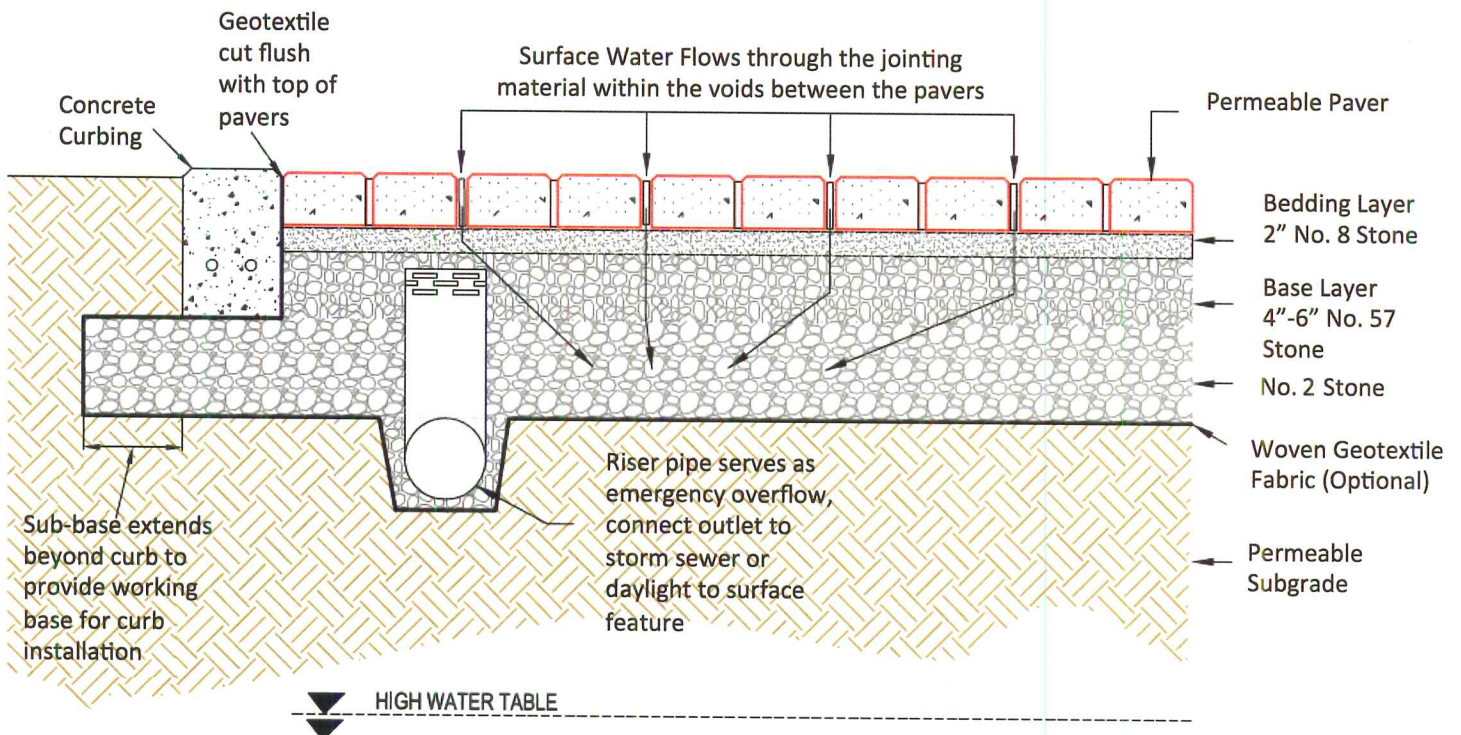

PICP is a system of concrete pavers with joints that allow for infiltration of water.

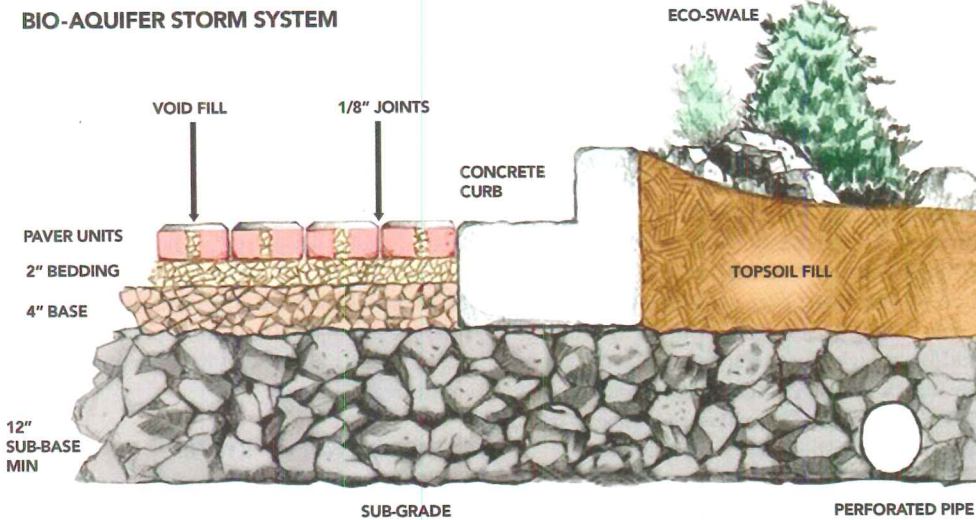

PICP systems are most effective if treated as a first design strategy.

Soil Considerations

The first step in designing a PICP system is a hydrologic analysis of in-situ soils or the sub-grade, with an additional structural analysis required for vehicular applications. Sub-grades should be at 92 percent density. For full exfiltration, the sub-grade should not be compacted during installation. If soils do not demonstrate a percolation rate greater than ½ inch per hour, a partial or no exfiltration

strategy should be considered. This would require compaction of sub-grade to 95 percent as well as use of an underdrain engineered to clear water from the loaded areas of the sub-grade within 24 (36) to 36 (72) hours. Clay soils lose strength when saturated; soil strengths are measured at a 96-hour saturated condition and will not perform as designed if saturated for a longer period.

Also, municipal peak discharge rates are set at 24 hours, and mitigating peak flows will be met by a permeable pavement system without compromising soil strength within this timeframe. If a longer time of concentration is required, the water should be moved to a non-vehicular loaded area or a structural tank, or a deeper aggregate cross-section should be considered to reduce excessive loading on the soils.

Aggregate System

PICP systems have three layers of aggregates, increasingly larger stones for the subbase, base, and bedding layers. The aggregates play an important part in filtering pollutants.

Most pollutants should be filtered out of the stormwater before it is discharged into the ground. In areas of higher pollutant levels or with high water tables, capture and treatment of the water are necessary. Depending on the pollutant level, a liner and biofiltration system may be used for a no-exfiltration system. A minimum of 12 inches of soil under the sub-base is necessary and will encourage removal of chlorides and some heavy metals with a full ex-filtration system.

Pollutants can be removed by the setting bed and void fill materials, or via the filtration action of the water passing by the aggregates laden with enzymes that will create a bacteria colony.

Void areas of the base and sub-base aggregate material play a key role in the system's reservoir capacity. Stormwater runoff is calculated for a site prior to development and expressed in a volume, e.g. cu-ft or ac-ft. When the site is developed, another hydrological analysis determines the increase in volume of runoff, the difference being the volume required for a detention or retention pond based on local regulations for a 2-year or 25-year or 100-year storm. The base and sub-base depth is designed to hold this increase in volume of water within the voids of the aggregates.

The void area or porosity of the sub-base aggregate will vary based on quarries and material runs and should be known prior to design. Typically, ASTM #2 develops voids at 41 to 45 percent, with a conservative value of 40 percent recommended to determine the appropriate detention/retention volume. The base material, #57, usually is credited at 32 to 35 percent void value. These values are also used to determine the depth of the aggregate sub-base based on area covered.

PICP System Design

ASTM #2 aggregate is used to build the sub-base. This will bridge clay soils without the use of a geotextile and provide a detention area of 40 percent suitable for detention/retention requirements. The base layer will act as a choking layer using ASTM #57 washed fractured stones that do not exceed a 4-inch depth. The setting bed layer will be washed and screeded to a level condition to receive the permeable pavers. Concrete permeable pavers that have been designed with ¼-inch minimum joints (and may or may not have non-structural openings larger than the joints called voids) when filled with ASTM #8, or #89 or #9 washed aggregates, will provide load transfer and infiltration and act as a filter. A concrete curb or edge restraint is required, and a bio-swale may be used as well to better enhance water quality. This system will provide a 20-year hydrological design value of 10 to 15 inches per hour.

Specifications and other guidelines may be reviewed at www.icpi.org; a design manual for PICP by ICPI is available as well as other design software for permeable pavement design.

Continues at ce.architecturalrecord.com



Oldcastle Architectural is the leading North American manufacturer of concrete masonry, lawn, garden, and paving products and a regional leader in clay brick. The group also produces packaged cement mixes, lightweight aggregates, bagged decorative stone, and lime and concrete roof tiles. Oldcastle Architectural operates across 35 states and 2 Canadian provinces. www.Belgardcommercial.com

WATER WILL DRAIN OUT.
COMPLIMENTS WILL POUR IN.



Belgard® Commercial permeable pavers and segmental retaining walls are the most innovative site solutions on the market. Cost effective and beautiful, they virtually eliminate runoff and can solve your storm water management issues. And, with top industry experts on staff who understand construction laws on a state-by-state basis, we offer consultation on any project. For more information on our diverse line of products and solutions available across the country, visit BELGARDCOMMERCIAL.COM.

CIRCLE 11

BELGARD®
— COMMERCIAL —

BELGARDCOMMERCIAL.COM

Building enclosures of all types create the barriers needed to assure good indoor air quality.



Designed, Sealed, Delivered— IAQ and the Building Enclosure

Materials used in the exterior enclosure affect the indoor environment too

Sponsored by UL Environment | By Peter J. Arsenault, FAIA, NCARB, LEED AP and Paul Bates, LEED AP, BD&C, Education and Training Program Manager, UL Environment

Historical building enclosures have evolved dramatically from simply providing basic shelter with little climate control other than shade and natural breezes. Today modern building enclosures rely on advanced engineering and architectural elements to control a full range of environmental conditions in addition to design aesthetics. In the quest to create higher-performing and environmentally preferable buildings, both new and renovated structures are influenced by a variety of professionals. Often the design of a building envelope is the responsibility of one part of a design team while indoor air quality can be the focus of

a separate interiors group. The reality is that these two areas are deeply interconnected. An understanding of those connections allows the entire design team to achieve a building design that truly performs well. Further, a coordinated approach can facilitate meeting certification standards for high-performing buildings.

THE MULTI-FACETED BUILDING ENCLOSURE

All buildings provide an enclosure to separate its inhabitants from the surrounding natural environment. The function of the enclosure is three-fold: first to protect the people and the interior of the building from the elements

—typically the enclosure keeps out heat, cold, water, bugs, UV rays, sound, etc. Second, it can keep in the desired humidity and temperature levels to maintain human comfort levels. And third, it can allow desirable connections to the natural environment such as daylight, views, air, access, etc. through openings in the enclosure.

Richard Rush, author of *The Building Systems Integration Handbook*, elaborates on the function and nature of building enclosures, which he refers to as the building envelope. He states: “The envelope has to respond both to natural forces and human values. The natural forces include rain, snow, wind, and sun. Human concerns include safety, security, and task success.” This



- 1** Below-grade construction consisting of foundation walls, concrete slabs, or other floor systems, which enclose the bottom side of the building
- 2** Exterior walls that enclose all sides of the building
- 3** Roof systems which define the top of the building
- 4** Fenestration or openings in the walls and roofing in the form of windows, doors, skylights, etc.

The functions of each of these four systems are to provide inherent structural support, moisture control, temperature regulation, air pressure stability, thermal comfort to occupants, and integrity of the assembly over time. Altogether, the enclosure also affects ventilation and energy use within the building. While each of the four systems typically relies on different materials and details to achieve these ends, each is typically constructed of building products assembled in multiple layers. Each layer may serve one or more of the following critical performance purposes:

Rainscreen or wearing surface. This is the exterior surface that is exposed to the elements.

Drainage plane. Behind the wearing surface, a secondary provision is made for water to be captured and drain away harmlessly from the rest of the assembly.

Air barriers. This layer keeps unwanted air infiltration from entering the building or the assembly.

Vapor barrier. Preventing airborne moisture from penetrating the assembly and/or other locations in the building.

gets tied all together when the building enclosure “provides protection by enclosing and balancing internal and external environmental forces.” The key is finding the right balance between those internal and external factors.

Enclosure Systems and Layers

With the basic purpose established, the definition of a building enclosure necessarily requires incorporating some version of each of four basic systems:

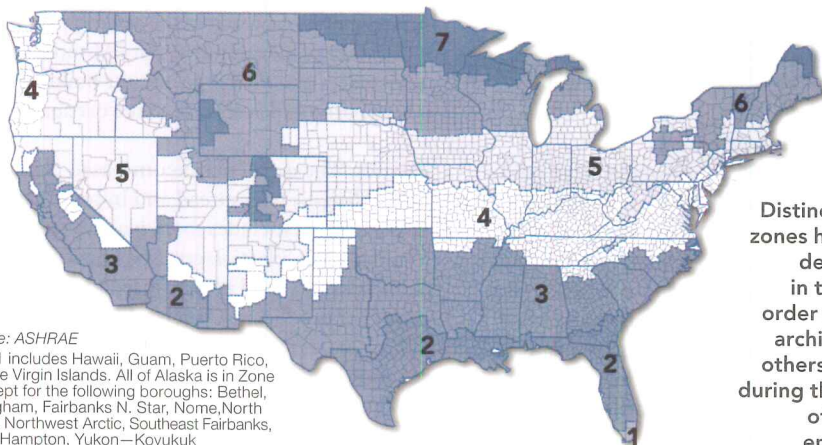

Source: ASHRAE
 Zone 1 includes Hawaii, Guam, Puerto Rico, and the Virgin Islands. All of Alaska is in Zone 7, except for the following boroughs: Bethel, Dellingham, Fairbanks N. Star, Nome, North Slope, Northwest Arctic, Southeast Fairbanks, Wade Hampton, Yukon—Koyukuk

Distinct climate zones have been determined in the U.S. in order to inform architects and others involved during the design of building enclosures.

CONTINUING EDUCATION



EARN ONE AIA/CES HSW LEARNING UNIT (LU)



EARN ONE GBCI CE HOUR FOR LEED CREDENTIAL MAINTENANCE

Learning Objectives

After reading this article, you should be able to:

1. Identify and recognize the critical component parts of the building envelope that can influence indoor air quality in buildings.
2. Investigate the sources of indoor air quality issues related to materials used in the building envelope.
3. Assess the impact of chemical exposure, ventilation, and moisture generated in building envelopes as they relate to indoor air quality.
4. Specify and design building envelope assemblies that mitigate or help prevent the potential issues of poor indoor air quality.

To receive credit, you are required to read the entire article and pass the test. Go to ce.architecturalrecord.com for complete text and to take the test for free.

AIA/CES COURSE #K1311J
 GBCI COURSE #0090010509

Thermal barrier. Materials used to slow the transfer of heat through an assembly. In ideal situations, this thermal barrier is not interrupted by structure or other elements.

Pressure boundary. A successful assembly will hold air back under pressure and not succumb to anticipated air pressure changes.

While the systems and layers may be thought of and designed individually, the goal of a well-designed building enclosure is that all of these work together for the same purpose.

Building Location

Building enclosures can be expected to respond to moisture, humidity, temperature and air pressure changes but how they do so will be highly influenced on the geographic location of the building. As would be expected, the local climate plays a big part in how the enclosure performs. Different climates have been well documented in engineering maps that identify different climate zones for the U.S. The particular climate zone where a building is located not only identifies the thermal performance criteria for a given building, it also dictates the placement of particular performance layers in the enclosure. This is especially true in locating control layers such as the vapor barrier and the air barrier.

Control Layer Continuity

Beyond location, an important aspect of each of the performance layers is the fact that they should all be continuous around the entire enclosure. A simple visual test to determine this continuity of layers involves looking at a cross sectional drawing of a building with all of the appropriate layers identified. Using a pencil and starting at the lowest level, draw a line along each of the layers all the way along the perimeter of the enclosure to see if the layers are in fact continuous. If you need to stop because something interrupts the layer, like a floor slab, structure, or protrusion, then the designer can see that this interruption is actually a breach in the layer and needs to be corrected.

Of particular significance are “thermal bridges” which are defined as conditions which create a breach in the thermal barrier layer. Essentially these conditions allow heat to be transferred directly through a conductive building element where that heat transfer was not intended. For example, an uninsulated concrete floor slab that protrudes out past an insulated exterior wall allows heat to be transferred directly between the inside and outside of a building, thus creating an unwanted thermal bridge.

Even in a carefully designed building, failures in the various systems and material layers can happen. Typically such failures occur in three main ways. First, moisture penetration into an assembly can cause deterioration of materials along with mold and mildew growth. Second, structural gaps, movements, or slab failures can cause a building to have multiple systems breached to the point where the building becomes uninhabitable. Third, people in the building can be exposed to potential health hazards. This third failure is one that we will focus on in the remainder of this article since it is often misconstrued to be limited only to materials used in interior construction. In fact, there are also health exposure hazards from building enclosure materials.

The Building Enclosure/IAQ Relationship

We often hear that people commonly spend 85 to 90 percent of their time indoors, meaning that they are primarily breathing the air from inside buildings. That indoor air is contained and directly influenced by the building enclosure. It is also common to hear that the indoor air quality (IAQ) in many buildings is worse than the outdoor air quality. This is usually because building occupants are exposed within the enclosure to a mix of pollutants including complex indoor chemicals and other irritants such as dust, pollen, mold, and VOCs. Surprisingly, many of these indoor air pollutants are only measured but not regulated by the U.S. Environmental Protection Agency (EPA) like they are for outdoor air contaminants.

HEALTH IMPACTS FROM ENCLOSURE COMPONENTS

The chart indicates common materials of concern, their potential health hazards, and the types of building products that they are found in.

PLASTICS

- Chlorinated plastics—**carcinogens**
- Found in weather stripping; water sealers; adhesives, roof membranes

POLYURETHANE

- **Bronchial irritants**
- Found in insulation; coatings/paints; caulks; adhesives

VOCs

- **Carcinogens**
- Formaldehyde; benzene; toluene
- Found in insulation, coatings; adhesives

SEMI VOCs

- **Endocrine disruptor, reproductive toxicants**
- Phthalates, halogenated flame retardants
- Found in cover base, coatings; insulation

HEAVY METALS

- **Neurotoxicants**
- Lead, mercury, chromium, steel
- Found in flashings, exterior siding; stainless steel

EPOXY RESINS

- **Endocrine disruptor**
- BPA
- Found in paints, adhesives

Direct Pollutant Sources

While there has been plenty of attention paid to things like carpeting, furniture, interior finishes, and other materials related to IAQ, the building enclosure has been found to be a significant contributor to indoor air pollutants as well. Depending on the materials used and the assembly design, the building enclosure can exclude, release, or trap pollutants or it can be a possible source of pollutants itself. These pollutants may include:

PLASTICS: ENVIRONMENTAL PREFERENCE SPECTRUM

While one of the largest IAQ offenders today is the prevalence of plastics in building materials, not all plastics are harmful as seen in this chart ranking those less harmful to humans.

AVOID

■ PVC

■ Plastics with highly hazardous additives

VOCs. According to the U.S. EPA, most sources of indoor air pollution come from materials and products that “off gas” or emit VOCs after they are installed. In the building enclosure, sources can include manufactured wood products, adhesives, sealants, caulks, paints, coatings, surfacing, cladding, insulation, air barriers, and even wall board. When the VOCs off gas into the enclosure assembly they are basically airborne and may remain suspended there. However, once any air, moisture, or pressure infiltration occurs, these VOCs can start to move with that infiltration and be transferred to the building interior.

Formaldehyde. The construction industry is the primary end-user of formaldehyde-based products, representing 70 percent of its use overall. Just like VOCs when formaldehyde outgasses in a building enclosure system, it can be impacted by air or moisture infiltration and permeate into the interior of the building.

Particulate matter (PM). Dust or other particles can become trapped or built up inside an enclosure assembly. A breach in the assembly or an air infiltration point can move that PM through the open spaces and discharge into the building where it is airborne and accessible to the occupants.

Plastics. The use of petroleum-based plastics in buildings is widespread and in some cases, growing. This includes foam plastics used for insulation, plasticizers used in certain materials, and solid plastics used for a wide variety of products. As such, plastics are coming to be seen as one of largest health offenders in buildings today. It is important to understand, however that there is a range of safety or harmfulness depending on the particular

ABS-Acrylonitrile Butadiene Styrene
 EVA-Ethylene Vinyl Acetate
 PET-Polyethylene Terephthalate
 PEX-Polyethylene (PE) Cross-linked(X)
 PVC-Polyvinyl Chloride
 TPO-Thermoplastic Polyolefin

Source: The Center for Health Design® and Health Care
 Without Harm, *Designing the 21st Century Hospital*.
 Pls. go online for complete source information.



PREFER

- ABS
EVA
Polycarbonate
Polystyrene
Polyurethane
Silicone
- PEX
PET
- Polyethylene
Polypropylene
TPO
- Biobased plastics—
sustainably grown

plastic used. Polyvinyl chloride (PVC) or plastics with hazardous additives are clearly less environmentally preferable. By contrast, bio-based plastics and compounds such as polyethylene, polypropylene, and thermal polyolefin, are much more preferable.

Persistent bio-accumulative toxins (PBTs).

This is a class of contaminants found in various envelope materials such as flame retardants and anti-microbials. The EPA describes PBT pollutants as chemicals that are toxic, persist in the environment, and bioaccumulate in food chains and, thus, pose risks to human health and ecosystems. The biggest concerns about PBTs are that they transfer rather easily among air, water, and land, and span boundaries of programs, geography, and generations.

Moisture. The right amount of moisture in indoor air is desirable, but when moisture is allowed to pass into an enclosure assembly, it can exacerbate conditions related to IAQ. For example, it may create mold if there is an organic food source material available or its presence on formaldehyde-containing materials may actually increase formaldehyde emissions.

This listing shows the major types and enclosure sources of indoor air pollutants. However, since many materials and products are manufactured using many ingredients, buildings can yield thousands of chemicals, some of which we do not have complete information on.

Of course the reason to be concerned about any of these items is the health effects on people. These can include respiratory health problems including the growing occurrences of asthma in the U.S. Poor indoor air quality has also been linked to cancer and effects on reproductive systems and development, particularly in school buildings. With the health, safety, and welfare in mind of building occupants, it becomes imperative then, that architects and other design professionals address these potential health risks and exposures in buildings, including the enclosure materials. Specifications that require use of materials with low or no VOCs and no added formaldehyde certified by strong emissions testing protocols can greatly improve indoor air quality. Further, moisture control must be properly addressed since failures can compound IAQ by creating mold, mildew, or other conditions which may complicate any existing health issues of occupants.

Indirect Enclosure Impacts on IAQ

Beyond the direct impacts from pollutants that a building enclosure can have on IAQ, there are indirect impacts that must be addressed since they can be critically important as well. Specifically, IAQ issues are affected by temperature, air pressure, and moisture content which are controlled by both the building envelope and HVAC system as discussed further.

Air movement. Air will move through a building enclosure in various ways, both desirable and

undesirable. Unwanted air leakage occurs when air moves through some portion of the building enclosure into cavities or other places within the assembly. Since no building construction is perfect, it is safe to say that all building enclosures leak air. The only question is how much air do they leak and where the leaks are located. Tight buildings will leak a little while others can leak a lot. The key to good performance is controlling that flow and minimizing leaks.

There are multiple areas of concern regarding air leakage. First, bringing in some fresh air is good, sometimes for ventilating cavity spaces or simply allowing the building to “breathe.” But unwanted or excess air leakage can gather, carry, and deposit pollutants either from outdoors or within the assembly, causing potential issues. So when there is leakage, it can actually bring pollutants in, to add to the ones that are already in the materials, thus exacerbating the problem. Fine particles are examples of pollutants that we don’t want to collect in the interior space. Second, using the enclosure to keep contaminants away from people is desirable, but if the enclosure is too tight it can create one set of problems while not building the enclosure tight enough can create another set of problems. Third, moving indoor pollutants out of the building is essential so some controlled way of moving air is needed.

The usual measure of air infiltration is the number of times within an hour that the volume of air in a building can be replaced. This is measured simply as air changes per hour (ACH). Depending on the building type and the circumstances, the preferred ACH level could be very low (less than .5 ACH) to something higher (over 1.0 ACH). The actual level will be determined by the tightness of the air barriers in the envelope, temperature, and the air pressure levels inside and outside of the building. Air pressure is commonly measured in an SI standard unit called a pascal (Pa) named after the French mathematician Blaise Pascal and commonly used for barometric pressure measurement.

Continues at ce.architecturalrecord.com

Peter J. Arsenault, FAIA, NCARB, LEED AP, is a nationally known architect, sustainability consultant, technical writer, and continuing education presenter. www.linkedin.com/in/pjaarch

Paul Bates is an internationally recognized speaker and author of topics related to sustainable products and services.



UL Environment works to advance global sustainability, environmental health, and safety by supporting the growth and development of environmentally preferable products, services, and organizations. They help purchasers find products they can trust. UL Environment offers environmental claim validations, multi-attribute product certifications, environmental product declarations, indoor air quality certification, product emissions testing, organizational sustainability certification, and consulting. www.ul.com/environment

Photo courtesy of ECOSilence

A recycled rubber underlayment works with a direct application of most floor finishes, including ceramic tile.



Controlling Sound Transmission in Multifamily, Healthcare, and Educational Environments

When designing quiet facilities, floor-ceiling assembly construction is crucial

Sponsored by ECOSilence

Although many building designers focus on visual aesthetics, acoustics play a vital role in every building environment. Owners expect homes to be quiet, so they don't hear the neighbors. In a classroom, students are expected to focus and learn without being distracted by sound or unable to hear what the teacher says because of competing noise. In healthcare facilities, quiet not only promotes healing, but privacy is mandated: Patients have the right to private conversations with their healthcare providers. In each of these settings, acoustics is the key to meeting basic owner expectations.

ACOUSTICS 101

Before delving into the topic of acoustic controls, we need to know what we mean by “noise,” “sound,” and “control.”

Simply put, noise is unwanted sound. An air conditioner makes a soft, constant hum in the

background. As such, this sound helps mask more objectionable noises, such as intermittent traffic from outside. For most people, sounds that are objectionable typically are:

- ▶ loud enough to be uncomfortable.
- ▶ intermittent rather than continuous.

Acoustics—the science of controlling sound—is made more challenging by the way people perceive sound. Sound is created by vibrating matter. A person speaks in one room, causing pressure waves to travel through the air like ripples on a pond. When these pressure waves strike the room's walls, ceilings, and floors, some of the sound is reflected back, creating a reverberation that continues to bounce around the room until it loses energy. Some of the sound waves can cause the wall, ceiling, and floor to vibrate. This vibration, in turn, transmits pressure waves on the building assemblies on the other side of the wall. These

CONTINUING EDUCATION

 EARN ONE AIA/CES HSW LEARNING UNIT (LU)

Learning Objectives

After reading this article, you should be able to:

1. Explain the difference between interior room acoustics and sound transmission.
2. Clarify how the sound transmission characteristics of building assemblies are rated.
3. Describe how flooring systems can affect interior room acoustics and sound transmission in a building.
4. Suggest strategies for solving acoustic issues in multifamily buildings, healthcare facilities, and classroom environments.

To receive AIA/CES credit, you are required to read the entire article and pass the test. Go to ce.architecturalrecord.com for complete text and to take the test for free.

AIA/CES COURSE # K1311F

waves then strike the ears of occupants in the adjacent rooms and are heard, provided the frequency is in the range of 20 to 20,000 cycles per second (Hz), and the occupants have decent, healthy hearing. How much sound is reflected and how much is absorbed depends on the type of surface materials in the room.

INTERIOR ROOM ACOUSTICS VS. TRANSMITTED SOUND

The basic mechanics of sound that have just been described explain only part of the picture that building designers need to see. When a person speaks (or a radio or television blares), the sound is carried through the air. In buildings, however, there are also structure-borne sounds caused by direct impacts against the structure, such as doors slamming or people walking or jumping on floors. Depending on the building type, these structure-borne vibrations can be very intense. Equipment, machinery, high-volume traffic, rolling gurneys in a hospital, or basketball practice next to a classroom or library all impart vibrations that must be controlled.

There are two primary areas of architectural acoustics that address methods of controlling both air-borne and structure-borne sound transmission.

- 1) Interior room acoustics
- 2) Sound transmission

Interior Room Acoustics

Interior room acoustics addresses airborne-sounds that are reflected back from the walls, ceilings, and floors. In this case, designers are most concerned with controlling reverberation (the energy reflected and re-reflected in an enclosed space). Controlling room acoustics happens at the surfaces, beginning with finish materials and furnishings that either absorb or reflect sound, depending on their acoustic qualities. Rooms with very hard surfaces—such as concrete floors, tiled walls, and decorative tin ceilings—reflect a lot of sound. A room with these finishes would be considered “acoustically live,” which may or may not be desirable. Some restaurants and retail centers like an active, busy ambience, whereas in an office or dorm room this acoustic emphasis would be inappropriate. To create a quieter ambience, designers need to select finish materials that absorb sound, such as carpet, acoustic ceiling tile, or perhaps thick fabric wall coverings.

To take room acoustics to a higher level, designers might also wish to control the direction and quality of the reflected sound waves. A lecture hall or performance space will need a variety of engineered baffles and surface

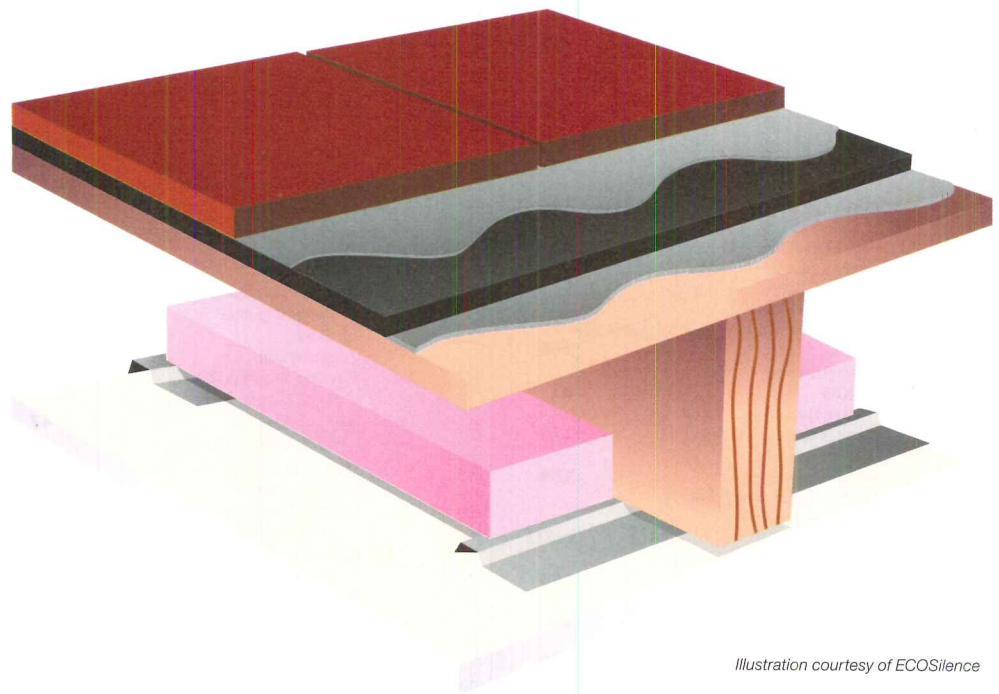

Illustration courtesy of ECOSilence

In the assembly shown here, the key materials are the black recycled rubber underlayment, the pink fiberglass insulation, and the resilient channel. The underlayment and resilient channel isolate structural members, minimizing structure-borne sound, while the fiberglass insulation provides absorption to minimize airborne sound.

textures to deliberately direct, diffuse, and distribute the sound waves within the space. Acoustic design for large performance spaces can get quite involved and is beyond the scope of this course. For now, it's enough to understand that interior room acoustics are primarily controlled by the material properties of interior finish materials. The chief emphasis is on limiting and controlling reflected sound waves.

Sound transmission is another animal altogether. To control the sound and vibrations that are transmitted through building materials from one space to the next, the focus should be on dampening vibrations that pass through building materials, and isolating one room from another by installing absorptive, isolating, and resilient materials within the building assemblies.

Sound Transmission

Sound transmission depends on the partition types. A thick concrete slab, for example, is unlikely to vibrate from individual foot falls, but the impact of heavy equipment or machinery, or even the multiple impacts of a stadium audience, can transfer a significant vibrational load. In a residential multifamily building—one with uninsulated steel joists supporting

hardwood floors and standard fire-rated drywall ceilings—foot traffic and perhaps even voices (or radio, television, etc.) will readily transfer to surrounding neighbors.

To control both interior room acoustics and sound transmission in buildings, it helps to understand some basic terms and definitions. In particular, designers need to understand the existing standards for evaluating the acoustical properties of building assemblies and materials.

SOUND PRESSURE LEVELS

Loudness is a subjective measurement, but sound pressure can be quantified in decibels (dB), which is a logarithmic unit: Each increase of 3 is twice as powerful although humans generally perceive an increase of 10 dB as being twice as loud. Ninety dB sounds twice as loud as 80, which sounds twice as loud as 70, etc. See the online version of this course for a table that correlates subjective interpretations of loudness with sound levels expressed in decibels, providing loudness in dB of some common noise sources.

Continues at ce.architecturalrecord.com



ECOSilence is proud to offer cutting-edge sound control underlayments, accessories, and solutions. ECOSilence underlayments and accessories work together to create ideal flooring systems and solutions. All ECOSilence underlayment is made from recycled rubber and holds a limited lifetime warranty against product defects and workmanship.
www.ecorecommercialflooring.com

Advertisers Index

Get Free Information

from our advertisers! Fill out this Reader Service Card and send back today
or go to ArchRecord.com > Products tab > Reader Service



Reader Service #	Advertiser	Page	Reader Service #	Advertiser	Page	Reader Service #	Advertiser	Page
74	Advance Lifts advancelifts.com	231	109	ECOsilence ecorecommercialflooring.com	222-223		National Building Museum nbm.org	203
96	AISC aisc.org	151	34	EFCO Corporation efcocorp.com	72	16	New Jersey's Clean Energy Program NJCleanEnergy.com/BENCHMARKING	106
73	Alcoa Architectural Products reynobond.com	21	88	EIKO eiko.com	174	23	Oldcastle® Architectural oldcastleapg.com/ceubim.html	212
52	ALPOLIC/Mitsubishi Plastics Composites America, Inc. alpolic-northamerica.com/case-studies	9	62	Engineered Lighting Products elplighting.com	70	11,107	Oldcastle Building Products Belgardcommercial.com	213-217
95	amerlux amerlux.com	165	33	EPSON epson.com	35	51	Oldcastle BuildingEnvelope® oldcastlebe.com	2-3
72	AMICO amicoarch.com	81	87	Figueras Seating USA figueras-usa.com	153	4	Ornamental Metal Institute ominy.org	8
42	Architectural Area Lighting www.aal.net	173	61	Forms & Surfaces forms-surfaces.com	47	81	Parex parex.com	75
	Architectural Record Continuing Education App archrecord.com	184	32	Gage Corporation, Int. gagecorp.net	228	3	PCI Precast/ Prestressed Concrete Institute pci.org/hpprecast	37
71	Armstrong armstrong.com/metalworks	cv2-1	10	Garland Company garlandco.com	230	22	Petersen Aluminum pac-clad.com	23
103	Artemide, Inc. artemide.net	166	60	Glen-Gery Brick glengerybrick.com	48	50	PPG Industries, Inc. ppgideascapescapes.com	24
102	ASI Group, The asigroup.us	69	31	Gordon Incorporated gordon-inc.com	155	80	Prodema prodema.com	92
70	ATAS International, Inc. atas.com	182	9	Harmonic Environments HarmonicEnvironments.com	74	105	Prudential Lighting prulite.com	179
94	AZZ Galvanizing Services azzgalvanizing.com	231	115	Hawa Americas Inc. hawa.com	190-193	21	RAB Lighting RABLED.com	156
101	BEGA bega-us.com	51	59	Holcim holcim.us	93	47	reThink Wood rethinkwood.com	18
41	Benjamin Moore & Co. benjaminmoore.com	45	86	Horton Automatics hortondoors.com	150	49	Rocky Mountain Hardware rockymountainhardware.com	19
93	Bison Innovative Products BisonIP.com	80	30	Huntco Supply LLC huntco.com	27	2	ROXUL roxul.com	181
69	Boston Architectural College the-bac.edu	176	12	Hunter Douglas Contract hunterdouglascontract.com	38-39	79	SAFTI Fire Rated Glass safti.com/ar	31
100	Bradley Corporation bradleycorp.com	40	8	Hunter Panels hunterpanels.com	52	111	SAGE Electrochromics, Inc. sageglass.com	194-197
40	C.R. Laurence Company crlaurence.com	53	57	International Code Council iccsafe.org	104	48	Samsung samsung.com/solve	78
92	Cambridge Architectural cambridgearchitectural.com	63	29	Invisible Structures Inc invisiblestructures.com	230	1	Scranton Products, Inc. scrantonproducts.com	66
68	Carlisle SynTec carlisle-syntec.com	105	85	Johns Manville jm.com	61		Skyscraper Museum, The skyscraper.org	231
13	Cascade Coil Drapery cascadecoil.com	177	7	Johnsonite, A Tarkett Company tarkettna.com/whatsyourinspiration	10	45	Sliding Door Company, The slidingdoorco.com	56
39	Ceilings Plus ceilingsplus.com	14-15	56	Julius Blum & Co. Inc. juliusblum.com	64	20	SlipNOT Metal Safety Flooring slipnot.com	227
67	CENTRIA centria.com/reimaginemetal	33	28	Kawneer kawneer.com	7	78	SORAA sorama.com	169
91	CertainTeed Gypsum certainteed.com	41	84	Kepeco+ kepecoplus.com	229	99	Sound Solutions soundsolutions.ca	90
38	Charles Loomis, Inc. charlesloomis.com	177	55	Kim Lighting kimlighting.com	162	19	Specialty Doors barndoorhardware.com	28
113	Chase Doors chasedoors.com	208-211	27	La Cantina Doors lacantinadoors.com	94	77	State Farm Insurance st8.fm/bizinsurance	103
66	Collins CollinsWood.com	152	54	Landscape Forms landscapeforms.com	107	46	Steel Institute of New York siny.org	6
90	Columbia Lighting columbialighting.com	170	6	Lorin Industries Lorin.com	198	76	StressCrete Group stresscretegroup.com/Insert	229
37	Construction Specialties, Inc. c-sgroup.com	13	112	Lorin Industries Lorin.com	199-202	106	Sub-Zero and Wolf, Inc. Technical Glass Products tgpamerica.com	16a-h 228
65	Cree, Inc. CreeLEDLighting.com	175	26	Louis Poulsen louispoulsen.com	67	18	ThyssenKrupp Elevator Corporation thyssenkruppelevator.com	29
104	Deep Root Partners deeproot.com	178	110	Lutron Electronics Co., Inc. lutron.com	186-189	17	Toto USA totousa.com	20
	DODGE DodgeBuildsBiz.com	17	83	Lutron Electronics Co., Inc. lutron.com	cv4	97	UL Environment ul.com/environment	218-221
36	DORMA dorma-usa.com	71	53	Manning Lighting Inc. digitalspeck.com	177	108	Underwriters Laboratories Inc. ul.com	22
64	Doug Mockett & Company, Inc. mockett.com	176	25	McNichols Co. mcnichols.com	57	44	Unilock unilock.com	91
89	Dri-Design dri-design.com	cv3	5	MechoShade Systems, Inc. mechosystems.com	108	75	VT Industries, Inc. vtindustries.com	4-5
114	Dryvit Systems, Inc. dryvit.com	204-207	82	Metl-Span metlspan.com	50	43	Western Red Cedar Lumber Association realcedar.org	42
35	DuPont Tyvek fluidapplied.tyvek.com/casestudies	76	98	Modern Fan Co., The modernfan.com	65	15	Xypex xypex.com/ww	183
58	Duro-Last Roofing Inc. duro-last.com	154	24	modularArts modulararts.com	226			
63	E. Dillon & Company edillon.com	68						

PRODUCT SPOTLIGHTS

Advertisement

DOORS, WINDOWS

SAVING ENERGY

G

Azon

▲ Structural thermal barrier technologies and Warm-Light® warm-edge spacer for insulating glass—energy efficiency and high strength for aluminum fenestration products.

Product Application:

- Storefront and curtain wall applications
- Commercial aluminum, windows, doors, skylights; thermal barriers for framing, glazing

Performance Data:

- Intelligent technologies reduce overall U-factor
- Higher CRF (condensation resistance factor)

www.azonintl.com
800.788.5942

Circle 150



ROOFING, SIDING, THERMAL & MOISTURE PROTECTION

PERIMETER/ROOF EDGE SYSTEMS

\$\$\$ | G | NEW

Petersen Aluminum Corporation

▲ PAC Perimeter Systems are high-performance roof edge solutions for low-slope buildings. Petersen offers a complete line of fascia and coping systems for a wide variety of commercial applications.

Product Application:

- University of Texas at Dallas Student Housing Living/Learning Center II, Richardson, TX

Performance Data:

- Produced in 12-ft.-o-in. lengths for extra cost savings
- Exceptional wind uplift protection

www.PAC-CLAD.com
800.722.2523 | Contact: Blake Batkoff

Circle 154

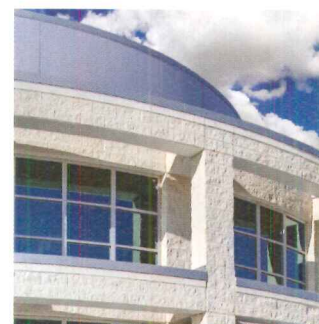

DOORS, WINDOWS

GLASS FIREWALLS

\$\$\$

Technical Glass Products

▲ Pilkington Pyrostop® is a UL listed and labeled fire-rated and impact safety-rated glazing material that blocks radiant heat transfer.

Product Application:

- Volkswagen Manufacturing Plant, Chattanooga, TN
- NYFD Engine Co. 239 Firehouse, New York, NY
- The Morgan Library & Museum, New York, NY

Performance Data:

- Barrier to radiant and conductive heat transfer
- Fire ratings up to 2 hours

www.fireglass.com
800.426.0279 | Contact: sales@fireglass.com

Circle 151



INTERIOR FINISHES, FURNISHINGS

SOUND-ABSORBING INTERIOR FINISHES

G

Pyrok, Inc.

▲ The StarSilent system is a smooth, seamless, sound-absorbing, durable plaster finish system for walls and ceilings. This environmentally friendly product allows designers to utilize a seamless gypsum board look with sound-absorbing qualities. Contact Pyrok, Inc. for details. Photo: Burchfield Penney Art Center, Buffalo, NY.

www.starsilent.com
914-777-7070 | Contact: Howie Podolsky

Circle 152



ROOFING, SIDING, THERMAL & MOISTURE PROTECTION

ARCHITECTURAL CONCRETE CLADDING

WR | G | NEW

Easi-Set Worldwide

▲ Ultra Hi-Performance Slenderwall is a 28 lb./sf award-winning architectural precast concrete and steel-stud exterior panel system wind-load tested to 226mph.

Product Application:

- BioInnovation Center, New Orleans, LA
- Hilton Gardens, Montreal, Quebec, Canada
- Westin Luxury Hotel, Virginia Beach, VA

Performance Data:

- Continuous closed-cell foam insulation and optional factory-installed windows
- H2Out Pressure Equalized Joint Rainscreen

www.slenderwall.com
800.547.4045 | Contact: Arthur Miles

Circle 153

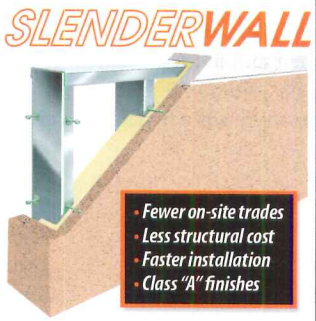

CLASSIFIEDS

POSITIONS VACANT

COLLEGE OF DESIGN

UNIVERSITY OF MINNESOTA

Located in one of the major design cities and in one of the largest research universities in the U.S., the College of Design encompasses the full range of design disciplines at the University of Minnesota and is home to seven undergraduate majors, 19 graduate degree programs, 10 centers including the Center for Sustainable Building Research and the Metropolitan Design Center.

We currently seek candidates for the following opportunities:

- Assistant Professor in Architecture, Architectural History and Theory
- Director and Associate Professor/Professor, Center for Sustainable Building Research

For more information and application instructions please visit:

<http://design.umn.edu/about/employment>

Offers of employment are contingent upon a satisfactory background check.

The University of Minnesota is an equal opportunity educator and employer

WWW.SMPSCAREERCENTER.ORG

Find marketing/BD professionals with A/E/C experience. Call 800-292-7677, ext. 231

To view Architectural Record online visit:
www.architecturalrecord.com

Ongoing Exhibitions

Lebbeus Woods is an Archetype

Los Angeles

Through December 1, 2013

This exhibition and public-art installation focusing on the late architect Lebbeus Woods was assembled by a team including Hernan Diaz Alonso, Christoph A. Kumpusch, Dwayne Oyler, and Alexis Rochas. Complemented by a symposium and catalogue, this exhibition in the Southern California Institute of Architecture (SCI-Arc) Gallery—as well as related large-scale public-art installation in the Arts District's Bloom Square—aims to demonstrate the fearless nature with which the late visionary architect and draftsman created. For more information, visit sciarc.edu.

Donald Judd: Stacks

New York City

Through December 7, 2013

Featuring 10 stacks from four decades, this is the first exhibition devoted to the iconic form in Donald Judd's oeuvre and within the history of modern sculpture. Judd is known for his geometric explorations of volume, space, and color. When Judd created his first stack in 1965—an arrangement of identical iron units stretching from floor to ceiling—the work represented a breakthrough in his integration of art and architecture. At the Mnuchin Gallery. For more information, visit mnuchingallery.com.

Participatory City: 100 Urban Trends from the BMW Guggenheim Lab

New York City

Through January 5, 2014

This exhibition is the culmination of the experiences and concepts generated during the two-year run of the BMW Guggenheim Lab. The Lab—an urban think tank, community center, and public gathering space that traveled to New York, Berlin, and Mumbai—inspired innovative ideas about urban life and cities. Tens of thousands of participants engaged with the Lab's free public programs, urban projects, and research initiatives, both on-site and online, which informed and helped shape the exhibition. At the Solomon R. Guggenheim Museum. For more information, visit guggenheim.org.

Green Schools

Washington, D.C.

Through January 5, 2014

The National Building Museum is hosting the first-ever museum exhibition dedicated to

the greening of American schools. Featuring more than 40 exemplary projects, from new construction to rehabs to modular classrooms, the exhibition surveys the breadth of green-school design in the United States through sample building materials, photographs, video, and green products. For more information, visit nbm.org.

Bob Marley Messenger

Miami

Through January 5, 2014

The Miami-based firm Shulman + Associates designed *Bob Marley Messenger* at HistoryMiami. The exhibit uses artifacts, photographs, and interactive elements to explore the musician's life and career. S + A's design enhances the exhibit's themes, transforming Marley's messages into space and creating a textual backdrop. The firm collaged media on a neutral dark-gray backdrop with vibrant Rastafarian colors and rich black-and-white photography. Exhibition programs include a panel discussion on the life of Bob Marley with journalists, historians, and music-industry professionals. For more information, visit historymiami.org.

Chris Burden: Extreme Measures

New York City

Through January 12, 2014

This expansive presentation of Chris Burden's work, at the New Museum, marks the first New York survey of the artist and his first major exhibition in the U.S. in over 25 years. Occupying the entire museum and featuring a dynamic installation on the facade and roof, the exhibition examines the many ways in which Burden has continuously pushed limits by investigating the breaking point of materials, institutions, and even himself. For more information, visit newmuseum.org.

Practical Utopias: Global Urbanism in Hong Kong, Seoul, Shanghai, Singapore, and Tokyo

New York City

Through January 18, 2014

Over the past 20 years, the pace and scale of urbanization in Asia has been unprecedented in both the emerging and maturing economies of the region. This exhibition explores new cities built up just outside, immediately adjacent to, or even within the old. Conceived as extensions or embellishments of existing capitals of finance and culture, these new cities within cities serve as focal points for future visions and global ambitions. At the Center for Architecture. For more information, visit aiany.org.

* **InterlockingRock®**
FEATURE WALLS

in manageable, self-aligning modules.

modulararts.com | 206.788.4210

MADE IN THE USA

CIRCLE 24

modulararts® WALL = SCULPTURE™

In Focus: Architecture

Los Angeles

Through March 2, 2014

Drawn from the J. Paul Getty Museum's collection, this show demonstrates how architectural photography has grown from straightforward documentary-style photographs to genre-bending works like those of Peter Wegner from 2009. The exhibition traces the long, interdependent relationship between architecture and photography through a selection of more than 20 works from the museum's permanent collection, including recently acquired photographs by Andreas Feininger, Ryuji Miyamoto, and Peter Wegner. For more information, visit getty.edu/museum.

The Playground Project

Pittsburgh

Through March 16, 2014

The Playground Project presents some of the most outstanding and influential playgrounds from Europe, the U.S., and Japan from the mid- to late-20th century in order to prompt a reconsideration of our time and the way we approach childhood, risk, public space, and education. The project, on view at the Heinz Architectural Center at the Carnegie Museum of Art, puts the concept of play into the foreground as an important way of thinking. A recently added Lozziwurm—a play sculpture designed in 1972—is on display in front of the museum. For more information, visit ci13.cmoa.org.

James Turrell: A Retrospective

Los Angeles

Through April 6, 2014

This Los Angeles County Museum of Art retrospective explores nearly 50 years in the career of James Turrell. The exhibition includes early geometric light projections, prints and drawings, installations exploring sensory deprivation and seemingly unmodulated fields of colored light, and recent two-dimensional work with holograms. One section is devoted to the Turrell masterwork-in-process, *Roden Crater*, a site-specific intervention into the landscape just outside Flagstaff, Arizona, which will be presented through models, plans, photographs, and films. The exhibition includes a separately ticketed experience, *Light Reignfall*, from the artist's *Perceptual Cell* series, with a limited number of tickets available. For more information, visit lacma.org.

Out of Hand: Materializing the Postdigital

New York City

Through July 6, 2014

This exhibition at the Museum of Arts and Design is the first survey dedicated to exploring the impact of computer-assisted methods of production on contemporary art, architecture, and design. This exhibition brings together more than 120 works of sculpture, jewelry, fashion, and furniture by 85 artists, architects, and designers to examine how new technologies are pushing the boundaries of artistic expression and creation. For more information, visit madmuseum.org.

Lectures, Conferences, and Symposia**2013 Urban Land Institute Fall Meeting**

Chicago

November 5–8, 2013

Cities in the U.S. and around the world are facing 21st-century challenges resulting from population and demographic shifts, new economic drivers, and increasing concerns related to climate change. Held at the McCormick Place convention center, the meeting will cover a broad range of issues, from property

**SMART DESIGN. SAFE SOLUTIONS.**

PUBLIC ACCESS. INDUSTRIAL. COMMERCIAL. FOOD PROCESSING

Slip Resistant Metal Safety Flooring

SlipNOT® manufactures slip resistant metal products that increase safety and decrease your risk exposure.

SEE US AT PROCESS EXPO | BOOTH #4239
www.slipnot.com | 800.754.7668

SlipNOT®

CIRCLE 20



GAGE
earth metal™ 78
DIMENSIONAL SURFACING

gage78.com

info@gage78.com

CIRCLE 32

dates&events

outlooks to healthy communities. The conference routinely draws nearly 7,000 participants, including internationally renowned land-use experts. For more information, visit uli.org.

DIEM: Design Intersects Everything Made Los Angeles

November 8, 2013

DIEM: Design Intersects Everything Made is a one-day symposium dedicated to good design. This year, journalist and design host for public-radio station KCRW Frances Anderton will be hosting and curating the daylong event, which takes place in the West Hollywood Design District. Design professionals and enthusiasts are invited to engage with one another through forums, presentations, and keynote addresses from leaders in the fields of design, decorative arts, fashion, architecture, fine arts, and culinary arts. For more information, visit westhollywooddesigndistrict.com.

Chase the Dark

Various Locations

November 14, 2013

The International Association of Lighting Designers (IALD) presents *Chase the Dark*, a series of lighting installations across the globe, demonstrating the power of light in urban communities. Each host city—including Sydney, Dubai, Berlin, Stockholm, and New York—will invite participants to shape an urban environment with light, creating miniature lit scenarios over the course of 1 to 2 hours. These displays will be installed for just a matter of moments; the images of each light project will be captured on camera and shared on Twitter throughout the evening. For more information, visit iald.org.

Competitions

AIA Emerging Professionals Summit Essays

Submission deadline: November 4, 2013

The American Institute of Architects (AIA) is seeking essays that will address what role architects will play in society in 2033. Are architects being prepared adequately? If not, what changes need to happen now to better position the profession for the future? In January 2014, the AIA will bring together leaders from across the profession to address how practice culture can be shaped to prepare current and future architects for their role in society. Individuals selected to attend the summit will receive complimentary registration, airfare, lodging, and meals during the summit in Albuquerque. For more information, visit aia.org.

TGP.
IT'S PERSONAL.

Seeking long-term relationship with secure, polished single with a clear view of the world. Not into labels (except the fire-rated kind). Must be beautiful on the inside and out. Can you take the pressure? Don't reply if you are looking for the dull or wired type. Email me sales@fireglass.com

FireLite® Family of Products
Build a LTR with TGP and get unmatched service and support, plus the very best products like FireLite. This fire-rated glazing's unique ultraHD® Technology delivers a clearly superior product. Take a closer look at how the clarity and sharpness compares to the competition at fireglass.com/hd.

- Fire ratings up to 3 hours
- High impact safety ratings
- UL listed and labeled

CLASSIFIED
UL

FireLite®
Family of Products

TGP  **FIRE RATED**
one source. many solutions.®

fireglass.com

CIRCLE 18



Dedication to innovation, advanced technology and excellence in engineering has led to a comprehensive line of industry-leading outdoor LED fixtures. Style and performance, uniquely King Luminaire.

A highly efficient line of post top, pendant and area lighting fixtures offering:

- 5x the usable life of HID fixtures
- Instant on/off
- Excellent light distribution
- Energy Savings
- Effective uplight control

For more information on our LED product line, and for a full list of fixtures offered, please visit us at www.stresscretegroup.com or email led@kingluminaire.com



King Luminaire • StressCrete • Est. 1953

STRESSCRETE GROUP

Quality People • Quality Products

The full DLC Qualified Products list is available at: http://www.designlights.org/schlistate/about/QualifiedProductsList_Public2.php check this list regularly for updates.

Northport, Alabama • Atchison, Kansas
Jefferson, Ohio • Burlington, Ontario

CIRCLE 76

OfficeUS Principals: Call for Fellowship Applications

Submission deadline: December 2, 2013
OfficeUS is seeking five fellows to take on the role of principals during the 2014 Venice Biennale at the U.S. Pavilion. From May 23 through November 23, 2014, the principals will speculate on and project new futures of a history of American architectural exports on exhibit at the pavilion. The work of OfficeUS will be published as a book and exhibited at Storefront for Art and Architecture in the spring of 2015. Each fellow will receive a \$15,000 stipend for the 6-month period. For more information, visit storefrontnews.org.

Queensway Connection: Elevating the Public Realm

Submission deadline: January 6, 2014
This competition supports Friends of the Queensway and The Trust for Public Land in their efforts to transform an abandoned rail right-of-way into a greenway serving diverse neighborhoods in central and southern Queens, New York. This conversion is similar in urbanism and density to the Bloomingdale Trail conversion in Chicago. This competition seeks to supplement the ongoing feasibility study for the railway's transformation by proposing ways the future park can be used in addition to recreation and leisure. For more information, visit enyacompetitions.org.

New Practices New York 2014

Submission deadline: January 6, 2014
New Practices New York is a biennial juried portfolio competition sponsored by the New Practices Committee of the AIA New York Chapter. The competition identifies firms with unique and innovative strategies in both projects and practices. Architecture and design firms founded since 2004 and located within the five boroughs of New York City are encouraged to submit a practice narrative and a mini-portfolio of built, unbuilt, or theoretical work. Winners will receive a stipend for an installation and exhibition at the Center for Architecture. The competition jury will include Alejandro Zaera-Polo, dean of architectural design at Princeton University; Elaine Molinar, director of strategic planning and business development at Snøhetta; and William Menking, editor in chief at *The Architect's Newspaper*. For more information, visit aiany.org.

E-mail information two months in advance to recordevents@mcgraw-hill.com.

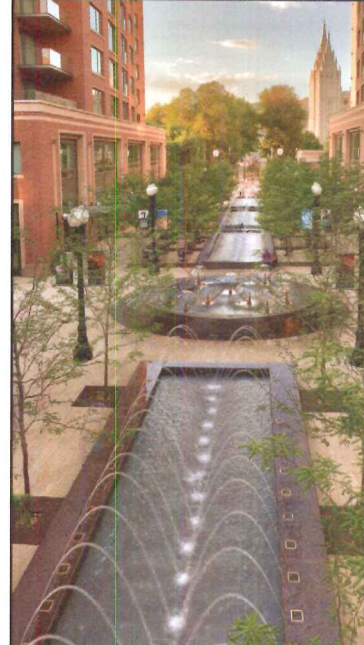
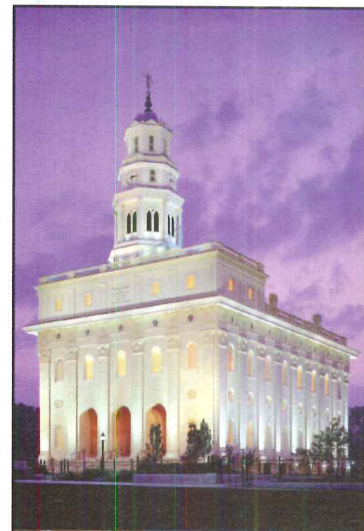

SPECIALIZING IN THE DESIGN, FABRICATION, AND INSTALLATION OF NATURAL STONE EXTERIORS

KEPCO+
Architectural Cladding Systems

KEPCOPLUS.COM

CIRCLE 84

The Best Pavements Are Invisible

Grasspave²

grass porous paving

Gravelpave²

gravel porous paving



InvisibleStructures.com | 800-233-1510

CIRCLE 29

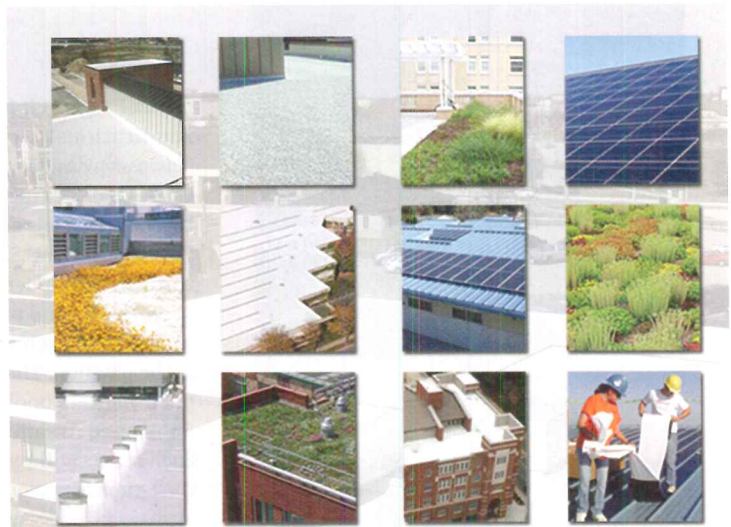

Sustainable Vision

Looking for an environmentally responsible roofing solution?

- High-performance roofing solutions with lifetime warranties
- ENERGY STAR® qualified restorations and enhancements
- Eco-friendly maintenance and repair solutions
- Integrated rooftop solutions incorporating solar



The Garland Company, Inc.
800-741-3157 • www.garlandco.com

CIRCLE 10

AN IMPORTANT NOTICE TO OUR CUSTOMERS ABOUT PRIVACY

McGraw Hill Construction respects your privacy. We use your contact information to fulfill your request, service your account and provide you with additional information from McGraw Hill Construction and other parts of McGraw Hill Financial you may find of interest. We occasionally make a portion of our mailing list available to selected third parties whose products or services may be of interest to you. For further information or to let us know your preferences with respect to receiving marketing materials, please send an email or written note with your name, address and account number to: Amy Sidelinger, Security Manager, McGraw Hill Construction, 148 Princeton-Hightstown Road, East Windsor, NJ 08520 or email Construction_Privacy_Policy@mcgraw-hill.com. You may also enter your request online at http://construction.com/Privacy_opt-out/. You can view the Customer Privacy Policy for McGraw Hill Financial at www.mhfi.com/privacy. To learn more about how McGraw Hill Construction applies this Policy, please visit <http://construction.com/privacy-notice.asp>.

LEGAL NOTICE U.S. POSTAL SERVICE STATEMENT OF OWNERSHIP, MANAGEMENT, AND CIRCULATION (ACT OF AUGUST 12, 1970: SECTION 3685, TITLE 39, UNITED STATES CODE)

1. Title of publication: **Architectural Record**
2. Publication number: 132-650
3. Date of filing: October 1, 2013
4. Frequency of Issue: Monthly.
5. Number of issues published annually: 12
6. Annual subscription price: \$72.00, U.S.; \$79 CAN/MEX; \$199 International
7. Complete Mailing Address of Known Office of Publication: 1221 Avenue of the Americas, New York, NY 10020-1095.
8. Complete Mailing Address of Headquarters of General Business Offices of the Publisher: Architectural Record, 2 Penn Plaza, 9th floor, New York, NY 10121
9. Full Names and Complete Mailing Addresses of Group Publisher, Editor, and Managing Group Publisher: Laura Viscusi, Architectural Record, 2 Penn Plaza, 9th floor, New York, NY 10121
Editor: Cathleen McGuigan, Architectural Record, 2 Penn Plaza, 9th floor, New York, NY 10121; Managing Editor: Beth Broome, Architectural Record, 2 Penn Plaza, 9th floor, New York, NY 10121
10. Owner: Stockholders holding one percent or more of outstanding common stock: McGraw Hill Financial, Inc., 1221 Avenue of the Americas, New York, NY 10020; Harold W. McGraw III c/o McGraw Hill Financial, Inc., 1221 Avenue of the Americas, New York, NY 10020; Capital World Investors, 333 South Hope Street, Los Angeles, CA 90071; Citibank, NA, 3800 Citibank Center B3-12, Tampa, FL 33610; Dodge & Cox, 555 California Street, San Francisco, CA 94104; Highfields Capital Management, 200 Clarendon St., Boston, MA 02116; Manning & Napier Advisors, LLC, 290 Woodcliff Drive, Fairmont, NY 14450; Oppenheimer Funds, Inc. 6803 S. Tuscan Way, Centennial, CO 80112; State Street Bank & Trust Co., 1776 Heritage Drive, North Quincy, MA 02171; UBS Financial Services, 1200 Harbor Boulevard, Weehawken, NJ 07086
11. Known bondholders, mortgagees, and other security holders owning or holding one percent or more of total amount of bonds, mortgages or other securities: None.
12. Not applicable.
13. Architectural Record
14. Issue date for circulation data below: September 2013
15. Extent and nature of circulation:
 - A. Total number of copies-average number of copies of each issue during preceding 12 months: 103,587; actual number of copies of single issue published nearest to the filing date: 98,708.
 - B. Paid and/or requested circulation-(1) Paid or requested outside-County mail subscriptions stated on Form 3541-average number of copies of each issue during preceding 12 months, 36,924; actual number of copies of single issue published nearest to the filing date, 37,723. (2) Paid In-County subscriptions-average number of copies of each issue during preceding 12 months, 0; actual number of copies of single issue published nearest to the filing date, 0. (3) Sales through dealers and carriers, street vendors and counter sales, and other non-USPS paid distribution-average number of copies of each issue during preceding 12 months, 10,078; actual number of copies of single issue published nearest to the filing date, 9,313. (4) Other classes mailed through the USPS-average number of copies of each issue during preceding 12 months, 16; actual number of copies of single issue published nearest to the filing date, 16.
 - C. Total paid and/or requested circulation-average number of copies of each issue during preceding 12 months, 47,017; actual number of copies of single issue published nearest to the filing date, 47,052.
 - D. Nonrequested Distribution by mail-(1) Outside county as stated on Form 3541-average number of copies of each issue during preceding 12 months, 47,445; actual number of copies of single issue published nearest to the filing date, 42,454. (2) In-county as stated on Form 3541-average number of copies of each issue during preceding 12 months, 0; actual number of copies of single issue published nearest to the filing date, 0. (3) Other classes mailed through the USPS-average number of copies of each issue during preceding 12 months, 7,467; actual number of copies of single issue published nearest to the filing date, 7,758. (4) Nonrequested distribution outside the mail-carriers and other means-average number of copies of each issue during preceding 12 months, 1,635; actual number of copies of single issue published nearest to the filing date, 1,432.
 - E. Total free distribution-average number of copies of each issue during preceding 12 months, 49,103; actual number of copies of single issue published nearest to the filing date, 43,898.
 - F. Total distribution-average number of copies of each issue during preceding 12 months, 96,120; actual number of copies of single issue published nearest to the filing date, 90,950.
 - G. Copies not distributed-average number of copies of each issue during preceding 12 months, 7,467; actual number of copies of single issue published nearest to the filing date, 7,758.
 - H. Total-average number of copies of each issue during preceding 12 months, 103,587; actual number of copies of single issue published nearest to the filing date, 98,708.
 - I. Percent of paid and/or requested circulation: average number of copies of each issue during preceding 12 months, 48.9%; actual number of copies of single issue published nearest to the filing date, 51.7%.
16. PS Form 3526-X Worksheet for Architectural Record for claiming electronic copies
 - A. Requested and Paid Electronic Copies-average 12 months, 2,367; September 2013, 2,300
 - B. Total Requested and Paid Print Copies (Line 15C) + Requested/Paid Electronic Copies-average 12 months, 49,384; September 2013, 49,352
 - C. Total Requested Copy Distribution (Line 15F) + Requested/Paid Electronic Copies-average 12 months, 98,487; September 2013, 93,250
 - D. Percent Paid and/or Requested Circulation (Both Print & Electronic Copies)-average 12 months, 50.1%; September 2013, 52.9%
17. Publication of Statement of Ownership for Requester is required and will be printed in the issue of this publication November, 2013
18. I certify that the statements made by me are correct & complete. McGraw Hill Financial, Inc., Laura Viscusi, Publisher, 10/1/2013.



DOCK LIFTS EVERY DOCK NEEDS A LIFT

MAXIMUM VERSATILITY

AN ADVANCE DOCK LIFT IS THE ONLY EQUIPMENT THAT CAN SERVICE ALL TRUCKS.

Full line of dock lifts including:

- ▶ Portable
- ▶ Top Of Ground
- ▶ Pit Mounted



AVOID BACK INJURIES



INCREASE PRODUCTIVITY

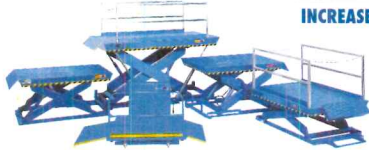

We can tailor a dock lift to fit your needs and budget.



ENGINEERED FOR THE MOST LIFE PER \$ SPENT

1-800-THE DOCK

www.advancelifts.com

CIRCLE 74

THE SKYSCRAPER MUSEUM

SKY HIGH

the logic of luxury

October 2013 -
April 19, 2014

432 Park Avenue
Courtesy of CIM Group & MacKlowe Properties
Image by DBOX

For more info, visit:
www.skyscraper.org

39 Battery Place, NY, NY 10280 | Wed.-Sun., 12-6



Galvanizing is Thinking Big Picture.

Preserve Your Project
Before It's Even Built.

Hot-dip galvanizing with AZZ Galvanizing Services is the best way to ensure that your project will stand the test of time, saving money in costly maintenance repairs later. And since using eco-friendly zinc is less expensive than other corrosion barriers, the cost savings begin before the construction does — and will extend the life of the structure. Save money now and in the big picture.



We Protect More Than Steel.



azzgalvanizing.com

CIRCLE 94



AFTER SPENDING more than a decade photographing forgotten remnants of the Holocaust across his native Slovakia, artist Yuri Dojc turned to Daniel Weil, a partner at design consultancy Pentagram, to create a traveling exhibition for the resulting documentary project, *Last Folio*. This summer, the photographs—close-ups of moldering Hebrew texts found in an abandoned school, images of vacant synagogues' peeling interiors, and portraits of aged survivors—were displayed at a derelict synagogue in Košice. "This is a witness, a recording, a document," Weil says. When designing the display cases for the exhibition, first presented at the Gonville and Caius Library at the University of Cambridge in 2009, Weil envisioned delicate wood-framed, glassless volumes that would evoke disappearance and memory. Remarkably—perhaps magically—the geometry of the Košice synagogue was almost identical to *Last Folio's* original venue at Cambridge. The effect is haunting: the ethereal vitrines blend into the decaying architecture like a silent congregation. "Every year, after you finish reading the Torah, you scroll it back and start again—the return," Weil explains. "There was the idea that the synagogue of Košice was that return." Anna Fixsen